

FOUR QUADRANT REPRESENTATION OF ELECTRICITY

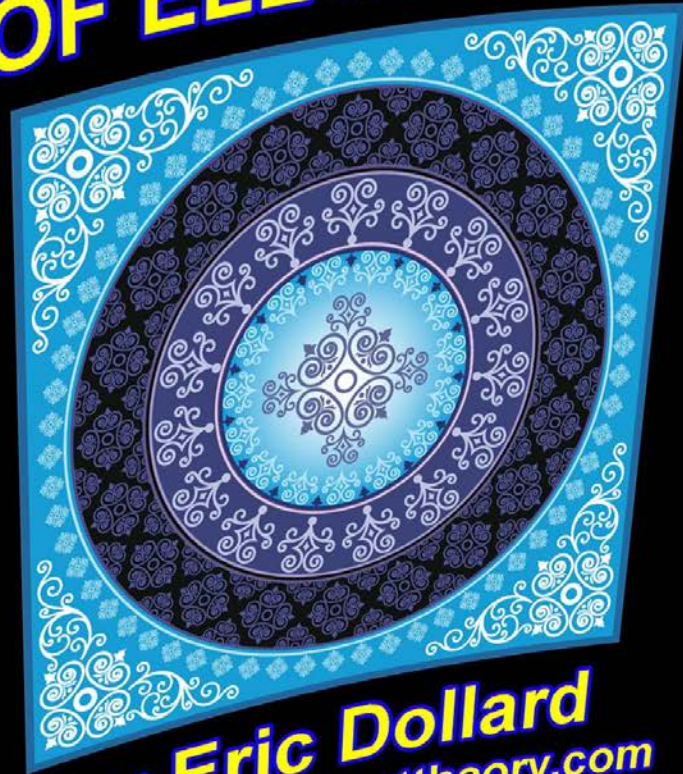

by **Eric Dollard**

www.fourquadranttheory.com

ERIC DOLLARD

Four Quadrant Representation of Electricity

by

Eric P. Dollard

Published by
A&P Electronic Media
Liberty Lake, Washington

Cover Layout: Aaron Murakami
A&P Electronic Media
Liberty Lake, Washington

Interior Images by: Eric Dollard & Other Sources
Internet sources, used with attribution.

Transcribed from the author's notebooks by Jeffery Moe <http://myplenum.com>
Final edit and layout by Peter Lindemann

Copyright 2013 A & P Electronic Media

All Rights Reserved, Worldwide. No part of this publication may be reproduced, stored in an electronic retrieval system, or transmitted in any form, or by any means, without the prior, written permission of the copyright holders or the publisher. Unauthorized copying of this digital file is prohibited by International Law.

Digital Edition Published by: A&P Electronic Media
PO Box 713
Liberty Lake, WA 99019
<http://www./>

First Edition:

First Printing: November 2013
Digital Format: PDF File
50,000 authorized Downloads

Book Version

Original Version 1.0 - Release Date November 7, 2013

Table of Contents

Introduction	page 10
(1.1) Objectives	page 10
(1.2) Subject Division	page 11
(1.3) Misnomers	page 12
(1.4) Origin of Subject	page 13
(1.5) Initiation	page 14
Section One	page 15
Metaphysical Aspects of Quadrapolar Versor Algebra	
Part I Pythagoras of Samos	page 16
[1] Pythagoras	page 17
(1.1) Introduction	page 17
(1.2) Pythagorean Theorem	page 17
(1.3) Island of Samos	page 18
(1.4) Origin of Mathematics	page 29
(1.5) The Pythagoreans	page 31
[2] Ancient Concepts	page 33
(2.1) Chaldean Number System	page 34
(2.2) Geometric Manifestation	page 36
Part II Van Tassel of Giant Rock	page 42
[1] Van Tassel and His Integratron	page 43
(1.1) Four Quadrant Theory	page 43
(1.2) The Integratron	page 46
(1.3) Integratron Operation	page 47
(1.4) Epilog	page 61
Section Two	page 63
Mathematical Aspects of Quadrapolar Versor Algebra	
Part I The Knowledge of Electrical Phenomena	page 64
[1] Alternating Current Machines	page 64
(1.1) Rotating A. C. Apparatus	page 65
(1.2) Arithmetic Expression	page 65

(1.3) Algebraic Expression	page	65
(1.4) Higher Order Expression	page	66
[2] The Long Line Problem	page	68
(2.1) Electric Transmission	page	68
(2.2) Electric Wave Theory	page	69
[3] Space Algebra and Electricity	page	71
(3.1) Cartesian and Quaternion Systems	page	72
(3.2) Michael Faraday	page	76
(3.3) James Clerk Maxwell	page	80
(3.4) Oliver Heaviside	page	85
(3.5) Quaternions and Maxwell	page	93
(3.6) Lost in Space	page	95
(3.7) Engineering Reality	page	97
Part II Symbolic Representation of Cyclic Phenomena	page	105
[1] Primordial Symbolic Representation	page	106
(1.1) Nature	page	107
(1.2) Quadrapolar Geometry	page	108
(1.3) The Lunar Cycle	page	109
[2] Lunar Versors	page	110
(2.1) The Four Lunar Phases	page	110
(2.2) Exponents of the Phases	page	111
[3] Quadrapolar Relations	page	118
(3.1) Quadrapolar Arithmetic	page	118
(3.2) Real and Imaginary Lines	page	119
Part III The Versor Operator j	page	123
[1] Rotational Operation	page	124
(1.1) The Unit Rotation	page	125
(1.2) Bipolar Operations	page	128
[2] Real and Imaginary Operators	page	129
(2.1) Arithmetic Operations	page	129
(2.2) Alternating Current Analog	page	131
(2.3) Four Versor Operators	page	132
(2.4) The Rotational Operator	page	137
(2.5) Versor Operations	page	137
(2.6) The Bipolar Operator	page	142
(2.7) The Alternating Operator	page	143
(2.8) Real and Reactive Power	page	144
[3] The Quadrapolar Versor Operator	page	146

(3.1) Bipolar Operation	page 146
(3.2) Fourth Order Expression	page 146
[4] Duo-Binary Representation	page 150
(4.1) Bipolar Real and Bipolar Imaginary	page 150
(4.2) The Exponential Series	page 150
(4.3) Roots of a Unit	page 151
(4.4) Lunar Representation	page 151
Part IV Versor Relations Between Sun, Moon, and Earth .	page 152
[1] Versor Attributes of Light and Dark	page 153
(1.1) Quadrapolar Aspects	page 153
(1.2) Positions of the Sun and Moon	page 154
(1.3) Co-Axial Systems	page 156
(1.4) Quadrature Relations	page 156
(1.5) Ratios of Light and Dark	page 159
[2] Solar-Lunar Co-Axial Versors	page 160
(2.1) The Pair of Cycles	page 160
(2.2) Solar-Lunar Cycles	page 161
(2.3) Counter Rotational Cycles	page 163
(2.4) Alternating Current Analog	page 164
Part V The Lunar Phases	page 165
[1] Light and Dark on the Lunar Face	page 166
(1.1) Proportion of Light and Dark	page 166
(1.2) Positions of the Sun, Moon, and Earth	page 167
[2] Electric Analogs	page 170
(2.1) Lunar and Electric Phases	page 173
(2.2) Proportion of Energy	page 173
(2.3) Cycle of Light and Dark	page 173
[3] Co-Axial Versor Form	page 175
(3.1) Energy Relations	page 175
Part VI Ratios, Projections, and the Sine and Cosine Functions	page 177
[1] Projections of the Cycle	page 178
(1.1) Image of Light and Dark	page 178
(1.2) Lunar shadow	page 179
(1.3) Sine and Cosine	page 181
(1.4) Shadows	page 184
(1.5) Co-Operation of the Sine and Cosine Functions	page 184

Section Three	page 186
Practical Aspects of Quadrapolar Versor Algebra	
Part I The Method of Descartes	page 187
[1] The Cartesian Co-ordinate System	page 188
(1.1) Sine and Cosine	page 188
(1.2) Symmetrical Co-ordinate Systems	page 192
(1.3) Latitude and Longitude	page 196
(1.4) Co-ordinate Derived Positions	page 199
(1.5) Pythagorean Ratios	page 200
[2] Ratios Derived from the Unit Radius	page 203
(2.1) Positions in Terms of Co-ordinates	page 203
(2.2) Radius of Unit Value	page 204
(2.3) Electrical Analog	page 233
(2.4) Angular and Rectangular Representation	page 234
Part II The Method of Steinmetz	page 235
[1] Application of Versor Algebra	page 236
(1.1) Symbolic Representation	page 236
(1.2) Steinmetz' Method	page 236
(1.3) Promethean Myth	page 238
[2] Steinmetz the Wizard	page 239
(2.1) Experiments	page 239
(2.2) The Lizard	page 240
(2.3) His Origin	page 241
(2.4) The Educator	page 243
Part III The Rotary Field of Nikola Tesla	page 245
[1] The four Quadrant Archetype	page 246
(1.1) Quadrantal Natural Laws	page 246
(1.2) Quadrantal Attributes and Archforms	page 247
[2] The Synchronous Machine	page 253
(2.1) The Invention	page 253
(2.2) Real and Imaginary Currents	page 256
(2.3) Rotating Transformer	page 257
(2.4) Synchronous Motor	page 258
(2.5) Space-Time Phase	page 259

[3] Motor Operation	page 261
(3.1) Basic Motor layout	page 261
(3.2) The Four Motor Poles	page 262
(3.3) Sine and Cosine Functions	page 263
(3.4) Rotating Magnetic Pole	page 265
[4] The Vision of Nikola Tesla	page 268
(4.1) Goethean Vision	page 268
(4.2) Rotating Pole	page 270
(4.3) Four Phase A. C.	page 270
(4.4) Epilog	page 271

Appendices page 273

[1] In the Beginning, Versors	page 274
[2] Four Quadrant Energy Exchange	page 286
[3] Quadrapolar Resonant Circuit	page 320

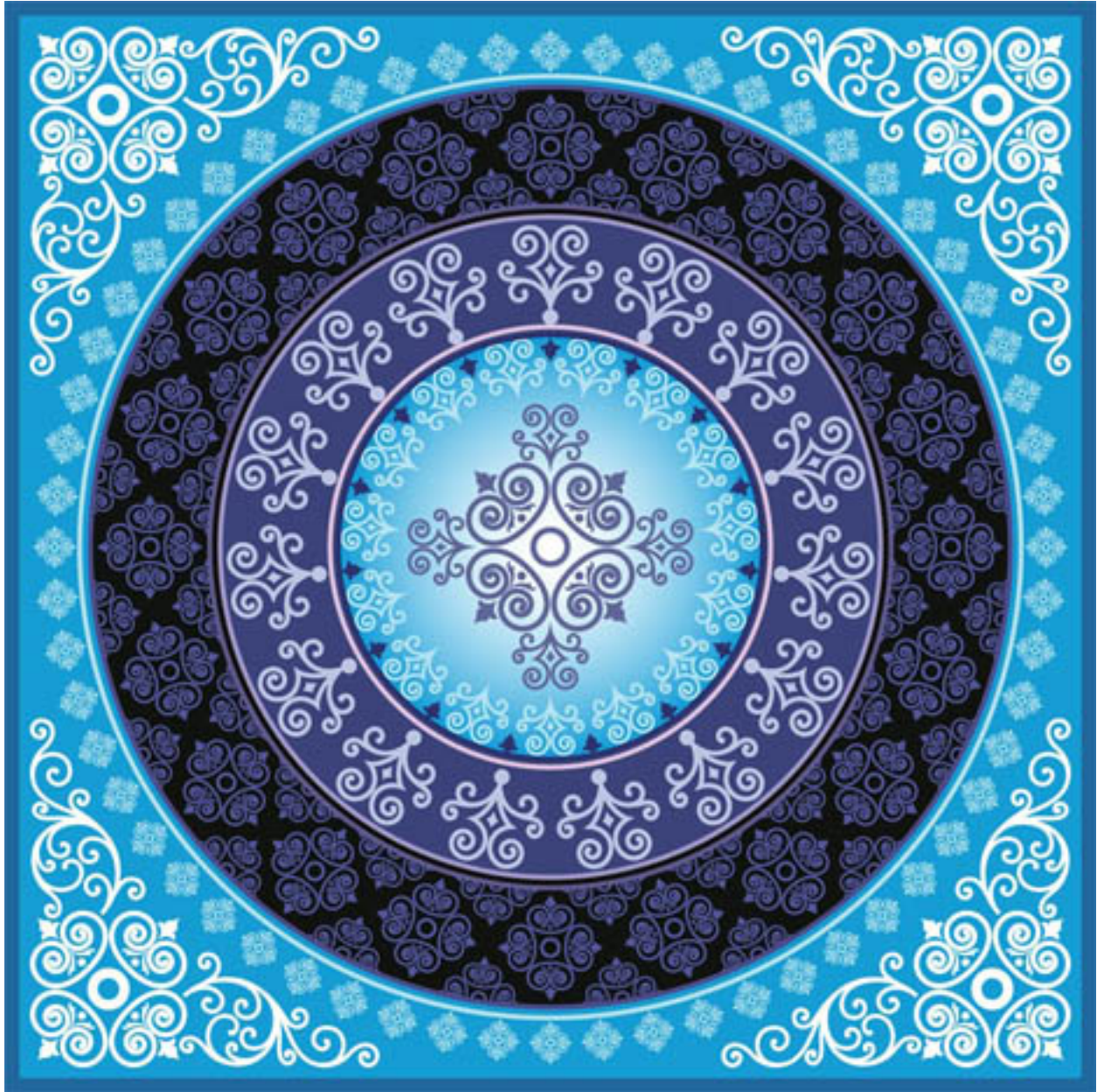

Introduction

1.1 Objectives

The objective of the following writing is to provide an introduction of Versor Algebra and its application to the Four Phase Cycle. This will be directed to the common understanding rather than that of the engineer or mathematician.

Versor algebra is well suited for the inner workings of the Alternating Current Cycle. The cycle is the fundamental dimension of alternating current, given as Per Second. This is a dimension of change. The cycle and its phases are best represented by versor symbolism. This symbolic representation in quadrapolar form is the fundamental geometric algebra in natural and electrical cycles of revolution.

What will in essence be represented here is a doorway into “Another Dimension” to use the words of physics. The aim is to cross the border from the “Real” into the “Imaginary”, to cross over into the “Other Side”. The “Red Pill” to take us down the “Rabbit Hole” will be the Square Root of Negative One.

1.2 Subject Division

This subject will be presented in three sections:

- I) Metaphysical
- II) Mathematical
- II) Practical

The first section will relate this subject to the purely metaphysical. Such concepts have become foreign to the modern mind, to be regarded as delusions or works of fantasy. Moreover, the metaphysical is rejected with a singular fervor by modernists. However, such a form of understanding serves as the foundation of music, mathematics, and the creative process itself.

The second section is strictly mathematical, but no attempt is made to develop practical formulae. The aim of the second section is to develop an archetypal view of the cyclic process, this given in terms of the *Lunar Cycle*. The concept of a *Quadrantal Versor* is developed in this section.

The third section is directed towards a more practical understanding of the *Quadrantal Versor* form of the representation and its application to *Four Quadrant Geometries*. The specific application in the third section is the

symbolic algebra of Carl Proteus Steinmetz, and the synchronous machine of Nikola Tesla. The work of these two pioneers is the progenesis of today's alternating current technology.

1.3 Misnomers

Three misnomers exist in any discussion or presentation of electric phenomena. First is the notion of *Current Flow*, second is that of an *Alternating Current*, and the third is the use of the term *Imaginary*. In order not to confuse matters, these terms will continue to be used in the following writings. This will however be done with qualification, as follows:

I) Current Flow:

The pre-historic concept of *Electric Current Flow* is a persistent holdover from the ideas prevalent before the discoveries of Faraday and Maxwell. This current in reality is no more than a mathematical fiction, derived from the notions of physics. This misconception works great harm into the functional understanding of electricity.

II) Alternating Current:

The machines of Nicola Tesla are not based upon *Alternating Current*, but upon a *Rotating Continuous Current*. This is the novelty of Tesla's discovery. *Alternating Current* is but a shadow, or projection of the *Rotating Electric Wave*. A.C. is a *Direct Current* undergoing cyclic reversals. With an *Alternating Current* rotation is not possible, a situation facing motor builders prior to the discoveries of Nikola Tesla.

III) Imaginary:

The term *Imaginary* is a holdover from the view of mathematics that the *Square Root of Negative One* is an algebraic impossibility. However, *Imaginary Currents* can act with as much force as *Real Currents*, but the laws of behavior can be very much different.

1.4 Origin of Subject

The origin of the *Versor System* of representation as presented in the following writings begins with Dr. Alexander MacFarlane, University of Texas in Austin. His two groundbreaking papers on the subject of Versor Algebra are:

- I) The Imaginary of Algebra
- II) The Principles of the Algebra of Physics

Three subsequent papers were written by me, as an extension of MacFarlane's writings:

- I) Symbolic Representation Of The Alternating Electric Wave
- II) Symbolic Representation Of The Generalized Electric Wave In The Time Domain
- III) Symbolic Representation Of Induction In Space

These three papers are an adaption of MacFarlane's view through the methods of Steinmetz and Kennelly. Carl Steinmetz developed his A.C. symbolic geometry for General Electric, and Arthur Kennelly developed his D.C. symbolic geometry for Edison Electric. Space algebra found no further development after the initial work of Dr. MacFarlane. Induction in Space is a preliminary attempt to overcome the crippling limitation of Maxwell's Quaternions and Heaviside's vector calculus, both useless in transformer analysis.

1.5 Initiation

The writings that now follow are an attempt towards a reduction of the subject to a more common level of understanding. As a mathematical subject, it is by its very nature an abstract one, it lives in unseen dimensions of the unknowable, as does electricity. Music, mathematics and electricity exist in this type of co-referencing triad.

This abstract character will be difficult for the layman to grasp, it may be impossible for some. However, the subject is here presented in a

methodical and repetitive form, this given as new names for known elementary ideas. For those who can hold on, the image in the mind of Nikola Tesla, which revealed a rotating magnetic field, will give rise to itself again in the mind of the reader. The reader must continue on in the *“Spirit of a bold sense of curiosity for the adventure ahead”*

Section One

The Metaphysical Aspects of Quadrapolar Versor Algebra

(I) Pythagoras of Samos

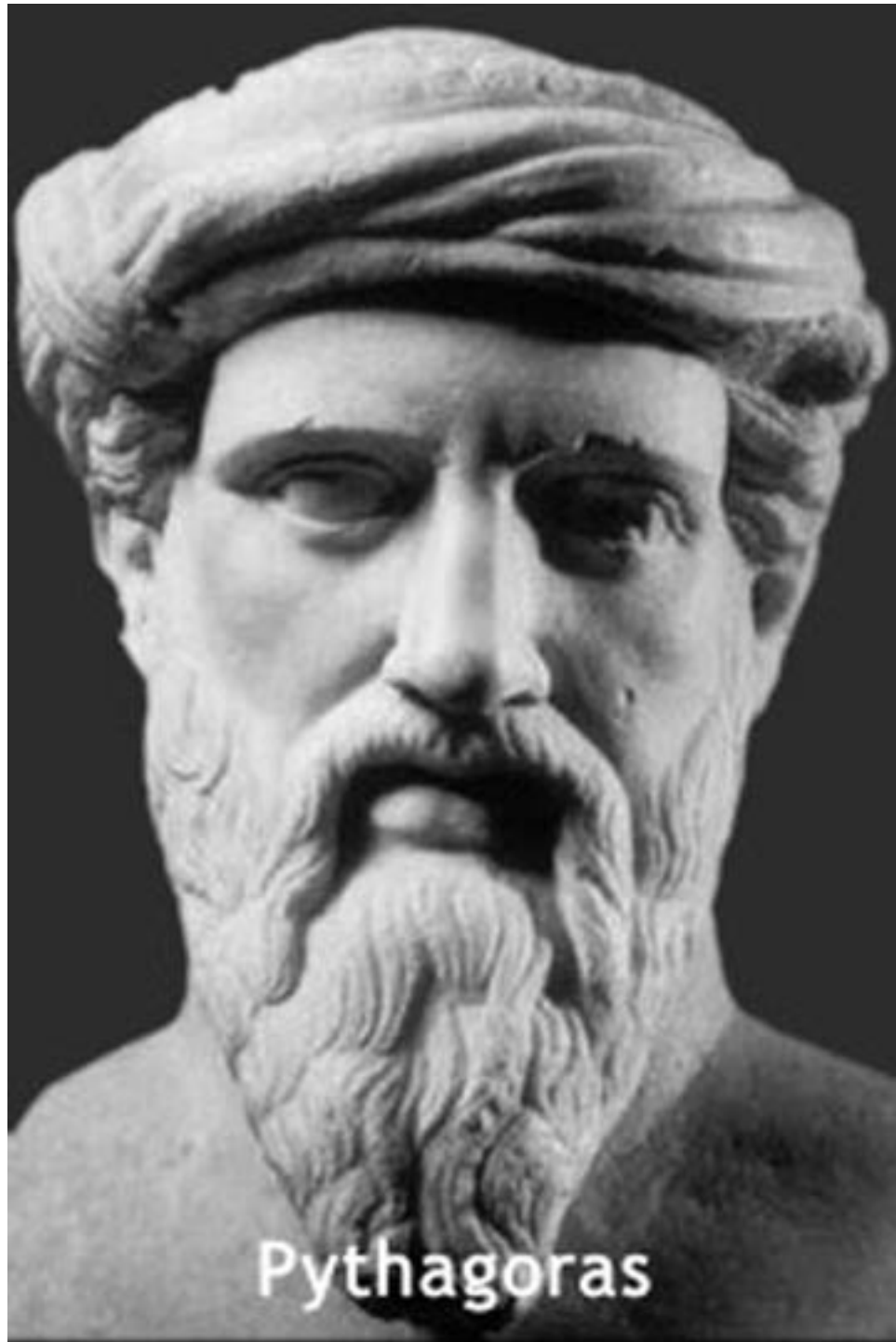

Figure 2

[1] Pythagoras

1.1 Introduction

Any endeavor of this nature must begin with Pythagoras of Samos. Pythagoras is the grandfather of mathematics and music. His discovery of most significance to the engineer is the *Pythagorean Theorem of Squares*. This theorem plays an important role in *Alternating Current Theory*.

1.2 Theorem

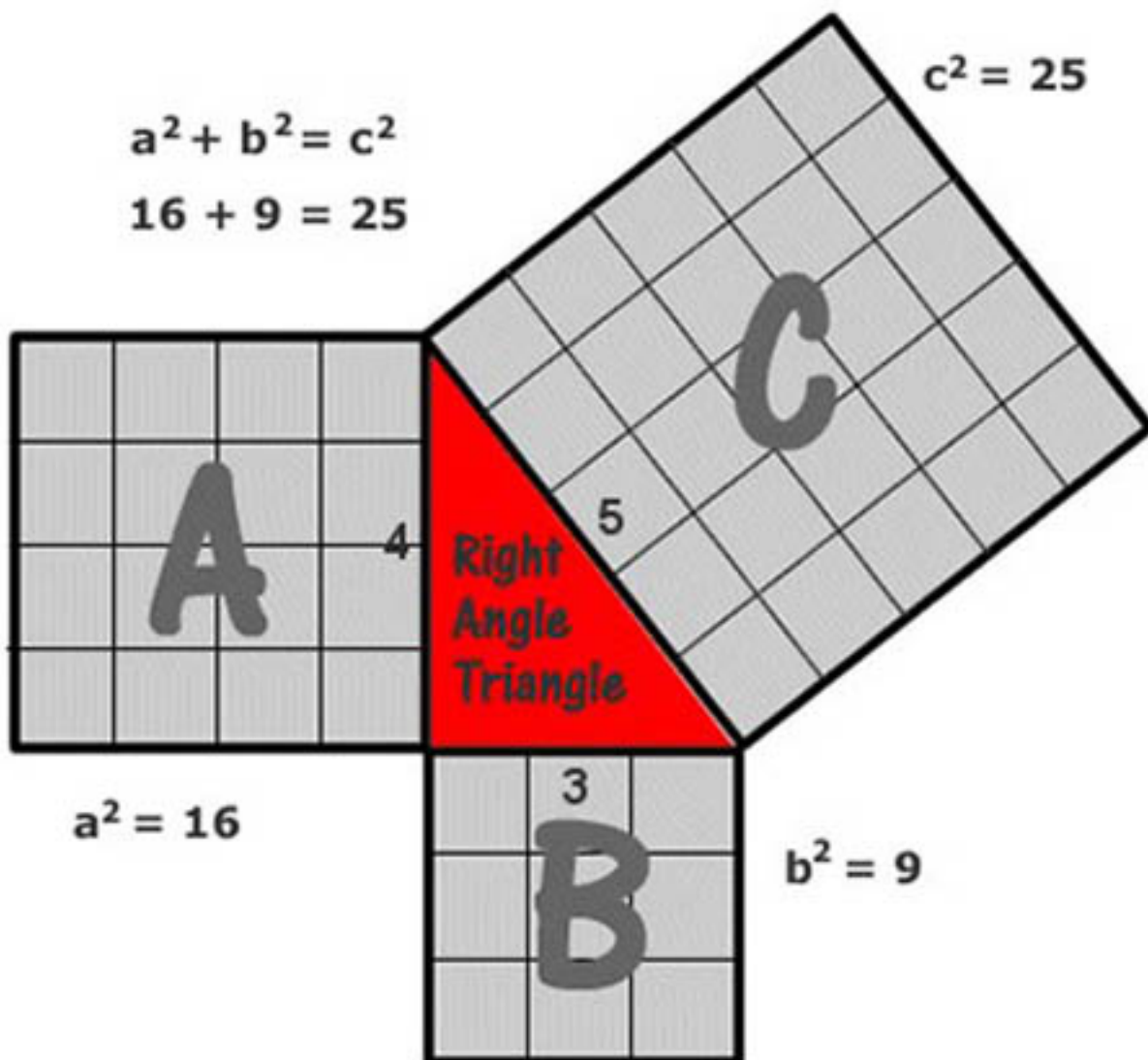

PYTHAGOREAN THEOREM OF SQUARES

Figure 3

The theorem states a relation which allows for the addition of *Real & Imaginary quantities*¹, such as current or E.M.F. Shown is a Real Length, **b**, it is added to Imaginary Length, **a**. The sum of the *Real Length* and the Imaginary Length, is given by the resultant, or Complex Length, **c**. By stacking unit squares of equivalent total side length, it is found that the complex sum square is the sum of the square of **a** and the square of **b**. The resulting complex length, **c**, is then the square root of the square, that is the square root of **c** squared. This square root, a second order relation, is the source of a particular complication as will be seen later on.

1.3 Island of Samos



ISLAND OF SAMOS

Figure 4

¹ Real here is a new word for horizontal, Imaginary a new word for vertical.

The island of Samos was, and still is, a small fishing village. Its location is obscure, today a location never heard about. In the era of Pythagoras its location was central to the great cultures of antiquity. Samos was the crossroads of the ideas of these cultures.



LOCATION OF SAMOS

Figure 5

Pythagoras lived in a world very much different than the modernistic world of today. To comprehend the world of Pythagoras is at best unlikely. His world was a musical world, an infinite universe manifesting in geometric ratios.

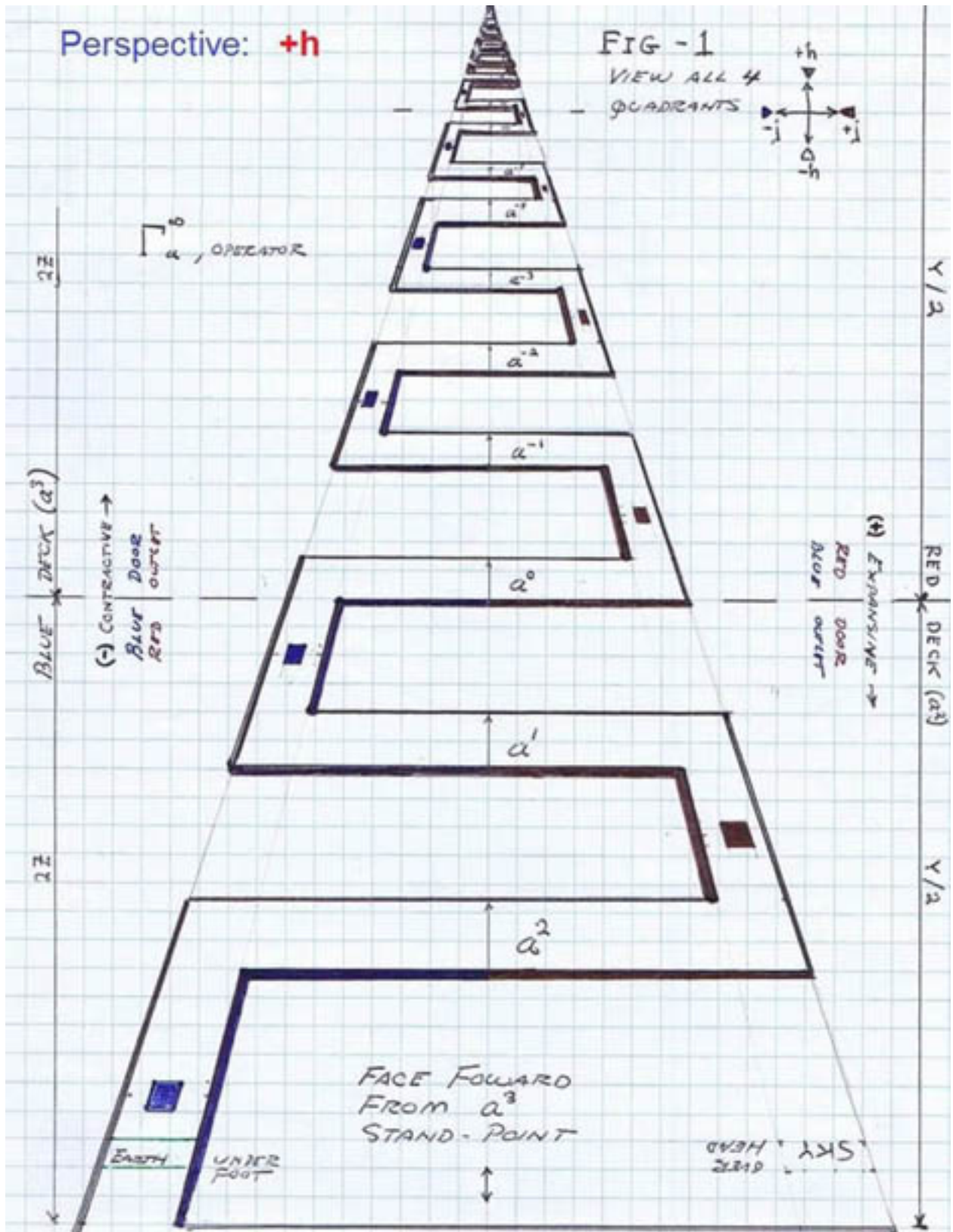

Figure 6

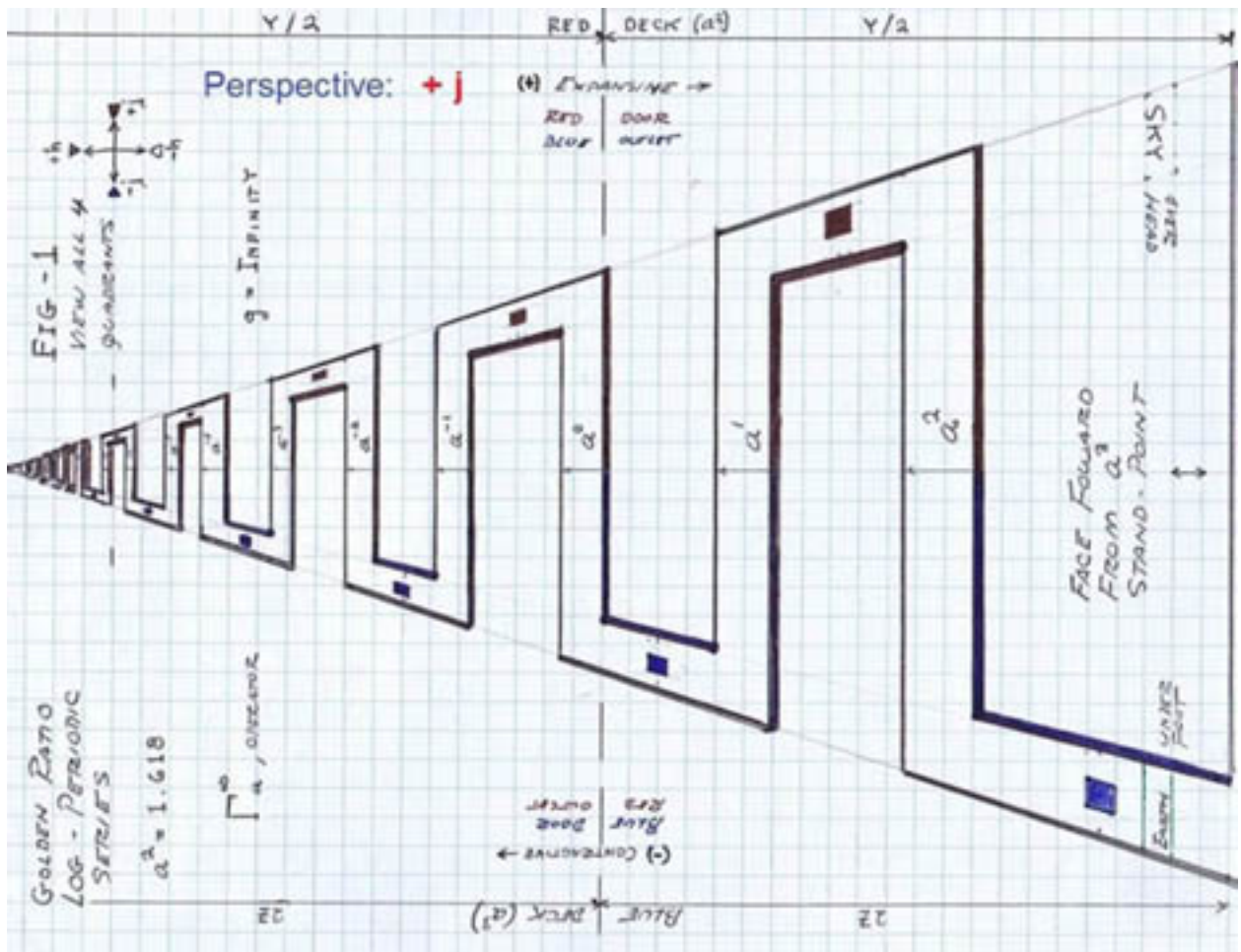

Figure 8

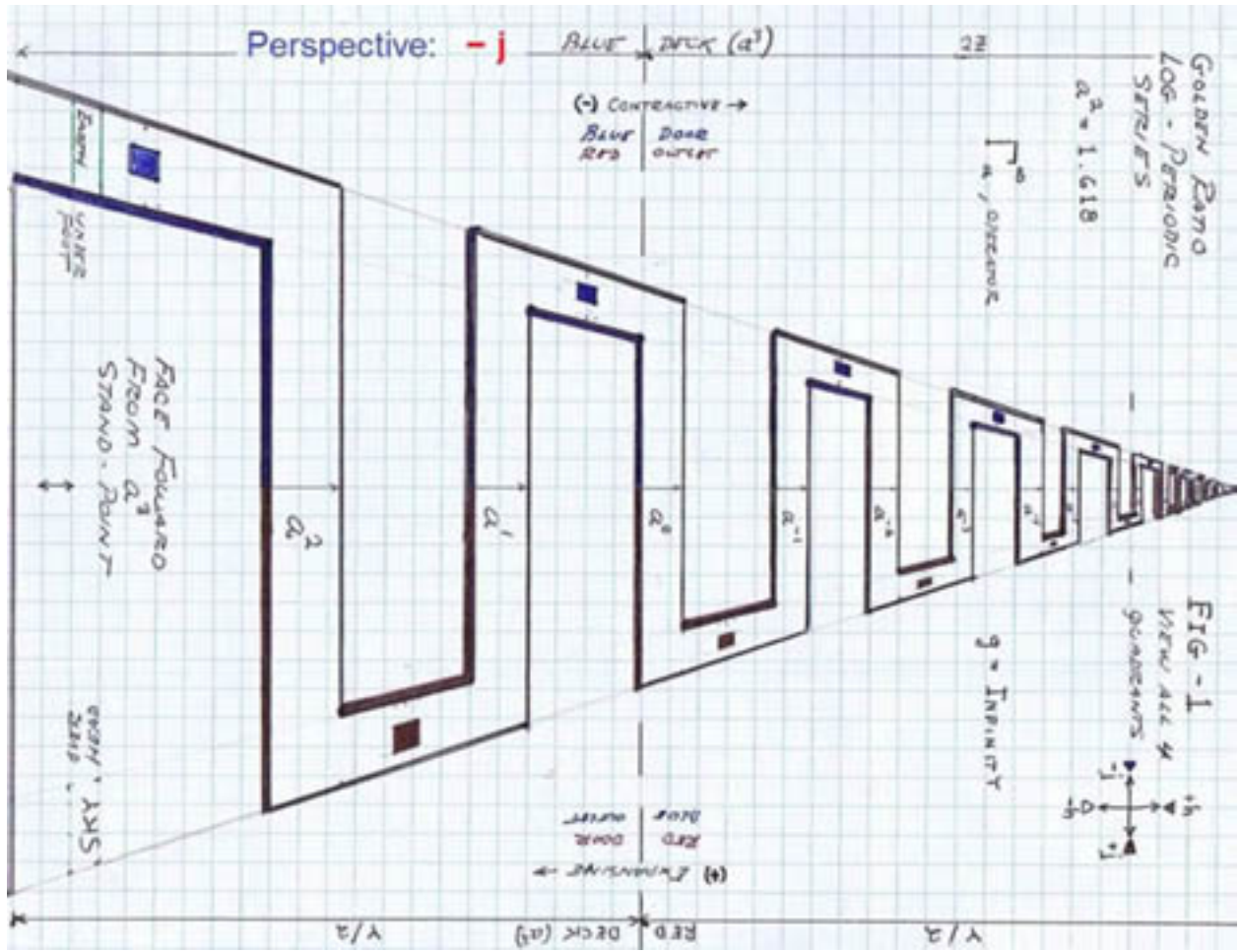

Figure 9

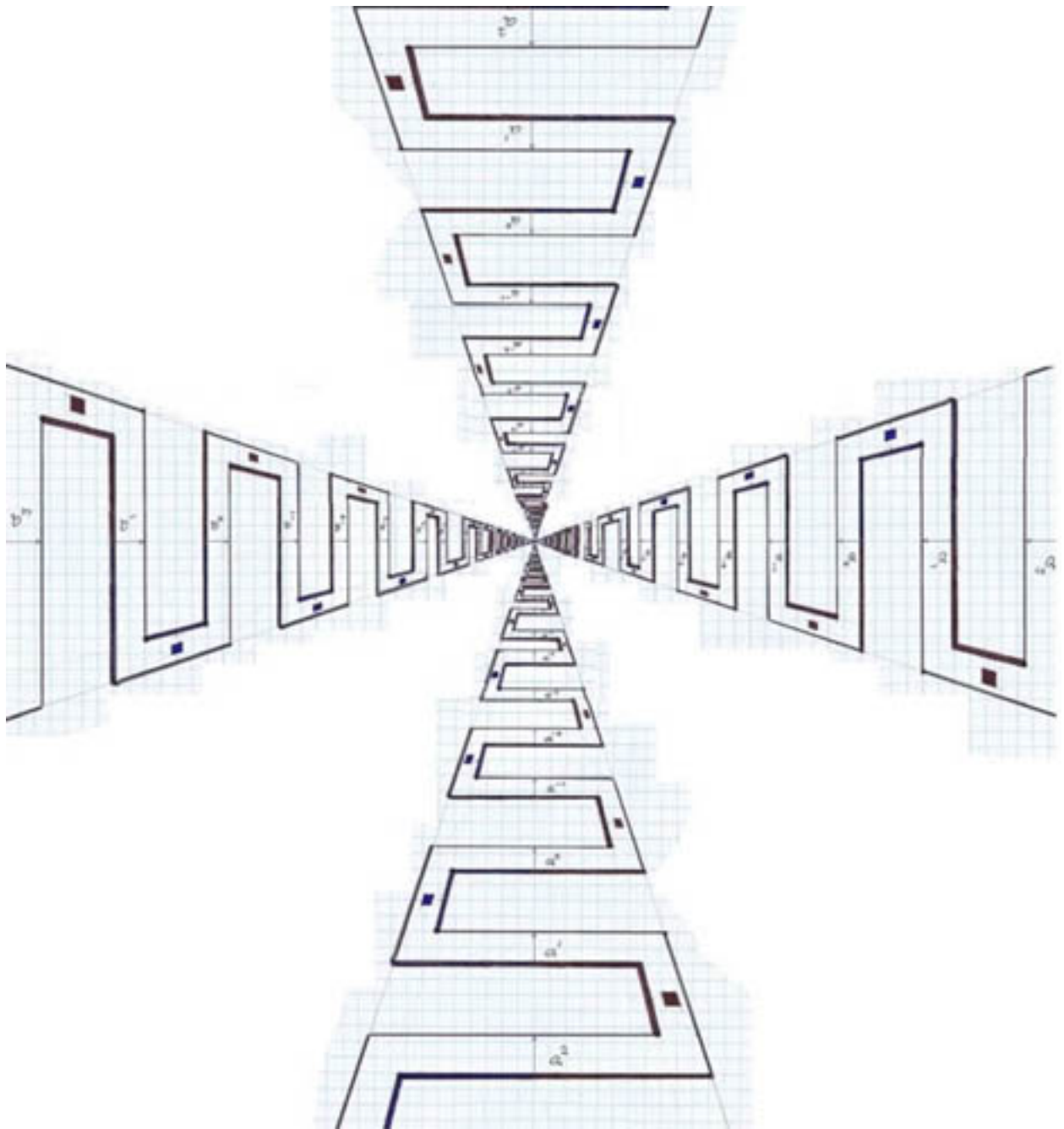

Figure 10

Shown is the Geometric Pattern of the Infinite.



Shown is the geometric pattern of music, and its analog to *Electric Form*.

Figure 11

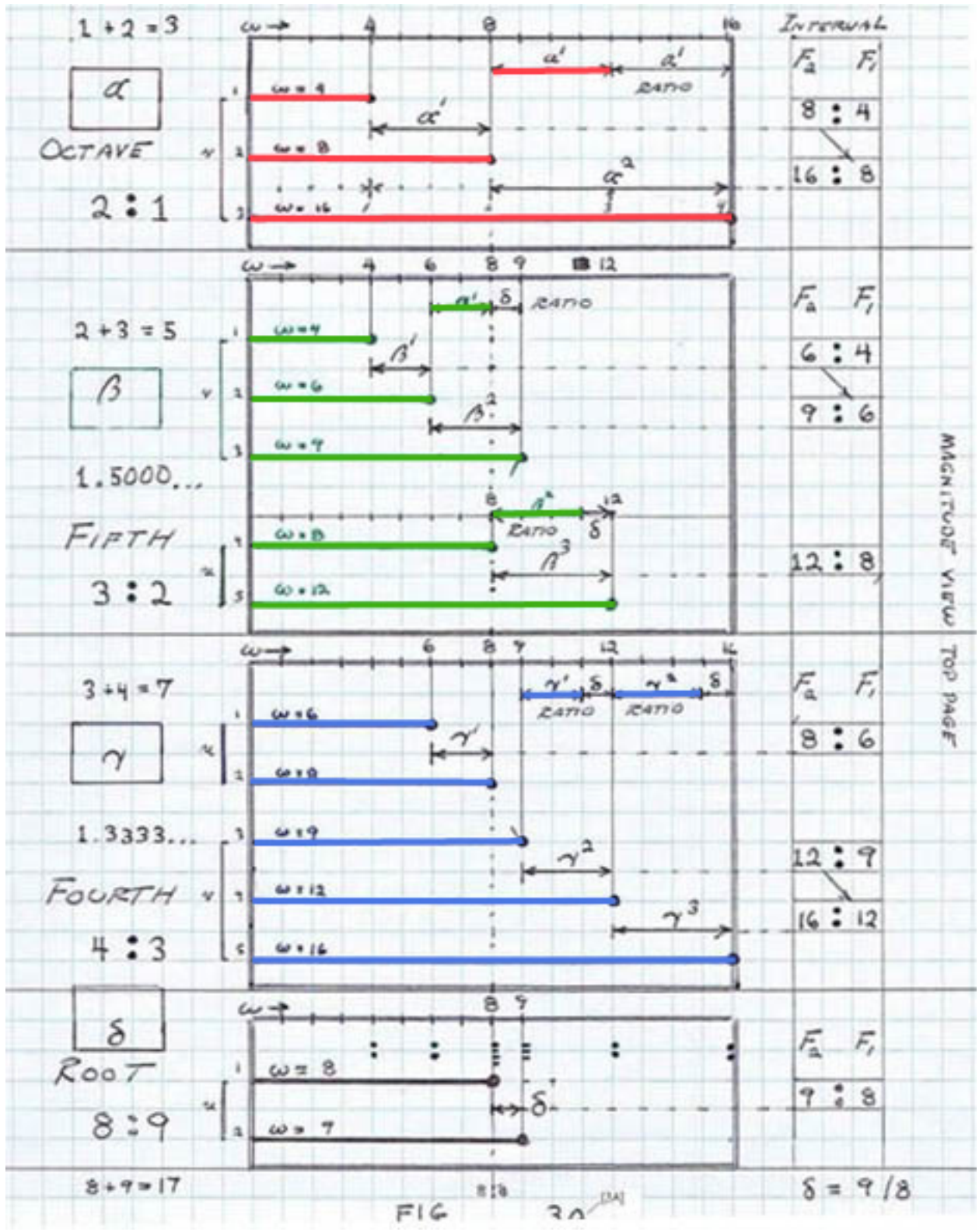

Pythagorean Analog of Heaviside Telegraph Expression
Figure 12

XB

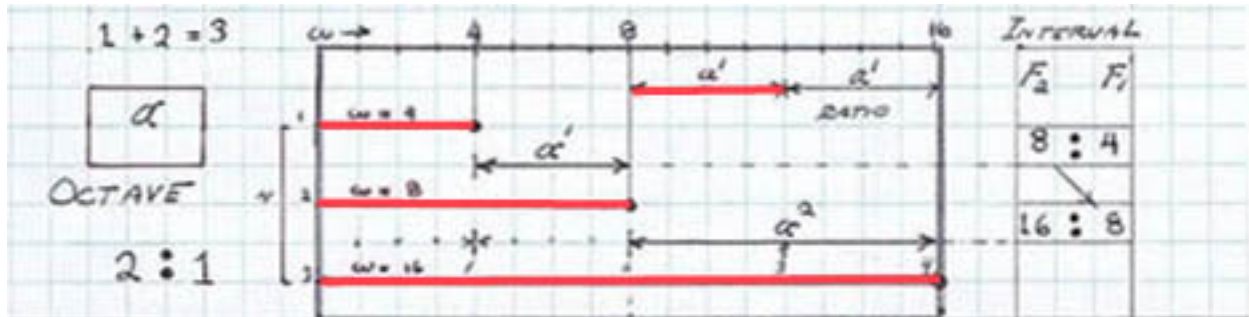

RG

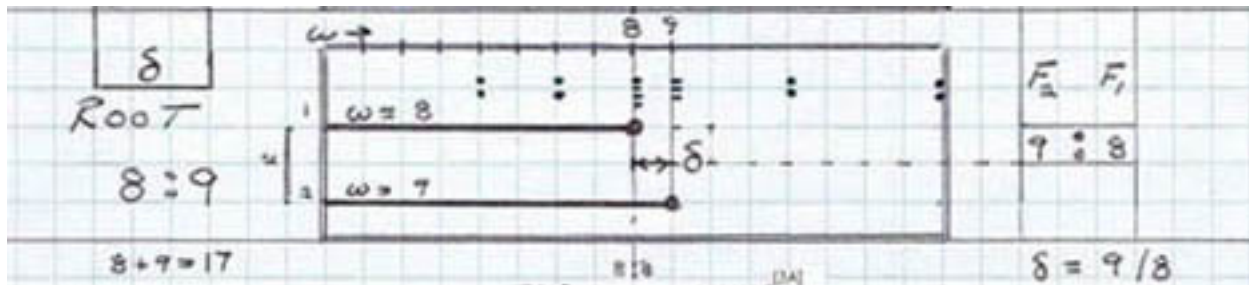
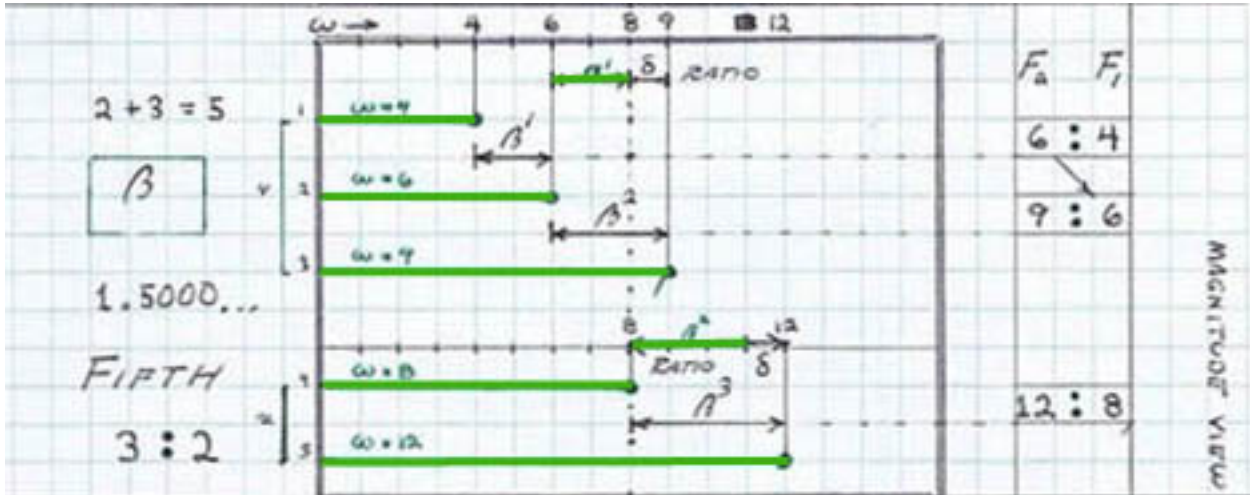

Figure 13

XG



RB

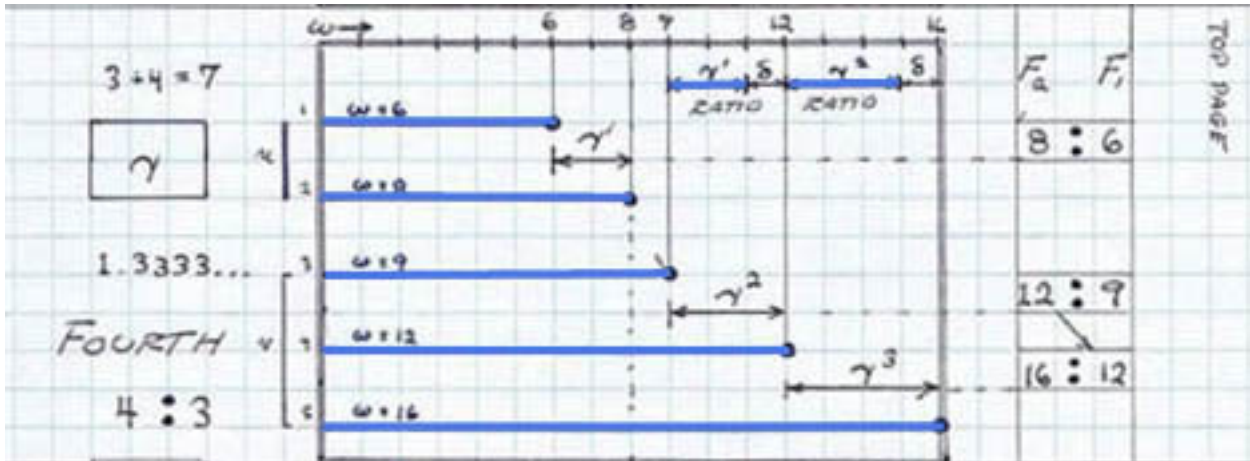

Figure 14

$$(\text{XB} + \text{RG}) + j (\text{RB} - \text{XG})$$

(Heaviside Telegraph Expression)

In the Pythagorean mind, everything is linked canonically in a cosmic series of octaves, these spanning from the infinitesimal to the infinite, no end in either direction. Each entity in the universe has its niche in a particular span of octaves; everything is a part of everything else. Nothing was isolated or separate in the reasoning of the Pythagorean.

1.4 Origins of Mathematics

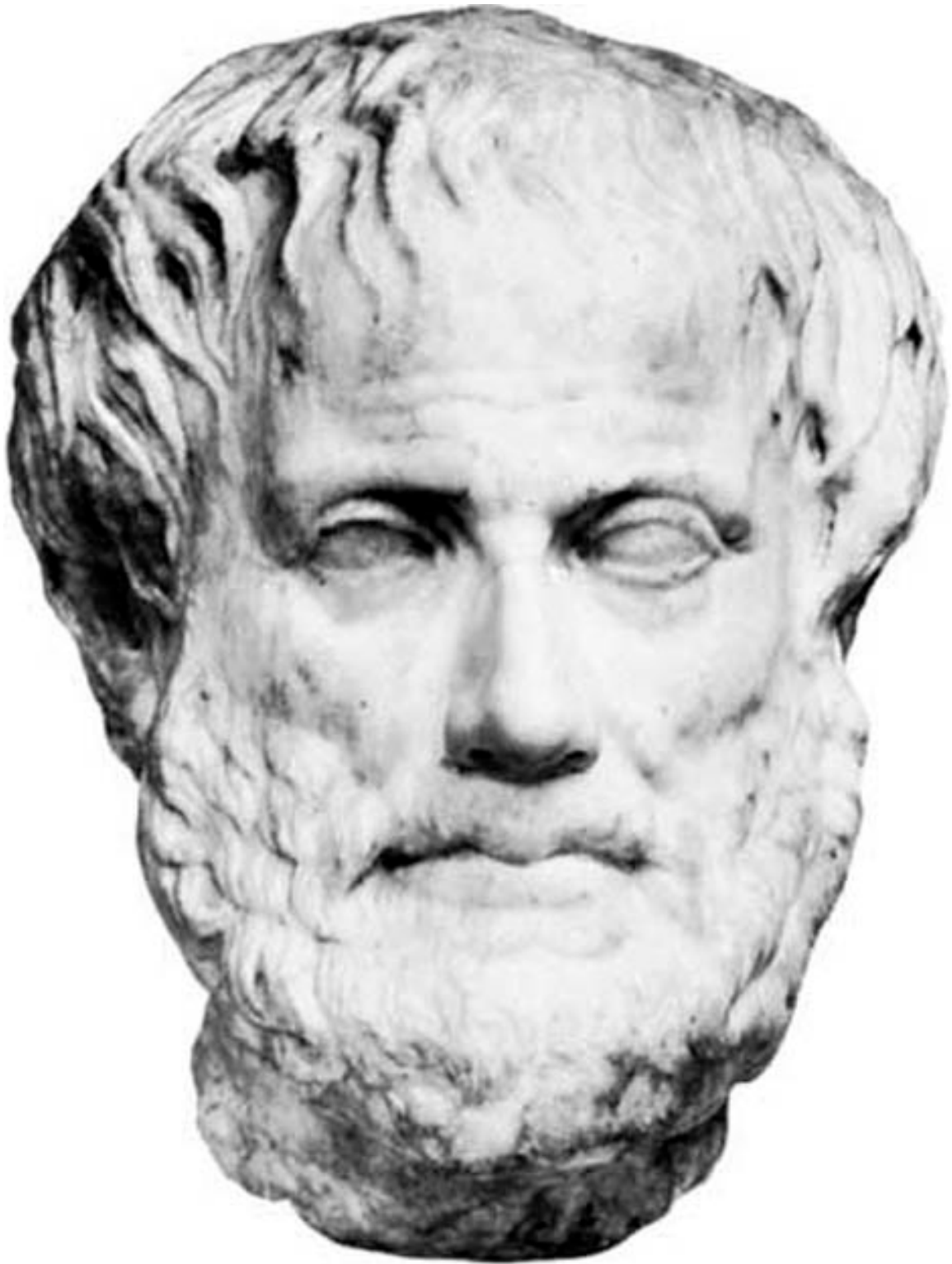

Figure 15

Pythagoras and his followers were hermetic occultists, a secret brotherhood. Theirs alone were the sacred secrets of ancient Aegypt. The Pythagoreans are considered the founding fathers of mathematics, but may actually have delivered to the world the mathematics as a Promethean endeavor. For the most part, it can be said that the knowledge of mathematics begins with Pythagoras of Samos, 582 B.C.

As one would expect, Pythagoras was killed by political operatives and his followers were scattered. Hereby the *Tale of Prometheus* holds true.

1.5 The Pythagoreans



Aristotle
Figure 16

Aristotle, 384 B.C., can be considered the grandfather of science. In his book titled Metaphysics, three hundred years after Pythagoras, he wrote:

- I) The Pythagoreans, as they are called, devoted themselves to mathematics.
- II) They were the first to advance this study, and having been brought up upon it they thought its principles were the principles of all things.
- III) Since the principles of numbers are by nature first, and in numbers they seemed to see many resemblances to things that exist or come into being.
- IV) Since again, they say the attributes and ratios of the musical scales were expressible in numbers.
- V) Since, then, all other things seemed in their whole nature to be modeled after numbers, and numbers seemed to be the first things in the whole of nature, they supposed the elements of numbers to be the elements of all things and the whole heaven to be a musical scale and a Number.

[2] Ancient Concepts

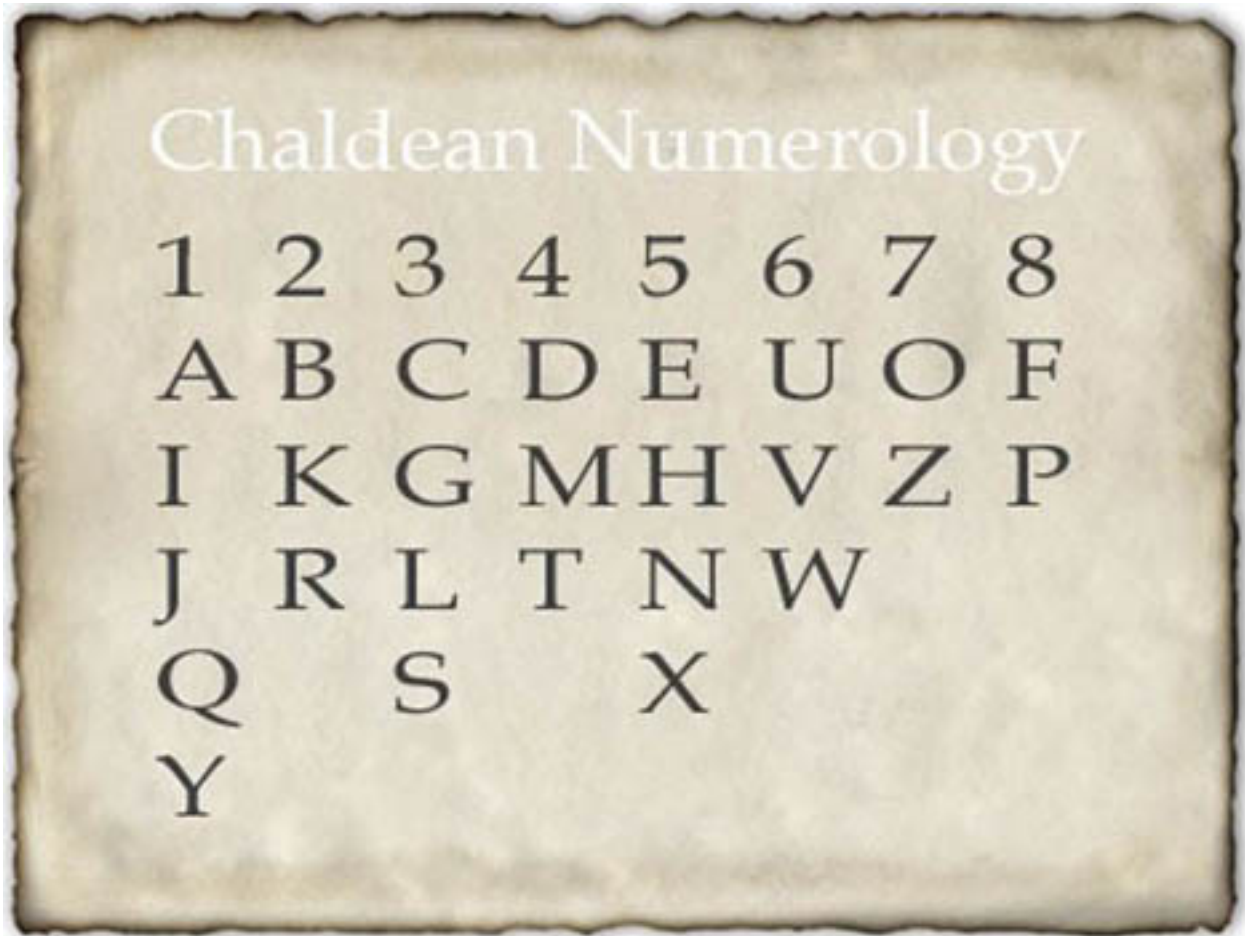

Chaldean Numerology

1	2	3	4	5	6	7	8
A	B	C	D	E	U	O	F
I	K	G	M	H	V	Z	P
J	R	L	T	N	W		
Q		S		X			
Y							

Figure 17

2.1 Chaldean Number System

In the era of Pythagoras the concept of numbers was much deeper than that of mere numeration or counting. Numbers were considered symbolic arch forms. This was the philosophy of the ancient Chaldeans.

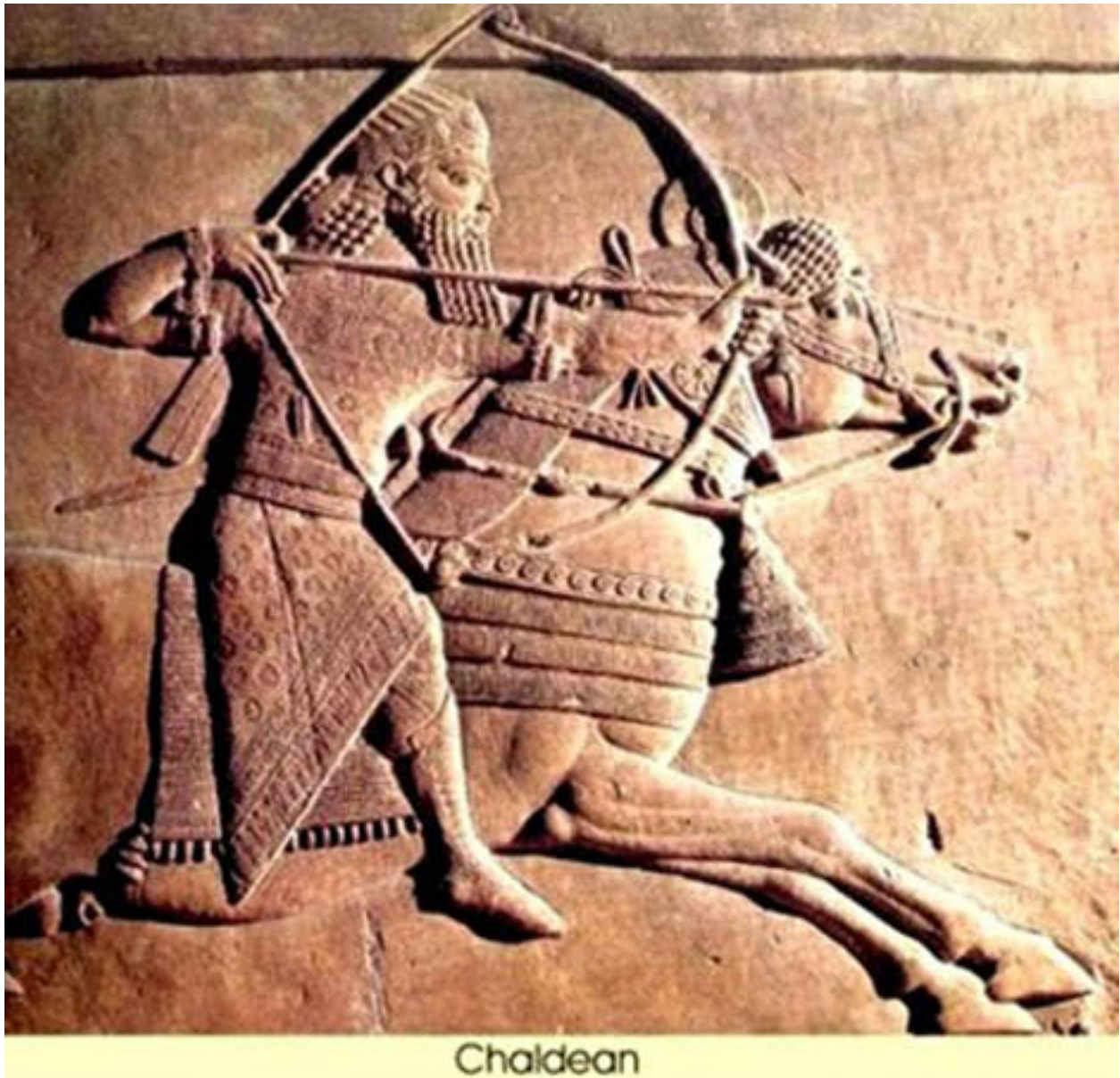
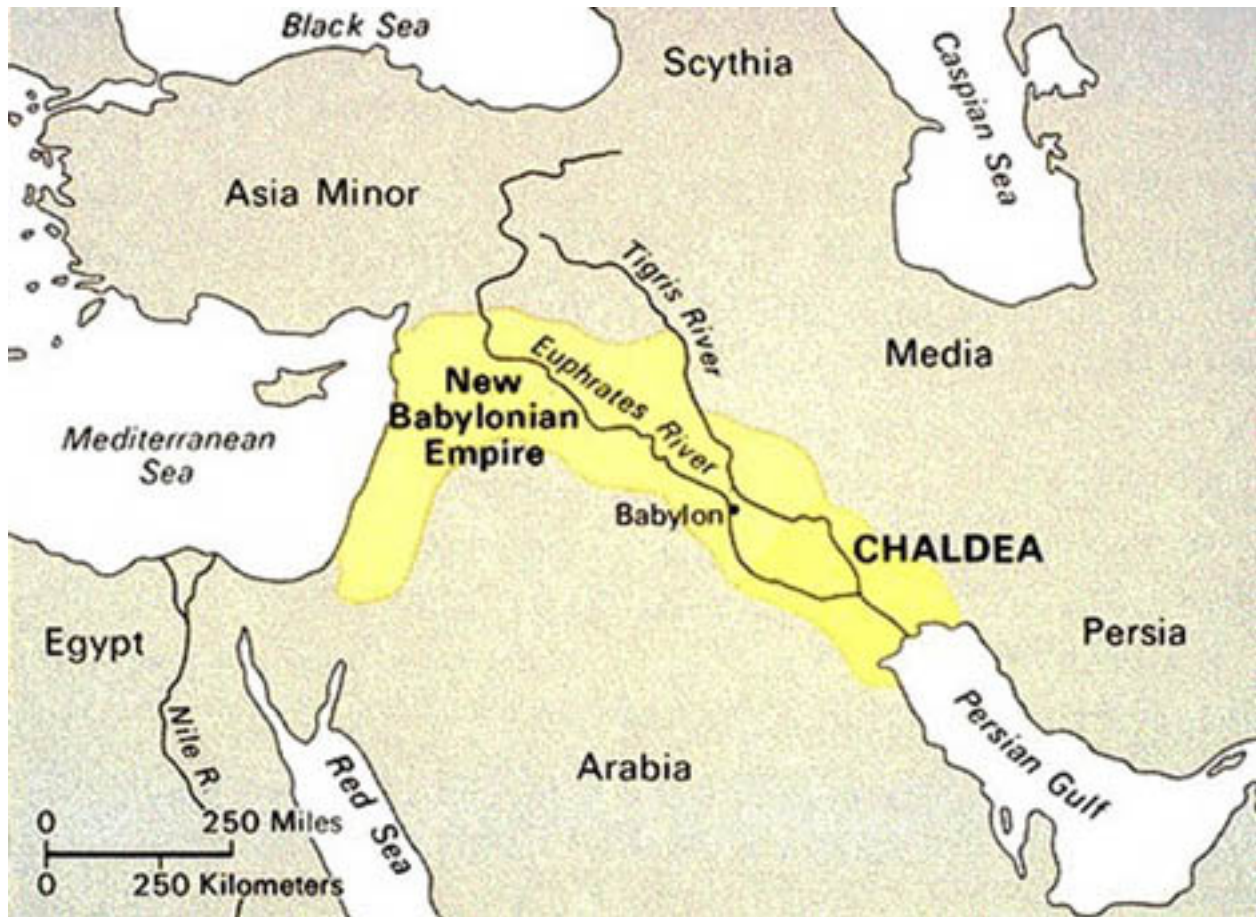

Figure 18



612-539 BC

Figure 19

To the Chaldeans, each number contained an intrinsic arch form. This arch form directs the formative forces, which in turn act upon the *Primordial Aether*. The Aether is hereby molded into concrete reality. This is in line with the reasoning of the Pythagoreans and to them numbers were considered *Divine Ratios*.

2.2 Geometric Manifestation

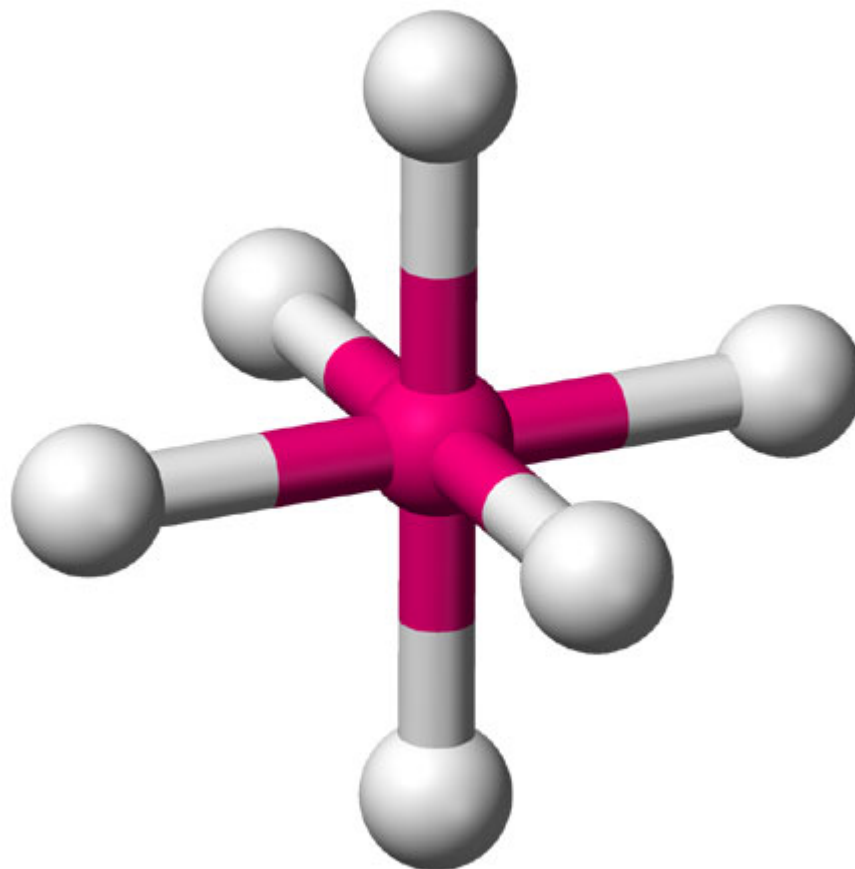

Figure 20

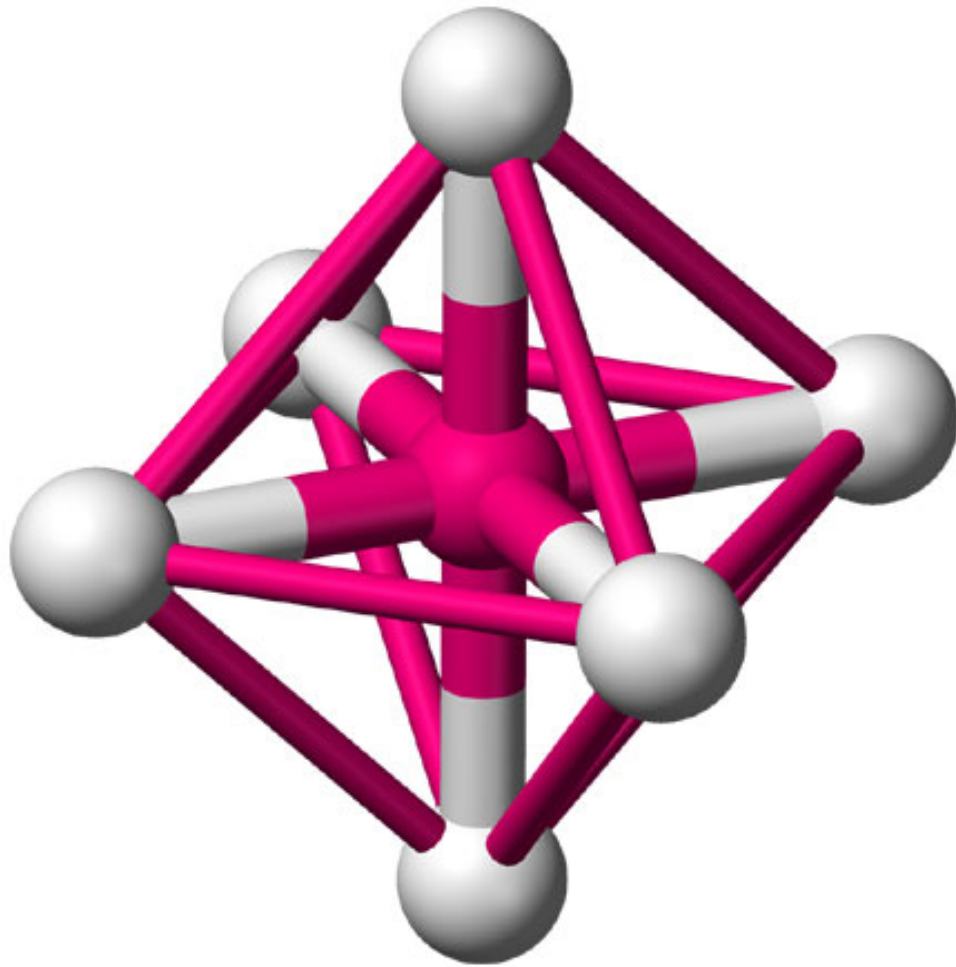
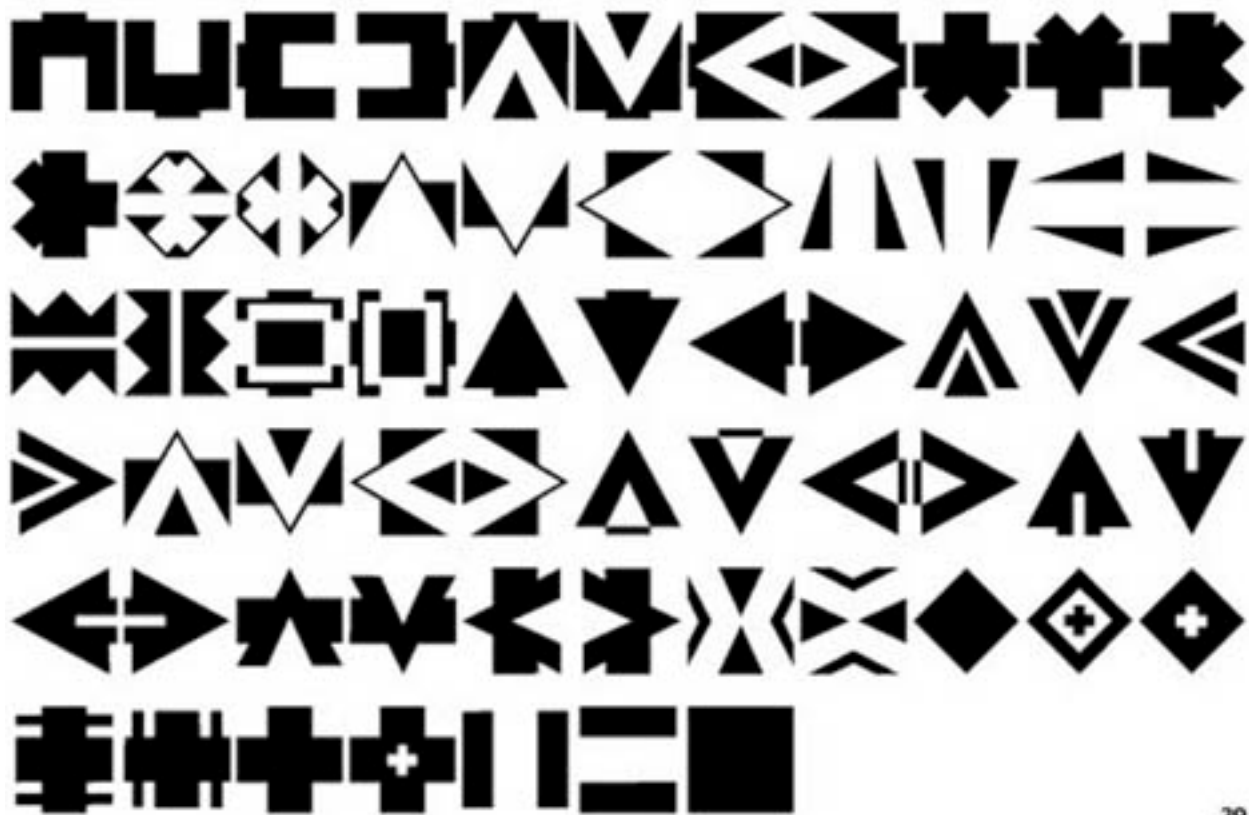

Figure 21



Figure 22

The numerical arch form for electricity is the number *Four*. Electricity establishes itself in quadrapolar relationships, it manifests in *Four Phases* and other quadrature configurations. This can be seen in its concrete arch forms as motors, transformers, transmission lines and etc.



39

Figure 23

Any variety of quadrapolar arch forms are possible, some more *“Electrical”* than others. Here we are concerned specifically with alternating current, or properly with the alternating electric wave, of which so called A.C. is a projection. These waves exist in cycles of revolution, this progressing through the Four Phases of the cycle. It is a rotational phenomenon in cycles per unit time, such as the common 60 cycles per second.

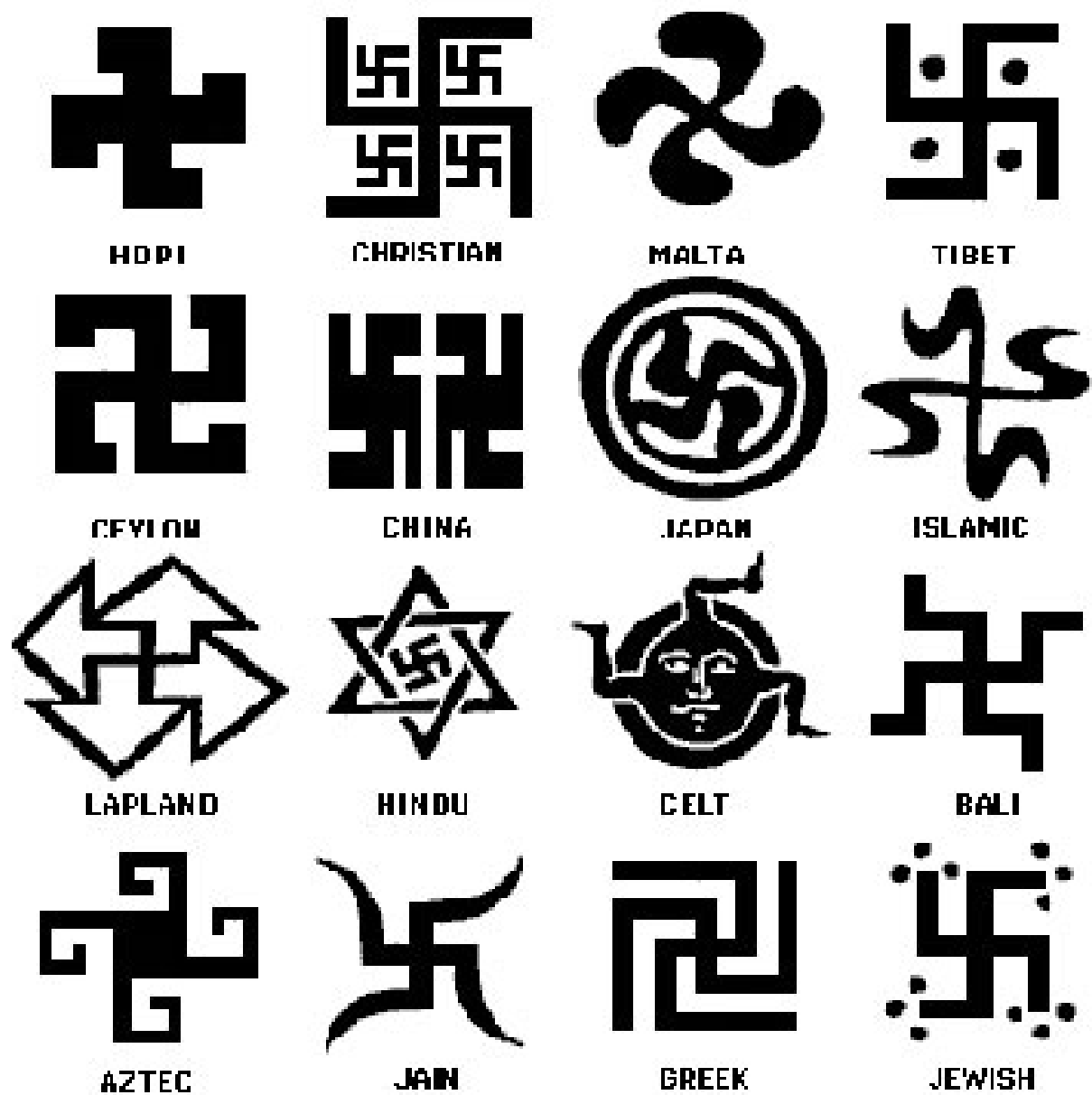

Figure 24

The primitive arch forms shown in the figure are various cultural expressions of the rotational Four Phase Cycle. The offsets at the ends of the Four poles give the sense, or direction, of the cyclic rotation; that is, if it is clockwise, or counter-clockwise.



Figure 25

The primitive arch form most suited for A.C. theory is shown in this figure. This consists of a pair of Four pole forms, each rotating in an opposite direction. The light is rotating in one direction; the dark is rotating in the other direction. This light-dark relationship is in direct analogy with the magnetic-dielectric relationship in the Alternating Electric Wave. Each time the poles of the counter-rotating forms coincide or overlap, a specific aspect of the cycle manifests, this occurring four times per cycle, giving the four cyclic aspects:

- I) Energy Production
- II) Energy Return and Storage
- III) Energy Consumption
- IV) Energy Storage and Return

(II) Van Tassel of Giant Rock



GEORGE VAN TASSEL 1910-1978

Figure 26

[1] Van Tassel and his Integratron

1.1 Four Quadrant Theory

The ancient symbolic arch forms were adapted into the Four Quadrant Theory of George Van Tassel, the designer of the Integratron. Van Tassel saw the Earth as an enormous electric Generator and sought to duplicate its actions with his Integratron.

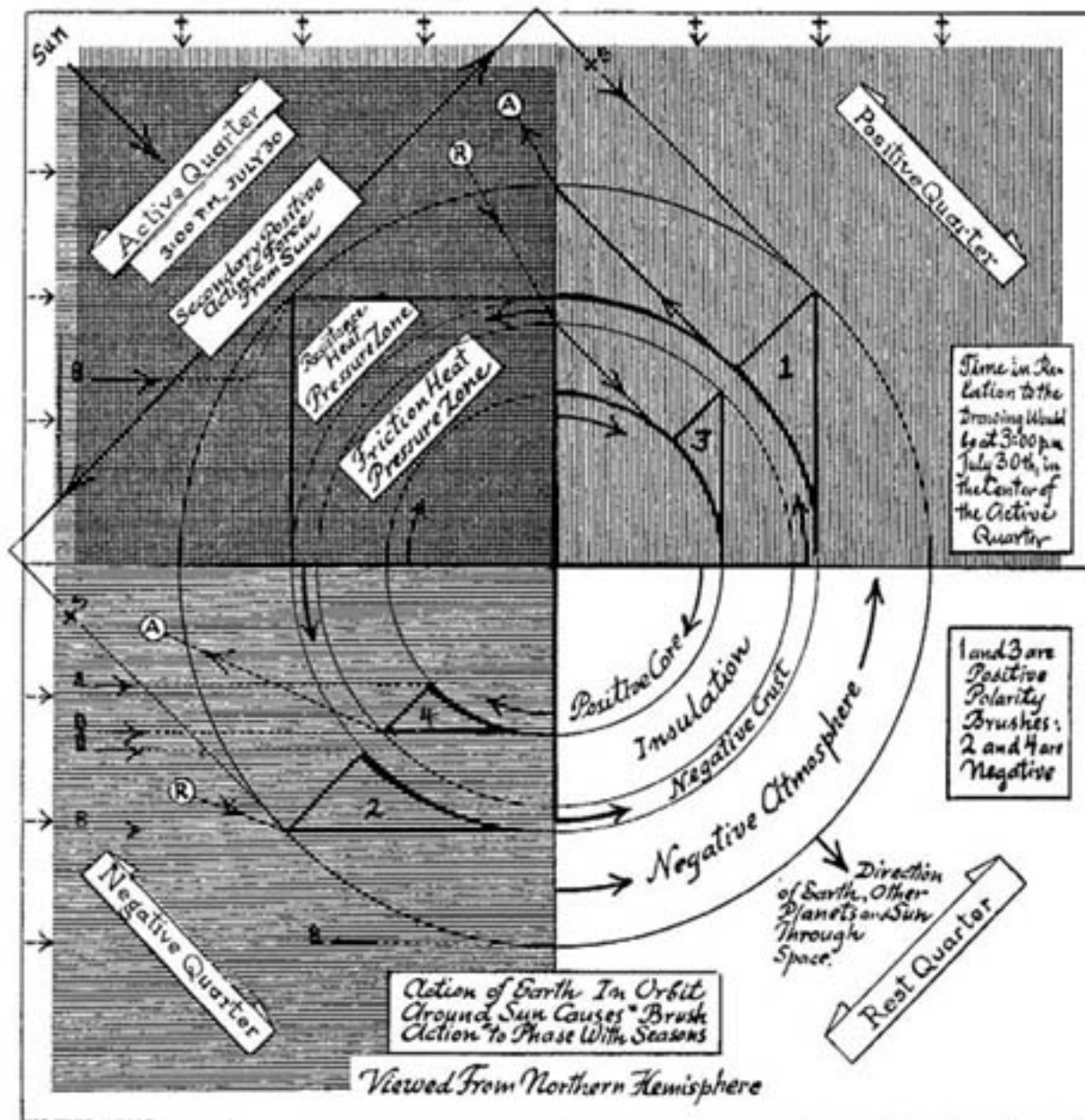

Rotation Principle Of The Earth

Figure 27

This diagram explains his Four Quadrant Theory as it is manifested in the actions of the Earth's rotation.

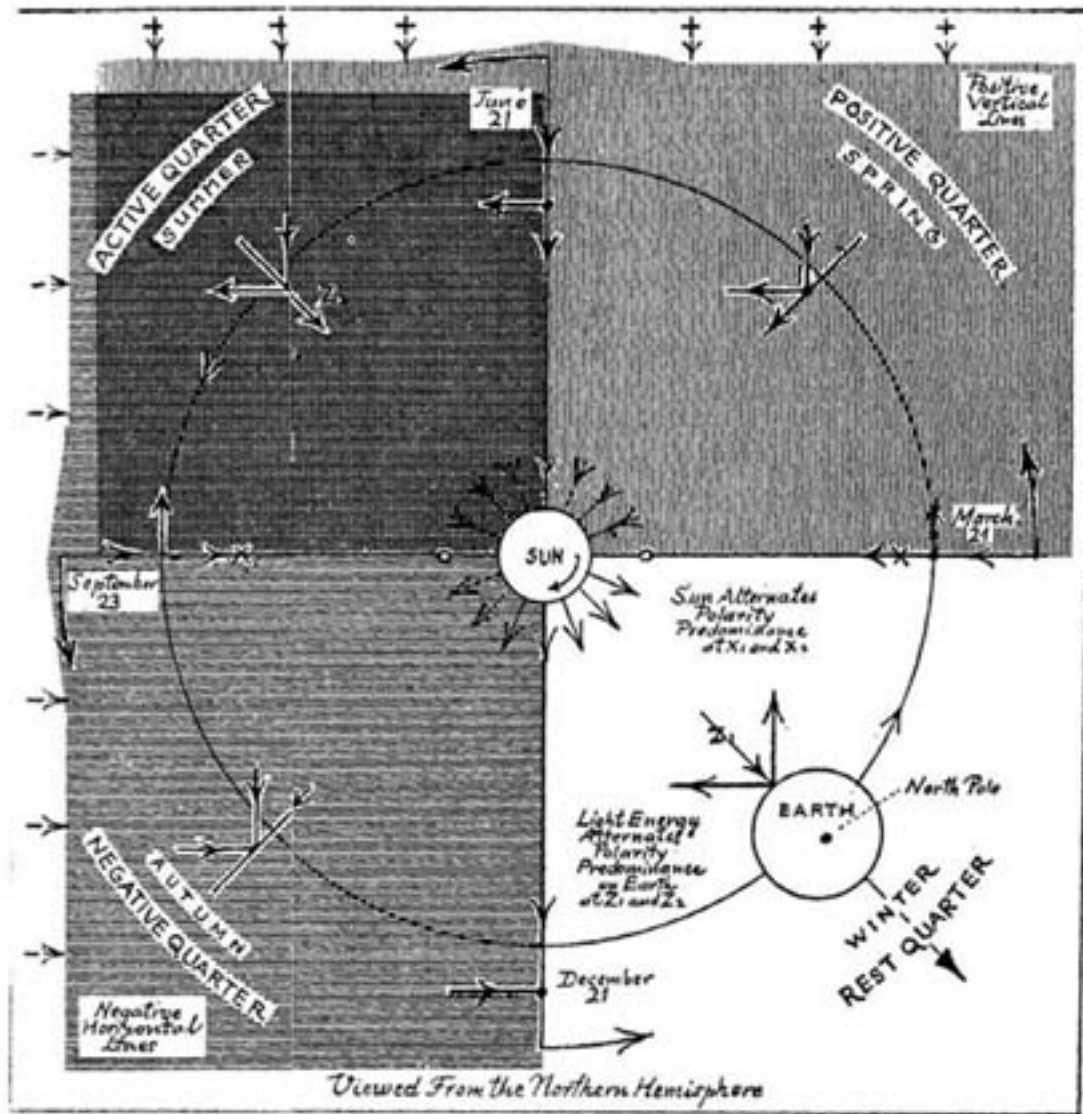

Orbit Principle Of The Earth

Figure 28

Here shown is the Earth-Sun relation, this in a Four Quadrant expression.

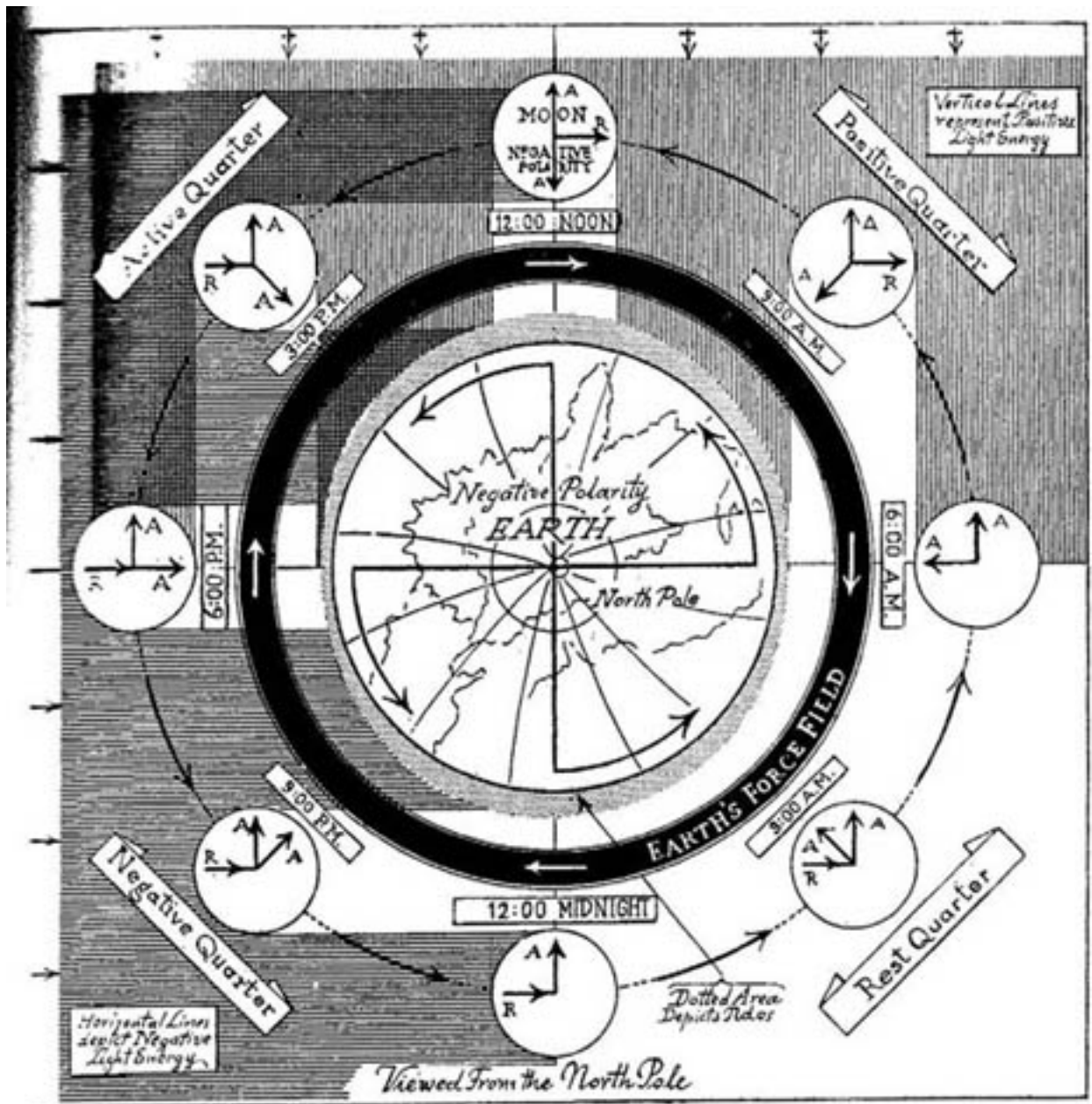

Orbit Principle Of The Moon
Figure 29

Shown is the lunar cycle. The Lunar cycle in its Four Quadrant arch type. This will be extensively treated in later chapters.

The Four Quadrant Theory of Van Tassel portrays an *Aether-Dynamical System*, this involving the Earth, Sun, and Moon. The quadrapolar dynamic brings into being the seasons, tides, and life itself on Earth. This conception of George Van Tassel bears a remarkable resemblance to that Four Quadrant understanding of the Aboriginal American. Van Tassel's theory and the figures shown are given in his book When Stars Look Down.

1.2 The Integratron



Figure 30

The Four Quadrant Theory of George Van Tassel describes his Integratron. It was a large magneto-dielectric apparatus, which claimed to have the largest rotary electro-static generator in existence. This machine created a potential of hundreds of thousands of volts.

The Integratron was a domed structure 55 feet in diameter and 30 feet in height. It had the appearance of an alien space craft. In fact, Van Tassel claimed the instructions for the Integratron were provided by the extra-terrestrials. Accordingly the ideas of George Van Tassel are not taken seriously. Here the Integratron serves as an introductory example of a Four Quadrant Electro-Dynamic apparatus, which of whatever origin or purpose, must never the less possess a frequency and an impedance as do all forms of electric systems.

1.3 Integratron Operation



INTEGRATRION – LOWER LEVEL

Figure 31



INTEGRATRON – UPPER LEVEL

Figure 32

The Integratron was composed of two levels, a lower level and an upper level. The lower level was a cylindrical form, this with a central hollow core, or column. The upper level was a void space enclosed by a hemispherical wooden dome. The inner surface of the dome was covered in thin aluminum sheeting. The outside of the dome was painted with a special dielectric paint. The wooden dome enclosed the metallic foil as a dielectric coating. This hemispherical structure served as a terminal condenser, similar to that found in designs of Nikola Tesla. The admittance of this terminal coupled the Integratron into the Earth-Ionosphere condenser. Because of the dielectric stresses involved, the Integratron building was of non-metallic construction, no nails or screws.



INTEGRATRON MODEL – BOTH LEVELS
Figure 33



INTEGRATRON – CEILING TRANSFORMER WINDINGS & CENTRAL COLUMN
Figure 34

90 turns
10 gauge insulated copper wire

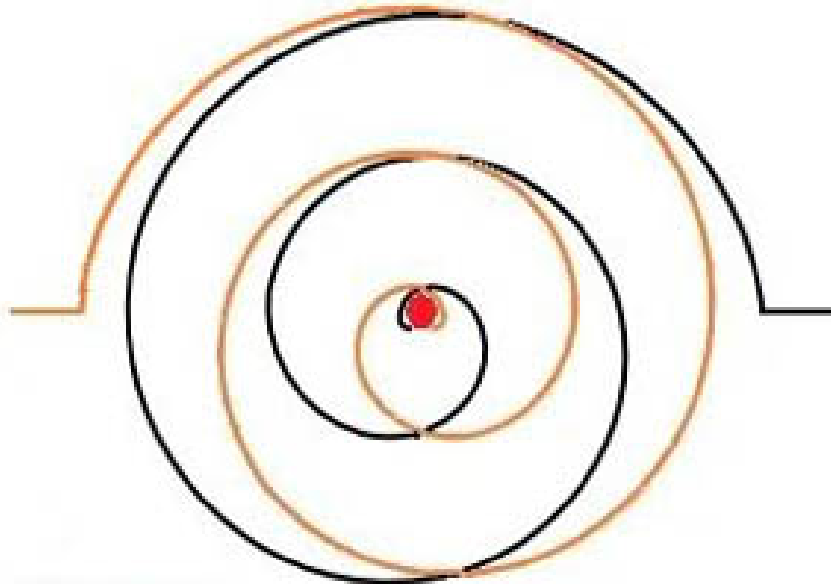

90 turns
14 gauge insulated iron wire

INTEGRATRON – TRANSFORMER WINDING DIAGRAM

Figure 35

On the ceiling of the lower level was wound a large transformer. This unique transformer consisted of a pair of flat spiral coils, in the manner of Nikola Tesla. Each coil was wound with 5000 feet of wire, divided into 90 turns. The two coils were wound in opposite directions, one clock-wise, the other counter-clock-wise. One coil was wound with insulated 14 gauge iron wire, the other wound with insulated 10 gauge copper wire. Each coil had an inside terminal at the central column, and an outer terminal that ran to the outer periphery of the hemispherical dome. The terminals of the iron coil were situated opposite to the terminals of the copper coil. The axis formed by the iron vs. copper terminal arrangement was in a particular alignment with the poles of the Earth, a 22.5 degree space phase displacement. This Pi over Eight angle was important in the operation of the Integratron, this as a certain "Angle of Hysteresis".

On the same plane as the transformer, and around the outside of the dome, was the electro-static rotor.



INTEGRATRON – ELECTROSTATIC GENERATOR

Figure 36



INTEGRATRON – ELECTROSTATIC TERMINAL PLACEMENT
Figure 37



INTEGRATRON – ELECTROSTATIC TERMINAL
Figure 38

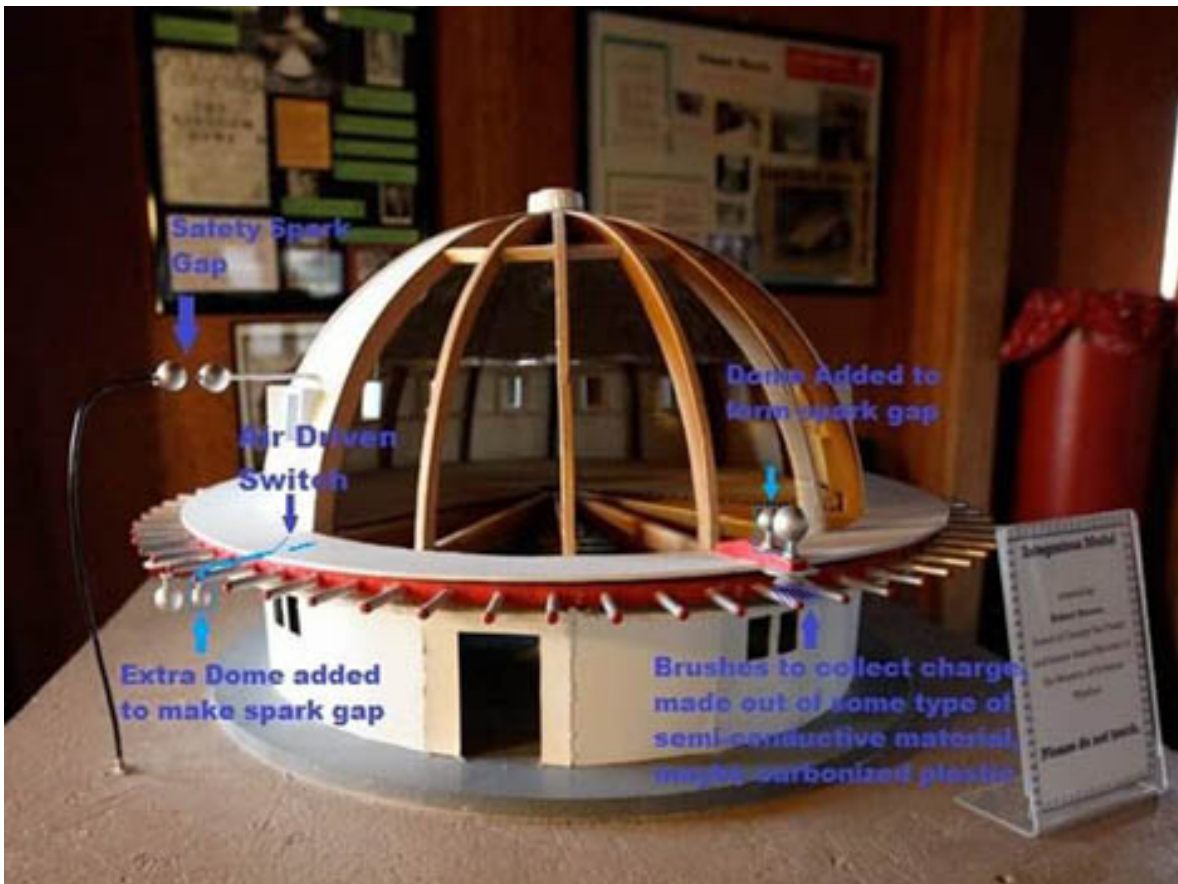

INTEGRATRON – ELECTROSTATIC TERMINAL PLACEMENTS

Figure 39



INTEGRATRON – QUADRAPOLAR LAYOUT

Figure 40



INTEGRATRON BASED ON BASIC DIROD GENERATOR

Figure 41

This was an electro-static generator commonly known as a Di-Rod machine. It is in use in many designs, serving as a motor or generator and has the advantage of not needing two counter-rotating rotors; this greatly simplifying large scale units such as the Integratron.

The rotor was to be driven by compressed air supplied through dielectric piping from a 100 horsepower air compressor. The compressor was in a shack distant from the electric field of the Integratron.

This rotating generator had Four poles, two coincided with the transformer terminals; the other two coincided with the terminals on the hemispherical condenser. The transformer pair of terminals exists in space quadrature with the condenser pair of terminals, all in a $\frac{\pi}{8}$ angular relation to the poles of the Earth. $\frac{\pi}{8}$, or 22.5 degrees is the 16th order division of the circle.

A four pole system of triggered spark gaps commutated the rotor, the hemispherical condenser, and the transformer. The spark gaps were triggered by air through dielectric pipes from a remote time function generator.



**INTEGRATRON – TRANSFORMER DETAIL
CENTRAL COLUMN CONDENSER (RED)**

Figure 42



INTEGRATRON – TRANSFORMER & CENTRAL COLUMN CONDENSER (YELLOW)
Figure 43

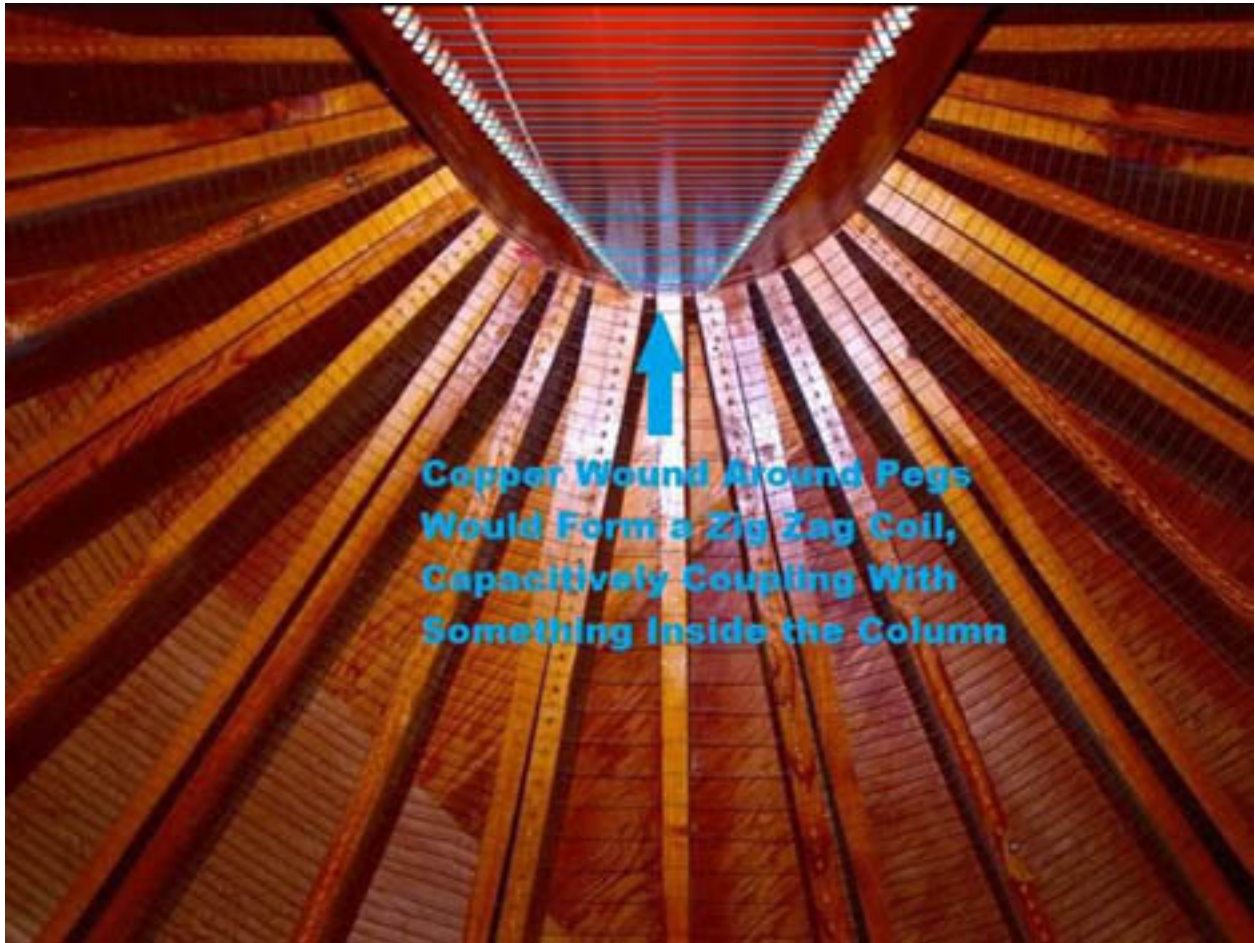

INTEGRATRON – CONDENSER NETWORK ON COLUMN (RED)

Figure 44

The iron and copper inner terminals of the transformer each terminated into a zigzag condenser structure which was configured on the outside of the central column. This column is hollow, enclosing a void space. This void is accessible from a hatch on the upper floor. The iron-copper zigzag condenser enclosed this void space, one on each side as pair of condenser plates. The void space between the plates hereby became the seat of the dielectric activity.

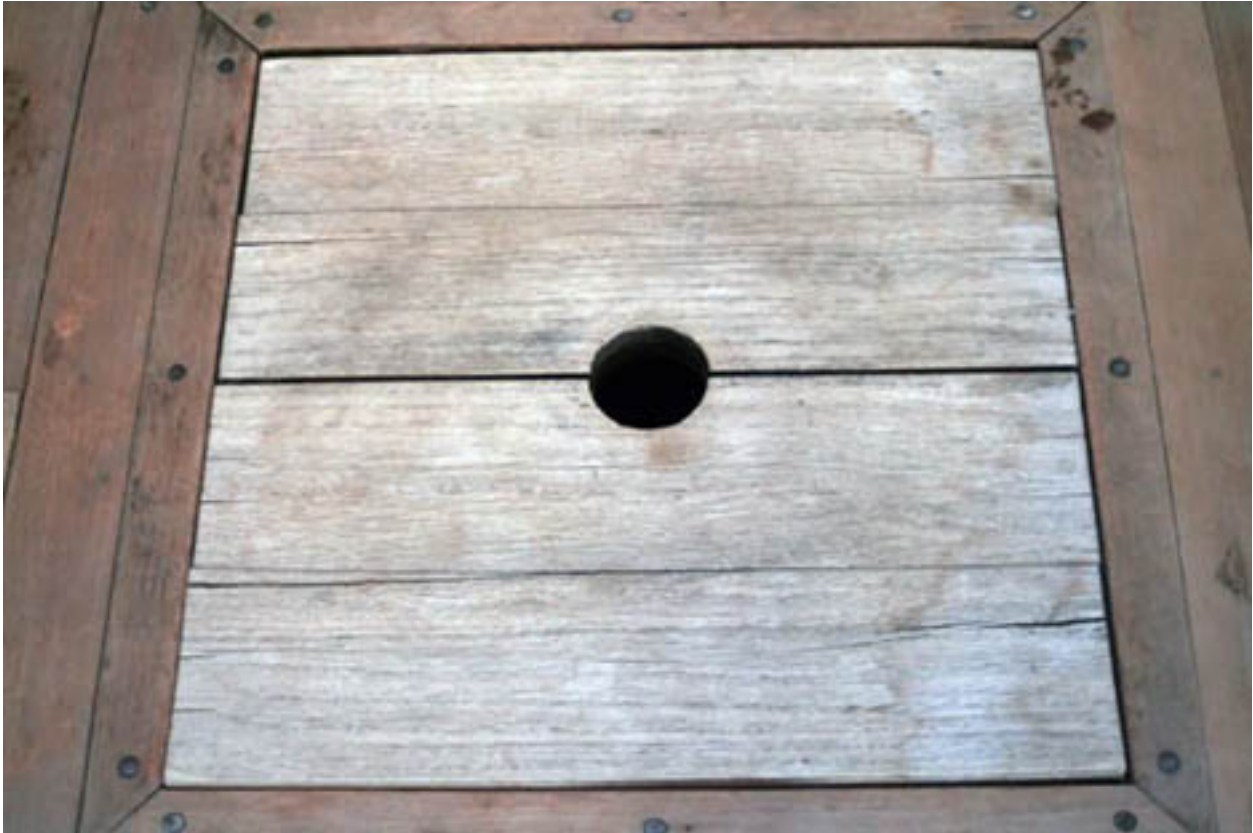

**INTEGRATRON – UPPER LEVEL DECK HATCH
DOWN INTO CENTRAL COLUMN VOID**

Figure 45

In the upper level a special network was lowered through the opening in the floor, down into the void. The network then operated within the iron-copper condenser dielectric flux. This network is the mystery never revealed by the extra-terrestrials. It was said that work on the Integratron stopped at this point, however the immense difficulties in driving the rotor may be the cause; it is an unknown.

The Integratron was to be brought into synchronism with the electrodynamic Earth. Its space phase position, and its time phase function generator aligned the Integratron with the time position of the Earth. The Integratron can be seen as a form of synchronous condenser.

The general layout of the Integratron would suggest the transfer of electric energy between its two basic ports, one is the energy taken from or delivered to the Earth-Ionosphere condenser, the other is the energy into or out of the field of induction enclosed in the void of the central column.

1.4 Epilog

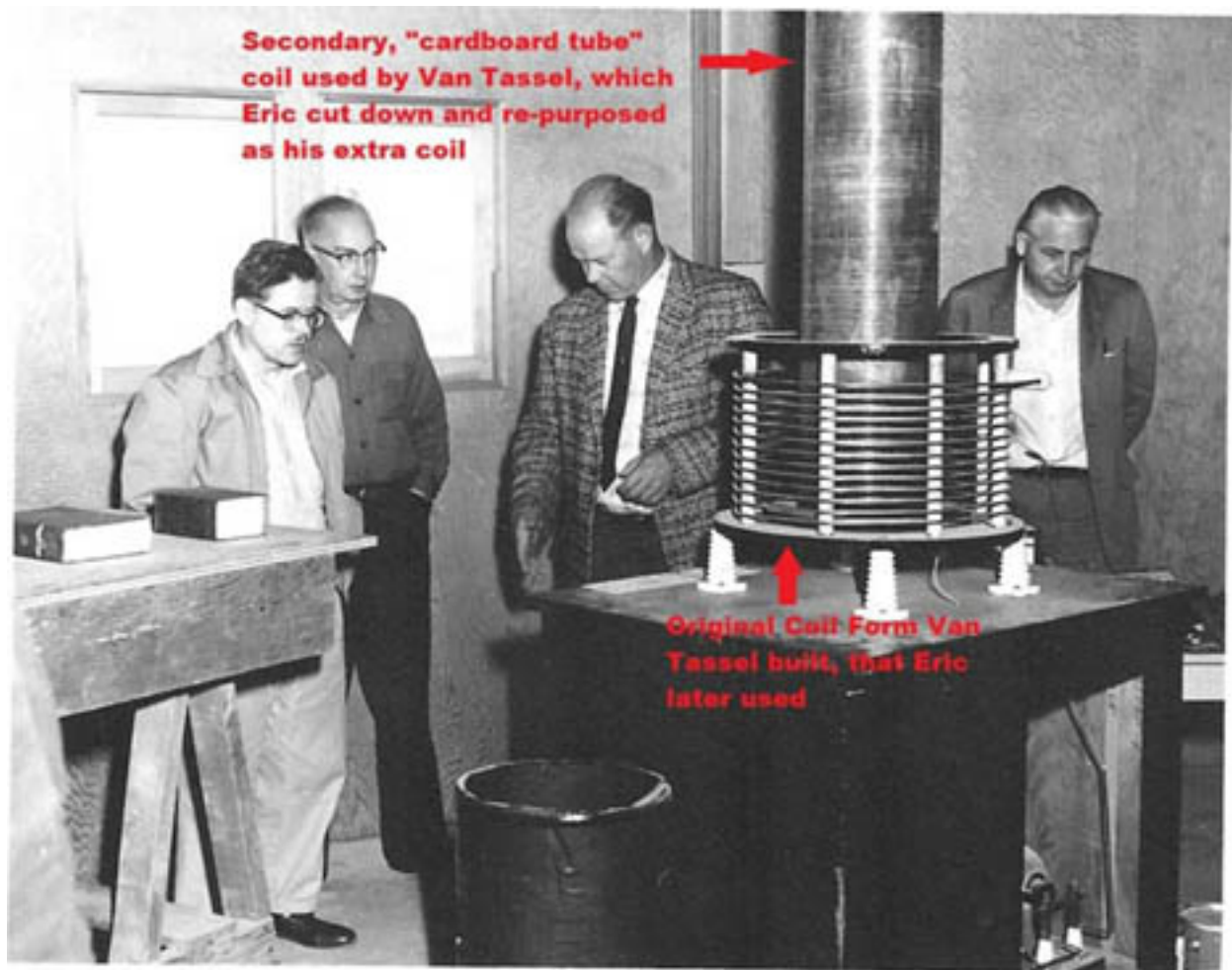

INTEGRATRON – VAN TASSEL & ASSOCIATES

Figure 46

The objective of the Integratron, by Van Tassel's account, was to establish an intense Four Quadrant Field of electric induction. This is shown in his book. He claimed that out of phase operation of this field would result in a violent discharge of similar magnitude to a large H-Bomb.

The operating flux of the Integratron, as an induction generator, would exist in the lower level. This operating flux was established by the transformer structure. This flux would have a profound effect on objects put within it.

Two doors enter the Integratron lower level, these in quadrature with respect to each other. These were to facilitate human passage through one specific quadrant of the *Four Quadrant Electric Field*. Someone walking through this quadrant was expected to be biologically rejuvenated. The opposite quadrant would have the opposite effect; biological destruction.

It is possible that the Integratron would somehow cancel out the dimensions of time or of space. The cancellation of space, or the space scalar condition, would allow for moving objects from one point to another point without traversing the distance in between; a new type of radio. In common language, walking into one door of the Earth Integratron leads to walking out of the other door of the Integratron of a distant planet.

At its least, the Integratron is an interesting extra-terrestrial fairy tale, a myth intended here to provoke thought into a mode of fantastic possibilities, the prelude to invention. The Integratron provides an example of a *Four Quadrant Theory*, and an electro-dynamic apparatus constructed upon that theory.

Section Two

Mathematical Aspects of Quadrapolar Versor Algebra

(I) The Knowledge of Electric Phenomena

[II] Alternating Current Machines

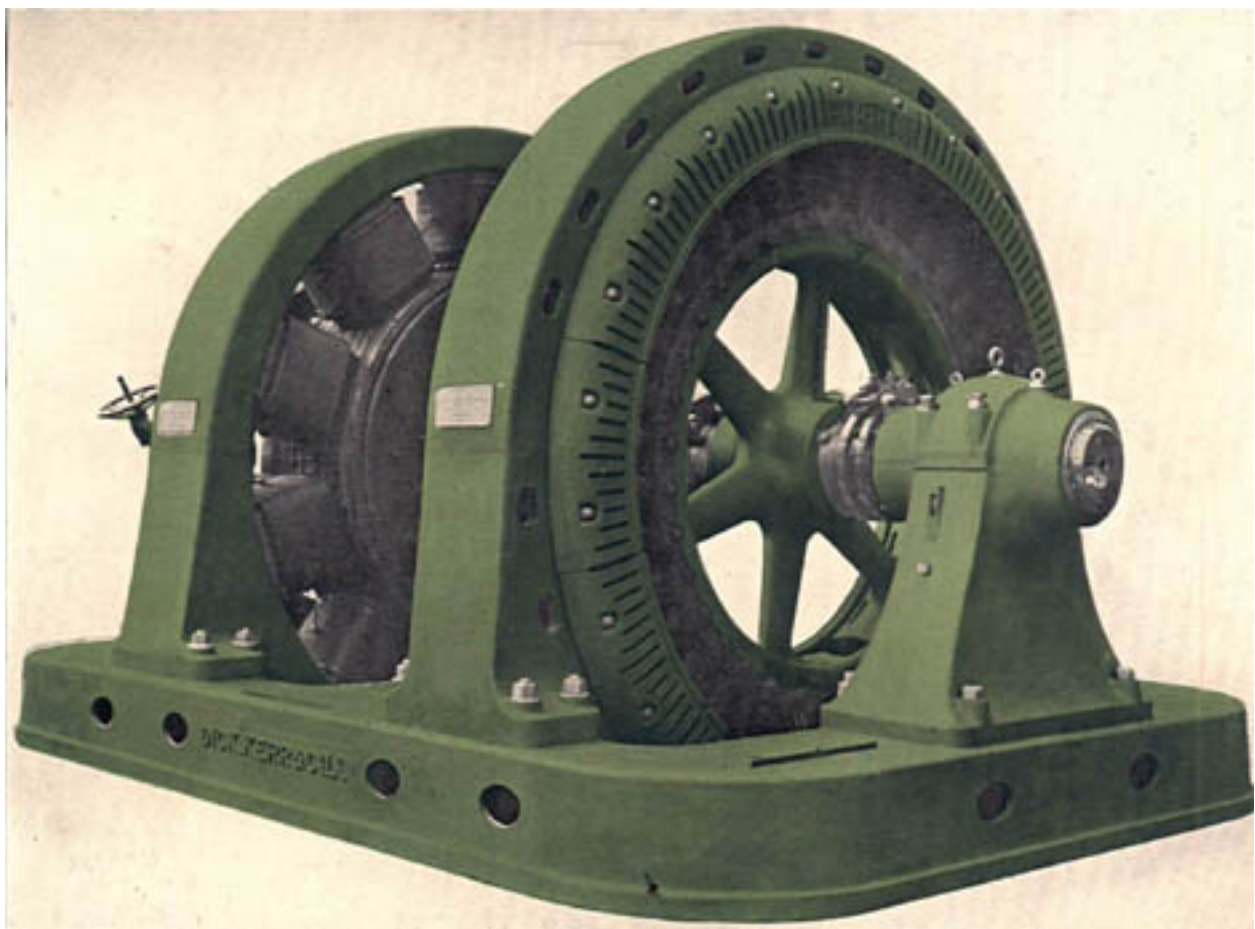

AC/DC MOTOR GENERATOR SET

Figure 47

1.1 Rotating A.C. Apparatus

Shown in the figure is an alternating current synchronous motor driving a direct current generator. The A.C. machine is in the foreground. This motor-generator set utilizes the rotary force developments of Nikola Tesla. The A.C. machine is an invention of Tesla, the D.C. machine is his improvement upon the designs of Thomas Edison.

1.2 Arithmetic Expression

To develop an engineering understanding of the inventions of Nikola Tesla, certain mathematical relations are required. These relations are of a higher order than is commonly understood. Conventional mathematics is rooted in a dualistic, or bipolar, form of expression. Plus and minus serve as the poles in common electrical configurations, but this is not so with the configurations of Nikola Tesla in his synchronous machine.

Two arithmetic operations are derived from plus and minus; these are addition and subtraction, respectively. In bipolar symbolic representation, two operators are defined, positive one and negative one. In symbolic terminology, positive one is a real number and negative one is an imaginary number. Subtraction, or negative one, is considered here and imaginary operation by reason of subtraction existing beyond the bounds of common additive numeration, such as counting with the fingers (digits). This line of reasoning can be carried further into multi-polar symbolic representation, such as is required for poly-phase A.C systems. This is the principle objective of these writings.

1.3 Algebraic Expression

Second order algebraic expressions are also bipolar relations in that they always resolve into two solutions, or a pair of roots. Typically one solution is positive and the other is negative; the two poles of the second order expression. For example, the square root of positive one is a second order expression since it is the "Second Root" of one. This expression then must

have two roots, positive one, the real root, and negative one, the imaginary root. It is common place to neglect the imaginary root, leaving only the real, that is, just one. Everyone has been taught this way, the square root of one is just one. This so-called “Fact” creates a source of misunderstanding in how to properly represent the roots of the unit, the basis of Versor Algebra. In its proper representation, the square root of positive one defines the bipolar arithmetic operator, that is one to the one half power, its roots being positive one, addition, and negative one, subtraction. The exponent one half is the exponential representation of the bipolar arithmetic operator.

1.4 Higher Order Expressions

$$a\Omega^4 + b\Omega^3 + c\Omega^2 + d\Omega + e = 0.$$

4TH ORDER ALGEBRAIC EXPRESSION

Figure 48

The algebraic expressions for alternating current are fourth order. This creates a complication in expression. The rotating machines of Nikola Tesla have four phases or sets of poles. Direct current machines only have two poles, plus and minus; for A.C. machines this is only half the equation. When A.C. is represented by a second order expressions its solutions become prefixed by the square root of negative one. This is considered an impossible solution by conventional mathematical reasoning. The common concept of the imaginary number has its origin in the square root of negative one. This is the Imaginary of Algebra as discussed by Dr. MacFarlane.

To properly understand alternating current requires solutions to fourth order algebraic expressions. This gives four roots, or solutions, one for each of the Four Phases.

The second order expression yields its pair of roots via what is known as the quadratic equation; this being a sort of calculating tool. No such equation exists for the fourth order expression. In fact no definite solutions exist for any algebraic expression higher than the second order. Solutions must be found via trickery and guesswork. Hereby, electrical theory is mired in bipolar mathematics, as are the mathematicians themselves.

Engineers must find their way out of this dilemma, in the manner of Steinmetz. Since mathematicians cannot assist, nature will provide the guidance.

To understand the electrical developments of Nikola Tesla and other situations of higher order, a "New Math" is required. This will find its beginning in the originator of mathematics, Pythagoras, and his ancient arch forms will serve as a guide. The objective here is the development of quadrapolar mathematics for the representation of the electric phenomenon.

[2] The Long Line Problem



TWO DOUBLE CIRCUIT 115KV, 3-PHASE AC TRANSMISSION LINES

Figure 49

2.1 Electric Transmission

Shown in the figure is a pair of double circuit, 115 kilovolt, 3 phase transmission lines. This is the power of one hundred locomotives; this power moving near the speed of light flows in each circuit. For all the activity, no visible presence exists of this tremendous flow of electrical energy.

The polyphase A.C. System of Nikola Tesla allows for the transmission of great quantities of energy over very long distances. The polyphase system is used world-wide, but for all its grandeur, for all the self edification if its educators and administrators, very little is actually known about electrical transmission. A rigorous solution for the transmission lines shown in the figure is an insurmountable mathematical task, the work of a lifetime. In

fact, no rigorous solution exists even for the simple open wire telephone pair on glass insulators. Only a mind like that of Oliver Heaviside could grasp the complexity of such a seemingly simple problem. Any transmission theory that exists can be traced back to the writings of Heaviside, but unfortunately he was not a good teacher of his ideas. Most of the complexity in the long line problem is introduced through the distortion caused by electronic actions within the metallic “conductors”. This creates a serious imbalance between magnetic and dielectric energies.

2.2 Electric Wave Theory

What do we really know? The deficiency of knowledge is aptly stated by Ernst Guillimen in his book Communications Networks, Vol. 2, the first chapter, Engineering Solutions to the Long Line Problem. He describes the line calculations for the telephone pair as “A huge mathematical task”. This is the task he undertook in the writing of his book.

Guillimen explains how the equations that have become so commonplace are in actuality only certain terms of more complex, and less understood, equations. These are never mentioned, swept under the carpet so to speak. He goes on to explain that out of all the possible orders of electric waves, only three are acknowledged to exist. One is the guided, or transmitted wave, bounded in the space enclosed by the so-called conductors; second is the radiated wave, escaping the conductor boundaries; third is the dissipated wave, which sinks into the conductor, expending its energy as heat. No other electric waves are reasoned to exist.

For the electric waves that are recognized, their understanding is derived from the *Maxwell-Heaviside Electro-magnetic Theory*. This theory finds its origin in the writings of Michael Faraday. Faraday stated:

“The seat of electricity is not within the conductor, but is in the space surrounding it”.

In other words, electricity is not a property of matter, it is a property of the aether. This view is not popular in the common way of thinking today, particularly in the minds of physicists, who are endeared to matter in an Einsteinian space.

[3] Space Algebra and Electricity

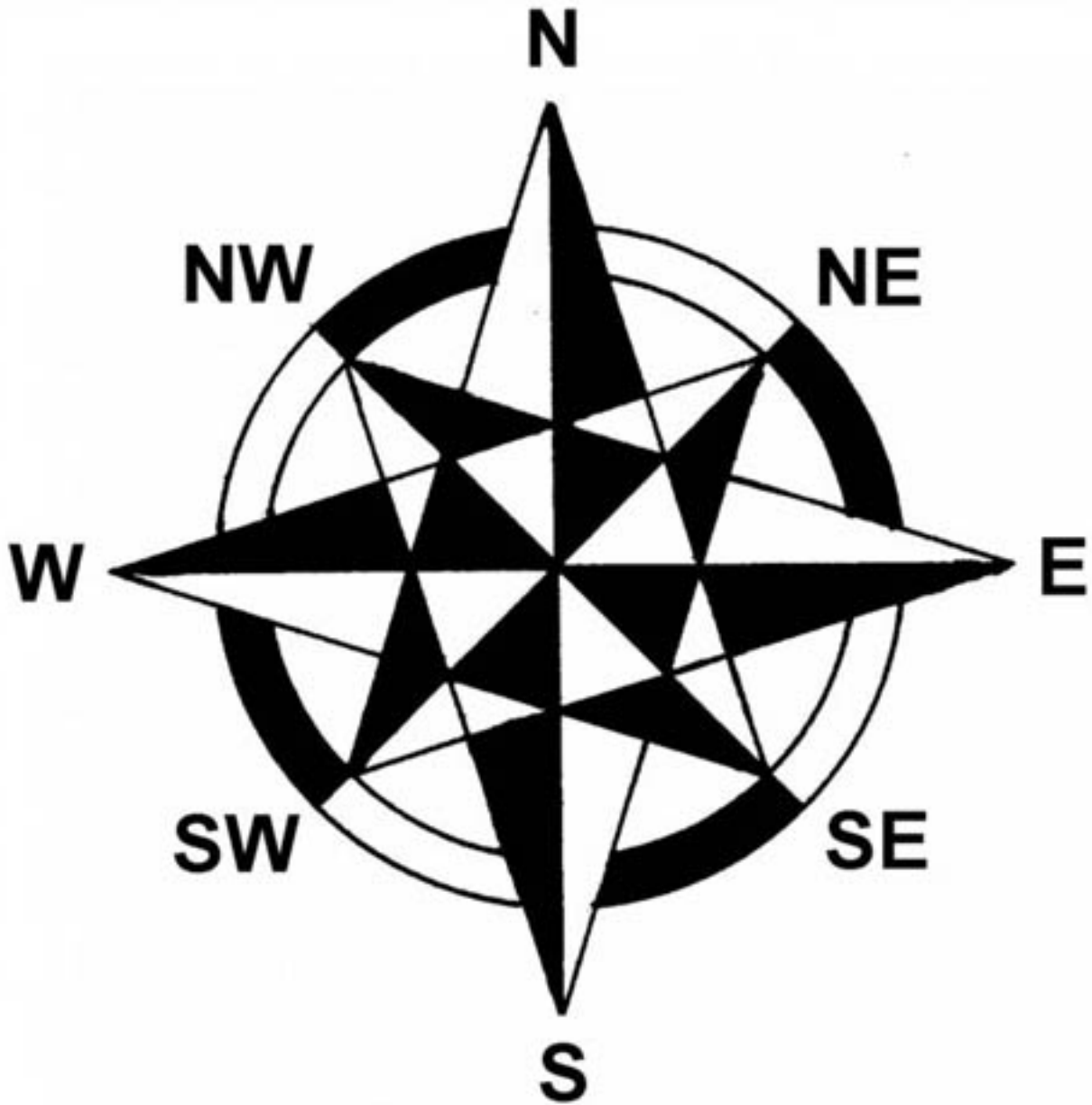

ALGEBRA OF SPACE

Figure 50

3.1 Cartesian and Quaternion Systems

The symbolic representation of dimensions in space, or space algebra, is a relatively recent development. It followed closely the development of the understanding of electricity, in fact, the two grew together, one aiding the other at times. But not at all times, and the stunted growth of space algebra retarded progress in the development of the understanding of electricity.

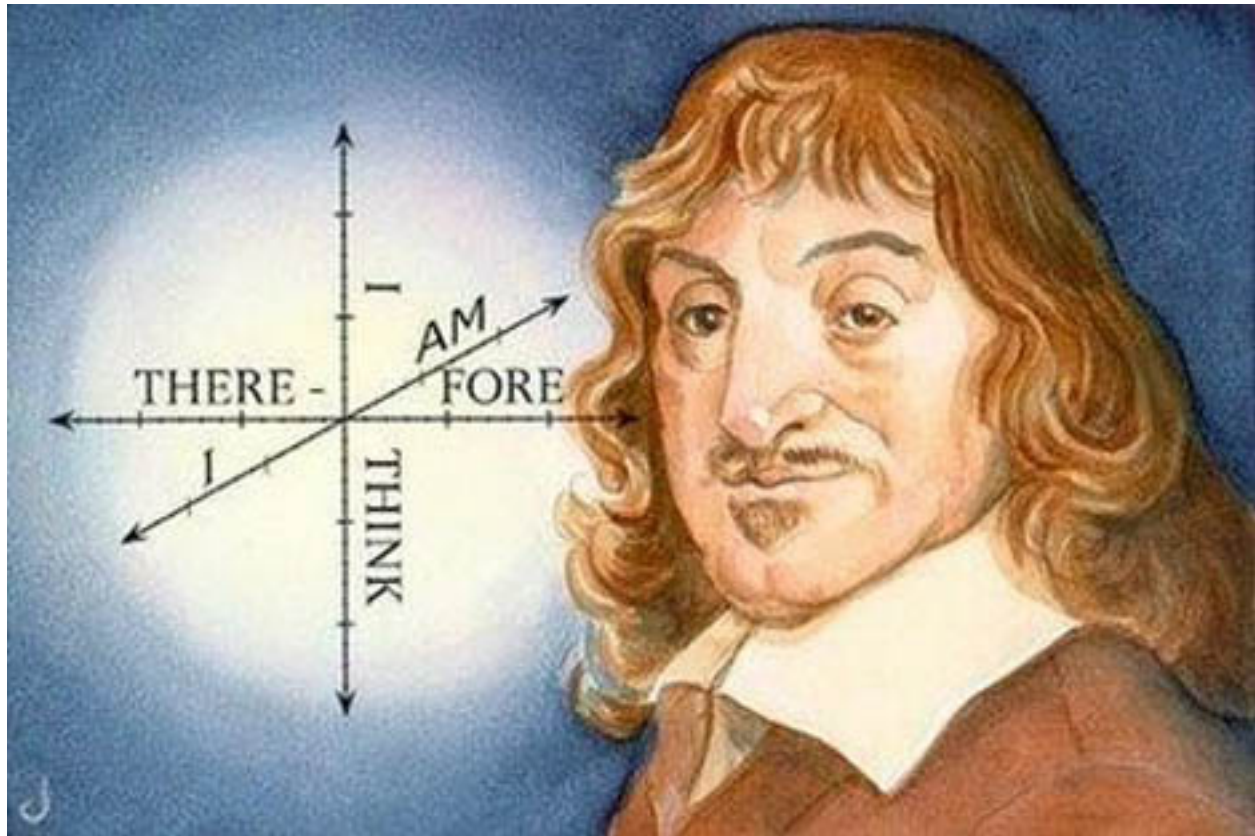

CARTESIAN COORDINATE SYSTEM

Figure 51

Space algebra, as it is understood, was not easy to arrive at. It required evolutionary contributions from the greatest minds in mathematics. The process finds its origins in the work of Rene Descartes, 1596 - 1650. Developments continue with Leonhard Euler, 1707 to 1783, and then Jean-Robert Argand, 1768 to 1822. Many others contributed and the effort came to rest with Alexander MacFarlane in 1892, and Oliver Heaviside in 1891.

From that point onward space algebra became retrograde, dissolving into the Theory of Relativity, where space became confounded in the dimensional ratio of velocity, and sank beneath the waves.

Argand Diagram

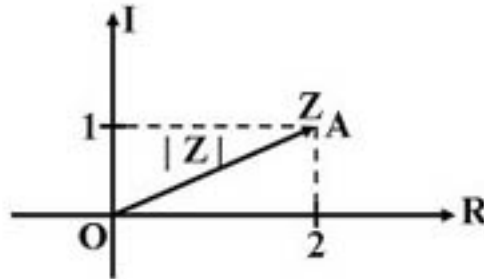

Figure 52

Principle in the development of space algebra is the concept of the plane vector, originating in the Argand diagram, 1806. A working space algebra was defined within the bounds of two independent coordinate systems, these confined to a plane. This space algebra permits the representation of a physical quantity existing in terms of a plane vector, an entity divisible into two quadrature components. One component is parallel to what is called the Real Line, the other component parallel to what is called the Imaginary Line. These terms will be defined later on. In this manner the physical laws of plane vectors can be written in an algebraic expression.

A logical next step was to extend this representation of physical quantities into what is called "Three Dimensional Space". Here is where the seemingly insurmountable complications begin. Foremost is the notion of Descartes that there is but one dimension of space, and that is space itself.

Coordinates are not actual dimensions but represent "Mathematical Fictions" to use the words of Carl Steinmetz.

Principle in the effort of extending the algebra of space into a tri-dimensional relationship was Sir William Rowan Hamilton, 1805 - 1865.



SIR WILLIAM ROWAN HAMILTON

Figure 53

Hamilton took on the task of trying to retain the laws of the Cartesian plane and then extend them into the realm of three mutually orthogonal axes. The laws of the Hamiltonian system of representation became known as quaternions. It serves as a first attempt towards a more general space algebra.

$$\begin{aligned}ij &= k \\ji &= -k \\jk &= i \\kj &= -i \\ki &= j \\ik &= -j \\i^2 &= j^2 = k^2 = ijk = -1\end{aligned}$$

QUATERNION RULES OF MULTIPLICATION

Figure 54

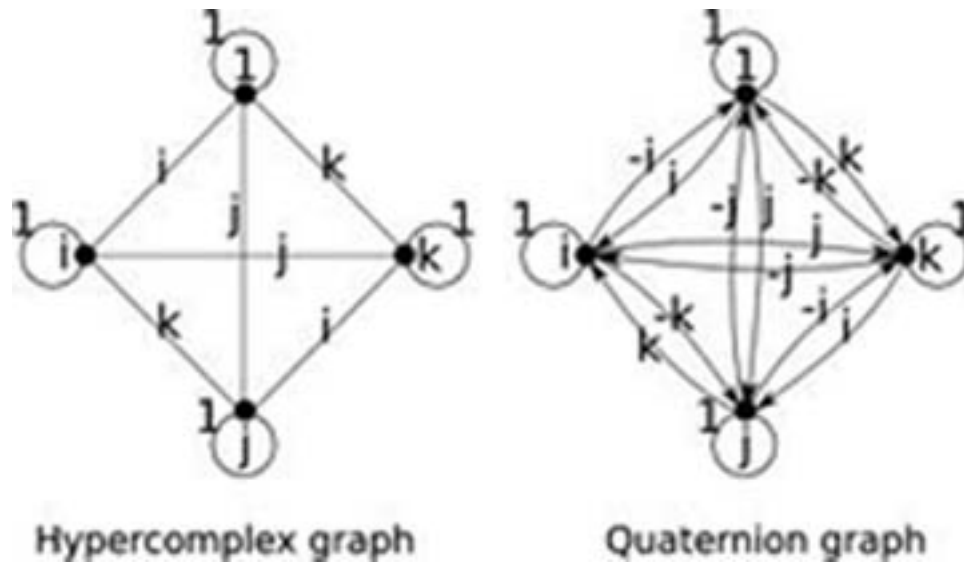

VERSOR SYSTEM VS. QUATERNION SYSTEM

Figure 55

The Cartesian plane representation conforms to the laws of algebra, the Hamiltonian quaternion does not. Two breakdowns occur, first, the square of a quantity is negative, but in physical form it is positive, second is that the terms of a quaternion expression cannot be interchanged. This is to say that A times B is not equal to B times A . This violates a most fundamental law of algebra. No space algebra has as of yet overcome this problem, all systems violate what is known as the commutative principle.

The overall complication with space algebra suggests the view of Kant; "Algebra is the science of time, geometry is the science of space". Is a space algebra possible?

3.2 Michael Faraday

A workable knowledge of electricity begins with Benjamin Franklin, 1706 to 1790. His important contribution was to find that electricity manifests in a bipolar form, it is a polar phenomena. He perceived this polarity to exist in a single "Electric Fluid", a unified electric medium. Through his understanding the "Leyden Jar" was transformed by him into what is known as an electro-static condenser.



Benjamin Franklin

Hans Christian Ørsted

Figure 56

The next important step in electrical knowledge comes with Hans Oersted, 1777 to 1851. Oersted's ground breaking discovery was reached quite by accident. In the course of a laboratory demonstration he had aligned a compass with a current carrying wire, this in such a way as to have the current impel the needle of the compass to fall in line with the direction of current flow. No such alignment could be detected. In closing the demonstration Oersted moved the compass and its needle promptly

aligned itself perpendicular to the flow of current in the wire. Here the direction of the needle is in space quadrature with the current impelling it. The first known quadrature aspect of electricity had presented itself to Oersted.



Michael Faraday 1791-1867

Figure 57

In this phase of electrical history only the electro-static and the magneto-static aspects of electricity were being considered. Dynamic, or Time Variant, aspects were still to be discovered. Numerous theories with incongruous mathematics abounded and began to solidly establish themselves. Michael Faraday 1791 to 1867, would significantly alter this scenario, with his discovery of the Law of Electro-Magnetic Induction, and his establishment of the concept of what he named the "Dielectric".

Oliver Heaviside wrote of Faraday as "The Prince of Experimentalists", Nikola Tesla once called Faraday "The Columbus of Electricity". Michael Faraday provided the primordial foundation for all existing future understanding of electricity and its practical application. He would be the inspiration for future renowned British theoreticians who would establish the greater part of electrical knowledge that exists today. With Faraday began The Golden Age of Electrical Science.

Two fundamental understandings were arrived at with Faraday's work. One was his discovery in 1837 that the charge capacity of an electro-static condenser increased when a dielectric material, such as glass, was placed within the space between the condenser metallic surfaces. The findings of Faraday were not received well by his contemporaries. He expanded these studies until it became obvious that electricity is not a property of matter, but rather a property of *Space*. This has been, and still is, an unpopular idea.

Within space, electricity was found to exhibit complex and revealing geometries. This gave the basis for the Faradic Lines of Force, these the polarization of his "*Contiguous Particles of the Aether*". In common expression this is the iron filings around the bar magnet.

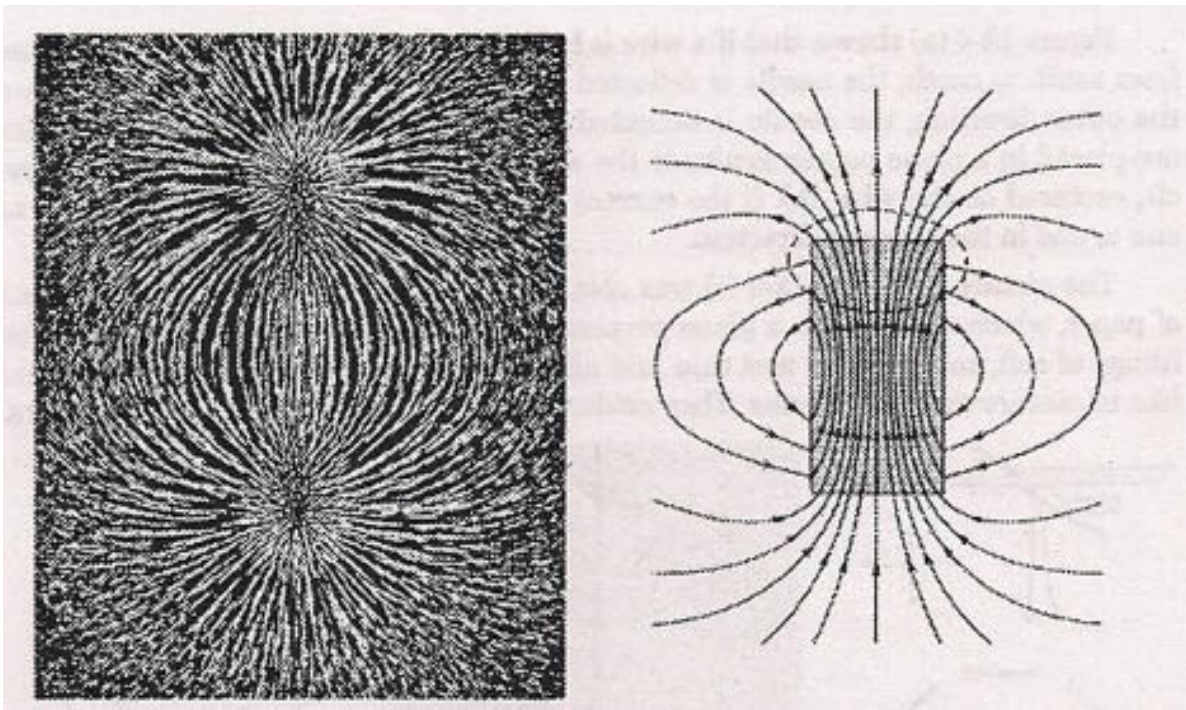

Figure 58

The particles of iron polarize into the shape and form that the Aether corpuscles take in Faraday's theory.

The need for a mathematical interpretation was now required. However, Faraday was not a mathematician, he was an experimenter, as was Ben Franklin.

Faraday's second important discovery was a step out of the conventional static, time invariant, condition of known electrical quantities. He observed that when the conditions for magnetism are caused to vary with respect to time, actions manifest in the current carrying conductor. He called this the "*Electro-Tonic State*", and this gave rise to an "*Extra Current*". This electro-tonic condition is now known as an Electro-Motive Force, or E.M.F. for short. The variation of magnetism and the intensity of the E.M.F. are given in his Law of Electro-Magnetic Induction, later formulated by Clerk Maxwell. Through this process electricity and magnetism became interchangeable through the dimension of time, this leading to the electric generator, and the basis of all alternating current apparatus.

3.3 James Clerk Maxwell

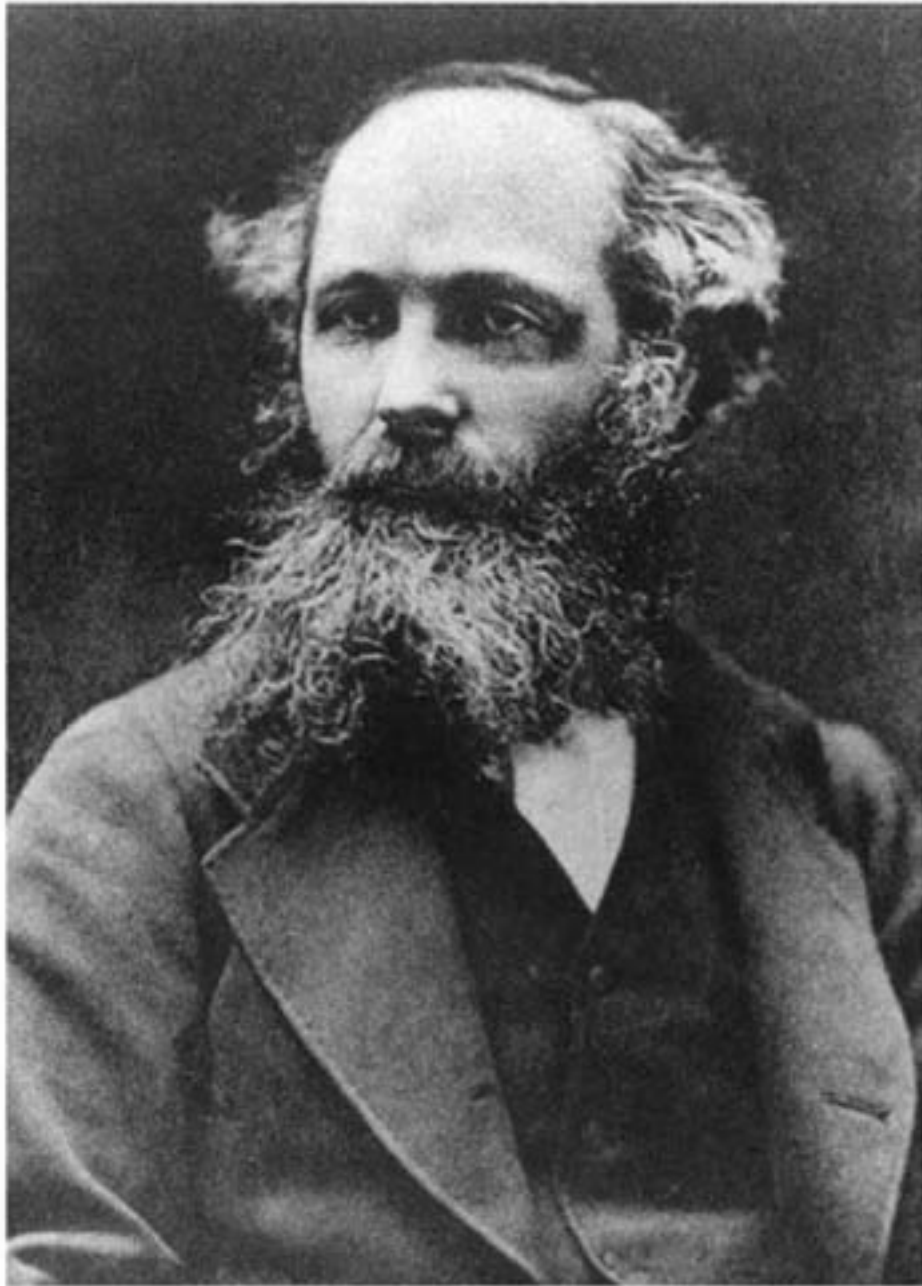

JAMES CLERK MAXWELL 1831-1879

Figure 59

James Clerk Maxwell began the study of Faraday's work in 1850 at age 19. Maxwell was quite impressed with the concept of spatial fields of induction connecting physical bodies. Accordingly he sought the mathematical description that Faraday could not provide. It has been said that "*Maxwell put the math into Faraday*".

The conception of electricity in the time before Faraday was based upon its static condition, no motion in time or space, it was stationary. This condition was reasoned to exist within matter as electric fluids which soak into it. Faraday's discovery of a time variant resultant, the E.M.F., introduced the dynamical aspect of electricity. The E.M.F. was only actually half of the equation and Maxwell would find the other half.

Maxwell carried out research into the Faraday concept of the dielectric seeking out its various aspects. He then founded the discovery that would eventually jolt the scientific community; the ability of the dielectric material to concentrate an electro-static field was a function of the velocity of light in that dielectric. This discovery unified electricity and optics, but in a way not yet quite understood. This connection would occupy the minds of scientists for a century afterwards, ending with Albert Einstein.

Maxwell's continued research into Faraday's dielectric field resulted in what might not be his most profound discovery, but possibly his most important. His discovery was the companion to the Faraday Law of Electro-Magnetic Induction.

Maxwell discovered that when the condition for a dielectric field are altered, or caused to change with respect to time, actions in the dielectric material manifest. Maxwell called this action "Displacement' and it existed as a form of electric current. It is a response to a change in the electric strain within the dielectric, or insulating body in general. Such displacement can also exist in free space. Here now exists the companion to Faraday's Law of Electro-Magnetic Induction and its Electro-Motive Force.

The European theoreticians were horrified. Two most fundamental of their dictums had been violated upon by the British. The first violation is related to the notion of the electro-static potential. It was reasoned that a potential is incapable of manifestation within a conductive metallic body. However, Faraday's E.M.F. acted as a potential did, and this inside the metallic body. The second violation relates to the notion of current flow. It was reasoned that a current is incapable of manifesting within an insulating dielectric body. However, Maxwell's displacement current acted much like a conduction current, this inside an non-conductive, or insulating body. The European noses went high, and they rejected Maxwell's work as a mere "*Paper Theory*" and it was incapable of verification. The E.M.F. and displacement are reactions to the time rate of variation of electricity, the Europeans knew only of the static condition.

Maxwell's advancement at this point in his work defines the first primordial quadrapolar aspects of electricity:

- I) The Circulatory Magnetism
- II) The Electro-Motive Force
- III) The Strain of Dielectricity
- IV) Displacement Current

Maxwell presents a beautiful complimentary symmetrical electrical relationship and this would be continued throughout his work, endearing the minds of later important researchers.

Maxwell's genius created a synthesis of all things magnetic and dielectric, as well as their interactions, into a pair of fundamental field equations. This was a scientific achievement of singular grandeur. He finally identified light as electromagnetism through the formulation of his idea of a transverse electromagnetic wave. This wave represents a complete quadrapolar electric configuration, the first to draw attention to itself in the study of electricity. The notion of the propagation of electricity through space without interconnection here presented itself to Maxwell. Here exists one of the most important advances in the knowledge of electricity,

expressing a quadrupolar relation and the existence of electric waves. Heaviside would say, "*The Heaven-Sent Maxwell*".

The space geometry of electromagnetism consists of three mutual perpendiculars, this existing in the same manner as the tri-dimensional space of mathematics. The electromagnetic field idea of Maxwell was a natural home for the quaternion system of Hamilton. Ultimately, quaternions would serve to hinder the effort, forcing electricity into a form which it manifests only in certain configurations. Maxwell's ideas needed expression in a symbolic representation that did not exist. Quaternions did not serve electricity, electricity served quaternions.

As much as it was, his elegant theory was none the less still regarded as a "*Paper Theory*". No experimental verification had yet been established. No means existed in 1873 to generate the requisite frequencies, nor did any device that could detect these waves exist. This situation remained for 15 years.

In 1888, one of their own in Germany broke rank with the prevailing thought. This was Heinrich Hertz, he demonstrated the transmission of electricity through empty space across the room of his laboratory. In a rapid succession of experiments, Hertz continued to verify the theory of Maxwell until it became a proven fact. Then the world loved it, Maxwell was a genius, Hertz was a hero. The accolades rang loud!

Along with Heinrich Hertz and his research into electric waves came those of Nikola Tesla. Tesla carried the Maxwell idea even farther, perfecting the high frequency devices required to study electric waves, this far beyond the ability of his contemporaries. He noted certain discrepancies in the Hertz Wave Theory, not surprising since the apparatus of Hertz was primitive. Hertz was a physicist, Tesla was an electrical engineer and could create much more refined apparatus. Tesla travelled to Germany to work these matters out with Hertz, the untimely death of Hertz at age 33 ended any further work. Tesla continued on and wireless communication was

soon a reality. However, Tesla was an American and the credit would go to others deemed more worthy.

Nikola Tesla, with his very refined instruments and apparatus would discover aspects of Maxwell's theories that the quaternions kept from view. This was in the realm of electro-static waves, and Maxwell's dielectric displacement. These waves were unlike those of electro-magnetism, no tri-dimensional geometry existed; propagation was in a single coordinate system, not understood by mathematics. Public demonstrations of these waves were considered beyond awesome, some ran in fear.

The absence of a tri-polar geometry and any known representation would throw Tesla back into the wilderness of the European potentials and currents, but his work would not find friends in either camp, and it was uniquely American. Tesla never wrote on the theoretical basis of his discoveries, but he did refer to Maxwell as an "Electrical Poet" and held him in high regard. Public statements would indicate that Nikola Tesla derived his ideas from the German theoretician Herman Von Helmholtz, who wrote on the subject of longitudinal waves. To this day, however, the understanding of Nikola Tesla remains an enigma.

3.4 Oliver Heaviside



OLIVER HEAVISIDE 1850-1925

Figure 60

Electro-magnetic telegraphy was invented by a joint effort of Samuel Morse and Joseph Henry, in 1838. The first telegraph line went into service in 1844, but little was yet known about the theory of propagation, nor the theory of circuits. No theoretical basis existed for the electro-magnetic telegraph, but it worked anyway.

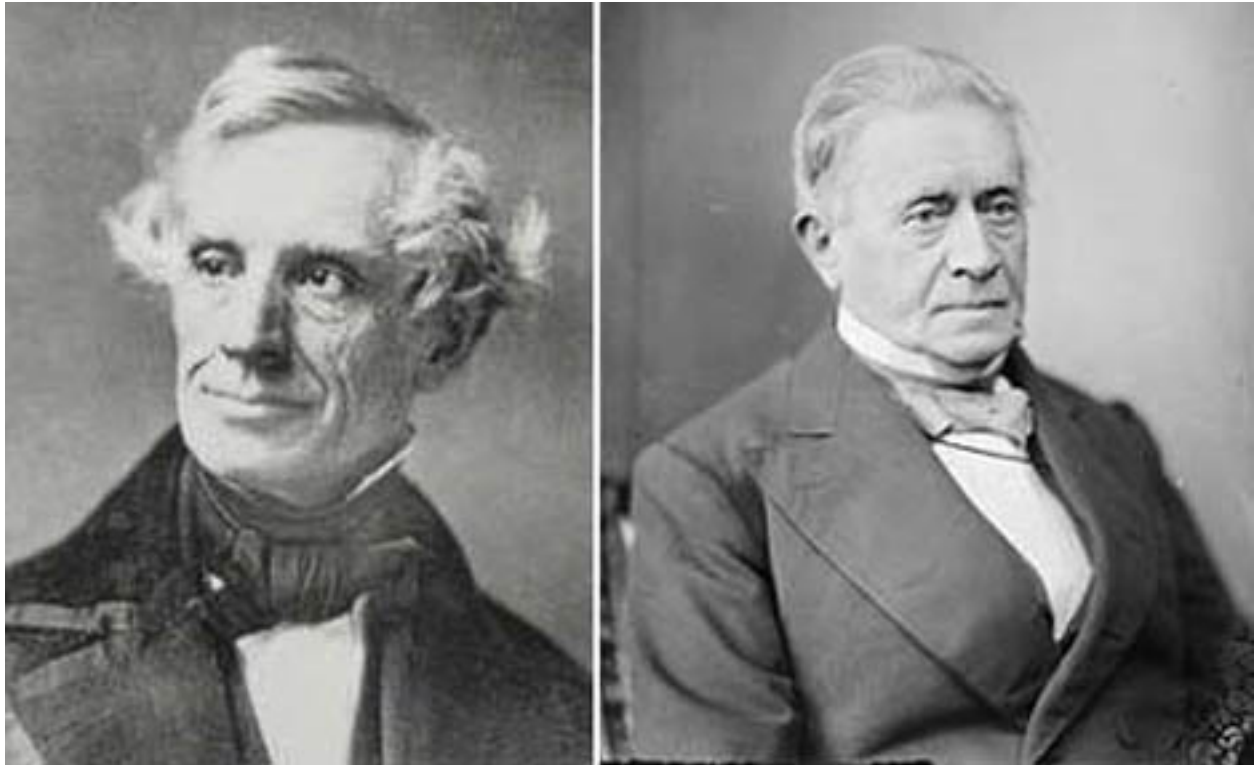

SAMUEL MORSE 1791-1872

Joseph Henry 1797-1878

Figure 61

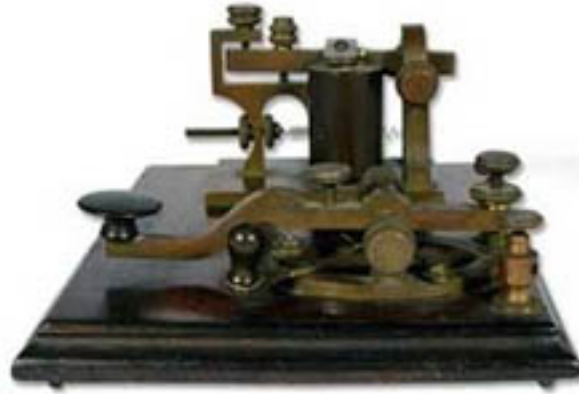

MORSE TELEGRAPH SET and FIRST LONG DISTANCE TELEGRAPH LINE
Figure 62

Samuel Morse was a painter by profession and knew little about electricity. None the less, he began tinkering with wire coils and voltaic piles, this bringing in the efforts of Henry. Morse developed the first binary code, this in a digital format known as the Morse Code. Henry worked on devising the electro-magnets for the telegraphic sounders. Joseph Henry is known as the American Faraday. Not only did he independently discover the law of electro-magnetic induction, but years before Hertz, Henry demonstrated the propagation of electric waves through free space, and solid walls. His

work, as an American, was ignored abroad. The electro-magnetic telegraph was ahead of the understanding of electricity that existed in its time. Theory would have to follow the telegraph, like it or not.

The tremendous success of this telegraph system led to the consideration of extension through undersea cables and in 1851 one became operational between England and France. This opened the fantastic possibility that a trans-continental submarine cable could be constructed and put into use. This would allow for "Instant" communication between England and America.

The cable between England and France exhibited puzzling problems, the signals arrived weak and distorted. Transmission was much slower, and more garbled than an equivalent distance of open wire line. No one knew why. In 1855 Sir William Thomson, known as Lord Kelvin, demonstrated in theory that trans-continental transmission is a mathematical impossibility. Using the diffusion of heat theory, Kelvin arrived at a capacitance-resistance propagation factor, then known as the "*KR Law*". This was to be one of the greatest mistakes in electrical theory. Fortunately, the notions of Kelvin did not discourage Cyrus Field, who did not place much stock in physics. He started laying cable across the Atlantic Ocean in 1857. The distortion was severe, but it worked! However, Lord Kelvin was the physicist of highest esteem so the KR Law remained The Law.

Major advancements in telegraphy were carried out in England by Sir Charles Wheatstone, where he is sometimes called the "*Father of Telegraphy*". He was also the uncle of Oliver Heaviside. Oliver Heaviside was born in London on May 13, 1850, the date when Maxwell would begin his theoretical treatment of Faraday's work. Wheatstone stimulated Heaviside's interests in telegraphic theory and Oliver Heaviside presented his first paper on the subject at age 22. He began work under the employ of the Great Northern Telegraph Company where he gained much valuable experience. He left his position for reasons unknown in 1874 and began his undivided study of Maxwell's "*Treatise on Electricity and Magnetism*". He became fascinated, if not obsessed, with Maxwell's field equations. This

would lead to his profound advancement of space algebra and its application to electrical engineering. Heaviside's work carried forth Maxwell's theory into innumerable applications, providing an astonishing clarity without undo modification.

Maxwell's theory at the time of his death in 1879 was still a "*Paper Theory*", there was no experimental evidence of electromagnetic wave propagation. Oliver Heaviside's first paper on the subject, On Induction Between Parallel Wires, was published in 1881. He demonstrated, in terms of mathematics, the existence of travelling electromagnetic waves. These waves consisted of both magnetic and dielectric induction in the complimentary-symmetrical form of Maxwell. Kelvin's KR Law was based upon a heat like diffusion of electro-static force and ignored the magnetic induction. Here would exist a conflict with established law. Heaviside remarks on this are numerous.

To quote:

"Now very few (if any) un-mathematical electricians can understand this fact; many of them neither understand it nor believe it. Even many who do believe it simply because they are told so, and not because they can in the least feel positive about its truth of their knowledge. As an eminent practitioner remarked, after prolonged skepticism, "When Sir William Thompson (Lord Kelvin) says so, who can doubt it? What a world of worldly wisdom lay in that remark".

The KR Law was enforced by the head of the British Telephone and Telegraph System, William Preece.



WILLIAM HENRY PREECE 1834-1913

Figure 63

In 1885 Heaviside began regular publication of his papers on electromagnetic propagation in telegraph lines, emphasizing the importance of the magnetic component. This gave rise to the "Telegraph Equation" the foundation of transmission theory. Oliver Heaviside made a most remarkable theoretical discovery, when the rate of magnetic dissipation was made equal to the rate of dielectric dissipation, the distortion on the line vanished. Moreover, the long line equation reduced to a very simple algebraic expression. This so angered William Preece that Heaviside was banned from any further publishing on the subject. The KR Law had become Admiralty Law! In America the work of Heaviside laid the basis for long distance telephony and led to the great success of the American Telephone and Telegraph Company, and its creation of the "Bell System"



The Bell System, 1885-1986
Figure 64

With his "*Telegraph Equation*" Oliver Heaviside made a most important advance in the quadrupolar understanding of electricity. Needless to say, it mirrors the quadrupolar form shown earlier in Maxwell. The electromagnetic wave in wire line propagation can be represented in terms of four constants exhibited by the wire line structure. These are:

- I) Resistance, representing the rate of magnetic decay
- II) Inductance, representing the ability to contain magnetism
- III) Conductance, representing the rate of dielectric decay
- IV) Capacitance, representing the ability to contain dielectricity

In general, the resistance, R , is a property of the so-called conductors, the conductance, G , is a property of the so-called insulators. The magnetic inductance and the dielectric capacitance, L , and, C , respectively are both a property of the space bounded by the conductors, and containing the insulators. LC then represents the propagation, or velocity, of the wave, RG represents the consumption of the wave in the course of its propagation, its dissipation.

Heaviside would coin many new words in the course of his writings, such as Inductance, or Reactance, for example. These were extensions of the commonly used word, Resistance. His terminology horrified the literary critics, of which James Swineburne wrote:

"A prolific inventor of new terms", or "A murderous hatred of the Queen's English, with words like Leakance, Reactance, and etc".

Nevertheless, these words of Heaviside have today become the language of electrical engineering. In fact, the work of Oliver Heaviside is the basis for almost the entirety of electrical engineering. Steinmetz, Kennelly, and others would continue from Heaviside's work. It is very striking how something which was so vigorously opposed, is now in such common acceptance as to be regarded as indispensable.

3.5 Quaternions and Maxwell

$$\begin{aligned} Q &= q_0 \hat{u} + q_1 \hat{i} + q_2 \hat{j} + q_3 \hat{k} \\ &= (q_0 \hat{u}) + (q_1 \hat{i} + q_2 \hat{j} + q_3 \hat{k}) \\ &= (\phi, \vec{A}) \end{aligned}$$

MAXWELLIAN QUATERNION EXPRESSION

Figure 65

Maxwell was bogged down in the quaternion system of Hamilton and Tait. When Heaviside studied Maxwell he clearly saw the need for a more suitable form of mathematical expression, even Maxwell himself began the task by modification of the quaternion notation. Heaviside had decided to take on the task of "Removing the Baggage from Maxwell". His dislike for the quaternion, as well as those who professed it few, finally becoming hostile to them. In the journals of the time considerable conflict existed on these subjects of space algebra and Heaviside kept the fires burning hot, particularly with his biting parables. One such parable opens in volume three of his "Electromagnetic Theory", Chapter IX:

Adagio...Andante..Alegro Moderato

The following story is true:

There was a little boy, and his father said, "Do try to be like other people. Don't frown". And he tried and tried, but could not. So his father beat him with a strap; and then he was eaten up by lions.

Reader, if young, take warning by his sad life and death. For though it may be an honour to be different from other people, if Carlyle's dictum about the 80 million still be true, yet other people don't like it. So if you are different, you had better hide it, and pretend to be wooden headed. Until you can make your fortune. For most wooden headed people worship money; and, really, I do not see what else they can do. In particular, if you are going to write a book, remember the wooden headed. So be rigorous; that will cover a multitude of sins. And do not frown.

Heaviside completely rejected the quaternion method and began the development of his own vector algebra methodology exclusively. He transformed all prior modes of expression and representation, eliminating all confusing symbolism. Establishing his new basis for space algebra he took over where Maxwell had left off, but kept his faith in the soundness of Maxwell's theory of electromagnetic waves. Heaviside set out to expound the Maxwellian understanding in very clear and systematic terms. The result was the now well known Heaviside Equations shown in the figure.

$$\begin{aligned}
 \nabla \cdot \vec{\mathbf{B}} &= 0 \\
 \nabla \times \vec{\mathbf{E}} + \frac{\partial \vec{\mathbf{B}}}{\partial t} &= 0 \\
 \nabla \cdot \vec{\mathbf{D}} &= \rho \\
 \nabla \times \vec{\mathbf{H}} - \frac{\partial \vec{\mathbf{D}}}{\partial t} &= \vec{\mathbf{J}}
 \end{aligned}$$

HEAVISIDE VECTOR EXPRESSION

Figure 66

The historical scribes took a dim view of Heaviside, so today this set of equations has been given the name "Maxwell's Equations", but where are the quaternions? And the parrots chatter on.

Ultimately Heaviside had backed himself into the same corner as Maxwell, his expressions still bore the arch type of transverse electromagnetism in a tri-dimensional space. The theoreticians were married to "Three Dimensional Space", a mathematical fiction, but written in stone. Heaviside could not help but denounce anything outside transverse electromagnetism.

So what lay still uncovered in the writings of James Clerk Maxwell, buried in quaternions? Are his ideas the totality of all things? His work is primordial, born of Leyden jars, and milligram balances, this compounded with no means of expression. Is it wise to place too much stock in Maxwell? Heaviside states this in the very beginning of his book, to quote:

"It is by no means to be concluded that Maxwell spells finality. It cannot be even said that the Hertzian waves prove Maxwell's Theory".

So what is left to be discovered?

3.6 Lost In Space

The subject of space algebra was one of controversy in the days of Oliver Heaviside. The conflicts sometimes became severe. The reality was that the math did not represent the actual physical process, it is as if the physical reality had become subordinate to mathematical theory. Edwin Armstrong best put this to words: *"They substitute words for reality, and then talk about the words"*. When space algebra degenerated into Einstein-Minkowsky Relativity, Nikola Tesla made a strong statement; *"Today's scientists have substituted mathematics for experiments and they wander off through equation after equation and eventually build a structure which has no relation to reality."*

Oliver Heaviside was a strong opponent of the physical becoming subservient to the mathematical, and worked this way in his space algebra. As for the quaternions, he states: "*Quaternion was, I think, defined by an American school girl to be an ancient religious ceremony*". The resulting situation with regard to space algebra is that it is derived from two principle formats, the quaternion system of Hamilton and Tait, and the vector system of Gibbs and Heaviside. And off to the side is the "*Ausdehnungslehre*" of Grassman.



ALEXANDER MACFARLANE 1851-1913

Figure 67

A synthesis was derived from the methods of all these mathematical formats by Alexander MacFarlane. This is presented in his paper The Principles of the Algebra of Physics. MacFarlane begins with a discussion on the relative merits of each format, emphasizing the distinction between versor, vector, and tensor. Further on is his presentation of a more unified format with a particular emphasis on the versor form of expression. His paper leads to some rather remarkable results and provides the ground work for a new, more general, form of space algebra. This is where to begin. To quote Heaviside: *"There is a time for all things; for shouting, for gentle speaking, for silence, for the washing of pet and the writing of books. Let now the pots go black, and set to work. It is hard to make a beginning, but it must be done"*.

3.7 Engineering Reality



500kv Electric Arc - Vacuum Switch Failure

Figure 68

From the position of the electrical scientist, if such an entity even exists in our day, the question is, what do we have to work with? To start, the "Ore" from which to build is almost all Maxwellian, and since his electromagnetic theory aided and abetted the Special Theory of Relativity, is he a good place to start? Then there is the Helmholtz-Tesla approach, but little information exists here to work with. To compound the situation the space algebra that exists is useless in representing anything but transverse waves. Finally, the situation is rendered hopeless by the social operative that the right thing to do when something is not understood is to suppress it, or make certain to destroy it if necessary. Then heard is Amen!

The objective here is to derive a quadrapolar representation electricity, this for any dimension, time or space, and etc. Everything seems against this effort as far as established theory provides. Heaviside's approach bitingly emphasizes again and again - go back to the physical, the real world, and derive from this the mathematical. He considered mathematics an experimental science. Just as one would configure an idea into an assemblage of resistors, condensers, and transistors, he would configure his ideas into an assemblage of operators, functions, and variables. Academic mathematicians despised Heaviside for this, but his "Magic Equations" could work wonders.

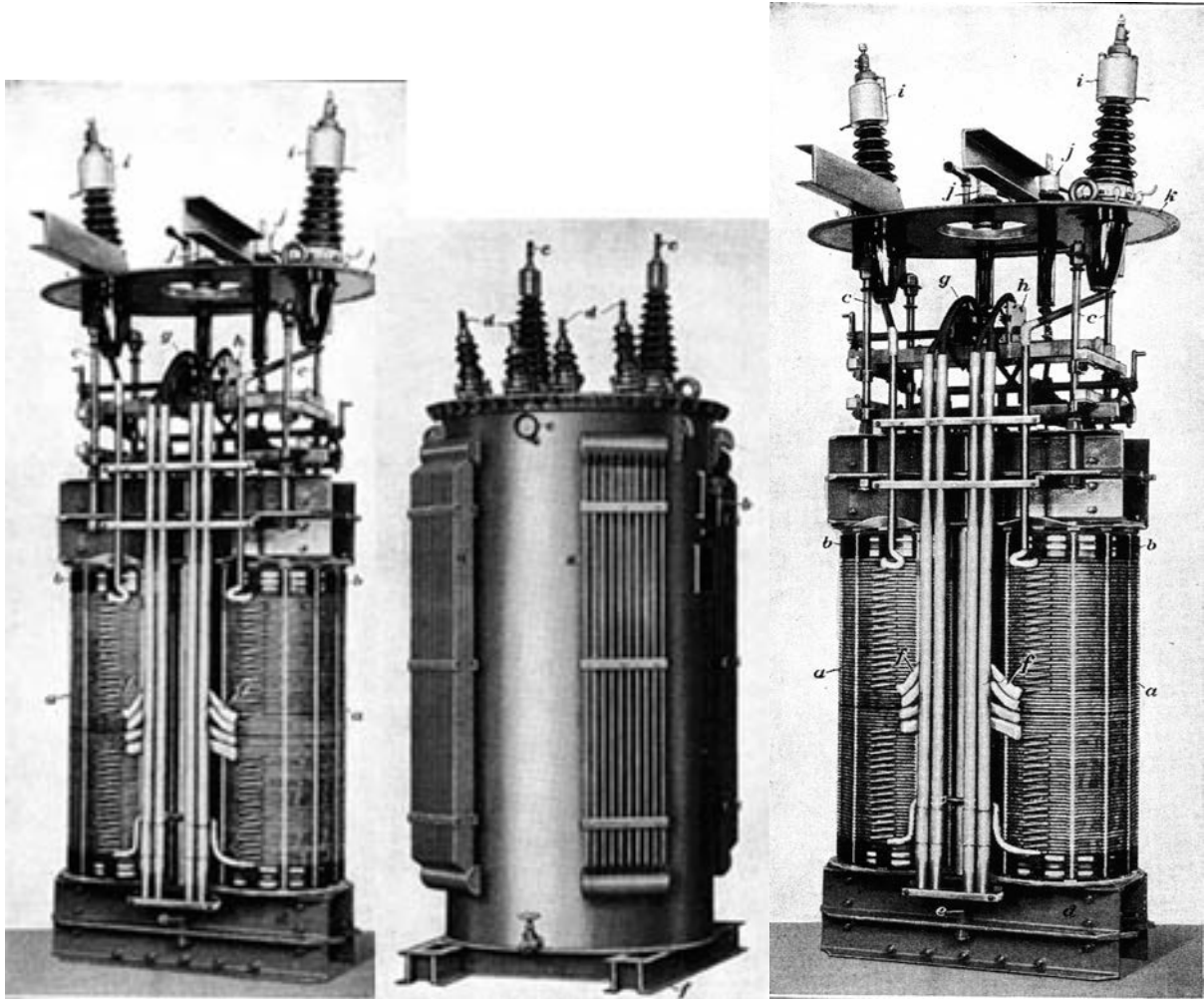

Transformers
Figure 69

A fundamental electrical engineering situation is that of travelling waves in transformer windings. This physical structure is incapable of a rigorous expression in any form of existing mathematics. The Heaviside-Maxwell Equations are of no use in this application. Approximation and misrepresentations must be resorted to. However, the geometry of the transformer windings is self evident, and an intrinsic quadrapolar form presents itself, and the elegant symmetry found by Maxwell and Heaviside is buried within the winding structure in a more sophisticated form.

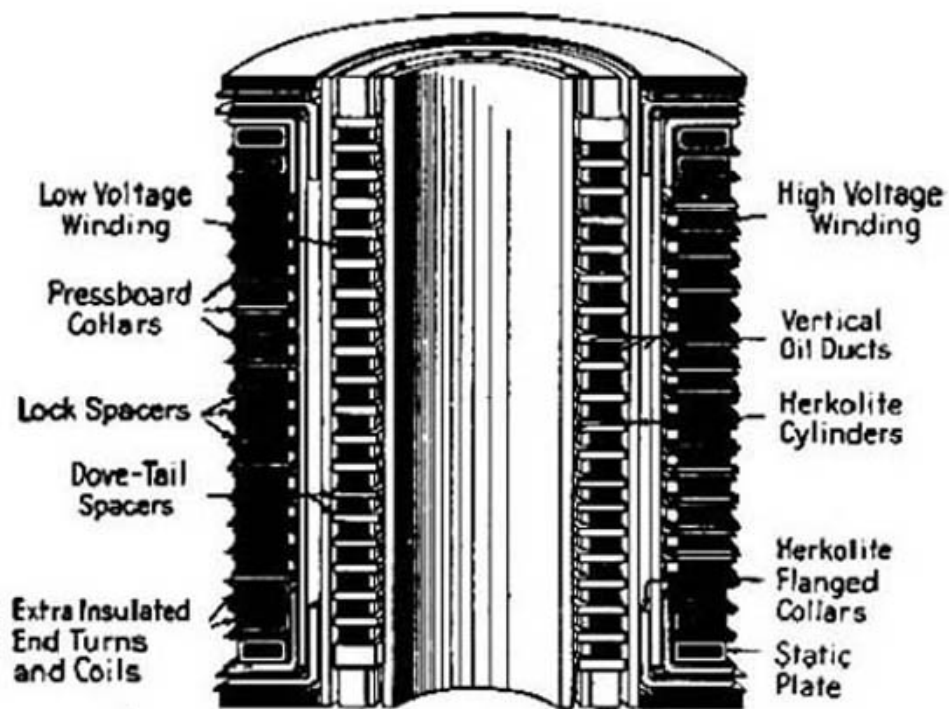

FIG. 97.—Cross-Section of Comparatively High-Voltage Power Transformer

Figure 70

GENERAL DIFFERENTIAL EQUATION

Referring to Fig. 101, the fundamental circuit equations are:

$$i_{k1} = K_1 \frac{\partial^2 e_1}{\partial x \partial t} \quad (4)$$

$$i_{k2} = K_2 \frac{\partial^2 e_2}{\partial x \partial t} \quad (5)$$

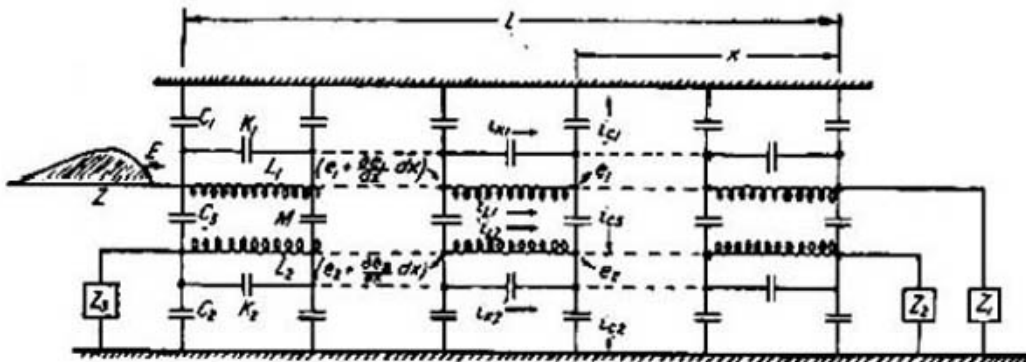

FIG. 101.—Complete Idealized Circuit of a Transformer to High-Frequency Transients

$$i_{c1} = C_1 \frac{\partial e_1}{\partial t} = \frac{\partial i_{k1}}{\partial x} + \frac{\partial i_{L1}}{\partial x} - i_{c3} \quad (6)$$

$$i_{c2} = C_2 \frac{\partial e_2}{\partial t} = \frac{\partial i_{k2}}{\partial x} + \frac{\partial i_{L2}}{\partial x} + i_{c3} \quad (7)$$

$$i_{c3} = C_3 \frac{\partial}{\partial t} (e_1 - e_2) \quad (8)$$

The fluxes of (2) induce voltage gradients

$$\frac{\partial e_1}{\partial x} = \frac{n_1}{10^8} \frac{\partial \phi_1}{\partial t} \quad (9)$$

$$\frac{\partial e_2}{\partial x} = \frac{n_2}{10^8} \frac{\partial \phi_2}{\partial t} \quad (10)$$

Figure 71

FIGURE (4)

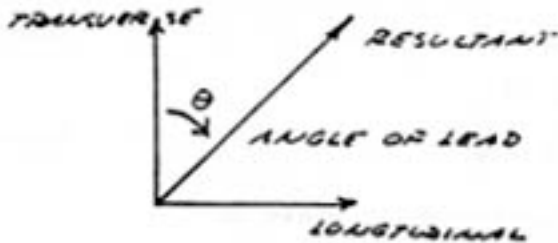
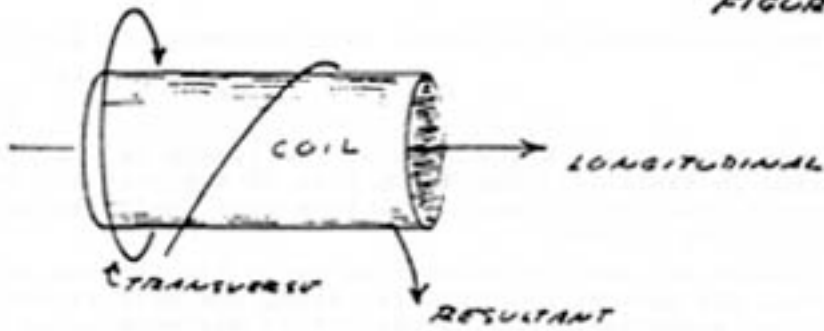

The characteristic impedance of the resonant coil is given by

$$Z_c = \sqrt{\frac{L_o}{C_o}} \quad \text{Ohms (9)}$$

Hence,

$$Z_o = NZ_s \quad \text{Ohms (10)}$$

Where

$$Z_s = \left[(182.9 + 406.4n)p \right]^{\frac{1}{2}} \quad \frac{1}{2} 10^3 \quad \text{Ohms (inches) (11)}$$

and N = number of turns. The values of sheet impedance, Z_s , are tabulated in table (3).

The time constant of the coil, that is, the rate of energy dissipation due to coil resistance is given by the approximate formula

$$u = R_o/2L_o = \left(\frac{2.72}{r} + \frac{2.11}{l} \right) \pi \sqrt{F_o} \quad \text{Nepers/sec (12) (inches)}$$

Where r = coil radius
 l = coil length

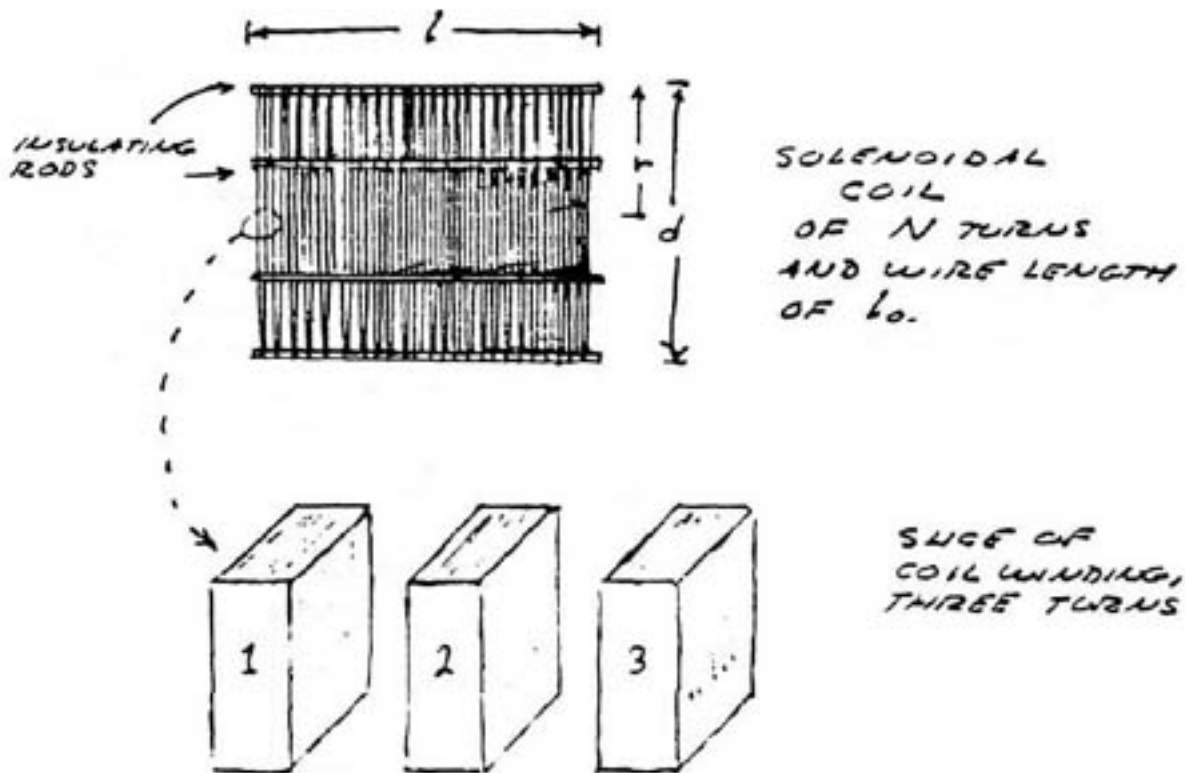
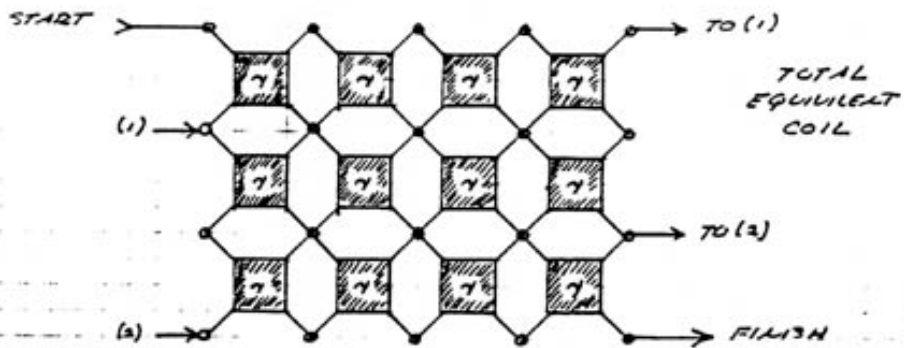
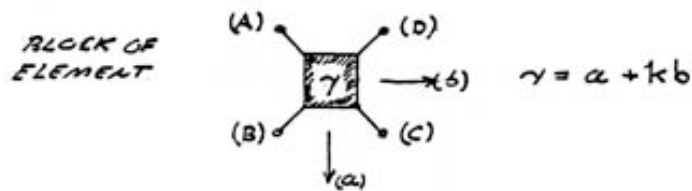
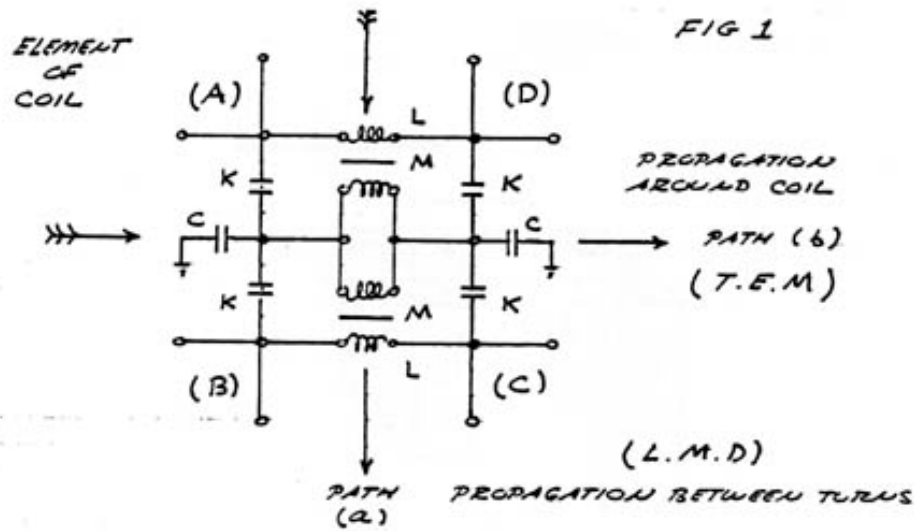

Figure (1)

Figure 73

Shown in the figure is the basic single layer solenoidal winding, such as used in the "Tesla Transformer". Two paths for propagation exist rather than the customary one path for propagation as in the long line problem. One path is the transverse electro-magnetic, this moving circumferentially around the coil. The other path is the longitudinal magneto-dielectric, this moving axially along the coil. These two component waves exist in a space quadrature relation, like Oersted's compass needle. A quadrature relation implies a four quadrant expression, or quadrapolar format; this is the start.



35

COMPLEX SPACE ANALOG

Figure 74

The figure shown expands the windings into the form of a synthetic network. Here the complexity of the problem presents itself, and it is incapable of treatment by conventional transmission theory. It appears to be a gargantuan matrix problem. It is beyond the scope of these writings and will be continued in the appendix.

(II) Symbolic Representation of Cyclic Phenomena

[1] Primordial Symbolic Representation



ABORIGINAL AMERICAN
Figure 75

1.1 Natural Form

The science of electricity has its roots in the knowledge of natural forces, those of nature. Originally this was known as “Natural Philosophy”. The science of electricity is derived of natural science and philosophy. This philosophy is for the most part forgotten. To understand nature is to partake in it and thereby engage in the natural process. An electrical apparatus constitutes an arch form. It is that particular shape or geometric configuration that makes things happen. This arch form engages the formative forces, here the magnetic and dielectric, which act upon the primordial aether. The resultant is electric activity. This process exists throughout all nature, and by Pythagorean reasoning, all natural forces must exhibit a common unifying relationship. Hereby, one set of forces which are unknown can be derived by relation to another set of known forces. The unknown can be understood through analogy and similitude, by finding the underlying principle common to each.

1.2 Quadrapolar Geometry

The fundamental arch type of electricity is quadrapolar. It has four poles, phases, or directions. The four phases define four quadrants, each quadrant defines a unique aspect of electricity, giving four aspects total.

Aboriginal Americans express quadrapolar form and patterning throughout their culture. They are in their own way experts on the subject of four quadrant relationships. Since we are lost in the wilderness of bipolar thinking, the Aborigine may well serve as our guide into the symbols of electricity.

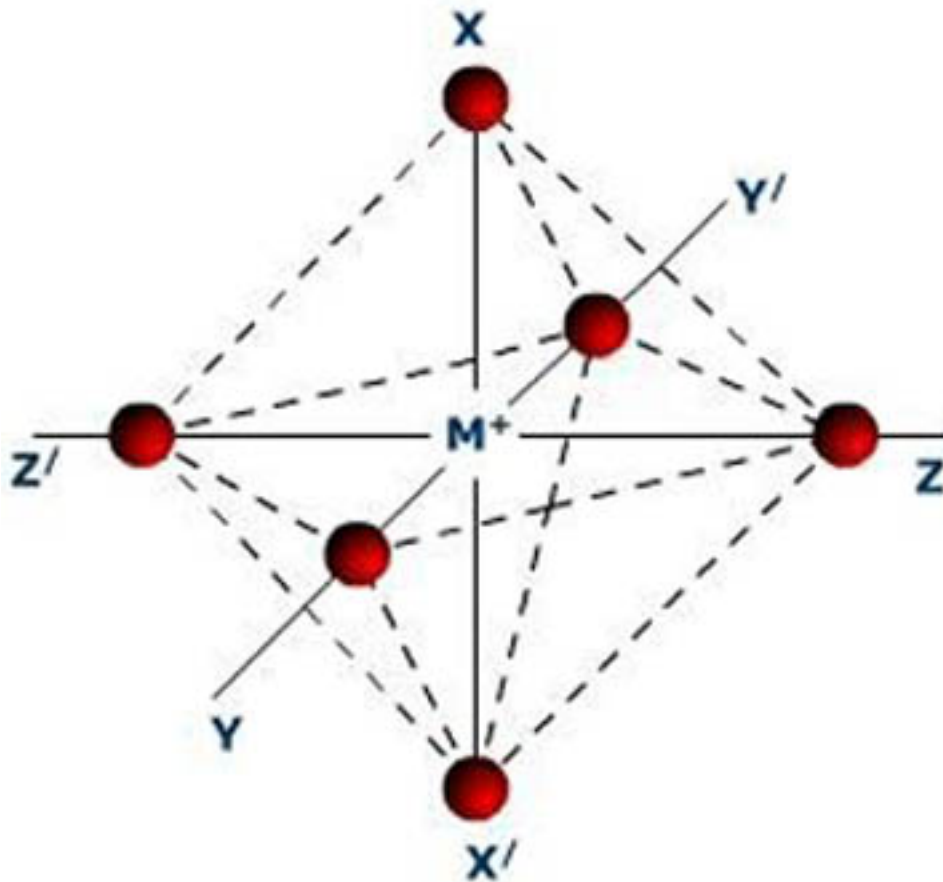

QUADRAPOLAR ARCHETYPE OF ELECTRICITY

Figure 76

1.3 The Lunar Cycle

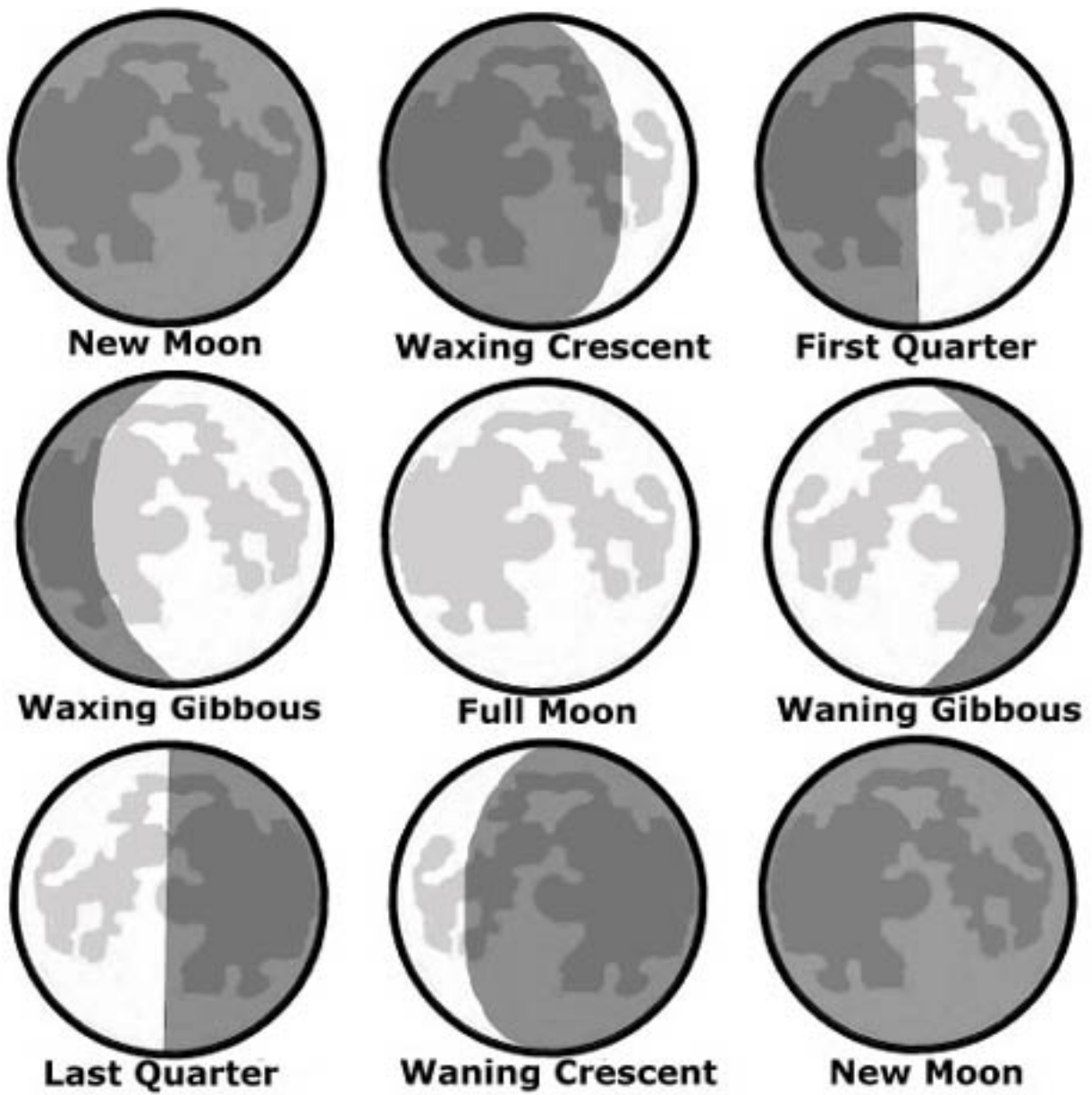

LUNAR PHASES

Figure 77

The Aboriginal American derives his symbols and understanding from his direct participatory contact with nature. For him the forces are awesome, but also relentless; they are undeniable. It is the law of nature that directs the mind of the so-called Indian. This is expressed in his production of his arch forms.

As with electricity, the natural forces are in constant motion; this motion often exists in the form of cycles. These cyclic motions are made visible through the observation of the four seasons, for phases of the Moon and etc. These motions are of a four quadrant form, as defined by four distinct phases or sub-divisions of the cycle. These natural motions are quadrapolar as are the motions of electricity.

[2] Lunar Versors

2.1 The Four Lunar Phases

The Lunar cycle provides much insight into the workings of the quadrapolar relationship. Details of the Lunar cycle escapes the modernist, whose existence is closed off inside barricaded dwellings surrounded by fences and locked gates. Firearms and paranoid eyes are directed radially outwards. To the modernist mind, nature causes cancer. This is not the case for the Indian who cannot hide or escape from nature; he must be part of it. For him the lunar cycle is a sort of sacred relation; this is a part of daily existence. For the Indian this is an engineering reality. This reality is quadrapolar.

This lunar cycle will here serve as an analog to the alternating current cycle. What follows here will be a detailed analysis of the lunar cycle in mathematical form; this deriving expressions for quadrapolar relationships. These will then be applied to alternating current theory.

2.2 Exponents of the Lunar Phases

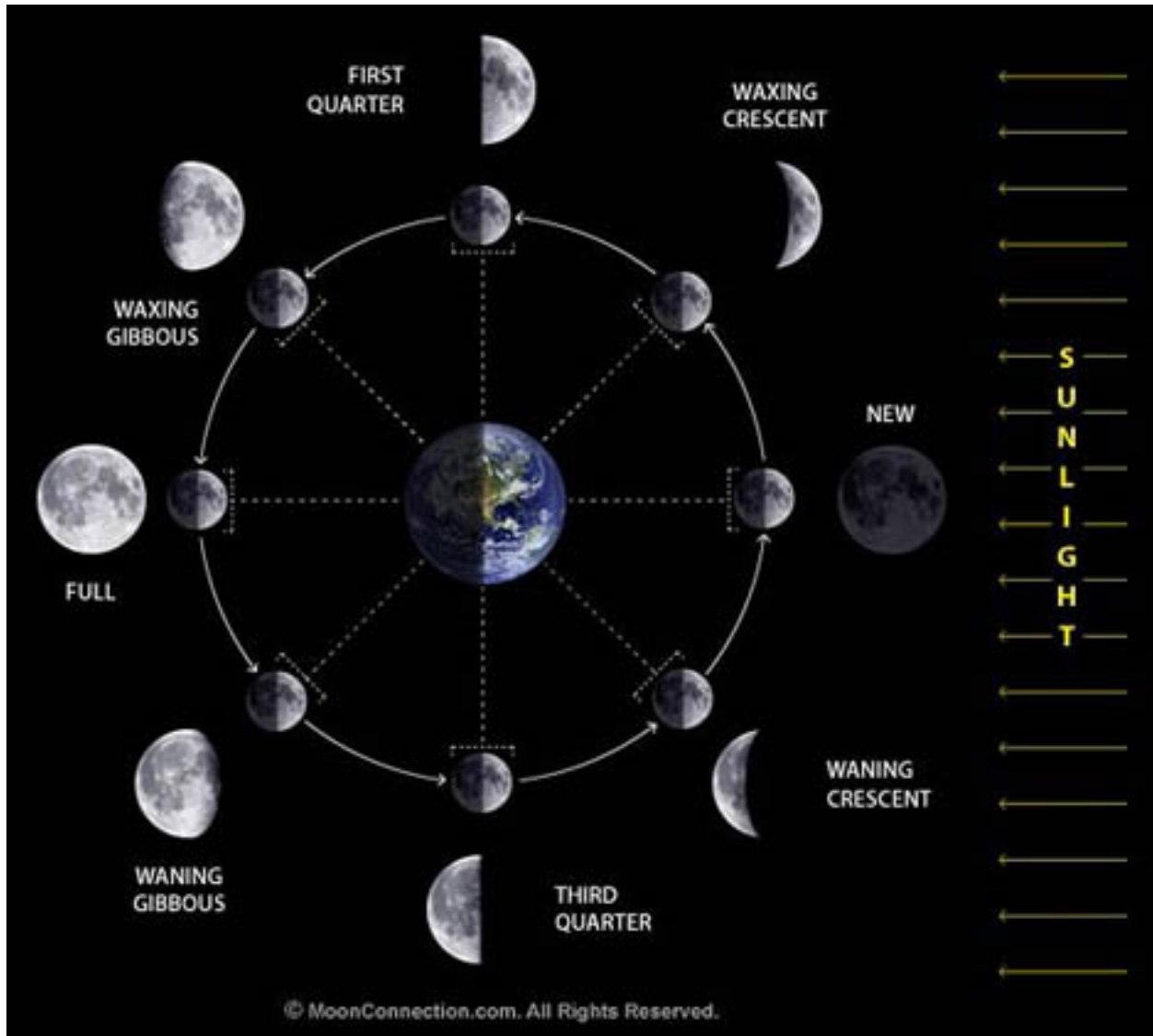

LUNAR POSITIONS

Figure 78

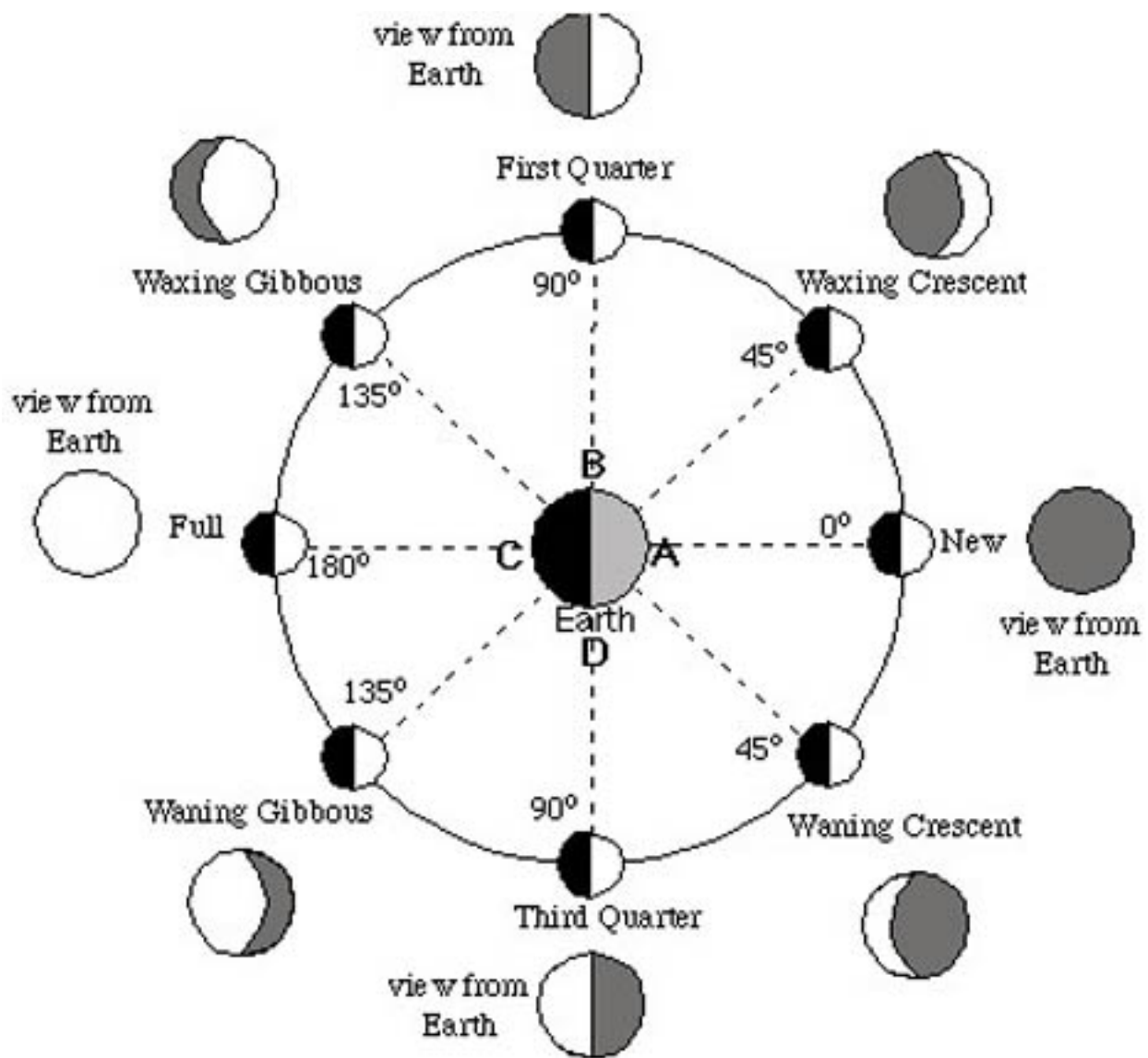

VERSOR LUNAR POSITIONS

Figure 79

The four lunar phases represent the basic quadrupolar relation. The four unit poles or phases are defined as:

- I) New Moon
- II) Leading Quadrature Moon
- III) Full Moon
- IV) Lagging Quadrature Moon

These four lunar phases can be represented by a progressive series of numerical exponents. Each distinct phase of the moon can be identified with a specific exponent. This exponent can also be given as an angle in radians. Each exponent numerically represents a particular lunar phase, or what will be called a unit versor position. Here in the manner of Pythagoras, each phase is a Number:

Zero – New Moon

One – Leading Moon

Two – Full Moon

Three – Lagging Moon

Since the exponent four completes the cycle at New Moon, it is equal to Zero. That is, the fourth power is the next Zeroth power, the start of a new cycle. Four is equal to Zero in a quaternary number system. This number system consists of four numerals as phases.

CYCLE 1			
PHASE	NUMERALS		
1	0	0	0
2	0	0	1
3	0	0	2
4	0	0	3

CYCLE 2			
PHASE	NUMERALS		
1	0	1	0
2	0	1	1
3	0	1	2
4	0	1	3

CYCLE 3			
PHASE	NUMERALS		
1	0	2	0
2	0	2	1
3	0	2	2
4	0	2	3

CYCLE 4			
PHASE	NUMERALS		
1	0	3	0
2	0	3	1
3	0	3	2
4	0	3	3

CYCLE 5			
PHASE	NUMERALS		
1	1	0	0
2	1	0	1
3	1	0	2
4	1	0	3

CYCLE 6			
PHASE	NUMERALS		
1	1	1	0
2	1	1	1
3	1	1	2
4	1	1	3

Figure 80

A more familiar number system is the bipolar, or binary system. It is based upon two numerals as phases. In binary exponential form, two is equal to zero, since the exponent Two is zero in the next sequence, similar to a cycle.

ALTERNATION 1	
PHASE	NUMERALS
1	0 0 0 0
2	0 0 0 1

ALTERNATION 2	
PHASE	NUMERALS
1	0 0 1 0
2	0 0 1 1

ALTERNATION 3	
PHASE	NUMERALS
1	0 1 0 0
2	0 1 0 1

ALTERNATION 4	
PHASE	NUMERALS
1	0 1 1 0
2	0 1 1 1

ALTERNATION 5	
PHASE	NUMERALS
1	1 0 0 0
2	1 0 0 1

ALTERNATION 6	
PHASE	NUMERALS
1	1 0 1 0
2	1 0 1 1

ALTERNATION 7	
PHASE	NUMERALS
1	1 1 1 0
2	1 1 1 1

Figure 81

DECIMAL		QUATERNARY			BINARY				
10	1	16	4	1	16	8	4	2	1
0	0	0	0	0	0	0	0	0	0
0	1	0	0	1	0	0	0	0	1
0	2	0	0	2	0	0	0	1	0
0	3	0	0	3	0	0	0	1	1
0	4	0	1	0	0	0	1	0	0
0	5	0	1	1	0	0	1	0	1
0	6	0	1	2	0	0	1	1	0
0	7	0	1	3	0	0	1	1	1
0	8	0	2	0	0	1	0	0	0
0	9	0	2	1	0	1	0	0	1
1	0	0	2	2	0	1	0	1	0
1	1	0	2	3	0	1	0	1	1
1	2	0	3	0	0	1	1	0	0
1	3	0	3	1	0	1	1	0	1
1	4	0	3	2	0	1	1	1	0
1	5	0	3	3	0	1	1	1	1
1	6	1	0	0	1	0	0	0	0

Figure 82

In binary, the exponents are fixed to Zero and One, in quaternary the exponents are fixed to Zero, One, Two and Three. The highest exponent in the system is always one less than the number of phases in the exponential representation.

Two laws of exponents present themselves in any exponential representation. The first law states in essence that any ratio to the Zero power is self annulling. The result of this operation is unity, or One; this without position or direction. It is simply the number One.

The second law states that any ratio to the first power is self identifying. The result of this operation is as if nothing has happened, except the exponent vanishes, leaving only the unchanged ratio.

For example, if a ratio, k , is raised to the Zero power, it becomes equal to One; the ratio k vanishes. If the ratio k is raised to the first power it remains the ratio, k , and the exponent one need not be shown. The Zero power can be taken as the reference phase, this giving phase one, or the start of the cycle.

In the lunar cycle, the zero power gives the reference position, New Moon. This is the starting point of a unit cycle, phase One or New.

The first power in the lunar cycle is one unit degree of the turning into the New cycle, this arriving at the leading quadrature moon, One unit step beyond the New Moon. All higher numerical powers identify a certain multiple of unit steps into the cycle. Four unit steps start the cycle again at the New Moon. This representation can be given to alternating current.

[3] Quadrapolar Relations

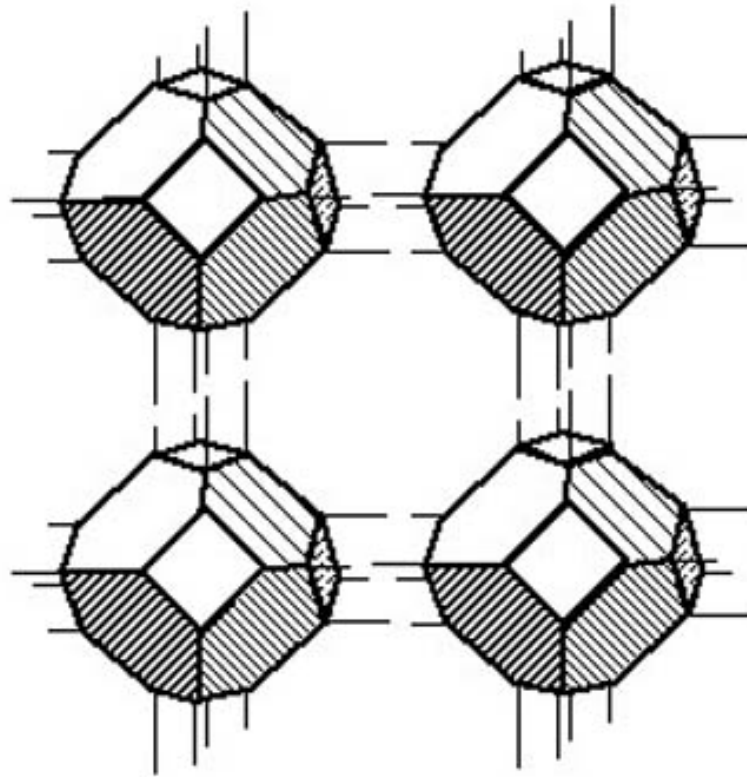

4-POLAR STRUCTURES

Figure 83

3.1 Quadrapolar Arithmetic

Quadrapolar arithmetic exists beyond the bounds of common arithmetical laws. The basic arithmetic operations of addition and subtraction must be extended to include another pair of operations, giving the required total of four.

Addition, or plus, in symbolic representation is positive one; New Moon. Subtraction, or minus, in symbolic representation is negative one; Full Moon. The question is how are the Leading Moon or Lagging Moon to be represented by arithmetical operators. The guide shows the path is from Pythagoras to Steinmetz, and this we will follow.

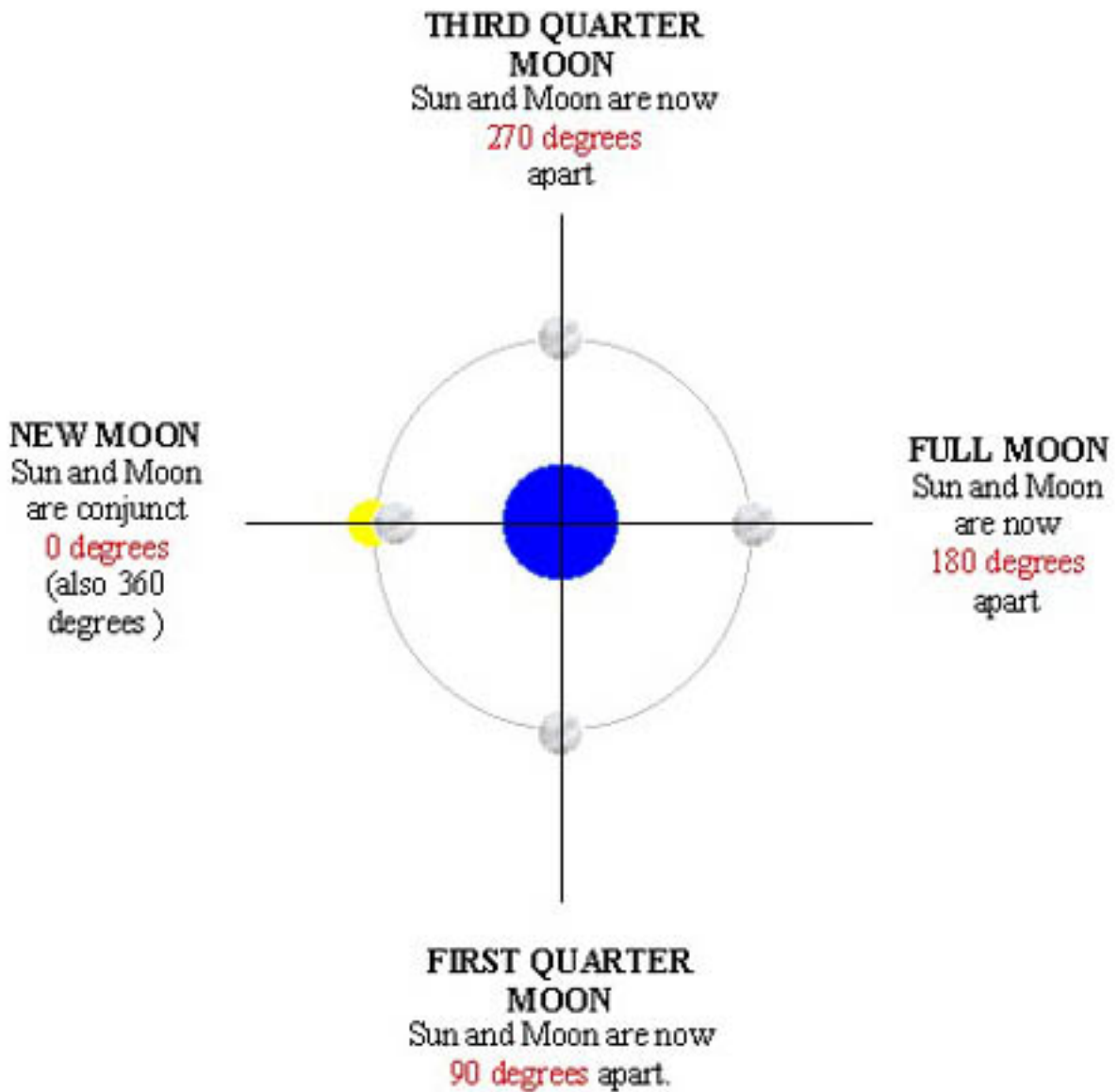

REAL LINE & IMAGINARY LINE

Figure 84

3.2 Real and Imaginary Lines

The unit positions of the New Moon and of the Full Moon establish a line. This line spans positive one, New, and negative one, Full. The Earth is between so this line is co-linear with the Sunrise-Sunset Line on Earth. This New-Full Line will be called the Real Line.

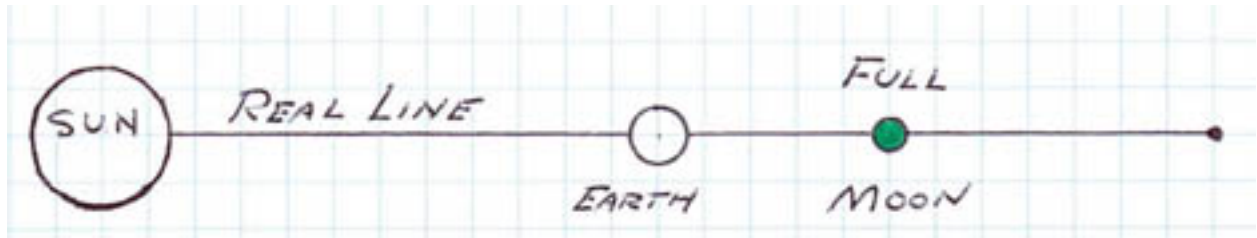

Figure 85

Likewise, the unit positions of the Leading Moon and the Lagging Moon also establish a line, but this line is in quadrature with the Sunrise-Sunset Line on Earth. The Earth is no longer between the Sun and Moon, now the Earth and Moon stand side by side. The Leading-Lagging Line is now co-linear with the Noon-Midnight Line on Earth. The Noon-Midnight Line is in quadrature with the Sunrise-Sunset Line. For reason of this quadrature displacement the Leading-Lagging Line will be called the Imaginary Line.

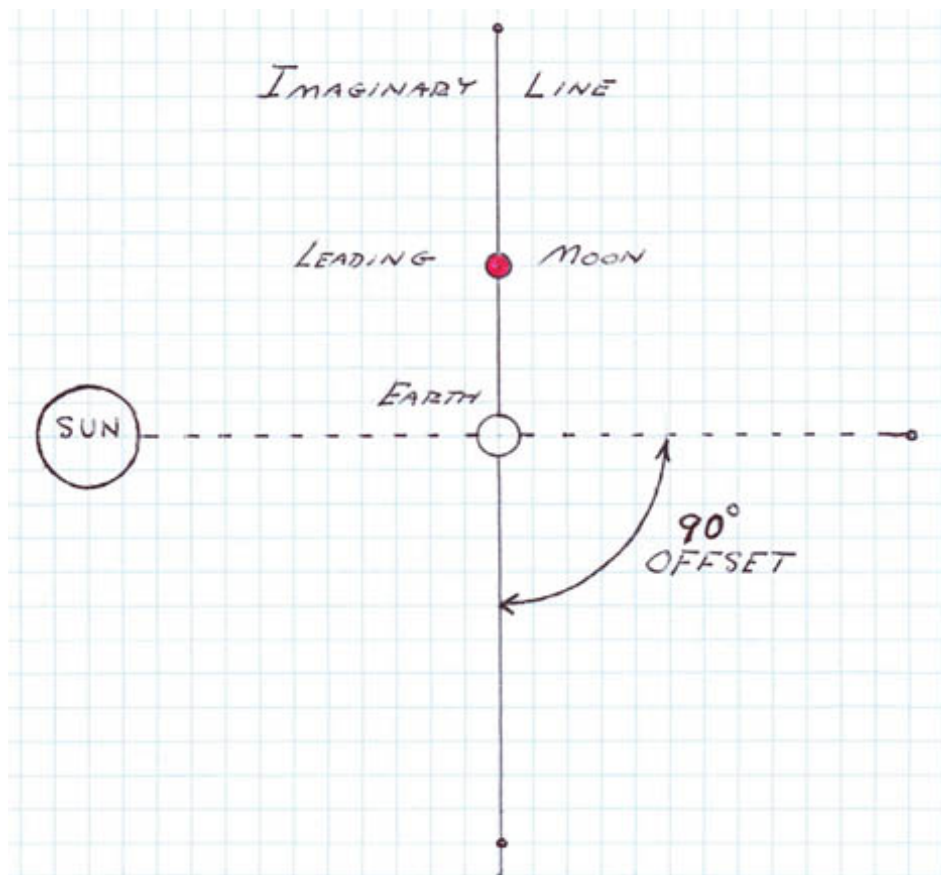

Figure 86

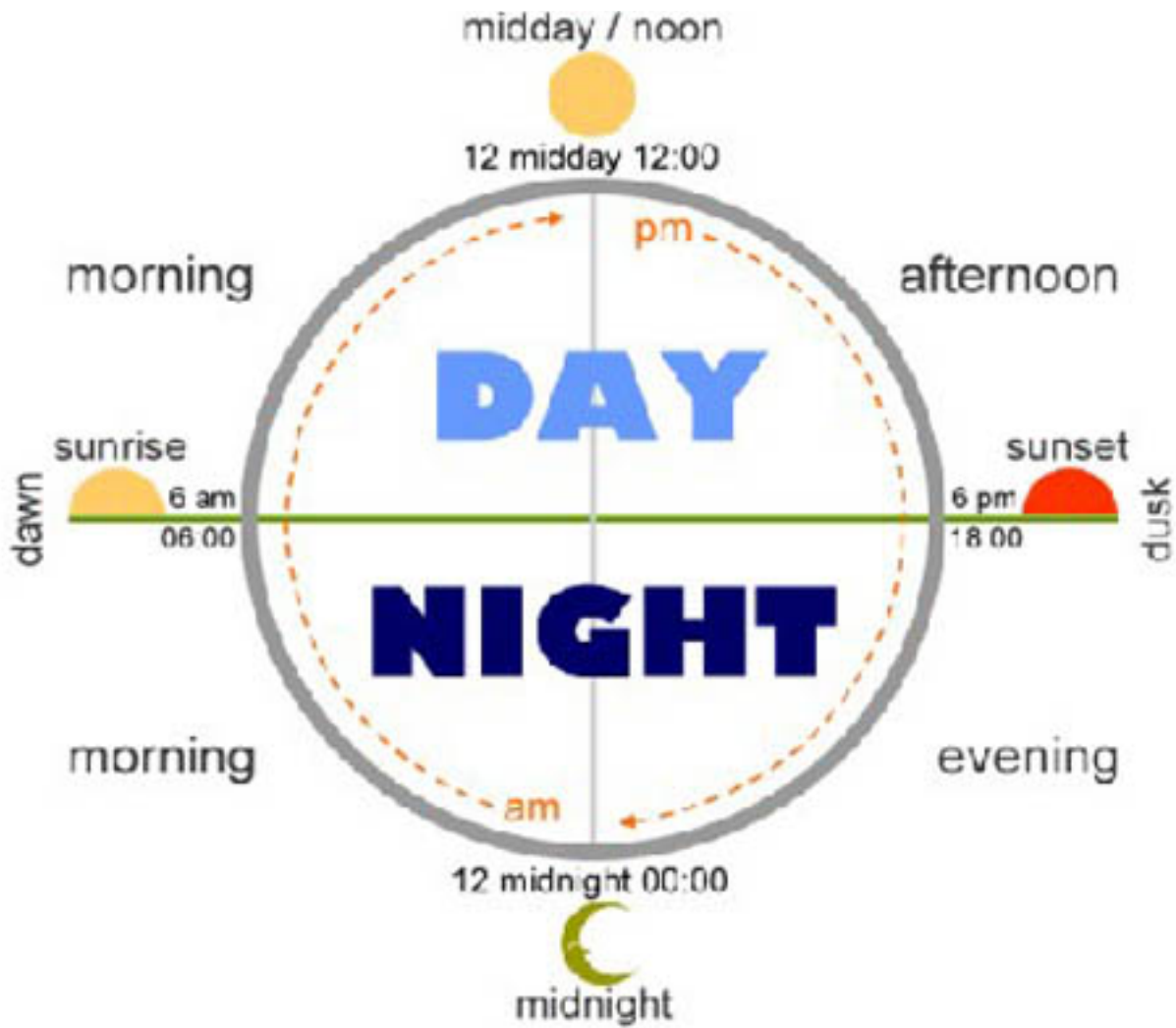

Figure 87

Four poles exist in the Earthbound relationship:

- | | | |
|------|----------|-----------|
| I) | Sunrise | Real |
| II) | Noon | Imaginary |
| III) | Sunset | Real |
| IV) | Midnight | Imaginary |

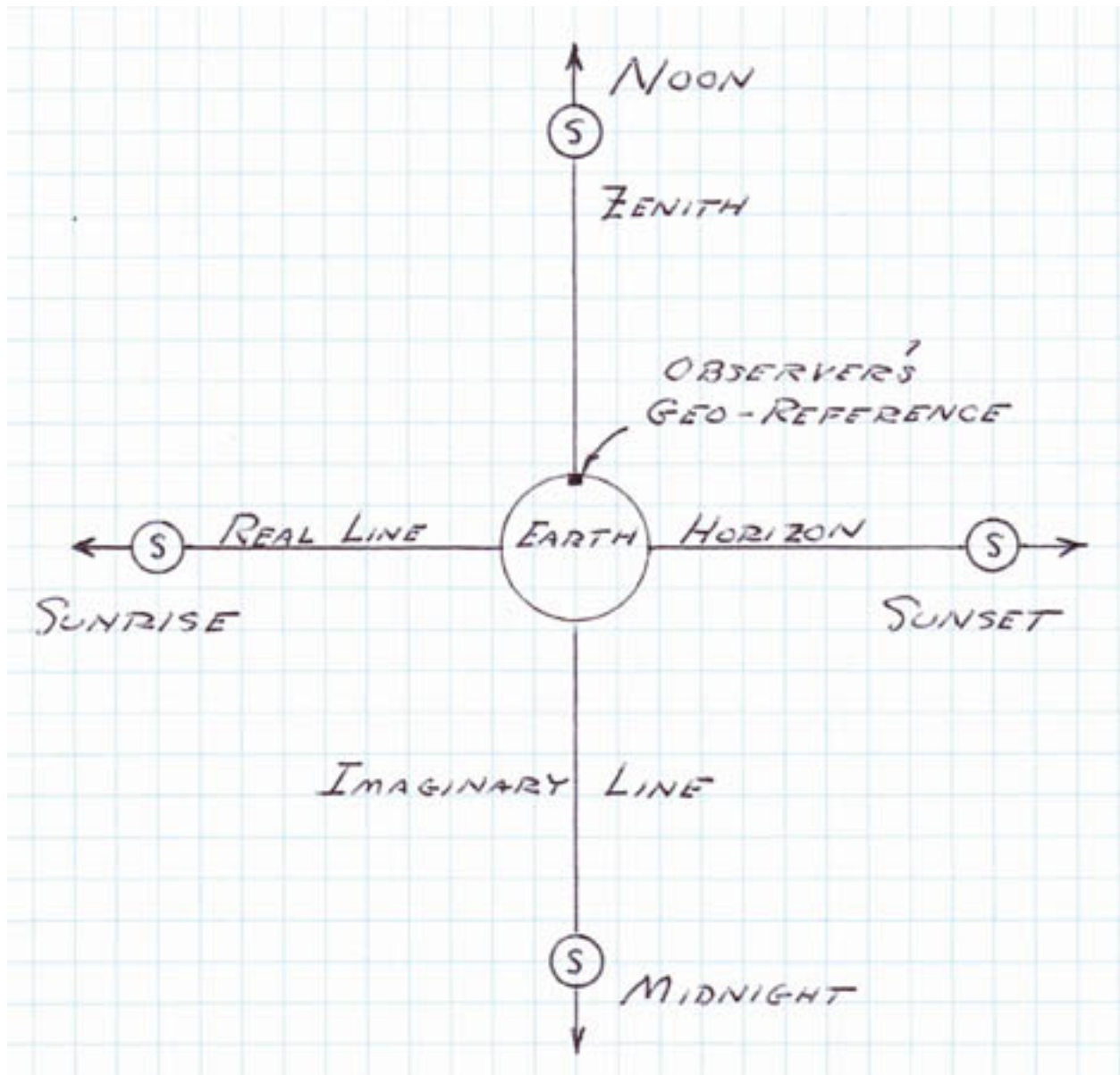
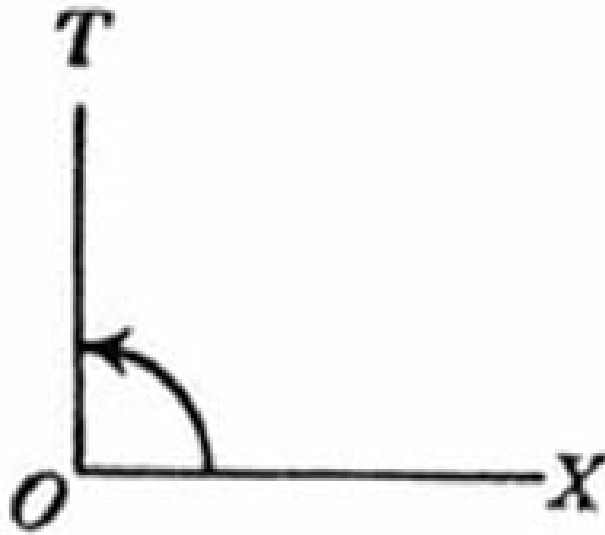

Figure 88

The Imaginary Line is in a 90 degree relation with the Real Line. It is said to be in quadrature. The Imaginary Line is one unit step in advance of the Real Line. This step is one unit versor rotation. Here is the cornerstone in Alternating Current Theory.

(III) The Versor Operator j

[1] Rotational Operation



UNIT VERSOR ROTATION

Figure 89

1.1 The Unit Rotation

The Sunrise-Sunset Line is transformed into the Noon-Midnight Line by one unit rotation of pi over two, or 90 degrees. This unit rotation is a Versor Operation; it is one unit amount of turning. This operation represents a rotation on an axis, such as the rotational axis of the Earth, and the Moon around it.

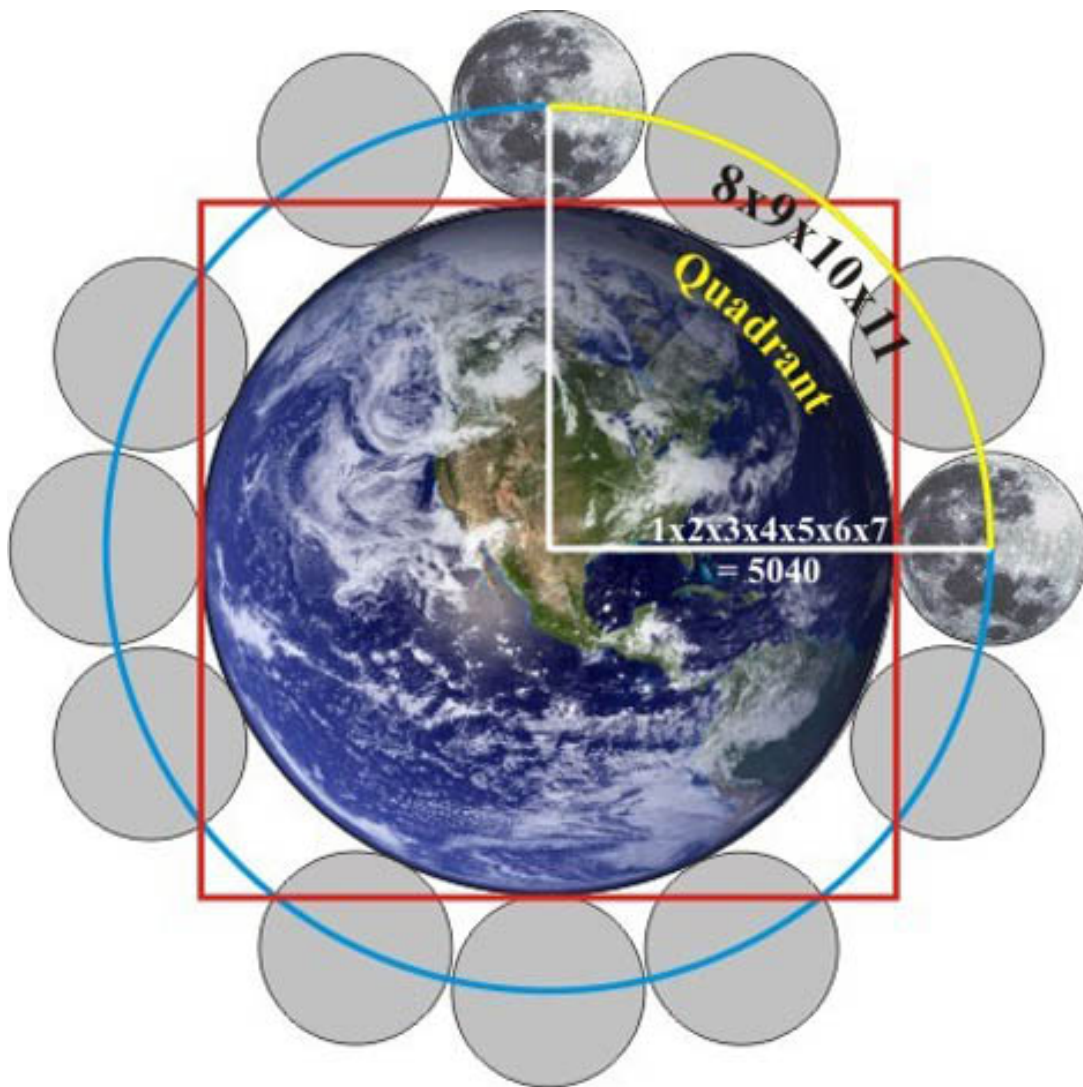

UNIT VESOR LUNAR ROTATION

Figure 90

In versor symbolic form one advancing unit of rotation will be represented by the letter j . This letter j serves as an operator in a manner similar to the plus sign and minus sign which serve as arithmetic operators. The letter j is a versor operator.

In rigorous form, this operator j exists as a pair, just as do the arithmetic pair of operators. The versor operators are hence, plus j and minus j . In symbolic representation the generalized operators are given as:

Positive 1, Positive j
Negative 1, Negative j

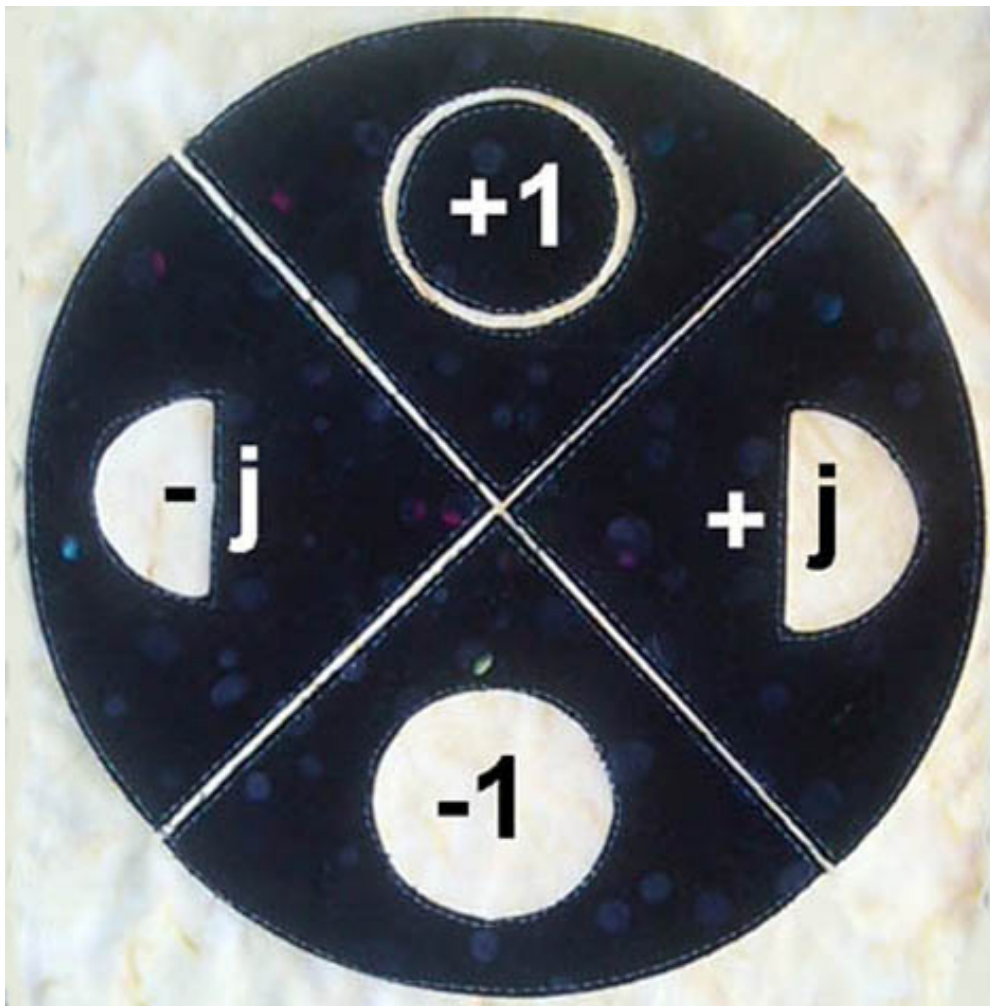

VECTOR LUNAR POSITIONS

Figure 91

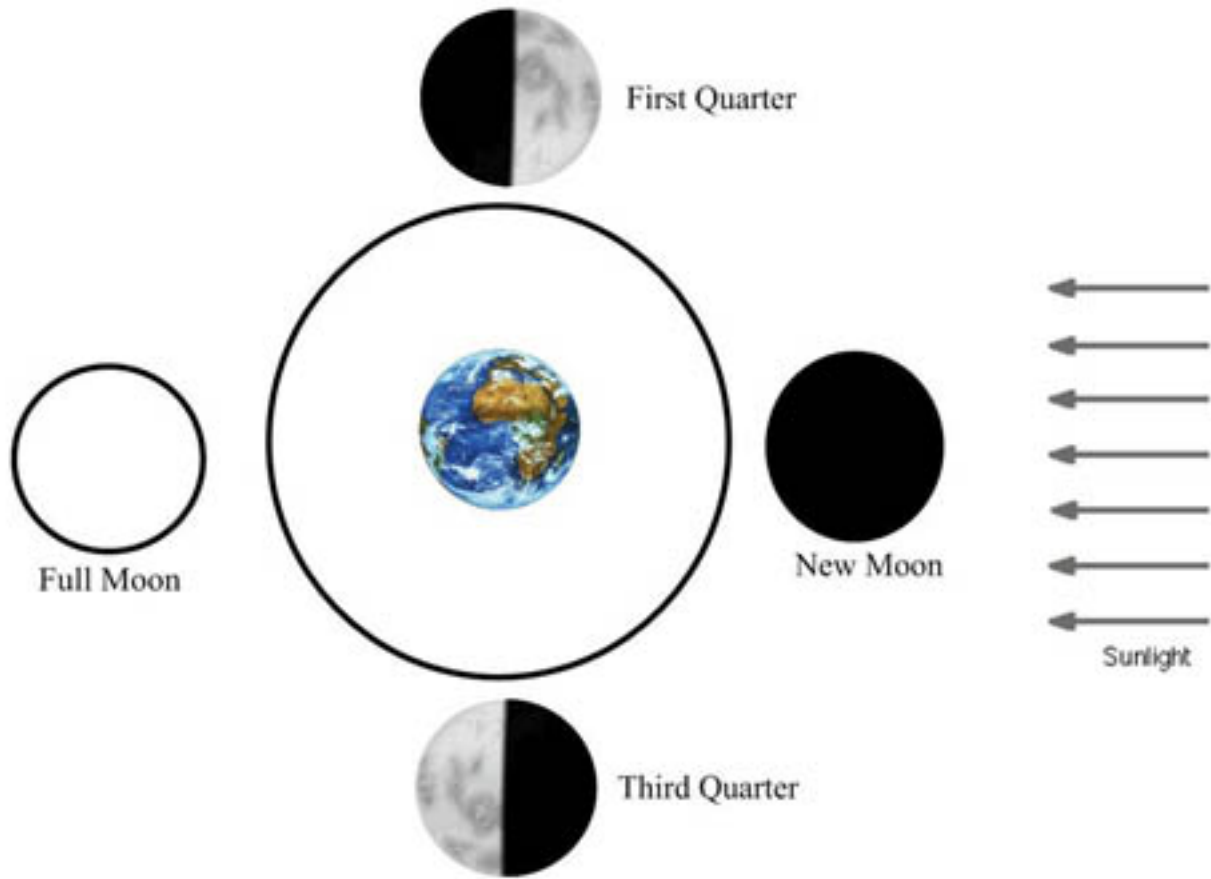

VECTOR LUNAR POSITIONS

Figure 92

From the rotational standpoint, the versor position j is midway between the arithmetic positions of plus one and minus one.

1.2 Bipolar Operations

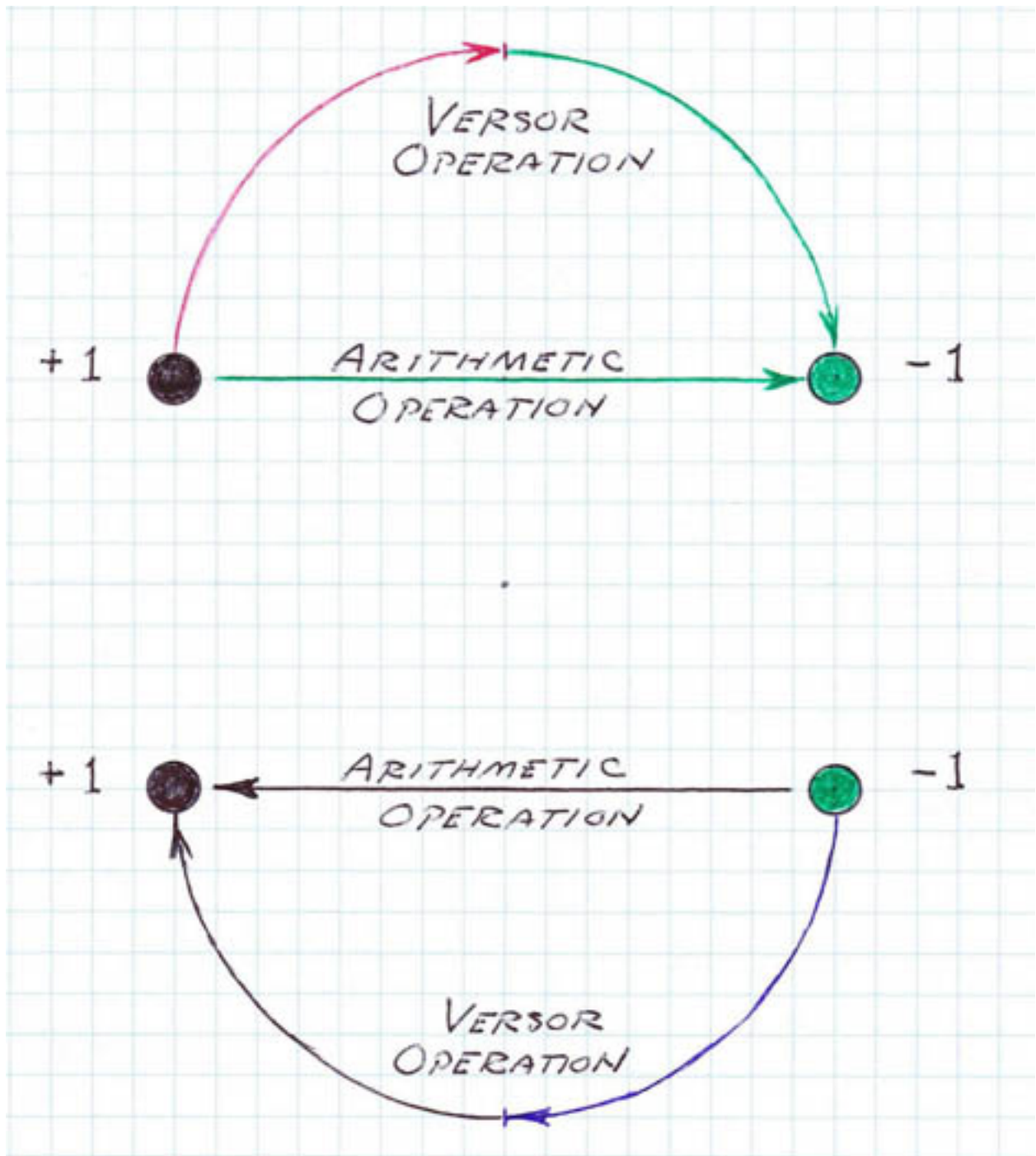

Figure 93

The arithmetic operation is a bipolar operation, the versor operation is a quadrapolar operation. An arithmetic operation can be derived from two successive versor operations. One unit bipolar operation is a reversal, or it is a turning of 180 degrees. The two are not operationally equivalent however. This can be a source of confusion. A unit bipolar operation transforms the New Moon into the Full Moon. Negative one is one unit arithmetic step. In bipolar form the operation negative one is not a 180 degree, or one pi radian rotation; it is an oppositional reversal of position. Its transformation is along a line, not around a circle.

Here shown is the versor and arithmetic operations, while analogous, are not equivalent. In analogy, the arithmetic operator is a bipolar versor operator that is non-rotational; it is a reversal. The quadrapolar versor operator is rotational, and reversal is derived via this rotation.

This creates a similar distinction in Alternating Current Theory. The bipolar form of A.C. is commonly known as Single Phase. Single Phase A.C. is not rotational; it exists as sequential reversals. Here exist the reason for the difficulties in the creation of the alternating current motor; reversals do not produce rotation.

[2] Real and Imaginary Operators

2.1 Arithmetic Operators

Since the Leading Moon and the Lagging Moon are positioned at the end points of the Imaginary Line, they are in opposition to each other; that is, they are subtractive.

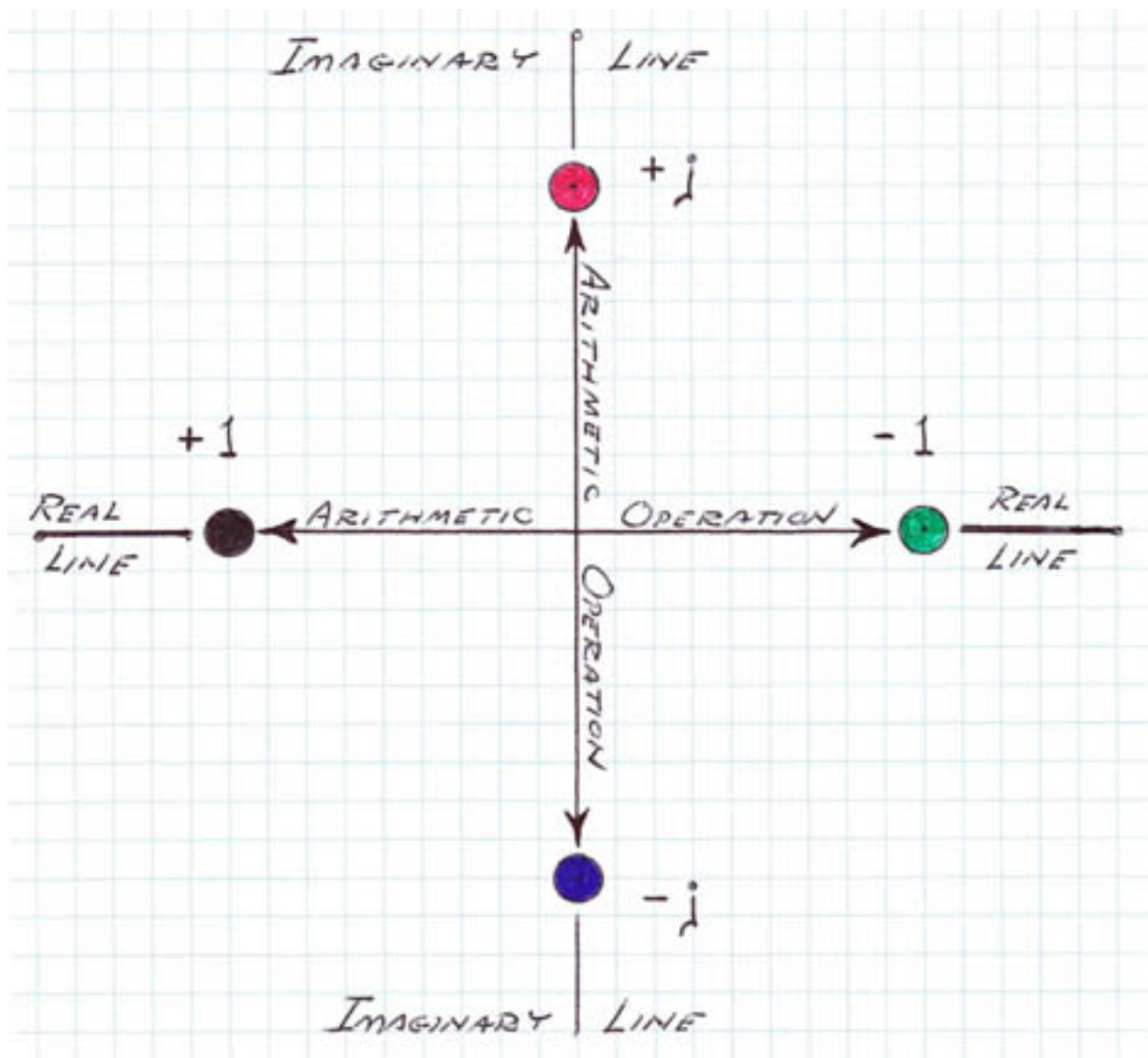

Figure 94

On the Real Line, the versor positions are New of Positive One, and Full, or Negative One. Accordingly, on the Imaginary Line the versor positions are Leading, or Positive j , and Lagging, or Negative j . The arithmetic operations of plus and minus are operable on the Imaginary Line just as they are on the Real Line. However, arithmetic operations as commonly understood do not allow operations between the Real Line and the Imaginary Line. They are heterogeneous and cannot be directly combined. Here the laws of arithmetic must be extended to include this cross operation, this is done by utilizing the Pythagorean Theorem.

2.2 Alternating Current

Analogy can be made with alternating current relations. The Real Line can be related to the process of direct current. This is a unidirectional plus to minus process. The Imaginary Line can be related to the process of Single Phase Alternating Current. This is a bi-directional process plus to minus-minus to plus. With D.C., the current is continuous and one way; in A.C. the current is in constant variation in both ways, but in A.C. as well as D.C. only a plus-minus relation exists, that is, both are bipolar.

2.3 Four Versor Operators

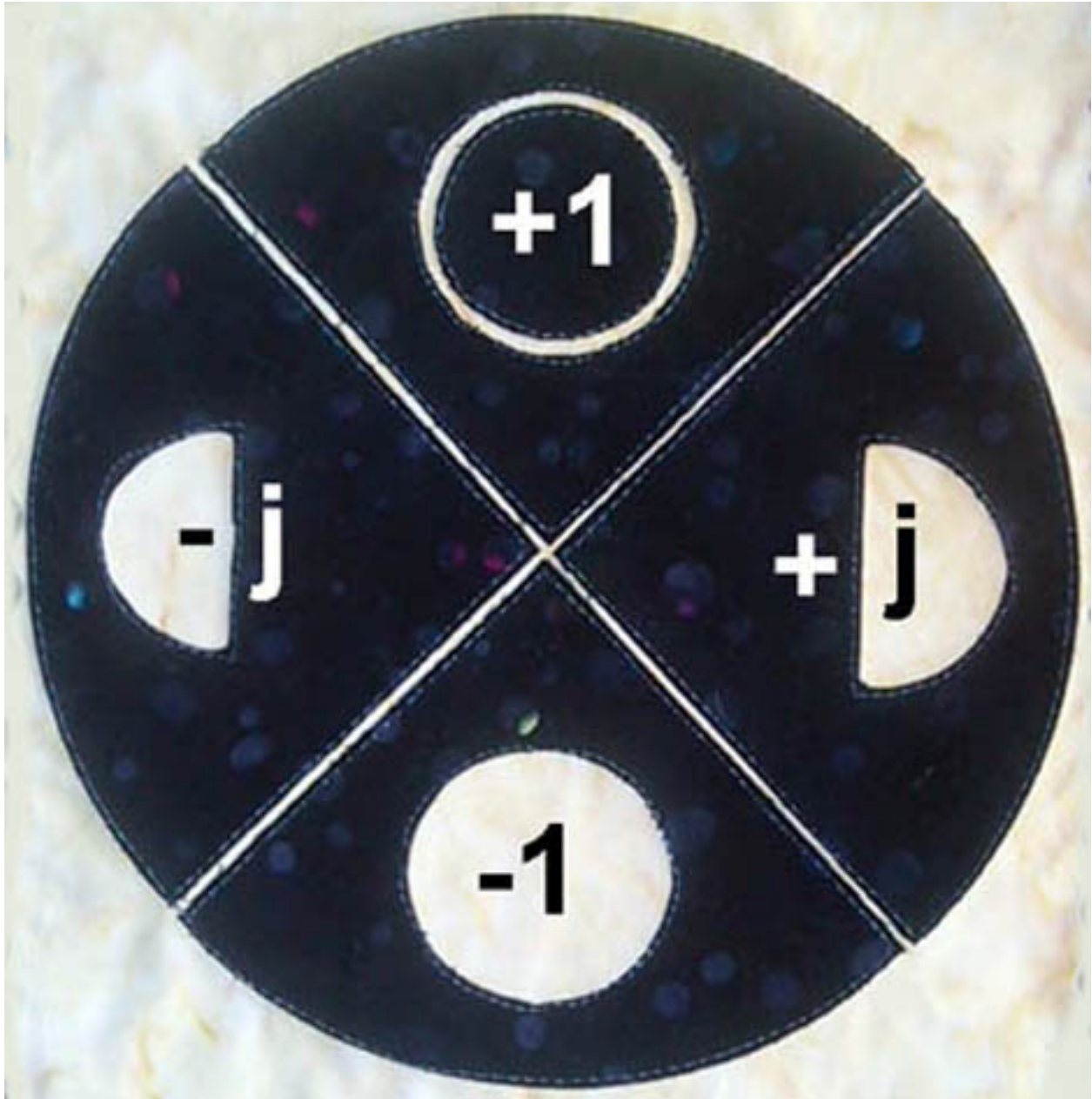

VECTOR LUNAR POSITIONS

Figure 95

In all, there are four versor operators. This is divided into a pair of oppositional versor operators that within themselves are arithmetic operators. One pair is the Real Line of positive one and negative one; the other pair is the Imaginary line of positive j and negative j . The Real Line is

in quadrature with the Imaginary Line. This defines the four quadrature versor operators:

- I) Positive One, The New Moon
- II) Positive j , The Leading Moon
- III) Negative One, The Full Moon
- IV) Negative j , The Lagging Moon

Here establishes the symbolic representation of the lunar cycle. This quadrature form of the cycle establishes four unit versor positions and four unit versor rotations; these from one unit position to the next. One unit rotation is expressed by the symbolic operator j . In terms of rotation rather than position this is given as:

- I) Positive One, No Rotation, No Change
- II) Positive j , One Unit Rotation, Pi Over Two Change (90°)
- III) Negative One, Two Unit Rotations, One Pi Change (180°)
- IV) Negative j , Three Unit Rotations, Three Pi Over Two Change (270°)

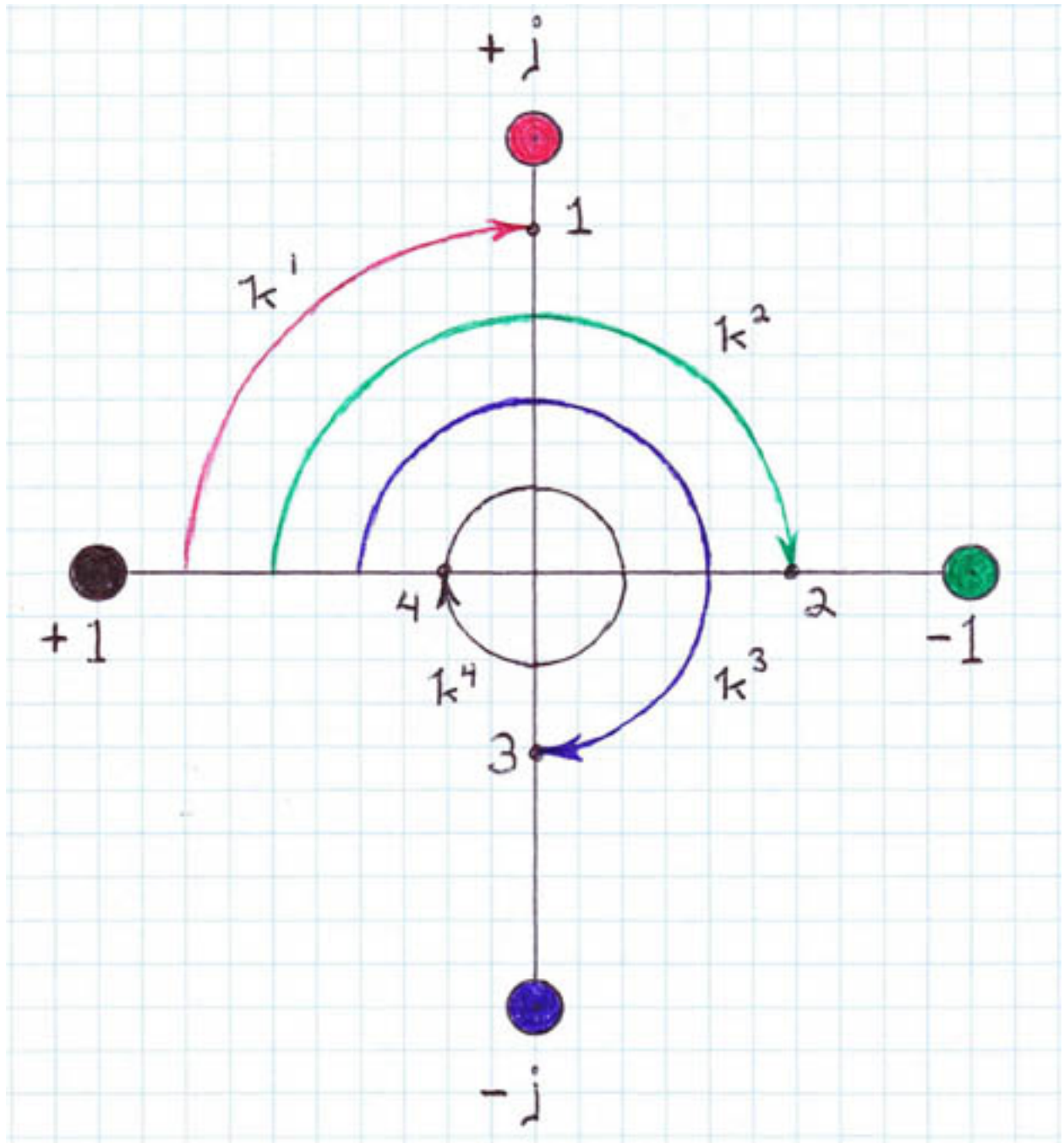

Figure 96

This expresses four unit rotations through a lunar cycle of four unit positions, or phases. The sense of rotation is from:

New to Leading, One
Leading to Full, Two
Full to Lagging, Three
Lagging to New, Four

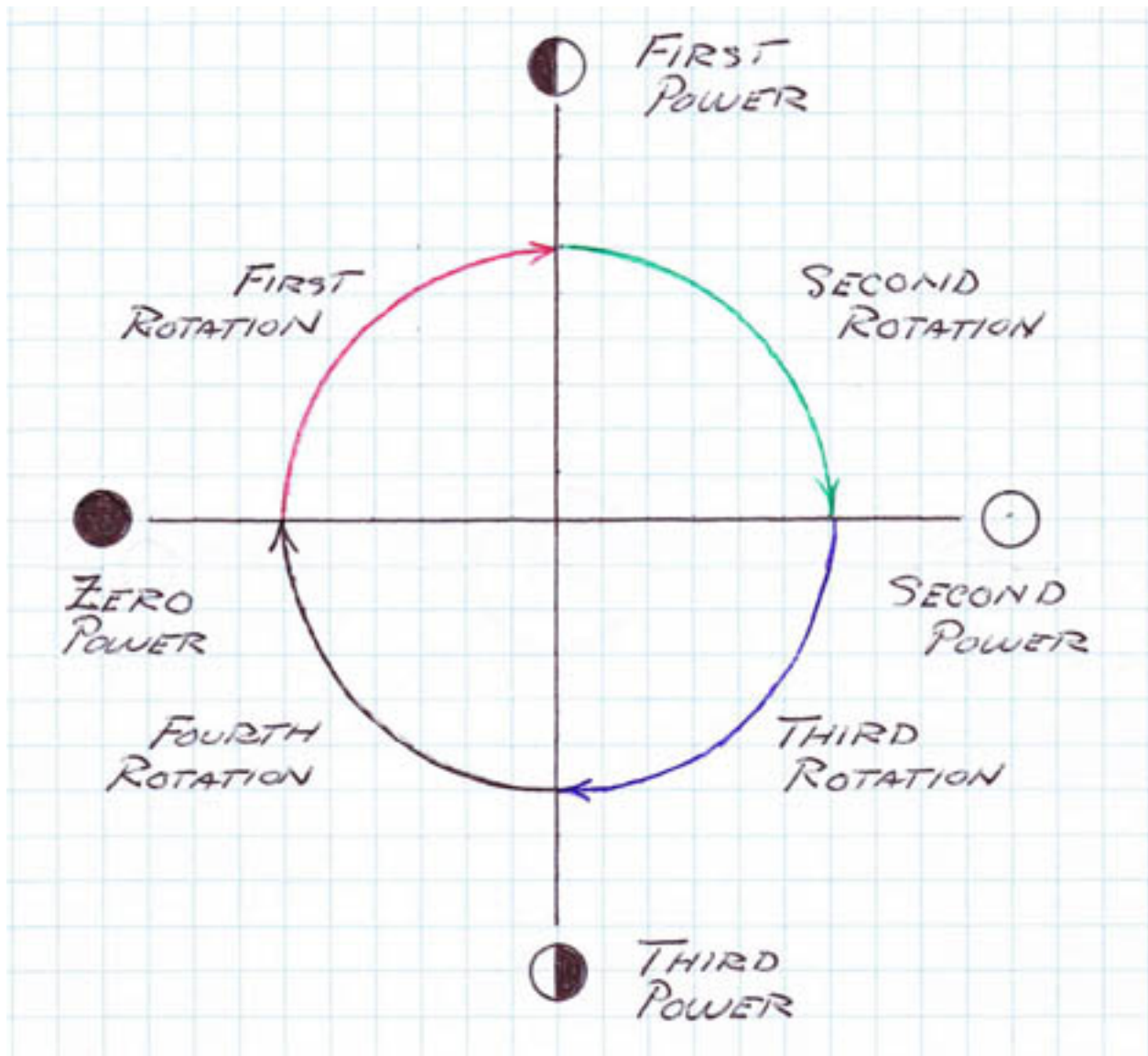
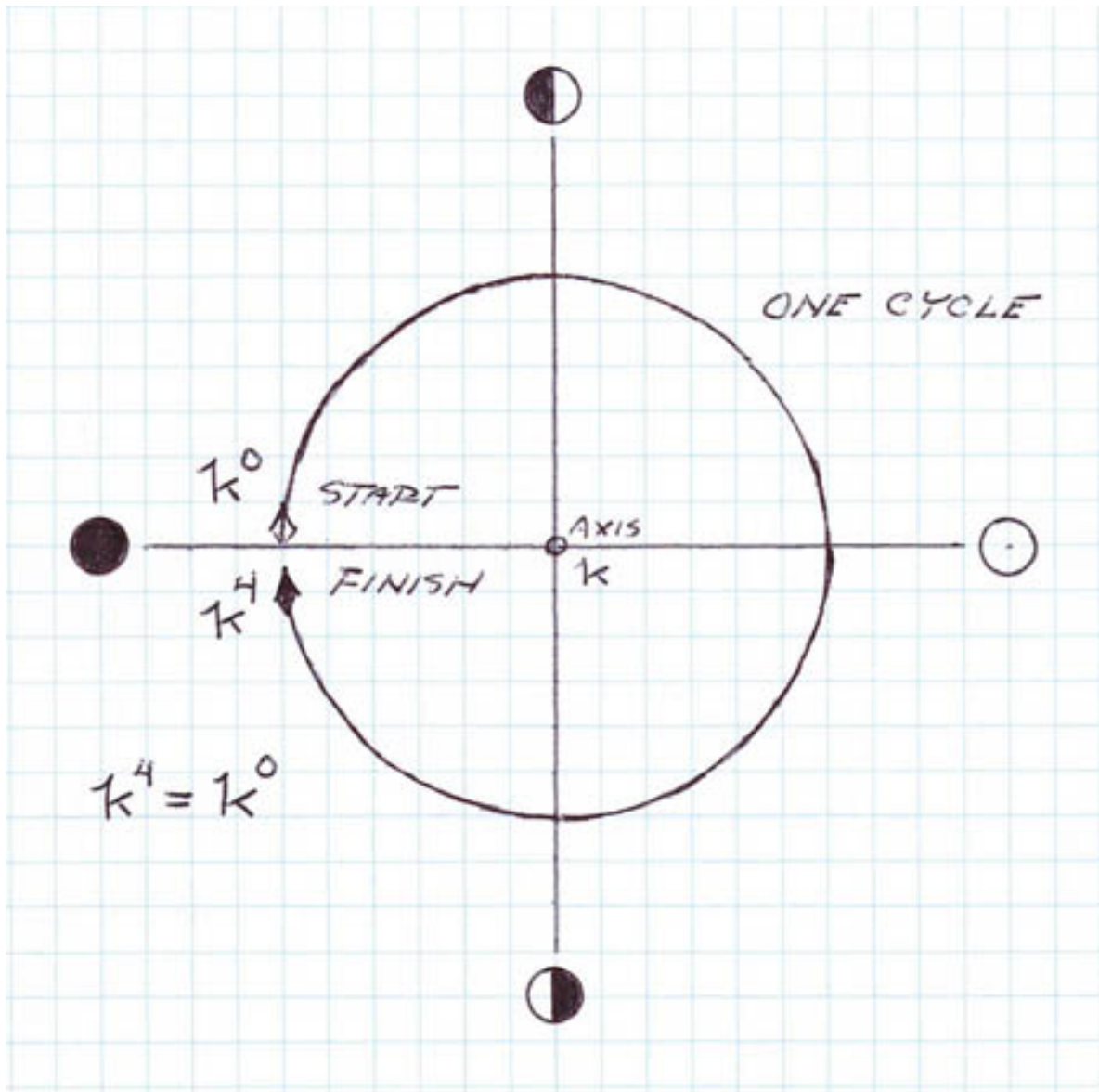

Figure 97

The exponents are given as:

- Zero No Rotation
- One First Unit Rotation
- Two Second Unit Rotation
- Three Third Unit Rotation
- Four Fourth Unit Rotation



Four unit rotations complete the cycle at Zero.

Figure 98

2.4 The Rotational Operator

Each unit rotation can be represented by the letter j . Each unit rotation is one unit versor operation or one unit amount of turning in advance. The letter j defines a rotational operator, that is, operation by j advances the cycle by one unit step.

The number of unit advances can be expressed by raising the operator j to a certain power or exponent. By the law of exponents j to the first power is still j , one unit degree of turning. Likewise in arithmetic form positive j is still only j , one unit degree of turning.

2.5 Versor Operations

The versor operation j acts upon a given versor position. A versor position is the starting or stopping point for a versor operation. The operation is the act of rotating between positions. The versor operator is given by the letter j . In an analog form the arithmetical operator is given by the letter h . The letter j is a quarter cycle change; the letter h is a half cycle change. The symbolic operator h constituted an arithmetic reversal.

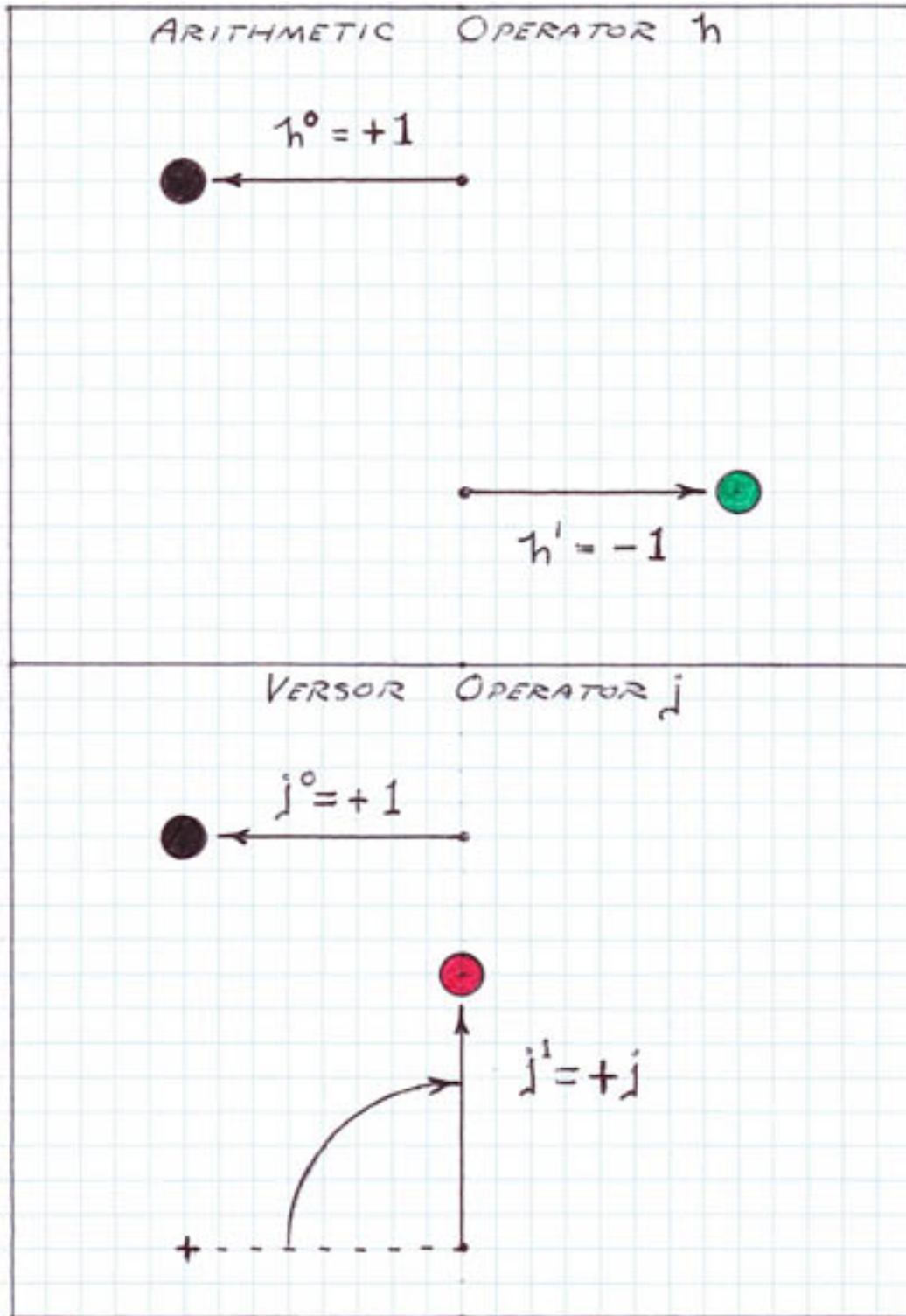

Figure 99

For example, the New Moon is operated upon by j ; the result is the Leading Moon.

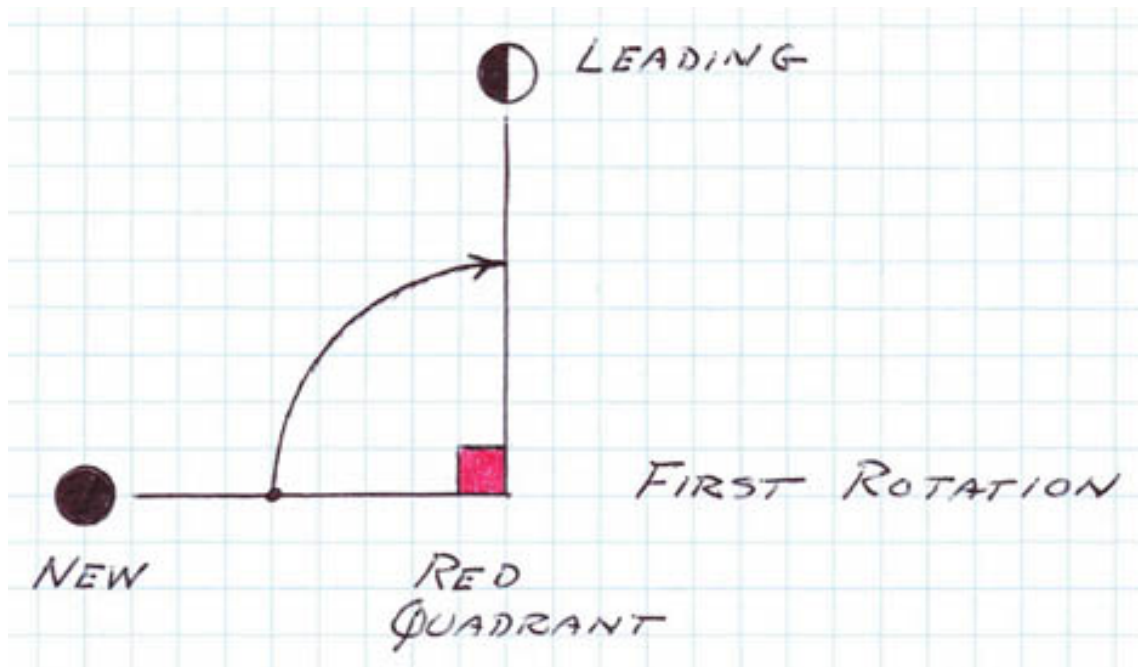

Figure 100

The Leading Moon is again operated upon by j ; the result is the Full Moon.

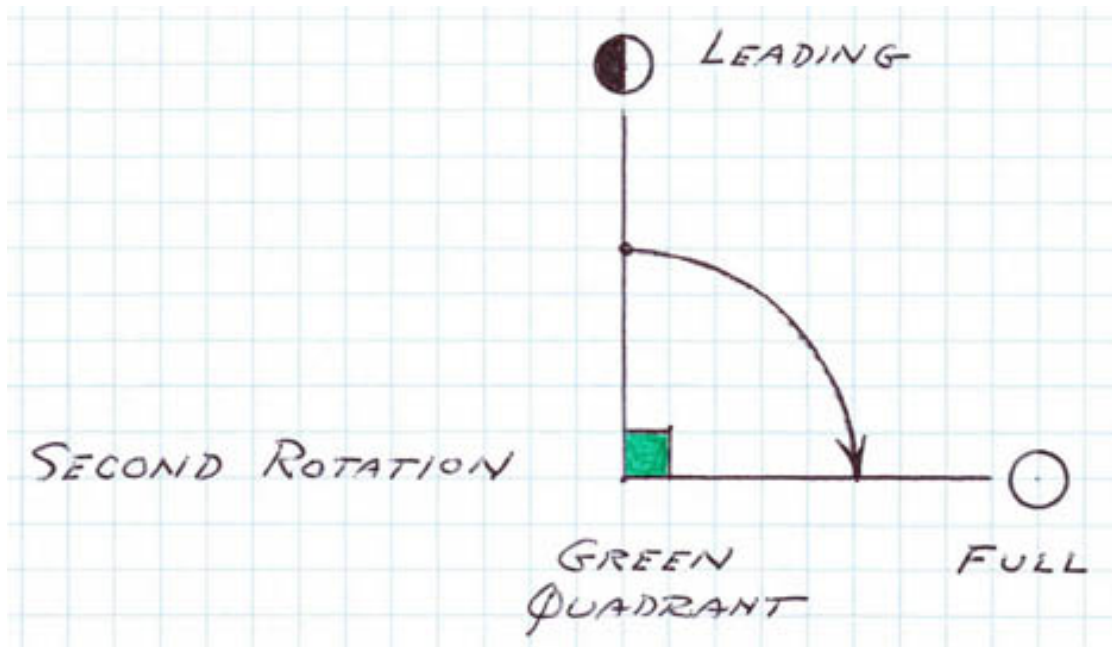

Figure 101

The Full Moon is again operated upon by j ; the result is the Lagging Moon.

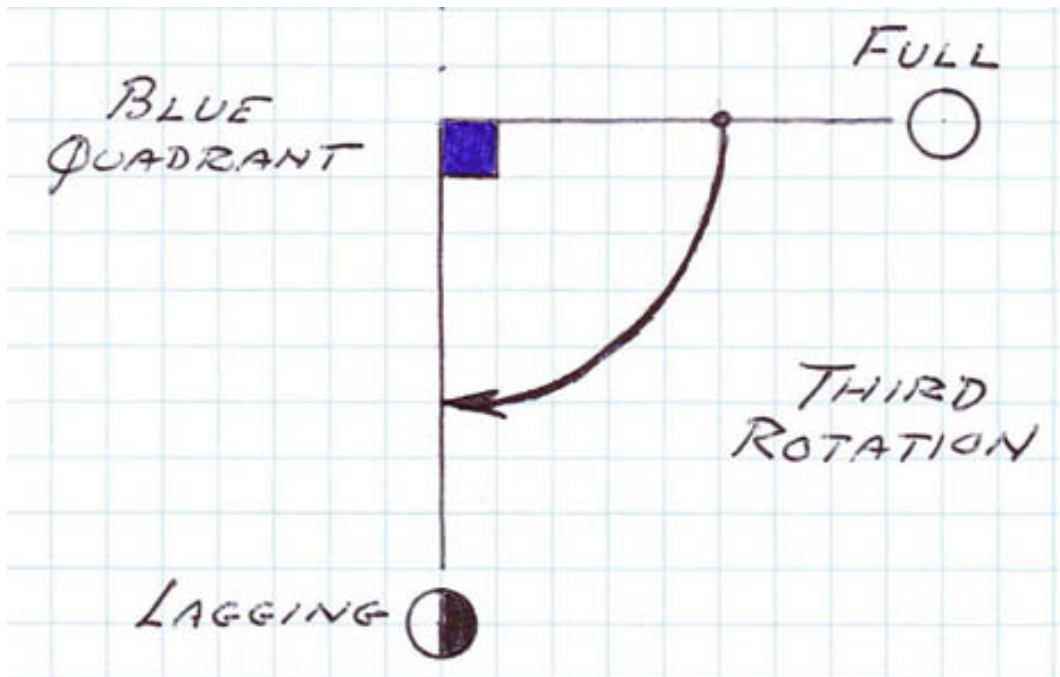

Figure 102

Finally, the operator j is applied to the Lagging Moon; the result being the completion of the cycle at the New Moon.

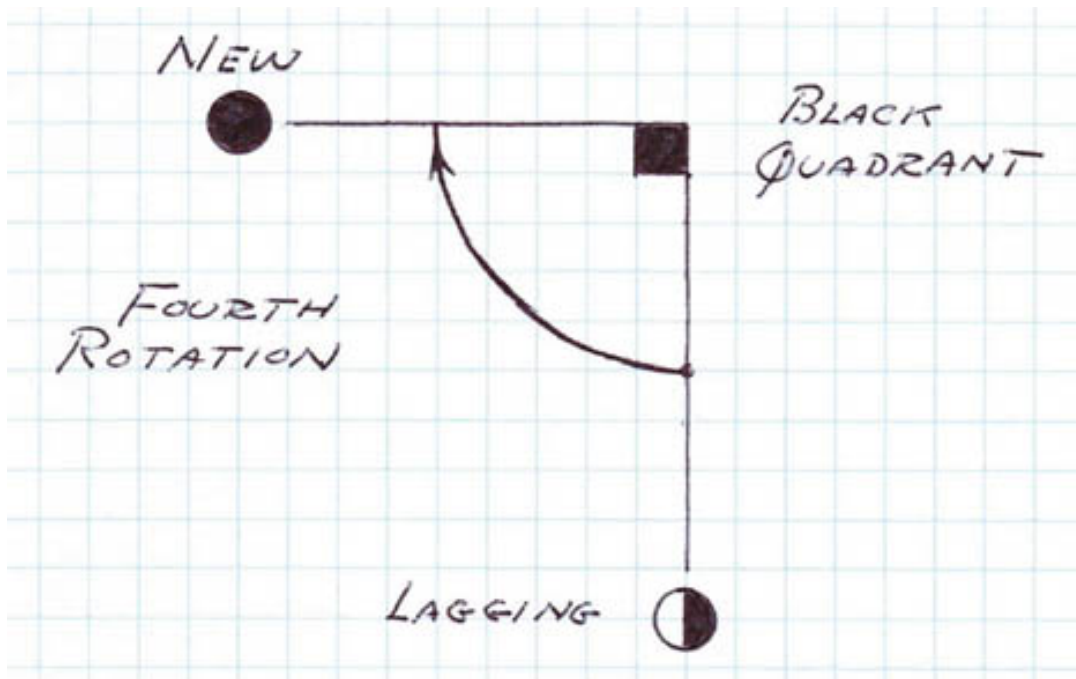

Figure 103

The operator j was applied once, its first power, the operator j was applied a second time, its second power, it was applied a third time, its third power, finally the fourth application of j returns to the zero power. The powers of the operator j define the number of times the operation has been performed. The numerical exponent defines the number of unit versor steps.

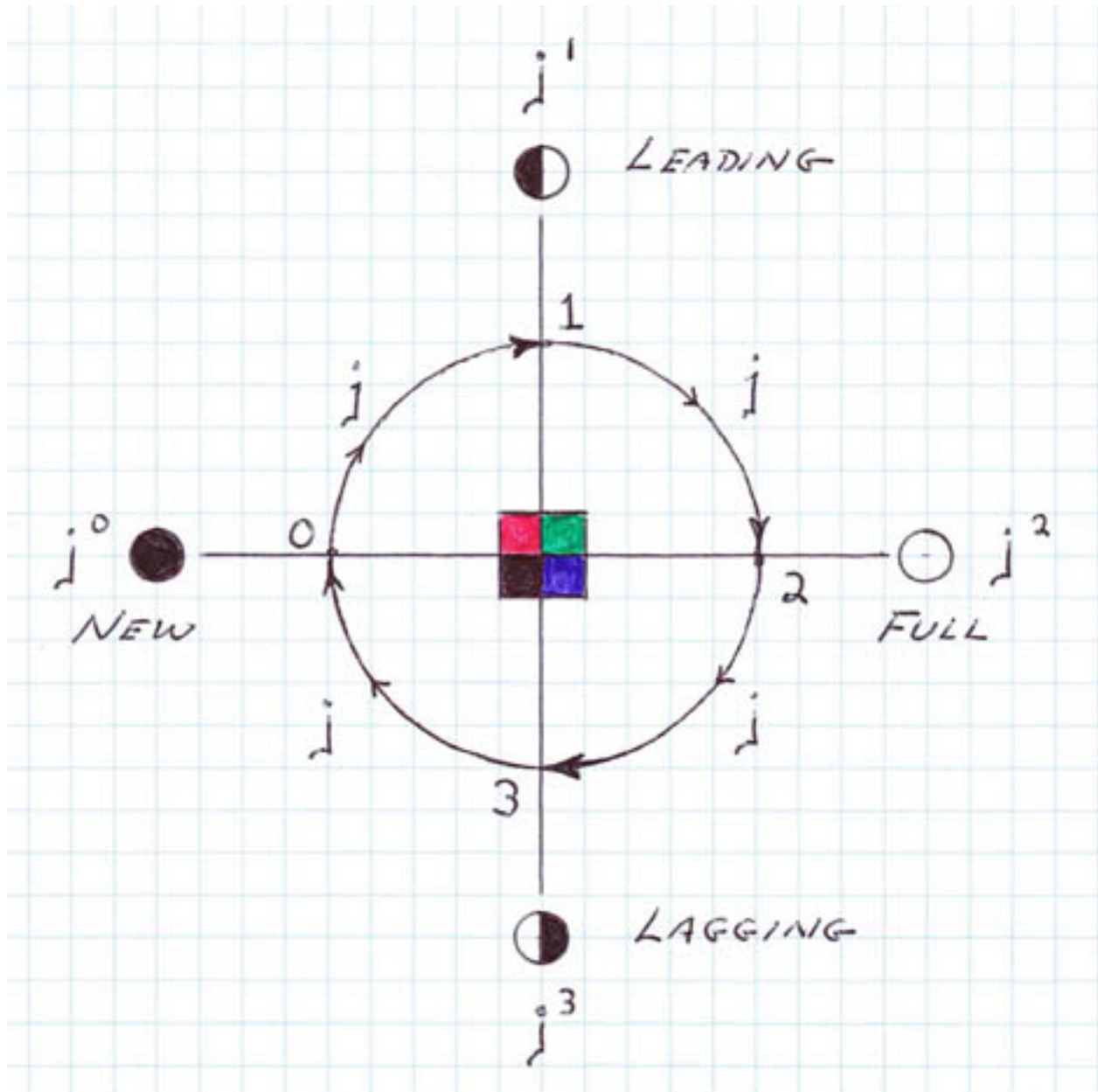

Figure 104

2.6 The Bipolar Operator

A similar example exists for bipolar symbolic representation. The New Moon is operated upon by h , the result is the Full Moon.

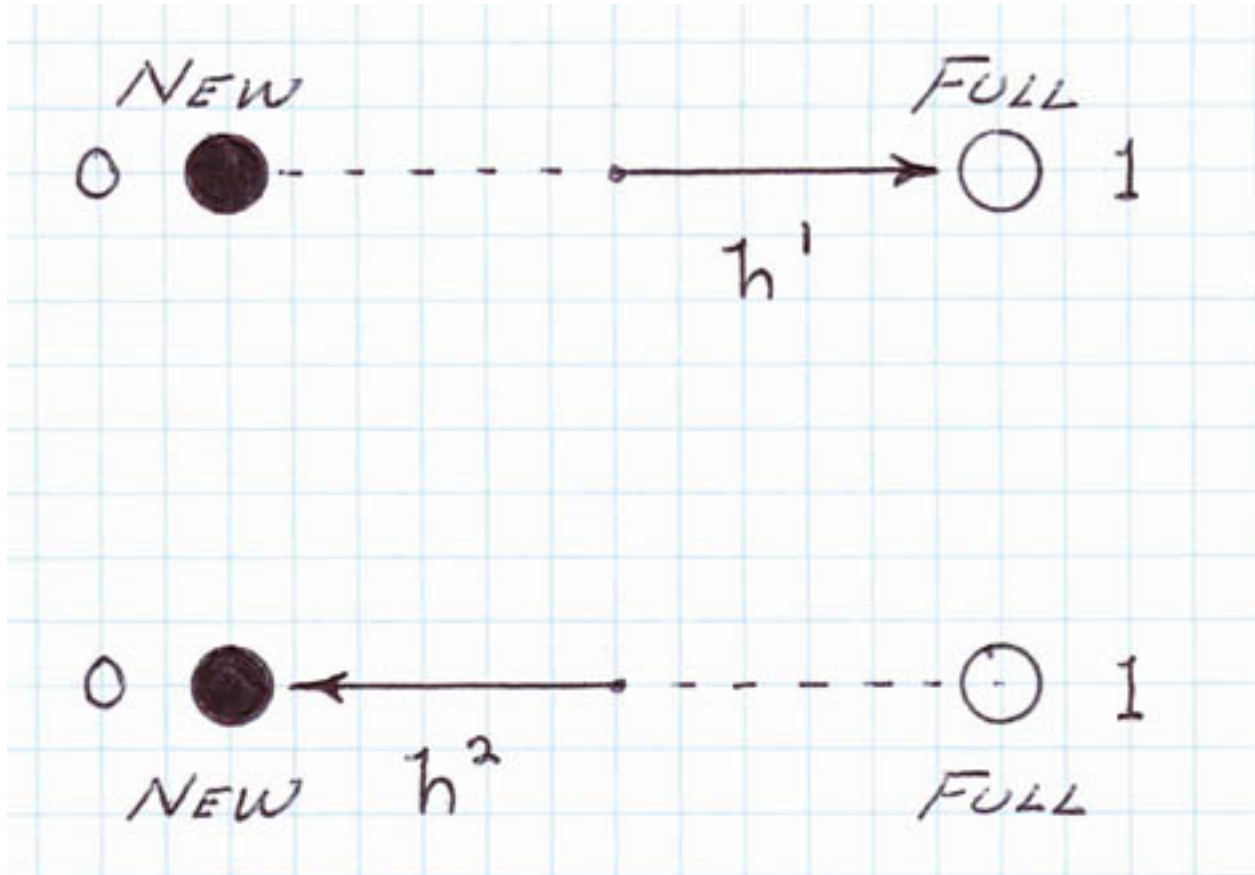

Figure 105

The Full Moon is in opposition to the New Moon, it is minus the New Moon.

The Full Moon is again operated upon by h , the result is the New Moon.

The New Moon is in opposition to the Full Moon, again a minus relation, the New Moon is minus the Full Moon.

The operator h applied once is its first power, the operator h applied a second time is its second power, which takes it back to the start, or New, the zero power. Once is minus, twice is plus, back to the starting point of the reversals. It can be seen four operations j complete a cycle, and that two operations h complete an alternation.

2.7 The Alternating Operator

The bipolar "Cycle" alternates between minus and plus. Its lunar form is New, Full, New, Full, and etc. This is representative of so-called single phase alternating current. Common A.C. is in reality bipolar and thus single phase is a misnomer. Bipolar is two phase. This has become an entrenched misunderstanding, distorting the Theory of Phases. Actual single phase has but one pole positive one and its transmission involves only one wire, such as the telluric transmission system of Nikola Tesla.

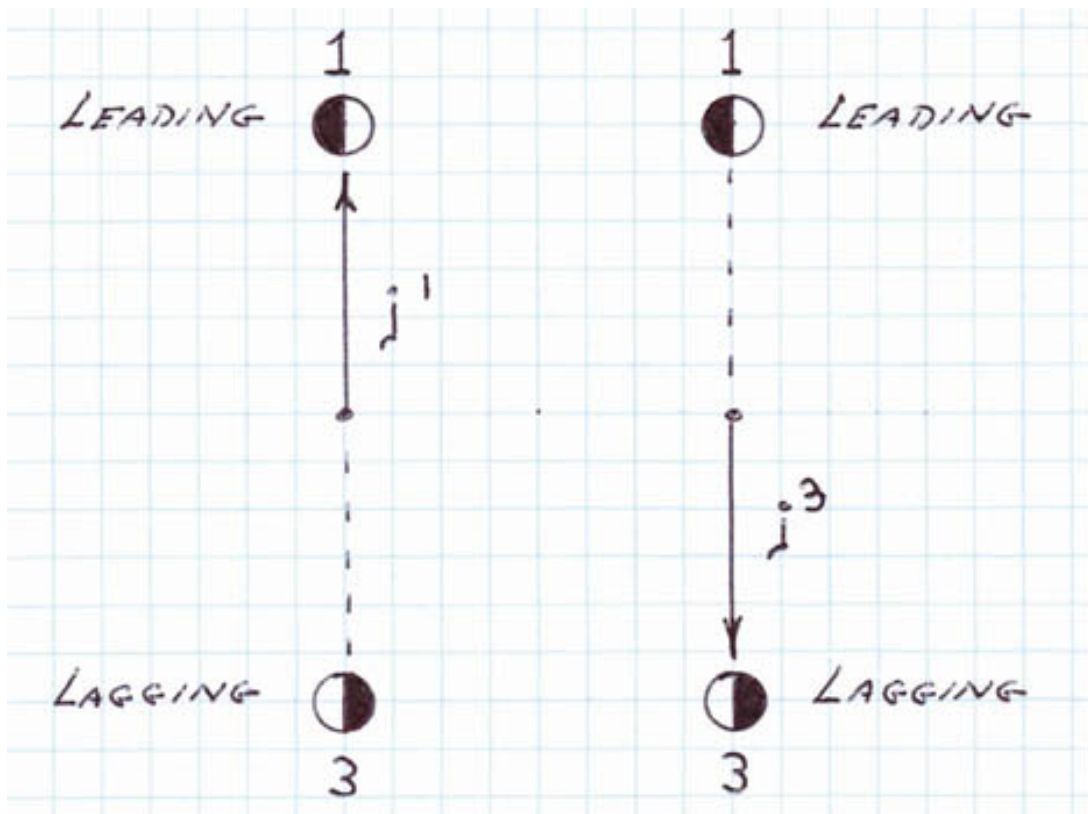

Figure 106

In lunar representation it is more correct to alternate between Leading and lagging in a bipolar A.C. configuration. This keeps in accord with the quadrapolar conception. Here the Leading Moon is operated upon by h , resulting in a Lagging Moon. The Lagging Moon is again operated upon by h , resulting in a Leading Moon, back to the point of origin. The continued operation is Leading, Lagging, Leading, Lagging, and etc. This again is an alternation, but now as an oscillation.

2.8 Real and Reactive Power

The New-Full alternation is on the Real Line, the Leading-Lagging oscillation is on the Imaginary Line. The alternation and the oscillation exist in a quadrature relation, displaced by one unit versor step.

In the alternating current analog the Real Line represents what is called "Real Power", the Imaginary Line represents what is called "Reactive Power". Real Power is the time rate of energy flow from production to consumption. This flow is in one direction, but alternates in its intensity. The reactive power is the rate of energy exchange between storage and return, this between two alternate forms of energy storage. This flow is bi-directional, oscillating between forms of storage. Here the energy is trapped, none is produced or consumed, it is continuously re-cycled over and over again. These two energies and power flows, the Real and the Reactive, are in quadrature with each other in the A.C. cycle. The Real and the Reactive are displaced by one unit versor step j .

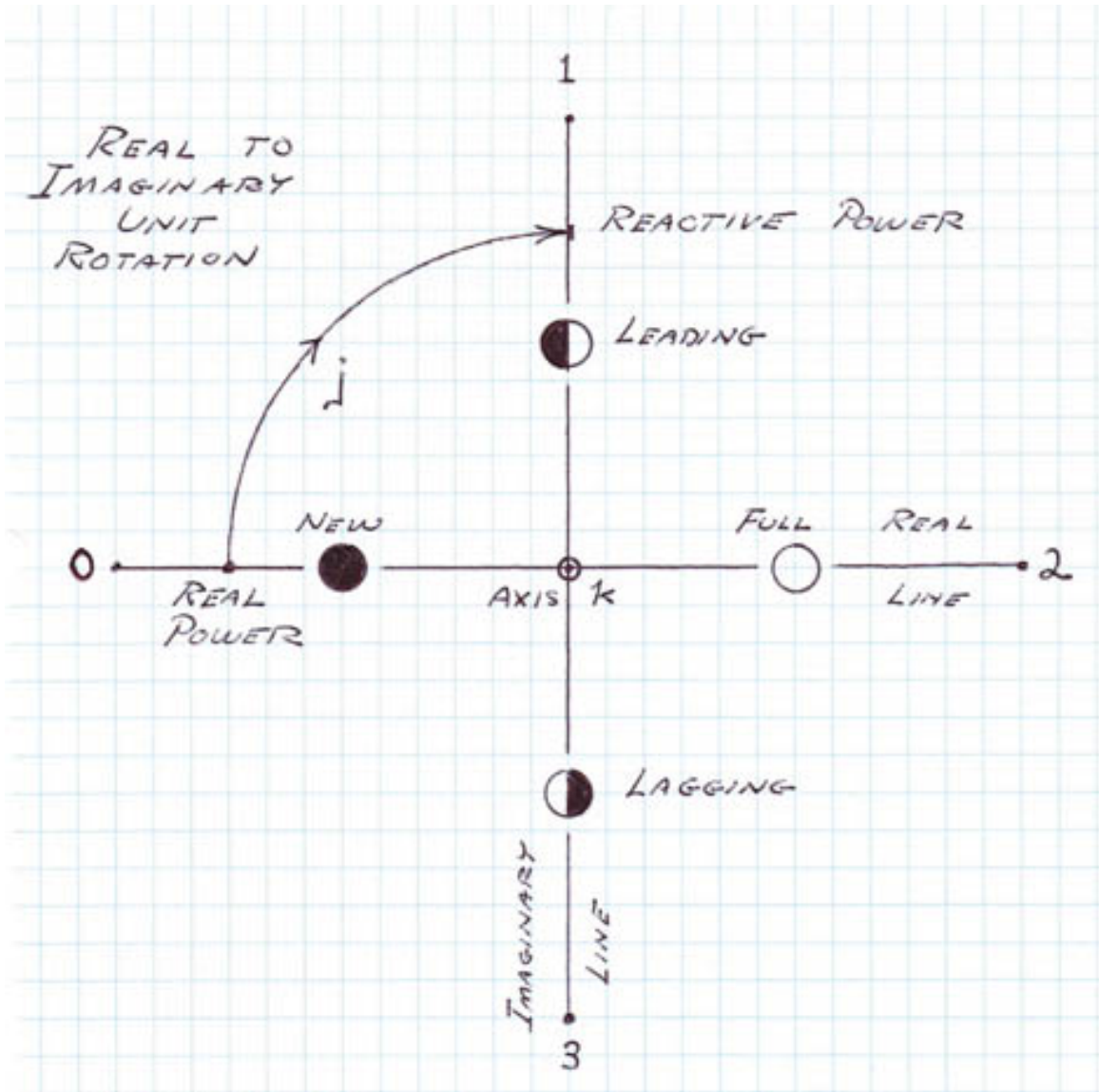

Figure 107

[3] The Quadrapolar Versor Operator

3.1 Bipolar Operation

The bipolar alternation represents reversals between two states or positions. The operator is h . The quadrapolar cycle represents rotations between four states or positions. The operator is j .

The bipolar form gives the so-called single phase A.C. The quadrapolar form gives the so-called polyphase A.C. The operator h in succession is a single phase wave, the operator j in succession is a polyphase wave. Operator h to the second power is one complete alternation or two reversals. Operator j to the fourth power is one complete cycle or four rotations.

3.2 Fourth Order Expression

One complete cycle is the result of four unit versor operations j , these in succession. Since the operator j is applied four times, j is multiplied by itself four times. Exponentially this is j to the fourth power. Hence, j to the fourth power is an identity of the quadrapolar cycle, lunar or A.C.

Since this is one unit cycle, the expression is j to the fourth power and is equal to positive one.

$$\mathbf{j^4 = 1}$$

4TH ORDER EXPRESSION OF UNITY

Figure 108

This is the fourth order algebraic expression of one unit cycle.

In logarithmic form, the algebraic definition of the quadrapolar versor operator j is the fourth root of positive one, in exponential form this is expressed by positive one to the one fourth power.

$$j^0 = +1$$

$$j^1 = +j$$

$$j^2 = -1$$

$$j^3 = -j$$

FOUR ROOTS OF THE QUADRAPOLAR VERSOR OPERATOR

Figure 109



$$1^{\frac{1}{4}}$$



QUADRAPOLAR VERSOR OPERATOR
Figure 110

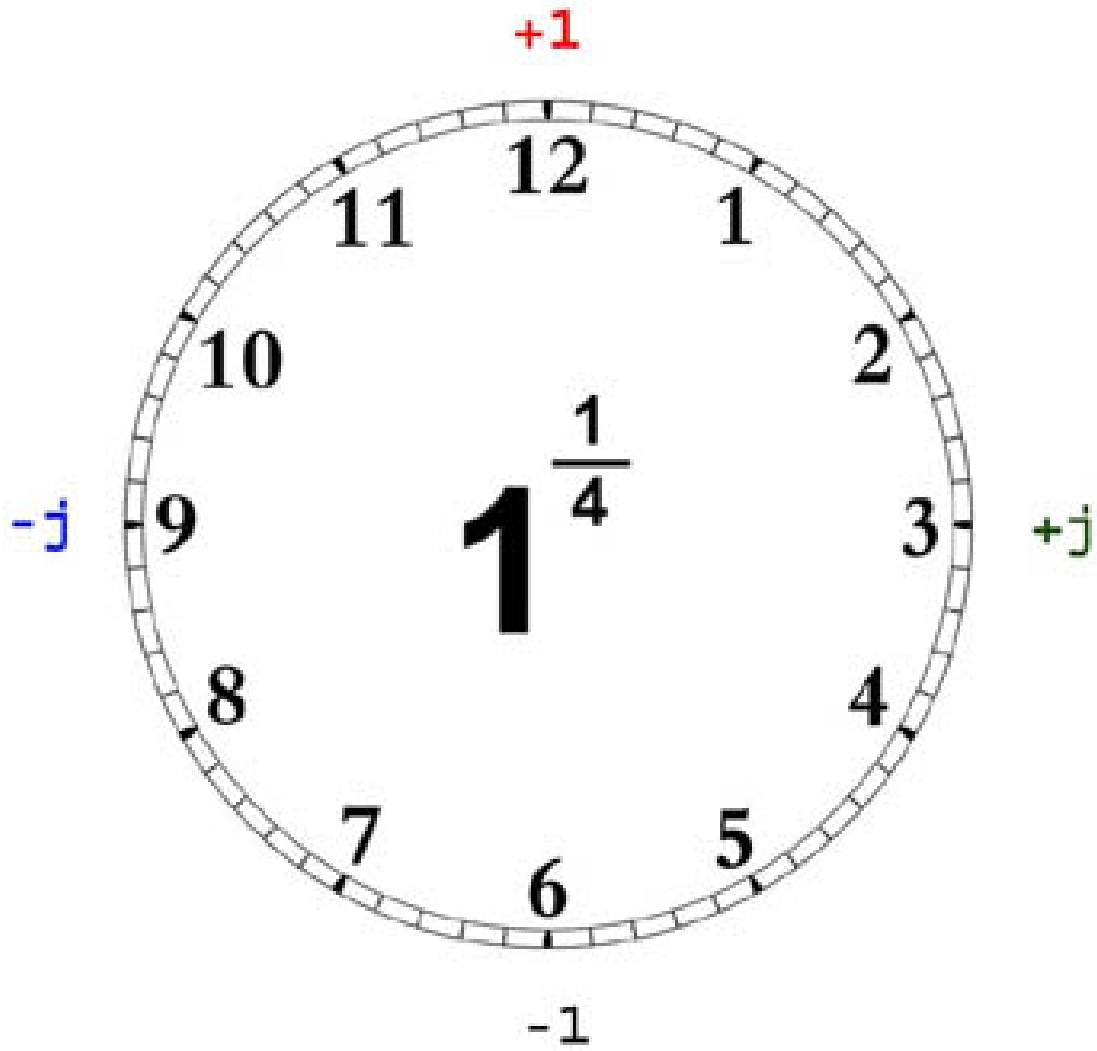

$$\begin{array}{lll}
 +1 = j^0 & -1 = j^2 & \sqrt{+1} = +1, -1 \\
 +j = j^1 & -j = j^3 & \sqrt{-1} = +j, -j
 \end{array}$$

Figure 111

This fourth order expression has four roots:

- I) j to the zero power, positive one
- II) j to the first power, positive j
- III) j to the second power, negative one
- IV) j to the third power, negative j

[4] Duo-Binary Representation

4.1 Bipolar Real, Bipolar Imaginary

A fourth order expression must have four roots, these can be given in a quaternary number system of exponents, zero, one, two, and three. Likewise a second order expression must have two roots, these can be given in a binary number system of exponents, zero and one.

It was shown that the Real Line, or the Imaginary Line each are bipolar within themselves. Each can be their own second order expressions, each has two roots in a binary series. The quaternary series of exponents can hereby be represented as a duo-binary series of exponents. This pairing is unique to the four phase arch form in that it can be derived from two so-called single phase forms in a quadrature relation, this is a great simplification.

4.2 The Exponential Series

In the duo-binary form of representation the quaternary form is split into an interlinked pair of binary type sequences. The exponents in the real binary sequence are the alternating numerals, zero and two. The exponents in the imaginary binary sequence are the alternating numerals, one and three.

In the duo-binary form each successive numeral exponent alternates between the Real and Imaginary sequences.

- 0, Real, Even
- 1, Imaginary, Odd
- 2, Real, Even
- 3, Imaginary, Odd

4.3 Roots of the Unit

The four roots in duo-binary form are given as a pair of second order expressions, each having their own pair of square roots. Here the fourth root of positive one is given as a tandem pair of square roots, the square roots of positive one and the square roots of negative one. Each square root has two roots, this giving the four roots total. This gives the relations:

- I) Square Root of Positive One
 - 0) Positive one, Zero Power
 - 2) Negative One, Second Power

- II) Square Root of Negative One
 - 1) Positive j , First Power
 - 3) Negative j , Third Power

4.4 Lunar Representation

In lunar form the New Moon and Full Moon is the Real Line. This is given by the square root of positive one, giving two roots, New and Full, that is, Positive and Negative One.

The Leading Moon and Lagging Moon is the Imaginary Line. This is given by the square root of negative one, giving two roots, Leading and Lagging, that is positive and negative j . In all this gives four roots, the four lunar phases, here in duo-binary form.

This provides the rigorous definition of what is exactly meant by the “square root of minus one”. It is an incomplete set of roots for the fourth root of positive one, these roots defining the operator j .

(IV) Versor Relations Between Sun, Moon, and Earth

[1] Versor Attributes of Light and Dark

1.1 Quadrapolar Aspects

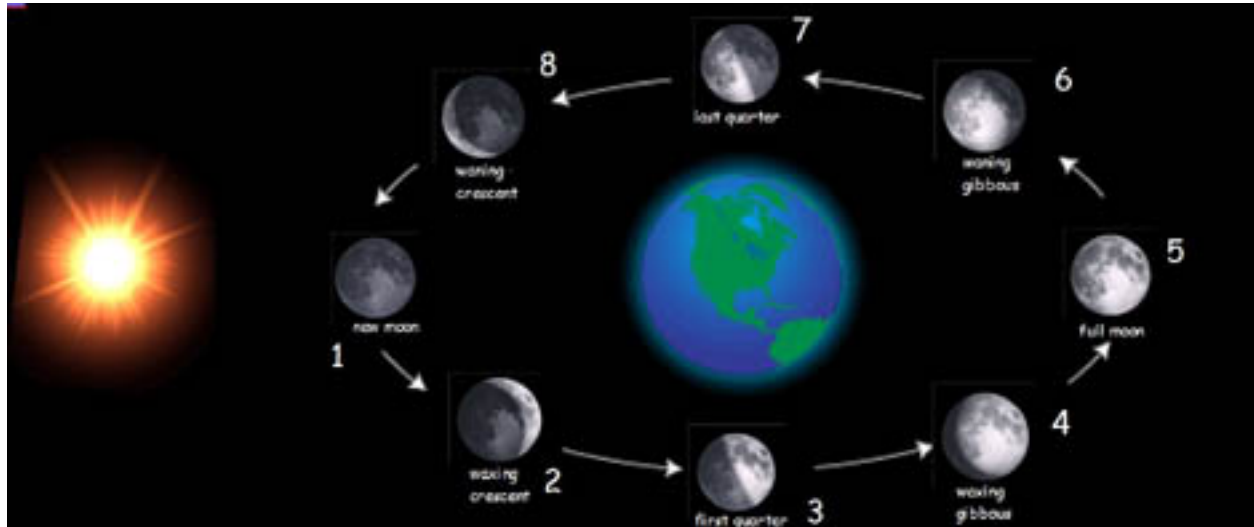

POSITIONS OF SUN, MOON & EARTH

Figure 112

Examination of the relative positions of the Sun, Moon, and Earth gives further insight into quadrapolar relationships and their application in alternating current theory.

Each unit versor rotation describes a quadrant in its passage from one unit versor position to the next, that is, from one phase to the following phase. Four unit rotations complete the cycle, this describing four distinct quadrants. Each quadrant manifests a distinct aspect of the cycle, such as winter, spring, summer, and fall. In lunar representation, a principle aspect is the ration of light to dark on the lunar face. These aspects can be related to aspects of alternating current.

1.2 Positions of the Sun and Moon

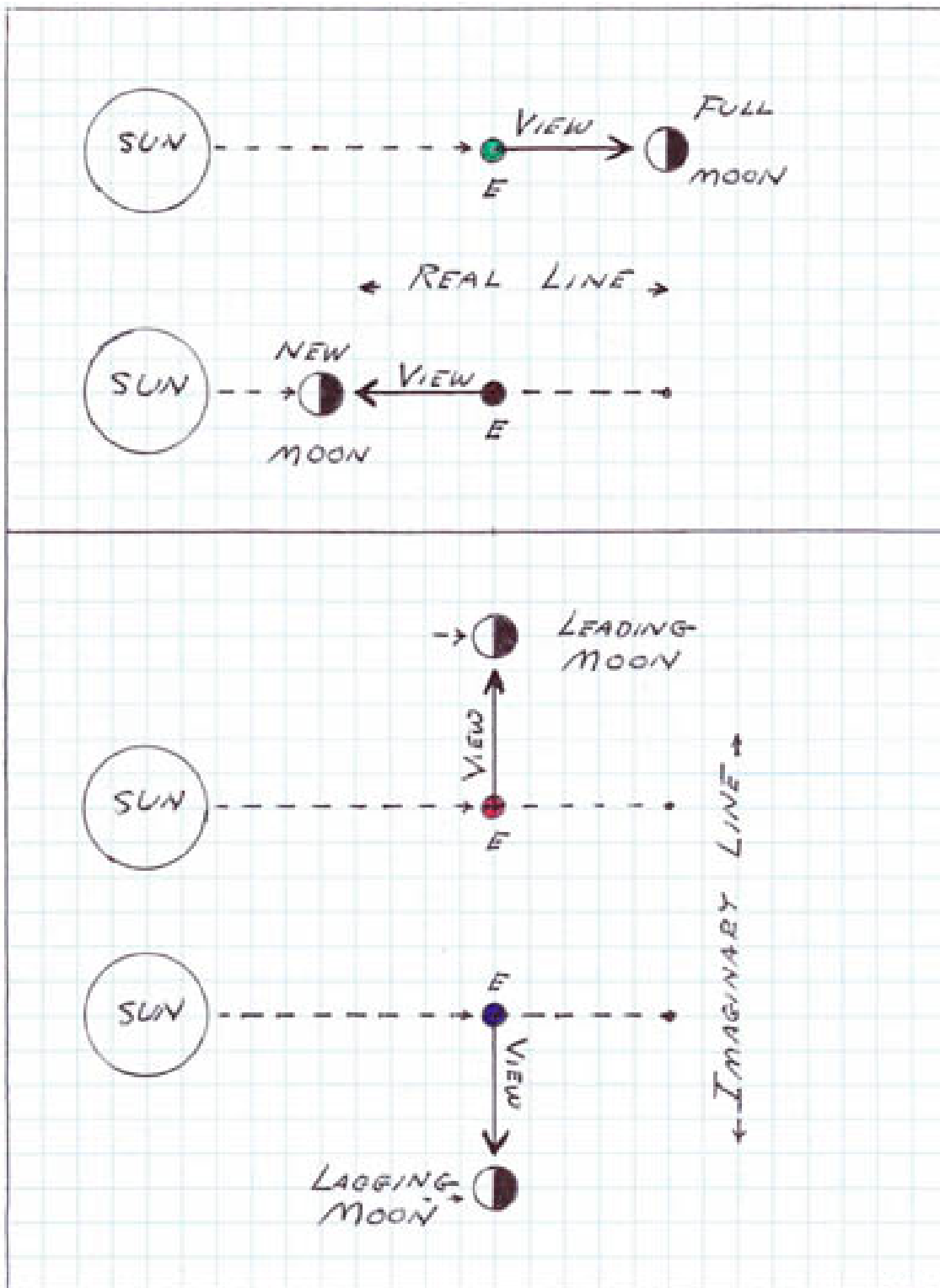

Figure 113

While facing a Full Moon the Sun is directly behind you. The Sun, Moon, and Earth are all in the same line, the Real Line. The Earth is positioned between the Sun and Moon. The face of the Moon is directed at the Sun behind you, this giving full illumination to the lunar face. Because the Sun and Moon are on opposite sides of the Earth, the Moon is in phase opposition; hence, the operator negative one.

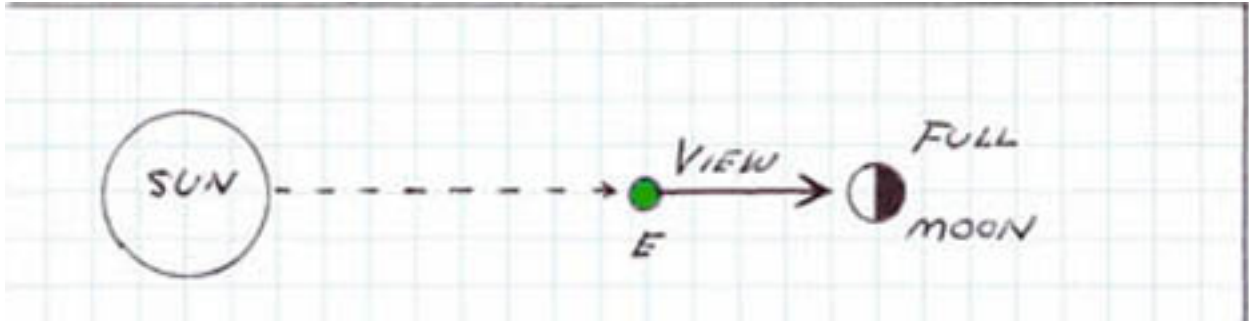

Figure 114

During the New Moon you face the Sun and Moon. The Sun, moon, and Earth again are all in a line, the Real Line, but now the Moon is positioned between the Earth and Sun. The Moon and Earth have exchanged positions relative to the Full Moon. The face of the Moon is directed at the Earth, not the Sun, hence the New Moon is not visible, is it dark. Because the moon and Sun are on the same side of the Earth, the Moon is in phase conjunction; hence the operator positive one.

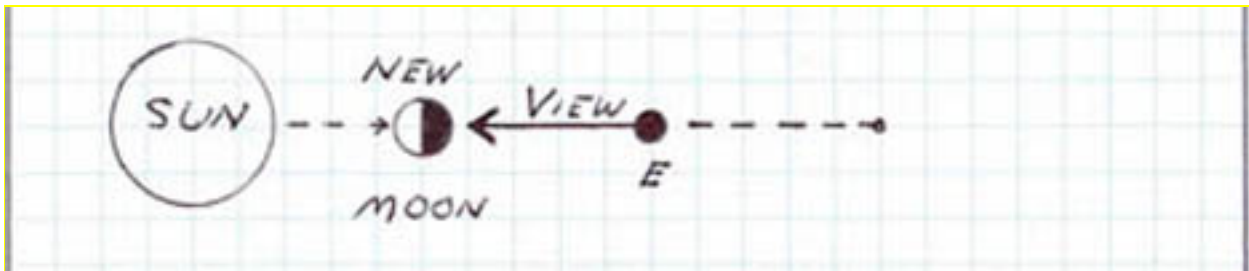

Figure 115

1.3 Co-Axial Systems

Both the Full Moon and the New Moon are positioned on the Real Line. Phase conjunction is the position of positive one, phase opposition is the position of negative one. In the plus configuration the Sun and Moon are on the same side, in the minus configuration the Sun and Moon are on opposite sides.

The New and Full Moon are on the Real Line and this line is co-linear with the Sunrise-Sunset line. The Full Moon is at sunset, the New Moon is at sunrise. The Full Moon rises in the East the moment the Sun sets in the West. Here the lunar cycle of New-Full and the solar cycle of Sunrise-Sunset are co-axial versor systems. These share a common axis, that of the Earth. However, each is an independent rotation.

1.4 Quadrature Relations

The Leading-Lagging Moon establishes the Imaginary Line. Now the Sun, Moon, and Earth are not in the same line, the Sun and Moon are at right angles with respect to the Earth. Both the Moon and Earth face the Sun, side by side. Hereby only half the lunar face is light, the side directed at the Sun, the half directed away from the Sun is dark.

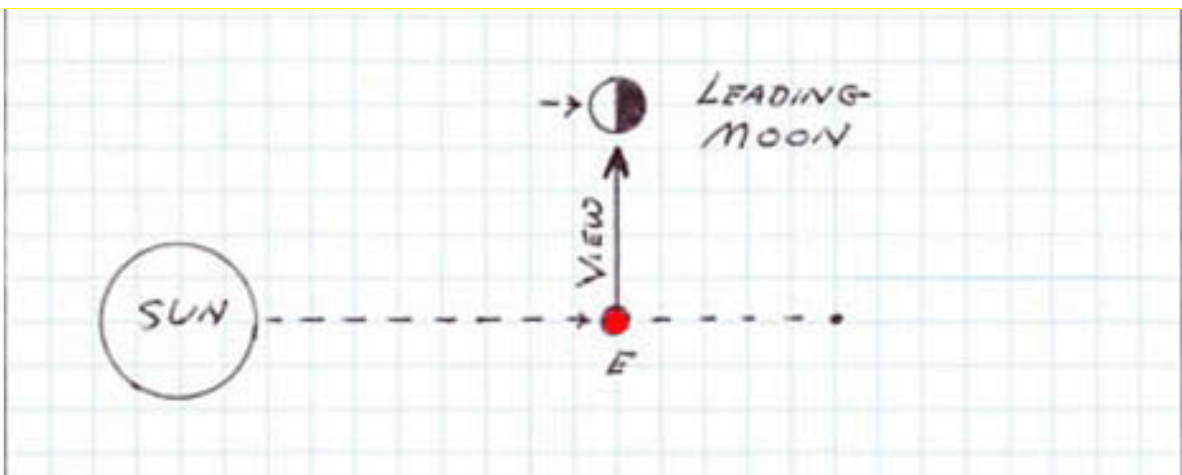

Figure116

When the angle between the Moon-Earth-Sun is one pi over two (90°), or positive j , the Moon is in Phase Leading Quadrature. When the angle between the Moon-Earth-Sun is three pi over two (270°), or negative j , the Moon is in phase Lagging Quadrature.

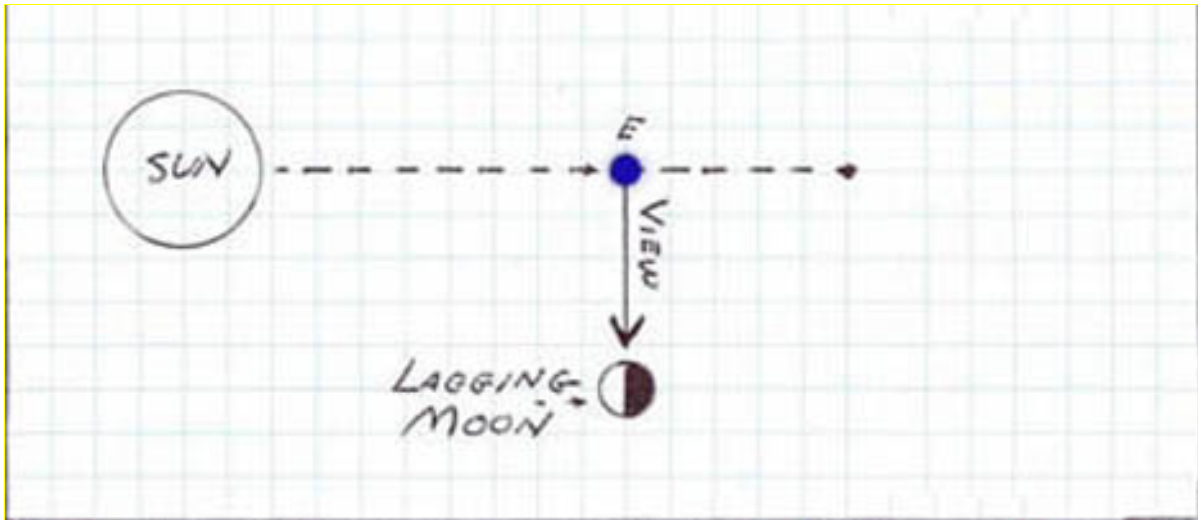

Figure 117

Both the Leading Moon and the Lagging Moon are positioned on the Imaginary Line. The Phase Leading Quadrature is positive j , the Phase Lagging Quadrature is negative j . In the plus j configuration the Moon is on the noon position of Earth, the Sun is at the Sunset position of the Earth. The Moon and Sun are in Quadrature. In the minus j configuration the Moon is on the midnight position of the Earth, the Sun is on the sunrise position of the Earth. Again the Sun, Moon, and Earth are in Quadrature, but in an opposite sense. Sunrise and Sunset are on the Real Line, Leading and Lagging are on the Imaginary Line. The lunar cycle and the solar cycle are co-axial versor systems, but here the lunar cycle is n Quadrature with the solar cycle, they are "Out of Phase". The Leading Moon is in the noon position that was occupied by the Sun in another part of the cycle; they are in different time frames, displaced one unit versor step. Likewise the Lagging Moon is in the midnight position occupied by the Sun in a different part of the cycle, and it is also displaced one unit versor step, just as was

the Leading Moon. The two co-axial versor systems, lunar and solar, are out of phase by one unit versor rotation j .

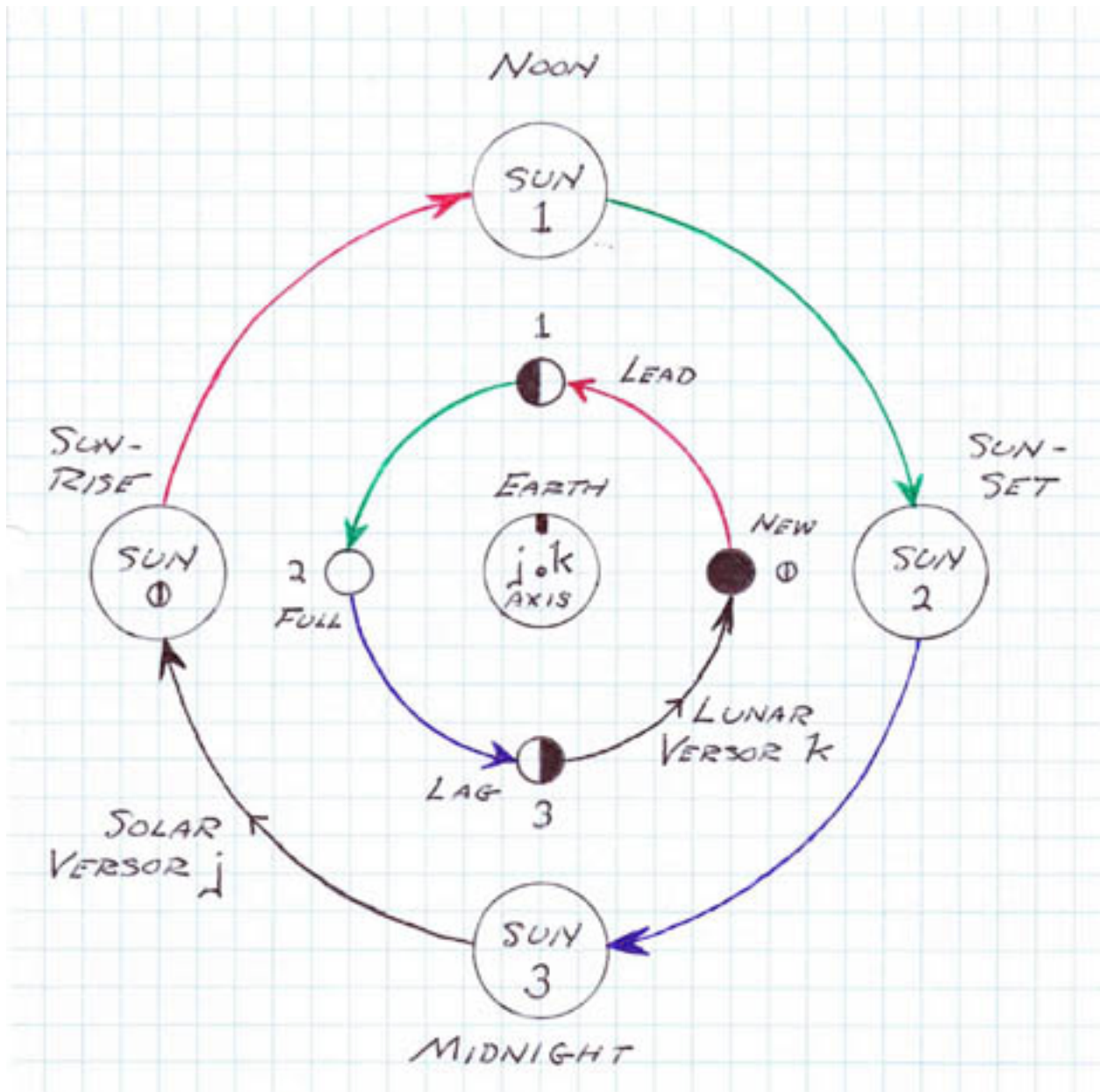
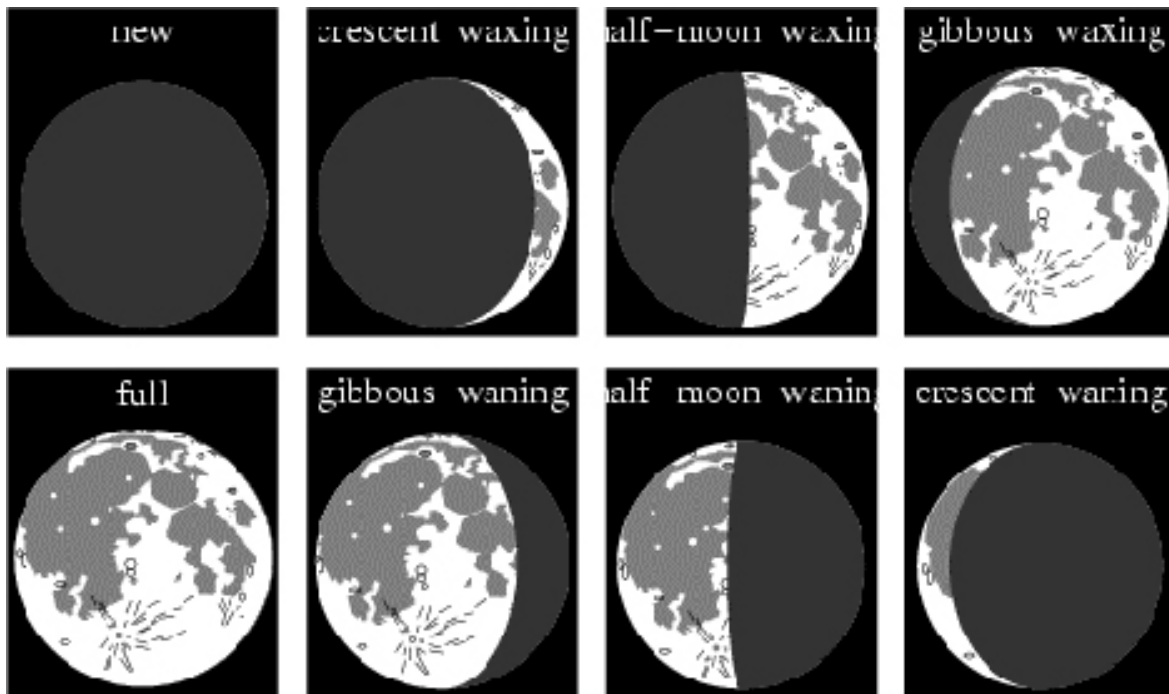

Figure 118

1.5 Ratios of Light and Dark



LUNAR RATIOS OF LIGHT & DARK

Figure 119

The ratio of light and dark for Leading and Lagging is the same, 50 percent. However, the relative positions of light and dark are reversed from leading to Lagging. When the Leading Moon is in the noon position the light face points towards the Sun setting in the West, its dark face points away to the East. Thus the face of the Moon appears half dark to the East, and half light to the West. This will be called a positive 50 percent. When the Lagging Moon is in the midnight position its light face points to the Sun rising in the East, the dark face pointing away to the West. The dark to light ratio is now the light to dark ratio, but both ratios are 50 percent. This will be called a negative 50 percent. Two 50 percent ratios exist: Leading, Positive 50 percent, Lagging, negative 50 percent.

The Full Moon is 100 percent light, 0 percent dark. The New Moon is 100 percent dark, 0 percent light. Between the Full and New Moon is a total change from light to dark, that is, from all to none, and none to all. This is

not the case with the Leading-Lagging Moon. In both phases there is no change in the ratio of light to dark, only in its direction. This serves as an important distinction between the conditions of the Real Line and the imaginary Line. Analogous is the condition of Real Power and Reactive Power.

[2] Solar-Lunar Co-Axial Versors

2.1 The pair of Cycles

In the examples presented, two distinct cycles exist, lunar and solar. Both rotate upon the same axis. One set of phases is New, Leading, Full, Lagging, the other set of phases is sunrise, noon, sunset, midnight. Each set of phases is a versor system, and these two systems are co-axial, they share a common axis, the rotational axis of the Earth.

The quadrapolar versor relations of both cycles are given in exponential form as:

The Lunar Cycle

- (0) Zero Power, New
- (1) First Power, Leading
- (2) Second Power, Full
- (3) Third Power, Lagging

The Solar Cycle

- (0) Zero Power, Sunrise
- (1) First Power, Noon
- (2) Second Power, Sunset
- (3) Third Power, Midnight

Both cycles begin anew at the fourth power.

2.2 Solar-Lunar Cycles

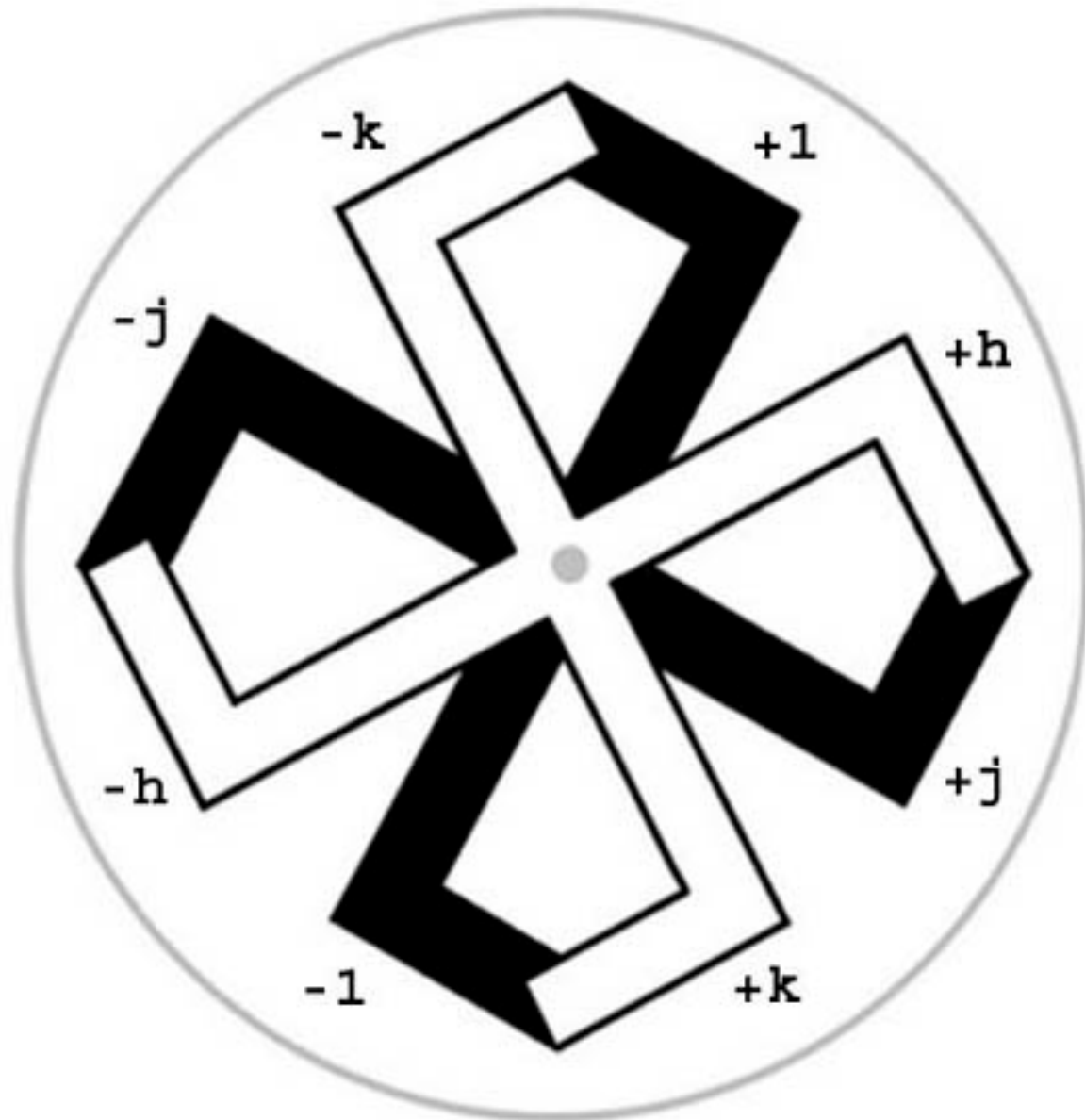

$+1 = j^4$	$-1 = j^2$
$+h = \sqrt{j}$	$-h = h^5$
$+j = h^2$	$-j = j^3$
$+k = h^3$	$-k = h^7$

COAXIAL VERSOR OPERATORS

Figure 120

The figure shows the basic relationships in a pair of co-axial versor systems. The light (White) system represents the solar cycle, the dark (Black) system represents the lunar cycle. The lunar cycle is continuously falling behind the solar cycle. Therefore, the lunar cycle does not revolve at the same rate as the solar cycle, it is slower. The net result is that the phases of the Moon change from day to day. The lunar cycle is on a different frequency than the solar cycle. This leads to a complex analysis situation.

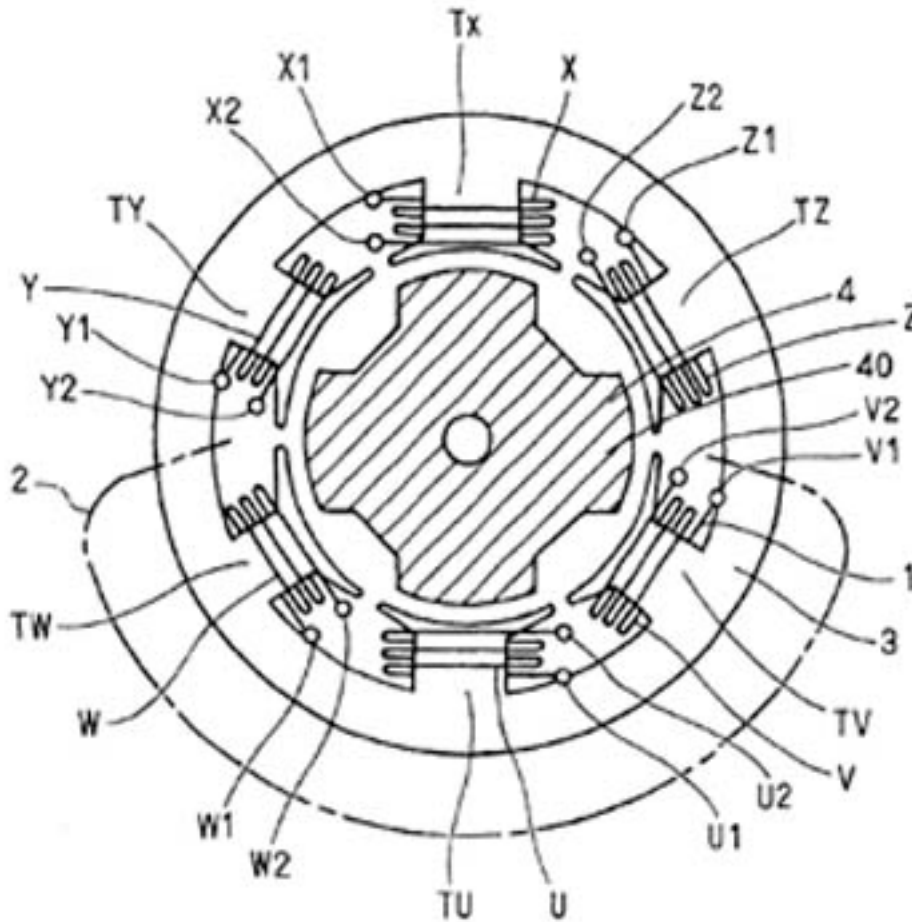

INDUCTION MOTOR ARCH FORM

Figure 121

These co-axial versor systems rotate at different frequencies, these two frequencies in combination give rise to a difference frequency, know as a Beat Frequency; it is much slower than the rate at which the lunar and solar cycles revolve. Therefore, while the positions of the Sun and Moon rotate on a daily basis, the difference rotates on a near monthly basis, giving the

cycle of lunar phases, commonly known as the “Lunar Cycle”. This difference is known as a “Slip Frequency”. This slip frequency gives the apparent lunar cycle, that of the phase change, this being the difference of the solar cycle and the actual lunar cycle of revolution.

A similar condition of slip is encountered in the A.C. induction motor. Here the rotor constantly falls behind the rotating field of the stator. In basic terms, the rotor drags energy out of the stator, this at the rate of the slip frequency, by constantly falling behind.

2.3 Counter Rotational Cycles

Co-axial versor systems can also be counter-rotational. Refer again to Double Swastika (See Figure 120). Here the dark quadrapole rotates in the counterclockwise direction; the light quadrapole rotates in the clockwise direction. In relation to a slip frequency, it is now the sum of the counterclockwise frequency and the clockwise frequency. If the dark and light quadrapoles counter-rotate at the same rate, that is, with equal but opposite frequencies, the slip frequency will be twice this. Therefore, counter-rotational cycles of a common frequency, 60 cycles per second for example, the resultant slip will be two times this, 120 cycles per second.

At certain positions in the counter-rotating cycles, the poles of the light quadrapole overlap the poles of the dark quadrapole. During this overlap of light and dark poles, a distinct aspect of the cycles occurs.

Shown in the figure the light cycle and dark cycle are one half versor step “Out of Phase”. This constitutes one eighth of a unit cycle. The symbolic notations show, 1, h, j, k, are arbitrary representations in this more complex versor relationship, not as previously utilized. Certain complex interrelations are shown at the bottom of the figure.

2.4 The Alternating Current Analog

The counter-rotational co-axial versor system can represent the structure of alternating current power. In this analog, the light quadrapole represents the electromotive force (E.M.F.) of magnetic activity; the dark quadrapole represents the displacement current of dielectric activity. The superposition of these two activities, in cooperation, gives rise to electric power.

Since both the light and dark quadrapoles are rotating at the same rate, but in opposite directions, the resultant power frequency is of twice the rate. For example, in a 60 cycle per second system the 60 cycle E.M.F. is counter rotational to the 60 cycle current. This gives rise to sum and difference frequency for the cycle of power. Hence, for a 60 cycle per second system, the cycle of power contains 120 cycles per second, the sum and zero cycles per second, the difference. The zero frequency is a D.C. offset representing the direction of power flow; the double frequency is the pulsation of power flow. Hence, the cycle of A.C. power is very much different than the pair of cycles that gave rise to it.

At certain positions in their counter-rotating cycles, the poles of the light and dark quadrapoles overlap. This happens four times per cycle. Each overlap represents a specific electrical aspect.

The four aspects are given as:

- I) Energy Production, First Overlap
- II) Energy Return and Storage, Second Overlap
- III) Energy Consumption, Third Overlap
- IV) Energy Storage and Return, Fourth Overlap

(V) The Lunar Phases

[1] Light and Dark on the Lunar Face

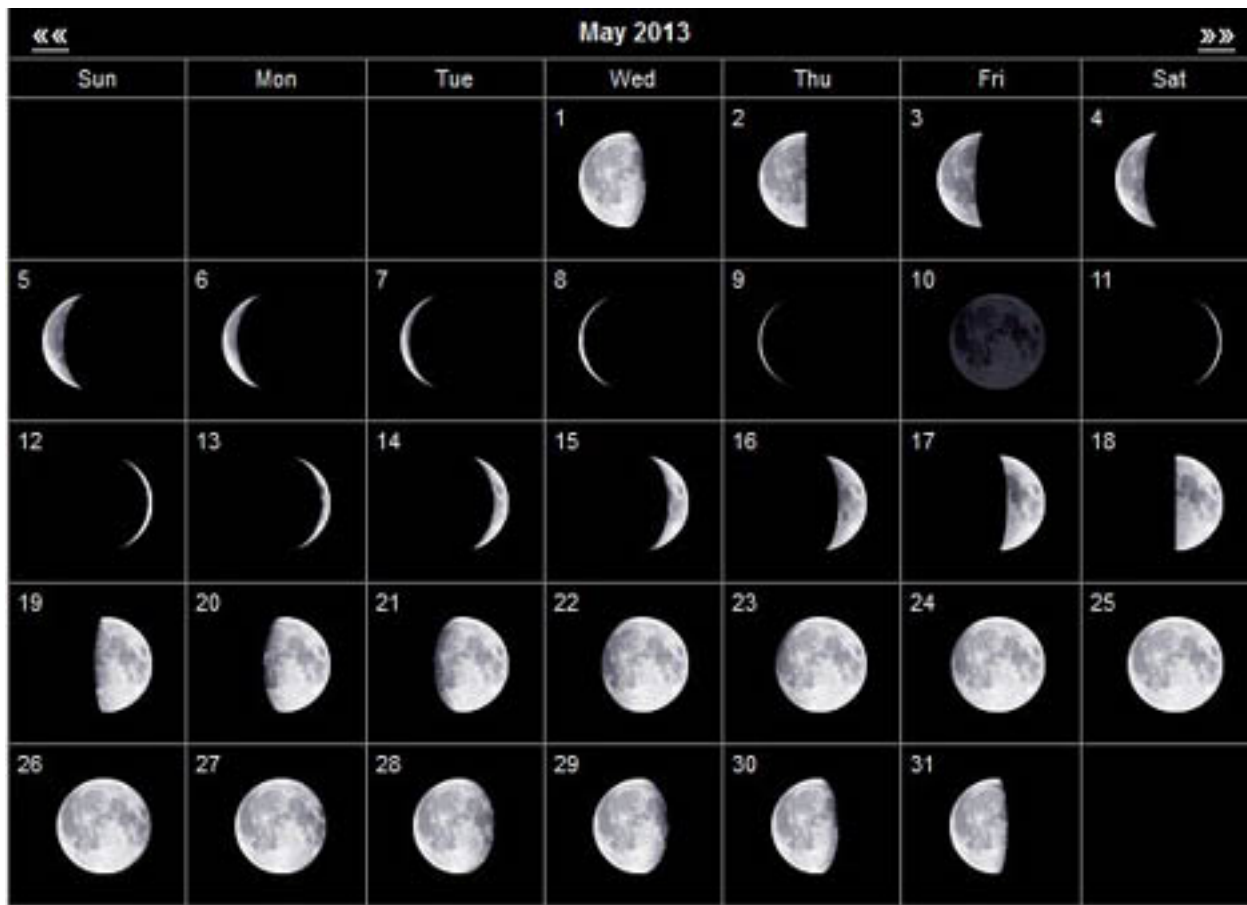

Figure 122

1.1 Proportion of Light and Dark

An important set of aspects are those produced by the proportion of light and dark on the lunar face. Four unit ratios of light and dark exist in the lunar quadrupolar relationship. These exist as a complimentary pair, the ratio of light to dark, and the ratio of dark to light.

This given is:

New	100% Dark	0% Light
Leading	50% Dark	50% Light

And

Full	100% Light	0% Dark
Lagging	50% Light	50% Dark

1.2 Positions of the Sun, Moon, and Earth

The dark side of the New Moon faces away from the Sun, the light side of the Full Moon faces toward the Sun. This is along the Real Line.

For the condition of Leading Moon only half the light side is visible and only half the dark side is visible. The light side faces the Sun, but the Earth is now in Quadrature with the Sun and Moon. For the Lagging Moon again only half the light side is visible and only half the dark side is visible. Since the Lagging Moon is on the opposite side of the Earth, the positions of light and dark on the lunar face are reversed. During the Leading Moon the light side is directed at sunset. During the Lagging Moon the light side is directed at sunrise. The ratio for both are 50 percent, but the positions of light and dark are reversed.

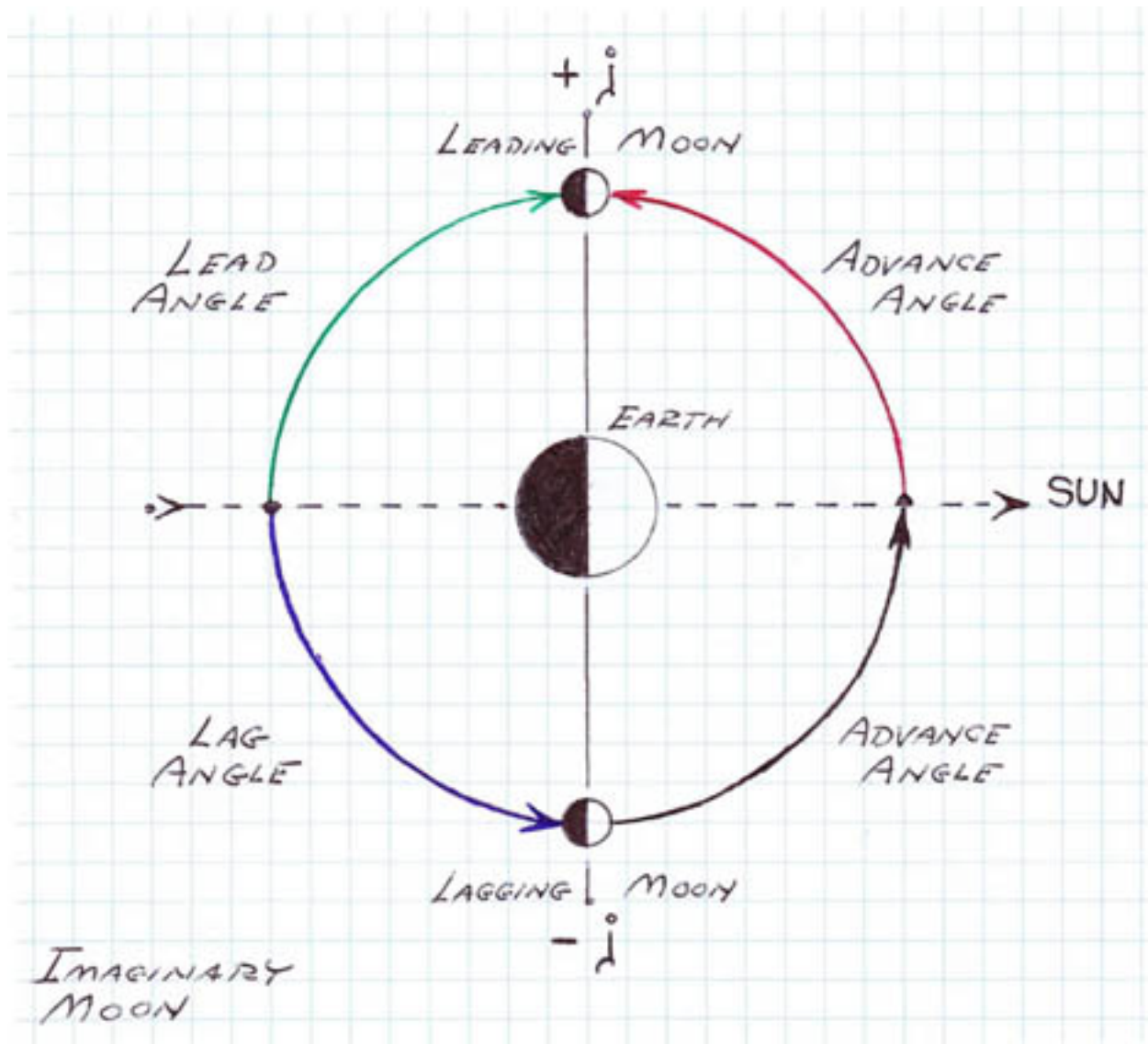

Figure 123

In the conditions of Full and New Moon, the light or dark face is on the Real Line. However, in the condition of Leading and Lagging Moon these lay on the Imaginary Line, the direction of the light side is in Quadrature with this Imaginary Line. For the New-Full conditions the directions are co-linear, for the Leading-Lagging conditions the directions are split into a Quadrature pair. These are important distinctions in Real and Imaginary relationships.

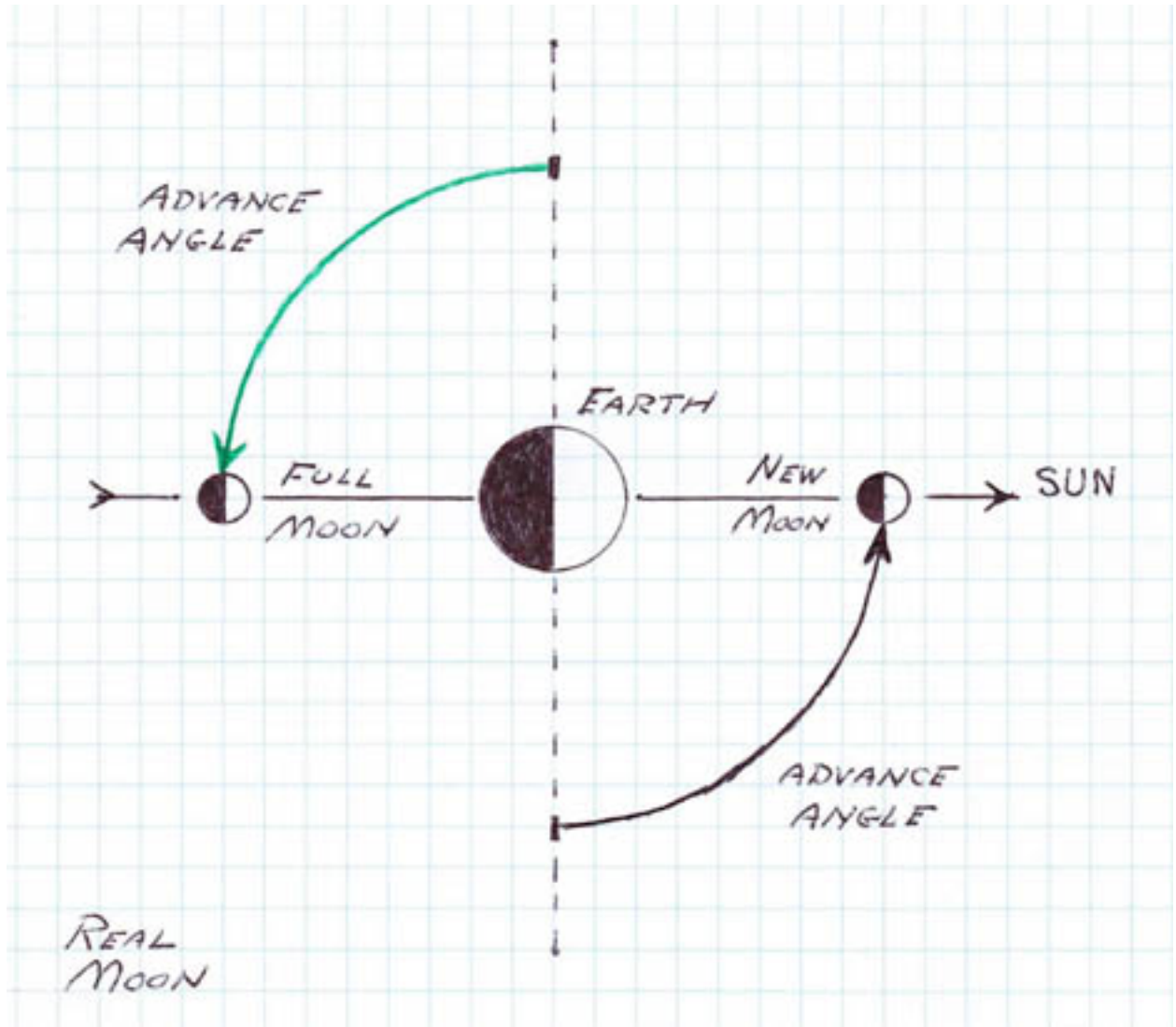
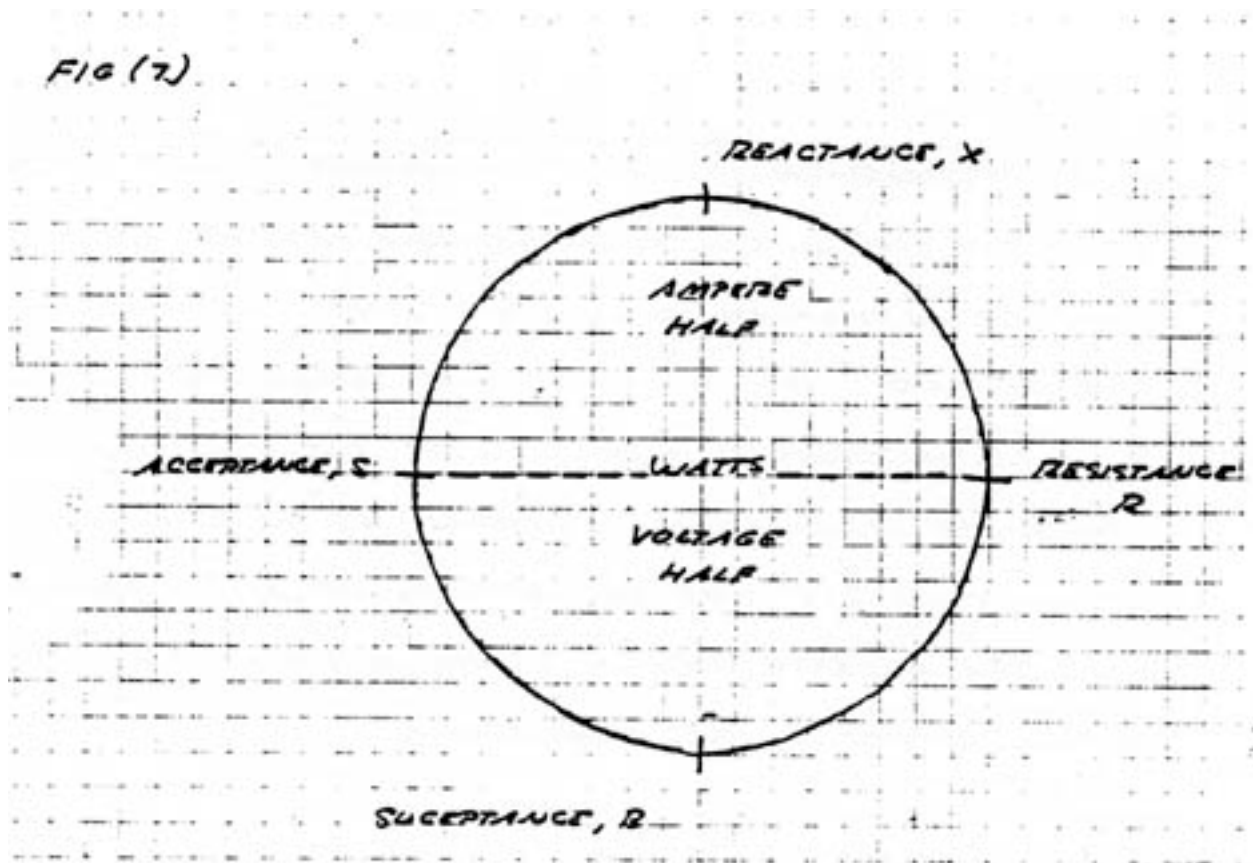

Figure 124

[2] Electric Analog



ALTERNATING CURRENTS VERSOR DIAGRAM
EMF AND DISPLACEMENT CURRENT

Figure 125

THESE ROTATIONS ARE REPRESENTED BY FIGURES (5), (6), & (7)

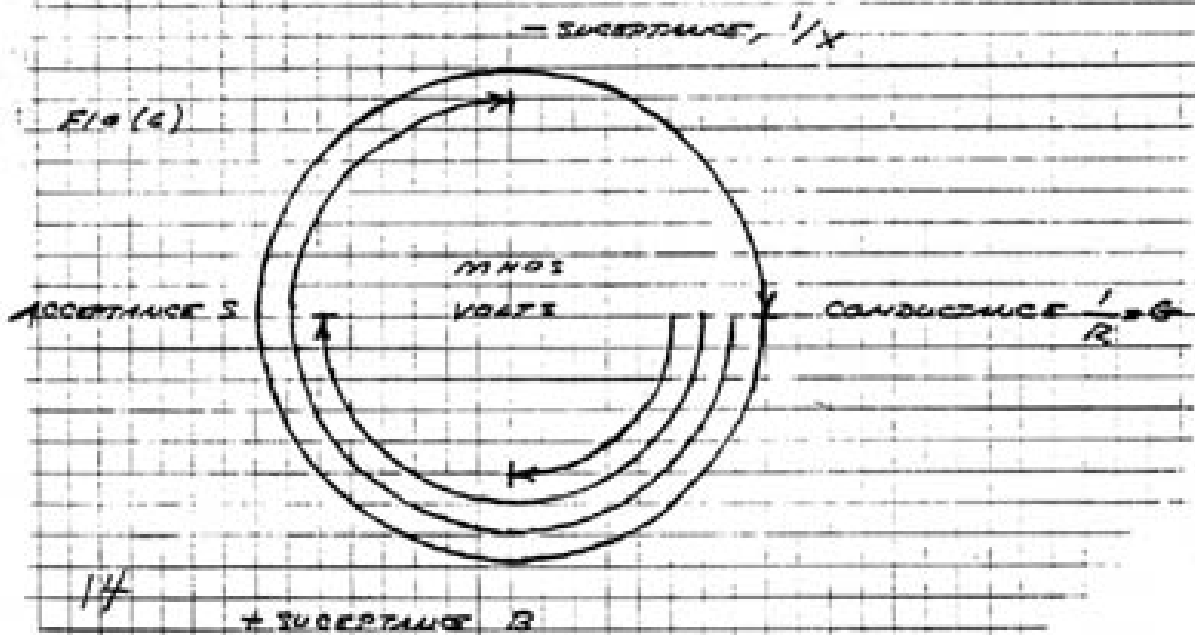
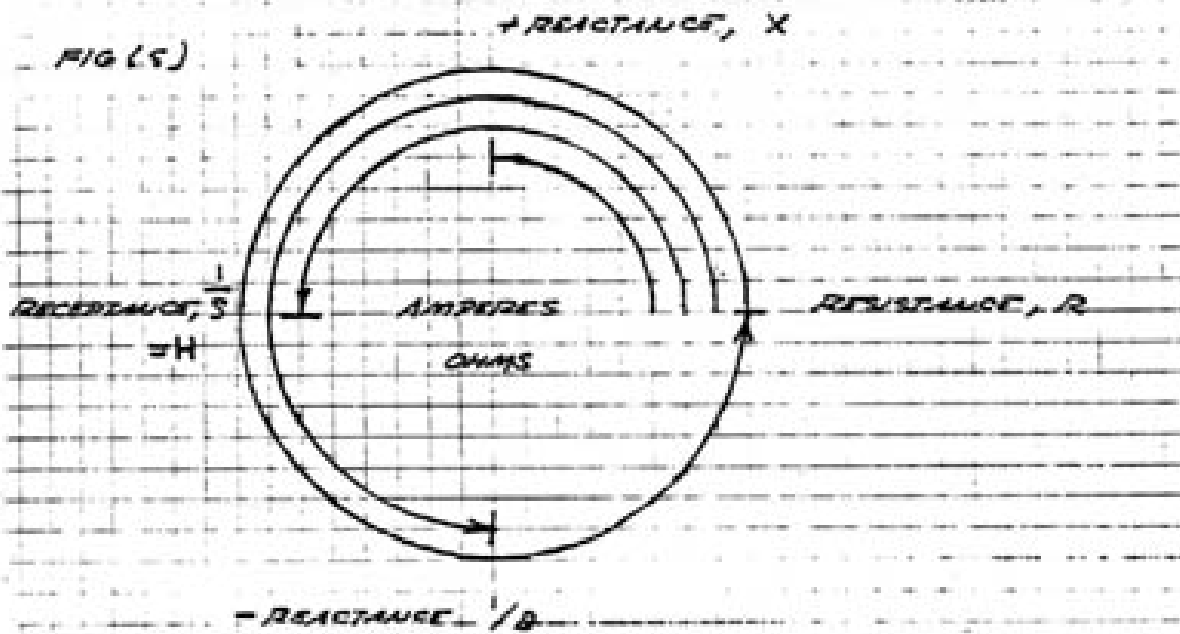

UNIT VECTORS ROTATIONS IN THE AC CYCLE

Figure 126

GRAPHICALLY, IT IS, $\mathcal{K}^2 =$

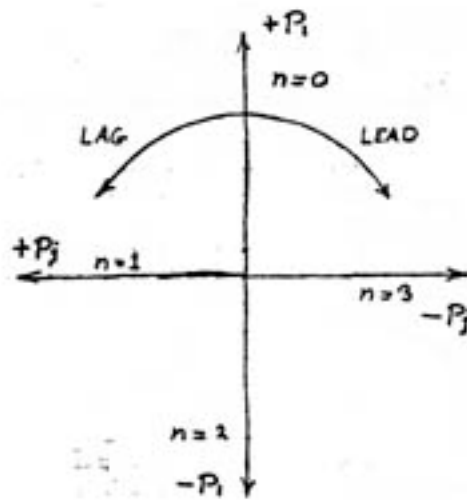

THUS, FOUR QUADRANTS,

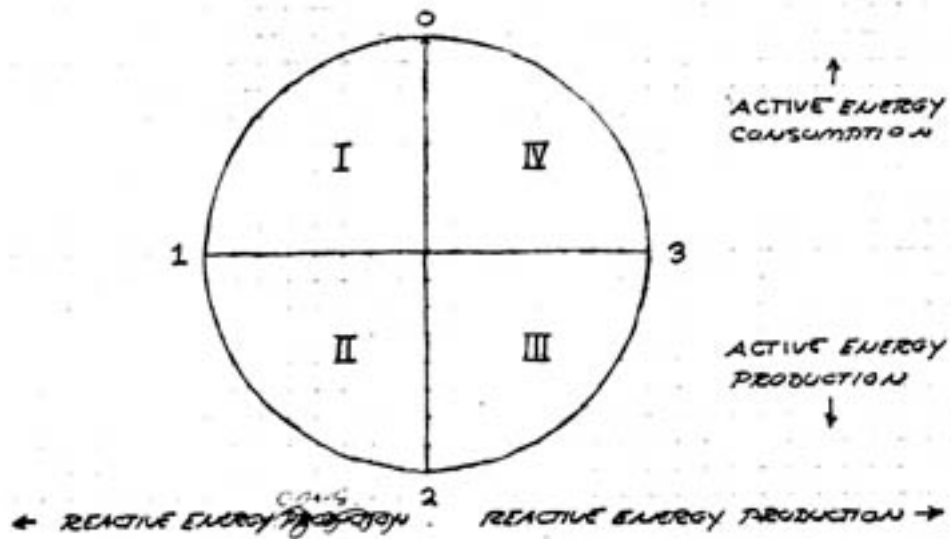

FOUR QUADRANTS OF ALTERNATING CURRENT
Figure 127

2.1 Lunar and Electric Phases

The lunar aspects of light and dark in relation to the unit lunar phases can be made analogous with the aspects of alternating current. Four aspects exist in A.C. relationships as has been shown previously. These are:

- 1) Energy Production
- 2) Energy Return and Storage
- 3) Energy Consumption
- 4) Energy Storage and Return

Production and consumption are on the Real Line, and storage and return are on the Imaginary Line.

2.2 Proportion of Energy

Energy production is an analogy to the dark phase, energy consumption is an analogy to the light phase. The proportions of light and dark are analogous to the proportions of production and consumption. These relations are given as:

- | | |
|---------|--|
| New | 100% Dark, Energy Production |
| Leading | 50% Dark, Energy Return
50% Light, Energy Storage |
| Full, | 100% Light, Energy Consumption |
| Lagging | 50% Light, Energy Storage
50% Dark, Energy Return |

2.3 Cycle of Light and Dark

The New Phase and the Leading Phase in the first half of the cycle deliver energy, part is produced; part is returned from storage. For the Full Phase and the Lagging Phase in the second half of the cycle energy is taken, part by consumption, part being returned to storage, for delivery in another

part of the cycle. These relations can be given in a complimentary symmetrical form:

100% Dark, 0% Light
50% Dark, 50% Light
0% Dark, 100% Light
50% Dark, 50% Light

100% Production
0% Consumption

50% Production
50% Consumption

0% Production
100% Consumption

50% Production
50% Consumption

And back to:

100% Production
0% Consumption

Energy is delivered in the first half of the cycle, energy is taken in the second half of the cycle. The dark aspect is the supply of energy; the light aspect is the demand of energy. Here given is the basic framework for the Four Quadrant Representation of the alternating electric wave.

[3] Co-Axial Versor Form

3.1 Energy Relations

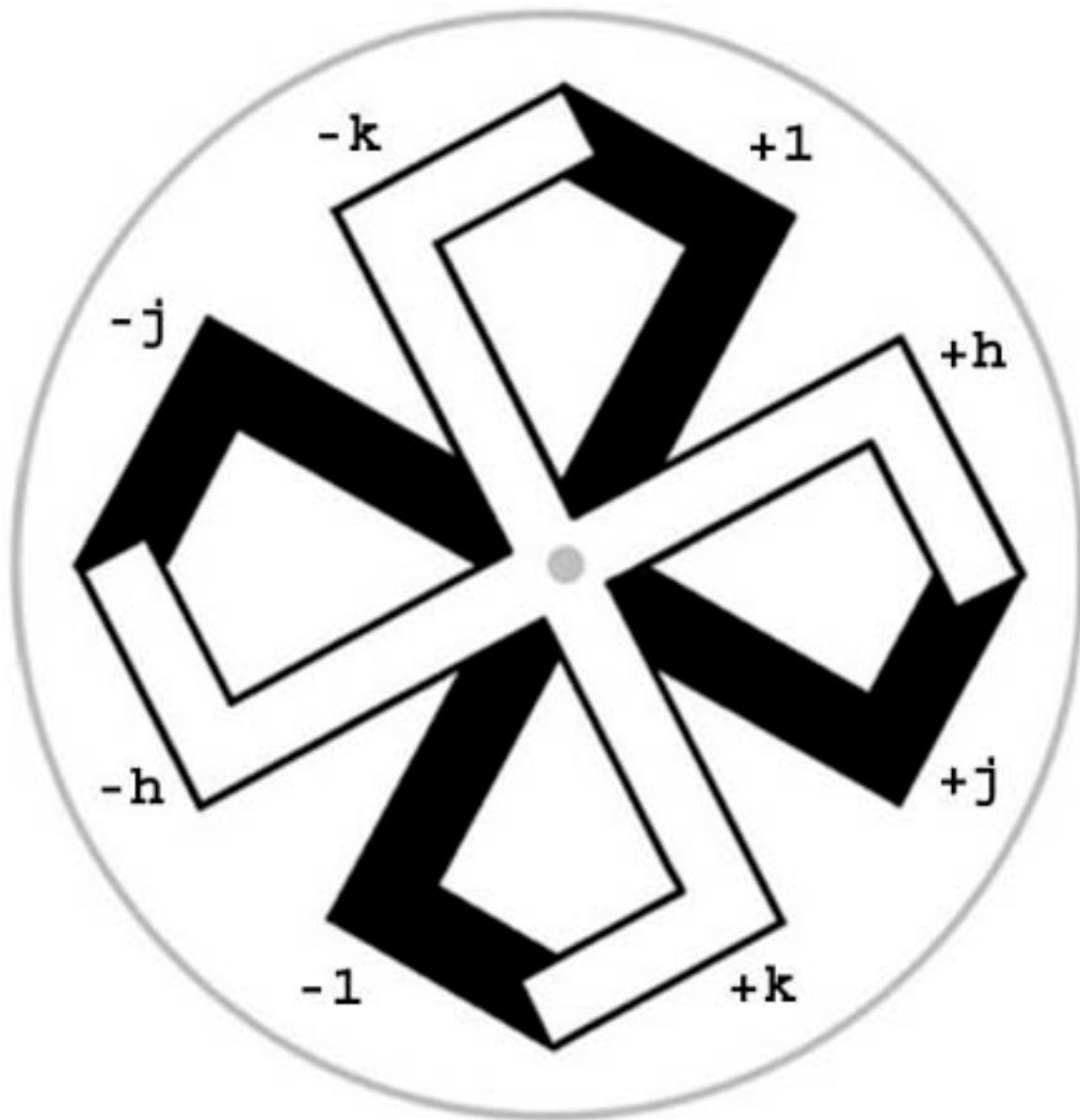

COUNTER ROTATION OF EMF & DISPLACEMENT CURRENT
VERSORS SYSTEMS

Figure 128

Referring again to the Double Swastika, one cycle is a cycle of light, the other cycle is a cycle of dark. The two cycles are counter-rotating quadrapoles, that of light revolving clockwise, that of dark revolving counterclockwise. The two quadrapoles are shown as a pair of co-axial versor rotations. In cooperation the two quadrapoles represent various configurations of electric energy.

On the Real Line it is a single direction from production to consumption. Nothing is stored or returned, it is the same for A.C. or D.C. On the Imaginary Line it is in two directions, from return to storage and back from storage to return. Nothing is produced or consumed and it is strictly an A.C. condition.

On the Real Line the flow of energy is direct and can also be instantaneous, as with D.C. This energy arrives from external form and leaves to external form. On the Imaginary Line the flow of energy is in an oscillation at a definite cyclic frequency. The energy is trapped internally with nowhere to go. Energy is cyclically exchanged in form from Storage to return and etc. Here established is the idea of Real Energy, doing work, and Imaginary Energy, existing only in a potential form, doing no work. The Real Energy and the Imaginary Energy are in Quadrature within the cycle of the alternating electric wave.

VI) Ratios and Projections and the Sine and Cosine Functions

[1] Projections of the Cycle

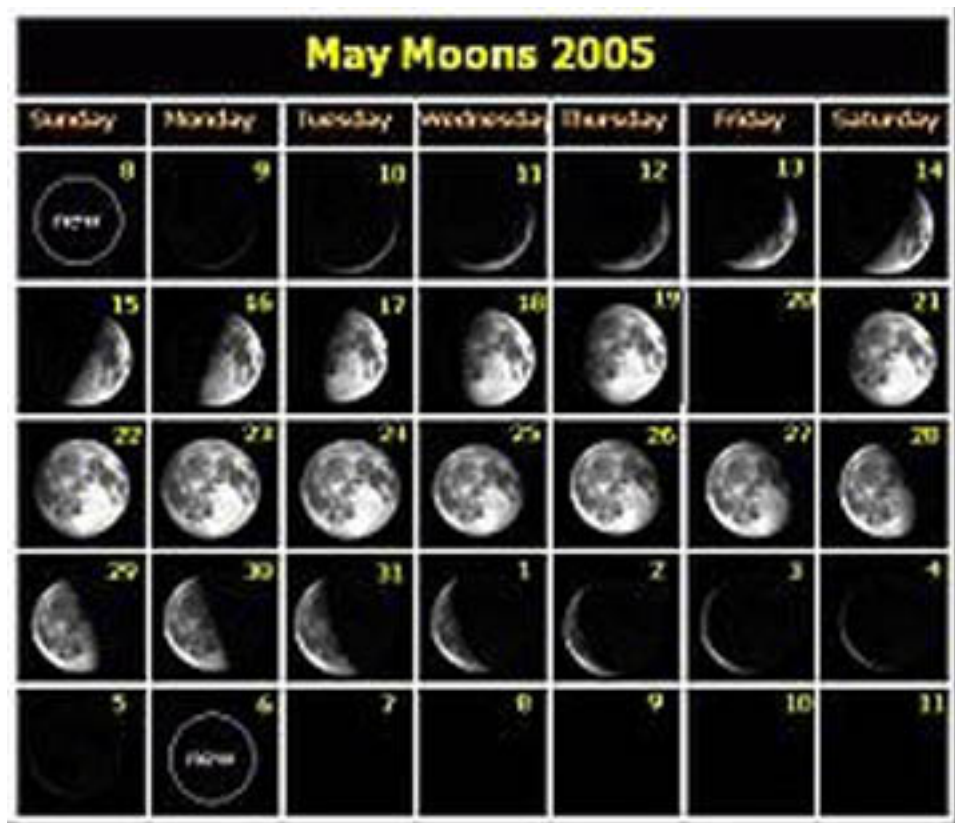

PROPORTIONS OF LIGHT & DARK THROUGH THE LUNAR CYCLE

Figure 129

1.1 Images of Light and Dark

The lunar ratios of light and dark are the result of angular projections seen on the Earth. The spherical surface of the Moon is always half light and half dark. On the Earth the Moon is not seen as spherical, but seen as a circular disk. The phases seen on Earth result from the slip frequency.

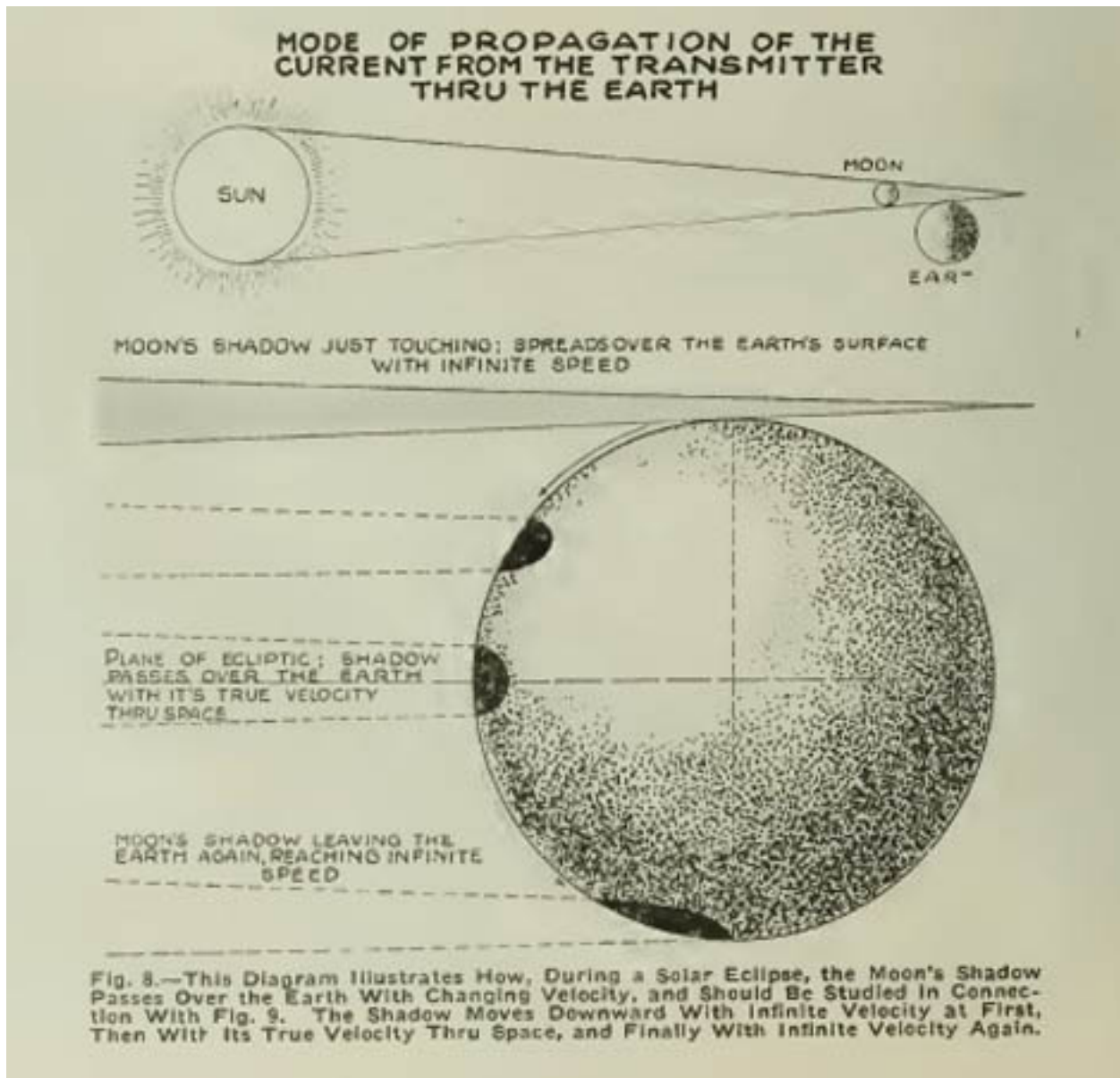

LUNAR PROJECTIONS UPON SURFACE OF EARTH

Figure 130

1.2 Lunar Shadow

As shown in the figure, the shadow of the Moon sweeps across the Earth during a solar eclipse, it forms a projection.

This projection is what is called a "Function" of the lunar position. This function is only an aspect of what gives rise to it. The projection shown

gives the basis for what is known as the tangent function. The rapid increase of shadow length at sunset is also based upon the tangent function. At the moment of sunset the shadow length is infinite, a characteristic of this kind of function.

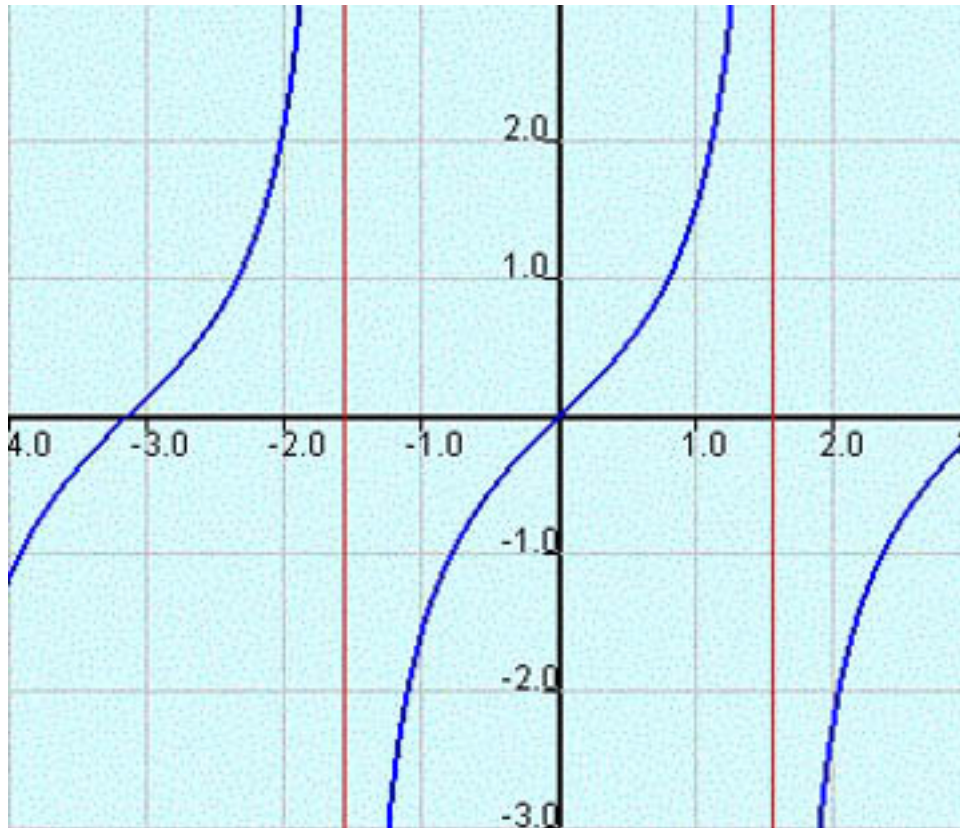

TANGENT FUNCTION
Figure 131

1.3 Sine and Cosine

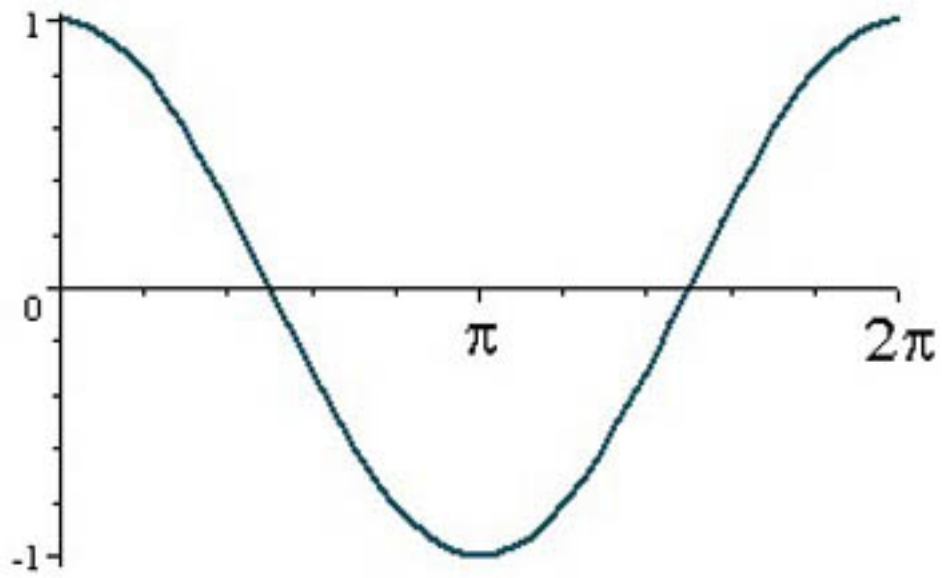

COSINE WAVE

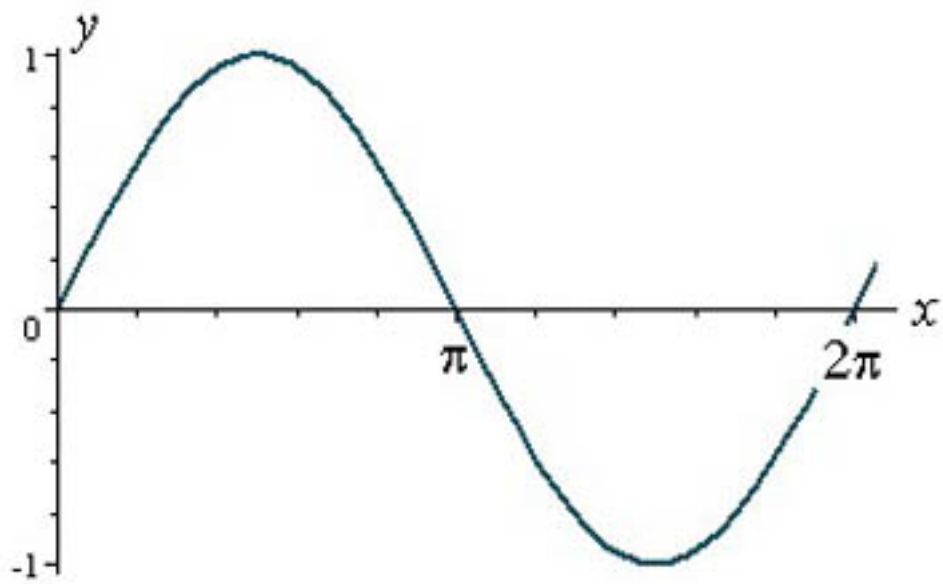

SINE WAVE

Figure 132

A fundamental function in alternating current theory is the Sine Function. Its complementary function is the Cosine Function, and it is often neglected in A.C. theory. These functions relate to ratios that involve light and dark, or Real and Imaginary.

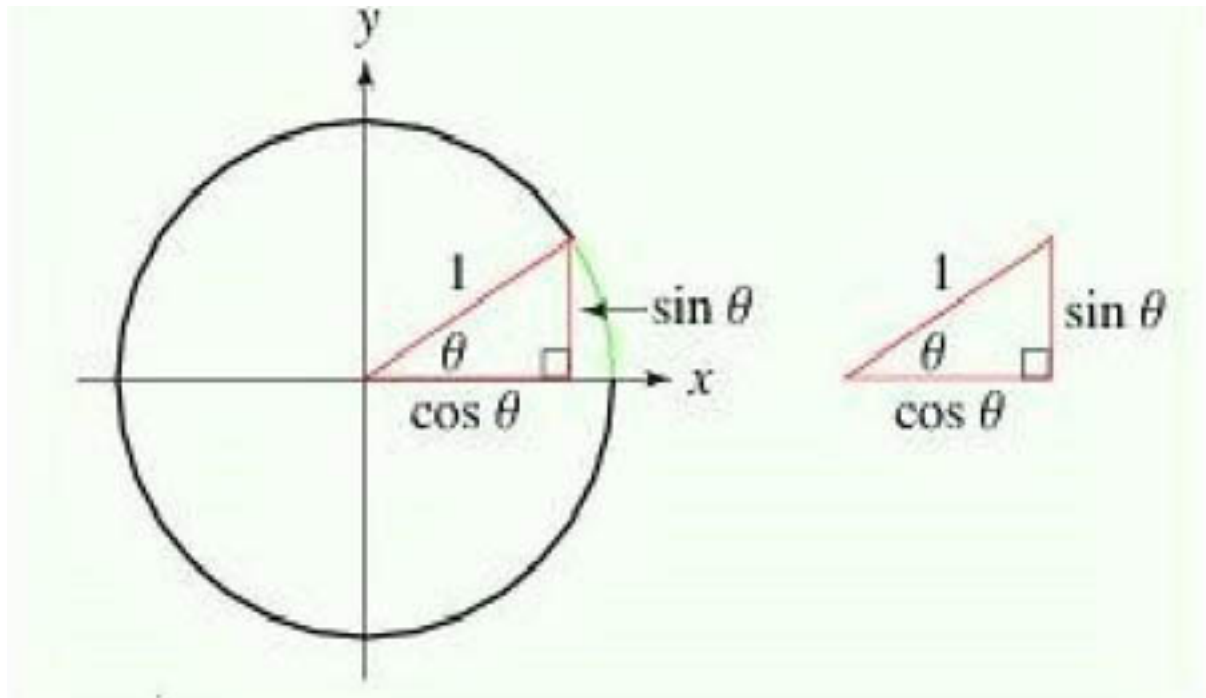

SINE AND COSINE PROJECTIONS ON IMAGINARY & REAL LINES

Figure 133

In the figure shown are given the two fundamental projections, Sine and Cosine. These projections exist as shadows of a rotating length upon the Real Line or upon the Imaginary Line.

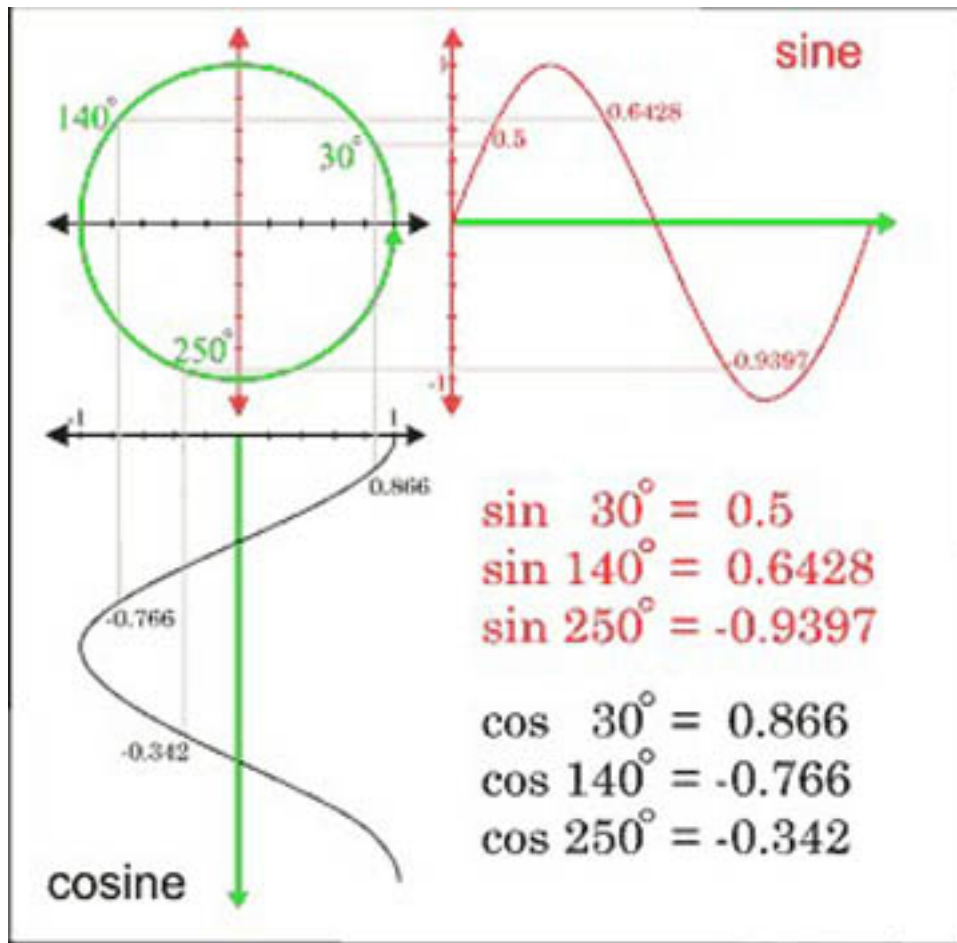

CO-OPERATION OF SINE AND COSINE FUNCTIONS

Figure 134

In cooperation the Sine Function and the Cosine Function identify the position of the radius distance in the cycle of revolution. For the Sine Wave the view is from the side of the circular cycle. This view is the projection drawn on the Imaginary Line. As the cycle moves around the circle, the projection upon the Imaginary Line moves up and down along its length, describing a Sine Wave.

For the Cosine Wave again the view is from the side of the circular cycle, but this view is rotated 90 degrees, one unit versor step from the Sine Wave view. The projection is now drawn on the Real Line. As the cycle moves around the circle, the projection moves back and forth along the line length, describes a Cosine Wave.

1.4 Shadows

The projections that give rise to Sine and Cosine functions are only shadows of the cyclic position upon the Imaginary Line or the Real Line. They are a sort of “Mathematical Fictions” as Steinmetz would say. In themselves they do not completely represent a cycle, but only a certain aspect of it. Only by operating in cooperation can these two functions represent the cycle of revolution. In themselves they can only represent a cycle of alternation, such as single phase.

1.5 Cooperation of the Sine and Cosine functions

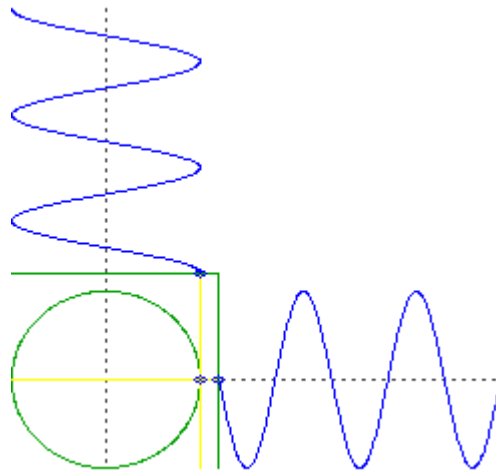

Figure 135

(Editor's Note: To see an animation of this image, go to this website.)

http://www.math.tamu.edu/~alarios/courses/TAMU/2013_fall_M151/mathgifs.html

The cooperation of the Sine function and the Cosine function together define a position in the cycle. The position is here defined by a pair of ratios acting in Quadrature with respect to each other. The two ratios in themselves are alternations, but in cooperation are a rotation. Here exists the common misunderstanding that the alternating electric wave can simply be defined by the Sine wave. The alternating wave is a circle; it is a

rotational cycle of revolution. It is a constant change in position, the amplitude is that of the radius length which is constant. In this view the alternating electric wave is a rotating continuous current. The misnomer presents itself here as to the use of the term alternating. Here it is a constant magnitude rotating at a constant rate. This is called a continuous wave or C. W. for short. These considerations are important in the understanding of the synchronous machine.

Section Three

Practical Aspects of Quadrapolar Versor Algebra

(I) The Method of Descartes

[1] The Cartesian Coordinate System

1.1 Sine and Cosine

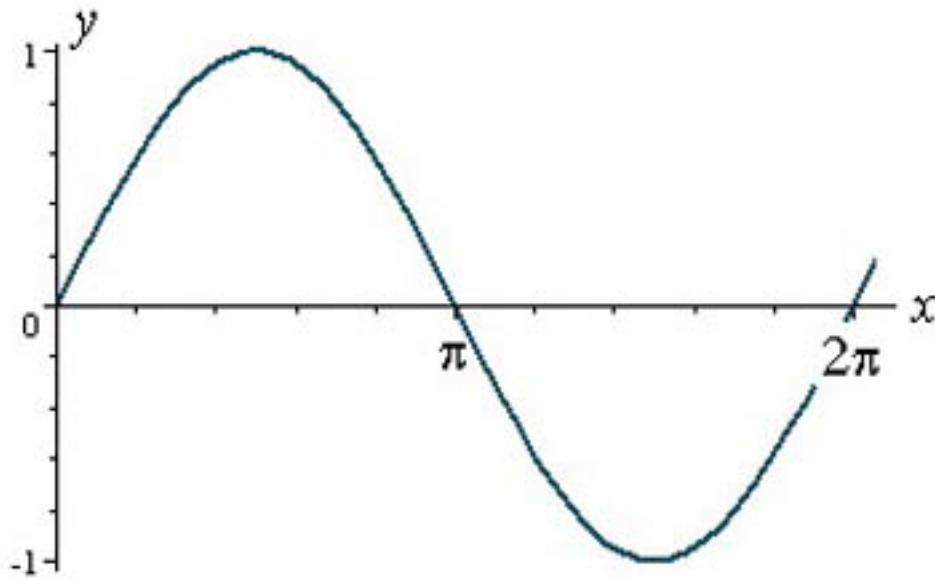

SINE WAVE
Figure 136

The Sine function and the Cosine function are only devices to aid in defining a position in a cycle. They in a way are like the blind man and the deaf man, which on their own are incapable of a complete perception, but in cooperation can define a reality.

The use of Sine and Cosine to determine a cyclic position is known as the trigonometric method. An alternate method more suited to versor algebra is known as rectangular coordinates. This method determines the position by use of defining coordinates, one on the Real Line, one on the Imaginary Line. This works in accord with the principles of versor operators and the Pythagorean Theorem.

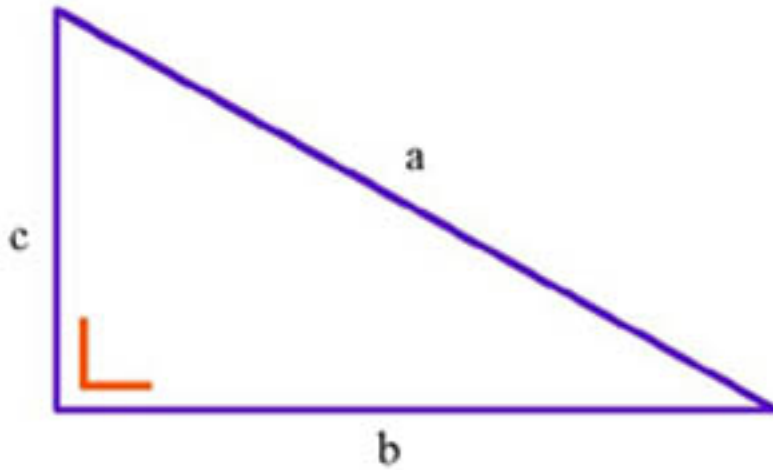

Pythagorean Theroem

$$a^2 = b^2 + c^2$$

PYTHAGOREAN ADDITION OF RADIUS

Figure 137

The method of rectangular coordinates originates with Rene Descartes; he is the father of the four quadrant representation, a very important concept in mathematics. Descartes was also first in proposing a Corporeal Aether, the idea later developed by Michael Faraday.



RENE DESCARTES 1596-1650
Figure 138

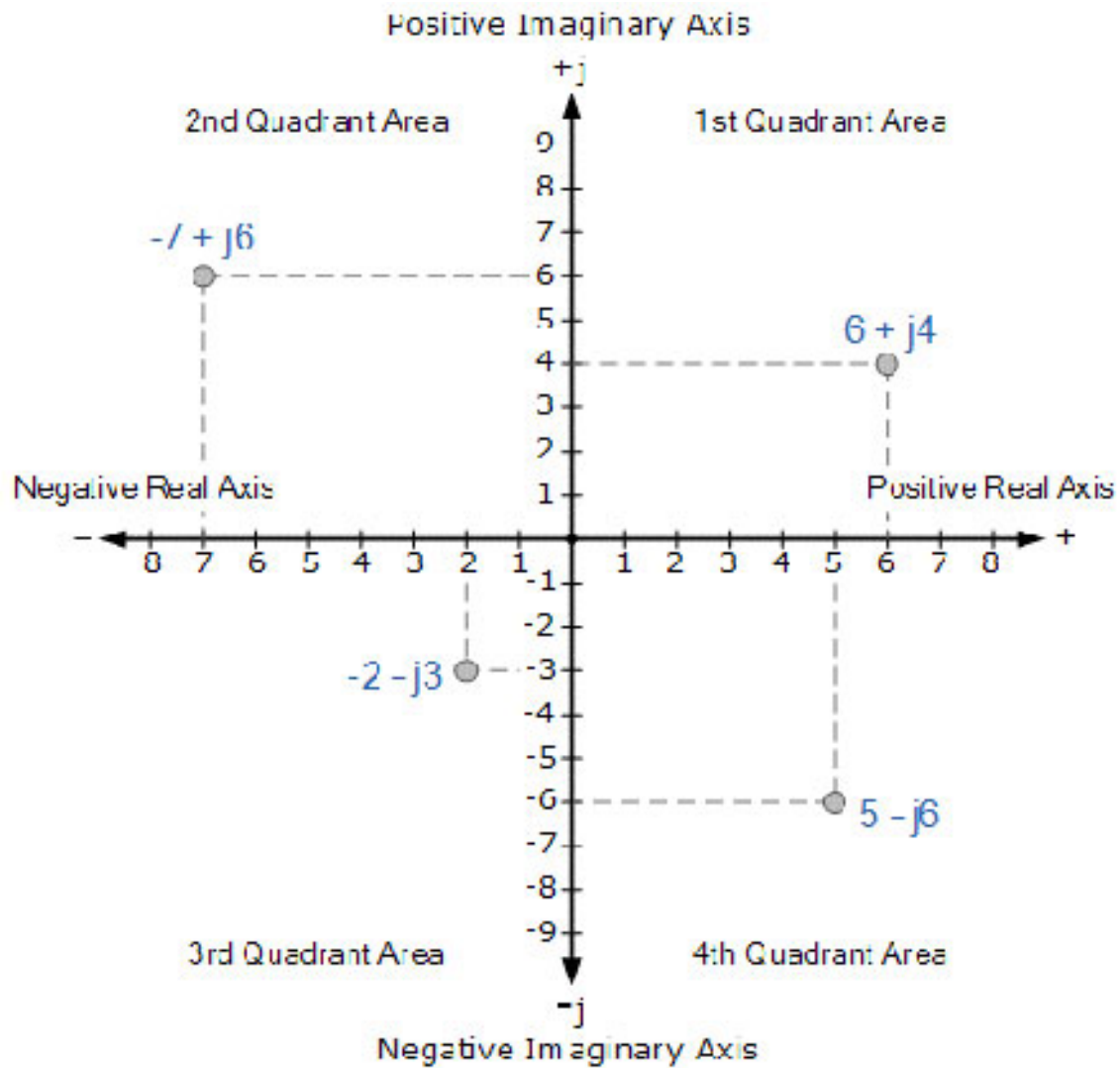

FOUR QUADRANT RECTANGULAR COORDINATE SYSTEM
Figure 139

1.2 Symmetrical Coordinate Systems

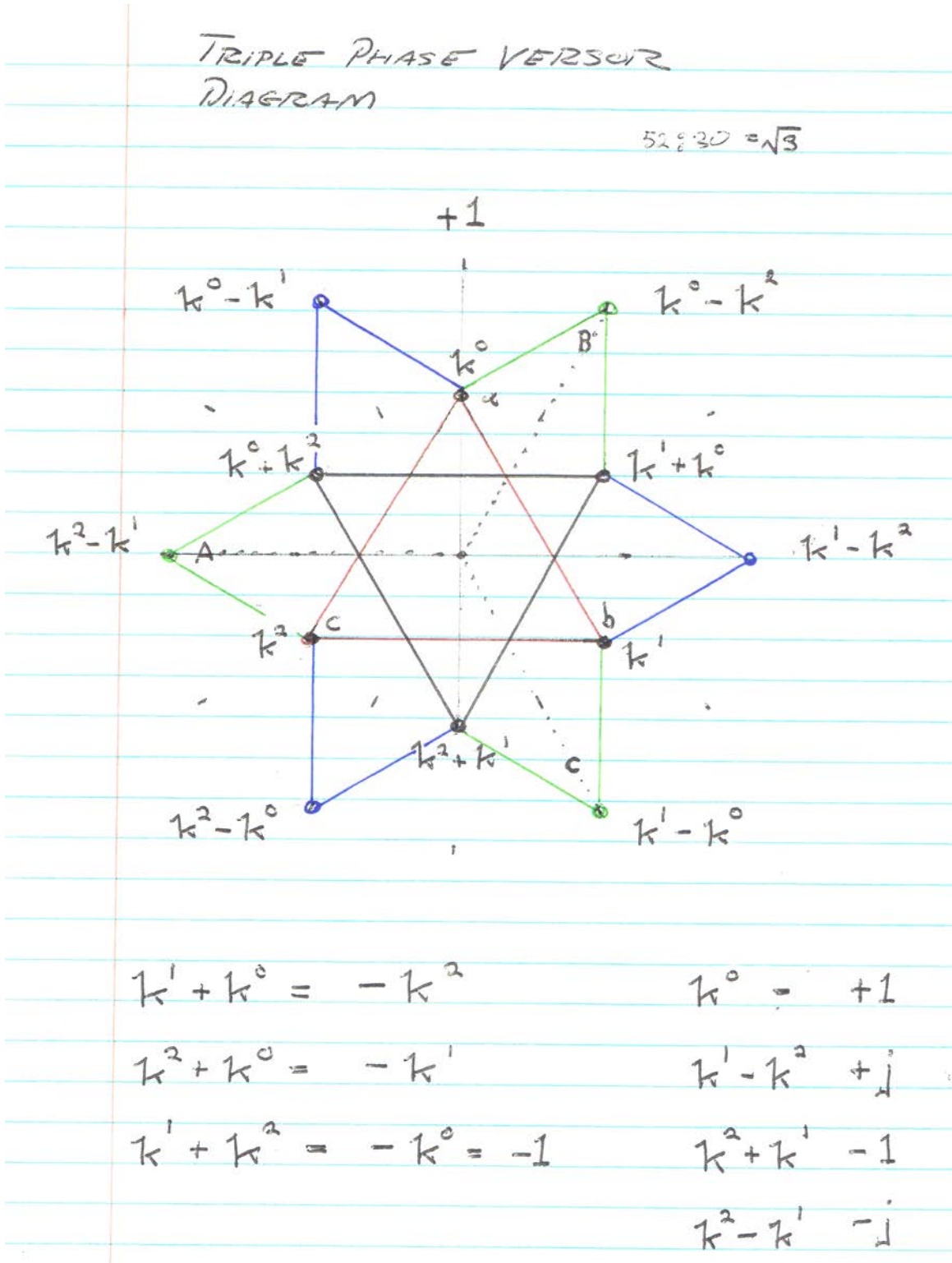
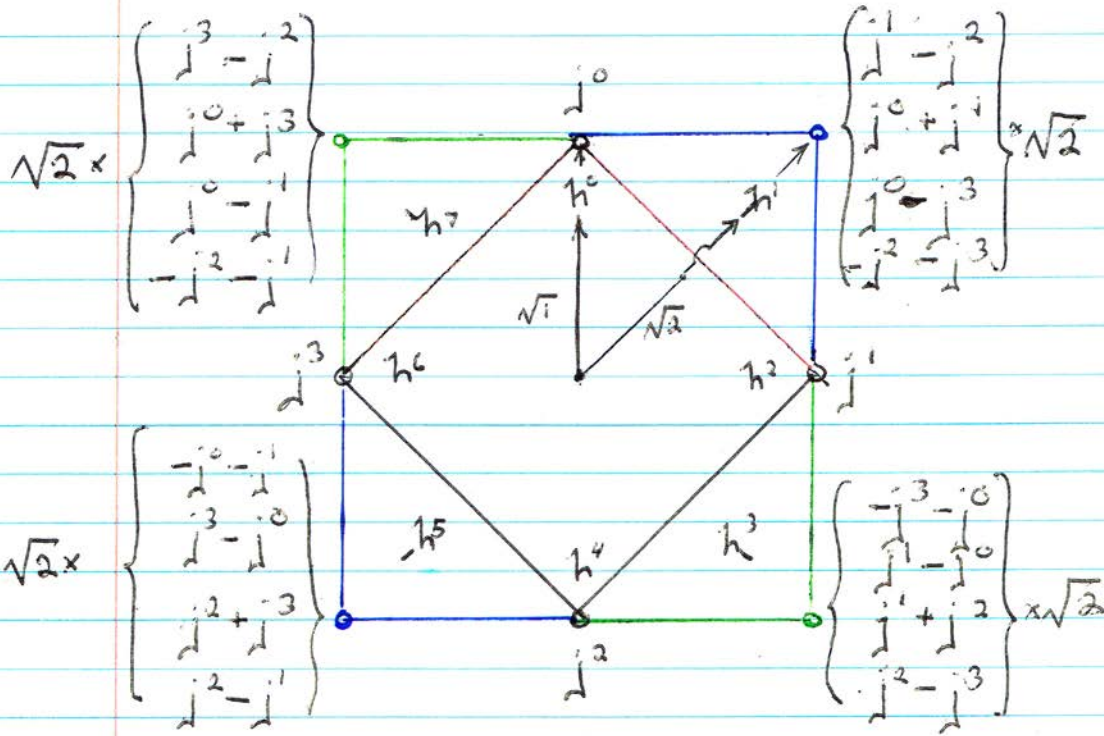

Figure 140

FOUR PHASE VECTOR DIAGRAM



$$j^0 + j^1 = \sqrt{2} h^1$$

$$j^0 + j^2 + j^1 = j^1 = \sqrt{2} h^1 + j^2$$

$$j^0 - j^1 = \sqrt{2} h^7 = j^0 + j^3$$

50:34

$$50:35 = \sqrt{2}$$

20 TOTAL

4 x 5

Figure 141

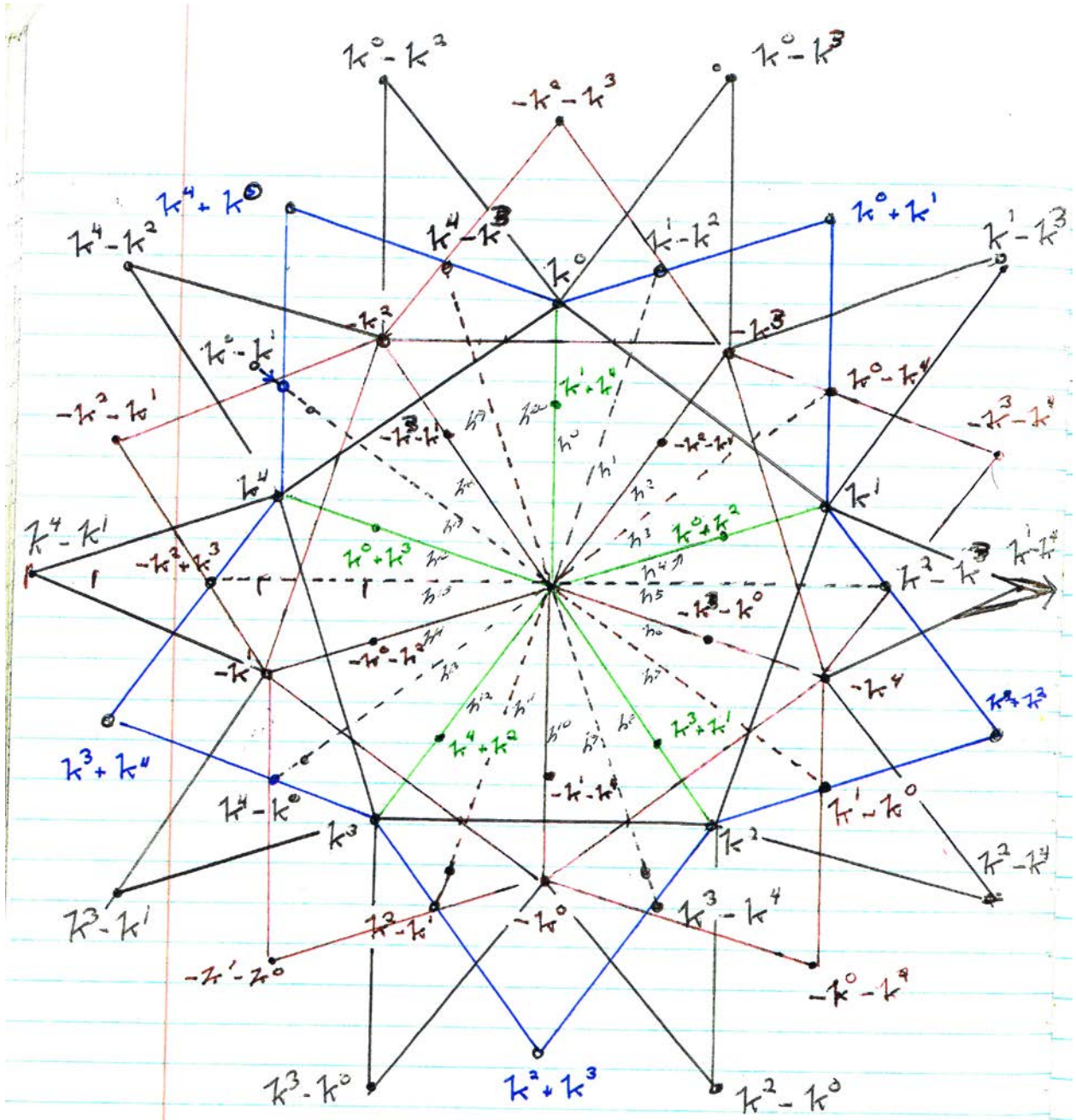

$$h_3 = \sqrt[20]{+1} \quad 5 \text{ PHASE} \times 4$$

$$h_3 = \sqrt[12]{+1} \quad 3 \text{ PHASE} \times 4$$

Figure 142

The system of rectangular coordinates gives four distinct quadrants and is well suited for quadrapolar cycle representation. It also has become the basis for graphical analysis. It is limited to rectangular configurations and cannot properly represent other forms of symmetrical coordinates, such as the triangular coordinates of three phase alternating current. All three phase problems must be converted to rectangular coordinates before calculation, such has become commonplace.

After Steinmetz's work Dr. Charles Fortescue of Westinghouse Electric Co. developed a more general system known as symmetrical coordinates, later known as symmetrical components by engineers using this system. This system defines a position in a cycle for any number of poles or phases, not just two or four. This method is very well suited for tripolar cycles, by utilizing tripolar versor operators. These are shown, as are other polypolar versors in the figures.

While this method has found extensive application in electrical engineering, and it is a virtual revolution in analysis, also holding the key to solutions for higher order algebraic expressions, symmetrical components are completely ignored by mathematicians, and no book of general theory was ever written by Dr. Fortescue, his work as abandoned by mathematics.

1.3 Latitude and Longitude

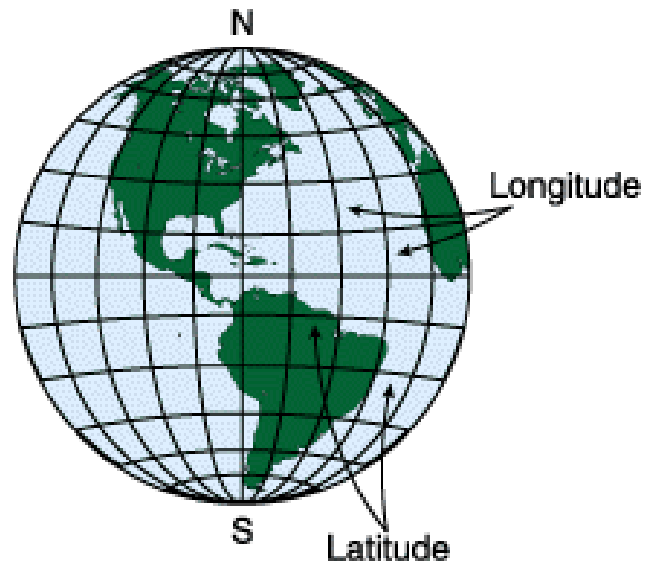

Figure 143

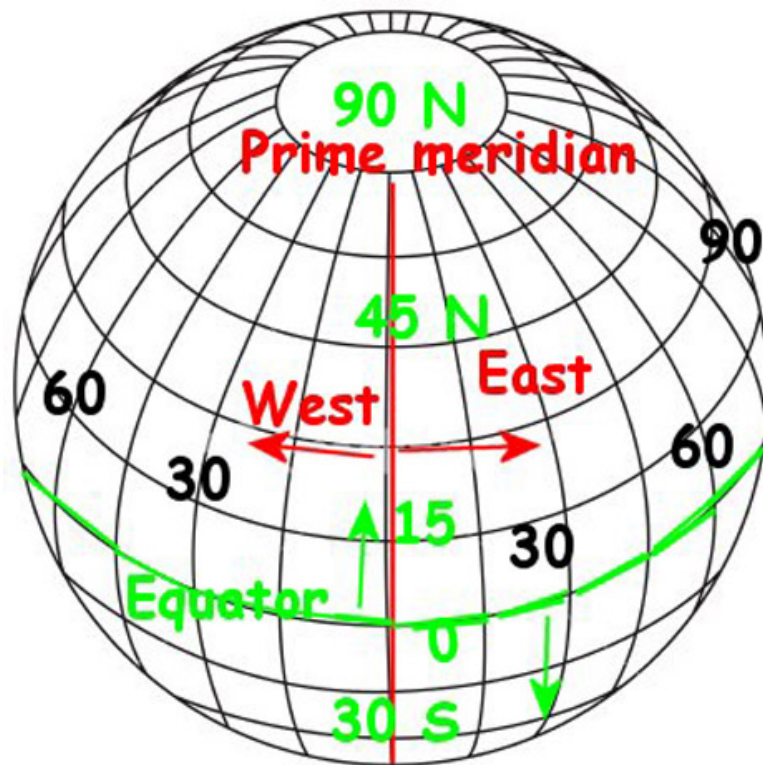

Figure 144

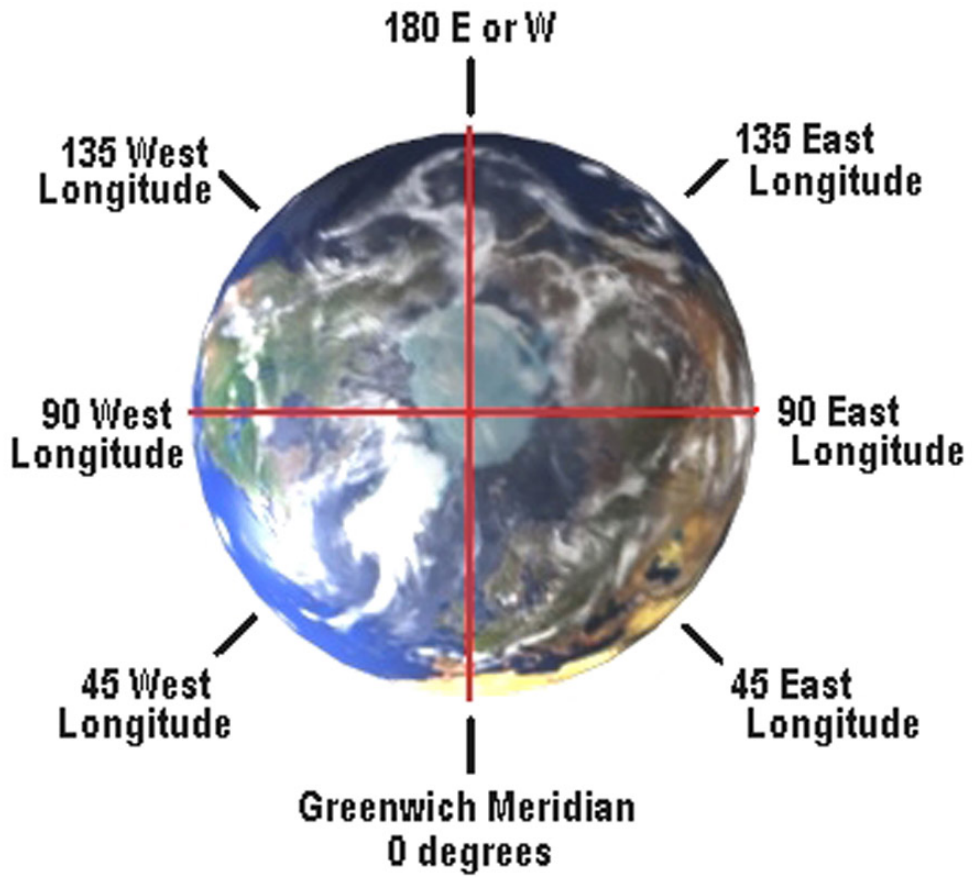

Figure 145

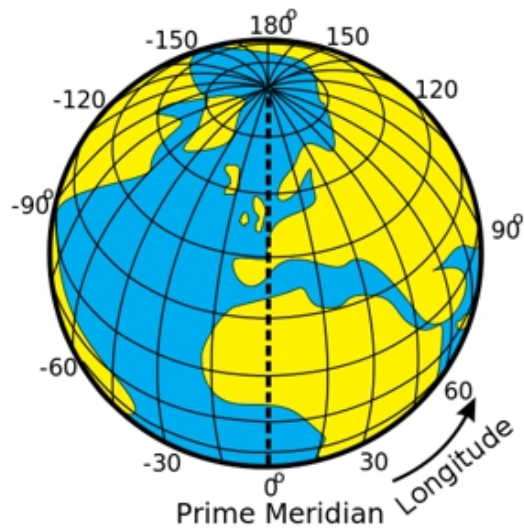

Figure 146

The system of Descartes is given the common name of “*The Cartesian Coordinate System*”. This work gave rise to the concept of Latitude and Longitude, and their use in defining a position on the surface of the Earth. This led to a major advance in navigation. It is the origin of the mathematics of position.

Latitude is the Imaginary coordinate, Longitude is the real coordinate. The surface of the Earth is divided into squares by individual lines of Real and Imaginary orientation.

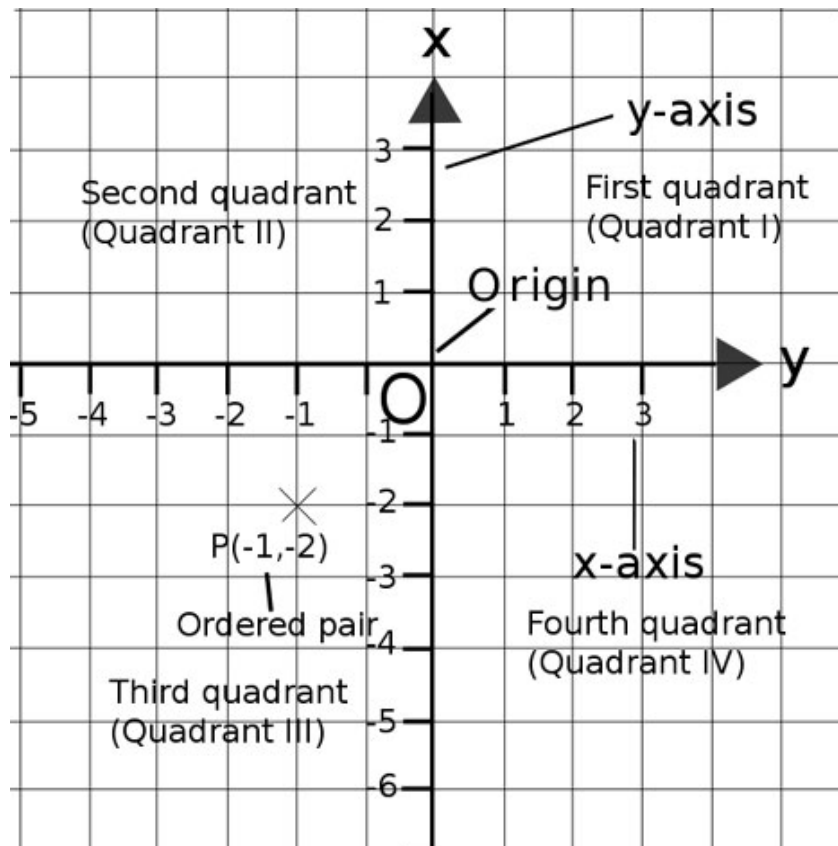
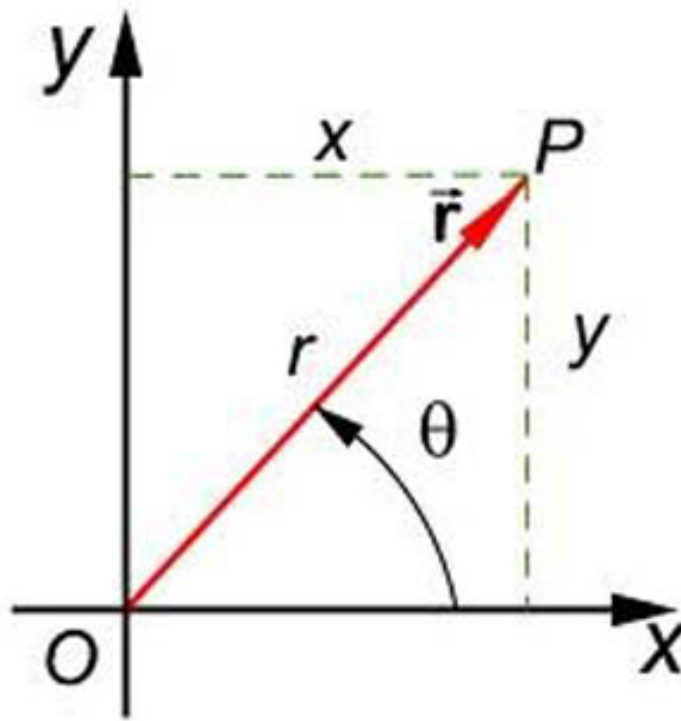

Figure 147

As depicted in the figure the X coordinate Real Line is the equator of the Earth, the Y coordinate Imaginary Line arbitrarily chosen, Greenwich, England for example. The X line is the Latitude, the Y line is the Longitude.

1.4 Coordinate Derived Positions



RECTANGULAR COORDINATE REPRESENTATION OF CIRCULAR RADIUS VECTOR

Figure 148

As shown in the figure the coordinate chosen on each line defines a position P. One quadrant out of a possible four is shown in the diagram. Vertical coordinates are Imaginary, prefixed by a positive j. Horizontal coordinates are Real, prefixed by positive one. This is the New-Leading Quadrant, and both coordinates are positive. In general the coordinates are as follows:

<u>Quadrant</u>	<u>Real</u>	<u>Imaginary</u>
1	Positive 1	Positive j
2	Positive 1	Negative j
3	Negative 1	Negative j
4	Negative 1	Positive j

In lunar representation a similar relation exists:

<u>Phase</u>	<u>Left Side</u>	<u>Right Side</u>
New	Dark	Dark
Leading	Dark	Light
Full	Light	Light
Lagging	Light	Dark

Each quadrant has its own relations of positive-negative or light-dark.

1.5 Pythagorean Ratios

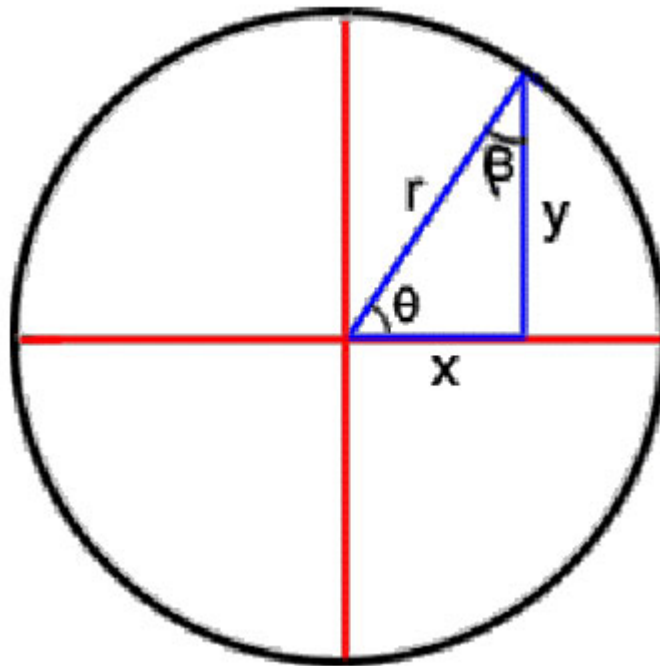

PYTHAGOREAN THEOREM APPLIED TO A CIRCLE

Figure 149

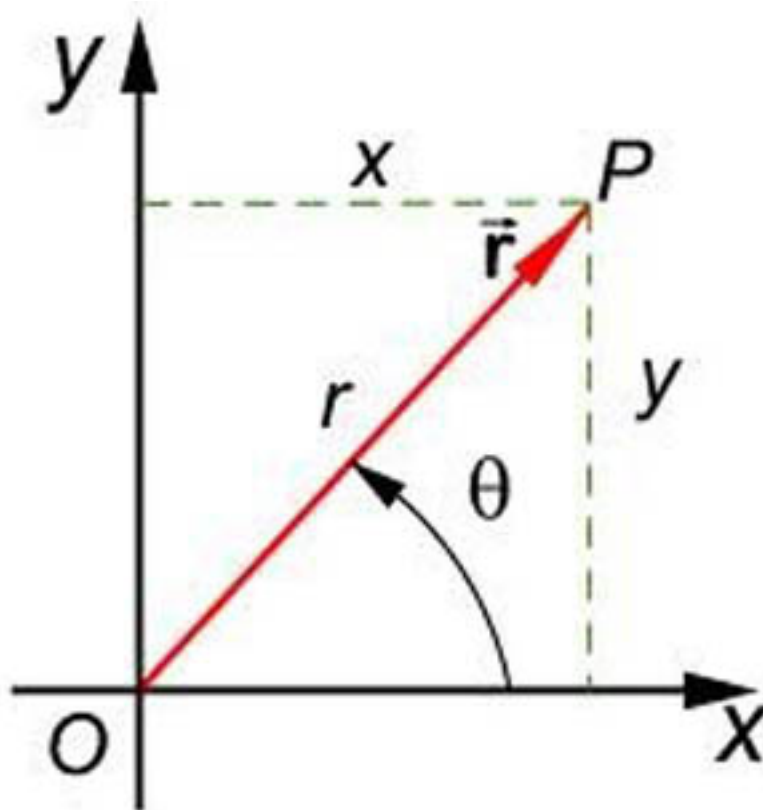

**ROTATIONAL RADIUS $r = 1$
POSITIONAL POINT P**

Figure 150

The length of the radius extending from the point of origin, O , to the positional point, P , is shown in the figure as a directed radius, r . This radius can be the distance, r , from the center of the Earth, O , out to the distant Moon, P .

The length of radial distance r can be derived from the vertical Imaginary coordinate, this in quadrature with the horizontal Real coordinate. This is derived by means of the Pythagorean Theorem. Here the two coordinates are added together in a complex manner. The Pythagorean relation allows for the extension of the laws of arithmetic to include Quadrature addition and subtraction between Real and Imaginary quantities. The methods of Pythagoras and Descartes gives the basis for a four quadrant arithmetic.

In common arithmetic the resultant is determined by the sum of the coordinates on only a single line, the Real or Imaginary Line. Here Real cannot be added to Imaginary. In Pythagorean arithmetic the square of the sum is the sum of the Real coordinate squared and the Imaginary coordinate squared. The complex sum is then the square root of the sum of the squares. This resultant is the radial distance from the origin or center out to the circle of the cycle. This radius is of unit value such as, the distance to the Moon, the power contained in the A.C. system, etc. The Real and Imaginary coordinates become percentages, or ratios, of this unit radius equal to one or 100%.

[2] Ratios Derived From the Unit Radius

2.1 Positions in Terms of Coordinates

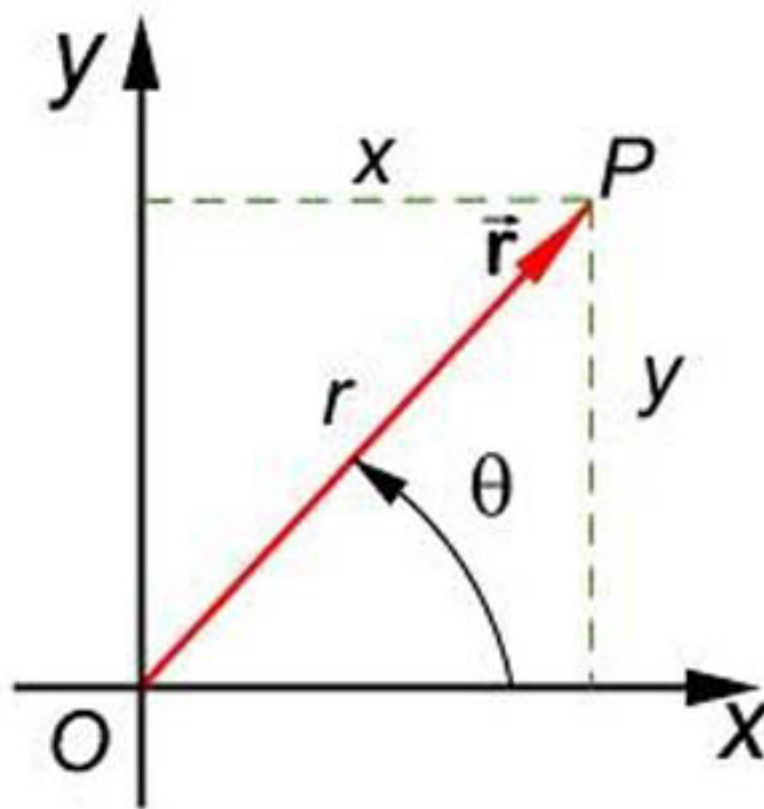

RECTANGULAR COORDINATE REPRESENTATION OF CIRCULAR RADIUS VECTOR

Figure 151

Point of origin, O , and positional point, P , establish a radial distance, r . This radius is rotated from the New position by angle, Θ . The positional point, P , is derived from the Real coordinate, x , and the Imaginary coordinate, y . The radius, r , has a magnitude derived from Pythagorean addition. There exists the angle of rotation, Θ , the ratio of X to the unit radius and the ratio of y to the unit radius. The radius is 100%. Here the rotational angle works with the ratios and gives position, P . The y ratio is the Sine Function, the x ratio is the Cosine Function. Radius, r , in terms of an angle, Θ , is called the polar representation of the cycle, or just the polar method.

2.2 Radius of Unit Value

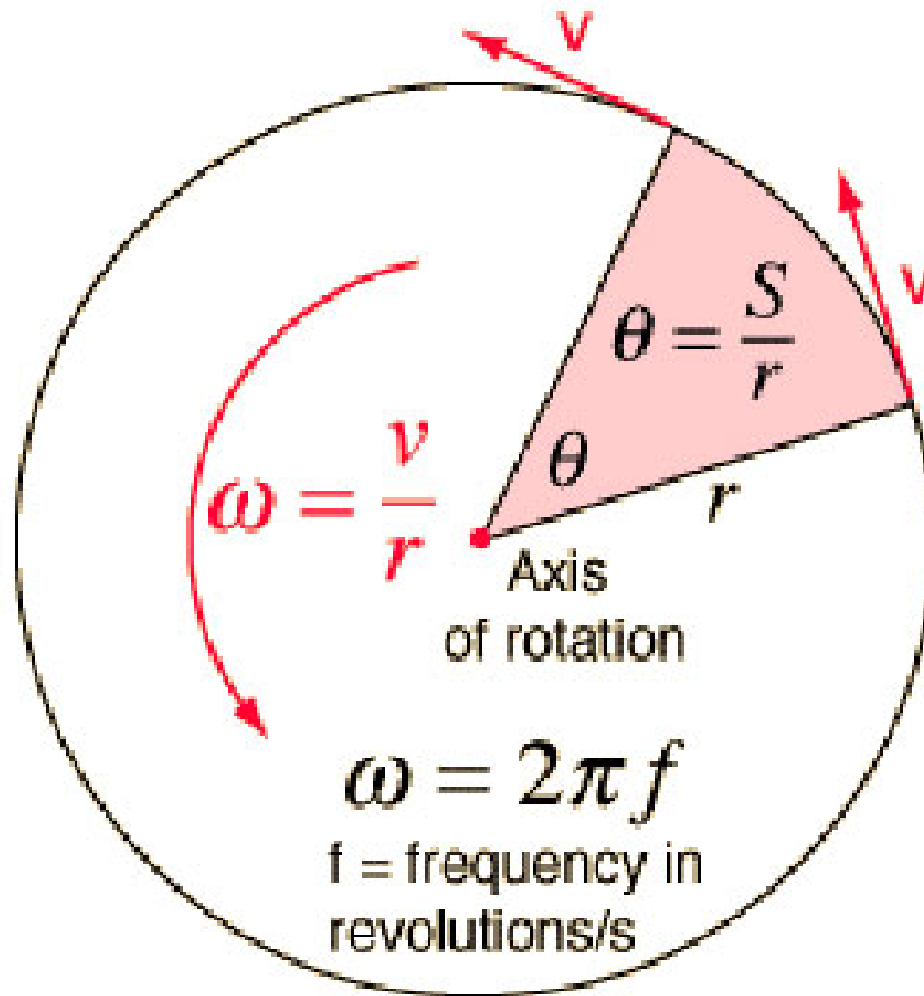

Figure 152

The given radius in a cycle is a constant and is normalized so as to equal one. This distinguishes a versor operation from a vector operation. The vector operation is for a radius of any length, the versor operation is for a radius of unit length. A vector is a direction, a versor is a rotation. This often gets confused and Heaviside warns of this.

The versor is dimensionless.



UNIT HAND LENGTHS

Figure 153

For the Imaginary coordinate the projection on the Imaginary Line is a percent, or fraction, of radius, r . This is the Sine Function of the angle, Θ . For the Real coordinate the projection on the Real Line is a percent, or fraction of the radius, r . This is the Cosine Function of the angle, Θ .

The radius, r , is constant, and it is 100% of its self. As positional point, P , progresses along the circle of the cycle, the shadows of radius, r , on the Real and Imaginary Lines go through a continuous and complimentary variation in magnitude. The Sine and Cosine Functions perform the transform between polar and rectangular coordinate systems.

For the rotational cycle of the lunar phases, or the A.C. wave, the radius is made unit value, it is equal to one, or 100%. The coordinates, x , and y , are a certain percentage of this unit value. When a coordinate is coincident with the radius then the coordinate is a maximum of 100%, its complimentary coordinate is 0%. For example, if the rotating unit radius is horizontal, x , is 100%, y is 0%. Conversely, if the rotating unit radius is vertical, y , is 100%, x , is 0%. When this radius is coincident with the Real Line, or the Imaginary Line, then a unit phase, or versor position is established in the quadrapolar relationship. The system of rectangular coordinates is a geometrical identity of a quadrapolar system, this making it very well suited for the task of representation.

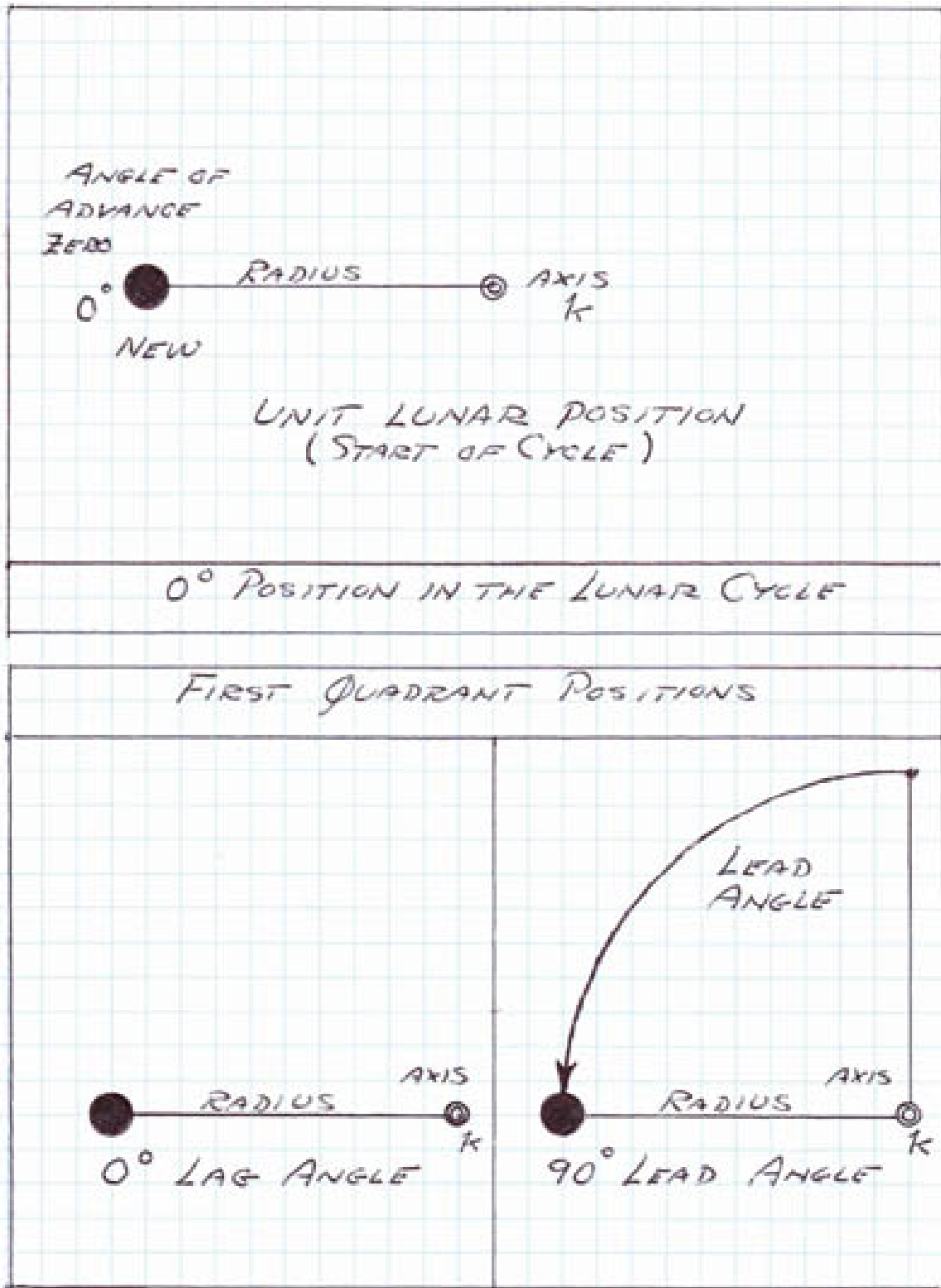

Figure 154

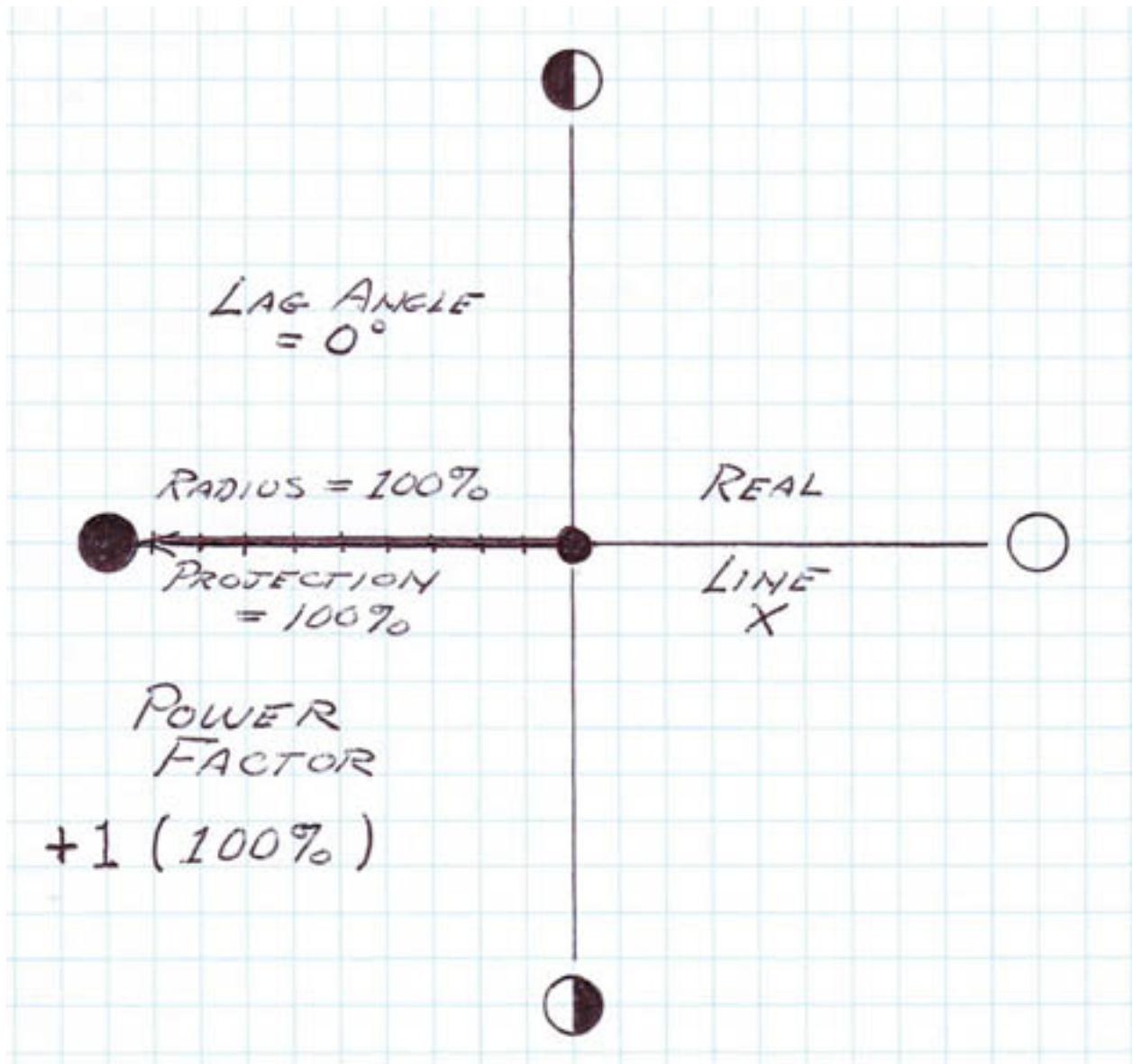

Figure 155

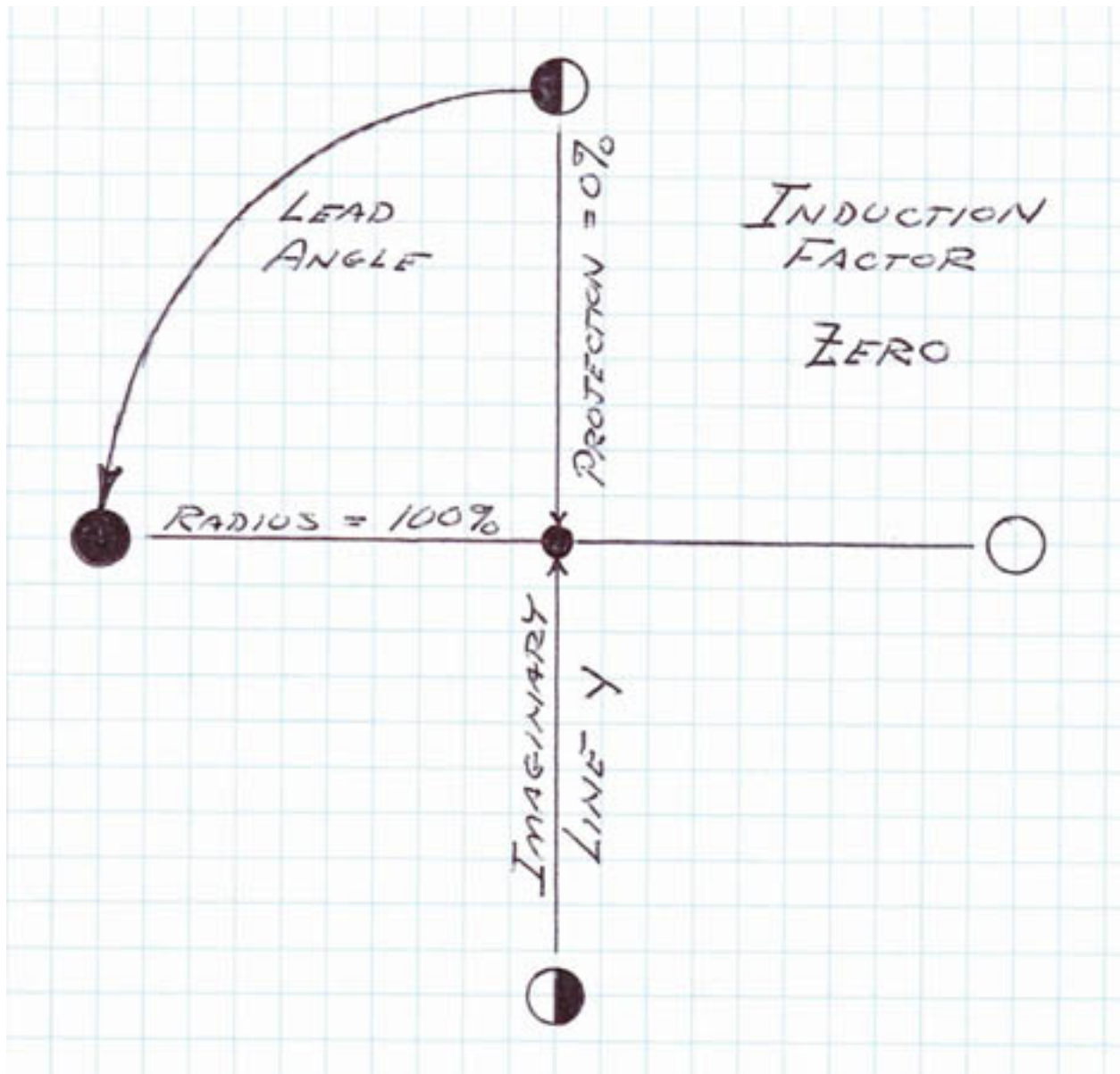

Figure 156

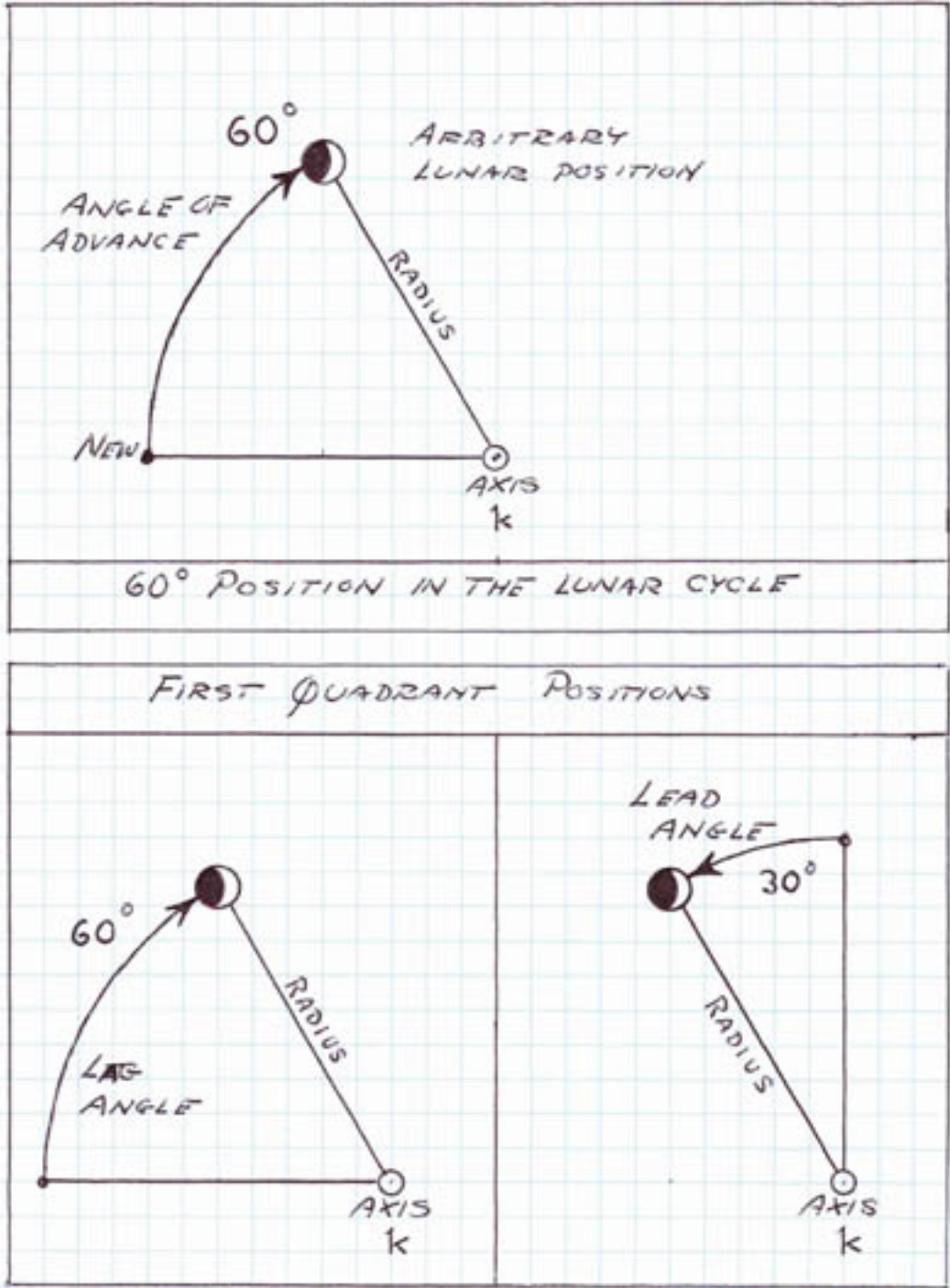

Figure 157

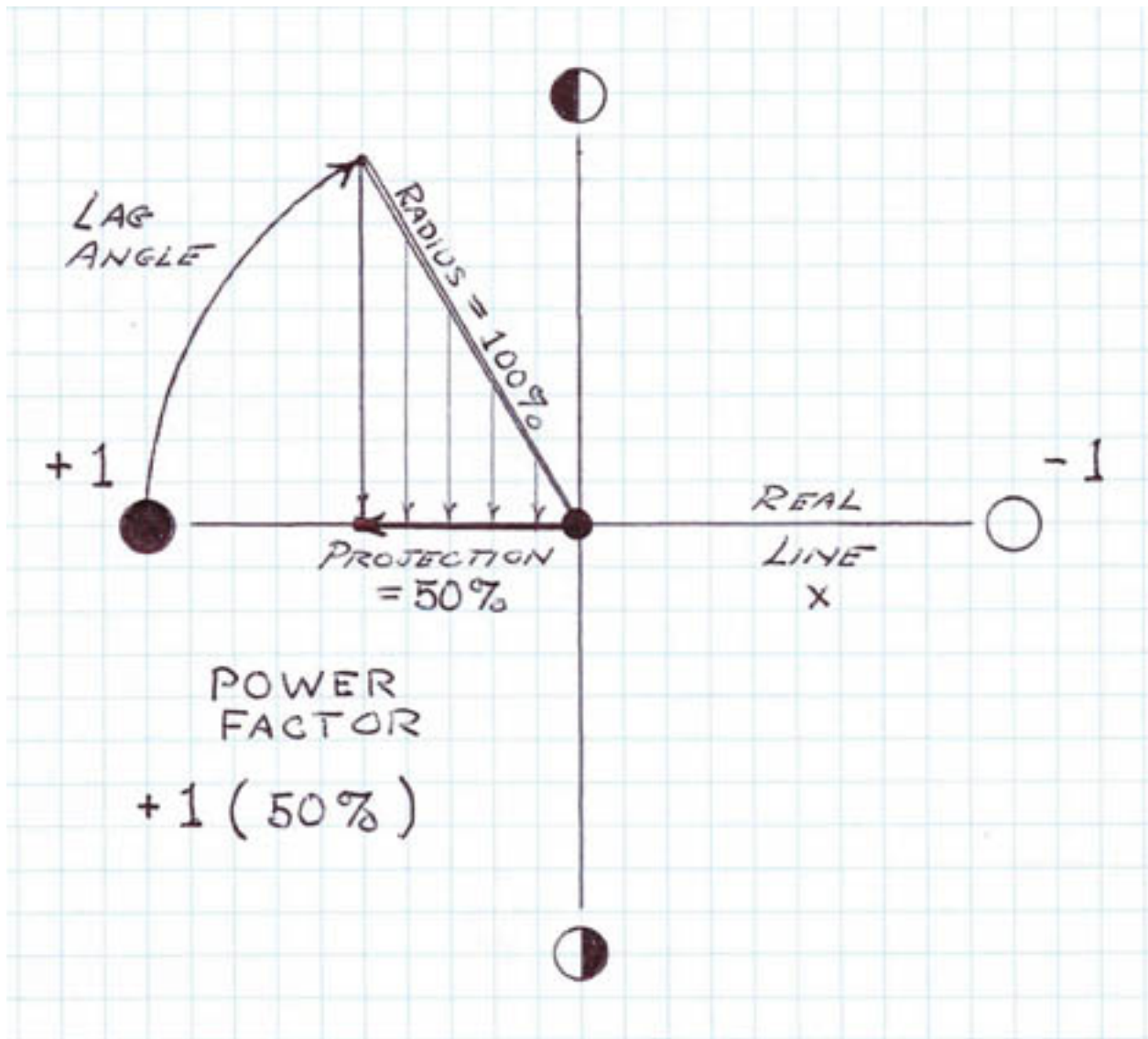

Figure 158

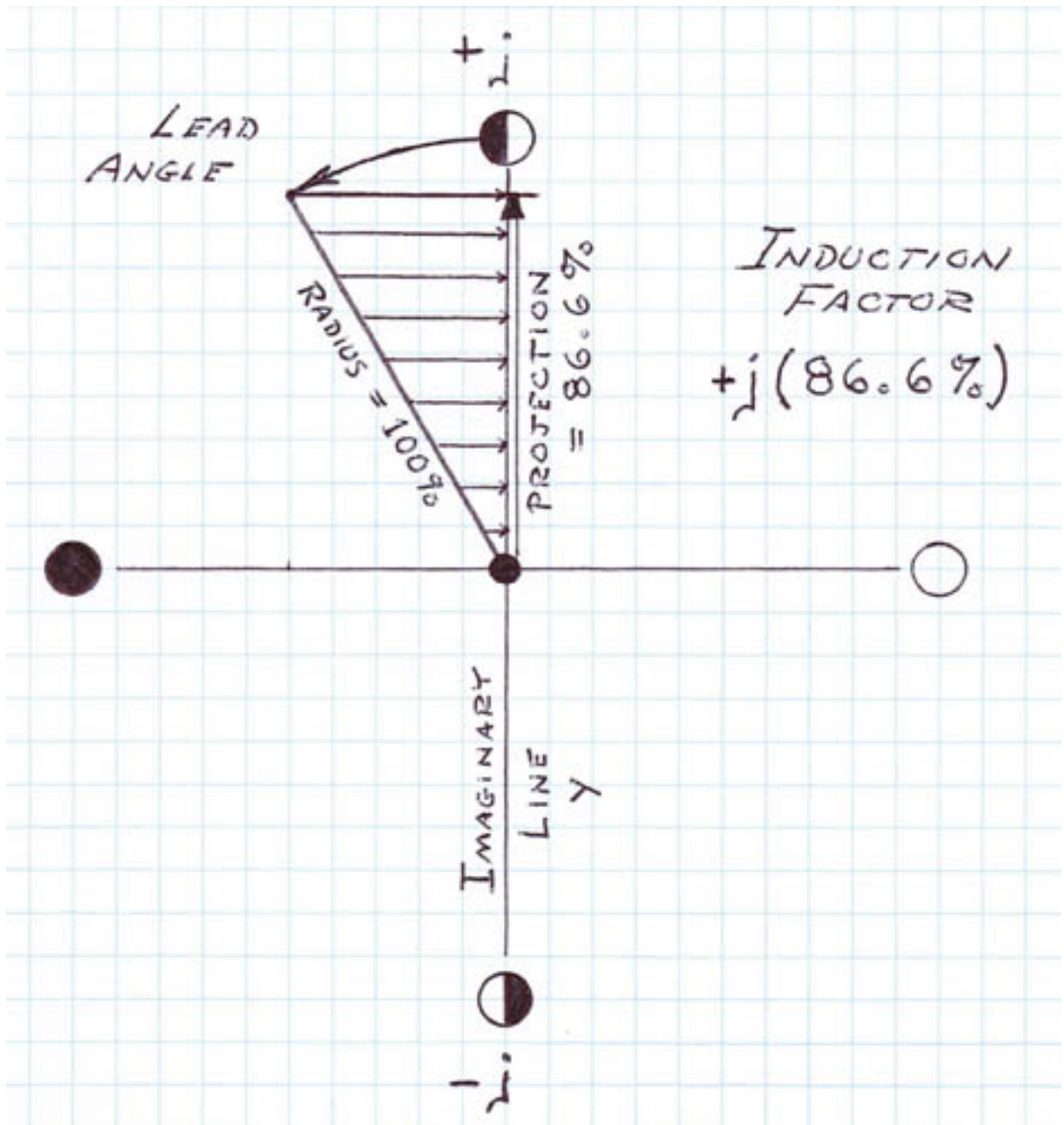

Figure 159

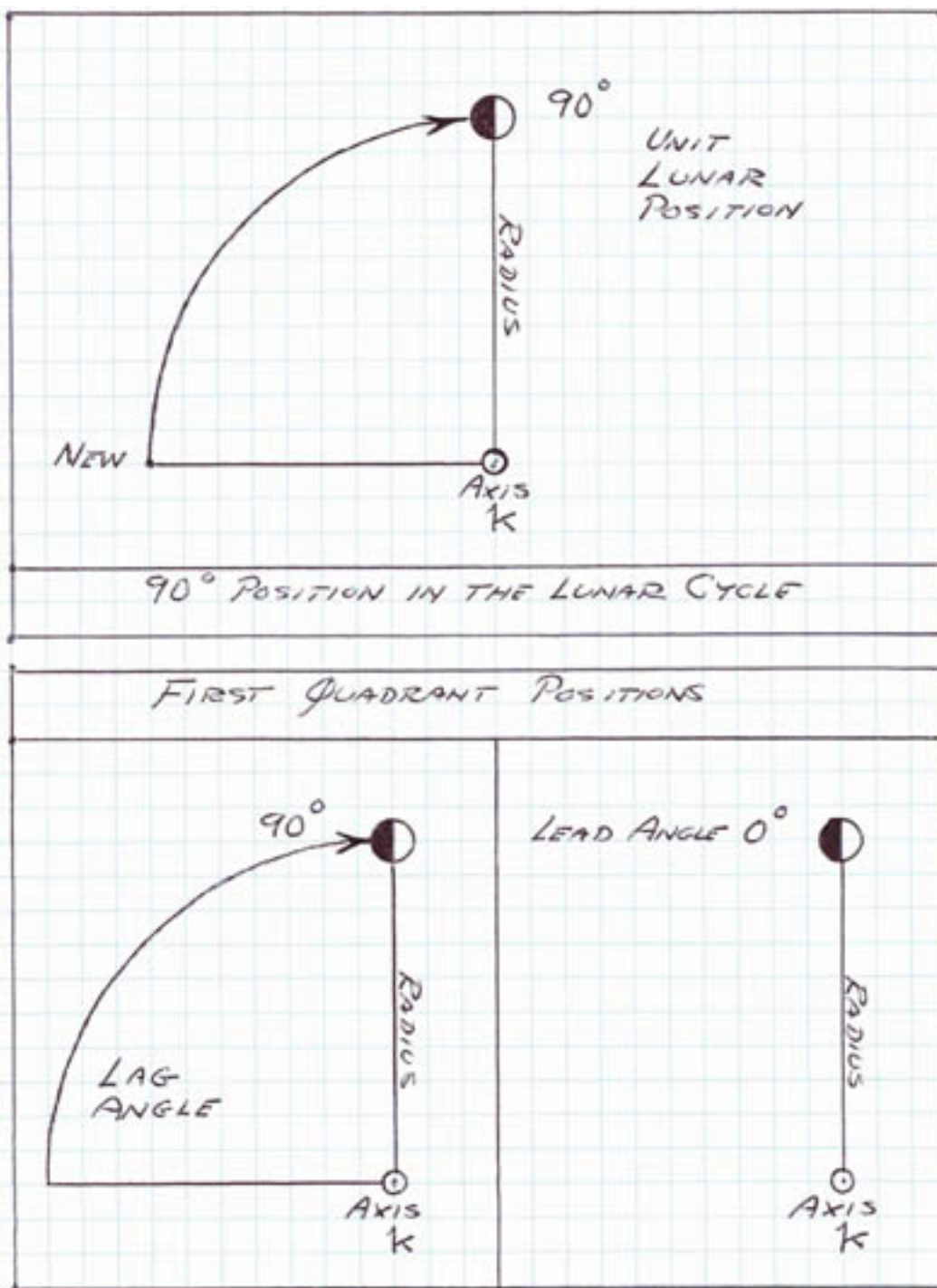

Figure 160

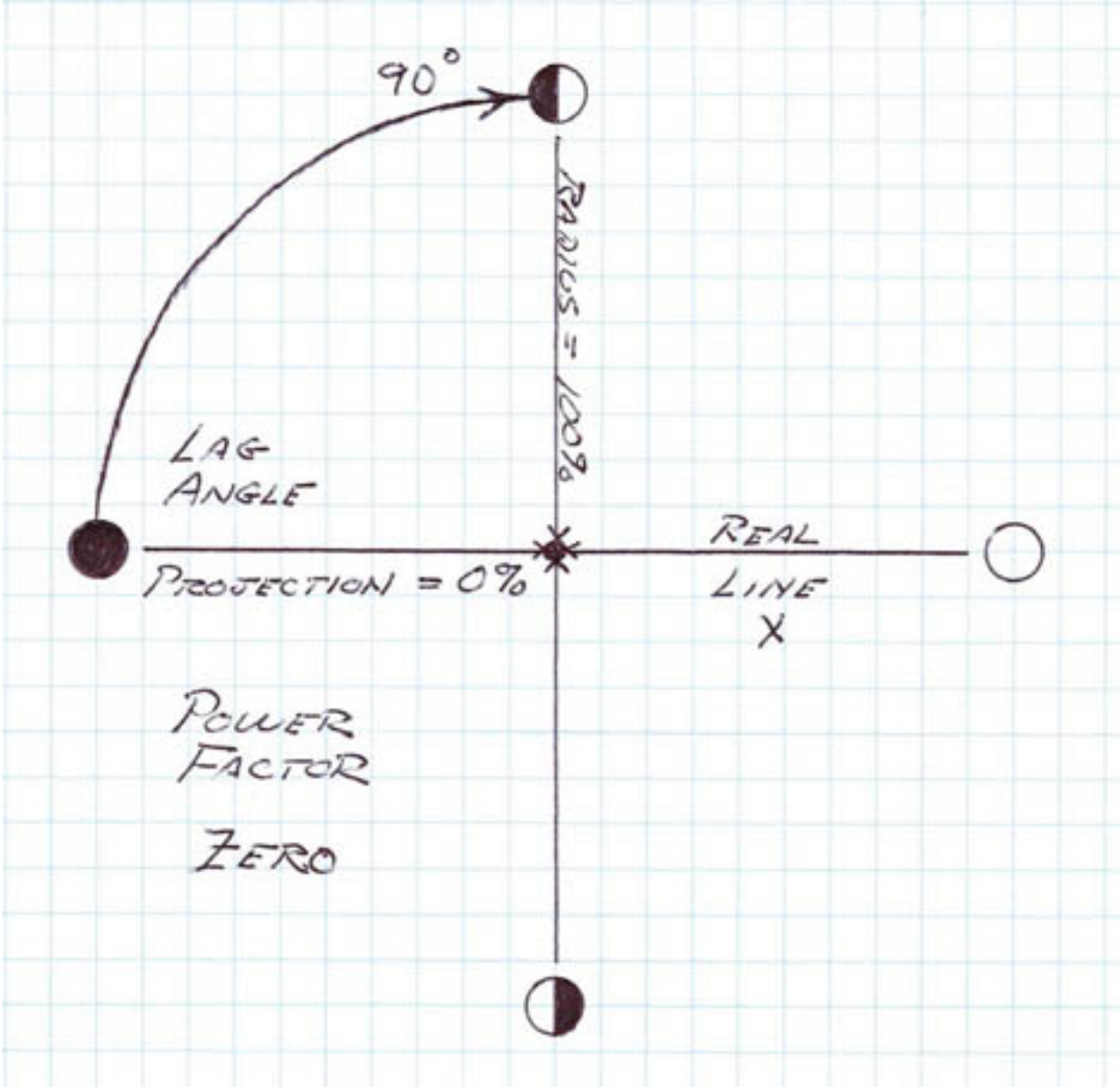

Figure 161

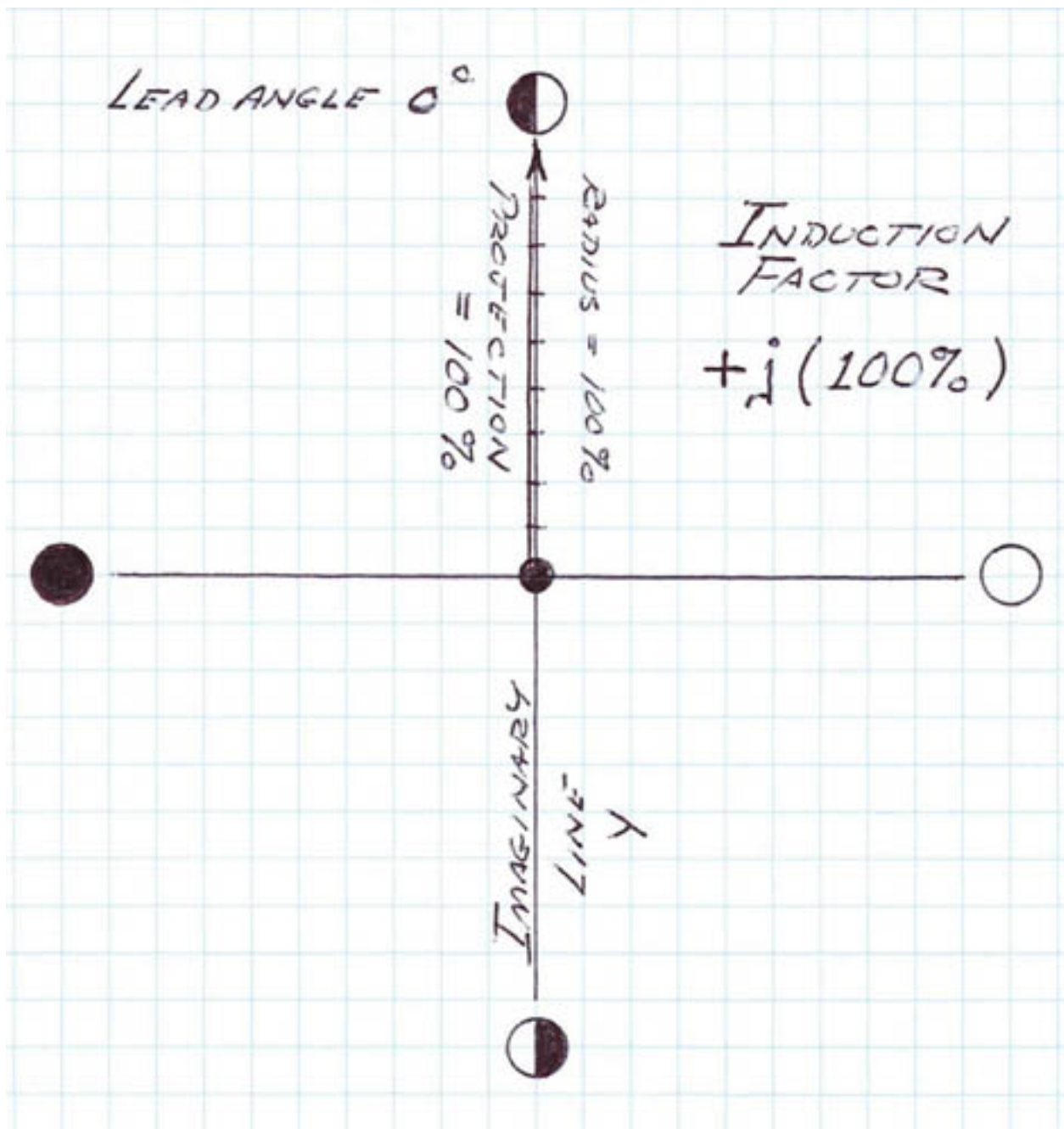

Figure 162

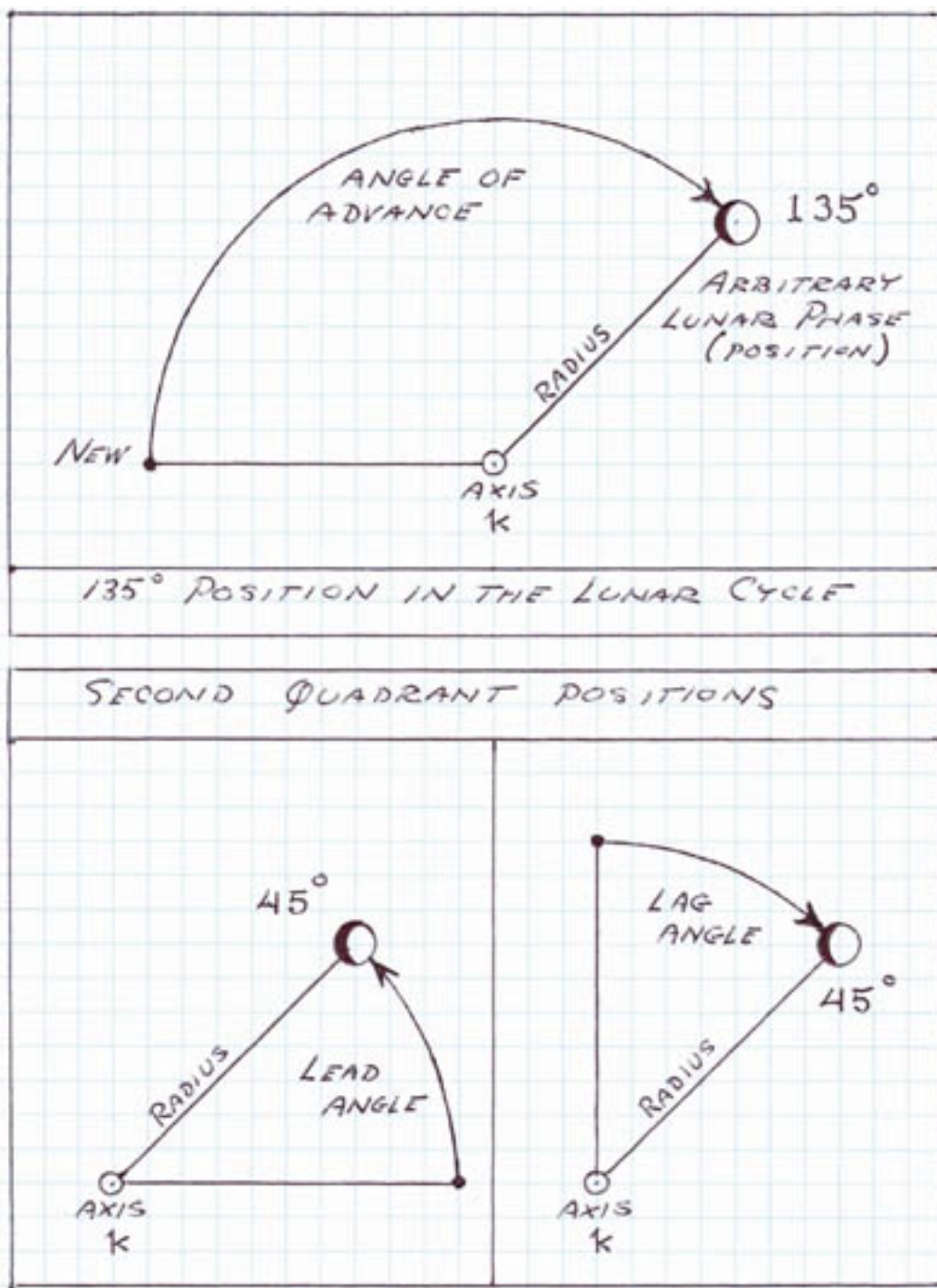

Figure 163

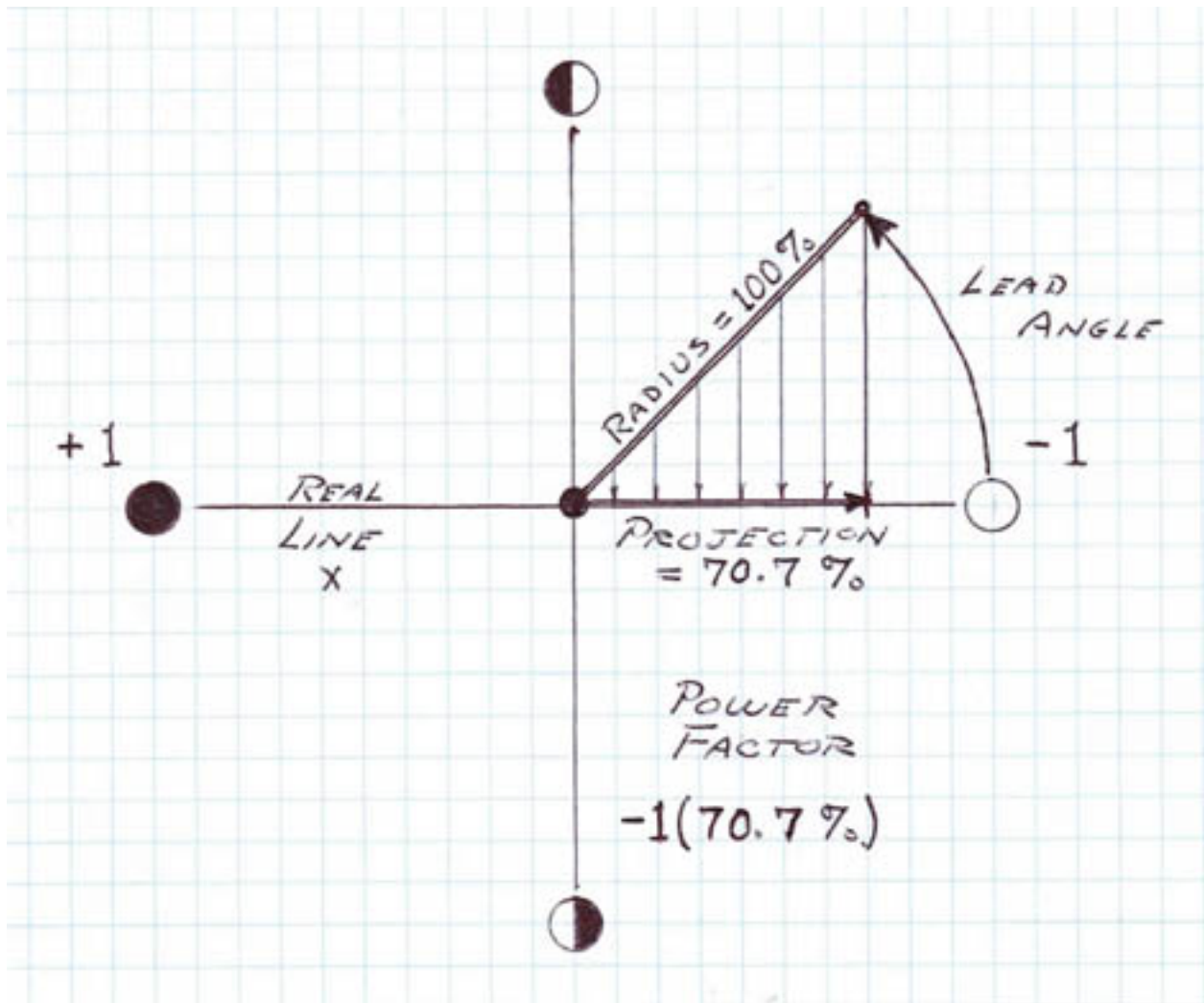

Figure 164

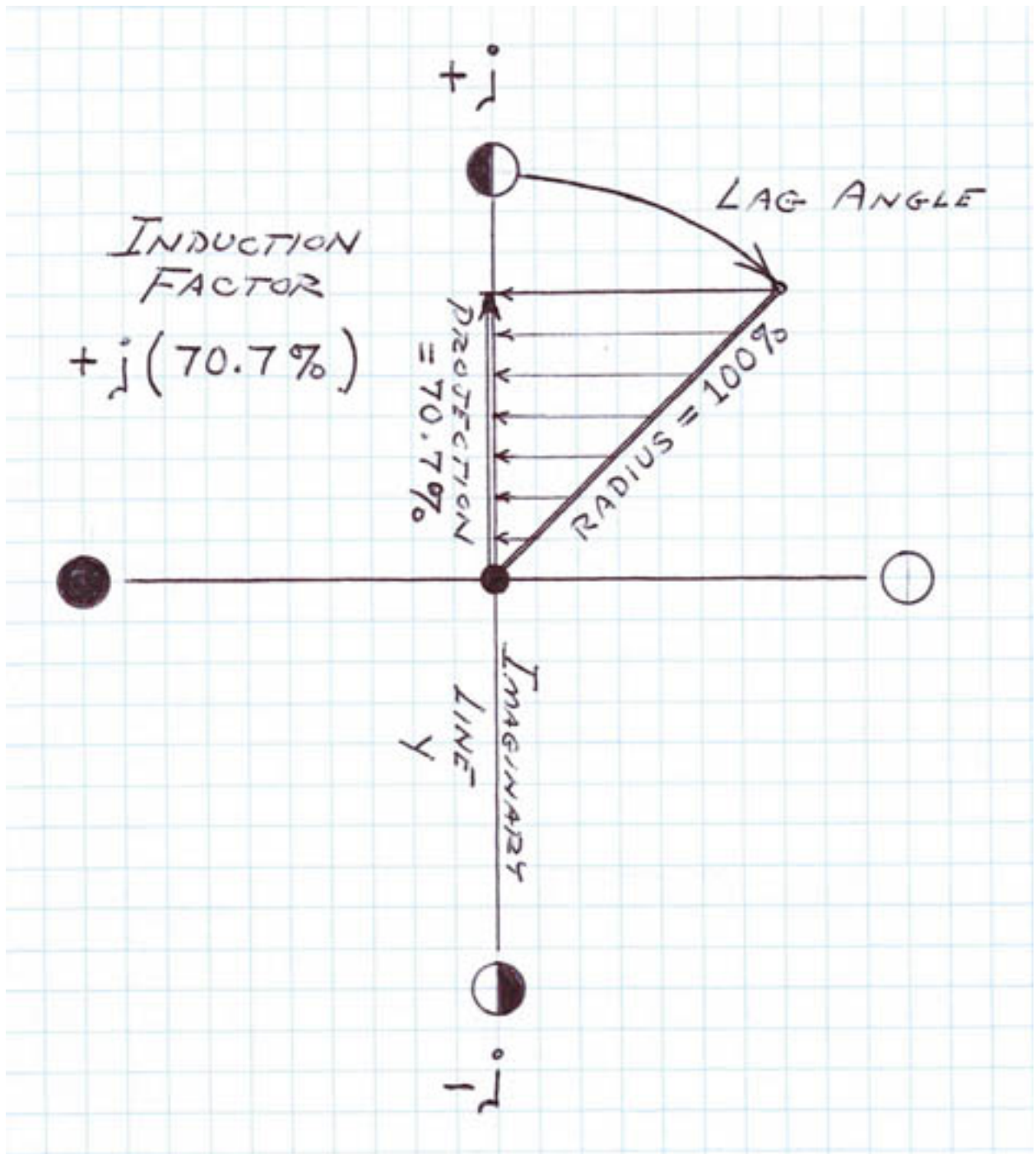

Figure 165

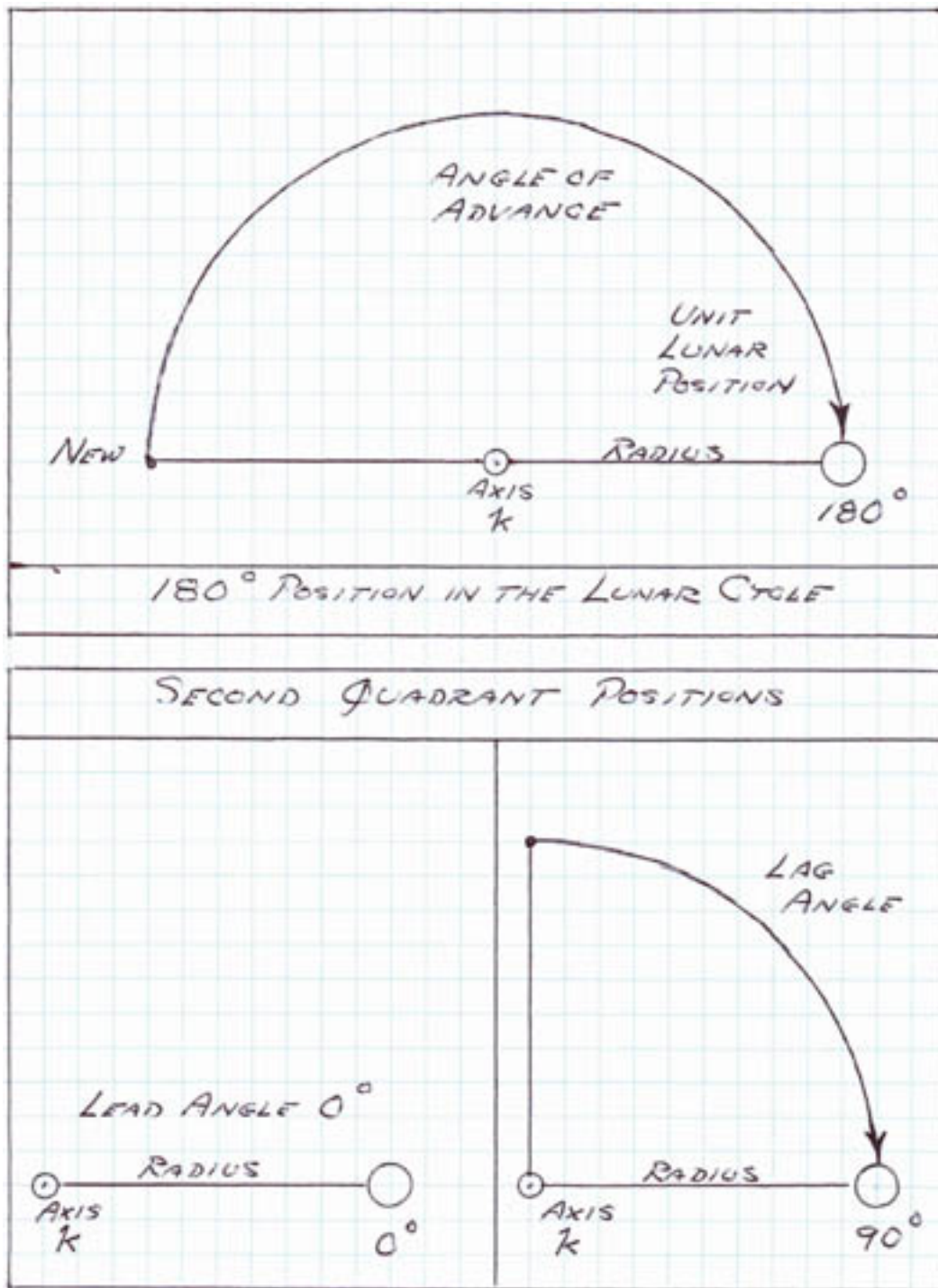

Figure 166

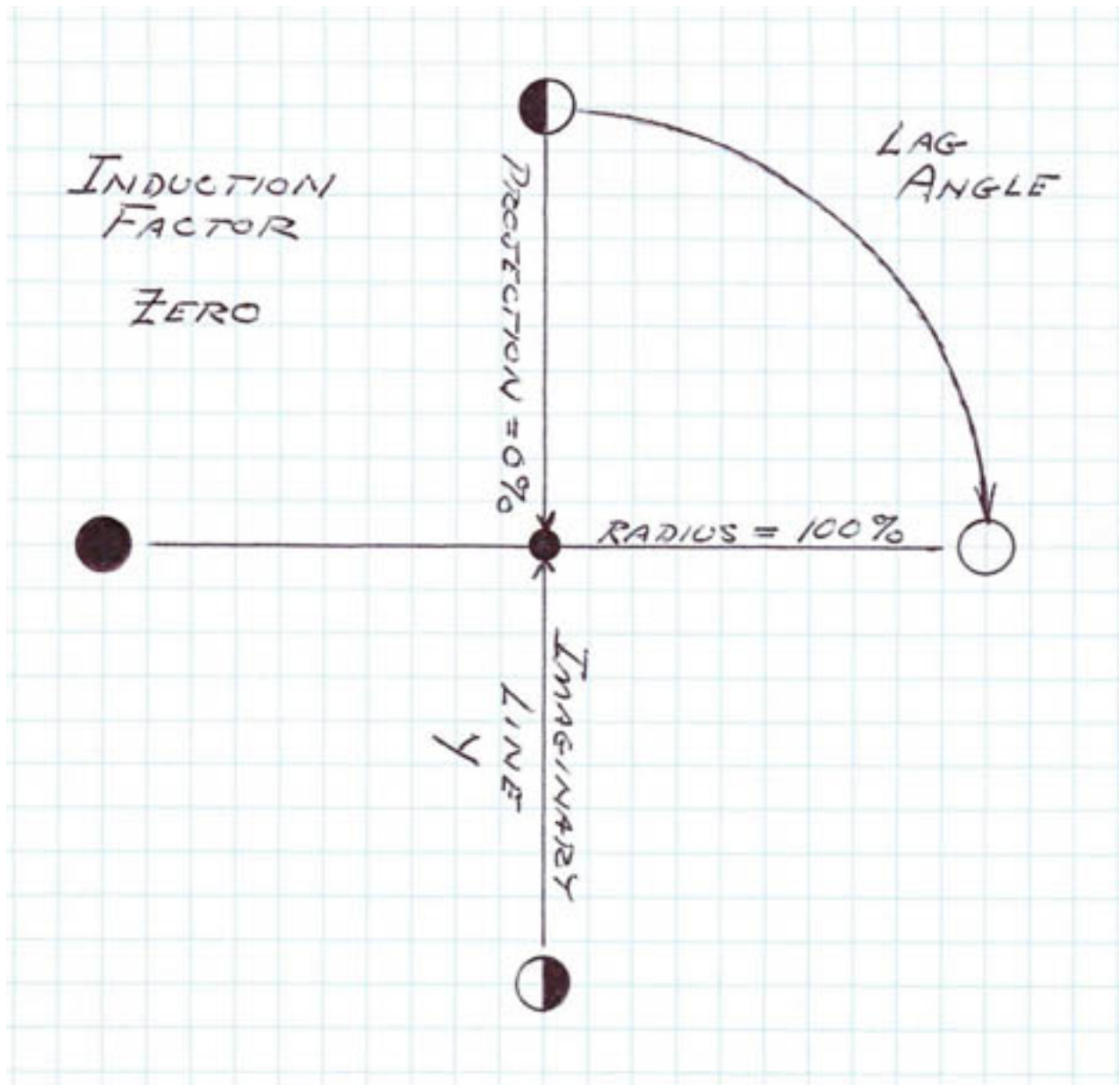

Figure 167

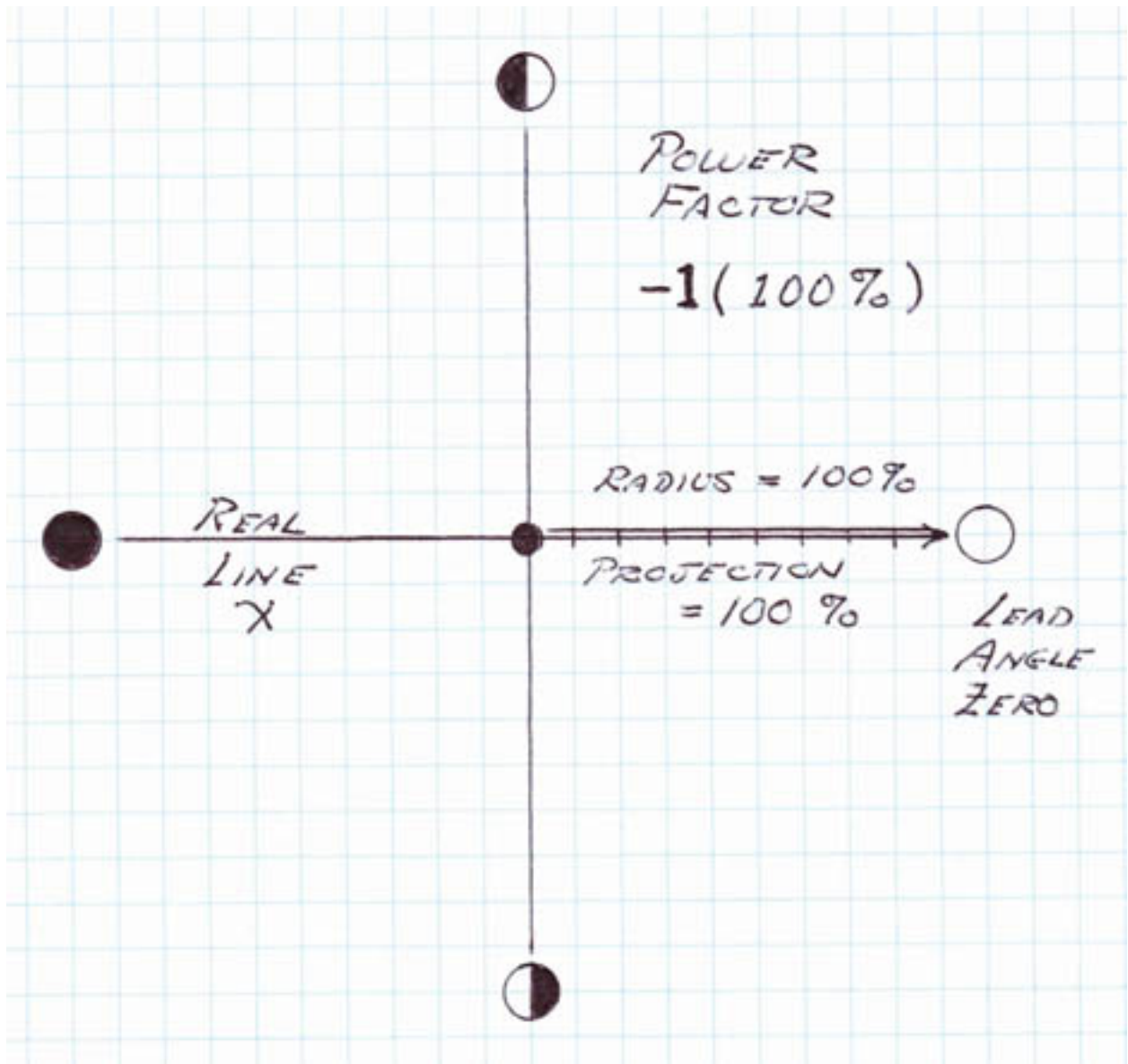

Figure 168

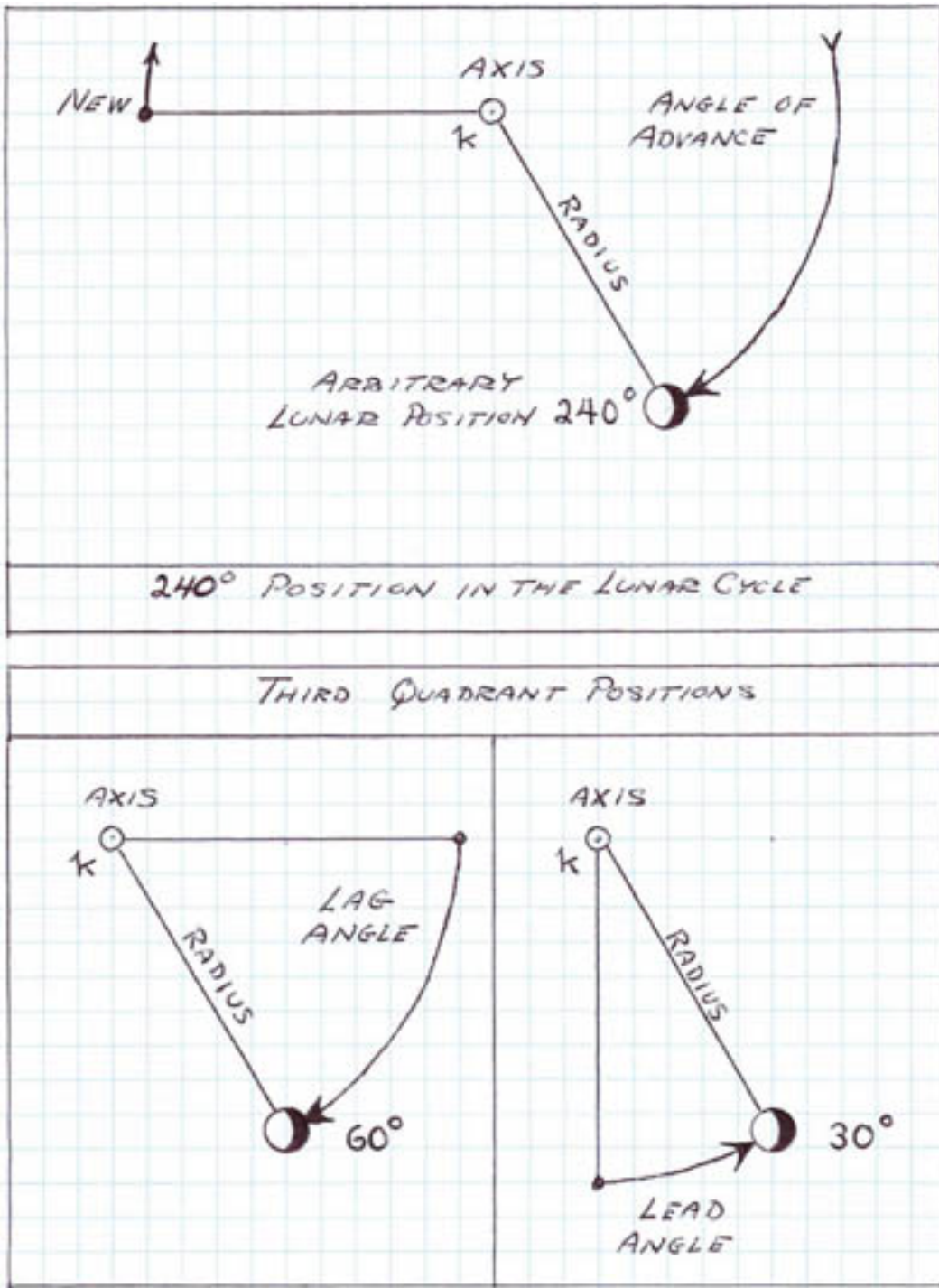

Figure 169

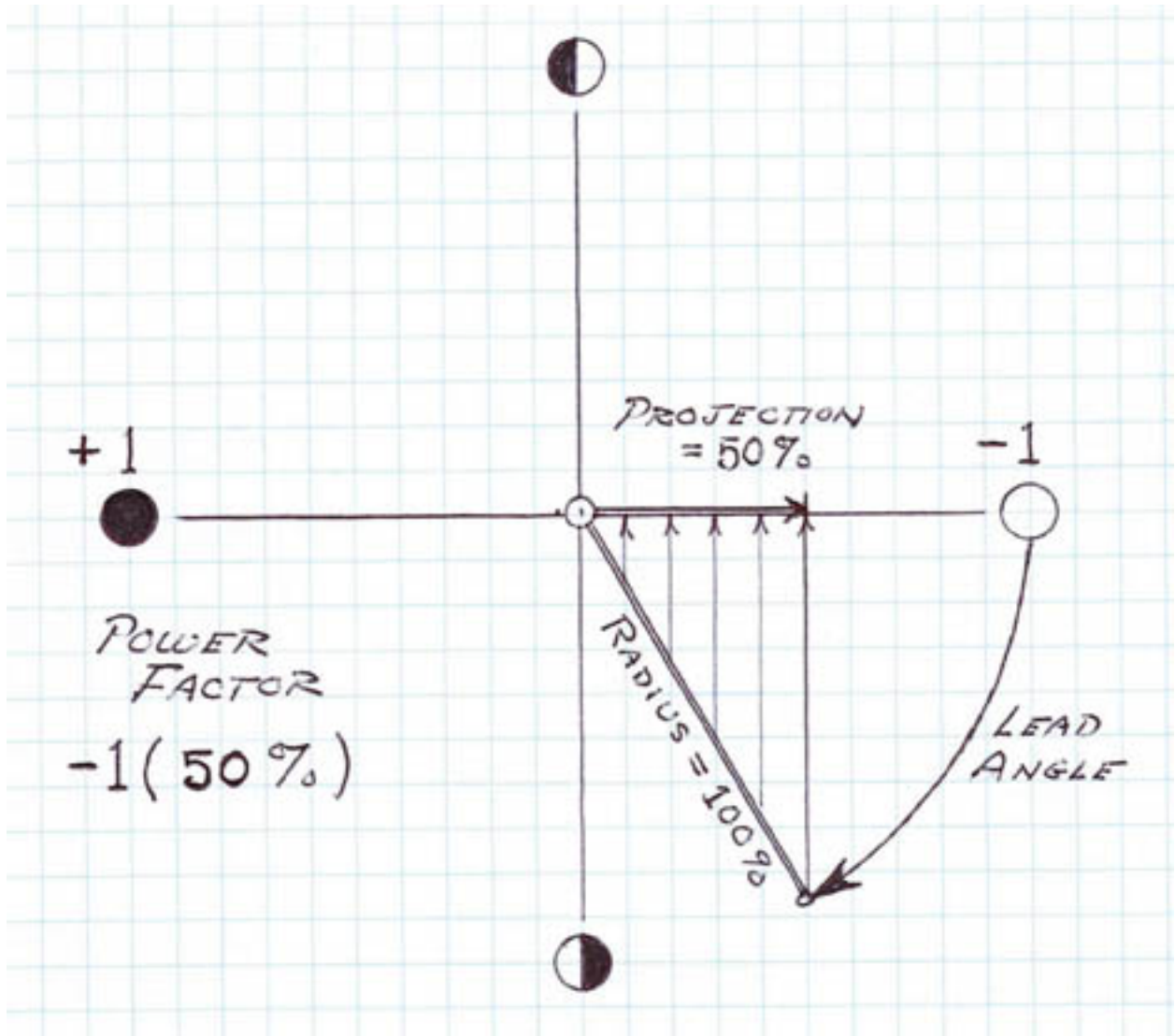

Figure 170

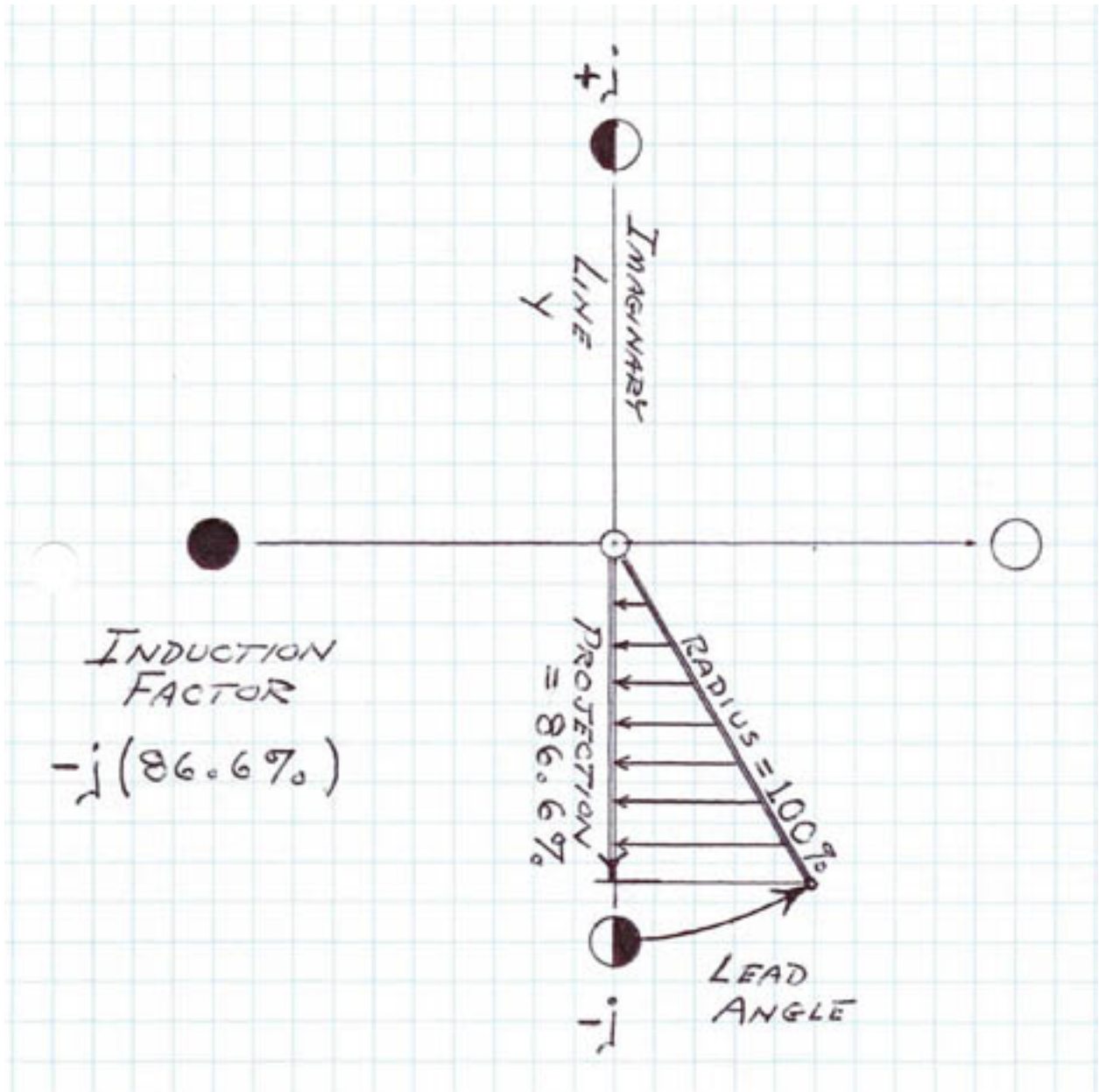

Figure 171

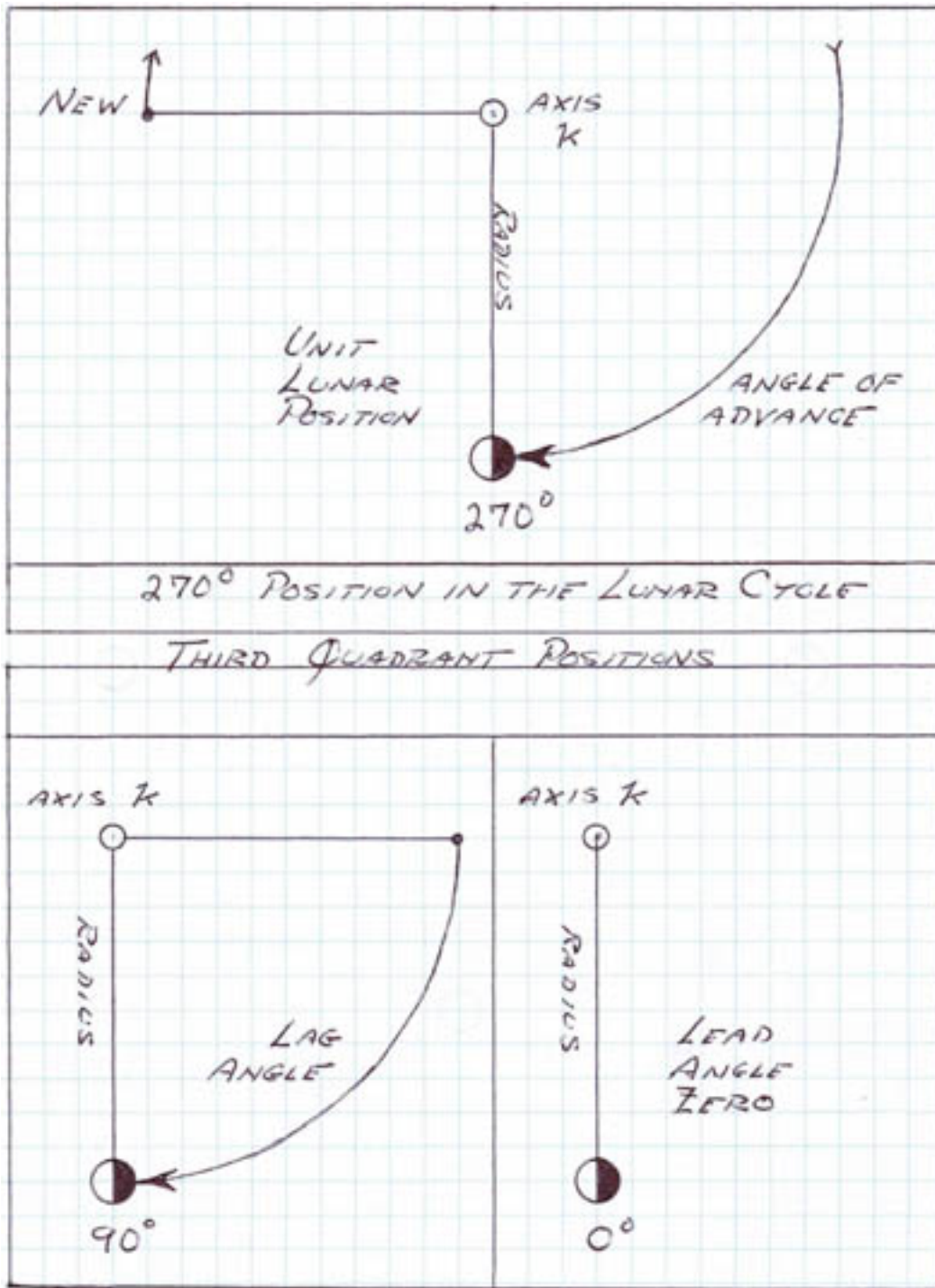

Figure 172

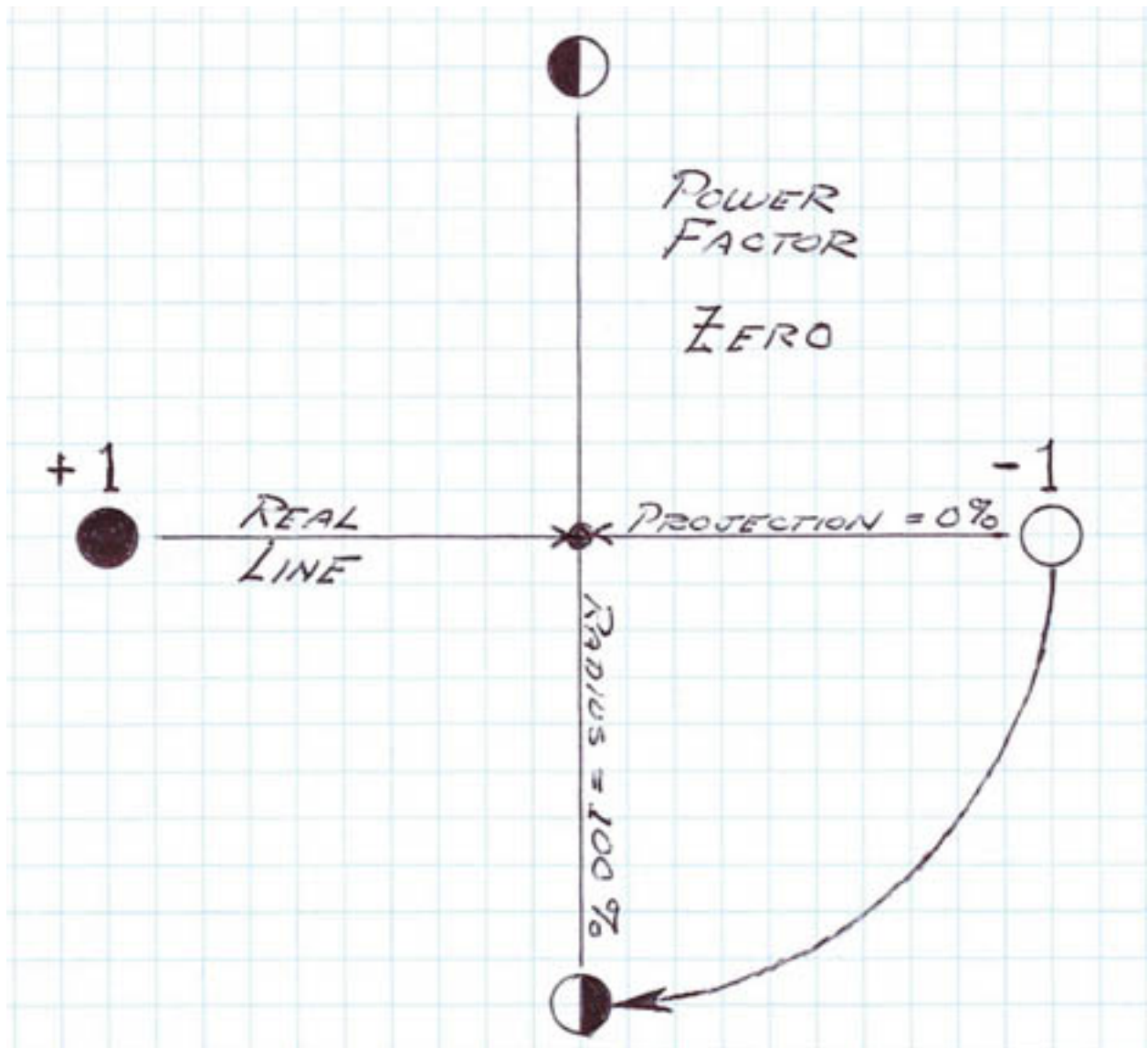

Figure 173

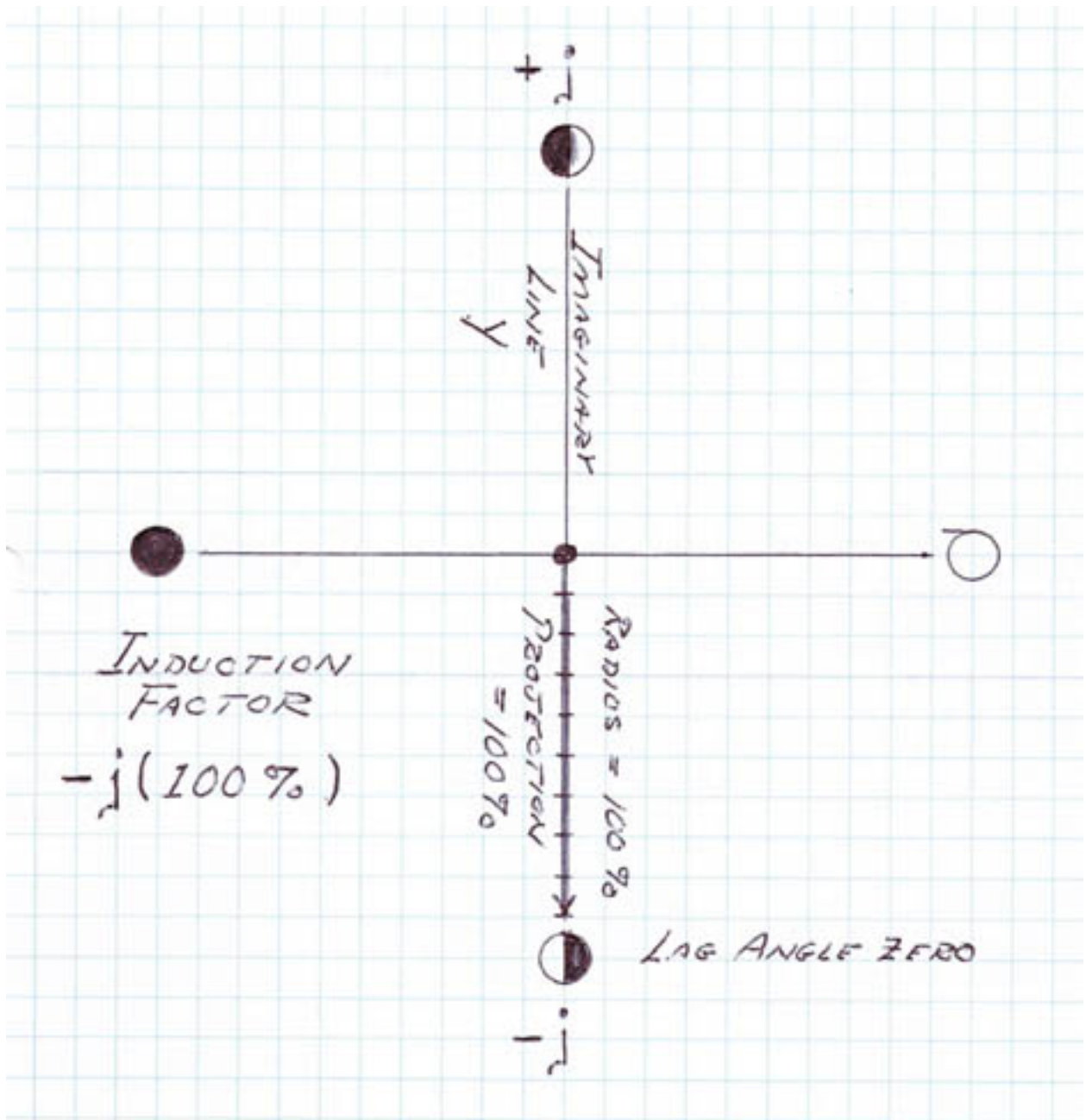

Figure 174

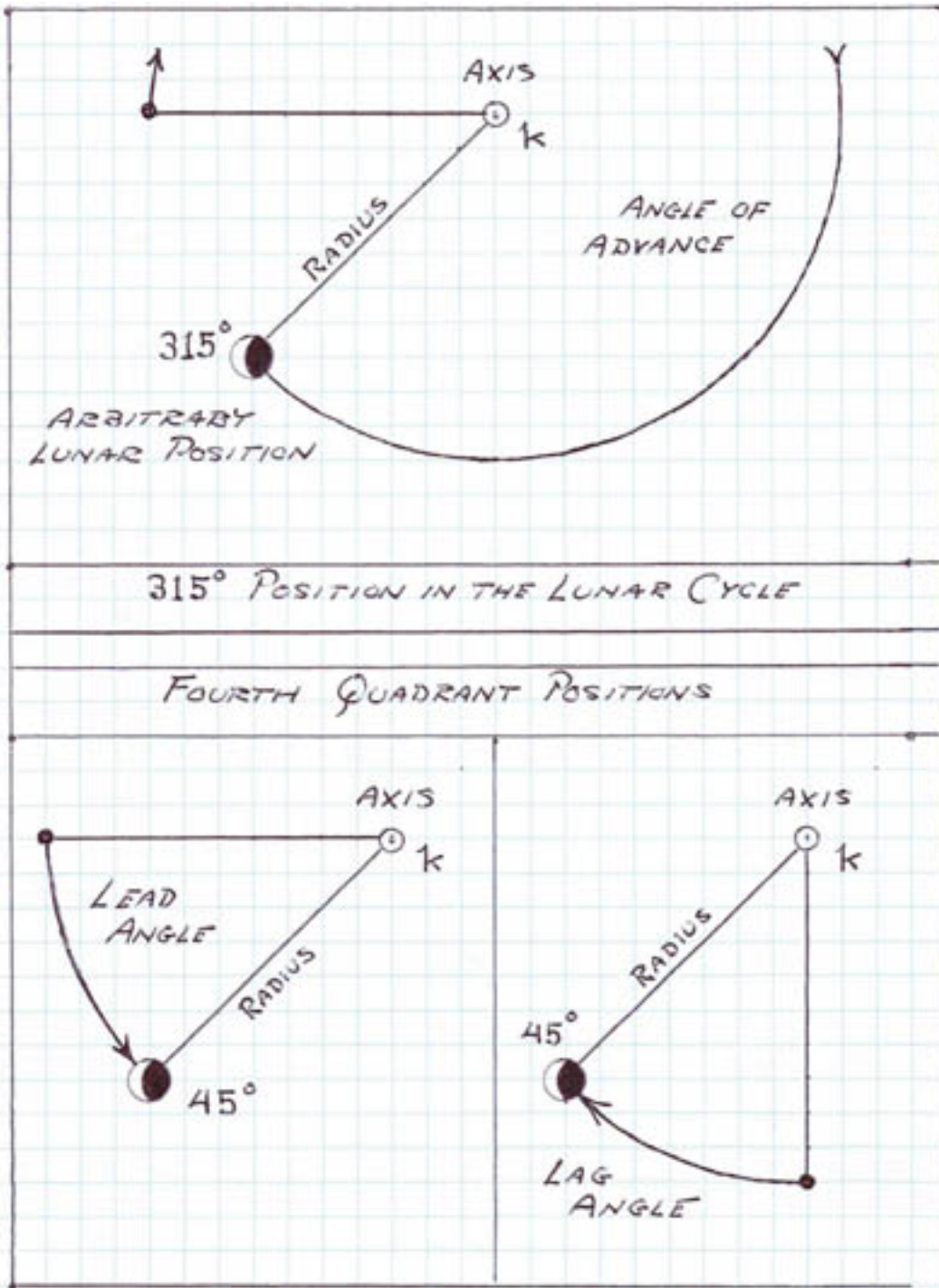

Figure 175

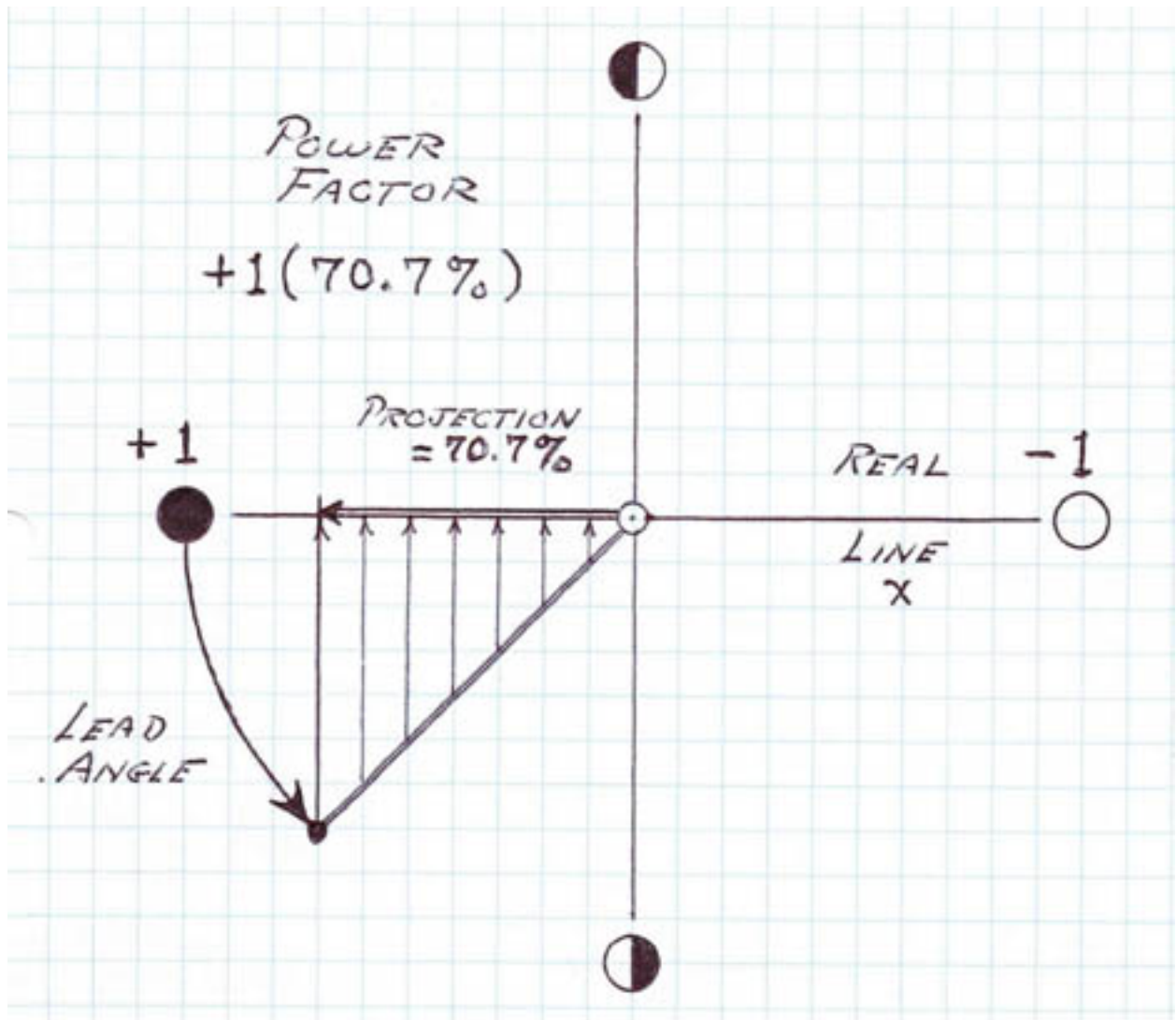

Figure 176

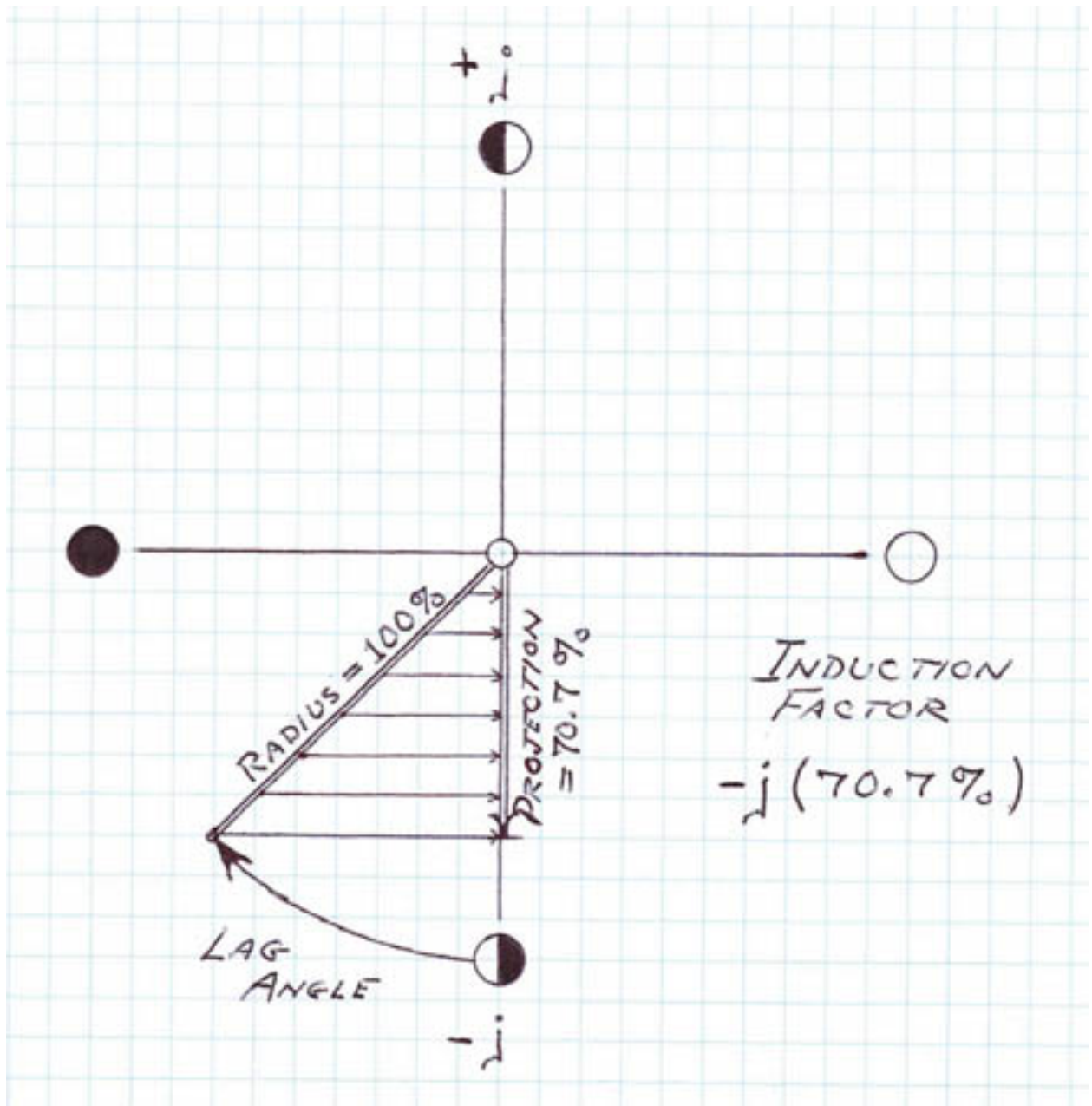

Figure 177

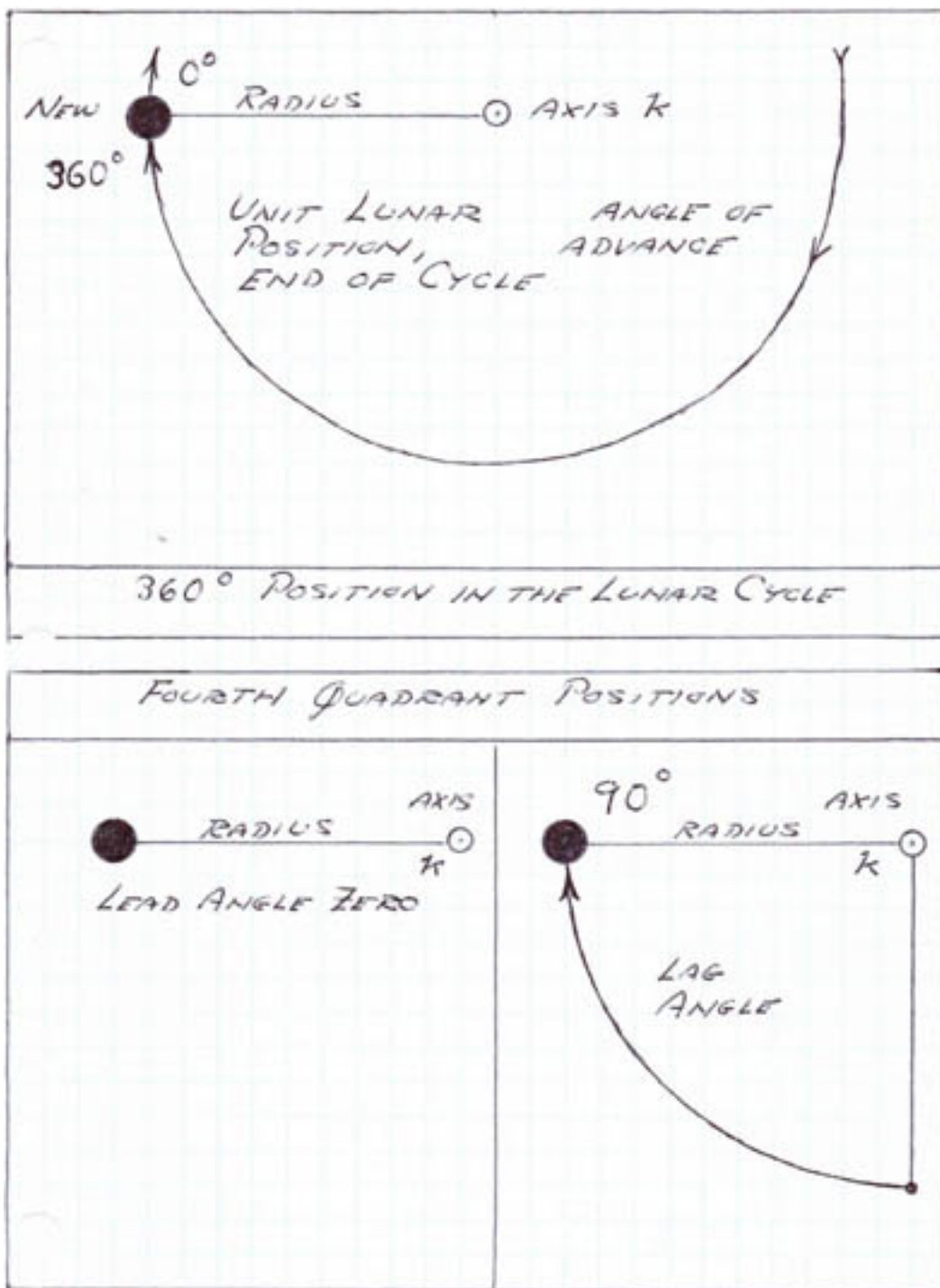

Figure 178









POSITION	POWER FACTOR	INDUCTION FACTOR
 0° NEW	100% NEW	0% LEADING
 60°	50% NEW	86.6% LEADING
 90° LEADING	0% NEW	100% LEADING
 135°	70.7% FULL	70.7% LEADING
 180° FULL	100% FULL	0% LAGGING
 240°	50% FULL	86.6% LAGGING
 270° LAGGING	0% NEW	100% LAGGING
 315°	70.7% NEW	70.7% LAGGING
 360° NEW CYCLE	100% NEW	0% LEADING

Figure 179

2.3 Electric Analog

The position of point P is in constant motion as the rotational cycle advances. As this point moves along its circular path on the unit circle the percent values, x , and, y , go through constant variation. These variations are known as alternations. The ratios involving, x , and, y , with respect to the unit radius also are in constant variation, describing a Sine wave and its complimentary Cosine wave.

The ratio of the Imaginary coordinate to the unit radius defines the Sine function, and its angle Θ . The ratio of the Real coordinate to the unit radius defines the Cosine function, and its angle Θ . A coordinate is always a decimal fraction of the unit radius, thus it can be expressed as a percent.

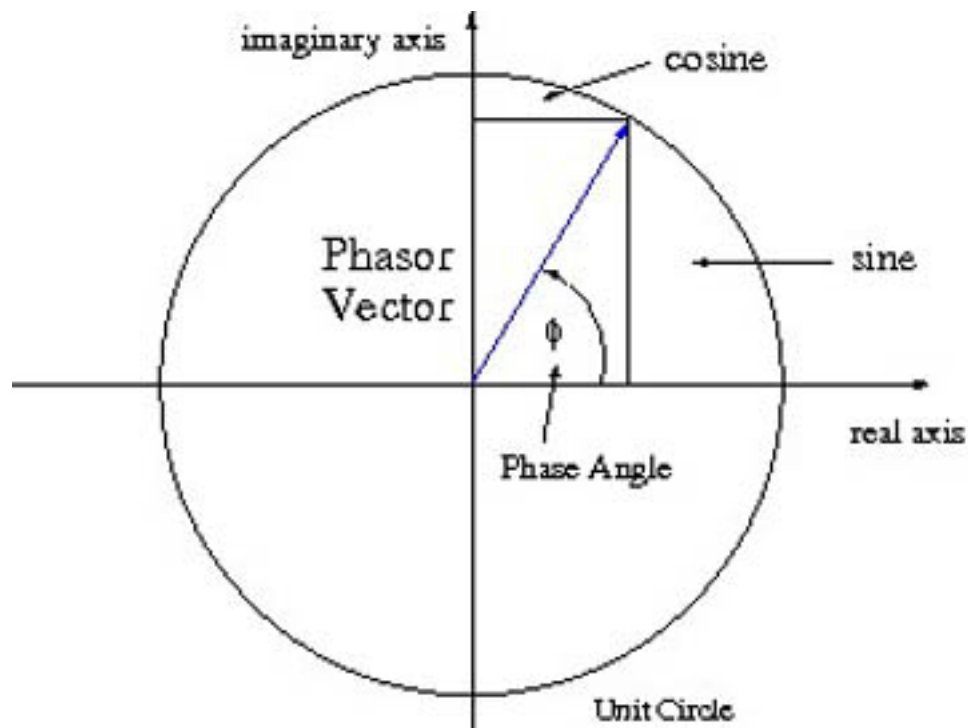

SINE AND COSINE PROJECTIONS
INDUCTION FACTOR & POWER FACTOR

Figure 180

In alternating current theory the percent Real, or Cosine function, is known as the power factor. This factor is the ratio of the Real Power to the Pythagorean sum of the Real and Imaginary powers, this known as the Apparent Power. The percent Imaginary Power, or Sine function, is called the Induction Factor. This factor is the ratio of the Imaginary Power to the Apparent Power. The Induction Factor is generally ignored. Imaginary Power is also known as Reactive Power. In both cases the Apparent Power is the Pythagorean sum of the Real and Reactive Power.

The Power Factor expresses the energy produced or consumed; energy that does real work. The Induction Factor expresses the energy stored, energy that does no work but is confined to storage elements. In a cooperative manner, as with the Sine and Cosine functions, the Power and Induction Factors conjointly act to give the position of the alternating wave with respect to the unit, or reference, A.C. cycle.

2.4 Angular and Rectangular Representation

Through the application of the Power Factor and the Induction Factor the Sine and Cosine Functions can be left out of the A.C. representation, as can the attendant complexities of the trigonometric functions in general. The A.C. wave is hereby not expressed in an angular form, but in the form of simple ratios, these relating to Real and Reactive Power as read from the common watt meter and VAR meter on the A.C. switchboard. The Power Factor and Induction Factor work together to define a versor position at any point along the A.C. Cycle. Differential equations become versor equations and great simplification results.

Rectangular coordinates give the quadrantal versor positions. This leads to the form of mathematical representation known as the "Steinmetz Method". This is a simple, but most powerful mathematical tool, for alternating current engineering.

(II) The Method of Steinmetz

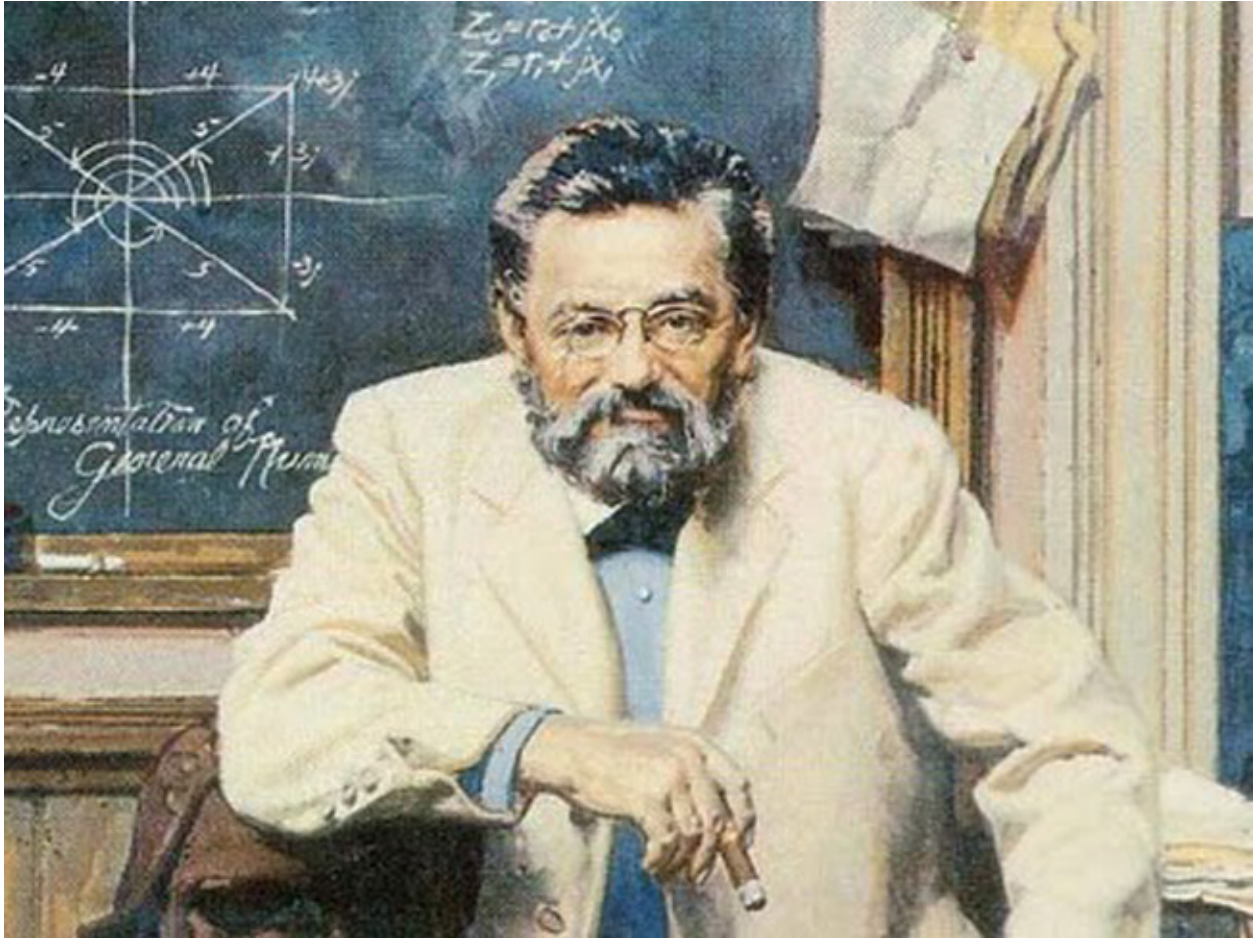

Charles Proteus Steinmetz
Figure 181

[1] Application of Versor Algebra

1.1 Symbolic Representation

Thus far an extensive treatment of versor operators and versor positions has been presented. The concept of Real and Imaginary has been solidly established as well as the basic polar and rectangular coordinate systems. These concepts have here been directed toward the development of a quadrapolar symbolic algebra, or what may be called a geometric algebra.

While this has been a very complex and detailed journey, it has been a necessary passage from Pythagoras to Steinmetz. A symbolic representation of the alternating electric wave has been arrived at. What follows is the application of the knowledge gained, this directed toward the works of Steinmetz and Tesla, the masters of alternating current.

1.2 The Steinmetz Method

Unification of the four quadrant rectangular coordinate system with a quadrapolar versor operator system gives what is known as the symbolic method. The symbolic method allows for the algebraic expression of alternating current problems. Engineering is founded upon algebra, and this eliminates the need for highly complicated graphical representation in Cartesian coordinates, and polar representation involving lengthy trigonometric operations. Moreover, the symbolic method is remarkably simple and easy to understand, this in striking contrast to the original representation in terms of the differential calculus. This does not find favor with mathematicians, but is eagerly accepted by engineers, so much so that Ernst Alexanderson emigrated from Sweden to America to work side by side with Carl Steinmetz, promoter of the symbolic method.

The symbolic method finds its origin in the work of Carl Proteus Steinmetz. Accordingly it is known as the "Steinmetz Method". This method of A.C.

analysis created world fame for Steinmetz and it has become the foundation of the theory and calculation of alternating current phenomena. However, there are those die-hards who still submit to the self-flagellation of trigonometric functions and identities.

The Steinmetz Method is based upon his application of the versor operator j . In his application the operator j is reworked into his won quadrantal vector operator. Oliver Heaviside gave warning about mixing versors and vectors in his writings. This complication gives rise to certain imitations in the methods of Steinmetz.



SQUARE ROOT OF MINUS ONE

Figure 182

Although Steinmetz initially defines his operator as the fourth root of positive one, he applies it in a duo-binary form, this defining his operator as the square root of negative one. The name of Steinmetz is inexorably connected with the phrase "The Square Root of Minus One", accordingly out of his work.

1.3 Promethean Myth

It was once said that “General Electric gave Steinmetz permission to create electricity from the square root of minus one”. What does this mean? This would involve a rotation turning Reactive Energy into Real Energy. Since Reactive Energy involves no work, but Real Energy does, this statement by G.E. would covertly imply energy synthesis, the Holy Grail of electrical engineering. In the mind of the physicist this is impossible, but in the mind of the mathematician the square root of minus one is impossible. When Steinmetz was asked later in life if he discovered a “*New type of electricity*” his answer was no. Can we believe him?

In any case it can be said that he was a Prometheus that stole the fire, the square root of minus one, from the Gods, the mathematicians. And it came to pass that the Gods were not happy.

[2] The Wizard



THOMAS ALVA EDISON (1847-1931) WITH STEINMETZ

Figure 183

2.1 Experiments

Steinmetz was known as “The Wizard of Schenectady”. Schenectady, New York was the home of General Electric. Shown in the figure is Steinmetz with Edison. The two spent much time together. It should be noted that General Electric was in its origins Edison General Electric, but Edison’s company was taken away from him.

Both Steinmetz and Edison were avid experimenters. In fact, this is what makes the work of Steinmetz so significant, it is that his work was founded upon actual experiments, not just elegant theories. One can only imagine what these two may have had going on in their late night experiments. Shown in the figure is Edison and Steinmetz examining insulator damage during an artificial lightning experiment.

It is known that Thomas Edison has been intent on making a telephone to talk with the dead. Moreover, it has been rumored that Carl Steinmetz was making a "Time Television" in order to view past historical events. These two experimenters, with their incredible knowledge and resources may have created the original Outer Limits episode called "Borderlands". It is of interest to note that the world of the square root of minus one inspired Lewis Carroll to write his Through The Looking Glass, commonly known as "Alice in Wonderland".

2.2 The Lizard



STEINMETZ WRITING A BOOK IN HIS CANOE

Figure 184

To the few that knew Carl Steinmetz personally, he may have been better called the "Lizard of Schenectady". He would often vanish into the bushes

of upstate New York, no to be seen for weeks. General Electric would have to send a search party to find him. He would be found on some stream in his canoe, busy writing one of his famous books. Steinmetz called his hole in the bushes “Camp Mohawk”.

2.3 His Origin



KARL RUDOLPH STEINMETZ

Figure 185

Steinmetz was born Karl Rudolph Steinmetz on April 9, 1865 in Breslau, Germany. He emerged into this world as a deformed hunchback dwarf. His own father was considering having him euthanized at birth. The adult figure of Steinmetz was much like that of Igor the switchboard operator for

Dr. Frankenstein. Surely Steinmetz in his G.E. laboratory would fit the scene in *The Mole*. (Dr. Frankenstein as Tesla?)

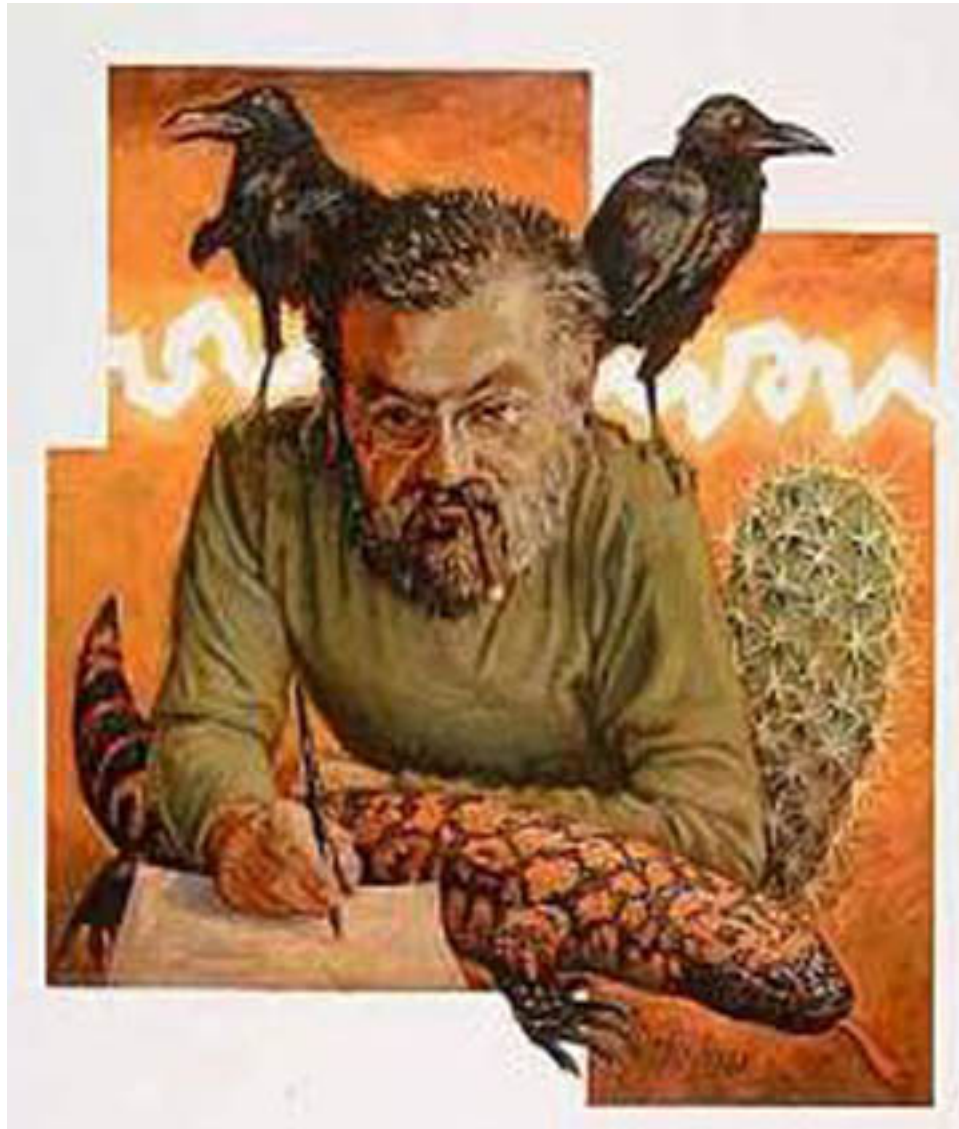

THE LIZARD OF SCHENECTADY

Figure 186

Steinmetz filled his home with desert wildlife, toxic snakes, and lizards included. Open wire lines and knife switches on the walls adorned the home of Steinmetz. He lived an isolated existence from a social standpoint, and a few friends saw to his basic needs. (The Berg family adopted him). However in the public mind, Carl "Proteus" Steinmetz was a "Hero Figure",

a Thor that threw giant bolts of his homemade lightning and walked through the "Looking Glass" of mathematics. It is unfortunate that his fame finally got the best of him later in life and he finally succumbed to the delusional theories of Albert Einstein as did so many other unfortunate souls.

2.4 The Educator



CHARLES PROTEUS STEINMETZ 1865-1923

Figure 187

What seemed important to Steinmetz was education and accordingly he was an excellent educator. His ability to make the complex so simple is unparalleled. He established a regular lecture series at Union College. The series led to his book Discharges, Waves and Impulses.

During his college years in Germany he was a communist agitator, working in defiance against Chancellor Bismarck. He was to be arrested and executed, but escaped to America. His socialist-political interests were active throughout his life. This probably is what in part led to his position as director of the New York Department of Education.

By far, Steinmetz was the foremost professor of electricity. The natural complementary-symmetry of electrical forces is made very clear in the writings of Steinmetz, something not found in the works of others. Steinmetz died at age 59 on October 26, 1923 and is best remembered as The Professor of Electricity.

(III) The Rotary Field of Nikola Tesla

[1] The Four Quadrant Arch Type

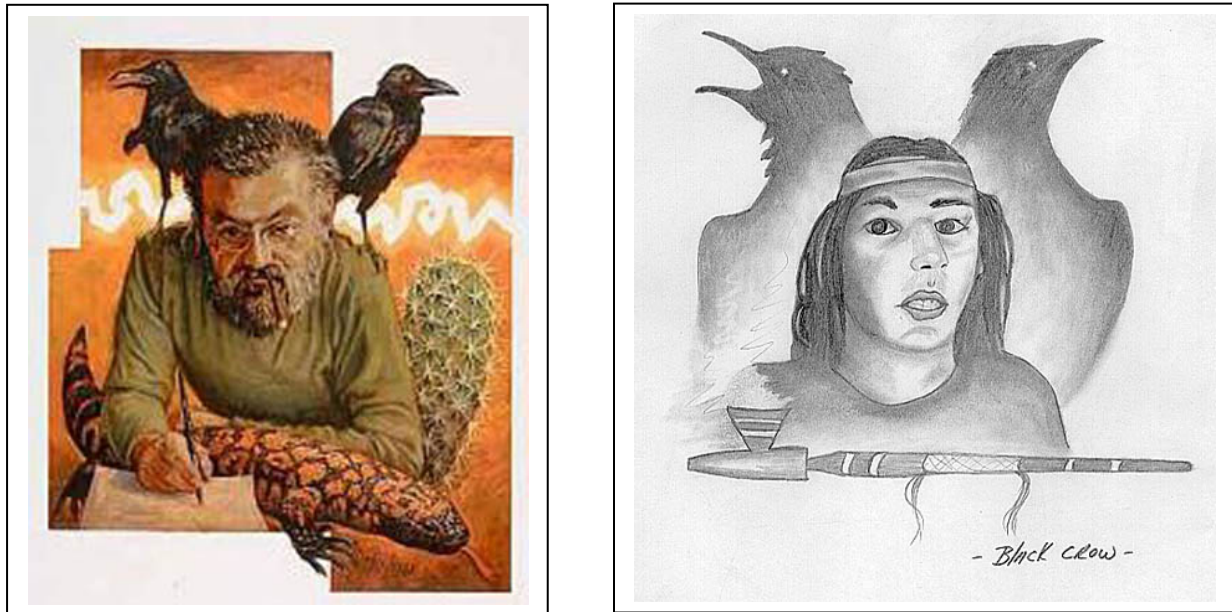

Figure 188

1.1 Quadrantal Natural Laws

The works of the masters is rooted in an understanding of nature's laws. Steinmetz wrote his books in nature's wilderness at Camp Mohawk. Nikola Tesla's visions came via his observation of natural events. Natural knowledge is gained through experiment, observation, and experience.

The laws of electricity are but a subset of the laws of nature. Electricity is not just something concocted in someone's mind, electricity was here before anyone even thought about it. Its presence eluded the mind of man for untold centuries.

The arch forms of electricity were already latent in the arch forms of the American Indian, he was the first American to utilize the basic Four Quadrant Arch Type. The inventions of Nikola Tesla, for the most part, are quadrapolar and accordingly the A.C. math of Steinmetz is quadrapolar.

The Integratron is a unique merging of the quadrapolar forms of the American Indian and those of Nikola Tesla, with the math of Steinmetz.

1.2 Quadrantal Attributes and Arch Forms



INDIAN QUADRANTAL ASPECTS

Figure 189

Each unit versor rotation sweeps out a quadrant as it passes from one unit versor position to the next in the cycle of revolution. This quadrant spans one pair of phases. One complete cycle of revolution spans four quadrants. Each of these quadrants has its own particular attributes or aspects, this for the Moon, the seasons, or for alternating current.

One particular set of aspects has been the ratio of light and dark on the lunar face, another has been the ratios of Real and Reactive Power on the A.C. cycle. Shown in the figure are the aspects of four distinct quadrants, this in American Indian expression. Four phases are given in a quadrantal symbolic form:

<u>Versor</u>	<u>Name</u>	<u>Phase</u>	<u>Color</u>
0	Wolf	1	Red
1	Hawk	2	Yellow
2	Bear	3	White
3	Snake	4	Black

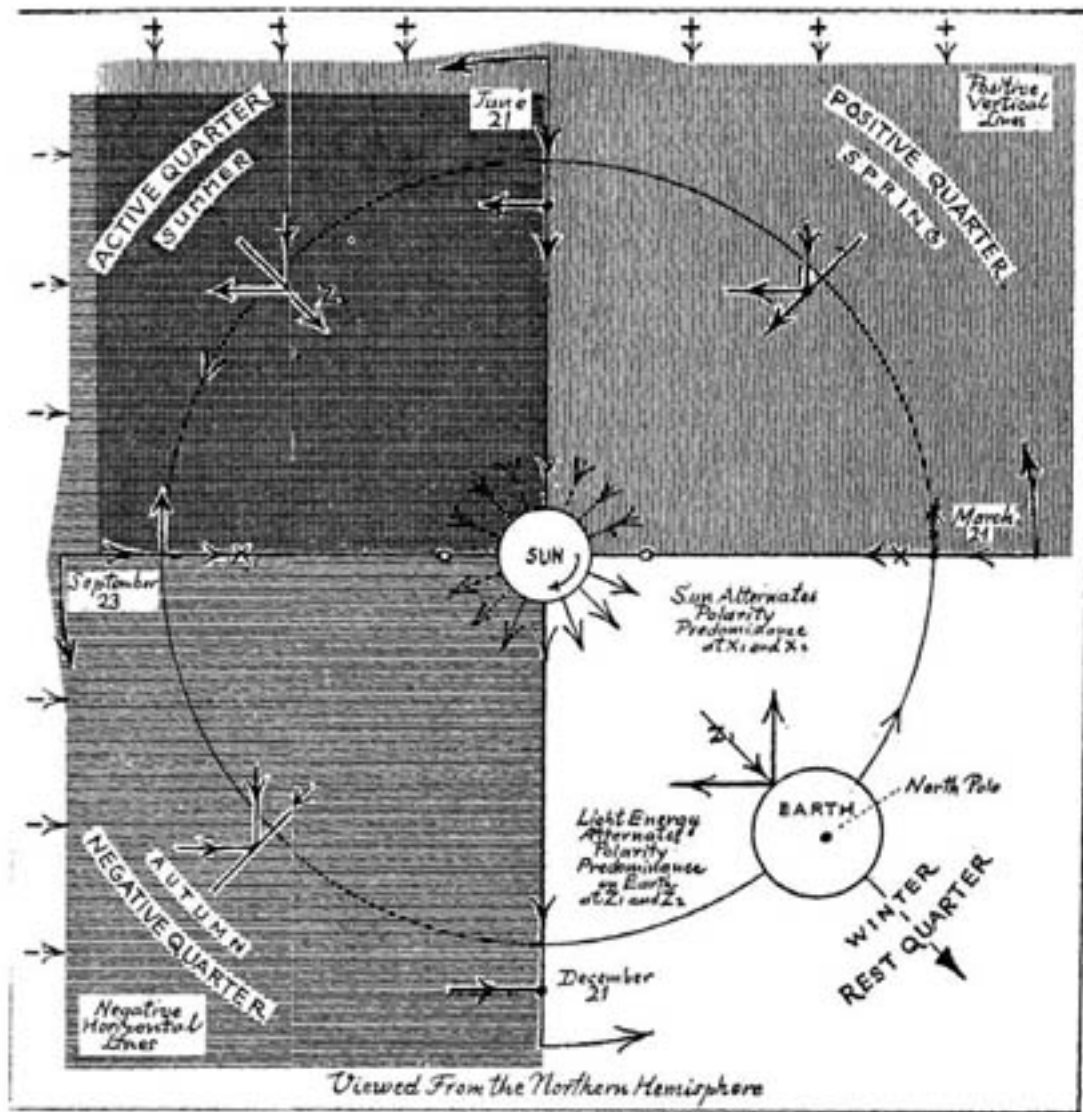

Orbit Principle Of The Earth

Figure 190

The symbolic diagram of George Van Tassle closely resembles that of the American Indian. However, his diagram is one unit versor rotation, j , behind that of the Indian. His use of the colors Red and Yellow on the central column condenser structures is noteworthy.



SYMBOLIC QUADRANTAL ARCH FORM
Figure 191

The figure shown is a symbolic four quadrant arch form, note again the color coding:

<u>Phase</u>	<u>Color</u>
1	Red
2	Yellow
3	White
4	Black

Red and White are in opposition on the Real Plane, Yellow and Black are in opposition on the Imaginary Plane.



INDIAN SYMBOLIC ROTOR

Figure 192

Shown is a more basic arch form of American Indian origin. This consists of string color coded windings on a toroidal core. Another set of windings is on an internal quadrature pair of straight cores.

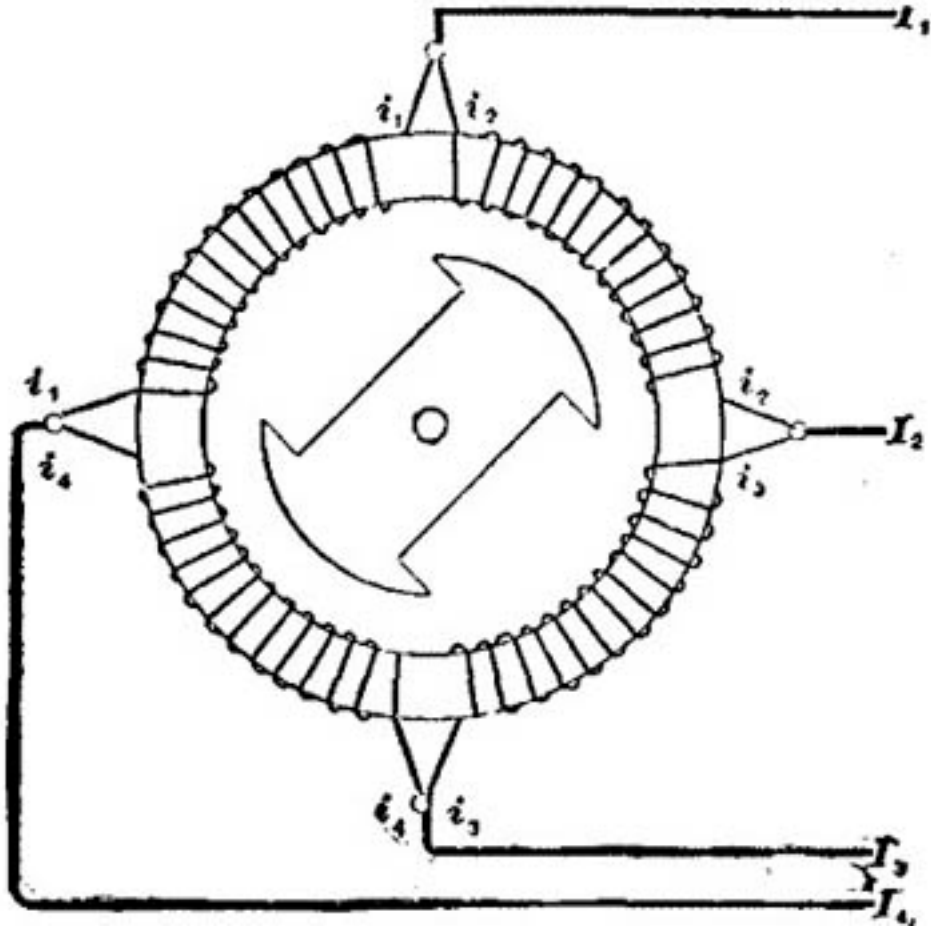

TESLA SYNCHRONOUS MOTOR

Figure 193

Nikola Tesla captured in his mind these arch forms during his polyphase field vision. The arch form of the Indian is transformed into the arch form of the Tesla motor. This is the synchronous machine of Nikola Tesla's invention.

[2] The Synchronous Machine

N. TESLA.
ELECTRO MAGNETIC MOTOR.
No. 381,968. Patented May 1, 1888.

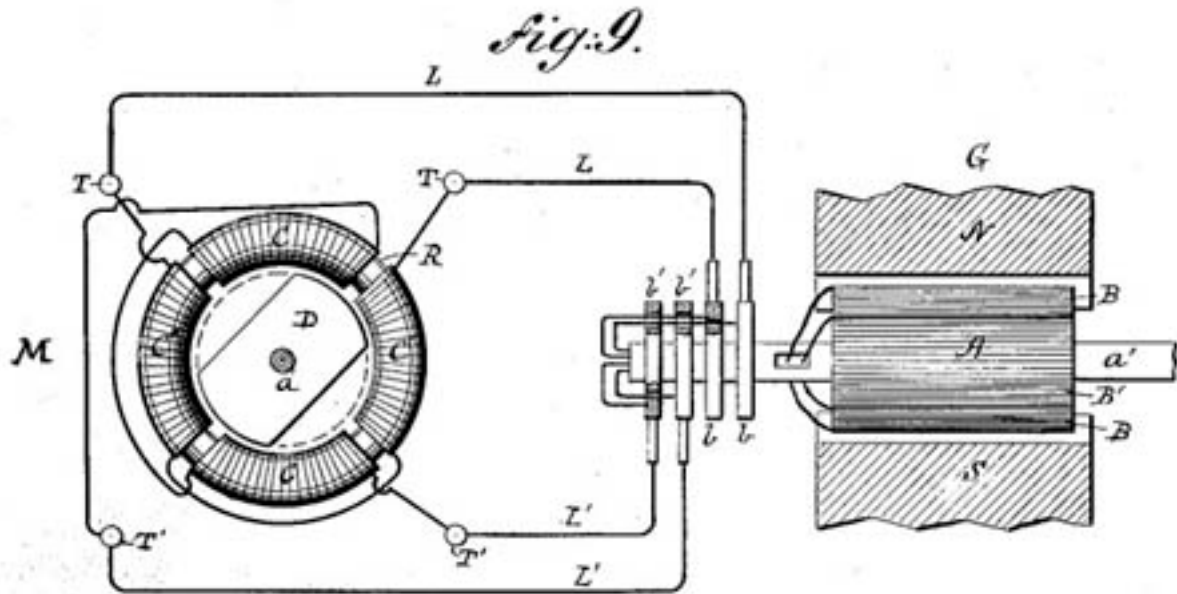

2.1 The Invention

Shown in the figure is the patent diagram of the synchronous motor invention of Nikola Tesla.



NIAGRA GENERATOR NAME PLATE
Figure 195

This invention developed into the giant multi-megawatt synchronous alternators installed at Niagara nine years after his patent was issued.



SYNCHRONOUS ALTERNATORS IN OPERATION

Figure 196

Shown in the figure is a typical application and installation of synchronous alternators, these used for hydroelectric generation.

2.2 Real and Imaginary Currents

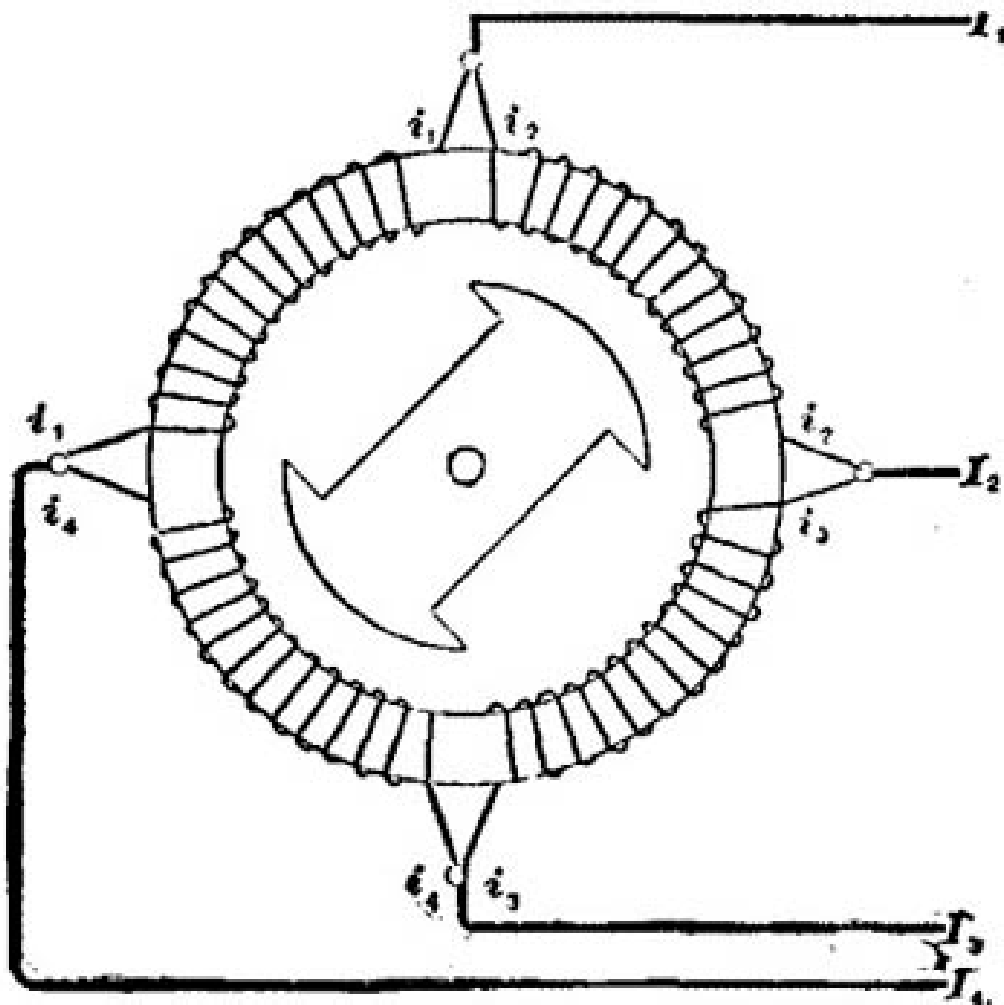

TESLA SYNCHRONOUS MOTOR

Figure 197

The Tesla synchronous arch form shown serves to demonstrate certain basic principles of its operation. It is of a four pole construction with a bipolar rotor structure. The stator windings are connected in mesh, this in a closed loop constituting a four phase square. Shown is a four currents drawn from four phase conductors, or "Four Wire" configuration. The four currents are shown as, i_1 , i_2 , i_3 , and i_4 . Each current leads the previous current by one quarter cycle, or one unit versor rotation.

The net result of this mesh connection is that a pair of currents is established:

$$I_1 = i_2 + i_4$$

$$I_2 = i_1 + i_3$$

Current One is a Real Current and Current Two is an Imaginary Current. These two currents act at right angles, or in space quadrature, upon the rotor magnet. One current leads the other, this in a "New Leading" relation. This displacement impels the rotor to revolve.

The specific position of the rotor magnet is locked in phase with the A.C. cycle, and the rotor follows the A.C. wave revolving in the stator. The rotor turns in synchronism with the A.C. wave, hence the name "Synchronous Machine".

2.3 Rotating Transformer

The synchronous machine transforms energy between a rotary mechanical form and a rotary electrical form. This transformation is bidirectional in that the same machine can be a motor, or it can be a generator. Moreover, the synchronous machine can be both at the same time, this in accord with the law of reciprocity. This classifies the synchronous machine as a transformer, it transforms between mechanical and electrical forms of energy. This gives the synchronous machine a distinct advantage over other forms of rotating electrical apparatus.

2.4 Synchronous Motor

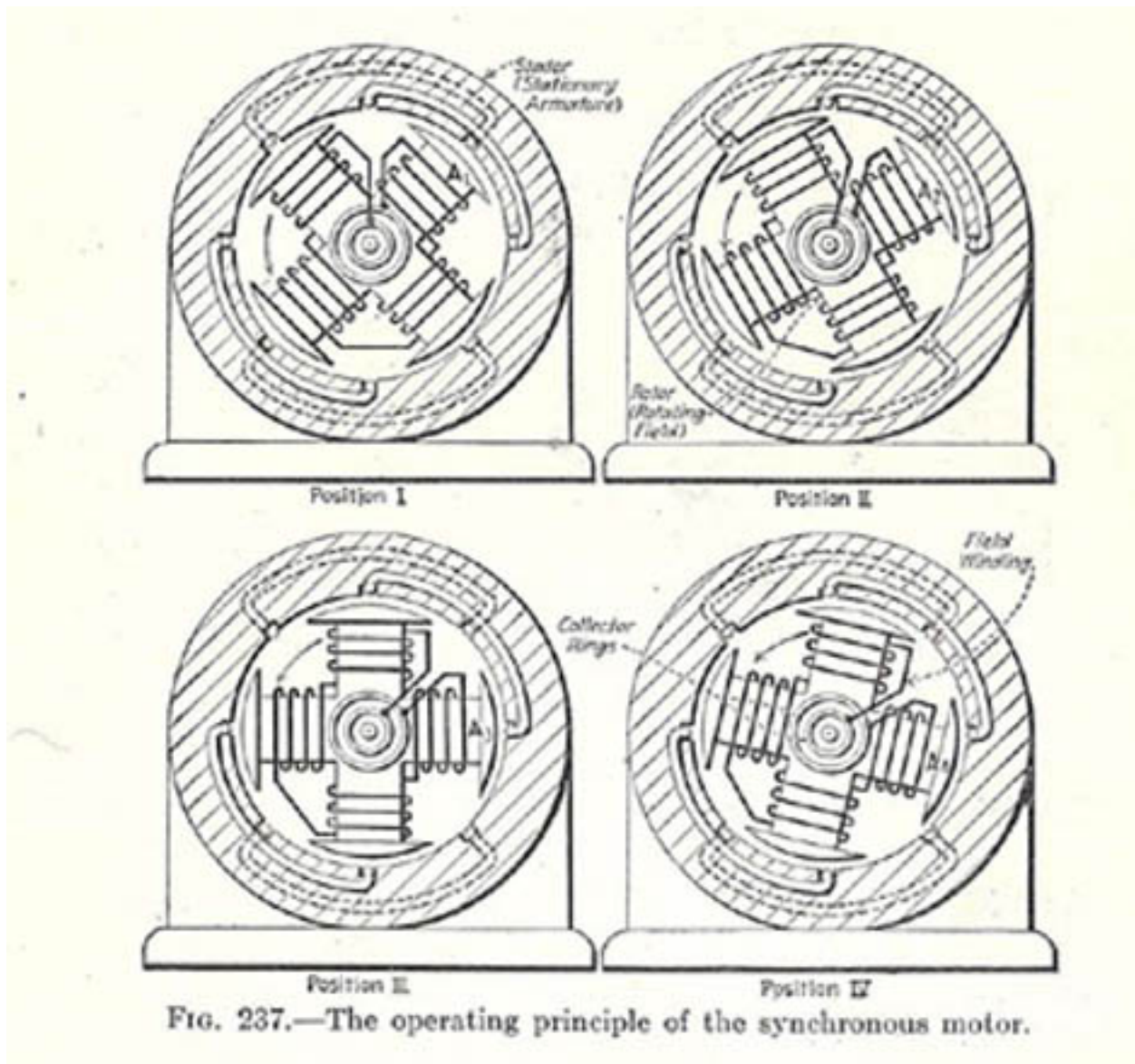

Figure 198

Shown is a schematic representation of a common form of synchronous motor. This machine uses a quadrature pair of rotor magnets rather than the single rotor magnet shown in the patent. This is typical in practical construction. The stator windings are reconfigured in accord with the double rotor and is called in practice a "Four pole Machine". This type of synchronous motor thus turns at one half speed. The more poles the lower fraction of speed.

Here exists two members, a stator electromagnet, and a rotor electromagnet. The stator windings are flat loops embedded into the stator iron, the rotor windings are solenoidal on salient iron poles. The rotor windings are energized with a direct current rendering the salient poles magnets. The stator windings are fed by a four phase alternating current. These poly-phase currents impel the rotation of the rotor magnets.

Two currents are fed into the stator windings, a Real Current is sent through one set of windings, an Imaginary Current is sent through the other set of windings. The "Real Coils" are shown as solid lines, the "Imaginary Coils" are shown in dotted lines.

The D.C. current in the rotating windings flows in series through its coils giving an alternate North-South-North-South polarity on the salient poles. The pole faces follow the rotating field produced by the poly-phase currents in the stator windings.

2.5 Space-Time Phase

A unique property of the synchronous machine is its controlled phase characteristics. Shown in the figure of the motor is the rotor assuming various positions with respect to the stator windings. Each rotor position shown is in step with a particular aspect of the rotating electric wave. There are four total:

- I) Energy Production
- II) Energy Return and Storage
- III) Energy Consumption
- IV) Energy Storage and Return

The rotor, as shown, can be in the energy consumption position, or it can be in the energy storage position, this position on the rotating electric wave. In the former case, the machine acts as a motor, in the latter case it acts as a reactance, neither consuming nor producing energy. The

synchronous machine can synthesize any aspect of the rotating electric wave by setting the rotor excitation to that aspect.

Here exists the remarkable condition that the position of the rotor in space is in an equivalence with the position of the A.C. wave in time. The Space Phase and the Time Phase are in unison. It can be reasoned here that the synchronous machine operates as a Space-Time Transformer.

[3] Motor Operation

3.1 Basic Motor Layout

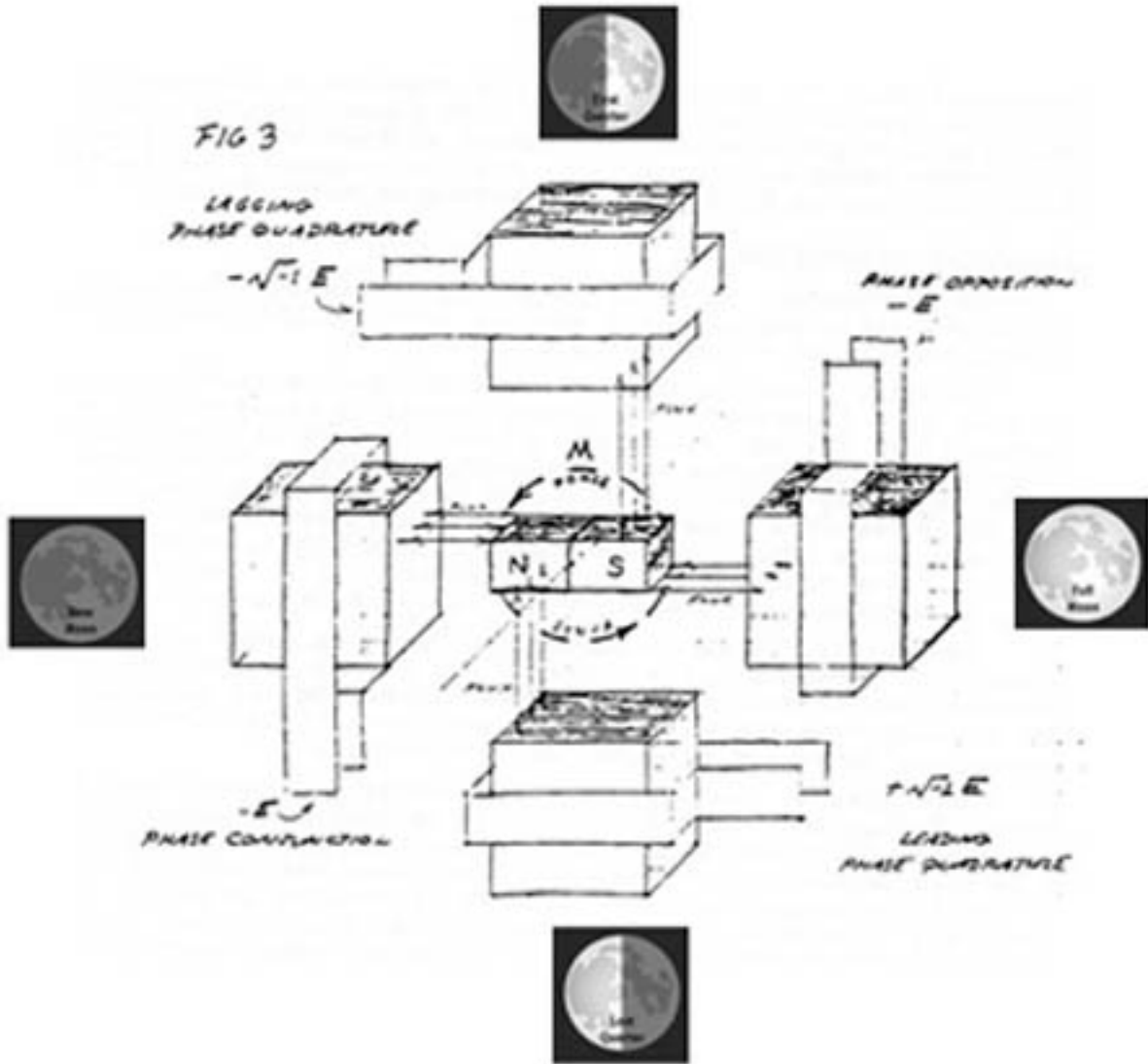

SYNCHRONOUS MACHINE OPERATION

Figure 199

The elementary principles of Nikola Tesla's rotating magnetic field can be understood with the aid of the figure shown. Here exists a stator assembly consisting of four cubical A.C. electromagnets, each with a copper strip winding of one turn. These stator electromagnets are arranged in a

quadrapolar configuration. The rotor is a bar magnet free to rotate on a transverse shaft. Since this rotor is a permanent magnet it needs no windings or D.C. excitation.

The stator windings are connected in opposing pairs, the horizontal electromagnets in series as one current path; the vertical electromagnets in series as another current path. Two independent currents exist, the horizontal and the vertical. The opposing poles in each pair are in phase opposition so that when one pole face is North, the opposing pole face is South. The flow of magnetism is then between the left and right poles, or between the upper and lower poles.

The two current paths are connected to two independent sources of current. The horizontal path is fed with Real Current, the vertical path is fed with Imaginary Current. The Real Current establishes a South polarity on the left pole face, and a North polarity on the right pole face. The Imaginary Current establishes a South polarity on the upper pole face and a North polarity on the lower pole face.

The two alternating currents create alternating magnetic polarities between their opposing pole faces.

3.2 The Four Motor poles

Each of the four pole faces can be equated with a corresponding lunar versor position:

(0)	Left pole	New	Phase 1
(1)	Upper pole	Leading	Phase 2
(2)	Right pole	Full	Phase 3
(3)	Lower pole	Lagging	Phase 4

In each versor position the current in that position is a maximum, and its pole face is South. A maximum South pole identifies the rotating versor position of the A.C. wave as it moves from pole to wave as it moves from

pole to pole, from left being South, then upper being South, and so forth around the stator assembly.

The four pole faces enclose a space around the rotating bar magnet. The rotor magnet is shown in the horizontal, or Real Position. The North end of the magnet is facing the New pole, which is not yet energized, but the magnet has oriented itself to the nearest magnetic material in the stator. The rotor bar magnet is now static.

When the electric wave is first applied, the Real Current acts with full force while the Imaginary Currents are still dormant. The bar magnet is now held rigidly in place by the left and right electromagnets. No current flow exists yet in the upper and lower electromagnets, hence, they have no influence upon the rotor. The A.C. cycle and the bar magnet are now both in the New Position.

3.3 Sine and Cosine Functions

The curves shown in the figures show the Real Currents as a Cosine Wave, and the Imaginary Currents as a Sine Wave. The A.C. cycle is shown from its start at angle Zero Pi, to its end at angle Two Pi. The stator electromagnets were energized at the start of the cycle in its New Position. At this start of the cycle the Cosine Current is at its maximum, it is 100 percent, as given by the Cosine Function. Also, at the start the Sine Current is at its zero crossing, it is zero percent, as given by the Sine Function. At this point in the cycle only the horizontal electromagnets act, holding the bar magnet in the New Position.

As the cycle advances onward from its New Position, the Cosine Current wanes and the Sine Current waxes. The Rising Sine, or Imaginary, Current in the vertical electromagnets give rise to an increasing magnetic force between the upper and lower pole faces. The Falling Cosine, or Real, Currents in the horizontal electromagnets result in a wakening magnetic force between the left and right pole faces. Cyclically the horizontal poles lose their influence on the rotor magnet which is taken upon by the gaining

influence of the vertical poles. In response the rotor magnet swings around toward the straightening upper pole face as it becomes South. One quarter period later the Cosine Current in the horizontal electromagnets is Zero Percent, and the Sine Current in the vertical electromagnets is 100 Percent, as given by Cosine and Sine Functions respectively. The vertical electromagnets are now fully energized, now the upper pole is full South and the lower pole is full North.

The rotor bar magnet has now advanced in position in accord with the instantaneous position in the A.C. cycle. It is now held rigidly in place between the upper and lower pole faces. Both the rotor magnet and the cycle have advanced from the New Position to the Leading Position, one unit versor rotation. The upper pole face is now the active point along the A.C. cycle and the rotor is "In Phase" with it. This is what is known as synchronism.

As the cycle further advances onward, the Cosine Current again strengthens after passing through its Zero crossing. Its magnetic polarity is now reversed. The Sine Current now weakens, as did the Cosine Currents one quarter period earlier. The Sine, or Imaginary, Currents in the vertical electromagnets have a weakening magnetic force and lose their influence upon the bar magnet. At the same time the reversed Cosine, or Real, Current is beginning to strengthen increasing the magnetic force between the right and left electromagnets. At this position in the A.C. cycle the right pole face is now South and the left pole face has become North, in opposition to the start of the cycle. The poles have flipped around and the rotor bar magnet swings accordingly. The rotor is now captured by right pole face.

One half period after the start of the cycle the Cosine Current is negative 100 percent while the Sine Current is going through its Zero crossing and is Zero Percent. This is given by the Cosine and Sine Functions. The horizontal electromagnets are now fully energized, in reverse, holding the bar magnet rigidly in place. The vertical electromagnets are again dormant.

The rotor bar magnet has advanced with the cycle, it following the South pole of the stator assembly. The rotor is now aligned with the horizontal pole faces in the Full Position of the A.C. cycle. It is now in opposition with the New Position at the start of the cycle in accord with the opposite direction of current flow in the horizontal electromagnets.

By continuing the cycle the rotor bar magnet is carried onward through the cycle, from Full to Lagging, and then from Lagging to its origin at New. The rotor moves in synchronism with the active point on the A.C. cycle as it revolves in the stator assembly. This condition is known as the Rotating Magnetic Field, a discovery of Nikola Tesla. Here it is a travelling South pole moving from one pole face to the next.

3.4 Rotating Magnetic pole

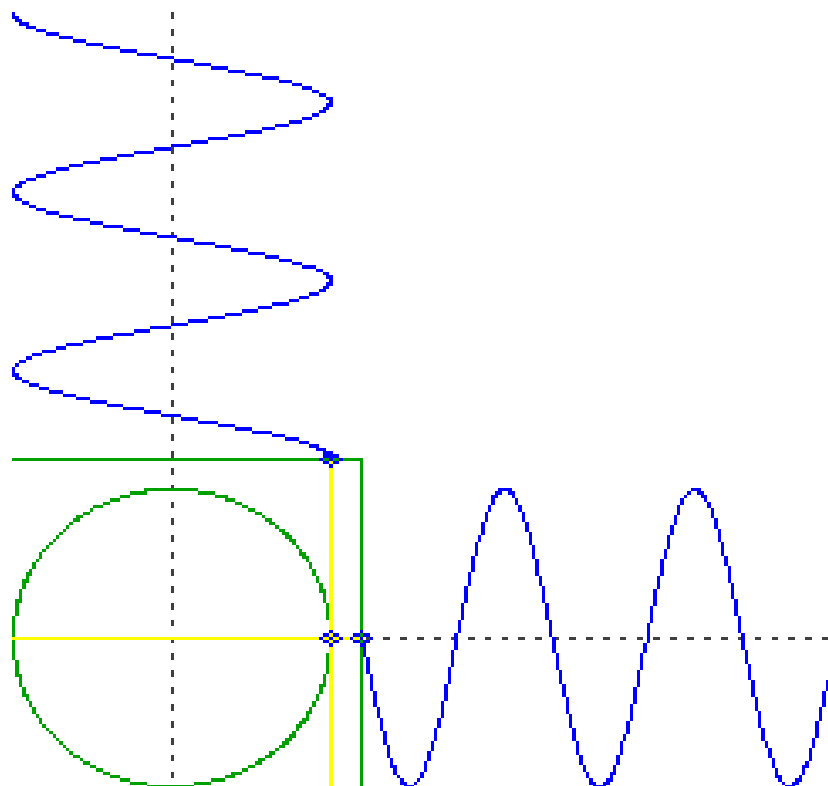

COOPERATIVE SINE & COSINE FUNCTIONS

Figure 200

(Editor's Note: To see an animation of this image, go to this website.)
http://www.math.tamu.edu/~alarios/courses/TAMU/2013_fall_M151/mathgifs.html

COOPERATIVE SINE & COSINE FUNCTIONS ENGAGED IN ROTATION

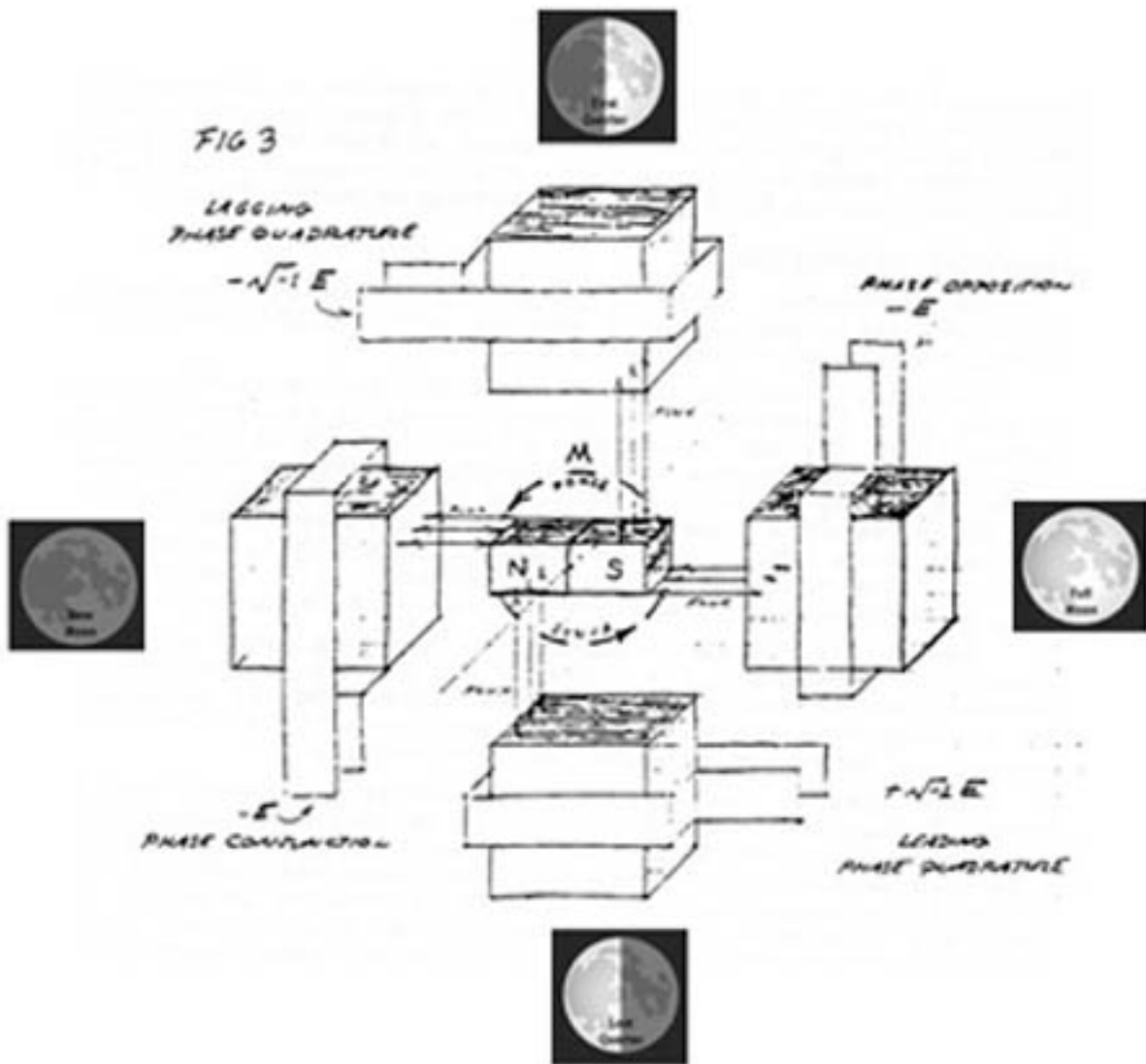

SYNCHRONOUS MACHINE OPERATION
Figure 201

As the Cosine Current wanes and the Sine Current waxes the horizontal electromagnets lose influence and the vertical electromagnets gain influence. The rotor magnet positions itself in accord with the relative pole strength. One eighth period, or an angle of $\frac{\pi}{4}$, into the cycle, it is half way between the New Position and the Leading Position. Here at this point in the cycle the Cosine Current and the Sine Current are of equal strength and both are 70.7 Percent of their maximum magnitudes. This is given by the Cosine and Sine Functions.

The current in the horizontal electromagnets is equal to that in the vertical electromagnets, they now exert equal influence upon the rotor bar magnet. The rotor now orientates itself half way between the left and upper pole faces, just as the A.C. cycle is half way between its New and Leading positions. Here exists the equivalency of the Space Phase Position of the rotor and the Time Phase Position in the stator. This is the act of synchronism and represents a transform between space and time.

In this position of Space Phase the rotor bar magnet is not orientated to any physical pole face, it is pointed into a Void Space between the left pole and the upper pole. At this $\frac{\pi}{4}$ instant in the cycle the rotor magnet is held just as rigidly as if it were held between a pair of physical pole faces, this in the horizontal or vertical positions. Since the North pole of the rotor bar magnet is always pointed to a South pole on the stator assembly, a South pole must now exist in the Void Space between the left and upper pole faces. This non-physical South pole exerts as Real of a force upon the rotor as does the actual physical pole faces.

This is the key feature of the discovery of Nikola Tesla. This is what is called a "Virtual Magnetic Pole". This virtual pole moves through space in accord with the phase position of the A.C. wave that gives rise to this pole. A virtual electromagnet is spinning in the stator while the physical stator is stationary. This gives a "Magnetic Versor", or rotating magnetic pole. Here defined is a Rotating Magnetic Field.

[4] The Vision of Nikola Tesla

4.1 Goethean Vision



JOHANN WOLFGANG VON GOETHE 1749-1832

Figure 202

How did Nikola Tesla arrive at this idea of a Virtual Magnetic Pole? By his own account, it came to him in a "Single Flash of Light". Tesla was watching the sun as it set and this sparked the idea in his mind.

As the sun was in the process of setting, Tesla began to recite a particular poem about sunset, this written by the German poet and philosopher Goethe. The philosophy of Goethe had an important influence upon the mind of Tesla. As he watched the sun go down, the words of the poem stated, "To follow, to follow soaring". This was the trigger for the mind of Tesla who by now was in one of his hallucinogenic trances that he often and uncontrollably experienced. His mind had for some time been working on the A.C. motor problem, the problem of converting alternating current into a rotary force rather than just an alternating force. In this "Flash of Light" that problem has been solved.



Figure 203

Tesla envisioned in his mind of being carried along with the sun in its apparent motion around the Earth. His mind was in synchronous motion with the sun, it would follow the Noon position of the sun as it raced onward around the Earth. It is always noon somewhere on Earth and Tesla's mind was there. He would follow soaring, the Earth racing backwards under his feet.

The constant relative motion of the sun around the Earth's surface constitutes a rotating pole. Its reference phase here is Noon. This Noon Position moves along the Earth's surface, just as the reference phase moves in the stator assembly.

4.2 Rotating Pole

The sun can be thought of as a giant magnetic pole, this pole directed at the Earth. This would cause a magnetic object on Earth to move with it. This object would follow the sun-magnet pole in its travelling Noon Position. The object is now moving at 1000 miles per hour along the earth's surface to keep up with the sun, it is moving at synchronous speed in relation to the apparent motion of the sun.

In the mind of Nikola Tesla, the sun was a Virtual Magnetic Pole in view of his A.C. motor revelation. He was the rotor magnet to be carried along with the sun. Around and around, this at a synchronous speed. This was his vision of the A.C. motor.

4.3 Four Phase A.C.

When one observes the setting sun, at that same moment it is in its Noon Position, one quarter rotation to the West. This is one unit versor rotation. This relation in the mind of Tesla during his revelation gave an image of four phases, or versor positions:

Sunrise	One
Noon	Two
Sunset	Three
Midnight	Four

Nikola Tesla envisioned the Four Phase System of alternating current to create his rotating magnetic field. This quadrupolar form allows for the use of a pair of currents one quarter period "Out of Phase", the Real Current and the Imaginary Current. This gives rise to the rotary motion. This is known as poly-phase alternating current.

4.4 Epilog

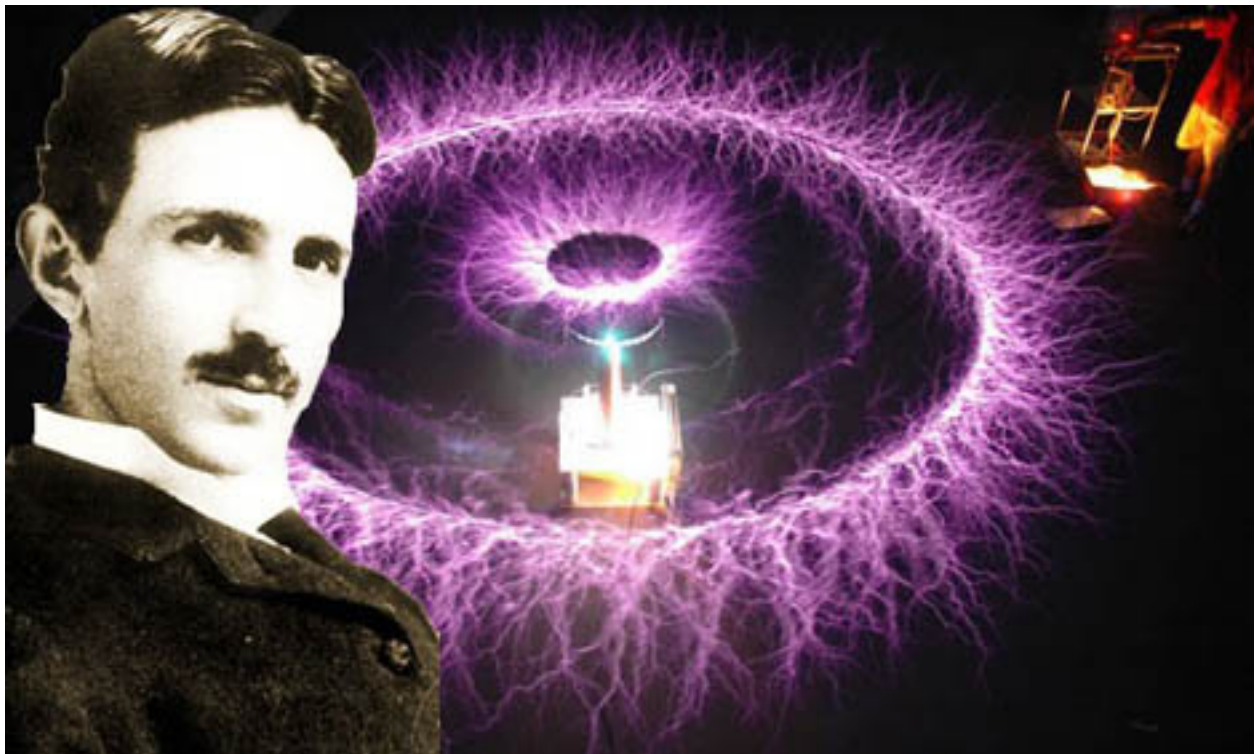

NIKOLA TESLA 1856-1943

Figure 204

At the height of his revelation, his first words were "Watch me make it reverse", as he began drawing diagrams in the sand on the ground, to show

his stunned friend. By reversing the direction of one of the currents, while leaving the other unchanged, the rotor quickly reverses its direction. Moreover, since the synchronous motor is in synchronism with the synchronous alternator. ANY change of speed or direction at the alternator will be quickly matched by an identical change in speed or direction at the motor.

This synchronous A.C. system of Nikola Tesla constitutes an electrical driveshaft. What is mechanically applied at one end is what is mechanically taken at the other end. This works in both directions, linking the sending end to the receiving end as if by a solid shaft.

Rotational power can now be carried long distances with no intervening mechanical linkage, only a static A.C. transmission line. The function of gear boxes is replaced by transformers, rotary or static. This could possibly be one of the most powerful four quadrant arch forms ever conceived by the human mind.

Finish

Appendices

[1] In The Beginning, Versors

[2] Four Quadrant Energy Exchange

[3] Quadrapolar Resonance

Appendix #1

And in The Beginning, Versors

by E. P. Dollard

(I) What of this thing called versors, and why is it that we should be interested in them? In the most basic conception a versor operator is a means to “move about” in a given dimension or dimensional relation. In an extended conception a versor operator is a means of moving from one dimension into another dimension. In the most general conception versor algebra is the algebra of position.

In nature there exists the four polar positions of our moon. This gives four unit versor positions,

k_4^0 , new, conjunction

k_4^1 , leading, quadrature

k_4^2 , full, opposition

k_4^3 , lagging, quadrature

Hence the Lunar Versor operator,

$$(1) \sqrt[4]{1} = 1^{\frac{1}{4}}$$

k_m^n , $n = 0, 1, 2, 3$.

These unit versor positions occur when at a given geographic location the following exact relations exist;

Full, moonrise at sunset

Lead, moonrise at noon

New, moonrise at sunrise

Lag, moonrise at midnight

This leads to a versor algebraic expression. Hence a natural set of versor relations in quadrapolar form. It should be noted that Nikola Tesla's original archetypal vision of alternate electric waves was his poetic versor rotation of the Sun-Earth relation. Needless to say versor algebra finds extensive application in alternating current theory. Read first part "Symmetrical Components" by Wagner and "Power and Double Frequency Quantities" by Steinmetz, (from his A.C. book), for advanced concepts.

A most important application of versor algebra is the study of complex electric waves in space. There has been no progress beyond the cumbersome and under-developed quaternions of J.C. Maxwell, nor the transverse electromagnetic vector algebra of Oliver Heaviside. This is an important task. Such an electrical condition is found in the propagation of electric waves within transformer windings. The networks of Nikola Tesla and Ernst Alexanderson follow from an analysis of complex electric waves in the common transformer. However this knowledge evades us. It is that the present state of versor algebra has not developed out of its infant form, the square root of negative one. It's engineering application was founded by C.P. Steinmetz (1898 A.D.) and he also suggested higher order versors as given in his A.C. book, "Roots of The Unit", and etc. Steinmetz however never applied these to engineering even though their possible application was evident. He later on became rather "stuck up" on his own established work, this a side effect of G.E. using Steinmetz to promote their own image. A more generalized conception of versor algebra was attempted by Alexanderson McFarlane but this also never developed into any engineering applications. This is where versor algebra sits today.

(II) The concept of a versor algebra is not new, nor is it limited to electro-dynamics. One of the oldest versor systems is the symbolic representations of the Aborigines (Indians) of the American Continent. These systems found advanced development in the cultures of Central America. Noteworthy here is the "Mayan Calendar". In versor symbols this calendar states,

For $1 \frac{1}{m}$ unit,

And it is nearing the time

$$k_m^0 = 1_{\text{unit}},$$

Where m is an unknown unit division in a grand cosmic cycle of

$$2.5 \times 10^4 \text{ years.}$$

This in common language, equation one states “Happy Grand New Year”. A versor axis, here given as k_m^n , raised to a zero power, is like midnight, or the new moon, it is the start of a “new day”.

In mechanics there exists the condition called “top dead center”. In electrics there exists the condition called “unity power factor”. In both cases it is a vertical reference, zero degrees, pointing upward. This is expressed by “high noon” on the face of the clock. This hereby establishes the position of a reference versor,

$$(2) k_n^0 = 1 \text{ unit}$$

(III) Another versor system of antiquity is that developed by Pythagoras of Ancient Greece (570 – 495 B.C.) This system is called “Music”. It is based upon the HARMONIC SUBDIVISIONS of an oscillating string, two to one, two to three, four to five, and etc. Each subdivision represents a versor position. This developed into a base seven versor,

$$(3) \sqrt[7]{1} = 1^{\frac{1}{7}}$$

$$k_7^n, n = a, b, c, d, e, f, g$$

It is however than n is a fractional and sometimes complex quantity. Therefore music represents a most complex versor system. This versor algebra, or music, found slow development until the era leading to Martin Luther, 1400 A.D. – 1500 A.D. The foremost development of this era is what are known as the “Church Modes”

Modal Scales: The Ancient "Church Modes"

Ionian	Phrygian	Lydian
Mixolydian	Aeolian	Locrian
Dorian		

It is of interest to note that one Church Mode in particular has a hysteresis loop. The rising scale takes a different path of notes than that path of notes for a descending scale. Here exists a musical analog of a hysteresis cycle. M. Luther (1500 A.D.) published his archetypal musical series using the Church Modes. Of these, his "Ein Fest Burg", is well known in church music today, it is the "standard".

After 1600 A.D. music found considerable advancement in Italy, mostly thru the efforts of the Italian Priest, Antonio Vivaldi. (1678 – 1741 A.D.) From here forward the use of the church modes was confined to only two out of the complete group. Today these are known as the MAJOR scale, and as the MINOR scale. Transformation between frames of reference known as "keys" (the frequency bands) was not possible until the system of "Equal Temperament" by J.S. Bach (1700 A.D.). Bach's versor system was based upon the expression

$$b = \sqrt[12]{A} \text{percent.}$$

This gave one unified versor system of divisions called the chromatic scale. This twelfth root relation is the basis for the diatonic scale of today. It is however that Equal Temperament is at odds with the original percentages, or ratios, of the Pythagorean System. This remains as an unsolved condition in the versor algebra called music.

During the era following the church modes, the versor expressions of time became increasingly developed. This led to the "Age of Clocks". Time versor operators became important parts of the music structure. The CANON is the most basic versor relation and it led to the more developed FUGE. Time versor algebra reached its greatest heights in the works of J.S. Bach, 1685 – 1750. In many ways Bach's work is analogous to that of Steinmetz, and moreover J.S. Bach can verily be regarded the Tesla of the music world. Here is where to begin the understanding of versor algebra. A simple music keyboard, and a set of church modes is all that is required. Listening to the music of J.S. Bach replaces the reading of the equations of C.P. Steinmetz. In many ways the two are the same. As a musical reference is "Switched on Bach" performed by Carlos, in particular Bach's "Brandenburg Concerto Number Three".

(IV) As for the "Age of Clocks", the versor positions of the clock face provide a most fundamental and intrinsically basic system for the study of the use of versor operators. The versor operators of music on the other hand provide a most complex but intrinsically heuristic system for the study of the theory of versor operators. For the engineer the clock represents a most important primordial advancement in the conception of versor algebra. It should be noted that the clock, the music keyboard, and the calendar, all serve as analog computers for the expression of versor position in time and/or space. The Grand Pipe Organs of Europe, some with more than 10,000 pipes,

stand as the greatest analog computing systems ever to be created. Here engineering rose to heights incapable of being reached today.

The clock as an analog computer is a link to the cycles of the Earth, Moon, and Sun, in a manner of resembling that of the American Aborigines. In the era of the clock, these analog versor systems developed into advanced analogs of the entire solar system, superclocks. These superclocks came to be known as "Planetariums". In its fundamental expression the common clock involves the most basic cyclic functions. In its simplicity the divisions are equidistant and the hands remain unit length during progress thru the cycle. And importantly, it is divisible into four quadrants. Hence our rudimentary examination of versor operators begins with the ordinary clock face.

The basic versor operator for the clock, in hours, is given by the expression

$$\sqrt[12]{1} = 1^{\frac{1}{12}} \text{unit}$$

And thereby,

$$(4) k_{12}^n, n = 1, 2, 3 \dots 11 \text{unit}$$

Is the versor operator. This is to say there are 12 hours, or unit divisions, of one complete rotation on the face of the clock. All other degrees of rotation are fractional. Hence the unit division of one hour is represented by the symbol, k. This is the fundamental versor operator of the clock. The expression,

$$(5) k_{12}^0 = 1 \text{unit}$$

Is called "Noon", fig (1). Hence for this versor operator, k, it is

$$k^0 = \text{Noon},$$

$$k^3 = \text{Three O'clock}$$

$$k^6 = \text{Six O'clock},$$

$$k^9 = \text{Nine O'clock}$$

$$k^{12} = \text{Midnight},$$

$$k^n = n \text{ O'clock}$$

(V) Let the versor operator

$$(6) h_{12}^n \text{unit}$$

Be called Standard Time, fig (2).

Let the versor operator

$$(7) j_{12}^n \text{unit}$$

Be called Daylight Time, Fig (3)

Hereby there exists two distinct time frames, let us say Pacific Standard Time, P.S.T. and Pacific Daylight Time, P.D.T. These two time frames now co-exist in the same space. In symbolic form let Standard Time be real, or h time, and let Daylight Time be imaginary, or j time. This is now in accord with A.C. theory, but with a twelfth root rather than a square root. The two versor operators, h and j, are called co-axial versors. This is to say, the h hand, and the j hand are on the same axis, fig (4). Here Daylight Time is a unit DISPLACEMENT on the face of the clock. Depending upon the time frame chosen there now exists the complication of two noons, fig 4a & 4b, but only one noon can be real. Noon by definition is that position in time when the Sun is at its highest position in the sky. This position is evidenced by the condition of a shadow being in its shortest length upon the Earth. This is the reference versor, or top dead center. In the imaginary time frame (P.D.T.) noon in that frame is one unit versor leading, or conversely real noon is one unit versor lagging. This can be expressed as,

$$(8) a = k_{12}^1 b \text{unit}$$

Or simply

$$(9) a = j b \text{unit}$$

Where,

(10)

a, real noon

b, imaginary noon

This is entirely analogous to A.C. theory. Hereby versor theory is now extended beyond its application by Steinmetz, and the versor operator j remains a transform between the real and imaginary co-ordinate systems. The time in the imaginary (P.D.T.) system must be multiplied by the versor operator j in order to transform to the real positions of noon and midnight. This in a way vindicates Steinmetz's assertion that the most general algebraic number can always be expressed by

$$(11) \dot{\gamma} = \alpha + j\beta_{\text{unit}},$$

But this can only be true for the dimension of time.

In common language, those existing in the imaginary time frame of "Daylight Savings Time" are one over jOUT OF STEP with nature. This represents a 30 degree unit displacement on the face of the 12 hour clock. On a 24 hour cycle imaginary time is 15 degrees OUT OF STEP with the rotation of the Earth. In other words for those in imaginary time, this time is a place on Earth 15 degrees distant from the location of its natural occurrence. Your time is now in a place you are not. In A.C. Terms

$$(12) a = \cos 15^\circ, \text{ percent}$$

The Power Factor

$$(13) b = \sin 15^\circ, \text{ percent}$$

The Induction Factor

Hence

$$(14) \dot{\gamma} = a + jb_{\text{unit percent}}$$

Where $j = \sqrt{-1}$

(VI) A common man conception of the versor concept is not complete without a related N.F.G. Historically, the works of J.S. Bach suffered the same fate as the works of Nikola Tesla. Shortly after the death of J.S. Bach (1750) all his important work was thrown into the garbage, this regarded as obsolete junk. If it was not for Herr Forkel, who recovered Bach's work from the garbage and wrote the first book about Bach, all memory of Bach, and his work, would have been lost forever. Today, it is seen by some, that as with N. Tesla, the works of J.S. Bach is inimitable and profound. But it is of no value to modern society. The music of today has degenerated into the gutter sounds of "Hump N' Slap," and "Eubonic Barking Savages", then the Boom....Boom Boom..... Accordingly it is seen that the so called Science has followed a parallel path. This is known as "Quantum Mechanics", the science of delusions. This "Science" in reality is no more than one big "Khazarian Circle Jerk". And finally? Art! What an absolute joke. To criticize it is like slaying the slain. Today one can obtain a grant from the "Sheisenburg Foundation" to express one's "artistic talent" by smearing human fecal matter onto a large canvas. Upon calling it "God" it will be worth millions. This is society today, COMPLETELY DEGENERATE.

So verily we are lost souls, hence the importance of reconstructing what has been lost to us. And it is to be noted that even Bach and Tesla themselves are only steps on a path,

or as said by Heaviside "There is no finality." But who is going to support this effort, or who is even interested at all? Rest assured that no support will be provided by our Babylonian society. This endeavor is more like becoming a Christian in Ancient Rome, a dangerous undertaking. See the movie "Fahrenheit 451" for an excellent portrayal of what awaits.

73 DE N6KPH

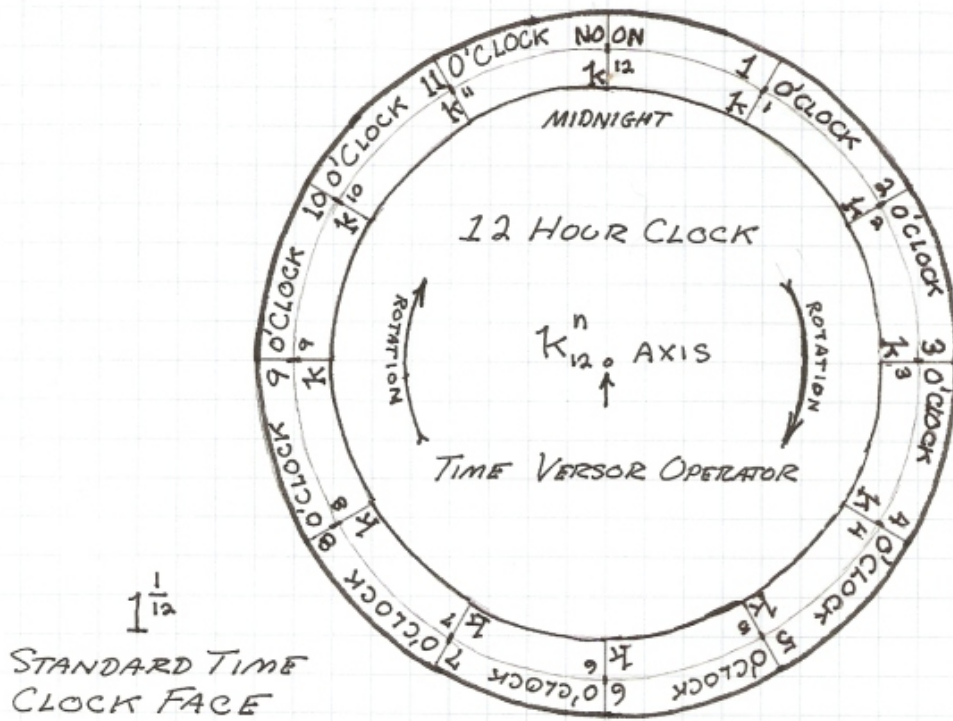

FIG 1

DAYLIGHT SAVINGS TIME

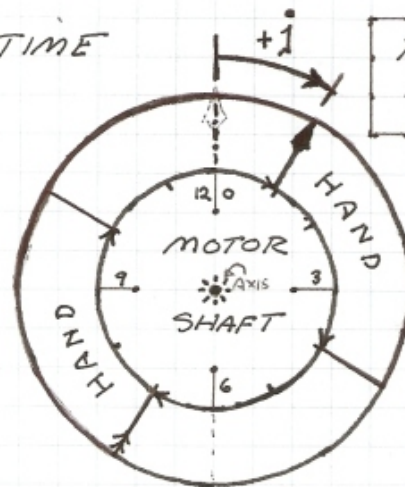
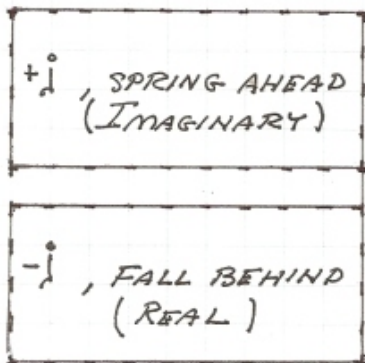

FIG 4

TRANSFORMATION; STANDARD TIME \rightarrow DAYLIGHT TIME

h -HAND, h -FACE

$h k^0 = h$

$h^0 = \text{SHAFT}$

START (1)

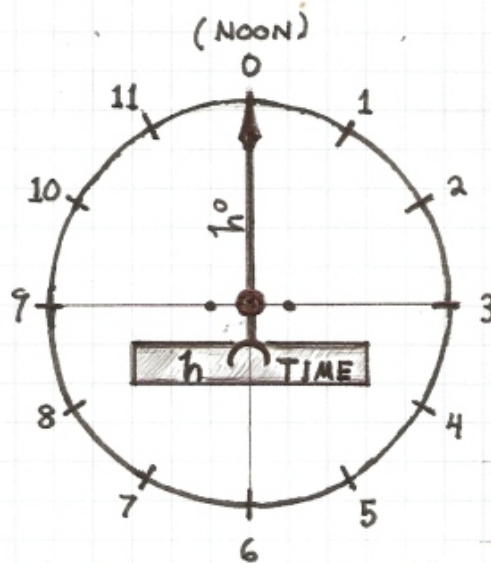

MULTIPLY BY ONE

REFERENCE VERSORS

REAL TIME

FIG 2a

$-j$ -HAND, h -FACE

$h k^{+1} = h^2$

$-j = \frac{\text{HAND VS}}{\text{SHAFT SLIP}}$

FIRST (2)

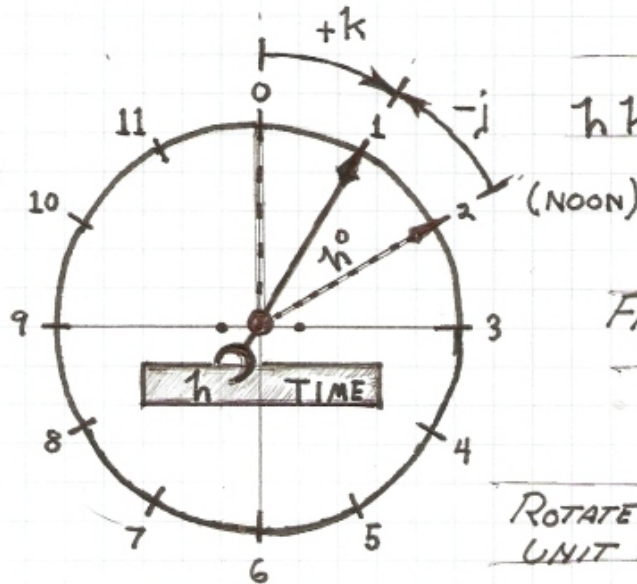

MULTIPLY BY k

ROTATE HAND ONE UNIT FORWARD

IMAGINARY TIME (PARTIAL REAL)

FIG 2b

h -FACE, j -HAND

$$t_j = \frac{\text{SHAFT VS}}{\text{HAND SLIP}}$$

DIVIDE
BY k

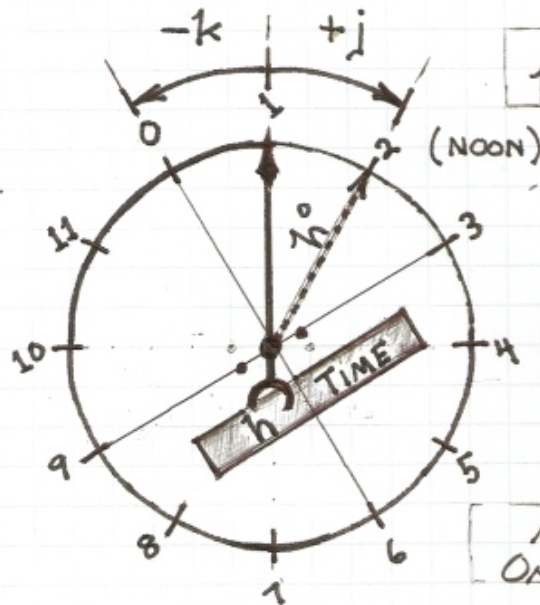

$$h k^+ k^- = h$$

SECOND (3)

ROTATE CLOCK
ONE UNIT BACKWARD

COMPLEX TIME

FIG 3a

j -FACE, j -HAND

j IS HAND

MULTIPLY
BY k

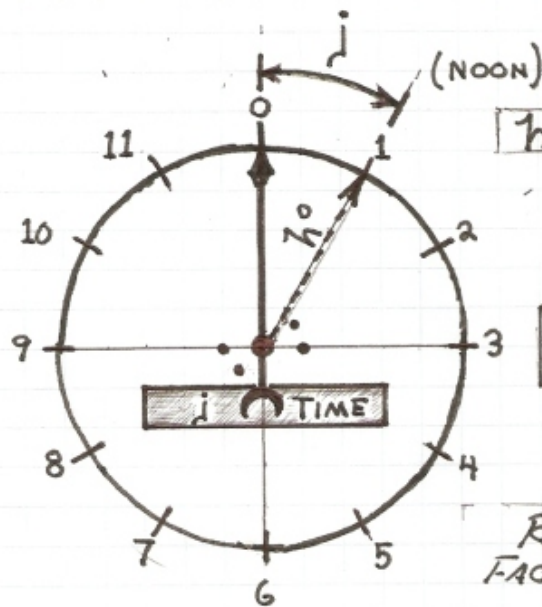

$$h k = j$$

THIRD (4)

ROTATE CLOCK
FACE ONE UNIT
FORWARD

IMAGINARY TIME

FIG 3b

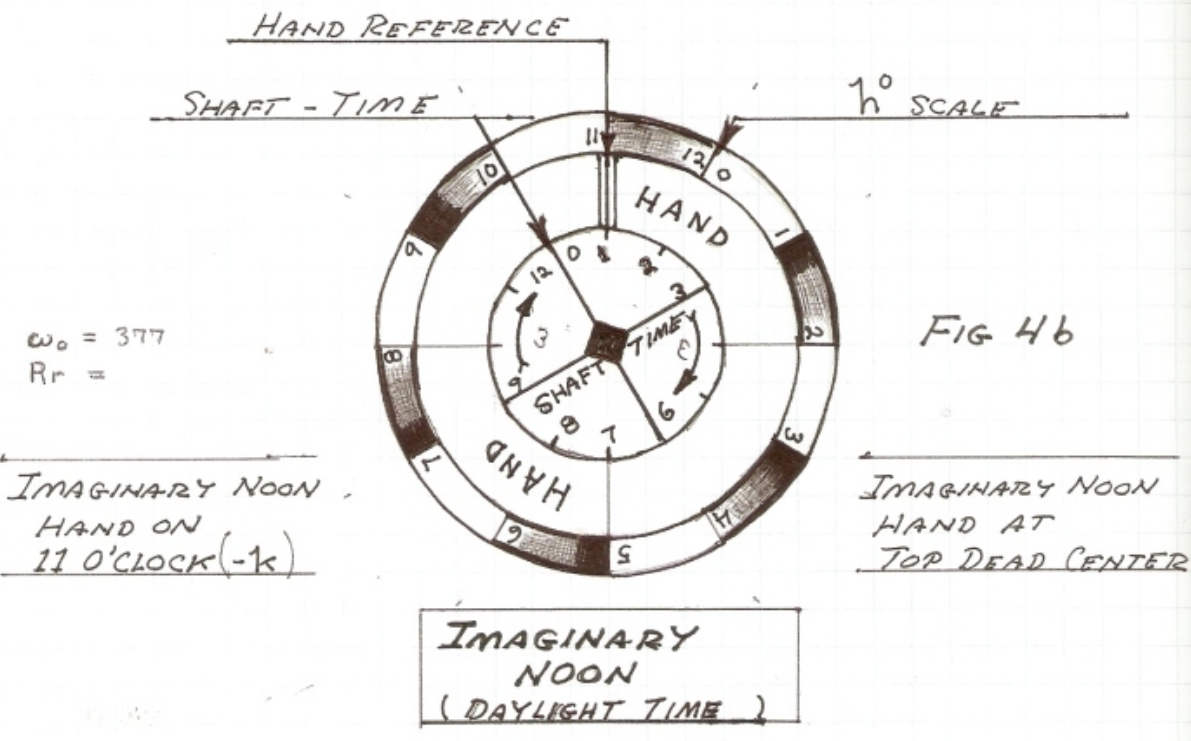
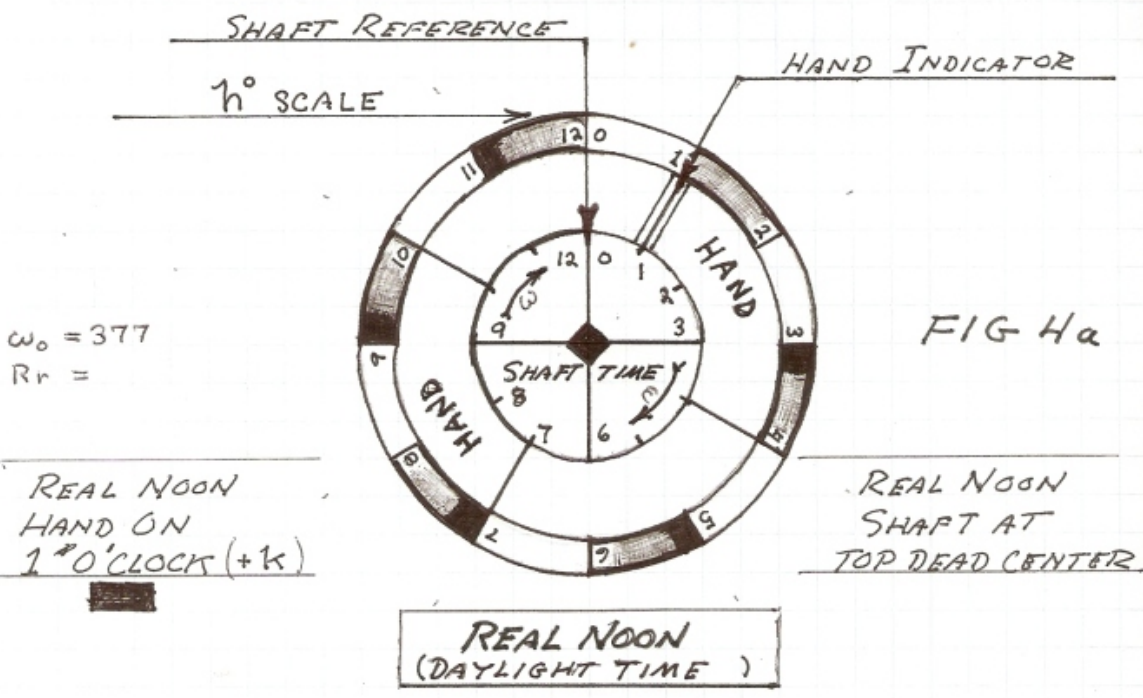

Appendix #2

Four Quadrant Energy Exchange in Magnetic & Dielectric Fields of Induction Part One

The Magnetic Field of Induction, Φ , is directly related to the magneto-motive force, or "current", i , in amperes. A constant, time invariant, M.M.F. constitutes a constant, or "direct current", magnetic field. This constant M.M.F., or direct current, gives rise to no reactionary Electro-Motive Force, E . E.M.F. is a result of the magnetic field acting to maintain a constant current in a regulatory manner. Here the current, and hence the M.M.F. are already constant, thus zero E.M.F. In this condition no energy is exchanged, thus the magnetic energy is "static", or all Potential Energy, in Weber-Ampere.

Since Electric Activity, or Power, in watts, is the product of this constant current, i , and an E.M.F., E , which is zero, the Activity, or Power is also zero. Thus in the absence of an E.M.F. no Power is required in order to maintain a static Magnetic Field of Induction, Fig 1A.

Likewise, a Dielectric Field of Induction, Ψ , is directly related to an electro-static potential, e , in volts. A constant, time invariant potential constitutes a constant, or "D.C.", Dielectric Field. This constant potential gives rise to no reactionary Displacement Current, I , in amperes. Displacement is the result of the Dielectric Field acting to maintain a constant potential, but here the potential is already constant, thus the Displacement is zero. In this condition no energy is exchanged, thus the Dielectric Energy is "static", or Potential Energy in Coulomb-Volts.

Since Electrical Activity, or Power, P , in watts, is the product of this Constant Potential, e , and a Displacement Current, I , which is zero, the Activity, or Power is also zero. Thus in the absence of Displacement no power is required to maintain a static Dielectric Field of Induction, Fig 1B.

A violent magnetic discharge, in the form of an intense forward E.M.F., results from the path for current, i , being broken, or open circuited. This forward E.M.F. is the result of the stored energy within the Magnetic Field acting to maintain a continuous current, and its M.M.F., which now has been disrupted by an open circuit. An open circuit is the

denial of any current flow, thus an infinite E.M.F. is developed within the Metallic-Dielectric Geometry of the Inductance. Fig 1C.

Likewise, a violent dielectric discharge, in the form of an intense Forward Displacement Current, results from the Potential, e , being Short Circuited. This Forward Displacement is the result of stored energy within the Dielectric Field acting to maintain a Continuous Potential which now has been disrupted by a short circuit. A short circuit is the denial of any Potential, thus an infinite Displacement is developed within the metallic-dielectric geometry of the Capacitance. Fig 1D.

The Flow of Power, or Activity, is indefinite in all four of the above conditions. No products can be formed since it is either the current is zero, or the potential is zero. The energy involved is only that contained in the Fields of Induction themselves, no energy exchanged, or transfer, exists with outside forces. The static charge, or Transient Discharge must remain within the metallic-dielectric geometry of the Inductance, or the Capacitance.

For the static case, the energy remains in a signal form, magnetic or dielectric. For the disrupted case, the energy escapes into its conjugate form within the Counter-Spatial Dimensions of the Inductor, or the Condenser, containing the energy involved. For the Disrupted Magnetic Discharge the extreme E.M.F., E , becomes an extreme electro-static potential, e , thus the energy escapes into Dielectric Form within the Inductor.

Likewise, for the disrupted Dielectric Discharge, the extreme displacement, I , becomes an extreme M.M.F., i , thus the energy escapes into Magnetic Form within the Condenser. Because no energy is dissipated, powerful electric oscillations are produced within the Inductor or Condenser. The trapped energy is continuously reflected to and fro between Magnetic & Dielectric Forms within the metallic-dielectric geometry of the device. Little Theoretical or Experimental knowledge exists on this subject, but here enters the work of Nikola Tesla, and his disruptive discharge apparatus.

When the energy contained within the Fields of Induction is delivered to, or taken from, external forms, a set of relations exist as shown in Fig 2. This condition of energy transfer involves Electrical Activity, or Power, P , in watts. Power is The Time Rate of Energy Transfer into, or out of The Field of Induction. The Dimension of Time now takes part. Thus energy transfer gives rise to Frequencies and Time Constants.

For this condition of External Energy Transfer, the external device is a specifically constructed drycell, this the size and shape of the common "D" cell as used in a flashlight. This drycell has virtually no internal losses. It also has been proportioned to

have a Natural Impedance of one ohm, and thus a Natural Admittance of one siemens. Hence the following characteristics of this "XD" drycell;

Open Circuit Potential, e_o , 1 Volt

Short Circuit Current, i_o , 1 Ampere

And thus the ratio of one volt to one ampere is

Natural Impedance, Z_o , 1 Ohm

The Polarity markings for e_o and i_o are shown on the drycell in Fig 2.

This unit drycell is hereby a source of Constant Potential to a Charged Condenser of Equal Potential, and a source of Constant Current to a Charged Inductor of the Same Current. The Displacement or E.M.F. is zero. In both conditions the energy is static, no Transfer of Energy takes place giving rise to Activity. The Power is zero thus the conditions revert to those of Fig 1A & 1B.

This unit drycell contains a certain quantity of Stored Chemical Energy. This Chemical Energy can be taken out and delivered to an external form, or it can be given back to Chemical Form within the drycell, taking energy from an external form. Energy can be taken from or given to this unit drycell, it is rechargeable.

This unit drycell thus can be a Negative Resistance, or a Negative Conductance, when supplying Energy to External Forms. It also can be a Positive Resistance, or a Positive Conductance, when taking energy from external forms. For the condition of constant current this unit drycell is a Positive Resistance, R , in ohm when taking in energy from an External Form, or it is a Negative Resistance, a "Receptance", H , in ohm when giving out Energy to an External Form.

Likewise, for the Condition of Constant Potential this unit drycell is a positive Conductance, G , in siemens when taking in energy from External Forms, or a negative Conductance, and Acceptance, S , in siemens when giving out energy to External Forms.

This unit drycell is here shown to be a bi-directional resistance or conductance. In ordinary Resistances R or Leakages G energy flow is always a uni-directional flow, out, in the form of Heat Energy commonly. Here then is a Versor Resistance, or a Versor Conductance. The D.C. Versor operator is derived from the expression,

(1)

$$\sqrt[2]{+1}$$

Symbolically it is

$$(2) \\ +1^{\frac{1}{2}}$$

With roots, +1 and -1

The versor operator becomes, for this D.C. condition of bi-directional flow,

$$(3) \\ 1^{\frac{1}{2}} = h_2^N, \quad N = 0, 1$$

And

$$h^0 = +1 \\ h^2 = +1$$

$$h^1 = -1 \\ h^3 = -1...etc$$

Hereby the versor relations of the bi-directional device, such as the unit drycell are given

$$(4) \\ R = h^1 H, \quad G = h^1 S$$

$$H = \frac{R}{h^1}, \quad S = \frac{G}{h^1}$$

$$\text{And it is } \frac{1}{h^1} = -1$$

The energy stored within the Magnetic Field of Induction can be supplied to, or taken from the unit drycell. Likewise the energy stored within the Dielectric Field of Induction can be supplied to or taken from the unit drycell. Whereas the disruptive circuit condition completely open circuits the Inductance, or completely short circuits the Capacitance, here now the unit drycell is inserted in the place of the open circuit, or the short circuit. Circuit Continuity is hereby maintained by the drycell. Energy can now be transferred in a finite manner.

The Magnetic Inductance can take the Chemical Energy out of the drycell, storing it within its magnetic field. Conversely, The Magnetic Inductance can deliver its Stored Energy to the Chemical Energy of the drycell. This is a two way Reciprocal Relation.

Likewise, The Dielectric Capacitance can take the Chemical Energy out of the drycell, storing it within its Dielectric Field. Conversely, The Dielectric Capacitance can deliver its Stored Energy to the Chemical Energy of the drycell. Again this is a two way

Reciprocal Relation. The Inductance and Capacitance can give or take energy just as can the drycell.

Hereby Four Distinct Conditions exist, a pair for each Field of Induction, one pair the Energy Transfer between the Drycell and Inductor, (1) charge, (2) discharge, the second pair the Energy Transfer between the Drycell and Condenser, (3) charge, (4) discharge. Hence,

(1) The Energy, W , in Joules, stored in the Magnetic Field, Φ , in Weber, is delivered by Electrical Activity, P , in Watts, Fig 2A, to the drycell

(2) The Energy, W , in Joules, stored in the Dielectric Field, Ψ , in Coulomb, is delivered by Electrical Activity, P , in Watts, Fig 2B, to the drycell.

(3) The Energy, W , in Joules, stored in the Magnetic Field, Φ , in Weber is derived from the Electrical Activity, P , in Watts, Fig 2C, out of the Chemical Energy of the drycell.

(4) The Energy, W , in Joules, stored by the Dielectric Field, Ψ , in Coulomb, is derived from the Electrical Activity, P , in Watts, Fig 2D, out of the drycell.

Hence Magnetic Power Flow in watts can transfer energy from the Magnetic Field, or to the Magnetic Field, this energy to, or from, the Chemical Energy of the drycell. The flow of power is two way, or bi-directional. It is a differential quantity.

Likewise hence, Dielectric Power Flow in watts can transfer energy from the Dielectric Field, or to the Magnetic Field, this Energy to, or from, the drycell. Again the Power Flow is bi-directional, a differential quantity.

The Magnetic Inductance develops an Electro-Motive Force, E , during the Time of Energy Transfer with the drycell. This E.M.F. acts in conjunction with, or in opposition to, the Continuity of Current (M.M.F.), i , this developing the Electrical Activity, E_i , in watts, of Energy Transfer. This Activity, or Power, P_m , is the time rate of Energy Transfer.

Likewise, the Dielectric Capacitance develops a Displacement Current, I , during the Time Interval of Energy Transfer with the drycell. This Displacement acts in conjunction with, or in opposition to, the Continuity of Potential, e , this developing the Electrical Activity, I_e , in watts, of Energy Transfer. This Activity, or Power, P_d , is the Time Rate of Energy Transfer.

It hereby can be seen that the dimension of Time plays an important role in this Energy Transfer. Electrical Activity is the time rate of Energy Transfer,

Watt, or Joule per Second. (5)

The longer, more prolonged, time rate of transfer, the less in magnitude is the Power Flow. Likewise, the shorter, more instantaneous, time rate of transfer, the greater in magnitude is the Power Flow. The Disruptive Discharge is a Limiting Condition, and as well is the Static Charge. In both cases the Flow of Power is zero. The Energy remains within the Inductor or the Condenser.

Thru adjustment of the time rate of charge, and the time rate of discharge, involved in Energy Transfer into, or out of, a Field of Induction, any magnitude of Electrical Activity, P , can be developed from a given quantity of stored Energy, W , Fig 3, Fig 4.

Denoting the charge time as t_1 , and the discharge time as t_2 , taking the ratio as,

$$\frac{-t_1}{t_2} = -n, \text{ Numeric (6)}$$

The Power Magnification is given as

$$-P_2 = nP_1, \text{ Watts, (7)}$$

And thru Energy Conservation, it is,

$$t_2 P_2 - t_1 P_1 = 0, \text{ Joules (8)}$$

The factor n is called The Magnification Factor of Energy Exchange.

While a Magnetic Inductance is gathering energy from the Chemical Energy of the drycell, a backward directed E.M.F., E , is developed within this Inductance. This E.M.F. acts to maintain a constant M.M.F., or current, i , that is it acts to maintain the quantity of Energy Stored within the Magnetic Field. While an Inductance is delivering its Magnetic Energy to the Chemical Energy of The Drycell, a forward directed E.M.F., E , is developed within the Inductance. This E.M.F. also serves to maintain a constant M.M.F. or current, i , that is it acts to maintain The Quantity of Energy Stored within the Magnetic Field. Fig 2A & 2C.

Hence the charging Inductance, gaining Magnetic Energy, develops an E.M.F., E , in opposition to the Potential, e , of the Drycell. The resulting Voltage Difference combines with the current, i , in delivering Energy to the Magnetic Field of Induction. This E.M.F. is called the "Back E.M.F.". Also, the Discharging Inductance, losing Magnetic Energy, develops and E.M.F., E , in conjunction with the Potential, e , of the Drycell. The Resulting Voltage Summation combines with the current, i , in delivering Energy to the drycell. This E.M.F. is called the "Forward E.M.F.". The E.M.F. is thus a differential magnitude, Back E.M.F. on charge, $+E$, Forward E.M.F. on discharge, $-E$. Fig 3.

Likewise, hence the Charging Capacitance and Displacement Current, I , in opposition to the current, i , of the drycell. The resulting current flow combines with Potential, e , in Delivering Energy to the Dielectric Field, taking it from the Chemical Energy of the drycell. The Discharging Capacitance develops a Displacement Current, I , this in conjunction with the current, i , of the drycell, in Delivering Energy to the drycell, taking it from the Stored Energy of the Dielectric Field, Fig 2B & 2D. The Charging Displacement is called the "Back Displacement," and The Discharging Displacement is called the "Forward Displacement". Back Displacement, $-I$, Forward Displacement, $+I$, the displacement is a differential magnitude. Fig 3.

Hereby, The Four Primary Energy Transfer Relations

1) Magnetic Energy Discharge,
Forward E.M.F., Fig 2A.

2) Dielectric Energy Discharge
Forward Displacement, Fig 2B.

3) Magnetic Energy Charge,
Back E.M.F., Fig 2C.

4) Dielectric Energy Charge
Back Displacement, Fig 2D.

Note, the unfortunate condition exists that the Production of Energy is taken as a Negative Value, the Consumption of Energy is taken as a Positive Value. However, this is the established convention, despite the confusion it creates.

The following relations for power flow are hereby derived,

MAGNETIC POWER FLOW;

1) Charge, $+Ei = +P_m(9)$

2) Discharge, $-Ei = -P_m(9)$

DIELECTRIC POWER FLOW;

3) Charge, $+Ie = +P_d(10)$

$$4) \text{ Discharge, } -Ie = -P_d(10)$$

The versor expressions for charge and discharge are given as.

$$(11)$$

$$+E = h^0 E,$$

$$+I = h^0 I$$

$$-E = h^1 E,$$

$$-I = h^1 I$$

Where h^N is the charge/discharge versor operator. Substituting these expressions into the general relations of Power Flow, the magnetic,

$$(12)$$

$$+P_m = +Ei,$$

$$h^0 P_m = h^0 Ei$$

$$-P_m = -Ei,$$

$$h^1 P_m = h^1 Ei$$

And, the dielectric,

$$(13)$$

$$+P_d = +Ie,$$

$$h^0 P_d = h^0 Ie$$

$$-P_d = -Ie,$$

$$h^1 P_d = h^1 Ie$$

Hence the most general expression for Versor Power is,

$$(14)$$

$$\dot{P}_m = h^N P_m, \text{ Versor Watts}$$

$$\dot{P}_d = h^N P_d, \text{ Versor Watts}$$

Where, $N = 0,1$.

FIG 1

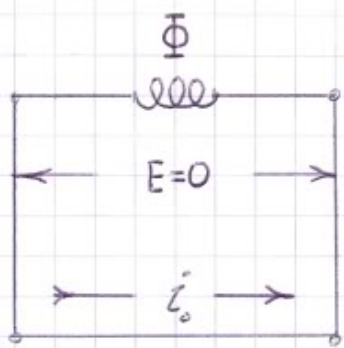

(A) MAGNETIC
STATIC
CHARGE

i_0 , CONSTANT CURRENT
 $P_m = 0$

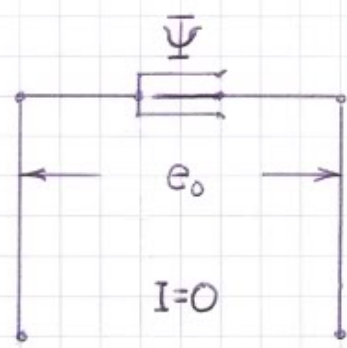

(B) DIELECTRIC
STATIC
CHARGE

e_0 , CONSTANT POTENTIAL
 $P_d = 0$

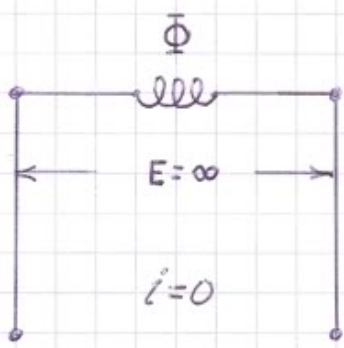

(C) MAGNETIC
DISRUPTIVE
DISCHARGE

i , DISRUPTED CURRENT
 $P_m \rightarrow \infty$

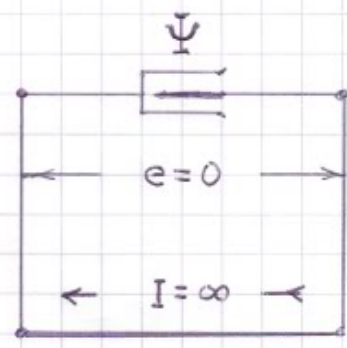

(D) DIELECTRIC
DISRUPTIVE
DISCHARGE

e , DISRUPTED POTENTIAL
 $P_d \rightarrow \infty$

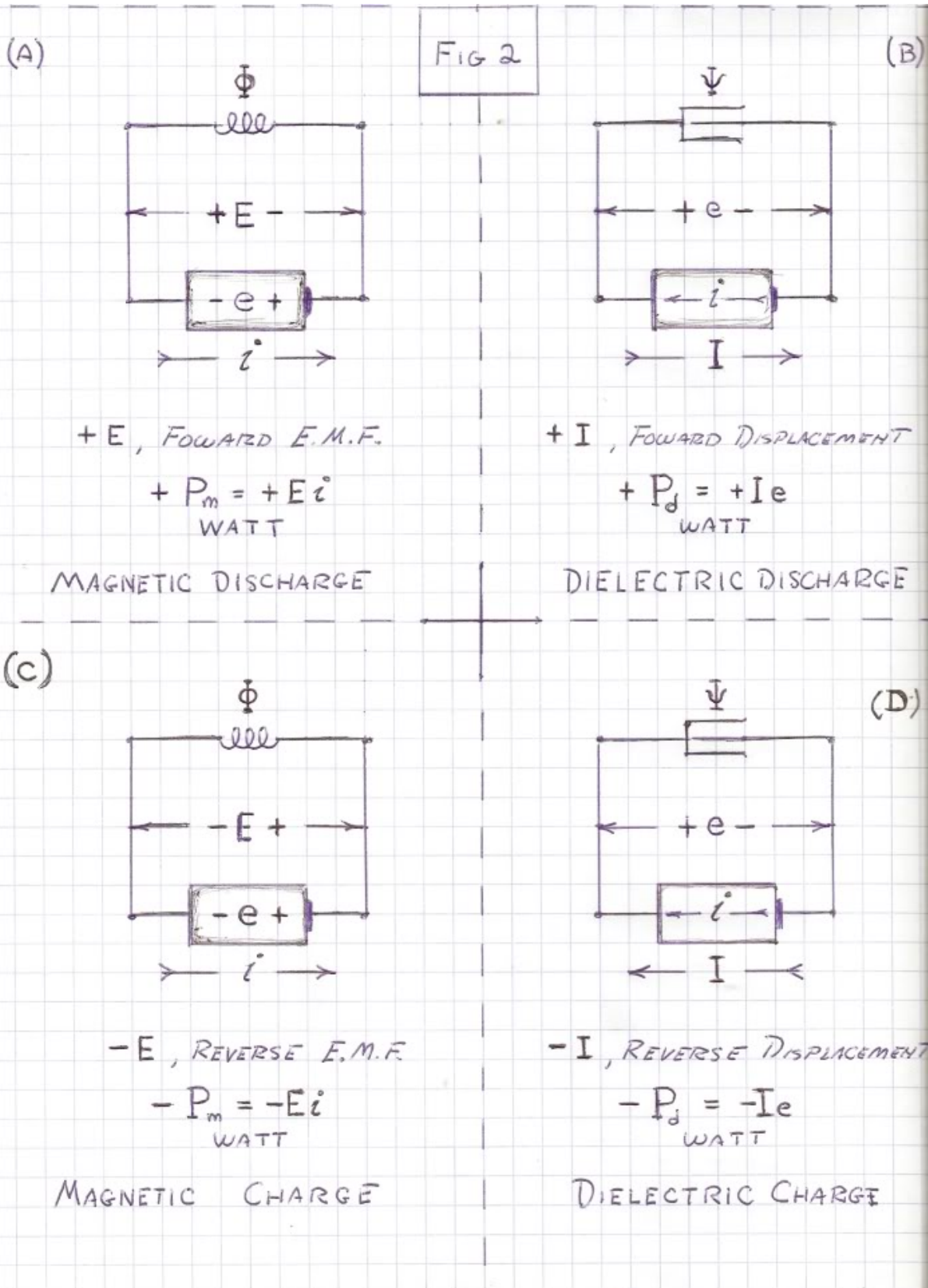

FIG-3
ELECTRIC FIELD
CHARGE / DISCHARGE
DIAGRAM

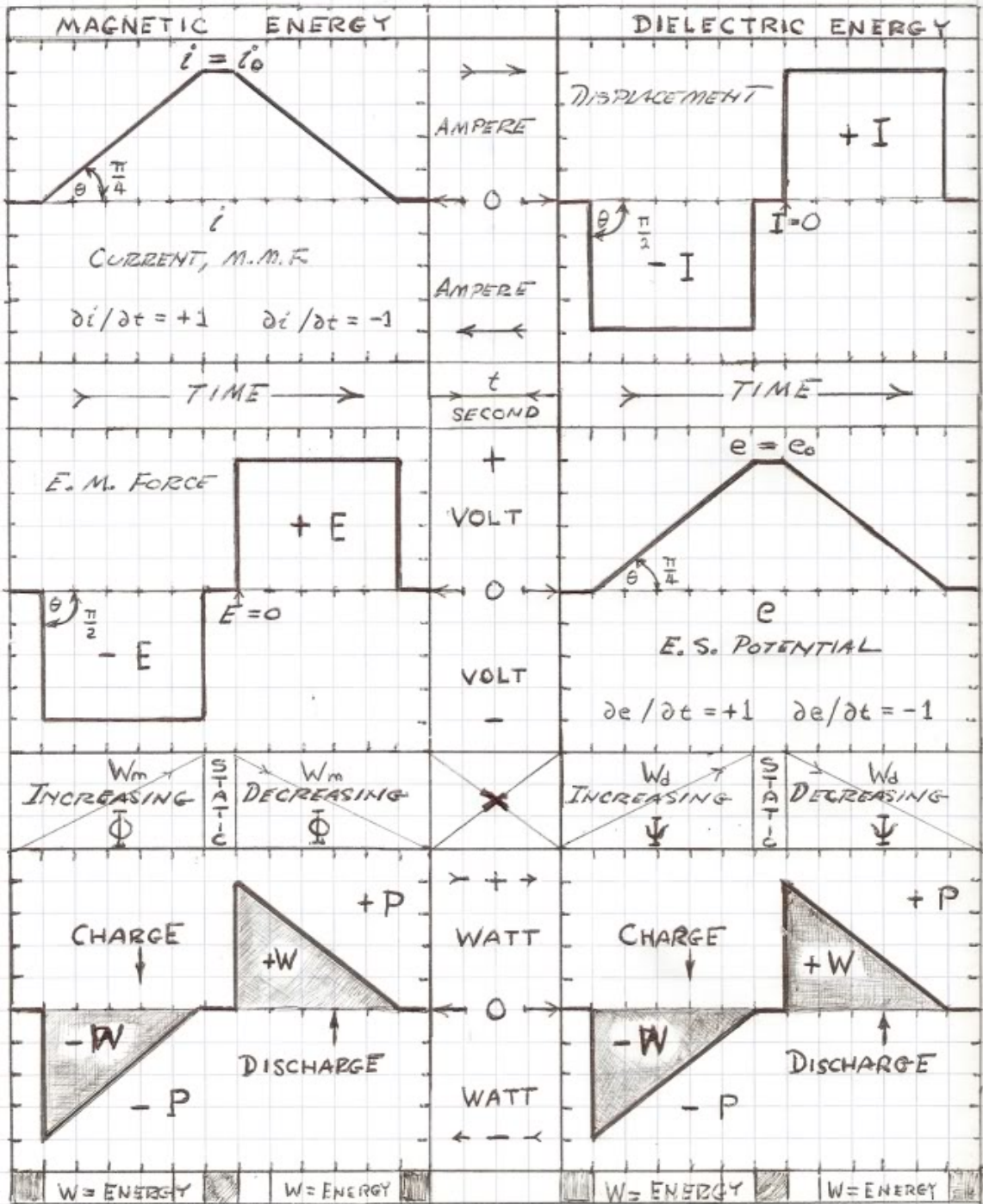
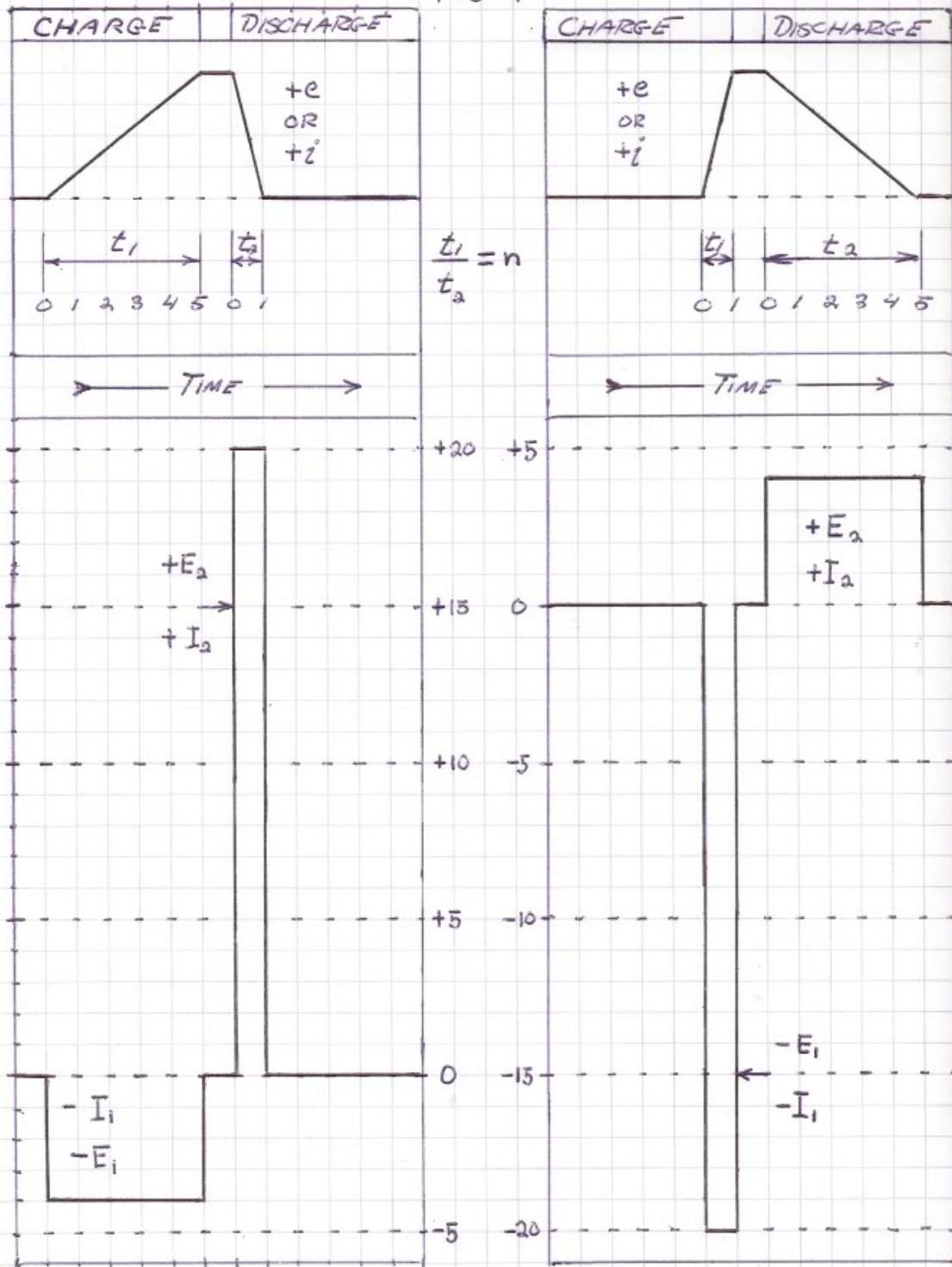

FIG-4



The Four Quadrant Theory of Electrical Activity

Part Two

In part one the energy transfer was one only of two forms, the transfer of Magnetic Energy, or the transfer of Dielectric Energy. Only one form of Inductive Energy exists. It is a single energy, and accordingly it is called a Single Energy Transient. Only one form of stored energy is active in a Single Energy Transient.

This stored energy can exist in one of two distinct forms,

The Magnetic Energy,

$$(1) W_m = \frac{1}{2} i\phi, \text{ Ampere-Weber}$$

The Dielectric Energy,

$$(2) W_d = \frac{1}{2} e\psi, \text{ Volt-Coulomb}$$

Because these stored energies are static quantities, they are time invariant. The dimension of time has no role in their existence. It is however that time is a necessary dimensional requirement for the existence of energy. So where then is the energy?

These dimensional expressions for stored energy represent only the Potential for Energy Existence. It is that the expressions given for the energy stored by a field of induction are no more than expressions for the magnitude, and quantity, of the magnetic induction, and dielectric induction, themselves. No union of the two inductions exist to form the product, Electrification, Q, and its time rate, Energy, W.

The single energy transient is a Magnetic Energy Transient, a transient of Electro-Motive Force, E, or it is a Dielectric Energy Transient, a transient of Displacement Current, I. These two reactive transients give rise to products, these with their respective potentials, the electro-static potential, e, and the magneto-motive force, i. M.M.F. is also considered a potential in that it is static. These products of reaction and potential represent The Electrical Activity of their respective Single Energy Transients. Thus a pair of Products, one for each field,

The Magnetic Activity

$$(3) \dot{P}_m = h^N Ei = (+Ei, -Ei), \text{Watt}$$

The Dielectric Activity

$$(4) \dot{P}_d = h^N Ie = (+Ie, -Ie), \text{Watt.}$$

Each Versor Activity, \dot{P}_m or \dot{P}_d , represents one form of energy only, magnetic or dielectric, not both.

Also shown in part one was the magnification factor is a negative numeric. This magnification factor, n , is the ratio of two time spans, the time span for charge, to the time span for discharge. For the numeric ratio to be negative, one time span must also be negative. Hence the magnification factor is the ratio of a negative time span, the charge time, to a positive time span, the discharge time. The magnification factor is given as

$$(5) -n = \frac{-t_1}{t_2}, \text{Numeric}$$

By the Law of Energy Conservation for the stored inductive energy, the amount of energy given to the field must equal the amount of energy that the field can give back. This is to say the energy sent into a field of induction is the same energy sent out of the field of induction. Hence the two energies are in opposition with regard to the flow of power, the power in, and the power out, this resulting in a negative transfer constant, the magnification factor, n .

This results in the expressions for power flow containing a negative dimension, now exists one power flow forward in time, and another power flow, reverse in time. Power can now flow in both directions with regard to the dimension of time. Hence Power is free to move about in the dimension of Time, that is, it is a Versor Power Flow.

Here exists an analog of power flow in space along the length of a transmission line, where power is free to move along the length of the line in either direction. Thus the analog of a "Length of Time". Here then the existence of forward and reflected waves in time, just as was seen for waves on a transmission line. Hereby a composite transient, the superposition of a wave moving forward in time and a wave moving backward in time, can be developed for any instant in time. One wave travels from the past to the future, the other wave travels from the future to the past, a pair of traveling waves in time, traveling in opposite directions. The superposition of the opposing waves is the Present, or Now, t equals zero.

The versor of Electrical Activity hence resides in the metrical dimension of Time, giving the relation as

$$(6) \dot{T} = h^N T = (+t, -t), \text{ Seconds.}$$

Time is now a bi-valent dimension, two values of time,

+ t , real time, seconds,

- t , imaginary time, seconds.

It is then given by the Law of Energy Conservation,

$$(7) t_2 P_2 - t_1 P_1 = 0, \text{ Watt-Second}$$

Imaginary Time can be called “Counter – Time”, this in analog to “Counter – Space”. There is however an important difference between the two. The expression for Counter-Space is given by

$$(8) L^h, \text{ Per Centimeter}$$

Where h = -1

However, the expression for Counter-Time is given by

$$(9) hT, \text{ Negative Second}$$

Space is given here in terms of algebraic products, whereas Time is given here in terms of algebraic sums. This suggests a relation between Time and Space, or Time – Space where it is

$$(10) h = 1^h, \text{ Versor}$$

$$(10a) h = -1, \text{ Unit Versor}$$

A similar condition can be found for the versor condition

$$(11) K_N^5 = 1^{1/5}, \text{ Versor}$$

Reducing this to a base two versor, h^N , gives the pair of projections,

$$(12) \quad h^N \Gamma = \frac{1}{2}(1 \pm \sqrt{5}), \text{ Numeric}$$

This resulting in a pair of ratios

$$(13) \quad \Gamma_1 = 0.618\dots, \text{ Numeric}$$

$$(14) \quad \Gamma_2 = -1.618\dots, \text{ Numeric.}$$

Little theoretical knowledge exists on this subject. It is of interest to note here the relations,

$$(15) \quad \Gamma_2 = \Gamma_1 + h, \text{ Numeric}$$

And

$$(16) \quad \Gamma_2 = \Gamma_1^h, \text{ Numeric}$$

Thus

$$(17) \quad \Gamma_1^h = \Gamma_1 + h, \text{ Numeric}$$

In part one the unique condition of a disruptive discharge was given. In the disruptive discharge of a magnetic field of induction, or a dielectric field of induction, the discharged energy is confined within the metallic-dielectric geometry. No external energy transfer exists. In this condition the given field, the magnetic, or the dielectric, exchanges its energy with its Conjugate Form, the dielectric, or the magnetic. This is to say that Every Condenser has a bit of Inductance, it is the very nature of an aether filled metallic-dielectric geometry.

Because this "parasitic" capacitance or inductance has a very small value as a coefficient of energy storage, the Disruptive Discharge Develops Transients of great intensity and of Very Short Duration in Time. For the discharging inductor the intensity is given by

$$(18) \quad E = iZ_c, \text{ Volts}$$

Where

$$(19) \quad Z_c^2 = \frac{L}{C}, \text{ Henry Per Farad}$$

And C is the Parasitic Capacitance

And for the Discharging Condenser,

$$(20) I = eY_c, \text{ Ampere}$$

Where

$$(21) Y_c^2 = \frac{C}{L}, \text{ Farad per Henry}$$

And L is the Parasitic Inductance.

Because one form of energy storage is the denial of the other form of energy storage, in the disruptive discharge, no steady state condition is possible. The energy has nowhere to roost, it is continuously thrown back and forth, remaining within the metallic-dielectric geometry. Here the stored energy is continuously exchanged between spatial and counter-spatial forms of energy storage, this continuously moving back and forth thru time and counter time. Because the Inductance in the steady state is a short circuit, it cannot maintain a potential, e, and because the Capacitance in the steady state is an open circuit, it cannot maintain a current, i. Thus a potential, e, can only exist as a time variant E.M.F., E, and likewise a current, i, can only exist as a time variant displacement, I.

No energy is transferred into, or out of, the metallic-dielectric geometry, it is only exchanged between denials of form. It is then given

$$(22) E_i = -I_e, \text{ Volt-Ampere}$$

$$-E_i = I_e, \text{ Volt-Ampere}$$

Substituting the following

$$(23) E = e, \text{ Volt}$$

$$I = i, \text{ Ampere}$$

Gives the expression for the electrical activity of the disruptive discharge as

$$(24) P_o = EI, \text{ Volt-Ampere}$$

Instead of allowing the disrupted Field of Induction to discharge back into its conjugate form within the metallic-dielectric geometry, an external conjugate form can be utilized. That is to say, an External Condenser, or an External Inductor. Equations (19) and (21) now apply to the external energy storage element rather than the internal parasitic values. These represent the natural impedance of the pair of energy storages. The metallic-dielectric geometry now is reduced to a magnetic inductance connected with an external condenser, or it is reduced to a dielectric capacitance connected with an external inductor. This is given in a sequence of diagrams, Fig 1.

(1) Fig 1A. A discharging Magnetic Inductance transfers its energy into a Charging Dielectric Capacitance.

(2) Fig 1B, A discharging Dielectric Capacitance transfers its energy into a Charging Magnetic Inductance.

(3) Fig 1C, A charging Magnetic Inductance transfers its energy out of the Discharging Dielectric Capacitance.

(4) Fig 1D, A charging Dielectric Capacitance transfers its energy out of the Discharging Magnetic Inductance.

Here given are the four quadrants of energy exchange between a pair of mutually conjugate forms of energy storage, the inductor and the condenser. The stored energy is being continuously transformed from one form into its conjugate form in an endless cyclic rate. The time rate of this energy exchange is the electric activity, P_o , in volt-amperes. This activity represents the flow of power between the Inductor and the Condenser. Rather than a single energy transfer, it is now a pair of energy transfers. This is now a double energy transfer, or a Double Energy Transient.

In the double energy transient the stored energy is trapped with no escape. Thus this energy remains stored energy in an alternating current form, stored A.C. energy. The activity, or the flow of power is a continuous cyclic energy exchange, an opposing pair of energy transfers each moving in opposite directions in time. One energy transfer travels forward in time, the conjugate energy travels backward in time. The superposition of this opposing pair of traveling waves in time gives rise to a stationary wave in time. This is an analog to the standing wave on the length of a transmission line.

Because the inductor is charging while the condenser is discharging, or the condenser is

charging while the inductor is discharging, the relations for power flow are given by

$$(25) -t_1 P_m = t_2 P_d, \text{ watt-second}$$

And rearranging gives the relation

$$(26) 0 = t_2 P_d - t_1 P_m, \text{ watt-second}$$

The expression of the Law of Energy Conservation.

For the condition of oscillatory energy exchange the time relations are given by

$$(27) -t_1 + t_2 = 0, \text{ seconds}$$

The two time spans, the charge time span, t_1 , and the discharge time span, t_2 , are now equal and opposite. Hence a single time span can represent both t_1 and t_2 .

$$(28) |-t_1| = |+t_2| = t_o, \text{ seconds.}$$

This time span is the one quarter period of a complete cycle of Energy Exchange, T. In the condition of cyclic energy exchange the magnification factor is expressed by the relation

$$(29) -n = \frac{-t_1}{t_2} = -1, \text{ versor.}$$

Hence the magnification factor is always unity. The Magnetic Power, P_m , is equal to the Dielectric Power, P_d . This is to say the Charge Power Flow is equal to the Discharge Power Flow. No charge-discharge magnification exists here. This magnification factor is now just a versor operator establishing the Law of Energy Conservation.

For the condition of energy transfer, the single energy transient, the transfer of energy is into, or out of the single stored energy. It is a one way flow, backward flow, or forward flow. It is uni-directional like a direct current. However, for the condition of the double energy transient the energy is reflected back upon itself between an opposing pair of energy storages. The double energy transient is a bi-directional power flow like an alternating current.

The single energy transient can be considered a traveling wave in time, the double energy transient can be considered a standing wave in time. This is in analogy to

traveling and standing waves on a transmission line. Here time is an analog of length in the movement of electric energy.

The activity of the oscillatory energy exchange is given by the product of the Electro-Motive Force, E , and the Displacement Current, I . The four quadrantal activities are thus given by,

Fig, 1A, $-EI$

Fig, 1B, $-IE$

Fig, 1C, $+EI$

Fig, 1D, $+IE$

Each of the above activities exist in their respective quadrant in the cycle of energy exchange. It is given algebraically that,

$$(30) -EI = -IE$$

$$+EI = +IE$$

No energy is gained or lost, thus the activity is identical for each quadrant in the time cycle of energy exchange. Hereby a single effective activity exists for the double energy transient in its exchange of energy between Magnetic Form and Dielectric Form. This is given as in equation (24)

$$(24a) P_o = EI \text{ volt-ampere}$$

This is the electric activity of the oscillatory energy exchange between the Inductor and the Condenser. This is not an actual power in watts, but an electric activity in volt-amperes.

For the condition of energy transfer, the single energy transient, a pair of electrical activities exist,

eI , iE , watts.

Each represents the flow of power in the Dielectric, or Magnetic Energy Transfer. Here the charge time span and the discharge time span are independent time frames. An

indefinite static time interval can exist between these two time frames. However, the double energy transient of oscillatory energy exchange has no possible static time interval, no possible steady state. Also the charge time span is identical to the discharge time span. One is the mirror image of the other, both of equal length in time. The two opposing energy transfers cancel out, just as do two opposing traveling waves. This leads to a stationary wave and one resultant electric activity only, that of the Cyclic Energy Exchange. No energy is gained or lost, it is confined to the oscillating system. This represents a stored alternating current and as such must possess an angular velocity of energy exchange since A.C. is a circular function. Hence it is,

$$(31) \quad \omega = \frac{2\pi}{T}, \text{ radian per second}$$

Where T is the time span of one cycle of energy exchange.

This exchange is then in the form of a perpetual motion which gradually weakens due to energy leakage, that is, the losses in the metallic-dielectric geometries where the energy exchange takes place.

Power magnification in the oscillating energy transfer takes on a different form in the oscillating energy exchange. No magnification is possible between the charge and discharge portions of the cycle of energy exchange, they are equal and opposite time spans. It is however that a finite quantity of stored energy exists, and its activity is the time rate of energy exchange between magnetic and dielectric forms. A definite time cycle exists, where the transfer time, t_o , is one fourth the time span of a complete cycle of energy exchange, T. The transfer time defines the rate at which the stored energy is transferred back and forth, that is, the rate at which it is exchanged. Thus the relations for power and energy are given by

$$(32) \quad W_o = t_o P_o \text{ watt-second}$$

$$(33) \quad P_o = \frac{W_o}{t_o} \text{ watt, or volt-ampere.}$$

Where t_o is one fourth period T. The Time Period, T, and thus the angular velocity of energy exchange can be derived from the Laws of Induction, these for an alternating current form. Thus given

The Law of Magnetic Induction,

$$(34) \quad \omega\phi = E = 2\pi\frac{\phi}{T}, \text{ weber per second}$$

The Law of Dielectric Induction,

$$(35) \quad \omega\psi = I = 2\pi\frac{\psi}{T}, \text{ coulomb per second}$$

Rearranging (34) and (35) gives

$$(36) \quad \omega = \frac{I}{\psi}, \text{ and } \omega = \frac{E}{\phi}, \text{ radians per second}$$

And substituting the relations

$$(37) \quad \psi = EC, \text{ and } \phi = IL, \text{ Induction}$$

Into the relations of (36) gives

$$(38) \quad \omega = \frac{I}{EC}, \text{ and } \omega = \frac{E}{IL}, \text{ radians per second}$$

It is however,

$$(39) \quad Y = \frac{I}{E}, \text{ and } Z = \frac{E}{I} \text{ siemens, ohm}$$

Thus the relations (38) become,

$$(40) \quad \omega = \frac{Y}{C}, \text{ and } \omega = \frac{Z}{L}, \text{ radians per second}$$

Substituting the defining ratios,

$$(41) \quad Y = \sqrt{\frac{C}{L}}, \text{ and } Z = \sqrt{\frac{L}{C}}, \text{ siemens - ohm}$$

Into relations (40) gives the expressions for the angular velocity of energy exchange

$$(42) \quad +\omega = \frac{1}{\sqrt{LC}}, \text{ and } -\omega = \frac{-1}{\sqrt{LC}}, \text{ radian per second}$$

$$\text{Hence (42a) } \omega^2 = \frac{1}{LC}, \text{ by definition.}$$

The expressions (42) for the angular velocity of energy exchange represent a pair of velocities, one forward in time, one reverse in time. The time period of one cycle of energy exchange is therefore given by the expression,

$$(43) \quad T = 2\pi\sqrt{LC}, \text{ seconds}$$

And thus the time span of energy transfer is given by

$$(44) \quad \frac{1}{4}T = t_o = \frac{\pi}{2}\sqrt{LC}, \text{ seconds}$$

Substituting these relations into the expression for power, equation (33), where it is,

$$(43a) \quad F = \frac{1}{T}, \text{ per second}$$

$$(45) \quad P_o = 4W_oF, \text{ volt - amperes}$$

Where, F, is the frequency of oscillation, in cycles (2π radian) per second. Hence the magnification of activity for a given quantity of energy in the oscillating energy exchange is not a function of the ratio of charge to discharge times, since they are now equal. The magnification is here given as a function of the rate of energy exchange, the Frequency of Oscillation, F, in cycles per second. The more rapid the energy exchange, the higher the frequency and thus the larger the magnitude of the resulting electric activity. Power is directly proportional to frequency.

In the above condition of energy exchange the charge time span is equal in length to the discharge time span. No charge/discharge magnification is possible. It is however that the energy storage coefficients, the Inductance L, and the Capacitance, C, can be altered between charge and discharge intervals, Fig 3. This alteration can be done in two ways. One method is to use separate inductive elements in the charge/discharge cycle. For example, an inductance can take energy from one capacitance on charge and deliver this energy to another capacitance on discharge, or alternately a capacitance can take energy from one inductance on charge and deliver this energy to another inductance on

discharge. Energy exchange has now reverted to a pair of energy transfers, and an indefinite static interval. The frequency of oscillation is according different for the different charge or discharge intervals. Hence the magnification factor is given by the relation

$$(46) \quad -n = \frac{\omega_2}{-\omega_1, \text{ numeric}}$$

Where ω_1 is the angular time rate of charge and ω_2 is the angular time rate of discharge. This magnification was utilized by Nikola Tesla for the purpose of Power Amplification with no electronic elements.

The other method of altering the charge/discharge cycles is thru synchronous Parameter Variation. Rather than switching the energy storage elements, the co-efficients of energy storage, L, and, C, can be made variable throughout the cycle of Alternating Energy Exchange. Hereby the capacitance can vary between charge and discharge intervals, or the inductance can vary between charge and discharge intervals, and both can be varied throughout the cycle of alternating energy exchange. The magnification factor is now a complex quantity, or versor expression. Little theoretical knowledge exists on this subject.

The relations for electric activity for differing charge and discharge frequencies are hereby the same expressions as those for single energy transfer,

$$(47) \quad P_2 = -nP_1, \text{ volt-ampere}$$

$$(48) \quad P_2 - nP_1 = 0, \text{ volt-ampere}$$

$$(49) \quad \frac{P_2}{\omega_2} - \frac{P_1}{\omega_1} = 0, \text{ volt-ampere-second}$$

Equation (49) states the Law of Energy Conservation, this for the condition of switching energy storage elements. Since the magnification factor is a complex quantity for the condition of Synchronous Parameter Variation, the Law of Energy Conservation is indeterminate.

In all that has been covered thus far the Metrical Dimension of Time has been the primary consideration. Energy and Power are Products of Time. This is expressed in the relation

$$(50) \quad T = \frac{W}{P}, \text{ joule per watt}$$

The relationship between Energy and Power is Time. The energy has been a stored energy, and the power has been the time rate of the stored energy movement.

What has not been considered thus far is the condition of an actual Direct Current, a Time Invariant Condition, nor the condition of negligible co-efficients of energy storage, very insignificant values of inductance or capacitance. These are conditions of Zero Energy Storage. The dimension of time has no role in these conditions. This is the "Time Scalar" condition. Here is the fourth and final condition in the Flow of Electric Power.

In the scalar condition the transfer of energy exists with no form of energy storage, there is no charge or discharge interval. The transfer is constant. As it was in the beginning, so it shall be for now and ever more, the continuous, or Direct Current. Even with the application of an alternating current, the energy transfer is still direct, it following exactly the cycle of the applied alternating current. Hence the scalar condition is FREQUENCY INDEPENDENT, as would be expected for a time invariant condition. Thus the transfer can be instantaneous. Time does not exist in the scalar condition. The notions of constant, cyclic, or instantaneous, play no part in this condition. They can only arise from external causes.

The scalar condition is then the result of one of two distinct conditions,

- 1) No time variation of the fields of induction, as with direct current,
- 2) Negligible energy storage so as not to react with time variant currents, as with transient current.

In both conditions the Electro-Motive Force, E, and the Displacement Current, I, are zero. Hence no energy exchange or transfer exists with any field of induction.

Because the dimension of time in the scalar condition is indeterminate the dimensional relation of energy is also indeterminate, since energy is a product of time. It is however that power flow actually takes place as a product of the potential, e_o , and the current, i_o , that is,

$$(51) \quad P_s = e_o i_o, \text{ watt}$$

It is however

$$(52) \frac{P_s}{W} = 0, \text{ per second}$$

This is to say that the time span is indefinite. Hence energy can only be expressed as power in the time scalar condition.

Also, in the absence of an electric field of induction both phi and psi are non-existent, thus the product, Q, is non-existent,

$$(53) Q = \phi\psi = 0, \text{ planck.}$$

Therefore the energy is non-existent

$$(54) \frac{Q}{T} = W = 0, \text{ joule}$$

So where then is the energy? In the scalar condition all energy is created and dissipated in the same instant, no intermediary energy exists. It is "on demand". Obviously, as with the similar situation of the disruptive discharge condition, there is always a bit of something somewhere that leads to a determinate solution, such as the connecting wires. The actual scalar condition can only exist within inter-molecular dimensions.

The scalar condition can be derived by the interconnection of resistances and conductances. Resistance, R, in Ohms, and Conductance, G, in Siemens. No energy storage is possible in these elements and thus they are Time Invariant quantities. There is no energy, whatever energy is given here instantly vanishes, appearing as a source of heat. This scalar condition thus contains no electricity, it simply eliminates it. The rate at which energy is eliminated is given as a flow of power, P, in watts, this as a product of a dissipative E.M.F. and a dissipative displacement.

-e, , E.M.F.

-i, Displacement

Because of the scalar condition it is the E.M.F. is also the Potential, and the displacement also the current. No electric field exists. Thus the power is given by

$$(55) P_s = ei, \text{ watt.}$$

In a manner similar to the condition for oscillating energy exchange, no cross product exists between a reaction and a potential, as it is with the relation

$$(24) P_o = EI, \text{ volt-ampere}$$

Thus the relations exist for the scalar condition as analogs to the exchange condition. This gives,

$$(56) R_c^2 = \frac{R}{G}, \text{ ohm per siemens}$$

$$(57) G_c^2 = \frac{G}{R}, \text{ siemens per ohm}$$

And

$$(58) \Gamma^2 = RG, \text{ scalar numeric.}$$

Where

R_c , the natural resistance

G_c , the natural conductance

Γ , the propagation constant.

The scalar condition can also exist for the interconnection of receptances and acceptances, receptance, H, in Ohm, and Acceptance, S, in Siemens. Here the energy is instantly produced, drawn out of the inter-molecular dimensions of the receptances and acceptances. With the resistance-conductance configuration the energy is instantly destroyed, pulled into the intermolecular dimensions of the resistances and conductances. Both are instant, no lag time is involved.

These conditions can be established with a pair of unit drycells. This condition involves time invariant energy transfer. It is instantaneous. When a charged unit drycell is connected with a discharged unit drycell a constant unidirectional transfer of energy takes place. This transfer is in space, not in time. This transfer takes place from the charged drycell to the discharge drycell, a one way trip.

As with the prior conditions of energy movement four relations exist with regard to the

flow of power. These are shown in the diagrams of Fig 4. Hence the four relations,

Fig, 4A, $-ei$, watts

Fig, 4B, $-ie$, watts

Fig, 4C, $+ei$, watts

Fig, 4D, $+ie$, watts

And algebraically it is given

$$(58) -ei = -ie , \text{ watts}$$

$$+ei = +ie , \text{ watts}$$

The transfer of energy and thus the flow of power is bi-directional, any drycell can charge any other drycell, that is,

$-ei$ & $+ei$.

And hereby the flow of power is given as

$$(59) h^N P_s = \pm ei , \text{ watts}$$

In the scalar condition there is no electrical activity because of the time invariant nature of this condition. Likewise, in the exchange condition there is no electrical power because of the time variant nature of this condition. One is NOT the other. Thus the relations are,

$$(60) EI = P_o , \text{ volt-amperes,}$$

$$ei = P_s , \text{ watts.}$$

Both are real quantities and thus algebraically additive. The volt-amperes represents the complete storage of energy with no leakage whereas the watts represents the complete absence of energy storage with the complete leakage of energy. Here "leakage" is defined as leakage into, or out of, the metallic-dielectric geometry.

Here in final form are thus the four distinct conditions for the flow of power in an

electrical configuration:

0) The Scalar, or Anti-Electric, Product;

$$(61) \ ei = P_s, \text{ watt}$$

1) The Forward Cross, or Magnetic, Product;

$$(62) \ Ei = P_m, \text{ joule per second}$$

2) The Axial, or Magneto-Dielectric, Product

$$(63) \ EI = P_o, \text{ volt-ampere}$$

3) The Reverse Cross, or Dielectric, Product

$$(64) \ Ie = P_d, \text{ joule per second}$$

Hereby the Heaviside Expression for the Movement of Energy as a flow of power can be assembled, giving the general form as,

$$(65) \ \dot{P} = (k^0 P_s + k^2 P_o) + (k^1 P_m + k^3 P_d)$$

$$\dot{P} = h^N P_a + j^N P_b, \text{ versor watt}$$

The apparent power flow is given as the square root of the sum of the squares,

$$(66) \ P = \sqrt{P_a^2 + P_b^2}, \text{ watt}$$

$$\text{Where } P_a = (P_s + h^N P_o), \ P_b = (P_m + h^N P_d), \text{ watt}$$

The versor operators are tentative, however they can be derived from "Symbolic Representation of The Generalized Electric Wave", E.P. Dollard. One such versor form is given as

$$(67) \ k_N^8 = jh = -1^{1/4}, \text{ versor}$$

$$(67a) \ k = jh, \text{ versor}$$

The Three Fundamental Factors can now be derived for the electrical configuration,

utilizing equations (65) and (67), hence given are,

$$(68a) \quad a = \frac{P_a}{P}, \text{ Power Factor, percent}$$

$$(68b) \quad b = \frac{P_b}{P}, \text{ Induction Factor, percent}$$

$$(68c) \quad n = \frac{P_b}{P_a}, \text{ Magnification Factor, numeric}$$

Where it is,

$$n = \frac{b}{a}, \text{ numeric}$$

For the condition of equation (66) it is a circular function and

$$(69) \quad a^2 + b^2 = 1, \text{ unity}$$

And the general versor expression is given as,

$$(70) \quad \gamma = a + jb, \text{ versor}$$

Taking equation (66) as

$$(66a) \quad P = \sqrt{P_a^2 - P_b^2}, \text{ watt}$$

As the condition of a hyperbolic function gives the relation

$$(71) \quad a^2 - b^2 = 1, \text{ unity}$$

And the general versor expression is given as

$$(72) \quad \gamma = a + hb, \text{ versor}$$

It can be seen that each quadrant is in itself another four quadrant relation. One relation is compounded with another. The versors are inordinately complex, back to the J. S. Bach. These relations given are found in "The POWER of Music, Alexander's Feast", by G.F. Handel, The Final Choral Movement. Consider this required listening.

FIG 8
1

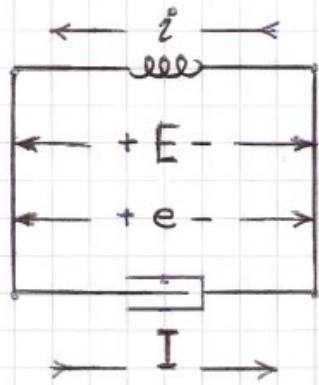

MAGNETIC DISCHARGE
CONSTANT CURRENT

$$-P_m = (+E) (-i)$$

$$+P_d = (+I) (+e)$$

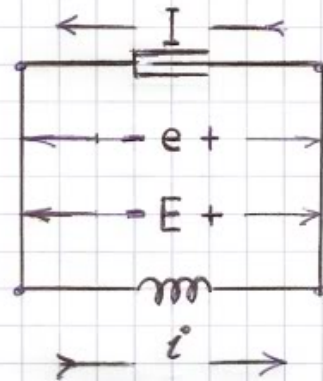

DIELECTRIC DISCHARGE
CONSTANT POTENTIAL

$$-P_d = (+I) (-e)$$

$$+P_m = (-E) (-i)$$

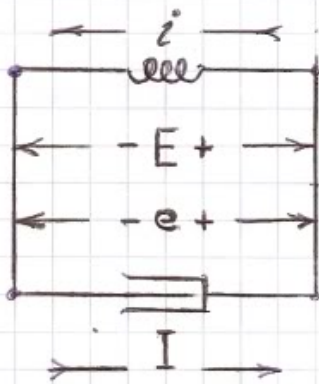

MAGNETIC CHARGE
CONSTANT CURRENT

$$+P_m = (-E) (-i)$$

$$-P_d = (+I) (+e)$$

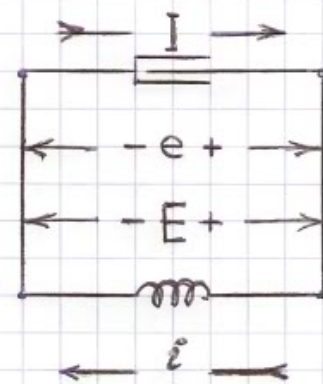

DIELECTRIC CHARGE
CONSTANT POTENTIAL

$$+P_d = (-I) (-e)$$

$$-P_m = (-E) (+i)$$

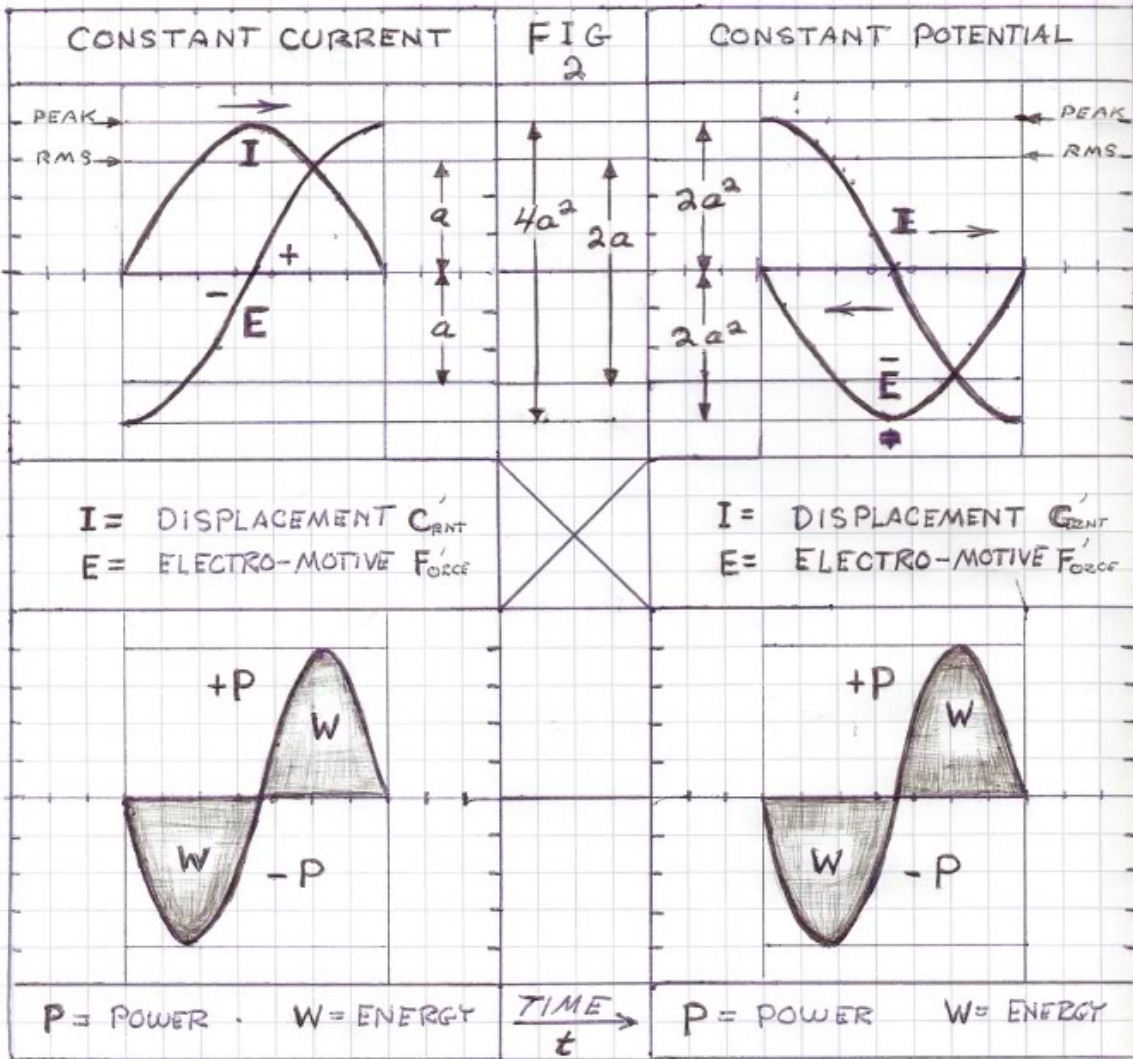

OSCILLATING
ENERGY
EXCHANGE

FIG 3

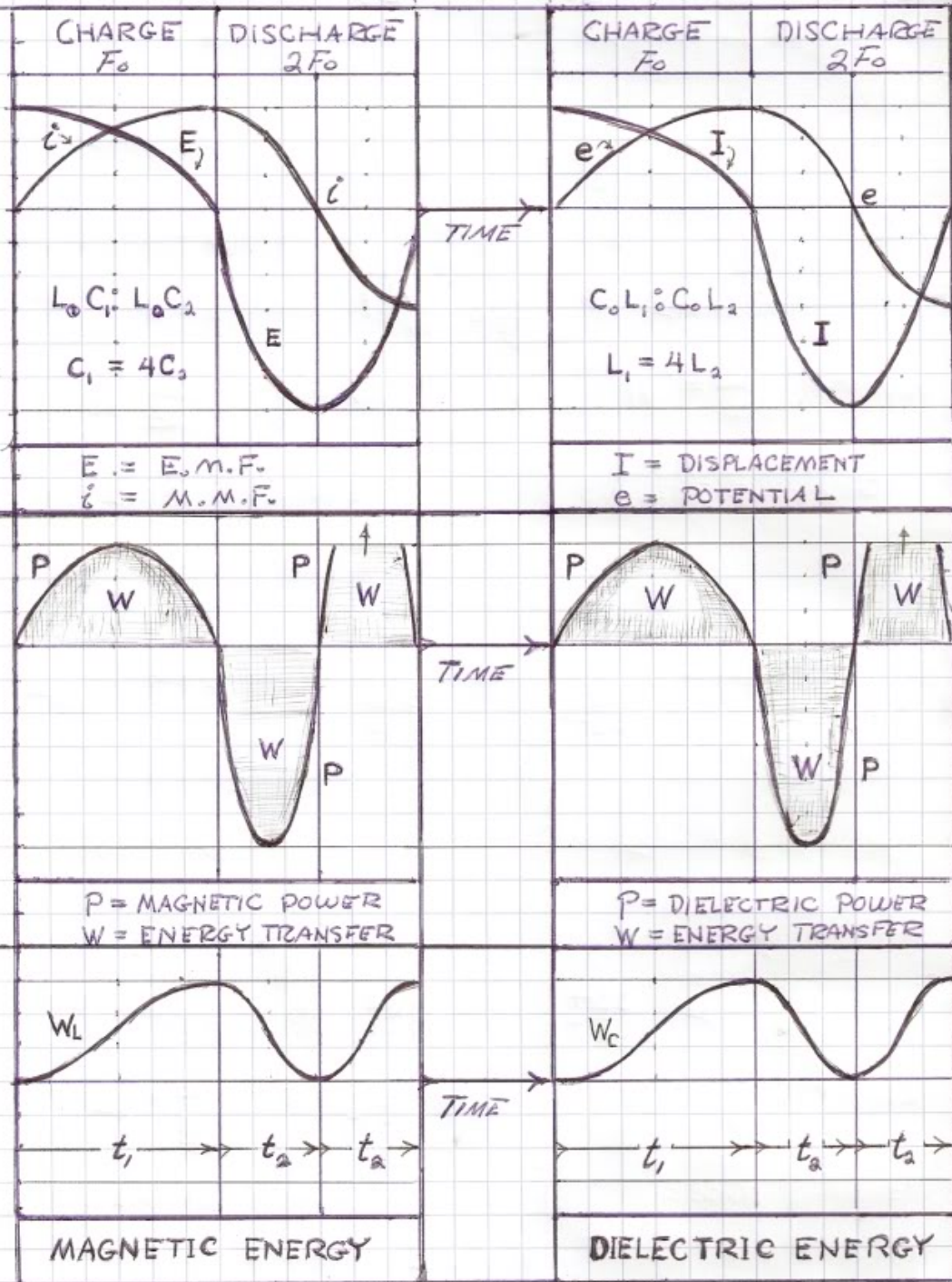

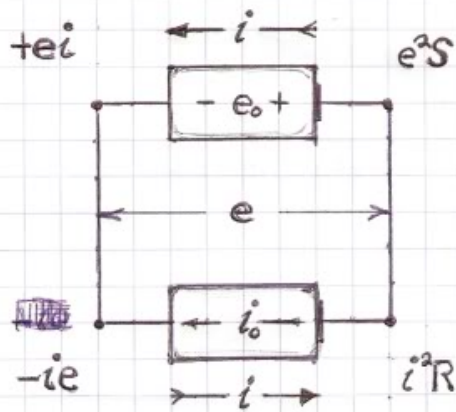

$$G_o^a = \frac{S}{R}, \quad \gamma^a = RS$$

POTENTIAL DISCHARGE

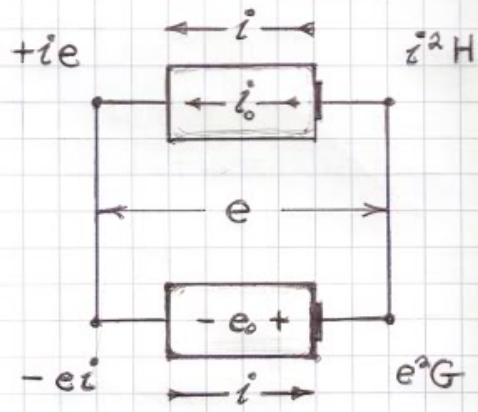

$$R_o^a = \frac{H}{G}, \quad \gamma^a = HG$$

CURRENT DISCHARGE

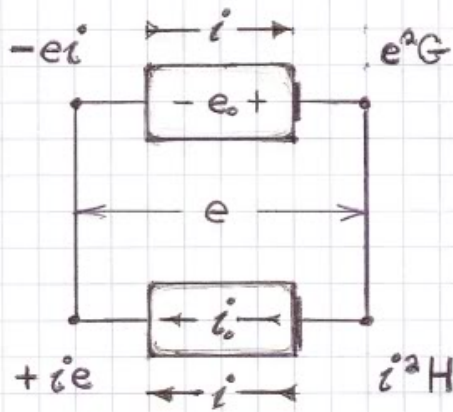

$$G_o^a = \frac{G}{H}, \quad \gamma^a = HG$$

POTENTIAL CHARGE

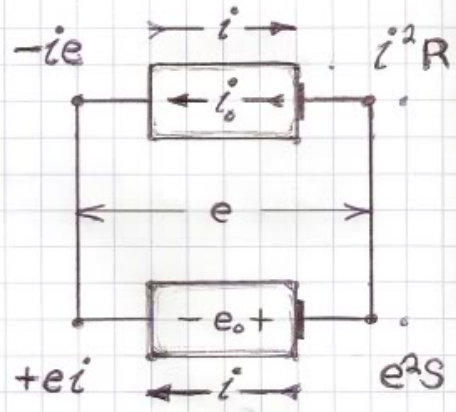

$$R_o^a = \frac{R}{S}, \quad \gamma^a = RS$$

CURRENT CHARGE

FIG. 4

Appendix #3

Quadrapolar Resonant Circuit

QUADRIPOLAR RESONANT CIRCUIT

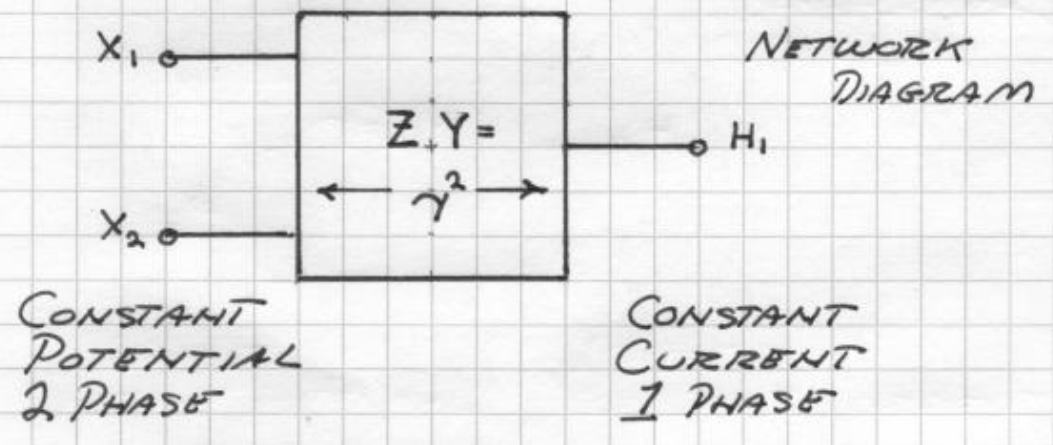
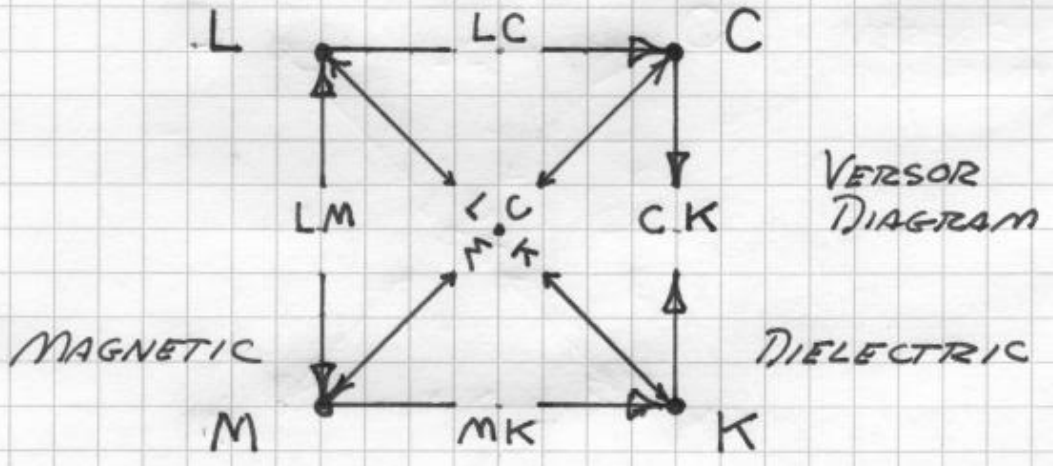
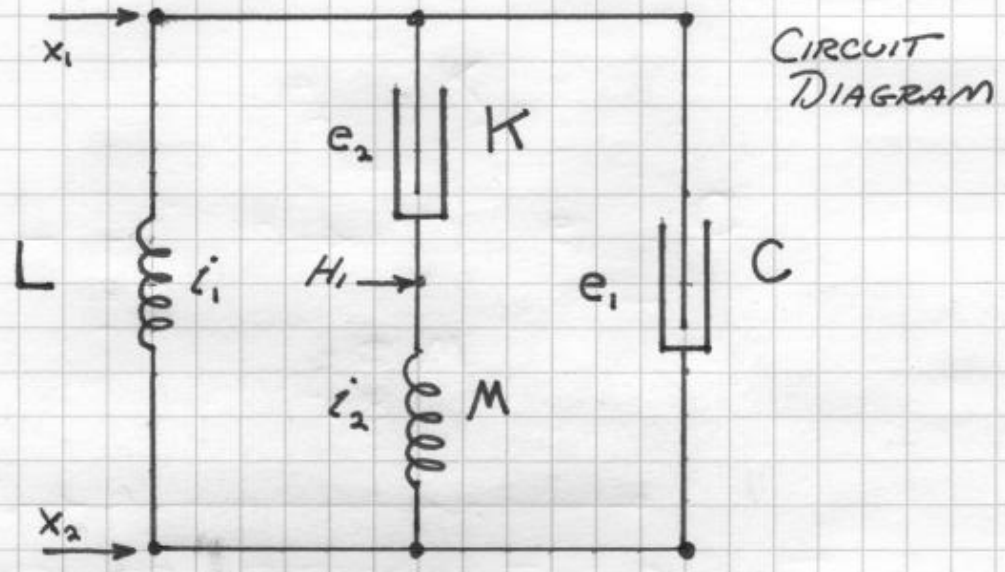

$$i_1^2 L = i_2^2 M^{-1} = e_1^2 C = e_2^2 K^{-1}$$

$$\omega_1^2 = \omega_2^2, \quad P_1 = P_2$$

THE FUNDAMENTAL RELATIONS FOR QUADRAPOLAR RESONANCE

SHUNT ADMITTANCE

$$Y_1 = \frac{i_1}{e_1} : Y_1 = \sqrt{\frac{C}{L}}$$

SIEMENS

SERIES IMPEDANCE

$$Z_1 = \frac{e_2}{i_2} : Z_1 = \sqrt{\frac{K}{M}}$$

OHM

TRANSFER ADMITTANCE

$$Y_0 = \frac{i_2}{e_1} : Y_0 = \sqrt{MC}$$

SIEMENS

TRANSFER IMPEDANCE

$$Z_0 = \frac{e_2}{i_1} : Z_0 = \sqrt{LK}$$

OHM

SHUNT FREQUENCY

$$\omega_1^{-1} = \sqrt{LC}$$

SECOND PER RADIAN

SERIES FREQUENCY

$$\omega_2^{+1} = \sqrt{MK}$$

RADIAN PER SECOND

TRANSFER FREQUENCY

$$N_0^{-1} = \sqrt{\frac{C}{M}}$$

SECOND PER RADIAN

TRANSFER FREQUENCY

$$N_0^{+1} = \sqrt{\frac{K}{L}}$$

RADIAN PER SECOND

MAGNETIC AND DIELECTRIC RELATIONS

$$\omega_s^{-2} = L_s C_s$$

<p style="text-align: center;">MAGNETIC PROPORTION</p> $\alpha_m = \sqrt{LM}$ <p style="text-align: center;">NUMERIC</p>	<p style="text-align: center;">DIELECTRIC PROPORTION</p> $\alpha_d = \sqrt{CK}$ <p style="text-align: center;">NUMERIC</p>
<p style="text-align: center;">NATURAL INDUCTANCE</p> $L_s = \sqrt{\frac{L}{M}}$ <p style="text-align: center;">HENRY</p>	<p style="text-align: center;">NATURAL CAPACITANCE</p> $C_s = \sqrt{\frac{C}{K}}$ <p style="text-align: center;">FARAD</p>

$\omega_1^2 = \omega_2^2$	$(LC)^{-1} = (MK)$
$LCMK = P_1 = P_2$	$(MC)^{-1} = (LK) = 1$
$\frac{\alpha_m}{\alpha_d} = 1$	$(CK)^{-1} = (LM)$

THE CONDITION OF QUADRAPOLAR RESONANCE