

QC
171
S45++
v. 2

CORNELL
UNIVERSITY
LIBRARY





Cornell University
Library

The original of this book is in
the Cornell University Library.

There are no known copyright restrictions in
the United States on the use of the text.

<http://www.archive.org/details/cu31924012325399>

ELECTRODYNAMIC WAVE-THEORY OF PHYSICAL FORCES

VOLUME II

NEW THEORY OF THE AETHER

Definitely establishing

The Cause of Universal Gravitation, Magnetism, Electrodynamical Action, Molecular, Atomic and Explosive Forces, etc., including a notable improvement in the Foundations of the Wave-Theory of Light, and discovery of the Cause of Acoustic Attraction and Repulsion, which is especially suitable for illustrating the invisible Processes of Gravitational Attraction.

In Seven Mathematical Memoirs Reprinted from the *Astronomische Nachrichten*, 1920—1922; to which are added two Mathematical Memoirs on the Earth, and one on the Sun and Variable Stars.

By

T. J. J. SEE,

A. M., Lt. M., Sc. M. (Missou.); A. M., Ph. D. (Berol.);

Professor of Mathematics, U. S. Navy, Formerly in Charge of the 26-Inch Equatorial Telescope of the U. S. Naval Observatory, Washington, D. C., More Recently in Charge of the U. S. Naval Observatory, Mare Island, California.

Ὁ Θεὸς ἀεὶ γεωμετρεῖ — Plato.

1922.

Astronomische Nachrichten, Kiel.

I. Hermann, Paris. Thos. P. Nichols & Son Co., Lynn, Mass., U. S. A.
Wheldon & Wesley, London.

GC

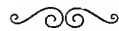
174

S457t
v.2

~~A525863~~

D.E

DEDICATED
TO MY BELOVED WIFE
FRANCES GRAVES SEE
WHOSE STEADFAST SUPPORT
MADE POSSIBLE THE COMPLETION
AND SUITABLE PUBLICATION
OF THESE DISCOVERIES IN THE
NEW THEORY OF THE AETHER.



Ἔτι τοίνυν, ἔφη, πάμμεγά τι εἶναι αὐτό, καὶ ἡμᾶς οἰκεῖν τοὺς μέγροι Ἡρακλείων στηλῶν ἀπὸ Φάσιδος ἐν μικρῷ τινὶ μορίῳ, ὥς περ περὶ τέλμα μύρμηκας ἢ βατραχούς, περὶ τὴν θάλατταν οἰκοῦντας, καὶ ἄλλους ἄλλοθι πολλοὺς ἐν πολλοῖσι τοιούτοις τόποις οἰκεῖν. εἶναι γὰρ πανταχῇ περὶ τὴν γῆν πολλὰ κοῖλα καὶ παντοδαπὰ καὶ τὰς ἰδέας καὶ τὰ μεγέθη, εἰς ἃ ξυνερόνηκται τό τε ὕδωρ καὶ τὴν ὀμίχλην καὶ τὸν ἀέρα. αὐτὴν δὲ τὴν γῆν καθαρὰν ἐν καθαρῷ κεῖσθαι τῷ οὐρανῷ, ἐν ᾧ περ ἔστι τὰ ἄστρα, ὃν δὴ αἰθέρα ὀνομάζειν τοὺς πολλοὺς τῶν περὶ τὰ τοιαῦτα εἰωθότων λέγειν. οὐδὲν ὑποστάθμηται ταῦτα εἶναι καὶ ξυρόειν ἀεὶ εἰς τὰ κοῖλα τῆς γῆς.

Πλατῶν, Φαίδων, 109.

I believe that the earth is very vast, and that we who dwell in the region extending from the river Phasis to the Pillars of Heracles inhabit a small portion only about the sea, like ants or frogs about a marsh, and that there are other inhabitants of many other like places; for everywhere on the face of the earth there are hollows of various forms, and sizes, into which the water and the mist and the lower air collect. But the true earth is pure and situated in the pure heaven — there are the stars also; and it is the heaven which is commonly spoken of by us as the Aether, and of which our own earth is the sediment gathering in the hollows beneath. — Plato, Phaedo, 109.

Introduction.

During the past six years several of the most venerable Scientific Societies in Europe have been considerably occupied with the Theory of Relativity, — without, however, taking the usual philosophic precaution to inquire whether such a theory is at all necessary to our understanding of the Physical Universe. The introduction of unnecessary complications into our processes of Scientific Thought always has been viewed as an evil, great in proportion as it is indefensible.

Thus in his Rules of Philosophy (Principia, Lib. III) *Newton* lays down the following as the First Rule:

„We are to admit no more causes of natural things than such as are both true and sufficient to explain their appearances“.

„To this purpose the philosophers say that Nature does nothing in vain, and more is in vain when less will serve; for Nature is pleased with simplicity, and affects not the pomp of superfluous causes“.

Accordingly, whilst many investigators were debating the mystical Theory of Relativity, — with Four-dimensional Time-Space manifolds, Geodetic Curves, the Curvature of Space, and similar devices for adding hopeless complexity to our geometrical and physical conceptions, — I took refuge in *Newton's* rule of maximum simplicity, and developed the New Kinetic Theory of the Aether, which showed that the Theory of Relativity is entirely devoid of physical foundation.

In fact, early in the year 1914, I entered upon the development of The Electrodynamical Wave-Theory of Physical Forces, in the hope of illuminating the unsolved problem of the Cause of Universal Gravitation. Now that eight years have elapsed, and the memoirs of these two volumes are published, it may interest the reader to learn that in November, 1914, when the present researches were still in a primitive stage, I sent the first outline of them to the Royal Society, — in the belief that any definite light on the Cause of Universal Gravitation, which Sir *Isaac Newton* had not been able to obtain, ought first to be communicated to that illustrious Society.

At that time, however, the War was very disturbing to European investigators. And if my preliminary Paper was studied attentively by the Referees of the Royal Society, it is probable that they did not understand it, — possibly because several of the leading physicists in England already were proposing to do away with the Aether. Yet, whatever cause operated to obscure the start which had been made, it is a fact that fifteen months elapsed before any report from the Royal Society was made to me (May, 1916). Meanwhile my researches had been renewed and much extended, and in due time were published under the title: *Electrodynamical Wave-Theory of Physical Forces*, vol. I, Quarto, 171 pages, Boston, London, Paris, 1917.

This was, however, only the first part of the New Theory of Physical Forces, and the subject therefore has been extended and greatly improved during the past four years. These later discoveries in the Kinetic Theory of the Aether, which the Editor of the *Astron. Nachrichten* has done me the honor to publish in that celebrated Journal, 1920-22, already are widely known to the Scientific Public.

Perhaps it may not be inappropriate to point out also the failure of the Royal Astronomical Society and several more of the oldest Scientific Societies in Europe. Sagacious observers have regretfully remarked how they have wasted both time and precious resources in fruitless speculations on the mysticism of the Theory of Relativity, with no other result than to confuse the public mind.

In view of the definite results here brought forth, the student of sound Physical Science may find it interesting to contrast the barren discussion of the abandoned Theory of Relativity — based on the inadmissible *Gerber* formula, equation (1) below, now clearly shown to violate the Conservation of Energy, — with the Kinetic Theory of the Aether, which has led to the Cause of Universal Gravitation, and the Wave-Theory of the various Physical Forces.

Thus it occurs to me that it would be a convenience to many investigators if these Memoirs were collected into a volume. Accordingly, with the kind permission of the learned Editor, Professor Dr. *H. Kobold*, I am enabled to offer to investigators the Second Volume of the Electrodynamical Wave-Theory of Physical Forces, 1922.

Although these Memoirs have been published serially only a short time, it appears that they have awakened no ordinary interest among investigators who are inclined to examine the Physical Causes underlying the Phenomena of Nature. Until this fundamental work is carried much further than has yet been done, we shall not be able to make satisfactory progress in dealing with even the simpler natural phenomena.

And as for the more intricate phenomena, the methods of research heretofore in use, — based so largely on undiscerning if not blind empiricism, thus utterly ignoring the physical properties which Transcendental Physics always was capable of correctly assigning to the Aether as a Monatomic Gas 689321600000 more elastic than Air in proportion to its density, — were of course hopelessly inadequate. The first prerequisite of progress was therefore a valid Kinetic Theory of the Aether, deduced directly from observed phenomena, and thus capable of furnishing a secure foundation for the Science of Dynamics.

The strange proposal recently made in certain quarters to do away with the Aether, is of course inadmissible and indefensible, because the elementary principles of Mechanics show us that there must be a Medium pulling towards the Sun, to overcome the centrifugal force of a planet's orbital motion, with Tension equivalent to the breaking strength of millions of immense cables of the strongest steel. Such an unauthorized proposal merely illustrates the need of profounder researches into the foundations of Natural Philosophy. The physical necessity for the Medium was so fully recognized by *Newton* and by *Maxwell* that to the competent investigator it requires no defense.

In his letter to *Bentley*, Febr. 25, 1692-93, Sir *Isaac Newton* remarks: „That gravity should be innate, inherent and essential to matter, so that one body may act upon another at a distance through a vacuum, without the mediation of anything else, by and through which their action and force may be conveyed from one to another, is to me so great an absurdity, that I believe no man who has in philosophical matters a competent faculty of thinking can ever fall into it. Gravity must be caused by an agent acting constantly according to certain laws; but whether this agent be material or immaterial, I have left to the consideration of my readers.“ In *Newton's* discussion the Aether evidently is taken to be immaterial, which conforms to modern views in Physical Science.

In his Account of Sir *Isaac Newton's* Philosophical Discoveries, London, 1748, p. III, *Maclaurin* says:

„He (*Newton*) has plainly signified that he thought that those powers (of Gravitation) arose from the impulses of a subtile Aetherial Medium that is diffused over the Universe, and penetrates the pores of grosser bodies. It appears from his letters to Mr. *Boyle* that this was his opinion early; and if he did not publish it sooner, it proceeded from hence only, that he found he was not able, from experiment and observation, to give a satisfactory account of this medium and the manner of its operation in producing the chief phenomena of Nature.“

What Sir *Isaac Newton* ascribed to the Impulses of a subtile aetherial medium, we now define as Waves; and in the New Theory of the Aether, we make known the manner of the operation of these wave-impulses in producing the chief phenomena of Nature. The leading objection to the Theory of Gravitation, in *Newton's* time, — that it introduced into philosophy occult qualities, — no longer will hold in our day, because wave-impulses in the Aether are universally recognized by modern Physical Science.

In the Preface to the Second Edition of *Newton's Principia*, 1713, his celebrated pupil *Coates* combats the reasoning of that time as follows:

„But shall gravity therefore be called an occult Cause, and thrown out of philosophy, because the Cause of Gravity is occult and not yet discovered?“ . . . „Some there are who say that gravity is praeternatural, and call it a perpetual miracle. Therefore they would have it rejected, because praeternatural causes have no place in Physics.“

In view of such reasoning, we can well understand the statement of *Voltaire*, that although the great *Newton* outlived the publication of the *Principia* by more than forty years, yet at the end of that time he had not over twenty followers outside of England. Indeed, since *Newton* had clearly shown the nature of the planetary forces, and the laws they obey, and the beautiful Science of Celestial Mechanics was thus developed for two centuries — only to be contradicted recently, by the strange claim that „Gravity is not a force, but a property of Space“ (*De Sitter*, Monthly Notices, Oct. 1916, p. 702) — we may more justly regard it as a miracle that any progress can be made and sustained in Physical Science as recently cultivated.

The difficulty of making progress would be much less than it is, but for the state of confusion which has arisen in Physics from certain mystical speculations, now at length recognized to be both vague and chimerical. For example, there can be no defense for a Theory based on *Gerber's* formula for the Potential (*Zeitschrift für Mathematische Physik*, Band XLIII, 1898, p. 93-104),

$$V = \frac{k^2 m m'}{r \left(1 - \frac{1}{c} \frac{dr}{dt}\right)^2} = \frac{k^2 m m'}{r} \left\{ 1 + \frac{2}{c} \frac{dr}{dt} + \frac{3}{c^2} \left(\frac{dr}{dt}\right)^2 + \dots \right\} \quad (1)$$

which contradicts the great principle of the Conservation of Energy. For this formula differs from the Potential of *Weber's* Law, long ago shown by *Maxwell* to be valid and conformable to the Conservation of Energy (cf. *Maxwell's Treatise on Electricity and Magnetism*, section 856). This *Weber* Potential is:

$$V = \frac{k^2 m m'}{r} \left\{ 1 - \frac{1}{c^2} \left(\frac{dr}{dt}\right)^2 \right\} \quad (2)$$

and therefore essentially different from the *Gerber* formula. Accordingly, since it conforms to the Conservation of Energy, the *Weber* Potential alone is admissible in a valid physical theory of the Universe. Incidentally it may be noted that the *Weber* Potential corresponds to a wave-field, and thus points to the Electrodynamic Wave-Theory of Physical Forces.

Recently the writer was asked by an astronomer how he came to take up the New Theory of the Aether. The answer was that such hopeless confusion existed in this vital subject that a valid clearing up of the foundations was necessary to our progress; and as others had not been able to carry it out, the labor finally was devolved upon the present author. It will therefore be allowable to trace a few features of this progress which appear to me somewhat remarkable.

In view of the many researches heretofore carried out in the theory of wave-motion, it will always seem very extraordinary that earlier investigators were not led to the simple relationship between the mean velocity (\bar{v}) of the Corpuscle of a Monatomic Gas and the Velocity (V) of a wave in the Gas, namely (cf. AN 5079, p. 234):

$$\bar{v} = \frac{1}{2} \pi V. \quad (3)$$

Yet in reaching this Theorem it was not sufficient merely to notice the geometrical ratio theoretically existing between the paths of oscillating particles describing a semi-circumference while the wave traverses the diameter, which is $\frac{1}{2} \pi$: on the contrary, it was deemed necessary, as a physical precaution, to confirm the ratio from the best experimental data of six actual gases, with the following results:

Gas	Mean Molecular velocity \bar{v}	Observed velocity of Sound in Gas at 0° C.	Ratio \bar{v}/V without correction	Correction factor $\sqrt{k_1/k_2}$	Corrected ratio $\bar{v}/V \cdot \sqrt{k_1/k_2}$ corresponding to Monatomic Gas
Air	459.0 m	332.0 m	1.38	1.09	1.51
Hydrogen	1694.0	1265.0	1.34	1.09	1.46
Oxygen	461.0	316.2	1.46	1.09	1.58
CO	493.0	337.1	1.46	1.09	1.59
CO ₂	393.0	359.4	1.51	1.13	1.71
NO ₂	393.0	281.1	1.40	1.13	1.58
					$\bar{v} = 1.57V$ $= \frac{1}{2}\pi V.$

From this table it follows that for the six best determined actual gases, the theorem $\bar{v} = \frac{1}{2}\pi V$ holds true; and on treating the Aether as a Monatomic Gas, we find the velocity of the Aetherons to be 471239 kms per second, or 294000 miles. The Aetheron therefore is the most rapidly moving object in the Universe, the mean velocity being 23.5 times the maximum velocity of the Electron, according to *Crowther*, 1914. Accordingly whatever be the importance of the Electron in physical theory and experimentation that of the Aetheron is enormously greater and will always so remain so long as Wave-Motion is studied.

Among the many wonders brought to light in the New Theory of the Aether, nothing is more wonderful than the historical fact that previous investigators, with the exception of *Newton*, should have regarded the Aether as homogeneous! Thus in the Baltimore Lectures, 1904, p. 265, under date Nov. 16, 1899, Lord *Kelvin* says: „We have strong reason to believe the density of Ether is constant throughout interplanetary and interstellar space“.

If this were so, it is inconceivable that there could be gigantic forces at work for governing the motions of the stars and planets. The forces which curve the Earth's orbit are equivalent to the breaking strength of an 11-inch cable of 30-ton steel (to the square inch) on each square foot of a hemispherical cross section of the globe; so that the bending of the Earth's path into an elliptical orbit requires that this globe be almost covered with such mighty cables of steel strained to the utmost limit of their tensile strength. Such stupendous stresses across space are sustained by the elastic body of the Aether; and in the Sixth Paper we see how the equipotential surfaces about two equal stars are visibly distorted by this tremendous tension between them, with corresponding increase of pressure beyond them. Our solution of this problem therefore is as simple as it is illuminating.

In 1842, when the French Chamber of Deputies was on the point of publishing a complete set of the works of *Laplace*, *Arago* prepared a Biography of this great geometer, in which he says:

„Those persons form a very imperfect estimate of the meaning of one of the greatest questions which has occupied the attention of modern inquirers, who regard *Newton* as having issued victorious from a struggle in which his two immortal predecessors had failed. *Newton* did not discover the cause of gravity any more than *Galileo* did. Two bodies placed in juxtaposition approach each other. *Newton* does not inquire into the nature of the force which produces this effect.“

„The applause of the scientific world did not prevent the immortal author of the *Principia* from hearing some persons refer the principle of gravitation to the class of occult qualities. This circumstance induced *Newton* and his most devoted followers to abandon the reserve which they had hitherto considered it their duty to maintain. Those persons were then charged with ignorance who regarded attraction as an essential property of matter, as the mysterious indication of a sort of charm; who supposed that two bodies may act upon each other without the intervention of a third body. This force was then either the result of the tendency of an ethereal fluid to move from the free regions of space, where its density is a maximum, towards the planetary bodies, around which

there exists a greater degree of rarefaction, or the consequence of the impulsive force of some fluid medium."

This is a good summary of *Newton's* conception that the Aether is heterogeneous, which we now establish by definite mathematical and physical demonstration, (AN 5044), showing that in tri-dimensional space waves propagated or reflected from the particles of matter necessarily produce such outward increase of density, $\sigma = \nu r$, owing to the law of Amplitude $A = k/r$, with the central force $f = k^2/r^2$.

Accordingly, the Potential of Gravitation (*Oeuvres Complètes de Laplace*, Tome X, p. 348)

$$V = \iiint \frac{\sigma \, dx \, dy \, dz}{\sqrt{(x-x')^2 + (y-y')^2 + (z-z')^2}} = \iiint \frac{\sigma \, dx \, dy \, dz}{r} \quad (4)$$

varies as the reciprocal of the Aether Density, as centrally thinned out by wave-action. The Potential is thus shown to be an accumulated state of stress incident to the triple integration for the superposed Wave-Amplitudes of the various Atoms, $A_i = k_i/r_i$.

Comformably to *Newton's* impression, *Arago* points out that the Aether tends to move towards the planetary bodies, yet under the increased amplitudes of the receding waves encountered towards these centres, it is so churned up or thinned out, that it does not really move — only exerts a steady stress in that direction, thus yielding an energy flux or gravitative force proportional to the energy of the vibrating Aetherons and therefore proportional to the square of the Amplitude $A^2 = k^2/r^2$. The only way to decrease this central stress is to remove the matter of the planet on which the waves depend, — the motion of the Aetherons in Collision with the Atoms in some way generating the receding waves, or renewing them from the incoming waves already existing and incessantly propagated from the other bodies of the Universe. The infinitude of vibrating Atoms in each of an infinite system of bodies renders the wave-field infinitely complex; but from any one planetary mass, the receding waves pursue paths of Least Action, and the state of the central gravitative stress therefore is perpetual.

It will always appear wonderful to investigators that the brilliant *Maxwell* should have made the unaccountable slip of imagining Gravitation due to a pressure in the direction of the force, and an equal tension at right angles thereto (cf. AN 5048, p. 163-164). It appears that prior to the publication of these Papers, English physicists never questioned *Maxwell's* erroneous assumption; and thus they handed down his errors for half a century, when the truth of the matter could have been noticed and verified by any good student of Mechanics. For *Maxwell's* postulated stresses were dynamically impossible; and although the learned Professor *Minchin* of Oxford, in 1886, found that they would not explain Gravitation, he did not suspect the error underlying them, nor remove it.

The learned Editors of *Maxwell's* Scientific Papers, in the two imposing volumes published by the University of Cambridge, 1890, equally failed to notice what was required to balance the centrifugal force, — as simply and clearly explained by *Huyghens* and *Newton* over two centuries before. The mischief thus done came in time to be spread over the entire world, and vividly illustrates the perversion of thought which may arise from the slip of a great authority. The slowness of our progress under these circumstances is less remarkable than it might seem at first sight.

Looking to the future, for valid and simple conceptions of the Cause underlying Gravitation, we consider the new explanation of Acoustic Attraction (AN 5130, p. 342) to be especially suitable for disclosing vividly the unseen wave-processes operating from star to star, in straight line minimum paths, throughout the immensity of the heavens. This wave-field of Gravitation is dealt with more fully in the Sixth Paper, and fully illustrated by plates admitting of one interpretation and only one. Thus we establish the Cause of Universal Gravitation by necessary and sufficient conditions. The proof therefore is absolute and always will remain incontestable (AN 5140, p. 95-127).

It appears that the discovery of the Cause of Gravitation now rests on six classes of phenomena:

1. The Fluctuations of the Moon's Mean Motion, Dec. 10, 1916, (cf. AN 5048, p. 159).
2. The New and Direct explanation of Acoustic Attraction, in which the wave-process is rendered visible to the eye, 1916, (AN 5130, p. 341-42, AN 5140, p. 98-100, plate 7).

3. The Proof of the Cause of the Distortion of the Equipotential Surfaces, about two equal Stars, 1917, at length somewhat more fully developed in the Sixth Paper, 1921, (AN 5140, p. 95-127).

4. *Majorana's* Physical Experiments on the Absorption of Gravitational Wave-Action by a layer of Mercury, 1919, (cf. *Philosophical Magazine* for May, 1920, also AN 5079, p. 301-302).

5. The experiments by Dr. *Chas. F. Brush* of Cleveland, Ohio, (*Proc. Am. Philos. Society*, Philadelphia, vol. LX, no. 2, Jan. 1922) showing that under conditions otherwise identical the Earth's attraction exerts a different grip on pendulums of different metals — a Bismuth pendulum gaining rapidly on one of Zinc. In discussing the Kinetic Theory of Gravitation Dr. *Brush* adopts the view that the energy of the Aether is in wave-form, in other words, the Wave-Theory.

6. It has long been recognized that Earth Currents, Aurorae, etc., recur periodically with certain Solar disturbances. The writer has now (Sept., 1921) obtained a new and direct proof that Aether waves upwards of 2400 meters in length are continually received upon the Earth from commotions in the Sun. These are long enough to pass through the solid body of the Earth with but slight refraction, dispersion and absorption. And as wireless waves of corresponding length are bent around the globe by the resistance of this solid body, (cf. AN 5044, p. 71), we thus have observational proof that Gravitational waves, such as are modified by our globe to produce the Fluctuation of the Moon's motion, do really exist, and can be experimentally studied in Radio-telegraphy.

Accordingly our present proof that the Cause of Gravitation is to be found in Wave-Action is most ample: and we may safely predict that further investigation will only confirm the results indicated by the sextuple proof above cited.

The Wave-Theory of Magnetism outlined in the Third Paper is treated with greater rigor in the Seventh Paper. The Harmonic Law there developed definitely connects the Magnetism of the Earth with Universal Gravitation. Extending *Gauss'* method for calculating the amount of Magnetism in the Earth, we compute the amount of Magnetism in the Sun! It appears that Magnetic Action is conveyed not in right lines, like Gravitation, but along the Curved Lines of Magnetic Force; and thus the new Law of Nature very appropriately becomes a geometric tribute to the memory of the great mathematician *Gauss!*

In the Fourth Paper, AN 5085, will be found the Correction of a fundamental difficulty in the Wave-Theory of Light which has stood for a full century. *Poisson's* Geometrical Theory of the nature of the vibrations in the Aether is fully confirmed, and harmonized with the most refined optical phenomena. The longitudinal component in Light is shown to be utterly insensible to observation, $\lambda = 1 : (66420 \cdot 10^6)$, (cf. AN 5085, p. 427-428, footnote). The removal of this longstanding difficulty in the Wave-Theory of Light, and its harmonization with the Theory of Sound, as *Poisson* always held should be possible, is a triumph of no ordinary character.

Attention should be called to the simple explanation of the *Michelson-Morley* experiment of 1887, by means of the Kinetic Theory of the Aether, (AN 5048, p. 181-183). No change is required in the dimensions of moving bodies, and such assumptions as *Fitzgerald's* Hypothesis are shown to be unauthorized. As the Aetherons move with the velocity of 471000 kms the state of the wave-field is instantly adjusted to any state of steady motion; and thus there is no such thing as the Earth moving through the Aether. At all times the Earth carries its wave-field with it, adjusted to perfect Kinetic equilibrium; and thus the *Michelson* experiment is perfectly explained, without any Theory of Relativity whatever. The outstanding motion of Mercury's perihelion is explained by an absorption of wave-energy, like that noticed in *Majorana's* experiments, and harmonizing still better since *Grossmann* has shown, (AN 5115), that the outstanding motion is less than 43", between 29" and 38" per century, with 14.5 still to be deduced for the propagation in time, according to *Weber's* Law (cf. AN 5048, p. 137).

Accordingly, in the Second Paper, (AN 5048), we show that the whole Theory of Relativity is a foundation laid in Quicksand. A discerning investigator who has studied this new aspect of the Kinetic Theory of the Aether, with the resulting abandonment of the Theory of Relativity, could now say with *Laplace*, in dealing with another matter: „I have no use for this Hypothesis“.

In removing the mystery of the *Michelson-Morley* experiment, without the hypothesis of the Earth moving through the Aether, and therefore without Relativity, we solve at the same stroke of the pen the historical difficulty of the Aberration. The solution of the difficulty of the Aberration is simply the parallelogram of motions, and thus as clear as any theorem in Geometry (cf. AN 5048, p. 183).

The problem of the density of the Aether is found to be capable of direct and simple solution by the following process. It is fully established by precise Laboratory experiments that Hydrogen propagates Sound four times faster than Oxygen, which is a gas 16 times denser. The Cause of the rapid velocity of Sound in Hydrogen is therefore the lightness and high molecular velocity of the molecules of that gas.

Now the Aether propagates wave motion 217839 times faster than Hydrogen, when the latter is corrected for a Monatomic constitution. Therefore Hydrogen is $(217839)^2$ times denser than Aether, or the Aether has $1:47453880000$ of the density of Hydrogen, making the Aether's absolute density $1888.15 \cdot 10^{-18}$ (cf. AN 5079, p. 236).

The argument here developed from exact experimental data in the Theory of Sound thus settles the question, without raising any other perplexing problem. For just as the four times slower propagation of wave motion in Oxygen, compared to Hydrogen, indicates that the Oxygen is 16 times heavier; so also the Hydrogen must be held to be $(217839)^2$ denser than Aether, which propagates waves 217839 times faster.

In view of the simplicity of this reasoning, it is strange that the Aether should have been spoken of by certain electronists as 2000 million times denser than lead! No such result is authorized by the laws of experimental Physics; and all such inference is as mischievous as it is contrary to our Common Sense.

Out of this New Theory of the Aether, in which each body carries with it a wave-field, requiring adjustment every time the velocity changes, has grown a new theory of Inertia, Momentum etc. The adjustment of the wave-field is treated of briefly at the end of the Third Paper, (AN 5079, p. 299); and as it explains Inertia, Momentum, etc., it is especially worthy of the attention of natural philosophers.

In the Fifth and Sixth Papers we have dealt with Molecular and Atomic Forces. These Forces are traced to short waves in the Aether, by an argument from the theory of Physical Continuity which will be found difficult to evade. If wave-action be the Cause of one of these forces, it will also be found to be the active agency in the others. Thus we have been able to throw much light on the secret of Capillarity and of Vital Forces, and have worked out the source of the awful power noticed in Explosive Forces, and in the mysterious forces of Chemical Affinity and of Cohesion which bind together the Molecules of an Elastic Solid. This view is strikingly confirmed in a recent development of the New Theory of the Aether, 2nd Postscript to the Sixth Paper, and is so notable that I forbear to enter into elaborate comment.

But we may point out that the Sextuple Integral defining the Molecular Strength or power of resistance of a solid body to molecular displacement is given the form

$$\Omega = \int^{\alpha} [(r^4 - hr^3 + k) dr + C]_{r_4}^{r_1} \cdot \int d\varepsilon = \left[\frac{r^5}{5} - \frac{hr^4}{4} + kr + C \right]_{r_4}^{r_1} \cdot \varepsilon. \quad (\pi) \dots (5)$$

As the integration is to be extended from r_4 to r_1 , and over the whole of this range the functions are both finite and continuous, we may subdivide the range into parts for the entire region of stability, r_4 to r_1 , thus:

$$\Omega = \left\{ \left[\frac{r^5}{5} - \frac{hr^4}{4} + kr + C \right]_{r_4}^{\alpha} + \left[\right]_{\alpha}^{\beta} + \left[\right]_{\beta}^{\gamma} + \left[\right]_{\gamma}^{\delta} + \dots + \left[\right]_{\nu}^{r_1} \right\} \cdot \varepsilon. \quad (6)$$

Now we see by the accompanying (see p.xii) Fig. a, from the 2nd Postscript to the Sixth Paper that some of these areas are positive, as in the whole region between r_3 and r_1 . These positive areas correspond to the accumulation of attractive forces. When the molecular distances accord with this region, and the oscillations do not carry the particles beyond the range $r_1 - r_2$, the wave action only binds the molecules more solidly together. This is a state of entire stability, as in typical elastic solids such as Stone, Steel, Diamond, etc.

But if the parts of the molecules come into close contact and so oscillate as to range from r_4 to r_1 , repulsive forces begin to assert themselves quite powerfully; yet the stability may be secure, at least until a distance r_5 , smaller than r_4 is approached, — at which the repulsive forces rapidly become infinite.

This region of excessively close contact, r_4-r_5 , is the danger zone, because the repulsive forces increase asymptotically. Thus when the molecule has its parts suddenly rearranged, and they come into such close contact, the stability it dissolved and the reaction gives a wide oscillation beyond r_1 , so that evaporation or an explosion may follow. Such sudden outbursts may occur from waves of Heat, or the waves of an electric current, or when the Atomic Structure of certain molecules is geometrically rearranged, thus breaking down in becoming more compact. The reaction incident to this sudden exertion of repulsive forces yields of course a tendency to a violent explosion — the degree of violence depending on the closeness of the contact in the molecular rearrangement.

As the explosive force increases asymptotically at small distance, we see that the most terrific concentration of power resides in certain atomic and molecular structures. This power comes from the Aether itself, as already explained in paragraph (iii) of Section 5, of the Sixth Paper. Yet the evaluation of the Sextuple Integral for Ω , in the 2nd Postscript, has given us a better grasp of the extreme power of Molecular and Atomic Forces, because we see from the Curves why the integration, giving the explosive action, rapidly becomes infinite.

Viewing the Aethereal Medium in its larger aspects, chiefly as the vehicle for propagation of waves, it appears surprising that heretofore only three authors have investigated the elastic constant:

- | | |
|---|------------------------------|
| 1. <i>Newton</i> , Optics, 1721, p. 326 | $\epsilon = 490000000000$. |
| 2. <i>Sir John Herschel</i> , Familiar Lectures, 1867, p. 282 | $\epsilon = 1148000000000$. |
| 3. <i>See</i> , AN 5044, p. 62 | $\epsilon = 689321600000$. |

In this Elastic Constant of the Aether rests the power of the stresses exerted through this medium in the form of Physical Forces; and the interactions of the waves in traversing the various bodies give them their molecular and other physical properties. *Maxwell* had developed the Theory of the Medium to an enormous extent in electrical and magnetic phenomena; and he even concluded that the forces observed in Nature are due to stresses in the Aether. But owing to his premature death at 48 years of age he had not formulated any modus operandi as to how such stresses could arise in the Medium, nor studied the Elastic Constant of the Aether, $\epsilon = 689321600000$.

Accordingly we have labored to extend and to improve the work of *Newton* and of *Maxwell*, and endeavored to give a working theory of the chief Forces observed in Nature.

In conclusion it only remains to call attention to the two Memoirs on the Earth, and especially the Memoir on the Sun and Variable Stars. This latter investigation is so very remarkable that it can scarcely fail to be of the widest interest. It is not often that one can bring to light the true physical cause of so many great mysteries of three centuries since the age of *Kepler* and *Galileo*!

The author's most grateful acknowledgements are due above all to *Mrs. See*, for the loyal support of an unflinching faith in the outcome of this very extensive investigation; to Professor *Dr. H. Kobold*, for his indefatigable labor and care in supervising the publication, amidst many difficulties; to *Mr. W. S. Trankle*, who has aided so greatly in completing the work, between the numerous engagements of the public service.

Starlight on Loutre, Montgomery City, Missouri, 1922 May 8.

T. J. J. See.

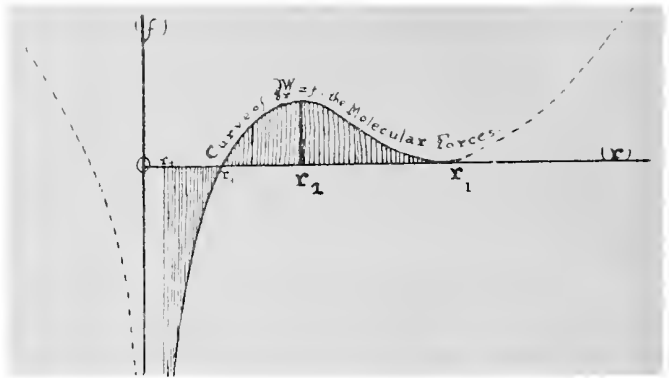


Fig. a. Illustration of the curve of molecular forces $\partial W/\partial r = f$, the unessential parts outside the limits r_1-r_4 being indicated by pointed lines.

New Theory of the Aether. By T. J. J. See.

(First Paper.)

I. The Medium of the Aether is necessary for conveying Physical Action across Space.

A superfine medium associated with the stars and with the light of day, known as the Aether (*Αιθηρ*), has been universally recognized since the time of *Homer* (Iliad, XV.20, and XVI.365). During the last three centuries the greatest natural philosophers and mathematicians, from *Huyghens*, *Newton*, and *Euler* to *Maxwell*, Lord *Kelvin* and *Poincaré*, have regarded this aetherial medium as a necessary condition for the action of physical forces across space. In his *Mécanique Céleste* 4.541, 1896, *Tisserand* expresses the general opinion thus:

»Les théories les plus récentes de la physique donnent lieu de croire que les attractions des corps célestes ne peuvent se transmettre à distance que par l'intermédiaire d'un milieu, sans doute l'éther. Mais on ne connaît rien encore sur ce mode de transmission. Il paraît probable que le même milieu sert de véhicule à des actions électriques ou électromagnétiques«.

Notwithstanding the very secure foundation for a valid theory of the aether erected by the labors of the most eminent geometers and natural philosophers since the age of *Newton*, a strange tendency has arisen within recent years, for abandoning the aether as an unnecessary hypothesis. Whether this reactionary tendency is based upon adequate grasp of the geometrical and physical considerations involved may be doubted by the more experienced natural philosophers of today. At any rate we leave this to the judgement of those investigators who follow the argument here developed.

In their treatise on Magnetism and Electricity, London, 1912, *Brooks* and *Poyser*, who were inspired by the electronic theories emanating from Cambridge, express themselves thus:

»In this book, we have implicitly assumed the existence of a medium, which is the seat of the phenomena denoted by the terms electric and magnetic lines of force. It may, however, be mentioned that at the present moment the various questions associated with the ether give rise to problems of great complexity and difficulty. The experimental knowledge acquired during the last twenty years, taken in conjunction with recently acquired knowledge regarding the electron and the constitution of matter, leads to apparently irreconcilable results, and the real nature of the ether — if it exists at all in the old sense of the word — must be regarded as absolutely unknown. For instance, if the ether is incompressible, as it is usually assumed to be, we are driven, by one line of argument, to the conclusion that it is 2000 million times denser¹⁾ than lead and possesses enormous energy of internal motion. On the other hand, if it is compressible, it may be much rarer than the rarest gas. There

is no intrinsic difficulty in either view, but at present no method is known by which we may hope to discriminate between them. The whole subject of the ether is in that state of uncertainty and apparent confusion, which in other branches of science has usually preceded some great advance in knowledge«.

Such an attitude as the above, by physicists of recognized authoritative connections, is confusing enough; but an even more bewildering doctrine has been put forth by *Einstein*, and quite widely adopted in England, though it generally is rejected in America. The english observers of the total solar eclipse of May 29, 1919, found some evidences of a deflection of the light of stars by the field of the sun, but it was by no means conclusive, and the weakness of the whole Theory of Relativity was impressively pointed out by Dr. *Silberstein*, (Observatory, November 1919, p. 396-7), who showed that *Einstein's* theory will not account for the refinement of moving perihelia, and would even permit a planet or comet to move in a straight line, under the gravitative action of the sun. In view of these facts Dr. *Silberstein* justly says that the *Einstein* theory stands or falls by the *Evershed* and *St John* spectral observations, which are ample, yet do not confirm the theory.

In an interview at Chicago, Dec. 19, 1919, Professor *A. A. Michelson*, the eminent authority on light, openly rejects *Einstein's* theory, because it does away with the idea of light traveling by means of vibrations in the aether which is supposed to fill all space. »*Einstein* thinks there is no such thing as aether«, remarked *Michelson*. »He does not attempt to account for the transmission of light, but holds that the aether should be thrown overboard«

In view of the confusion of thought introduced by the electronists, on the one hand, and by the *Einstein* pure mathematicians, on the other, — both extremes leading to ideas not appropriate to the facts, which Dr. *Whewell*, History of the Inductive Sciences, 1847, I.81, showed was the cause of the failure of the physical sciences among the greeks — it seems highly important to enter upon an account of certain unpublished researches on the aether made by the present writer during the past six years, omitting so far as possible the results already available in volume I of the *Electrodynamic Wave-Theory of Physical Forces*, Boston, London and Paris, 1917.

And first we shall show that the aether is necessary for holding the planets in their orbits, from the established law of the centrifugal force. This centrifugal motion must be counteracted, otherwise a planet can not be made to curve the path at every point and thus revolve in a Keplerian ellipse with the sun in the focus.

¹⁾ In a future paper a conclusive criterion will be given for rejecting this claim of a large density for the aether.

It is well known that the centrifugal force is given by the expression,

$$f = mv^2/\rho \quad (1)$$

where m is the revolving mass, v is the instantaneous velocity, and ρ the radius of curvature of the orbit. As the planetary orbits and the orbit of the moon are not far from circular, we may with sufficient approximation calculate the centrifugal force for circular orbits. In the case of the earth's attraction for the moon, it suffices to take the earth's weight in metric tons, the moon's mass = $1/81.45$, and the distance of the moon 60 terrestrial radii, so that the weight at the earth's surface is to be reduced by the divisor 3600. Then, as gravity balances this centrifugal force, we have for the attraction of the earth on the moon:

$$\begin{aligned} f &= (5.956292 \times 10^{21}) / (81.45 \times 3600) \\ &= 20.3137 \times 10^{15} \text{ metric tons.} \end{aligned} \quad (2)$$

This enormous tension would require for its support the full breaking strength of a weightless solid circular column of steel 645 kms in diameter, when the steel has the tensile strength of over 30 metric tons to the square inch = 6.4 sq. cms, and such a small bar of steel would thus about lift a modern battleship of the largest type. The tensile strength of the above single column, 645 kms in diameter, would be equivalent to about 5000000000000 columns of such weightless steel, each of one square foot cross section, 922 sq. cms, or about one such column to each area $16 \times 16 = 256$ sq. feet of a hemispherical cross section of the earth. So much for the stresses which control the moon's motion.

But the gravitational attraction of the sun upon the earth is very much more powerful than that of the moon. The attraction of the sun upon the earth is of course equal to that of the earth upon the sun, which is easily seen to be

$$\begin{aligned} f &= 332750 / (23445)^2 \times 5.956292 \times 10^{21} \\ &= 3.60572 \times 10^{18} \text{ metric tons} \end{aligned} \quad (3)$$

where the number 332750 represents the sun's mass, in units of the earth's mass, and 23445 is the sun's mean distance, in units of the earth's radius.

This attraction of the sun on the earth is equivalent to the tensile strength of 1000000000000 weightless circular pillars of steel, like that discussed above, but each having a diameter of 30 feet, about 9 metres. This is equivalent to the tensile strength of a forest of weightless steel pillars, each 11 inches or 28 cms in diameter, on each square foot of a hemispherical cross section of the earth; so that the surface of the globe would be almost covered with these cables of steel.

Such calculations of the enormous gravitative power of the heavenly bodies were first brought to my attention by Professor *Joseph Ficklin*, of the University of Missouri, about 33 years ago, and have never been overlooked in my subsequent studies of the cause of gravitation. Now with these concrete figures before us, we see that the cause assigned for gravitation must be adequate to sustain these tremendous forces, miraculously pulling like stupendous cables of steel, imagined as weightless as spider webs, yet stretched to the utmost limits of their tensile strength across the celestial spaces, for holding the planets in their orbits.

Accordingly *Einstein's* proposal to do away with the aether is chiefly remarkable for the lack of understanding of

the physical universe which it displays. Sir *Isaac Newton* himself denounced those who believed action could occur across empty space as not having a competent faculty of thinking in philosophical matters. In his letter to *Bentley*, 1692-3, Febr. 25, he says:

»That gravity should be innate, inherent and essential to matter, so that one body may act upon another at a distance through a vacuum, without the mediation of anything else, by and through which their action and force may be conveyed from one to another, is to me so great an absurdity that I believe no man who has in philosophical matters a competent faculty of thinking, can ever fall into it. Gravity must be caused by an agent acting constantly according to certain laws; but whether this agent be material or immaterial I have left to the consideration of my readers«.

In a paragraph cited below, *Maclaurin* tells us that *Newton* held gravitation to be due to impulses of the aether but could not make out exactly how they arose; and the passage shows that *Newton* did not regard this medium as ordinary material.

a) It is shown below that the elasticity of the aether is 689321600000 times greater than that of our air in proportion to its density: it has therefore enormous power of contraction, if any natural process be at work to cause it to collapse.

b) It is shown in the *Electrodynamic Wave-Theory*, *Phys. Forc. I*, 1917, that between any two sources, as the sun and earth, the waves so interpenetrate, with rotations in opposite directions, as to decrease the stress and cause collapse of the medium between the sun and the earth; and this therefore develops an enormous tension, with maximum stress in the right line between the bodies, while beyond them there is corresponding increase of stress and thus an external pressure also overcoming the effects of the centrifugal force, and compelling the planet to follow the Keplerian ellipse about the sun in the focus.

c) It is shown in section 7 below, that the potential is simply an expression for the total accumulated stress due to the waves from all the individual atoms of a body, each wave following the law of amplitude,

$$A = k/r \quad (4)$$

and giving an element of force, as in gravitation,

$$f = k^2/r^2.$$

Accordingly we see that *Laplace's* definition of the potential, 1782, points directly to the wave-theory:

$$V = \iiint \{ \sigma / V [(x-x')^2 + (y-y')^2 + (z-z')^2] \} dx dy dz. \quad (6)$$

d) Therefore it is natural to hold that gravitation is a wave phenomenon in the aether, and to dismiss all other hypotheses as not fulfilling conditions essential to a true physical cause. This wave-theory of gravitation will give a new ground for the deflection of the light of stars when their paths of their rays pass through the gravitational field of the sun, as indicated in the eclipse of May 29, and reported at the meetings of the Royal Society and Royal Astronomical Society, Nov. 6, 1919.

e) It will be shown below that both the density and rigidity of the aether increases as we go outward from the sun, according to the laws

$$D = vr \quad E = v'r. \quad (7)$$

Accordingly the velocity of the waves remains approximately constant, (Electrodynamic Wave-Theory of Physical Forces I:14-157, 1917)

$$V = CV(E/D) = CV(v'r/vr). \quad (8)$$

But experience alone can determine whether this condition holds with geometrical rigor, or whether along the actual path, containing diffuse coronal matter, the stationary condition,

$$\delta \int ds = 0 \quad (9)$$

may not lead to a small deflection of the original path of light.

f) Such an increase of density in the aether, as we recede from the sun was suspected by *Newton* in 1721, (3rd edition of Optics, p. 325). It is of authentic record that *Newton* believed gravitation arises from the impulses of a subtle aethereal medium, but he »was not able, from experiment and observation, to give a satisfactory account of this medium, and the manner of its operation, in producing the chief phenomena of nature«, (*Maclaurin*, Account of *Newton's* Philosophical Discoveries, London, 1748, p. 111), and thus he left the problem of the cause of gravitation to future investigators.

g) The observed deflection of the rays of stars passing near the sun, amounting to about 1".75, may be most naturally explained by the action of the gravitational and magnetic wave-fields, under the influence of coronal matter, varying as the inverse fourth power of distance, and the arrangement of the density and rigidity of the aether, near the sun. An arc of 1" at the sun's mean distance corresponds to an absolute space of 725 kms, 1".75 to 1269 kms. In the presence of the sun's strong gravitational and magnetic fields, and the magnetized faint coronal matter pervading that wave-agitated region, it is probable that a central refraction or deflection of the light, of this magnitude, somewhat analogous to an unsymmetrical *Zeeman*-effect, may be anticipated. The rotation of the beam of polarized light by magnetism, in *Faraday's* experiment of 1845, would lead us to expect some action in the sun's coronal wave-field.

h) As *Einstein's* predicted displacement of the spectral lines towards the red could not be confirmed by *Evershed* and *St John*, who had ample telescopic power to make this shift-effect at least 50 times the probable error of their measures, it cannot be presumed that the deflection of starlight passing near the sun is a confirmation of a purely mathematical theory. The deflection of the light must rather be explained by the physical properties of the aether, interspersed with faint coronal matter, varying as the inverse fourth power of the distance, in the region of intense wave-agitation about the sun.

i) At the joint meeting of the Royal Society and Royal Astronomical Society, Nov. 6, 1919, no one attempted to answer the weighty objections brought forward by Dr. *Silberstein*, who had made a careful study of *Einstein's* theory, and thus pointed out the bizarre conclusions drawn by some pure mathematicians who are prone to forget that the deflection of starlight near the sun is as purely a physical problem as the refraction of light in the earth's atmosphere. Now the sun's deflection of light is similar to refraction, but

very minute, — half of it being 0".875, as against 2000" in our atmosphere, or about 2300 times smaller.

j) Since, according to the report of the observers of the eclipse of May 29, 1919, this minute deflection disappears, when the sun moves out of the path of the light from the stars lying behind it, such a temporary effect cannot properly be attributed to »a warp of space«, but only to the refractive action of the sun's envelope. When *Newton* observed the refraction of light by a prism he had no thought of attributing the effect to »a warp of space«; and one cannot but reflect how fortunate it is that the physical theory of astronomical refraction was perfected by *Newton*, *Laplace* and *Bessel* before such confusing terms as »fourth-dimension-time-space-manifolds« were introduced into science.

k) It cannot be held that *Einstein's* theory enlightens us on the motion of mercury's perihelion, because at least half a dozen explanations, some of them approved by *Newton*, *Hall*, *Newcomb* and *Seeliger*, are already known; and another simple one, involving no mysticism and no rash assumptions, but following from definitely established physical laws, will be brought out in the present investigation.

2. New Law of the Density and Rigidity of the Aether.

To deduce the law of the wave amplitude (4) in tri-dimensional space, we proceed as follows. The displacement of any particle of a medium due to wave motion, of a given wave length, is independent of the periodic time, and since the oscillatory orbits of the particles are described in equal times, under continuous flow of the waves, these orbits will be proportional to the displacements or other homologous lines pertaining to the periodic paths of the particles. Let the velocities of the moving particles be v , and m their mass; then their kinetic energies will be represented by $\frac{1}{2}mv^2$. In the spherical expansion of the aether waves, there will be no loss of energy in free space; hence on two successive sphere surfaces of thickness dr , the energies are equal, so that we have:

$$4\pi r^2 \cdot \frac{1}{2}mv^2 = 4\pi r'^2 \cdot \frac{1}{2}mv'^2 \quad (10)$$

or

$$v^2 : v'^2 = r'^2 : r^2$$

The kinetic energy of the vibrating molecules varies inversely as the square of the distance. But the velocity varies also as the amplitude, in simple harmonic motion: therefore, for the amplitudes A' and A'' , corresponding to the radii r' and r'' , we have by taking the square root in equation (10):

$$A' : A'' = r'' : r' \quad (11)$$

$$A'' = A' r' / r'' = k'' / r'' \quad (12)$$

Accordingly the amplitude or side displacement becomes,

$$A = k/r. \quad (13)$$

And

$$V = M/r =$$

$$= \iiint \{ \sigma / V[(x-x')^2 + (y-y')^2 + (z-z')^2] \} dx dy dz \quad (14)$$

which is the law of the potential first used by *Laplace* in 1782. Thus it appears that if there be aether waves propagated outwardly from any molecule of matter, the amplitude, or maximum displacement of the oscillating particles of the aether, will vary inversely as the radius of the spherical wave-surface.

A partial development somewhat like this is given in certain treatises on physics, such as *Wüllner's Experimental Physik*, 1.784, and *Mitchie's Elements of Wave Motion*, p. 11, but no importance is attached to the result, as in my *Electrodynamic Wave-Theory of Physical Forces*, 1.14-157, 1917. So accurately is this true, that when I brought this simple formula for the wave amplitude, $A = k/r$, before the Academy of Sciences of St. Louis, in a public address, Sept. 21, 1917, great surprise at the simplicity of the formula was expressed by such experienced investigators as Professor *F. E. Nipher*, and President *E. A. Engler*. Thus it is necessary to develop the subject a little more fully in the present paper, since no adequate discussion of the problem appears to be available in existing works on physical science.

Let us now consider the arrangement of the density of the aether about the sun.

1) Suppose we consider carefully the amplitude of the waves from the sun in any solar spectral line, such as that of sodium, D . It is evident that if we disregard all other radiations, and fix attention upon this sodium light alone, then as the wave amplitude varies inversely as the distance from the sun's centre, this amplitude of our vibrations constituting sodium light will be 219 times greater at the sun's surface than at the surface of the earth — since the earth's mean distance is 219 solar radii.

2) Similar reasoning will hold for the waves of light of the spectrum of such elements as strontium, barium, boron, calcium, hydrogen, carbon, iron, nickel, cobalt, copper, titanium, etc. Thus all the light waves of all elements conform to the law: $A = k/r$.

3) All these chemical elements also radiate heat waves which follow the same law of amplitude. And for both light and heat the above law holds rigorously true. If there be any other type of waves in the aether, the same law will hold for these undulations also.

4) Now magnetism and gravitation have been referred to electrodynamic waves, in the author's work on physical forces, 1917. If these waves exist, they also will follow the same law $A = k/r$; and that they do exist is shown by a variety of phenomena, which admit of no other interpretation. For example, the electrodynamic action of a current of electricity is due to waves: thus arise electrical forces: also magnetic forces, gravitational forces, etc.

5) Gravitation admits of no other explanation, while on this explanation we have an immediate insight into the fluctuations of the moon's mean motion, which so long proved utterly bewildering to astronomers. And there must be not only a cause of gravitation, but a simple one, harmonizing with electrodynamic action, in the generation of electrical forces, magnetic forces, etc. The electrodynamic wave-theory alone fulfills this necessary and sufficient condition, for the following special reason.

6) The aether is shown to have an elastic power 689 321 600 000 times greater than that of our air in proportion to its density. Hence it will have practically unlimited power of contraction, and thus be able to generate the

stupendous forces required for holding the planets and stars in their orbits.

7) But this will be possible only if the aether is arranged according to the law of density $\sigma = \nu r$; which in turn will follow if electrodynamic waves recede from the sun, having amplitudes $A = k/r$. For the amplitudes increasing towards the sun's centre insures a decrease of density of the aether about that centre, owing to the increasing wave-agitation near the sun's surface.

8) Now all these mutual arrangements, favorable to the wave-theory, would not exist, unless that theory represented a law of nature. Because not only are all facts of the aether harmonized, but also all the forces brought under the principles of the conservation of energy, and of least action. Thus nature not only acts simply, but also by the most uniform processes throughout all space. It is not therefore admissible to hold any theory of the aether other than that it is an infinite aeolotropic elastic solid, with the density arranged about the heavenly bodies to increase directly with the distance. And the wave amplitudes varying inversely as the radius, $A = k/r$, supports this theory, by geometrical considerations, which exclude every other theory of the medium for the interpretation of the forces operating throughout the physical universe.

9) In the course of the article *Aether* (*Encyclopedia Britannica*, 9th. ed., 1877), *Maxwell* calculates the density as $\rho = 1.07 \times 10^{-18}$, thus implying homogeneity, and speaks of this medium as »a vast homogeneous expanse of isotropic matter.«

But it is obvious on reflection that this medium cannot be homogeneous¹⁾; for in that case there would be no stresses in the medium for generating the forces which govern the mutual interaction of bodies throughout space. The mutual actions between bodies is an observed fact. In motion the bodies are everywhere found to describe ellipses, parabolas or hyperbolas about one another. Nothing but forces, due to tension between the bodies, and increase of pressure beyond them, could possibly produce this remarkable power for holding the planets in their orbits.

10) Thus forces imply waves, and waves lead to forces, when the mutually interpenetrating waves are so directed as to undo one another, and cause the collapse of the medium in the right line between the bodies. As the gravitational forces are of enormous intensity, it follows that the elastic power of the aether has to be tremendous, in order to generate the forces actually observed.

11) Accordingly, the existence of forces implies stresses in the aether: the stresses imply waves: the waves imply heterogeneous density in the medium, which must vary with the radius from any mass according to the law $\sigma = \nu r$. There is no other view of the aether which can be held. Homogeneity of density would imply no stresses; no stresses would imply no forces; no forces would imply an inert universe; which is contrary to observation and thus wholly inadmissible.

¹⁾ In the Baltimore Lectures, 1904, p. 265, under date of Nov. 16, 1899, Lord *Kelvin* says: »We have strong reason to believe that the density of ether is constant throughout interplanetary and interstellar space«. This error is very widespread, and its persistence shipwrecks physical research!

12) The aether is therefore arranged about the sun with the density following the law, $\sigma = \nu r$, which results from wave-agitations having amplitudes, $A = k/r$. The energy of the forces generated by these waves is proportional to the square of the amplitude, and therefore we have for the force,

$$f = k^2/r^2 \quad (15)$$

which explains all the observed effects of gravitation, magnetism, etc.

13) Now quite aside from the simplicity and continuity of the process of reasoning here outlined, it remains a fact that the wave-theory is adequate to explain all the observed phenomena of nature. The simple law of density of the aether here imagined may therefore be admitted to really pervade the universe. So far from being homogeneous, the aether is really very heterogeneous. Indeed, it is a gas, behaving as an elastic solid — an infinite aeolotropic elastic solid — fulfilling the law of density, $\sigma = \nu r$, and of wave amplitude, $A = k/r$, and therefore yielding forces following the law, $f = k^2/r^2$, as required by *Newton* in 1721, for explaining the cause of universal gravitation.

At the earth the density of the aether is 219 times what it is at the sun's surface, because the earth's mean distance is 219 times the solar radius. But *Newton's* formula for the velocity,

$$V = CV(E/D) \quad (16)$$

would give a change of velocity if the density alone increased, while the elasticity E remained constant.

Now the velocity of light across the planetary spaces was originally found by *Römer*, 1675, from the eclipses of Jupiter's satellites, and subsequently confirmed by the elaborate researches of *Delambre*, on the motions of these satellites (cf. C. d. T. 1788, and *Astronomie Théorique et Pratique*, 1814). By discussing a thousand eclipses of the 1st satellite *Delambre* fixed the constant of aberration at 20".255, while *Michelson's* velocity of light, near 300 000 kms., and the solar parallax 8".80 makes the aberration about 20".48.

Thus V is about the same for the aether across the diameter of the earth's orbit, and for the aether of the terrestrial atmosphere, in which the velocity has been investigated experimentally by *Cornu*, *Michelson*, *Newcomb* and others.

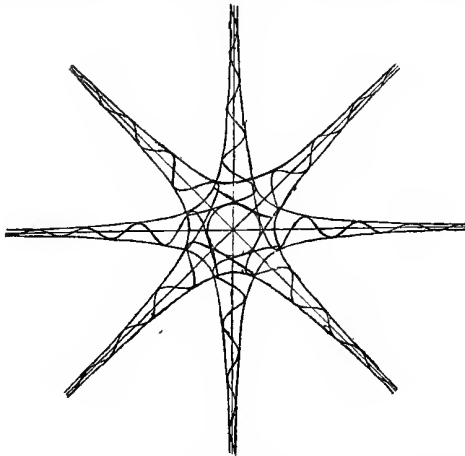


Fig. 1. Diagram showing graphically the decrease of the density of the aether towards the sun, owing to the asymptotic increase in wave amplitude.

Accordingly, this observational fact requires us to hold that E increases in about the same ratio as D , so that our law of V for the heavenly spaces becomes,

$$V = C V(\nu' r / \nu r) \quad (17)$$

and therefore $E = \nu' r$. Thus both the elasticity and rigidity of the aether increase directly as the radius from the sun, or other heavenly bodies.

The reason for this remarkable law is this: namely, the viscosity of a gas depends upon the friction of the molecules projected from one layer of gas into the adjacent layer, and vice versa. In the case of the aether the viscosity becomes rigidity. And with the increase of the density of the aether particles there should be more molecules projected into the adjacent layers mutually, by the ordinary kinetic exchange, in strict proportion to the density. Thus the rigidity of the aether increases directly as the density, as in the above formula.

It may be noted that by the formula of *Newton*, an increase of the density by the factor 219, without change in E , would lead to a reduced velocity of only about $1/15^{\text{th}}$ of the original. No such enormous difference, in the velocity of light as determined by observations of Jupiter's satellites, and that found by terrestrial experiments, is admissible; and thus the above law of rigidity of the aether is approximately verified by the comparison of celestial and terrestrial observations. But a more exact test of the value of V , from eclipse observations of Jupiter's satellites, taken as directly as possible across the diameter of the earth's orbit, for comparison with the experimental value found by *Michelson*, is highly desirable.

3. The Relation between the Mean Molecular Velocity of a Gas and that of a Wave transmitted in such a Medium.

The *Philosophical Magazine* for June and September, 1877, contains two important articles on the theory of gases by Dr. *S. Tolver Preston*, and also notes on the conclusions then reached by the celebrated Professor *J. Clerk Maxwell*, with whom *Preston* was in correspondence. In the first of these papers, p. 452, § 19, *Preston* reaches the following remarkable conclusion: »That the velocity of propagation of a wave (such as a wave of sound) in a gas is solely determined by, and proportional to, the velocity of the molecules of the gas; that this velocity of propagation of the wave is not affected by density, pressure, or by the specific gravity of a gas, or by anything else excepting the velocity of its molecules«.

In the second Postscript, p. 453, *Preston* states *Maxwell's* conclusion as follows:

»Professor *Clerk Maxwell*, to whom this paper was communicated, and who has taken a kindly interest in the subject, has worked out mathematically the velocity for a wave or impulse propagated by a system of particles moving among each other according to the conditions of equilibrium investigated in the first part of this paper — the diameter of the particles being assumed so small as to be negligible compared with their mean distance, and the particles being further assumed spherical, so that there is no movement of rotation developed at the encounters (which would involve loss of velocity)«.

»Under these premises, the velocity of the wave was found to be $\frac{1}{3}\sqrt{5}$ (or 0.745) into the mean velocity of the particles. In most gases the velocity of sound is slightly less than this. This is referable to the movements of rotation developed at the encounters of the molecules (which calculably would delay the wave to a certain extent). In vapour of mercury, according to the determinations of *Kundt* and *Warburg*, the velocity of sound is exactly $\frac{1}{3}\sqrt{5}$ into the molecular velocity«.

According to these announcements, the corpuscles of the aether, viewed as a monatomic gas, should have a mean molecular velocity of $\frac{3}{\sqrt{5}} \cdot V = 1.34 V$, where $V = 3 \times 10^{10}$ cms, the velocity of light. A conclusion of such great importance, which received the approval of the luminous mind of *Maxwell*, is entitled to profound attention. Thus I have had it before me for some five years, but only

undertook the mathematical verification and physical test of this *Preston-Maxwell* theorem quite recently; and, as my results differ slightly from those of *Preston* and *Maxwell*, I will give the process of test and verification employed.

In order to confirm this theory I have compared the observed velocity of sound for the four leading gases which are best determined, with their mean molecular velocities, and find the following indications of experiment, without regard to the *Preston-Maxwell* theory. In the experimental data there remains a little uncertainty. For the older values of \bar{v} and k_2 the table yields for the corrected ratio a mean of 1.64, which is 0.07 above the theoretical value of 1.57. The newer data, preferred by *Jeans*, *Dynamical Theory of Gases*, 2nd edition 1916, p. 9-131, give a mean value of 1.57, though the discordance between the results for the individual gases is somewhat increased.

Gas	Mean molecular velocity \bar{v}		Observed velocity of sound in gas at 0° C V	Ratio \bar{v}/V without correct.		Correction factor for $V(k_1/k_2)$ *)		Corrected ratio \bar{v}/V	
	older values	newer values		older values	newer values	older values	newer values	older values	newer values
Air	498m	459m	332.0m	1.50	1.38	1.09	1.09	1.63	1.51
Hydrogen	1859	1694	1265.0	1.47	1.34	1.09	1.09	1.60	1.46
CO	497	493	337.1	1.50	1.46	1.10	1.09	1.65	1.59
CO ₂	396	393	259.4	1.52	1.51	1.10	1.13	1.67	1.71

Mean value for a monatomic gas: 1.64 | 1.57

*) $k_1 = 1.66$ for a monatomic gas; $k_2 = 1.40$ for a biatomic gas like the air or hydrogen; $k_2 = 1.36$ for CO and CO₂ in the older values. But in the newer values air, hydrogen and CO have $k_2 = 1.40$, and CO₂ has $k_2 = 1.30$, from the data given by *Jeans*.

It thus appears from the most reliable data available that the ratio should be larger than *Maxwell* indicated by about 17%. His processes of calculation are not known, but a theoretical ground for the above result may be deduced as follows. Consider the particles of a monatomic gas to move with the velocity \bar{v} , as in the reference circle, in simple harmonic motion, while the wave advances across the diameter of the circle with the velocity V . Then it is evident that the two motions are in the ratio of π to 2, which gives 1.5707963, in exact agreement with the above value as corrected for a monatomic gas.

This theoretical and practical conclusion is confirmed also by the profound researches of *Airy* on Tides and Waves, *Encyclopedia Metropolitana*, 1845. In Plate I, fig. 27, we find a very exact representation of the motions of the elements which go to make up the form of a wave in water. As the wave advances these elements describe small circles about a mean position, while the forward and backward motion incident to the passing of the wave is over two diameters of the elementary circles, giving the obvious ratio $2\pi/4 = 1.57$, as before. It was from the study of *Airy's* researches that I became doubtful of the numerical accuracy of *Maxwell's* result, and was led to subject the theory to a practical as well as a theoretical test.

If therefore light be observed to have a velocity of 300000 kms per second, the particles of the aether will have an average molecular velocity of 471239 kms per second. This is a very important result, and it confirms the general theory outlined by *Preston* and *Maxwell*, though the details of their processes are altered.

4. Exact Calculation shows the elastic power of the aether to be 689321600000 times greater than that of our air in proportion to its density: Thus it cannot be disrupted by any known force, and only the quick action of dynamite will generate waves in it.

In the »Electrodynamic Wave Theory of Phys. Forc.«, 1, 1917, the writer has referred the chief forces of nature to wave action, and explained the mode of wave action for gravitation, magnetism, electrodynamic action, etc. As the aether was taken to be corpuscular, yet known to behave like an elastic solid, owing to the enormous velocity of the particles, the elasticity was recognized to be adequate to produce the postulated dynamical effects, but it is highly desirable to have this working hypothesis for so important a constant verified by exact calculation.

In the passage above cited from the *Optics*, 1721, p. 325, *Newton* gave the first outlines of a correct theory of the elasticity of the aether. It was subsequently rediscussed by Sir *John Herschel*, in the well known address on light, (*Familiar Lectures on Scientific Subjects*, London, 1867, p. 282); yet owing to the importance of an understanding of the elasticity of the medium for the *Electrod. Wave-Theory* of Phys. Forc., I have reexamined the whole subject. The present results establish beyond doubt the almost infinite power of expansion and contraction always operating in the aether for generating the stupendous physical forces observed throughout nature.

It is therefore certain that wave action in such an elastic medium is adequate to account for all the varied

operations of the physical universe. Moreover, since light, heat, chemical affinity, etc., have long been referred to such waves in the aether, the more general electrodynamic wave-theory thus gives complete continuity to our theories of physics, thereby confirming the correlation of all natural forces, and giving new physical grounds for the doctrine of the conservation of energy.

In the closing paragraph to his celebrated Treatise on Electricity and Magnetism, 1873, *Maxwell* justly says that »whenever energy is transmitted from one body to another in time, there must be a medium or substance in which the energy exists after it leaves one body and before it reaches the other«. This also points to wave action, such as *Gauss* was considering in 1835, and of which *Weber* gave the fundamental law in 1846, *Newton's* law of 1686 being a special case corresponding to circular orbits.

In the Principia, Lib. 2, Prop. 48, Sir *Isaac Newton* deduces the formula for the velocity of waves or pulses propagated in an elastic medium, such as waves of sound in the air,

$$V = CV(E/D).$$

This is now written

$$V = V\{(kgh\sigma/D) \cdot (1 + \alpha t)\} \\ = 331.76 \text{ m } V(1 + 0.003665 t) \quad (18)$$

where t is the temperature; α is a coefficient, 0.003665; g = acceleration of gravity, 981 cm; h = normal barometric pressure, 76 cm; σ = 13.6, density of Mercury; D = the density of air, 0.001293; and k = 1.4050 (cf. *Willner's* Experimental Physik, 3.552) is the ratio of the specific heat of air under constant pressure to that under constant volume, introduced by *Laplace* for harmonizing *Newton's* theoretical formula with the observed velocity of sound in air.

In many investigations it is possible to determine the velocity with which waves are propagated, but it is not always possible to determine independently the elasticity or density of the medium — we can only find the ratio E/D . This is partly true of the aether, for-example, which transmits light waves or electrodynamic waves with the speed of 300000 kms per second, but gives no process of fixing the elasticity of this medium except by an independent calculation of the density, which, however, may be made by the process first used by Lord *Kelvin* in 1854, (Baltimore Lectures, 1904, p. 261-263), and afterwards adopted by *Maxwell*, Scientific Papers, 2.767.

In section 5 below we find, by the process here described, that at the sun's surface the density of the aether is $\rho = 2 \times 10^{-18}$ and the rigidity 1800. Using these constants in *Newton's* formula, we may verify the observed velocity of wave propagation:

$$V = V(n/D) = V\{1800/(2 \times 10^{-18})\} = 3000000000 \text{ cms} \\ = 3 \times 10^{10}, \text{ the velocity of light.}$$

To compare a perfect monatomic gas like the aether with diatomic gases like the air, we use the formula for the velocity of sound:

$$V = V\{(gh\sigma/D) \cdot k \cdot (1 + \alpha t)\} = \\ = V\{(9.808 \times 0.76 \times 13.59/0.001293) \cdot (1.405) \cdot (1 + \alpha t)\} \\ = 331.8 \text{ m } V(1 + 0.003665 t) \text{ at } t^\circ \text{ C.} \quad (19)$$

This shows that the velocity of light is 904268 times swifter than sound. Squaring this number, and dividing the result by $1.666/1.405 = 1.18624$ we get the immense number 689321600000; which shows how much the elasticity of the aether, regarded as a monatomic gas, exceeds that of the air in proportion to its density¹⁾. In the Optics, 3rd edition, 1721, p. 326, *Newton* makes this number 490000000000, which is 71 per cent correct.

In view of this excessive elasticity of the aether, in proportion to its very small density, compared to that of air, we can understand the almost inconceivable velocity of light. It is also necessary to bear in mind this enormous elasticity in order to understand why the aether is practically incompressible. When a wave begins to be generated, the disturbance is propagated away so rapidly that the wave amplitude necessarily is small compared to the wave length. In the calculations of section 5 we have taken the wave length as 101.23 times its amplitude, which *Maxwell*, Lord *Kelvin* and *Larmor* consider a safe basis in all numerical determinations.

The incompressibility of the aether is due to the very high mean velocity of the aether corpuscles, 471239 kms per second, and their enormously long free path, 572959 kms: which makes the medium behave as an elastic solid for quick acting forces, but enables the corpuscles to move out of the way of the swiftest planets with a 10000-fold greater speed. Owing to its enormous elasticity, the aether instantly adjusts itself to any state of steady motion, and thus this medium offers no resistance whatever to uniform celestial motions.

This circumstance fully explains a grave difficulty which has been felt from the age of *Newton*, and hitherto appeared utterly bewildering to natural philosophers. In connection with such extraordinary physical conditions in the medium, it may be useful to recall an account of the interior constitution of the sun given by Professor *Newcomb* in the Encyclopedia Americana, 1904:

»Yet another unknown factor is the temperature of the interior, . . . it may be 1000000 degrees. As the highest temperature which it is possible to produce artificially probably does not amount to 10000 degrees, it is impossible to say what effect such a temperature would have upon matter. Thus we have two opposing causes, the one an inconceivable degree of heat, such that were matter exposed to it on the surface of the earth, it would explode with a power to which nothing within our experience can be compared, and a pressure thousands of times any we can produce, tending to condense and solidify this intensely heated matter. One thing which we can say with confidence as to the effect of these causes is that no chemical combinations can take place in matter so circumstanced. The distinction between liquid and gaseous matter is lost under such conditions. Whether the central portions are compressed into a solid, or remain liquid, it is impossible to say.«

¹⁾ In his thoughtful Familiar Lectures on Scientific Subjects, 1867, p. 282, Sir *John Herschel* gives this figure as 114800000000; but he omits altogether the ratio 1.66 which applies to the aether as a monatomic gas. This correction is verified both by theory and by observation on such monatomic gases as Mercury vapor, Helium, Argon, Krypton, Neon, Xenon.

In the writer's Researches on the Physical Constitution and Rigidity of the Heavenly Bodies, 1904-5, he reached the conclusion that the confined solar matter must necessarily be gaseous, though acquiring the property of a highly rigid solid under the enormous pressure and high temperature to which the matter is subjected. In fact it was found by calculation that the layers of the sun's globe have an average rigidity of over 2000 times that of steel, (AN 4104, equation 22, p. 384), while the average rigidity of the matter, accumulated with increasing density in the interior layers, may be 6000 times that of Nickel steel (AN 4104, equation 38, p. 392).

Such a globe must be viewed as bursting internally with pent up explosive energy, yet kept in equilibrium by the accumulating pressure of the surrounding layers: the confined matter is gaseous, yet rigid to the highest degree, and in such confinement must have the property of a solid of enormous rigidity.

Now the rigidity of the aether is variable with the radius vector drawn to the sun's centre, but generally less than that of solids such as glass, which is about 10^{11} . Yet with such high elasticity, due to the enormous molecular velocity 471239 kms, we see that it cannot be rent or cracked, as Lord *Kelvin* once suggested, (Popular Lectures and Addresses, 1.336), by any forces at work in nature. The only artificial forces yet found capable of setting up waves in the aether were the extremely quick explosions of dynamite used by Professor *Francis E. Nipher* of St. Louis.

5. Table of the Physical Constants of the Aether.

The general method employed for determining the physical constants of the aether is based on the process for calculating the mechanical value of a cubic mile of sunlight devised by Lord *Kelvin*, 1854, and first published in the Transactions of the Royal Society of Edinburgh, (cf. »Mechanical Energies of the Solar System«, 1854, and Baltimore Lectures, 1904, p. 261-265). This method was adopted and somewhat improved by *Maxwell*, 1875, in the Article Aether, Ency. Brit. 9th ed. Some further improvements have been introduced by the present writer, especially in those constants of the kinetic theory of the aether, which were never calculated by *Kelvin* or *Maxwell*. These are due entirely to the recent investigations, and are here outlined for the first time.

We adopt the constant of solar radiation recently found by *Bigelow*, namely, 3.98 ca., 1919. (Supplement No. I to the Treatises on the atmospheres of the sun and the earth. Four fundamental formulas for discussing the observations made with various types of pyrheliometers, *F. H. Bigelow*, John Wiley & Sons Inc., New York, 1919, p. 4).

A certain factor in the kinetic theory of the energy of the aether waves coming from the sun was taken by Lord *Kelvin* as between $\frac{1}{2}$ and 1, (Baltimore Lectures, p. 263, § 5), and by *Maxwell* as $\frac{1}{3}$. Working out the problem somewhat more fully than Lord *Kelvin* has done, thus taking account of the inclinations of all the wave elements in plane, circularly and elliptically polarized light, I find that this factor for the total energy should be a little greater than one half, namely:

$$\mathcal{F} = 1/(1/2\pi) \cdot \int_0^{1/2\pi} \cos \theta d\theta = 2/\pi = 0.63662.$$

Accordingly we thus arrive at the following

Table of Constants of the Aether:

1. Constant of solar radiation, found by *Bigelow* from observations, $R = 3.98$ ca.
2. Assumed ratio of amplitude to wave length $A/\lambda = 1/101.23$, which is nearly the same as was used by *Maxwell*, so that $Ap = 2\pi/101.23 = 1/16.115$.
3. Energy per cubic centimetre at the sun's surface = $(0.63662) \rho V^2 (Ap)^2 = 4.41455$ ergs.
4. Greatest tangential stress per sq. cm at the sun's surface = $\rho V^2 (Ap) = 111.1713$ dynes.
5. Coefficient of rigidity of the aether:
at the sun's surface = $\rho V^2 = 1800$,
at the earth's surface $219 \rho V^2 = 394200$.
6. Density of the aether at the sun's surface $\rho = 2 \times 10^{-18}$.
7. Density of the aether at the earth's surface $\rho' = 219 \rho = 438 \times 10^{-18}$.
8. Mean velocity of the aetheron, $\bar{v} = 47123900000$ cms.
9. Molecular weight of the aetheron, ($H = 1$)
 $= 15.56 \times 10^{-12}$.
10. Average length of mean free path, at the sun's surface, $l = 572959$ kms.
11. Number of corpuscular collisions per second, at the sun's surface, $C = 0.82246$.
12. Radius of aether corpuscle = 3.346×10^{-12} , or $1/4005$ of the radius of a Hydrogen molecule.

The radius of a molecule of Hydrogen is taken as 1.34×10^{-8} , and the density assumed equal. In computing the molecular weight of the aetheron in 9 above, we disregard the so-called 'Electrical mass' because Professor Sir *J. J. Thomson*, (Electricity and Magnetism, 4th ed., 1909, p. 521), and *Crowther*, (Molecular Physics, 1914, p. 70), and other authorities, admit that this 'Electrical mass' resides in the aethereal medium itself, which we are investigating. This subject will be more fully discussed in a future paper.

It may be noticed that the aether gas, is endowed with enormously high molecular velocities and excessively long range of mean free path, so that the highly elastic aether is very different from the ordinary terrestrial gases. This is forcibly brought out in the following table; yet the similarity with the other gases is also notable, even for such an extreme case as the aether. It is this enormous mean molecular velocity and the long free path which causes the aether to vibrate as an elastic solid for rapidly acting forces, but easily gives way to slow motions. It is worthy of notice that the particles of the aether move out of the way ten thousand times more rapidly than the swiftest planets revolve in their orbits.

The constants for the tables assembled below were drawn originally from *O. E. Meyer's* Kinetic Theory of Gases, but in the final revision I have adopted the mean of the values cited by *Jean's*, Kinetic Theory of Gases, 2nd ed. 1916.

Table for Comparing the Physical Properties of the Aether with well known Terrestrial Gases.

Gas	Mean velocity of molecule \bar{v}	Molecular wt. ($H=1$)	Coefficient of viscosity η at 0°C .	Mean free path $l = 3\eta/\rho\bar{v}$	Collisions per second $c = \bar{v}/l$ — 8 percent, for collision rebound	Radii of molecules calculated by four independent processes, except in the case of the aether
Aether	47 123 900 000 cms	15.56×10^{-12}	1800	57 295 900 000 cms = 57 295 9 kms	0.82	2.537×10^{-12} (= $1/4005$ of H)
Air	49800 »	14.43	0.0001724	0.0000059 cms	7765×10^6	1.86×10^{-8}
Hydrogen	185900 »	1	0.0000867	0.0000116 »	14743×10^6	1.34×10^{-8}
Helium	132 113 »	1.98	0.0001889	0.0000171 »	7108×10^6	1.11×10^{-8}
Oxygen	46 100 »	16	0.0001896	0.0000063 »	6732×10^6	1.81×10^{-8}
Nitrogen	49 200 »	14	0.0001660	0.0000057 »	7941×10^6	1.90×10^{-8}
Argon	41 527 »	19.96	0.000210	0.0000063 »	6064×10^6	1.81×10^{-8}
CO	49 700 »	14	0.0001626	0.0000058 »	7901×10^6	1.88×10^{-8}
CO ₂	39 600 »	22	0.0001410	0.0000040 »	9108×10^6	2.28×10^{-8}
Chlorine	31 262 »	35.36	0.0001287	0.0000029 »	9874×10^6	2.68×10^{-8}
Steam H ₂ O	62 000 »	9	0.0000912	0.0000040 »	14260×10^6	2.27×10^{-8}

As was first clearly shown by *Maxwell*, viscosity is due to the molecular resistance developed when one layer of gas slides over another. In the case of such a superfine gas as the aether the viscosity passes into rigidity; the processes for establishing this transition of viscosity into rigidity is explained in *Daniell's Principles of Physics*, 3rd ed., 1895, p. 227, and the theoretical basis of *Maxwell's* theory of viscosity is notably improved by *Jeans*, *Dynamical Theory of Gases*, 2nd ed., 1916.

As the aether is a gas made up of corpuscles 4000 times smaller in diameter than a hydrogen molecule, and having only 15.56 millionths of a millionth of the mass of the hydrogen molecule, we readily see why this superfine medium pervades all gross bodies. But as the aether is the ultimate medium of the universe, and is not underlain by anything finer, we also perceive that energy carried in such a medium cannot be dissipated, because there is no finer medium to which wave energy might be given up. Thus it follows that *Larmor's* argument (in the article Aether, *Encyc. Brit.* 11th ed., 1911), to the effect that aether is not molecular, is not well founded. There is no valid objection to a corpuscular aether, such as was conceived by *Newton*, 1721, and approved by *Preston* and *Maxwell*, 1877. The kinetic theory of this superfine gas is here worked out in somewhat greater detail, and we see that quite unexpectedly it affords the most substantial physical ground ever developed for the most fundamental of all physical doctrines, namely, the conservation of energy.

Somewhat more detailed explanation of the processes of calculation used to derive the high molecular velocity of the aetheron are given in section 6 below. At present we need only point out the obvious advantages of having before our minds definite numerical results which show what manner of gas the aether is.

6. The excessively high molecular velocity of the aetheron, its long free path, and small mass, with radius only one four-thousandth of that of a Hydrogen molecule, ensures both great elasticity and great power of penetration to the aether.

The extraordinary elastic properties of the aether are due mainly to the excessively high velocity of the aetheron,

its long free path, and small mass, with a radius of only one four-thousandth of that of a Hydrogen molecule. As far back as 1845, *Stokes* recognized (*Trans. Camb. Phil. Soc.*, 8.287), that the aether is similar to well known solids, but has their physical properties in an accentuated degree. Thus ice, treacle, pitch, beeswax, molasses pulled for candy, and other substances are fluid for slowly acting forces, allowing hard bodies pressed into them to pass through without any fracture, by a gentle yielding or flow of the substance; but yet when struck violent blows these bodies vibrate like elastic solids, and may be fractured like glass or other brittle substances.

It thus appears that a solid is one which does not yield readily to the forces applied to it, and the resistance to change of shape with time measures the rigidity. All bodies, however, yield to forces in some degree. Now in the case of the aether the corpuscles have the enormous velocity of 47 123 900 kilometres per second, as already pointed out: and in comparison with such tremendous speed, all earthly velocities are trivial. Even the velocities of our swiftest planets, like Mercury and Venus, are exceeded 10000-fold by the extreme swiftness of the aetherons. In addition to their rapid motion, they have the immensely long free path of 573000 kms, nearly one and a half times the moon's distance.

The enormous velocity of the aetheron and the great length of the mean free path makes the aether unique among all physical bodies. For rapidly acting forces it vibrates and transmits waves with a velocity of 30000 kms per second, and is capable of exerting the most tremendous stresses, such as are required for holding the planets in their orbits; but for slowly acting forces yields without resistance, because its own molecular motions are so rapid. The particles, travelling with such extreme velocity, get out of the way of all moving bodies — absolutely without hindrance, when the bodies move uniformly; and offer but slight resistance for changing velocity of movement due to acceleration or retardation.

It is recognized that the viscosity of gases, as determined by the diffusion experiments of *Loschmidt*, *O. E. Meyer*, *Maxwell* and others, depends on the molecular friction of the moving molecules projected from one layer of gas into another adjacent layer, when two layers are slid relatively

past each other. In this way, the experiments on diffusion have given us the viscosity of air and other gases.

The mean free path, for example, follows quite accurately the law:

$$l = 3z/\rho\bar{v} \quad (20)$$

where z is the viscosity of the gas, and \bar{v} the mean velocity of the molecule in cms per second, and ρ the absolute density.

It is important to notice that in the case of the aether, viscosity passes into rigidity, by a process of reasoning fully explained in *Daniell's Principles of Physics*, 3rd ed., 1895, p. 227. In calculating the mean free path of the aetheron, we use the rigidity of the aether at the solar surface, 1800, because both the density and rigidity of the aether vary with the distance from the sun, as already explained in section 2. Thus for the aetheron the mean free path is $l = 572959$ kms.

It is a fundamental doctrine in the kinetic theory of gases that all gases have an equal number of molecules in unit volume, under like conditions of temperature and pressure; but it is not yet possible to decide on the absolute value of this number, different estimates being indicated by various eminent authorities: $N = 19 \times 10^{18}$ (*Maxwell*), $N = 1000 \times 10^{18}$ (*Crookes*), $N = 6000 \times 10^{18}$ (*Kelvin*).

About all we can say is that the number of molecules in a cubic centimetre of gas at the ordinary temperature and pressure probably is not smaller than that assigned by *Maxwell*, $N = 19 \times 10^{18}$, the latest determination being 27×10^{18} (cf. *Crowther*, *Molecular Physics*, Phila., 1914, p. 3).

Using the value for the aether,

$$\bar{v}_2 = 471239000 \text{ m}$$

and for Hydrogen, $\bar{v}_1 = 1859 \text{ m}$

we have by the principle first enunciated by *Maxwell* (*Scient. Pap.* 2.365), that on the average every molecule great or small will have the same energy of motion*, the equation:

$$\frac{1}{2} m_1 \bar{v}_1^2 = \frac{1}{2} m_2 \bar{v}_2^2 \quad (21)$$

which gives

$$m_2 = m_1 (1859^*)^2 / (471239000)^2 = 15.56232 \times 10^{-12}. \quad (22)$$

Thus it follows that an aetheron has a mass of 15.56 millionths of a millionth of the mass of a Hydrogen molecule. This is equivalent to 2.7389×10^{-8} of an electron, or about one thirty-six millionth of an electron.

If we take the density of the aetheron as equal to that of the Hydrogen molecule, we find by calculation that the radius of the aetheron is equivalent to

$$r = 1/4005.36 \cdot H \quad (23)$$

or one four-thousand-and-fifth of the radius of a Hydrogen molecule. This explains why the aether so readily penetrates all bodies, even the most solid. It makes the size of an aetheron to a molecule of Hydrogen as a globe two miles in diameter is to the earth. Between masses as large as our terrestrial globe or larger, globes two miles in diameter would freely penetrate in great numbers, even if the larger globes were in contact, which of course is not the case with any solid or liquid, and still less is this true of a gas, in which the molecules are separated by distances relatively immense in comparison with the diameters of the molecules.

If the molecule of Hydrogen be taken to have a radius of 1.34×10^{-8} , that of the aetheron becomes

$$r = 1.34 \times 10^{-8} / 4000 = 3.346 \times 10^{-12}, \text{ nearly.} \quad (24)$$

To form a convenient picture of the small size of the aetheron compared to the Hydrogen molecule, we may recall the trifling height of a mountain a mile high compared to the immense radius of the earth. If other molecules be larger than Hydrogen, as is generally supposed to be true, then the aetheron will be a small globe of the size of a moderate mountain peak 10000 feet high; so that the various molecules will resemble Venus and the earth, Uranus and Neptune, Jupiter and Saturn.

To fix upon a more familiar everyday image of this world structure, we may imagine a box filled with large oranges, and the finest dust, like that of lime, or smoke from a cigar, penetrating the relatively vast spaces between the oranges, which however should not be in contact, but in rapid motion. If now the cigar smoke, or the particles of lime dust, be imagined to have stupendous velocity, flying hither and thither with inconceivable speed, and thus moving with the utmost freedom in the open spaces between the oranges, as well as outside of them, we shall have a very good image of the behavior of the aether in respect to matter.

The aether not only penetrates all matter freely, but even waves in it pass through all physical bodies, with only the hindrance incident to refraction and dispersion such as we see in light. The refraction is due to the unequal resistance offered by matter to the advance of the wave front, and the dispersion to unequal resistance to various wave lengths. Shorter waves encounter relatively more resistance, because their oscillations are more rapid, and thus the aether yields and adapts itself less easily to the resisting molecules in the path of the waves, when the waves are short, and the changes, due to their advance, extremely rapid.

7. The geometrical and physical significance of the potential.

In the *Mémoires* of the Paris Academy of Sciences for 1782, p. 113, *Laplace* introduces the use of the analytical expression since known as the potential, from the designation first used in 1828 by the English mathematician *George Green* (*Essay on the application of mathematical analysis to the theories of electricity and magnetism*, Nottingham, 1828). The potential is defined thus:

$$V = M/r = \iiint \left\{ \sigma / \sqrt{(x-x')^2 + (y-y')^2 + (z-z')^2} \right\} dx dy dz. \quad (25)$$

This expression has come into the most extensive use in all the physical sciences, and been of the highest service in the mathematical theory of gravitational attraction, magnetism, electrodynamic action, and also in theory of static electricity.

But it is very remarkable that up to the present time an expression of such universal use has not been given a clear geometrical or physical interpretation. The difficulty doubtless arose originally from beliefs like that expressed by *Laplace*, in the opening paragraph of the *Méc. cél.* I, 1799 that the nature of force is now and always will be unknown*

* *Joule's* value of molecular velocity of Hydrogen, which makes the aetheron perhaps a little too large.

In the state of darkness, relative to the invisible aethereal medium, existing at the close of the 18th century, *Laplace* doubtless considered it sufficient to deal with expressions which give the forces acting on the planets, without inquiring into the geometrical nature and physical mechanism involved in the generation of these forces, which were then believed to lie beyond the reach of the investigator.

After the development of *Faraday's* Experimental Researches in Electricity, and *Maxwell's* mathematical interpretation of these results, very different views came to be entertained by geometers and natural philosophers. Yet it was only the developments brought out in the »Electrod. Wave-Theory of Phys. Forc.«, which seemed to justify definite expectations of forming clear geometrical and physical conceptions of the mechanism involved in the action of the magnetic and the planetary forces across space. Recently these conceptions have been verified and extended, and therefore we shall here attempt to give a geometrical and physical interpretation of the potential which so long proved bewildering to the physical mathematician.

In the »Electrod. Wave-Theory of Phys. Forc.«, 1917, p. 134, it is pointed out that if waves be the basis of physical action across space, then the amplitude of such waves when propagated spherically and without resistance, in tridimensional space, will be given by the equation:

$$A = k/r. \quad (26)$$

In an address to the Academy of Sciences of St. Louis, Sept. 21, 1917, I gave this simple formula and pointed out its geometrical and physical significance. Professors *F. E. Nipher*, *E. A. Engler* and other physicists were present and showed great interest in the results announced, from which it would appear that this law had largely or entirely escaped the notice of earlier investigators.

Now by comparing this expression (26) with that in (25) above, we notice that the wave amplitude has the same form as the potential defined by *Laplace* in 1782. The question thus arises: Can the coincidence in form be due to chance, or is the potential in fact an analytical expression for the total aether stress due to the superposition of waves from all the atoms, each of the waves being of the average wave amplitude, appropriate to the coordinates in the field of force about an attracting mass? To get at the truth in this interesting inquiry, we notice that *Laplace's* formula of 1782 integrates the mass of every particle of the attracting body, divided by its distance, which corresponds to a summation of the effects due to the superposed wave amplitudes and thus increases directly as the mass, each set of waves superposed from the atoms in any element $\sigma dx dy dz/r$, being independent of all the rest, but the triple integral including the accumulated wave action of the whole mass:

$$V = M/r = \iiint \{ \sigma / V [(x-x')^2 + (y-y')^2 + (z-z')^2] \} dx dy dz. \quad (25)$$

The elements under the integral signs represent the individual potentials of every particle, and thus the potential increases directly as the mass whose wave-effects are integrated. This conforms rigorously to our conceptions of the *Newtonian* law of attraction, and involves no approximation,

since the element of mass $dm = \sigma dx dy dz$ can be made so small as to apply to every single particle or atom.

At first sight the mere fact that the potential V as thus defined follows the law of wave amplitude in tridimensional space strikingly suggests that the wave-theory represents the order of nature. To find out by exact calculation what is the probability of such a coincidence occurring by mere chance, we may proceed as follows.

Taking the expressions for two independent curves, the amplitude and the potential, we have:

$$A = y = k/x, \quad V = y = M/x. \quad (27)$$

It will be noticed that they belong to the same geometrical species — both being rectangular hyperbolas referred to their asymptotes — and can be made identical throughout, from $x = 0$ to $x = \infty$, by introducing a summation Σ , such that $\Sigma k = M$.

Accordingly it appears that by the mere variation of a parameter the curves are made to coincide rigorously, point by point, from $x = 0$ to $x = \infty$. Therefore the chances against such a rigorous coincidence accidentally occurring throughout infinite space, $x = 0$ to $x = \infty$, becomes infinity to one, or,

$$C = \int_0^{\infty} dx = \infty \quad (28)$$

and thus its actual occurrence points unmistakably to a true law of nature.

It seems therefore certain and incontestible that the potential represents geometrically and physically the total accumulated stress due to the whole mass under the average wave amplitude of the field about the attracting body in question.

It is to be noticed also that physically our definition of the potential confirms this conclusion: In free space there is no cause to alter the spherical distribution of the waves, as they expand with increase of r . But in or near the shadows of the earth, as shown in the »Electrod. Wave-Theory of Phys. Forc.«, a circular refraction of the sun's waves will necessarily occur. The sun's potential varies, even at a constant distance, near the shadow of the earth; and owing to this refraction, fluctuations of the moon's motion should arise near the time of lunar eclipses, as fully explained in this work of 1917. This circular refraction of the electrodynamic waves in passing through the earth's mass changes the potential or total accumulated stress due to the integration of the waves from all the atoms, under the average wave amplitude and distribution of the waves in the space near the shadow of the earth: and therefore also the sun's forces acting on the moon.

Partially released from the sun's control, by the interposition of the body of the earth, with its refractions of the sun's wave-field, the moon tends to fly the tangent while traversing the region of the shadow cone, and thus arise the fluctuations of the moon's mean motion, connected with lunar eclipses, which long perplexed *Laplace*, *Hansen*, *Newcomb*, *Hill*, *Brown* and other astronomers.

8. Explanation of the Propagation of the Wireless Waves around the Earth.

In the unpublished manuscript sent by the writer to the Royal Society in November, 1914, which was the first

outline of the »Electrod. Wave-Theory of Phys. Forc.« the following figure was used to illustrate the propagation of wireless waves around the earth.

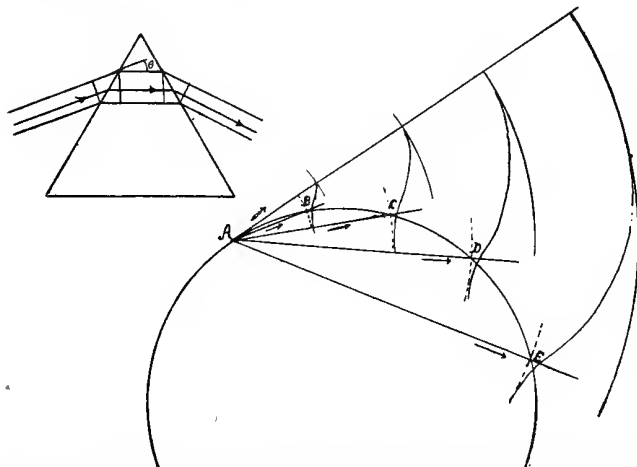


Fig. 2. Illustration of the refraction of the wireless wave about the earth, and of light in a prism, owing to slower propagation of waves in dense masses.

It is a sufficient explanation of this figure to say that it corresponds exactly with the propagation of light through a glass prism, as shown in the figure of the prism above. The wireless waves travel faster in air than through the solid earth. The enormous elasticity of the aether, as set forth in section 4, prevents bodily rupture of the medium; and this secures continuity of the wave front, by bending the surface backward near the globe, to correspond to the slower propagation in that dense mass. The retardation of the waves propagated straight through the earth causes the wave front to be bent and held back near the curved surface of the earth, and thus the wireless wave is refracted around the earth by the much greater resistance encountered in that solid mass.

The correct theory of the bending of the wireless wave about the globe is thus the same as that of a ray of light by a prism, as shown in the accompanying figure. The speed in the air is 4, but in the glass only 3, and thus there is a bending of the wave front through the angle θ when the light enters the glass, and also when it leaves the glass, as long recognized by physical investigators.

The explanation of the refraction of light in a prism is directly confirmed by *Foucault's* celebrated experiment on the relative velocity of light in air and in water, (*Annales de Chim. et de Phys.* Sér. 3, t. 41, 1854), which has always been recognized as a crucial test of the wave theory of light, and which finally led to the total rejection of the emission theory.

The simplicity of the above explanation of the propagation of wireless waves about the globe is thus remarkable. But it is also confirmed experimentally by observations made by officers of the American Navy, upon wireless waves sent from Mare Island to San Diego, California, and received by submarines lying on the bed of the sea, through a depth of some 30 metres of sea water. In some experiments with the receiving apparatus underground the same effect was observed.

It appears that the earth also conducts the signals, so that wireless apparatus may be installed and used in deep mines, which would enormously increase the power of signalling in case of accidents interrupting communication by the shafts and tunnels.

It is probable, however, that the irregularity in the structure and conducting power of the earth's strata would somewhat handicap such underground signalling, yet not prevent the successful development of the method of signalling through the earth to the limited depths at which miners work.

The problem of explaining the propagation of wireless waves about the earth has hitherto challenged the ingenuity of the foremost mathematicians. It has been unsuccessfully attacked by Professor *H. M. Macdonald* (*Proc. Roy. Soc.* 1903 and *Phil. Trans.* 1910), Lord *Rayleigh* and Prof. *H. Poincaré* (*Proc. Roy. Soc.* 1903). See also *Poincaré's* Lectures of 1908 (*La Lumière Électrique*, vol. 4, 2nd series, Nov. 28, Déc. 5, 12, 19, 1908, especially p. 323). Professor *A. Sommerfeld* (*Ann. der Phys.*, vol. 28, p. 665, 1909) has shown that a surface wave should exist; and Professor *J. W. Nicholson* (in the *Phil. Mag.*, March, April, May, 1910) has dealt with certain problems of the exponential factor of the wave amplitude, but none of these eminent mathematicians arrived at any satisfactory theory of wave propagation about the globe.

In his well known work on the *Principles of Electric Wave Telegraphy and Telephony*, London, 3rd edition, 1916, p. 826-851, Professor *J. A. Fleming* gives a full and accurate account of the difficulty experienced by these and other mathematicians. In this revised edition of 1916, *Fleming* gives the following: »General conclusions as to the mode of propagation of long electric waves round the earth«.

»Summing up the conclusions so far reached by radiotelegraphists we may say that the effect produced by a radiotelegraphic transmitter at a great distance, say 2000 or 6000 miles over the surface of the earth, is a complex one in which several different actions play a part«.

»There is, first, a propagation through the aether of a true space electromagnetic wave which is diffracted round the earth. The extent to which this contributes to the whole effect is, perhaps, greater than was formerly supposed, but is yet an undetermined quantity. Some mathematicians are now inclined to attribute to it the major portion of the transmission by day«.

»Then in the next place there is undoubtedly a contribution made to the effect by waves which have suffered a refraction equivalent to a reflection by ionized air at high altitudes, and a very small effect due to the decrease in refractive index of air as we ascend upwards«.

»These causes tend to make the ray follow round the curvature of the earth and so assist as it were diffraction. It is to this variable ionic refraction that we must attribute the diurnal and annual variations in signal strength, and also the greater signalling distance by night as well as the irregularities attending the transition times of sunrise and sunset«.

»Then in addition we may inquire how far any contribution is made by a surface wave of the type investigated by *Sommerfeld*, which is equivalent to an electric wave propagated through or along the earth«.

»It has been definitely proved that we can receive signals from stations hundreds of miles away without any high receiving aerial, but merely by connecting one terminal of the receiving circuit to earth, and the other terminal to any large well-insulated mass of metal, whether inside or outside of a house does not matter«.

If I understand the difficulties so lucidly outlined by *Fleming*, they will be found to have proceeded from the inadequate theory of the aether heretofore in use, the discussion being based upon diffraction around the earth, instead of upon refraction and dispersion within the denser mass of the earth, and thus a bending of the wave front. This will sufficiently justify this quotation, since it is essential that the difficulties heretofore encountered should be authoritatively described. The reader can then judge as to whether a simpler and more practicable solution of this problem has been obtained.

As to the feebleness of wireless transmission by day, I have reached the settled conviction that it results from the magnetic wave field of the sun. When this storm of waves fills our air by day, the wireless waves have great difficulty in getting through, — just as any system of regular water waves in a lake, used for signalling across it, would be almost lost in distinctness, owing to the surface churning of the lake under the violence of a wind storm. The transmission is more difficult with the distance, and, after a certain distance, entirely fails. At night the sun's magnetic wave field is largely absent, and thus wireless transmission is much better.

It only remains to add that the celebrated argument of *Cauchy*, to the effect that refractive dispersion of light necessarily implies a granular structure in the transparent matter, is equally valid for showing that the aethereal medium itself is corpuscular. In his Popular Lectures and Addresses 1. 190, Lord *Kelvin* has modified *Cauchy's* theory of refractive dispersion in his usual lucid manner. It is believed that the considerations adduced in this paper will render the arguments of both *Cauchy* and *Kelvin* somewhat more definite and interesting.

When the aetheron is so small, and moving so rapidly, the generation and propagation of waves in the aether is intelligible. The refractive dispersion, by the resistance to the waves from the much larger molecules of ordinary matter, is easily understood; and thus refractive dispersion implies in common matter, coarser granules than those of the medium itself, but yet points to the moving aetherons as easily deranged by the resistance of the waves dispersed.

It will be shown hereafter that resistance soon changes the form of the wave, and causes it to break up into two distinct parts, the larger having increased amplitude, and shorter length, hence encountering more resistance than the original wave. It is certain therefore that we not only have retardation in the propagation through the earth, but also dispersion of the fragmentary waves, and absorption of some of their energy as heat.

9. Outlines of the Wave-Theory of Magnetism, with explanation of the mechanism of Attraction and Repulsion.

For the sake of completeness the present investigation requires a brief notice of the cause of attraction and repulsion in magnets, and in electrodynamic action, as first outlined in the vol. 1, *Electrod. Wave-Theory of Phys. Forc.*, 1917. Accordingly we begin with magnetism, which the celebrated English physicist *Maxwell* had been so long engaged upon, but had failed to solve at the time of his death 40 years ago.

The accompanying figure from the work of 1917 will illustrate to the eye the essential character of a magnet, as conceived in the wave-theory of physical forces. A large magnet *A* is exhibited in the same field with two smaller magnets, *B*. In the first case unlike poles are presented, and we have mutual attraction. In the second case the poles presented are like, with the well known result of mutual repulsion. But how does this attraction and repulsion come about? What mechanism is involved, and in what medium does it work? Obviously the medium is the aether, because an electric current produces a magnet from a piece of steel wound in a solenoid, and because also the electrodynamic action of a current travels with the velocity of light, as was first inferred by *Maxwell*, and afterwards proved by experiment.

A) In the case of attraction, it will be seen that the waves from the small magnet *B* have the elements of the aether rotating in the opposite direction to the rotations in the more fully outlined waves from the magnet *A*. The plane waves from *A* are to be imagined, for the sake of simplicity, in the central plane, or equator, and travelling away with the velocity of light, — for the reason just assigned in electrodynamic action, by which magnets are produced.

As shown graphically by the curve traced just above the heavy waves in the figure, the amplitude of these receding waves decreases according to the law:

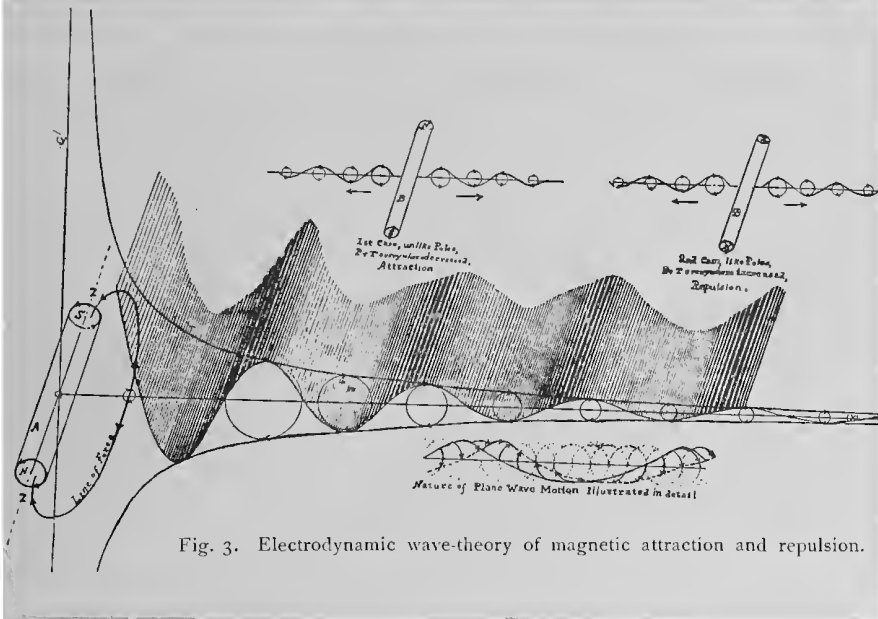


Fig. 3. Electrodynamic wave-theory of magnetic attraction and repulsion.

$$A = k/r \quad (29)$$

and as the force due to wave action is shown, in works on physics, to be proportional to the square of the amplitude, we have for the force:

$$f = k^2/r^2 \quad (30)$$

which is the form of law for gravitation, magnetism, and all similar forces of nature obeying the law of the inverse squares.

Now let the waves from magnet *B* interpenetrate the waves from magnet *A*. It will be seen that at every point of space the rotations of the elements of the two sets of waves are exactly opposite: the result is that the rotations from magnet *B* undo as far as possible the opposite rotations from magnet *A*. Accordingly the stresses in the medium due to rotations of the aether, in the field between *A* and *B*, and also beyond *A* and *B*, are reduced: the medium is thus everywhere less agitated than before, and shrinks, so as to collapse or contract between *A* and *B*. But a collapse of the aether is equivalent to a contraction, and thus the two bodies attract as if held together by a stretched mass of india rubber. This is a simple and direct explanation of attraction. Nothing is postulated except waves like those known to exist in light and heat, but here seen to be exactly parallel and somewhat differently directed from those of light and heat, which usually have their planes tilted in haphazard fashion.

B) The cause of repulsion is similar to that of attraction, but in this case the poles presented are like; and if we examine the above diagram, we discover that when the waves from magnet *B*, 2nd case, interpenetrate the waves from magnet *A*, the rotations at every point will be conformable and in the same direction. The medium therefore at every point is more agitated than before. The amplitudes of the disturbed waves are thereby increased, and hence there is an increase of stress; and under the elasticity of the aether the result is an expansion of the medium, which gives a mutual repulsion of the two bodies.

This is a simple explanation of repulsion, and it had never been worked out prior to the researches published by the writer in 1917. *Maxwell* was unable to conceive of any mechanism for the explanation of attraction and repulsion of magnets, though he found that mathematical stresses of a certain type, yielding tension along the lines of force and pressure at right angles thereto, thus dynamically equivalent to those outlined above, would account for the phenomena of magnetism.

It is true that *Maxwell* believed that there are rotations around the *Faraday* lines of force, as Lord *Kelvin* had also rendered probable as early as 1856; but neither *Kelvin* nor *Maxwell* had seen that this would arise from the type of waves here outlined, though *Faraday's* experiment of 1845, on the rotation of the plane of a beam of polarized light, — when passed along the line of force, through a dense medium such as lead glass, — should have suggested the correct theory of the magnetic waves to *Kelvin* and *Maxwell*, as it did to me in 1916.

As *Maxwell* was unable to unlock the secret of magnetism, with both attraction and repulsion, it will not greatly surprise us to learn that he was utterly bewildered by the

mystery of gravitation, and could not make a successful attack upon this most difficult problem.

In fact no considerable progress as to the cause of gravitation has been made by other investigators since the time of *Newton*. As the subject of gravitation is immense, we must not enter upon it here, except to say that the evidence is most conclusive that it is a wave-phenomenon, closely allied to that of magnetism, but differing from magnetism which has a parallel arrangement of the atoms and what *Airy* calls (*Treatise on Magnetism*, 1870, p. 10) a duality of powers — two poles — while gravitation is a central action only, owing to the haphazard arrangement of the planes of the atoms.

It is well known that about 1822 *Ampère* first made electro-magnets out of common steel, by means of an electric current sent through a solenoid. The way in which the wire is wound about the bar being magnetized suggests, and, in fact, proves that the wire bearing the current has a wave-field about it. There is proof that the waves are flat in the planes through the axis of the wire: this conception harmonizes all the known phenomena of magnetism, in relation to electro-dynamic action, and also harmonizes *Ampère's* theory of elementary electric currents about the atoms with the wave-theory of magnetism above set forth.

The wave-theory of magnetism explains all the phenomena of terrestrial magnetism, in relation to the periodic influences of the sun and moon, such as magnetic storms, earth currents, the aurora, and the semi-diurnal magnetic tide depending on the moon, of which no other explanation is known. For the dependence of magnetic storms on sunspots consult a paper by the author, in the *Bulletin Société Astr. de France*, November, 1918.

There has been such a bewildering confusion of thought connected with the whole subject of physical action across space that it is necessary to bear in mind clearly the fundamental principles of natural philosophy. In the well known article on attraction, (*Scientific Papers*, vol. 2.487), *Maxwell* points out that in the *Optical Queries* included in the third edition of the *Optics*, 1721, *Newton* shows that if the pressure of the aethereal medium is less in the neighborhood of dense bodies than at great distances from them dense bodies will be drawn towards each other, and if the diminution of pressure is inversely as the distance from the dense body, the law will be that of gravitation. *Maxwell* considers that *Newton's* conception rests largely on the idea of hydrostatic pressure, as in incompressible liquids. But we have shown that the amplitude of the waves, $A = k/r$, with forces $f = k^2/r^2$, fulfills the condition which *Newton* held to be essential.

10. Integration of the General Differential Equations of an Elastic Solid, which applies to the Aether, when this Medium is viewed as an Infinite Aeolotropic Elastic Solid propagating Waves.

As is usual in the theory of an elastic solid, let *m* denote a function of the bulk modulus *k*, and of the rigidity *n*, such that

$$m = k + \frac{1}{3}n. \quad (31)$$

Then $k = m - \frac{1}{3}n$, and this bulk modulus measures the elastic force called out by, or the elastic resistance against, change of volume. On the other hand the »compressibility« is measured by

$$\frac{1}{k} = \frac{1}{m - \frac{1}{3}n}. \quad (32)$$

Let α, β, γ be the component displacements experienced by a particle, so that when undisturbed the coordinates are x, y, z , and when disturbed $x+\alpha, y+\beta, z+\gamma$. Then a strain of any magnitude is specified by six elements:

$$\begin{aligned} A &= \left(\frac{\partial\alpha}{\partial x} + 1\right)^2 + \left(\frac{\partial\beta}{\partial x}\right)^2 + \left(\frac{\partial\gamma}{\partial x}\right)^2 & a &= \frac{\partial\alpha}{\partial y} \frac{\partial\alpha}{\partial z} + \left(\frac{\partial\beta}{\partial y} + 1\right) \frac{\partial\beta}{\partial z} + \frac{\partial\gamma}{\partial y} \left(\frac{\partial\gamma}{\partial z} + 1\right) \\ B &= \left(\frac{\partial\alpha}{\partial y}\right)^2 + \left(\frac{\partial\beta}{\partial y} + 1\right)^2 + \left(\frac{\partial\gamma}{\partial y}\right)^2 & b &= \frac{\partial\alpha}{\partial z} \left(\frac{\partial\alpha}{\partial x} + 1\right) + \frac{\partial\beta}{\partial z} \frac{\partial\beta}{\partial x} + \left(\frac{\partial\gamma}{\partial z} + 1\right) \frac{\partial\gamma}{\partial x} \\ C &= \left(\frac{\partial\alpha}{\partial z}\right)^2 + \left(\frac{\partial\beta}{\partial z}\right)^2 + \left(\frac{\partial\gamma}{\partial z} + 1\right)^2 & c &= \left(\frac{\partial\alpha}{\partial x} + 1\right) \frac{\partial\alpha}{\partial y} + \frac{\partial\beta}{\partial x} \left(\frac{\partial\beta}{\partial y} + 1\right) + \frac{\partial\gamma}{\partial x} \frac{\partial\gamma}{\partial y} \end{aligned} \quad (33)$$

All particles in an unstrained state, which lie on a spherical surface:

$$r_1^2 = \xi_1^2 + \eta_1^2 + \zeta_1^2 \quad (34)$$

will, in a strained state, lie on an ellipsoidal surface:

$$A\xi^2 + B\eta^2 + C\zeta^2 + 2a\eta\xi + 2b\zeta\xi + 2c\xi\eta = r_1^2 \quad (35)$$

Accordingly, if the external forces at $P(x, y, z)$ along the axes of x, y, z , be X, Y, Z , per unit of mass, and the internal stresses be:

$$\begin{aligned} \left(\frac{dp_{xx}}{dx} + \frac{dp_{yx}}{dy} + \frac{dp_{zx}}{dz}\right) dx dy dz &= \left(\frac{dP}{dx} + \frac{dU}{dy} + \frac{dT}{dz}\right) dx dy dz \\ \left(\frac{dp_{xy}}{dx} + \frac{dp_{yy}}{dy} + \frac{dp_{zy}}{dz}\right) dx dy dz &= \left(\frac{dU}{dx} + \frac{dQ}{dy} + \frac{dS}{dz}\right) dx dy dz \\ \left(\frac{dp_{xz}}{dx} + \frac{dp_{yz}}{dy} + \frac{dp_{zz}}{dz}\right) dx dy dz &= \left(\frac{dT}{dx} + \frac{dS}{dy} + \frac{dR}{dz}\right) dx dy dz \end{aligned} \quad (36)$$

Then the equilibrium of all the forces, internal and external, leads to the following equation:

$$\begin{aligned} \left(\frac{dp_{xx}}{dx} + \frac{dp_{yx}}{dy} + \frac{dp_{zx}}{dz} + \rho X\right) dx dy dz &= \left(\frac{dP}{dx} + \frac{dU}{dy} + \frac{dT}{dz} + \rho X\right) dx dy dz = 0 \\ \left(\frac{dp_{xy}}{dx} + \frac{dp_{yy}}{dy} + \frac{dp_{zy}}{dz} + \rho Y\right) dx dy dz &= \left(\frac{dU}{dx} + \frac{dQ}{dy} + \frac{dS}{dz} + \rho Y\right) dx dy dz = 0 \\ \left(\frac{dp_{xz}}{dx} + \frac{dp_{yz}}{dy} + \frac{dp_{zz}}{dz} + \rho Z\right) dx dy dz &= \left(\frac{dT}{dx} + \frac{dS}{dy} + \frac{dR}{dz} + \rho Z\right) dx dy dz = 0 \end{aligned} \quad (37)$$

These are the general equations of equilibrium of an elastic solid, when subjected to strain by any system of forces, internal and external.

For an isotropic solid, the equations become much simplified. Using $m = k + \frac{1}{3}n$, as in (31), we find the well known formulæ for an elastic solid, of density ρ per unit volume, (cf. *Thomson and Tait, Treatise on Natural Philosophy*, edition 1883, § 698)

$$\begin{aligned} m \frac{d}{dx} \left(\frac{\partial\alpha}{\partial x} + \frac{\partial\beta}{\partial y} + \frac{\partial\gamma}{\partial z}\right) + n \left(\frac{\partial^2\alpha}{\partial x^2} + \frac{\partial^2\alpha}{\partial y^2} + \frac{\partial^2\alpha}{\partial z^2}\right) + \rho X &= 0 \\ m \frac{d}{dy} \left(\frac{\partial\alpha}{\partial x} + \frac{\partial\beta}{\partial y} + \frac{\partial\gamma}{\partial z}\right) + n \left(\frac{\partial^2\beta}{\partial x^2} + \frac{\partial^2\beta}{\partial y^2} + \frac{\partial^2\beta}{\partial z^2}\right) + \rho Y &= 0 \\ m \frac{d}{dz} \left(\frac{\partial\alpha}{\partial x} + \frac{\partial\beta}{\partial y} + \frac{\partial\gamma}{\partial z}\right) + n \left(\frac{\partial^2\gamma}{\partial x^2} + \frac{\partial^2\gamma}{\partial y^2} + \frac{\partial^2\gamma}{\partial z^2}\right) + \rho Z &= 0 \end{aligned} \quad (38)$$

When an elastic substance is strained, as in the propagation of waves, its different elements undergo changes both of form and of volume.

$$\text{Let } \delta = \partial\alpha/\partial x + \partial\beta/\partial y + \partial\gamma/\partial z \quad (39)$$

denote the amount of dilatation in volume experienced by an element of the substance and put

$$\nabla^2 = d^2/dx^2 + d^2/dy^2 + d^2/dz^2 \quad (40)$$

for the Laplacian operation: then we shall be able to reduce these expressions (38) to the very simple form:

$$\begin{aligned} m \cdot d\delta/dx + n \nabla^2 \alpha + \rho X &= 0 \\ m \cdot d\delta/dy + n \nabla^2 \beta + \rho Y &= 0 \\ m \cdot d\delta/dz + n \nabla^2 \gamma + \rho Z &= 0 \end{aligned} \quad (41)$$

Now when the solid is isotropic, the density may be omitted in these formulæ, or taken as unity. Accordingly if we differentiate these successive equations with respect to

x, y, z respectively, and add the results, we shall get the equation for an Isotropic Solid:

$$(m+n) \nabla^2 \delta + (dX/dx + dY/dy + dZ/dz) = 0 \quad (42)$$

II. Identity of the Dilatation

$$\delta = \partial\alpha/\partial x + \partial\beta/\partial y + \partial\gamma/\partial z$$

with the Potential V for an Infinite Elastic Solid: Confirmation of the Wave-Theory by Lord *Kelvin's* Integrals of 1848.

It is remarkable that under certain conditions, to be more fully discussed hereafter, the equations of an infinite elastic solid admit of a very simple interpretation. This amounts to admitting the identity of the dilatation δ with the potential V , in the case of an infinite elastic solid. Indeed it was upon this tacit assumption, seventy two years ago, that Lord *Kelvin* obtained his celebrated integrals for

an infinite elastic solid (cf. Cambridge and Dublin Mathematical Journal, 1848).

It may be noted that the density of an isotropic solid, which does not vary with the coordinates (x, y, z) , is expressed by the ratio,

$$\rho = [(m+n) \nabla^2 \delta] / (dX/dx + dY/dy + dZ/dz); \quad (43)$$

But by Poisson's equation we have

$$\nabla^2 V + 4\pi \rho = 0 \quad \rho = -\nabla^2 V / 4\pi \quad (44)$$

$$\text{or } \rho = -(1/4\pi) (\partial^2 V / \partial x^2 + \partial^2 V / \partial y^2 + \partial^2 V / \partial z^2). \quad (45)$$

By comparing (43) and (45), we find that if a mass of density,

$$\rho = 1/[4\pi(m+n)] \cdot \left(\frac{dX}{dx} + \frac{dY}{dy} + \frac{dZ}{dz} \right) \quad (46)$$

be distributed throughout space, we may conclude that its potential at (x, y, z) will be identical with the dilatation of the elastic solid substance:

$$\delta = \partial \alpha / \partial x + \partial \beta / \partial y + \partial \gamma / \partial z. \quad (47)$$

For if we divide (42) by $(m+n)$, and subtract from it the first of (44), we get:

$$\nabla^2 \delta + (dX/dx + dY/dy + dZ/dz) / (m+n) - \nabla^2 V - 4\pi \rho = 0 \quad (48)$$

$$\text{which gives } \nabla^2 (\delta - V) = 0 \quad (49)$$

$$\delta = 1/[4\pi(m+n)] \cdot \int_{-\infty}^{+\infty} \int_{-\infty}^{+\infty} \int_{-\infty}^{+\infty} (dX'/dx' + dY'/dy' + dZ'/dz') / V[(x-x')^2 + (y-y')^2 + (z-z')^2] \cdot dx' dy' dz'. \quad (52)$$

$$\text{For the element of the mass is } \rho = 1/[4\pi(m+n)] \cdot (dX'/dx' + dY'/dy' + dZ'/dz') \quad (53)$$

$$\text{and the mutual distances of the elements of mass filling the element of space } dx dy dz \text{ is } r = V[(x-x')^2 + (y-y')^2 + (z-z')^2]. \quad (54)$$

These expressions may be rendered more convenient by integrating by parts, and noticing the prescribed condition of convergence, according to which when x' is infinite,

$$\int_{-\infty}^{+\infty} \int_{-\infty}^{+\infty} X' / V[(x-x')^2 + (y-y')^2 + (z-z')^2] \cdot dy' dz' = 0. \quad (55)$$

And, therefore, for the three components of finite value, resolved along the coordinate axes, and integrated throughout all space, we have:

$$\delta = 1/[4\pi(m+n)] \cdot \int_{-\infty}^{+\infty} \int_{-\infty}^{+\infty} \int_{-\infty}^{+\infty} [X'(x-x') + Y'(y-y') + Z'(z-z')] / V[(x-x')^2 + (y-y')^2 + (z-z')^2] \cdot dx' dy' dz'. \quad (56)$$

We may integrate each of the equations (38) in the same way, for α, β, γ respectively. The result for these displacements is:

$$\alpha = u + U \quad \beta = v + V \quad \gamma = w + W \quad (57)$$

where u, v, w, U, V, W denote the potentials at (x, y, z) of distributions of matter through all space of densities respectively $(m/4\pi n) \partial \delta / \partial x, (m/4\pi n) \partial \delta / \partial y, (m/4\pi n) \partial \delta / \partial z, X/4\pi n, Y/4\pi n, Z/4\pi n.$ (58)

In other words the functions are such that throughout all space

$$\nabla^2 u + (m/n) \partial \delta / \partial x = 0 \quad \nabla^2 U + X/n = 0 \quad \nabla^2 v + (m/n) \partial \delta / \partial y = 0 \quad \nabla^2 V + Y/n = 0 \quad (59)$$

$$\nabla^2 w + (m/n) \partial \delta / \partial z = 0 \quad \nabla^2 W + Z/n = 0.$$

Accordingly, if X'', Y'', Z'' denote the values of X, Y, Z for a point (x'', y'', z'') , we find

$$\alpha = (1/4\pi n) \int_{-\infty}^{+\infty} \int_{-\infty}^{+\infty} \int_{-\infty}^{+\infty} (m \cdot \partial \delta'' / \partial x'' + X'') / V[(x-x'')^2 + (y-y'')^2 + (z-z'')^2] \cdot dx'' dy'' dz''$$

$$\beta = (1/4\pi n) \int_{-\infty}^{+\infty} \int_{-\infty}^{+\infty} \int_{-\infty}^{+\infty} (m \cdot \partial \delta'' / \partial y'' + Y'') / V[(x-x'')^2 + (y-y'')^2 + (z-z'')^2] \cdot dx'' dy'' dz'' \quad (60)$$

$$\gamma = (1/4\pi n) \int_{-\infty}^{+\infty} \int_{-\infty}^{+\infty} \int_{-\infty}^{+\infty} (m \cdot \partial \delta'' / \partial z'' + Z'') / V[(x-x'')^2 + (y-y'')^2 + (z-z'')^2] \cdot dx'' dy'' dz''.$$

$$\text{if } dX/dx + dY/dy + dZ/dz - 4\pi \rho(m+n) = 0 \quad (50)$$

or the density is defined by the expression:

$$\rho = 1/[4\pi(m+n)] \cdot (dX/dx + dY/dy + dZ/dz). \quad (51)$$

This specifies the density throughout space of the infinite isotropic solid, that of the finite solid body in (41) being unity per unit of volume.

To reach Lord Kelvin's result most directly, we let R denote the resultant of the forces, X, Y, Z , at any point (x, y, z) , at the distance $r = V(x^2 + y^2 + z^2)$ from the origin, whether discontinuous and vanishing in all points outside some finite closed surface, or continuous and vanishing at all infinitely distant points with sufficient convergency to make Rr converge to 0 as r increases to ∞ . Then the convergency of Xr, Yr, Zr to zero, when r is infinite, clearly makes $V = 0$ for all infinitely distant points. Accordingly, if S be any closed surface round the origin of coordinates, everywhere infinitely distant from it, the function $(\delta - V)$ is zero for all points of it, and satisfies the equation $\nabla^2 (\delta - V) = 0$ for all points within it. Therefore $\delta = V$ throughout the infinite isotropic solid.

Now let X', Y', Z' denote the values of X, Y, Z at any point (x, y, z) , and by a triple integration throughout all space, we shall have for the potential V or dilatation δ :

By substituting for δ'' its value in (56), we obtain expressions for α, β, γ depending on the sums of a sextuple integral and a triple integral, the integrations having to be performed from $-\infty$ to $+\infty$:

$$\begin{aligned}\alpha &= \frac{1}{4\pi n} \iiint \left\{ m \frac{d}{dx} \left[\frac{-1}{4\pi(m+n)} \iiint \frac{X'(x''-x') + Y'(y''-y') + Z'(z''-z')}{\sqrt{[(x''-x')^2 + (y''-y')^2 + (z''-z')^2]^{3/2}}} dx' dy' dz' + X'' \right] dx'' dy'' dz'' \right\} \\ \beta &= \frac{1}{4\pi n} \iiint \left\{ m \frac{d}{dy} \left[\frac{-1}{4\pi(m+n)} \iiint \frac{X'(x''-x') + Y'(y''-y') + Z'(z''-z')}{\sqrt{[(x''-x')^2 + (y''-y')^2 + (z''-z')^2]^{3/2}}} dx' dy' dz' + Y'' \right] dx'' dy'' dz'' \right\} \\ \gamma &= \frac{1}{4\pi n} \iiint \left\{ m \frac{d}{dz} \left[\frac{-1}{4\pi(m+n)} \iiint \frac{X'(x''-x') + Y'(y''-y') + Z'(z''-z')}{\sqrt{[(x''-x')^2 + (y''-y')^2 + (z''-z')^2]^{3/2}}} dx' dy' dz' + Z'' \right] dx'' dy'' dz'' \right\}\end{aligned}\quad (61)$$

Lord Kelvin shows how to simplify these sextuple integrals, and obtains the following general solution for the displacements produced by any distribution of force through an infinite elastic solid filling all space (limits of integration as before $-\infty$ and $+\infty$):

$$\begin{aligned}\alpha &= \frac{1}{24\pi n(m+n)} \iiint \left\{ \frac{2(2m+3n)X'}{\sqrt{[(x-x')^2 + (y-y')^2 + (z-z')^2]} - m[(x-x')^2 + (y-y')^2 + (z-z')^2]} \frac{d}{dx} \frac{X'(x-x') + Y'(y-y') + Z'(z-z')}{[(x-x')^2 + (y-y')^2 + (z-z')^2]^{3/2}} \right\} dx' dy' dz' \\ \beta &= \frac{1}{24\pi n(m+n)} \iiint \left\{ \frac{2(2m+3n)Y'}{\sqrt{[(x-x')^2 + (y-y')^2 + (z-z')^2]} - m[(x-x')^2 + (y-y')^2 + (z-z')^2]} \frac{d}{dy} \frac{X'(x-x') + Y'(y-y') + Z'(z-z')}{[(x-x')^2 + (y-y')^2 + (z-z')^2]^{3/2}} \right\} dx' dy' dz' \\ \gamma &= \frac{1}{24\pi n(m+n)} \iiint \left\{ \frac{2(2m+3n)Z'}{\sqrt{[(x-x')^2 + (y-y')^2 + (z-z')^2]} - m[(x-x')^2 + (y-y')^2 + (z-z')^2]} \frac{d}{dz} \frac{X'(x-x') + Y'(y-y') + Z'(z-z')}{[(x-x')^2 + (y-y')^2 + (z-z')^2]^{3/2}} \right\} dx' dy' dz'.\end{aligned}\quad (62)$$

This whole investigation is based upon the integration of the general equations for an infinite isotropic elastic solid: which implies that the density throughout all space shall be equal to ρ as defined by (46).

Lord Kelvin's definition of X, Y, Z as any arbitrary functions whatever of (x, y, z) , either discontinuous and vanishing at all points outside some finite closed surface, or continuous and vanishing at all infinitely distant points with sufficient convergency to make the product of their resultant $R = \sqrt{X^2 + Y^2 + Z^2}$, by the distance

$$r = \sqrt{[(x-x')^2 + (y-y')^2 + (z-z')^2]}$$

namely R/r , converge to zero as r approaches infinity, implies that the density may vary through changes in the differential elements $dX/dx + dY/dy + dZ/dz = \nabla^2 W$ (63) as shown below.

But no other changes than those in $\nabla^2 W$, the Laplacian operation on the potential can occur; and even this is chiefly at the boundaries of solid bodies. Accordingly it becomes advisable to investigate these possible changes a little more closely.

12. Geometrical and Physical Conditions which the Forces generated must satisfy.

Suppose X, Y, Z to denote the components of the forces acting on an element of the solid $dm = \rho dx dy dz$, temporarily imagined to be fluid at (x, y, z) , reckoned per unit of the mass. Then the difference of the pressures on the two faces $\delta y \delta z$ of the rectangular parallelepiped of the fluid is

$$\delta y \delta z (d\mathfrak{p}/dx) dx \quad (64)$$

and this fluid element will be in equilibrium when the

following equations are satisfied:

$$\begin{aligned}\delta y \delta z (d\mathfrak{p}/dx) dx - X \delta x \delta y \delta z &= 0 \\ \delta z \delta x (d\mathfrak{p}/dy) dy - Y \delta x \delta y \delta z &= 0 \\ \delta x \delta y (d\mathfrak{p}/dz) dz - Z \delta x \delta y \delta z &= 0;\end{aligned}\quad (65)$$

which give the necessary and sufficient condition for the equilibrium of any fluid mass:

$$d\mathfrak{p}/dx = X \quad d\mathfrak{p}/dy = Y \quad d\mathfrak{p}/dz = Z. \quad (66)$$

From these equations we obtain immediately

$$\begin{aligned}d\mathfrak{p} &= d\mathfrak{p}/dx \cdot dx + d\mathfrak{p}/dy \cdot dy + d\mathfrak{p}/dz \cdot dz \\ &= \rho (X dx + Y dy + Z dz).\end{aligned}\quad (67)$$

This equation shows that $X dx + Y dy + Z dz$ is the completed differential of a function $\mathfrak{p}(x, y, z)$ of three independent variables, or may be made so by a factor. Physically this is equivalent to concluding that the pressure in the fluid is along the lines of force, and thus a series of surfaces exists which cuts the lines of force at right angles. If the forces belong to a conservative system, say when a gravitational mass has attained a state of internal equilibrium, as in the theory of the figures of the heavenly bodies, no factor is required to render the differential complete, and we may put

$$X dx + Y dy + Z dz = -dV \quad (68)$$

or by (67) $d\mathfrak{p} = -\rho dV$. (69)

This expression shows that the pressure \mathfrak{p} is constant over the equipotential surfaces,

$$\rho = -d\mathfrak{p}/dV \quad (70)$$

and the density also is a function of the potential V . This condition arises when the density of the body is uniform, over the equipotential surfaces, for the distribution of force

to which the components (P, Q, R) belong — corresponding to a homogeneous elastic solid, or a mass of incompressible liquid held in a rigid vessel, with the density so distributed as to be in equilibrium. The second equation of (67) is satisfied by this condition, and we have,

$$dX/dx + dY/dy + dZ/dz = \nabla^2 W \quad (71)$$

Accordingly by (42) we have the original equation of an elastic solid:

$$(m+n) \nabla^2 \delta + \nabla^2 W = 0 \quad (72)$$

which is satisfied by the assumption $\delta = -W/(m+n)$.

The Aether as an Infinite Elastic Solid.

Hence if this analysis applies to the aether, as an infinite elastic solid, the density of the medium must be arranged so as to give a potential augmenting about each mass of matter embedded in it, as shown in my Dynamical Theory of Globular Clusters, 1912. This latter condition of the potential is described analytically as follows:

$$\omega = \iiint \frac{\rho \, dx \, dy \, dz}{V[(x-x')^2 + (y-y')^2 + (z-z')^2]} = \int \frac{dm}{r} \quad (73)$$

and the inference, from Dynamical Theory, that the potential is greater towards the centres of matter, finds obvious physical illustration in the accumulated arrangement of globular clusters, with the starlight increasing in brightness till it attains a perfect blaze near the centre, in such splendid globular clusters as 47 Tucani and ω Centauri.

This increase in potential towards the centres occupied by matter can only be attributed to centripetal stresses in the aether: the medium is thus filled with waves receding from these masses, and the density in the agitated medium is inversely as the wave amplitude or directly as the radius (cf. Electrod. Wave-Theory of Phys. Forc. I.134, 157-8, 1917).

Since the dilatation

$$\delta = \partial\alpha/\partial x + \partial\beta/\partial y + \partial\gamma/\partial z \quad (74)$$

is required to fulfil the equation

$$\nabla^2(\delta - V) = \alpha^* \quad (75)$$

where V is the potential, we see at once that the dilatation throughout the aether is similar to the potential. The potential is merely an expression for the total accumulated stress based on average amplitude of the waves, $A = k/r$, and the density $\sigma = \nu r$, and the attractive force $f = k^2/r^2 = \partial V/\partial r = -M/r^2$. This proves the Electrod. Wave-Theory of Phys. Forc. to represent the true order of nature.

Accordingly, we have the following table for the displacement or wave amplitude, density, potential and force:

Displacement or amplitude $A = k/r$	$f = k^2/r^2 = A^2 = \delta^2$ $= \partial V/\partial r = -M/r^2$
Density of the aether $\sigma = \nu r, \nu = 1/k$	
Potential $= V = M/r$	
$V = \delta = A$.	

Since the direction of the force always is central, and the waves react towards the origin at the centre of gravity, we conclude from this whole investigation:

1. That the aether behaves as an infinite aeolotropic elastic solid, with displacements everywhere identical with the electrodynamic wave amplitude δ and also identical with

the potential V . This gives a geometrical and physical significance to the potential, which hitherto has been entirely lacking, and long proved bewildering to the geometer and the natural philosopher.

2. If this were not true, the general equations for an infinite elastic solid could not have been integrated by Lord Kelvin as outlined above (cf. Cambridge and Dublin Mathematical Journal, 1848). But as this celebrated geometer effected such an integration for the general equations of an infinite isotropic elastic solid, without giving a physical interpretation to the solution found, we see that Lord Kelvin's mathematical genius builded better than he knew, and natural philosophers are now enabled for the first time to interpret physically one of the sublimest results in the whole range of mathematical science.

Newton surmised that if the density of the aether varied directly as the distance from the centre, it would press towards the centre so as to develop the force of gravitation. Maxwell holds that Newton conceived this action as analogous to hydrostatic pressure, but we have shown that the reaction of the waves with amplitudes $A = k/r$ produces this arrangement of density and would generate an effect similar to mere hydrostatic pressure (cf. Electrod. Wave-Theory of Phys. Forc., I.134, 1917).

Why the Forces between the Sun and Planets Operate in Right Lines: Weierstrassian Theory of the Resulting Least Action.

a) Imagine waves propagated from the sun and earth as shown in the accompanying diagram: and let the velocities of the mutually interpenetrating waves from the centres S and E be V_1 and V_2 .

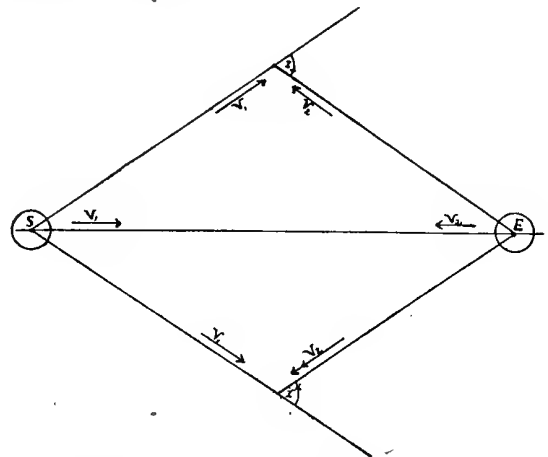


Fig. 4. Illustration of the interpenetration of waves between the sun and earth, which gives maximum tension along the line SE , where the interpenetration is with double the velocity of light.

The problem arises as to the effect of the relative interpenetration of the waves, the velocities V_1 and V_2 being equal, but the amplitude and direction of propagation different at every point of space.

*) By referring to fig. 1, section 2, we see the physical meaning of this equation: the aether has dilatation, $\delta = V$, near the sun, owing to the increasing amplitude of the waves. This dilatation and decreased density of the medium exists about every star and planet.

β) It is obvious that between the bodies in the right line *SE*, we shall have for the relative velocity of the wave interpenetration $\Omega_i = V_1 + V_2 = 2V$. (76)

But on either side of the line *SE* the value of Ω_i will be less than in that line, where Ω_i^* becomes a maximum, double the velocity of light. For the two radii vectores ρ_1 and ρ_2 meet at an angle *I*, and the relative velocity of the interpenetration in general will be:

$$\Omega_i = V_1 + V_2 \cos I. \quad (77)$$

γ) It is only between the bodies in the line *SE* that $\cos I = 1$, and the velocity of the relative interpenetration is a maximum. When the radii vectores meet at right angles, the angle $I = 90^\circ$, and $\cos I = 0$, so that $\Omega_i = V_1$, only, or V_2 only, as the case may be. If the angle *I* exceeds 90° , the addition in (77) becomes negative, and the value of Ω_i is less than V_1 , or V_2 separately. And when $\cos I = 180^\circ$, the addition gives $\Omega_i = V_1 - V_2 = 0$. (78)

δ) From this reasoning it follows that:

- a) If the medium contracts owing to the mutual interpenetration of waves, the contraction will be a maximum in the right line *SE* where Ω_i is a maximum.
- b) The contraction will be zero when $I = 180^\circ$, and thus the tension in the medium is wholly between the bodies, or on either side of the line connecting them. It is zero in the line *SE* prolonged, but as the waves here superpose, the pressure or stress will increase externally.

ε) This accords with experience in gravitational, magnetic, and electrodynamic forces, etc. And as the theory of least action is recognized to hold generally in nature, this geometrical plan of the contraction of the medium, under mutual wave interpenetration, must be held to conform to the rigorous criterion of least action or maximum wave interpenetration. This function attains the maximum with least action of the forces thereby developed; and according to the geometrical methods of *Weierstrass*, this points to a rigorous mathematical law.

ζ) It is not accidental that the mutual wave interpenetration should be a maximum between the bodies, in the line *SE*, a minimum in the line *SE* prolonged. For as the aether is under an elastic power of 698321600000 times greater than that of air in proportion to its density, the medium will always contract to the maximum extent possible, and thus pull in the right line connecting the two bodies *SE*. Hence if the postulated waves exist, the waves superposed being accumulated with the mass, they will fully explain the stupendous gravitational forces which govern the motions of the planets.

Starlight on Loutre, Montgomery City, Missouri, 1920 Jan. 14.

Zusatz. Am 25. April sandte Herr Prof. See telegraphisch folgende Nachricht: »Have discovered from wave theory new method for determining density of aether, only advance since Lord *Kelvin's* method 1854. Now find density 472×10^{-18} against 438×10^{-18} by *Kelvin's* method. See.«

η) That the waves exist is obvious from several considerations:

- a) Forces can only result from maximum tension in the line *SE*, and this implies interpenetration of waves; for no other cause could produce this effect, whereas waves certainly would do so.
- b) Waves also make gravitational forces conform to other physical forces, according to the recognized law of conservation of energy.
- c) When a known general cause exists, it must be held to be the true cause; in default of any other known cause.
- d) The probability is infinity to one that no cause other than a true one could fulfill all the geometrical conditions of gravitational forces without resting on the true laws of nature.

θ) As the wave-theory harmonized all gravitational phenomena under the recognized criteria of least action, and without the introduction of any mystical hypothesis, it must, from geometrical and physical laws, be held to represent the true order of nature.

In closing this first paper it remains to add that the second paper will deal with the Fourier solutions of the celebrated equation of *Poisson* (*Traité de Mécanique*, 2.697, 1833).

$$d^2 \Phi / dt^2 = a^2 \nabla^2 \Phi \quad \Phi(x, y, z, t)$$

where Φ is a scalar quantity, and *a* the velocity of wave propagation. This applies to wave motion in normal gases, the aether, and an elastic solid. As the aether is a gas, but under such elastic forces, that it behaves as an elastic solid for quick acting forces, and is of infinite extent, while on the other hand Lord *Kelvin's* integration of the general equations of an infinite elastic solid likewise confirms this conclusion, the deductions thus brought out will establish the wave-theory with the required geometrical rigor. The outstanding motion of the perihelion of Mercury, and of the lunar perigee, together with the lunar fluctuations, under the Newtonian law, as generalized by *Weber* in 1846, will harmonize every known celestial phenomena without the introduction of any mystical hypothesis.

In the third and fourth papers I hope to give a simplified view of certain outstanding electrical problems and of *Michelson* and *Lodge's* experiments, and throw a very unexpected, but searching light on the nature of molecular forces. Thus the several fields covered will lead us to apply the wave-theory to such varied phenomena of nature, that it may not be without interest to both the geometer and the natural philosopher.

I am indebted to Mr. *W. S. Trankle*, for efficient aid in completing these researches.

T. J. J. See.

I. Gravitational Action propagated with the Velocity of Light.

In the first paper on the New Theory of the Aether, AN 5044, we have shown that the existence of this medium is a necessary condition for conveying physical action from one body to another across the celestial spaces, and have given the elements of the kinetic theory of the aether-gas as the subtle vehicle of energy. *Maxwell* had a very clear conception of this medium 47 years ago, when he pointed out, in the closing paragraph of the celebrated Treatise on Electricity and Magnetism, 1873, vol. II, p. 493, that »whenever energy is transmitted from one body to another in time there must be a medium or substance in which the energy exists after it leaves one body and before it reaches the other«.

No better description can be given of the aether, as the vehicle of energy, than that just quoted. And since *Maxwell* says that the energy must exist in the medium, after it has left one body, but before it has reached the other, owing to the propagation in time, we see that this energy obviously must be conveyed through the agency of waves travelling with the velocity of light, just as radiant heat from the sun and electrodynamic action travel with the same velocity, 300 000 kms per second.

From the celebrated letter of *Gauss* to *Weber*, March 19, 1845, (*Gauss*, Werke 5.629) we learn that as early as 1835 *Gauss* looked upon physical action across space as conveyed in time, and was trying to formulate a law of this action, but put it aside temporarily, and only recurred to it when *Weber* had formulated his fundamental electro-dynamical law, published in 1846:

$$f = (mm'/r^2) \{1 - (1/c^2)(dr/dt)^2 + (2r/c^2)d^2r/dt^2\}. \quad (1)$$

The first term of this formula is *Newton's* law of gravitation, 1686, whilst the other terms take account of the effects of induction in the relative motion of the two bodies *m* and *m'*. The minor terms thus give the energy effects of the velocity and acceleration or change of velocity, under wave action, in the direction of the radius vector, as required by the present author's Electrodynamic Wave-Theory of Phys. Forc., vol. 1, 1917.

In the work here cited (p. 143-149) I have calculated the effects of *Weber's* law upon the progressive movement of the perihelia, periplaneta, and periastra of the best known bodies of the solar system and of the sidereal universe. The tabulated $\delta\omega$ is the progression of the orbital perihelia in a Julian century, owing to the propagation of gravitation with the velocity of light.

Progression of Perihelia in a Julian Century, *Weber's* Law.

Planets	$\delta\omega$	Satellites	$\delta\omega$	Comets	$\delta\omega$	Binary Stars	$\delta\omega$
Mercury	14.511	Jupiter: V	4.233655	Encke	0.62198	η Cassiopeiae	0.00066902
Venus	2.9125	I	1.8212385	Tempel ₂	0.11461	β Persei	3291.927
The Earth	1.2964	II	1.143450	Brorsen	0.223072	40 α^2 Eridani	0.000316413
Mars	0.45619	III	0.715544	Tempel-L. Swift	0.120988	α Aurigae	65.7045
Jupiter	0.02104	IV	0.40508	Winnecke	0.140366	α Canis maj.	0.0069185
Saturn	0.004613	VI	0.068685	De Vico-E. Swift	0.078878	α Geminorum	0.00051013
Uranus	0.00080395	VII	0.064658	Tempel ₁	0.067616	α Canis min.	0.0066018
Neptune	0.0002615	VIII	0.034681	Finlay	0.118332	γ Virginis	0.00308893
		IX	0.034128	D'Arrest	0.089622	α Centauri	0.0018777
Satellites				Biela (I)	0.12570	70 Ophiuchi	0.001968103
The Moon (Earth)	0.00637	Saturn: Mimas	1.2403	Wolf	0.075939	δ Equulei	0.1524535
Phobos (Mars)	0.02651	Enceladus	0.966394	Holmes	0.062773	85 Pegasi	0.0432729
Deimos »	0.011098	Tethys	0.78066	Brooks	0.063389		
Ariel (Uranus)	0.18439	Dione	0.60811	Faye	0.066373		
Umbriel »	0.13235	Rhea	0.43644	Tuttle	0.051076		
Titania »	0.080504	Titan	0.188423	Olbers	0.0077034		
Oberon »	0.060339	Hyperion	0.157842	Halley	0.012637		
		Iapetus	0.102376	Newton, 1680	0.0121184		
		Phoebe	0.018751	1843 I	0.219474		
				1882 II	0.1081733		

This table shows that the difference between the effects of *Newton's* law, with fixed perihelia, and of *Weber's* fundamental electrodynamic law, with progressing perihelia, is always small. The chief interest centers around the motion of Mercury's

perihelion, which *Leverrier* in 1859 found to have a progression larger than known gravitational theory would explain.

As the unexplained motion of Mercury's perihelion found by *Newcomb* in 1881 is about 43" per century, the

above effect of *Weber's* law removes 14".5 of the total amount ¹⁾, leaving outstanding about 28".5 instead of the 43" assumed in *Einstein's* Theory of Relativity. The outstanding 28".5 can be explained by the transformation and absorption of wave energy from the atoms on the opposite side of the sun, yielding a law of attraction of the very form approved by *Newton* in the *Principia*, 1687:

$$f = mm' / r^{2.0000001046} . \quad (2)$$

This explanation of the motion of Mercury's perihelion is more fully discussed below. Such a result was long ago anticipated by *Newton*, and in 1894 carefully examined and proposed by *Hall*, and subsequently used by *Newcomb* and *Seeliger*. It therefore has the sanction of the most eminent astronomers, and as it rests upon a known physical cause, it involves no vague and chimerical reasoning such as underlies *Einstein's* mystical Theory of Relativity.

Towards the end of this paper, we develop a new view of the experiments of *Michelson* and *Morley*, 1887, and of *Sir Oliver Lodge*, 1891-97, which results from the kinetic theory of the aether, originally outlined by *Newton*, 1721, approved by *Maxwell* and *S. Tolver Preston*, 1877, and recently developed by the present writer, as shown in the first paper. This new view of the chief physical experiments on which the theory of relativity so largely rests may well claim the attention of natural philosophers. As bearing on the same question we treat carefully of the outstanding motions of the perihelion of Mercury and of the lunar perigee; and show that neither phenomena lends the slightest support to non-Newtonian mechanics.

In fact, although the theory of relativity has occupied much space in scientific literature, and many treatises, memoirs, and other papers have appeared on the subject, it is impossible for a careful observer to escape the conviction that the whole development heretofore brought out is false and misleading, — a veritable foundation laid on quicksand — and that some day philosophers will wonder that such an improvised absurdity ever became current among men. Among the most pernicious of these temporary doctrines is *FitzGerald's* hypothesis, which under the kinetic theory of the aether is wholly untenable.

A considerable number of persons are much impressed with the admissibility of any doctrine which becomes current among contemporaries, yet the study of the history of science shows that truth is neither dependent upon popularity, nor discovered by majorities, but by the few individuals who think carefully and frequently in complete isolation, and who thus attain superior vision into the deeper mysteries of nature.

In promulgating his new System of the World, 1543, *Copernicus* describes his reasoning in daring to depart from the opinion of the majority:

»Though I know«, he says, »that the thoughts of a philosopher do not depend on the judgment of the many, his study being to seek out truth in all things as far as that is permitted by God to human reason: yet when I considered«,

¹⁾ In the Monthly Notices for April, 1917, p. 504, Dr. *Silberstein* treats at some length of the *Einstein* calculations, based on *Gerber's* formula (*Zeitschr. Math. Phys.* 43.93-104, 1898) in which for the Newtonian potential M/r is put $M/r(1 - 1/c \cdot dr/dt)^2$, and concludes: »As far as I can understand from *Jeffrey's* investigation, (MN 77.112-118), it would rather alleviate the astronomer's difficulties if the sun by itself gave only a part of these 43 seconds.« Accordingly this is all the more reason for adopting *Weber's* law, though I reached it from a different point of view.

²⁾ This increase of amplitude will prove of high importance in the new theory of molecular forces, to be dealt with in a future paper.

he adds, »how absurd my doctrine would appear, I long hesitated whether I should publish my book, or whether it were not better to follow the example of the Pythagoreans and others, who delivered their doctrines only by tradition and to friends«.

2. The Effect of Resistance is to break up Long Waves into Shorter Ones and actually to increase the Amplitude of the Principal Component, as noticed in Breakers at the Sea Shore.

In his celebrated work on Tides and Waves, *Encyclopedia Metropolitana*, 1845, *Sir George Airy* obtained one of the most comprehensive and useful theories of wave motion ever developed. *Airy's* theory has the advantage of being intensely practical, because it applies to wave motion in a canal, water being the chief liquid found upon the earth, and nearly incompressible. The formula for the periodic time of the waves is
$$T^2 = (2\pi\lambda/g)(e^{4\pi k/\lambda} + 1)/(e^{4\pi k/\lambda} - 1) . \quad (3)$$

It may be shown analytically that when the wave length is shortened, as by resistance to the movement of the fluid, the exponential expression $e^{4\pi k/\lambda}$ increases, and thus the amplitude increases ²⁾. This change has been much discussed in various treatises and memoirs, and we shall not attempt to add to it here, except in the practical application of the result to physical problems.

Now *Airy* finds (art. 201-210) the following theoretical curves for the breaking up of water waves in rivers, considered as straight canals, with smooth banks. After explaining his analysis of these theoretical waves in water, *Airy* interprets the results as follows:

»(201). To represent to the eye the form of the wave produced by the combination of the two terms, we have constructed the curve in figure 9. The horizontal line represents the level line of the mean height of water: the elevation or depression of the curve represents (on an enormously exaggerated scale) the elevation or depression above the mean height, given by the expression above. The value of x' is supposed to increase from the left to the right: on which supposition the quantity $mut - mx'$, representing the phase of the wave, diminishes from the left to the right (mut being constant).«

»(202.) To exhibit to the eye the law of the ascent and descent of the surface of the water at different points of the canal, the figures 10, 11, 12, and 13 are constructed. The first of these is intended for the point where the canal communicates with the sea: the others for points successively more and more distant from the sea. The horizontal line is used as a measure of time, or rather of phase $mut - mx'$: in which, for each station, x' is constant: the elevation or depression of the corresponding point of the curve represents the corresponding elevation or depression of the water above its mean height, as given by the expression above.«

»An inspection of these diagrams will suggest the following remarks:

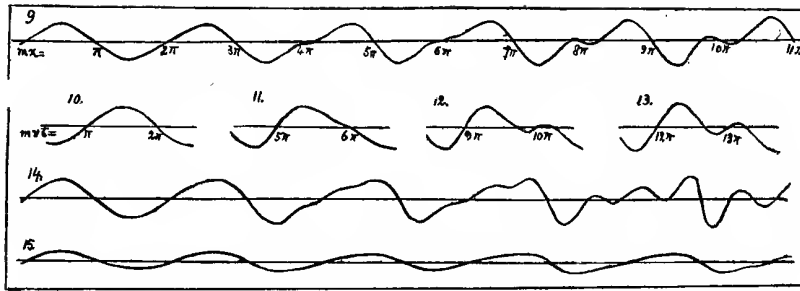


Fig. 1. *Airy's* graphical illustration of the breaking up of waves under resistance. The canals considered are connected with the sea and of uniform width.

9. Theoretical form of tide-wave in a shallow river, to second approximation. $m\pi = 0$, first station, the sea; $m\pi = 4\pi =$ second station, $m\pi = 8\pi =$ third station.
- 10-13. Theoretical tidal curves for different stations on the river. 10 = first station at mouth of river, 11 = second, 12 = third, 13 = fourth station.
14. Theoretical form of tide-wave in a shallow river to third approximation with large tide.
15. The same with small tide.

»(203.) When the wave leaves the open sea, its front slope and its rear slope are equal in length, and similar in form. But as it advances in the canal, its front slope becomes short and steep, and its rear slope becomes long and gentle. In advancing still further, this remarkable change takes place in the rear slope: it is not so steep in the middle as in the upper and the lower parts: at length it becomes horizontal at the middle: and, finally, slopes the opposite way, forming in fact two waves (figure 9).«

»(204.) At the station near the sea (see figure 10), the time occupied by the rise of the water is equal to the time occupied by the descent: at a station more removed from the sea (figure 11) the rise occupies a shorter time than the descent: the rise is steady and rapid throughout, but the descent begins rapid, then becomes more gentle, then becomes rapid again: at stations still farther from the sea (figures 12 and 13) the descent, after having begun rapid, is absolutely checked, or is even changed for a rise, to which another rapid descent succeeds: in this case there will be at that station two unequal tides corresponding to one tide at the mouth of the canal.«

This numerical and practical discussion by *Airy*, with curves for illustrating the results is more satisfactory than any purely theoretical analysis of the effects of resistance, and thus all we need to do is to point out, that, just as water waves in canals degenerate and break up into partial waves, under the action of a variable resistance, depending on the depth of the water, and its distance up the river from the sea: so also in the aether, the long waves encounter resistance which progressively is more and more disintegrating on their existence, kinetic stability, and continuity. Accordingly we may be sure that long waves in the aether will undergo corresponding changes by disintegration into shorter waves, and that the chief component will have increased amplitude.

There are various physical illustrations of this effect which may be cited, as when the sun's radiation impinges on the earth, and the longer invisible infra-red rays, so much studied by *Langley*, pass into heat waves of shorter wave length.

Again, in our electric stoves and heaters, the electric current, made up of very long waves, first develops heat, so that the resisting wire acquires a dull glow, then a red heat, and finally becomes incandescent, with light of shorter and shorter wave length the longer the action continues. The transition here sketched is therefore known to be a reality in dealing with the transformation of electric energy into heat and light, under conditions observed daily in every part of the world.

The analogies here cited are so obvious and familiar to us in the changes noticed when waves pass into breakers at the sea shore, that it seems impossible to deny the validity of the conclusion above drawn from every day experience, and fortified by the profound researches on tides and waves produced by one of the greatest mathematicians and natural philosophers of the past age.

To those who hesitate at the contrast between water and aether, we point out that it is true that water is heavy and inert, and sluggish in its movements, whereas the aether is excessively rare, with density at the earth's mean distance equal to 438×10^{-18} , and having an enormous elastic power, 689321600000 times greater than that of our air in proportion to its density. Thus the light and electric waves in the aether travel 902000 times faster than sound waves in the air, and about 200000 times faster than sound in water at 30°C ., which travels 4.54 times faster than in air, owing to the high incompressibility of the water.

There is thus much difference between the speed of waves in the aether and in water, even if the dense water, like the rare aether, be highly incompressible. But notwithstanding this difference, due chiefly to the extreme rarity of the aether, water being in comparison with aether 228×10^{13} times denser, there is a substantial physical basis for comparison of the actions in the two media.

Our reasoning therefore is not speculative or hypothetical, but purely practical, since it rests upon facts definitely determined by experience, and verified by careful observations of recognized phenomena of the physical universe.

In order to bring out the practical bearing of the wave-theory upon the motion of the perihelion of Mercury, and the lunar fluctuations, discussed below, we notice that as long ago as 1901, Professor *Planck* of Berlin supposed that in all matter there were a great number of »resonators« of every possible period (Ann. d. Physik, 4.556, 1901). Thus matter would receive and emit vibrations of all possible periods, as postulated in the Electr. Wave-Theory of Phys. Forc. 1.85-88, 1917. The lunar fluctuations occur where the sun's gravitational waves have to traverse the solid mass of the earth, and thus the action on the moon is decreased near the time of lunar eclipses; and the moon partially released from the sun's control, thus tends to fly the tangent. This gives rise to disturbances in the mean motion which *Newcomb* declared to be the most enigmatical phenomenon presented by the celestial motions.

Now the lunar theorists were unable to find the periodicities required to explain the lunar fluctuations, until I discovered the obstructing cause at work, near the shadow of the earth, to modify the sun's gravitative action on the moon.

If this explanation of the fluctuations of the moon be conceded, a similar cause will have to be admitted to act on the planet Mercury, which renders our sun gravitationally unsymmetrical or lopsided, as if a small part of the matter on the opposite side of the sun were removed, or ineffective, owing to the interposition of the sun's huge globe in the path of gravitational action. In other words, owing to refraction, dispersion, absorption, large masses of matter exercise a slight screening effect.

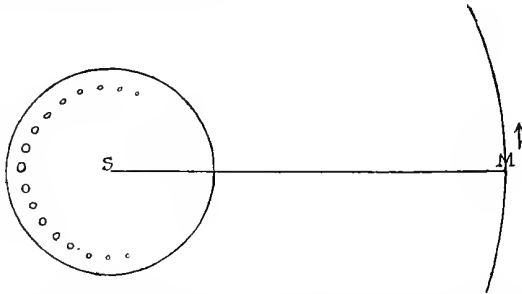


Fig. 2. Illustrating the absorption and circular refraction of some of the waves from part of the matter in the side of the sun opposite to Mercury, as if parts of the Sun's mass had been removed, and the globe thus rendered slightly lopsided. Compare also Fig. 3, in section 5 below.

Mercury therefore is less attracted than if the strict law of inverse squares established by *Newton* held, and thus we have the feeblor law of force explained below:

$$f = mm'/r^{2.0000001046} = (mm'/r^2) \cdot (1/r^{0.0000001046}) \quad (4)$$

whence arises the hitherto unexplained progression of Mercury's perihelion, by 28".44 per century, which has proved so bewildering to geometers and astronomers ever since *Leverrier* discovered the difference in 1859.

This explanation is very much simpler than any heretofore offered, and as it harmonizes the motion of Mercury with the motion of the moon, under well established physical laws, without introducing any vague and chimerical hypotheses, it would seem difficult to deny its essential physical truth.

3. Explanation of the outstanding Motion of the Perihelion of Mercury, based on the Electrodynamic Wave-Theory of Physical Forces.

Aside from the investigation of the amount of the outstanding motion of Mercury's perihelion, by *Leverrier*, 1859, and by *Newcomb*, 1881, duly noted below, we cite the following researches as offering various explanations of the phenomenon:

1. Untersuchungen über die Bewegung des Planeten Merkur, and other notices of researches by Dr. *J. Bauschinger*, AN 109.32.

2. Über die Bewegung des Merkurperihels, by *P. Harzer*, AN 127.81, 1891. *Harzer* investigates the effects of unequal moments of inertia of the sun about polar and equatorial axes, and of the matter in the corona, and finds these hypotheses admissible.

3. A Suggestion in the Theory of Mercury, by *A. Hall*, AJ 14.49, 1894. *Hall* adopts the suggestion of *Newton* that the law is not exactly that of the inverse squares, and puts

$$f = mm'/r^{2.00000016} \quad (5)$$

4. Hypothesis, that gravitation towards the sun is not exactly as the inverse square of the distance, *Astronomical Constants*, p. 118, by *S. Newcomb*, 1895. *Newcomb* adopts *Hall's* hypothesis, with very slight modification:

$$f = mm'/r^{2.0000001574} \quad (6)$$

5. Über die empirischen Glieder in der Theorie der Bewegung der Planeten Merkur, Venus, Erde und Mars. VJS 41.234-240, by *H. Seeliger*.

Das Zodiakallicht und die empirischen Glieder in der Bewegung der inneren Planeten. Sitz.-Ber. d. Kgl. Akad. d. Wiss. zu München, 36.595-622, by *H. Seeliger*.

Seeliger assumes the matter of the zodiacal light to be distributed in two ellipsoids, an outer one and an inner one, which will effect Mercury's perihelion, as observed, without disturbing the other planets. He gets a very perfect agreement with observations, fully as good as that supplied by *Einstein's* theory, without the vagueness of relativity. *Seeliger's* chief results are:

	<i>Newcomb</i>	<i>Seeliger's</i> Ellipsoids	Outstanding Residuals
Mercury $e \Delta \pi =$	+8".64	+8".49	+0".15
$\sin i \Delta \Omega =$	+0.61	+0.62	-0.01
$\Delta i =$	+0.38	+0.49	-0.11

Seeliger's theory applies equally well to Venus, the Earth and Mars.

6. A Memoir on the outstanding anomalies of the celestial motions, by Professor *E. W. Brown*, Amer. Journ. of Science, 29, in which various hypotheses, including the effects of the magnetic fields of the earth, sun and moon, are examined and rejected. See also Report of British Association for 1914, for Prof. *Brown's* Address to Section A, p. 311-321.

7. *Einstein's* General Theory of Relativity, 1916, in which this author uses the value $\delta \varpi = +43''$, and deduces the term of *Gerber's* formula:

$$V = (M/r) (1 - 1/c \cdot dr/dt)^{-2} \quad (7)$$

required to be added to the law of gravitation to make this difference between theory and observation disappear. By using the value $\delta \varpi = +43''$ per century, and deducing a very exact agreement based on this difference, instead of the

difference $28''.44$, which results from *Weber's* law, *Einstein* adds to the improbability of his theory.

It has long been remarked that among the outstanding motions of the solar system recognized by astronomers during the past sixty years, and of which geometers have sought a valid explanation, none is more justly celebrated than the excessive progression of the perihelion of Mercury, announced by *Leverrier* to the Paris Academy of Sciences, Sept. 12, 1859, (CR 49.379).

Leverrier's announcement of an outstanding motion of $38''$ per century in Mercury's perihelion seemed to find almost immediate confirmation in Dr. *Lescaubault's* supposed observation of an intra-mercurial planet named Vulcan; and this anomaly therefore was made the basis for the provisional elements assigned to the new planet.

If on the one hand later observational researches, during many total solar eclipses, have shown no signs of an intra-mercurial planet, it may be noticed, on the other, that the fullest confirmation of *Leverrier's* analysis of the planetary motions, 1859, has been obtained by later investigators, especially by *Newcomb*, who used all the observations of the transit of Mercury from 1677 to 1881, and deduced an outstanding motion in excess of that found by *Leverrier*, namely about $43''$ per century. (Astron. Pap. of the Amer. Ephem., 1.367-484, 1881.)

Accordingly, *Leverrier* spoke conservatively in the original announcement of his discovery, when he said:

»The necessity of an increase in the secular motion of the perihelion of Mercury results exclusively from the transits of the planet over the disc of the sun. The exactitude of these observations is beyond doubt.«

The anomalous motion of Mercury's perihelion thus established by *Leverrier* and *Newcomb*, has been widely discussed in natural philosophy, and in fact combined with the *Michelson-Morley* experiment of 1887, for laying the foundation of a Theory of Relativity, on which already many treatises have appeared, without, however, thus constituting a simple and consistent physical doctrine which commands universal assent.

There are, I think, grave reasons for doubting the whole Theory of Relativity, as now developed, on grounds which will be more fully outlined in treating of the *Michelson-Morley* experiment. For the present it must suffice to allude to the unsatisfactory theory resulting from *Leverrier's* discovery of an outstanding motion in Mercury's perihelion, and the growth in natural philosophy of a doctrine which many regard as both vague and chimerical.

In 1894, Prof. *Asaph Hall* of Washington outlined a new view of the anomalous motion of Mercury's perihelion (AJ 14.49), based on the hypothesis that for some unknown reason the Newtonian law of the inverse squares might not be strictly correct.

Already in 1686, while preparing the *Principia*, (Lib. I, sect. IX), Sir *Isaac Newton* had considered such a possible modification of the law of attraction; and even included some computations, in which he assumes that the central force departs a little from the inverse square of the distances.

Newton found that the perihelia would move forward under such a modification of the law of attraction (Lib. I,

sect. IX, Prop. XLV, Prop. XXXI, cor. I), but considered the observed approximate fixity of the planetary perihelia a strong proof of the accuracy of the law of the inverse squares. His final view evidently is expressed in the General Scholium to the *Principia*, 1713, where he says that in receding from the sun gravitation »decreases accurately in the duplicate proportion of the distances as far as the orb of Saturn, as evidently appears from the quiescence of the aphelia of the planets; nay, and even to the remotest aphelia of the comets, if these aphelia also are quiescent«.

In the *Mécanique Céleste*, 1799, *Laplace* likewise concluded that the law of gravitation holds accurately for the satellites as well as for the planets, (Liv. II, ch. I, § 6). In Liv. XVI, chap. IV, however, *Laplace* investigated more fully the effect on certain terms of the moon's motion of some assumed changes in the Newtonian law of attraction, but from his remarks it is evident that he did not consider it probable that there is a departure from the strict law of the inverse squares.

Thus, up to the time of *Leverrier's* researches on the motion of Mercury, 1859, there were no well established deviations from the Newtonian law which might be made the basis of observational inquiry, so as to serve as a crucial test of the accuracy of that law.

In his paper of 1894, however, Professor *Asaph Hall* sagaciously remarks:

»If the Newtonian law of attraction is not a rigorous law of nature, or if it is modified slightly under certain conditions, probably this lack of rigor would become apparent first among the swiftly moving bodies of our solar system, such as our moon and the planet Mercury« (AJ 14.49).

Our moon indeed does not move so swiftly, but owing to its great proximity to the earth and the eclipse records extending over nearly 3000 years, the motion is very accurately known, — both by observation and by theoretical research and calculation, — so that the smallest disturbances may become sensible to observation (cf. *Electr. Wave-Theory of Phys. Forc.*, I.113, 1917), which doubtless is the chief point Prof. *Hall* had in view.

That *Leverrier's* researches on the motion of Mercury, 1859, set in motion several new lines of inquiry of great theoretical importance is shown by two investigations developed within the next fifteen years.

1. The researches of *Tisserand* on the motion of a planet under *Weber's* electrodynamic law, communicated to the Paris Academy of Sciences, Sept. 30, 1872, by the eminent geometer *Bertrand*, who had inspired these investigations.

2. The problem proposed in 1873 by *Bertrand* to the Paris Academy of Sciences, (CR 84), to find the closed curve described by a planet when the forces have the form of an unknown function $R = \Phi(x, y)$ of two independent variables x and y , and the differential equations of motion are

$$m \cdot d^2x/dt^2 = -R \cdot x/r \quad m \cdot d^2y/dt^2 = -R \cdot y/r \quad (8)$$

it being required to find the function R whatever be the initial values of the coordinates x_0, y_0 , and of the components of the velocity

$$x_0' = (dx/dt)_0 \quad y_0' = (dy/dt)_0 \quad (9)$$

The solution of this problem showed that this function

always takes the form $R = m r^n$, where m is the mass of the planet, and r the radius vector.

It was *Bertrand's* theoretical improvement in the treatment of *Newton's* problem of a moving perihelion which led to *Hall's* hypothesis of 1894, for explaining the excess in the motion of the perihelion of Mercury. Since *Hall's* hypothesis has been further developed by the writer's recent researches in the Electr. Wave-Theory of Phys. Forc., it is necessary to treat of these successive steps for attaining an Electrodynamic Theory of the motion of Mercury's perihelion.

(1). *Bertrand's* solution of *Newton's* problem of finding the central force for a moving perihelion. As proposed to the Academy of Sciences, in 1873, *Bertrand's* problem reads (CR 77):

»We consider a planet attracted by the sun under a force of which the intensity depends only on the distance. We suppose known this one fact: that the planet describes a closed curve, whatever be the magnitude and direction of its velocity. We have to find the law of attraction from this single datum.«

Bertrand remarks that as the force is central, the motion takes place in a plane through the centre of the sun, and *Kepler's* law of equal areas in equal times holds true. If the force have the form $R = m r^n$ (10)

it is found that there result just two formulae:

$$R_2 = m/r^2 \quad (11)$$

$$R_1 = m r \quad (12)$$

And these are the only two laws of attraction which permit a planet to describe a closed curve, whatever be the initial data (the velocity being nevertheless below a certain limit). And if we suppose the attraction zero at an infinite distance, there remains only one formula (11), or the law of *Newton*, which could thus be deduced from the sole fact of observation: that any planet whatever describes a closed curve, without our being able to know the nature of this curve (cf. *Tisserand's* Mécanique Céleste, I.48, 1889).

Resuming *Newton's* problem of a moving perihelion, *Bertrand* derives a perfectly general formula for the arc Θ swept over by the planetary radius vector between the minimum value (r_1) and the maximum value (r_2)

$$\Theta = \left\{ \frac{\pi}{V(n+3)} \times \left[1 + \frac{1}{24}(n-1)(n+2) \left[\frac{(r_2-r_1)}{(r_2+r_1)} \right]^2 + \dots \right] \right\} \quad (13)$$

He remarks that when $r_2 - r_1$ tends towards zero, we have in the limit the Theorem of *Newton*, 1686:

$$\text{Lim } \Theta = \pi / V(n+3) \quad (14)$$

which applies to an orbit almost circular described by a planet under the influence of a central force proportional to a power of the distance.

If for the motion of a planet around the sun, we take with *Newton*, $n = -2$, $R = m/r^2$, the relation (14) gives $\Theta = \pi$, which is rigorous. Thus it only remains to find what will happen when we modify slightly the exponent -2 in the *Newtonian* law of gravitation.

If, for example, we supposed $n = -2.001$, it follows that we should have:

$$\text{lim } \Theta = \pi / V(1-0.001) = \pi (1 + \frac{1}{2} 0.001 + \dots) = 180^\circ 5' 24'' \quad (15)$$

or a progression of the apsis line at each revolution of $10' 48''$, which is so large a quantity as to be totally inconsistent with observation. Without further examination of the effects of changing the exponent in *Newton's* law (cf. Principia, Lib. I, Prop. XLV), we recognize that the change in the exponent must be extremely small. This case has been considered by Prof. *Asaph Hall*, who has applied the hypothesis to the motions of the planets and of our moon.

(2) *Hall's* hypothesis of 1894, that the law of attraction may be $f = mm'/r^{2+\nu}$, where $\nu = 0.00000016$. In A. J. No. 319, June 3, 1894, Prof. *Asaph Hall* remarks that on applying *Bertrand's* formula to the case of Mercury — with *Newcomb's* value of the outstanding motion of the perihelion, or $43''$ per century — he finds that the perihelion would move as the observations indicate by taking

$$n = -2.00000016 \quad (16)$$

the difference of the exponent from the law of *Newton* being $\nu = 0.00000016$.

The change in the law of attraction required for producing this progression of the line of apsides is therefore very minute. If we use *Weber's* law, as in the author's Electr. Wave-Theory of Phys. Forc. and *Newcomb's* value of the outstanding motion of Mercury's perihelion (Astr. Pap. of the Amer. Ephem. I.473); namely, $\delta\varpi = 42'' 95$, we shall obtain an outstanding motion of $28'' 44$ per century, which is to be accounted for by modification of the exponent in the law of attraction.

(3) Law of attraction indicated by the outstanding motion of Mercury's perihelion. As the motion of Mercury's perihelion offers the principal difficulty in modern celestial mechanics, we take the law of attraction to have the form:

$$f = mm'/r^{2+\nu} \quad [\delta\varpi]_{00} = +28'' 44 \quad (17)$$

and determine ν by the condition that the outstanding centennial motion of the perihelion shall be $+28'' 44$.

If the perihelion shifts $28'' 44$ in 100 years, it will shift $0'' 2844$ in one year; and as there are 4.1521 revolutions of this planet in a year, the shift will be $0'' 0684956$ in a single revolution, and therefore, $0'' 0342478$ in a half revolution of Mercury.

By *Bertrand's* formula (13) above, we notice that when the orbit is considerably eccentric, as in the case of the planet Mercury, the term depending on $[(r_2 - r_1)/(r_2 + r_1)]^2 = e^2$ becomes sensible. In fact Θ in this formula depends on the products of two series as follows:

$$\begin{aligned} \Theta &= \frac{\pi}{V(n+3)} \times \\ &\left\{ 1 + \frac{1}{24}(n-1)(n+2) \left[\frac{(r_2-r_1)}{(r_2+r_1)} \right]^2 + \dots \right\} \\ &= \frac{\pi}{V(1-\nu)} \cdot \left\{ 1 + \frac{1}{24}(3+\nu)\nu \cdot e^2 + \dots \right\} \\ &= \pi \left\{ 1 + \frac{1}{2}\nu + \frac{3}{8}\nu^2 + \dots \right\} \left\{ 1 + \frac{1}{8}\nu e^2 + \frac{1}{24}\nu^2 e^2 \right\} \quad (18) \end{aligned}$$

$$\begin{aligned} \Theta &= \pi \left\{ 1 + \frac{1}{2}\nu + \frac{1}{8}\nu e^2 + \frac{5}{48}\nu^2 e^2 + \frac{15}{192}\nu^3 e^2 + \dots \right\} \\ &= \pi \left\{ 1 + \nu \left(\frac{1}{2} + \frac{1}{8}e^2 \right) + \dots \right\} \quad (19) \end{aligned}$$

Accordingly, our equation of condition is:

$$\begin{aligned} \Theta &= \pi \left\{ 1 + \nu \left(\frac{1}{2} + \frac{1}{8}e^2 \right) + \dots \right\} \\ &= 180^\circ 0' 0'' 0342478 = 648000'' 0342478. \quad (20) \end{aligned}$$

As the coefficient of the term involving ν in the case of Mercury becomes $(\frac{1}{2} + \frac{1}{8}e^2) = 0.5052839$, we find from (20) by calculation that

$$\nu = 0.0000001045977 \quad (21)$$

And the modified Newtonian law becomes:

$$f = mm'/r^{2.0000001046} \quad (22)$$

Applying this law of attraction (22) to the eight principal planets of the solar system we have the following table of centennial progressions for their perihelia:

	$[\delta\varpi]_{00}$		$[\delta\varpi]_{00}$
Mercury	28".44	Jupiter	0".577448
Venus	11.1341	Saturn	0.2325307
The Earth	6.8496	Uranus	0.0815288
Mars	3.6418	Neptune	0.0415681

The progression of the perihelia here calculated from the modified Newtonian law are not contradicted by any known phenomena. The exact position of the perihelion of Venus is not well defined by observations, owing to the great circularity of the orbit; and some slight uncertainty also attaches to the position of the perihelia of the earth and of Mars.

It will be seen that the change made in the Newtonian law is exceedingly minute. For the change in the exponent the ratio is

$$1/2\nu = 1046/20000000000 = 1/19120459 \quad (23)$$

a little less than one nineteen-millionth of the whole. Such an infinitesimal alteration in the resulting attractive force would give no sensible effect in a single revolution, but as the change $\delta\varpi$ accumulates with the lapse of time, it finally becomes very sensible, and we are obliged to take account of the secular progression of the perihelion.

This cumulative effect is very similar to the alteration in the moon's mean longitude which results from the secular acceleration of the moon's mean motion, first explained by *Laplace* in 1787, under forces which are insensible for short intervals, but by continuing for long ages in the same direction, finally become sensible and have to be calculated in the formation of tables of the moon designed for use over many centuries.

4. The Modification of the Newtonian Law indicated by the outstanding Difference between the observed and calculated Motions of the Lunar Perigee.

Just as the motion of Mercury's perihelion is the chief means for throwing light on the form of the law of attraction for the planets of the solar system, so also the motion of the lunar perigee affords the best criterion for the form of the law of attraction operating on the motion of the satellites. As the subject has been but little discussed heretofore, we shall briefly outline the results of astronomical research on this interesting problem.

In the Monthly Notices of the Royal Astronomical Society 74.396, 1914, Prof. *E. W. Brown* gives the annual motion of the lunar perigee depending on the ellipticity of the earth as follows:

$$(\partial\varpi/\partial t)_e = +6".41, \text{ for an oblateness of } 1:296.3. \quad (24)$$

He adds that for an oblateness of 1:297, the value would be reduced by the factor

$$(1/297 - 0.001734):(1/296.3 - 0.001734) \quad (25)$$

$$\text{and become: } (\partial\varpi/\partial t)_e = +6".38. \quad (26)$$

From these data it follows that the annual motion of the lunar perigee for an oblateness of 1:298.3 would be

$$(\partial\varpi/\partial t)_e = +6".32. \quad (27)$$

The above values by *Brown*, as thus reduced to an oblateness of 1:298.3, are confirmed by the part of the motion of the lunar perigee depending on the ellipticity of the earth's figure calculated by Dr. *Hill*, in his supplement to *Delaunay's* Theory of the Moon's Motion, Astron. Pap. 3.334, namely:

$$(\partial\varpi/\partial t)_e = +6".82. \quad (28)$$

This value, however, refers to *Hill's* oblateness of 1:287.71, and must be reduced to correspond to the oblateness of 1:298.3; which leads to a result differing only 0".01 from that found by *Brown* and cited above. *Hill's* value for this reduced ellipticity of the earth therefore is:

$$(\partial\varpi/\partial t)_e = +6".33. \quad (29)$$

Hence we conclude that this value of the annual perturbation of the lunar perigee depending on the ellipticity of the figure of the earth is very accurately known. The difference in these two authorities would be only 0".0124 per annum, or 1".24 in a century, which is below the limit of determination in the present state of science.

Prof. *E. W. Brown* also gives data to show (MN 75.514), that when the theoretical secular acceleration of the perigee is determined with the highest accuracy, it is 16" per century smaller than the observed centennial motion of the perigee. This is for an ellipticity of the earth of 1:297. By changing the ellipticity to 1:294 *Brown* reduces this value from 16" to 3"; and by taking an ellipticity of 1:293.7, the outstanding difference entirely vanishes.

Such a large value of the oblateness, however, seems to be quite inadmissible; and thus on calculating the excess in the actual motion of the perigee over the theoretical motion, for an oblateness of 1:298.3, I find it to be 21".9, or say 22" per century. If we admit this ellipticity of the earth¹⁾, — which is decisively indicated by the four best methods —, namely:

- 1) Pendulum observations of gravity, as discussed by *Helmert* and the U. S. Coast Survey,
 - 2) Geodetic measurements of arcs on the earth's surface,
 - 3) The lunar inequality in latitude,
 - 4) The fluid-theory of the earth, isostasy and *Laplace's* law of density;
- then it will follow incontestibly that the moon has an outstanding motion of its perigee of about 22" per century, almost exactly one half the outstanding motion observed in the perihelion of Mercury.

To form a better idea of the accuracy heretofore attained in these calculations, of the centennial motions of the lunar perigee, we recall the results of *Hansen* and *Brown*:

Observed	Calculated	Diff. O—C	Authority
$[d\varpi/dt]_{00} = 14643560"$	$14643404"$	$+156"$	<i>Hansen</i> , Darlegung, 1864, p. 348
$[d\varpi/dt]_{00} = 14643520"$	$14643504"$	$+16"$	<i>Brown</i> , MN 75, 1915.

¹⁾ In the writer's "Determination of the oblateness of the terrestrial spheroid", begun in 1904, but not yet published, this question has been carefully examined, and the value 1:298.3 shown to be the most probable of the various values heretofore proposed.

As above pointed out, the difference of 16" per century here indicated by *Brown's* calculation of the theoretical motion of the perigee becomes 22" when the ellipticity of the earth is reduced to 1 : 298.3.

It is also to be noticed that the observed centennial motion of the lunar perigee used by *Hansen* is 40" larger than that used by *Brown*. It would seem that very little doubt could attach to the increased accuracy of *Brown's* observed motion, though owing to the fluctuations in the mean longitude the value 14643520" for the observed centennial motion of the perigee may yet admit of some improvement, if any of the observational equations should prove to be vitiated by this troublesome cause.

Indeed, it is a little difficult to understand why so considerable a difference as 40" per century should exist in the observed centennial motion of the perigee used by two such very modern authorities as *Hansen* and *Brown*. For the position of the perigee is given with considerable accuracy from the eclipse records of the Greeks, and the calculations of *Hipparchus* and *Ptolemy*; and as about 226 revolutions of the perigee would occur in 2000 years, the motion of the perigee ought to be quite accurately fixed by the eclipse records of the Greek astronomers. The above difference of 40" per century, increasing as the square of the time, in 20 centuries would accumulate to 16000", nearly four and a half degrees, or about nine times the diameter of the moon.

The difference of 100" between the above calculated centennial motions of the perigee is less striking than it otherwise would appear, but such differences warn us not to overrate the accuracy attained.

It seems remarkable that the eclipse records of the Greeks would leave the position of the perigee open to so much uncertainty. Besides, in the modern observations of the moon since 1750, which are quite accurate, an uncertainty of even 20" per century, or an accumulated difference of 57"8, in the interval of 170 years, ought not to exist. Still more intolerable is the difference of 115"6, based on the difference of 40" per century! But *Hansen* was unaware of the fluctuations in the moon's mean longitude; and as the fluctuations affect the node as well as the longitude, it may also have vitiated sensibly his calculation of the observed centennial motion of the perigee.

It is worthy of notice that *Hansen's* outstanding difference between the observed and calculated centennial motion of the lunar perigee is $O - C = +156''$; while *Brown's* values make this difference $O - C = +22''$. The mean of these two values is $O - C = +89''$.

Now, in default of definite knowledge it is not quite safe to assume that *Hansen's* values are wholly wrong, and *Brown's* entirely right, notwithstanding the preeminence of the latter's exhaustive researches in the lunar theory. Both investigators may be somewhat in error, for one reason or another, or for several reasons combined. Thus, apparently the safest thing is to assume that the truth lies between +156", as found by *Hansen*, and +22", which results from *Brown's* calculations. And as we do not know what weights should

be assigned to these extreme values, we can only take the simple mean of the two outstanding motions of the perigee, and thus we have: $[(\partial\varpi/\partial t)_{\epsilon}]_{100} = +89''$. (30)

It is to be observed also that in our researches on the outstanding motions of Mercury's perihelion, we found the exponent of *Newton's* law should be modified from 2 to $2 + \nu$, where $\nu = 0.0000001046$.

To calculate the resulting outstanding motion for the lunar perigee we notice, in the first place, that the effect of the time of propagation of gravitation by *Weber's* law, as shown in the table of section I above, is almost insensible, $\delta\varpi = 0.00637$ per century. Thus we need consider only the effect of the exponential change for a body having a mean motion 3.219763 times greater than that of Mercury. And since the unexplained motion of Mercury's perihelion is 28".44, we get for the corresponding motion of the lunar perigee

$$[(\partial\varpi/\partial t)_{\epsilon}]_{100} = +28.44 \times 3.219763 = +91.57. (O - C) (31)$$

This calculated value is so very near the mean of the values found by *Hansen* and *Brown* as to appear worthy of attention. If for example, *Hansen's* value $O - C = +156''$ were 65" too large, leaving $O - C = +91''$, while *Brown's* were as much too small, yielding $O - C = 22'' + 65'' = +87''$, the two values would be quite reconciled. And since *Hansen* and *Brown* disagree as to the value of the observed centennial motion of the perigee to the astonishing extent of 40", the possibility of such unknown errors in their several results is not to be wholly excluded.

Accordingly, for some hitherto unsuspected reason, *Hansen's* value of the observed centennial motion of the perigee may be substantially correct, namely:

$$[(\partial\varpi/\partial t)_{\epsilon}]_{100} = +14643560''. (32)$$

In this case, it would suffice to assume an error of 18" per century in *Brown's* calculated motion of the perigee.

Unfortunately Prof. *Brown* even proposed to adopt an oblateness of the earth of 1 : 293.7, as if to avoid a modification of the form of the Newtonian law¹⁾; and hence it seems not wholly improbable that an error of 18" per century in the calculated centennial motion of the perigee may have been introduced, through some step based upon the tacit assumption of the strict rigor of the Newtonian law.

Under the circumstances, since *Hansen's* value of the outstanding residual in the centennial motion of the perigee apparently was obtained without prejudice, it should not be rejected, till *Brown's* values are independently tested and found to be not only the more accurate, but also wholly free from possible prejudice due to assumed rigor in the Newtonian law, or other systematic cause which might thus unexpectedly creep in.

Under the present circumstances, it follows that if the outstanding residual in the centennial motion of the perigee be $[(\partial\varpi/\partial t)_{\epsilon}]_{100} = +91.57$ the exponent of the law of attraction for the moon would be the same as that for the planet Mercury, namely: $f = mn'/r^{2.0000001046}$. (33)

¹⁾ In his address to the British Association in Australia, 1914, p. 316, *Brown* estimates that the exponent in the Newtonian law does not differ from 2 by a fraction greater than $1 : 400000000 = 0.000000025$; but the present discussion shows that this prediction probably overrates the accuracy we are justified in claiming, from 10 to 42 times.

In conclusion, it would appear from this investigation that the change in the exponent for the law of attraction may be the same for the moon and for Mercury. But if future researches should develop a smaller difference in the observed and calculated centennial motions of the lunar perigee, such as $22''$ per century, which seems to be the minimum value now admissible; then there would be a smaller value of ν in the exponent of the modified law of *Newton*. The value $22''$ per century leads to a value about one-fourth of that found for the planet Mercury, as may be seen from the following considerations.

The moon makes 1336.85126 revolutions in a century, and therefore: $11''/1336.85126 = 0.0082283$ is the amount of this secular progression of the perigee in half a lunation. The equation of condition:

$$\theta = \pi \{1 + \frac{1}{2}\nu + \dots\} = \pi \{1 + 0.0082283/648000\} \quad (34)$$

therefore gives $\nu = 0.00000025396$.

But although there can be no assurance that this modification of the exponent for the earth would be the same as for the sun — the earth being so different in density, size, and physical constitution from the sun — yet at present apparently we are not justified in using this smaller value, because in the existing state of our knowledge there are no definite grounds to authorize it.

Accordingly for the sake of simplicity and uniformity the value of ν applied to the motion of the perihelion of Mercury is preferable also for the motion of the lunar perigee.

5. Outline of the Cause of the Fluctuations of the Moon's Mean Motion.

In the *Electrodynamic Wave-Theory of Physical Forces*, vol. 1, 1917, it is shown that the previously unexplained fluctuations of the moon's mean motion, discovered by *Newcomb* in 1909, after a study of the moon's motion extending over more than forty years, (1867-1909), is due to the refraction, dispersion, and perhaps absorption of the sun's gravitational waves in passing through the solid globe of the earth. The result is a slight decrease in the sun's gravitative action upon the moon when near the shadow of our globe in space, by which, near the time of Lunar eclipses, the moon is slightly released from the sun's control, and in the tendency to »fly the tangent«, has certain long period disturbances introduced into its mean motion.

An attempt to find such disturbances in the motion of the moon depending on the 18-year period, had been made by Dr. *K. F. Bottlinger*, in a crowned prize Inaugural Dissertation, at the University of Munich, *Die Gravitations-theorie und die Bewegung des Mondes*, (Freiburg i. B., 1912). *Bottlinger* deduced some evidence of an 18-year period, but in the case of the longer disturbances (61.7006 years, and 277.59 years respectively) he was not able to find the slightest indications of the required periods; so that in his address on the moon's motion at the meeting of the British Association in Australia, 1914, p. 319, Prof. *E. W. Brown* spoke as follows:

»The shading of gravitation by interposing matter, e. g. at the time of eclipses, has been examined by *Bottlinger*. For one reason alone, I believe this is very doubtful. It is difficult

to see how new periodicities can be produced; the periods should be combinations of those already present in the moon's motion. The sixty to seventy years fluctuation stands out in this respect, because its period is not anywhere near any period present in the moon's motion or any probable combination of the moon's periods. Indeed Dr. *Bottlinger's* curve shows this: there is no trace of the fluctuation«.

From this citation it is evident that *Bottlinger* not only had not convinced *Brown* of the reality of the fluctuations depending on the interposition of our globe in the path of the sun's gravitative action, but also that *Brown* felt that an explanation of the 60-year and 275-year periods in the observed fluctuation could not be based on the theory of gravitational disturbances depending on the known cycles of the moon's motion, in relation to the eclipse periodicities.

Notwithstanding this confidence of Professor *Brown*, resulting from his great experience in the lunar theory, I was fortunate enough to discover such long period inequalities in the moon's motion, bearing the closest analogy to the forces acting in the great inequality of Jupiter and Saturn, of which the physical cause was discovered by *Laplace* in 1785, — after *Euler* and *Lagrange* had searched in vain for the mystery underlying the celebrated 900-year inequality of these great planets.

Without attempting to give a detailed account of these researches in the lunar theory, we shall endeavor to outline briefly the leading points, because this advance of 1917 bears very directly on the wave-theory, above applied to the motion of the perihelion of Mercury and of the lunar perigee.

It is shown from an extension of *Maxwell's* theory of circular refraction in the eye of a fish (Cambridge and Dublin Math. Journal, vol. XI), that a similar circular refraction of gravitational waves occurs when the path of these waves is through the solid mass of the earth. For in the earth, as in the eye of the fish, the concentric shells are each of uniform density, but with the density increasing from layer to layer towards the centre. Thus a circular refraction of the sun's gravitational waves will occur in propagation through the globe of the earth, and also of the moon's gravitational waves in passing through the same globe, owing to the concentric layers of which it is made up. The accompanying figure 3 (pag. 156) illustrates the refraction of the sun's waves in passing through the earth.

By virtue of this circular refraction of the gravitational waves in passing through the globe of the earth, it follows that the mutual interpenetration of the waves from the sun and moon are not the same when the earth interposes its solid mass in their path of action.

The result is a weakening of the sun's gravitative action on the moon; and, when our satellite is thus partially released from the sun's control, it tends to »fly the tangent«, as near the time of lunar eclipses. The outcome is a series of disturbances in the moon's mean longitude depending on the motions of the perigee and node of the lunar orbit, with respect to the Saros or eclipse cycle.

The principal eclipse cycles, incessantly repeated in the theory of the moon's motion, are the following¹⁾:

¹⁾ Cf. *Electrod. Wave-Theory of Phys. Forc.*, 1.101-102.

1. The Saros, made up of 223 synodic months = 6585.32 days, discovered by the Chaldeans and used at Babylon for predicting the return of eclipses, in conjunction with the eclipse year of 346.62 days.

2. The eclipse year of 346.62 days, the average time of the sun in passing around the heavens from the moon's node and returning to the same node again as it retrogrades under the sun's disturbing action in 18.6 years. Nineteen of these eclipse years make 6585.78 days, almost exactly equal to the cycle of the Saros given above, which is 6585.32 days.

The difference in these two periods is only 0.46 of a day, and therefore after 18 Julian years 10.82 days (0^d.46 less than 19 eclipse years) the Saros of eclipses is very nearly repeated, except that the location on the terrestrial globe is 0^d.32 = 7^h40^m.48^s further west in longitude.

3. The nodical or draconitic month made up of 27^d.21222: and thus 242 × 27^d.21222 = 6585^d.357. This again is of almost the same length as the 223 synodic months and 19 eclipse years defined in paragraphs 1 and 2 above.

4. The anomalistic month made up of 27^d.55460; and thus 239 × 27^d.55460 = 6585^d.549. Accordingly, after 223 months the moon not only returns very closely to its original position in respect to the sun and node, but also in respect to the line of apsides of the moon's orbit; so that the perturbations near perigee, during the interval of the difference in these two cycles, 6585^d.549 - 6585^d.32 = 0^d.229 = 5^h29^m.8 are so small as to modify but very slightly the return of the cycle of eclipses composing the Saros.

Accordingly, these four fundamental lunar cycles recur in the following periods:

- 1. The Saros = 223 synodic months = 6585^d.32
- 2. 19 eclipse years of 326^d.62 each = 6585.78
- 3. 242 nodical or draconitic months of 27^d.21222 each = 6585.357
- 4. 239 anomalistic months of 27^d.55460 each = 6585.549

Now the Saros = 6585^d.32 = 18 Julian years 10.82 days, or 18.0293 sidereal years of 365^d.2563582 (*Hansen*). And according to *Neison* the period of the circulation of the lunar perigee is 8.855 years. In the 10th edition of his *Outlines of Astronomy*, 1869, p. 472, Sir *John Herschel* uses the period 3232^d.575343 = 8.85031 Julian years, which is only slightly different from the value cited above.

Accordingly, the forward motion of the perigee will carry it twice around the heavens in 17.71 years, while the node revolves in the retrograde direction in 18.6 years. Thus if we call Ω the yearly motion of the node, and ϖ the corresponding motion of the perigee, we have

$$\begin{aligned} \Omega &= -19^{\circ}.35484 = 360^{\circ}/18.6 \\ \varpi &= +40^{\circ}.6550 = 360^{\circ}/8.855. \end{aligned} \quad (35)$$

From the above data, it follows that the node will retrograde through 360° in 18.6 years, but in the same time the lunar perigee will progress through an angle of 756°.183 = 720° + 36°.183; so that after an interval of 18.6 years the perigee is displaced forward by 36°.183 in respect to the restored node.

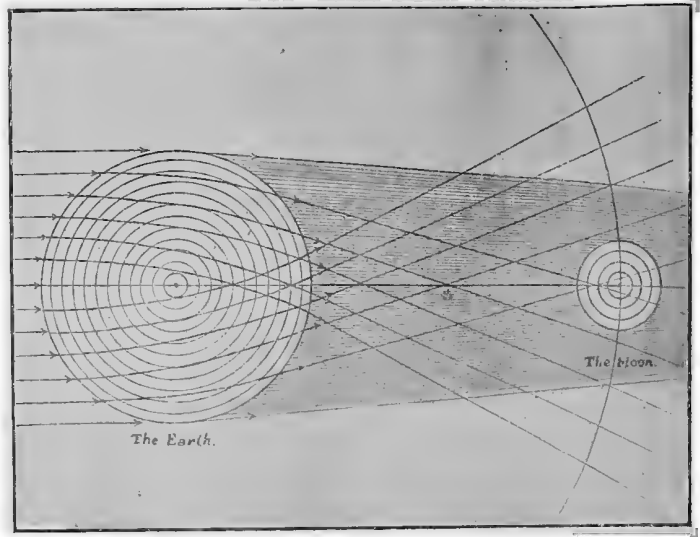


Fig. 3 Refraction of the sun's gravitational waves in passing through the earth's mass, by which the moon is slightly released from the sun's control near the time of lunar eclipses.

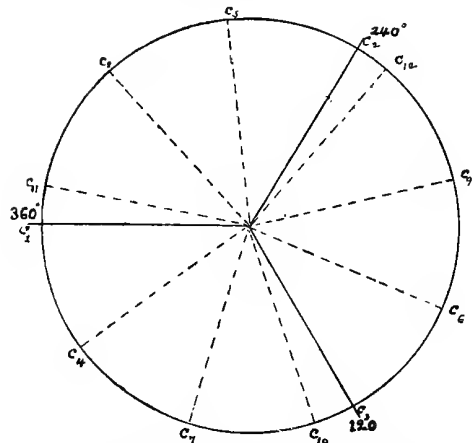


Fig. 4. Illustration of the progress of the moon's perigee in respect to the node, in the 61.7-year fluctuation.

(1) Determination of the period of the 60-year fluctuation.

It is very easily shown that owing to the relative magnitudes of these direct and retrograde revolutions the angular conjunctions will tend to recur in the regions of 360°, 240°, 120°, like the actual conjunctions of the planets Jupiter and Saturn in the theory of the celebrated 900-year inequality which was first theoretically explained by *Laplace* in the year 1785. Here, too, as in the theory of Jupiter and Saturn, the conjunction lines move forward. The amount of the displacement is 36°183 in 18.6 years; and in 3.31648 such periods, 3.31648 × 18.6 years = 61.7006 years, the angular conjunction which started out at the angle 360° will revolve forward through 120°, and the cycle of angular conjunctions at all three points will begin over again, exactly as in the great inequality of Jupiter and Saturn. This leads

at once to the second long inequality in the moon's mean motion, which, without suspecting the cause, *Newcomb* estimated at »60 years, more or less«. His judgment of the period was surprisingly accurate; and as he concluded that the coefficient might be about $3''0$, here again his value could be adopted.

(2) Determination of the period of the great fluctuation in 277.590 years.

In the case of the great fluctuation in the moon's mean motion, of which *Newcomb* estimated the period at about 275 years, the calculation of the period is somewhat similar to that just cited, but also somewhat different. It is physically obvious that the modification of the sun's gravitation in passing through the body of the earth will depend on the relative shifting of the line of angular conjunctions node-perigee.

Now it is easily found by calculation that the angles of the node-perigee are in angular conjunction, on a line $11^{\circ}670$ in advance of the original conjunction, after an interval of 17.9971 years. For in this time the perigee progresses over an arc of $4\pi + 11^{\circ}670$, and the node retrogrades over an arc of $2\pi - 11^{\circ}670$, and meet exactly at the conjunction line specified.

The problem thus arises to find the interval in which this secular displacement of the angular conjunction line will complete the cycle in the moon's motion due to the reduction of gravitation near the shadow of the earth. In each period of 17.9971 years, the node retrogrades through the angle 2π in respect to the shifting mean position of the perigee, and in the same interval the perigee progresses through the double of this angle, 4π , in respect to the retrograding mean node; so that on the average their opposite motions amount to 6π in 17.9971 years.

As the physical effect of the reduction of gravity near the shadow of the earth is the same whether the shifting conjunction line node-perigee refer to ascending or descending node, we perceive that this advancing conjunction line need only sweep over the angle π to give the required interval for completing the cycle due to the changes of gravitation near the shadow of the earth.

Now $180^{\circ}/11^{\circ}670 = 15.422$, and therefore in an interval of 15.422×17.9971 years = 277.590 years, the cycle of the changes of gravitation near the shadow of the earth will be complete.

This is the period of the great fluctuation in the moon's mean longitude which *Newcomb* estimated at 275 years, from the modern observations, and used in calculating the secular acceleration from the eclipse records extending over 2600 years since the era of the Babylonians.

The diagram in Fig. 5 presents to the eye a continuous representation of the changes in node (outside circle) and perigee (inside circle) during 18 years. At the end of 18 years they both are in conjunction at 1, near the original line of conjunction, 360° , but $11^{\circ}670$ further forward. In each of these periods of 18 years the nodes turn to every part of the heavens, so that eclipses occur all around the earth's orbit, with the earth and moon at all possible distances from the sun. In this interval the lunar perigee revolves twice, and the node once; so that the effect of the progression of

the perigee goes through symmetrical phases in respect to the earth's orbit in 18 years, as shown by the above diagram.

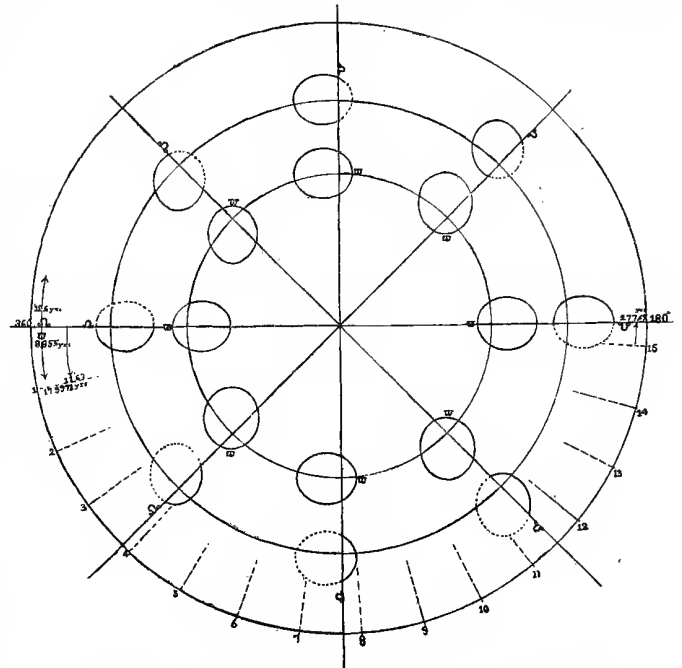


Fig. 5. Illustration of the progress of both node and perigee for producing the moon's great fluctuation in 277.59 years.

This diagram also illustrates the secular progress of the line node-perigee, the restoration to parallelism in this conjunction line, advancing by $11^{\circ}670$ every 17.9971 years, and requiring 277.590 years for completing the full cycle of a semi-circumference.

We may express this result also by observing that physically the decrease of gravitation near the shadow of the earth will take place with equal effect whether the eclipse be near the ascending or the descending node; and this decrease will always correspondingly affect the moon's mean longitude. Therefore, the 18-year movement of node-perigee conjunction line over the arcs 1, 2, 3...n, where $n = 15.422$ at 180° , will comprise all possible combinations of the conjunction line node-perigee for modification of the sun's gravity on the moon when near the shadow of the earth.

(3) Determination of the 18-year period of the Saros cycle.

The Saros cycle is so well known that we need scarcely add that a minor disturbance in the moon's mean longitude will recur in this period of 6585.32 days = 18.0293 years. In this period the symmetrical eclipse cycle of 223 lunations is complete and the eclipses begin to repeat themselves, with the moon very near the same relative position with respect to the sun and node, and also with respect to the line of apsides or perigee. This Saros cycle of the Chaldeans gives rise to a minor disturbance in the moon's mean longitude, with period of 18.0293 years, and a coefficient of about $1''0$. It is the smallest of the moon's sensible fluctuations, yet indicated by the researches of *Newcomb* and *Bottlinger*, and illustrated graphically by the accompanying Fig. 6 (p. 159).

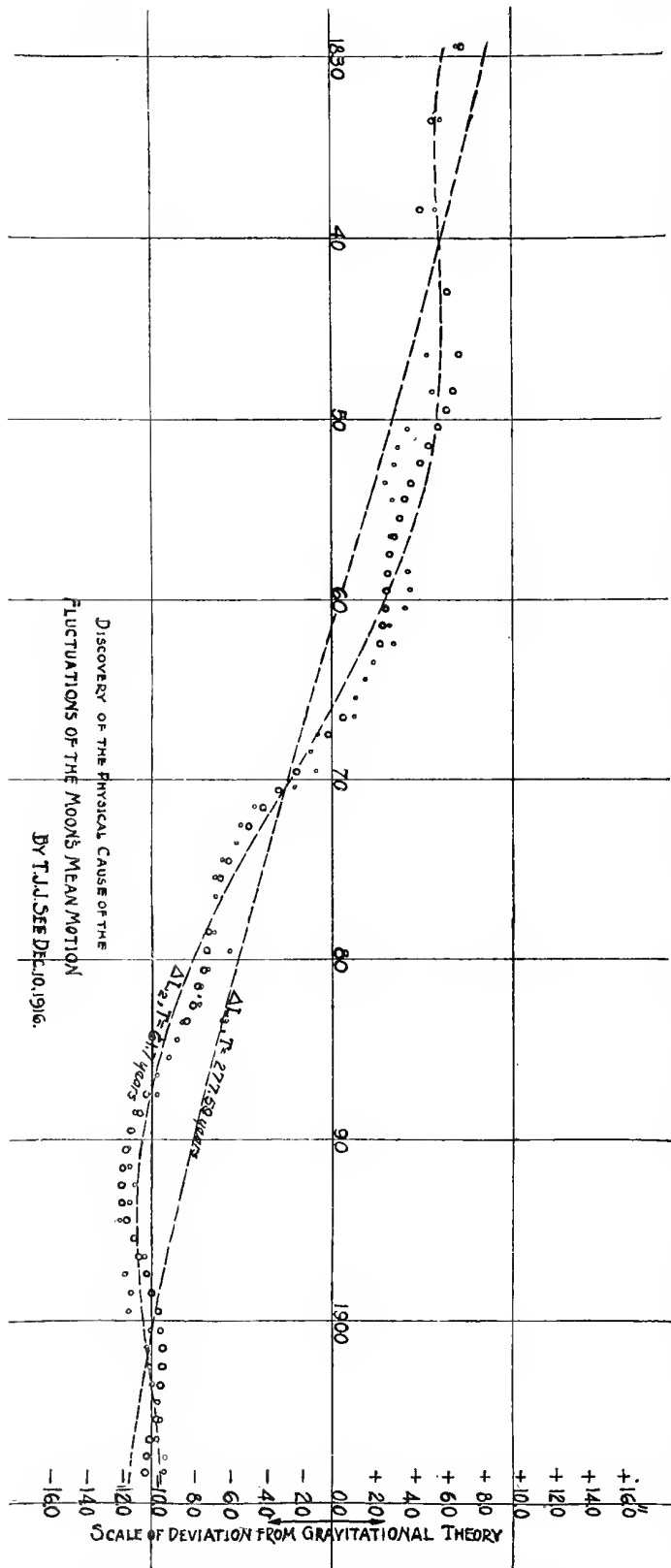


Fig. 6. Graphical illustration of the three chief fluctuations in the moon's mean motion. The small dots represent the observed, the small circles the calculated, places of the moon.

The close analogy of this explanation of the 61.7-year period in the mean motion of the moon, which is the most powerful of these fluctuations, with the celebrated 900-year inequality of Jupiter and Saturn is shown by the following figure 7 for illustrating *Laplace's* discovery, 1785, involving a forward shift of the conjunction lines of these two great planets through 120° .

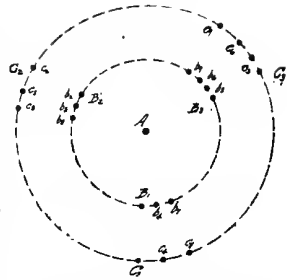


Fig. 7. Diagram of the shifting conjunctions of Jupiter and Saturn, for illustrating *Laplace's* discovery of the cause of the great inequality.

In the case of *Laplace's* discovery the conjunction lines of the planets revolve forward, whereas in the case of the lunar fluctuations, it is the angular movement of the conjunction lines node-perigee which has to be considered. On this relative angular movement depend the small uncompensated forces for the release of the moon from the sun's gravitational control when near the shadow of the earth, whence arises the long period inequalities in the moon's mean longitude.

I arrived at the cause of the lunar fluctuations from the study of the close analogy with the great inequality of Jupiter and Saturn, which I had suspected, and called to the attention of Prof. *E. W. Brown*, in 1914, after reading his address to the British Association in Australia. It appears that neither *Brown* nor *Bottlinger* had been encouraged by results of the researches they had made; yet *Bottlinger's* investigation of 1912 proved very suggestive to me, and the analogy with *Laplace's* discovery of 1785 was so close that it finally enabled the cause of the lunar fluctuations to be made out.

In the Observatory for May, 1918, Mr. *Harold Jeffreys* has a review of my researches on the lunar fluctuations. After recounting the method employed, and admitting the force of the results brought to light, he finally holds (p. 219) that the angular progressions in the two fluctuations, namely that in 61.7006 years and 277.59 years respectively, should stand in the ratio of exactly 9 : 2, and thus that my constants are not quite exact. If the shorter period of 61.7006 years be exact, *Jeffreys's* argument would make the longer period 277.652 years, instead of 277.59 years found by me.

This difference is very trifling, and of no practical importance, but the relation 9 : 2 may eventually be of value to the future investigators of these movements when the course of centuries shall make known the constants of the lunar movement with increasing precision. At present I think the final value of these periods can scarcely be attained, because each fluctuation involves very slightly the period of the other; so that we scarcely know which period may be chosen, or how the two may be adjusted and compensated to the exact ratio of 9 : 2.

In closing this brief discussion of the lunar fluctuations, which *Newcomb* pronounced the most enigmatical phenomenon presented by the celestial motions, it is scarcely necessary to add that the result attained is a very notable triumph for the wave-theory.

We have seen that the motion of the perihelion of Mercury admits of a half a dozen different explanations,

in addition to the mystical one offered by *Einstein*, which is devoid of physical basis; and finally the natural and simple explanation based on the wave-theory, and outlined above in section 3.

On the other hand, the lunar fluctuations, which are vastly more complicated than the motion of Mercury's perihelion, admit of but a single known explanation, namely, that discovered by the present writer in 1916. It is therefore with some reason that the most experienced physical mathematician at Cambridge wrote me, Jan. 28, 1917:

»I wish the perihelion of Mercury could be resolved similarly (to the new work on the lunar fluctuations). Otherwise we have an unlimited number of ingenious kinds of relativity on our hands; which will be remarkable for self-contradiction of the principle that everything is relative«.

It is just such confusion as this that I have labored to get rid of, and now my theory of the motion of Mercury's perihelion is found to conform to the wave-theory, and to correspond to the ideas of *Newton*, 1686, that the law of gravitation in certain cases differs a little from the exact law of the inverse squares — the difference being explained by the wave-theory, and the nature of the aether.

6. Gravitational Action is propagated by Stresses due to Waves in the Aether, but *Maxwell's* conception that the Stress is based on Pressure in the Direction of the Line of Force and on an equal Tension in all directions at right angles thereto is not admissible.

From the electro-d. wave-theory of gravitation, outlined in the writer's work of 1917, it follows that gravitation is propagated by stresses in the aether due to the interpenetration of waves, and the action across space therefore travels with the velocity of light. This mode of action is already outlined also in the first paper on the new theory of the aether, AN 5044. Forty-seven years ago in the celebrated Treatise on Electricity and Magnetism, 1873, vol. 1, Chap. V, §§ 103-116, *Maxwell* gave a remarkable theorem for the stresses between two electrically charged material systems, as producible by a distribution of stress over closed surfaces about these systems.

He takes two electrical systems, namely, E_1 , with volume density q_1 , of the element whose coordinates are x_1, y_1, z_1 ; and similarly for the other system, E_2, q_2, x_2, y_2, z_2 . Then the x -component of the force acting on the element of E_1 , owing to the repulsion of the element of E_2 , will be:

$$\begin{aligned} dX &= q_1 q_2 (x_1 - x_2)/r^3 \cdot dx_1 dy_1 dz_1 dx_2 dy_2 dz_2 \\ r^2 &= (x_1 - x_2)^2 + (y_1 - y_2)^2 + (z_1 - z_2)^2 \\ X &= \iiint \iiint \iiint (x_1 - x_2)/r^3 \cdot q_1 q_2 dx_1 dy_1 dz_1 dx_2 dy_2 dz_2 \end{aligned} \quad (36)$$

This is as in the theory of action at a distance, and the integrals will not be altered by extending the limits from $-\infty$ to $+\infty$.

Maxwell then proceeds to remark (§ 105) that if the action of E_2 on E_1 is effected, not by direct action at a distance, but by means of a distribution of stress in a medium extending continuously from E_2 to E_1 , it is manifest that if we knew the stress at every point of any closed surface s which completely separates E_1 from E_2 , we shall be able to determine completely the mechanical action of E_2 on E_1 . Accordingly, he concludes that if it is possible to account for the action of E_2 on E_1 by means of a distribution of stress in the intervening medium, it must be possible to express this action in the form of surface integrals extending over the surface s , which completely separates one system from the other.

Maxwell then develops the solution at some length, and after obtaining the required mathematical expressions, (§§ 105-110), remarks (§ 111): »I have not been able to make the next step, namely to account by mechanical considerations for these stresses in the dielectric. I therefore leave the theory at this point.«

It can be shown that the action of waves, flat in planes normal to the lines of force will explain the mechanical difficulties here noted by *Maxwell*. For in his work on Matter, Aether and Motion, Boston, 1894, Prof. *A. E. Dolbear* describes an experiment of the following kind:

»If a dozen disks five or six inches in diameter are set loosely an inch apart upon a spindle a foot long, so that they may be rotated fast, yet left free to move longitudinally upon the spindle, they will all crowd up close together, as the pressure is less between them than outside. If one can imagine the spindle to be flexible and the ends brought opposite each other while rotating, it will be seen that the ends would exhibit an apparent attraction for each other, and if free to approach, would close up, thus making a vortex ring with the sections of disks. If the axis of the disks were shrinkable, the whole thing would contract to a minimum size that would be determined by the rapidity of the rotary movement, in which case not only would it be plain why the ring form was maintained, but why the diameter of the ring as a whole should shrink. So long as it rotated it would keep up a stress in the air about it. So far as the experimental evidence goes, it appears that a vortex ring in the air exhibits the phenomenon in question.«

The behavior of the flexible spindle in this experiment is analogous to that of the lines of force, which *Faraday* long ago observed had a notable tendency to shorten themselves. The gaseous medium of the air between the disks is thinned out, by the effect of the centrifugal force, just as the aether itself is near a magnet, owing to the rotations¹⁾ of the wave elements about the lines of force. Hence the lines of force tend to shorten themselves, as *Faraday* observed in his experiments with magnets and electric currents.

In view of this experiment it is not remarkable therefore that the lapse of time has confirmed *Maxwell's* stresses

¹⁾ We hold the lines of force to be filaments of the aethereal vortices, due to rotations of the wave elements, as the waves recede from a magnet. If dm be the element of aethereal mass in rotation, and the z -axis coincide with the axis of the magnet, the angular momentum of an element in the plane of the magnetic equator will be: $A = \sum dm (y \cdot dx/dt - x \cdot dy/dt)$. This momentum of masses of aether $\sum dm$, about the axis of the line of force, tends to beat back the aether in the equatorial plane, and causes it to press in on the two ends, parallel to the z -axis. Hence we see the inevitable tendency of the lines of force to shorten themselves. Cf. *Maxwell*, On Physical Lines of Force, 1862, Scientific Papers, Vol. 1, p. 508.

for electrical action, yet shown on the other hand that the stresses conceived by him for gravitation are invalid, because in this latter case he conceived the pressure to be in the direction of the lines of force.

Maxwell's conclusion as to gravitation is announced in the article Attraction (Scientific papers, vol. 2, p. 489): »To account for such a force (gravitation) by means of stress in an intervening medium, on the plan adopted for electric and magnetic forces, we must assume a stress of an opposite kind from that already mentioned. We must suppose that there is a pressure in the direction of the lines of force, combined with a tension in all directions at right angles to the lines of force. Such a state of stress would, no doubt, account for the observed effects of gravitation. We have not, however, been able hitherto to imagine any physical cause for such a state of stress.«

It seems remarkable that *Maxwell* himself should not have seen the error underlying this reasoning. When we whirl a stone by a string, it is the tension of the cord which holds the stone in its circular path, thus overcoming the centrifugal force. If the string breaks, the stone goes flying away, along the tangent to the instantaneous path at the moment when the tension of the string is released.

Innumerable examples of this central tension or pulling, necessary to overcome centrifugal force, should have occurred to *Maxwell*, as perfectly analogous to the forces which hold the planets in their orbits.

It was seven years after the death of *Maxwell* (1879) before the mathematical test required to overthrow the validity of his gravitational stresses was given by Prof. *George M. Minchin* in his Treatise on Statics, Oxford, 1886, Vol. II, pp. 448-455. *Minchin* calculates the Maxwellian gravita-

tional stress intensities at any point P and finds the components to be:

$$A = -R^2/8\pi\gamma \quad B = R^2/8\pi\gamma \quad C = R^2/8\pi\gamma \quad (37)$$

where R is the resultant force intensity, and γ the gravitation constant. These expressions show that the three principal stresses are equal. The component A , along the line of force, is, by *Maxwell's* hypothesis, a pressure, and the other two components are tensions.

Apparently Prof. *Minchin* never seriously suspected the fallacy underlying *Maxwell's* assumption, that pressure in the medium along the radius vector of a planet could make its orbit curve about the sun, where in fact a tension, corresponding to the full breaking strength of stupendous cables of steel, is required to be exerted for holding a planet in its elliptical path. The nature of the curvature of the elliptic orbit was established by *Kepler* from the observations of *Tycho*, 1609, and first explained by *Newton* from the law of gravitation, 1687.

After a very learned discussion, Prof. *Minchin* only reaches the conclusion that since on trial, the mathematical conditions specified by the stress analysis are not fulfilled, — »either gravitation is not propagated by the Maxwellian stress, or the aether is not of the nature of a solid body.«

This is a good historical example of a false premise, on which much ingenious mathematical effort was spent, without detecting the physical error underlying the hypothesis. It will forcibly remind natural philosophers of *Einstein's* bizarre proposal to do away with the aether, without substituting any medium or substance in the planetary spaces which might exert contractile power for holding the planets and stars in their orbits.

It is scarcely necessary to add that if the signs of *Maxwell's* stresses given above be changed, so as to give a component of tension in the line of force, and two equal pressures at right angles thereto, thus:

$$A = +R^2/8\pi\gamma \quad B = -R^2/8\pi\gamma \quad C = -R^2/8\pi\gamma \quad (38)$$

gravitational phenomena would be explained.

In the *Electrod. wave-theory of Phys. Forces*, 1917, pp. 131-133, will be found an explanation of why the aether tends to contract between any two bodies, as the sun and earth. This may be made a little more obvious by the following diagram, in which each body is shown surrounded by a wave-field, the aether near either body being so agitated by the waves from its own atoms as to be of less density towards either centre than in the remoter spaces between the masses.

We are to conceive the waves from either centre, by interpenetrating with those from the other centre, undoing the wave stress, depending on the other mass, and thus causing a constant tendency of the aether to collapse, which results in pulling with maximum tension along the right line connecting the two bodies.

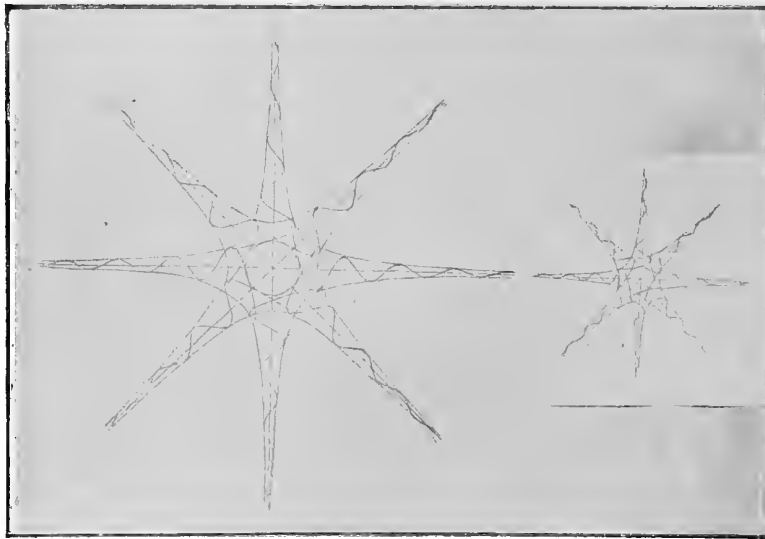


Fig. 8. Illustration of the development of stress between the sun and earth, owing to the interpenetration of the waves, rotating in opposite directions, from these two independent wave-fields, thus causing a tendency to collapse, in the medium between the two bodies, which furnishes the tension required to hold the planets in their orbits.

This gives us a very simple and direct grasp of the mechanism underlying the planetary forces, which is not very different from those operative in electricity and magnetism, except for the essentially haphazard arrangement of the planes of the atoms in the heavenly bodies. These bodies are only slightly magnetic, — this power depending on the lining up of a small fraction of their atoms, in planes which are mutually parallel, as in common magnets; while the great mass of the atoms are tilted haphazard. The resulting action yields the central force called gravity, instead of the duality of powers noted by *Airy* (Treatise on Magnetism, 1870, p. 10) for the magnetic attraction directed towards two poles.

7. Sextuple Integration, under *Fourier's* Theorem, for solving *Poisson's* Partial Differential Equation $\partial^2\Phi/\partial t^2 = a^2\nabla^2\Phi$ for the velocity-potential, in a medium like the aether, capable of freely propagating waves.

We consider the partial differential equation for the velocity-potential Φ in wave motion:

And as this will apply to the several variables, we get by three successive integrations between the limits $-\infty$ and $+\infty$:

$$\Phi = \Omega(x, y, z, t) = (1/8\pi^3) \iiint \iiint \iiint e^{AV^{(-1)}} \cdot \Omega(\xi, \eta, \zeta, t) \cdot d\xi d\eta d\zeta d\lambda d\mu d\nu. \quad A = (\xi - x)\lambda + (\eta - y)\mu + (\zeta - z)\nu. \quad (41)$$

If now we substitute the derivatives of this result in (39), observing by the form of A , in (41), that we have upon actual derivation:

$$(\partial^2/\partial x^2 + \partial^2/\partial y^2 + \partial^2/\partial z^2) e^{AV^{(-1)}} = e^{AV^{(-1)}} (-\lambda^2 - \mu^2 - \nu^2) \quad (42)$$

we have for the solution of the original equation involving the four variables:

$$\partial^2\Phi/\partial t^2 - a^2(\partial^2\Phi/\partial x^2 + \partial^2\Phi/\partial y^2 + \partial^2\Phi/\partial z^2) = 0$$

$$\Phi = \Omega(x, y, z, t) = (1/8\pi^3) \iiint \iiint \iiint e^{AV^{(-1)}} \cdot \{\partial^2/\partial t^2 + a^2(\lambda^2 + \mu^2 + \nu^2)\} \Omega(\xi, \eta, \zeta, t) \cdot d\xi d\eta d\zeta d\lambda d\mu d\nu = 0 \quad (43)$$

(limits of integration $-\infty$ and $+\infty$). This equation will be satisfied, if $\Omega(\xi, \eta, \zeta, t)$ is determined so as to satisfy the equation:

$$\partial^2\Omega(\xi, \eta, \zeta, t)/\partial t^2 + a^2(\lambda^2 + \mu^2 + \nu^2)\Omega(\xi, \eta, \zeta, t) = 0. \quad (44)$$

We therefore integrate this differential equation, and in place of arbitrary constants, we introduce arbitrary functions Ψ_1 and ψ_1 of ξ, η, ζ . Accordingly our solutions yield the following particular integrals:

$$\Omega(\xi, \eta, \zeta, t) = e^{Bht} V^{(-1)} \Psi_1(\xi, \eta, \zeta) \quad \Omega(\xi, \eta, \zeta, t) = e^{-Bht} V^{(-1)} \psi_1(\xi, \eta, \zeta) \quad B = (\lambda^2 + \mu^2 + \nu^2)^{1/2}. \quad (45)$$

If now we substitute the first of these in (41), and include the integration factor $1/8\pi^3$ in the arbitrary function, we have (limits of integration $-\infty$ and $+\infty$):

$$\Phi = \Omega(x, y, z, t) = \iiint \iiint \iiint e^{(A+Bht)} V^{(-1)} \Psi_1(\xi, \eta, \zeta) \cdot d\xi d\eta d\zeta d\lambda d\mu d\nu. \quad (46)$$

This is a particular integral of equation (41), and the second value in (45) would lead to an identical result, as may be proved by actual substitution. Thus it only remains to complete the solution from such particular solutions.

$$\text{Let} \quad \partial^2/\partial x^2 + \partial^2/\partial y^2 + \partial^2/\partial z^2 = A \quad t = \theta \quad (47)$$

$$\text{so as to reduce the given equation to the symbolical form:} \quad \Phi - [A/D(D-1)] e^{2\theta} \cdot \Phi = 0 \quad (48)$$

$$\text{where } \partial/\partial\theta = D. \text{ Then the transformation:} \quad \Phi = e^{-\theta} \cdot \partial\chi/\partial\theta = \partial\chi/\partial t \quad (49)$$

$$\text{will give:} \quad \chi - [A/D(D-1)] e^{2\theta} \cdot \chi \quad (50)$$

which is of the same form as the equation for Φ in (48).

$$\begin{aligned} \partial^2\Phi/\partial t^2 &= a^2\nabla^2\Phi & \Phi &= \Omega(x, y, z, t) \\ d\Phi &= \partial\Phi/\partial x \cdot dx + \partial\Phi/\partial y \cdot dy + \partial\Phi/\partial z \cdot dz \end{aligned} \quad (39)$$

$d\Phi$ being an exact differential, to which *Poisson* (Traité de Mécanique, 1833, Tome II, p. 697) and *Cauchy* have given so much attention, in the period immediately preceding and following the development of *Fourier's* analysis, (1807-1821). This method finally appeared in the celebrated *Théorie Analytique de la Chaleur*, 1821. Besides the above reference to *Poisson's* Mechanics, we cite the important memoirs indicated below¹⁾.

Poisson usually treats his differential equation in the form: $\partial^2\Phi/\partial t^2 - a^2(\partial^2\Phi/\partial x^2 + \partial^2\Phi/\partial y^2 + \partial^2\Phi/\partial z^2) = 0$.

Thus Φ is any solution of the equation (39), which involves three variable coordinates, x, y, z , and the time, t .

By a well known form of *Fourier's* theorem we have:

$$\Omega(x) = 1/2\pi \cdot \int_{-\infty}^{+\infty} \int_{-\infty}^{+\infty} e^{(\xi-x)\lambda} V^{(-1)} \cdot \Omega(\xi) \cdot d\xi d\lambda. \quad (40)$$

¹⁾ 1. *Fourier*. Oeuvres de *Fourier*, Tomes I et II, publiées sous les auspices du Ministère de l'Instruction Publique par les soins de *Gaston Darboux*, Paris, 1888.

2. *Poisson*: a) Mémoire sur la Théorie des Ondes, Déc. 18, 1815; Mém. de l'Acad., T. I.

b) Mémoire sur l'Intégration de quelques équations linéaires aux différences partielles, et particulièrement de l'équation générale du mouvement des fluides élastiques. Juill. 19, 1819, Mém. de l'Acad., T. III.

c) Mémoire sur le Mouvement de Deux Fluides Élastiques Superposés. Mars 24, 1823, Mém. de l'Acad., T. X.

d) Mémoire sur l'Équilibre et le Mouvement des Corps Élastiques. Avril 14, 1828, Mém. de l'Acad., T. VIII.

e) Mémoire sur l'Équilibre des Fluides. Nov. 24, 1828, Mém. de l'Acad., T. IX.

f) Mémoire sur la Propagation du Mouvement dans les Milieux Élastiques. Oct. 11, 1830, Mém. de l'Acad., T. X.

g) Mémoire sur l'Équilibre et le Mouvement des Corps Crystallisés. Oct. 28, 1839, Mém. de l'Acad., T. XVIII.

3. *Cauchy*: a) Théorie de la Propagation des Ondes à la surface d'un Fluid Pesant d'une Profondeur Indéfinie, 1815.

b) Sur l'Intégration d'Équations Linéaires. Exercices d'Analyse et de Physique Mathématique, T. I, p. 53.

c) Sur la Transformation et la Réduction des Intégrales Générales d'un Système d'Équations Linéaires aux différences partielles, ibid. p. 178.

It thus follows that χ admits of expression in the form (46), and therefore by merely changing the arbitrary function, we have (limits of integration $-\infty$ and $+\infty$):

$$\chi = \Omega'(x, y, z, t) = \partial/\partial t \iiint \iiint \iiint e^{(A+Bht)} V^{(-1)} \cdot \Psi_2(\xi, \eta, \zeta) \cdot d\xi d\eta d\zeta d\lambda d\mu d\nu. \tag{51}$$

To get the complete integral from these independent particular integrals (46) and (51), we add the two solutions multiplied by arbitrary constants, (cf. *Hattendorff's* edition of *Riemann's* Partielle Differentialgleichungen, 1882, p. 100), which may be included under the sextuple integral signs (limits of integration $-\infty$ and $+\infty$):

$$\Phi_1 = c_1 \Phi + c_2 \chi \tag{52}$$

$$= \iiint \iiint \iiint e^{(A+Bht)} V^{(-1)} \cdot \Psi_1(\xi, \eta, \zeta) \cdot d\xi d\eta d\zeta d\lambda d\mu d\nu + \partial/\partial t \iiint \iiint \iiint e^{(A+Bht)} V^{(-1)} \cdot \Psi_2(\xi, \eta, \zeta) \cdot d\xi d\eta d\zeta d\lambda d\mu d\nu. \tag{53}$$

These sextuple integrals admit of reduction to double integrals leading to a form of solution originally obtained by *Poisson*; but *Cauchy* has made this reduction by means of a trigonometrical transformation. The only essential precaution to be taken is to avoid processes by which the functions to be integrated become infinite within the limits.

The above equation belongs to the general form

$$\partial^2 \Phi / \partial t^2 = A \Phi \tag{54}$$

where A is a function of the derivatives with respect to the coordinates $\partial/\partial x, \partial/\partial y, \partial/\partial z$. For all such equations the method above outlined furnishes directly a solution expressed by sextuple integrals, which are reducible to the *Poisson-Cauchy* double integrals, if A is homogeneous and of the second degree, as in the case of a sphere surface, with radius increasing uniformly with the time:

$$x^2 + y^2 + z^2 = c^2 t^2 \tag{55}$$

where c is the parameter representing the velocity of light.

As was long ago pointed out by *Fourier, Poisson* and *Cauchy*, integrals of this type are peculiarly appropriate for the expression of those disturbances involving the transmission of energy in a medium, as in the steady flow of waves, whether of sound, light, heat or electrodynamic action. These wave disturbances are propagated through the medium in question with a finite velocity, and unless the waves are regularly renewed the original disturbance leaves no trace behind when it has passed by; so that the upkeep of the energy flow involves periodic renewal of disturbances for maintaining the steady flow of waves. In his *Théorie Analytique de la Chaleur*, 1821, *Fourier* continually emphasizes the incessant movement of heat.

Solution of *Poisson's* equation for the velocity-potential Φ in wave motion from n bodies.

Let there be n bodies emitting waves: m_1 with coordinates (x_1, y_1, z_1, t_1) surrounded at the instant t_1 by an infinite series of wave surfaces, which for simplicity we may suppose to be spherical:

$$\begin{aligned} x_1^2 + y_1^2 + z_1^2 - c_1^2 t_1^2 &= 0 \\ x_2^2 + y_2^2 + z_2^2 - c_2^2 t_1^2 &= 0 \\ \dots\dots\dots \\ x_l^2 + y_l^2 + z_l^2 - c_l^2 t_1^2 &= 0. \end{aligned}$$

$$\begin{aligned} \Phi &= \Phi_1, (m_1) + \Phi_2, (m_2) + \Phi_3, (m_3) + \dots + \Phi_n, (m_n) \\ \Phi_n, (m_n) &= \iiint \iiint \iiint k_{I_n} / V [(\xi_{I_n} - \xi_{I_i})^2 + (\eta_{I_n} - \eta_{I_i})^2 + (\zeta_{I_n} - \zeta_{I_i})^2] \cdot e^{(A_n + B_n h_n t_i)} V^{(-1)} \cdot \Psi_n(\xi_n, \eta_n, \zeta_n) \cdot d\xi_n d\eta_n d\zeta_n d\lambda_n d\mu_n d\nu_n \\ &+ \partial/\partial t \iiint \iiint \iiint k_{I_n} / V [(\xi_{I_n} - \xi_{I_i})^2 + (\eta_{I_n} - \eta_{I_i})^2 + (\zeta_{I_n} - \zeta_{I_i})^2] \cdot e^{(A_n + B_n h_n t_i)} V^{(-1)} \cdot \psi_n(\xi_n, \eta_n, \zeta_n) \cdot d\xi_n d\eta_n d\zeta_n d\lambda_n d\mu_n d\nu_n. \end{aligned} \tag{57}$$

Accordingly, at the time t_1 there are $\sum_{I=1}^{I=\infty} I = \infty$ of these concentric wave surfaces, all moving with the velocity c , which is the velocity of light. But the time t also flows on, and if there be i intervals, the summation $\sum_{i=1}^{i=\infty} i = \infty$ will yield for the double integration of intervals and waves:

$$\sum_{i=1}^{i=\infty} \sum_{I=1}^{I=\infty} i I = \infty^2$$

which corresponds to all the points in an infinite plane.

Imagine another system of coordinates (ξ_I, η_I, ζ_I) , with its origin at the centre of gravity of $m_1 (\xi_{h1}, \eta_{h1}, \zeta_{h1}, t_1)$, to which the moving waves are referred at i times, so that for the n bodies we have:

For the Bodies.	For the Waves emitted.
$m_1 (x_1, y_1, z_1, t_1)$	$m_1 (\xi_{h1}, \eta_{h1}, \zeta_{h1}, t_1)$
$m_2 (x_2, y_2, z_2, t_1)$	$m_2 (\xi_{h2} - \xi_{h1}, \eta_{h2} - \eta_{h1}, \zeta_{h2} - \zeta_{h1}, t_1)$
$m_3 (x_3, y_3, z_3, t_1)$	$m_3 (\xi_{h3} - \xi_{h1}, \eta_{h3} - \eta_{h1}, \zeta_{h3} - \zeta_{h1}, t_1)$
.....
$m_n (x_n, y_n, z_n, t_1)$	$m_n (\xi_{hn} - \xi_{h1}, \eta_{hn} - \eta_{h1}, \zeta_{hn} - \zeta_{h1}, t_1)$

Then, from the preceding investigation it will follow that the solution of *Poisson's* equation $\partial^2 \Phi / \partial t^2 = a^2 \nabla^2 \Phi$ for the velocity-potential Φ and transmission of energy of wave motion, in the case of n bodies will be similar to that already found for a single wave centre, except that as the waves from the several bodies are everywhere superposed, the velocity-potentials $\Phi_1, \Phi_2, \Phi_3, \dots, \Phi_n$ from the several centres must be added together to get the total effect, $\Phi_1 + \Phi_2 + \Phi_3 + \dots + \Phi_n = \Phi$, when the waves from the n bodies mutually interpenetrate, giving maximum tension in the right lines which connect the bodies in pairs, and maximum pressure in the prolongation of these lines beyond the masses.

Accordingly, if we introduce the amplitude of the waves from each mass, $A_{Ii} = k_{Ii} / V (\xi_{Ii}^2 + \eta_{Ii}^2 + \zeta_{Ii}^2)$ and retain the amplitude $e^{(A+Bht)} V^{(-1)}$ for deteriorating wave changes, under resistance, we shall find for the general solution the expression (all integrations between the limits $-\infty$ and $+\infty$):

This solution of *Poisson's* equation for the velocity-potential Φ is well calculated to show the complexity of the problem of explaining the forces which govern the operations of the physical universe. The velocity-potential is essentially a function of the elasticity in a gas, condensation alternating with rarefaction, by which wave motion once generated is maintained at all points of space, and at velocities suitable to the elasticity and density of the medium at these points. Thus wherever waves penetrate the velocity-potential must also exist.

And we see not only that the domain penetrated by the waves includes all space, from minus infinity to plus infinity, in a sextuple integration, which corresponds to an integration connecting every point of space with every other point; but also that it must be continuous, that is, repeated for every pair of points two and two.

The waves from the individual atoms are infinitely more complex still, and in fact cannot be given except by an integral like the foregoing, infinitely extended. This infinite integral could be written out analytically, yet its contemplation would aid us but little in grasping the infinitely complex phenomena of nature.

In practice it suffices to remember that from every body an infinitely complex system of waves goes forth, to interpenetrate and combine with the like infinitely complex wave systems going forth from all other bodies. The summation of all these disturbances is an infinite integral of the effects of small commotions, the final result of which is the system of forces operating throughout the physical universe.

In the *Principia* (Lib. III, Props. VI-VIII and Prop. XXIV) Sir *Isaac Newton* points out how the gravitative force due to one body may penetrate into the regions occupied by any other body or system, just as if the other body or system did not exist; so that each body or system acts independently of the others, yet the final effect is a combination of the separate effects. Gravitation, therefore, is an interpenetrating power — just such an influence as would arise from waves propagated from the several centres, and extending throughout all parts of the system of the world.

8. Geometrical Conditions fulfilled by the Velocity-potential Φ , expressions for the molecular velocity and condensation at any distance from the source of disturbance, with an indication of the energy due to the waves of various lengths observed in nature.

The solution of the problem of vibrating cords runs back to *Daniel Bernoulli* and *D'Alembert*, but the method of analysis was generalized by *Lagrange*, and *Poisson* has greatly improved the theory for application to all classes of waves. The energy in the wave function depends on three coordinates, x, y, z , and the time t , because when a disturbance originates in a medium it spreads in all directions,

sometimes at rates depending on the wave conductivity along certain axes, but always at a rate defined by the time t .

If the medium be gaseous, as in the kinetic theory of the aether, Φ must be the velocity-potential¹⁾. Accordingly, we outline the equations of such a medium:

$$\begin{aligned} d\Phi &= \partial\Phi/\partial x \cdot dx + \partial\Phi/\partial y \cdot dy + \partial\Phi/\partial z \cdot dz \\ &= u dx + v dy + w dz \\ u &= \partial\Phi/\partial x \quad v = \partial\Phi/\partial y \quad w = \partial\Phi/\partial z \end{aligned} \quad (58)$$

where u, v, w are the component velocities.

The general equation of equilibrium is:

$$\begin{aligned} dV &= X dx + Y dy + Z dz \\ \text{whence } X &= \partial V/\partial x \quad Y = \partial V/\partial y \quad Z = \partial V/\partial z \end{aligned} \quad (59)$$

Now put $\int(1/\rho) d\Phi = P$; and we have the well known relations:

$$\begin{aligned} (1/\rho) \partial\Phi/\partial x &= \partial P/\partial x \quad (1/\rho) \partial\Phi/\partial y = \partial P/\partial y \\ (1/\rho) \partial\Phi/\partial z &= \partial P/\partial z \\ V - P &= \partial\Phi/\partial t + 1/2[(\partial\Phi/\partial x)^2 + (\partial\Phi/\partial y)^2 + (\partial\Phi/\partial z)^2] \end{aligned} \quad (60)$$

And the equation of continuity:

$$\partial\rho/\partial t + \partial/\partial x(\rho \cdot \partial\Phi/\partial x) + \partial/\partial y(\rho \cdot \partial\Phi/\partial y) + \partial/\partial z(\rho \cdot \partial\Phi/\partial z) = 0. \quad (62)$$

For an incompressible fluid the second expression in (62) vanishes:

$$\partial^2\Phi/\partial x^2 + \partial^2\Phi/\partial y^2 + \partial^2\Phi/\partial z^2 = 0. \quad (63)$$

But the aether is not incompressible, and this equation therefore does not apply to any gaseous medium.

In general the exact form of the wave surface cannot be defined, owing to changes in the density and elasticity of the bodies penetrated by the advance of the wave front. If the medium be symmetrical in respect to three axes at right angles, as in the case of certain crystals, then the wave surface, from a disturbance at the centre of such a mass, will pass from the spherical form:

$$x^2 + y^2 + z^2 - c^2 t^2 = 0 \quad (64)$$

and take the form of an ellipsoid of three unequal axes:

$$x^2/\alpha^2 + y^2/\beta^2 + z^2/\gamma^2 - c^2 t^2 = 0 \quad (65)$$

where the axes α, β, γ denote the conductivities along the axes of the ellipsoid, and $ct = r$, at any stage of the progress with the wave surface in the form of the ellipsoid:

$$x^2/\alpha^2 + y^2/\beta^2 + z^2/\gamma^2 = 1. \quad (66)$$

It follows therefore that the problem of wave motion involves the solution of *Poisson's* equation:

$$\partial^2\Phi/\partial t^2 = a^2(\partial^2\Phi/\partial x^2 + \partial^2\Phi/\partial y^2 + \partial^2\Phi/\partial z^2) \quad (67)$$

where a is the velocity of the wave propagation (cf. *Poisson, Traité de Mécanique*, 1833, tome II, p. 663-720; or *Lord Rayleigh's Theory of Sound*, vol. II, chapter XIII).

Let u, v, w be the component velocities parallel to the axes Ox, Oy, Oz of an element of mass dm , at the instant t , so that,

$$x - x' = \int u dt \quad y - y' = \int v dt \quad z - z' = \int w dt. \quad (68)$$

¹⁾ If for any part of an elastic fluid mass $d\Phi = u dx + v dy + w dz = 0$ be a perfect differential at one moment, it will remain so for all subsequent time. When Φ is single valued, the integral round any closed circuit vanishes, $\int d\Phi = 0$. This is the irrotational condition of hydrodynamics. Hence, with condensations and rarefactions alternating, and of equal intensity, in wave motion, the above condition $\int d\Phi = 0$ is met by the plane wave $\Phi = A \cos[2\pi/\lambda \cdot (x - at)]$, which is typical of the velocity-potential in general.

If we neglect the squares of the velocities $\partial\Phi/\partial x$, $\partial\Phi/\partial y$, $\partial\Phi/\partial z$, and put $v = 0$, $w = 0$, Φ will become a function of x and t only:

$$\partial^2\Phi/\partial t^2 = a^2\partial^2\Phi/\partial x^2 \quad (69)$$

$$\Phi = \Omega(x, t) = A \cos[2\pi/\lambda \cdot (x - at)]^1.$$

The solution obviously is an undulation of flat wavelets parallel to the axis of x , traveling with velocity a .

Let ζ be the velocity in the direction of the radius vector, so that the resultant

$$\zeta = \sqrt{u^2 + v^2 + w^2} \quad (70)$$

then since for spherical disturbances

$$x^2 + y^2 + z^2 = r^2 \quad x dx + y dy + z dz = r dr \quad (71)$$

$$u = \zeta x/r \quad v = \zeta y/r \quad w = \zeta z/r$$

we get $u dx + v dy + w dz = \zeta dr \quad \zeta = \partial\Phi/\partial r \quad (72)$

$$\partial\Phi/\partial x = \partial\Phi/\partial r \cdot x/r \quad \partial\Phi/\partial y = \partial\Phi/\partial r \cdot y/r \quad (73)$$

$$\partial\Phi/\partial z = \partial\Phi/\partial r \cdot z/r.$$

Differentiating a second time, we have

$$\partial^2\Phi/\partial x^2 = \partial^2\Phi/\partial r^2 \cdot x^2/r^2 + \partial\Phi/\partial r \cdot (y^2 + z^2)/r^3 \quad (74)$$

$$\partial^2\Phi/\partial y^2 = \partial^2\Phi/\partial r^2 \cdot y^2/r^2 + \partial\Phi/\partial r \cdot (z^2 + x^2)/r^3$$

$$\partial^2\Phi/\partial z^2 = \partial^2\Phi/\partial r^2 \cdot z^2/r^2 + \partial\Phi/\partial r \cdot (x^2 + y^2)/r^3.$$

By means of these values, *Poisson's* equation,

$$\partial^2\Phi/\partial t^2 = a^2(\partial^2\Phi/\partial x^2 + \partial^2\Phi/\partial y^2 + \partial^2\Phi/\partial z^2) \quad (75)$$

becomes $\partial^2\Phi/\partial t^2 = a^2(\partial^2\Phi/\partial r^2 + 2/r \cdot \partial\Phi/\partial r).$

This is the same as

$$\partial^2_r\Phi/\partial t^2 = a^2(\partial^2_r\Phi/\partial r^2) \quad (76)$$

the complete integral of which is

$$r\Phi = f(r+at) + F(r-at) \quad (77)$$

where f and F are two arbitrary functions.

By extending his analysis (*Traité de Mécanique*, 1833, vol. II, p. 706) *Poisson* shows that since $\zeta = \partial\Phi/\partial r$, we have

$$\zeta = 1/r \cdot f'(at-r) + 1/r^2 \cdot f(at-r) \quad (78)$$

$$s = 1/ar \cdot f'(at-r).$$

Accordingly, *Poisson* concludes that at a great distance from the centre of this disturbance we may neglect the second terms of the values of ζ , which are divided by r^2 , in comparison with the first, which are divided by r . Thus for the whole duration of the movement we get for the condensation or dilatation $s \quad s = \zeta/a. \quad (79)$

By equation (78), therefore, the velocity of the molecules in a gaseous medium decreases inversely as r , just as in the amplitudes of the waves postulated in the kinetic theory of the aether. The condensation or dilatation s varies as the velocity in the direction of the radius vector, which itself varies inversely as r ; and also inversely as a , the velocity of wave propagation. Accordingly, for a highly elastic medium, s is small, and decreases very rapidly; which confirms our view that the amplitudes of the aether waves are very minute, and decrease inversely as r in receding from the sun.

In finishing this paper, Febr. 19, 1920, I am surprised to notice *Poisson's* sagacious remark (p. 706): »La vitesse propre des molécules d'air décroît alors en raison inverse

de r «: which affords an unexpected verification of the writer's formula for the amplitudes of the aether waves, $A = k/r$, also derived from the kinetic theory, but by a different process. It thus appears that *Poisson* had such a result for the waves of sound 87 years ago, and its neglect for nearly a century is remarkable.

As Lord *Rayleigh* points out in his *Theory of Sound*, 2nd edition, 1896, vol. II, p. 16: the rate at which energy is transmitted across unit area of a plane parallel to the front of a progressive wave may be regarded as the mechanical measure of the intensity of the radiation. This is the basis of Lord *Kelvin's* celebrated paper of 1854, »On the possible density of the luminiferous medium, and on the mechanical value of a cubic mile of sunlight«, (*Trans. Roy. Soc., Edinburgh*, 1854), which we have used, in our first paper on the new theory of the aether, for calculating the density of this medium. The energy transmitted, in the direction of the three coordinate axes, Φ being taken successively as a function of x (and t), y (and t), z (and t) only, is given by the approximate equations:

$$\partial^2\Phi/\partial t^2 = a^2 \cdot \partial^2\Phi/\partial x^2 \quad \partial^2\Phi/\partial t^2 = a^2 \cdot \partial^2\Phi/\partial y^2 \quad (80)$$

$$\partial^2\Phi/\partial t^2 = a^2 \cdot \partial^2\Phi/\partial z^2$$

which are expressed in (75) above.

In case the gravitational wave transmission occurs within a mass of density ρ , we have *Poisson's* equation for the potential:

$$\partial^2 V/\partial x^2 + \partial^2 V/\partial y^2 + \partial^2 V/\partial z^2 + 4\pi\rho = 0 \quad (81)$$

instead of the equation of *Laplace*:

$$\partial^2 V/\partial x^2 + \partial^2 V/\partial y^2 + \partial^2 V/\partial z^2 = 0. \quad (82)$$

And thus within an elastic solid the equation (80) would become:

$$\partial^2\Phi/\partial t^2 = a^2 \cdot (\partial^2\Phi/\partial x^2 + \partial^2\Phi/\partial y^2 + \partial^2\Phi/\partial z^2 + 4\pi\rho) \quad (83)$$

which is of the form adopted by *Riemann*, for the induction of electric currents, in the memoir presented to the Royal Society of Göttingen in 1858, but subsequently withdrawn, and after the death of the author, published in *Poggendorff's Annalen* 131.237-263, 1867.

This investigation of *Riemann* was examined by *Clausius* (*Poggendorff's Annalen* 135.612) who doubts the validity of the mathematical processes for the phenomenon of electric induction, chiefly on the ground that the hypothesis that potential is propagated like light, does not lead either to the law of *Weber* or to the other laws of electrodynamics.

In our *Electrod. Wave-Theory of Phys. Forc.*, however, it is not held that potential is propagated like light; on the contrary that the potential is a function $V = f(x, y, z, \rho)$, is fixed in space, yet depends on the total accumulated stress due to wave amplitudes of all the matter involved. Hence this criticism is not valid against the wave-theory here dealt with.

Moreover, we use *Poisson's* equation for the potential, $\nabla^2 V + 4\pi\rho = 0$, only within solid masses, *Laplace's* equation $\nabla^2 V = 0$ applying to all free space. Thus we adopt a transition between these two equations at the boundary of any mass of matter, as long recognized by geometers and natural philosophers.

The physical meaning of the transition is the sharp difference in velocity of propagation for all aether waves at

¹⁾ Lord *Rayleigh*, *Theory of Sound*, vol. II, p. 15-16, 2nd edition, 1896.

the boundary of a mass of matter; and moreover the decrease in total accumulated stress due to the aether waves from all the atoms, as the moving point $p(x, y, z)$ enters the body of density ρ , and leaves behind a part of the mass, — the aether waves coming from the atoms of this shell from all directions just balancing in a homogeneous sphere. But whatever the law of density or form of the body, there is a change in the sum of the second differentials of the potential at the boundary of the body, from *Laplace's* to *Poisson's* equation:

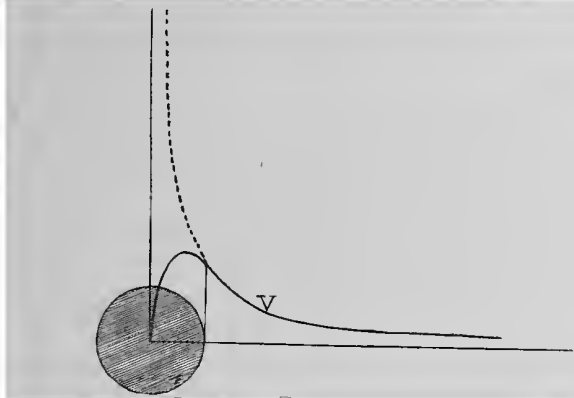


Fig. 9. Curve of the potential function V , showing its asymptotic decrease with the distance, and the tendency to an asymptotic increase towards the centre; but owing to finite dimensions of the mass, a gradual decline to zero.

This difference between *Laplace's* equation of the potential for free space, and *Poisson's* corresponding equation for space filled with matter of density ρ , owing to the intervention of boundary conditions, is distinctly favorable to the wave-theory of physical forces. We therefore presented the treatment of the wave equation of *Poisson* $\partial^2 \Phi / \partial t^2 = a^2 \nabla^2 \Phi$ for free space, by the general method of integration based on *Fourier's* theorem.

This solution will hold for waves of any initial wave length, propagated with the velocity of light, from n bodies, in all parts of space, and everywhere mutually interpenetrating so as to generate maximum tension in the right lines connecting the n bodies in pairs, in accordance with the observed phenomena of universal gravitation.

If the solution will hold for separate bodies, from which spherical waves are emitted, it obviously will hold also for separate vibrating particles, within a single body; but here the mathematical difficulty is increased, by virtue of the unequal conductivity which heterogeneous solid bodies offer to wave propagation; so that the expression of the effects of the waves from the atoms would be infinitely complex. Yet the above equation (57) gives the approximate representation of the propagation of wave energy from atoms, which may be useful in certain problems of molecular physics.

The solution in (57) already involves an infinitely complex integration, repeated n -times for the n bodies of the universe. To include the initial waves of all possible lengths, we should have to integrate this complex expression for Φ between the limits, $\lambda = 0$; $\lambda = \infty$, involving all possible periodicities, the number of which is: $n = [V/\lambda]_{\lambda=0}^{\lambda=\infty}$.

Now, according to the researches of Prof. *Planck* on thermodynamic radiation, the energy E of wave length λ is given by the rather complex expression

$$E_\lambda d\lambda = (k/RT\lambda) / (e^{k/RT\lambda} - 1) \cdot 8\pi RT\lambda^{-4} d\lambda \quad (84)$$

which admits of integration within certain limits.

In this formula, R and T are the gas-constant and absolute temperature, $k = hV$, V being the velocity of light, and h is *Planck's* new constant, $h = 6.55 \times 10^{-27}$ ergs secs, so that if the wave frequency be ν , $\lambda = V/\nu$ and

$$x = k/RT\lambda = h\nu/RT. \quad (85)$$

And *Planck's* fundamental equation for the quantum of energy of ν frequency is

$$\epsilon = h\nu. \quad (86)$$

By the use of *Planck's* formula therefore

$$E_\lambda d\lambda = 8\pi RT\lambda^{-4} [x/(e^x - 1)] d\lambda. \quad (87)$$

This integration, to take account of the various wave lengths, could be carried out, but the subject is in too primitive a condition to be undertaken at present.

9. A Definite Criterion for deciding between the Great and Small Densities claimed for the Aether.

In Section I of the first paper on the new theory of the aether, we have cited the claim put forward by certain electronists, that, on the hypothesis of incompressibility, the aether has a density 2000 million times that of lead. In his *Aether of Space*, 1909, p. 91-105, Sir *Oliver Lodge* finds from electrical theory that the density of the aether is 10^{12} , a million million times that of water.

It is only fair to point out that as the aether transmits waves, as in light, heat, magnetism, electrodynamic action, and radio telegraphy, of the most varied length, and of various amplitudes, it is not conceivable that it should be incompressible, so that the dilatation is zero in the equation:

$$\delta = \partial\alpha/\partial x + \partial\beta/\partial y + \partial\gamma/\partial z = 0 \quad (88)$$

where α, β, γ , are the displacements, and

$$\partial^2 \Phi / \partial t^2 = a^2 (\partial^2 \Phi / \partial x^2 + \partial^2 \Phi / \partial y^2 + \partial^2 \Phi / \partial z^2) = 0$$

by equation (63). For this would make the wave velocity infinite, which is contrary to observation. Accordingly, whilst the aether is highly incompressible, owing to the enormous velocity of the aetherons, and the resulting kinetic elasticity, this medium certainly is not incompressible.

In the article *Aether*, *Encyclopedia Britannica*, 11th ed., 1911, Prof. Sir *Joseph Larmor* is more poised and cautious than the writers previously cited, but his faith in the older theories is so shaken, that he intimates that the ratio of the amplitude of the waves to the wave length, taken by *Maxwell* and *Kelvin* at about 10^{-2} , may be enormously overestimated. *Larmor* adds: »It is not impossible that the coefficient of ultimate inertia of the aether is greater than the coefficient of inertia (of a different kind) of any existing substance«; which shows his tendency to an abandonment of the older theory, under the teachings of the electron theorists.

It thus appears that the excessively small density, found by *Kelvin* and *Maxwell*, namely, about 10^{-18} , or my own value at the earth's mean distance 438×10^{-18} , is opposed by the modern teaching in favor of an enormous density, about 10^{12} , as stated by Sir *Oliver Lodge*. The difference

between the two results presents an enormous contrast, namely the almost unlimited factor:

$$F = 10^{30}, \text{ with the value of Kelvin and Maxwell; (89)}$$

$$= 0.0023 \times 10^{30}, \text{ with See's value.}$$

Accordingly, progress is nearly impossible with this irreconcilable difference of opinion among the learned. *Brooks and Poyser*, as representatives of the opinion of the electronists, state: »There is no intrinsic difficulty in either view, but at present (1912) no method is known by which we may hope to discriminate between them.«

The present writer has therefore labored to develop a criterion for the rejection of one of these competing values, which would leave the other in possession of the field. Besides the above criticism, that the finite velocity of wave propagation excludes the incompressibility of the medium, I have given in the *Observatory*, Nov. 1918, p. 411-412, a brief discussion of the consequence of the intolerable disagreement in the values of the aether density.

A simple calculation has enabled me to exclude *Lodge's* density as wholly inadmissible, because if true the energy of the waves from the sun falling upon a single square centimetre of the earth's surface would be able to vaporize the entire terrestrial globe in less than one minute of time, when we use *Bigelow's* value of the constant of solar radiation, and *Kelvin and Maxwell's* density.

The mass of the earth is 5956292000000000000000 metric tons. If we take the average specific heat of the globe at 0.2, and the vaporizing point of its average matter at 3000°C., the total amount of heat required to reduce it to vapour — the interior being assumed to be without heat — would be

$$H = 5.956292 \times 10^{21} (0.2 \times 3000) \times 1000000 \text{ calories,}$$

$$= 6 \times 5.956292 \times 10^{29} = 3.6 \times 10^{30}, \text{ nearly. (90)}$$

Now *Bigelow's* value of the solar constant is 3.98 cal. per minute, or 0.0663 cal. per second; and, as *Lodge's* value of the density of the aether is about 10^{30} that above cited from *Kelvin and Maxwell*, and 0.0023×10^{30} times my own value, we have for the effect of such an increase in density the raising of the solar radiation by the factor 10^{30} :

$$H = 0.0663 \times 10^{30} = 6.63 \times 10^{28}, \text{ Kelvin and Maxwell (91)}$$

$$\text{or } H = (0.0663 \times 0.0023) \times 10^{30}, \text{ with See's value.}$$

The first of these values would vaporize the earth in 54 seconds of time, the second in 0.277 of a day. But in nature this vaporization does not occur, and thus we conclude that the density of the aether stands at a value near that fixed by *Kelvin and Maxwell* many years ago, but slightly improved in the writer's new theory of the aether.

In the *Observatory*, for Dec., 1918, p. 446, Sir *Oliver Lodge* has attempted to reply to my criticism by pointing out that the energy of the solar radiation depends on the amplitude of the wave, compared to the wave length, which with *Kelvin and Maxwell* I took at 10^{-2} , a value pronounced by Sir *Joseph Larmor* (in the article *Aether*, p. 292) »a very safe limit«. *Lodge* also adds: »many facts have suggested that the amplitude of the most brilliant light is exceedingly small compared with its wave length«.

Now if any good ground can be adduced for decreasing the ratio of the amplitude to the wave-length, I am willing to consider such a modification in the belief of the most eminent physicists, — such as *Kelvin, Maxwell, Larmor* — but it should be pointed out that to make the reconciliation of the extreme values complete, the ratio of the amplitude to the wave-length will have to be lowered by the enormous factor

$$F = 10^{-30} \quad (92)$$

so that A/λ now taken at 10^{-2} , would become

$$A'/\lambda = 10^{-32}. \quad (93)$$

The difficulty of this extreme step is so great that I dismiss it as quite inadmissible. Until new evidence, resting on ground more secure than mere assumption, is available it must be held that Sir *Oliver Lodge's* attempt to reply to this criticism completely breaks down. For even if we took

$$A/\lambda = 10^{-5}, \text{ or } A'/\lambda = 10^{-6} \quad (94)$$

— which are values 1000 or 10000 times more extreme than appealed to the experienced judgements of Lord *Kelvin, Maxwell* and *Larmor*, — the required factor would scarcely be reduced in a sensible degree; and practical experience in physical science certainly would not justify us in exceeding the limit of 10^{-6} .

As a final argument against the electrical theory, assigning the aether a density of 2000 million times that of lead (namely: $11.352 \times 200000000 = 2270400000000$ times that of water!), we may recall the familiar experience of a man swimming in water. Here the swimmer is immersed in an inert liquid of about the same density as his body; yet to move about a strong exertion is required of the most powerful muscles, completely under the control of the will.

If the liquid had the density of quicksilver, the swimmer would scarcely sink down to his boot-tops, and his muscles would be altogether too feeble to displace such an inert and heavy liquid, if he were required to move through it: yet he could walk over such a magma, by great effort, analogous to that required when we walk in very yielding volcanic ashes.

Now the density of mercury (13.6) is a little greater than that of lead (11.352), but the moment we consider an aether 2000000000 times denser than lead, we perceive the culmination of absurdity! Even if it penetrated all bodies quite perfectly, and gave equal pressure on all sides, still some displacement of the particles would be required when we move about in it, as in the case of water displaced by a swimmer. Obviously no living physical body would be capable of displacing such a dense medium; and we see that even the strongest stars, planets and comets would be dispersed to atoms under the changing resistance such a medium would interpose to their variously accelerated motions. The electrical theory assigning the aether a density 2270400000000 greater than that of water is therefore the best possible illustration of a physical *Reductio ad Absurdum*, and we know that either some premise or some

link in the chain of reasoning eventually will not bear investigation¹).

In the article Aether, *Encyclopedia Britannica*, 11th ed., 1911, Prof. Sir *Joseph Larmor* concludes that we must treat the aether as a plenum. Under the influence of electrical theory, he even speaks as if the aether were not molecular. In discussing the transparency of the celestial spaces, — to which much attention was given by *Cheseux* and *Olbers*, *W. Herschel* and *W. Struve* — (cf. *Etudes d'Astron. stell.*, St. Pétersbourg, 1847) — *Larmor* first recalls the well known transparency of space shown by astronomical research, and then adds:

»If the aether were itself constituted of discrete molecules, on the model of material bodies, such transparency would not be conceivable. We must be content to treat the aether as a plenum, which places it in a class by itself; and we thus recognize that it may behave very differently from matter, though in some manner consistent with itself, — a remark which is fundamental in the modern theory.«

The first part of this reasoning apparently implies that the aether is not molecular, at least »on the model of material bodies«. This may be correct in part, because no one would suppose the aether to be made up of complex molecules, overlaid by a finer medium, such as the aether is to the more complex masses of common matter. On the other hand there is not the smallest objection to an aethereal medium made up of spherical perfectly elastic monatomic elements, so called aetherons, having a diameter of 1:4005th of a hydrogen molecule, and a mass of 15.56 millionths of a millionth of such a molecule, such as we show do really exist.

As no finer medium would underly such a monatomic aether, it could not dissipate the energy of wave motion, »on the model of material bodies«, and thus it would fulfill *Larmor's* condition of a plenum. This would give such an excessively fine monatomic molecular structure that the medium would penetrate all material bodies, but waves in such an aether would be very noticeably retarded in solid or liquid bodies, and much less so in gases, in accordance with physical experience.

That the aether must necessarily be molecular follows at once from our every day experience with such granular bodies as fine gravel, grains of corn, sand, shot or mustard seed. If we fill a glass vessel with such coarse granular masses, and insert the fingers or any solid body, such as a rod, into the granules, we perceive that they are thrust aside to make way for the hand or solid rod. If we fill the vessel with water, oil, alcohol, ether, or any similar liquid, our experience in such displacement is the same. The liquid is visibly thrust aside and this holds even when the molecular structure is relatively so fine that a drop of water might be magnified to the dimensions of the earth without exhibiting

the molecules of larger size than footballs, — as shown by Lord *Kelvin* in his well known researches on the size of atoms.

But it will be said that the aether penetrates all bodies, and thus we cannot sensibly displace it, as we can water, oil, alcohol or ether. We reply that it is perfectly true that the aether penetrates freely all bodies, even the dense and highly elastic or rigid masses of the earth, sun and stars, almost as if their molecular structure were absent: yet we learn from the phenomena of refraction and diffraction in our laboratories, that light waves in the aether are very perceptibly retarded in their motions through transparent bodies; and in our investigation of celestial phenomena, we find from the investigation of the motion of the moon that the sun's gravitational waves, though of such length as to pass through the earth, are yet sensibly refracted; and perhaps dispersed or partially absorbed at the time of total eclipses of the moon, — whence arises the fluctuations of the moon's mean motion established by *Newcomb* in 1909, and explained by the present writer in 1916, (cf. *Electrod. Wave-Theory of Phys. Forces*, vol. 1).

From these considerations it appears that we have both terrestrial and celestial evidence that the aether is molecular, but of such excessively fine grained structure that no finer medium whatever underlies it: thus it penetrates all bodies freely, under an elastic power, or expansive tendency, 689321600000 times greater than our atmosphere exhibits in proportion to its density, as more fully shown in the first paper, sect. 4.

10. The Kinetic Theory of the Aether accords with the Views of *Newton*, 1721, and of *Maxwell*, 1877.

In order to further illuminate the above discussion we may recall the earlier though little known views of *Newton* and *Maxwell*, on the physical constitution of the aether.

a) Views of Sir *Isaac Newton*, *Treatise on Optics*, 3rd ed., 1721, p. 325 et seq.²)

»Qu. 20. Doth not this Aethereal Medium in passing out of Water, Crystal, and other compact and dense Bodies, into empty Spaces, grow denser and denser by degrees, and by that means refract the Rays of Light not in a point, but by bending them gradually in curve lines? And doth not the gradual condensation of this Medium extend to some distance from the Bodies, and thereby cause the Inflexions of the Rays of Light, which pass by the edges of dense Bodies, at some distance from the Bodies?«

»Qu. 21. Is not this Medium much rarer within the dense Bodies of the Sun, Stars, Planets and Comets, than in the empty celestial Spaces between them? And in passing from them to great distances, doth it not grow denser and denser

¹) In the *Optics*, 1721, pp. 342-3, *Newton* discusses the very problem here treated of in the following manner: »The resistance of water arises principally and almost entirely from the vis inertiae of its matter; and by consequence, if the heavens were as dense as water, they would not have much less resistance than water; if as dense as quick-silver, they would not have much less resistance than quick-silver; if absolutely dense, or full of matter without any vacuum, let the matter be never so subtle and fluid, they would have a greater resistance than quick-silver. A solid globe in such a medium would lose above half its motion in moving three times the length of its diameter, and a globe not solid (such as are the planets) would be retarded sooner. And therefore to make way for the regular and lasting motions of the planets and comets, it's necessary to empty the heavens of all matter, except perhaps some very thin vapours, steams or effluvia, arising from the atmospheres of the earth, planets and comets, and from such an exceedingly rare aethereal medium as we described above. A dense fluid can be of no use for explaining the phaenomena of nature, the motions of the planets and comets being better explain'd without it.«

²) Quoted at length, because this edition is very inaccessible to the modern reader.

perpetually, and thereby cause the gravity of those great Bodies toward one another, and of their parts towards the Bodies; every Body endeavouring to go from the denser parts of the Medium towards the rarer? For if this Medium be rarer within the Sun's Body than at its surface, and rarer there than at the hundredth part of an inch from its Body and rarer there than at the fiftieth part of an inch from its Body, and rarer there than at the Orb of Saturn; I see no reason why the increase of density should stop anywhere, and not rather be continued through all distances from the Sun to Saturn, and beyond. And though this Increase of density may at great distances be exceeding slow, yet if the elastick force of this medium be exceeding great, it may suffice to impel Bodies from the denser parts of the Medium towards the rarer, with all that power which we call Gravity. And that the elastick force of this Medium is exceeding great, may be gathered from the swiftness of its Vibrations. Sounds move about 1140 English feet in a Second Minute of Time, and in seven or eight Minutes of Time they move about one hundred English Miles. Light moves from the Sun to us in about seven or eight Minutes of Time, which distance is about 70000000 English Miles, supposing the horizontal Parallax of the Sun to be about 12". And the Vibrations or Pulses of this Medium that they may cause the alternate Fits of easy Transmission and easy Reflexion, must be swifter than Light, and by consequence above 700000 times swifter than Sounds. And therefore the elastick force of this Medium, in proportion to its density, must be above 700000 times 700000 (that is above 490000000000) times greater than the elastic force of the Air in proportion to its density. For the Velocities of the Pulses of elastic Mediums are in a sub-duplicate Ratio of the Elasticities and the Rarities of the Mediums taken together.«

»As Attraction is stronger in small Magnets than in great ones in proportion to their bulk, and Gravity is greater in the surfaces of small Planets than in those of great ones in proportion to their bulk, and small Bodies are agitated much more by electric attraction than great ones; so the smallness of the Rays of Light may contribute very much to the power of the Agent by which they are refracted. And so if any one should suppose that Aether (like our Air) may contain Particles which endeavour to recede from one another (for I do not know what this Aether is) and that its Particles are exceedingly smaller than those of Air, or even than those of Light: The exceeding smallness of its Particles may contribute to the greatness of the force by which those Particles may recede from one another, and thereby make that Medium exceedingly more rare and elastick than Air, and by consequence exceedingly less able to resist the motions of Projectiles, and exceedingly more able to press upon gross Bodies, by endeavouring to expand itself.«

»Qu. 22. May not Planets and Comets, and all gross Bodies, perform their Motions more freely, and with less resistance in the Aethereal Medium than in any Fluid, which fills all Space adequately without leaving any Pores, and by consequence is much denser than Quick-silver or Gold? For instance; If this Aether (for so I will call it) should be supposed 700000 times more elastic than our Air, and 700000 times more rare; its resistance would be above 600000000

times less than that of Water. And so small a resistance would scarce make any sensible alteration in the Motions of the Planets in ten thousand years.«

In *Newton's* views above quoted, Qu. 20, dating from 1721, it will be noticed that he not only held the aether to be a superfine gas, of enormous elasticity, but also calculated this elastic power to be $\varpi = 490000000000$ times greater than that of air in proportion to its density. By the most careful calculations that can be made today, we find this relative elastic power to be $\varpi = 689321600000$; which shows that the value found by *Newton* two centuries ago was 71 percent correct, — a wonderfully accurate result, even for so incomparable a geometer as *Newton*!

His remarks in Qu. 22 have been misconstrued by Sir *Oliver Lodge* (Introduction to his »Aether of Space«, 1909), in an effort to make it appear that *Newton* held the aether to have a large density, but the context shows the misconception involved in this claim. When *Newton* says that there is »less resistance (to the planets) in the aethereal medium than in any fluid which fills all space adequately without leaving any pores, and by consequence is much denser than quick-silver or gold?«, he means that the aether is very fine grained, more so than any material fluid like quick-silver or gold, which has pores. He thus held the aether to be so fine grained that it could truly act as a plenum, yet assigned this medium excessively small density. »May not its resistance be so small as to be inconsiderable? For instance: If this aether (for so I will call it) should be supposed 700000 times more elastic than our air, and above 700000 times more rare« — which shows clearly that *Newton's* value of the density of the aether is:

$$\sigma = \frac{1}{700000} \times 10^{-5} = 0.00000001849 \quad (95)$$

that of water = 1, or $\sigma = 1/700000$, that of air = 1.

b) Views of *Maxwell*, 1877.

In the article Aether, *Encyclopedia Britannica*, 9th ed., p. 572, 1878, *Maxwell* speaks as follows regarding the molecular constitution of the aether: »Mr. *S. Tolver Preston* (Phil. Mag., Sept. and Nov., 1877) has supposed that the aether is like a gas whose molecules very rarely interfere with each other, so that their mean path is far greater than any planetary distances. He has not investigated the properties of such a medium with any degree of completeness, but it is easy to see that we might form a theory in which the molecules never interfere with each other's motion of translation, but travel in all directions with the velocity of light; and if we further suppose that vibrating bodies have the power of impressing on these molecules some vector property (such as rotation about an axis) which does not interfere with their motion of translation, and which is then carried along by the molecules, and if the alternation of the average value of this vector for all the molecules within an element of volume be the process which we call light, then the equations which express this average will be of the same form as that which expresses the displacement in the ordinary theory.«

Accordingly it will be seen that the present paper is a development of the reasoning sketched by *Newton*, 1721, and again briefly outlined by *Maxwell* in 1877.

The vector property, such as rotation about an axis, which *Maxwell* supposes might be impressed on the aether molecules, will be furnished by the wave motion in the aether, when the waves are taken to be flat in the planes of the equators of ordinary atoms. This is shown in the theory of magnetism outlined in the first paper, and will be treated of more fully in the third paper, in connection with a correction to the fundamental conceptions of the wave-theory of light.

11. Under the Kinetic Theory of the Aether *Michelson's* celebrated Experiment of 1887 should yield a Negative Result. New Theory of Stellar Aberration based on the Motion of Light relatively to the moving Earth.

In the Philosophical Magazine for 1887, Prof. *Michelson* describes the famous experiment which he devised to detect the effect of a supposed aether drift past the earth, due to an assumed effect of the earth's orbital motion. In this experiment a beam of light, from a terrestrial source, is split into two parts, one of which is sent to and fro across the line of the supposed aether drift, while the other is sent along the line of the aether drift.

A semi-transparent mirror set at a 45° angle is employed to split the beam, and a pair of normal and ordinary mirrors set perpendicular to the two half beams, are employed to return the half beams whence they came, thus enabling them to enter the observer's eye through a telescope.

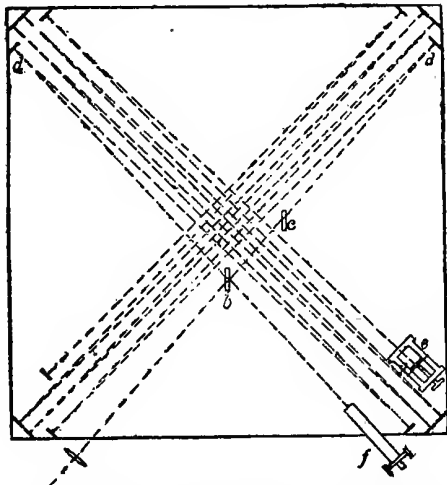


Fig. 10. Illustration of the paths of the split beam of light in *Michelson's* experiment of 1887, one part traveling along the direction of the earth's orbital motion, the other at right angles thereto.

The apparatus was mounted on a stone support about 4 feet square, and one foot thick, and this stone in turn mounted on a circular disk of wood which floated in a tank of mercury. The resistance to rotation of the floating disk is very small, and a slight pressure on the circumference enables the observer to turn it around in say five minutes, with practically no oscillation.

The path of the light, from a terrestrial source, is thus made parallel and perpendicular to the direction of the earth's orbital motion; and the two half beams mutually interchanged for observation of the relative displacement of the interference fringes.

In his work on Light Waves and their Uses, 1903, p. 158, *Michelson* sums up his experience thus:

»It was found that there was no displacement of the interference fringes, so that the result of the experiment was negative and would, therefore, show that there still is a difficulty in the theory itself; and this difficulty, I may say, has not been satisfactorily explained«.

By the reasoning given below, in describing *Fitzgerald's* hypothesis, sect. 12, it is shown that the effect sought is very small, depending on the square of $v/c = 1/10000$, the ratio of the velocity of the earth in its orbit to the velocity of light, and thus of the order of $1:100000000$. But *Michelson* estimates that by his improved apparatus he could see fringe displacements of 1 part in 4000000000 if they existed; and thus the precision of the apparatus exceeded the magnitude of the fringe displacement sought by forty fold.

On repeated trial, under favorable conditions, everything behaved exactly as if the aether were stagnant. *Michelson* therefore suspected the difficulty to be in the theory itself; and we shall now examine into this question, to see if any ground for this impression can be found.

Owing to the translatory motion of the earth, we may change the fixed Newtonian coordinates to correspond to uniform motion in the direction of the x -axis:

$$x' = x - vt \quad y' = y \quad z' = z \quad t' = t. \quad (96)$$

At the initial epoch $t = 0$, we may equate these coordinates to zero, and our transformations, owing to the motion of the earth, become:

$$x' = a_1(x - vt) \quad y' = b_1 y_1 \quad z' = c_1 z_1. \quad (97)$$

Since the velocity of light is the same in reference to the fixed and moveable systems of coordinates, at the instant $t = t' = 0$, we get for identities of the spherical wave surfaces propagated from the moving source of light:

$$x^2 + y^2 + z^2 = c^2 t^2 \quad x'^2 + y'^2 + z'^2 = c^2 t'^2 \quad (98)$$

where c is the velocity of light.

Under the kinetic theory any heavenly body carries an electrodynamic wave-field about its centre of figure, in perfect kinetic equilibrium. The amplitude of the waves and therefore the density of the aether is arranged as shown in the accompanying diagram (p. 183), where the two stars may have the independent motions indicated by the vectors. The motion of either star automatically carries with it that star's own wavefield, and each field is independent of the other, just as the field of light waves emitted by any star is independent of that propagated from any other star. Hence owing to the earth's orbital motion we have the phenomenon of stellar aberration, as if the aether were really stagnant, because the wave-field has no motion relatively to the earth, though the earth itself moves, and thus generates the aberration, as follows:

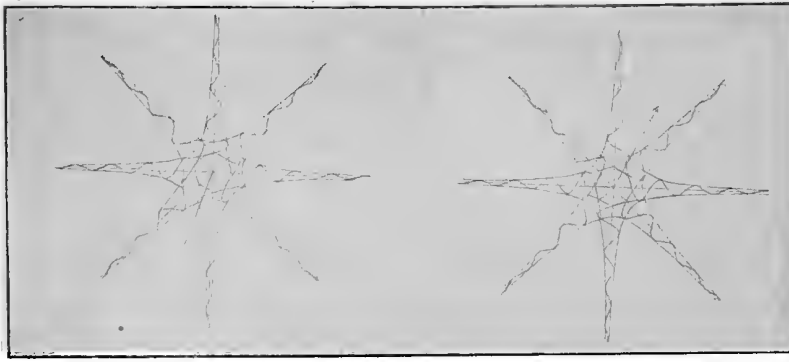


Fig. 11. Illustration of the proper motion of two stars which carry with them concentric wave-fields in perfect kinetic equilibrium, just as they carry their spheres of gravitational influence due to these waves. There is thus no such thing as a motion of the aether past the earth, in the sense imagined by Young, 1803, who compared the aether, supposed to be streaming through the earth, to the wind blowing through the tops of trees.

The light from a distant star travels independently of the motion of the earth and of its moving aether wave-field. Hence to take account of the earth's forward motion, in respect to space, we may imagine the parallel rays of light from the star to be given a backward motion *Sb* identical with the forward motion of the earth, *Ef*. This is the true motion of the light relatively to the moving earth, and by this simple device, stellar aberration is perfectly explained. The light actually comes from the direction *ES*, and a refractive medium in the path will have no effect whatever.

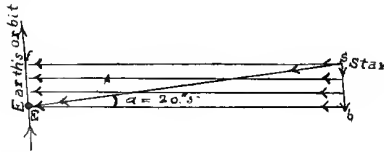


Fig. 12. A direct and simple explanation of the phenomenon of stellar aberration, based on the motion of light relatively to the moving earth.

The reasoning of *Klinkerfues*, about the refractive index of the medium in which the light penetrates, does not deal with the motion of the light relatively to the moving earth, and thus has no bearing on the subject. And likewise *Airy's* observational experiment, with the zenith telescope tube 36 inches long, filled with water (Greenwich Observations, 1871, p. 1-16), is misapplied ingenuity¹⁾. The negative results obtained by these authorities is proof of the correctness of the simple view here set forth.

Accordingly, just as each star carries its own wave-field with it, so also, each particle of vibrating matter in the earth, sends out its system of spherical waves, and the whole

wave-field in kinetic equilibrium, moves with the earth, and the gravitational potential depends on the integration of all these wavelets between the limits $-\infty$ to $+\infty$.

Thus the triple integral for the potential corresponds to a trebly infinite system of wavelets due to stresses decreasing with the distance, yet superposed at all points of space, but the potential for any body itself is finite, as in the theory of action at a distance.

$$v = \iiint \sigma / V [(x-x')^2 + (y-y')^2 + (z-z')^2] \times dx dy dz. \quad (99)$$

Some of the individual wave surfaces from any one particle become:

$$\begin{aligned} x^2 + y^2 + z^2 &= c^2 t^2 \\ x'^2 + y'^2 + z'^2 &= c^2 t'^2 \\ x''^2 + y''^2 + z''^2 &= c^2 t''^2 \\ \dots \dots \dots \\ x^{n^2} + y^{n^2} + z^{n^2} &= c^2 t^{n^2}. \end{aligned} \quad (100)$$

The individual wave surfaces have a common and parallel displacement in space, $v = ds/dt = 30$ kms, owing to the orbital motion of the earth.

Yet the stress of the aether, in kinetic equilibrium, is determined by the compounding of the effects of the waves emanating from the earth. This fixes the density and rigidity of the aether, which is arranged symmetrically about the vibrating particles of the globe. Accordingly, under the kinetic theory, the aether is stagnant in respect to the moving earth, precisely as found by *Michelson* in his celebrated experiment of 1887.

Hence no theory but the kinetic theory, with the particles moving 1.57 times faster than light, can be admitted. This follows at once from our investigation of the enormous elasticity of the aether, which gives the physical cause of the observed velocity of 300000 kms per second, for the wave motions constituting light and electricity.

Thus it only remains to state clearly the kinetic hypothesis underlying the wave-theory of physical forces, namely: We conceive all atoms of matter to receive and to emit waves, without regard to the motion of these atoms relatively to other atoms, just as we know the stars emit their typical spectral lines in spite of their proper motions in space.

Accordingly, as the Aether corpuscles have the enormous velocity of 471000 kms per second, this medium is taken to be in kinetic equilibrium about the moving earth, which will secure the law of density $\sigma = \nu r$, and of wave amplitude $A = k/r$. For the aether has an elasticity 689321600000 times greater than that of our air in proportion to its density, and if any lack of perfect kinetic equilibrium existed, it would disappear from the aethereal envelope of the earth

¹⁾ Though I have examined many authorities I can find no satisfactory explanation of the aberration. They are all confused by some such reasoning as the following, from *Michelson's* Light Waves and their Uses, 1903, p. 151: "The objection to this explanation (*Bradley's*) was, however, raised that if this angle (20'5") were the ratio of the velocity of the earth in its orbit to the velocity of light, and if we filled a telescope with water, in which the velocity of light is known to be only three-fourths of what it is in air, it would take one and one-third times as long for the light to pass from the center of the objective to the cross-wires, and hence we ought to observe, not the actual angle of aberration, but one which should be one-third greater. The experiment was actually tried. A telescope was filled with water, and observations on various stars were continued throughout the greater part of the year, with the result that almost exactly the same value was found for the angle of aberration."

in an infinitely small fraction of a second, owing to the mean velocity of the aetherons being 471000 kms per second.

12. Sir *Oliver Lodge's* Experiments for detecting the Viscosity of the Aether, 1891-97, and *Fitzgerald's* Hypothesis of a contraction of the dimensions of bodies in the direction of their motion.

In the *Philosophical Transactions*, 1893-97, Sir *Oliver Lodge* describes elaborate experiments with revolving steel disks, about a meter in diameter, which he had spun with the highest possible speed, in close proximity to a split beam of light, arranged as in *Michelson's* experiment of 1887, in the hope of discovering a relative displacement of the fringes, due to viscosity of the aether. The experiment was well conceived, and executed with great skill, but it failed to give the smallest indication of a displacement such as viscosity of the aether would be supposed to yield. The results were entirely negative, and *Lodge*, like *Michelson*, could only conclude that the aether behaves as if it were absolutely stagnant.

Let us now consider why the negative results of *Michelson* and *Lodge* follow, if the aether be a kinetic medium such as *Newton*, *Maxwell* and Dr. *S. Tolver Preston* conceived it to be, and such as we have found it to be by exact calculations.

If the aether be corpuscular, the particles having a velocity 1.57 times that of light, it is obvious that it will adjust itself instantly to any state of steady motion, and that this kinetic equilibrium will be obtained more rapidly than even the propagation of light. And when Sir *Oliver Lodge's* moving disk is revolving steadily, the aether will act as if it were absolutely stagnant.

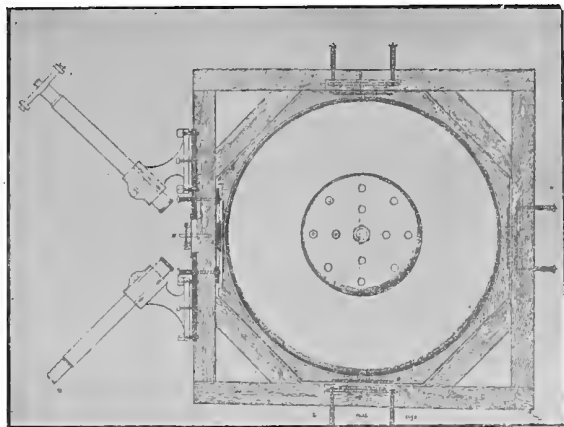


Fig. 13. Illustration of Sir *Oliver Lodge's* apparatus for effecting a displacement of the aether, owing to viscosity, by the rapid rotation of disks of steel, near which a split beam of light is passed.

Hence the conclusion reached by Sir *Oliver Lodge* (*Aether of Space*, p. 82), as to the revolving disk experiments, was natural enough and quite justified in the premises, when he declared: »I do not believe the ether moves. It does not move at a five-hundredth part of the speed of the steel disks. Further experience confirms and strengthens this estimate, and my conclusion is that such things as circular-saws, flywheels, railway trains, and all ordinary masses of matter

do not appreciably carry the ether with them. Their motion does not seem to disturb it in the least.«

»The presumption is that the same is true for the earth; but the earth is a big body -- it is conceivable that so great a mass may be able to act when a small mass would fail. I would not like to be too sure about the earth -- at least, not on a strictly experimental basis. What I do feel sure of is that if moving matter disturbs ether in its neighborhood at all, it does so by some minute action, comparable in amount perhaps to gravitation, and possibly by means of the same property as that to which gravitation is due -- not by anything that can fairly be likened to etherial viscosity. So far as experiment has gone, our conclusion is that the viscosity or fluid friction of the ether is zero. And that is an entirely reasonable conclusion.«

In view of our theory of a kinetic medium, we may now go further than *Fresnel*, *Michelson* and Sir *Oliver Lodge*, and declare that as the corpuscular aether readjusts itself instantly to any state of steady motion, it follows that the motion of the earth can in no way disturb it. There is planetary induction indeed, from the wave-effect due to the relative motion of the sun and earth, but this is observable only by magnetic instruments, and not by means of other apparatus used in physical experiments.

If, as is definitely proved by calculation, the aether has an elasticity 689321600000 times greater than that of our air in proportion to its density, it is obvious that it not only penetrates all bodies, but even the electrodynamic waves in the aether may traverse the body of the terrestrial globe with only a small resistance, giving merely refraction, dispersion, and perhaps absorption of part of the energy, as we have shown in the theory of the lunar fluctuations (*Electrod. Wave-Theory of Phys. Forc.*, vol. I, 1917). It not only follows that this adjustment of the aether to any state of steady motion will occur, but also that no power in the universe could prevent such a kinetic adjustment, in the all-pervading medium, under the above stupendous elastic power which it exerts against itself. It is thereby rendered almost incompressible, the waves traveling with a velocity of 300000 kms per second.

The physical meaning of such rapid propagation of waves is this: When a wave begins to be generated, the disturbance speeds away very rapidly, so that the movement is not cyclicly complete until a wave length λ has been traversed. As the amplitude a is very small, compared to λ , -- as Lord *Kelvin*, *Maxwell* and *Larmor* have shown, -- it follows that the aether is nearly incompressible, though the density at the sun's surface is only

$$\sigma = 2.0 \times 10^{-18}.$$

These last considerations also show why we cannot disturb the aether by revolving disk experiments. Accordingly it is not remarkable that Prof. *F. E. Nipher*, of St. Louis, has succeeded in disturbing the aether only by means of explosions of dynamite, an explosive of enormous power and excessively quick action. This not only shows the futility of viscosity experiments, with comparatively slow, steady motions, as when the revolving disks, a meter in diameter, make 66 rotations in a second¹⁾, but also confirms the

¹⁾ This is only 1:2356195 of the velocity of the aetheron, 471239000 m per second.

extremely rapid readjustment of the aether when disturbed. Therefore it follows that our theory of a kinetic medium, with the particles traveling 1.57 times faster than light, is in accordance with all the established facts of observation.

After giving a summary of all the known effects (Aether of Space, p. 62-63), *Lodge* concludes that the aether behaves under experiment as if it were stagnant with respect to the earth. »Well then, perhaps it is stagnant. The experiments I have quoted do not prove that it is so. They are equally consistent with its perfect freedom and with its absolute stagnation, though they are not consistent with any intermediate position. Certainly, if the aether were stagnant nothing could be simpler than their explanation.«

The new theory of the aether as a kinetic medium gives the stagnant quality sought by *Michelson* and *Lodge*, yet it preserves the »perfect freedom« with which the experiments are consistent.

Accordingly, the aether being a perfectly elastic corpuscular medium, always adjusting its internal stresses with at least the velocity of light — the individual particles having a velocity of 1.57 times greater yet, — it follows that around a body moving with uniform velocity there could be exerted no sustained forces, impressed or acting upon the atoms, to alter the linear dimensions of the uniformly moving body; and hence we reject *Fitzgerald's* hypothesis as altogether misleading.

Fitzgerald's Hypothesis, that the linear dimensions of bodies are altered by motion relative to the aether, superfluous and misleading.

In *Nature* for June 16, 1892, Sir *Oliver Lodge* mentions a conversation with the late Prof. *Geo. F. Fitzgerald*, (cf. also *Lodge's* Aether of Space, 1909, p. 68) to the effect that the dimensions of material bodies are slightly altered when they are in motion relative to the aether. The negative result of the *Michelson-Morley* experiment of 1887 was the occasion which called forth *Fitzgerald's* hypothesis.

If V be the velocity of the earth's orbital motion, c the velocity of light, l the length of path traversed by the beam of light divided in *Michelson's* experiment; then, one of the two portions of a split beam of light should make its journey in less time than the other by the interval $V^2 l / c^2$, if the aether itself be motionless, as *Michelson* supposed. This difference, however, would be compensated if the arm of the apparatus pointed in the direction of the earth's motion were shorter than the other by an amount $\frac{1}{2} V^2 l / c^2$, which would follow if the linear dimensions of moving bodies are contracted in the direction of their motion in the ratio of $(1 - \frac{1}{2} V^2 / c^2)$ to 1.

Now for the earth the ratio in question is:

$$V/c = 30 \text{ km/sec} : 300000 \text{ km/sec} = 1/10000 \quad (101)$$

$$\text{and the square } V^2/c^2 = 1/100000000 \quad (102)$$

which shows that the alteration in dimensions — namely

$$\delta l = (\frac{1}{2} V^2 / c^2) l \quad (103)$$

is only one two hundredth millionth. The minuteness of this hypothetical observed effect would make detection by experiment extremely difficult, even if a valid method could be devised. But let us consider, on other grounds, whether

such an alteration in dimensions is consistent with sound physical laws.

By this hypothesis of *Fitzgerald*, the end-on-dimensions of a moving body is shortened

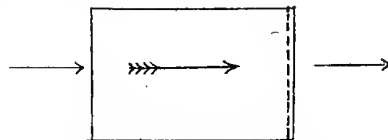


Fig. 14. Illustration of *Fitzgerald's* hypothesis that the dimensions of a body, moving freely, uniformly, and without constraint, is decreased in the direction of the motion.

as shown in the figure. This hypothetical change is not postulated for the starting of a body in motion — where its figure might be changed in overcoming inertia, when the forward velocity is being developed — but for a body already in uniform rectilinear motion, and thus so far as is known subjected to no strain of its linear dimensions.

Newton's first law of motion (*Principia*, Lib. I, Axioms) is: »Every body perseveres in its state of rest, or of uniform motion in a right line, unless it is compelled to change that state by forces impressed thereon.«

»Projectiles persevere in their motions, so far as they are not retarded by the resistance of the air, or impelled downwards by the force of gravity. A top, whose parts by their cohesion are perpetually drawn aside from rectilinear motions, does not cease its rotation, otherwise than as it is retarded by the air. The greater bodies of the planets and comets, meeting with less resistance in more free spaces, preserve their motions both progressive and circular for a much longer time.«

If these axioms were obvious to Sir *Isaac Newton*, it will no doubt be equally obvious to us that a body may have its dimensions altered in acquiring a velocity, — as when a ball is struck by a bat — yet the elasticity of the body will immediately assert itself, so that the figure will oscillate about its mean or undisturbed form; and after a certain time the original figure will become restored. And thereafter there will be no permanent change of figure. This is a fact of universal experience, and may be verified experimentally in our laboratories by all manner of actual measurements.

The most careful physical experiments show that bodies placed under constraint, tend very rapidly to restore their figures of equilibrium. Accordingly it follows that bodies having uniform motion of long duration in any direction, could not undergo changes of figure, in virtue of uniform motion, without physical constraint, which in turn would call forth the power of restitution, at the instant of release. Hence in uniform unrestrained motion no alteration in the figure of equilibrium appropriate to a state of rest would be possible, and *Fitzgerald's* contraction hypothesis is contrary to the order of Nature.

In concluding this second paper, it is scarcely necessary to point out that prior to the development of the kinetic theory of the aether, experiments like those made by *Michelson* and *Morley* and Sir *Oliver Lodge* led to the idea of a stagnant

aether. There are indeed profound reasons why the aether should act as if it were absolutely stagnant, whereas the particles really move 1.57 times faster than light, and thus the medium instantly adjusts itself to any state of steady motion, whatever it may be; because the motion of the aetheron is 10000 fold faster than that of our swiftest planets, and over two millions of times faster than any steady artificial motions which we can make experimentally, as in the researches of Sir *Oliver Lodge* with rapidly revolving disks of steel.

On the old hypotheses the *Michelson-Morley* experiment of 1887 was admirably adapted to detect the effect of the earth's motion through the aether. Little did these eminent experimenters dream that the earth carried its wave-field of aether with it, — all infinitely extended and adjusted in perfect kinetic equilibrium. This wave-field has decreased density towards the centre, in virtue of the increased amplitudes of the waves emanating from the atoms, and thus is truly stagnant about the moving earth in respect of waves of light from distant stars, in the phenomenon of aberration.

Accordingly, whether the components of the split beam of light, from a terrestrial source, as used by *Michelson*, travel in the direction of the earth's orbital motion, or at right angles thereto, no shift of the fringes is theoretically possible, because of the perfect kinetic equilibrium of the wave-field of the aether about the earth and extending away from it indefinitely.

For similar reasons *Fitzgerald's* hypothesis rests on a false premise, and only beclouds the reasoning in this difficult subject. The fundamental condition required for real progress is a valid kinetic theory of the aether, such as *Newton* first outlined two hundred years ago, and *Maxwell* approved in 1877, but left very incomplete, owing to the premature death of this great mathematician.

Since the difficulties connected with the motion of the perihelion of Mercury and of the lunar perigee, as well as the lunar fluctuations, which *Newcomb* pronounced the most enigmatical phenomena presented by the celestial motions, are fully overcome, without any mystical doctrine such as *Einstein* introduces, it is evident that the whole theory of relativity, as heretofore developed, is shaken to its foundations, and will no longer deserve the serious consideration of natural philosophers.

For several years experienced investigators in all parts of the world have wondered at the strange sight presented by British men of science in unjustifiably abandoning the established natural philosophy of *Newton*, and hastily em-

Starlight on Loutre, Montgomery City, Missouri, 1920 Febr. 19.

bracing the untenable speculations of *Einstein* when the facts of observation themselves are insecurely established.

And as for the overdrawn statement of Prof. Sir *J. J. Thomson*, President of the Royal Society, that the supposed larger value of the solar deflection of light indicated by the eclipse observations of May 29, 1919, »is the most important result obtained in connection with the theory of gravitation since *Newton's* day, and it is fitting that it should be announced at a meeting of the society so closely connected with him«, it suffices to call attention to the unfortunate impression thus conveyed to investigators, who remember on the one hand the historical fact that the Royal Society in 1686 refused to publish ¹⁾ *Newton's Principia*, and thus it had to be issued at the private expense of Dr. *Edmund Halley* (cf. *Brewster's Life of Newton*, 2 vols., 1855), and on the other hand the vast development and perfection of the theory of gravitation since made by *Euler*, *Clairault*, *Lagrange*, *Laplace*, *Poisson*, *Bessel*, *Gauss*, *Hansen*, *Leverrier*, *Airy*, *DeLaunay*, *Adams*, *Tisserand*, *Gylden*, *Hill*, *Newcomb*, *Poincaré*, *Darwin*, and several eminent geometers still living.

In contradistinction to the singular spectacle thus presented in the Royal Society, it is a relief to find a much more cautious attitude in the Monthly Notices for Nov., 1919, p. 23, where Prof. *Newall* gives good reasons for rejecting *Einstein's* theory of the deflection of light in the sun's field, in favor of optical refraction.

In the Nineteenth Century Magazine, for Dec., 1919, Sir *Oliver Lodge* likewise is skeptical; for he reasons that if we accept *Einstein's* theory in its entirety, »the death knell of the aether will seem to have been sounded, strangely efficient properties will be attributed to emptiness, and theories of light and of gravitation will have come into being unintelligible on ordinary dynamical principles«. Such protests would indicate that the Newtonian philosophy still has some supporters in England, but apparently they are not aware of the real strength of their cause, as now brought to light in the New Theory of the Aether.

Accordingly, in view of the comprehensive results already reached in the New Theory of the Aether, the defenders of the Newtonian mechanics could hardly wish for a more complete triumph. And it is gratifying to realize that it is based upon the original conceptions of Sir *Isaac Newton* himself, after the simple and elegant theory of this great philosopher had been almost completely abandoned by his countrymen.

I am indebted to my young friend Mr. *E. L. Middleton*, for valuable assistance in the completion of this investigation.

T. J. J. See.

¹⁾ The well known delay of 14 years (1807-1821) in the publication of *Fourier's* mathematical researches on the theory of heat seems to place the Paris Academy of Sciences in an equally unfortunate light. In the *Eloge Historique* of *Fourier* delivered by *Arago*, blame is placed on the commissioners of the Academy — *Lagrange*, *Laplace* and *Legendre* — for poisoning the pleasure of *Fourier's* triumph, which Lord *Kelvin* has also criticized. As no commissioners could be more competent than the three geometers just cited, history often is witness to the weaknesses of the highest academies of sciences; and hence, in his very original *Researches in the Lunar Theory*, 1877, Dr. *G. W. Hill* had recourse to private publication, which probably was better than the fate accorded to *Newton* and *Fourier*.

New Theory of the Aether. By T. J. J. See.

(Third Paper.) (With 3 Plates.)

I. Two Remarkable Theorems on the Physical Constitution of the Aether.

In the year 1910 Professor *E. T. Whittaker* published, under the auspices of the Dublin University Press, a valuable »History of the Theories of Aether and Electricity« from the age of *Descartes* to the close of the 19th century. The title of this useful treatise and the general usage of science recognizes that there is some connection between aether and electricity, yet in spite of the great learning shown in *Whittaker's* work, the nature of that connection remains profoundly obscure, and the modern investigator therefore labors in vain to obtain any clear light upon the subject.

If we could prove, for example, that an electric current is nothing but a series of waves of a certain type propagated in the aether along and from the wire which bears the current, and also connect these waves with magnetism and light, by an extension of the reasoning thus laid down, it would add so much to our understanding of the processes underlying the unseen operations of the physical universe, as to be worthy of almost any effort. Indeed, it would be worth hazarding any chance offered by the conscientious contemplation of known phenomena. And thus I venture to add some considerations, which, without exhausting the subject, may open a new field to those who have the independence, practical energy and firm resolution to pursue pioneer paths in science. These untrodden paths alone offer the hope of important discoveries in the physical universe.

And first we must confirm a new and important theorem on the velocity of wave-propagation in monatomic gases, announced in the first paper, and also make known a new and very remarkable method for determining the density of

the aether based on an extension of recognized processes in the theory of sound. As the only method for attacking the problem of the density of the aether heretofore known is that invented by Lord *Kelvin* in 1854, this new method will prove extremely useful as an independent check on the numerical values attained in these recondite researches; and be found the more valuable because it is absolutely decisive against the doctrine of a large density for the aether, which has recently exerted in science an influence both baneful and bewildering.

(i) The new theorem $v = \frac{1}{2}\pi V$, connecting the mean molecular velocity of a monatomic gas with the velocity of wave-propagation, by means of half the Archimedean number, exactly confirmed by observation in case of oxygen and nitrous oxide.

Since finishing the first paper on the New Theory of the Aether, Jan. 14, 1920, I have had occasion to discuss the new theorem

$$v = \frac{1}{2}\pi V \quad (1)$$

connecting the mean molecular velocity of a monatomic gas and the velocity of wave-propagation, by means of half the Archimedean number π , with the celebrated English physicist Sir *Oliver Lodge*, on the occasion of a public address at San Francisco, April 11, 1920. And as Sir *Oliver Lodge* kindly showed a great interest in this theorem, regarded it as very important, and urged me to extend the use of the theorem, I have searched for other gases to which it might be accurately applied.

The observed data given in the following supplementary table are taken from *Wüllner's* Experimental-Physik, Band 1, p. 804, and were accidentally overlooked in the preparation of my earlier table.

Gas	V (Air = 1)	v̄ observed	molecular wt.	k ₂	v̄/V (observed)	v̄/V · V(k ₁ /k ₂)
Oxygen, O	0.9524 (<i>Dulong</i>) = 316.2 m	461.0 m	32.0	1.402	1.458	1.5893
Nitrous-Oxide, NO ₂	0.7865 (<i>Dulong</i>) = 281.1	393.0	44.0	1.295	1.398	1.5858

The last column gives the observed ratio \bar{v}/V as corrected for a monatomic constitution, or

$$\bar{v}/V \cdot V(k_1/k_2) = 1.58 \quad (2)$$

which verifies with great accuracy the use of half the Archimedean number π , in the theorem,

$$\bar{v} = \frac{1}{2}\pi V$$

connecting the mean molecular velocity with that of wave-propagation in monatomic gases.

As this theorem is now minutely verified for the six best determined gases, namely:

- | | |
|-----------------------|-----------------------------------|
| 1. Air | 4. Carbon dioxide CO ₂ |
| 2. Hydrogen | 5. Oxygen |
| 3. Carbon monoxide CO | 6. Nitrous oxide NO ₂ |

all of which are of comparatively simple molecular constitution, we may regard it as fully established by experiment that such a physical law governs the motions of waves in monatomic gases, and that the velocity of wave motion is solely dependent upon the mean velocity of the molecules.

But in addition to the argument thus built up, for a high wave velocity, where we have a rare gas of enormous molecular velocity, we may use the observed velocity of wave-propagation generally to throw light upon the molecular weights of all gases whatsoever. In the reference above given to *Wüllner's* Experimental-Physik, Band 1, p. 804, we find that the velocity of sound in hydrogen was found by *Dulong* to be 3.8123 times that in air, and by *Regnault*, 3.801 times that in air. The mean of the two values is 3.80665. Now

the velocity of sound in oxygen found by *Dulong* was 0.9524 times that in air; and on multiplying this by 4, we get 3.8096 for the theoretical velocity of sound in hydrogen.

But since oxygen is supposed to have only 15.98 times the molecular weight of hydrogen, we should use the square root of this number, or 3.9975, instead of 4, for the multiplier, which gives 3.8072; an almost exact agreement with the mean of the velocities of sound in hydrogen found by *Dulong* and *Regnault*.

It follows, from these considerations, that the velocity of wave motion in similar gases varies inversely as the square roots of their densities. The fourfold increase in the velocity of sound in hydrogen compared to that in oxygen gives us a definite law which may be applied directly to all comparable gases, and even to monatomic gases by the use of the faktor $V(k_1/k_2)$.

(ii) New method for determining the density of the aether from the velocity of light and electric waves compared to that of sound in terrestrial gases.

Up to the present time only one general method has been available for calculating the density of the aether, namely, that devised by Lord *Kelvin* for determining the mechanical value of a cubic mile of sunlight, and first published in the Transactions of the Royal Society of Edinburgh for May, 1854 (cf. Baltimore Lectures, 1904, p. 260). This method was somewhat improved by the subsequent researches of Lord *Kelvin*, *Maxwell*, and the present writer, as duly set forth in the first paper on the New Theory of the Aether (AN 5044, 211.49), yet the principle underlying it remains largely unchanged.

As it would be very desirable to have a second independent method for determining the density of the aether, I have held in mind this great desideratum while occupied with the researches on the wave-theory, and finally it occurred to me to attack the problem from the point of view of the velocity of sound in gases. For we have now shown that the aether is a gas, with particles traveling 1.57 times swifter than light; and this general theory is again confirmed by the discussion above given for waves of sound in oxygen and nitrous oxide.

Owing to its extreme rarity, the aether is the one absolutely perfect gas of the universe; and we may even use the velocity of light in the aether to calculate the density of this medium. It will be shown, especially in the fourth paper, that there is much less difference between the waves of sound and light than we have long believed. In his luminous but neglected memoir of 1830, the celebrated French geometer *Poisson*, showed and thrice repeated, in spite of the earlier repeated objections of *Fresnel*, that in elastic media the motions of the molecules, at a great distance from the source of disturbance, are always normal to the wave front, as in the theory of sound. And we shall show later how optical and magnetic phenomena are to be reconciled with this incontestible result of *Poisson's* analysis.

From the data given in the first paper on the New Theory of the Aether it follows that the velocity of light is 904268 times swifter than that of sound in air. As sound

in hydrogen has a velocity 3.80665 times greater than in air, this is equivalent to 237550 times the velocity of sound in hydrogen. But hydrogen is a biatomic gas with the ratio $k_2 = 1.401$, while aether is monatomic, with the ratio $k_1 = 1.666$; and therefore to reduce the motion in hydrogen to the basis of a monatomic gas, we have to divide this number by $V(k_1/k_2) = 1.090477$, which leads to the number 217839. This is the ratio of the velocity of light in a monatomic aether to that of sound in a hypothetical monatomic hydrogen, yet with density 0.0000896.

This result is based on the wave theory of sound as given by Sir *Isaac Newton* in the Principia, 1686 (Lib. II, Prop. XLVIII), which was corrected by *Laplace* in 1816 (cf. Mécanique Céleste, T. V. Liv. XII, p. 96, and Ann. Phys. et Chim., T. III, p. 288), to take account of the augmentation of speed due to the ratio of the specific heat of a gas under constant pressure to that under constant volume. As above used the formula for the propagation of sound is further corrected to take account of the increase in velocity in a monatomic gas, first inferred theoretically by *Clausius* about sixty years ago, but since verified experimentally for mercury vapor, argon, helium, neon, xenon, and krypton. The formula thus becomes for aether and hydrogen, as reduced to a monatomic elasticity:

$$V_1/V_2 = V(E_1\sigma_2/E_2\sigma_1) = 217839. \quad (3)$$

Under identical physical conditions at the surface of the earth, $E_1 = E_2$, and thus

$$V_1/V_2 = V(\sigma_2/\sigma_1) = 217839$$

or

$$N_1 = V_1^2/V_2^2 = \sigma_2/\sigma_1 = (217839)^2 = 47453880000 \quad (4)$$

which is the density of hydrogen in units of that of aether.

To get the density of water in units of that of aether, we take

$$N_2 = N_1/0.0000896 = 52961900000000. \quad (5)$$

Accordingly the absolute density of the aether at the earth's surface becomes:

$$1/N_2 = \sigma = 1888.15 \cdot 10^{-18}. \quad (6)$$

• It should be noted that Lord *Kelvin's* method of 1854, which we used in the first paper on the New Theory of the Aether, is not strictly valid, because although it gives the density at the earth's mean distance, in units of the assumed density at the sun, this latter value itself cannot be found by *Kelvin's* method, because of the decrease in the aether density near the earth, not heretofore taken account of.

Let q_3 be the density at the neutral distance, q_3 , where the sun's gravitational intensity is just equal to that of the earth. Then, since at the solar surface the mean gravity is 27.86555 times terrestrial gravity (cf. AN 3992), we have:

$$27.86555/(219)^2 = 1/q_3^2 \quad (7)$$

where q_3 = distance at which solar and terrestrial gravity will just balance. This gives by calculation $q_3 = 41.4868$ terrestrial radii, about $\frac{2}{3}$ of the moon's distance. The following table gives the results of similar calculations for the absolute density of the aether at the surfaces of the sun and principal planets of the solar system.

Table of the Absolute Density of the Aether near the Principal Bodies of Solar System.

Body	<i>i</i>	Mean radius <i>R</i>	Mean gravity at surface <i>g_i</i>	Mean distance of planet in solar radii <i>r_i</i>	Absolute density of aether at orbit of planet <i>σ_i</i>	Distance at which gravity of planet and sun are equal, in mean radii of the planet <i>ρ_i = r_i V(g_i/g₀)</i>	Absolute density of the aether at surface <i>σ_s = σ_i/ρ_i</i>
The Sun	0	696098 kms	273.016 m	1	—	—	357.6865 · 10 ⁻¹⁸
Mercury	1	2175.31	1.87944	84.7746	30322.74 · 10 ⁻¹⁸	7.0337	4311.1 · 10 ⁻¹⁸
Venus	2	6090.86	8.7537	158.4125	56661.04 · 10 ⁻¹⁸	28.365	1997.56 · 10 ⁻¹⁸
The Earth	3	6370.521	9.79762	219.000	78333.34 · 10 ⁻¹⁸	41.4868	1888.15 · 10 ⁻¹⁸
Mars	4	3365.87	3.7714	333.687	119355.9 · 10 ⁻¹⁸	39.219	3043.3 · 10 ⁻¹⁸
Jupiter	5	69449	26.21704	1139.414	407553.1 · 10 ⁻¹⁸	353.085	1154.26 · 10 ⁻¹⁸
Saturn	6	57635	11.4423	2089.006	747209.5 · 10 ⁻¹⁸	427.664	1746.19 · 10 ⁻¹⁸
Uranus	7	21101	13.0400	4202.894	1503319 · 10 ⁻¹⁸	729.620	1636.65 · 10 ⁻¹⁸
Neptune	8	21643	14.6460	6585.450	2355527 · 10 ⁻¹⁸	1525.288	1544.32 · 10 ⁻¹⁸

Accordingly for reasons already indicated we reach the following conclusions.

1. Whatever be the density of the aether at 41.4868 terrestrial radii, where the sun's and earth's attractions are equal, the aether density, from that point, must decrease towards the earth, by the divisor 41.4868, and towards the sun by the divisor 219.

2. That is at the earth's surface

$$\sigma_{3s} = \sigma_s / 41.4868. \tag{8}$$

3. Owing to this decrease of σ near the earth, where observations are made, *Kelvin's* method of 1854 is not valid, even for the calculation of the density at the sun's surface, because it rests on the hypothesis of homogeneity throughout interplanetary and interstellar space.

4. At earth's surface the new method shows

$$\sigma_{3s} = 1888.15 \cdot 10^{-18}.$$

At sun's surface therefore

$$\sigma_{0s} = (1888.15 \cdot 10^{-18} / 219) \cdot 41.4868 = 357.6865 \cdot 10^{-18} \tag{9}$$

This is about 178.84 times greater than was obtained by *Kelvin's* method, which, as above shown, is not applicable without modification. But as the aether density always is excessively small, this latter experimental-theoretical value for the solar surface may be accepted without question as the true value of the absolute density of the aether.

Accordingly at the sun, $\sigma_{0s} = 357.6865 \cdot 10^{-18}$ (10)
at the earth, $\sigma_{3s} = 1888.15 \cdot 10^{-18}$

which fulfills the laws of wave action:

$$\begin{aligned} \text{Amplitude, } A &= k/r \\ \text{Force, } f &= A^2 = k^2/r^2 \end{aligned} \tag{11}$$

in accordance with the observed force of gravitation.

For upon trial we may verify the above calculations:

$$\begin{aligned} \sigma_{3s}/\sigma_{0s} &= 1888.15/357.6865 = 5.27788 = V(g_0/g_3) \tag{12} \\ \text{or } (\sigma_{3s}/\sigma_{0s})^2 &= g_0/g_3 = 273.016/9.79762 = 27.86555. \end{aligned}$$

The accompanying table for the absolute density of the aether may be extended to any binary system among the fixed stars in which the masses and dimensions are known, and thus the new theory of the aether has all the accuracy of the theory of universal gravitation.

(iii) The new method based on the velocity of wave-propagation, as in the theory of sound, definitely excludes a large value for the density of the aether.

Since it is an observed fact that hydrogen propagates sound 3.9975 times faster than oxygen, and is 15.98 times lighter, we know that the rapidity of the wave-propagation in the aether can only point to a gas of extremely small density. No other hypothesis is admissible. And adopting this experimental method, the result for the density of the aether at the earth's surface becomes

$$\sigma_{3s} = 1888.15 \cdot 10^{-18}$$

in approximate agreement with the density derived from the energy of the sun's radiation, namely:

$$\sigma = 438 \cdot 10^{-18}$$

which however is no longer valid, as already pointed out.

The question may properly be raised as to how far this approximate agreement of the density of the aether, $438 \cdot 10^{-18}$, and $1888.15 \cdot 10^{-18}$, derived from the theory of the sun's radiation, and the theory of sound respectively, is accidental or brought about by systematic tendencies involving constant bias due to unknown and unsuspected causes.

It always is difficult to affirm the total absence of such systematic errors, or causes which bias judgement, but in view of the directness and simplicity of the above reasoning, I cannot see any ground for doubting the accuracy of the new method, which is based on *Newton's* formula of 1686, as corrected by *Laplace*, 1816, and now further corrected to take account of a gas of monatomic constitution, as experimentally shown to exist in the cases of mercury vapor, argon, helium, neon, xenon, krypton.

For when we have two similar gases, such as oxygen and hydrogen, both biatomic, with the ratio of the specific heat under constant pressure to that under constant volume, $k_2 = 1.401$, we may connect their velocities at the same temperature and pressure by the formula:

$$V/V_2 = V(E\sigma_2/E_2\sigma). \tag{13}$$

And, since the physical condition of the two gases is identical, we may put $E = E_2$, and thus, in accordance with experiment,

$$V/V_2 = V(\sigma_2/\sigma) = 1/3.80665 \tag{14}$$

as already pointed out.

And when the gases are dissimilar in molecular constitution, as in the case of the aether and hydrogen, but the ratio of the specific heat under constant pressure to that under constant volume is known, we may still calculate their

theoretical value of wave propagation from the use of the ratio $V(k_1/k_2)$. And if the velocity of the wave-propagation be observed in both cases, and we desire to determine the relative density of one of the gases, we may effect this as in the above case of the aether, which absolutely excludes the possibility of a large density. As the aether is a gas of excessively small density, it is therefore compressible, as previously inferred, but only by powerful, quick-acting forces.

The study of the aether as a gas, in accordance with the views entertained by *Newton* in 1721, and approved by *Maxwell* in 1877, thus opens new possibilities, and introduces criteria of the utmost value to physical science.

2. Geometrical and Physical Outline of the Relationship between Light, Magnetism and the Electrodynamic Action of a Current.

In the 3rd edition of the celebrated Treatise on Optics, 1721, Query 28, Sir *Isaac Newton* treats of *Huyghens'* theory of double refraction in Iceland spar, on the hypothesis of two several vibrating mediums within that crystal, for refracting the ordinary and extraordinary rays, but says that *Huyghens* was at a loss to explain them. »For pressions or motions, propagated from a shining body through an uniform medium, must be on all sides alike; whereas by these experiments it appears, that the rays of light have different properties on their different sides.«

In proof of this confession of failure, by *Huyghens*, *Newton* cites from the *Traité de la Lumière*, 1690, p. 91, the words: »Mais pour dire comment cela se fait, je n'ay rien trouvé jusqu'ici qui me satisfasse.«

Newton then argues effectively against the explanation of *Huyghens*, and points out the improbability of two aethereal media filling the celestial spaces, which has been emphasized in recent times by *Maxwell*, who declared it unphilosophical to invent a new aether every time a new phenomenon was to be explained.

In the early days of the modern wave theory of light, the properties of polarized rays were carefully investigated by *Fresnel* and *Arago*, and subsequently verified by Sir *John Herschel* and *Airy*, who fully confirmed *Newton's* conclusion that such rays have sides with dissimilar properties on opposite sides. The account of *Fresnel's* progress given by *Arago* in his *Éloge Historique*, July 26, 1830, is very instructive, since *Arago* was associated with many of *Fresnel's* discoveries. Besides the able analysis in the celebrated and comprehensive article Light, *Encyclopedia Metropolitana*, 1849, Sir *John Herschel's* Familiar Lectures on Scientific Subjects, 1867, are valuable, in showing his mature conclusions.

It being thus recognized that a ray of polarized light has sides, with dissimilar properties on opposite sides, it remains for us to form a clear image of such a ray of light, and to examine the phenomena of magnetism and electricity, to ascertain if a relationship to light can be established.

The late Professor *Paul Drude's* comprehensive *Lehrbuch der Optik*, Leipzig, 1900, may be consulted for a modern analysis of purely optical problems; but, as our object is to outline relationships not heretofore developed, we shall make the optical treatment very brief.

Let u denote the displacement of the aether particle from its vertical position of equilibrium, as on the surface of still water. Then we have for a flat wave in the plane xy the wellknown equation

$$u = a \sin(2\pi \cdot t/\tau + p) = a \sin(2\pi \cdot x/\lambda + p) \quad (15)$$

where u represents the displacement at right angles to the x -axis, a is the amplitude, λ the wave length, and p the phase angle, from which the revolving vector of radius a is measured. Such a flat wave represents motion like that propagated along the surface of still water, and the movements are given in detail by figure 1, Plate 4, which is slightly modified from that used by *Airy* in his great treatise on Tides and Waves, 1845.

It will be noticed that each particle of water undergoes an oscillation about a mean position, shown by the centres of the circles, in this very accurate figure, while the wave form moves on, in a direction corresponding to the axis of x in equation (15). Thus the particles undergo not only a vertical oscillation, as the wave passes, but also a longitudinal oscillation. This is typical of all waves in water.

Now it is usual to take (15) as the equation of the motion of the aether in light, and to call u the light vector, and to describe this light vector as revolving, when the wave advances. The motion u in (15), however, is simply a side displacement normal to the x -axis, which may be produced by the revolution of the radius a in the circles, as in our figure modified from *Airy's* analysis of water wave-motion. The real motion of the aether particles should be somewhat elliptical, but much like those of the water particles, about a mean position of radius a . Equation (15) then will give only the side displacement, normal to the x -axis; and to get the whole motion of the particles we have to take the components v and w normal to the y -axis and z -axis respectively. Then the three components of the directed magnitude, which represents the oscillation of the particle about its mean position, will be

$$u = a \cos(2\pi \cdot t/\tau + p)$$

$$v = b \cos(2\pi \cdot t/\tau + q) \quad (16)$$

$$w = c \cos(2\pi \cdot t/\tau + r)$$

$$(u/a)^2 + (v/b)^2 + (w/c)^2 = 1 \quad (17)$$

$$s = \sqrt{u^2 + v^2 + w^2}. \quad (18)$$

It will be proved hereafter that there is a fundamental error in the wave-theory of light, as handed down by tradition from the days of *Young* and *Fresnel*; and that in a ray of common light the aether particle not only has transverse motion, but also a corresponding longitudinal motion, depending on the small ratio of the amplitude a to the wave length λ . After polarization these natural free motions of the aether are restricted, by the resistance impressed upon natural light, in the surface action of reflection, or transmission through transparent bodies, crystals, etc., and by unsymmetrical transparency in different directions, as in tourmaline, which forces half the light into one plane and destroys the other half. Originally the general path of the aetheron was elliptical, and although now transformed into oscillations near one plane the vibrations in most cases still are narrow ellipses, because it is proved by the reflection of plane polarized light from

a silver surface that an almost circular polarization results, whereas that reflected from galena has very narrow ellipses. This could not well result unless the polarized light before reflection from these metals described narrow ellipses, which are not exactly straight lines.

Now the elliptical paths established by equations (16), (17), (18), are similar to those analysed by *Herschel* in Section 618 of his great article *Light*, 1849. Suppose we consider the part of these waves which in a polarized ray have only right-handed rotations. Then if such a selected beam traveling along the x -axis be looked at flat on, from a point on the z -axis, the paths of the aetherons would resemble the motions of the particles of water in *Airy's* figure given as fig. 1, except that the aetherons may have paths more highly elliptical than are shown by *Airy*. This is the simplest form of the oscillations in the new wave-theory of light, which will be developed in the fourth paper: and we shall now see if it is possible to find corresponding oscillations in the field of a magnet and of an electric current.

In the year 1845 *Faraday* made a celebrated experiment in which he passed a beam of plane polarized light along the lines of force; and discovered that when the light travels in a material medium such as heavy lead glass, carbon-disulphide, etc., the plane of polarization is twisted by the action of the magnetic field. Not only is the plane of polarization rotated, but the rotation increases in direct proportion to the length of path traversed; and even when the light is reflected back and forth many times the twisting of the plane of polarization is always in the same direction like the helix of a circular winding stairs, as was long ago noted by Sir *John Herschel*.

In the article *Wave-Theory*, *Encyclopedia Britannica*, 9th edition, Lord *Rayleigh* describes this rotation of the plane of polarization by magnetism as follows:

»The possibility of inducing the rotatory property in bodies otherwise free from it was one of the finest of

Faraday's discoveries. He found that, if heavy glass, bisulphide of carbon, etc., are placed in a magnetic field, a ray of polarized light, propagated along the lines of magnetic force, suffers rotation. The laws of the phenomenon were carefully studied by *Verdet*, whose conclusions may be summed up by saying that in a given medium the rotation of the plane for a ray proceeding in any direction is proportional to the difference of magnetic potential at the initial and final points: In bisulphide of carbon, at 18° and for a difference of potential equal to unit C.G.S., the rotation of the plane of polarization of a ray of soda light is 0.0402 minute of angle.«

»A very important distinction should be noted between the magnetic rotation and that natural to quartz, syrup, etc. In the latter the rotation is always right handed or always left handed with respect to the direction of the ray: Hence when the ray is reversed the absolute direction of rotation is reversed also. A ray which traverses a plate of quartz in one direction, and then after reflexion traverses the same thickness again in the opposite direction, recovers its original plane of polarization. It is quite otherwise with the rotation under magnetic force. In this case the rotation is in the same absolute direction even though the ray be reversed. Hence, if a ray be reflected backwards and forwards any number of times along a line of magnetic force, the rotations due to the several passages are all accumulated. The non-reversibility of light in a magnetized medium proves the case to be of a very exceptional character, and (as was argued by Sir *W. Thomson*) indicated that the magnetized medium is itself in rotatory motion independently of the propagation of light through it.«

Now if I understand this subject aright — and my personal correspondence with the late Lord *Rayleigh* shows that he concurred in the present writer's views — we must conceive a line of force, circling around between the poles of a magnet, to be the axis of rotation in magnetic wave-motion, as shown by figure 2, repeated from the first paper on the *New Theory of the Aether*.

If this interpretation be admissible, we see that just as plane polarized light has sides, — with dissimilar properties on the opposite sides, as remarked by *Newton*, *Fresnel*, *Arago* and Sir *John Herschel*, — so also there are plane waves receding from magnets with exactly the same sides, with dissimilar properties on the opposite sides. It is these sides with oppositely directed rotations in the waves of the aether which gives poles to magnets.¹⁾

Magnetic polarity is thus directly connected by similarity of the rotations in the plane waves with plane polarized light. And just as the amplitude of light waves decrease inversely as r , the distance from the radiating centre (cf. *Drude*, *Lehrbuch der Optik*, 1900, Teil II, Kap. II)

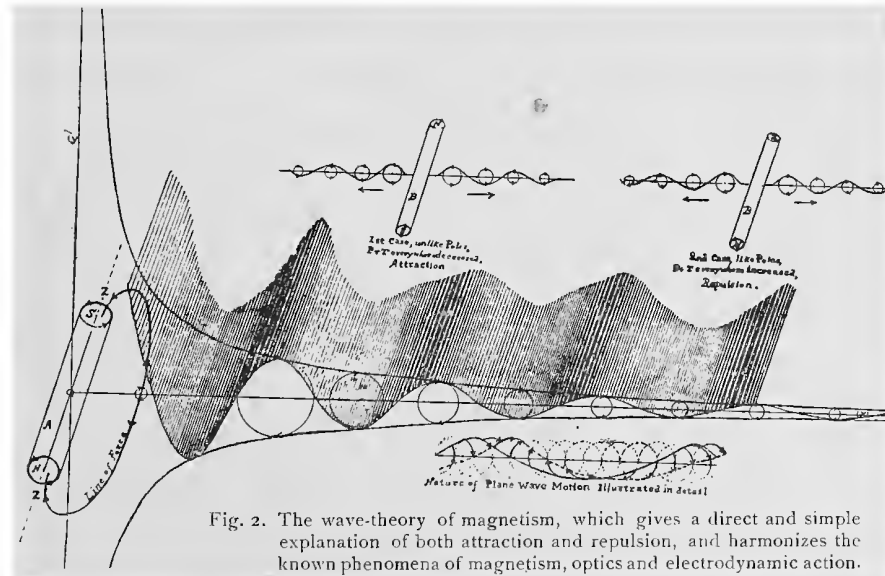


Fig. 2. The wave-theory of magnetism, which gives a direct and simple explanation of both attraction and repulsion, and harmonizes the known phenomena of magnetism, optics and electrodynamic action.

¹⁾ »*Newton* came to the conclusion that each of the two rays (of polarized light) had two sides; and from the analogy of this two-sidedness with the two-endedness of a magnet the term polarization arose« — *Gage's Principles of Physics*, 1897, p. 404.

so also in magnetism, the wave amplitudes follow the law: $A = k/r$, giving the force $f = k^2/r^2$, as observed in the actions of magnetism and universal gravitation (cf. *Electrod. Wave-Theory of Phys. Forc.*, Vol. 1, 1917). Accordingly, the connection between magnetism and light is obvious, the moment we do not restrict our conceptions of light to the side displacement in (15)

$$u = a \sin(2\pi \cdot x/\lambda + \phi) \quad (19)$$

but regard light as a disturbance involving a circular or elliptical displacement of the particles about a mean position, as the vector a representing this displacement in the case of a circle, revolves in a plane, which may be tilted at any angle relative to the coordinate axes.

In his celebrated article *Light*, 1849, Sir *John Herschel* shows, by carefully considered reasoning, that in the elliptical paths of the aethereal vibrations constituting light, the motion of the aetheron is about the centre of the ellipses, just as is the path of a vibrating conical pendulum, which may also change the path of its motion under the steady application of small impulses.

Suppose the undisturbed position of an aetheron be taken as origin, and let two radii vectores, drawn from the centre of the elliptical path to the disturbed aetheron, be q and q' ; then we have the wellknown equations

$$\begin{aligned} q^2 &= x^2 + y^2 + z^2 & q'^2 &= x'^2 + y'^2 + z'^2 \\ qq' \cos \theta &= xx' + yy' + zz' \end{aligned} \quad (20)$$

$$\begin{aligned} \cos \theta &= \cos \alpha \cos \alpha' + \cos \beta \cos \beta' + \cos \gamma \cos \gamma' \\ \cos^2 \alpha + \cos^2 \beta + \cos^2 \gamma &= \cos^2 \alpha' + \cos^2 \beta' + \cos^2 \gamma' = 1. \end{aligned} \quad (21)$$

The angle θ measures the motion of the light vector in the plane of the ellipse, while the angles $\alpha, \beta, \gamma, \alpha', \beta', \gamma'$ are fixed by the direction cosines of the revolving radius vector at any time.

It now remains to examine the disturbances taking place about a wire bearing an electric current flowing from south to north, as in *Oersted's* experiment of 1819. Here we notice that if the needle be suspended beneath the wire, the north pole is deflected to the west by the action of the current. If the needle be suspended above the wire, under like conditions, the north pole is deflected to the east.

It thus appears that just as magnets have plane waves — like those of plane polarized light rotating in one direction, and thus having dissimilar properties on opposite sides — so also an electric current has plane waves with sides, and with dissimilar properties on opposite sides, as shown by the study of *Oersted's* experiment of 1819. This follows also from the production of magnets from common steel under the electrodynamic action of a solenoid, as in *Ampère's* experiment of 1822.

The correct theory of an electric current is that it is made up of plane waves, flat in the plane through the axis of the wire, as shown in figure 12, section VI, and more fully in figure 18 (Pl. 6), section IX, below.

In his celebrated address on the relations between light and electricity, Sept. 20, 1890, *Hertz* tried to illuminate the connection previously recognized by *Maxwell*, and distinctly referred both light and electricity to the aether. »I am here«, he says, »to support the assertion that light of every kind is itself an electrical phenomenon — the light

of the sun, the light of a candle, the light of a glow-worm. Take away from the world electricity, and light disappears; remove from the world the luminiferous ether, and electric and magnetic actions can no longer traverse space« (cf. *Hertz*, *Miscellaneous papers*, p. 313).

Hertz was not able to make out the details of the relationship sought, but the experiments which he devised to show that electric waves are refracted, reflected and interfere, like light waves, marked an epoch in the development of radiotelegraphy, and have long since become classic. Yet when others took up the work, after *Hertz's* premature death, whilst they verified and used his results, they did not add to the theory of the aether, which *Hertz* considered essential to scientific progress. Hence the need still remained to traverse the lofty summits not yet explored (*Hertz*, l. c., p. 327), and to make out geometrically the nature of the displacements involved in these waves.

Accordingly we have gone into the nature of light and electric waves in such a way as to illuminate this relationship. *Hertz* remarks that to many persons *Maxwell's* electromagnetic theory is a book sealed with seven seals. Thus the breaking of the seals, that we may read the details of the illuminated pages, would alone give us a direct view of nature's secrets, and justify any treatment which would throw light on this obscure subject and confirm the doctrine of continuity in natural philosophy.

3. *Euler's* Defective Theory of Magnetism has misdirected Thought in Modern Science: Simple Explanation of Induction, and of the Dynamo on the Wave-Theory.

(i) *Euler's* theory of aethereal circulation, and its persistence since 1744.

Nothing could better illustrate the unsatisfactory state of the traditional doctrines of electricity and magnetism, than the old conception of a magnet, first outlined by *Euler* at Berlin, 1744, and since handed down, with very slight changes, and thus copied, with the original defects of symmetry, into hundreds of works on physics used by the principal nations of the world.

It is authenticated, that in his university career at Basel, *Euler* had studied both anatomy and physiology. As an outcome of this anatomical research he was familiar with the circulation of the blood in the human body. Thus he understood the valvular structure in the arteries, which secures the flow of the blood in one direction only, as the heart beats to expel the blood through the arterial system.

Accordingly when *Euler* attempted, twenty years later, to develop a theory of magnetism, which should reconcile all the known facts, including the attraction of unlike and the repulsion of like poles, he assumed a flux of the aether, along the axis of the magnet, inward at the south pole and outward at the north pole, as shown in figure 3. Plate 4 from *Euler's* work (*Dissertatio de Magnete*, 1744, published in *Euler's* *Opuscula*, vol. III, Berlin, 1751, Plate I).

This remarkable figure has been handed down by tradition for 176 years, and its validity apparently seldom or never questioned, though it probably is less used of late years than formerly. It appears in the physical treatises of

all countries, and has vitiated even the mathematical theory of *Maxwell* (Treatise on Electricity and Magnetism, vol. II., p. 28, § 404).

Maxwell's reasoning is as follows:

»The magnetic force and the magnetic induction are identical outside the magnet, but within the substance of the magnet they must be carefully distinguished.«

»In a straight uniformly magnetized bar the magnetic force due to the magnet itself is from the end which points north, which we call the positive pole, towards the south end or negative pole, both within the magnet and in the space without.«

The lack of symmetry and of appropriate physical basis to this reasoning is so truly remarkable as to occasion genuine surprise that it should have been used by *Maxwell*. He continues:

»The magnetic induction, on the other hand, is from the positive pole to the negative outside the magnet, and from the negative pole to the positive within the magnet, so that the lines and tubes of induction are reentering or cyclic figures.«

This artificial and unnatural theory is outlined in the accompanying sketch, see Fig. 4 Pl. 4. Fig. 5 Pl. 4 illustrates the usage of *Euler's* Circulation Theory of a Magnet in various modern works. The figure above, on the left is from *Millikan and Gale's* First Course in Physics, 1906; that to the right is from *Gazebrook's* Electricity and Magnetism, 1903; the sphere below is from *Crystall's* article on Magnetism, *Encycl. Brit.*, 9 Ed., 1875; while the figure to the right, below, is from *Drude's* Physik des Aethers, 1894.

It appears that *Maxwell* adhered to *Euler's* conceptions so far as induction is concerned, but added to it to explain magnetic force.

The anomaly of imagining the magnetic force to oppose the induction within the body of the magnet, but not without, is striking, and probably due to the habit of referring all actions to that of a unit north pole.

On the other hand the much simpler conceptions of the Wave-theory, 1917, need no emphasis. We there imagine the stress in the aether to be due to waves from all the atoms, so that the lines of force — which are the axes of rotation of the receding waves — tend to shorten themselves, as *Faraday* had observed, and as we have explained mechanically in the second paper on the New Theory of the Aether.

It is very difficult to account for the defective theory of 1744 except by remembering that *Euler* had injured eyesight, which did not enable him to detect the true symmetrical nature of magnetism, by experiments with soft iron, or with smaller magnetic needles, as shown in the accompanying photograph, see Fig. 6 Pl. 4, of an experiment made by the present writer, 1914.

Soft iron paper fasteners freely suspended by threads are used to indicate the pulling from the equator towards either pole of the magnet. The lines of force thus visibly tighten and shorten themselves by the aetherial suction into either pole; and *Euler's* defective theory of an inward flow at the south pole and an outward flow at the north pole is disproved by observations which any-one can make for himself.

To be sure that no injustice was done to *Euler*, I took a small magnetic needle, suspended by a thread accurately fastened to its centre, and found by actual trial how this small magnet behaved when substituted for the soft iron wire described above.

We find by trial that the suspended needle also is drawn from the equator of the magnet towards either pole, exactly as in the case of the soft iron wire above used. The deflection of the supporting thread from the vertical direction of gravity, shown by the glass marble suspended in the centre of the field, under actual trial, shows this clearly and unmistakably.

It seems therefore absolutely certain that *Euler's* defective theory of magnetism, with fatal lack of essential symmetry, yet copied in all the works on physics for the past 176 years, was an oversight due to the partial blindness of that great mathematician, and thus excusable. But what shall we say of the careless reasoning of physicists, which has enabled this unsymmetrical and unnatural figure to be handed down unchanged through nearly two centuries, or else mended by strained reasoning like that used by *Maxwell* above?

It may perhaps be allowed that the above experimental result definitely establishes the electro-d. wave-theory of magnetism, set forth in the *Electrod. Wave-Theory of Phys. Forc.*, vol. I, 1917. Accordingly, since we have attained a natural point of view, based on recognized symmetry, for the theories of electricity and magnetism, we shall see how fully the new theory is confirmed by definite phenomena which are simple and easily understood.

(ii) *Maxwell's* difficulties overcome by the wave-theory.

But, first of all, we call attention to the fact that in his paper *On Physical Lines of Force* (*Scientific Papers*, vol. I, p. 468) *Maxwell* searched diligently but in vain for the answer to the question: »what is an electric current?«

»I have found great difficulty,« he says, »in conceiving of the existence of vortices in a medium side by side, revolving in the same direction about parallel axes. The contiguous portions of consecutive vortices must be moving in opposite directions; and it is difficult to understand how the motion of one part of the medium can coexist with, and even produce, an opposite motion of a part in contact with it.«

»The only conception which has at all aided me in conceiving of this kind of motion is that of the vortices being separated by a layer of particles, revolving each on its own axis in the opposite direction to that of the vortices, so that the contiguous surfaces of the particles and of the vortices have the same motion.«

»In mechanism, when two wheels are intended to revolve in the same direction, a wheel is placed between them so as to be in gear with both, and this wheel is called an 'idle wheel'. The hypothesis about the vortices which I have to suggest is that a layer of particles, acting as idle wheels, is interposed between each vortex and the next, so that each vortex has a tendency to make the neighbouring vortices revolve in the same direction with itself.«

The difficulty here described by *Maxwell* is immediately solved by the wave-theory, for when a continuous series of waves are flowing, the rotatory motions of all the particles

of the medium are in the same direction, as we see from the above Fig. 1, Pl. 4, from *Airy*, and no such antagonism as *Maxwell* mentions can arise. Surely this removal of *Maxwell's* difficulty, along with the complicated structure of »idle wheels«, which he devised for the stationary aether vortices, in default of wave-motion, must be considered a very remarkable triumph of the wave-theory.

In 1914 I found by careful experiment that a suspended magnetic needle is bodily attracted to a wire bearing a current, owing to the interactions of the waves from the wire and the needle. But it appears from *Maxwell's* address on Action at a Distance, (Scientific Papers, vol. II, p. 317) that he did not look upon an electric current as bodily attracting¹⁾ a suspended magnetic needle.

»We have now arrived at the great discovery by *Oersted* of the connection between electricity and magnetism. *Oersted* found that an electric current acts on a magnetic pole, but that it neither attracts it nor repels it, but causes it to move round the current. He expressed this by saying that the electric conflict acts in a revolving manner.«

»The most obvious deduction from this new fact was that the action of the current on the magnet is not a push-and-pull force, but a rotatory force, and accordingly many minds were set a-speculating on vortices and streams of aether whirling round the current.«

And I have not been able to find any clear statement of the proved attraction of needle to a wire bearing a current, in later writers; they all evade it, by arguments as to the behavior of a unit north pole, when no such single pole exists. In the theory of magnetism it is no more pertinent to discuss the actions of half of a magnet than it would be in human physiology to treat of one side of our bodies only, when the whole body is perfectly symmetrical, and not to be split up into halves, and cannot act as such. One leg, one arm, one side of the brain and spinal column performs no functions alone and all such discussion is unscientific and a very imperfect makeshift.

(iii) Induction due to motion of a magnet explained by the wave-theory.

In the year 1824 it was observed by *Gambey* that a compass needle oscillating in its box came to rest sooner if the bottom were made of metal than if of wood. What is the reason of this dragging action of the metal? In the *Electrod. Wave-Theory of Phys. Forc.*, we have explained induction by wave-action, and shown that when waves having, say, positive rotation suddenly penetrate a metallic substance, the effect of these positive whirls is to generate negative metallic whirls, in virtue of the disturbances of the aether.

That is to say, no such permanent disturbances will occur when both the magnet emitting waves and the non-

magnetic metal is at relative rest, but the moment any relative motion takes place, the wave-field penetrating the non-magnetic metal undergoes change, and this change of the wave-field disturbs the equilibrium of the aether in the non-magnetic metal, and the result is induction, or the generation of electric waves in the metal, which becomes temporarily magnetic. The metal therefore emits waves with whirls or rotations opposite to that of the inducing magnet.

Now in our demonstration of the cause of magnetism, 1917, it is shown that the reason why opposite poles attract, is that the opposite rotations in the waves from such poles cause an undoing of the stress of the medium, so that it collapses, and this tendency to contract is what we call attraction. In the same way the relative motion of a compass needle over a metal plate induces in it opposite polarity, with opposite rotations in the waves emitted therefrom; and then the temporary magnetism induced in the plate by the relative motion of the needle, calls forth attraction between the needle and the metal. Accordingly, this induction acts as a drag on the vibrations of the needle, and brings it to rest sooner than would be the case if the vibrations were over wood, which is almost devoid of inductive effect, because it is non-metallic.

(iv) *Arago's* rotations and the dynamo explained.

Soon after *Gambey's* observation in 1824, the subject was investigated by *Arago*, who found that a copper plate under the needle was most effective in damping its vibrations. On rotating the copper disc in its own plane beneath the needle, he found that the needle was dragged around by an invisible friction; and when the magnet was rotated near the copper disc, the disc was dragged by the rotating magnet. This action was spoken of for a time, as a sort of magnetism of rotation, but in 1831, *Faraday* discovered induction, and showed that *Arago's* rotations depend on this cause.

According to *Faraday* a magnet moved near a solid mass or plate of metal, induces in it disturbances which result in currents when they are properly directed, as from a dynamo. If they are not directed through a circuit, they flow from one point to another, and the energy is frittered down into heat, but meanwhile the electromagnetic forces act as a drag on the rotations taking place.

Fig. 7, Pl. 5, illustrates the eddy currents long recognized in such experiments. But from our electrodynamic wave-theory of magnetism, we recognize these whirls as the elements of rotations in waves receding from the magnet.

If we spin the disc of copper as shown in fig. 7, and lead off the disturbances by a circuit of wire connecting the points *a* and *b* we get the current generated by a dynamo, which was also invented by *Faraday*.

The above explanation of the generation of a current

¹⁾ *Whewell*, History of the Inductive Sciences, 3rd ed. 1857, vol. III, p. 73, expresses himself in about the same way: »On attempting to analyse the electro-magnetic phenomena observed by *Oersted* and others into their simplest forms, they appeared, at least at first sight, to be different from any mechanical actions which had yet been observed. It seemed as if the conducting wire exerted on the pole of the magnet a force which was not attractive or repulsive, but transverse; — not tending to draw the point acted on nearer, or to push it further off, in the line which reached from the acting point, but urging it to move at right angles to this line. The forces appeared to be such as *Kepler* had dreamt of in the infancy of mechanical conceptions; rather than such as those of which *Newton* had established the existence in the solar system, and such as he, and all his successors, had supposed to be the only kinds of force which exist in nature. The north pole of the needle moved as if it were impelled by a vortex revolving round the wire in one direction, while the south pole seemed to be driven by an opposite vortex. The case seemed novel, and almost paradoxical.«

by a dynamo is new. It is so simple that it constitutes a remarkable proof of the wave-theory. The old doctrine of cutting lines of force, by the revolution of a commutator, between the poles of an electro-magnet, is good enough as a working rule of thumb, but gives no insight into the mechanism underlying electro-dynamics.

As set forth in the first paper on the New Theory of the Aether, *Maxwell* was greatly occupied with the nature of magnetism; but although he was able to show that certain stresses admitting of mathematical formulation will account for magnetic phenomena, he was unable to conceive of any natural mechanism from which it could arise. Having outlined the wave-theory very briefly in the first paper, we have here examined the foundations of this new theory somewhat more in detail — without, however, in any way exhausting

$$Z = \sum dm (y \cdot dx/dt - x \cdot dy/dt) = \iiint \sigma (y \cdot dx/dt - x \cdot dy/dt) dx dy dz \quad (22)$$

This expression holds for small regions of space in the equatorial plane of the magnetic field, and the development may be made general by proper extension of the action to any region of the space (x, y, z) .

4. Direct Proof of the Undulatory Character of an Electric Current deduced from the ratio between the Electromagnetic and Electrostatic Units, $L/T = v$.

Notwithstanding the enormous development of modern electrical science, it appears that the true physical character of an electric current has remained a great mystery. It seems to have successfully challenged the ingenuity of the foremost geometers and natural philosophers. For in his comprehensive *Mathematical Theory of Electricity and Magnetism*, 3rd ed., 1915, Dr. *J. H. Jeans* acknowledges that no progress has been made:

(a) »We have even obtained formulae for the stresses and the energy in the ether. But it has not been possible to proceed any further and to explain the existence of these stresses and energy in terms of the ultimate mechanism of the ether« (p. 485).

(b) »On the other hand the ultimate mechanism with which electromagnetic theory is concerned is that of action in the ether, and we are in utter ignorance of the ultimate laws which govern action in the ether. We do not know how the ether behaves, and so can make no progress towards explaining electromagnetic phenomena in terms of the behaviour of the ether« (p. 486).

(c) »In nature, there are certain acts which we can perform (analogous to the motion of other ropes), but the ultimate mechanism by which the cause produces the effect is unknown. For instance we can close an electric circuit by pressing a key, and the needle of a distant galvanometer may be set into motion. We infer that there must be some mechanism connecting the two, but the nature of this mechanism is almost completely unknown« (p. 486).

1. The only tenable explanation of the mechanism of an electric current heretofore put forth¹⁾ seems to be that

the subject, which would be altogether beyond the scope of these papers.

In the second paper, section 6, we cited *Dolbear's* experiment with circular discs set loosely but revolving on an axis and thus expelling the air by the centrifugal effects of the rotation, so as to tend to shorten the resulting vortex, as was observed by *Faraday* for his lines of force. This valid dynamical model and its known mechanical effects, combined with other phenomena, especially *Faraday's* experiment of 1845, on the rotation of polarized light by magnetism, enabled us to concur in the conclusions of Lord *Kelvin* and *Maxwell*, that around a magnet the elements of the aether are in rapid rotation. And we gave for the angular momentum (Z), of an element of mass dm , of the aether, in the plane of the equator, taken as that of xy :

brought to light in the writer's *Electrod. Wave-Theory of Phys. Forc.*, where the undulatory character of the current is shown to be probable in the highest degree. But even a decisive illumination of this difficult subject needs further development, if it be possible to find an element of electric dimensions which is perfectly simple, in the electromagnetic and electrostatic systems, and thus might disclose the true mechanism of a current.

To this end we choose the element known as resistance, which in the electromagnetic system has the dimensions $L/T = v$, a velocity, and appears in the electrostatic units in the dimensions TL^{-1} , the difference v^2 being an expression of work done or electric energy transformed by the resistance to the progress of the waves along the wire.

2. It appears by the table given below that in electromagnetic units, resistance is always expressible as a velocity, $v = L/T$, and therefore must be a measurable effect, dissipative in character, due to the motion of waves in the aether, traveling along a conductor with very nearly the velocity of light. All electric currents, as is well known, involve some dissipation of energy, in the form of heat and light, and electric circuits usually are arranged so as to offer small resistance, in order to give minimum loss of electric energy. When light is to be produced the conversion of energy into light takes place only in the filaments of the lamps, and the heating of the rest of the electric circuit is kept at a minimum.

3. Now, although the modern theory of electric oscillations has been developed to a vast extent, and the process used in radio-telegraphy, yet it appears that a clear understanding of the nature of a steady electric current is not yet attained by electrical investigators. By means of alternators, in a circuit containing both capacity and inductance, with low Ohmic resistance, these electric oscillations have been made to reach frequencies of from 10000 to 15000 per second, and in some cases even 120000. More recently the oscillations have been made to exceed 10000000 per second, the minimum wave length being only 0.4 cm = 4 mm.

¹⁾ *Crowther's* earlier theory that an electric current consists in the flow of electrons is discussed in Section 12, (ii), below, and shown to be untenable.

But we should look into the history of the subject since the earliest experiments, eighty years ago, in order to get a connected view of the whole subject of electric oscillations.

4. In 1842, Professor *Joseph Henry* was occupied with the study of the discharge of a Leyden jar, and reached the conclusion that what appears to the naked eye as a single spark, »is not correctly represented by the single transfer of an imponderable fluid from one side of the jar to the other.« »The phenomena,« he adds, »require us to admit the existence of a principle discharge in one direction and then several reflex actions backward and forward, each more feeble than the preceding until equilibrium is obtained.« »Henry's conclusions were drawn from observations of the irregular magnetizations of steel needles when Leyden jar discharges are directed through a coil, as in *Savary's* experiments.

5. *Henry's* conclusions were mathematically confirmed in 1853 by Lord *Kelvin*, who reached the formula for the time of these oscillations:

$$T = 2\pi\sqrt{1/KL - R^2/4L^2} \quad (23)$$

where K is the capacity of the condenser, now usually expressed in Farads; L the inductance, now usually expressed in Henrys; and R the resistance, in Ohms. If $K = 0.01$ Microfarad, $L = 0.00001$ Henry, and $R = 0$, the time of an oscillation will be found to be 1:503000, or the frequency of the oscillations 503000 per second. They may be made as rapid as 1000000 per second, or even of higher frequency; yet we cannot make them as rapid as the waves of light, because our physical apparatus is not of atomic dimensions.

6. When $R^2/4L^2$ is so small as to be negligible compared to $1/KL$, the time of oscillation becomes like that of undamped simple harmonic motion:

$$T = 2\pi\sqrt{KL}. \quad (24)$$

But if $R^2/4L^2$ is small, yet not wholly insensible, the discharge is oscillatory, for under the damping due to resistance, the period is altered, and the time of oscillation becomes of the form used in radio telegraphy:

$$T = 2\sqrt{(\pi^2 + l^2) \cdot \sqrt{KL}} \quad (25)$$

where l is the logarithmic decrement.

7. In 1858 *Feddersen* experimentally confirmed Lord *Kelvin's* theory of the oscillatory character of the Leyden jar discharge, by photographing the image of the spark in a rotating mirror, and found that the image of light was drawn out into a series of images, due to sparks following each other in rapid succession. The illustration of this oscillatory discharge in Fig. 8; Plate 5, was obtained in 1904 by *Zenneck*, who used a *Braun* tube as an oscillograph.

8. Now in the case of a steady electric current, the conductor connects points having difference of potential: this difference tends to adjust itself, by the electric contact, resulting from the conductor, and thus the aether is set into oscillation and the waves travel along the wire, just as water runs down hill from higher to lower gravitational potential, and in this transfer some dissipation of energy results.

Inductance is present in the wire, and as it has also capacity, the contact yields electric oscillations, when energy

is released, as in the discharge of a Leyden jar. If only one of these factors, inductance or capacity, were present, but not both, the disturbance would rise and fall according to some exponential function of the time, yet without regular oscillations.

When both inductance and capacity are present, as in all metallic systems, the disturbance calls forth both elasticity and inertia, because the electric disturbance is physically impeded and the aether is set into wave motion of the kind above described.

9. So long as difference of potential is maintained at the two ends of a circuit this electric wave oscillation is maintained along the wire. As in the case of the Leyden jar, so also for a battery; the oscillatory discharge begins the moment the circuit is complete, and continues to flow as a steady current. Since there is finite but small loss of wave energy through the body of the wire, owing to its physical resistance to the free movements of the aether, the wave disturbance envelopes the wire cylindrically, traveling more rapidly in the free aether outside; but the wave front is continually bent inward towards the metallic cylinder, just as the wireless wave is bent around the globe, by the greater resistance to the motion of the radio wave in the solid globe of the earth.

The above explanation of the waves propagated from a conductor gives a very satisfactory account of the phenomena from a physical standpoint. But it is advisable to look into the matter also from the historical point of view, in order to perceive the drift of research during the past sixty years.

10. In the celebrated Treatise on Electricity and Magnetism, 1873, § 771 et seq., *Maxwell* first brought out the fundamental difference between electromagnetic and electrostatic units, and showed that the ratio is always equal to $L/T = v$, a velocity. Upon this basis *Maxwell* erected the foundation of the electromagnetic theory of light, which has come into general use, though the mystery of the connection between light and electricity was not fully cleared up. For example, Lord *Kelvin* never could see how it helped the wave-theory of light (Baltimore Lectures, 1904, p. 9).

As already pointed out, it will be seen from the table given below, that the dimensions of resistance, in electromagnetic units, is LT^{-1} , which represents a velocity. This is a very remarkable fact, having profound physical significance, which may well claim our attention. Is it possible that the resistance felt in all conductors, and obeying *Ohm's* law, is an indication of the motion of electromagnetic waves along the wires, by which the resistance is generated? If so, the dimensions in electromagnetic units should be v^2 times that in electrostatic units, as actually observed.

11. In his celebrated discussion of the electric medium *Maxwell* showed how » v « could be determined experimentally. In fact, *Weber* and *Kohlrausch* as early as 1856, 17 years before *Maxwell's* treatise appeared, had already carried out a numerical determination, and obtained the approximate value $v = 310740000$ metres per second (*Poggendorff's Ann.*, 1856, Aug., pp. 10-25).

This constant has since been determined by many

investigators, working along lines indicated by *Maxwell*, with very accordant results, the latest and no doubt the best being that by Professor *E. B. Rosa* and *N. E. Dorsey* of Washington, 1907, Bulletin of the Bureau of Standards, vol. 3, nos. 3 and 4, p. 601, namely:

$$v = 2.997 \cdot 10^{10}.$$

12. As these publications are universally accessible, we shall not go into the details of these electrical experi-

13. Table of the equivalent dimensions in the two theoretical systems of units.

		Electrostatic	Electromagnetic
1. Charge of electricity	e	$M^{1/2} L^{3/2} T^{-1} = M^{1/2} L^{1/2} \cdot v$	$M^{1/2} L^{1/2}$
2. Density	ρ	$M^{1/2} L^{-3/2} T^{-1} = M^{1/2} L^{-5/2} \cdot v$	$M^{1/2} L^{-3/2}$
3. Electromotive force	E	$M^{1/2} L^{1/2} T^{-1} = M^{1/2} L^{3/2} T^{-2} \cdot 1/v$	$M^{1/2} L^{3/2} T^{-2}$
4. Electric intensity	$R (X, Y, Z)$	$M^{1/2} L^{-1/2} T^{-1} = M^{1/2} L^{1/2} T^{-2} \cdot 1/v$	$M^{1/2} L^{1/2} T^{-2}$
5. Potential	V	$M^{1/2} L^{1/2} T^{-1} = M^{1/2} L^{3/2} T^{-2} \cdot 1/v$	$M^{1/2} L^{3/2} T^{-2}$
6. Electric polarization	$P (f, g, h)$	$M^{1/2} L^{-1/2} T^{-1} = M^{1/2} L^{-3/2} \cdot v$	$M^{1/2} L^{-3/2}$
7. Capacity	C	$L = L^{-1} T^2 \cdot v^2$	$L^{-1} T^2$
8. Current	i	$M^{1/2} L^{3/2} T^{-2} = M^{1/2} L^{1/2} T^{-1} \cdot v$	$M^{1/2} L^{1/2} T^{-1}$
9. Current per unit area	(u, v, w)	$M^{1/2} L^{-1/2} T^{-2} = M^{1/2} L^{-3/2} T^{-1} \cdot v$	$M^{1/2} L^{-3/2} T^{-1}$
10. Resistance	R	$L^{-1} T = L T^{-1} \cdot 1/v^2$	$L T^{-1}$
11. Specific resistance	r_s	$T = L^2 T^{-1} \cdot 1/v^2$	$L^2 T^{-1}$
12. Strength of magnetic pole	m	$M^{1/2} L^{1/2} = M^{1/2} L^{3/2} T^{-1} \cdot 1/v$	$M^{1/2} L^{3/2} T^{-1}$
13. Magnetic force	$H (\alpha, \beta, \gamma)$	$M^{1/2} L^{1/2} T^{-2} = M^{1/2} L^{-1/2} T^{-3/2} \cdot v$	$M^{1/2} L^{-1/2} T^{-1}$
14. Magnetic induction	$B (a, b, c)$	$M^{1/2} L^{-3/2} = M^{1/2} L^{-1/2} T^{-1} \cdot 1/v$	$M^{1/2} L^{-1/2} T^{-1}$
15. Inductive capacity	K	$I = L^{-2} T^2 \cdot v^2$	$L^{-2} T^2$
16. Magnetic permeability	μ	$L^{-2} T^2 = I \cdot 1/v^2$	I

Table of practical units in the two systems.

Quantity	Name of Unit	Measure in electromag. units	Measure in electrostatic units ($v=3 \cdot 10^{10}$ CGS)
Charge of electricity	Coulomb	10^{-1}	$3 \cdot 10^9$
Electromotive force	Volt	10^8	$1/(3 \cdot 10^2)$
Electric intensity			
Potential			
Capacity	Farad	10^{-9}	$9 \cdot 10^{11}$
Capacity	Microfarad	10^{-15}	$9 \cdot 10^5$
Current	Ampère	10^{-1}	$3 \cdot 10^9$
Resistance	Ohm	10^9	$1/(9 \cdot 10^{11})$

It will be seen from the element, resistance, no. 10, in the above table, that to establish equivalence, the electrostatic unit must be divided by $(TL^{-1})^2$ or by v^2 , which is the square of the dimensions in electromagnetic units. This indicates that electromagnetic waves resisted by a conductor do work depending on the square of the velocity with which they travel, which conforms to general experience in all physical problems where energy is expended.

14. It thus appears that the ratio between the two sets of units is uniformly $L/T = v$, in the first or second power, and thus v undoubtedly represents a velocity, as first clearly set forth by *Maxwell*, Treatise on Electricity and Magnetism, § 771 et seq. Fortunately it happens that this ratio can also be determined experimentally, from a current of electricity in motion, and from an identical electrostatic charge, at rest: thus v admits of electric measurement, independently of any theory of light. But as the value of v is the same as the velocity of light, *Maxwell* naturally concluded that the electric medium is identical with the luminiferous aether. The following is an outline of the method of measurement.

ments. It suffices to confine our attention to a physical explanation of the results obtained, but apparently not yet clearly understood by natural philosophers.

On comparing the dimensions of the electromagnetic units with those of the electrostatic units, we find that there is always a uniform difference depending on the common factor $L/T = v$, or $L^2/T^2 = v^2$, as shown in the following tables.

For simplicity, suppose a condenser is charged with electricity, and let its quantity, Q , be measured in electrostatic units, by determining for instance the repulsion which a given proportion of the total charge produces in a torsion balance of known dimensions.

Let the condenser be again charged to the same extent, and let it be discharged through a galvanometer. By measuring the deflection produced, the constants of the instrument being known, we may determine the quantity of electricity which deflected the galvanometer. This gives by direct observation

$$Q(\text{e.m.})/Q(\text{e.s.}) = C \cdot 3.0 \cdot 10^{10}/C = 3.0 \cdot 10^{10} = \text{velocity of light.}$$

16. The process may be numerically illustrated in the following way. The e. m. f. of a Daniell's cell may be measured by such an instrument as Lord *Kelvin's* absolute electrometer, and found to give in electrostatic units of potential say 0.0036.

The same difference of potential measured in electromagnetic units will be found to have the value

$$1.088 \cdot 10^8 = 0.01088 \cdot 10^{10} \cdot 3/3 = 0.0036 \cdot (3.0 \cdot 10^{10}).$$

Hence the ratio of the electromagnetic to the electrostatic units is $3.0 \cdot 10^{10} = \text{velocity of light.}$

The electrostatic quantity $Q(\text{e.s.})$ is the quantity of electricity which attracts or repels another equal quantity at a distance of 1 cm, with a force of a dyne. The electromagnetic quantity $Q(\text{e.m.})$ is the quantity of electricity which traverses the wire of the galvanometer in a second when the current set up by the discharge has unit intensity.

17. The ratio between the units is always of the dimensions of a velocity, and as it holds under the condition that the centimetre is the unit of length, and the second the unit of time, we see by experiment that the

ratio is the actual velocity of light, $3.0 \cdot 10^{10}$, which establishes the identity of the electric medium with that of the luminiferous aether.

This was also shown by *Hertz* in the celebrated experiments which led to the development of wireless telegraphy, and thus the subject requires no further treatment at present. We merely call attention to the electrodynamic waves about a wire bearing a current as diagrammed in the author's work of 1917, Fig. 12, below, and now somewhat better represented in Fig. 18, Plate 6.

18. This picture shows clearly that an electric current is nothing but a certain type of aether waves propagated away from the wire. Accordingly, when such a current is set up in the aether; through the waves generated and maintained by the e. m. f. of the battery, it is obvious that the electromagnetic measure of this electric action should involve the motion of the waves or velocity; while in the case of the electrostatic action no velocity is involved, but only a stationary difference of potential.

This theory completely accounts for the difference v in the units, and harmonizes all known electrical phenomena, and is an especially satisfactory termination of a half century of scientific discussion of the relation between electromagnetics and electrostatics. It is not by chance that only v and v^2 appear in the above table.

If the actions of the medium involved something besides say induction, where v appears, or resistance, where v^2 appears, it should be expected to find v in perhaps the third or fourth powers; but no such powers are established by observation, which confirms the above interpretation.

5. The Geometrical and Physical Significance of *Biot* and *Savart's* Law for the Intensity of a Current on a Straight Wire, and of *Ohm's* Law for the Resistance.

1. The law of *Biot* and *Savart* for an electric current on a straight wire has the simple form (*Biot et Savart*, Ann. Chim. Phys., 15 p. 222, 1820):

$$I = KH/r \quad (26)$$

where K is a constant, and I the intensity of the electric action which varies inversely as the distance r from the wire, and directly as the current strength H .

2. We shall give a simple geometrical basis for *Biot* and *Savart's* law of the inverse distance. In the *Electrod. Wave-Theory of Physic. Forc.*, we have shown that the action of an electric current is due to flat waves, with their planes of rotation containing the axis of the straight wire, the rotation of the wave elements being around the lines of force, which are circles about that axis. All points of the wire emit waves, but the waves are so conditioned as to expand in the form of a cylindrical surface, thus spreading as a circular cylinder around the wire, but not in the direction of the wire. The element of cylindrical surface becomes:

$$ds = dl r d\omega \quad (27)$$

where $r d\omega$ is an element of the circles of expansion, increasing as the radius r , and dl is constant, along the length of the cylinder.

3. Now since the element of length dl is constant, as

the wave spreads outward, and only $r d\omega$ varies, the cylindrical sector thus increases like the circumference of a circle, $2\pi r$, perpendicular to the axis of the wire. The expansion of the radius of the circle thus determines the increase in the area of ds , the elementary area of the cylindrical surface, in which the electrical waves must expand.

4. Now the area of the circular cylindrical sector varies as $r d\omega$ or as the radius, $d\omega$ being constant in a fixed element of the sector. And as the waves thus become less crowded, in the direct ratio of the distance, r , it follows that the intensity of the wave action decreases, varying inversely as r . This is a direct and simple view of the geometrical basis of *Biot* and *Savart's* law, heretofore apparently little studied by natural philosophers.

5. This remarkable law of *Biot* and *Savart* thus has the simplest of explanations: namely, the elementary cylindrical surface ds increases directly as r , and the resulting electrical action therefore decreases inversely as r . The law thus follows at once from the restricted freedom of the waves propagated from the wire: and as it was confirmed by experiments of *Biot* and *Savart*, 1820, the law in turn establishes the dependence of current action on electrodynamic waves. No other agency than waves could produce this result, because waves involve expansion, and the agitation has to follow the geometrical inverse law of the increase of space.

6. By extending the above reasoning, we see that if the waves from a body can spread in all directions, they will fill a sphere surface, $s = 4\pi r^2$, and hence the law of decrease of the intensity for the action varies inversely as r^2 , namely: $f = m/r^2$, which holds for universal gravitation, magnetism, and other physical forces of nature.

7. As the coincidence between the requirements of waves and the space expansion is rigorous, from $x = 0$ to $x = \infty$, the chances against such a mere accidental conformity, without physical cause, are infinity to one. Accordingly, *Biot* and *Savart's* law furnishes direct proof of the utmost rigor that waves underlie electrodynamic action, as well as gravitation, magnetism, etc.

There has been such a bewildering confusion of thought connected with the whole subject of physical action across space that it is necessary to bear in mind clearly the fundamental principles of natural philosophy. To this end we need obvious proofs of the causes underlying physical action, under the simplest of nature's laws. The simple laws exclude the larger number of complicating circumstances, and enable the cause involved to stand out in such a way that we may recognize it.

Very different indeed is the confusion of thought carried on in certain scientific circles. At a discussion of the Theory of Relativity, as reported in the Monthly Notices for December, 1919, Sir *Oliver Lodge* justly complains that Professor *Eddington* thinks he understands it all. »To dispense with a straight line as the shortest distance between two points, and to be satisfied with a crazy geodesic that is the longest distance between two points, is very puzzling.« . . . »The whole relativity trouble arises from giving up the ether as the standard of reference — ignoring absolute motion through the ether —, rejecting the ether as our standard of reference,

and replacing it by the observer. By putting the observer in the forefront and taking him as the standard of reference you get complexity. If you describe a landscape in terms of a man in a train looking out of the window, the description is necessarily complicated. The surprising thing is that this theory has arrived at verifiable results. « . . . » The theory is not dynamical. There is no apparent aim at real truth. It is regarded as a convenient mode of expression. Relativists seem just as ready to say you are rising up and hitting the apple as that the apple is falling on you. It is not common sense, but equations can be worked that way.«

8. It is quite remarkable that heretofore the law of *Biot* and *Savart* should have been so little studied by investigators. A law of such simplicity (compare Fig. 9, Plate 5) has enormous advantages over any complex law, especially when it comes to searching for the causes which produce the phenomena observed in nature. Thus it is preeminently these simple laws, which admit of one interpretation and only one, that should claim the attention of natural philosophers.

9. In the closest analogy with what *Biot* and *Savart's* law puts before us, for the intensity of an electric current, on a straight wire, the Newtonian gravitational potential, for a homogeneous sphere or a heterogeneous sphere made of concentric layers of uniform density, presents to us the excessively simple formula:

$$V = M/r \quad (28)$$

which we have already interpreted in terms of waves freely expanding in tridimensional space.

Any other interpretation than that given for the Newtonian potential function in these simple cases seems absolutely excluded, by virtue of the simplicity and directness of the most obvious special relations, as when the waves expand outwardly from a spherical mass such as the sun.

10. Any modification which renders these formulae complicated or non-homogeneous is to be viewed with profound suspicion. Thus the substitution of *Gerber's* formula:

$$V = M/r(1 - 1/c \cdot dr/dt)^2 \quad (29)$$

for *Newton's* as cited in equation (28) above, is unjustifiable and indefensible; yet in the perverse search for complexity instead of simplicity, such bewildering confusion goes on.

Dr. *P. Gerber* first published this unauthorized formula in the *Zeitschrift für Mathematische Physik*, Band XLIII, 1898, p. 93-104, and the exploitation of it since made by *Einstein* and his followers ignores the fundamental fact that by introducing the second power factor, $\gamma^2 = (1 - 1/c \cdot dr/dt)^2$ in the divisor, the dimensions of the equation are changed, which is physically inadmissible and equivalent to violating the essential mathematical condition of homogeneity for the equation for the potential. Such an objection is fatal¹⁾, since it rests upon both geometrical and physical grounds; and thus we witness the adoption of a mere convenience, in violation of recognized scientific principles.

11. The fact that the *Einstein* speculations involve this fatal contradiction seems to have been overlooked by previous

investigators, who thus exhibit a feeble grasp of the most essential conditions of geometrical and physical research.

Accordingly, since this *Gerber* formula is invalid, when applied to a homogeneous sphere, or a spherical mass made up of concentric layers of uniform density like the sun, its general admissibility must be wholly denied. In fact it has neither geometrical nor physical validity; and its use in contemporary journals and the transactions of learned societies is a bizarre performance, in vague and chimerical reasoning, little to the credit of our time.

12. We have now to consider the geometrical and physical significance of the law of electric resistance discovered by Dr. *George Simon Ohm* (*Ann. d. Phys.* VI, 1826, p. 459):

$$I = H/R \quad (30)$$

where *R* is the resistance, *H* the electromotive force, and *I* the intensity, as measured at any point by a suitable apparatus, such as a galvanometer. This law of *Ohm* likewise is remarkably simple, and quite similar to that of *Biot* and *Savart* above explained. Accordingly let us see what connection, if any, exists between *Ohm's* law and that of *Biot* and *Savart*.

a) In *Biot* and *Savart's* law we vary the distance, with fixed electromotive force, and observe the change in the intensity: the observed result confirms the wave-theory.

b) In *Ohm's* law we also deal with a current in a wire, or wires, and when the electromotive force is fixed, we study the law of resistance (*R*), or intensity of action (*I*), at a fixed distance, where the needle of the galvanometer may be located.

c) Thus *Biot* and *Savart's* law, with a fixed steady current, serves for calculating the varying intensity at any distance, in accordance with the requirements of the wave-theory. In the same way, *Ohm's* law, when *H* is constant, but with varying resistance, *R*, serves for calculating the intensity at a fixed distance.

13. Accordingly it appears that these two laws are mutually supplementary. For all the effects, in the field of electrodynamic waves about a wire, should include both those occurring at a fixed distance, as calculated by *Ohm's* law, and those occurring at a varying distance, as calculated by the law of *Biot* and *Savart*. The two laws are thus brought into immediate and necessary relationship, and both conform to the wave-theory.

We may write *Biot* and *Savart's* law in the form:

$$I = KH/r \quad (31)$$

and *Ohm's* law in the form:

$$I = H/R. \quad (32)$$

Accordingly on combining the two expressions which we may do by equating the identical intensity at any point, we obtain

$$KH/r = H/R \quad \text{or} \quad K = r/R. \quad (33)$$

Therefore, we find on substituting for *K* its value, for any value *H* and *r*,

$$I = rH/Rr = H/R \quad (34)$$

¹⁾ This may be made a little clearer by noticing what would happen if the exactly analogous formula for the velocity, $V = L/T$, had a factor γ^2 introduced into the divisor *T*. Such an arbitrary modification of the expression for the potential is purely a change de convenance, and not permissible on mathematical or physical grounds

which again yields *Ohm's* law, in the form which holds for any fixed distance.

14. These two laws therefore confirm the wave-theory of the entire field about a wire bearing a steady current. *Ohm's* law implies a cylindrical wave field — the resistance and intensity being the axes of a rectangular hyperbola referred to its asymptotes — *Biot* and *Savart's* law also represents a rectangular hyperbola of the same type, but with r varying instead of R (compare Fig. 10, Plate 5).

These two laws give the complete theory of the electrodynamic wave-action, in the whole field about a wire bearing a steady or variable current, and thus greatly simplify the theory of the electromagnetic field.

6. *Oersted's* Experiment, 1819, *Arago's* Experiment with copper wire, 1820, and the Magnetic whirl shown by iron filings near a conducting wire all confirm the wave-theory, which also agrees with *Ampère's* theory of elementary electric currents circulating about the atoms.

In the *Electrod. Wave-Theory of Phys. Forc.* we have given a simple and direct explanation of the deflection of the magnetic needle first observed by *Oersted* in 1819, the adherence of iron filings to copper wire conducting a current, first observed by *Arago* in 1820. We also explained the circular whirl assumed by iron filings near a conducting wire, and finally were enabled to harmonize the wave-theory with *Ampère's* theory of elementary electric currents about the atoms (comp. Fig. 11, Plate 5).

Such an illumination of the obscure subject of the magnetic field is too remarkable to rest on mere chance; and thus we shall describe the argument briefly, as the best means of unfolding the true order of nature. The electrodynamic waves propagated from the wire bearing the current lie in planes through the axis of the wire, and are of the type

$$\begin{aligned} s &= a \sin(2\pi x/\lambda + \phi) \\ &= a \sin(2\pi y/\lambda + \phi) \end{aligned} \quad (35)$$

where x and y are interchangeable, owing to the symmetry of the waves about the z axis, which is taken as the axis of the wire. Owing to cylindrical symmetry the axes of x and y might be rotated about that of z without any change in the expressions for the waves receding from the wire under the action of the current.

But as we have already pointed out the amplitude a decreases as in *Biot* and *Savart's* law, inversely as

$$r = \sqrt{(x^2 + y^2)}.$$

(i) *Oersted's* Experiment of 1819.

In the experiment of 1819, it was observed by *Oersted* that if the magnetic needle be below the wire, and the current from the copper positive pole of the battery directed north, the deflection of the north pole would be to the west.

If the needle be above the wire, but the other circumstances unchanged, the deflection of the north pole was observed to be towards the east. The needle might thus be revolved in a circle about the wire, without any change of the relative position in relation to the axis of the wire. Accordingly it appears that the axis of the needle, sets itself

tangential to the lines of force, which are circles normal to the axis of the wire.

If now, without other circumstances being altered, the direction of the current be changed, the two poles of the needle immediately interchange at all points about the wire: The south pole is deflected to the west when beneath the wire, and to the east when above the wire. And in general, every point in the orientation is exactly reversed.

What can be the meaning of this phenomenon in which the current acts as if it has sides, when reacting on the magnetic needle? We shall see that just as the magnet has two poles of opposite properties, so also the current has two sides, due to waves which appear to be righthanded rotations when viewed from the opposite point.

Consider the case first cited above, with the current from the positive copper plate of the battery flowing north and the needle suspended beneath the wire, but with the north pole deflected to the west when the current flows. This means that the waves descending below the wire have vortices rotating righthanded, as shown in the following figure, from the writer's work of 1917.

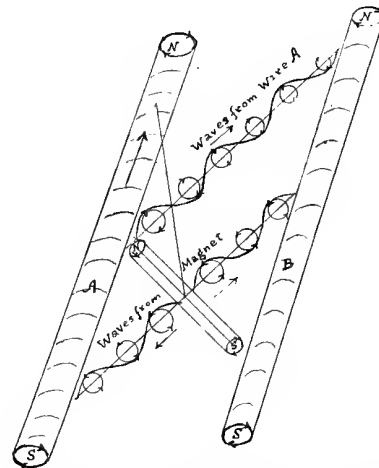


Fig. 12. New theory of *Oersted's* and *Arago's* experiments, 1819-20, and of induction.

It means also that the rotations of the waves receding from the south pole of the needle have the opposite direction of rotation, as shown in the figure.

1. For it is found by experiment that the needle is bodily attracted to the wire, by the action of the current, and hence the waves from the wire must undo the opposite rotations in the waves from the needle. Accordingly the medium tends to collapse, and by this contraction of the volume of the medium the needle is drawn to the wire.

2. In all the works on electricity and magnetism which I have seen including *Maxwell's* great treatise, this question is somewhat evaded by the claim that the north pole tends to wrap itself around the wire, in one direction, while the south pole tends to wrap itself around the wire in the opposite direction; and that this actual bending of the needle would occur if the needle were flexible. I proved by direct experiment in 1914, that the needle is bodily attracted to the wire in

every possible position it may take, but I cannot find so simple a statement of this essential fact in any earlier work on electricity and magnetism.

3. The usual discussion about the tendency of the unit north pole is very unsatisfactory, because while the tendency thus outlined is fairly accurate, it conveys the impression that all power is centred in the pole, rather than in all the particles, — notwithstanding the fact that if we break the magnet we get as many separate magnets as we have fragments, and since this subdivision may be extended to molecular dimensions, we know that the theory of pole action is altogether misleading, yet such vague teaching continues to be handed down from generation to generation, and eminent scholars have often remarked how difficult it is to get rid of the most obvious errors, when entrenched in authority by the lapse of time.

4. Further proof of the above theory of the action of an electric current upon a magnetic needle might be deduced from the fact that in nature physical actions always are mutual. Thus if the needle is attracted to the wire, the conducting wire obviously is equally attracted to the needle — otherwise action and reaction would not be equal, as proved by universal experience. Accordingly, no other conclusion can be held than that waves of the kind outlined proceed from the needle and also from the wire, and by their interpenetration develop forces of the kind observed in nature. It is not enough that waves proceed from one body, but not from the other: there undulations must proceed from both bodies incessantly, and travel with the velocity of light. This is proved by observation, for the wave actions propagated along the wire, and thence inferred also for the waves of a magnet itself, though the velocity of the waves from a natural magnet have never been directly measured. Yet since magnets are made by the action of a current upon a bar of steel inserted in a solenoid¹⁾, it follows that the velocity of the two classes of waves, one from the current and the other from the magnet, must be the same, and in both cases identical with the velocity of light, $v = 3.0 \cdot 10^{10}$ cms.

(ii) *Arago's* Experiment of 1820.

5. As to *Arago's* experiment of 1820, it is obvious that copper wire conducting a current will give a wave field about it similar to any other wire. If iron filings be near such a conducting wire, it is obvious that they should adhere to it, since each filing will become a temporary magnet, the ends having opposite poles, owing to the nature of the whirl of magnetic waves about the wire. Accordingly *Arago's* experiment is simply a verification of *Oersted's* experiment, but rendered more general by the use of a copper wire, and soft iron filings, which therefore fall off when the current stops, and the wave field about the copper wire disappears.

6. It is worthy of note that since the lines of force about a magnet are reentrant vortices, — the filaments within the axis of the magnet rotating in exactly the opposite direction to those in the magnetic equator, for example, — the waves emitted by the conducting wire in *Oersted's* and *Arago's* experiments, described above, will have their elements rotating in perfect agreement with the vortices inside the body of the magnetic needle. The waves from the wire thus support the physical oscillations within the more resisting body of the needle, and by rendering the sum total of the mutual actions a minimum, the balanced needle is in equilibrium in the position observed by *Oersted*, 1819.

7. It is now easy to reconcile *Ampère's* theory of elementary electric currents about the atoms of a magnet with the wave-theory. The formula for a plane wave is

$$s = a \sin(2\pi x/\lambda + \phi). \quad (36)$$

And as we may shift the point of the revolving vector, by altering the phase angle ϕ , we see that by changing ϕ from 0° to 2π , we should have a complete oscillation of the wave. This would correspond to the movement of the electric current once about the atom; and also to the advance of the wave along the x -axis by one periodic oscillation. The wave-theory is therefore in perfect accord with *Ampère's* theory of elementary electric currents about the atoms of matter.

8. If it be imagined that the atoms probably have a smaller circumference than a wave length λ of the wave emitted from the atom, all we need to do is to point out that we do not know the mechanism by which waves originate, and it does not follow that the wave length in the aether should correspond to that of the atom. An undetermined multiplier probably is involved here, but at present we cannot fix it with any accuracy.

(iii) Nature of atomic vibrations considered.

For in the case of sound, the dimension of the *Helmholtz* resonators is not closely related to the length of the corresponding sound waves received and emitted by the elastic oscillation of the resonator. And even if this could be found in air, it would not be the same in hydrogen, oxygen, nitrogen, or other gases, but depend on the properties of these media, as well as on the physical properties of the resonator, its shape, mass, elasticity, rigidity, etc.

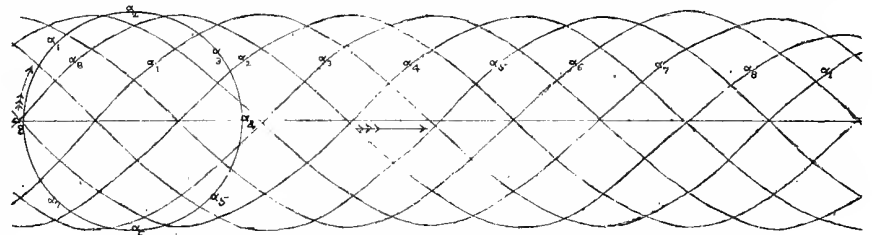


Fig. 13. *Ampère's* theory of elementary electric currents about atoms reconciled with the wave-theory.

¹⁾ As far back as 1820 *Ampère* showed that if a wire be wound into a solenoid, delicately pivoted in mercury contacts, and a current passed through it, it behaved as a magnet, with a north and south pole. Hence *Ampère* was impressed with the solenoidal character of magnets; and imagined that the elementary currents about the atoms mutually destroyed each other within the body, and remained effective only in the surface layer of the magnet, which was thus viewed as a shell. But *Ampère's* reasoning is equally useful for proving that there are waves proceeding from the wires bearing the current, and that they are flat in the plane through the axis of the wire.

So also within the aether, the vibrations of the atoms are determined by causes which at present are but little understood; and we can only infer that the atomic dimensions are not directly related to the wave length, or wave lengths emitted, though there probably is some correspondence which may be made out in time.

9. It appears from the researches in spectroscopy heretofore made that the atom of a single element may emit a complicated series of spectral lines, which means a very complicated series of vibrations, some of which are connected by the formulae of *Balmer* and other investigators. Now most of the vibrations of the visible spectrum are below the resolving power of the microscope, and thus the waves are so short that such vibrations do not penetrate solid or even transparent fluid bodies to any appreciable depth. But we know by the transmission of the sun's rays through such a medium as the terrestrial atmosphere that longer waves have increased penetrating power. And since *Langley* extended the length of the solar spectrum to some 20 times that observed by *Newton*, without finding any indication of an end, it is natural to hold that the waves upon which gravitation, magnetism, electrodynamic action, etc., depend must be of comparatively great length, otherwise they would not penetrate solid masses as they are observed to do in actual nature.

10. It thus appears that the shorter atomic waves therefore do not produce forces acting across sensible spaces, and in dealing with the long range forces of the universe we must look to waves of considerable length, which have the required penetrating power, and are least delayed in propagation through solid masses. Such waves will explain gravitation, magnetism, electrodynamic action, and are the only means of making intelligible the correlation of forces and the conservation of energy, since light and heat certainly are due to waves in the aether. Unless the other energies be due to waves also there would be violation of the doctrine of continuity, which is so fundamental in natural philosophy.

(iv) The wave-theory establishes the attraction of currents flowing in the same direction, and the repulsion of currents flowing in opposite directions, and therefore assigns the true physical cause of these electrodynamic phenomena.

1. From the foregoing discussion it follows that when from the east of the meridian we look at a positive current flowing to the north (from the copper terminal of a battery) we find the elements of the waves propagated away to be rotating righthanded (clockwise) beneath the wire, but lefthanded (counterclockwise) above the wire (cf. Fig. 18, Plate 6). This follows also from the relative positions taken by the freely pivoted magnetic needle, which presents to us a south pole when beneath the wire, but a north pole when above the wire.

2. Now suppose we have two such independent currents flowing north: what will be the mechanical effects of the mutual interactions of their waves? If we imagine one wire above the other, for conformity to the wave picture just outlined in paragraph 1, we perceive that between the wires, the wave elements from the two conductors will rotate in opposite directions: which will cause the undoing of the separate wave stresses, and a collapse of the medium, and the result of this contraction will be attraction.

3. On the outside of the two wires, on the other hand, the rotations of the wave elements will be in the same direction, the stress or agitation of the medium will therefore be increased, so that it expands: which will tend to press the wires together from the outside. Hence the wires will be made to attract both from the internal and the external wave actions. Accordingly, we have a simple and natural explanation of the mutual attraction of currents flowing in the same direction. And it is based upon the same conceptions as are involved in the attraction of magnets presenting unlike magnetic poles. In fact by the suspension of magnetic needles close to the two conducting wires, the same conclusions follow: for unlike poles are presented in proximity, which means attraction.

4. Now let the direction of one of the currents be reversed. It is easy to see that between the wires the rotations of the wave elements will appear to be in the same direction, as viewed from the east of the meridian; and thus the agitation of the medium will be increased, the medium will expand, and the wires be forced apart, so that the action leads to repulsion, just as when like poles are presented by two magnets.

5. On the outside of the two wires, however, the rotations of the waves, flowing in opposite directions, will each tend to undo the other: in the external region the medium will tend to collapse, which will allow the wires to be forced apart, so that repulsion from the region between the wires will be accentuated by this external tendency of the medium to collapse. Accordingly mutual repulsion will be observed whenever two currents flow in opposite directions.

6. This is equivalent to the mutual repulsion of two magnets which present like poles: the interpenetration from opposite directions of waves with like rotations caused the medium to expand between the bodies, and to collapse beyond them, so that repulsion immediately follows. Accordingly the whole theory of the attraction and repulsion of electric currents flowing in the same and in opposite directions respectively, is analogous to the mutual actions of two magnets, and the causes are one and the same. And as the outcome greatly simplifies our theory of electrodynamic action, so also we are correspondingly assured that the results conform to the true laws of nature. The harmony of so many distinct phenomena would not be possible unless based upon the true causes involved: for the probability of such an accidental outcome approaches zero.

7. *Weber's Law* indicates that Gravitational, Magnetic, and Electrodynamic Actions are all due to Waves traveling with the Velocity of Light; thus explaining the Semidiurnal Tide in the Earth's Magnetism depending on the Moon, which *Newton's Law* will not account for.

As we have previously pointed out, *Weber's* fundamental law of electrodynamic action, published in 1846, has the form:

$$f = \frac{mm'}{r^2} \{1 - (1/c^2) (dr/dt)^2 + (2r/c^2) \cdot d^2r/dt^2\}. \quad (37)$$

The first term of the second member is identical with *Newton's* law of gravitation, 1686, and of course gives the

principal part of the force which regulates the motions of the heavenly bodies. But there are slight effects resulting from the second and third terms, which were first numerically investigated by *Tisserand* in 1873 (cf. *Tisserand's Mécanique Céleste*, Tome IV, last chapter), but the theory was rendered more complete in the present writer's *Electrodynamic Wave-Theory of Phys. Forc.*, vol. I, 1917, where tabular data will be found for the planets, satellites, comets and binary stars.

The chief effect of the minor terms of equation (37) is to give the perihelion a small progressive motion, which in the case of the planet Mercury amounts to $\delta\varpi = +14''.51$ in a Julian century. This reduces the anomaly in the outstanding motion of that perihelion to about two-thirds of its value, namely from $\delta\varpi = +42''.95$ to $\delta\varpi = +28''.44$, but does not obliterate the anomaly, which is more exhaustively investigated in the second paper on the new theory of the aether.

It was in his celebrated paper of 1864, *A Dynamical Theory of the Electromagnetic Field*, that *Maxwell* reached the conclusion that the velocity of electrodynamic action is identical with that of light, as already indicated by *Kohlrausch's* experimental determination of v , in 1856. But although such a conclusion followed from *Kohlrausch's* experiments, and from *Maxwell's* theory of the electromagnetic field, it was necessary to form a more definite conception of the nature of the action, than was then available, before the use of v could be introduced as a working hypothesis.

Maxwell's electromagnetic theory of light was put in such shape that the existence of electric waves was rendered probable, but not directly verified by any tangible experiment, till *Hertz's* discovery of the electric waves (1887-94) which bear his name, along with a method for investigating their properties, including an experimental demonstration that they travel with the velocity of light.

This practical development of the theory of electric oscillations, with experimental determination that the velocity of the electric waves is identical with that of light, left no doubt of the identity of the electric medium with the luminiferous aether. Otherwise it is inconceivable that the two velocities should be identical. The previous and subsequent determinations of v have confirmed this conclusion, so that such a result has now been accepted for about a quarter of a century. It remained, however, to form some demonstrable physical conception of magnetism and of gravitation, which would justify the claim not only that electric waves travel with the speed of light, but also that magnetic and gravitational forces are due to a similar cause, which was the aim of the writer's researches, 1914-1917.

1. First, it was necessary to show that a physical theory of magnetism may be based on the mutual action of waves¹), and to disclose the nature of these waves, which must meet certain requirements in electrostatics, and cosmical magnetism, so as to be adaptable to the more hidden problem of universal gravitation. This requirement was met by the theory of waves from atoms, shown to conform to *Ampère's* theory of elementary electric currents about these particles,

but of such length that they may be propagated through solid masses without very great loss of energy.

2. The wave is taken to be flat in the equator of the atom, so that in this plane, the waves are perfectly plane waves, while in the two hemispheres of the atom the rotations give righthanded or lefthanded helices, as actually observed in polarized light when propagated through certain crystals. This specification fulfilled the most necessary optical requirements, and thus presented no difficulty from the point of view of light or electricity.

3. The magnetic requirement, that common steel should be capable of magnetization by the action of an electric current, was met by the theory of *Ampère* that before magnetization the planes of the atoms lie haphazard, with their equatorial planes tilted indifferently in all directions. The action of the electric current, with waves flat in the planes through the axis of the conducting wire, will yield electric oscillations in the form of plane waves, oriented at right angles to the axis of a bar of steel under magnetization in a solenoid. Hence these electric oscillations or plane waves due to the current, will force the atoms of the steel bar to tilt around, so as to make their vibrations conform to those due to the current in the solenoid; and when the magnetized steel bar is cooled suddenly, by plunging into water or oil, the result will be a permanent electromagnet of the type first made by *Ampère* about 1822. Thus the atoms of the magnet are set in planes at right angles to the axis through the poles, and all vibrate in concert.

4. Accordingly, we find a direct relation between magnetism and electrodynamic action, and as dynamic electricity is found by experiment to travel on wires with nearly the velocity of light, it is impossible to doubt that the waves emitted by natural and artificial magnets travel also with the same speed. In fact it follows that before magnetization the steel emitted waves of the same type as after action by the electric current, yet prior to the action of the current through the solenoid the orientation of the atoms was a haphazard one. The act of magnetization consists in forcing the equators of the atoms into parallel planes, so that they may vibrate in concert, which explains the great strength of magnetism in comparison with the feeble force of gravitation.

5. This brings us directly to the problem of cosmical magnetism and of gravitation. In steel magnets of good quality all or nearly all the atoms are forced into parallelism by the agitations of the current through the solenoid. Now the heavenly bodies contain some iron, nickel and other magnetic elements, but much of their matter, of a stony or glassy character, exhibits magnetic properties in a very feeble degree. Moreover, the planets are subjected to no very strong solenoidal action other than that due to the sun's magnetic field. It is not remarkable therefore that they are only partially magnetic. Their magnetism may have been acquired or considerably modified by the secular action of the sun since the formation of the solar system.

6. Accordingly, *Faraday's* great discovery that under current action all bodies are more or less magnetic, while

¹) The fact that waves will explain the attraction and repulsion of magnets, under the observed laws of magnetism, must be regarded as a very notable triumph. As no other explanation is known, the simple cause thus assigned must be held to be the true cause.

nickel, iron, steel, etc., are the most perfectly adaptable to the process of magnetization, would lead us to expect cosmical magnetism to be a very general phenomenon, but always somewhat feebly developed, in accordance with actual observation. Herein lies the connection with universal gravitation, which *Maxwell* found so difficult to conceive. When the equators of the atoms are not lined up in parallel planes, so as to oscillate in concert, they naturally are tilted haphazard, and do not lead to poles, — as in a magnet, which *Airy* describes as exhibiting a duality of powers, — but to the central action called gravitation. As the heavenly bodies are partially magnetic, this means that they have feeble magnetic poles, in addition to the powerful central gravitational action, and thus two independent wave fields are developed about them, one due to the atoms lined up and acting in concert, called magnetism, and the other to gravitation (cf. Fig. 14, Plate 6).

7. It is impossible to hold any other view of the interlocked magnetic and gravitational fields observed about a planet. In the case of the earth *Gauss* found that about 1:1380th part of the matter acts as if it were magnetized (*Allgemeine Theorie des Erdmagnetismus*, 1838, p. 46), while the remainder, 1379:1380^{ths}, should give the central action of gravitation. By the observations taken at Mt. Wilson Solar Observatory the sun's magnetic field appears to be some 80 times stronger than that of our earth. Whether this is due to the heat of the sun, and the resulting greater conductivity of wave action through its matter, so that the action on the planets produce a larger secular effect upon their atoms, or to some unknown cause, cannot at present be determined. The strength of the sun's magnetic field has no doubt added to the cosmical magnetism of the planets, though the changes are excessively slow.

8. It is more than probable that the secular changes in the earth's magnetism should be ascribed to the working of the sun's strong magnetic field, which is not equally powerful at all times, but varies appreciably with the sunspot cycle, the relative position, and seasonal tilt of the earth's axis, etc. As the magnetic storms are definitely shown to be related to the cycles of the sunspots, as is also the aurora, and the earth currents, these related phenomena deserve a more detailed investigation than they have yet received. The periodic phenomena all appear to depend on the sunspots, with their magnetic fields uncovered, and thus are more active with the maximum of the spot cycle.

9. For many years a great difficulty existed in accounting for the semidiurnal tide in the magnetism of the earth, depending on the action of the moon. This was first detected by *Kreil* at Prague in 1841, but independently discovered by *John Allan Brown*, 1845. A very accurate analysis of the observations at Dublin was published by Dr. *Lloyd* about 1858, which showed that the magnetism of the earth had the same semidiurnal period as the tides of our seas. Accordingly *Airy* declared that there is »a true lunar tide of magnetism, occurring twice in the lunar day, and showing

magnetic attraction backward and forward in the line from the Red Sea to Hudson's Bay« (*Treatise on Magnetism*, 1870, p. 206).

10. This semidiurnal tide in the earth's magnetism depending on the moon's action is shown to be copericodic with that of gravitation (cf. *Electrod. Wave-Theory of Phys. Forc.*, 1917, pp. 50-53). And on examining *Lloyd's* analysis in the *Philosophical Magazine* for March, 1858, I have shown it to be vitiated by a subtle error, in that he retained the hour angle θ instead of the 2θ which occurs in the expressions for the tide-generating potential. Apparently he did not suspect that there could be such a thing as a magnetic tide, and thus his mode of analysis simply begs the question, and the resulting error is repeating in many later works. For example, in his *Mathematical Theory of Electricity and Magnetism*, 1916, p. 402, *Feans* asserts that the daily variation of the earth's magnetism is not such as the heavenly bodies could produce — thus repeating *Lloyd's* error of 1858. Of course this is not true, for a careful examination of the problem shows that the larger part of the terrestrial magnetism is constant, as depending on the arrangement of 1/1380th of the atoms of the globe, whilst the variable effects are superposed by the actions of the sun and moon. Thus all the known periods of the terrestrial magnetism are shown to follow from those of the heavenly bodies.

11. Now it is found that *Newton's* law will explain all gravitational phenomena, but not the phenomena of the magnetic tide depending on such a body as the moon. For as *Airy* points out, this implies attraction backward and forward, in the line from the Red Sea to Hudson's Bay, which is along the line of force of the earth's magnetism. The intensity of the earth's magnetism thus varies in semidiurnal periods, just as the direction of the vertical varies under the gravitational attraction of the moon, and in similar periods.

12. Accordingly, the attraction to the earth's magnetic pole is subjected to a true tide in the earth's magnetism, and can only be explained by *Weber's* law, which takes account of induction under the changing distance of the partially magnetized matter of the globe, the lines of force towards the magnetic pole being subjected to the same ebb and flow as the central forces called gravitation. This connects magnetism with gravitation, by direct observation: for the earth has feeble polarity, with magnetic lines of force directed to the magnetic poles, as well as the much more powerful central lines of force producing the phenomenon of gravitation. Now the phenomenon of local gravitational change, due to the moon's action, is indicated by the oscillations of the sea, while that due to the moon's magnetic action is felt only by magnetic instruments which show the variation of the northward component of the earth's magnetism.

13. When the tide-generating potential is developed in hour angle h_0 (westward), longitude l and latitude λ of the place of observation, declination of the moon δ , the components of the gravitational attraction are shown to be:

$$V = (3/2 ma^2/r^3) \{ 1/2 \cos^2 \lambda \cos^2 \delta \cos 2(h_0 - l) + \sin 2\lambda \sin \delta \cos \delta \cos(h_0 - l) + 3/2(1/3 - \sin^2 \lambda) \} \quad (38)$$

$$\text{Westw. Comp.} = \partial V / \partial \cos \lambda d\lambda = 3/2(m/M)(a/r)^3 \{ \cos \lambda \cos^2 \delta \sin 2(h_0 - l) + \sin \lambda \sin 2\delta \sin(h_0 - l) \} \quad (39)$$

$$\text{Southw. Comp.} = -\partial V / \partial \lambda = 3/4(m/M)(a/r)^3 \{ \sin 2\lambda \cos^2 \delta \cos 2(h_0 - l) - 2 \cos 2\lambda \sin 2\delta \cos(h_0 - l) + \sin 2\lambda(1 - 3 \sin^2 \delta) \}. \quad (40)$$

It will be noticed that the westward component is made up of two periodic terms, one going through its variations twice and the other once a day, while the southward component undergoes like periodic oscillations, as illustrated by the following figure, from Sir *George Darwin's* Tides and Kindred Phenomena of the Solar System, 1899.

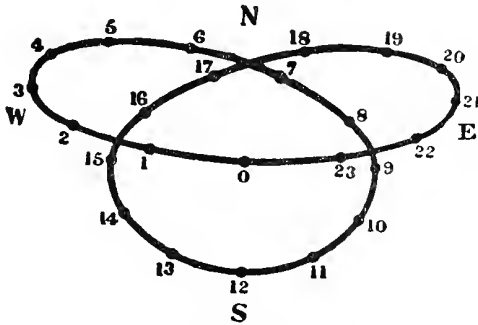


Fig. 15. *Darwin's* Diagram of the semidiurnal movements of a pendulum.

14. As *Newton's* law will explain the periodic variations of gravitation depending on the heavenly bodies but not the observed magnetic tides due to these bodies, it follows that *Newton's* law is only a first approximation, though accurate enough for two centuries of astronomical science. The universe is governed by electrodynamic laws, and *Weber's* fundamental law of 1846 is the chief law of nature. This is another reason why we must use *Weber's* law in calculating the motion of Mercury's perihelion, which therefore should progress $\delta\varpi = +14''.51$ per century, instead of the arbitrary and accidental amount of $43''$, as inferred by *Einstein*, without first taking account of the time of propagation of gravitation. By connecting magnetism with electrodynamic action and with gravitation we know all these actions take place with the velocity of light.

15. Since magnetism is thus connected with electrodynamic action, and shown to travel with the velocity of light, and on the other hand directly connected with gravitation through the semidiurnal magnetic tide depending on the moon, we perceive that gravitation must be propagated with the velocity of light, and therefore all these forces necessarily depend on waves.

It is not wonderful therefore that in the earth's magnetism the main dependence is on the orientation of the atoms of the globe, at the same time we have minor terms depending on the following periods:

- (1) A semidiurnal magnetic tide depending on the sun; also a smaller but very definite semidiurnal magnetic tide depending on the moon, discovered by *Kreil* at Prague in 1841, but independently detected by *John Allan Broun* in 1845.
- (b) A solar diurnal variation of the magnetic declination, changing slowly through the year.
 - (2) A fluctuation in 25.93 days depending on the sun's mean rotation period.
 - (3) A fluctuation in 29.53 days, which is the synodic month.
 - (4) A yearly period depending on the motion of the sun.

(5) An 11-year fluctuation depending on the sun spot cycle.

(6) A period of 18.6 years — which is the cycle of the revolution of the moon's nodes.

16. This result confirms *John Allan Broun's* discovery that the diurnal variation depending on the moon follows very accurately the law of the inverse cube of the moon's distance. *Broun* remarks that «the ratio of the moon's mean distance from the earth in the half orbit about apogee is to that in the half orbit about perigee as 1.07 to 1; as the cube of 1.07 is 1.23 nearly, we see that the mean range of the curves for the two distances are in the ratio of the inverse cubes of the moon's distance from the earth, as in the theory of the tides.» (*Stewart's* Article Meteorology, Encyc. Brit. 9th ed., p. 179).

As *Broun* had observed the lunar magnetic effects to be as 1 to 1.24, and *Sabine* had found similar results, he naturally regarded the verification of this tidal law in the lunar semidiurnal variation as very important. With the above correction of *Lloyd's* error of analysis, this result of *Broun* shows conclusively that all the diurnal effects observed can be explained by the magnetism of the sun and moon.

It is not strange therefore that in his celebrated article on Terrestrial Magnetism, § 139, *Balfour Stewart* recognized that as the moon's magnetic influence follows as nearly as possible *Broun's* law of the inverse cube of the distance from the earth, it is impossible to refrain from associating this magnetic influence either directly or indirectly with something having the type of tidal action. *Stewart* points out that *Airy* found a similar semidiurnal inequality depending on the sun in the Greenwich records, and *A. Adams* found corresponding «Earth Currents» to be induced in the crust of the globe at the corresponding hours.

8. Plane Waves propagated from the Equators of the Atoms of a Magnet fulfill *Poisson's* Equation of Wave Motion $\partial^2\Phi/\partial t^2 = a^2\nabla^2\Phi$, and yield the Law of Amplitude required to produce the Forces observed in Magnetism.

The oscillatory motion in a plane wave propagated along the x -axis may be defined by the well known equation:

$$\xi = a \cos(2\pi x/\lambda + \rho) \quad (41)$$

where the zero of the angle $(2\pi x/\lambda + \rho)$ is reckoned from the parallel to the y -axis.

But in plane wave motion the particles not only undergo a periodic side displacement like that exhibited in a curve of sines, but also a longitudinal motion, supplementing the above, which may be expressed in the form:

$$\eta = \beta \sin(2\pi x/\lambda + \rho). \quad (42)$$

In general the particles thus undergo elliptical motion defined by the equation:

$$\xi^2/\alpha^2 + \eta^2/\beta^2 = 1. \quad (43)$$

This may become circular motion for surface waves in still water, as illustrated graphically in the foregoing figure 1, Plate 4, from *Airy's* celebrated Treatise on Tides and Waves, Encyc. Metrop., 1845.

In the electrodynamic wave-theory of magnetism it is held that when the magnetism is imperfect the atoms may

have their equatorial planes tilted at any angles in respect to the coordinate axes. The plane waves above outlined would apply to the midplane of a perfect magnet, but it is necessary to consider the most general case.

Now the equation of a plane passing through the origin of coordinates is $lx + my + nz = 0$. (44)

If the wave be flat in this plane it will travel with the velocity a and at the end of the time t , will have spread to a distance at . Accordingly, the argument

$$s = lx + my + nz - at \quad (45)$$

will represent the motion of the disturbance with velocity a .

But s is the equation of a plane whose normal has the direction cosines l, m, n , and whose distance from the origin is $at + s$. It is inferred that the plane is therefore traveling in the direction of its normal with the velocity a ; but it is equally logical to say that a wave originating in the plane is traveling in all directions with this velocity, and at the end of time t , the sphere surface $(at)^2 = x^2 + y^2 + z^2$ would be this distance $(at + s)$ from the original centre of disturbance. Thus instead of considering the plane to travel, we may consider the wave to travel and carry a plane $s + at = lx + my + nz$, with it parallel to the plane in (45). The directions cosines of the plane fulfill the law

$$l^2 + m^2 + n^2 = 1. \quad (46)$$

Now with the value of s in (45), we may take the equation

$$\Phi = \Phi(lx + my + nz - at) \quad (47)$$

and derive the following results by simple differentiation:

$$\frac{\partial \Phi}{\partial x} = l \Phi'(s) \quad \frac{\partial \Phi}{\partial y} = m \Phi'(s) \quad (47a)$$

$$\frac{\partial \Phi}{\partial z} = n \Phi'(s) \quad \frac{\partial \Phi}{\partial t} = -a \Phi'(s),$$

$$\frac{\partial^2 \Phi}{\partial x^2} = l^2 \Phi''(s) \quad \frac{\partial^2 \Phi}{\partial y^2} = m^2 \Phi''(s) \quad (47b)$$

$$\frac{\partial^2 \Phi}{\partial z^2} = n^2 \Phi''(s) \quad \frac{\partial^2 \Phi}{\partial t^2} = a^2 \Phi''(s).$$

Therefore, by addition of these terms we find:

$$\frac{\partial^2 \Phi}{\partial x^2} + \frac{\partial^2 \Phi}{\partial y^2} + \frac{\partial^2 \Phi}{\partial z^2} = \nabla^2 \Phi = (l^2 + m^2 + n^2) \Phi''(s) = \Phi''(s). \quad (47c)$$

And hence by the last of the above second differentials we obtain $\frac{\partial^2 \Phi}{\partial t^2} = a^2 \nabla^2 \Phi$ (48)

which is *Poisson's* celebrated equation of wave motion. (Sur l'intégration de quelques équations linéaires aux différences partielles, et particulièrement de l'équation générale du mouvement des fluides élastiques, « Mémoires de l'Académie Royale des Sciences, Tome III, Juillet 19, 1819.)

If u represents the displacement of the particles above considered, in the direction of the x -axis, we may derive a less general but more obvious form of *Poisson's* equation, which was applied by *Euler* to the theory of sound.

$$\text{Put } u = \sin(nt - kx) \quad n = 2\pi a/\lambda \quad k = 2\pi/\lambda. \quad (49)$$

And then we may derive immediately:

$$\frac{\partial u}{\partial t} = n \cos(nt - kx) \quad \frac{\partial u}{\partial x} = -k \cos(nt - kx) \quad (50)$$

$$\frac{\partial^2 u}{\partial t^2} = -n^2 u \quad \frac{\partial^2 u}{\partial x^2} = +k^2 u \quad (51)$$

$$\text{whence } \frac{\partial^2 u}{\partial t^2} = -(n^2/k^2) \frac{\partial^2 u}{\partial x^2}. \quad (52)$$

In the use of *Poisson's* equation of wave motion

$$\frac{\partial^2 \Phi}{\partial t^2} = a^2 \nabla^2 \Phi \quad (48)$$

we may multiply both sides of the equation by the element

of volume $d\tau = dx dy dz$, and integrate throughout the volume bounded by a closed surface S

$$\iiint (\frac{\partial^2 \Phi}{\partial t^2}) d\tau = a^2 \iiint (\frac{\partial^2 \Phi}{\partial x^2} + \frac{\partial^2 \Phi}{\partial y^2} + \frac{\partial^2 \Phi}{\partial z^2}) d\tau = -a^2 \iint (\frac{\partial \Phi}{\partial n}) dS. \quad (53)$$

If the surface S is a sphere of radius r with its centre at the point P , we may proceed as follows:

$$-\iint (\frac{\partial \Phi}{\partial n}) dS = \iint (\frac{\partial \Phi}{\partial r}) r^2 d\omega = r^2 (\frac{\partial}{\partial r}) \iint \Phi_r d\omega \quad (54)$$

where Φ_r denotes the value of Φ at points on the surface of the sphere of radius r , about the centre P .

When we introduce polar coordinates into the first member of (53) we obtain:

$$(\frac{\partial^2}{\partial t^2}) \iiint \Phi d\tau = (\frac{\partial^2}{\partial t^2}) \iint d\omega (\int_0^r \Phi_r r^2 dr). \quad (55)$$

On differentiating the right member relative to r , we get from the original equation (48) by means of (53):

$$r^2 (\frac{\partial^2}{\partial t^2}) \iint \Phi_r d\omega = a^2 (\frac{\partial}{\partial r}) (r^2 (\frac{\partial}{\partial r}) \iint \Phi_r d\omega). \quad (56)$$

Yet the surface integral $\iint \Phi_r d\omega$ which appears in both members of (56) is 4π times the mean value of the function Φ_r on the surface of a sphere of radius r . Suppose this mean value be denoted by $\bar{\Phi}_r$; then since $\iint \Phi_r d\omega = 4\pi \bar{\Phi}_r$ we have

$$r^2 (\frac{\partial^2 \bar{\Phi}_r}{\partial t^2}) = a^2 (\frac{\partial}{\partial r}) (r^2 \frac{\partial \bar{\Phi}_r}{\partial r}). \quad (57)$$

On differentiating and dividing by r , we may put this in the form:

$$\frac{\partial^2 (r \bar{\Phi}_r)}{\partial t^2} = a^2 \frac{\partial^2 (r \bar{\Phi}_r)}{\partial r^2}. \quad (58)$$

We may now introduce two new variables u and v , as follows:

$$u = at + r \quad v = at - r. \quad (59)$$

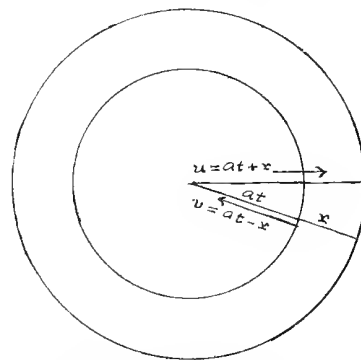


Fig. 16. Illustrating the Wave Theory of *Poisson*, as in reflected Light.

Then if, for brevity, we put $r \bar{\Phi}_r = \psi$ we have for the derivatives:

$$\frac{\partial \psi}{\partial t} = \frac{\partial \psi}{\partial u} \frac{\partial u}{\partial t} + \frac{\partial \psi}{\partial v} \frac{\partial v}{\partial t} = a (\frac{\partial \psi}{\partial u} + \frac{\partial \psi}{\partial v}) \quad (60)$$

$$\frac{\partial \psi}{\partial r} = \frac{\partial \psi}{\partial u} \frac{\partial u}{\partial r} + \frac{\partial \psi}{\partial v} \frac{\partial v}{\partial r} = \frac{\partial \psi}{\partial u} - \frac{\partial \psi}{\partial v} \quad (61)$$

$$\frac{\partial^2 \psi}{\partial t^2} = a^2 [\frac{\partial^2 \psi}{\partial u^2} + 2 \frac{\partial^2 \psi}{\partial u \partial v} + \frac{\partial^2 \psi}{\partial v^2}] \quad (62)$$

$$\frac{\partial^2 \psi}{\partial r^2} = \frac{\partial^2 \psi}{\partial u^2} - 2 \frac{\partial^2 \psi}{\partial u \partial v} + \frac{\partial^2 \psi}{\partial v^2}. \quad (63)$$

By equation (58) we have through the addition of the terms of the right of (62) and 63

$$\frac{\partial^2 \psi}{\partial u \partial v} = 0. \quad (64)$$

This equation yields the general solution:

$$\psi = f_1(u) + f_2(v) \quad (65)$$

where f_1 and f_2 are perfectly arbitrary functions of their arguments.

If $r = 0$, the left member vanishes:

$$0 = f_1(at) + f_2(at). \quad (66)$$

And as this holds for all values of t , it follows that the functions f_1 and f_2 are not independent, but one is the negative of the other, namely

$$f_1(at) = -f_2(at) \quad (67)$$

by (66), whatever be the value of the argument at .

Accordingly we now put

$$f_1 = f \quad f_2 = -f \quad (68)$$

and then we have

$$r \bar{\Phi}_r = f(at+r) - f(at-r). \quad (69)$$

When we differentiate relative to r , we get:

$$\bar{\Phi}_r + r \partial \bar{\Phi}_r / \partial r = f'(at+r) + f'(at-r). \quad (70)$$

And on putting $r = 0$, this leads to

$$\bar{\Phi}_r = 2f'(at) \quad (71)$$

$$= \Phi_P, \text{ when } r = 0. \quad (72)$$

On differentiating (69) relative to r and t , we get successively:

$$(\partial/\partial r)(r \bar{\Phi}_r) = f'(at+r) + f'(at-r) \quad (73)$$

$$(\partial/\partial t)(r \bar{\Phi}_r) = a \{f'(at+r) - f'(at-r)\}. \quad (74)$$

Accordingly, by addition, we obtain

$$\partial(r \bar{\Phi}_r) / \partial r + (1/a) \cdot \partial(r \bar{\Phi}_r) / \partial t = 2f'(at+r). \quad (75)$$

And for $t = 0$,

$$[\partial(r \bar{\Phi}_r) / \partial r + (1/a) \cdot \partial(r \bar{\Phi}_r) / \partial t]_{t=0} = 2f'(r). \quad (76)$$

When we use the original value of $\bar{\Phi}_r = (1/4\pi) \iint \Phi_r d\omega$ it thus appears that we obtain:

$$2f'(r) = [(\partial/\partial r) \{r/4\pi \cdot \iint \Phi_r d\omega\} + (1/a) \{r/4\pi \cdot \iint (\partial \Phi_r / \partial t) d\omega\}]_{t=0}. \quad (77)$$

Now suppose that at the initial instant, $t = 0$, the values of Φ and its time derivative $\partial \Phi / \partial t$ are given in functions of the coordinates of a point in space:

$$[\Phi]_{t=0} = F(x, y, z) \quad [\partial \Phi / \partial t]_{t=0} = f(x, y, z). \quad (78)$$

Then by (77) we have

$$2f'(r) = (\partial/\partial r) \{r/4\pi \iint F_r d\omega\} + r/4\pi a \iint f_r d\omega. \quad (79)$$

But when $r = at$, we have by (72) $2f'(at) = \Phi_P$ at the centre, and thus finally we obtain:

$$\Phi_P = (1/4\pi) [(\partial/\partial at) (at \iint F_{at} d\omega + t \iint f_{at} d\omega)] \quad (80)$$

which is *Poisson's* general solution of the equation (48), for wave motion.

From this solution, it follows that the value of Φ may be computed for every point P if we know the mean value of $\partial \Phi / \partial t$ at a time earlier by the interval at , for all points on the surface of a sphere of radius at about P , as well as the rate of the variation of the mean value of Φ as the radius of the sphere changes. This is the typical condition specified in wave motion.

Suppose, for example, that initially Φ and $\partial \Phi / \partial t$ are both zero, except for a certain region R , whose nearest point is at a distance r_1 from P , while the remotest point lies at a distance r_2 .

Then so long as $t_1 < r_1/a$ the mean value of Φ on the sphere of radius at , is zero, because the waves from the nearest point have not yet reached P . After an interval $t_2 > r_2/a$ there will be no more waves and $\partial \Phi / \partial t$ will again be zero at P .

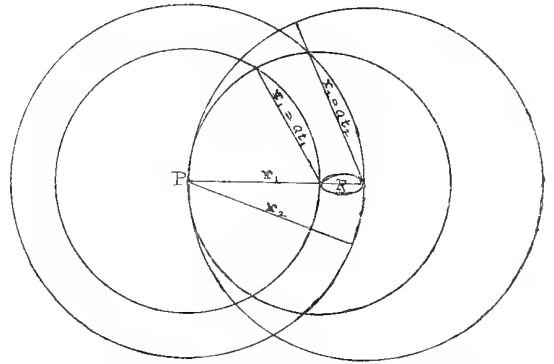


Fig. 17. Illustrating *Poisson's* Theory of Waves.

Accordingly disturbances will prevail only in the time $r_1/a < t < r_2/a$ and the power of disturbance, or velocity potential Φ , is propagated in all directions with the velocity a . By using polar coordinates *Poisson* has obtained a more direct solution, because Φ then becomes independent of the angular coordinates. Equation (48) becomes:

$$\partial^2 \Phi / \partial t^2 = a^2 (\partial^2 \Phi / \partial r^2 + 2/r \cdot \partial \Phi / \partial r) \quad (81)$$

$$\text{or} \quad \partial^2 (r \Phi) / \partial t^2 = a^2 \cdot \partial^2 (r \Phi) / \partial r^2. \quad (82)$$

A solution of this equation is

$$r \Phi = f(at-r) \quad (83)$$

which yields:

$$\Phi = f(at-r)/r. \quad (84)$$

Thus for all points of space, and all times for which $at-r$ has the same particular value we have the same value $r \Phi$, as the particular value of Φ travels outward with the velocity a .

It should be noted that the value of Φ is inversely proportional to the distance r traversed. And although the analytical form (84) makes Φ infinite when $r = 0$, yet in reality this condition does not occur, because physical limitations imposed by the structure of matter excludes the value $r = 0$, and Φ is always finite.

Following the method of *Poisson*, Lord *Rayleigh* and other writers on sound are accustomed to take the velocity potential:

$$\Phi = \Omega(x, t) = A \cos[2\pi/\lambda \cdot (x-at)] \quad (85)$$

which fulfills the irrotational condition of hydrodynamics:

$$\iint d\Phi = \iint (u dx + v dy + w dz) = 0. \quad (86)$$

But it is a fact of great importance, which will be discussed at length in the fourth paper on the new theory of the aether, that *Poisson* never concurred in the theory of transverse vibrations for light. *Poisson's* dissent from *Fresnel's* assumptions was based on the mathematical theory of waves

in an elastic fluid. Besides the celebrated memoir of 1819, already cited, *Poisson* treated the matter in another able paper, presented to the Academy of Sciences, March 24, 1823, *Mémoire sur la Propagation du Mouvement dans les Fluides Élastiques*, finally published under the title: *Sur le Mouvement de Deux Fluides Élastiques Superposés* (*Mémoires de l'Institut*, Tome X) in which this celebrated geometer confirmed the conclusions previously reached, namely, that whatever be the direction of the original disturbance, the vibratory motions of the particles finally become normal to the wave front.

When *Fresnel* and his followers objected to *Poisson's* processes as founded on mathematical abstraction, though deduced from the assumption of contiguous elements, the celebrated geometer returned to the subject in a series of later memoirs, as follows:

1. *Mémoire sur l'Équilibre et le Mouvement des Corps Élastiques*, Avril 14, 1828. *Mémoires de l'Institut*, Tome VIII, pp. 357-627.
2. *Mémoire sur l'Équilibre des Fluides*, Nov. 24, 1828. Tome IX, 1-88.
3. *Mémoire sur la Propagation du Mouvement dans les Milieux Élastiques*, Oct. 11, 1830, Tome X, pp. 549-605.
4. *Mémoire sur l'Équilibre et le Mouvement des Corps Crystallisés*, Tome XVIII, pp. 3-152.

In all of these memoirs the earlier conclusions of 1823 are confirmed and emphasized, that whatever the primitive disturbance may have been, at a great distance the motion of the molecules finally becomes perpendicular to the wave surface. This is deduced in the memoir of 1830, pp. 570-571, by an argument which cannot well be evaded, and announced in these words:

«Il en résulte donc qu'à mesure que l'on s'éloigne du centre de l'ébranlement primitif, la vitesse du point M approche de plus en plus d'être dirigée suivant son rayon vecteur r , et qu'à une très-grande distance, où l'onde mobile peut être regardée comme sensiblement plane dans une grande étendue, on doit, en même temps, considérer le mouvement des molécules qui la composent, comme perpendiculaire à sa surface, quel qu'ait été l'ébranlement primitif.»

On pages 574-5 of the same memoir of 1830, *Poisson* deduces the formula $\Phi = 1/r \cdot \psi(r-at, \mu, \lambda)$ and passes to the case $at > r + \epsilon$,

$$\Phi = 1/r \cdot \Psi(\mu, \lambda) \quad (87)$$

where we should have

$$s = 1/a^2 \cdot \partial \Phi / \partial t = 0. \quad (88)$$

«Il résulte de cette discussion que dans le cas où la formule $u dx + v dy + w dz$ ne satisfait pas à la condition d'intégrabilité, les lois de la propagation du mouvement, à une grande distance de l'ébranlement, ne diffèrent pas essentiellement de celles qui ont lieu, lorsque cette condition est remplie, ainsi que je l'avais supposé dans mon ancien mémoire sur la théorie du son.»

«Le mouvement imprimé arbitrairement à une portion limitée d'un fluide homogène se propage toujours en ondes sphériques autour du lieu de cet ébranlement. A une grande

distance, ces ondes sont sensiblement planes dans chaque partie, d'une petite étendue par rapport à leur surface entière; et alors, la vitesse propre des molécules est, dans tous les cas, sensiblement normale à leur plan tangent. Mais on peut aussi considérer directement la propagation du mouvement par des ondes infinies et planes dans toute leur étendue. Or, on va voir que la vitesse des molécules sera encore perpendiculaire à ces sortes d'ondes en mouvement.»

Accordingly, in his most mature memoirs, after researches on the theory of waves extending over 25 years, *Poisson* confirmed the conclusion that in elastic media, of the type of a gas, the motion of the molecules is always like that of sound. This result will be found to have great significance when we come to deal with a fundamental error in the wave-theory of light, in the fourth paper on the New Theory of the Aether.

9. Rejection of *Thomson's* Corpuscular Theory of an Electric Current, because of the Small Velocity thus attainable: Theory of a Magneton also rejected because of its Inconsistency with Electrodynamic Action: observed High Velocity of Electron under Charge explained by Acceleration due to Aether Waves.

(i) *Thomson* and other electronists hold that an electric current is due to the motion of electrons.

In his *Corpuscular Theory of Matter*, 1907, Sir *J. J. Thomson* put forth the view that an electric current consists in the motion of the electrons. «On the corpuscular theory of electric conduction through metals the electric current is carried by the drifting of negatively electrified corpuscles against the current. . . . »The corpuscles we consider are thus those whose freedom is of long duration. On this view the drift of the corpuscles which forms the current is brought about by the direct action of the electric field on the free corpuscles.» (p. 49.)

«As, however, the mass of a corpuscle is only about $1/1700$ of that of an atom of hydrogen, and therefore only about $1/3400$ of that of a molecule of hydrogen, the mean value of the square of the velocity of a corpuscle must be 3400 times that of the same quantity for the molecule of hydrogen at the same temperature. Thus the average velocity of the corpuscle must be about 58 times that of a molecule of hydrogen at the temperature of the metal in which the molecules are situated¹). At 0° C. the mean velocity of the hydrogen molecule is about $1.7 \cdot 10^5$ cm/sec, hence the average velocity of the corpuscles in a metal at this temperature is about 10^7 cm/sec, or approximately 60 miles per sec. Though these corpuscles are charged, yet since as many are moving in one direction as in the opposite, there will be on the average no flow of electricity in the metal. Although the change produced in the velocity of the corpuscles by this force is, in general, very small compared with the average velocity of translation of the corpuscles, yet it is in the same direction for all of them, and produces a kind of wind causing the corpuscles to flow in the opposite direction to the electric force (since

¹) The spacing-out of the concluding sentence is mine — not in the original.

the charge on the corpuscle is negative), the velocity of the wind being the velocity imparted to the corpuscles by the electric force¹).«

Thomson's calculations of the velocity of 60 miles per second are based upon the formulæ cited in Section 12, below, which I had made before I found the above statement. *Thomson* does not dwell on the inadequacy of this velocity of 60 miles per second to explain the transmission of electric signals on wires, which have a velocity only slightly less than that of light.

On page 68, however, he points out that in a Röntgen-ray-bulb giving out hard rays the velocity of the corpuscles in air may be about 10^{10} cm/sec, or 10^3 times the velocity of those in the metals.

It is held in the theory of ionization of gases by X-rays, that the positive and negative parts of the atoms are separated. »The positive ions are attracted to the negative electrode and the negative ions to the positive electrode, and the movement of these electric charges constitutes a current,« says *Duffs*, Text Book of Physics, (ed. 1916, p. 498). This is used at the University of California, and this discussion was written by Prof. *R. K. McClung* of the University of Manitoba, who is a Doctor of Science of the University of Cambridge, England, and thus speaks with authority.

Likewise, *Crowther* says on p. 139 of his Molecular Physics: »We have now come to connect electricity with electrons, and hence an electric current is a flow of electrons from a place of high to a place of low potential. We may regard a conductor, then, as a substance containing electrons which are free to move under the action of an electric field, while in non-conductors the electrons are fixed and unable to follow the impulse of the field.«

Observed V	Authority	Remarks
463133 Km.	<i>Wheatstone</i> , Phil. Trans., 1834	Duration of Electric Spark Method.
310475	<i>Kirchhoff</i> , <i>Gano's</i> Physics § 796	Theoretical Calculation from the Measurements of Constant Electric Currents.
179890	<i>Fizeau</i> and <i>Gounelle</i>	Signals on Copper Wire.
99938	—	Signals on Iron Wire.
230500 }	<i>Siemens</i> and <i>Frölich</i> , Poggend.	Observations on Telegraph Wires of Iron, 23372 Kms. long.
256600 }	Ann. Bd. CLVII.	
241800	» » »	Observations on Telegraph Wires 7352 Kms. long.

These measurements, which are of very unequal value, give a mean of 254618 Kms., which would not seem improbable, in view of the fact that the *Siemens-Frölich* series, apparently by far the best, give a mean 242966 Kms. for electric waves on iron wires. As the electric disturbances should travel with the velocity of light, 300000 Kms., except for the resistance of the wires, it would thus appear that the velocity is reduced about $\frac{1}{3}$ th or $\frac{1}{6}$ th of the whole. The resistance causes the disturbance to travel slower in the wire and thus the waves around the wire envelope it, and necessarily follow it as a conductor.

A more modern investigation of the velocity of electric waves on wires was made by Prof. *John Trowbridge* and

Again, (p. 140) *Crowther* adds: »These electrons, if no electric force be acting, will be moving in all directions, so that if we take any cross section of the metal the number of electrons crossing it in one direction will be the same as the number crossing it in the opposite direction, and so the total transference of electricity across the section will be zero.«

»If, however, we apply an electric field to the body there will be a force on each electron urging it in the direction of the field. Thus in addition to the irregular motion due to the heat energy of the body, there will be a steady drift of the electrons as a whole in the direction of the electric force.«

This discussion, like that of *Thomson*, admits that an electric field is necessary so set the electrons in motion, but the nature of the electric field itself is not explained, beyond the general phrase that difference of potential is involved. This is almost as unsatisfactory as the failure of the electronists to account for the high velocity of electric signals on wires.

(ii) Experimental tests of the velocity of electric waves on wires.

The problem of the velocity of the electric waves along wires has been much discussed, and formulas given in such works as *Cohen's* »Calculation of Alternating Current Problems«, whilst the propagation of waves in metals has been treated theoretically by *Drude*, Lehrbuch der Optik, 2, Chap. IV, and by other authorities.

But when we come to deal with concrete measurements of actual velocities, such measurements do not seem to be plentiful: yet we note a few values in the following table.

W. Duane, and published in the Philosophical Magazine for 1895, vol. 40, p. 211. They used a pair of parallel short wires, 58.6 metres long, but determined the duration of the electric oscillation in the wire very accurately by photography of the sparks in a rapidly rotating mirror. The wave length was 56.77 m, and the duration of the spark was found to be $1.8907 \cdot 10^{-7}$ second. The mean value of the velocity of the wave on the wire came out $V = 3.003 \cdot 10^{10}$ cm/sec., which slightly exceeds the adopted velocity of light.

But a much more thorough direct comparison of the velocity of electric waves on wires with light itself was quite recently undertaken by the French physicist *C. Gutton*, Journal de Physique, 1912 (5), vol. 2, p. 41. This experiment

¹ I quote at length from the chief authorities, in order to feel sure that the views of the electronists are correctly cited. As I consider the electron theory to be greatly overrated, this precaution is deemed necessary, in justice to their researches, which I might find difficulty in accurately condensing into any briefer statements.

was arranged with great ingenuity, and the apparatus so designed as to show a small difference in the two velocities, if such difference existed. The first observations showed that the two velocities were nearly identical, yet not rigorously the same.

Under the delicate and dependable means of adjustment used *Gutton* discovered that the velocity of the electric wave on the wire was a little less than that of light. And he found that the difference thus very accurately determined amounted to about one-half of one percent. Accordingly for the velocity of electric waves on wires *Gutton's* values would be:

$$\begin{array}{l} \text{Electric waves } V = 298500 \text{ Kms.} \\ \text{Light } V = 300000 \text{ Kms.} \end{array}$$

This retardation of the electric waves by wires is small, but fortunately the experiment of *Gutton* was so well designed that no doubt can attach to the reality of the difference. We must therefore admit that the electric waves on wires are slightly retarded by the resistance in the wires. This has been probable on general principles, and indicated by the older experiments, and it now takes its place as an established fact of observation.

The result is similar to that reached in the first paper on the New Theory of the Aether, where we showed that wireless waves travel more slowly through the solid mass of the earth, and the wave front is thus bent around the globe, — which explains the observed fact that the wireless wave travels around the earth. This propagation of the wireless wave around the globe had proved very mysterious, and no satisfactory explanation of it had been forthcoming.

As we have now definite proof of the retardation of electric waves by the resistance encountered within a metallic wire, we see that the wire is surrounded by an envelope of waves in the free aether tending to proceed with the velocity of light, yet held back by the resistance within the wire, and thus the advancing wave envelopes and is made to follow the wire. Is it not probable that we have here the true explanation of the nature of a conductor?

Of course a conductor must be metal, which has both the power of inductance and capacity, — otherwise the electric disturbances would not take the form of waves, thus expending the energy due to difference of potential. Yet, there must be another physical cause at work to make the disturbance follow the wire. It is this, that the wave in the free aether travels more rapidly than within the dense resisting wire, and owing to this resistance, the waves follow the wire, being bent towards it on all sides, as shown in the inner part of the Fig. 18, Plate 6.

The discharge spark of a Leyden jar is due to the oscillations of the invisible aether, rendering particles of air luminous by the agitation; and when this spark is photographed in a rapidly revolving mirror, the oscillations are shown as indicated on the axis of the wire to the left. We must therefore assume electric surges from one side of the wire to the other, just as in a Leyden jar. Moreover, as the aether is compressible, this compressibility contributes to the development of waves.

It is to be noted that the oscillations photographed in the mirror have their phases spread along in time, and

therefore the disturbances are spread along in space, when we deal with a wire on which the disturbance travels, so that the oscillations diagrammed on the left are repeated throughout the wire.

The reflection of any element of the aether wave outside the wire is given double effect by the surge from the opposite surface of the wire, as shown in the diagram. And thus the wave rotations take the reversed directions shown above and below the wire. This is the wave field we investigate in *Oersted's* experiment, and find to follow *Biot* and *Savari's* law, as already explained in Section 5.

Accordingly the delay in propagation through the wire causes a slight whirling of the aether particles against the wire, then a rebound, with rotations in the opposite direction — in waves which are propagated away as shown in the diagram of the wave field. In regard to such reflection from metallic surfaces, Prof. *Fleming* says: »This electrical radiation (waves of length approaching 4 cms.), penetrates easily through dielectric bodies. It is completely reflected from metallic surfaces, and is also more or less reflected from the surfaces of insulators« (p. 411).

(iii) Rejection of the theory of a magneton as contrary to electrodynamics.

We now pass to the discussion of the so-called magneton.

1. It appears that the existence of the so-called magneton is purely hypothetical. It was at first admitted, with some hesitation, as a possible corpuscle, in magnets, analogous to the electron in the problems of electricity. This idea seemed logical in terminology, and the name appeared in certain papers of the Philosophical Transactions of the Royal Society, and it has since come into more general use.

2. But the above described terminology apparently overlooks the fact that magnets are produced by the action of an electric current. If therefore electrons be active in a current, and the current generates a magnet, it is more natural to explain magnets by the effects of electrons, and to do away with the magneton as superfluous.

3. In the present author's work, however, waves are made the basis of the generation of a magnet out of steel by the lining-up action of an electric current. It is thus illogical to introduce fictitious corpuscles imagined to have rotatory properties, when simple waves in the aether suffice for all practical purposes.

4. In the Principia, Lib. III, 1686, *Newton* lays down as the first rule of philosophy: »We are to admit no more causes of natural things than such as are both true and sufficient to explain their appearances.« »To this purpose the philosophers say that nature does nothing in vain, and more is in vain when less will serve; for nature is pleased with simplicity, and affects not the pomp of superfluous causes.«

5. Under the circumstances, there is no need for the hypothesis of a magneton, and thus we reject it because its use is inconsistent with electrodynamic phenomena as explained by the wave-theory.

(iv) Velocity of the electron made to approximate that of light by the action of electric waves.

In his later researches on the ratio of the charge to

the mass of cathode ray particle, *Thomson* devised a method for exactly balancing the electric and magnetic forces, and was able to determine the ratio e/m , and get V from the ratio of the strength of the electric field X to the strength of the magnetic field H , both of which could be measured. In this way he found $V = 2.8 \cdot 10^9$ cms. per second, or about one-eleventh of the velocity of light.

This value was found to be not quite constant, but to vary somewhat with the potential in the tube, yet the value e/m was found to be $1.7 \cdot 10^7$, and shown to be independent of the nature of the gas used in the tube. The greatest value of e/m known in electrolysis is for the hydrogen ion, and comes out 10^4 , whence it was concluded that the value for the cathode particle is 1700 times that for the hydrogen ion. As the charge e carried by the cathode particle was found to be the same as for the hydrogen ion, it was held that the mass of the cathode particle is $1/1700$ of the hydrogen ion or atom.

It will be seen that notwithstanding the great ingenuity displayed by *Thomson* and his pupils, this whole subject is involved in considerable uncertainty. Perhaps it may fairly be asked whether any of these phenomena are yet interpreted on their final basis. No doubt the experiment as described supports the result found, but it is always difficult to feel sure that some entirely different view of these matters may not develop hereafter, owing to further experimentation, or improvement in the theory of the aether.

The net result is therefore as follows:

1. Viewing the electron as a corpuscle of a gas, it would attain a velocity of only about 98 kms. (60 miles) per second, or $1:3000^{\text{th}}$ of the velocity of light. This is very insignificant compared to the velocities observed in light and electric waves.

2. Under the action of impulses in the tube not yet fully understood, but generated under considerable electric tension, the velocity of the charged particle may be augmented nearly 300 fold, so as to become a little less than a tenth of the velocity of light and electric waves.

3. The mass of the corpuscle is considered to be due wholly to the charge, but too little is yet known to justify this claim, and it cannot be admitted. Apparently wave action alone could produce the velocity of the electron, $2.8 \cdot 10^9$, approaching one tenth that of light, because the aetherons move 1.57 times faster yet.

4. In his work on Molecular Physics, p. 7-8, *Crowther* describes how much energy may be given to a small mass by increasing its speed to about $1/15^{\text{th}}$ of the velocity of light.

»Such particles, however, actually exist, and it is the discovery of these particles and the measurements made upon

them that have led to the great advances in molecular physics which we are about to describe. Particles having this velocity are shot out in large numbers from radioactive bodies. To anticipate a little we may say that the α -particles from radium consist of atoms of helium shot out with a speed of this order of magnitude, and bearing a positive charge. Thus it is that a single α -particle is able to cause a flash of light when it strikes upon a screen covered with a suitable material.«

The view that the high velocity attainable by the electron is due to the action of electric waves is suggested by *Crowther's* further remarks:

»The α -particles consist of helium atoms only. Velocities approaching that of the α -particles can be given to atoms and molecules of other substances by passing an electric discharge through them in the gaseous state at very low pressures. The phenomena of the discharge tube have indeed afforded the best means of investigating the properties of moving electrified particles, and we shall proceed to their consideration immediately.«

Accordingly it seems that the electron researches strongly support the wave-theory as the only means of generating the velocity of the electron found by observation¹⁾. If helium atoms or α -particles can be given such high velocities by electric charges, still more may electrons, in view of their very small size, be given the high velocities approaching $1/10^{\text{th}}$ that of light. For as helium gas is monatomic but twice as heavy as hydrogen, the electron is about 6800 times lighter than helium, and under gaseous laws a velocity of over 80 times that of a helium atom might be expected for the electron, if equal energy were concentrated in a single corpuscle. This gives ample power to account for the observed velocity of projection of the electron, and the high velocity therefore is naturally attributed to wave-action.

It is worthy of note that, with *Crowther's* estimate that the electrons attain a velocity of $1:15^{\text{th}}$ of the speed of light, the aetherons have a speed $15 \cdot 1.57 = 23.55$ times that of the swiftest corpuscle heretofore recognized. The New Theory of the Aether thus bids fair to give quite an impetus to the study of high velocities.

10. The Identity of the Velocity of Electric Waves with that of Light shows that the Aether underlies both Classes of Phenomena: the Formal Public Discussions on doing away with the Aether recently held before the Royal Societies in London striking Evidence of the General Bewilderment.

(i) The physical significance of the identity of the velocity of electric waves with that of light.

¹⁾ In his History of the Inductive Sciences, *Whewell* bestows high praise on *Roemer*, — who lived about a century in advance of his contemporaries, so that his discovery of the velocity of light was accepted by very few, chiefly by *Newton* and *Huyghens*, — because this celebrated discoverer noticed that the eclipses of Jupiter's satellites were delayed in time in proportion to the distance of the earth from Jupiter. Thus when Jupiter was near opposition, the eclipses came about 16 minutes earlier than when the earth was on the opposite side of the sun; and *Whewell* remarks on the highly philosophic character of *Roemer's* argument for the gradual propagation of light across space, which no one before him had suspected from the earliest ages.

Now in our time the researches of the electronists have occupied great prominence, but without any inquiry, so far as I know, being instituted by them to account for the known velocity of electric waves on wires and radio waves across free space. This neglect greatly weakens the position of the electronists, and when they propose to do away with the aether, without accounting for the propagation of light and electricity, they add presumption to carelessness; and therefore if *Roemer's* course was highly philosophic the course adopted by the electronists has been just the reverse — unphilosophic and indefensible!

The early evidence deduced by *Maxwell*, in 1864, and his successors during the next quarter of a century, to the effect that electrical actions travel sensibly with the velocity of light, received a remarkable confirmation from the physical discoveries of *Hertz*, who devised methods for investigating electrical waves of the type since used in radio-telegraphy. And the progress of radio-telegraphy has been such that the velocity of these waves between Paris and other parts of France, and between Paris and Washington, has been measured as accurately as is humanly possible in the determination of intervals of time less than a fiftieth of a second.

We cannot say indeed that the measurements between Paris and Washington give incontrovertible experimental proof that the electrical waves travel with exactly the velocity of light. Perhaps the velocity of propagation is involved in say five percent of uncertainty; yet all the observations are consistent with the speed of light. And in view of the accuracy of the determinations of V , by such methods as were employed by the American Bureau of Standards in 1907, we must hold that the radio-waves between Washington and Paris travel with the observed laboratory velocity, which appears to be exactly identical with that of light.

The fact that approximately the same speed is attained by light and radio-electric waves, reduces us to the necessity of admitting:

1. Either the two classes of waves travel with precisely the same velocity.
2. Or we must assume the existence of two media with slightly different elastic powers, yet giving waves of practically the same velocity.

Maxwell long ago protested against the unphilosophic habit of inventing a new medium every time we have a new phenomenon to explain; and fortunately in this case measurement supports *Maxwell's* contention, by showing more and more conclusively that the two velocities are identical. The difference between the velocity of electric waves in free aether and light is now so small as to be within the probable error of the separate determinations; and it is difficult to decide which method affords the greater accuracy of measurement. We must therefore wholly reject any claim for two media, and acknowledge that light and dynamic electricity depend on one and the same medium — the aether. And we have discussed the physical character of that medium, and fixed the constants with such great accuracy that when the density is calculated by a new method, in the present paper, it is found to be

$$\sigma = 1888.15 \cdot 10^{-18}$$

as against the other value, now no longer admissible, as shown above in section I,

$$\sigma = 438 \cdot 10^{-18}$$

yet found in the first paper by the method invented by Lord *Kelvin* in 1854 and since improved by *Kelvin*, *Maxwell* and the present writer.

The physical significance of the identity of the velocity of light and electricity is therefore unmistakable; namely, electricity in motion consists of waves in the aether, and as they travel with the same velocity as light, we know that electricity and light both depend on the aether, and are

simply waves of different length and type in this all-pervading medium.

(ii) Accordingly, as Sir *Oliver Lodge* correctly says, *Einstein* has not done away with the aether, but simply ignored it, and thereby shown a remarkable lack of understanding of the physical universe.

In a public address at San Francisco, April 11, 1920, Sir *Oliver Lodge* dealt with the physical properties of the aether, as the vehicle of energy, and emphasized the view that although totally invisible, the aether is capable of exerting the most stupendous power throughout space, and thus is the medium or vehicle which transmits the forces which govern the motions of the planets and stars in their orbits.

Not only is the aether necessary for conveying the light of the sun and stars across space, but also for conveying the stresses to generate the planetary forces, which are equivalent to the breaking strength of gigantic cables of steel stretched between the sun and planets. These stupendous gravitative mechanisms are wholly invisible, and yet from the observed operation of centrifugal force, we know that the gravitative forces for balancing them do really exist. Under the circumstances, as Sir *Oliver Lodge* pointed out, we cannot hold that appearances correspond to reality. We know of the aether chiefly from its transmission of wave action, which in free space travels with the velocity of light.

Accordingly, after tracing the physical properties of the aether, Sir *Oliver Lodge* justly exclaimed: »You have heard of *Einstein*, and probably know that he has no use for the aether. He has, however, not done away with the aether, but simply ignored it.«

This concise statement covers the case exactly; but in view of the fact that *Einstein* shuts his eyes to the unseen operations of the physical universe, which *Newton* attributed to impulses in the aethereal medium, it is not remarkable that the many sagacious investigators of natural phenomena are obliged to reject the mystical and misleading doctrines of *Einstein*.

To turn away from a mechanical explanation of the world, and attempt to account for phenomena by mere formulae reposing on the supposition of action at a distance, and to further complicate the reasoning by the assumption of the curvature of space, — when such an hypothesis is unnecessary and purely fictitious, — is not a sign of penetration, but of lack of experience in natural philosophy.

It is just such unwarranted procedure which *Newton* denounces as resting on »vain fictions«, in the second sentence of the discussion following the statement of Third Rule of Reasoning in Philosophy: »We are certainly not to relinquish the evidence of experiments for the sake of dreams and vain fictions of our own devising; nor are we to recede from the analogy of nature, which uses to be simple and always consonant to itself« (Principia, Lib. III).

It appears from *Newton's* discussion that electrical actions conveyed along wires and across space, as in radio-telegraphy, and found by actual experimental measurements to be transmitted with the velocity of light, are the very kind of »evidence of experiments« which that great philosopher says we are not to relinquish for the sake of dreams and vain fictions

of our own devising; yet *Einstein* and his followers have thus plainly violated *Newton's* Third Rule of Philosophy, in proposing to do away with the aether. Without this medium the phenomena here cited are not explainable, so that even a child can see the necessity for the aether. The sun and stars are the perpetual witnesses to the existence of the aether, and all who live and behold the light, as *Homer* says, thereby recognize this superfine medium (*Αἰθήρ*).

(iii) The formal discussions on the theory of relativity before the Royal Astronomical Society, Dec., 1919, and Royal Society, Feb. 5, 1920, wholly unprofitable, in default of a kinetic theory of the aether.

In view of the above criticisms it is unnecessary to emphasize the unprofitable character of the formal discussions held before the Royal Astronomical Society, Dec., 1919, and the Royal Society, Feb. 5, 1920. But the fact that two of the oldest scientific societies in Europe did not refuse to waste their time and resources of publication on the vague and chimerical theory of relativity — thereby still further confusing the public mind, already bewildered by the misapplication of mathematics which rests on no physical basis, when the problem is primarily a physical one — may well deserve our attention.

A report of these meetings will be found in the Monthly Notices, and in the Proceedings of the Royal Society, and other journals, such as the Journal of the British Astronomical Association, for Nov., 1919, and Jan., 1920, which appear a month or so late. We may condense the discussion as an American physicist summarized a similar discussion held in Washington about ten years ago:

»When we got through, we did not know any more than when we started.«

Now we submit that such methods are not those by which science is advanced. And when the proceedings of learned societies take the form of unprofitable debates, on mere subtleties, or on reasoning which rests on false premises, — such as a mere mathematical foundation, when a physical foundation is required, — it is a sign of the mysticism which usually accompanies intellectual decadence. There can be no defense for the policy of exploiting *Einstein's* theory without first considering the kinetic theory of the aether, which renders such mystical doctrines unnecessary and wholly inadmissible.

To cite an example of historic interest, the chimerical character of *Kepler's* early speculations is judiciously pointed out by *Laplace* (*Précis de l'Hist. d'Astron.*, p. 94):

»Il est affligeant pour l'esprit humain de voir ce grand homme, même dans ses dernières ouvrages, se complaire avec délices dans ses chimériques spéculations, et les regarder comme l'âme et la vie de l'astronomie.«

Delambre is even more severe, and subscribes to the judgement of *Baillly* in regard to *Kepler* (*Astron. du moyen âge*, 1819, p. 358):

»After this sublime effort (discovering the planetary laws, is meant). *Kepler* replunges himself into the relations of music to the motions, the distance, and the eccentricities of the planets. In all these harmonic ratios there is not one

true relation; in a crowd of ideas there is not one truth: he becomes a man after being a spirit of light.«

The results brought out in the first and second papers on the New Theory of the Aether, show the worthless character of the whole theory of relativity. We are justified in saying it is a foundation laid in quicksand, when a foundation of granite was near at hand. And therefore the whole theory of relativity, as heretofore taught, is now shaken to its foundations, and thus no longer deserves the serious consideration of natural philosophers.

As throwing some historical light upon the unprofitable subtleties of the theory of relativity, and the vague and chimerical discussions which the Royal Astronomical Society and the Royal Society have inflicted upon a bewildered and long suffering public, we recommend an attentive reading of the latter part of the first volume of *Whewell's* History of the Inductive Sciences. *Whewell* dedicated this justly celebrated work to Sir *John Herschel*, and it ought to be familiar to every modern investigator.

Whewell's luminous discussion of the »Indistinctness of Ideas in the Middle Ages«; »Collections of Opinions«; »Indistinctness of Ideas in Mechanics«; »Indistinctness of Ideas in Architecture«; »Indistinctness of Ideas in Astronomy«; »Indistinctness of Ideas shown by Skeptics«, (pp. 253-268) is especially worthy of study.

In opening the treatment of »Indistinctness of Ideas shown by Skeptics« *Whewell* remarks:

»The same unsteadiness of ideas which prevents men from obtaining clear views, and steady and just convictions, on special subjects, may lead them to despair of or deny the possibility of acquiring certainty at all, and may thus make them skeptics with regard to all knowledge. Such skeptics are themselves men of indistinct views, for they could not otherwise avoid assenting to the demonstrated truths of science; and, so far as they may be taken as specimens of their contemporaries, they prove that indistinct ideas prevail in the age in which they appear. In the stationary period, moreover, the indefinite speculations and unprofitable subtleties of the schools might further impel a man of bold and acute mind to this universal skepticism, because they offered nothing which could fix or satisfy him. And thus the skeptical spirit may deserve our notice as indicative of the defects of a system of doctrine too feeble in demonstration to control such resistance.«

Accordingly, from the considerations here advanced, it follows that the recent formal discussions before the Royal Society and Royal Astronomical Society of the theory of relativity, which is both vague and chimerical, have confused rather than clarified the subject in the public mind; and thus in the cause of truth I have felt obliged to protest against the misuse of the powers of these learned societies.

II. Rejection of the Theory of 'Electrical Mass' except for Small Particles of Common Matter expelled under Electric Charges: the so-called 'Electrical Mass' thus not applicable to the Aetherons, or Corpuscles of which the Aether is made up.

(i) Description of the so-called 'electrical mass'.

Of late years a number of physicists occupied with

experiments involving the ejection of small charged particles; in an electric field of very considerable intensity, have laid much stress upon the so-called 'electrical mass', and even gone so far as to entertain the view that all mass is electrical (cf. *Crowther*, *Molecular Physics*, 1914, pp. 67-85). It is true no doubt that under the charges involved in these experiments there is an 'electrical mass' because the small mechanical mass is thereby thrown out of electric equilibrium with its surrounding field.

But when we deal with the aether as an all-pervading medium, we have to do with the motions of the aetherons only, and as common matter is not involved, we have to reject the 'electrical mass' as applied to the aether, for the reason that the aetherons make up the field, and normally are in kinetic equilibrium, so as not to be subjected to any forces except those due to passing waves in the aether, involving concerted displacement of neighboring aetherons.

It is well known that *Newton* was quite aware of the effect of the resistance of a medium upon the motion of a sphere or other body projected through it. In the *Optics*, 1721, pp. 342-3, *Newton* discusses the very problem here treated of in the following manner:

»The resistance of water arises principally and almost entirely from the vis inertiae of its matter; and by consequence, if the heavens were as dense as water, they would not have much less resistance than water; if as dense as quick-silver, they would not have much less resistance than quick-silver; if absolutely dense, or full of matter without any vacuum, let the matter be ever so subtle and fluid, they would have a greater resistance than quick-silver. A solid globe in such a medium would lose above half its motion in moving three times the length of its diameter, and a globe not solid (such as are the planets) would be retarded sooner. And therefore to make way for the regular and lasting motions of the planets and comets, it's necessary to empty the heavens of all matter, except perhaps some very thin vapours, steams or effluvia, arising from the atmospheres of the earth, planets and comets, and from such an exceedingly rare aethereal medium as we described above. A dense fluid can be of no use for explaining the phenomena of nature, the motions of the planets and comets being better explain'd without it.«

In this passage we have spaced the sentence especially applicable to the problem of the 'electrical mass', which is explained as follows. Let m be the ordinary mechanical mass of the moving particle; then the ordinary kinetic energy due to its motion becomes

$$E = \frac{1}{2} m v^2. \quad (89)$$

But electrical experiments on small particles ejected under considerable charge, show that there is in addition a quantity of energy due to that charge. The total energy is found to be made up of the two parts shown in the right member of the following equation:

$$E = \frac{1}{2} m v^2 + \frac{1}{3} e^2 v^2 / a = \frac{1}{2} [m + \frac{2}{3} e^2 / a] v^2 \quad (90)$$

the first term yielding the mechanical energy depending on m , and the second that depending on the so-called 'electrical mass', $\frac{2}{3} e^2 / a$, where e is the electrical charge borne

by the particle, and a is the radius of the spherical space occupied by the charge. The 'electrical mass' is not quite constant for all velocities, but the above formula holds approximately for moderate speeds.

(ii) The rejection of the theory of the so-called 'electrical mass', as an effect of the aether due to the systematic arrangement of the waves, justified by *Thomson's* views of the motion of a corpuscle through an electrical field.

In his *Elements of Electricity and Magnetism*, 4th ed., 1909, p. 521, Prof. Sir *J. J. Thomson* indicates that if m be the mass of an uncharged sphere, the kinetic energy of such a sphere with charge e , magnetic-permeability μ , and radius of action a , is

$$E = \frac{1}{2} [m + \frac{2}{3} \mu e^2 / a] v^2. \quad (91)$$

The effect of the charge is to increase the mass of the sphere by $\frac{2}{3} \mu e^2 / a$. This is a resistance called the 'electrical mass', and the question arises whether it should be regarded as an increase of mass, as described by *Thomson*, or an effect of the field in which the sphere moves, as described by *Newton* in the discussion above cited from the *Optics*, 1721.

Sir *J. J. Thomson* compares the motion of a corpuscle through an electrical field with that of a sphere through a liquid, which he says leads to an increase in the effective mass, because the moving sphere drags some of the liquid along with it. Thus when a sphere moves through a liquid it behaves as if the mass were increased from m to $m + \frac{1}{2} m'$, where m' is the mass of the liquid displaced by the sphere. Again, when a cylinder moves at right angles to its axis through a liquid, its apparent mass is $m + m'$, where m' is the mass of the liquid displaced by the cylinder.

»In the case of bodies moving through liquids«, says *Thomson*, »the increase in mass is due to the motion of the body setting in motion the liquid around it, the site of the increased mass is not the body itself but the space around it where the liquid is moving. In the electrical problem, we may regard the increased mass as due to the *Faraday* tubes setting in motion the ether as they move through it« (p. 522).

This reasoning concedes that the so-called 'electrical mass' depends not on the sphere itself, but on the field about it; in other words the 'electrical mass' is an effect due to the surrounding field, and not inherent in the body itself. For that reason it is necessary to consider carefully whether the 'electrical mass' in the larger mechanics, ought not to be rejected altogether as fictitious, and due to disturbances in the aether filled with waves and thus polarized, the arrangement of the waves exerting the force called the 'electrical mass'.

(iii) Theory of *J. A. Crowther*, 1914.

In his *Molecular Physics*, 1914, p. 70, (Philadelphia, Blakiston's Son & Co.), *J. A. Crowther*, also of the Cavendish Physical Laboratory, Cambridge, points out that the extra or 'electrical' mass is due to the fact that the particle carries a charge. *Crowther* even says that if the 'mechanical' mass m be zero, the 'electrical' mass will still persist. Analytically this follows from the above formula (91), but physically there is no proof that such an 'electrical' mass can exist

independently of matter, and thus *Crowther's* claim cannot be admitted.

Crowther announces his final conclusions thus (pp. 70 and 71):

»Since this 'electrical' mass is really that of the magnetic field surrounding the particle, it resides not in the particle itself but in the medium surrounding it, that is, in that mysterious fluid which we call the ether¹). As soon, however, as we attempt to alter the motion of the particle this energy flows into it from all sides, so that, as far as experiments upon the particle itself are concerned, the results obtained are precisely the same as if it resided permanently there.«

»To make this somewhat novel idea a little clearer we may consider a close and very servicable analogy, where the mechanism of the extra mass is a little clearer than in the electrical case. If any body is moving through water, or any viscous fluid, it carries with it a certain amount of the liquid through which it is moving. In the case of a sphere, for example, the quantity carried along by the motion of the body amounts to half the volume of the sphere itself. A long cylinder moving at right angles to its own length will carry with it a quantity of fluid equal to its own volume. On the other hand, if it moves in the direction of its own length the fluid entangled is practically nil. Thus, in order to set the body in motion with a velocity v , we have to supply to it energy enough to give this velocity, not only to the sphere itself, but also to the mass of fluid which it carries with it. That is to say, if M is the mass of the sphere itself, and M' the mass of the attached fluid, the work done in starting the body is $\frac{1}{2}(M+M') \cdot v^2$. In other words, the body will behave as if its mass were increased by the mass of the fluid entangled by it. Just as in the electrical case, this extra mass resides in the surrounding medium.«

Accordingly, it clearly appears, from *Thomson's* and *Crowther's* arguments, that the 'electrical' mass $\frac{2}{3}e^2/a$ depends wholly on the field in which the charged corpuscle is moving, not upon the body itself, and changes when the motion through the field is altered. All that the arguments can be said to prove therefore is that the aether in a magnetic field, exerts an influence on bodies moving through it. This shows that the aether really exists, is polarized near magnets and electric wires bearing currents, and acts physically according to definite laws.

This is a reason therefore why the theory of the aether cannot be rejected, as some superficial writers have held. The other reasons for admitting the aether are as convincing as stupendous cables of steel would be if we could actually see them stretched from the sun to the several planets for holding these huge masses in their orbits. For the centrifugal force of the planets has to be balanced and the aether is the medium which sustains the tremendous forces required to curve the paths of the planets at every point, and enable them to describe Keplerian Ellipses about the sun as the focus.

(iv) We therefore conclude that the 'electrical mass depends wholly upon the aether.

As the 'electrical' mass admittedly depends on the aether, and the influence it exerts depends on the wave motion in this medium, it is better for most purposes to reject the doctrine of a so-called 'electrical mass' as fictitious, and consider separately the common Newtonian mass m , and the influence exerted by the field in which m is moving.

In case of the 'electrical mass':

$$E = \frac{2}{3}\mu e^2 v^2 / a \quad (92)$$

where a is the radius of the space occupied by the charge, and μ the magnetic-permeability of the medium, e the charge, it is thus obvious that E becomes truly a drag exerted on the moving mass m . It is evident that this effect ought to depend on e^2 , and v^2 , since the induction due to the waves is thus developed like ordinary mechanical work done.

For it must be remembered that there are waves in the field, produced by the bodies and charges of the universe, and also waves, or Faraday tubes of force, produced by the moving corpuscle itself, with charge e . Since the charge e is a measure of the electrification of the corpuscle, the field about it necessarily will have a corresponding condition, but negative in character, and the interaction of the charged corpuscle on the field will be measured by the product of these charges, and thus by e^2 .

This explains the nature of the formula (92), except the divisor a . And *Crowther* (pp. 162-3) shows that the total energy in the field is the integral of the total magnetic energy between two spheres of radius r and $r+dr$, when taken from the surface of the electron of radius a to infinity, becomes:

$$E = \frac{1}{3}\mu e^2 v^2 \int_a^{\infty} dr/r^2 = \frac{1}{3}\mu e^2 v^2 / a. \quad (93)$$

From this line of investigation it appears that we are justified in rejecting, and even required to reject, the 'electrical mass' for the aetherons, which pervade the universe, and by their vibrations render the aether the vehicle of energy. Accordingly our conclusions are:

1. It appears that Prof. Sir *J. J. Thomson's* argument for the 'electrical mass' is an extension of that given by *Newton*, but is likely to be misapplied, unless the specific condition of non-electric equilibrium underlying the experiments with small particles is clearly borne in mind.

2. The doctrine of the 'electrical mass' has therefore a very limited field of validity. On page 81 of the work above cited *Crowther* says that most physicists cherish the belief at the bottom of their hearts that all mass is electrical in origin, »but it cannot at present be said to be much more than a pious hope.«

(v) The nature of the X-rays investigated.

It will be recalled that for a long time great mystery attached to the nature of the X-rays. Soon after these rays were discovered by *Röntgen*, in the winter of 1895-6, three different theories were formed of their nature: (1) Electrified material particles projected with great speed from within the

¹) The spacing-out is mine.

bulb quite through the walls of the glass tube; (2) the Ultra-violet theory, which supposes the energy to be aether-wave motion of the same character as light, but of only about $1:10000^{\text{th}}$ part of the wave length of visible light; (3) the longitudinal aether-wave theory, at first favored by *Röntgen*, *Faumann* and others, which ascribed the observed effect to longitudinal motion in the aether waves.

Probably something could still be said in favor of each of these theories, and it is not yet certain that the nature of the X-rays is understood. In the usage of men of science however, the ultra-violet wave-theory has found most favor.

In 1912 the Swiss physicist Dr. *Laue* first made use of X-rays to investigate the structure of crystals, and from this beginning has grown a resourceful method for attacking the problem of molecular arrangement in crystals, which may even throw light on the internal structure of the atoms themselves. An article on this subject by Prof. *W. L. Bragg*, on »Crystal Structure«, will be found in *Discovery*, Feb., 1920; and a review of the subject appears in the *Journal of the British Astronomical Association* for March, 1920, pp. 199 till 200.

The following table gives an outline of the different types of waves, expressed in Ångström units, or tenth-metres, $1 \text{ m} \cdot 10^{-10}$, *Duff's Physics*, p. 640:

Gamma rays	0.1
X-rays	1
Shortest ultra-violet waves	600
Shortest visible waves (violet), about	3800
Violet, about	4000
Blue	4500
Green	5200
Yellow	5700
Red	6500
Longest visible waves (red)	7500
Longest waves in solar spectrum, more than	53000
Longest waves transmitted by fluorite	95000
Longest waves by selective reflection	
from rock salt	500000
from potassium chloride	612000
Longest waves from mercury lamp	3140000
Shortest electric waves	40000000 = 4 mmi.

It is very difficult to understand how such very short waves as X-rays are supposed to be, on the ultra-violet theory, could penetrate so easily through the human body and other semi-solid substances, as they are found to do in practice. The experiments of *Laue*, *Bragg* and others in crystal photography show the extreme fineness of the X-rays, and their great penetrating power.

But it is perhaps possible that what appears to be a passage of X-rays through resisting structures is rather a general agitation of the aether by which the atoms emit waves¹⁾ which can impress the photographic plate, than an

actual passage of such short waves through these resisting masses. If so, the facts of experience would lend a strong support to the wave-theory since it might be much easier to evoke vibration of appropriate length than for such short waves to actually pass. The waves evoked by agitation of the aether would show crystalline structure, and even the diffraction of X-rays, quite as well as the passage of X-rays waves.

In confirmation of this view that the X-rays observed are waves evoked by agitation, we quote from *Duff's Text-Book of Physics*, 1916, p. 641:

»Glass is opaque to waves shorter than 3500 Ångström units, and longer than about 30000 Ångström units. Quartz is transparent between the wave-lengths 1800 and 70000, and for some longer waves; rock salt is transparent between 1800 and 180000, and fluorite, one of the most transparent substances, will transmit ultra-violet waves from about $\lambda = 1000$ to $\lambda = 95000$.«

A similar argument has also been adduced by Prof. Sir *J. J. Thomson* to the effect that X-rays depend on collisions by negatively charged particles. They are evoked by the somewhat irregular agitation of the wave-field, the disturbance produced being due not so much to regular continuous wave motion, as to isolated wave impulses, which travel throughout the neighboring aether, and set free the corpuscles from the atoms. Such X-rays could not well interfere, and their diffraction, if observed, would be of the type photographed by *Laue* in crystals, corresponding to short waves, probably produced by the degeneration and breaking up of longer aether impulses of no considerable regularity of movement.

This puts the ultra-violet theory in a new light, in line with the wave-theory, and at the same time explains the mechanically injurious effects of X-rays in surgery²⁾ as due to the irregular wave impulses, which regular ultra-violet waves could hardly produce. And it explains also why calcium tungstate may render the X-rays capable of casting shadows visible to the eye. For the irregular impulses would come with sufficient rapidity to give an effect which optically is apparently continuous. When observing the X-ray through calcium tungstate I have noted an appearance of rapid flickering, as in the case of rapid but irregular electric sparks, or lightning flashes in quick succession but at unequal intervals.

In connection with this subject it is well to bear in mind that magnetism, which in the wave-theory depends on polarized waves of perfect regularity, can penetrate thick plates of glass or any other substance, but the action seems to take a little time. Probably the polarized character of magnetic waves and their length makes this penetration possible, whereas it is possible for the confused waves of light only within fixed limits. Thus we hold that the irregular impulses in X-rays correspond to long waves, which under degeneration call forth the very short ones used for the newer investigations in crystals.

¹⁾ This idea is suggested by *Röntgen's* original experiment of cutting off all cathode rays with black card board, yet noting that some crystals of barium platino-cyanide in the darkened room were rendered luminous by the general agitation in the aether.

²⁾ A dispatch from Paris, May 26, quotes *M. Daniel Berthelot* as reporting, May 25, to the Academy of Sciences a new method for protecting operators against the injurious effects of X-rays, which are neutralized by a simultaneous application of infra-red rays. This use of infra-red rays to counteract the X-rays confirms the theory here developed; unless the agitations underlying the X-rays were long, the long infra-red rays could hardly afford the protection reported. — Note added, May 26, 1920.

12. The acknowledged Failure of the Electron Theory, which represents a Subordinate Phase of Scientific Progress: The Larger Problems of the Universe can only be attacked through the Wave-Theory based on the Kinetic Theory of the Aether.

(i) The acknowledged failure of the electron theory.

In his interesting but unconvincing work on Molecular Physics, Philadelphia, 1914, *Crowther* treats of many molecular phenomena from the point of view of the electron theory. Including the effect of the electrical mass, $\frac{2}{3}e^2v^2/a$; *Crowther* concludes (p. 81) that the mass of an electron is $8.8 \cdot 10^{-28}$ gms., while the value of the charge it carries is $1.57 \cdot 10^{-20}$ units. Thence he deduces for the radius of the electron $1.87 \cdot 10^{-13}$ cms.¹⁾

Calling attention to the conclusion that the radius of an atom is of the order of 10^{-18} cms, he adds a comparison which I give spaced:

»We may now say that small as the atom is, the electron is so much smaller that the electron bears to the atom which contains it very much the same relation as a pea to a cathedral.«

»We have seen that the whole of the mass of the electron is due to the charge which it carries. The thought at once suggests itself: Are there indeed two kinds of mass or is all mass electrical in its origin? Probably most physicists cherish this belief at the bottom of their hearts, but it cannot at present be said to be much more than a pious hope. The mass of a negative electron is about $\frac{1}{1700}$ part of the mass of a hydrogen atom. Neglecting the positive charge of the atom, of which we know practically nothing, it would require 1700 electrons to make up the mass of a single hydrogen atom. This of course is not a priori an impossible number considering the smallness of the electron; and speculations along these lines were for a time freely indulged in. In this case, however, experiment failed to confirm the bold conjecture. The number of electrons in the atom has been determined at any rate approximately, and affords no support for such a theory.«

Crowther then examines at some length the question of the number of electrons in an atom, and after admitting the obscurity of positive electrification, finally concludes, pp. 83-84 as follows:

»Unfortunately, we are not yet acquainted with the nature of positive electricity. Prof. Sir J. J. Thomson's experiments on the positive rays, brilliant as they have been, have not at present thrown much light upon this exceedingly difficult problem. For the present the term 'positive electrification' remains for the physicist very much what the term 'catalytic action' is for the chemist — a not too humiliating

method of confessing ignorance. If we suppose that the positive electricity is distributed uniformly over a sphere of the size of the atom (a hypothesis which lends itself very readily to mathematical treatment), the author's result would indicate that the number of electrons in an atom is almost exactly three times its atomic weight. That is to say, the number of electrons in a hydrogen atom would be three.²⁾ If we go the other extreme, and suppose that the positive electrification is a sort of nucleus at the centre of the atom, and that the electrons revolve around it somewhat after the manner of the rings of Saturn, the number of electrons in a hydrogen atom works out at unity, the number in any other atom being equal to its atomic weight. The assigning of unit atomic weight to hydrogen would then have a very definite physical significance, as it would be the lightest atom which could possibly exist. In either case the number of electrons in an atom is only a very small multiple of its atomic weight. We cannot, therefore, assign any appreciable fraction of the mass of the atoms to the negative electrons it contains.«

»There still remains, of course, the possibility that the mass is electrical, but that it resides in the positive portion of the atom. If the formula for the electric mass be examined, it will be seen that for a given charge the mass is inversely proportional to the radius of the sphere upon which it is concentrated. If we suppose the positive charge on the hydrogen atom to be concentrated upon a sphere of $\frac{1}{1700}$ of the size of the negative electron, its mass would be 1700 times as great, that is to say, equal to that of the hydrogen atom. Our perfect ignorance of the nature of positive electricity renders the suggestion not untenable, though evidence for it is sadly lacking.«

This is a very frank confession of a failure of the electron theory, for two chief reasons.

1. In size the electron bears to the atom about the ratio of a pea to a cathedral.

2. The number of such electron peas to the atom cathedral is very small, either 1 or 3 for hydrogen, and always a small multiple of the atomic weight. Hence the important conclusion: »We cannot, therefore, assign any appreciable fraction of the mass of the atoms to the negative electrons it contains.«

Accordingly it is not surprising that *Crowther* admits that »for the present our belief in the electro-magnetic nature of all mass remains an expression of our faith that all the varied phenomena with which we have to deal are manifestations of some single principle or essence which underlies them all.«

Another important and much more elaborate work, »The Electron Theory of matter«, by Prof. O. W. Richardson

¹⁾ Another proof of the great uncertainty attaching to the theory of the electron is afforded by conflicting deductions as to the absolute dimensions of this little mass.

1. *Crowther*, pp. 81-165, gives for the radius of the electron $1.87 \cdot 10^{-13}$ cm, and for the radius of a hydrogen atom $1.21 \cdot 10^{-8}$ cm. Thus the hydrogen atom has about 66000 times greater diameter, yet it has only 1700 times the mass of the electron, which makes the electron relatively very heavy for its small diameter. If of equal density with the hydrogen, this mass would make the hydrogen atom have a diameter 11.93 times that of the electron.

2. But the diameter of the electron itself must be very uncertain. In Phys. Rev. vol. 114, pp. 247-259, Sept. 1919, A. H. Compton, who had previously estimated the diameter to be $2 \cdot 10^{-10}$ cms, now finds it to be $(1.85 \pm 0.005) \cdot 10^{-10}$ cms, or $r = 0.925 \cdot 10^{-10}$ cm. This is about 2000 times larger than *Crowther's* value; so that apparently no confidence whatever can be put in these results.

²⁾ The spacing-out is mine.

of King's College, London, appeared under the auspices of the University Press, at Cambridge, 1914, pp. 1-612. We cannot attempt to describe the treatment, except to say that it is similar to *Crowther's* work, but less experimental, and sets forth the mathematical theory in greater detail.

In spite of the elaborateness of this treatise, *Richardson* is obliged to admit the short-comings of the electron theory. On page 592 the author admits that »we cannot be sure that the mass of the electrons is not appreciably different in different substances.« Accordingly it would appear that the mass of the electron is definitely fixed only in particular substances which have been experimentally investigated. It is acknowledged that nearly all the atomic problems are clouded in great obscurity.

Under the head of General Conclusions, p. 600, we read:

»A review of the preceding discussion shows that the electron theory is not in a position to make very definite assertions about the nature of gravitational attraction. It seems likely that the Newtonian law of attraction between elements of matter is one between elements of mass or confined energy and that it is of a very fundamental character. It is doubtful¹⁾ if it can be replaced by a modified law of electrostatic force between electrons or elements of electric charge, unless the modified law includes the associated mass explicitly. Even so, the case does not appear very simple.«

In closing *Richardson* concurs in the opinion of *Lorentz* that gravitation may be an electrodynamic effect propagated with the velocity of light, like that since developed in greater detail by the present writer.

(ii) The electrons usually assumed to be more or less 'bound' to atoms, and set free chiefly in metals (conductors), to make up an electric current: but this will not explain the propagation of electric disturbances with the velocity of light, and thus the electrons cannot replace the aether.

It is well known that the electrons usually are taken to be more or less 'bound' to the atoms, with which they are associated. A vast amount of discussion has arisen as to the setting free of the electrons, by heat and electric disturbances. It will be noted therefore:

1. The electrons are not taken to be entirely free, to pervade all space and all bodies, like the aetherons, which travel with a velocity 1.57 times that of light, 471238 kms.

2. The speed of the electrons is not taken to be in any case greater than one third that of light. As the mass of the electron is considerable, though only about $\frac{1}{1700}$ of that of a hydrogen atom, this smaller velocity, of say 100000 kms. is very intelligible.

The hypothesis of *Crowther*, and others, (Molecular Physics, p. 139), that »an electric current is a flow of electrons from a place of high to a place of low potential« cannot be admitted, because the observed velocity of 300000 kms. for light and electricity could not be attained by such heavy masses as electrons.

Crowther states this electron theory as follows:

»We may regard a conductor, then, as a substance

containing electrons which are free to move under the action of an electric field, while in non-conductors the electrons are fixed and unable to follow the impulse of the field.«

»How are these electrons set free? In the first place it may be noticed that the only good conductors of electricity are metallic, that is to say, electro-positive in character, substances which we know from other phenomena readily part with an electron under the slightest provocation. Now in a solid such provocation may well be supplied by the close propinquity of the neighbouring molecules. It is well known that a charged body will attract light uncharged substances. The attraction of a well-rubbed stick of sealing wax for small pieces of paper is generally our first introduction to the science of electricity. The attraction is of course mutual, the force on the charged body being equal to that on the uncharged paper. Hence an electron in one atom is attracted by a neighbouring uncharged atom, and under favourable circumstances, and especially in the case of an atom only too ready to part with its electrons, the attraction may well be sufficient to enable it to make its escape.«

It is obvious without further discussion that this theory is so very defective that it cannot be seriously entertained by investigators who are familiar with the propagation of electric and radio-telegraphic waves and light across free space. For, in the first place, it claims to account for disturbances along conductors, which cannot be done with electrons of the recognized mass. And, in the second place, the electron theory gives no explanation of light and radio-telegraphic waves across free space, where the aether alone is involved.

Accordingly the electron theory cannot explain the phenomena of the aether, and it must be admitted that the subject of the electron is still involved in great obscurity. So far as we can judge it can only be cleared up by the further development of the wave-theory, deduced from the new kinetic theory of the aether.

For although the mass of the aetheron given in the first paper on the New Theory of the Aether, will have to be multiplied by about 4.31 to take account of the increased absolute density of the aether, found by the new method of section I above, after Lord *Kelvin's* method was shown to be invalid: yet the total change in the mass of the aetheron is comparatively slight, namely: molecular weight = $67.077 \cdot 10^{-12}$.

Accordingly the general mass and dimensions of the aetheron are but slightly altered, yet the size of this corpuscle is somewhat increased and becomes:

1. The radius of the aetheron = $\frac{1}{2461.2}$ of that of a hydrogen molecule.

2. This radius is equivalent to $5.44 \cdot 10^{-12}$ cms., that of hydrogen being taken as $1.34 \cdot 10^{-8}$ cms.

(iii) The electron theory like that of radio-activity is a subordinate phase of scientific progress.

The electron theory developed during the last quarter of a century by a considerable group of experimental physicists led by Prof. Sir *J. J. Thomson* and others, has now acquired such definite form and shows such defects, that we-

¹⁾ The spacing-out is mine.

are safe in considering it a subordinate phase in scientific progress. If it should prove to be an ultimate development, apparently this can only be owing to the more fundamental wave-theory, which underlies the electron-theory and gives a physical basis for the phenomena of electrons.

1. The alpha-, beta-, gamma-rays, recently so much observed, are held to give experimental proof that small particles, under electric charges of greater or less intensity, are ejected from certain bodies with velocities which may be one third that of light.

2. It is very difficult to understand how alpha-, beta-, gamma-particles can be ejected with this enormous speed unless commotions incident to wave action underlie the ejections. For electrodynamic waves travel with the velocity of light, and material particles caught up by a combination of such waves might travel more slowly than light, but yet with so great a speed as to approach that speed or a large fraction of it.

3. It is inconceivable that velocities approximating one third that of light could be generated without some association with the release of elastic action in the aether, which speeds on with the enormous velocity of 300000 kms per second. Even in solid bodies the aether waves advance at a rate which is a large fraction of that in free space.

4. Now molecular and atomic velocities are very small indeed compared to that of light. Hence it is apparent that no ordinary molecular collisions or disturbances could eject particles with these enormous speeds. But if invisible electrodynamic waves underlie these ejections their speeds are easily accounted for. Under oscillating electric charges the particles might be carried along from the surface or even into the interior of a solid anode or cathode, or similar terminals.

5. In the author's work of 1917, p. 20, we have explained the nature of an electric current, and illustrated the waves about a conducting wire by a figure (cf. fig. 12, p. 260, above) showing the rotations which make up the waves. The waves act in concert, the elements whirling everywhere in the same direction. If therefore, there be a particle small enough to be ejected, yet observable, it might be carried away with great speed.

6. But in a Geissler-tube, or similar rarified gaseous medium, we have rarified gas itself for the conductor or discharge of the electric strain at the terminals. In such a good conducting partial vacuum, it apparently would be much easier for a small particle to be ejected with great speed than from any conductor of metallic constitution.

7. Thus, in all the phenomena of electric discharges through rarified gases, on which Prof. Sir J. J. Thomson has experimented for so many years, the indications are that the observed velocities of the ejected particles are attained under wave influences or releases of electric stresses, by commotions in the aether traveling with the velocity of light.

8. Since the rarified gas acts as a conductor — Prof. John Trowbridge of Harvard University having found that rare air is a more perfect electric conductor than even copper wire —, we should in fact expect certain solid particles to be transported along with a large fraction of the velocity of light. Thus the electron phenomena are not remarkable, but naturally follow from the wave-theory.

9. Accordingly, it hardly seems possible that the alpha-, beta-, gamma-particles, so much studied in the electron theory, can be other than a temporary phase in the progress of science. Important as the results attained are, they do not disclose to us any workable theory of the universe. Even the ejections of small charged bodies must rest on the wave-theory: there is no other possible way in which we can explain the ejection of these corpuscles, and their enormous velocities, whereas the wave-theory makes their ejection natural and requires it to be at high speed.

10. Incidentally, the electron theory renders the corpuscular theory of the aether more probable than it otherwise would be. It all implies excessively rapid motion for very small bodies. Unless there be waves traveling with the velocity of light, it is impossible to explain the phenomena of radio-activity.

To show the difficulty of reconciling these results, we add a few calculations. Let us assume in the first case that the free electrons behave as a gas, and thus follow the law announced by *Maxwell*, that all molecules have equal kinetic energy, which is verified by experience for many actual gases. Then, if m and v denote respectively the mass and the velocity of a molecule of hydrogen, while m' and v' denote corresponding quantities for an electron, we have:

$$\frac{1}{2}mv^2 = \frac{1}{2}m'v'^2. \quad (94)$$

Accordingly if $v = 1696$ ms, and $m' = \frac{1}{3400}$ of a hydrogen molecule, which contains two atoms, we find

$$v' = \sqrt{3400 \cdot v} = 58.31 \cdot 1696 \text{ ms} = 98.893 \text{ kms}. \quad (95)$$

This is a comparatively small velocity, a little over 60 miles per second; and thus we find the electron as a gas particle could not attain a sensible fraction of the velocity of light, 300000 kms. Different authorities give different velocities for charged particles: *Crowther* (p. 76) considers a particle moving with one tenth of the velocity of light, and *Millikan* has asserted the probability of a speed of one-third that of light. Such high velocities are wholly impossible, on the kinetic theory of gases; but as expelled under electric charges they might be possible, if carried along by the wave action traveling at 300000 kms per second. But the acceleration of the velocity appropriate to a gas, under the kinetic theory, would have to be very great.

For the above value 98.893 kms is less than $\frac{1}{30000}$ th that of light; and if we take *Millikan's* estimate of $\frac{1}{3}$ the velocity of light for the swiftest charged particles, ejected, the above kinetic velocity will have to be accelerated a thousand times its calculated value, or receive energy augmented by the factor $(1000)^2 = 1000000$ fold.

Now in view of our ignorance of molecular physics, it is difficult to say upon what forces such an acceleration may depend; but I know of nothing adequate except waves traveling with the higher velocity of 300000 kms per second.

A particle having a speed of $\frac{1}{3} V$, would have only $\frac{1}{9}$ th of the energy of a particle traveling with the velocity V . It looks therefore as if waves passing by with much greater velocity might have given the particle a velocity which is a considerable fraction of the velocity of light.

On p. 81, *Crowther* attributes the whole mass of the electron to the charge which it carries. We can not admit

such a supposition, for reasons already given; yet if the charge exerts a drag on the aether in which the waves are traveling, the velocity attained will be reduced to a fraction of that of light, in accordance with observations. No other hypothesis than that here adopted will explain the phenomena; and it seems certain that the electron phenomena are explicable by means of the aether, but not without this much finer medium.

(iv) Explanation of inertia, momentum, the laws of motion and of static electricity.

Ever since the formulation of the Newtonian philosophy in the *Principia*, 1686, the problem of inertia, momentum and the laws of motion have appeared to natural philosophers as phenomena requiring elucidation; yet for a long time no solid progress could be made in this inquiry, because there was no adequate theory of the aether. Now that a kinetic theory of the aether is outlined, and the properties of the medium somewhat understood, we consider it advisable to suggest an explanation of the chief mechanical actions which underlie natural philosophy.

1. Since the aether is filled with waves and presses symmetrically upon bodies at rest, or in uniform motion, — and all bodies carry their wave fields with them, — whatever their state of rest or motion, we perceive that the high elasticity of the aether makes it impossible to move a body at rest, or alter the velocity of a body in motion, without expending energy upon it. For in every case the wave-field about the body must be readjusted, and under the elastic power of the aether, this involves work, — just as the aether waves of solar radiation, for example, do work when arrested in their motion at the surface of the earth. The kinetic theory of the aether therefore accounts for inertia, which represents the energy to be overcome in readjusting the wave-field about any body.

2. To make this a little clearer we recall a remark of *Tyndall* in his work on sound, 3rd ed., 1896, p. 73:

»A certain sharpness of shock, or rapidity of vibration, is needed for the production of sonorous waves in air. It is still more necessary in hydrogen, because the greater mobility of this gas tends to prevent the formation of condensations and rarefactions.«

In further proof of *Tyndall's* remark as to the increased difficulty of starting waves in hydrogen compared to air, we cite the fact that heretofore Prof. *F. E. Nipher* of St. Louis is the only experimenter who has been able to generate waves in the aether by mechanical means. To this end *Nipher* used dynamite, which generates tremendous forces acting with extreme quickness — exactly as *Tyndall* points out should be the case for a gas having very great mobility of its molecules. This confirms the kinetic theory of the aether and the cause assigned for inertia by an experimentum crucis.

3. In the case of momentum, the physical cause involved is the same as that assigned for inertia; for very obvious reasons. For momentum is the product of mass by velocity, mv , and as the mass does not change, the change can only occur in v , the velocity, and thus momentum and inertia are identical as to physical cause.

We may even go a little further, and say that all

kinetic energy depends on the aether; for the formula for the kinetic energy

$$E = \frac{1}{2}mv^2 = \frac{1}{2}md^2s/dt^2 \quad (96)$$

involves only mass m , which is constant, and the velocity v , any change in which is resisted by the moving wave-field about the body, exactly as in the case of inertia.

4. As *Newton's* laws of motion, *Principia*, Lib. 1, are concerned with motion, which involve chiefly changes of velocity, we perceive that these laws have their recognized form in virtue of the kinetic medium of the aether; and that all changes of motion involve changes in the aether wave-fields about bodies, and are thus proportional to the forces acting, and produce effects in the direction of these forces, or stresses, in the aether.

5. It only remains to point out that as we ascribe dynamic electricity, or electric currents, to waves of the aether in motion, so also we ascribe static electricity to a non-equilibrium of the wave-field of the aether due to the escape of certain waves, under friction or other disturbing causes, which facilitates the escape faster than restoration takes place, and thus leads to the development of charges of static electricity. Thus it is easy to throw the universe out of electric equilibrium, and develop electric stresses.

6. As a charge of static electricity is not permanent, but accompanied by a gradual discharge, it is natural to hold that the insulators on which the electric stress accumulates do not allow of an adequate flow of aether waves to maintain the electric equilibrium in the local field of the universe. Hence static charges accumulate, and may be discharged by various causes.

This may involve gradual restoration of the equilibrium, by wave dissipation through the air or other media, or a sudden restoration, when metallic contact is made by a conductor connecting the so-called positive and negative charges, and a motion of aether waves along the wire restores complete equilibrium.

It will be seen that the views set forth in this paper and maintained with vigor are very different from those previously current among investigators. In the search for truth we do not enter upon such new paths from any mere love of novelty, but only from the hope of finding a way out of the general confusion heretofore recognized to exist.

If it be thought somewhat audacious to depart from these old ways of thinking, in extenuation thereof I must point to the triumph of the theory of a very small density for the aether, after a density of 2000 million times that of lead had been held by the electronists, as outlined in the first paper. The small density now appears to be established on an unshakable basis, by the discovery of the new method for determining the absolute density of the aether. And in general when nothing is hazarded in the hope of the discovery of new truth, history shows that important discoveries cannot be made.

Thus I think it infinitely better to venture upon paths which promise progress rather than to hold to lines of mere conservatism, which return to some part of the old dark labyrinth, without leading out to real light under a clearer and brighter sky. If others are able to add to the development here brought forth I shall heartily welcome their ad-

vance; and I ask no more of others, in respect to following the new path here struck out in the hope of discovery, than I voluntarily exact of myself, in the search for light, more light!

As this paper is somewhat lengthy I shall defer going into further details of static electricity, till we come to deal with the phenomenon of lightning and the molecular forces.

I am indebted to Mr. *E. L. Middleton*, Mr. *G. L. Haley*, and especially Mr. *W. S. Trankle*, for facilitating the completion of this paper.

Starlight on Loutre, Montgomery City, Missouri,
1920 May 8. *T. F. F. See.*

Postscript:

Since this paper was finished, I have just received Science Abstracts, No. 270, June 30, 1920, with notice of the Theoretical and Experimental Researches on Gravitation by Prof. *Q. Majorana*, of Rome (Phil. Mag., vol. 39, pp. 488-504. May, 1920), who raises the question as to the absorption by a dense medium of the energetical flux which is supposed to proceed from all matter and cause gravitative attraction.

Mr. *P. E. Shaw* gives the following account of *Majorana's* researches:

»A particle of mass dm would put forth a flux kdm . If this flux passes through distance x of a dense medium, having quenching factor H , the flux at the end would be $kdm \cdot e^{-Hx}$. Here H is proportional to the density of the medium $= h\varrho_v$. Now, suppose the particle of mass dm to be a particle inside a sphere, the author finds that the total flux emerging from all points in the sphere is

$$F = k\pi\varrho_v R^3 \left[1/p - 1/2p^3 + e^{-2p} (1/p^2 + 1/2p^3) \right]$$

where ϱ_v = density of the sphere, R = radius of the sphere, and $p = RH$. Let M_a = the apparent mass of the sphere. This is less than the true mass M_v on account of this absorption effect. Let $M_a = M_v\psi = \frac{4}{3}\pi\varrho_v R^3\psi$, where

$$\psi = \frac{3}{4} \left[1/p - 1/2p^3 + e^{-2p} (1/p^2 + 1/2p^3) \right].$$

The relation of p to ψ is shown graphically. The case of the sun is specially considered. The astronomical density of the sun is 1.41. This is the apparent density. On certain hypotheses we can arrive at a value for the true density, and from this deduce the values of ψ , p , and H successively. The values of ψ , p , and H the author draws up in a table, giving a range of hypothetical density from 1.41 to 20.0. For a material of density 1.0 the value of H is h . This factor h is supposed to be a universal constant of value between 10^{-12} and 10^{-11} .

»In order to find the value of h , the author has performed the following experiment. From a delicate balance in vacuo hangs a lead sphere, counterpoised by a similar sphere. One lead sphere is hung in a chamber surrounded by one which can be used empty or filled with mercury, so as to surround the lead symmetrically. The lead has mass 1274 gm, the mercury has mass 104 kg. By means of a mirror, the balance, and a distant scale it is possible to estimate the mass to $1/1700$ mgm on each reading. On trying the experiment, the author finds that in all cases the weight of the lead is reduced when it is surrounded by mercury. This indicates an absorption effect by the mercury. The observed decrease in weight is (0.00209 ± 0.00007) mgm.

But various corrections must be applied. These include the attraction of the mercury on the counterpoise, and on the beam, and on other parts used. The greatest admissible error for asymmetry of the mercury is ± 0.00009 mgm. The net effect after the application of these corrections is (0.00008 ± 0.00016) mgm. The author next considers other possible causes of error, such as electrostatic or magnetic action, radiometric or electromagnetic action, heat effects, and mechanical perturbation. He considers these effects negligible.

»The value found for k is $6.73 \cdot 10^{-12}$. On applying these results to the sun, the author considers the sun's true density to be 4.27, which is three times as great as that believed in by astronomers.

This remarkable result seems so striking as to be worthy of careful attention. It may be recalled that in the *Electrod. Wave-Theory of Phys. Forc.*, vol. 1, 1917, p. 155, paragraph 18, I pointed out that »up to the present time the researches of astronomers throw but little light on the amount of matter within the heavenly bodies. They have simply calculated the amount of matter within these masses which may make itself effective by external attraction; and the amount of matter actually there may be considerably larger than we have heretofore believed.

Perhaps it may appear premature to claim that my prediction of 1917 is already definitely verified by *Majorana's* researches, but as his experiments were well planned, and executed with such care as to command approval in the highest scientific circles, the evidence certainly indicates the detection by delicate physical experiment of a screening effect in the action of universal gravitation which I first discovered from the fluctuations of the moon's mean motion, Dec. 10, 1916, as recurring with the eclipse cycles, and thus depending on the interposition of the solid globe of the earth in the path of the sun's gravitative action on the moon.

The course of this celestial-terrestrial progress is the more remarkable, because Prof. *E. W. Brown*, the leading lunar theorist, had pronounced against the theory, after *Bottlinger* and *Seeliger* had been unable to confirm the interception of part of the sun's gravitation near the time of eclipses. It would now seem that *Majorana's* experiments open a new line of attack on the nature of gravitation, which can scarcely be interpreted except in terms of the wave-theory.

If so, it will no longer be admissible to speak of action at a distance, when the sun's action on the moon is shown to be partly cut off by the interposition of the earth's mass near the time of lunar eclipses, while terrestrial gravitation can be sensibly reduced by the layer of mercury made to surround one of two delicately balanced lead spheres, in *Majorana's* laboratory experiments.

It may be noted also that the explanation of the progression of the perihelion of mercury given by me in AN 5048, p. 143, seems to be triumphantly verified, and that too without resorting to relativity or the theories of *Einstein*, which I believe to depart from the laws of nature, because they are both lacking in physical basis. It is not by accident that *Majorana's* experiments confirm my lunar researches of 1916, and the simple explanation of the outstanding motion of Mercury's perihelion given in AN 5048.

1920 August 18.

T. F. F. See.

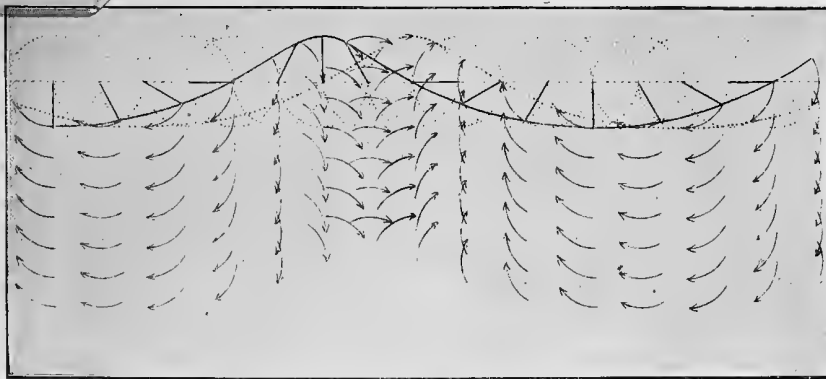


Fig. 1. *Airy's* illustration of the motion of the particles in a wave of water. Each particle moves about a mean position, which is shown by the centre of the circles; and the radius vector drawn from the centre, shows the water vector at various phases of the oscillation.

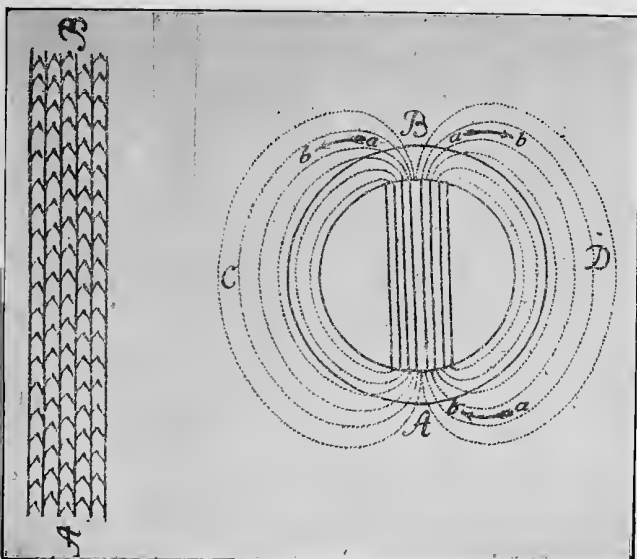


Fig. 3. *Euler's* Theory of Magnetism, 1744, which conceived a magnet as having valves in the "Arteries" along its axis, permitting the aether to flow in one direction only, from the South to the North Pole, AB. This misleading principle has been used in nearly all works on magnetism for the past 176 years, though it sometimes is adapted to modern thought by the round about and complicated processes of *Maxwell*.

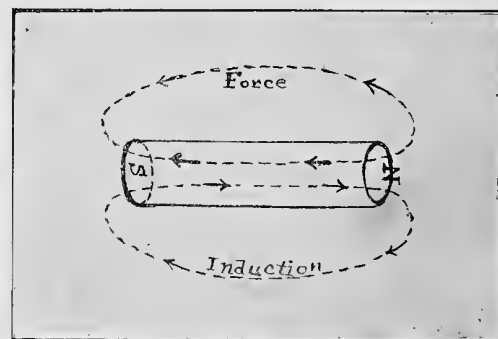


Fig. 4. Diagram showing the adaptation of *Euler's* theory of 1744 made by *Maxwell*, *Treatise on Electricity and Magnetism*, 1873, vol. II, § 404.

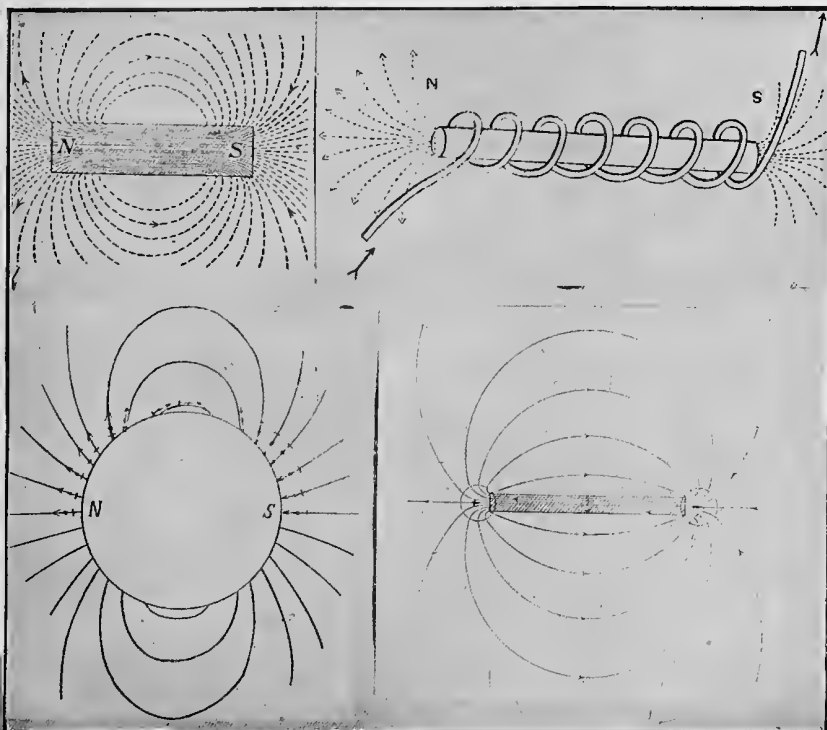


Fig. 5. Illustrations of the usage of *Euler's* Circulation Theory of a Magnet, 1744, in various modern works.

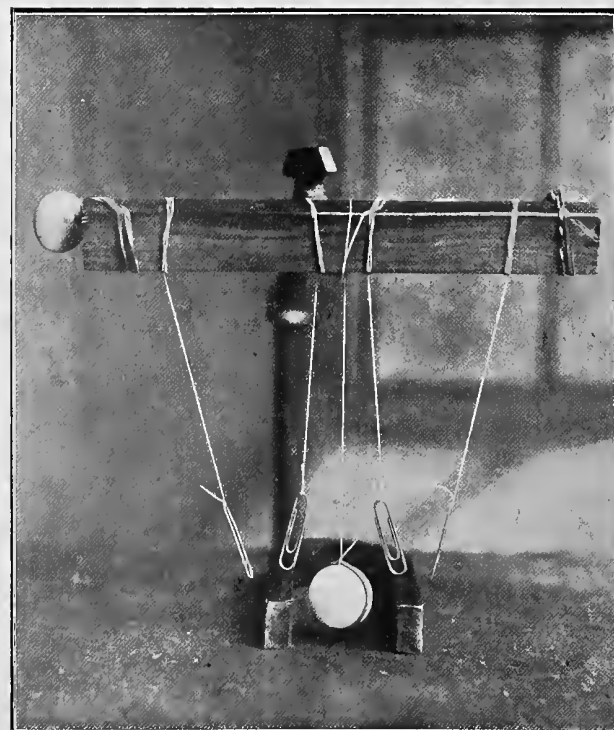


Fig. 6. Experimental confirmation of the Electrodynamical Theory of the attraction of soft iron to magnetic poles.

T. J. J. See. New Theory of the Aether.

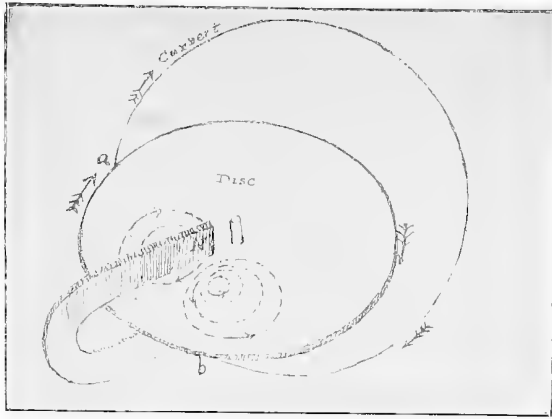


Fig. 7. Diagram of the Eddy Currents induced in a disc of metal by motion relative to a magnet, and thence the generation of a current, as in a dynamo.

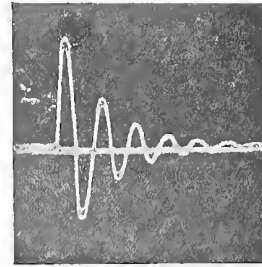


Fig. 8. Photograph of the oscillatory character of the discharge of a Leyden jar, taken in 1904 by Zenneck, who used a Braun tube as an oscillograph.



Fig. 9. Illustration of the restricted amplitudes of the waves receding from a straight wire, under Biot and Savart's law, which permits space expansion, and thus decrease of amplitude, varying inversely as the square root of the distance r .

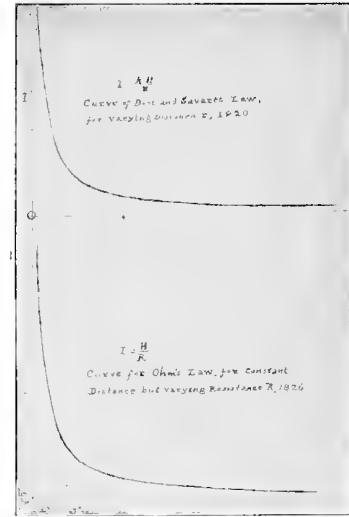


Fig. 10. Illustration of Biot and Savart's law, 1820, where we measure the intensity I as the distance r varies; and of Ohm's law, 1826, in which at a constant distance and with uniform electromotive force we measure the resistance R , or current strength I .

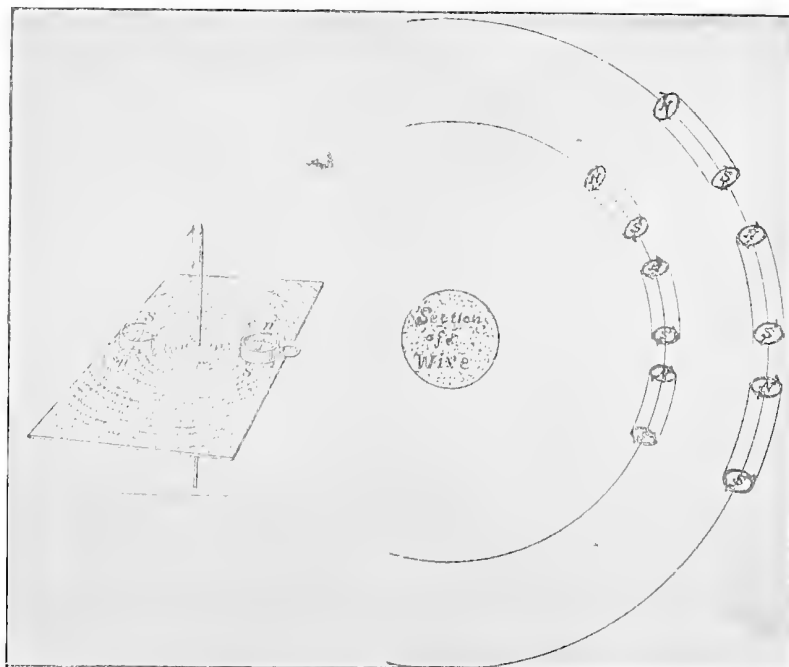


Fig. 11. Illustration of a magnetic whirl about a wire, with Wave-theory of this whirl, on the right. Each little piece of iron filing becomes a small magnet, and they are drawn together by the attractions of their opposite poles.

New Theory of the Aether. By T. F. F. See.

(Fourth Paper.) (With 3 Plates.)

By way of introduction, we remark at the outset that this Fourth Paper is occupied chiefly with the foundations of the wave-theory of light. The subject is presented from a new point of view, in harmony with the electrodynamic wave-theory of magnetism, to which I have been led by the researches on electrodynamic action and universal gravitation outlined in the preceding papers.

As will be remembered by those familiar with the historical development of the wave-theory of light, *Newton*, *Huyghens* and *Euler* had not considered the modern theory of vibrations confined to the plane of the wave-surface, normal to the direction of propagation. Indeed these great founders of the physical sciences did not discriminate between the nature of the molecular oscillations which produce sound and those which produce light. But about 1817 Dr. *Thomas Young*, in England, and *Fresnel* and *Arago*, in France, were led to assume that in light the molecular motions of the aether are normal to the direction of the ray, like the lateral vibrations of a stretched cord. This view seemed like a very startling hypothesis, and thus for a time it encountered great opposition.

At a somewhat earlier period both *Poisson* and *Cauchy* had been occupied with profound researches in the mathematical theory of wave-motion, and each of these eminent geometers presented a number of brilliant memoirs to the Paris Academy of Sciences, chiefly between the years 1810 and 1840. When the first of these researches were presented to the Academy the venerable *Lagrange*, who died in 1813, was still numbered among its most honored members; and *Laplace* continued to take a deep interest in the wave-theory till his death in 1827.

It thus appears that *Lagrange* died before *Young* and *Fresnel* brought forward the theory of transverse vibrations (1817) for explaining the interference and polarization of light; but *Laplace* lived to witness this development for ten years; and, with his pupil *Poisson*, always held to the historical views of wave movement handed down by *Newton*, *Huyghens* and *Euler*, that at a great distance from the source the vibrations of the particles of the aether are largely in the direction of the radius drawn from the center of disturbance, as in the theory of sound.

From these circumstances, and the new physical experiments of *Young*, *Fresnel* and *Arago*, on polarization and interference, there arose a celebrated controversy on the wave-theory of light, which occupies a prominent place in the *Memoirs of the Paris Academy, 1819-1839*. A brief but lucid review of these papers as they successively appeared is given by *Lloyd* in his contemporary Report on the Progress and Present State of Physical Optics, made to the British Association for the Advancement of Science, 1834,

and reprinted in *Lloyd's Miscellaneous Papers* connected with Physical Science, London, 1877, pp. 19-148. It will be remembered that *Lloyd* had experimentally confirmed *Hamilton's* theoretical prediction of conical refraction, and therefore speaks with authority.

After the appearance of *Poisson's* memoir of 1819, the French academicians were divided into two groups: the geometers, led by *Laplace*, *Poisson*, *Lamé*, contending that at great distances from the source of disturbance the vibrations of the particles are in the direction of the radius, as held by *Newton*, *Huyghens*, *Euler*, and *Lagrange*; and the physical group, led by *Fresnel*, *Arago*, and *Cauchy*, claiming that in light the vibrations are transverse to the direction of propagation, and thus exactly opposite to those recognized in the theory of sound.

This celebrated philosophical controversy extended over some twenty years, but never led to any satisfactory conclusion. The mathematical genius of *Cauchy* came to the rescue of *Fresnel's* experiments, by showing the possibility of a medium transmitting transverse waves. Yet neither *Cauchy* nor *Fresnel* showed how such transverse waves could arise; and after the death of *Poisson*, in 1839, there was a gradual acquiescence in the doctrine, without any theoretical explanation of the origin, of the transverse waves in light. Since 1840 there has been no change in the theory, though it often has appeared far from satisfactory to eminent investigators who expect unbroken continuity for the whole body of wave-phenomena in nature.

In his lucid article on Light, *Encyclopedia Americana*, 1904, Prof. *Chas. S. Hastings*, of Yale University, states the crucial difficulty more recently encountered by the wave-theory of light as follows:

»This great work of *Fresnel* was looked upon, as indeed it well deserves to be, as one of the greatest monuments to the human understanding — comparable to *Newton's* doctrine of universal gravitation — and it long remained of almost unquestioned authority. Ultimately, however, one of its fundamental postulates, namely, that the vibrations are always at right angles to the direction of the motion of the light, began to give rise to difficulties. The fact also that the theory could not determine specifically whether the direction of vibration of plane-polarized light is in the plane of polarization or perpendicular to it was not only a manifest incompleteness, but it was a constant stimulus to a critical inspection of its premises. The more these points were studied the more insoluble the difficulties appeared, until there came to be a tolerably widespread belief that the theory was not only incomplete, but that in some way it must be essentially in error.«

From the development given below it appears that

after considerable uncertainty, extending over a full century, the New Theory of the Aether now makes it possible to reconcile the difficulties which so perplexed the illustrious geometers and physicists of the Paris Academy of Sciences. This greatly simplifies our view of the wave-theory of light, without introducing any arbitrary hypotheses. And as the new wave-theory connects the theory of light directly with the theory of sound, according to the views of *Poisson*, 1830, it must be considered not the least fortunate solution of a problem which greatly bewildered some of the most illustrious academicians of France.

I. As the Aether is a Gas, and thus Isotropic in all Directions for Ordinary Terrestrial Distances, it is a Fundamental Error in the Wave-Theory of Light to deny Radial Motion, in Order to hold to the Doctrine of Vibrations almost wholly transverse to the Direction of a Ray.

It is fully realized that the modern wave-theory of light is so vast a subject that any treatment, even of the foundations merely, necessarily is much more incomplete than those given in standard treatises¹⁾ on light. Yet even a partial discussion of the foundation principles, provided it unfolds a new aspect of the theory of light, may be welcome to investigators who seek the laws of nature.

Thus I deem it worth while to present the results at which I arrived. Under no other principles have I been able to bring the varied phenomena of light into harmony with those of electricity, magnetism, and gravitation.

And since Prof. *Majorana*, of Rome, in the Philosophical Magazine, vol. 39, May, 1920, pp. 488-504, has been able to confirm experimentally the conclusion respecting gravitation to which I was led in 1917, (Electrod. Wave-Theory of Phys. Forc., vol. 1, p. 155) — that the amount of matter within the heavenly bodies is much greater than we heretofore have believed, actually making the sun's true mass three times that accepted by astronomers, — we see evidence of a coming transformation of doctrine in physical science, greater than any which has occurred since the age of *Kepler*, *Galilei*, and *Newton*. The new theory of the lunar fluctuations, motion of Mercury's perihelion, and of the problems of the aether treated of in AN 5044, 5048, seems to have triumphed incontestably.

Under the circumstances it will not do to shut our eyes to new conceptions just because they have not been handed down by traditions. When so many difficulties have arisen in the wave-theory of light, which can not be overcome on the old theory, it seems to be a sign of error in the assumed foundations of the theory itself; and the need for a modification of the theory is therefore urgent, not only in the hope of winning new truth, but also of attaining harmony and simplicity.

If by following the principles of the new theory of the

aether already unfolded we have been able to confirm the work of 1917, — as by *Majorana's* experiment of 1919, — and also obtain a much simpler view of magnetism, electrodynamic action and universal gravitation, — there is plain indication that we should attempt to harmonize the wave-theory of light with this theory of the aether.

In venturing upon this new line of thought, in accordance with the views of *Poisson*, 1830, it is of course understood that investigators should welcome suggestions for improvements which have not yet been made, owing to difficulties in the old point of view, as handed down by tradition from the days of *Young*, *Fresnel*, *Arago*, and *Cauchy*.

In preparing the third paper we discovered a new method for determining the absolute density of the aether, and developed a process by which we were enabled to calculate this density at the surfaces of the sun and planets of the solar system. This new method was found to be applicable to any stellar or sidereal system, where the force of gravity is known by observation, and thus may be extended throughout the immensity of space.

The method has proved to be of great importance in confirming and definitely establishing the small density of the aether, in accordance with the views of *Newton*, *Herschel*, *Kelvin*, and *Maxwell*. This not only does away with the strange claim put forward by electronists that the aether may have an immense density (estimated to be 2000 million times that of lead!), but also definitely establishes the compressibility of the aether when powerful forces act quickly, as in the explosions of dynamite, which was successfully employed by Prof. *Francis E. Nipher* of St. Louis, to disturb the quiescence or the medium.

Since the aether therefore is a gas, with properties which make this medium approximately isotropic for ordinary distances at the surface of the earth, though aeolotropic in respect to the heavenly bodies, as distant centres of wave-agitation, we perceive that the doctrine of the wave-theory of light, that the vibrations are wholly transverse to the direction of the ray, rests on a fundamental error, and a correction is required to take account of the gaseous character of the aether, and its equal compressibility in all directions. Thus, contrary to the assumptions of *Green*, and others, who get rid of the longitudinal component by arbitrarily making that component of the velocity infinite, there is a longitudinal component in light, as in sound; but it is very small, because it depends on the ratio of the amplitude to the wave-length $A/\lambda = 10^{-5}$, due to the very slight compressibility of the aether. The longitudinal component thus becomes $A = (A/\lambda) \cdot \rho$, where ρ is the spherical projection factor, about $1/40$, deduced from Fig. 1, Plate 7; so that the longitudinal component probably does not exceed $1/4000000$ ²⁾. According to the very accurate experiments described by Prof. *Hastings*, in section 5 below, *Huyghens's* construction for the extra-

¹⁾ Among the great standard treatises on light, that by Sir *John Herschel*, Encyclopedia Metropolitana, 1849, is to be especially commended for its comprehensiveness, and because it reflects the state of the subject just after the epoch of *Young*, *Fresnel* and *Arago*. *Drude's* Theory of Optics, translated by *Mann* and *Millikan*, (Longmans, Green & Co., London and New York, 1917) is the best recent treatise with which I am familiar. Lord *Rayleigh's* article Wave-Theory, Encyclopedia Britannica, 9th ed., 1887, presents a masterly survey of the subject, based on great personal experience, and may be unreservedly recommended.

²⁾ Compare the later calculation in the notes of Sept. 12 in section 4, and in section 8, below, which indicate that this component is about $1 : (66420 \cdot 10^6)$.

ordinary wave surface certainly is accurate to 1:10⁶, which therefore lends a remarkable support to the new theory of transverse waves in light.

Finally, it remains to point out that although in our new theory of the aether we usually speak of the waves as resembling the waves on the surface of still water, — which convey to the mind the image of particles revolving in circular or elliptical paths, while the wave form moves on, — yet, [as in the theory of sound, it is allowable, in many phenomena, to conceive the oscillations of the particles to take place in such narrow ellipses as to be practically rectilinear, in the normal to the wave front, according to *Poisson's* theory of 1830. Such approximate rectilinear motion always is referable to simple harmonic motion, according to the ordinary theory of uniform motion in the circle of reference. Thus our theory is not restricted in any way, but is applicable to any possible elliptical oscillation of the particle, from a circle on the one hand, to a straight-line ellipse on the other, as in the displacements referred to simple harmonic motion in the theory of sound.

In the third paper on the new theory of the aether (AN 5079), near the end of section 8, equations (86) to (88) and beyond, we have carefully cited the reasoning of *Poisson*, who devoted over 25 years to the mathematical theory of waves, and in his last papers (1819–1839) maintained that at a great distance from the source of disturbance the motion of the molecules always is sensibly normal to the wave front, as in the theory of sound.

Thus *Poisson* never concurred in the views of *Fresnel*, *Arago*, and *Cauchy*, which were gradually adopted in the traditional wave-theory of light. And it must be plainly pointed out that *Fresnel's* doctrine of purely transverse waves was an assumption pure and simple, which offered a needed explanation of the interference of polarized light.

It is a matter of authentic record that at first *Fresnel* and *Arago* hesitated to take such a radical departure as to postulate transverse waves (cf. *Arago's* Eulogy on *Fresnel*, English translation, Boston, 1849, pp. 212–213).

In regard to the reluctance of the early investigators to admit a lateral vibration in light, it may be pointed out that *Huyghens*, *Newton*, and *Euler* had held to the view of oscillations chiefly in the line of the rays, though *Euler's* equations involve no necessary restrictions as to the direction of vibration, being of the same general form as in the theory of sound,

$$d^2u/dt^2 = -c \cdot \partial^2u/\partial x^2 \quad u = a \sin [2\pi/\lambda \cdot (Vt - x)]. \quad (1)$$

But at length, *Young* began to entertain the idea that the molecules of the aether might oscillate in parallel directions transverse to the direction of the ray, though he thought that longitudinal vibrations might exist also. *Fresnel* independently reached the idea of transverse vibrations, but like *Young* he could not account for it dynamically.

In his *History of the Inductive Sciences*, vol. II, 3rd ed.,

1857, pp. 332–333, Dr. *Whewell* quotes the remarks of *Fresnel* »M. *Young*, more bold in his conjectures and less confiding in the views of geometers, published it before me, though perhaps he thought of it after me.« And from personal information of the progress of the theory of transverse waves, Dr. *Whewell* adds:

»And M. *Arago* was afterwards wont to relate, (I take the liberty of stating this from personal knowledge) that when he and *Fresnel* had obtained their joint experimental results, of the non-interference of oppositely-polarized pencils, and when *Fresnel* pointed out that transverse vibrations were the only possible translation of this fact into the undulatory theory, he himself protested that he had not the courage to publish such a conception; and, accordingly, the second part of the memoir was published in *Fresnel's* name alone. What renders this more remarkable is, that it occurred when M. *Arago* had in his possession the very letter of *Young* (Jan. 12, 1817), in which he proposed the same suggestion.«

From the circumstances here reported it will be seen that *Fresnel* and *Arago* did not feel very secure¹⁾ in their position, under the criticisms of *Laplace*, *Poisson* and their followers. Accordingly *Fresnel* and *Arago* were more than glad to have the mathematical support of *Cauchy*, in favor of the possibility of transmitting transverse waves, if once they existed. But that was all that *Cauchy's* analysis proved. It did not indicate how such transverse waves would arise in nature, nor did *Fresnel* and his followers throw any light on this difficult problem.

Accordingly it appears that the origin of the transverse vibrations in light has never been explained on a satisfactory basis; and for that reason it is hoped that the simple theory in section 4 below may commend itself to geometers and natural philosophers.

Another difficulty of quite fundamental character in the wave-theory of light has been before me for many years. We commonly have offered to us for illustration of transverse waves the vibrations of a single stretched cord: this looks obvious and convincing, when we deal only with a single cord free to vibrate in empty space.

But in the theory of light we should have to imagine all space, in the sphere $V = \frac{4}{3}\pi r^3$, $r = 0$, $r = r$, about the source of light, filled entirely full of such cords, which would thus mutually crowd each other on every side; so that no one of them would have the assumed freedom of the single cord used in our class-room illustrations. The surface of the sphere has the area $S = 4\pi r^2$, and for a spherical shell of thickness dr , the volume is $4\pi r^2 dr$, and the integral of volume is $V = 4\pi \int r^2 dr$.

Now by no possibility can the sphere surface $S = 4\pi r^2$ be increased. Accordingly no one cord can be moved sideways, in transverse vibration, without crowding all the other cords extending outward from the centre, unless we assume simultaneous motion of all the cords in the same direction

¹⁾ In another place, *Hist. of the Induct. Sciences*, vol. II, p. 350, Dr. *Whewell* explains the embarrassment of *Arago* as follows: M. *Arago* would perhaps have at once adopted the conception of transverse vibrations, when it was suggested by his fellow-labourer, *Fresnel*, if it had not been that he was a member of the Institute, and had to bear the brunt of the war in the frequent discussions of the undulatory theory, to which theory *Laplace*, and other leading members, were so vehemently opposed, that they would not even listen with toleration to the arguments in its favour. I do not know how far influences of this kind might operate in producing the delays which took place in the publication of *Fresnel's* papers.«

for the spherical shell $4\pi r^2 dr$. The chances are infinity to one against this occurring.

These considerations alone show that the old wave-theory of light is inadmissible. The same difficulty does not arise in *Poisson's* theory of 1830, which makes the vibrations normal to the wave front, as in sound, and thus allows vibrational increase of space equal to $dV = 4\pi r^2 dr$, where dr is the amplitude of the oscillations. With the new theory as to why the waves are mainly transverse, more fully set forth in section 4, below, it is believed that the last outstanding difficulty in the wave-theory of light has been removed. But before quitting this subject, we may state the expansive difficulty pointed out above with somewhat greater mathematical rigor. If Φ be the velocity-potential, we have the usual differential expression

$$d\Phi = udx + vdy + wdz. \quad (2)$$

Now it is well known that the line integral of the tangential component velocity around any closed curve of a moving (incompressible) fluid remains constant throughout all time; so that when $d\Phi$ is a complete differential, the circulation $\int d\Phi$ is zero, just as in the obvious case when the fluid is at rest:

$$\delta \int d\Phi = \delta \int (udx + vdy + wdz) = 0. \quad (3)$$

When the fluid is incompressible this integral round a closed circuit is evanescent, and the momentum, like the circulation, is zero; but for a compressible fluid, the existence of a velocity-potential Φ does not imply evanescence of the integral momentum round a closed circuit (cf. *Lord Rayleigh, Theory of Sound*, 2nd ed., 1896, vol. 2, pp. 8-9).

In the case of the aether, however, the fluid is so nearly absolutely incompressible that the above theorems will hold, and we may take $d\Phi$ to be essentially an exact differential; so that the velocity in any direction is expressed by the corresponding rate of change of Φ , and therefore

$$du/dx + dv/dy + dw/dz = \partial^2\Phi/\partial x^2 + \partial^2\Phi/\partial y^2 + \partial^2\Phi/\partial z^2. \quad (4)$$

Let us now consider any closed surface, such as that of the sphere already spoken of, $S = 4\pi r^2$. Then the rate of flow of the fluid outward, across the element dS , becomes:

$$dS \cdot d\Phi/dn.$$

And when the density is constant, the total loss of fluid in time dt is given by the double integral:

$$(\delta/\delta t)(\frac{4}{3}\pi\sigma r^3) = \iint d\Phi/dn \cdot dS dt \quad (5)$$

where the integration is to be extended over the entire surface $S = 4\pi r^2$.

Now when the sphere surface S is full both at the beginning and at the end of dt , the loss of fluid vanishes, so that

$$(\delta/\delta t)(\frac{4}{3}\pi\sigma r^3) = \iint d\Phi/dn \cdot dS dt = 0. \quad (6)$$

The equation of continuity, for an incompressible fluid deduced from the spacial element $dx dy dz$, under this condition of no loss of fluid across the boundary, is

$$\partial^2\Phi/\partial x^2 + \partial^2\Phi/\partial y^2 + \partial^2\Phi/\partial z^2 = 0 \quad (7)$$

or briefly $\nabla^2\Phi = 0$.

And as *Poisson's* equation of wave motion is

$$\partial^2\Phi/\partial t^2 = a^2\nabla^2\Phi. \quad (8)$$

we see that $\nabla^2\Phi = 0$, excludes the existence of waves, if this condition held rigorously for the time dt .

Wherefore we conclude that in traversing the surface S , the condition in (6) will hold for the wave from the centre at the beginning and also at the end of the time dt , corresponding to the propagation of a wave through all its phases, over the wave-length λ , which represents a complete oscillation of the fluid.

But for shorter intervals, the equation (6) will not hold rigorously; so that temporarily, over an interval less than the wave frequency, $\tau = 2\pi/v = \lambda/V$, there is both slight compressibility and a flow of the fluid across the boundary $S = 4\pi r^2$; and, for $\delta t < \tau$ we have:

$$(\delta/\delta t)(\frac{4}{3}\pi\sigma r^3) = \iint d\Phi/dn \cdot dS dt = \pm dm \quad (9)$$

where dm is the total fluid temporarily lost, an infinitesimal mass positive or negative.

Accordingly, in the wave motion of the aether, there is slight compressibility, and a minute temporary radial motion of the fluid does take place. Hence we cannot have purely transverse motion, as assumed in the traditional form of the wave-theory of light due to *Fresnel* and *Cauchy*.

During the last half century these problems have been discussed by many eminent natural philosophers — *Lord Kelvin, Maxwell, Lord Rayleigh, Larmor, Glazebrook*, etc., — but whilst they give up *Green's* views, they do not reach satisfactory accord in their views of the aether. A useful summary of their reasoning is given in *Daniell's Principles of Physics*, 3rd edition, 1895, p. 510. Under the circumstances we have felt that the older views must be entirely abandoned, and the waves in the aether treated as in *Poisson's Theory* of 1830. There is no experimental evidence of different velocities for compressional and distortional waves, and no such assumptions are authorized by the existing state of our knowledge.

2. *Maxwell's* Electromagnetic Theory of Light rests on Vibrations wholly transverse to the Direction of a Ray, and thus in View of the above Considerations the Electromagnetic Theory also must be rejected as not based strictly on the Laws of Nature.

We have just outlined the geometrical and physical difficulty encountered by *Fresnel's* classical conception of vibrations wholly transverse to the direction in which light is propagated; and have shown how waves flat in the equators of the atoms, under haphazard arrangement of the atomic planes, would be equivalent to the uniform spherical distribution of the elliptical vibration paths exhibited to the eye in Fig. 1, Plate 7. This new principle in the wave-theory of light gives two remarkable results:

1. From any spherical source of light, or luminous mass, where the number of atoms is large, it would lead to vibrations so nearly transverse, that the longitudinal component probably would not exceed the value $1/(4 \cdot 10^6)$, and thus be insensible¹⁾ to observation in optical experiments.

¹⁾ A much smaller value $1/(66420 \cdot 10^6)$, is reached in section 4 below, Sept. 12, 1920.

2. It makes the molecules oscillate primarily in the direction of the normal to the wave-front, as held by *Huyghens*, *Newton*, *Euler*, *Lagrange*, *Laplace* and *Poisson*, prior to the theory of lateral vibrations of the stretched cord introduced by *Young*, *Fresnel* and *Cauchy*. Thus we have at once a vindication of the profound wave-theory of *Poisson*, 1830, without need for recourse to the artificial and dynamically inadmissible theory of *Fresnel*, that the vibrations are wholly transverse.

The above citations from *Whewell* show that *Young*, *Fresnel* and *Arago* were loth to entertain the theory of purely lateral vibrations, which they could not account for dynamically, as contrary to the views of geometers since the age of *Newton*. Apparently it never occurred to *Young* and *Fresnel* that a theory of projection for *Poisson's* normal elliptical paths, such as is shown in Fig. 1, Plate 7, multiplied by the small ratio A/λ , would give mean vibrations almost normal to the ray, without the strained and unnatural theory of lateral motion appropriate to a stretched cord.

The theory of lateral vibrations, drawn from the example of the stretched cord, is approximately correct, as respects the smallness of the longitudinal component, but it is wholly lacking in physical basis, as shown above in section I. Moreover it introduces an unfortunate and unnecessary conflict between the doctrines of experimental physics and geometry. The eminent experimenters, *Fresnel* and *Arago*, and the great analyst *Cauchy*, were thus arrayed against *Laplace*, *Poisson*, and *Lamé*; yet apparently it was not possible for these illustrious academicians to settle the controversy which thus arose, because the premises in their reasoning departed from the order of nature.

If the theory above traced be admissible, it follows that the claims of geometers since the days of *Newton* and *Euler*, as put forth by *Laplace* and *Poisson*, certainly were correct, that at a great distance from the source of the disturbance the molecular oscillations are normal to the wave front. On the other hand, the average vibration in light is nearly normal to the ray, owing to the effect of the spherical projection from the variously tilted elliptical paths at the source of the light, and the smallness of A/λ . Accordingly we are impressed with the necessity of the most crucial test of the premises underlying our reasoning in natural philosophy.

In order to outline this defect clearly, we shall now treat of the difficulty of the electromagnetic theory of *Maxwell*, which will also show the unwarranted assumptions underlying the *Fresnel-Cauchy* wave-theory.

»If I knew,« says *Lord Kelvin*, (Baltimore Lectures, 1904, p. 9) »what the electromagnetic theory of light is, I might be able to think of it in relation to the fundamental principles of the wave theory of light. But it seems to me that it is rather a backward step from an absolutely definite mechanical motion that is put before us by *Fresnel* and his followers to take up the so-called electromagnetic theory of light in the way it has been taken up by several writers of late. In passing, I may say that the one thing about it that seems intelligible to me, I do not think is admissible. What I mean is, that there should be an electric displacement perpendicular to the line of propagation and a magnetic

disturbance perpendicular to both. It seems to me that when we have an electromagnetic theory of light, we shall see electric displacement as in the direction of propagation, and simple vibrations as described by *Fresnel* with lines of vibration perpendicular to the line of propagation, for the motion actually constituting light.«

If *Lord Kelvin* had such difficulty in understanding the electromagnetic theory of light, it undoubtedly is very allowable for the present writer to attempt to put the theory of light on a simpler basis.

The figure from *Maxwell's* Treatise on Electricity and Magnetism, vol. II, p. 439, cited below, will put before our minds the electric and magnetic vibrations, conceived to be in planes at right angles to each other, and thus calling forth the above severe criticism by *Lord Kelvin*, who was long an associate and friend of *Maxwell*. It seems to be certain that *Lord Kelvin* was very much bewildered by the unnatural complications of the electro-magnetic theory, and thus it proved of little or no value to him.

In his *Électricité et Optique*, 1901, p. 73, *Poincaré* has pointed out the difficulties and contradictions he found in following *Maxwell's* processes. »Il ne faut pas attribuer à cette contradiction trop d'importance. J'ai exposé plus haut en effet les raisons qui me font penser que *Maxwell* ne regardait la théorie du déplacement électrique ou du fluide inducteur que comme provisoire, et que ce fluide inducteur auquel il conservait le nom d'électricité, n'avait pas à ses yeux plus de réalité objective, que les deux fluides de *Coulomb*.«

The importance of having a perfectly clear understanding of *Maxwell's* electromagnetic theory is so great that we quote his reasoning in full. It is not very long, and the deductions will justify it (pag. 438-39-40).

»790. Let us now confine our attention to plane waves, the fronts of which we shall suppose normal to the axis of z . All the quantities, the variation of which constitutes such waves, are functions of z and t only, and are independent of x and y . Hence the equations of magnetic induction, (A), Art. 591, are reduced to

$$a = -dG/dz \quad b = dF/dz \quad c = 0 \quad [13] \quad (10)$$

or the magnetic disturbance is in the plane of the wave. This agrees with what we know of that disturbance which constitutes light.«

»Putting $\mu\alpha$, $\mu\beta$ and $\mu\gamma$ for a , b and c respectively, the equations of electric currents, Art. 607, become

$$\begin{aligned} 4\pi\mu u &= -db/dz = -d^2F/dz^2 \\ 4\pi\mu v &= da/dz = -d^2G/dz^2 \\ 4\pi\mu w &= 0. \end{aligned} \quad [14] \quad (11)$$

»Hence the electric disturbance is also in the plane of the wave, and if the magnetic disturbance is confined to one direction, say that of x , the electric disturbance is confined to the perpendicular direction, or that of y .«

»But we may calculate the electric disturbance in another way, for if f , g , h are the components of electric displacement in a non-conducting medium,

$$u = df/dt \quad v = dg/dt \quad w = dh/dt. \quad [15] \quad (12)$$

»If P , Q , R are the components of the electromotive intensity,

$f = K/4\pi \cdot P$ $g = K/4\pi \cdot Q$ $h = K/4\pi \cdot R$ [16] (13)
 and since there is no motion of the medium, equations (B), Art. 598, become

$$P = -dF/dt \quad Q = -dG/dt \quad R = -dH/dt, \quad [17] \quad (14)$$

Hence

$$u = -K/4\pi \cdot d^2F/dt^2 \quad [18] \quad (15)$$

$$v = -K/4\pi \cdot d^2G/dt^2 \quad w = -K/4\pi \cdot d^2H/dt^2.$$

Comparing these values with those given in equation [14], we find

$$d^2F/dz^2 = K\mu \cdot d^2F/dt^2 \quad [19] \quad (16)$$

$$d^2G/dz^2 = K\mu \cdot d^2G/dt^2 \quad d^2H/dz^2 = K\mu \cdot d^2H/dt^2.$$

»The first and second of these equations are the equations of propagation of a plane wave, and their solution is of the well known form

$$F = f_1(z - Vt) + f_2(z + Vt) \quad [20] \quad (17)$$

$$G = f_3(z - Vt) + f_4(z + Vt).$$

The solution of the third equation is

$$H = A + Bt \quad [21] \quad (18)$$

where A and B are functions of z . H is therefore either constant or varies directly with the time. In neither case can it take part in the propagation of waves.«

»791. It appears from this that the directions, both of the magnetic and the electric disturbances, lie in the plane of the wave. The mathematical form of the disturbance therefore agrees with that of the disturbance which constitutes light, being transverse to the direction of propagation.«

»If we suppose $G = 0$, the disturbance will correspond to a plane-polarized ray of light.«

»The magnetic force is in this case parallel to the axis of y and equal to $1/\mu \cdot dF/dz$, and the electromotive intensity is parallel to the axis of x and equal to $-dF/dt$. The magnetic force is therefore in a plane perpendicular to that which contains the electric intensity.«

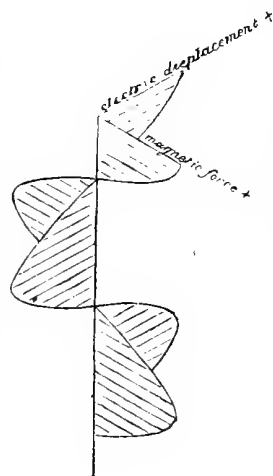


Fig. 2 = Maxwell's Fig. 67.

»The values of the magnetic force and of the electromotive intensity at a given instant at different points of the ray are represented in Fig. 67, (cf. Fig. 2), for the case of a simple harmonic disturbance in one plane. This corresponds to a ray of plane-polarized light, but whether the plane of polarization corresponds to the plane of the magnetic disturbance, or to the plane of the electric disturbance, remains to be seen.«

Critical Analysis of Maxwell's Processes.

1. Maxwell conceived the vibrations to be entirely in the wave-front, normal to the axis of z , and thus wholly dependent on x and y . This is a pure assumption, in accordance with the orthodox theory, but indefensible, as is more fully shown hereafter.

2. It appears that Maxwell did not regard the electric or magnetic vibrations as having any kind of vortical rotation as the wave form moves on, because he expressly states, near the close of section 791, that »this corresponds to a ray of plane-polarized light,« which in the orthodox classical theory of Fresnel is conceived to be direct linear vibrations, at right angles to the direction of the ray, as shown in Maxwell's figure.

3. After much investigation, we have reached the conclusion that such suppositions are pure hypotheses, not justified by anything in nature. For we cannot hold the aether to be a superfine gas, the aetherons having all the degrees of freedom appropriate to Poisson's equation

$$[\partial^2\Phi/\partial t^2 = a^2(\partial^2\Phi/\partial x^2 + \partial^2\Phi/\partial y^2 + \partial^2\Phi/\partial z^2)] \quad (19)$$

and fail to admit three component motions depending on x , y and z .

4. There was a celebrated controversy on this point between Poisson and Fresnel and their followers, in the Institute of France, (1819-1839), but to the end Poisson held to the conclusion that in general the vibrations are not normal to the direction of the ray. Fresnel himself held such views, in virtue of the necessity of explaining polarization, interference, etc.; and Cauchy's mathematical researches seemed to indicate that if vibrations existed normal to the ray, they could be propagated in the aether.

5. There is no doubt that any kind of vibrations, once established in the aether, may be propagated in that medium; but this does not show that the actual vibrations in polarized light are of this type. Here is a fundamental error in the wave-theory of light, which the wave-theory of magnetism has enabled us to correct.

6. We hold that light must have a longitudinal component depending on the ratio of the amplitude to the wave length, which is small but finite. In the Philosophical Magazine for Sept., 1896, Fitzgerald has a thoughtful and useful paper on this subject, beginning as follows:

»In most investigations on the propagation of light, attention has been concentrated on the transverse nature of the vibration. Longitudinal motions have been relegated to the case of pressural waves, and investigators have devoted themselves to separating the two as much as possible. In Sir George Stokes's classical paper on Diffraction, and in Lord Kelvin's Baltimore Lectures, the existence of a longitudinal component is mentioned; but it is mentioned only to show that it is very small and that the motion is mostly transverse. Now the longitudinal component is no doubt generally small, except in the immediate neighbourhood of a source; but it by no means follows that, as a consequence, the actual direction of motion is transverse at all points in a wave. In every complicated wave there are points and often lines along which the transverse component vanishes, and at all these places the small longitudinal component may be, and often is, of great relative importance, so that the actual motion is largely in the direction of wave-propagation at these places.« (cf. Fitzgerald's Scientific Writings, 1902, p. 418.)

7. The principle of the dependence of the longitudinal component in light on the ratio of the amplitude to the

wave length, $\lambda = A/\lambda \cdot q$, will enable us on the one hand to reconcile the views of *Poisson*, on wave propagation, with those of *Fresnel* and *Cauchy*; and on the other hand to correct a fundamental defect in the wave-theory of light, which has stood for nearly a century.

8. Thus it will be seen that *Maxwell's* figure above given has handed down the defect of lack of rotation of the wave elements, whatever be the amplitude, and therefore does not represent nature. No wonder that Lord *Kelvin* and others have failed to understand the electromagnetic theory. As given by *Maxwell* it is contrary to the profound and conscientious researches of *Poisson*, which were critically examined by *Laplace* and *Fourier*, and not at all authorized by the researches of *Cauchy*. With *Poincaré*, therefore, we dismiss *Maxwell's* electromagnetic theory as 'provisoire', not deduced from the laws of nature, but from certain arbitrary assumptions, and therefore fundamentally defective.

3. The *Cauchy-Fresnel* Theory of wholly Transverse Vibrations dynamically Inadmissible for a Gaseous Medium of High Elasticity and practically Incompressible, whether Isotropic or Aeolotropic.

In his celebrated article on the Wave-Theory, *Encyclopaedia Britannica*, 9th ed., the late Lord *Rayleigh* often points out the weakness of the wave-theory of light, and shows that although we may adopt it as a working hypothesis, we are not to trust the theory as a representation of nature. Thus on pp. 422-445-446, he points out *Green's* assumption that the longitudinal component has infinite velocity, in order to get rid of this difficulty; but it is evident that Lord *Rayleigh* regarded this procedure as a somewhat violent hypothesis, scarcely justified by any known phenomenon. *Rayleigh* says:

»The idea of transverse vibrations was admitted with reluctance, even by *Young* and *Fresnel* themselves. A perfect fluid, such as the ethereal medium was then supposed to be, is essentially incapable of transverse vibrations. But there seems to be no reason a priori for preferring one kind of vibration to another; and the phenomena of polarization prove conclusively that, if luminous vibrations are analogous to those of a material medium, it is to solids, and not to fluids, that we must look. An isotropic solid is capable of propagating two distinct kinds of waves, — the first dependent upon rigidity, or the force by which shear is resisted, and the second analogous to waves of sound and dependent upon compressibility. In the former the vibrations are transverse to the direction of propagation, that is, they may take place in any direction parallel to the wave front, and they are thus suitable representatives of the vibrations of light. In this theory the luminiferous ether is distinctly assimilated to an elastic solid, and the velocity of light depends upon the rigidity and density assigned to the medium.«

»The possibility of longitudinal waves, in which the displacement is perpendicular to the wave-front, is an objection to the elastic-solid theory of light, for there is nothing known in optics corresponding thereto. If, however, we suppose with *Green* that the medium is incompressible, the velocity of longitudinal waves becomes infinite, and the objection is in great degree obviated.«

On page 422 *Rayleigh* had already indicated the limitations of the elastic-solid theory:

»For these and other reasons, especially the awkwardness with which it lends itself to the explanation of dispersion, the elastic-solid theory, valuable as a piece of purely dynamical reasoning, and probably not without mathematical analogy to the truth, can in optics be regarded only as an illustration.«

In order to set forth this difficulty somewhat more clearly we shall outline the mathematical theory of plane waves in homogeneous elastic solids. The new theory of magnetism, in relation to light, recently developed, requires for comparison a definite outline of the theory of plane waves in a homogeneous elastic solid. It is only in this way that we can decide whether the waves from a magnet are similar to those of a solid, or are of a somewhat different nature.

The following very brief outline is founded on Lord *Kelvin's* article Elasticity, *Ency. Brit.* 9th ed., p. 824-5; but is in accord with the researches of *Cauchy*, *Rankine*, *Green*, Lord *Rayleigh*, *Love*, and many other eminent authorities.

(i) Definitions. Let the rectangular axes OX , OY , OZ be so oriented that OX is perpendicular to the wave front, and OY , OZ in the plane of the wave front. Then if α , β , γ be the displacements of a particle of the solid, whose undisturbed coordinates are (x, y, z) we have for any time the disturbed coordinates $x + \alpha$, $y + \beta$, $z + \gamma$. Accordingly the displacements α , β , γ are functions of x and t , and this is the definition of wave motion.

There is therefore a simple longitudinal strain ξ in the direction of OX , and two differential slips, η parallel to OY , and ζ parallel to OZ , which are simple distortions, in the shear of planes of the material one over the other.

The values are

$$\xi = d\alpha/dx \quad \eta = \sqrt{2} \cdot d\beta/dx \quad \zeta = \sqrt{2} \cdot d\gamma/dx. \quad (20)$$

(ii) Calculation of the work done to produce strain.

If W denote the work per unit volume required to produce this strain, the stress quadric becomes:

$$W = \frac{1}{2} (A\xi^2 + B\eta^2 + C\zeta^2 + 2D\eta\zeta + 2E\zeta\xi + 2F\xi\eta) \quad (21)$$

which is an ellipsoidal surface, A , B , C , D , E , F being moduluses of elasticity of the solid.

If p , q , r be the three components of the traction per unit area of the wave front, we shall have the linear equations connecting the strain and slips with the moduluses of elasticity:

$$\begin{aligned} p &= A\xi + F\eta + E\zeta \\ q\sqrt{1/2} &= F\xi + B\eta + D\zeta \\ r\sqrt{1/2} &= E\xi + D\eta + C\zeta. \end{aligned} \quad (22)$$

Now let it be further assumed ξ , η , ζ fulfill linear relations, with the moduluses of elasticity in the three directions:

$$\begin{aligned} M\xi &= A\xi + F\eta + E\zeta \\ M\eta &= F\xi + B\eta + D\zeta \\ M\zeta &= E\xi + D\eta + C\zeta. \end{aligned} \quad (23)$$

The resulting determinantal cubic gives three real positive values for M , which define the ways in which the solid may be strained. If we substitute any one of these values

in (23), we may derive the ratios $\xi:\eta:\zeta$; and the components of the traction yield

$$p = M \cdot d\alpha/dx \quad q = M \cdot d\beta/dx \quad r = M \cdot d\gamma/dx. \quad (24)$$

The three components of the whole force due to the tractions of the sides of an infinitesimal parallelepiped $\delta x \delta y \delta z$ of the solid obviously are:

$$d p/dx \cdot \delta x \delta y \delta z \quad d q/dx \cdot \delta x \delta y \delta z \quad d r/dx \cdot \delta x \delta y \delta z. \quad (25)$$

Now these component forces are in equilibrium with the mass ρ in the same element of space; and hence we have the resulting equations:

$$\begin{aligned} d^2\alpha/dt^2 \cdot \rho \delta x \delta y \delta z &= d p/dx \cdot \delta x \delta y \delta z \\ d^2\beta/dt^2 \cdot \rho \delta x \delta y \delta z &= d q/dx \cdot \delta x \delta y \delta z \\ d^2\gamma/dt^2 \cdot \rho \delta x \delta y \delta z &= d r/dx \cdot \delta x \delta y \delta z. \end{aligned} \quad (26)$$

(iii) Equations of motion for waves in an elastic solid.

Without regard to the space of the element, therefore, the equations of motion are:

$$\begin{aligned} d p/dx &= \rho \cdot d^2\alpha/dt^2 & d q/dx &= \rho \cdot d^2\beta/dt^2 \\ d r/dx &= \rho \cdot d^2\gamma/dt^2. \end{aligned} \quad (27)$$

Substituting the values of ξ , η , ζ from (20), in (23) and integrating in respect to x , we get

$$\begin{aligned} A\alpha + (F\beta + E\gamma)V_2 &= M\alpha \\ F\alpha + (B\beta + D\gamma)V_2 &= M\beta V_2 \\ E\alpha + (D\beta + C\gamma)V_2 &= M\gamma V_2. \end{aligned} \quad (28)$$

The three roots of his determinantal cubic may be called M_1 , M_2 , M_3 ; and the corresponding values of the ratios β/α , γ/α , determined by (28), may be denoted by b_1 , c_1 , b_2 , c_2 , b_3 , c_3 .

Accordingly the complete solution of (27), subject to (28), becomes of the form:

$$\begin{aligned} \alpha &= \alpha_1 + \alpha_2 + \alpha_3 \\ \beta &= b_1 \alpha_1 + b_2 \alpha_2 + b_3 \alpha_3 \\ \gamma &= c_1 \alpha_1 + c_2 \alpha_2 + c_3 \alpha_3 \\ \alpha_1 &= f_1[x + tV(M_1/\rho)] + F_1[x - tV(M_1/\rho)] \\ \alpha_2 &= f_2[x + tV(M_2/\rho)] + F_2[x - tV(M_2/\rho)] \\ \alpha_3 &= f_3[x + tV(M_3/\rho)] + F_3[x - tV(M_3/\rho)]. \end{aligned} \quad (29)$$

(iv) Three different wave velocities inferred.

In the above equations f_1 , f_2 , f_3 , F_1 , F_2 , F_3 are arbitrary functions. Owing to the form of these expressions it is therefore inferred that there are three different wave velocities, namely:

$$V_1 = V(M_1/\rho) \quad V_2 = V(M_2/\rho) \quad V_3 = V(M_3/\rho) \quad (30)$$

and three different kinds of waves, determined by (28), and depending on the aeotropic character of the solid. The waves are therefore very complex, but are much simplified in an isotropic medium.

Simple case of waves in an isotropic solid.

Let the solid be isotropic, and then the modulus of elasticity reduce to the Form:

$$\begin{aligned} B &= C & D &= E = F = 0 \\ M_1 &= A & M_2 &= M_3 = B. \end{aligned} \quad (31)$$

Accordingly, the above three different kinds of waves with three different velocities now reduce to just two: Compressional or Longitudinal.

1. A compressional wave, like that of sound in air, or other elastic fluid, with the motion normal to the wave front. This corresponds to the conclusion reached by *Poisson* in his celebrated memoir of 1830, and holds for any elastic medium.

2. A transverse wave, with the motion parallel to the wave front. This wave depends on the assumed properties of an elastic solid, which resists shearing motion, as when one layer slides over another.

(v) The simplest case of waves in an incompressible solid, aeotropic or isotropic.

When the solid is incompressible *Green* has shown from equation (21) above, that the modulus of elasticity $A = \infty$; and hence the displacement along the x -axis vanishes, or $\alpha = 0$, $\xi = 0$. Therefore (21) becomes simply

$$W = B\eta^2 + C\zeta^2 + 2D\eta\zeta. \quad (32)$$

And the first of (23) vanishes, leaving merely:

$$B\eta + D\zeta = M\eta \quad D\eta + C\zeta = M\zeta. \quad (33)$$

This restriction of the oscillations to the plane of $\eta\zeta$, gives a determinantal quadratic instead of cubic, yielding two wave velocities and two wave modes. The velocity along the axis of x is thereby taken to be infinite and α disappears; leaving the two velocities:

$$V_2 = V(M_2/\rho) \quad V_3 = V(M_3/\rho). \quad (34)$$

And in the case of isotropy, $V_2 = V_3$, as in (31), and M_2 and M_3 are principal modulus, each equal to the modulus of rigidity.

As Lord *Kelvin* points out, M_1 is a mixed modulus of compressibility and rigidity — not a principal modulus generally, because the distortions by differential motions of planes of particles parallel to the wave front give rise to tangential stresses orthogonal to them, which do not influence the wave motion.

(vi) Conclusion applicable to the elastic medium of the aether gas.

This outline of the theory of plane waves in homogeneous elastic solids enables us to form a fair idea of the possible types of motions of waves in the aether. When the motion of the aether wave is not through ponderable bodies, it is free of most restrictions, and follows rectilinear paths: if through ponderable masses, the action always follows *Fermat's* minimum path, defined by *Hamilton's* stationary condition, $\delta \int ds = 0$.

Accordingly we learn from the above analysis that most any kind of motion may be transmitted by the waves of an elastic solid: and the question to be discussed is therefore not the type of waves which may be transmitted, but rather the type of waves which actually exist in nature, and have therefore to be transmitted by the aetherial medium.

This is mainly an observational question, and the observations should therefore be extended to the phenomena of magnetism and gravitation as well as to those of light and heat:

1. Since the aether is a gas, and therefore compressible, by extremely powerful quick-acting forces, it follows from the kinetic theory, that even if the propagation of waves

by means of vibrations wholly transverse to the direction of a ray of light be a geometrical possibility, and *Cauchy* showed, and *Airy* and *Herschel* confirmed by independent researches, it is physically inadmissible to assume transverse displacements, and deny corresponding longitudinal displacements, such as was implied in the theory of *Poisson*, 1836, and suggested by *Fitzgerald's* paper on the Longitudinal Component in Light, 1896.

2. For such an arbitrary restriction would give the aether gas anisotropic properties, — symmetrical as respects the xy -plane, but unsymmetrical in respect to the z -axis, along which the light is propagated, — for no assignable physical reason, except that the light is propagated along the z -axis.

3. And this unsymmetrical anisotropy would change its direction in space with the change in the direction of the ray of light, or the mere rotation of the axis about the origin of coordinates; and hence we see that the hypothesis is physically inadmissible. Such a physical doctrine that the property of the aether changes with the direction of the ray can no more hold a place in natural philosophy than can an established *reductio ad absurdum* in geometry.

4. If we view the aether in free space, as homogeneous and isotropic, except as rendered heterogeneous and aeolotropic at great distances, as of the celestial bodies, — as shown in the first paper on the New Theory of the Aether, AN 5044, — we cannot admit that its vibratory motion is different in different directions, and changing with the direction in which the light is allowed to travel.

5. Therefore if we admit a series of transverse displacements of the aether particles for making waves of the type imagined by *Fresnel*, *Cauchy*, Sir *John Herschel*, *Airy*, *Kelvin* and *Maxwell*, we must admit also corresponding longitudinal displacements of the aether in the direction of wave propagation — thus giving rise to rotations about mean positions, or true waves of the type imagined by *Poisson*.

6. Instead of the special polarized waves imagined by *Maxwell* of the type described in section 2 above, and implying merely a rectilinear side oscillation of the particles, like that of a stretched cord, we should therefore imagine waves of the *Poisson* type, referable to simple harmonic motion as illustrated by the modified figure of *Airy* for the surface of still water.

The geometrical conditions are fixed by the equations:

$$\begin{aligned} u &= a \cos(2\pi t/\tau + \rho) \\ v &= b \cos(2\pi t/\tau + \rho) \\ w &= c \cos(2\pi t/\tau + \rho) \end{aligned} \quad \begin{aligned} (u/a)^2 + (v/b)^2 + (w/c)^2 &= 1 \\ s &= \sqrt{u^2 + v^2 + w^2}. \end{aligned} \quad (35)$$

7. It is therefore evident that in adopting *Cauchy's* ideas of vibrations similar to that of a stretched cord, *Herschel* was misled, and he in turn misled *Airy* and others — substituting a mere geometrical abstraction, and practically a physical impossibility, for the valid physical theory of *Poisson*, which makes the vibrations of the aether similar to those of sound, but A/λ very small.

8. The result has been a traditional false teaching in the wave-theory of light, as hinted at by *Fitzgerald* in the memoir »On the Longitudinal Component of Light,« (The

Scientific Writings of *Fitzgerald*, p. 418), and by Professor *Chas. S. Hastings*, *Encyclopedia Americana*, 1904, article Light, quoted in section 1 above, where it is pointed out that the conviction has grown that the wave-theory is in some way wrong.

9. It is obvious that waves of the types imagined by *Cauchy* and *Fresnel* could be transmitted by the perfectly elastic aether if they existed — as is correctly held by *Herschel* and *Airy* — but the question of fact remains: Do they in general exist?

10. This important question must be answered in the negative. For in magnetism we recognize, from *Faraday's* rotation of a beam of polarized light, 1845, the rotations of the elements of the aether, the atoms having their equators lying in parallel planes. In common luminous bodies, on the other hand, no such parallelism in the atomic planes can be assumed: indeed this parallelism must be emphatically denied.

11. And as we cannot have luminous bodies, with the atomic planes all parallel, as in magnetism; so also we can not imagine these atoms so tilted as to send rays to us only from their combined poles. Hence the wave-theory of light as heretofore taught is physically inadmissible.

12. We must hold that the waves of light in general are flat in the planes of the equators of the atoms, and these planes tilted at all possible angles, as explained below in Section 4. If the axis of z be in the plane of the equator of the vibrating atom, the oscillation will be of the plane wave type commonly shown. If the axis of z lies in the northern hemisphere of the atom, the approaching waves, as we look at them, will seem to rotate left handed, in the form of a left handed helix. If the z -axis lies in the southern hemisphere of the atom, the waves received will seem to rotate right handed, like the coils of a right handed helix.

4. Geometrical Reasons why the Vibrations of Ordinary Light are mainly Transverse.

If we contemplate the hemisphere presented to our view by a luminous spherical source of light, such as the sun, it is evident that the waves propagated towards the observer will cover a surface of area

$$A = 2\pi r^2. \quad (36)$$

And in orthogonal projection this area will be reduced by one half, and become merely the area of a single great circle of the sphere

$$A' = \pi r^2. \quad (37)$$

The sphere surface seen by us in projection is enormously fore-shortened and contracted in area at the border, while at the centre no decrease in apparent area takes place. If therefore the atoms emit waves which are flat in the planes of their equators, and a haphazard arrangement of the atomic planes holds true, as should occur in a non-magnetic sphere, it follows that the beam of light emitted by the sun should have its vibrations so largely peripheral that, with A/λ very small, it will present practically the appearance of transverse vibrations, — as long taught in the wave-theory of light.

In order to examine into this subject somewhat more critically we may proceed as follows. Let Fig. 3, Plate 7, represent an orthogonal projection of the sun's hemisphere,

with the centre at O , and the coordinate axes OX and OY as shown in the diagram. Then, if we subdivide the quadrant of the circle into 20 parts, corresponding at the centre to an angular distance of 4.5° between the small circles about that point O as a pole, we may plot a curve along the radius OX which will represent a section of the visible surface of the hemisphere; as if the area were not decreased by the orthogonal projection. The equal distances along the radius OX will represent equal values of the sine of the polar distance, θ , or equal values of the cosine of the latitude reckoned from the base of the hemisphere here represented by the lower circle.

The curve may be drawn from a table of natural sines or cosines by taking y proportional to this function, so that the change will make a curve of the kind indicated in the Fig. 3, Plate 7, which is repeated on both sides of O , in order to show to the eye the enormous condensation of surface near the circumference of the projected hemisphere. In fact the double curve on both sides of O is a semicircle, drawn about Y as a centre, and thus exceedingly simple.

The coordinates of the curve, to four places of decimals, and the surface integral I for the component of *Poisson's* radial wave motion in line of sight, equation (38), are:

Angle θ_i	X_i = $\sin \theta_i$	Y_i = $1 - \cos \theta_i$	I
0°	0.0000	0.0000	0.00308
4.5	0.0785	0.0031	0.00915
9.0	0.1564	0.0123	0.01502
13.5	0.2334	0.0277	0.02052
18.0	0.3090	0.0489	0.02551
22.5	0.3826	0.0762	0.02985
27.0	0.4540	0.1090	0.03342
31.5	0.5224	0.1474	0.03634
36.0	0.5878	0.1910	0.03814
40.5	0.6494	0.2397	0.03916
45.0	0.7071	0.2929	0.03906
49.5	0.7603	0.3506	0.03824
54.0	0.8090	0.4122	0.03625
58.5	0.8526	0.4776	0.03350
63.0	0.8910	0.5460	0.02978
67.5	0.9238	0.6174	0.02761
72.0	0.9511	0.6910	0.02050
76.5	0.9723	0.7666	0.01501
81.0	0.9877	0.8436	0.00914
85.5	0.9969	0.9215	0.00310
90.0	1.0000	1.0000	$\sum_{i=1}^{i=20} = 0.50238$

$$I = (\sin \theta_i - \sin \theta_{i-1}) \sin^{1/2}(\theta_i + \theta_{i-1}) \quad I_m = 0.025119 = 1/40, \text{ nearly.}$$

$$I_m = 1/40 \quad A = A/\lambda \cdot I_m. \quad (38)$$

From these considerations it is evident that if we imagine the atoms in the sphere to have their equatorial planes directed radially, which will be the average position in a large mass, under haphazard atomic arrangement, the effect will be to give us an enormous preponderance of transverse vibrations near the periphery of our luminous

globe, or in a ray of ordinary light from a globe like the sun or a star. This reasoning applies to any luminous body or flame, such as that from a Bunsen-burner in our laboratories, which have haphazard arrangement of the atomic planes, all atoms vibrating so rapidly that from any single atom several hundred waves of the same type will reach the eye of the observer before the translatory motions of the luminous atoms will produce appreciable change.

In his *Undulatory Theory of Optics*, 1866, pp. 155-156, *Airy* says:

»Common light consists of successive series of elliptical vibrations (including in this term plane and circular vibrations), all the vibrations of each series being similar to each other, but the vibrations of one series having no relation to those of another. The number of vibrations in each series must amount to at least several hundreds; but the series must be so short that several hundred series enter the eye in every second of time.«

This criterion of *Airy* obviously is fulfilled by the light from any luminous source, since even in a very small mass the atoms are numbered by the trillion, and no change in their average orientation occurs with the lapse of time, though individual atoms in their mutual interactions will slowly shift their individual equatorial planes to new positions, as the millions of millions of vibrations are emitted.

The centre of the yellow light of the spectrum has a frequency of 517500000000 vibrations per second; and thus with such an enormous flow of waves, they might be subdivided into ten thousand million successive series and still leave a flood of 51750 groups of waves beating upon the eye in a second. Accordingly, *Airy's* criterion is perfectly consistent with the motions of the individual atoms, in mutual collisions at the rate of say 10000000000 per second (cf. AN 5044, p. 66), which is about the average for terrestrial gases under laboratory conditions:

Returning now to our figure for illustrating the enormous preponderance of transverse rays in a beam of ordinary light, we easily find by calculation that 62 percent of the light comes from the zone $\theta = 90^\circ$ to $\theta = 51^\circ 45' 27''$, near the periphery of the orthogonally projected sphere surface. We may even extend this zone inward to $\theta = 44^\circ 25' 30''$ and still not approach the centre of the circle more than 0.30 of the radius; yet this outer zone to θ' includes 71.4 percent of the luminous sphere surface. Thus we see from the corresponding small circles drawn in the figure about the pole O , why in ordinary light it may be described as practically transverse — since a great preponderance of the light from the atoms acts as if the vibratory motion were in the plane of the wave surface.

The great hollowing out of the curve of light near the centre of the figure, from which alone indications of a longitudinal component could be expected to come, and the smallness of the factor A/λ , shows why there is such a feeble indication of this longitudinal component in our actual experiments. It is not surprising therefore that in his *Undulatory Theory of Optics*, 1866, p. 91, Sir *George Airy* says:

»The reader who has possessed himself fully of this hypothesis, will see at once the connection between all the experiments given above.«

»For the general explanation of these experiments, and for the accurate investigation of most of the phenomena to be hereafter described, it is indifferent whether we suppose the vibrations constituting polarized light to take place parallel to the plane of polarization, or perpendicular to it. There are reasons, however, connected with the most profound investigations into the nature of crystalline separation and into the nature of reflection from glass, etc., and confirming each other in a remarkable degree, that incline us to choose the latter: and thus:«

»When we say that light is polarized in a particular plane, we mean that the vibration of every particle is perpendicular to that plane.«

»Thus, in the undulation constituting the ordinary ray of Iceland spar, the vibration of every particle is perpendicular to the principal plane of the crystal: in that constituting the extraordinary ray, the vibration of every particle is parallel to the principal plane. When light falls upon unsilvered glass at the polarizing angle, the reflected wave is formed entirely by vibrations perpendicular to the plane of incidence: the transmitted wave is formed by some vibrations perpendicular to the plane of incidence, with an excess of vibrations parallel to the plane of incidence.«

»The reader will perceive that it is absolutely necessary to suppose, either that there are no vibrations in the direction of the wave's motion, or that they make no impression on the eye. For if there were such, there ought in the experiment of (98) to be visible fringes of interferences: of such however there is not the smallest trace.«

If we examine the figure, we find from the integral in the plane xy , that the total light emitted is given by the expression

$$L = \int_0^x y \, dx \quad (39)$$

To derive a corresponding expression for the *Poisson* waves emitted radially from the sphere surface, we put

$$x = \sin \theta \quad y = 1 - \cos \theta \quad dx = \cos \theta \, d\theta. \quad (40)$$

And we integrate for θ between the limits 0 and $\frac{1}{2}\pi$, and, for the surface generated by revolving the axis of x , we use ω between the limits 0 and 2π . Thus we have as the surface integral of the hemisphere

$$L' = \int_0^{\frac{1}{2}\pi} \int_0^{2\pi} (1 - \cos \theta) \cos \theta \, d\theta \, d\omega = 2\pi. \quad (41)$$

To find the light in a beam we calculate the reduction of area by orthogonal projection.

If now we integrate for the light distributed over a more limited surface $S = f(\theta, \omega)$, we shall find the value of the integral so trifling, that till $\theta = 44^\circ 25' 30''$, $x = 0.7$, only 28.6 percent of the light will be included in the central canopy. Moreover the average factor for the part of the *Poisson* radial wave motion in the line of sight is only $\frac{1}{40}$, and the ratio $A/\lambda = 10^{-5}$, making¹⁾

$$A = A/\lambda \cdot \rho = 1/(4 \cdot 10^6). \quad (42)$$

Accordingly one would expect experimenters to reach

the very conclusion announced by *Airy*, in the above passage, that there is not the smallest trace of visible fringes of interference due to the longitudinal component, which of course has to come from the light near the centre of the canopy. *Airy* personally repeated the experiments which he described and reduced to mathematical expression: so that his conclusions have been widely accepted by natural philosophers.

It is by virtue of *Airy's* careful experimentation and analysis of the wave-theory of light, following the independent and profound analysis of Sir *John Herschel*, in the great treatise on Light, Encycl. Metropol., 1849, that we adopt *Airy's* presentation of the subject as authoritative. Our conclusions therefore are as follows:

1. About 71.4 percent of the sphere surface is included within the elevation of $45^\circ 34' 30''$ from the base of the hemisphere. This part of the sphere is a zone so near the circumference as to appear to the observer to be essentially peripheral. Hence the origin of the belief, in view of the smallness of the ratio A/λ , that the vibrations are actually transverse, and the integral for the longitudinal component insensible to the experimenter.

2. Light vibrations coming from this periphery would appear essentially as transverse waves; and by proper optical appliances could be polarized into right handed, left handed, circularly polarized or elliptically polarized light, as seen in that transmitted through crystals.

3. As only 28.6 percent of the sphere surface remains in the larger zone, near the pole, and a considerable part of the vibrations on that polar surface could be resolved likewise into circularly or elliptically polarized light, we see that in ordinary light, the average vibration is described as made up of elliptical vibrations (*Airy*, *Undulatory Theory of Optics*, 1866, p. 156).

4. In discussing experiments leading up to *Lloyd's* observations on conical refraction, *Airy* notes, in regard to polarization of light, that »if common light be incident, (which not improbably consists of successive series of waves polarized in every conceivable plane) rays will be formed directed to every point of the [Newton's] ring, each ray having the polarization proper to its point of the ring; and a conical sheet of light will be formed within the crystal« (*Undulatory Theory of Optics*, p. 106). Again, summarizing the description of ordinary polarization, *Airy* draws three conclusions: (1) »If from common light we produce, by any known contrivance, light that is polarized in one plane, there is always produced at the same time light more or less polarized in the plane perpendicular to the former« (p. 89).

5. On this first conclusion *Airy* comments as follows: »The first leads at once to the presumption that polarization is not a modification or change of common light, but a resolution of it into two parts equally related to planes at right angles to each other; and that the exhibition of a beam of polarized light requires the action of some peculiar forces (either those employed in producing ordinary reflection and refraction or those which produce crystalline double refraction

¹⁾ The calculations made Sept. 12, 1920, as given in the note to section 8, below, make $A/\lambda = 1 : 1660508000$, which would make $A = 1 : (66420 \cdot 10^6)$ — a value hopelessly beyond the range of observation. — Note added, Sept. 12, 1920.

tion) which will enable the eye to perceive one of these parts without mixture of the other. This presumption is strongly supported by the phenomena of partially polarized light. If light falls upon a plate of glass inclined to the ray, the transmitted light, as we have seen, is partially polarized. If now a second plate of glass be placed in the path of the transmitted light, inclined at the same angle as the former plate, but with its plane of reflection at right angles to that of the former plate, the light which emerges from it has lost every trace of polarization; whether it be examined only with the analyzing plate *B*, or by the interposition of a plate of crystal in the manner to be explained hereafter (145). This seems explicable only on the supposition that the effect of the first plate of glass was to diminish that part of the light which has respect to one plane (without totally removing it), and that the effect of the second plate is to diminish in the same proportion that part of the light which has respect to the other plane; and therefore that, after emergence from the second plate, the two portions of light have the same proportion as before. On considering this presumption in conjunction with the second and third conclusion, we easily arrive at this simple hypothesis explaining the whole«:

»Common light consists of undulations in which the vibrations of each particle are in the plane perpendicular to the direction of the wave's motion. The polarization of light is the resolution of the vibrations of each particle into two, one parallel to a given plane passing through the direction of the wave's motion, and the other perpendicular to that plane; which (from causes that we shall not allude to at present), become in certain cases the origin of waves that travel in different directions. When we are able to separate one of these from the other, we say that the light of each is polarized. When the resolved vibration parallel to the plane is preserved unaltered, and that perpendicular to the plane is diminished in a given ratio (or vice versa), and not separated from it, we say that the light is partially polarized.«

6. In view of the considerations here deduced by *Airy*, we see why the spherical distribution of waves from atoms in every conceivable plane will give rays directed to every point of the circumference of the end of a beam of light; just as in *Airy's* discussion of the polarization in Newton's rings, it is held that the waves »are polarized in every conceivable plane«, and »rays will be formed directed to every

$$M = II' \iint \iint \frac{1}{r} \cdot \cos \varepsilon \, ds \, ds' = -\chi \chi' \iint \iint \left(\frac{1}{r} \right) (dx/ds \cdot dx'/ds' + dy/ds \cdot dy'/ds' + dz/ds \cdot dz'/ds') \, ds \, ds' \quad (43)$$

$$\cos \varepsilon = \cos \alpha \cos \alpha' + \cos \beta \cos \beta' + \cos \gamma \cos \gamma' = \cos(I, I') \quad (44)$$

and yielding the general formula for electrodynamic action in universal gravitation, or *Ampère's* theory of elementary electric currents about the atoms:

$$\Omega = \iiint \iiint \iiint II' \cos(I, I') [(x-x')^2 + (y-y')^2 + (z-z')^2]^{-1/2} \, dx \, dy \, dz \, dx' \, dy' \, dz'. \quad (45)$$

Thus the difficulties of reconciling the wave-theory of light with the electrodynamic theory disappear. The resolved waves in polarized light are largely normal to the direction of propagation, but their original component flat wavelets were not, being in atomic planes inclined at all angles.

point of the ring, each ray having the polarization proper to its point of the ring.«

7. To view this reasoning graphically, imagine a series of planes drawn through the centre of the sphere and fixed at equal intervals normal to a meridian of the circumference having its pole in the observer's eye. Then imagine the whole set of fixed planes rotated about the pole through the observer's eye, and stopped at successive intervals of the circumference equal to those between the fixed planes. The equatorial portions of the hemisphere will thereby be divided into rectangular compartments with areas equal to $r^2 \cos \lambda \, d\lambda \, d\omega$, were ω is the angle about the pole, and λ is the latitude. To get compartments of equal areas in higher latitudes, the revolving system must stop at intervals equal to $d\omega/\cos \lambda = (2\pi/n)\sec \lambda$. From these considerations we perceive that in higher latitudes the number of rectangular compartments decreases rapidly; and if the number of flat wavelets of light are proportional to the rectangular areas on the sphere, the wave disturbance in light will be almost wholly peripheral, or transverse.

8. Small as is the amount of light depending on the vibrations in or near the line of vision, our sphere shows that the central great circles distributed in haphazard fashion, do not lie in the line of vision, but pass around it on all sides; and hence we perceive that the disturbance necessarily is rotational in character, and nearly transverse to the direction of propagation.

9. From considerations based on polarization, — tending to show that in the ordinary ray of Iceland spar the vibration of every particle is perpendicular to the principal plane of the crystal, while in that constituting the extraordinary ray, the vibration of every particle is parallel to the principal plane — the polarized light in both cases being already systematically resolved by the action of the crystal — *Airy* concludes in article 101 of his *Undulatory Theory of Optics*, that there is not the smallest trace of visible fringes of interferences.

10. If the considerations on the spherical distribution of the planes of the flat wavelets above deduced be valid, *Airy's* results could be true, and yet give us an unlimited number of component flat wavelets not originally normal to the direction of the wave propagation, but inclined to it by the angle ε , as in the electrodynamic formula of *Franz Neumann*, 1845:

5. Other Fundamental Objections to *Fresnel's* Theory that Light Waves are purely Linear Transverse Motions.

(i) Certain circumstances favorable to the old wave-theory of light permitted it to progress but did not establish it on a permanent basis.

1. In his memoir of 1830 *Poisson* showed that in elastic media waves propagated from a centre are essentially like sound waves, and at great distances the molecules move mainly in the direction of the normal to the wave front. But *Poisson* died in 1839, while *Cauchy* lived on till 1857; and moreover the deceptive argument drawn from the vibrations of an elastic cord misled *Herschel* and *Airy*, who failed to perceive that the underlying premise implies anisotropy in the medium.

2. As *Poisson* never concurred in the theory of vibrations normal to the direction of the ray, *Fresnel* and *Arago* sought comfort in the analytical results of *Cauchy*. And because such waves are theoretically possible when once they are generated, it was inferred that light has such motion as is observed in the vibrating cord.

3. *Cauchy's* analysis seems to have proved that if waves normal to the direction of propagation be started, they could be propagated by such transverse motion; yet he did not explain how they would arise, or would be started normal to the direction of propagation. Nor did his associates see the anachronism implied in a medium with anisotropic properties along x, y, z , $-z$ being in the direction of the ray, whatever that may be.

4. After a visit from *Arago*, 1816, *Young* began to form a theory of waves with motions normal to the direction of propagation. They were held to be similar to undulations carried along a stretched cord, as stated in a letter April 29, 1818, (cf. *Whittaker's* History of the Aether, p. 122). This example of the vibrating cord gave a physical analogy which was afterwards adopted by *Fresnel*, *Herschel*, *Airy* and others, but it was really an anachronism; for it implied a »stringy« condition in the aether, in any direction the wave might travel, but not in other directions. The z -component of the vibration along the ray vanished, which made $\zeta = 0$, and therefore $s = \sqrt{\xi^2 + \eta^2}$ becomes confined wholly to the wave surface.

5. As we have seen above, *Green* took the velocity of the longitudinal component of the waves to be infinite; which left the finite motion wholly in the wave surface. In the case of a gaseous aether of course there is no authority for this procedure; and thus it simply begged the question, by offering an arbitrary hypothesis.

6. *Hamilton's* prediction of conical refraction (conf. *Whittaker's* History of the Aether, p. 131) only showed *Fresnel's* ideas of the theory to be correct in general, but was not an accurate test in all details. The theory above outlined will explain conical refraction equally well. Accordingly in the absence of definite objections, the old wave-theory triumphed by default, at least temporarily; yet the assumptions made to get rid of the longitudinal component never were satisfactory, and could not be justified, because based on an arbitrary hypothesis.

7. The physical inadmissibility of *Green's* postulate that the longitudinal component has infinite velocity (*Green's* Collected Papers, p. 246) is easily shown by the following considerations:

a) In his work on Sound, Chap. V, *Tyndall* shows that when the bow of a violin is given a stroke along the violin

string a shrill sound arises, owing to the rapidity of the wave along the string, — giving high pitch to the sound. Owing to its higher elasticity, waves travel say ten times more rapidly along the string than through the air.

b) Now it is easy to see that this is analogous to *Green's* unauthorized procedure, which amounts to assuming a »stringy« condition of the aether in any direction in which light is sent. And the chance that the assumed longitudinal component would not manifest itself in some way is very slight, since the aether, with excessively small density, is naturally taken to be a gas, and the velocity of the aetheron $\bar{v} = 471000$ kms.

8. Again, in his work on Sound, (p. 73), *Tyndall* shows that a sharpness of shock, or rapidity of vibration, is necessary for producing sonorous waves in air. »It is still more necessary in hydrogen, because the greater mobility of this light gas tends to prevent the formation of condensations and rarefactions.«

Therefore the aether should present enormous difficulties in the generation of waves therein, and such is observed to be a fact. By way of experiment Prof. *Nipher* alone has generated disturbances in the aether; and to produce them he had to use dynamite, which gives intense forces quickly exerted. Observation thus verifies the high velocity of the aetheron, and will not permit us to assume different velocities of the aether wave in different directions.

(ii) Purely transverse vibrations in light would imply only transverse undulations in magnetism and electrodynamic action, which is contrary to observation.

The theory of transverse waves was first admitted somewhat reluctantly by *Young* and *Fresnel* in the early part of the 19th century, (1802–1829). But under the celebrated experiments on diffraction, double refraction, polarization and interference conducted by *Fresnel* and *Arago*, the theory became a new means of discovery. This apparent experimental triumph of the undulatory theory aroused such interest that a long series of brilliant mathematical researches were entered upon by the eminent natural philosophers then resident at Paris — *Navier*, *Poisson*, *Cauchy* and *Lamé*.

It is true that these mathematicians were by no means agreed among themselves as to the details, yet their work was mathematically so impressive that it created great interest in other countries, more especially in England, and was adopted by *Airy*, *Hamilton* and *Herschel*, and subsequently by *Green*, *Thomson* (Lord *Kelvin*), *Stokes*, *Maxwell*, and *Rayleigh*. In this way the undulatory theory as now taught came into wide use; and yet it was always suspected to be somewhat defective, and we shall now point out some additional reasons why the traditional view can not be valid.

1. The theory of purely transverse waves in light is directly inconsistent with the rotations actually known in magnetism, and with the electrodynamic action of a current on a magnetic needle, in such phenomena as *Oersted's* experiment of 1819.

2. For if the motion of the aether is linear and transverse in light, it would be logical to conclude that it must be of the same type in the waves by which electrodynamic action is propagated across space. Indeed, experiment proves

that both actions have the same velocity, and take place in the same medium. And we have no grounds for assuming a difference of wave type.

3. Yet we know by actual observation that in *Oersted's* experiment of 1819 the magnetic needle not only is directed in a definite way, depending on the direction of the current, but also attracted to the conductor by the action of electrodynamic waves propagated from the wire, as first pointed out by the present writer in 1914.

4. Now the electrodynamic waves discovered in 1914 can not be wholly transverse, as held by *Fresnel* and his followers in the wave-theory of light; for in that case there could be no actual attraction on the needle. On the contrary, *Maxwell* held (*Treatise on Electricity and Magnetism*, 3^d ed., § 793) that such transverse waves exert a slight repulsion, and on the premise employed it is difficult to refute his conclusion.

5. In order to exert the observed attraction, the electrodynamic waves must have rotations somewhat like those observed in water waves; and the needle must so orient itself that the elementary Ampère-currents of electricity about the atoms coincide in direction with those in the electrodynamic waves propagated from the wire.

6. The observed attraction of the magnetic needle to the wire therefore is inconsistent with *Fresnel's* doctrine of purely transverse waves, as taught in the theory of light and adopted by *Maxwell* in his electromagnetic theory. Now magnets themselves have circulation of currents about their atoms, as first shown by *Ampère's* experiments with currents in 1822; and these currents about the atoms give rise to the rotations about the Faraday-lines of force, thus forming the waves propagated outward from magnets. It is only in this way that we can imagine how magnets presenting unlike poles attract; and, when like poles are presented, repel, by a mechanism at last disclosed to our vision.

7. Therefore the magnetic needle is attracted to a conducting wire by the electrodynamic waves propagated outwardly from it; and magnets themselves also attract by sending out waves defined by the well known rotations about the Faraday-lines of force. Accordingly it follows that all such waves must necessarily involve rotations in the aether to make up the waves; and the waves incontestably are not wholly transverse, but only transverse in somewhat the same way that water waves are transverse.

8. The *Fresnel* theory of purely transverse light waves thus again is definitely disproved, and we may reconcile the varied mathematical researches of *Poisson*, *Cauchy*, and *Lamé*. It should be noticed, however, that *Cauchy's* reasoning had no physical basis, to control the legitimacy of the hypotheses underlying it, except the artificial analogy with the vibrating cord. *Poisson* and *Lamé* on the other hand never were fully convinced that the motion in light is wholly transverse. The theory outlined in section 4 above probably had never occurred to them.

9. Accordingly there are real weaknesses in the traditional wave-theory of light; and the difficulties noticed by the earlier investigators have never been satisfactorily overcome. The objections here pointed out appear to be new, and absolutely fatal to the theory of wholly transverse waves

as held by *Fresnel*. He was essentially a specialist in light, rather than a mathematician and all around natural philosopher, like *Poisson*, who never did believe that in nature the aetherial vibrations could be as *Fresnel* imagined. The temporary scepticism of the illustrious *Poisson* is now verified from a new point of view, after the lapse of nearly a century.

10. It is remarkable that such a palpable perversion as the theory of wholly transverse vibrations gained currency in science through the misdirected reasoning of the followers of *Cauchy*. They seem to have been misled by beautiful general formulae, valid enough as applied to wave motion in crystalline media, but utterly deceptive as applied to the simple case of the aether itself, viewed in free space as a uniform isotropic medium, which furnishes the general basis for the undulatory theory of light. This outcome is the more remarkable and unfortunate, since *Poisson* was a greater and more sagacious physical philosopher than *Cauchy*, who was chiefly a pure mathematician.

(iii) Difficulties in the wave theory of light as outlined by Prof. *Chas. S. Hastings*.

In a letter to the present writer, dated Aug. 17, 1916, Prof. *Hastings* speaks as follows:

»That light vibrations necessarily are transverse only is proved in many ways — perhaps most obviously by the fact that complete polarization is possible.«

»If light waves fall normally on a refracting surface, any free element of volume in the first medium is sustained in permanent transverse vibrations of definite period, but if it is attached to an element of the second medium as at the interface, the second medium having either a greater density or a greater rigidity, it will not (although necessarily retaining the same period) move so far from its position of equilibrium. Just at this region, therefore, so far as the first medium is concerned, we must add a system of waves of opposite phase and of an amplitude easily calculable from the ratio of light velocities in the two media — this constitutes the reflected light.«

»Now consider the refracted light. The element of volume just below the interface has the same period and amplitude as the attached element above; it is therefore a portion of a system of waves propagated in the same direction as the incident waves but with a velocity determined very simply by the density and rigidity.«

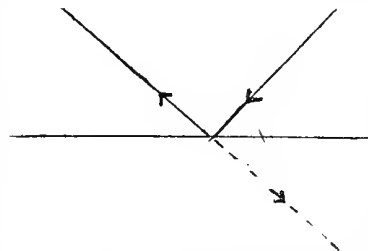


Fig. 4. Professor *Hastings's* diagram of the path of light at the interface.

»It is when we consider oblique incidences that we get into difficulties. *Fresnel* assumed that the same condition held in these cases also, but, as you can readily see from the diagram, there could exist a stable state of vibrations at the surface only when there is a system of compressional waves also proceeding from the interface in a direction and of an intensity easily calculable if the ratio of volume-elasticity to rigidity is known. Now no such system of

longitudinal waves exists under any circumstances, because the energy carried by the reflected and refracted wave systems taken together always equals the energy carried to the refracting surface by the incident wave system. (This, by the way, is the direct answer to your principal question. I might stop here but the fixed habit of an old teacher leads me to add: —) In order to get rid of the obvious difficulty *Fresnel* assumed that the volume-elasticity of the ether, both free and associated with matter, is infinitely great, in which case the velocity of the longitudinal wave system would be infinite and it would carry no energy with it. Aside from the fact that absolute incompressibility is difficult to conceive there are other serious difficulties in the theory connected with the phenomena of double refraction.«

»*Stokes* is said to have invented an elastic-solid theory, which, however, carried with it as a necessary consequence the proof that *Huyghens'* construction of the extraordinary wave surface in Iceland spar is slightly erroneous, say in the fourth decimal. *Fitzgerald* attempted to test this by accurate

$$\begin{aligned} \Phi = & (1/4\pi) \int_0^\pi \int_0^{2\pi} F(x+at \cos \theta, y+at \sin \theta \sin \omega, z+at \sin \theta \cos \omega) t \sin \theta \, d\theta \, d\omega \\ & + (1/4\pi) (d/dt) \int_0^\pi \int_0^{2\pi} II(x+at \cos \theta, y+at \sin \theta \sin \omega, z+at \sin \theta \cos \omega) t \sin \theta \, d\theta \, d\omega. \end{aligned} \quad (46)$$

Now the equation

$$lx + my + nz = 0 \quad (47)$$

represents a plane through the origin. And

$$lx + my + nz - (at+s) = 0 \quad (48)$$

represents a plane with perpendicular $p = (at+s)$ from the origin.

If plane waves proceed from the equator of an atom, the radius of the spherical wave surface about the atom will

$$\begin{aligned} \Phi = & (1/4\pi) \int_0^\pi \int_0^{2\pi} F\{l(x+at \cos \theta) + m(y+at \sin \theta \sin \omega) + n(z+at \sin \theta \cos \omega) - (at+s)\} t \sin \theta \, d\theta \, d\omega \\ & + (1/4\pi) (d/dt) \int_0^\pi \int_0^{2\pi} II\{l(x+at \cos \theta) + m(y+at \sin \theta \sin \omega) + n(z+at \sin \theta \cos \omega) - (at+s)\} t \sin \theta \, d\theta \, d\omega. \end{aligned} \quad (49)$$

And if we integrate this expression for the waves from all the atoms of a body, we shall have

$$\begin{aligned} \Phi = & \int_0^r \int_0^\pi \int_0^{2\pi} (\sigma/4\pi) \int_0^\pi \int_0^{2\pi} F\{l(x+at \cos \theta) + m(y+at \sin \theta \sin \omega) + n(z+at \sin \theta \cos \omega) - (at+s)\} r^2 \sin \theta \, dr \, d\theta \, d\omega \cdot t \sin \theta \, d\theta \, d\omega \\ & + \int_0^r \int_0^\pi \int_0^{2\pi} (\sigma/4\pi) (d/dt) \int_0^\pi \int_0^{2\pi} II\{l(x+at \cos \theta) + m(y+at \sin \theta \sin \omega) + n(z+at \sin \theta \cos \omega) - (at+s)\} r^2 \sin \theta \, dr \, d\theta \, d\omega \cdot t \sin \theta \, d\theta \, d\omega. \end{aligned} \quad (50)$$

This equation may be simplified somewhat by a transformation employed by *Poisson* in his Memoir of 1819, p. 127. In this we put:

$$la = p \cos \theta' \quad ma = p \sin \theta' \sin \omega' \quad na = p \sin \theta' \cos \omega' \quad (51)$$

and then the second terms under the integral signs become of the form

$$t \{ \cos \theta' \cos \theta + \cos(\omega - \omega') \sin \theta' \sin \theta \} = t \cos \psi \quad d\Omega = \sin \theta \, d\theta \, d\omega \quad (52)$$

and therefore

$$\begin{aligned} \Phi = & \int_0^r \int_0^\pi \int_0^{2\pi} (\sigma/4\pi) \int_0^\pi \int_0^{2\pi} F\{lx + my + nz - (at+s) + t \cos \psi\} r^2 \sin \theta \, dr \, d\theta \, d\omega \cdot t \sin \theta \, d\theta \, d\omega \\ & + \int_0^r \int_0^\pi \int_0^{2\pi} (\sigma/4\pi) (d/dt) \int_0^\pi \int_0^{2\pi} II\{lx + my + nz - (at+s) + t \cos \psi\} r^2 \sin \theta \, dr \, d\theta \, d\omega \cdot t \sin \theta \, d\theta \, d\omega. \end{aligned} \quad (53)$$

measurements (the first made since *Huyghens'*!) but failed in attaining adequate precision. Finally I demonstrated (*Amer. Jour. Sci.* somewhere) that *Huyghens'* construction is certainly accurate to $1:10^{-6}$ «

»More recently *Kelvin*, who was especially desirous of getting a defensible elastic-solid theory of light, proposed a zero volume-elasticity, or a collapsible ether. This gives zero velocity for compressional waves and hence no energy is carried away from the interface. *Kelvin* apparently left his readers to imagine an outer boundary condition which would prevent the ether-universe from collapsing.«

6. Outline of the General Theory of the Waves from any Body, whether due to Light, Magnetism, Electrodynamic Action or Universal Gravitation.

(i) Results of *Poisson's* analysis for wave motion.

As we have seen, in the third paper, *Poisson* reduces (*Memoir* of 1830, p. 556) the sextuple integral for the propagation of waves to the double integral:

increase with at ; and the disturbance, in the plane of the flat wave, in the equator of the atom, will travel away with the velocity at , and remain parallel to the original in all parallel planes. Thus $lx + my + nz - (at+s) = 0$ represents the disturbance in the equatorial plane of the flat waves from any atom, propagated in every direction parallel thereto.

Our integration should include the disturbances along these planes in which the waves are flat. Accordingly, for the waves from any atom we have

(ii) Simplified expressions for all the elements of a spherical surface with motion making any angle with the radius. Accordingly, when we have equations of the type found in *Poisson's* expression (Memoir of 1819, p. 127):

$$P = \int_0^\pi \int_0^{2\pi} f(g \cos u + h \sin u \sin v + k \sin u \cos v) \sin u \, du \, dv \quad (54)$$

we may put

$$g = p \cos u' \quad h = p \sin u' \sin v' \quad k = p \sin u' \cos v' \quad (55)$$

and thus obtain:

$$P = \int_0^\pi \int_0^{2\pi} f\{p[\cos u' \cos u + \cos(v-v') \sin u' \sin u]\} \sin u \, du \, dv \quad (56)$$

By using the simplifying formulae:

$$\cos \psi = \cos u' \cos u + \cos(v-v') \sin u' \sin u \quad d\omega = \sin u \, du \, dv \quad (57)$$

this reduces to

$$P = \int_0^\pi \int_0^{2\pi} f(p \cos \psi) \, d\omega. \quad (58)$$

Thus this quantity P represents the sum of all the elements of the spherical surface, multiplied each by a given function of the cosine of the angle comprised between its radius and a radius determined in position.*

A wave flat in the equator of the atom is defined by

$$lx + my + nz - (at + s) = 0. \quad (48)$$

The coordinates for the spherical propagation of the wave are

$$x + at \cos \theta \quad y + at \sin \theta \sin \omega \quad z + at \sin \theta \cos \omega. \quad (59)$$

Hence

$$\begin{aligned} \Phi &= (1/4\pi) \int_0^\pi \int_0^{2\pi} F\{l(x + at \cos \theta) + m(y + at \sin \theta \sin \omega) + n(z + at \sin \theta \cos \omega) - (at + s)\} t \sin \theta \, d\theta \, d\omega \\ &+ (1/4\pi) (d/dt) \int_0^\pi \int_0^{2\pi} H\{l(x + at \cos \theta) + m(y + at \sin \theta \sin \omega) + n(z + at \sin \theta \cos \omega) - (at + s)\} t \sin \theta \, d\theta \, d\omega. \end{aligned} \quad (60)$$

These solutions are general for wave motion in light, magnetism or similar natural phenomena; and thus it remains to examine certain expressions in *Gauss's* Theory of Terrestrial Magnetism, to ascertain if these phenomena are consistent with the wave-theory. But before entering upon magnetic phenomena, we summarize the hypotheses underlying *Poisson's* analysis as briefly as possible.

(iii) The equations for waves propagated spherically in an elastic medium.

Consider a system of waves propagated spherically, from any point, whose coordinates are x, y, z, t . Then the

$$\begin{aligned} \Phi &= (1/4\pi) \int_0^\pi \int_0^{2\pi} F\{x + at \cos \theta, y + at \sin \theta \sin \omega, z + at \sin \theta \cos \omega\} t \sin \theta \, d\theta \, d\omega \\ &+ (1/4\pi) (d/dt) \int_0^\pi \int_0^{2\pi} H\{x + at \cos \theta, y + at \sin \theta \sin \omega, z + at \sin \theta \cos \omega\} t \sin \theta \, d\theta \, d\omega. \end{aligned} \quad (63)$$

And the equation of wave motion is:

$$\partial^2 \Phi / \partial t^2 = a^2 (\partial^2 \Phi / \partial x^2 + \partial^2 \Phi / \partial y^2 + \partial^2 \Phi / \partial z^2). \quad (64)$$

The fundamental equations

$$\begin{aligned} du/dt &= a^2 ds/dx & dv/dt &= a^2 ds/dy & dw/dt &= a^2 ds/dz \\ ds/dt &= du/dx + dv/dy + dw/dz & s &= (1/a^2) d\Phi/dt \end{aligned} \quad (65)$$

lead to the components of the velocity of any molecule

$$u = d\Phi/dx + U \quad v = d\Phi/dy + V \quad w = d\Phi/dz + W \quad (66)$$

where U, V, W are arbitrary functions of x, y, z , in accordance with the conditions laid down by *Lagrange* in the *Mécanique Analytique*.

coordinates of the disturbed molecules at any time t , will be found in a sphere surface: $(at)^2 = (x-x')^2 + (y-y')^2 + (z-z')^2$

$$\begin{aligned} x - x' &= r \cos \theta & &= at \cos \theta \\ y - y' &= r \sin \theta \sin \omega & &= at \sin \theta \sin \omega \\ z - z' &= r \sin \theta \cos \omega & &= at \sin \theta \cos \omega. \end{aligned} \quad (61)$$

Accordingly at the time t the coordinates of the disturbed molecules will be:

$$x + at \cos \theta \quad y + at \sin \theta \sin \omega \quad z + at \sin \theta \cos \omega. \quad (62)$$

And *Poisson's* solution yields the integral over the sphere surface (at, θ, ω) :

(iv) *Gauss's* theorem that the sum total of positive and negative magnetic fluid in any magnet is zero confirms the wave-theory of magnetism.

In his *Allgemeine Theorie des Erdmagnetismus*, 1838, p. 21, *Gauss* has shown that the sum total of positive and negative fluid in the entire earth is zero, so that

$$\int d\mu = 0. \quad (67)$$

The expression for the potential, due to the magnetic mass μ , is

$$V = - \int 1/q \cdot d\mu \quad (68)$$

where the integral to be extended over the whole magnet, and q denotes the distance of the element of magnetic mass $d\mu$ from the point acted on (x', y', z') .

In rectangular coordinates we have:

$$q = V[(x-x')^2 + (y-y')^2 + (z-z')^2] \quad (69)$$

and, in the spherical coordinates used by Gauss,

$$q = V\{r^2 + r_0^2 - 2rr_0[\cos u \cos u_0 + \sin u \sin u_0 \cos(\lambda - \lambda_0)]\} \quad (70)$$

u and u_0 being polar distances, r and r_0 being radii of the earth, λ_0 a fixed longitude, and λ a variable longitude, to be used in extending the integration throughout the mass.

Thus

$$\begin{aligned} V &= -\int \frac{1}{q} \cdot d\mu = -\iiint (\sigma/q) dx dy dz \\ &= -\iiint (\sigma/q) dr \cdot r du \cdot r \sin u d\lambda. \end{aligned} \quad (71)$$

Accordingly when we extend Gauss' theorem to the entire terrestrial globe we have the expression for the potential:

$$V = -\int_0^{2\pi} d\lambda \int_0^\pi \sin u du \int_0^r (\sigma/q) r^2 dr. \quad (72)$$

This will give the potential at any point (r_0, u_0, λ_0), which may be outside the earth, as in the moon or sun.

(v) Extension of this theorem to the electrodynamic action between two spheres, as the earth and sun.

Imagine electric currents to circulate around the atoms of two globes: it is required to consider the resulting electrodynamic action. We have the sextuple integral

$$P = \iiint \iiint \iiint (\frac{1}{q}) i i' \cos(i, i') \sigma dx dy dz \sigma' dx' dy' dz'. \quad (73)$$

The two masses may be called M and m , the latter being the sun.

1. The coordinates of the sun (r_0, u_0, λ_0) may be taken as fixed, while the integration is being extended over the earth.

2. In the same way the coordinates of the earth as seen from the centre of the sun may be regarded as fixed while the integration is being extended over the sun's mass.

3. The two masses as respects each other are thus reduced to weighted points of mass M and m . The action

$$\begin{aligned} P &= \iiint \iiint \iiint (\frac{1}{q}) i i' \cos(i, i') \sigma dx dy dz \sigma' dx' dy' dz' \\ &= \int_0^{2\pi} \int_0^\pi \int_0^r \int_0^{2\pi} \int_0^\pi \int_0^{r_0} (\frac{1}{q}) i i' \cos(i, i') \sigma r^2 dr d\lambda \sin u du \sigma' r_0^2 dr_0 d\lambda_0 \sin u_0 du_0 = 0 \\ &\quad + \int_0^{2\omega} \int_0^{2\omega'} \int_0^r \int_0^{2\omega'} \int_0^{r_0} (\frac{1}{q}) i i' \cos(i, i') \sigma r^2 dr d\lambda \sin u du \sigma' r_0^2 dr_0 d\lambda_0 \sin u_0 du_0 = A. \end{aligned} \quad (77)$$

The latter expression A is positive, because all the factors depending on the cosine, $i i' \cos(i, i')$ are positive — the total angles of integration being in excess of a whole or semi-circumference by the amounts $2\omega, 2\omega'$. This last expression (77) explains why gravitation always appears as a positive force, though the electrodynamic action on a point vanishes, — because also it emits no waves. Both bodies fill measurable space, and the angular overlap is $2\omega, 2\omega'$ when the action of all the atoms in both bodies is considered.

7. Why Reflected Light is Polarized in a Plane at Right Angles to the Plane of Incidence and Reflection: Confirmation of Fresnel's Views.

of the sun on the earth's atoms is equivalent to the action of the earth on the sun's atoms:

$$P = m \int_0^{2\pi} d\lambda \int_0^\pi \sin u du \int_0^r (\sigma/q) r^2 dr \quad (74)$$

$$= M \int_0^{2\pi} d\lambda \int_0^\pi \sin u du \int_0^r (\sigma'/q) r^2 dr. \quad (75)$$

And both of these expressions are zero, in accordance with (67) and (71); for if in the case of the earth's magnetism involving $1/1375$ th part of the atoms, $\int d\mu = 0$, which means $\iiint (\frac{1}{q}) \sigma dx dy dz i i' \cos(i, i') = 0$; so also in the case of electrodynamic action depending on all the atoms, it follows that $\int d\mu/q = \iiint (\frac{1}{q}) i i' \cos(i, i') \sigma dx dy dz = 0$ (76)

if the integration is rigorously restricted to the limits specified in (74) and (75).

Now it happens that the actions between two globes M and m are not restricted to their centres as seen from each other; but the globes subtend measurable angles $2\omega, 2\omega'$, and the atoms are correspondingly dispersed. When the mass is concentrated at the centre, suppose it restricted to a minute measurable area of unit size; then the actual expanded bodies will be larger than this minute area in proportions of ν and ν' times. If the action on unit mass in the minute area be one unit, the action of all the mass in M will be $\nu\sigma$ times that powerful; and that of all the mass in m will be $\nu'\sigma'$. Hence the necessity of integration over every area however small and however minute the density.

(vi) The wave action positive as in the observed case of gravitation.

If the concentration of the action of the distant body in the centres M and m be indicated by integration with rigidly fixed limits, 2π in the case of λ , and π in the case of u , — which restricts the mutual action to a single minute area — we may write two integrals for the whole action: one with no special distribution, and the other variable throughout the solid angles $2\omega, 2\omega'$:

(i) Mechanical analogies are convincing.

1. We have found the aether to be enormously elastic, so that when any pencil of the medium is filled with a beam of light, which consists of waves tilted at all angles and flowing on in almost infinitely rapid succession, the pencil may be viewed as maintaining its figure by the elasticity of the medium and the rapid succession of the waves. If the pencil of light strikes a solid or liquid surface, the speed of the wave motion is suddenly checked, and reaction on the equilibrium of the pencil at the boundary takes place: so that the vibrations in certain directions are altered by the contact with the solid or liquid surface.

2. To judge by a tangible and familiar experiment, as to what may happen to a pencil of light, we may compare it to the stream of water flowing from the nozzle of a garden hose. The cross-section of the stream of water is assumed to be circular, and we recognize that the forces which keep it so, are chiefly the forward motion and surface tension, — the attraction of the water for itself. In the case of the pencil of light, the equilibrating forces depend on the elastic power within the aether, and thus are different; but the effect produced is very similar, for any slender cylinder filled with a flow of waves.

3. Now we know by daily observation, that when a round stream of water is thrown by a hose against a solid wall, the cross-section of the stream ceases to be circular, and becomes highly flattened, so that the new cross-section of the stream becomes an ellipse, having its longer axis normal to the plane of incidence and reflection. The flattening of the reflected stream of water is easily seen by the most careless of observers: and thus analogy leads us to expect a similar flattening of the vibrations in a beam of reflected light. It is true that the flattened stream of water is not vibrating like the aether, yet the reflected stream is flattened, and tends to retain that figure, with elliptical cross-section.

4. It has been proved by flash-light photography that when liquid drops are forming and falling, the detached spherules oscillate about a mean figure, — being alternately prolate, then spherical, and finally oblate. In the case of drops therefore the particles of the fluid oscillate about a mean position, under the influence of surface tension. The figure of the drop is drawn out of shape at the instant of detachment, and in falling the action of surface tension restores the normal figure, and carries it beyond, so that the globules oscillate about their mean form, which is spherical.

5. Now in the same way, when a pencil of light is reflected from a solid or liquid surface, the act of reflection brings into play, for an infinitesimal time dt , certain forces which tend to flatten the beam, as reflected, in a plane normal to the plane of incidence and reflection. Considering merely the relative motion of the beam in respect to the solid or liquid, we may regard the circular pencil as struck by the solid or liquid in the act of reflection. Owing to its elasticity, each element of the pencil rebounds like a rubber ball — flattened in the plane normal to that of polarization, as we see in the actual behavior of rubber balls in collision. Since each element of the pencil is elastic, there is incessant recovery from the flattening effect — so that the pencil continues to vibrate, but by relative crowding of the vibrating aetherons it has lost its circularity of cross-section, and become elliptical, owing to the restricted freedom imposed in the process of reflection.

6. In Fig. 6, Plate 8, we may imagine equal amplitudes of vibration, in all directions from the centre of the incident beam as shown above; but after reflection the resistance thus encountered forces the circle into the ellipse, as shown. The mutual crowding towards the centre, owing to restricted freedom at the instant of reflection, forces the pencil as a whole out at the sides, and thus it takes on a very elliptical form for the cross-section. In spite of a notable flattening of the

pencil of light the aether particles describe ellipses — not straight lines, as often stated, in the theory of polarization.

7. It has been shown by the recent researches of *Heiberg* that *Archimedes* used mechanical means of proving his theorems, at least in the first instance, and then made them rigorous by improving the geometrical demonstration. Accordingly, in dealing with polarization, we are justified in adopting similar methods. And the only question is one of devising a valid model which affords a true analogy. To this end we rely upon the evidence of experiments, in phenomena easily understood and admitting of but one interpretation.

8. The model of a reflected stream of water above outlined certainly is mechanically valid. And it may be confirmed and extended by considering the instantaneous forced form of a series of rubber balls, in such close succession as to be united into a solid tube, like the stream of water, yet not actually touching prior to reflection. At reflection each ball would be flattened by the resistance of the reflector, so that the vibrations of the aether in the pencil take the same form, as observed in polarized light.

9. When liquid drops are formed, in the breaking of a jet, flash-light photography shows them in rapid vibration, owing to surface tension. They form, and vibrate up and down, under gravity; but the waves of the aether pencil would vibrate normal to the plane of polarization, when they are reflected. The vibrations in a plane at right angles to the plane of polarization thus necessarily results from the reflection of waves in an elastic medium.

10. Accordingly, on the basis of actual experience, in well defined phenomena, it is impossible to imagine any kind of vibrations in reflected light other than that at right angles to the plane of polarization.

If we adopted the *Maccullagh-Neumann* theory of vibrations, in the plane of polarization, we should have to expect mechanically a similar effect when a circular stream of water is reflected by a smooth solid wall. No such effect is observed. And as reflection is equivalent to a blow against the round moving stream, renewed at every instant, at infinitesimal intervals dt , we see clearly that the distortion of the vibrations should take place, with the longer axis of the new elliptical motion at right angles to the plane of polarization. No other result is mechanically possible.

(ii) Analysis of light vibrations.

Let the three components of the revolving light vector be:

$$\begin{aligned} u &= a \cos(2\pi t/\tau + \alpha) & (u/a)^2 + (v/b)^2 + (w/c)^2 &= 1 \\ v &= b \cos(2\pi t/\tau + \beta) & s &= \sqrt{u^2 + v^2 + w^2}. \\ w &= c \cos(2\pi t/\tau + \gamma) \end{aligned} \quad (78)$$

The fourth of these equations indicates that the path described by the end of the light vector is an ellipse; and the fifth equation gives the displacement relatively to the equilibrium position of the aether particle at any time.

By altering the angles through $\frac{1}{2}\pi - \theta$, we are enabled to use sines in the place of cosines:

$$\begin{aligned} \sin(2\pi t/\tau + \rho) &= u/a = \sin(2\pi t/\tau) \cos \rho + \cos(2\pi t/\tau) \sin \rho \\ \sin(2\pi t/\tau + q) &= v/b = \sin(2\pi t/\tau) \cos q + \cos(2\pi t/\tau) \sin q \\ \sin(2\pi t/\tau + r) &= w/c = \sin(2\pi t/\tau) \cos r + \cos(2\pi t/\tau) \sin r. \end{aligned} \quad (79)$$

The quantities u, v, w , represent the rectangular coordinates of the end of the revolving light vector; and the equation for the path, quite independently of the time, may be obtained by eliminating t from equation (79), by the following process. If we multiply the expanded form of these equations by $\sin(q-r)$, $\sin(r-p)$, and $\sin(p-q)$ respectively, and add them, the right hand members will be found to vanish, and we get:

$$(u/a) \sin(q-r) + (v/b) \sin(r-p) + (w/c) \sin(p-q) = 0. \quad (80)$$

This linear equation connects u, v, w , which are the rectangular coordinates of the end of the light vector; and hence we see that the path described by it lies in a plane passing through the origin. The path of the vibration therefore is a plane curve.

To get the path as projected on the coordinate planes, we use two of the equations (79). Thus from the first two of these equations we obtain:

$$\begin{aligned} \sin(2\pi t/\tau)(\cos p \sin q - \cos q \sin p) &= (u/a) \sin q - (v/b) \sin p \\ \cos(2\pi t/\tau)(\cos p \sin q - \cos q \sin p) &= -(u/a) \cos q + (v/b) \cos p. \end{aligned} \quad (81)$$

If we square and add these two expressions; we get

$$\sin^2(p-q) = u^2/a^2 + v^2/b^2 - 2(u/a)(v/b) \cos(p-q). \quad (82)$$

And we see that this equation is that of an ellipse whose principle axes coincide with the coordinate axes when $p-q = \frac{1}{2}\pi$, so that only the first terms of the right member remain, and the left member is unity:

$$r = u^2/a^2 + v^2/b^2. \quad (83)$$

This represents elliptically polarized light, in which a and b may have any ratio.

If we put $w = 0$, $a = b$, $p-q = \pm \frac{1}{2}\pi$, we have the conditions for circularly polarized light:

$$\begin{aligned} u &= a \sin(2\pi t/\tau) & v &= a \cos(2\pi t/\tau) \text{ (right handed)} \\ u &= a \sin(2\pi t/\tau) & v &= -a \cos(2\pi t/\tau) \text{ (left handed)}. \end{aligned} \quad (84)$$

When the vibration ellipse reduces to a straight line, or in practice approximately so, $w = 0$, $p-q = 0$, or $p-q = \pi$, we have by taking the square root of (82):

$$u/a \pm v/b = 0. \quad (85)$$

In wave motion, the intensity of the action, or the energy of the disturbance, is proportional to the square of the amplitude. Hence we add, for the geometrical sum, the squares of the component amplitudes A, B, C , and thus obtain:

$$\mathcal{I} = A^2 + B^2 + C^2. \quad (86)$$

We shall now apply this composition theorem to polarized light. It is well known that such light is free from interference, when polarized in planes mutually inclined at right angles, but always gives an intensity equal to the sum of the intensities of the separate rays.

(iii) Analysis of the composition of polarized light compared with the evidence of observations.

Let us superpose upon the ray defined by equations (79) and traveling along the z -axis, a ray of equal intensity, but polarized at right angles to it. If the components of this new ray be u', v', w' , and the phase difference be δ ; then we shall have

$$\begin{aligned} u' &= B \sin(2\pi t/\tau + q + \delta) & v' &= -A \sin(2\pi t/\tau + p + \delta) \\ w' &= C \sin(2\pi t/\tau + r + \delta) \end{aligned} \quad (87)$$

Except for the phase difference δ , these components become identical with those in (79), by rotating the coordinate system through 90° , about the z -axis. Accordingly, we have by taking the sums of the components, thus geometrically compounded:

$$\begin{aligned} u+u' &= A'^2 = A^2 + B^2 + 2AB \cos(\delta + q - p) \\ v+v' &= B'^2 = A^2 + B^2 - 2AB \cos(\delta + p - q) \\ w+w' &= C'^2 = 2C^2(1 + \cos \delta). \end{aligned} \quad (88)$$

By simple addition we have from (86) the following geometrical composition of the components of the light vectors:

$$\mathcal{I}' = A'^2 + B'^2 + C'^2 \quad (89)$$

which is equivalent to

$$\mathcal{I}' = 2\mathcal{I} + 2C^2 \cos \delta - 4AB \sin \delta \sin(q-p). \quad (90)$$

But it is found by experiment that we have sensibly $\mathcal{I}' = 2\mathcal{I}$, or the intensity of the compound ray is equal to the sum of the intensities of the separate rays, and independent of the phase difference δ . Hence it follows that the second and third terms in (90) are so small as to be insensible to observation. Therefore we conclude that within the limits of observation:

$$C = 0 \quad p - q = 0. \quad (91)$$

That is, in polarized light the radius vector is sensibly perpendicular to the direction of propagation of the ray, and the motion therefore sensibly transverse. Also from equations (82) or (85) it follows that the particles vibrate sensibly in a straight line.

From this analysis, it follows that rays which have suffered double refraction or reflection at the polarizing angle are plane-polarized, and thus consist of vibrations which are sensibly transverse. We use the term sensibly transverse, instead of absolutely transverse, in order to reconcile other facts of observation with mathematical theory.

It is shown by experimental research that when plane polarized light is reflected from metals, the effect is to convert it into elliptical polarization, — the degree of the ellipticity depending on the direction of the incident ray, and on its plane of polarization, as well as on the nature of the reflecting metal (cf. *Ganot's Physics*, 14th ed., 1893, § 672, p. 656).

When the plane-polarized light is reflected from silver, the resulting polarization is almost circular — probably because silver is so perfect a conductor of electric or aether wave motion, that the normal tendency to elliptical motion is largely restored. But if the plane-polarized light be reflected from galena, a lead ore of low electric conductivity, the resulting polarization remains almost plane.

Now since elliptically polarized light never vanishes, when examined in a Nicol prism, though at alternate positions it becomes fainter, such elliptical motion in light must be considered the general type of vibration of the aether particle. If therefore plane-polarized light, by reflection from metallic surfaces, is rendered decidedly more elliptical in its motion, it would seem to follow that in plane-polarized light the motion is never strictly rectilinear; on the contrary such light always has in its motion a slight elliptical element, which permits of notable restoration, by reflection from silver and other high conducting metals.

It is for these reasons that, in our discussion of the above equations, (82) to (91), we admit the plane-polarized vibrations to be only sensibly transverse, not rigorously transverse, in rectilinear paths.

This conclusion from the combination of experimental research with mathematical analysis fully sustains our view that there necessarily is a longitudinal component in light. Any other view than that here set forth is contradicted by well established facts of observation, which appear to admit of but one interpretation.

8. The Undulatory Explanation of the Phenomenon of Interference in Polarized Light conforms to *Poisson's* Theory of the Elliptical Vibrations of the Aether Particles mainly in the Direction of the Normal to the Wave Surface.

(i) Explanation of interference when the particles describe ellipses.

We have shown in section 1 and 4 above that the traditional theory of the transverse vibrations in light is not strictly rigorous, but requires rational revision, to take account of the geometrical conditions specified by *Poisson*, and the related electrodynamic waves from each atom, which underlies the theory of magnetism. Thus it is advisable to reexamine the bearing of these results on the theory of interference of polarized light.

1. The ordinary explanation of interference handed down from the days of *Young* and *Fresnel* is based upon an assumed analogy with the side vibrations of an elastic cord. This theory allows disturbances given the cord to travel along it, while the particles of the cord have only a transverse motion. But we have seen that this explanation begs the question, in that it practically assumes a »stringy« condition of the aether, whereas *Poisson's* theory of elliptical vibrations, with their major axes in the direction of the normal to wave surface, gives an almost identical result, without physical premises involving the anisotropy of the medium, or geometrical postulates of purely lateral motion which cannot be admitted.

2. Accordingly, the analogy of the waves conveyed along a twisted cord seemed so plausible to those who did not study the problem deeply, that it came into general use, and still holds its place today. Yet a more mischievous doctrine seldom has been introduced into science, because although plausible, it is dynamically and geometrically unsound in principle.

For why is the aether, in the traditional form of the wave-theory, assumed to be capable of a transverse motion of appreciable dimensions, but incapable of an equally large longitudinal motion? The chief reason for this hypothesis — for it is merely a convenient hypothesis — is the problem of explaining interference, and polarization. It is known from modern research that diffraction only requires that the length of the waves shall be small compared to the dimension of the aperture.

3. Fig. 8, Plate 9, shows how a split beam of plane-polarized light may produce interference fringes when they differ in phase by $\frac{1}{2}\lambda$.

For reasons of simplicity in construction the oscillations of the particles in the figure are taken to be circular, yet

similar reasoning will hold true for elliptical paths of any kind, and hence the results here shown are true for every kind of vibrations in polarized light.

It will be noticed that the rays consist of plane waves with amplitude A and wave length λ , and the ratio A/λ is comparatively small, but here drawn on a scale large enough to enable us to see the rotation of the elements of the wave at every point. The waves are imagined to be flat in the plane of the paper, and hence they have a longitudinal component depending on the amplitude A .

4. The adjacent diagram of light and dark bands shows the interference effects, and is seen to have strips of darkness and of light, where the motions of the split rays are such as to destroy the rotation, or augment it by the superposition of the separate effects. If, for example, the wave travel along the x -axis, the displacement of the particle parallel to the y -axis is η , and ξ parallel to the x -axis:

$$\begin{aligned} \eta &= a \sin(2\pi x/\lambda + \alpha) = dy \\ \xi &= a \cos(2\pi x/\lambda + \alpha) = dx \\ s &= \sqrt{(\eta^2 + \xi^2)} = a, \text{ in circular motion.} \end{aligned} \tag{92}$$

Now a detailed treatment of the leading phenomena of interference is beyond the scope of this paper; yet we may sketch briefly the wave-theory of this subject, in order to show that in spite of the defect above pointed out in the form of the wave-theory of light handed down by *Young*, *Fresnel*, *Arago*, and *Cauchy*, this defect does not invalidate the explanation of interference.

(ii) Theory of the light and dark bands.

An adequate treatment of diffraction phenomena would require a mathematical discussion of *Fresnel's* integrals (*Drude's* Theory of Optics, pp. 188-196), which have the form:

$$\xi = \int_0^v \cos \frac{1}{2}\pi v^2 dv \quad \eta = \int_0^v \sin \frac{1}{2}\pi v^2 dv. \tag{93}$$

These functions may be thought of as the rectangular coordinates of a point in the light plane $\xi\eta$. Accordingly, from (93) we have at once:

$$d\xi = dv \cos \frac{1}{2}\pi v^2 \quad d\eta = dv \sin \frac{1}{2}\pi v^2 \tag{94}$$

$$ds = \sqrt{(d\xi^2 + d\eta^2)} = dv. \tag{95}$$

And when the spatial length s is measured from the origin, we have

$$s = v. \tag{96}$$

The functions ξ, η are illustrated by the following fig. 9 (*Drude's* Theory of Optics, p. 192), which has been calculated by the method originally due to *Cornu* (*Jour. de Phys.*, 3, 1874).

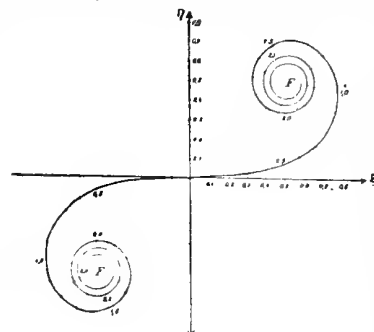


Fig. 9.

Diagram of the double spiral of *Fresnel's* integrals, for the diffraction of light. The curve coils about the two asymptotic points F and F' , where $v = +\infty$, and $v = -\infty$. The maxima and minima of intensity lie approximately at the intersections of the line FF' with the spiral curve. If the free intensity be 1, the maxima are $\mathcal{F}_1 = 1.34, \mathcal{F}_2 = 1.20, \mathcal{F}_3 = 1.16$; the minima $\mathcal{F}'_1 = 0.78, \mathcal{F}'_2 = 0.84, \mathcal{F}'_3 = 0.87$ (cf. *Fresnel Oeuvres Complètes*, 1, p. 322).

It is shown by *Cornu's* method that for the asymptotic points F and F' we have

$$\xi_F = \int_0^{\infty} \cos \frac{1}{2} \pi v^2 dv \quad \eta_F = \int_0^{\infty} \sin \frac{1}{2} \pi v^2 dv. \quad (97)$$

These integrals may be evaluated by putting x, y as the rectangular coordinates of a point P , $x^2 + y^2 = r^2$, where r is the distance from the origin. If, therefore, we put:

$$\int_0^{\infty} e^{-x^2} dx = M \quad \int_0^{\infty} e^{-y^2} dy = M \quad (98)$$

we get for their product the double integral:

$$\int_0^{\infty} \int_0^{\infty} e^{-(x^2+y^2)} dx dy = M^2. \quad (99)$$

Accordingly $dx dy$ may be looked upon as a geometrical surface element in the xy plane; and the problem is to evaluate *Fresnel's* integrals for the diffraction. It is shown that the asymptotic point F has the coordinates

$$\xi_F = \int_0^{\infty} \cos \frac{1}{2} \pi v^2 dv = \frac{1}{2} \quad \eta_F = \int_0^{\infty} \sin \frac{1}{2} \pi v^2 dv = \frac{1}{2} \quad (100)$$

with corresponding integrals for the point F' , whose coordinates are negative.

In the more general problem of diffraction we have the two integrals:

$$C = \int \cos [f(x, y)] d\sigma \quad S = \int \sin [f(x, y)] d\sigma. \quad (101)$$

Here the function

$$f(x, y) = (\pi/\lambda)(1/\rho_1 + 1/\rho_0)[x^2 \cos^2 \varphi + y^2] \quad (102)$$

and σ is a small opening of any form in a screen of infinite extent, while the radii vectores

$$\rho_1 = V(x_1^2 + y_1^2 + z_1^2) \quad \rho_0 = V(x_0^2 + y_0^2 + z_0^2) \quad (103)$$

$\varphi =$ angle of z -axis with ρ_1 $\cos(\pi\rho_0) = -\cos(\pi\rho_1) = \cos\varphi$.

Near a straight edge¹⁾ these functions C and S become:

$$C = \int_{-\infty}^x \int_{-\infty}^{+\infty} dx dy \cos \{(\pi/\lambda)(1/\rho_1 + 1/\rho_0)[x^2 \cos^2 \varphi + y^2]\} \quad (104)$$

$$S = \int_{-\infty}^x \int_{-\infty}^{+\infty} dx dy \sin \{(\pi/\lambda)(1/\rho_1 + 1/\rho_0)[x^2 \cos^2 \varphi + y^2]\}.$$

¹⁾ One of the great historical difficulties in the wave-theory of light was the problem of explaining with geometrical rigor the propagation in straight lines, since on *Huyghens' principle* each particle of the aether in the wave front becomes a centre of disturbance. The above integrals, as worked out by modern geometers, have their limits so fixed as to include the whole region of disturbance, yielding appropriate fringes due to interference, but otherwise giving rectilinear propagation.

The celebrated geometer *Poisson*, as we learn from the careful note appended to his posthumous memoir of 1839, pp. 151-152, was much occupied with the problem of the rectilinear propagation of light during his last illness:

"Quand le mal moins avancé lui permettait encore de causer science avec ses amis, il a dit qu'il avait trouvé comment il pouvait se faire, qu'un ébranlement ne se propageât dans un milieu élastique que suivant une seule direction; le mouvement propagé suivant les directions latérales étant insensible aussitôt que l'angle de ces directions avec celle de la propagation était appréciable. Il arrivait ainsi à la propagation de la lumière en ligne droite. Plus tard, cédant au mal, et se décidant enfin à interrompre l'impression de son mémoire: c'était pourtant, a-t-il dit, la partie originale, c'était décisif pour la lumière; et cherchant avec peine le mot pour exprimer son idée, il a répété plusieurs fois: c'était un filet de lumière. Puissent ces paroles, religieusement conservées par les amis de M. *Poisson*, les dernières paroles de science qui soient sorties de sa bouche, mettre les savants sur la trace de pensée, et inspirer un achèvement de son oeuvre digne du commencement."

It is unfortunate that *Poisson's* memoirs have become very scarce, and thus little known to modern readers. It has long been recognized that there is great need for the reprinting of *Poisson's* Collected Works. But for my good fortune in obtaining a set of *Poisson's* celebrated memoirs on waves, formerly belonging to the library of Sir *John Herschel*, the results brought out in this paper would not have been possible.

²⁾ In the note dated Sept. 12, below, it is shown that the longitudinal component is $\Delta = (A/\lambda)\rho = 1:(66420 \cdot 10^6)$, very much smaller than first estimated.

(iii) Application of the theory to the formation of diffraction patterns.

It is found in the application of the above functions, that the equations give the central fringe intensely white, with adjacent blackest area, near the centre of the pattern; here the double integral totally vanishes, but on either side of the centre there remains some illumination. When a space has been traversed along the x -axis equal to a certain length, the light reappears as it should do by the above equations depending on sine and cosine, with corresponding periodicities. The sharpness of the boundary is an essential condition of a well defined diffraction pattern; and without the fulfillment of this geometrical condition, a satisfactory exhibition of the theory can hardly be realized.

In practical experience therefore the values of the double integrals often are somewhat approximate, — the formulae being rigorously true in the centre of the dark and light bands, when the screen effect is mathematically sharp, but at other places only partly true, — and thus we have interference bands, shading away gradually and attaining maxima at intervals, where the contrast reaches a maximum, as shown in the diagram.

In general the researches of experienced physical investigators have shown that the theory of transverse waves accounts for the diffraction pattern with great accuracy. In section 5 above Prof. *Hastings* states that he found *Huyghens' construction* accurate to $1:10^6$, which is a remarkable degree of precision, and equally valid as applied to diffraction phenomena.

Now in our slight correction of the foundations of the wave theory of light, given in sections 1 and 4, we found that an accuracy of $1:(4 \cdot 10^6)$ might be attained before any sensible outstanding phenomena would be likely to arise²⁾. And as this is below the limits of our perception in modern experiments, we may dismiss the question as beyond the limits of detection in the present state of physical science.

But to show that a real longitudinal component should exist in light waves, though it is excessively small, we may recall an actual measurement of the smallness of the longitudinal component in a well determined experiment with sound. The late Lord *Rayleigh* observed the musical note f^{iv} due to a pipe of an organ which could be heard at a distance of 820 metres; and found by measurement that the

amplitude of the oscillation in these waves could not be greater than 0.06 of a millimetre.

Now in case of f^{iv} there are 2784 vibrations per second, and the length of the wave, under a velocity of 332000 mm per second, is therefore 120 mm. If the amplitude be 0.06 mm, as found by Lord *Rayleigh*, it follows that the wave length is 2000 times the amplitude. As a concrete example of the molecular oscillations which produce musical sound, this result is quite remarkable.

In the case of light we can determine the wave length very accurately, but we cannot measure the amplitude of the aether waves by any direct process¹⁾. Yet if the length of typical musical waves be some 2000 times their amplitude, it will follow, from the nature of the similar cause involved, that for so elastic a medium as the aether the waves should also be enormously longer than their amplitudes — much greater than 100 times, as assumed by *Kelvin*, *Maxwell*, and *Larmor*. This value of $A/\lambda = 10^{-2}$ is a relatively small amplitude, but it gives a longitudinal component 20 times larger than that noted in the sound wave above cited.

Accordingly there is reason to believe that in the case of so highly elastic a medium as the aether the amplitude A is less than $1 : 100000^{\text{th}}$ of the wave-length, or at least 1000 times smaller than *Kelvin*, *Maxwell*, and *Larmor* assumed. This would make the ratio in the case of the very elastic aether fifty times smaller than was observed by Lord *Rayleigh* for typical musical sound in our air. Such a value as $1 : 10^5$ certainly is not too large, but it may be that the ratio should be considerably smaller yet.

The following figure 11 illustrates the interference phenomena observed when light passes through a glass wedge, with the sides mutually inclined at a small angle.

This too represents interference, much like that of polarized light shown in the preceding discussion, but it exhibits the phenomena more in detail; and the phenomena exhibited are consistent with rotating elements in the waves like those in the first diagram. The wedge of glass explains why the waves interfere in bands at right angles to the

height of the wedge. In the first diagram the direction of the height of the wedge, for separating the phase of the wave by $\frac{1}{2}\lambda$, would have to be imagined horizontal, and the light returned along a path parallel to its emission.

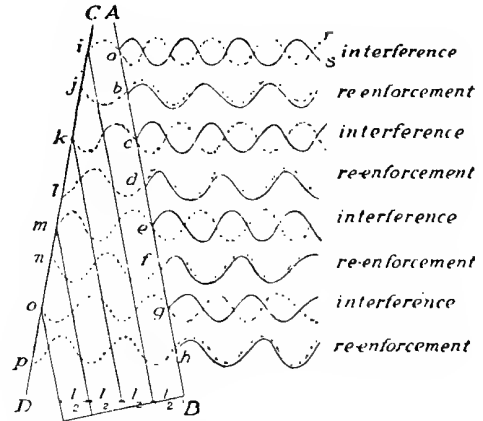


Fig 11. Familiar illustration of interference and reinforcement, when the light of a candle falls upon a glass wedge (*Millikan and Gale*). This gives bright and dark bands, parallel to the edge of the wedge, exactly as in the case of Newton-rings about the centre, in the case of a lens.

(iv) Integral expressions for the kinetic and potential energy of the medium when filled with waves.

Let ξ, η, ζ be the rectangular coordinates of a particle at the time t , then the differentials $d\xi, d\eta, d\zeta$ will denote the component velocities of a particle in the medium which is propagating the waves. The particle is oscillating periodically about a mean position, at any time t , and thus has both a velocity of which the components are $d\xi, d\eta, d\zeta$, and a distortion from its mean position, or displacement. It is well known that in wave motion half the energy is kinetic, half potential: therefore the kinetic energy due to the component velocities of the particles becomes:

$$T = \frac{1}{8} (\mu/\pi) \iiint [(d\xi/dt)^2 + (d\eta/dt)^2 + (d\zeta/dt)^2] dx dy dz. \tag{105}$$

For the potential energy due to the distortion of the elements of the medium we have:

$$W = (1/4\pi K) \iiint [(d\zeta/dy - d\eta/dz)^2 + (d\xi/dz - d\zeta/dx)^2 + (d\eta/dx - d\xi/dy)^2] dx dy dz. \tag{106}$$

In these equations the component velocities of the wave disturbances are $d\xi/dt, d\eta/dt, d\zeta/dt$, and the distortions of the form of the elements $\delta_1 = d\zeta/dy - d\eta/dz, \delta_2 = d\xi/dz - d\zeta/dx, \delta_3 = d\eta/dx - d\xi/dy$ give the displacements of the elements of the medium along the coordinate axes.

The total energy in the medium at any point is the sum of these two energies: $T + W = \Omega$, or

$$\Omega = (1/4\pi) \iiint \{ \frac{1}{2} \mu [(d\xi/dt)^2 + (d\eta/dt)^2 + (d\zeta/dt)^2] + \frac{1}{K} [(d\zeta/dy - d\eta/dz)^2 + (d\xi/dz - d\zeta/dx)^2 + (d\eta/dx - d\xi/dy)^2] \} dx dy dz \tag{107}$$

which illustrates the agitation of a medium filled with waves.

¹⁾ Since writing the above paragraph, it has occurred to me that we may calculate the theoretical ratio of the amplitude to the wave-length of the aether by the following process. We have proved that the aether is $\epsilon = 689321600000$ times more elastic than air in proportion to its density. And it is this elasticity which gives the aether waves their enormous velocity; and, as compared to air, the amplitude should be smaller in proportion to the square root of this number. For when a wave in the aether begins to be generated it speeds away so rapidly, under the enormous elasticity, that the amplitude is small in the same proportion that the velocity v is great. Now from the above value we find that $\sqrt{\epsilon} = 830254$; and as the ratio in air furnished by Lord *Rayleigh's* experiments is $1 : 2000$, we have for the aether the relative ratio: $1/830254 \cdot 1/2000 = 1/1660508000$, or 830254 times smaller than the ratio of the amplitude to the wave-length in the musical sound investigated of Lord *Rayleigh*. The true ratio thus appear to be 16605 times smaller than that indicated above, and should be $A/\lambda = 1 : (16605 \cdot 10^5) = 1 : (1.660508 \cdot 10^9)$, which makes $\Delta = (A/\lambda)\rho = 1 : (66420 \cdot 10^3)$. — Note added Sep. 12, 1920.

The wave-theory indicated by all the phenomena of nature.

In concluding this discussion we draw attention to the indications of nature from the widest survey of physical phenomena:

1. In the whole domain of mathematical physics, modern investigations lay great stress on boundary problems. Now boundary conditions naturally would have great importance if natural forces are due to the action of waves; because at the boundary of solid or liquid bodies the velocity of propagation is changed very suddenly by the resistance, and the tendency to refraction and dispersion.

2. In his celebrated article on light, *Encycl. Metrop.*, 1849, section 561, Sir *John Herschel* shows that the forces producing refraction are such as »may be termed infinite«. It is now recognized that these powerful actions appear in dispersion and diffraction, as well as in refraction, and give rise to the molecular forces, which in a future paper will be referred to wave motions, thus confirming the great importance of the wave-theory for all the phenomena of nature.

3. Now quite aside from the physical considerations of particular phenomena, we have general mathematical methods for treating partial differential equations, invented by *Fourier*, *Poisson*, *Cauchy* and other geometers about a century ago. Thus in our time practically all the equations of mathematical physics turn on the treatment of partial differential equations, as in sound, heat, light, electrodynamic action, magnetism, etc. And these general mathematical methods, so largely devised by *Fourier* and *Poisson*, point to waves in the aether as the underlying cause of physical forces.

4. Accordingly, the importance of boundary conditions, in problems of the transmission of energy through matter undergoing sudden transition of property, by virtue of fixed domains of discontinuity, and thus requiring the methods of partial differential equations for their exact treatment, seemed to be so remarkable an argument for the wave-theory that it should engage the attention of geometers and natural philosophers who aim at extending the researches of *Fourier* and *Poisson*.

9. Theory of the Propagation of Wave Energy, under *Poisson's* Equation $\partial^2\Phi/\partial t^2 = a^2 \nabla^2\Phi$, in a Continuous Elastic Solid, with an Analysis which shows Waves traveling in Different Directions.

In the New Theory of the Aether (AN 5044, 5048) we have calculated the mean molecular velocity of the aetheron to be $\bar{v} = \frac{1}{2}\pi V = 471239$ kms per second, and shown that the aether obeys certain laws of density and rigidity not heretofore suspected. The length of the mean free path is about 573000 kms, and in free space less than one collision per second occurs between the free aetherons, under normal motion. Owing to the decrease of density and rigidity towards large bodies like the sun and earth, all our old analogies with the traditional elastic solid have to be carefully revised, and adapted to the new theory with extreme caution.

After very careful consideration of these problems, in the light of the data contained in the first, second, third

papers on the New Theory of the Aether, I believe we may safely conclude that, notwithstanding the very extraordinary physical properties of the aether, in a certain sense it behaves as an elastic solid for quick acting forces: namely, that the aether will faithfully transmit any kind of vibration communicated to it, whether it involve dilatation of volume or mere change of form of any element $dx dy dz$.

Unless we grant this extraordinary power of transmission of wave motion, we can scarcely reconcile the new theory, including the extreme velocity of the aetheron $\bar{v} = \frac{1}{2}\pi V = 471239$ kms per second, with the known extreme elasticity of the aether, which is $\epsilon = 689321600000$ times greater than that of air in proportion to its density. It is evident that the aether is so different from air, in respect to the high velocity of the aetheron, and the enormous elasticity of the medium, that no movement of any kind can occur in it without the most perfect response to whatever waves arise.

In this sense I regard the aether as an infinite aeolotropic elastic solid; but I do not assume that all the physical restrictions of the ordinary elastic solid, which we can subject to experiment in our laboratories, necessarily hold for the aether. Some of these physical restrictions, which we ascribe to molecular forces in solids, may be and probably are missing in the aether, — owing to the absence of the complex molecular structure known in solids, and to the enormously greater rapidity of the motion of the aetherons.

Our conclusions therefore are as follows:

1. Any movement whatever given to the aether will be faithfully transmitted, — owing to the extremely high velocities of the aetherons, which gives the medium both extremely great elasticity and high rigidity, — yet the medium is not like ordinary solids, in that it has an extraordinarily small density.

2. The aether, therefore, has most of the wave transmitting properties of an elastic solid — will transmit any kind of wave; yet always with one velocity only, a uniform velocity $V = 3 \cdot 10^{10}$ cms, which is somewhat different from what is attributed to ordinary elastic solids, with two different velocities, of the following kind, namely:

(C) A compressional wave in an extended mass, say of steel, depending on both the compressibility k and the rigidity n :

$$V_c = V(k + \frac{4}{3}n) = 655000 \text{ cms per second} \quad (108)$$

$$n = 0.95 \cdot 10^{12} \quad k = 1.84 \cdot 10^{12}$$

(T) A purely transverse distortional wave (without change of volume) expressed by the simpler formula:

$$V_d = V(n/\sigma) = 348000 \text{ cms per second} \quad (109)$$

in the case of an extended mass of steel, $\sigma = \text{density} = 7.85$.

Thus for steel the former value is nearly twice the latter, which renders the theory doubtful, in view of the non-separation of the earthquake waves of these two classes.

3. In certain respects the aether is more like a gas than a solid, and up to this time it is probable that experiment has not fully established the two velocities theoretically predicted for an elastic solid by *Poisson*, *Cauchy* and other mathematicians. In his *Tides and Kindred Phenomena*

of the Solar System, 1899, pp. 261-2, Sir *George Darwin* remarks in regard to earthquake phenomena:

»The vibrations which are transmitted through the earth are of two kinds. The first sort of wave is one in which the matter through which it passes is alternately compressed and dilated; it may be described as a wave of compression. In the second sort the shape of each minute portion of the solid is distorted, but the volume remains unchanged, and it may be called a wave of distortion. These two vibrations travel at different speeds, and the compressional wave outpaces the distortional one. Now the first sign of a distant earthquake is that the instrumental record shows a succession of minute tremors. These are supposed to be due to waves of compression, and they are succeeded by a much more strongly marked disturbance, which, however, lasts only a short time. This second phase in the instrumental record is supposed to be due to the wave of distortion.«

»If the natures of these two disturbances are correctly ascribed to their respective sources, it is certain that the matter through which the vibrations have passed was solid. For, although a compressional wave might be transmitted without much loss of intensity, from a solid to a liquid and back again to a solid, as would have to be the case if the interior of the earth is molten, yet this cannot be true of the distortional wave. It has been supposed that vibrations due to earthquakes pass in a straight line through the earth; if then this could be proved, we should know with certainty that the earth is solid, at least far down towards its center.«

This reasoning implies that this eminent natural philosopher was in doubt as to the validity of the two-velocity theory, in practice, with actual masses like the earth.

In studying earthquake seismographic records and discussions I find the disturbance to rise very gradually and die down equally gradually. Thus I have not been able to verify the assumption of two distinct types of waves: we merely find that at a great distance from the source of disturbance the earthquake waves are spread out like a spectrum. This spreading out might be due to varying resistance to waves of one type, but of different length, as in optics.

On purely physical grounds it seems difficult to imagine the distortional wave being actually separated from the compressional wave. That actual nature would effect this ideal separation seems very doubtful. And so far it is not supported by earthquake phenomena admitting of verification by observation on the propagation of waves through our globe.

$$\begin{aligned} \Phi_0 = & \sum_{l=0}^{l=\infty} \sum_{m=0}^{m=\infty} \sum_{n=0}^{n=\infty} A_{lmn} \cos(l\pi x/\alpha) \cos(m\pi y/\beta) \cos(n\pi z/\gamma) \\ & + \sum_{l=0}^{l=\infty} \sum_{m=0}^{m=\infty} \sum_{n=0}^{n=\infty} B_{lmn} \sin(l\pi x/\alpha) \cos(m\pi y/\beta) \cos(n\pi z/\gamma) + \dots \end{aligned} \quad (114)$$

(cf. Lord *Rayleigh*, *Theory of Sound*, 2nd ed., 1896, p. 70).

The full set of eight coefficients, for all possible arrangements of sines and cosines, are given by the integral expressions:

$$A_{lmn} = (8/\alpha\beta\gamma) \iiint \Phi_0 \cos(l\pi x/\alpha) \cos(m\pi y/\beta) \cos(n\pi z/\gamma) \cdot dx dy dz \quad (115)$$

$$B_{lmn} = (8/\alpha\beta\gamma) \iiint \Phi_0 \sin(l\pi x/\alpha) \cos(m\pi y/\beta) \cos(n\pi z/\gamma) \cdot dx dy dz \quad (116)$$

5. Accordingly, it appears that the actual propagation of waves in solids deserves further study. Our premises so frequently are false that the actual facts, in regard to solids both homogeneous and heterogeneous, deserve more statistical inquiry, in cases where a definite decision may be attained. In his article on *Light*, *Encycl. Brit.*, 9th ed., § 19, p. 446, the late Lord *Rayleigh* says that in such bodies as jelly the velocity of the longitudinal vibrations is a large multiple of the velocity of the corresponding transverse vibrations. No doubt there is some assumed evidence for such a statement, besides the calculations above given, but as no authorities for conclusive experiments of this type are known to me, I think a result of such delicacy should be received with great caution.

6. A few cases, however, even if true, are not enough to establish general conclusions; and in view of the difficulty of conceiving how the two classes of waves can be actually separated in nature — one set of waves inevitably tending to run into the other — the only safe course is to appeal to a variety of experiments, under conditions which may lead to an experimentum crucis.

Notwithstanding this uncertainty as to the true order of nature — the theory being not certainly verified by experiment, — it seems best to examine briefly the chief mathematical conditions imposed by the propagation of waves in an elastic solid. In an elastic solid, the equation of *Poisson*

$$\partial^2 \Phi / \partial t^2 = a^2 \nabla^2 \Phi \quad (110)$$

is satisfied by the dilatation and three components of rotation as follows:

$$\delta = \partial \alpha / \partial x + \partial \beta / \partial y + \partial \gamma / \partial z \quad (111)$$

$$\begin{aligned} \omega_1 &= 1/2 (\partial \gamma / \partial y - \partial z / \partial \beta) & \omega_2 &= 1/2 (\partial \alpha / \partial z - \partial x / \partial \gamma) \\ \omega_3 &= 1/2 (\partial \beta / \partial x - \partial y / \partial \alpha) \end{aligned} \quad (112)$$

α, β, γ being the displacements at any point $p(x, y, z)$.

In the elastic solid solutions, the components of rotation $\omega_1, \omega_2, \omega_3$ are connected by the well known relation:

$$\partial \omega_1 / \partial x + \partial \omega_2 / \partial y + \partial \omega_3 / \partial z = 0 \quad (113)$$

and only two of the three sets of solutions are independent. Combining these with the solution for δ , we have, in all, three sets of independent solutions.

Take a rectangular volume of the elastic substance $x = 0, x = \alpha, y = 0, y = \beta, z = 0, z = \gamma$. Then at any time $t = 0, \Phi = \Phi_0$; and by *Fourier's* theorem the value of Φ_0 for any point within $\alpha \beta \gamma$ may be expressed by the following triple summations, which include all positive integral values of l, m, n from 0 to ∞ :

$$C_{lmn} = (8/\alpha\beta\gamma) \iiint \Phi_0 \cos(l\pi x/\alpha) \sin(m\pi y/\beta) \cos(n\pi z/\gamma) \cdot dx dy dz \quad (117)$$

$$D_{lmn} = (8/\alpha\beta\gamma) \iiint \Phi_0 \sin(l\pi x/\alpha) \sin(m\pi y/\beta) \cos(n\pi z/\gamma) \cdot dx dy dz \quad (118)$$

$$E_{lmn} = (8/\alpha\beta\gamma) \iiint \Phi_0 \cos(l\pi x/\alpha) \cos(m\pi y/\beta) \sin(n\pi z/\gamma) \cdot dx dy dz \quad (119)$$

$$F_{lmn} = (8/\alpha\beta\gamma) \iiint \Phi_0 \sin(l\pi x/\alpha) \cos(m\pi y/\beta) \sin(n\pi z/\gamma) \cdot dx dy dz \quad (120)$$

$$G_{lmn} = (8/\alpha\beta\gamma) \iiint \Phi_0 \cos(l\pi x/\alpha) \sin(m\pi y/\beta) \sin(n\pi z/\gamma) \cdot dx dy dz \quad (121)$$

$$H_{lmn} = (8/\alpha\beta\gamma) \iiint \Phi_0 \sin(l\pi x/\alpha) \sin(m\pi y/\beta) \sin(n\pi z/\gamma) \cdot dx dy dz \quad (122)$$

As Φ is a scalar quantity, we may suppose the rate of increase at any time $t = 0$, to be denoted by $\partial\Phi_0/\partial t$, which may be expanded in series similar to that in (114), but with accented coefficients, A'_{lmn} , B'_{lmn} , C'_{lmn} , etc.

Knowing the initial values of Φ and $\partial\Phi/\partial t$, we may at once write down the complete solution of (110), which is easily seen to be:

$$\begin{aligned} \Phi = & \sum_{l=0}^{\infty} \sum_{m=0}^{\infty} \sum_{n=0}^{\infty} \cos(l\pi x/\alpha) \cos(m\pi y/\beta) \cos(n\pi z/\gamma) (A_{lmn} \cos pt + A'_{lmn} \sin pt) \\ & + \sum_{l=0}^{\infty} \sum_{m=0}^{\infty} \sum_{n=0}^{\infty} \sin(l\pi x/\alpha) \cos(m\pi y/\beta) \cos(n\pi z/\gamma) (B_{lmn} \cos pt + B'_{lmn} \sin pt) + \dots \end{aligned} \quad (123)$$

In order to satisfy (110) we must have:

$$p^2 = a^2 \pi^2 (l^2/\alpha^2 + m^2/\beta^2 + n^2/\gamma^2). \quad (124)$$

We may now combine terms which have the same values of l, m, n in (123), and thus we find that Φ can be expressed as a sum of terms of the form:

$$\Phi = \sum K \cos(pt \pm l\pi x/\alpha \pm m\pi y/\beta \pm n\pi z/\gamma - \epsilon) \quad (125)$$

where the summation is to be extended to all values of $\pm l, \pm m, \pm n$, and the constants K and ϵ are of course different for each set of values.

Put in this form, it is clear, as *Feans* remarks (Dynamical Theory of Gases, 2nd ed., p. 383, 1916), that the solution represents sets of plane waves traveling in different directions. But from (124) it follows that all the waves are propagated with the same velocity a , as in the luminiferous aether.

If the elastic solid has continuous character, its particles have dynamically all the degrees of freedom appropriate to the aether, which is an absolute continuum, the finest molecular or atomic structure in the universe. A medium so constituted has the capacity to transmit waves from any direction. And in case the medium is the ultimate medium underlying the physical universe, no energy can be lost in the movement of the waves, which move incessantly from one body to another, and in free space travel with the velocity of light.

When the velocity of the waves is retarded, energy is expended, and pressure developed by the retardation of the wave front. Forces of a more intricate kind arise when refraction, dispersion, diffraction, etc., develop, as in the encounter with particles or bodies in which the velocity is suddenly changed, and the wave-field redistributed, so that the density and local internal pressure of the aether is altered. But we can only treat of this topic when we come to deal with molecular forces, which heretofore have defied explanation, owing to lack of a kinetic theory of the aether and the undeveloped state of the wave-theory.

Usually it is assumed that in an elastic solid both compressional and distortional waves co-exist, though pro-

pagated with different speeds. The two equations of *Poisson* thus become:

$$\begin{aligned} a_1 &= V(k + \frac{4}{3}n) & \partial^2\Phi/\partial t^2 &= a_1 \nabla^2\Phi \\ & \text{for the compressional wave;} \\ a_2 &= V(n/\sigma) & \partial^2\Phi/\partial t^2 &= a_2 \nabla^2\Phi \\ & \text{for the distortional wave.} \end{aligned} \quad (126)$$

With most solids the latter velocity a_2 is considerably smaller than a_1 , the velocity of the compressional wave. In the numerical example of steel above cited, a_1 is nearly twice as large as a_2 , but it still is uncertain to what extent a real separation of the two kinds of waves takes place. In other words, the two kinds of waves are distinct and should be separated, in theory; but it is quite uncertain whether this occurs in actual practice, owing to the limitations of freedom of movement in such material bodies as we find in nature. There is only one velocity of waves in the aether.

In the case of earthquake waves, there is no evidence of separation of the two kinds of waves, — all the seismographic records being explicable by the unequal velocities incident to mere wave-length, and thus having different speeds of propagation.

It is true that the earth's crust is a very complex structure, and the movement incident to an earthquake involves release of strain, and thus consists of a series of adjustments of the quasi-solid lava beneath faulted and mutually crowding blocks of granite some 20 miles thick. Perhaps we could not expect distinct separation in such a mass of tremors, partly direct and partly reflected, by the faulted blocks of the crust.

Yet if the two classes of waves actually separated in practice, we ought to perceive two distinct shocks from earth waves incident to explosions, as of powder magazines, masses of T.N.T., and other high explosives, which are powerful enough to be felt at a great distance, but do not involve complex direct and reflex actions in the crust, as in the lava adjustments due to earthquakes.

So far as I have been able to ascertain there is no well established record of double waves from such explosions

above ground; and thus the experimental evidence would seem to point to a merging of the two classes of waves into one.

In the case of the aether it is certain that only one class of waves is observed, which in free space travel with uniform velocity, as in the case of sound in gases. Accordingly the aether certainly behaves as a gas, yet its elasticity is so great that waves of any kind may be transmitted, as in an elastic solid, but apparently the velocity is uniform, whether the waves involve a rigidity, with sliding of one layer over another, or compression, as in gases.

10. Geometrical Theory of the Transmission of Light and other Physical Forces along *Fermat's* Minimum Path, $\delta\tau = \delta\int 1/v \cdot ds = 0$.

(i). The problem of refraction in the minimum path.

For any path in space, with radius of curvature ρ , and curvature $1/\rho$, we have for the length of the curved path s and the curvature:

$$s = \rho\chi \quad 1/\rho = d\chi/ds \quad (127)$$

where χ is the angle between the osculating tangent planes, and ds is the element of the curve, and ρ the radius of curvature, for the osculating circle passing through three consecutive points.

The curvature for any path is

$$1/\rho = 1/[(d^2x/ds^2)^2 + (d^2y/ds^2)^2 + (d^2z/ds^2)^2]. \quad (128)$$

And the direction cosines of the radius of curvature

$$\gamma_1 = \rho d^2x/ds^2 \quad \gamma_2 = \rho d^2y/ds^2 \quad \gamma_3 = \rho d^2z/ds^2. \quad (129)$$

Now in refraction, the path must be consistent with the principle of least time, and also conform to the principle of least action. The principle of least time was recognized by the Greek geometers at Alexandria, about 300 B.C., in the constructions of *Euclid*, (cf. *Electrod. Wave-Theory of Phys. Forc.*, vol. I, 1917, pp. 63-66), but the principle of the minimum path, in simple refraction, was discovered by *Fermat* (1601-1665), who found the actual path to conform to the law:

$$\tau = l_1 v_1 + l_2 v_2 \quad (130)$$

where the second member is made up of the sum of two terms, each a product of the length of path, l , by the velocity in that path, v .

In gradual refraction, such as that of light in the atmosphere, the direction of the ray changes at every point, chiefly because of the varying density. And thus if τ be the time of passage, we have the integral

$$\tau = \int 1/v \cdot ds. \quad (131)$$

And *Fermat's* condition of the minimum path becomes:

$$\delta\tau = \delta\int 1/v \cdot ds = 0. \quad (132)$$

To bring out the geometrical conditions of the theory of the minimum path, we have to develop the subject somewhat as outlined in the author's work of 1917.

By the method of the Calculus of Variations, equation (131) yields

$$\delta\tau = \int 1/v \cdot d\delta s - \int 1/v^2 \cdot ds \delta v. \quad (133)$$

If λ be the wave-length, it is obvious that the velocity would be defined by the functional relation

$$v = f(\lambda, x, y, z) \quad (134)$$

the form of the function f depending on the arrangement of the parts of the medium.

Making use of this value of v in (133) we obtain

$$\delta\tau = \int (1/v) (dx d\delta x + dy d\delta y + dz d\delta z)/ds - \int (1/v^2) ds (dv/d\lambda \cdot \delta\lambda + dv/dx \cdot \delta x + dv/dy \cdot \delta y + dv/dz \cdot \delta z) \quad (135)$$

$$\text{or } \delta\tau = [(1/v) (dx/ds \cdot \delta x + dy/ds \cdot \delta y + dz/ds \cdot \delta z)] - \delta\lambda \int (1/v^2) dv/d\lambda \cdot ds - \delta x \int (1/v^2) dv/dx \cdot ds - \delta y \int (1/v^2) dv/dy \cdot ds - \delta z \int (1/v^2) dv/dz \cdot ds. \quad (136)$$

The last three integrals of (135), under *Hamilton's* stationary condition, vanish, because the fixed terminal points make δx , δy , δz each equal to zero. The rest of the expression depends on the terminal points of the path, and on the wave-length only.

These conditions therefore lead to four equations

$$\delta\tau/\delta x = (1/v) dx/ds \quad \delta\tau/\delta y = (1/v) dy/ds \quad \delta\tau/\delta z = (1/v) dz/ds \quad \delta\tau/\delta\lambda = -\int (1/v^2) dv/d\lambda \cdot ds. \quad (137)$$

Now the tangent to the curved path ds is defined by the three differential direction cosines, fulfilling the condition

$$(dx/ds)^2 + (dy/ds)^2 + (dz/ds)^2 = 1. \quad (138)$$

And therefore if we square and add the first three equations of (137) we shall obtain

$$(\delta\tau/\delta x)^2 + (\delta\tau/\delta y)^2 + (\delta\tau/\delta z)^2 = 1/v^2. \quad (139)$$

(ii) Geometrical conditions fulfilled by *Hamilton's* characteristic function.

In 1823, when only eighteen years of age, *Hamilton* obtained insight into his method, and gradually introduced the consideration of a characteristic function A defined by the following differential equation for a single particle of unit mass,

$$\delta A = [dx/dt \cdot \delta x + dy/dt \cdot \delta y + dz/dt \cdot \delta z] - (dx_0/dt \cdot \delta x_0 + dy_0/dt \cdot \delta y_0 + dz_0/dt \cdot \delta z_0) + t \delta H \quad (140)$$

where H is the constant of the total energy $H = T + V$.

If the moving particle be entirely free, the seven variables in the right member of (140) are independent of one another; and thus the characteristic function A fulfills the following remarkable differential equations:

$$\begin{aligned} \partial A/\partial x &= dx/dt & \partial A/\partial x_0 &= -dx_0/dt \\ \partial A/\partial y &= dy/dt & \partial A/\partial y_0 &= -dy_0/dt \\ \partial A/\partial z &= dz/dt & \partial A/\partial z_0 &= -dz_0/dt \\ & & \partial A/\partial H &= t. \end{aligned} \quad (141)$$

Therefore we have at once

$$\begin{aligned} & (\partial A/\partial x)^2 + (\partial A/\partial y)^2 + (\partial A/\partial z)^2 = \\ & = (dx/dt)^2 + (dy/dt)^2 + (dz/dt)^2 = v^2 = 2(H - V) \end{aligned} \quad (142)$$

$$\begin{aligned} & (\partial A/\partial x_0)^2 + (\partial A/\partial y_0)^2 + (\partial A/\partial z_0)^2 = \\ & = (dx_0/dt)^2 + (dy_0/dt)^2 + (dz_0/dt)^2 = v_0^2 = 2(H - V_0) \end{aligned} \quad (143)$$

Now it is obvious that if physical forces be due to wave-action, these forces also will conform to the remarkable geometrical properties of *Hamilton's* characteristic function, and his analysis will be applicable alike to the propagation of light, electrodynamic action and universal gravitation.

Since the characteristic function A satisfies the partial differential equation:

$$(\partial A/\partial x)^2 + (\partial A/\partial y)^2 + (\partial A/\partial z)^2 = v^2 = 2(H - V) \quad (144)$$

it follows that the partial differential coefficients with respect to the coordinates represent the components of the velocity in a motion possible under the forces whose potential is V . And as V is the potential energy of the system, this result is very remarkable; for it assimilates the propagation of wave disturbances, such as light, and electrodynamic action, to the action of universal gravitation, which also fulfills the same condition.

By partial differentiation of (144) with respect to the co-ordinates we have

$$\begin{aligned} \partial A/\partial x \cdot \partial^2 A/\partial x^2 + \partial A/\partial y \cdot \partial^2 A/\partial x \partial y + \partial A/\partial z \cdot \partial^2 A/\partial x \partial z &= -\partial V/\partial x = X = d^2x/dt^2 = (d/dt)(dx/dt) \\ \partial A/\partial x \cdot \partial^2 A/\partial x \partial y + \partial A/\partial y \cdot \partial^2 A/\partial y^2 + \partial A/\partial z \cdot \partial^2 A/\partial y \partial z &= -\partial V/\partial y = Y = d^2y/dt^2 = (d/dt)(dy/dt) \\ \partial A/\partial x \cdot \partial^2 A/\partial x \partial z + \partial A/\partial y \cdot \partial^2 A/\partial y \partial z + \partial A/\partial z \cdot \partial^2 A/\partial z^2 &= -\partial V/\partial z = Z = d^2z/dt^2 = (d/dt)(dz/dt). \end{aligned} \quad (145)$$

Also, differentiating in respect to t , we have

$$\begin{aligned} dx/dt \cdot \partial^2 A/\partial x^2 + dy/dt \cdot \partial^2 A/\partial x \partial y + dz/dt \cdot \partial^2 A/\partial x \partial z &= (d/dt)(\partial A/\partial x) \\ dx/dt \cdot \partial^2 A/\partial x \partial y + dy/dt \cdot \partial^2 A/\partial y^2 + dz/dt \cdot \partial^2 A/\partial y \partial z &= (d/dt)(\partial A/\partial y) \\ dx/dt \cdot \partial^2 A/\partial x \partial z + dy/dt \cdot \partial^2 A/\partial y \partial z + dz/dt \cdot \partial^2 A/\partial z^2 &= (d/dt)(\partial A/\partial z). \end{aligned} \quad (146)$$

On comparing equations (145) and (146), we find that $dx/dt = \partial A/\partial x$ $dy/dt = \partial A/\partial y$ $dz/dt = \partial A/\partial z$ (147) satisfy simultaneously the two sets of equations.

If now we take α, β to be constants which may combine with H to give the complete integral of (144), it follows that the corresponding path and the time of its description are given by the equations:

$$\partial A/\partial \alpha = \alpha_1 \quad \partial A/\partial \beta = \beta_1 \quad \partial A/\partial H = t + \epsilon \quad (148)$$

where $\alpha_1, \beta_1, \epsilon$ are three additional arbitrary constants.

By complete differentiation of (148) with respect to t , through the three coordinates x, y, z , we have at once:

$$\begin{aligned} \partial^2 A/\partial x \partial \alpha \cdot dx/dt + \partial^2 A/\partial y \partial \alpha \cdot dy/dt + \partial^2 A/\partial z \partial \alpha \cdot dz/dt &= 0 \\ \partial^2 A/\partial x \partial \beta \cdot dx/dt + \partial^2 A/\partial y \partial \beta \cdot dy/dt + \partial^2 A/\partial z \partial \beta \cdot dz/dt &= 0 \\ \partial^2 A/\partial x \partial H \cdot dx/dt + \partial^2 A/\partial y \partial H \cdot dy/dt + \partial^2 A/\partial z \partial H \cdot dz/dt &= 0. \end{aligned} \quad (149)$$

Similar differentiation in respect to α, β, H , respectively, gives:

$$\begin{aligned} \partial^2 A/\partial \alpha \partial x \cdot \partial A/\partial x + \partial^2 A/\partial \alpha \partial y \cdot \partial A/\partial y + \partial^2 A/\partial \alpha \partial z \cdot \partial A/\partial z &= 0 \\ \partial^2 A/\partial \beta \partial x \cdot \partial A/\partial x + \partial^2 A/\partial \beta \partial y \cdot \partial A/\partial y + \partial^2 A/\partial \beta \partial z \cdot \partial A/\partial z &= 0 \\ \partial^2 A/\partial H \partial x \cdot \partial A/\partial x + \partial^2 A/\partial H \partial y \cdot \partial A/\partial y + \partial^2 A/\partial H \partial z \cdot \partial A/\partial z &= 1. \end{aligned} \quad (150)$$

On comparing these two sets of equations, we find $dx/dt = \partial A/\partial x$ $dy/dt = \partial A/\partial y$ $dz/dt = \partial A/\partial z$. (151) And as the first members of these equations represent the components of the velocity of the moving particle, it follows

that the second members also represent the same thing. Accordingly the proposition stated after equation (144) above is established, and obviously applies equally to light, electrodynamic action and gravitation.

(iii) The physical interpretation of *Hamilton's* analysis points to wave-action.

We have now to consider the physical interpretation of *Hamilton's* analysis, and we note first that the celebrated function A was invented by *Hamilton* for the treatment of light. Yet if all physical forces depend on waves due to vibrations in atoms, — with equatorial planes lying haphazard, or mutually inclined at various angles, — it will apply also to magnetism, gravitation, and all kinds of electrodynamic action. *Hamilton's* characteristic function A is therefore above all a wave-function, equally applicable to all the forces of the universe.

To interpret the above analysis, for the path of light, through a physical medium like the luminiferous aether, we resume the equation

$$(\partial \tau/\partial x)^2 + (\partial \tau/\partial y)^2 + (\partial \tau/\partial z)^2 = 1/v^2. \quad (152)$$

And we see that if we can obtain a complete integral of this equation, containing therefore two arbitrary constants α, β , in the form

$$\tau = F(x, y, z, \lambda, \alpha, \beta) \quad (153)$$

then the derived equations

$$\begin{aligned} \partial \tau/\partial \alpha &= \partial F(x, y, z, \lambda, \alpha, \beta)/\partial \alpha = \alpha' \\ \partial \tau/\partial \beta &= \partial F(x, y, z, \lambda, \alpha, \beta)/\partial \beta = \beta' \end{aligned} \quad (154)$$

will represent two series of surfaces, whose intersections give the path of the light in the medium.

As α' and β' are also arbitrary constants, the four constants $\alpha, \beta, \alpha', \beta'$ are necessary and sufficient for the purpose of making the two intersecting surfaces each pass through any two given points $p_0(x_0, y_0, z_0)$ and $p(x, y, z)$.

These *Hamiltonian* considerations, on simple refraction in non-homogeneous media, show, as was originally found by *Fermat*, that the actual path is that of least time, as well as that of least action.

Now in the case of light the physical cause of such action is known to be waves in the highly elastic aether, and propagated with unequal velocities, in different media, according to density, effective elasticity, and wave-length. Increase of density, due to the presence of ponderable matter, hinders the progress of the wave of given length, while increase of elasticity under thinning out of the matter accelerates it. And in general decreasing the wave-length increases the retardation in velocity.

Equi-actional surfaces, orthogonal to the path of light, are so distributed that the distances between them, for geometrical reasons, are always inversely as the velocity in the corresponding path.

Now [it is clearly shown in the third paper on the New Theory of the Aether (AN 5079), that electrodynamic action is conveyed by waves, traveling in free aether with the velocity of light, and therefore these waves will follow the same general laws as the waves of light. Such a physical cause necessarily takes the path of least time and of least action, which is also that of least resistance to the distur-

bances of the medium. And as the motions of the planets conform to these principles, the question may properly be asked whether any other cause than electrodynamic wave-action could be imagined to produce the attractions of the heavenly bodies.

This question has been dealt with at some length in the second paper (AN 5048), and from the additional discussion included in section 12 below it would seem to follow incontestably that no cause other than wave-action could explain the phenomena of universal gravitation.

II. The New Wave-Theory of Light accounts for all Known Optical Phenomena — Refraction, Dispersion, Anomalous Dispersion, Diffraction, Interference, and the Aberration of Light from the Fixed Stars.

(i) The problem of refraction.

It now remains to survey briefly the leading optical phenomena, to see if the new wave-theory of light will explain the observed phenomena as well or better than the old wave-theory, which assumes vibrations entirely normal to the direction of the ray, as in the motion of a stretched cord, but does not assume vibrations flat in the planes of the equators of the atoms.

And, first, the phenomenon of simple refraction presents no difficulty. For the bending of the light always is due to the unequal resistance offered to the two sides of the wave front, — the one which is more resisted being held back in its advance and the other therefore propagated more rapidly, and thus turning the direction of the ray of light towards the denser medium. This reasoning holds for refraction in water, a prism of glass, or such a slightly heterogeneous medium as the earth's atmosphere, where the air is nearly homogeneous for small distances, yet in the larger problems of the globe arranged in concentric layers, with increased density and refractive power towards the earth's surface.

On the old wave-theory of light this explanation has always been considered satisfactory; and on the new wave-theory it is equally valid, because we consider a beam of light to be made up of an infinite number of independent waves from the separate vibrating atoms. And as each wave is transmitted independently of the rest by the superfine medium of the aether, — just as on a telephone or telegraph wire large numbers of independent messages may be sent at the same instant — it follows that in transmitting the infinitely complex waves of common light, each atomic wave will be refracted exactly as if the others did not exist, and the integral effect after traversing a distance ds will be that all the waves will be refracted in the same direction, owing to the greater resistance on the same side of their common wave front.

Accordingly, the explanation of refraction remains unchanged, while that for dispersion is improved, as shown below.

(ii) The phenomena of dispersion, including anomalous dispersion.

In ordinary refraction, as we have seen, all the rays depending on the waves emitted by the individual atoms,

are bent in the same direction; and thus it is evident that if waves be of unequal length, they will encounter unequal resistance, — the shorter waves, owing to their more rapid oscillation, being relatively more resisted than the longer ones. The result of this unequal resistance is that the waves are dispersed, as in the spectrum, the longer waves being least refracted, while the shorter waves, in normal dispersion, suffer maximum refraction, thereby producing the spectrum effect of dispersion, as in a grating.

Now however, many separate waves enter a refracting medium, the refractive action on each vibration occurs as if the other vibrations did not exist: thus we have not merely refraction but also dispersion. In fact dispersion, depending on difference of wave length, seems to imply that the separate atoms, or same atoms, are emitting not only their own distinct waves, but in most cases each atom gives quite a variety of these waves, as we see by comparing the table of wave-lengths for the different elements, as sodium, calcium, hydrogen, iron, titanium, etc.

The observed phenomenon of dispersion is therefore favorable to the new wave-theory; for we realize from the known phenomena of the spectral lines that each atom has its own several periods of vibration; and thus dispersion, or unequal refraction depending on wave length, ought to occur.

As for anomalous dispersion the problem is more complex, because the substances giving this phenomenon exhibit extremely variable effects. But as each atom of a given substance emits its own characteristic waves, there is no reason why the effect of a given refractive medium should affect atoms of the different substances in the same way. The proportion of energy absorbed changes with each substance, and the resistance to each color is a function of the wave-length, but not the same for all wave-lengths, owing to the variable molecular reaction on the passing light waves.

Accordingly just as refraction depends on the wave-length, for homogeneous waves of one color, so also anomalous dispersion must depend on different resistances for different colors or wave-lengths, — due either to the absorptive effects of the substance, by which different wave lengths are unequally affected, with the thinning out of particular wave-lengths, or to the increased resistance of the substance to certain waves, thus causing them to crowd over into an adjacent part of the spectrum.

In the well known case of fuchsine, with the abnormal deviation of the violet rays, by which this color is less deviated than the longer red rays, we may suppose the fuchsine to have an inherent attraction for the violet rays great enough to offset its shorter wave length as compared to the red.

Kundt's careful observations on anomalous dispersion showed that it was common in bodies having surface color — or a different shade by reflected light from that given by transmitted light. Now since in reflection we perceive the colors which are not absorbed, it follows that bodies presenting surface color, different from that shown by light transmitted through them, must absorb the colors which they do not transmit. And therefore in transmission the spectrum is deficient, — certain waves being absorbed or taken up by the vibrating molecules, — so as to make possible the ob-

served deviation of the remaining waves from their arrangement in the normal spectrum shown by a grating.

It would appear from these considerations that the phenomenon of anomalous dispersion is highly favorable to the wave-theory. Unless all molecules emitted and absorbed waves appropriate to their own molecular structure, according to *Kirchhoff's* law, it does not seem possible to account for the actual results of observation. The theory that each molecule or atom vibrates in its own period, so as to absorb certain waves in transmission, but reflect others from the surface of a body so constituted, seems to harmonize all known facts in a simple way.

(iii) The problem of diffraction, interference, stellar aberration.

The phenomenon of diffraction consists in the bending of the waves through small apertures and at sharp corners, by which light is spread around and gathered into fringes which become distinct. The wave-theory accounts for the phenomenon, under the hypothesis that the waves are very short, which is fully verified by actual measurements. In fact for a given width of slit, different colored light gives an appreciable change in the position of the fringes, depending on the length of the waves in the light used: which obviously confirms the wave-theory, not only as heretofore taught, but also as now modified to take account of waves flat in the planes of the equators of the atoms. The theory of the waves from the individual atoms therefore does not add to the difficulty of the problem of diffraction in any way.

In the matter of interference, the conclusion is similar, as we have already found in section 8 above. This is natural, since the waves from each atom are by hypothesis independent of those from the other atoms; and whatever the positions of the equators, each wave is transmitted by the aether independently of the waves from the other atoms. Interference thus takes place in the modified theory just as in the older theory, except for the detailed changes already described.

In AN 5048, p. 183, we have given a new and simple explanation of the problem of stellar aberration. It is so very direct and simple as to be remarkable. In view of the difficulty felt since *Bradley's* discovery in 1727, which has been increased rather than decreased by the investigations of the last half century, it is surprising that this simple analysis of the problem of stellar aberration has not been developed before. It presents no difficulty from the old or the new point of view of the wave-theory, but rests wholly on the motion of the earth relatively to the independent motion of the rays of the star, in the moving wave-field carried along with the earth in its orbital motion about the sun.

All that we need consider is the independent motion of the rays of light relatively to the moving earth. We therefore give the parallel rays of light a common backward motion exactly equal and opposite to the forward motion of the earth in its orbit. The diagonal of the parallelogram gives the true motion of light relatively to the moving earth; and by drawing this diagonal of the parallelogram we have a direct and perfectly satisfactory explanation of the stellar aberration.

(iv) *Stokes' investigation* of 1845 harmonizes with the new theory of stellar aberration.

In the *Phil. Mag.*, 1845, 27.9, Sir *Gabriel Stokes* attempted to examine the theory of aberration so as to find out what distribution of velocity may be imparted to the aether about the earth, without changing the path of the rays of light in space. As the new kinetic theory of the aether (AN 5044) was not yet developed, *Stokes* was unwilling to accept the view that the earth could pass freely through the aether without setting it in motion; and he tried to find the conditions which would leave the observed aberration unchanged.

If c be the velocity of light in the stagnant aether, in a direction whose direction-cosines relative to axes fixed in space are l, m, n , and the components of the supposed velocity of the aether at any point are u, v, w ; then prior to the development of the new kinetic theory, with $\bar{v} = \frac{1}{2}\pi V$, the velocity of the ray in space at the point in question would be

$$V = c + lu + mv + nw. \quad (155)$$

Fermat's minimum path and *Hamilton's* principle of stationary time, as applied by *Stokes*, would lead to the geometrical condition

$$\delta \tau = \delta \int ds / (c + lu + mv + nw) = 0. \quad (156)$$

To quantities of the first order in $(u, v, w)/c$, this is equivalent to

$$\delta \tau = \delta \int ds / c - \delta \int (1/c^2) \cdot (u dx + v dy + w dz) = 0. \quad (157)$$

If the medium fulfills hydrodynamically irrotational conditions, without whirling motion of the parts en masse, so that $d\Phi = u dx + v dy + w dz = 0$ is a perfect differential, the second integral will depend on the values of u, v, w at the terminal points, and thus will be independent of the motion in the aether about the earth. When this hydrodynamical condition is satisfied, the path of the ray of light, between two points whose velocities are given, is determined wholly by the values of these velocities and does not depend on the motion of the aether between these points in the path of the light.

If the terminal points be x_0, y_0, z_0 , and x_1, y_1, z_1 , — and the intervening medium be filled with a uniform stream of aether flowing with a uniform velocity whose components are u, v, w , — then we shall have

$$\delta \tau = \delta \int_{x_0 y_0 z_0}^{x_1 y_1 z_1} 1/c \cdot ds - \delta \int_{x_0 y_0 z_0}^{x_1 y_1 z_1} 1/c^2 \cdot (u dx + v dy + w dz) = 0 \quad (158)$$

$$= \delta \int ds - \delta [1/c \cdot \{u(x_1 - x_0) + v(y_1 - y_0) + w(z_1 - z_0)\}]. \quad (159)$$

But by hypothesis the second term of the right member of this last equation is zero, and therefore we have

$$\delta \tau = \delta \int_{x_0 y_0 z_0}^{x_1 y_1 z_1} ds = 0. \quad (160)$$

Accordingly the path s obviously is a straight line, in the free aether, from (x_0, y_0, z_0) to (x_1, y_1, z_1) , which are the terminal points of the path. *Stokes* found that the differentially irrotational condition would be fulfilled if the aether behaves like a perfect fluid for the slow motion of material bodies through it.

Now in our new theory of the aether (AN 5044, 5048) we have shown that the aether particles fulfill the law of mean velocity $\bar{v} = \frac{1}{2}\pi V = 471239$ kms/sec.

Accordingly, the earth's motion is only 1:15708th part of the mean velocity of the particles. And since the velocity of the earth is very small and nearly uniform, owing to the circularity of the orbit, it follows that our planet experiences no secular resistance from the aether.

Moreover, the earth carries its aether wave-field with it, all arranged in perfect kinetic equilibrium, with law of density and wave amplitude

$$\sigma = \nu r \quad A = k/r \quad (161)$$

extending away from it indefinitely. Thus a ray of light from a fixed star enters the earth's aether wave-field as if this medium were absolutely stagnant. And under the relative motion of the rays of light and the moving earth, the stellar aberration discovered by *Bradley*, 1727, really takes place, just as in the emission theory of light.

For the ray of light from the star pursues a straight line in the earth's wave-field, and the identical component of the earth's motion forward, but directed backward, may be transferred to the moving rays of light before they reach our globe. Thus, relatively to the moving earth, the rays of light really come from the direction in which the stars appear, and ds is a straight line.

This explanation of stellar aberration is therefore geometrically rigorous and perfectly satisfactory. And since in the new wave-theory of light, no change is made in a ray of light as respects velocity and direction, but only as regards the internal tilting of the planes of the vibrations from the individual atoms, we perceive that the explanation of aberration leaves nothing to be desired.

Accordingly it follows that in respect to aberration not the smallest difficulty is encountered in the confirmation of the new wave-theory of light. Such entire agreement, in such diversified optical phenomena, can have no other meaning than that the new wave-theory of light accords with the order of nature.

Other phenomena examined under the new wave-theory of light.

In addition to the above general phenomena there are many special phenomena which might be used to investigate the nature of light. With this object in view I have looked into a variety of observed data to ascertain if any contradiction of the new wave-theory could be established, or even rendered probable. No such result could be brought out, though I have gone over the principal phenomena in optics and electro-optics.

1. Polarization in crystals, which presents complex and intricate interference phenomena, and would be likely to offer a contradiction if any existed in nature.

2. *Brewster's* law, $n = \operatorname{tg} \varphi$, where n is the index of refraction, and φ the angle of polarization by reflection. The partial failure of this law discovered by *Famin* and others, when φ differs from $55^\circ 35' 30''$, seems to point to the new theory rather than the old. It appears that the outstanding residuary phenomena, not in conformity with this law, but yielding maximum polarizing effect when $n = \operatorname{tg} \varphi$, is not

easily explained on the old conceptions of waves wholly transverse to the direction of propagation.

3. The external conical refraction mathematically predicted by Sir *W. R. Hamilton* about 1832, and soon afterwards experimentally verified by *Lloyd* for aragonite was found to be definite and decisive. Yet in examining the cusp-ray refraction *Lloyd* found that the »boundaries were no longer rectilinear, but swelled out in the form of an oval curve« — showing a very gradual diffusion, due to appreciable scattering of light (cf. *Lloyd's* Miscellaneous Papers Connected with Physical Science, London, 1877, p. 14, figures i and k).

4. Nearly all the very exact measurements on polarized light by Lord *Rayleigh*, *Drude*, *Famin*, and others bring out residuary phenomena which show a sensible departure from the classic undulatory theory (cf. *Glazebrook*, Physical Optics, London, 1914, pp. 355-387).

5. In the domain of electro-optics, the *Kerr* phenomenon directly points to the wave-theory, including the rotation of the plane of polarization by magnetism; and all this is even more consistent with the new wave-theory than with the old. If the poles of an electro-magnet are polished, and plane polarized light is reflected therefrom, it is found that when no current passes the plane of polarization is not rotated. If then the current flows in one direction, there is a corresponding rotation of the plane of polarization; and the moment the current flows in the opposite direction, and thus changes the pole to opposite polarity, the plane of polarization is rotated in the opposite direction. This is very definite proof of the wave-theory, both for optics and magnetism, for the *Kerr* and *Zeeman* phenomena.

6. The production of elliptically polarized light by letting a polarized beam fall upon a transparent insulator, such as glass, liquids or gases, under strong electric stress, — the region being filled by electric waves rotating in definite direction, as in a magnetic field — was first discovered by *Kerr*, and confirmed by *Becquerel*, *Kundt*, *Röntgen*, *Quincke*, *Lippich*, *Du Bois*, and others. When the medium is connected with the poles of an electric machine, the waves constituting the discharge make it possible to produce double refraction, as in a crystal, and in *Zeeman's* phenomena, where the spectral lines are doubled. All these phenomena are found to harmonize with the new wave-theory, quite as well as or better than with the classic theory of *Fresnel*.

12. The Wave-Theory of Gravitation towards a Single Body extended to the Case of Waves from Two Equal Bodies by means of the Geometrical Theory of Confocal Conics, in Conformity with the Observed Motions of Planets and Comets under the Newtonian Law.

(i) Why the aether remains heterogeneous and presses towards a single body like the sun.

1. In our theory of the emission of light and heat waves from the sun, (AN 5044), we have shown that under the spherical expansion of the wave surface in free space, the amplitude of the waves follows the law

$$A = k/r \quad (162)$$

and the force towards the centre due to the receding waves is therefore as the square of the amplitude:

$$f = A^2 = k^2/r^2 \quad (163)$$

which has the form of the law of gravitation observed in nature.

2. The mere existence of waves, as of light and heat, — which certainly radiate from the sun with tremendous energy, — thus necessarily operates to make the aether heterogeneous, according to the law $\sigma = \nu r$. There is no doubt of this law holding for light and heat waves; and if gravitational and magnetic waves exist, they too will follow this same law. It appears that 'Magnetic Storms' and 'Magnetic Tides' are referable only to waves, as shown in my work on Physical Forces, 1917; and aside from the connection of electrodynamics with gravitation previously shown to exist, it is fair to ask the broad question:

What is the probability that the force $f = A^2 = k^2/r^2$ would give an appropriate wave amplitude $A = k/r$, unless gravitational waves also exist? No such coincidence could occur by mere chance! In fact the chances against such a coincidence occurring for all the atoms of a body in the potential

$$V = \iiint [(x-x')^2 + (y-y')^2 + (z-z')^2]^{-1/2} \cdot \sigma dx dy dz \quad (164)$$

is at least infinity of the third order (∞^3) to 1.

Moreover, since electrodynamic action certainly is due to waves, and these exert a mechanical action like magnetism and gravitation, what is the chance that there is a sudden break in the continuity of natural forces at the boundary which is assumed to divide electrical action from universal gravitation? Evidently the probability is zero. For we find by experiments on all the forces of nature that the doctrines of the correlation of forces and the conservation of energy are valid. Thus it is impossible to separate gravitation from the other forces of nature, whose electrical character is so well established.

3. The aether is thus thinned out by wave agitation, towards all single masses; and as the aetherons have a velocity of 471239 kms per second, we perceive that the elasticity, $\epsilon = 689321600000$ times greater than that of our air in proportion to its density, would secure an instant homogeneity of the aether everywhere but for the incessant action of the receding waves. Accordingly the world is filled with waves, constantly received and constantly emitted from all atoms. The waves are in some way due to the motions of the aetherons, which collide with and are reflected by the reactions of the atoms.

4. Thus on the one hand, the receding waves would give by reaction the central pressure of gravitation; and on the other, the resulting heterogeneity of such an elastic kinetic medium also implies the same central pressure. Owing to the enormously rapid motions of the aetherons they tend powerfully to become equally distributed, and thus make the medium homogeneous, but as they are reflected violently from the atoms, — the collisions and reflections keeping up the waves incessantly — the medium remains heterogeneous, with the energy of the central inrush of the aetherons just balancing the loss of energy by the waves receding away.

5. In *Drude's Theory of Optics*, 1917, pp. 179-180, (English translation by *Mann and Millikan*), a very remarkable theorem is drawn from the rigorous formulation of *Huyghens' principle*, as follows:

»When the origin lies within the surface S ,

$$4\pi s_0 = \int \{ \partial[s(t-r/V)/r] / \partial r \cdot \cos(nr) - (1/r) \partial s(t-r/V) / \partial n \} dS. \quad [35] \quad (165)$$

»This equation may be interpreted in the following way: The light disturbance s_0 at any point P_0 (which has been taken as origin) may be looked upon as the superposition of disturbances which are propagated with a velocity V toward P_0 from the surface elements dS of any closed surface which includes the point P_0 . For, since the elements of the surface integral [35] are functions of the argument $t-r/V$, any given phase of the elementary disturbance will exist at P_0 , r/V seconds after it has existed at dS .

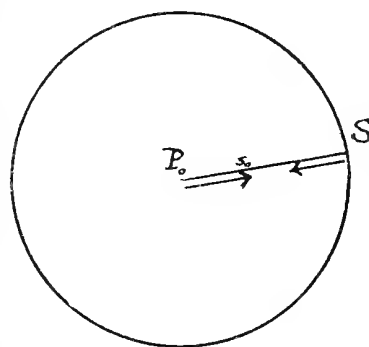


Fig. 12. Diagram of the disturbance s_0 reflected from the surface S about the point P_0 , and thus maintained in perpetuity.

6. It thus appears that disturbances emanating from P_0 towards dS in a conical solid angle $d\omega$, may be ascribed to disturbances from the element dS of the same conical solid angle $d\omega$, from any closed surface about P_0 . Just as the integral of the outflowing waves gives $4\pi s_0$, equation (165), so also the integral of the energy of the inflowing disturbances are equal, and oppositely directed, which proves the proposition.

7. The integral of the vibrations in the separate sources of the inflowing disturbances dS has to be taken over the whole closed surface, and thus the calculation is complicated, involving a surface integral at the interval dt over the solid angle $\omega = 4\pi$ about the point P_0 . And in order to maintain the action the integral has to be renewed at infinitely short intervals, dt , corresponding to surface thickness

$$dV = 4\pi r^2 \int_0^{dr} dr \quad (166)$$

But as these renewed integrals have the same value for the interval dt , we may take dV constant,

$$dV = 4\pi r^2 \int_0^{dr} dr = c \quad (167)$$

owing to the uniformity of the propagation of light.

Accordingly, if the aetherons were once heterogeneous, in spacial distribution, they would always rush inward, and perhaps generate waves even if they did not already exist. But once existing, and emitted as light, heat or other like radiation, the heterogeneous density of the aetherons will always exist. Hence the wave-field about a body like the sun depends on the kinetic exchange of the rapidly moving

aetherons, under the steady outflow of waves, and is therefore eternal like matter itself.

8. This explains rigorously the central pressure of gravitation. If waves exist, the density thereby becomes $\sigma = \nu r$; and since the waves of light and heat fulfill this law, the waves of magnetism and of gravitation also necessarily conform to it.

The moon's fluctuations show that gravitational waves really exist, and are long enough to traverse the earth's mass, just as similar gravitational waves traverse the bodies of Jupiter, Saturn, etc. It also follows that the aether is excessively fine grained, otherwise these refractive phenomena would not be distinctly realized, so as to become sensible to observation in the effects they produce on the moon's motion.

9. The above mathematical theorem, relative to the inward propagation of the disturbances from a closed concentric surface S , with velocity V , equal to the velocity of the waves traveling outward from the centre P_0 , will be fulfilled by the energy flow conveyed through the aether by the individual aetherons from any spherical surface $S = 4\pi r^2$. It is not necessary that the disturbances s_0 from the elements of the enclosing surface dS be waves; they may be stresses due to the energy of the individual aetherons produced by the heterogeneity incident to the receding waves, and thus converging to the centre whence the waves come.

Accordingly, the above integral (165) rigorously fulfills the geometrical condition for a heterogeneous aether: it is kept to the law of density $\sigma = \nu r$ by the receding waves, and the aetherons always pressing inward, by virtue of this very heterogeneity, and the enormous elasticity $\epsilon = 689321600000$ times greater than that of our air in proportion to its density.

(ii) Physical illustration of the effects of waves from the two foci of an ellipsoid, corresponding to a double star with equal components.

The accompanying wave plate Fig. 13 (*Guillemin, Les Phénomènes de la Physique, 1869, p. 182*) represents a faint system of confocal conics due to waves receding from two equal centres, such as a double star of equal components:

(a) The confocal hyperbolas represent the reacting pressures at the ellipsoidal boundary, if reflection were to take place there, or the inwardly directed stresses fulfilling the above equation for $4\pi s_0$, under *Huyghens'* principle for this more complex system of two bodies, instead of the one central mass already considered.

(b) Each wave from any centre as it reaches the hypothetical ellipsoidal boundary is met there by a wave from the other centre; and in reflection the reaction from the assumed bounding surface is in the direction of the hyperbolas, as shown in the figure. The reflection is perpendicular to the surface of the bounding ellipsoid; and, whether reflected or not, the stresses are along the hyperbolas shown.

(c) If one of the bodies be nearly insensible in mass, it is obvious that the other will emit practically all the waves, and the reaction or reflection would be central, as in the case of a spherical body like the sun. When there is a single centre of waves, a comet may be made to move about it in

a conic section, by giving it an initial velocity equivalent to the integrated effect of the two bodies from infinity, (the smaller being now removed from the simplified problem). Accordingly if the influence from the other focus be cut off, at the instant of starting, yet its integrated effect be included in the initial velocity, we have the motion in conic sections for a single body as laid down by *Newton*. There are infinite systems of hyperbolas, parabolas, ellipses, which may be described, depending on the initial conditions, as more fully set forth below.

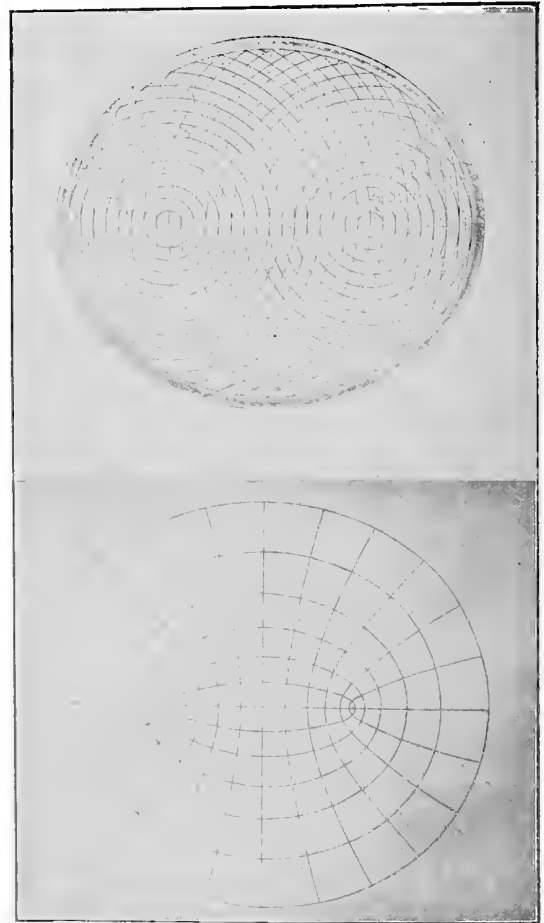


Fig. 13. The upper figure is a diagram of the waves propagated from two equal foci. As reflected from the enclosing ellipsoidal surface, they produce the confocal hyperbolas normal thereto. The entire system of confocal conics is made more distinct in the lower figure.

(d) These novel considerations throw a new light on dynamical problems, and bring the laws of celestial mechanics into harmony with the wave-theory. They are therefore of deepest interest in the theories of the motions of bodies. Every possible motion in a system of two bodies is accounted for, by the effects of perfectly simple waves, and the resulting stresses in the aether, towards central masses. Celestial mechanics thus acquires a hydrodynamical basis,

the aether being always subjected to stresses, owing to the waves receding from the stars and other bodies of the physical universe.

A very remarkable comparison may now be made between the waves from two foci reflected from an enclosing ellipsoidal surface, and that above given for waves reflected from a spherical surface enclosing a single centre.

1. We have seen that if the waves emanating from a single centre be reflected from the enclosing spherical surface $S = 4\pi r^2$, we have the equation (165).

2. From this equation it follows that if we imagine a wave-field established, in kinetic equilibrium, about a radiating star, and suddenly enclose that star by a perfectly reflecting surface, $S = 4\pi r^2$, the energy near the centre will flow outward, till reflected at the enclosing boundary, while that near the boundary will as steadily flow inward, to restore the energy lost by the central spherical shells,

$$4\pi \int_0^r r^2 dr$$

3. And as the velocity of propagation V is constant, we have

$$4\pi \int_r^{r+dR} r^2 dr = 4\pi \int_R^{R-dR} r^2 dr. \quad (168)$$

Accordingly, the loss of wave energy from the centre and its perfect restoration goes on without ceasing, and the motion of the waves thus confined is eternal.

4. Now in the same way, let us imagine waves emanating from two equal foci, as in the case of a double star with equal components, and suppose both foci suddenly enclosed by a perfectly reflecting, confocal, concentric, ellipsoidal surface:

$$x^2/(a^2+\lambda) + y^2/(b^2+\lambda) + z^2/(c^2+\lambda) = 1. \quad (169)$$

Then the waves from either focus will return to the other in an interval of time dt , corresponding to the distance $2a$, traveled before and after reflection, in any plane section of the ellipsoidal surface; and thus the wave-field about either focus will be perpetual. And just as the wave-field reflected for restoration is perpetual, so also the inward stress, from the aether outside the surface, is equal to the radiant energy constantly reflected, and thus also eternal. This is the foundation of celestial dynamics, resulting from the new theory of the aether.

5. The inwardly directed system of confocal hyperbolas indicate the direction of the wave stresses sustained by the ellipsoidal reflecting surface. And since if we remove the surface, the waves will proceed into infinite space, we recognize that a wave-field about the two radiating foci must have its equilibrium sustained by the inward stress of the external aether, which is therefore at every point normal to the enclosing ellipsoidal surface. The external aether thus exerts its stress along the tangents to the systems of confocal hyperbolas.

6. This geometrical description conveys to our minds a very clear dynamical illustration of the behavior of the aether about a system of two equal stars. The inward stress is no longer directed to each centre separately, but the total

effects for the two centres are combined as shown by the system of confocal hyperbolas. The system of confocal conics shown in the accompanying illustrations is thus of the highest dynamical interest.

(iii) The wave-theory rigorously extended to a system of two bodies, by means of the geometrical theory of confocal conics.

We have just investigated the physical theory of waves propagated from the two foci of an ellipsoid, and shown that very remarkable phenomena may thus arise. As the theory thus outlined may have great dynamical importance, it is necessary to examine the problem somewhat more critically from the point of view of geometrical rigor.

Perhaps it is not immediately obvious what all the physical phenomena would be in a wave-field about two equal stars. Yet there obviously is ample assurance that should the wave-theory triumph for a pair of equal binary stars, it would necessarily hold for triple and quadruple stars, and sidereal systems of higher order such as we find in the globular clusters. These splendid sidereal systems are so crowded with stars in their inner spherical shells as to attain a perfect blaze of starlight towards the centre, and thus the glory of globular clusters, like M.13 in Hercules, ω Centauri, and 47 Toucani, is unrivaled by any other objects in the starry heavens.

Accordingly we recall briefly the geometry of confocal conics, in the hope of illuminating the wave-fields in sidereal systems of high order, so much studied by the elder *Herschel*.

The equation of a system of confocal conics in the xy -plane is

$$x^2/(a^2+\lambda) + y^2/(b^2+\lambda) = 1. \quad (170)$$

And for the more general system of confocal conics, in tri-dimensional space, the corresponding equation is

$$x^2/(a^2+\lambda) + y^2/(b^2+\lambda) + z^2/(c^2+\lambda) = 1. \quad (169)$$

From the forms of these equations, we perceive that, what applies to the plane of xy , will apply also to the system of confocal conoids in xyz . Thus for the sake of simplicity we shall consider the system of confocal conics chiefly in the plane xy , as sufficiently general for the requirements of our present problem in tri-dimensional space.

If λ is positive in the equation, the resulting curve is an ellipse; but if λ is negative the curve becomes an hyperbola. The transition from the ellipse to the hyperbola is explained as follows.

From the form of (170) we perceive that the principal axes of the curve will increase as λ increases, and their ratio will tend more and more to equality as λ increases. Accordingly a circle of infinite radius, ($a = b = \infty$), gives the limiting form of the elliptical confocals.

On the other hand, when λ is negative, the principal axes will decrease as λ increases; and the ratio

$$q = (b^2+\lambda)/(a^2+\lambda) \quad (171)$$

will also decrease as λ increases. The ellipse thus becomes flatter and flatter, until λ is equal to $-b^2$, when the minor axis vanishes, $b^2+\lambda = 0$; and the major axis is equal to the distance between the foci. The curve thus narrows down to the line-ellipse joining the foci, which is a limiting form of one of the confocals.

If the process continue till $b^2 + \lambda = -\eta$, a small negative quantity, the transverse axis of the hyperbola is very nearly equal to the distance between the foci; and the complement of the line joining the foci is a limiting form of the hyperbola. This limiting form of the hyperbola is the narrow hyperbola shown in the figure at the right and left respectively. When $b^2 + \lambda = -\eta$ is a larger negative quantity, the hyperbola spreads its branches more widely and the vertex becomes more distant from the foci on the horizontal axis, as shown in the central part of the figure. As λ becomes greater and greater, the angle between the asymptotes of the hyperbola increases, and in the limit both branches coincide with the axis of y .

Accordingly, we perceive that by making λ approach $-b^2$, we narrow up the confocal ellipses into a straight line joining the foci. And when the change continues still further, $b^2 + \lambda = -\eta$, a very small negative quantity, the curve passes from the straight line joining the foci into another straight line running from either focus to infinity, which give the line-hyperbola, corresponding to the internal line-ellipse. The point describing the line-ellipse thus ceases to move between the foci, and returns to the other focus through infinity, when the limiting elliptical confocal passes into the limiting hyperbolic confocal. When λ is negative and numerically greater than a^2 , the curve is imaginary.

Let us now return to the above figures, and imagine two equal wave centres, as from a double star of equal components, like γ Virginis; then obviously we have two equal wave-fields, one about each focus, with the double system of confocal hyperbolas, as shown in the above figure. The entire solid angle about the centre of the confocal ellipses is $\Omega = 4\pi$.

But we may split the system of confocal hyperbolas into two equal parts, on either side of the median plane, each equal to $\frac{1}{2}\Omega = 2\pi$.

It will be evident on reflection that all the hyperbolas about the lower focus will curve about the right star f , just as in the case of comets revolving about our sun; and all about the upper focus will curve about the left star f' . And these infinite systems of hyperbolas will include curves of all possible eccentricity, with a perihelion distance less than a , half the distance between the two foci.

The waves propagated from two equal stars by generating a doubly infinite system of confocal conics — the ellipses cutting the corresponding hyperbolas at right angles — fix the paths of infinite varieties of comets about either focus, as will be more fully discussed below.

(iv) Geometrical properties of confocal conics.

(a) Two conics of a confocal system pass through any given point — one an ellipse, the other an hyperbola. After the above outline this is almost obvious, without further discussion, for if the equation of the original conic be

$$x^2/a^2 + y^2/b^2 = 1 \quad (172)$$

the equation of the confocal conic is

$$x^2/(a^2 + \lambda) + y^2/(b^2 + \lambda) = 1.$$

And it is obvious that this curve will pass through the given point $(x' y')$, if

$$x'^2/(a^2 + \lambda) + y'^2/(b^2 + \lambda) = 1 \quad (173)$$

To find the solution for this condition, we remember that $b^2 = a^2 - a^2 e^2$, and put $b^2 + \lambda = \eta' = a^2 - a^2 e^2 + \lambda$, and thus obtain from (173)

$$x'^2 \eta' + y'^2 (\eta' + a^2 e^2) - \eta' (\eta' + a^2 e^2) = 0 \quad (174)$$

or $\eta'^2 - \eta' (x'^2 + y'^2 - a^2 e^2) - a^2 e^2 y'^2 = 0$. This is a quadratic with two roots, both real, but of opposite signs, and thus there are two conics, $b^2 + \lambda = +\eta'$ being the ellipse, and $b^2 + \lambda = -\eta'$ being the corresponding hyperbola.

(b) One conic of a confocal system and only one will touch a given straight line.

From the equations

$$lx + my - 1 = 0 \quad x^2/(a^2 + \lambda) + y^2/(b^2 + \lambda) = 1 \quad (175)$$

we find for tangency:

$$(a^2 + \lambda) l^2 + (b^2 + \lambda) m^2 = 1 \quad (176)$$

which is linear in λ , and yields one value of λ , corresponding to one confocal conic, and only one, bounding the given straight line. This might be tangent to the ellipse, or to the hyperbola, but not to both at the same point, because the hyperbolas always are at right angles to the ellipses at their intersections.

By subtraction we have from the two equations

$$x^2/a^2 + y^2/b^2 = 1 \quad x^2/(a^2 + \lambda) + y^2/(b^2 + \lambda) = 1 \\ x'^2/[a^2(a^2 + \lambda)] + y'^2/[b^2(b^2 + \lambda)] = 0. \quad (177)$$

And as the condition of tangency is

$$x x' / a^2 + y y' / b^2 = 1 \quad x x' / (a^2 + \lambda) + y y' / (b^2 + \lambda) = 1 \quad (178)$$

we see that (178) shows the rectangularity of the curves at their intersections.

(v) Application of the theory of confocal conics to the motions of comets, as under the wave-theory of physical forces.

Referring to the figure given above for the waves from two equal stars, we notice that the boundary there represented is one of the confocal ellipses; others of greater oblateness are shown nearer the centre of the figure, but the approximations to the line-ellipses very near the centre are omitted, for reasons of clearness.

It will be found that the spherical waves propagated from these two centres give the confocal ellipses, and also the confocal hyperbolas, as clearly outlined in this figure. The independent circles about the two foci are at distances $a_1, a_2, a_3, \dots, a_n$.

At the boundary the waves from the two foci are reflected, with reaction in the direction of the perpendicular to the surface. Hence we see that the normals at these points of reflection give the confocal hyperbolas. Accordingly, if waves were traveling with uniform velocity from both foci, and reflected at the confocal elliptical boundary, there would thereby result stresses in the aether directed along the confocal hyperbolas at the intersections of these two systems. This result of the intersecting system of confocals is very remarkable, since it will hold for every point of infinite space, and thus for ellipses and hyperbolas of every possible form, mutually intersecting at right angles, as shown in the figure.

It was established by the researches of Prof. *Strömberg*, of the Royal Observatory, Copenhagen, about 1910-11, that all the comets heretofore observed describe ellipses about the sun in one focus. It had previously been supposed that the orbits of certain comets were hyperbolic, yet greater refinement of research proved the elliptical character of all these orbits; so that they return to our sun, and thus are relics of our primordial solar nebula, as set forth in my *Reséarches on the Evolution of the Stellar Systems*, vol. II, 1910.

If the comets had greater than the parabolic velocity of movement relatively to our sun, $v > kV(1+m) \cdot V(2/r)$, the paths would be hyperbolas; such orbits, however, are not yet of record. It is obvious that we can now interpret the physical significance of the system of confocal conics, in conformity with the observed laws of celestial mechanics, and the indications of the Wave-Theory of Physical Forces.

For example, if a comet with zero velocity were to cross the boundary to enter the field about the two foci, in the above wave-figure, the instantaneous stresses to the foci, on the line of the reflected waves, would cause the comet to pursue the indicated hyperbola, passing through the point (x, y) . Under slightly modified conditions this reasoning

might be greatly extended, but we shall not enter upon it here.

In conclusion, it only remains to add that in the fifth and sixth papers I hope to throw some light on the obscure physical cause underlying molecular and atomic forces. The calculation of the wave-stresses at the boundary of a liquid globule, such as a rain drop or a drop of dew, will lead us to the cause of surface tension, constantly acting for the generation of minimal surfaces throughout nature.

It is not by chance that all liquid drops take the spherical form! The geometer may discover therein a great secret of the physical universe!

If so, this advance will illuminate also the difficult problem of capillarity, which has already engaged the attention of so many eminent geometers. Whence we hope to attack the subject of cohesion and adhesion, and even of explosive forces, which heretofore have appeared even more bewildering.

Mr. *W. S. Trankle* has laid me under lasting obligations by facilitating the completion of this fourth paper. And Mrs. *See's* sympathetic interest in these researches has lent a support which often proved so invaluable as to be beyond all praise.

Starlight on Loutre, Montgomery City, Mo., 1920 Sept. 6.

T. F. See.

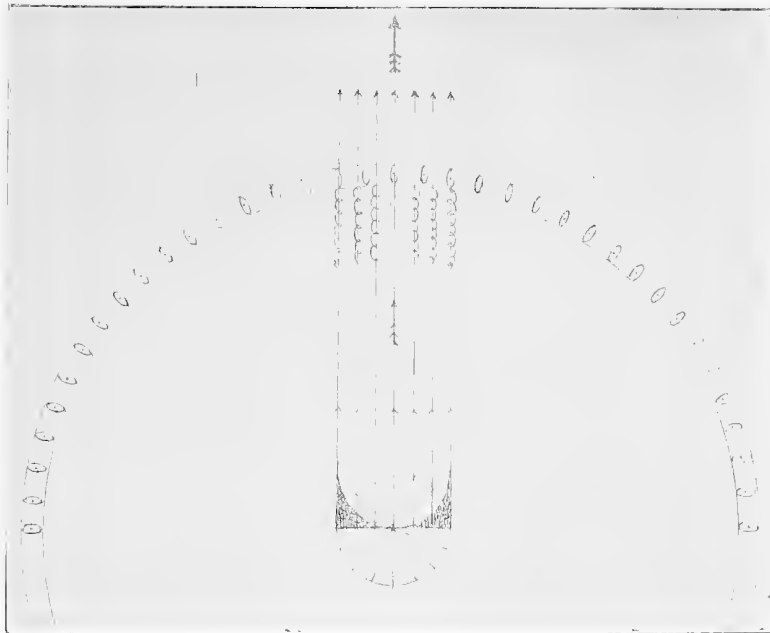


Fig. 1. Illustration of the effect of orthogonal projection, by which molecular motions, in *Poisson's* elongated ellipses normal to the wave front, at different parts of a sphere surface, become mainly transverse to the direction of the ray, at a great distance from the source. The outer circle is magnified to distinct visibility, so as to render the cause of the transverse vibrations in light more obvious to the imagination, as shown also by the darkened areas of the enlarged ray at the centre of the figure.

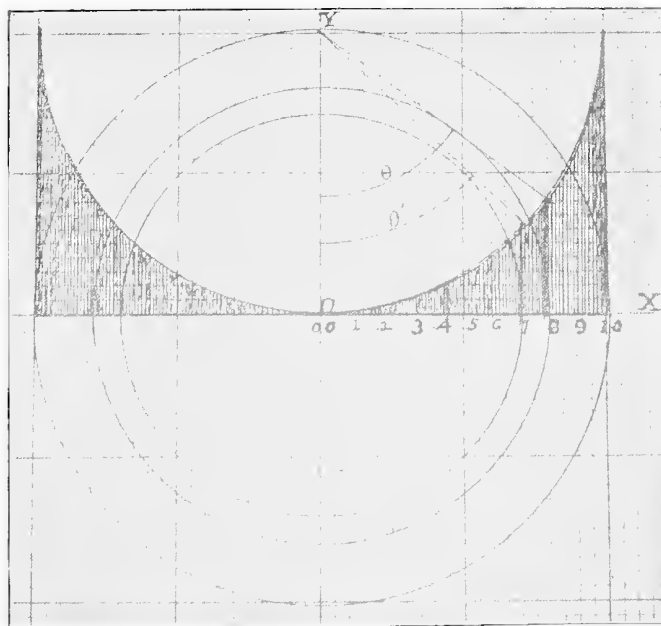


Fig. 3. Graphical illustration, by means of the shaded portion, of the enormous concentration of light vibrations in the periphery of a beam, under orthogonal projection of the sphere, with *Poisson's* elliptical paths for the molecular oscillations along the radii from the centre, and, by means of the small factor A, λ , thus making nearly all the vibrations transverse to the direction of the ray.

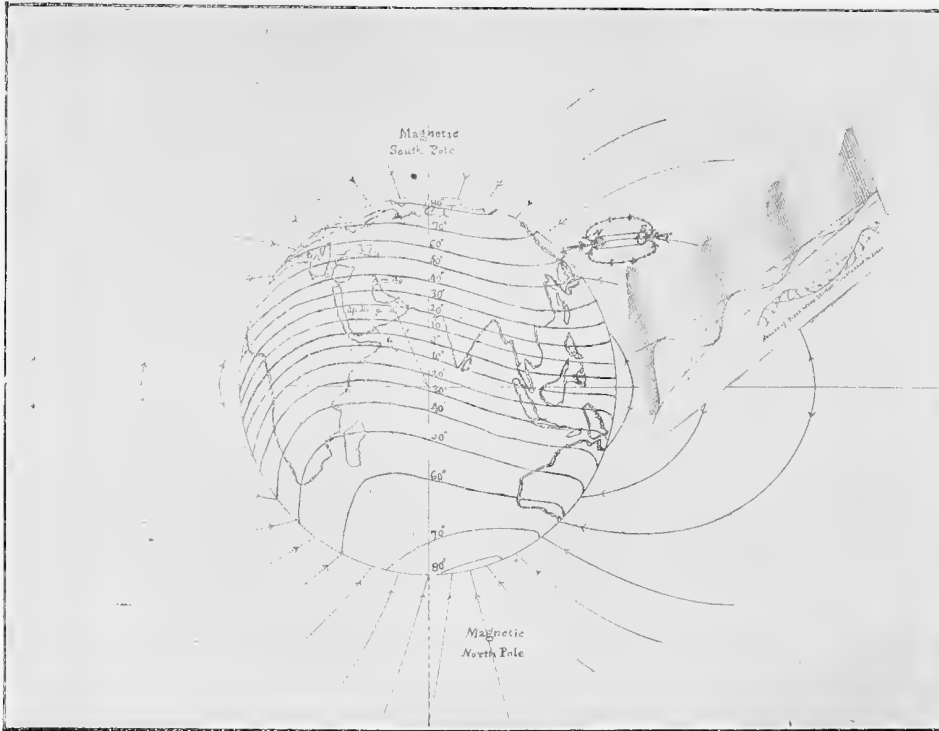


Fig. 5. General view of the magnetic field about the earth, with a specimen of the waves to which the field is due, shown on the right. The magnetic needle lies in the hollow of the waves, and thus we see why it points to the north. Gauss' Theory of the Earth's magnetism corresponds to the wave-theory for the part of the atoms which are lined up in parallel, to produce the earth's magnetic field, about $1/1380^{\text{th}}$ of the whole. The rest of the atoms, $1379/1380^{\text{ths}}$ of the whole, give the central action called gravitation, but the gravitational wave field is too complex to be shown in the diagram.

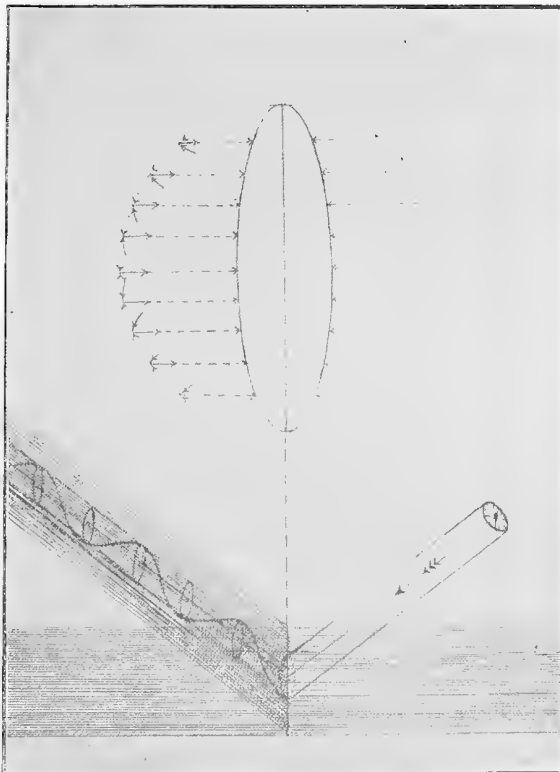


Fig. 6. Illustration of the restriction of free vibrations when the wave motion is suddenly resisted at the boundary of a solid body. Owing to the resistance to one side of the ray the beam of light is flattened like a reflected stream of water, and thenceforth becomes polarized, vibrating with greatest freedom and largest amplitude in the plane perpendicular to the plane of polarization, as held by Fresnel.

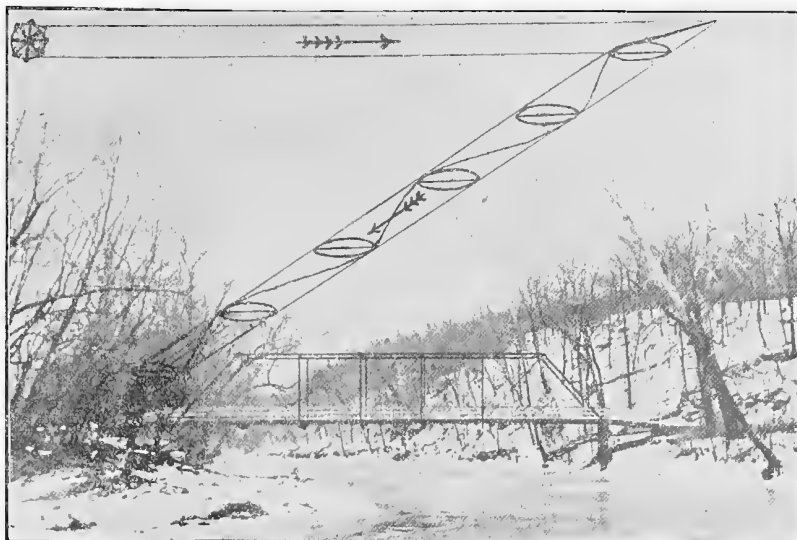


Fig. 7.
Illustration of light polarized by reflection from the blue sky. The vibrations are normal to the plane of polarization passing through the sun and the zenith, and the polarization attains a maximum at a point equally distant from the zenith.

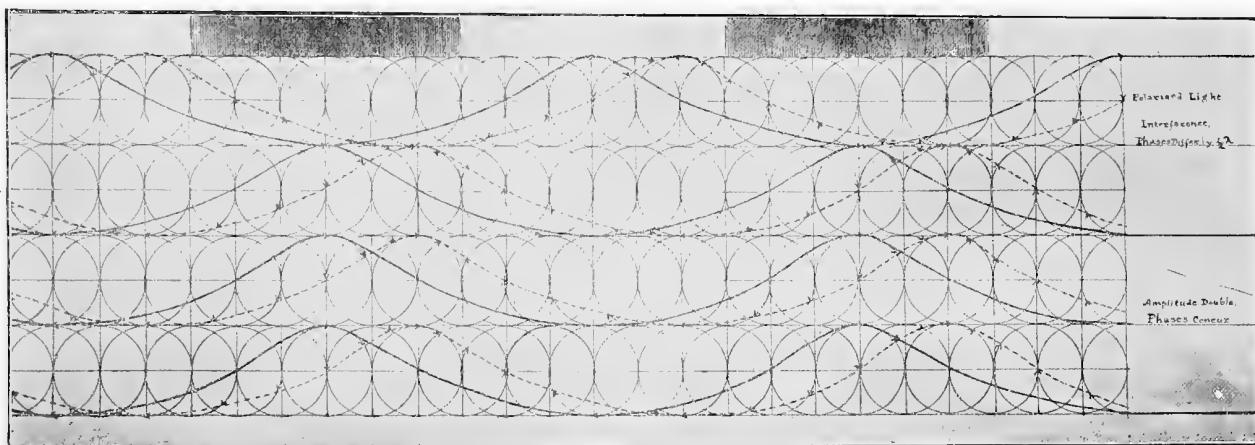


Fig. 8.

Undulatory explanation of the interference of polarized light, when the paths of the aetherons are circles. It will hold for ellipses, and even for straight lines, but such restrictions are not necessary. In the upper part of the figure the wave phases differ by $\frac{1}{2}\lambda$; in the lower part the phases concur, and give double intensity. The light and dark bands above correspond to the present position of the wave, indicated by the heavy line, while the arrows show the advanced position of the wave when it has moved to the right after an interval d .

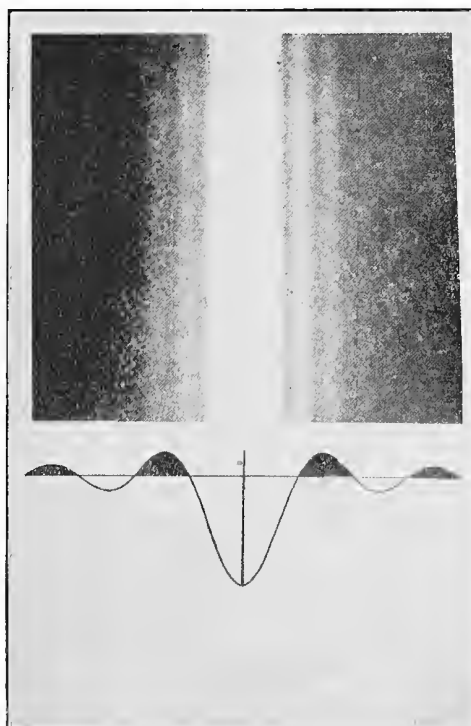


Fig. 10.

Illustration of the diffraction fringes due to a rectangular aperture, with the corresponding visibility curve above it, on slightly different scale (*Michelson*). The central band of light is nine times more intense than the first secondary maximum, while the higher orders of bands, all parallel to the sides of the rectangular slit, are still fainter.



Simon

New Theory of the Aether. By T. J. J. See.

(Fifth Paper.) (With 2 Plates.)

I. Outlines of a New Theory of Molecular Forces based on Wave-Action, which is also indicated by Laplace's Celebrated Criterion that these Forces become sensible only at Insensible Distances.

Since the renaissance of physical science in the age of *Galileo* natural philosophers have labored patiently for the discovery of the great laws of nature; and thus for about three centuries they have extended their investigations by means of delicate experiments and the most exact methods of mathematical analysis. Yet, notwithstanding this brilliant record of achievement, it remains a somewhat remarkable fact that molecular forces have not yet been assigned to any known physical cause. Accordingly in modern works on physics we still search in vain for an intelligible explanation of the mechanism underlying these forces. The subject therefore has remained very obscure, and continues to challenge the ingenuity of both the geometer and the natural philosopher.

The history of physical science shows that when the solution of a great standing problem at length is attained, it seldom is true that the first attack was wholly successful. Indeed, most of our final solutions of difficult problems result from successive processes of approximation. And thus it may be doubted whether the solution of the problem of molecular forces now in sight is quite complete.

But even if the new effort only opens the way towards the final solution, still it may be of the greatest service to science. For pioneer effort always has to precede the perfect development of science, just as somewhat rude specimens of sculpture and architecture preceded the perfect development of Greek art in the age of *Ictinus*, *Phidias* and *Praxiteles*.

Accordingly, having arrived at an efficient physical cause of molecular forces which seems to be in general operation throughout nature, we deem it desirable to set forth the results, because the suggestions which this development may convey to others are likely to prove fruitful.

(i) *Laplace's* criterion, that molecular forces become sensible only at insensible distances, seems to point to wave-action as the underlying physical cause.

In the introduction to his celebrated Theory of Capillarity, (*Mécanique Céleste*, Tome IV, 1806, with supplement to the theory issued in 1807) *Laplace* examines the theories of his predecessors with characteristic sagacity.

At the very outset of the discussion he alludes to the refractive power exerted by bodies upon light, and says that this force is the result of the attraction of their particles, yet he holds that the law of attraction cannot be determined because »the only condition required is that it must be insensible at sensible distances.« He then proceeds to deal with capillary attraction, in which extensive use is made of this same hypothesis. A part of his reasoning is as follows:

»A long while ago, I endeavored in vain to determine the laws of attraction which would represent these phenomena; but some late researches have rendered it evident that the whole may be represented by the same laws, which satisfy the phenomena of refraction; that is, by laws in which the attraction is sensible only at insensible distances; and from this principle we can deduce a complete theory of capillary attraction.«

»*Clairaut* supposes that the action of a capillary tube may be sensible upon the infinitely thin column, which passes through the axis of the tube. Upon this point I differ wholly from him, and think, with *Hawksbee* and other philosophers, that the capillary attraction is, like the force producing refraction, and all chemical affinities, sensible only at insensible distances. *Hawksbee* observed that in glass tubes, whether the glass is very thick, or very thin, the water rises to the same height, if the interior diameters are the same. Hence it follows that the cylindrical strata of glass, which are at a sensible distance from the interior surface, do not aid in raising the water, though in each one of these strata, taken separately, the fluid ought to rise above the level. It is not the interposition of the strata, which they include between them, which prevents their action upon the water; for it is natural to suppose that the capillary attraction, like the force of gravity, is transmitted through other bodies; this attraction must therefore disappear solely by reason of the distance of the fluid from these strata; whence it follows that the attraction of the glass upon the water is sensible only at insensible distances.«

Laplace justly lays stress upon *Hawksbee's* observation that in glass tubes, whether very thick or very thin, the water rises to the same height, if the interior diameters are the same. This indicated to *Laplace* that the interior particles of a thick tube of glass exerts no sensible action on the adhering fluid.

Though never suspected heretofore this reasoning of *Laplace* affords the most conclusive evidence that molecular forces really are due to wave-action. It will be shown hereafter that experimental researches by *Rücker* and others on the thickness of soapbubbles, at the critical instant of rupture, make the radius of action of these molecular forces so small that they correspond to the wave-lengths of the ultra-violet region of the spectrum, a fact which may be regarded as an experimental confirmation of the wave-theory of these physical forces.

It appears that *Laplace* himself came near to this line of argument, for in explaining the processes adopted, in the introduction to the theory of capillary attraction, he says that it is evident that »the distance at which the action of the tube ceases to be sensible is imperceptible; so that, if by means of a very powerful microscope, we should be able to make it appear equal to a millimetre, it is probable that the

same magnifying power would give to the diameter of the tube an apparent length of several meters. The surface of the tube may therefore be considered as very nearly a plane surface, for an extent which is equal to that of the sphere of its sensible activity; the fluid will therefore be elevated or depressed near that surface, in almost the same manner as if it were a plane. Beyond this point the fluid will be subjected only to the force of gravity and its own action on its particles; its surface will be very nearly that of a spherical segment, of which the extreme tangent planes, being those of the fluid surface at the limits of the sensible sphere of activity of the tube, will be very nearly, in the different tubes, equally inclined to their sides; whence it follows that all segments will be similar. The comparison of these results gives the true cause of the elevation, or depression, of fluids, in capillary tubes, in the inverse ratio of their diameters.«

»Therefore the attraction of a capillary tube has no other influence upon the elevation or depression of the fluid which it contains, than that of determining the inclination of the first tangent planes of the interior fluid surface, situated very near to the sides of the tube; and it is upon this inclination that the concavity or convexity of the surface depends, as well as the magnitude of its radius.«

(ii) The wave-theory underlies the mathematical analysis of *Fourier* and *Poisson*,¹⁾ based on the solution of partial differential equations.

In the Fourth Paper, near the end of Section 8, I have called attention to the great importance attached to boundary conditions by modern investigators in theoretical physics, and have also pointed out the prominent part played by partial differential equations in the mathematical methods applicable

$$(at)^2 = (x + at \cos \theta)^2 + (y + at \sin \theta \sin \omega)^2 + (z + at \sin \theta \cos \omega)^2 \quad (7)$$

which we have treated in previous papers.

In the treatment of *Poisson's* equation of wave motion,

$$\partial^2 \Phi / \partial t^2 = a^2 (\partial^2 \Phi / \partial x^2 + \partial^2 \Phi / \partial y^2 + \partial^2 \Phi / \partial z^2); \quad \Phi = \Omega(x, y, z), \quad t = 0 \quad (8)$$

we have found (AN 5048) that for three variables

$$\Phi = \Omega(x, y, z) = (1/8\pi^3) \int_{-\infty}^{+\infty} \int_{-\infty}^{+\infty} \int_{-\infty}^{+\infty} \int_{-\infty}^{+\infty} \int_{-\infty}^{+\infty} \int_{-\infty}^{+\infty} \Omega(\xi, \eta, \zeta) \cos \xi(x - \lambda) \cos \eta(y - \mu) \cos \zeta(z - \nu) d\xi d\eta d\zeta d\lambda d\mu d\nu \quad (9)$$

in which ξ, η, ζ and λ, μ, ν extend from $-\infty$ to $+\infty$

This may be transformed into

$$\Phi = \Omega(x, y, z) = (1/8\pi^3) \int_{-\infty}^{+\infty} \int_{-\infty}^{+\infty} \int_{-\infty}^{+\infty} \int_{-\infty}^{+\infty} \int_{-\infty}^{+\infty} \int_{-\infty}^{+\infty} \Omega(\xi, \eta, \zeta) \cos \lambda(\xi - x) \cos \mu(\eta - y) \cos \nu(\zeta - z) d\xi d\eta d\zeta d\lambda d\mu d\nu \quad (10)$$

$$= (1/8\pi^3) \int_{-\infty}^{+\infty} \int_{-\infty}^{+\infty} \int_{-\infty}^{+\infty} \int_{-\infty}^{+\infty} \int_{-\infty}^{+\infty} \int_{-\infty}^{+\infty} \Omega(\xi, \eta, \zeta) e^{[\lambda(\xi - x) + \mu(\eta - y) + \nu(\zeta - z)]} V^{-1} d\xi d\eta d\zeta dx dy dz \quad (11)$$

By including the factor $1/8\pi^3$ in the arbitrary function, this may be written in the well known form of the expression for any time t ,

¹⁾ In developing the new theory of the aether I found *Poisson's* Analytical Theory of Wave Motion, (1815-1839) so extraordinarily useful that I was led to apply to M. *Baillaud*, Director of the Observatory of Paris, for an authentic portrait of this unrivaled physical mathematician.

The portrait proved to be somewhat difficult to obtain, but as it reached me on the day this paper is finished, it seems appropriate to acknowledge M. *Baillaud's* kindness, and at the same time do honor to *Poisson's* memory and a service to geometers generally by using the portrait as a frontispiece to this Fifth Paper.

In his eulogy of *Poisson*, *Arago* relates that one day the venerable *Lagrange* remarked to the brilliant young geometer: »I am old, and during my intervals of sleeplessness I divert myself by making numerical approximations. Keep this one: it may interest you. *Huyghens* was thirteen years older than *Newton*, I am thirteen years older than *Laplace*; *D'Alembert* was thirty two years older than *Laplace*, *Laplace* is thirty two years older than you.« — which was *Lagrange's* delicate way of intimating to *Poisson* his destined place in the Pantheon of mathematical fame.

to physical problems. These two independent circumstances seemed to me an overwhelming argument for the wave-theory as representing the true order of nature, which we see exhibited most simply in the refraction of light.

In the New Theory of the Aether we have dwelt on the equation of wave motion developed by *Poisson*:

$$\partial^2 \Theta / \partial t^2 = a^2 (\partial^2 \Theta / \partial x^2 + \partial^2 \Theta / \partial y^2 + \partial^2 \Theta / \partial z^2) \quad (1)$$

Likewise *Fourier's* Théorie Analytique de la Chaleur, 1821, leads to the similar expression:

$$\partial^2 \Theta / \partial t^2 = a^2 (\partial^2 \Theta / \partial x^2 + \partial^2 \Theta / \partial y^2 + \partial^2 \Theta / \partial z^2) \quad (2)$$

$$\Theta = f(x, y, z, t); \quad \Theta = f(x, y, z), \quad t = 0$$

which holds for the propagation of heat, and other wave motions.

For constant temperature, $\partial \Theta / \partial t = 0$, and therefore

$$\partial^2 \Theta / \partial x^2 + \partial^2 \Theta / \partial y^2 + \partial^2 \Theta / \partial z^2 = 0. \quad (3)$$

For the disturbances in the theory of sound, *Poisson* usually writes for the velocity-potential φ , thus:

$$\partial^2 \varphi / \partial t^2 = a^2 (\partial^2 \varphi / \partial x^2 + \partial^2 \varphi / \partial y^2 + \partial^2 \varphi / \partial z^2) \quad (4)$$

$$\partial^2 \varphi / \partial t^2 = a^2 \nabla^2 \varphi; \quad \varphi = f(x, y, z), \quad t = 0.$$

In the theory of light, the same differential equation arises (cf. *Drude*, Theory of Optics, Part I, Chapter III, § 3)

$$\partial^2 s / \partial t^2 = V^2 (\partial^2 s / \partial x^2 + \partial^2 s / \partial y^2 + \partial^2 s / \partial z^2) \quad (5)$$

$$\partial^2 s / \partial t^2 = V^2 \nabla^2 s; \quad s = f(x, y, z), \quad t = 0.$$

In the theory of waves we have for plane waves along the x -axis:

$$y = A \sin [2\pi/\lambda \cdot (Vt - x) + \alpha] \quad (6)$$

But in tri-dimensional space, the disturbance spreads in all directions with the velocity $V = at$ (at)² = $x^2 + y^2 + z^2$ and from any point $P(x, y, z)$, the sphere surface becomes:

(7)

$$\Phi = \Omega(x, y, z, t) = \iiint_{-\infty}^{+\infty} \iiint_{-\infty}^{+\infty} \iiint_{-\infty}^{+\infty} e^{(A+Bht)} V^{-1} \Psi_1(\xi, \eta, \zeta) d\xi d\eta d\zeta d\lambda d\mu d\nu. \tag{12}$$

And finally, in the Fourth Paper, (AN 5085), we have reached *Poisson's* double integral:

$$\begin{aligned} \Phi &= \Phi' + \Phi'' \\ &= (1/4\pi) \int_0^\pi \int_0^{2\pi} F\{x+at \cos \theta, y+at \sin \theta \sin \omega, z+at \sin \theta \cos \omega\} t \sin \theta d\theta d\omega \\ &\quad + (1/4\pi) (\partial/\partial t) \int_0^\pi \int_0^{2\pi} H\{x+at \cos \theta, y+at \sin \theta \sin \omega, z+at \sin \theta \cos \omega\} t \sin \theta d\theta d\omega. \end{aligned} \tag{13}$$

This expression for the velocity-potential Φ , will hold rigorously for the waves emanating from any mathematical point $P(x, y, z)$ and traversing all space from that centre of disturbance. But in nature the waves proceed from all atoms of a mass, and thus we must extend the integral of *Poisson* by taking the triple integral for the volume and density:

$$\begin{aligned} \Phi &= \int_0^r \int_0^\pi \int_0^{2\pi} (\sigma/4\pi) \int_0^\pi \int_0^{2\pi} F\{x+at \cos \theta, y+at \sin \theta \sin \omega, z+at \sin \theta \cos \omega\} r^2 \sin \theta dr d\theta d\omega \cdot t \sin \theta d\theta d\omega \\ &\quad + \int_0^r \int_0^\pi \int_0^{2\pi} (\sigma/4\pi) (\partial/\partial t) \int_0^\pi \int_0^{2\pi} H\{x+at \cos \theta, y+at \sin \theta \sin \omega, z+at \sin \theta \cos \omega\} r^2 \sin \theta dr d\theta d\omega \cdot t \sin \theta d\theta d\omega. \end{aligned} \tag{14}$$

This is a double quintuple integral, and by referring to the equations (9) or (12) above we see that (14) corresponds to a single non-nuple integral in the original form of these equations, because the disturbances must be conceived to proceed from each atom of the mass,

$$m = \int_0^r \int_0^\pi \int_0^{2\pi} \sigma r^2 \sin \theta dr d\theta d\omega. \tag{15}$$

Now in the physical universe, such independent gravitational waves must be imagined to proceed from the several atoms of all bodies whatsoever, just as light waves do from each atom of the self-luminous gases of the stars. Accordingly such integration has to be extended to the waves from all masses severally; and as there is an infinitude of bodies, the result is an integral infinitely repeated, or an infinite integral, though the value of the disturbance remains finite at every point of space.

And not only is there a double infinite or infinite infinite system of interpenetrating waves, but also the resistances — with refraction, dispersion and interference — at the boundaries of all solids and liquid bodies. It is these resistances — refractions, dispersions, diffractions, and other wave transformations — which give rise to molecular forces. They usually are very powerful at the surfaces of bodies, and by their mutual interactions on contiguous atoms and molecules cause cohesion, adhesion, capillarity, and chemical affinity, and other phenomena heretofore utterly bewildering to the natural philosopher.

Now it is our purpose to outline a preliminary theory of these forces, in the hope that the light thus shed on a very obscure problem may induce others to extend these researches. It is obvious that the preliminary theory must necessarily remain very incomplete till the phenomena are carefully studied under a criterion which may operate as an experimentum crucis. But these verifications can only be deduced by investigators of great experience in the several branches of physical science.

2. The Recognized Refraction and Dispersion of Light in a Drop of Rain shows the Cause of the Rainbow, and suggests Similar Molecular Effects when the Source of Light is extended by Double Integration to the Surface of the Entire Celestial Sphere.

(i) Outline of the theory of the rainbow, as an introduction to the wave-theory.

Let the circle in Fig. 1 represent a section of a spherical rain-drop. As water is liquid and yields to the forces acting on the surface this hypothesis of sphericity implies that there are constantly acting forces at work to maintain this figure; and we know from the researches of Lord *Rayleigh* (Proc. Roy. Soc., May 5, 1879, no. 196), on the oscillation-periods of globules of liquid, that the forces at work are quite powerful, otherwise the oscillations of the drops of distorted form would not be so rapid as they are observed to be.

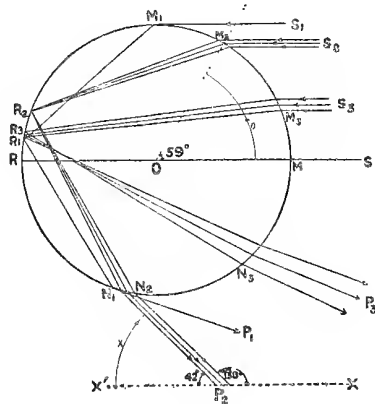


Fig. 1. Path of the sun's rays in the theory of the rainbow. The large circle represents the magnified raindrop, and OS the direction of the sun.

As our theory of molecular forces is based upon the action of waves of various lengths, we must be careful not to assume that waves other than those of the visible spectrum are absent, yet in the problem of the rainbow our reasoning of course relates to the visible spectrum. It is believed that waves shorter than the visible spectrum give rise to chemical affinity, capillarity, etc., while the waves of the infra-red region, having enormous wave-lengths, generate heat through breaking up into shorter and shorter wavelengths.

In figure 1 the circle represents a section of a spherical rain-drop, with parallel rays of sunlight $S_1 M_1$, and thus internally refracted along the path $M_1 R_1$, whence it is reflected along the path $R_1 N_1$, and then outwardly refracted along the path $N_1 P_1$. The line from the centre $O M_2$ makes an angle of 59° with the path of the incident light, which, at this small circle θ about M as a pole, is less deviated by two refractions and reflection, than is the light incident at other small circles about M . It appears that the surface of the rain-drop is divided into different zones about the pole M , and the path within depends on the polar angle θ , and also on the wave-length of the light.

It will be found that for rays of the visible spectrum, the light incident in the narrow zone or surface

$$ds = r d\theta r \sin\theta \int_0^{2\pi} d\omega = 2\pi r^2 \sin\theta d\theta, \theta = 59^\circ \quad (16)$$

operates to form a parallel pencil $N_2 P_2$ when the rays have undergone their last refraction in leaving the raindrop. In another smaller zone, as M_3 , nearer the pole, the incident light forms a divergent pencil $N_3 P_3$, when the originally parallel rays have departed. The direct illumination of the hemisphere of the drop turned towards the sun thus yields successive zones about the pole M :

$$2\pi r^2 \int_0^{1/2\pi} \sin\theta d\theta = 2\pi r^2 \left\{ \int_0^{\theta_1} \sin\theta d\theta + \int_{\theta_2}^{\theta_1} \sin\theta d\theta + \int_{\theta_3}^{\theta_2} \sin\theta d\theta \right\} \quad (17)$$

To understand the illumination of the sky noted in a rainbow, we notice that in the case of an emitted parallel pencil, the only decrease of the light with the distance depends on the absorption in the raindrop as a medium, which is small. But with the divergent pencil the case is very different, because the rays are spread over a greater and greater area as they recede from their point of intersection; and hence the illumination rapidly decreases.

Accordingly, in viewing such a raindrop from a distance, we should receive a considerable amount of refracted light in looking along the conical surface $P_2 N_2$, but very little when we look along any other conical surface about the anti-solar point.

After passing through the falling raindrops the light of the sun thus becomes redistributed in the sky, and a luminous band appears, corresponding to the rays which emerge as parallel pencils; but in the other zones there is relatively increased darkness, owing to the divergence of rays corresponding thereto.

It will be seen from the lower part of the figure that the angle $N_1 P_2 X' = \chi$ is 42° ; and hence all raindrops on the surface of the cone 42° from the anti-solar point will

be in such position that the light entering them will have undergone minimum deviation, and send to the observer a relatively large amount of light, on a darkened background. This simple theory briefly outlines the foundation of the rainbow, but the dispersion of colors is still to be explained.

We shall now include the effects of refraction and reflection, so as to take account of dispersion. As the sun's rays include all the wave-lengths of the spectrum, we must consider the production of color in the rainbow. It is obvious that if the source of light were a point and there were monochromatic light, the luminous band would be reduced to a mere line of one color circling about the anti-solar point. But when light of the whole spectrum is incident upon the drops, the violet rays are deviated more than the average; moreover the width of the source of light lets the waves fall at slightly different angles, and hence the inner side of the cone has an angle χ of about 40° . The rainbow is thus a conical band, about 2° wide, with the red band about 42° from the anti-solar point.

In addition to the primary rainbow thus briefly explained, there is a secondary rainbow due to light which has been twice reflected within the drop, as shown in figure 2.

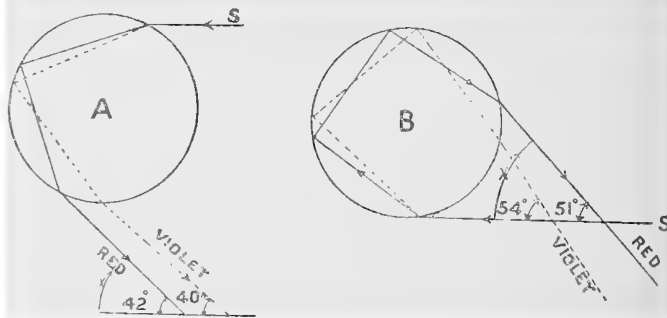


Fig. 2. Explanation of the primary and secondary rainbow, the latter by a reversed double reflection within the raindrop.

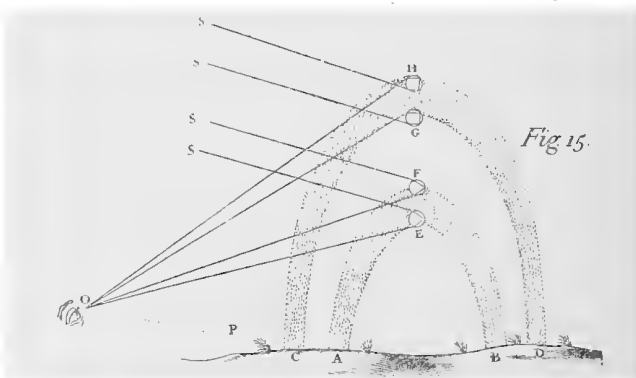


Fig. 3. General outline of the theory of the rainbow given in Newton's Optics, 1704.

Owing to the reversed nature of the reflection, from below upward, we perceive that the colors in the secondary bow should be reversed. Thus whilst the primary bow gives the red above and the violet below, the secondary bow has the violet above and the red below. And the angles χ of the cone are about 54° for the violet, and 51° for the red.

The secondary rainbow is therefore wider than the primary bow, and fainter, while the colors are exactly reversed.

From the reasoning here outlined, it follows that there are two zones for producing the rainbows:

1. The Primary Bow,

$$dS = 2\pi r^2 \int_{\theta_1}^{\theta_2} \sin\theta \, d\theta, \quad \chi_1 = 40^\circ, \quad \chi_2 = 42^\circ \quad (18)$$

2. The Secondary Bow,

$$dS = 2\pi r^2 \int_{\theta_3}^{\theta_4} \sin\theta \, d\theta, \quad \chi_3 = 51^\circ, \quad \chi_4 = 54^\circ \quad (19)$$

where $\chi_1, \chi_2, \chi_3, \chi_4$ are the angles of the cones from the anti-solar point.

Now consider what would be the result for greater changes in wave length than we have considered. Obviously the width of these luminous zones would be increased, and they might attain any width appropriate to the range in wave-length. Thus if the range of wave-length be multiplied say tenfold, the zone of light might become quite wide.

Finally, we should consider the effect of increasing the width of the luminous source, as by putting additional suns to radiating, side by side. Obviously each sun will generate its own rainbow, without regard to that due to the other sun; and thus we should have a superposed, or accumulated integral effect on the background of the sky. If there be suns side by side, from $\omega = 0^\circ$ to $\omega = 360^\circ$, where ω is the azimuth, the circular string of suns near the horizon, would fill the heavens with rainbows superposed three or more layers deep, and the whole lower part of the sky would become very luminous. And if the elevation of the ring of suns be increased, from the horizon to the zenith, $z = 90^\circ, z = 0^\circ$, where z is the zenith distance, we should fill the whole heavens several times over with the light of rainbows.

These conceptions, drawn from our theory of the rainbow, as extended by integrating the entire celestial sphere, will perhaps prove of value when we come to deal with the wave theory of molecular forces.

(ii) Sir *John Herschel's* argument that in refraction the mechanical forces exerted must be termed infinite, may be extended also to dispersion, and the hardness of bodies, as in section 10 below.

In his celebrated article on Light, *Encycl. Metrop.*, 1849, Sect. 561, Sir *John Herschel* has calculated the intensity of the refractive force in comparison with the force of gravity at the earth's surface. Whilst his result is obtained on the *Newtonian* emission theory, and not precisely applicable to the problem before us, yet this reasoning, as *Herschel* remarks, is well calculated to show the greatness of the power of molecular forces. This enormous force we now assign to waves action, and explain by the very high elasticity of the aether, which is $\epsilon = 689321600000$ times more elastic than our air in proportion to its density; and yet this enormously elastic aether not only has the wave surface refracted, and thus suddenly bent into a new position, at the boundary of solids and liquids, but also suffers an unequal refraction or dispersion of the waves according to their length.

Herschel's analysis of the intensity of the forces producing refraction is so worthy of careful study that we quote it as follows:

»Whatever be the forces by which bodies reflect and refract light, one thing is certain, that they must be incomparably more energetic than the force of gravity. The attraction of the earth on a particle near its surface produces a deflexion of only about 16 feet in a second; and, therefore, in a molecule moving with the velocity of light, would cause a curvature, or change of direction, absolutely insensible in that time. In fact, we must consider first, that the time during which the whole action of the medium takes place, is only that within which light traverses the diameter of the sphere of sensible action of its molecules at the surface. To allow so much as a thousandth of an inch for this space is beyond all probability, and this interval is traversed by light in the $\frac{1}{1267200000000}$ part of a second. Now, if we suppose the deviation produced by refraction to be 30° , (a case which frequently happens) and to be produced by a uniform force acting during a whole second; since this is equivalent to a linear deflexion of 20000 miles $\times \sin 30^\circ$, or of 10000 miles $= 3300000 \times 16$ feet, such a force must exceed gravity on the earth's surface 3300000 times. But, in fact, the whole effect being produced not in one second, but in the small fraction of it above mentioned, the intensity of the force operating it (see *Mechanics*) must be greater in the ratio of the square of one second to the square of that fraction; so that the least improbable supposition we can make gives a mean force equal to $4969126272 \times 10^{24}$ times that of terrestrial gravity. But in addition to this estimate already so enormous, we have to consider that gravity on the earth's surface is the resultant attraction of its whole mass, whereas the force deflecting light is that of only those molecules immediately adjoining to it, and within the sphere of the deflecting forces. Now a sphere of $\frac{1}{1000}$ of an inch diameter, and of the mean density of the earth, would exert at its surface a gravitating force only

$$\left(\frac{1}{1000}\right) \times (1 \text{ inch/diameter of the earth})$$

of ordinary gravity, so that the actual intensity of the force exerted by the molecules concerned cannot be less than

$$(1000 \cdot \text{earth's diameter}) / 1 \text{ inch} (= 46352000000)$$

times the above enormous number, or upwards of $2 \cdot 10^{44}$ when compared with the ordinary intensity of the gravitating power of matter. Such are the energies concerned in the phenomena of light on the *Newtonian* doctrine. In the undulatory hypothesis, numbers not less immense will occur; nor is there any mode of conceiving the subject which does not call upon us to admit the exertion of mechanical forces which may well be termed infinite.

3. Outline of New Theory of Surface Tension and of Capillarity based on Wave-Action.

(i) From the small radius of activity of the molecular forces observed by *Quincke* in 1869, — namely 50 micromillimetres, corresponding to a wave-length of only one half that of the shortest wave ever measured — it follows that these forces depend on waves in the invisible chemical spectrum.

In *Poggendorff's Annalen*, 137, 1869, *Quincke* gives certain results of his observational researches on capillarity

and similar phenomena, and is led to the conclusion that the molecular attraction becomes sensible at a distance of about 50 micro-millimetres, or 0.000050 mm, one millionth of a millimetre $1\mu\mu = 0.000001$ mm.

Reinhold and *Rücker* have strikingly confirmed *Quincke's* conclusions by their researches on soap bubbles. They found that the black film always formed before the stable bubble breaks, and that it has a uniform or nearly uniform thickness of 11 or 12 micro-millimetres, (Proc. Roy. Soc., June 21, 1877; and Phil. Trans. Roy. Soc., Apr. 19, 1883).

In his well known Address on Capillary Attraction Lord *Kelvin* remarks that the abrupt commencement and the permanent stability of the black film bring to light a proposition of fundamental importance in molecular theory: namely the tension of the film, which is sensibly constant when the thickness exceeds $50\mu\mu$, diminishes to a minimum, and begins to increase again when the thickness is diminished to $10\mu\mu$. It is not possible, Lord *Kelvin* concludes, to explain this fact by any imaginable law of force between the different portions of the film supposed homogeneous, and we are forced to the conclusion that it depends upon molecular heterogeneity.

Accordingly, the molecular structure and sustaining forces depend on distances of these dimensions, as if the forces are due to waves in the chemical spectrum. This reasoning is based on well established observational data on the radius of action of molecular forces; and thus it may also throw light on the cause of these forces in such phenomena as capillary attraction. Here is a suggestive summary, in which the micro-millimetre is the unit

1. Wave length of <i>D</i> -line of sodium	590 $\mu\mu$
2. Maximum of chemical action in the solar spectrum	400 "
3. Invisible spectrum begins	300 "
4. Shortest wave-length ever measured	100 "
5. <i>Quincke</i> observes molecular action effective	50 "
6. <i>Reinhold</i> and <i>Rücker</i> rupture soap bubbles at thickness of	10 "

It has long been known that chemical action is confined chiefly to the ultra-violet part of the spectrum. And now it appears from this table that the molecular forces, if due to wave action, are chiefly developed in the totally invisible spectrum, the violet *H* and *K* lines of the solar spectrum corresponding to about $400\mu\mu$. Lord *Kelvin* estimates the radius of action of the molecular forces as less than $250\mu\mu$, and on the wave theory this result is confirmed.

The question arises: How are we to interpret the development of these short waves? In any new theory there is much which still remains obscure, but the following outline enables us to interpret most if not all of the known phenomena:

1. In *Laplace's* theory of capillary attraction, based on the theory of molecular forces sensible only at insensible distances, he puts $f(r)$ as the unknown function of the forces, and takes

$$\varphi(r) = \int_{r_1}^{\infty} f(r) dr = 0 \quad (20)$$

or the action of the forces is insensible beyond a small limiting distance r_1 , which is the lower limit of the integral.

From the above reasoning we may suppose this value or $r_1 < 250\mu\mu$.

2. Now *Langley* found by his explorations of the infra-red spectrum, by means of the bolometer, that the heat spectrum was about 20 times the length of the visible spectrum observed by *Newton*, which runs from $A = 759.4\mu\mu$ to $K = 393.38\mu\mu$, and terminates quite suddenly at $200.0\mu\mu$, according to *Cornu*. Thus the heat spectrum, made up of long waves irregularly distributed over a wide space, is of enormous extent, ending in the other direction beyond the red, at say $7340\mu\mu$.

3. Magnetic and gravitational waves are supposed to be considerably longer than the heat waves, but an instrument to determine their length is not yet available. Thus the planetary forces undoubtedly depend on long waves, while the molecular forces depend on very short waves.

4. It is observed that the longest wave-length of light yet measured is $2500\mu\mu$, and the shortest electrical oscillation yet measured is some $600000\mu\mu$. And we know from the phenomena of waves in water of the sea and other fluids that long waves may be broken up into shorter ones by resistance. Accordingly, we conclude that by resistance long electric waves generate heat waves; and an additional breaking up of heat waves gives the still shorter light waves; while a still further disintegration of the light waves, gives the chemical waves of the invisible spectrum beyond the ultra-violet.

5. This transformation by breaking up of the waves appears to be the order of nature. It is exhibited constantly in the surface motions of the sea. And by turning on an electric current, — which was shown in the author's work of 1917, to be aether waves of a certain type — the disturbance is observed to heat a wire till it becomes red, by the resistance opposed to the motion of the longer electric waves. Further operation of the electric current makes the resistance wire glow with the brilliancy of the electric spark or arc, which is filled with violet light, like that of the sun. Still higher action of the current causes the vaporization of the luminous film of the electric light, and thus the generation of chemical waves, as in the light of the sun and stars.

6. The waves producing chemical affinity are thus held to be so short as to be invisible to the human eye. This whole process therefore confirms the following view:

(a) All short waves in nature come from the breaking up of longer waves in the aether.

(b) All molecular forces operative in chemical affinity, capillarity, cohesion, adhesion, surface tension, etc., are due to very short waves in the aether, which lie beyond the ultra-violet, in the region from 10 to $250\mu\mu$.

7. The maximum of the chemical activity in the solar spectrum, about $400\mu\mu$, is due to the greater agitation incident to the longer waves, which effect the greatest changes, while the shorter waves exert the greater forces of a steady character.

8. If this conclusion be admissible it confirms *Laplace's* theory of capillarity, which is mathematically expressed by the formula:

$$\varphi(r) = \int_{r_1}^{\infty} f(r) dr = 0. \quad (20)$$

And it indicates that different substances will exert different forces, according to their resistance or their transmission of the wave-lengths, $\lambda_1, \lambda_2, \lambda_3, \dots, \lambda_i, \lambda_i < r_1$:

$$\varphi(r) = K_1 \int_{r=\lambda_1}^{r=\lambda_2} f(r) dr + K_2 \int_{r=\lambda_2}^{r=\lambda_3} f(r) dr + K_3 \int_{r=\lambda_3}^{r=\lambda_4} f(r) dr + \dots + K_{i-1} \int_{r=\lambda_{i-1}}^{r=\lambda_i} f(r) dr \quad (21)$$

where $K_1, K_2, K_3, K_4, \dots, K_{i-1}$ are coefficients of conductivities, or resistance for the particular wave-length, the resistance being the reciprocal of the conductivity.

(ii) Direct proof that boundary pressure due to waves is the cause of molecular forces.

1. After the foregoing discussion of the general principles underlying the wave-theory, we now enter upon certain processes of exact calculation. The observational data are incomplete, yet the processes disclosed will prove very instructive. In treatises on physics, (cf. *Daniell's Principles of Physics*, 3rd edition, 1895, p. 142) we find the conclusion that the Kinetic Energy due to a steady flow of waves is

$$\varepsilon = \frac{1}{2} \rho v^2 \quad (22)$$

where ρ is the density of the medium and v the velocity of the waves.

2. Now for simple harmonic motion in a circle of radius a , which corresponds to a wave-amplitude a , we have:

$$v = 2\pi a/t, \quad v^2 = 4\pi^2 a^2/t^2 = 4\pi^2 a^2 \nu^2 \quad (23)$$

where $\nu = 1/t$ is the wave-frequency.

Using these values in (22) we obtain for the pressure due to the steady flow of waves:

$$\varpi = \frac{1}{2} \rho v^2 = 2\pi^2 a^2 \rho \nu^2 \quad (24)$$

dynes per square centimetre, or ergs per cubic cm.

3. When the waves are short, ν is increased, and thus the pressure ϖ is increased, unless the amplitude a is correspondingly decreased. This raises the question as to whether retarded waves have greater or less amplitude than the original unchanged waves. Investigation shows:

(a) The long waves break up into shorter waves, by a process fully outlined for water waves by Sir *George Airy*, *Tides and Waves*, *Encycl. Metr.*, 1845, (cf. Second Paper on the New Theory of the Aether, AN 5048, pp. 141-142).

It is shown that the wave front becomes steep, owing to resistance, and the crest breaks into two parts, and finally

$$\varpi = 2\pi^2 \int_0^a \int_0^{\rho} \int_0^{\nu} 2a da d\rho [2A\nu^2 + 8AB\nu^3 + 6(B^2 + AC)\nu^5 + 16BC\nu^7 + 10\nu^9] d\nu \quad (28)$$

6. It is to be remembered that the elasticity ε and density ρ are both variable in *Newton's* formula, for the velocity of a wave in free space:

$$V = K V(\varepsilon/\rho) = K V(\gamma\varepsilon/\gamma\rho) \quad (29)$$

so that the velocity V does not sensibly vary in planetary space (AN 5044). What may occur within transparent bodies is not definitely known, but it is usually assumed that both the density and elasticity varies. If the presence of corpuscular matter did not interfere with the wave propagation, the *Newtonian* formula $V^2 = K^2 \varepsilon/\rho$ (30)

would give $dV = [K^2/(2\rho^{3/2} \varepsilon^{1/2})] \cdot (\rho d\varepsilon - \varepsilon d\rho)$. (31)

forms two separate waves, the rear wave being shorter and having the smaller amplitude.

(b) The longer of the parts of the broken wave becomes actually of larger amplitude than the original wave. And when subdivision again occurs, the same tendency arises — more waves, and of larger amplitude. This conclusion of *Airy* is verified by the tide heights observed at San Francisco and at Mare Island — the tides at Mare Island being higher by the factor 1.26, which is a noticeable increase of amplitude in traveling 25 miles from the Golden Gate.

(c) In considering waves transformed by resistance we have to sum up the pressure due to all lengths, and the effects of their different amplitudes, which requires an integration of all the variable elements.

4. If n be the index of refraction, the refractive action at the boundary will be $(n^2 - 1)$, and the wave pressure exerted on the boundary of the fluid will be, in dynes per square cm or ergs per cubic cm:

$$\varpi = 2\pi^2 a^2 \rho \nu^2 (n^2 - 1) \quad (25)$$

But it is well known that ν and n are related, though not in a very simple way. According to the celebrated researches of *Cauchy* on the refraction and dispersion of light,

$$n = A + B\lambda^{-2} + C\lambda^{-4} = A + B\nu^2 + C\nu^4 \quad (26)$$

where A, B, C , are coefficients, and λ is the wave length, ν the corresponding wave frequency. This formula (26) holds quite accurately for the range of the visible spectrum.

5. Accordingly, for a given wave-amplitude, wave-length, and aether density, we have

$$\begin{aligned} \varpi &= 2\pi^2 a^2 \rho \nu^2 (n^2 - 1) \\ &= 2\pi^2 a^2 \rho \nu^2 [(A + B\nu^2 + C\nu^4)^2 - 1]. \end{aligned} \quad (27)$$

But as the amplitude a , density ρ , and wave-frequency ν are variable, when waves are resisted by matter and thus transformed, we must take the triple integral for these three independent elements, in order to get a rigorous calculation of the pressure at the boundary of the fluid:

But it is evident that the resisting forces, which transform waves, would also invalidate the use of this differential equation. In practice we have to rely, for moderately homogeneous waves, on equation (27) or on equation (28) when any process exists by which the triple integral may be evaluated. The difficulty of effecting the integration for the action of waves coming from all directions is increased by the circumstance that they are so short as to be wholly invisible, and the frequency ν thus indeterminate. Hence the amplitude also is indeterminate, and the effects must rest mainly on arguments of probability drawn from a true cause recognized to pervade the physical universe.

4. Physical Theory of the Globular Form of Liquid Drops.

(i) Least action leads to minimum deviation and therefore minimum dispersion in the passing waves, the paths for which are here illustrated for raindrops in the case of the rainbow.

If the direction of an incident beam of light passing through a prism, with section in the form of an equiangular or isosceles triangle, be such that the path within the prism be parallel to the base, it is well known that both the deviation and dispersion will be a minimum, and the external path of the transmitted light will be as nearly as possible identical with that of the incident ray. This result is the outcome of the principle of least action, which may be briefly outlined as follows.

In the case of simple refraction the law of *Snellius*, 1620, is

$$\begin{aligned} \sin i &= n \sin r \\ \sin r &= 1/n \cdot \sin i. \end{aligned} \quad (32)$$

To find the least action along the actual path, we remember that this action is for lengths of path $l_1, l_2, l_3 \dots l_i$:

$$A = (v_1 l_1 + v_2 l_2 + v_3 l_3 + \dots + v_i l_i). \quad (33)$$

And the condition for the minimum of this action is

$$\begin{aligned} \partial A / \partial s &= (\partial / \partial s) (v_1 l_1 + v_2 l_2 + v_3 l_3 + \dots + v_i l_i) = 0 \\ &= \partial / \partial s (l_1 + 1/n_1 \cdot l_2 + 1/n_2 \cdot l_3 + \dots + 1/n_{i-1} \cdot l_i) = 0. \quad (34) \\ ds &= dt \sqrt{[(\partial x / \partial t)^2 + (\partial y / \partial t)^2 + (\partial z / \partial t)^2]} \\ &= dt \sqrt{[(dx/dt)^2 + (dy/dt)^2 + (dz/dt)^2]}. \end{aligned}$$

The action or work is a minimum along the actual path, and there is no change for a small variation in the path: or, in *Hamilton's* phrase, the action is stationary.

If λ be the wave-length, the velocity $v = f(x, y, z)$, and the time of passage becomes

$$\tau = \int 1/v \cdot ds = \int [1/f(\lambda, x, y, z)] \cdot ds. \quad (35)$$

And for the minimum path our stationary condition is

$$\delta \tau = \delta \int_{x_1, y_1, z_1}^{x_2, y_2, z_2} [1/f(\lambda, x, y, z)] \cdot ds = 0 \quad (36)$$

The solution shows that the time of passage is defined by the function

$$r = F(x, y, z, \lambda, \alpha, \beta) \quad (37)$$

where α and β are constants of integration.

We may obtain a better geometrical and physical grasp of these actions by considering the following sketch of the waves of light, in passing through the raindrop for the production of the rainbow.

1. The waves are of velocity $V = 3 \cdot 10^{10}$ cm in the air, before entering the spherical drop; then at the boundary of the drop, the velocity $V' = V - g$, which for water gives a decrease of speed in the

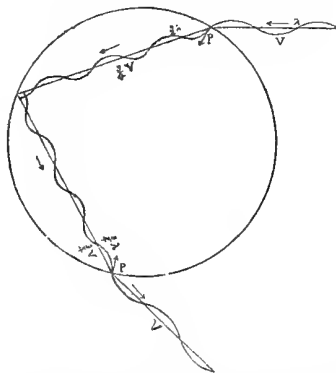


Fig. 4. Illustration of the sudden change of wave-length λ and wave-velocity V at the boundary of a raindrop, by which inward pressure is exerted at the surface of the fluid, as the waves are both coming and going.

ratio of 4:3. Within the drop, therefore, the waves are shorter than without, in the same ratio, because the same number are crowded into a less space $s' = \frac{3}{4}s$, as shown in the figure 4.

2. After reflection at the opposite boundary of the drop, the path returns, and the light emerges as shown in the figure. It may be noticed that just as the velocity and wave-length are decreased on entering the raindrop, in the ratio of 4:3, so also, on leaving the water, the velocity is increased at the boundary of the raindrop in the same ratio 3:4. And just as the retardation of the waves entering the drop gives a pressure of the aether against the surface $\varpi = +2\pi^2 a^2 \rho v^2 (n^2 - 1)$, here indicated by the arrow; so also, on leaving the drop, the sudden acceleration at the boundary, by reaction, gives an equal backward or negative pressure $\varpi = -2\pi^2 a^2 \rho v^2 (n^2 - 1)$. These forces, depending on waves from all directions, applied all over the drop, give rise to surface tension, which is really a central pressure operating through the stress generated in the aether at the boundary of the liquid, by the sudden change in the velocity of the waves.

(ii) The action of passing waves rounds up small masses of liquid into spheres or spheroids of minimum oblateness: Definite geometrical proof based on a theorem of *Archimedes*.

1. The researches of ancient and modern geometers on isoperimetric problems, more especially those of *Euler* and *Lagrange*, *Weierstrass* and *Schwarz*, have shown that a circle has maximum area for a given perimeter; so that for a fixed area, the circle, of all possible geometric figures, has the minimum perimeter.

Many years ago *Weierstrass* placed the Calculus of Variations on a basis of strict rigor; and following his methods, *Schwarz* has dealt extensively with the general problem of minimal surfaces. Of these surfaces the sphere is the simplest, and it is easily shown that it has maximum volume for a fixed surface; or for a fixed volume has the minimal surface.

2. The globular form of liquid drops of water is illustrated by the rainbow, where the smallest deviation from the spherical figure in the water drops would destroy the observed arrangement of colors. Mercury, molten metal, molten glass, suspended globules of oil, and other liquids, have a similar form; and we are naturally led to inquire why nature adopts what mathematicians call minimal surfaces for such masses of liquid.

3. If r be the radius of a sphere, the volume becomes

$$V = \frac{4}{3}\pi r^3. \quad (38)$$

And for the volume of an oblate spheroid, produced by the revolution of an ellipse about its minor axis, we have

$$V = \frac{4}{3}\pi a^2 b = \frac{4}{3}\pi a^3 \sqrt{1 - e^2} \quad (39)$$

where e is the eccentricity of the sections through the shorter axis b . For equal volumes, $V = V'$, the surfaces $S > S'$, or the surface of the spheroid S is always larger than that of the sphere S' , as may be proved by the following analysis. The differential expression for the length of a curve along the x -axis is

$$ds/dx = \sqrt{1 + (dy/dx)^2 + (dz/dx)^2} \quad (40)$$

and the integral:

$$s = \int \sqrt{1 + (dy/dx)^2 + (dz/dx)^2} dx. \quad (41)$$

4. And for an oblate spheroid we have

$$ds = (1 + b^4 x^2/a^4 y^2)^{1/2} dx. \quad (42)$$

If the surface be S we shall have by calculation:

$$S = 2\pi \int x ds = 2\pi \cdot ea^2/b^2 \cdot \int [y^2(e^2 - 1)/e^2 + b^4/a^2 e^2]^{1/2} dx \quad (43)$$

the solution of which is:

$$S = 2\pi a^2 + \pi a^2 \left\{ \frac{(1 - e^2)/e}{1 - e^2} \cdot \log_e \left[\frac{(1 + e)/(1 - e)}{(1 - e^2)/e} \right] \right\} \quad (44)$$

where \log_e denotes the natural or Neperian logarithm.

5. For a sphere surface we have the much simpler algebraic expression:

$$S' = 4\pi r^2 = 4\pi a^2 (1 - e^2)^{2/3} \quad (45)$$

where the radius $r = a(1 - e^2)^{1/3}$, is for the sphere of the equal volume with the spheroid.

6. To apply these formulae to a numerical example, we take the case of the earth with equatorial radius $a = 1$, and the oblateness $1/298.3$; which gives for the eccentricity of the terrestrial meridian

$$1 : 298.3 = 1 - \sqrt{1 - e^2} \\ e = 0.0818133. \quad (46)$$

By the second term of the formula for the surface, we find:

$$\frac{1}{2} (1 - e^2)/e = 6.070567. \quad (47)$$

$$\log \left[\frac{(1 + e)/(1 - e)}{(1 - e^2)/e} \right] = 0.0712213 \\ \log_e \left[\frac{(1 + e)/(1 - e)}{(1 - e^2)/e} \right] = 0.1639933. \quad (48)$$

And since $2\pi = 6.2831852$, the second term, with the factors depending on the eccentricity, becomes:

$$2\pi \frac{1}{2} (1 - e^2)/e \cdot \log_e \left[\frac{(1 + e)/(1 - e)}{(1 - e^2)/e} \right] = 6.2551140. \quad (49)$$

7. On adding the first term, we get for the whole surface of the oblate spheroid S , and of the equal sphere S' :

$$S = 12.538299 \\ S' = 12.538270. \quad (50)$$

The difference between the surfaces of the spheroid and sphere:

$$S - S' = 0.000029. \quad (51)$$

Accordingly, it thus appears that for small oblateness, there is very little difference between the surface of the spheroid, and the surface of a sphere of equal volume. In case of the earth's oblateness, $1/298.3$, the difference in the surfaces is only 29 parts in 12538270, or one part in 432000.

8. This example proves that the spherical surface is a minimum, because it is the figure to which the oblate spheroid approaches nearer and nearer as the oblateness is made smaller than any assignable quantity.

In the theory of capillarity and similar surfaces, in three dimensions, the surface has the general form:

$$S = \iint \sqrt{1 + (dz/dx)^2 + (dz/dy)^2} dx dy. \quad (52)$$

Yet for spheroidal drops of liquid of perfect symmetry the above simpler method of solution is sufficient, and we shall not go into more complex surfaces.

9. For from a physical point of view, we must remember that waves are propagated more rapidly in air than in liquids, such as water, oil, mercury, etc., as shown by the observed refractive indices and electric resistances. Thus, in passing through liquids, the waves encounter sudden resistance at the boundary, and the velocity in the liquid decreases from v to v' ; as the waves leave the liquid, the velocity increases from

v' to v . Wave energy is thus given up on entering the liquid, owing to internal retardation. On leaving the liquid, the waves are no longer retarded, but actually accelerated, and thus drawing new energy from the unlimited reservoir of the aether they react, or »kick back« correspondingly.

It has long been recognized that a ray of light follows the path of least resistance; electric disturbances follow the same law; and generally throughout nature all physical operations take place according to the principle of Least Action. Therefore if an infinite variety of waves from all directions enter and leave the globule of liquid, the action and reaction of their passage will be such as to make the total resistance a minimum. This can happen only when the figure of the globule is spherical or ellipsoidal, with minimum oblateness.

10. Up to the present time we know but little of these waves, yet they appear to correspond to the forces of surface tension, which are superficial in their character and power. Chemical affinity is known to depend on very short waves, as in ultra-violet light, which cannot penetrate solids, through even the thinnest layers. Such waves can hardly penetrate solids at all, and pass with difficulty through transparent liquids, and gases. Thus it is natural to attribute the forces of surface tension to waves, chiefly of the ultra-violet spectrum, and they may be of even shorter wave-length.

Owing to lack of penetrating power these short waves could not come directly from the interior of the globe, yet they could come from the stars in the immensity of space, the particles of the air, on all sides, and from the surface of the solid earth in the hemisphere below every drop of liquid. The resistance, on entering the liquid, and the reaction on leaving it, are equal, according to the theory of light, (Sir *Herschel's* article, *Light*, *Encycl. Metr.*, 1849, § 561). The total effect of the waves is as if the drop were pressed in on all sides, by central forces. This is our explanation of surface tension, and the globular figures noticed in drops of liquid.

11. Now waves coming and going in all directions, will do least work against the globule when its figure is spherical. For a sphere is a minimal surface, and thus gives least chance of collision with the moving aetherons. And when collision occurs for the waves, the spherical figure yields the shortest average path for the waves which enter the mass of liquid. This spherical figure corresponds therefore to the principle of least action for all the waves of the universe; but the truth of the principle can be made clearest by an illustration.

12. *Archimedes* showed, — in a famous theorem which he desired engraved on his tomb, and which was actually found there by *Cicero* when he was consul at Syracuse, 140 years afterwards — that the ratio of the volume of an inscribed sphere to that of the circumscribed cylinder is as 2 : 3. Thus, if waves enter the cylinder at the end they will encounter exactly $\frac{2}{3}$ as much resistance from the liquid sphere as from a continuous cylinder of the same liquid.

As the sphere is a minimal surface, and symmetrical in all directions, it is sufficient to consider the waves entering the end of the cylinder from any direction. Let the sphere be imagined to have an expansible but unelastic surface, and after expansion let the surface be punctured, to allow exchange

of the fluid. Under these conditions the enclosed and enclosing incompressible fluid may adapt itself to any alteration of the spheroidal volume. Then the altered surface will be greater than the original sphere surface, though the cylinder would still contain all the liquid. The distorted closed surface would thus fill more than $\frac{2}{3}$ of the circumscribed Archimedean cylinder; and the total resistance to all the waves within the inner mass of liquid would exceed $\frac{2}{3}$ of the total resistance due to the liquid cylinder alone. That is, the surface of the sphere would be increased by dS , so that if the original sphere surface be $S = 4\pi r^2$ the expanded surface would become $S' = S + dS = 4\pi r^2 + dS$; and the original volume $V = \frac{4}{3}\pi r^3$ would become

$$V' = V + dV = \frac{4}{3}\pi r^3 + dV. \quad (53)$$

From this application of the *Weierstrass-Schwarz* mathematical theory of minimal surfaces to a fixed volume of liquid confined within the Archimedean sphere and circumscribed cylinder, it follows therefore that waves passing from all directions through small masses of liquid of any figure whatever, but with greater resistance than air, necessarily will give least action, when the figures of the liquid masses are spherical. If the liquid globes be of appreciable size, the action of gravity on the figures of the liquid will resist the tendency to globular form; for the surface tension is superficial only, while gravity penetrates a mass, and the result is a corresponding spheroidal figure.

These figures of fluid drops evidently will be of minimum oblateness, or maximum sphericity, but be determined by the balance of forces between gravity on the one hand and surface tension on the other. By equating the observed compression due to gravity to the calculated wave action in the surface tension, we may be able to study the power of the wave action in the case of particular fluids. This method is somewhat analogous to that used by *Quincke* in his researches on surface tension and needs not be further discussed at present.

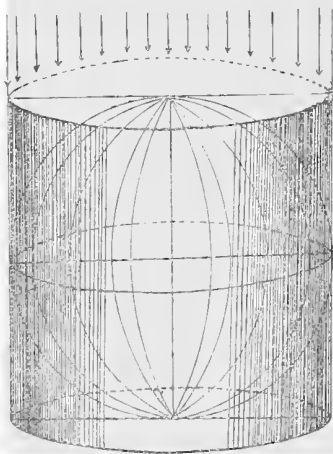


Fig. 5. Illustration of a sphere and circumscribed cylinder, with volumes in the exact ratio of 2 : 3. The illustration is here introduced to prove that if the cylinder be filled with an incompressible liquid, and the sphere surface be dilated into $4\pi r^2 + dS$ above or below, at any parts where the two geometrical figures are not in contact, the continuous fluid within the distorted sphere surface $S' = 4\pi r^2 + dS$ will offer more than 2 : 3 as much resistance to the passing waves as does the whole cylinder of liquid.

The Archimedean Theorem thus yields a rigorous proof that of all possible forms, a distorted drop of liquid may take, the sphere offers minimum resistance to the whole body of waves from all directions: and as nature converts falling globular drops into perfect spheres, this physical fact is a proof that waves incessantly traverse the universe in all directions.

5. New Theory of Lightning, based on the Accumulating Stress of the Aether at the Boundary of Coalescing Raindrops, and the Oscillatory Discharge.

(i) General remarks on the phenomena of atmospheric electricity and lightning.

In *Ganot's Physics*, translated by *Atkinson*, 14th ed. 1893, § 995, we find that the treatment of the causes of atmospheric electricity begins with the following suggestive admission that these operations of nature are clouded in impenetrable darkness:

»Although many hypotheses have been propounded to explain the origin of atmospheric electricity, it must be confessed that our knowledge is in an unsatisfactory state.«

Many observations are accordingly detailed, but the physical cause at work is so completely hidden from our view that no intelligible conclusion can be drawn.

In the wave-theory of molecular forces, we hold that all such forces as surface tension are boundary effects of wave-action; and as the boundaries change rapidly, when the small drops are coalescing into larger ones, there is change of aether stress at the surface of the drops. This is called an electric charge on the raindrops, and as the process goes on throughout the cloud, the derangement of the electric equilibrium becomes so pronounced that a discharge occurs, which is called lightning.

For in the condensation of the drops, the capacity for the enlarged drop to hold the collected charge varies only as the radius r , whereas the amount of electricity accumulating under the condensation is proportional to the number of drops collected together or the total volume of water, $\frac{4}{3}\pi r^3$, and thus varies as the cube of the radius, which is kr^2 times faster than stable electric equilibrium will support. Thus the tendency to discharge increases as kr^2 .

It is remarkable that surface tension of a drop does not increase with the size of the drop, which shows that it is a boundary effect, exactly the same whatever be the radius. This is very unusual with the forces of nature, and implies a tendency to a decrease of the central action in proportion as the surface increases, or as $4\pi r^2$. Hence if surface tension be an electric phenomenon, and the drops be condensing to larger size, the tendency to rupture the electric equilibrium at the boundary by oscillatory discharge will increase as kr^2 . This corresponds with the known development of lightning when the droplets coalesce into raindrops.

If the electric tension or aether stress at the boundary of a drop attains too high a value, it breaks away in the form of oscillations, as in the discharge of a Leyden jar. Different drops and different parts of the cloud are under unequal electric tension. And as the cloud of moist air (filled with drop-Leyden-jars, so to speak) is a conductor having both capacity and inductance, the discharge necessarily is oscillatory in character. A flash of lightning is thus a series of waves like that shown by photography from an oscillograph in our laboratories.

If electrodynamic forces control the motions of the planets, as shown in the author's work of 1917, and in AN 5044, 5048, it follows that all bodies are centres of

waves propagated from their atoms. Thus every star or planet is a great centre of waves; and the waves are in the medium of the aether, under an elastic power $\varepsilon = 689321600000$ times greater than that of our air in proportion to its density.

In the First Paper, AN 5044, it is shown that the gravitational potential introduced by *Laplace*, 1782,

$$V = \iiint [(x-x')^2 + (y-y')^2 + (z-z')^2]^{-1/2} \sigma dx dy dz \quad (54)$$

represents the accumulated stress under the corresponding amplitudes of waves from the mass

$$M = \iiint \sigma dx dy dz \quad (55)$$

thus making the potential have the simple form

$$V = M/r. \quad (56)$$

In the same way all electrical forces depend on wave-action. In the Third Paper on the new theory of the aether, (AN 5079) we have shown that an electric current is nothing but waves of a certain type about a conducting wire; so that aether and electricity are directly connected in a way which can scarcely be denied. Hence as an electric current is simply ordered waves in the aether, arranged in a certain way about a wire, and traveling away from it with the velocity of light, it is natural to inquire into dynamic and static electricity as we see it in the clouds.

In electrical investigations covering a wide field we find that steady waves maintained along a wire may operate as dynamic electricity. Electric current, for example, is generated by a dynamo out of the magnetic field of the earth, which always exists. Hence as the lightning represents dynamic electricity, due to discharge under accumulating aether stress at the surfaces of raindrops, we should study it in connection with the wave-theory as a whole, which includes the earth's magnetic wave-field.

A valid theory of the lightning, conforming to the wave-theory of physical forces, is therefore a most urgent desideratum of science. And until this is outlined, in accordance with the theory of electric waves and oscillations, the mystery of the lightning cannot be intelligently attacked.

Now since the aether has an elastic power $\varepsilon = 689321600000$ times greater than that of our air in proportion to its density, we see that lightning is a luminous effect of wave oscillations in this enormously elastic corpuscular medium, which accounts for the violence of the electric shock to material objects of the world. The aether vibrations resulting from lightning as an electric-wave agitation, naturally produce waves in physical bodies, which are then conveyed from the scene of the thunderbolt to other parts of the earth by vibrations in the air, and thus only travel with the speed of about 1100 feet per second.

This view that lightning is oscillatory is proved also by experience in high power telephone lines, which so frequently have their terminals burnt out by the waves induced by lightning. These injuries to the terminals are great sources of loss to telephone companies, and electric engineers thus labor to relieve such inductions in their lines in the hope of saving their terminals as much as possible.

Nothing but a series of electric waves, invisible and generally unsuspected, yet generated in the aether by the successive discharges of parts of the cloud in lightning, could

cause these disastrous inductions, which travel with the speed of light, 902000 times faster than sound in the air. The lines so burnt out are interrupted and out of service at the instant we see the flash, but the shock to the earth is felt somewhat later, owing to the slow propagation of the earth wave and the air waves, both of which travel with comparatively low speed.

We conclude therefore that the terrific power shown in the action of lightning has its source in the strain of the enormously elastic aether, and its sudden release, through a series of long waves like those of an oscillograph. This causes the whole aether-field of the earth to oscillate, in a series of waves long enough to penetrate solid bodies. The series of physical oscillations thus set up jar the very earth violently where the lightning strikes.

(ii) The molecular forces operating in raindrops are due to waves traversing the world, and thus lightning depends on such accumulating aether stresses at the boundary of the drops.

In many treatises on the atmosphere it is noted that clouds are in general electrified, usually positively, but sometimes negatively, and only differ electrically from the earth in their higher or lower potential. The formation of a positively electrified cloud is by some authorities attributed to the vapor disengaged from the earth. Our view, however, is that the waves which give rise to molecular forces are always traversing the world, but the state of the cloud, or vapor above the earth, by condensation of droplets, may vary the resistance to the passing waves, and thus give rise to difference of electric potential between the cloud and earth.

It is well known that the electrical capacity of a drop is equal to the radius; which shows that large drops have an increasing capacity, but it augments slowly, as the cube root of the mass. For if m be the mass, we have

$$m = \frac{4}{3}\pi r^3 \cdot \sum_{i=1}^{i=\infty} m_i = \frac{4}{3}\pi \sum_{i=1}^{i=\infty} r_i^3 \quad (57)$$

and the capacity $r = \sqrt[3]{\frac{3}{4}m/\pi}$. (58)

After condensation the radius of the large drop becomes

$$R = \sqrt[3]{\sum_{i=1}^{i=\infty} \frac{3}{4}m_i/\pi} = \sqrt[3]{\sum_{i=1}^{i=\infty} r_i^3} = \sum_{i=1}^{i=\infty} r_i. \quad (59)$$

Now when billions of such droplets coalesce, the capacity of the resulting drop increases as the cube root of the sum of their masses; but the quantity of the electric stress accumulating at the surface of the coalescing drops is merely added. Hence we have:

1. Capacity $R = \sum_{i=1}^{i=\infty} r_i. \quad (60)$

2. Ratio of accumulating total charge to capacity

$$\sum_{i=1}^{i=\infty} m_i : R = \frac{4}{3}\pi \sum_{i=1}^{i=\infty} r_i^3 : R = kr^2. \quad (61)$$

where r is the radius of the average droplet.

3. Accordingly, for equal drops, under the same charge, the tendency to rupture the electric equilibrium is equal to kr^2 , or increases as the square of the radius.

From this discussion it follows that the electric tension on the surface of the droplets of water increases as the droplets increase in size, in general as the square of the diameter of the drops. The coalescence of the droplets to form raindrops is therefore the one chief condition requisite to the development of lightning.

In the wave-theory of molecular forces, it is held that the retardation of the waves entering the drops, and their corresponding acceleration on leaving the drops, gives rise to æther stress in the boundary of these globules. This surface stress of the aether at the boundary is the cause underlying surface tension. When the aether is so stressed at the boundary, and the droplets are coalescing, there usually is a changing electrical state, and thus the cloud is electrified.

If we consider the infinitely complex aether wave-field about the earth, which we can form some conception of from figure 14 of the Third Paper (AN 5079), illustrating the earth's magnetic field, we shall easily perceive that it is not possible for droplets to coalesce without changing the electrical resistance or total tension in the aether due to the passing waves.

Before condensation this resistance, in modifying the free wave movements of the aether, is proportional to the total space occupied by the droplets of water, or to be cube of their radii. Yet the capacity of a drop to hold a fixed charge is proportional to its electrical capacity, or simply to the radius. In condensation, therefore, whereby many droplets coalesce into a single drop, the wave resistance remains proportional to the space filled with water, $V = \frac{4}{3}\pi R^3$, or R^3 ; but the capacity for maintaining electric equilibrium only increases simply as R .

Thus from the relatively inadequate capacity (R) of the growing drop, compared to the relatively rapid growth of mass (R^3) there arises a tendency to rupture the electric equilibrium, proportional to R^2 . This occurs on every raindrop, so that the whole cloud becomes electrically charged, with the condensation of the droplets; and as the process proceeds at unequal rates in different parts of the cloud the increasing electric stress (R^2) finally leads to the development of oscillatory discharge or lightning. This happens as soon as the conductivity of the air permits an oscillatory release of the increasing electric stress on the surface of some of the raindrops.

For observation shows that dry air is a non-conductor of electricity, and therefore when the atmosphere is devoid of moisture, a discharge is difficult, except in the form of sheet lightning, so often observed in dry weather. Accordingly, it will not surprise us to note that lightning develops chiefly during rain, especially if there be an atmospheric commotion, or storm, for changing rapidly the coalescence of the droplets, which also may lead to the freezing of some of them into hail. It is well known that hail usually accompanies most violent thunderstorms.

(iii) Under condensation of globules with the electric tension increasing as $k r^2$ a cloud or part of a cloud becomes charged and forms with another part of the cloud, or with the earth below, a condenser, — the intervening air being the dielectric.

As a flash of lightning may be several kilometres in length, it is obvious that the electric stress accumulates on the cloud as a whole, in respect to the earth below, which is separated by the dielectric of the atmosphere. Friction, condensation of droplets, and similar causes tend to disturb the electric equilibrium of the earth and clouds in the sky. The battery power of a large cloud in respect to the earth may correspond to 3500000 cells, as long ago shown by *De la Rue* and *Müller* for a lightning flash a mile in length.

This enormous electric power accumulating in the condensing droplets makes the electric tension too high for the relatively decreasing capacity of the drops, and tends to rupture the electric equilibrium relative to the earth below. This indicates that some very active physical agency is at work; and in view of the electro-dynamic wave operations of nature as a whole, it is difficult to refer lightning to any cause other than waves. This physical cause alone would make possible this accumulation of aether stress at the boundary of the globules of the clouds, because at this boundary the wave movement changes suddenly, and the result is electric tension released as lightning.

In an address before the Western Society of Engineers at Chicago, 1920, Dr. *Chas. P. Steinmetz*, the eminent electrical engineer, has discussed the older and the newer theories of lightning. He says that experience proves that not over 1 percent of the electrical discharges take place between the clouds and the earth — the other 99 percent being between parts of the cloud.

He concludes that flashes from one to two miles in length are progressive in their nature. They start with the puncturing of a short space between groups of drops out of electric equilibrium, 20 or 30 feet apart, and spread until the potentials are equalized to a value corresponding to the voltage required to maintain the discharge in the damp air. The period of the discharge is from 0.00001 to 0.25 second, for the slower-acting flashes of more uniform potential distribution. *Steinmetz* concurs in the view above expressed that only a small fraction of the lightning disturbances are due to direct strokes, — the vast body of the breaks and burnouts being due to electrical waves with induced voltages of from 500000 to 1000000.

According to the report in the Literary Digest of Nov. 20, »the method of accumulating a charge of 5000000 volts or possibly twice this value on a cloud was explained as involving an initial charge on small particles of condensed moisture, the initial charge being due to the position of the cloud with respect to the earth. It was explained that the earth was surrounded by an electrostatic field with a gradient outward from the surface. Moisture condensing at a distance of one-half mile from the earth would be in a field at a potential of 100000 volts to earth and would assume a charge corresponding to this potential. By collecting into larger particles the charge would be accumulated until values of 5000000 volts or more would be reached when drops of rain were finally formed. Inequalities of 1 or 2 percent of this value, between sections of a cloud quite close together, would suffice to cause a local discharge which would result in a redistribution of potentials and probably in an extended flash. From the effects of direct strokes it has been estimated

that the flow of current may be anywhere from 1000 to 100000 ampères, these estimates being based on the size of the conductors that have been melted during the discharge of a stroke to the ground. The illuminating effect of lightning was used to estimate that the light energy of a flash might be equivalent to ten horse-power-hours. «

The discharge is a release of electric tension in the aether at the surface of the drops, but it has to occur through the medium of the atmosphere, in which the cloud floats. As in Geissler-tube experiments, the velocity is great, but less than that of light; and as the electric resistance changes with the discharge, owing to induction in the clouds and other masses, the path may appear zigzag, as shown by actual flashes. Accordingly, although the electric tension is in a fixed direction, the direction alters with partial release, induction and redistribution of electric tension, so as to give the actual zigzag paths presented by lightning.

It must be understood, in viewing these discharge phenomena, that the electric tension is developed between the earth and cloud, or rather between billions of billions of raindrops in different parts of the cloud. Therefore as the discharge, in a group of drops, proceeds from one part of the cloud towards the earth, or towards an adjacent part of the cloud, the local tension is released, and redistributed as the flash advances; this gives rise to a very sudden rearrangement of the electric stress, and as the resistance along the path also changes, by the release, the zigzag path naturally results. In some cases parts of electrified clouds are so situated, that two or more discharges join together and we have forked lightning.

Now in the case of the Leyden jar discharge, we have seen that it is oscillatory, consisting of a series of waves or surges in the medium, coming with such rapid succession as to leave no impression on the eye, yet capable of being photographed by a rapidly rotating mirror called an oscillograph. In like manner, the lightning is an oscillatory discharge, of the very same kind; and if we could see the surging of the medium, we should perceive a very rapid movement to and fro in this agitation of the aether along the path, which thus becomes luminous because of the violent agitations of the particles of the atmosphere, — the length from the cloud to the earth being so great as to make lightning one of the most impressive and terrifying of the phenomena of nature (see fig. 6, plate 2).

6. Wave-Theory of the Adhesion of a Raindrop to a Window Pane: Outline of the Cause of Capillarity and of the Perfect Sphericity of Soap Bubbles.

(i) Wave-theory of the adhesion of a raindrop to a window pane.

The simplest phenomena often give us the most light on the invisible causes underlying the operations of nature; and thus we shall examine somewhat carefully why a raindrop adheres so securely to a windowpane. No phenomenon could be better known than this fact of every day observation. It is everywhere observed, and fortunately we are in a position to attack the problem presented by this phenomenon, because

the refractive index of water, and glass, and thus the wave velocities in the two media, are accurately known.

If, therefore, the adhesion of the water to the glass be due to wave action, we shall be able to enter upon the analysis of the forces with some degree of confidence. In figure 7 we show a cross-section of a windowpane, with a drop of rain adhering to it. And we remark that in glass, water, and air, waves of light would have velocities in the ratio of 10, 12, 16: for the refractive indices are inversely as the velocities, and the approximate values of these indices are

$$\begin{aligned} \text{Air-water, } n &= 1.33 \frac{16}{12} = \frac{16}{9} \\ \text{Air-glass, } n &= 1.60 \frac{16}{10} = \frac{16}{6} \end{aligned}$$

Accordingly, the following figure is very suggestive; for we see immediately the forces generated, in the propagation

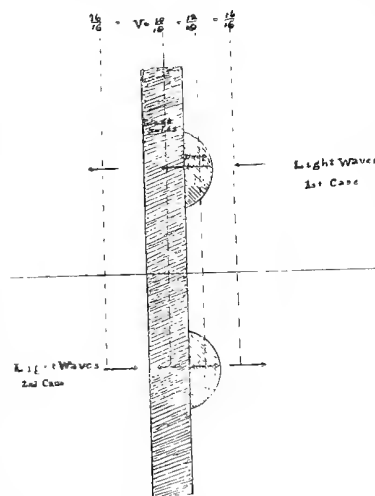


Fig. 7. Illustration of the adhesion of a raindrop to a windowpane, and of the sudden change in the velocity of the waves at the boundary of the three media, air, water, glass, upon which the adhesion depends.

of light. It thus becomes clear that in passing from air to water, waves of light are decreased in velocity by $\frac{4}{16}$ or $\frac{1}{4}$. In passing from water to glass the velocity likewise changes from $\frac{12}{16}$ to $\frac{10}{16}$, which is $\frac{1}{5}$. The wave motion thus changes velocity and generates a strain in the layer of aether and matter containing the surface of the water, and likewise at the surface between the glass and the water.

The tension of the molecules due to the aether stress of the surface of the water is called surface tension; that between the water and glass is called adhesion, and makes the water adhere to the windowpane. From the above figure we perceive that light waves passing from the air to the raindrop are delayed at the outer boundary of the drop, and thus the wave front presses in on the water, so as to give the surface tension observed. On passing on into the glass there is a second delay of the wave front at the boundary of the glass; and this aether stress or pressure over the surface between the water and glass causes the adhesion by which the water adheres to the glass.

The raindrop, however, adheres to itself somewhat more strongly than to the glass; because if the glass be inclined and jarred, the water will run down and fall off as a drop, leaving merely a thin layer of moisture on the glass. This recognized and obvious effect will hold for waves passing from the air to the glass, as shown in the upper half of the above figure.

But we must consider waves from all directions, and thus we ask what will happen if the waves move in the opposite direction, and have already traversed the glass, and

are leaving it to enter first the water, than the air? In this case the effect will be as shown by the arrows in the lower part of figure 7. As the velocity in glass is small, the waves will speed up on passing from glass to water, and again on passing from water to air. And in both cases they will react or »kick back«, giving an aether stress or adhesion of the water to the glass, and at the outer boundary a surface tension next to the air. Accordingly, whether the waves come from the air or from the glass they will give the aether stresses due to change of velocity, and result in the molecular forces observed.

The theory here briefly traced enables us to understand the adhesion of the rain drop to the windowpane. It is beyond doubt a wave phenomenon, because if the aether be filled with waves moving in all directions, these forces will necessarily result. This will hold true for light waves of the visible spectrum, or for waves of shorter length which are found to correspond to the radius of action for capillarity, as observed by *Rücker*, *Reinhold*, *Kelvin* and others.

(ii) The case of mercury, which gives a depressed column in a tube, and apparently is repelled by the glass.

The above explanation of the adhesion of a raindrop to a windowpane outlines briefly the wave-theory of capillarity, but a liquid like mercury which does not wet the glass must be examined. It will be found that the wave-theory will hold for the case of mercury as well as for that of water, but it is necessary to assume great resistance to the aether waves in the mercury, which is what should hold in the propagation of these waves through this dense medium. For in his experiments at the Physical Laboratory in Turin, 1919, Professor *Q. Majorana* found that even the long waves of gravity are sensibly intercepted by a layer of mercury, (cf. *Philosophical Magazine*, May, 1920, pp. 488-504).

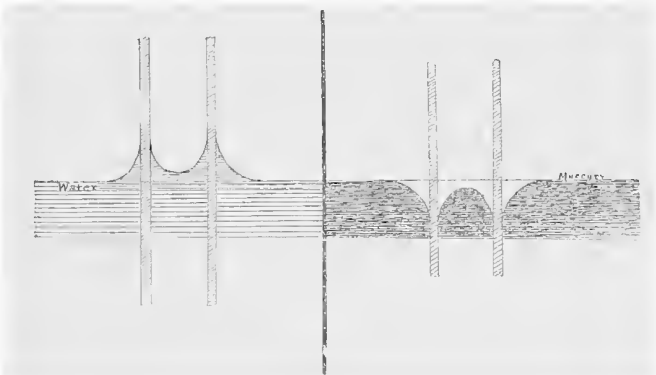


Fig. 8. Illustration of ordinary capillary phenomena, for water and mercury.

All we need to do to explain the negative adhesion of mercury to the glass tube is to take the velocity of propagation of the waves in the several media approximately as follows: air 16, water 12, glass 10, and mercury about half that of glass, or 5.¹⁾ These numbers are approximate only, and in the case of mercury the value is assumed, yet they are sufficiently exact for our present purposes. And thus we see that if mercury offers more resistance to the passage of waves

than glass, this fluid will be repelled by the glass tube, and the column of this liquid will be depressed, whereas water and similar fluids are elevated.

This explanation is not so very different from that put forth by *Laplace* in his theory of capillarity a century ago; for this great geometer explained the forces acting on mercury relative to a glass tube as negative, and by his analysis of the forces assumed to be sensible only at insensible distances, obtained a very satisfactory theory of the depression of mercury in capillary tubes. The present theory based on wave action is, however, more logical, and has the advantage of showing why the forces are negative, and can act only at insensible distances.

If mercury will sensibly intercept long gravitational waves, as *Majorana* shows, still more will it resist and quench the shorter waves active in capillarity.

The illustration, fig. 9, pl. 3, of the increasing depression of a mercury column with decreasing diameter of the tube may be regarded as direct proof of the close similarity of the forces which produce elevation of water in capillary tubes with those which depress the corresponding column of mercury. For in both cases the phenomena observed become more extreme with the narrowing of the column — the water rising higher and the mercury sinking lower, relatively to the level of the general free surface.

This effect is well shown in figure 9, plate 3, slightly modified from a work on Practical Physics, by *Black* and *Davis*, the MacMillan Co., New York, 1917, p. 74. Such a contrast in elevations of liquid columns would seem totally inexplicable without a simple and direct theory like that here presented. And if we can prove that with the narrowing of the tubes, wave action may increasingly elevate the height of water in capillarity, it will automatically establish the same cause for the depression of the level of mercury, in similar tubes, which is observed to become more pronounced with the narrowing of the tubes.

About two centuries ago it was observed by *Hawksbee* that if two vertical windowpanes be accurately set at a small angle of mutual inclination in a basin of water, the water line rises in the form of a rectangular hyperbola, showing that in such capillarity the lifting force varies inversely as the diameter or weight of the column to be lifted. I have recently made some observations on the form of the curve of depression for mercury, and confirmed the same law of the rectangular hyperbola referred to its asymptotes. Wherefore it seems impossible to doubt the wave-theory of these capillary phenomena, the cause of which long remained enigmatical and even bewildering to natural philosophers.

In *Atkinson-Ganot's* Physics, p. 1003, it is shown that the conductivity of mercury for electrical waves is low, 1.6, while for silver it is as high as 100.00, and for copper 99.9. Likewise, (p. 707), we learn that glass offers more electrical resistance than air and other dry gases, while water is a conductor offering much less resistance than either air or glass.

Accordingly, if waves of aether, inclined to the level surface are to pass through water, in contact with glass on one side and air on the other, it will follow that the level

¹⁾ On the scale here used the figure for mercury ought to be not larger than 1, if we judge by the electric resistance of mercury.

of the water should be raised in contact with the glass and be lowered on the side towards the air, in accordance with observation. We shall go into this at greater length in dealing with capillarity, and at present only dwell on it long enough to point out the verification of the wave-theory.

(iii) The perfect sphericity of soap bubbles explained by least action to surface waves, which makes the two concentric sphere surfaces also minimal surfaces.

Just as the *Archimedes-Weierstrass-Schwarz* theory of minimal surfaces, under wave action, will explain the molecular forces which give spherical or spheroidal forms to small masses of liquid; so also will it explain the molecular action of films in such phenomena as soap bubbles.

For a soap bubble is made up of two concentric sphere surfaces — the outer surface and the inner surface. The pressure of the cushion of air within the bubble prevents it from collapsing; and the waves traversing the outer surface act in the same way as in the case of a solid drop of liquid, and thus round up the mass from without.

On the inner surface there is an analogous wave pressure directed towards the liquid and thus acting in an outward direction. This is not from the confined air, which is a discontinuous cushion, but from the infinitely fine network of passing waves. The resistance to the waves through the entire bubble, with the double liquid wall, is least when the path in the water is the shortest; that is, when the waves go as near the centre of the hollow sphere as possible, as may be shown by mathematical analysis. But it may be seen immediately from the geometrical indications of the accompanying figure.

Just as the film of water is pressed together into a thin layer, by the inward passage of the waves from the outside, so also will the thickness of the bubble as a whole be compressed by inside wave pressure everywhere directed towards the outside. For as the waves near the tangent to the inner boundary of the fluid they react against the adjacent liquid, owing to the greater resistance along these adjacent paths.

By this reaction on the inner walls the liquid is pressed to itself from both sides, and the layer between the outer and inner surfaces made as thin as possible. As the waves keep the confined layer of liquid symmetrically compressed on both sides, rupture of the soap bubble is not very easy. In time it comes about, however, owing to the water trickling down under its own gravity, and thus rounding up into a liquid sphere or spheroid formed right on the lower side of the soap bubble, as it becomes unsymmetrical.

(iv) Direct proof of wave pressure at the boundary of a drop.

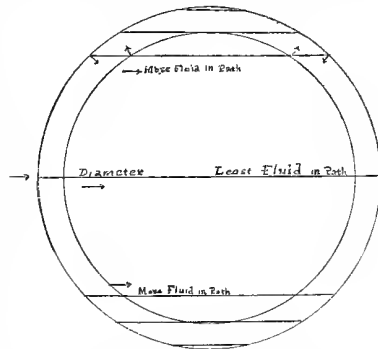


Fig. 10. Magnified cross section of a soap bubble, showing minimum thickness of liquid film at the centre, and least resistance to waves passing in that direction, which explains the central contraction and symmetrical form of a soap bubble.

The celebrated argument made by *Maxwell*, Treatise on Electricity and Magnetism, 1870, §§ 792-793, and the well known experiments of *Nichols* and *Hull* and *Lebedew*, 1901, shows that aether waves do exert pressure against any surface on which they impinge. Yet in order to have an objective proof of this important theorem drawn directly from nature, by observations which we can easily verify, it is advisable to go into this reasoning somewhat more carefully. We therefore consider the form and action of a series of steady waves in the sea.

1. It is well known that when the waves of the sea approach the shore, where the water is shallow, the motion of the base of the wave is retarded, while the top of it tends to move on as before. The result is the formation of breakers: the base of the wave is so held back that the top becomes steep, and finally curls over till the wave breaks in a whirling rush of foam.

2. Now this delay of the movement of the base causes the wave to exert a pressure against the shore which resists its advance. Accordingly we may thus verify *Maxwell's* conclusion that waves exert pressure against resisting objects. We see also the effects of such resistance in the wearing away of the sea shore when exposed to the dashing inrush of the waves. Sand and soft earth are carried bodily along with the waves, and even solid rock is slowly worn away by the incessant beating of the waves.

3. In order to make an experimentum crucis directly applicable to the problem now in hand, we shall imagine an island table-land in the open sea covered by the water to a depth comparable to the length of the waves which pass over it. Under these circumstances the waves will be retarded as they enter upon the submerged table-land; and in advancing across it they will be shorter and steeper as shown in figure 11. This is similar to the vertical surging of the surface, in a stream, which thus shows where rocks are in the bed; for the resistance of underlying movement manifests itself in alterations of the surface, so that the fluid is thrown into surface irregularities.

4. Accordingly, we perceive that as the resisted waves advance over the submerged table-land, which is not taken to be near enough to the surface to form breakers, they are shorter and steeper than the original waves as they come in from the deeper sea.

Now what will happen when the resisted waves at length depart from the table-land, and again enter the deep sea on the opposite side?

First, it is evident that the waves will take on greater speed in the deeper water; they will therefore become longer in the freely yielding deep sea, just as they become shortened by resistance as they ran over the shallow water.

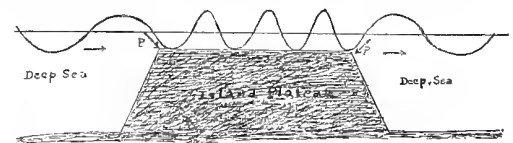


Fig. 11. Illustration of the pressure exerted by sea-waves against a submerged island plateau.

Second, as the longer waves, moving more freely into the deep sea, have the elements of their rotations accelerated, this more rapid whirl of the water will exert a backward pressure against the submerged table-land. Accordingly there is not only a pressure against the resisting land on approaching it, but also on leaving it.

5. We may easily satisfy ourselves of the correctness of this conclusion by the following independent experiment. Suppose an athlete standing on a spring board, and imagine the whole foundation carried along at a uniform rate, as if moving at a fixed speed on a railroad track. If the athlete wishes to accelerate his speed temporarily he will have to jump forward, by the exertion of his muscles, which will be sustained by the elastic rebound of the springboard. In other words, to give the athlete a greater velocity, forward, he must kick back against the foundation on which he is transported along. This is analogous to sea waves speeding up on leaving the submerged table-land: action and reaction are equal and opposite, and this general law is applicable to all nature.

6. Now consider the waves of light entering the raindrop and leaving it by the paths shown in the foregoing figure 4. Then, we know from *Maxwell's* reasoning, and these practical experiments, that there is an inward pressure against the surface of the water at the point of entrance, and a corresponding reaction against the surface at the point of emergence, because there is a sudden change of wave velocity at both points. This is the physical basis of our theory of surface tension.

7. If waves fill the world having all directions and wave lengths, it will follow that at the boundary of liquid drops, there is a sudden transition: the waves enter from all directions, but they also leave, in all directions, along various paths. And in every direction within the drop the speed is less than the original speed. There is thus a surface reaction towards the centre, owing to the decrease of action at the boundary, but coming and going.

7. The Fundamental Facts of Observation appear to furnish Criteria for a Wave-Theory of Capillarity.

(i) Detailed examination of the distortion of the wave-front and reaction of the waves in air, water, glass.

1. Consider waves traversing the universe, in all possible directions, and of any required length. What will happen when the waves pass from air to water and glass respectively? Take the refractive index of water at $n = 1.33$, and of glass at about 1.60; then it is evident that the velocity of waves of light or chemical activity will be swiftest in air, next swiftest in water, and slowest in glass. The relative velocities in the media air, water, glass are as 16, 12, 10 respectively.

2. Case 1, waves passing from air to water and glass.

Let figure 12 represent a section of plate glass partly surrounded by water: the ray will traverse the successive media, air-water-glass, and the wave surface will suffer distortion as shown in the figure. As the ray spreads out, under the effects of refraction, and the velocity is decreased both in the water and in the glass, the wave front will take the convex form shown by the heavy line.

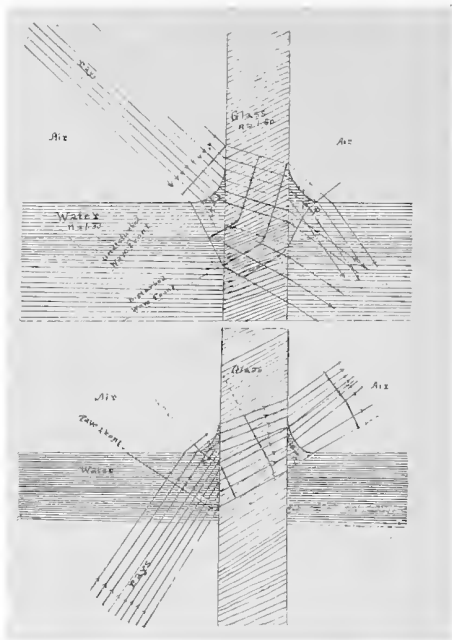


Fig. 12. Illustration of the disturbance of the wave-front when rays pass from air to water and glass in contact, giving rise to the observed capillary forces.

3. This change of the wave front from a plane surface into a convex surface will occur right at the surface of the water and glass. The ray r will spread in two directions, and its progress is most resisted by the glass and less resisted by the water at its contact with the glass. The water is fluid, while the glass is solid; and thus if the wave front is to remain continuous, the fluid must so adopt itself to the glass as to secure continuity — that is the level of the water must rise around the glass.

4. *Maxwell* showed (*Treatise on Electricity and Magnetism*, 1870, § 793) that all waves exert pressure against a surface on which they fall. Hence if there be pressure against the liquid surface, it will thereby be carried up around the glass which is solid. Thus it is easy to see why waves make the liquid film rise around the glass, as observed in the phenomenon of capillarity. The above argument and illustration will apply to all cases where the waves descend. For if they emerge on the opposite side of the glass, the reaction of the waves will carry the water up on that side also, as shown by the heavy line on the right.

5. Let us now consider the case in which the waves ascend, as shown by the arrows in the lower part of figure 12, of a cross-section of the wave front.

This figure shows what will happen in all cases of ascending waves, propagated more rapidly in air, less rapidly in water, and least rapidly in glass. On the right the reaction of the emerging wave front will force the level of the water up about the glass, by the reversed wave pressure p .

(ii) Detailed study of the distortion of the wave front when the waves are propagated in air, glass, mercury.

I. In the first instance suppose as before that the

waves descend from above, then the cross-section of the wave front is shown by figure 13, plate 3.

(a) If the resistance to the waves in mercury be greater than in air and glass, then the refractions and reactionary pressures to the wave surface as it advances will be of the type here pictured: the waves escaping from the mercury and speeding on more rapidly in the glass than in the mercury will by the rebound, $-\rho$, press the fluid back from the glass, on the left. On the right, the increased resistance to the waves due to the mercury, as the waves leave the glass and travel more slowly in the liquid mercury, will push that liquid away with a positive pressure $+\rho$.

(b) The result is a forcing of the fluid downward, by rebound, on the left; and forcing of it forward by equal direct pressure on the right. In both cases therefore the mercury is pressed away from the glass. The mercury therefore seems to attract itself more than it does the glass: which is the usual explanation of the negative capillarity of mercury. But we must also consider why the tube of mercury is below the normal level of the liquid, and hence we proceed to view the action of ascending waves.

$$I_{\lambda} = \frac{1}{2}H \iint d\mathbf{x} dy \{ \rho [1 + \rho^2 + q^2]^{-1/2} / \partial x + \partial [q [1 + \rho^2 + q^2]^{-1/2} / \partial y] \} = \frac{1}{2}H c \cos \varpi \quad (62)$$

where c denotes the circumference of the tube, and the angle ϖ is a constant found by observation.

To explain this formula, we remark that if $u = f(x, y, z)$ be the equation of the spherical surface of radius of curvature r touching the capillary surface at any point,

$$dr = [(\partial u / \partial x)^2 + (\partial u / \partial y)^2 + (\partial u / \partial z)^2]^{-1/2} du. \quad (63)$$

$$\text{The } z\text{-axis is vertical, and } \partial u / \partial z = 1; \partial u / \partial x = -\rho; \partial u / \partial y = -q \quad (64)$$

$$\partial r / \partial z = [1 + (\partial u / \partial x)^2 + (\partial u / \partial y)^2]^{-1/2} = (1 + \rho^2 + q^2)^{-1/2} \quad (65)$$

$$\partial r / \partial x = [1 + (\partial u / \partial x)^2 + (\partial u / \partial y)^2]^{-1/2} \partial u / \partial x = -(1 + \rho^2 + q^2)^{-1/2} \rho \quad (66)$$

$$\partial r / \partial y = [1 + (\partial u / \partial x)^2 + (\partial u / \partial y)^2]^{-1/2} \partial u / \partial y = -(1 + \rho^2 + q^2)^{-1/2} q. \quad (67)$$

Accordingly, if g be the acceleration due to gravity, σ the density of the fluid, and V the volume elevated by the force of capillarity, we get *Laplace's* equation, founded on the above integral:

$$g \sigma V = \frac{1}{2}H c \cos \varpi. \quad (68)$$

After deriving the above double integral and this formula *Laplace* remarks: »Thus the mass of the fluid elevated above the level by the capillary action is proportional to the circumference of the section of the inner surface of the tube.« That is, the lifting force is proportional to the extent of the glass surface acting on the fluid, — which again very strongly points to wave-action, exerting sensible influence only at insensible distances. The tube of glass is solid and cannot be raised, and the reaction simply sinks the central column of mercury as if repelled by the glass. Hence the marginal depression of the fluid is also accompanied by a lowering of the central column below that in the exterior basin of mercury.

4. From these sketches of the wave fronts taken by liquids of various power of resistance, under wave action from all directions, we perceive that the fundamental facts of capillarity established by observation agree qualitatively with the wave-theory. A better concordance probably could not be expected, and it is difficult to imagine such conformity in theory without a true physical cause underlying the observed laws of nature.

2. Waves from below would act as shown in the central part of figure 13, plate 3. In all cases the level of the mercury is depressed.

(a) On the left, the speeding up of waves leaving the mercury for the air and glass, gives a reaction with negative pressure, $-\rho$, and the mercury is forced back, or lowered around the glass, as if the fluid were repelled by the glass.

(b) On the right, the increased resistance due to the mercury, when the waves emerge from the glass into the air or mercury gives a direct action or positive pressure, forcing the mercury away, the reaction at the corner giving the most decided downward pressure. Thus the level of the fluid is lowered, whether the waves descend or ascend; and, as the waves come from every direction, the apparent repulsion of the mercury from the glass is symmetrical, as found by observation.

3. The change of level in the case of a column of mercury depressed in a tube is due to the above causes also. For when the mercury is acted upon powerfully on all sides, the action conforms to *Laplace's* integral (*Mécanique Céleste*, Liv. X. supplement 2)

Let us now recur to the theory of the rainbow, and note the shortening of the waves within the drop shown in the foregoing figure 4. As the velocity of the aether waves is changed suddenly at the boundary, both on entering and emerging from the drop, the pressure exerted at the boundary is obvious.

(iii) Method of calculating the kinetic pressure when the waves are resisted.

A mass of water m , in which waves are advancing with the velocity v , has the corresponding kinetic energy $\frac{1}{2}mv^2 = E$. After a certain amount of resistance, suppose the velocity of the waves becomes v_1 , then the kinetic energy becomes less, as $v_1 < v$, and we have:

$$E_1 = \frac{1}{2}mv_1^2 \quad (69)$$

Therefore the loss of energy due to retardation of velocity of wave motion becomes:

$$E - E_1 = \frac{1}{2}m(v^2 - v_1^2). \quad (70)$$

Accordingly, since a decrease of depth delays the propagation of sea waves, and constantly reduces the velocity, we infer that so long as the waves of the sea beat upon the shallow shore, there is decrease of energy in the waves. Part of the energy is lost by the dashing of the water against the shore. But any action which delays the speed of the water is equivalent to holding it back; and when the rush of the water is hold back it exerts a steady pressure against the resisting shore.

We take the normals as drawn from every point of the surface, and lay off thereon on the same side of the surface the length h . Let the volume thus arising be denoted by V , and we have

$$V = hS + \frac{1}{2}h^2 \iint (1/R_1 + 1/R_2) dS + \frac{1}{3}h^3 \iint (1/R_1 R_2) dS. \quad (83)$$

But there is another expression for this volume as follows:

$$V = \frac{1}{3}hS + \frac{1}{3}h \iint P (1/R_1 + 1/R_2) dS + \frac{1}{3}h^2 \iint (P/R_1 R_2) dS + \frac{1}{3}h^2 \iint (1/R_1 + 1/R_2) dS + \frac{1}{3}h^3 \iint (1/R_1 R_2) dS + \frac{1}{3}h \int \begin{vmatrix} X & Y & Z \\ x & y & z \\ dx & dy & dz \end{vmatrix} + \frac{1}{6}h^2 \int \begin{vmatrix} X & Y & Z \\ x & y & z \\ dX & dY & dZ \end{vmatrix} \quad (84)$$

In this equation X, Y, Z denote the cosines of the angles which the normals to the surface make with the directions of the coordinate axes, and the quantity

$$P = Xx + Yy + Zz. \quad (85)$$

The double integrals are to be extended over all elements of the surface, while the single integrals are to be extended over all elements of the boundary line.

By comparison of the coefficients of the terms in (83) and (84) multiplied by h and h^2 respectively, we find the equations:

$$2S = \iint P (1/R_1 + 1/R_2) dS + \int \begin{vmatrix} X & Y & Z \\ x & y & z \\ dx & dy & dz \end{vmatrix} \quad (86)$$

$$\iint \left(\frac{1}{R_1} + \frac{1}{R_2} \right) dS = 2 \iint \frac{P dS}{R_1 R_2} + \int \begin{vmatrix} X & Y & Z \\ x & y & z \\ dX & dY & dZ \end{vmatrix} \quad (87)$$

If $1/R_1 + 1/R_2 = 0$, which is the condition that the curvatures on the opposite sides are equal and opposite, equation (86) gives Schwarz's criterion for the area of a minimal surface (p. 178). In less rigorous form this criterion was first indicated by Euler, but Weierstrass and Schwarz have greatly improved the demonstration. Moreover Schwarz has discovered from theory a new surface afterwards verified by experiment, as shown below.

Minimal Surfaces of special physical interest.

1. The sphere,

$$x^2 + y^2 + z^2 = r^2. \quad (88)$$

2. The spheroid,

$$x^2/a^2 + (y^2 + z^2)/[a^2(1 - e^2)] = 1. \quad (89)$$

3. The spherical soap bubble, a film of liquid bounded by two concentric spheres:

$$\begin{aligned} x^2 + y^2 + z^2 &= r^2, \text{ outer surface,} \\ x_1^2 + y_1^2 + z_1^2 &= r_1^2, \text{ inner surface.} \end{aligned} \quad (90)$$

4. Surfaces with equal but opposite curvature at every point,

$$1/R_1 + 1/R_2 = 0. \quad (91)$$

(see figure 14, 15 on plate 3.)

5. Surfaces stretched from fixed frames, and bending under gravity (see figure 16).

6. Schwarz's theoretically predicted surface afterwards experimentally verified.

The accompanying figure 17, from Poincaré's *Capillarité*, Paris, 1895, p. 66, exhibits to the eye the form of one of Prof. Schwarz's helicoidal surfaces, which he was able to realize experimentally.

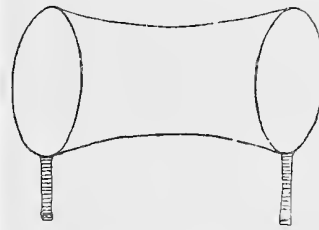


Fig. 16. Illustration of a cylindrical soap film drawn out by separating two wire frames to which the film is attached.

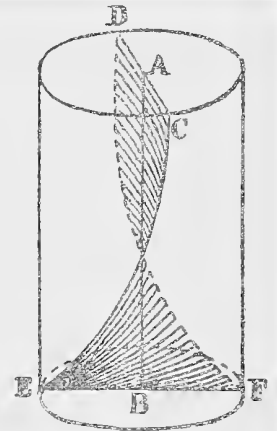


Fig. 17. Poincaré's figure of the helicoidal minimal surface, first theoretically predicted by Prof. Schwarz, and afterwards verified by experiment.

«M. Schwarz a pu réaliser expérimentalement cette surface d'équilibre.»

«Pource la, il tend un fil suivant l'axe AB d'un cylindre de verre au moyen de deux fils métalliques CD et EF s'appuyant sur les bases du cylindre. Ces deux fils étant parallèles, il forme une lame plane s'appuyant sur les trois fils AB, CD, EF . En tournant CD , la lame se déforme et engendre une surface $ECDF$ passant par AB et coupant normalement la surface du cylindre. Cette surface est un hélicoïde.»

«Avec quelques précautions on peut obtenir ainsi une surface à plusieurs spires. Si on supprime le fil vertical AB , l'hélicoïde n'en reste pas moins une surface d'équilibre, mais alors l'équilibre n'est plus stable et il est impossible d'obtenir expérimentalement une surface à plusieurs spires. M. Schwarz a même constaté que si, après avoir formé une telle surface à l'aide du fil central, on coupe ce fil, la lame hélicoïdale disparaît et se transforme en deux lames planes fermant les bases du cylindre de verre.»

(ii) The types of minimal surfaces which would result from waves coming from all directions.

These minimal surfaces obviously would be classed as follows:

1. Sphere surfaces, around liquid drops of any and every description, in accordance with observation, for all natural liquids known in nature, or produced artificially from

solids by the application of high temperatures. The perfect sphericity of figure for the globules implies that the waves come and go in every direction, that the pressure of the entering and the reaction of the departing waves on the average is exactly central.

2. Hollow spherical globules, such as soap bubbles, which have the liquid enclosed between two concentric sphere surfaces. These fluid films are perfectly symmetrical about the centre and tend to become thinner by the external and internal wave pressure at the boundaries. The compression of the liquid layer on the two surfaces of the bubble increases the elastic power of the aether and matter enclosed between the concentric surfaces of fluid, and thereby gives the film a certain tensile strength, as observed in soap bubbles.

3. The next most natural class of minimal surfaces would be those which fulfill the condition $1/R_1 + 1/R_2 = 0$, as first given by *Michael Roberts* (*Liouville's Journal de Math. pur. et app.*, II.300-312). *Roberts'* paper bore the title: Sur les surfaces dont les rayons de courbure sont égaux, mais dirigés en sens opposés. At the time of his investigation no one had the slightest idea why the curvature had to be equal but opposite at every point.

4. Now, under the wave-theory, we see that if waves come from every direction, and therefore also depart in every direction, after traversing the layer of fluid, in the minimal surface, it would be necessary for the curvature to be exactly equal and opposite at every point, — otherwise an unsymmetrical tendency in the liquid film would result, from the direct pressure of the entering and the reaction of the departing waves.

5. This type of minimal surfaces is actually observed, and as the mathematical criteria are rigorously fulfilled, the question arises whether any other cause except wave action could fulfill these geometrical laws of minimal surfaces. We may hold that no cause other than wave action could conform to these rigorous criteria, because of the infinite order of accuracy involved in the theory and found by observation to be fulfilled by liquid films in actual practice.

6. Thus we conclude that under wave action the only two chief types of surfaces which could result are:

(a) Solid spheres or drops of liquid, with the modification (b).

(b) Bubbles, symmetrical about a centre, or other double sheeted films symmetrical about an axis, on which the surface is extended. Symmetry is a fundamental condition of stability, as when a sheet of soap suds is stretched on a plane ring, symmetrical on the two sides.

(c) Minimal surfaces fulfilling the geometrical criterion of equal and opposite curvature at every point, $1/R_1 + 1/R_2 = 0$.

7. A profound argument could be drawn from the theory of probability to the following effect:

(a) The rigorous conformity of the complicated surfaces which would theoretically result from wave action with the surfaces fulfilled by liquids in actual nature, cannot possibly be due to mere coincidence.

(b) In view of the extreme rigor of these geometrical criteria, as applied to actual liquids, the chances against any theory of mere accidental coincidence is more than infinity to one.

8. For the disposition of the molecules in the required films involves the arrangement of an infinite number of these molecules in perfect order, in three dimensions, and thus the observed coincidence of the liquid films with the geometrical minimal surfaces, becomes at least an infinity of the third order (∞^3) to one, that the observed coincidence rests on a true physical cause, which therefore can be nothing but wave-action.

9. The fact mentioned by *Poincaré* (*Capillarité*, p. 66, 1895) that *Schwarz* concluded from geometrical considerations what form a certain helicoidal type of surface should take, and on the basis of this geometrical prediction it was shown by experiment to really exist, is a very remarkable example of the laws of geometry being used to fulfill the process of physical discovery. It is only established laws, founded on the true order of nature, which may thus be used to guide the explorer of the physical universe.

10. There are many examples of theoretical discovery handed down in the history of science. In all the celebrated cases they rest on the mathematical application of true laws of nature. *Laplace*, who used this method to discover the cause of the great inequality in the mean motion of Jupiter and Saturn, 1785, regarded the confirmation of mathematical theory by observation as the sublimest of triumphs. Similar views have been held by the successors of the illustrious author of the *Mécanique Céleste*, as in the theoretical discovery of Neptune by *Adams* and *Leverrier*, 1846, and of external conical refraction by Sir *W. R. Hamilton*, 1833.

(iii) The concluded cause of the minimal surfaces observed in nature.

From the above discussion of the minimal surfaces found in nature we conclude that the observed surfaces all fulfill rigorous and very remarkable mathematical criteria. They present either the minimal closed surface for a given volume, as in the globules of rain, dew, quicksilver, and other fluids which confront us on all sides; or an unclosed surface of double but opposite curvature fulfilling the geometrical condition $1/R_1 + 1/R_2 = 0$.

It is easy to show that if the minimal surface be closed, — like that of a globule of dew, with a single spherical surface, or the soap bubble, with two concentric spherical surfaces, — the action of waves from all directions will generate actions and reactions at the boundaries which will physically round up the figure of the fluid, and render the surfaces true minimal surfaces.

Of all the possible forms which mass of fluid may take, the sphere has minimal surface for given volume, or maximum volume for given surface. It is not by accident that in all liquid drops nature presents us with a never-failing recurrence of this beautiful and wonderful symmetry of figure. Accordingly we naturally conclude that the observed law can rest on no cause other than wave-action.

For the chances are infinity to one that an infinite multitude of drops of one fluid would not attain this figure except by the steady action of a true physical cause. And as the same law holds for an unlimited series of natural liquids the chances that a true cause is at work are again indefinitely increased. Finally, as the globular form for liquid drops is observed to hold for every solid rock, metal, and other solid compound of the crust of the globe, when rendered

molten, by an infinite series of changing temperatures, and pressures, we see another independent infinite probability that the assumption of the globular figure depends on a true physical cause, which can be nothing but wave-action.

Accordingly the compound probability of all these several events, everywhere recurring constantly, is not less than the maximum infinity of the third order, equivalent to all the points in space to one, namely:

$$P = \int_0^{\infty} \int_0^{\infty} \int_0^{\infty} dx dy dz = \infty^3. \quad (92)$$

We therefore dismiss the subject, and consider the cause of the globular figure proved incontestably by the most varied phenomena of nature.

When we come to the minimal surfaces of equal but opposite curvature, $1/R_1 + 1/R_2 = 0$, we see that the problem is physically less simple, yet the cause involved is of the same general type, because the surface is kept taught by stretching, just like the rubber layer of a toy balloon. As the surface tends incessantly to contract, it follows that it must be acted upon by forces tending to make its extent a minimum, as in the case of globules of liquid under the surface tension due to wave-action.

Thus as the tension, in the surfaces fulfilling the geometrical condition $1/R_1 + 1/R_2 = 0$, is similar to that in liquid globules, it follows that in this case also the effect is due to wave-action.

Moreover, the waves come equally from all directions, and thus the opposite curvatures of the surfaces necessarily are equal. Any lack of perfect symmetry, in the distribution of the wave-action from the opposite directions would render the surfaces unsymmetrical; so that they would not fulfill the required *Euler-Weierstrass-Schwarz* geometrical condition. The fact that *Schwarz* could predict a theoretical form of minimal surface, which was subsequently verified by experiment renders these laws capable of use in discovery.

The wave-theory of physical forces thus approaches the degree of accuracy characteristic of the theory of gravitation, in the celebrated case of the planet Neptune, discovered by *Adams* and *Leverrier*, 1846; or the dependability of the wave-theory of light, which enabled Sir *W. R. Hamilton* to predict the external conical refraction, observed by *Lloyd* for crystals of arragonite, 1833.

After careful consideration of these recondite researches of *Schwarz* on minimal surfaces, which we have now applied to the wave-actions incessantly going on in nature, we are of the opinion that few more useful results have been obtained since the foundation of modern mathematico-physical science; and thus in view of their usefulness these researches on minimal surfaces deserve to rank with the most celebrated discoveries in astronomy and natural philosophy.

¹) It will be noticed that in *Quincke's* table the surface tension T is quite large for mercury: 540 in air, 418 in water. Thus in air mercury has a surface tension which is nearly 7 times that of water. Considering the high reflecting power of mercury and its great resistance to an electric current, which is simply ordered wave motion, such a result was to be expected, and in fact strikingly confirms the wave-theory.

This result also conforms to *Majorana's* celebrated experiments at Turin, as communicated to the Acc. dei Lincei, Rome, 1919, in which it is shown that gravitational waves are sensibly intercepted by a layer of mercury placed symmetrically about a weight in one arm of a delicate balance. The present results for molecular forces, as well as *Majorana's* experiments of 1919, thus confirm the writer's discovery of 1916, that the fluctuations of the moon's mean motion are due to the interposition of the solid body of the earth in the path of the sun's gravitative action, near the time of lunar eclipses. (cf. *Elect. Wave-Theory of Phys. Forc.*, vol. 1, 1917). (Continuation see p. 323.)

9. Historical Survey of the Researches of Geometers on the Cause of Capillarity.

(i) References to the older scientific literature of capillarity, 1500-1804, A. D.

The literature of this subject is so extensive that a brief descriptive summary alone will enable the reader to appreciate the successive steps in our progress.

In an extensive examination of the history of the subject, quoted by *Maxwell*, *Poggendorff* held that *Leonardo da Vinci* (1452-1519) must be considered the discoverer of capillary phenomena. But the scientific observations on capillarity practically have all been made since the age of *Newton*, and begin with *Hawksbee*.

1. *Hawksbee*, *Physico-mechanical Experiments*, London, 1709, pp. 139-169: also *Phil. Trans.*, R. Soc., 1709-13.

(a) *Hawksbee* ascribed capillarity to an attraction between water and the glass tubes or plate; and observed that the effect is the same whether the tubes be thick or thin, and thus held that only those particles of glass which are very near the surface have any sensible influence on the phenomenon. This early observation of *Hawksbee* thus laid the foundation of the celebrated hypothesis afterwards developed by *Laplace* that molecular forces are sensible only at insensible distances.

(b) Dr. *Furin*, in the *Phil. Trans.*, 1718, no. 355, p. 739, and 1719, no. 363, p. 1083, extended the observations on capillarity, and discovered the law that the height to which the same liquid, such as water, rises in tubes is inversely proportional to their radii. This is easily verified by the curve taken by the surface of water between two vertical panes of glass, set mutually inclined at a small angle, which is a rectangular hyperbola referred to its asymptotes, as shown on the left of the foregoing figure 9.

(c) We may calculate the capillary elevation by *Furin's* method as follows. Let r denote the radius of the tube, ρ the density of the liquid, α the angle of contact reckoned from the downward vertical, T the tension of the surface film, and h the mean height to which the fluid is elevated.

Then the vertical component of the whole tension round the edge of the film obviously balances the weight of the liquid column, and we have the equation

$$\pi r^2 h \rho g = 2\pi r T \cos \alpha. \quad (93)$$

This gives for the mean height h and surface tension T

$$h = 2T \cos \alpha / r \rho g \quad (94)$$

$$T = h r \rho g / 2 \cos \alpha. \quad (95)$$

In the case of water the density $\rho = 1$, while the angle $\alpha = 0^\circ$, $\cos \alpha = 1$, and by observing h , and r we may calculate T directly.

In the 5th edition of the *Properties of Matter*, 1907, p. 265, Professors *Tait* and *Peddie* give the following table ¹)

of T from observations by Professor *Quincke*:

	Air	Water	Mercury
Water	81	—	418
Mercury	540	418	—
Alcohol	25.5	—	399

The unit here employed is one dyne per (linear) centimetre. More elaborate tables of *Quincke's* data will be found in *Maxwell's* celebrated article Capillary Action, *Scient. Pap.*, vol. 2. p. 589.

2. *Clairault*, *Théorie de la Figure de la Terre*, Paris, 1743.

(a) *Clairault* was the first to attempt to reduce capillarity to the laws of the equilibrium of fluids, by an exact analysis of the forces concurring to elevate the liquid in a glass tube. He explained the elevation as the result of two forces, one due to the attraction of the meniscus of the liquid, and the other due to the direct attraction of the tube itself on the molecules of the liquid.

(b) But *Clairault* erred in regarding the attraction of the tube as the principle force — imagining its power to extend as far as the central axis — which is contrary to the careful researches of *Laplace*, who subsequently showed, (1806–1807), that molecular forces are to be sharply distinguished from long range forces, such as gravity and magnetism, because observations prove that these molecular forces are sensible only at insensible distances.

Laplace's theory thus becomes a strong argument for the wave-theory, because of the minute range of action of the molecular forces, but as the undulatory theory of light was rejected by *Laplace*, he naturally did not suspect that waves could underlie the action of molecular forces.

(c) Owing to these defective hypotheses, *Clairault* failed to demonstrate from his theory that the ascent of the liquid should be inversely proportional to the diameter of the tube — as noted by observers since the time of *Furin*, 1718. And although *Clairault* arrived at a number of hypotheses, which would account for the observed elevation of the fluid, none were based on molecular forces sensible only at insensible distances, and thus it subsequently required all the mathematical ingenuity of *Laplace* to deduce from *Clairault's* theory an explanation of the elevation in tubes.

(d) *Clairault*, however, showed that if the attraction of the matter of the tube differs only by its intensity or coefficient, from that of the fluid on itself, then the fluid will rise above the surrounding level when the action of the tube exceeds half that of the fluid on itself — a remarkable theorem afterwards more fully developed by *Laplace* in his theory of capillary action.

3. *Segner*, *Comment. Soc. Reg. Götting. I.*, 1751, p. 301.

(a) Eight years after the publication of *Clairault's* *Theory of the Figure of the Earth*, 1743, containing the outline of his theory of capillarity above described, there appeared in the commentaries of the Royal Society of Göttingen an important work by *Segner*, who introduced the

useful and suggestive conception of the surface tension of liquids. He ascribed this surface tension to attractive forces, the sphere of whose action is taken to be so small as heretofore not to be perceived by the senses.

(b) *Segner* thus laid the foundation of the theory of surface tension, produced by attractive forces sensible only at insensible distances, — as in the theory of *Laplace*; and he used this new theory of surface tension to calculate the curvature of a meridional section of a drop of liquid, but did not investigate the curvature in a plane at right angles to the meridian. It is probable that *Segner* regarded the tense membrane of the surface of the liquid as stretched equally in all directions, unless the contrary was shown by the curvature of the surface observed.

(c) *Segner's* theory found confirmation in observations of *Leidenfrost* of Duisburg, 1756, on the contraction of soap bubbles, in which it was shown that the air in the bubble is expelled by the contraction of the membrane of the soap bubble. In the *Mém. de l'Acad. d. Sc.*, 1787, p. 506, *Monge* adapts the view that the adherence of the particles of fluid in capillarity have influence only at the surface itself and in the direction of the surface which thus follows *Segner's* theory of surface tension. *Monge* applied the theory of surface tension to explain the apparent attractions and repulsions between bodies floating on a liquid.

4. *Young's* theory of capillarity, 1804, founded on the action of surface tension like that of *Segner*, 1751.

In his essay on the Cohesion of Fluids, (*Phil. Trans.* 1805, p. 65) Dr. *Thomas Young* developed a theory of capillarity as *Segner* had done half a century before, founded on the principle of surface tension. He observed the constancy of the angle of contact of the liquid surface with the solid, and showed how the constancy of the angle and the tension of the surface enable the fluid to exhibit capillary phenomena. Whilst the theory of *Young* involves both cohesion and surface tension for explaining capillarity, it avoids as far as possible the use of mathematical symbols, yet it is held by *Maxwell* to be essentially correct.

(ii) The more recent researches on capillarity by *Laplace*, *Poisson*, *Gauss*, *Quincke*, *Maxwell*, *Kelvin*.

5. *Laplace*, *Memoir on capillary attraction*, Supplement to the tenth book of the *Mécanique Céleste*, 1806, and Supplement to the theory of capillary attraction, 1807.

The theory of *Laplace* is so well known, and so much used by all students of the subject that we shall not here go into it in detail, except to note certain difficulties to which attention should be called. In his *Capillarité*, Paris, 1805, p. 1–3, *Poincaré* condenses *Laplace's* theory into a few leading formulae, by taking the attraction to have the general form

$$A = m m' f(r) = \partial V / \partial r \quad (96)$$

where m and m' are the masses of the molecules, r their distance apart, and $f(r)$ an unknown function of the distance.

The wave-theory therefore is strikingly confirmed both by a large body of well established terrestrial phenomena, and by the discovery of the cause of the fluctuations of the moon's mean motion.

After mathematical researches extending over more than 40 years, *Newcomb*, in 1909, pronounced these lunar fluctuations to be the most enigmatical phenomena presented by the celestial motions; so that the discovery of the cause underlying these perplexing perturbations in the moon's mean longitude is a notable triumph in celestial mechanics.

Laplace's celebrated hypothesis that the capillary forces are sensible only at insensible distances, leads to the formula for zero forces at all distances greater than r :

$$\varphi(r) = \int_r^{\infty} f(r) dr = 0 \quad (97)$$

where r is the radius of molecular activity, shown by experiment of *Quincke*, 1869, to be $r < 50 \mu\mu$, 50 millionths of a millimetre.

In consequence of the first hypothesis in equation (96) the molecular forces admit of a potential

$$V = \sum_{r=0}^{r=r} m \varphi(r) \quad (98)$$

with the components for unit mass at x, y, z under the action of the mass m :

$$X = \partial V / \partial x, \quad Y = \partial V / \partial y, \quad Z = \partial V / \partial z. \quad (99)$$

If the whole of the attracting molecules form a volume, the expression of the potential becomes, for the density ρ :

$$V = \iiint \rho \varphi(r) dx dy dz. \quad (100)$$

Owing to the high incompressibility of liquids, *Laplace* adopts in effect the hypothesis that the density ρ is constant. In his *Nouvelle Théorie de l'Action Capillaire*, 1831, *Poisson* rejects *Laplace's* hypothesis; likewise *Poincaré* remarks that *Laplace's* assumption is illegitimate, because it is probable that the density is not the same at a distance less than the radius of molecular activity from the surface as at a distance greater than this radius.

But whatever be the exactitude of *Laplace's* hypothesis, it leads to the expression for the potential

$$V = \rho \iiint \varphi(r) dx dy dz. \quad (101)$$

And if $\rho = 1$ in the liquid considered

$$V = \iiint \varphi(r) dx dy dz. \quad (102)$$

The only other point in this theory to which we shall call special attention relates to *Laplace's* K , (*Méc. Cél.*, Liv. X, Suppl. à la *Théorie de l'Action Capillaire*), which implies that in every liquid there is a great internal pressure. Near the end of this supplement *Laplace* derives the formulæ for this internal pressure,

$$n^2 - 1 = 4K / V^2 \quad (103)$$

$$s = K/g = (n^2 - 1) V^2 / 4g \quad (104)$$

where $V =$ velocity of light, $n^2 - 1 = 7/9$, the refractive action, and $g =$ acceleration of gravity, $s =$ length of the column of water of equal pressure, in units of the sun's distance. This gives $s = 12000$, approximately, or a column of water over 10000 times longer than the distance from the earth to the sun. *Laplace* himself adds that »une aussi prodigieuse valeur ne peut pas être admise avec vraisemblance«, so that he apparently did not regard the value of $K = gs$ as probable. Accordingly it will not surprise us to find modern physicists rejecting it. In his *Properties of Matter*, 1899, p. 244, *Tait* says:

»In some statical theories of molecular action, especially that of *Laplace*, one of the most striking deductions is that there must be a very great internal pressure in every liquid mass: — a pressure wholly independent of the form and size

of the bounding surface. This is usually known as, *Laplace's* K . *Laplace's* own estimate of its value in water is given (with the caution, 'Une aussi prodigieuse valeur ne peut pas être admise avec vraisemblance') as the weight of the water which would fill a tube of unit section whose length is 10000 times the distance of the earth from the sun: i. e. something like 10^{12} tons weight per square inch. This was based on the corpuscular theory of light, the numerical data being the refractive index of water and the speed of light.«

It would be easy to show from practical experience, — as in human diving, and from the survival of fresh water and marine life, in such delicate animals as fish, which have bladders filled with air, etc., — that the view of an enormous internal pressure for water is not valid. If these views were true we could not dive without having our lungs crushed, and the bladders of the fish could not operate as they actually do; for the fish not merely survive, but are not injured when taken from the water a short time.

Laplace's final expression for the pressure in the interior of a fluid has the form

$$p = K + \frac{1}{2} H (1/R_1 + 1/R_2). \quad (105)$$

Here K is the assumed constant pressure, in that theory very large, which however does not influence observed capillary phenomena, H is another constant on which all capillary phenomena depend, and R_1 and R_2 are the radii of curvature of any two normal sections of the surface at right angles to each other.

If in the above formula we put $1/R_1 + 1/R_2 = 0$ in the second term of the right member, as in minimal surfaces, we see that within such films the pressure p would be equal to K only, which shows the connection between such films as soap bubbles, with double surface tension, and capillarity.

6. *Gauss*, *Principia generalia theoriae figurae fluidorum statu aequilibræ*, 1830, (*Werke*, V. p. 29).

Gauss forms the force-function for the potentials of all the pairs of particles in their mutual action. With the sign reversed he thus obtains the potential energy of the system. *Gauss* treats the problem of the forces urging the fluid with his usual lucidity, in three parts: the first depending on gravity; the second, on the mutual attraction between the particles of the fluid; and the third, on the action between the particles of the fluid and the particles of the solid or fluid in contact with it.

Gauss makes this aggregate expression a minimum:

$$\Omega = -gc \int z ds + \frac{1}{2} cc \iint ds ds' \varphi(ds \cdot ds') + cC \iint ds dS \Phi(ds dS). \quad (106)$$

In this formula $g =$ the force of gravity, $z =$ elevation above the base plane H , $c =$ density, taken as uniform in the spaces s and s' , $C =$ density of the solid, or fluid of different kind; and the spaces s and s' are filled by the mobile fluid, and S by the solid or fluid of different kind. With this explanation of *Gauss's* fundamental equation, made up of three terms, it only remains to add that the potential so constituted is a minimum, and therefore for such a level surface, the sum of the space differentials vanishes:

$$\delta\Omega = (\partial\Omega/\partial x) dx + (\partial\Omega/\partial y) dy + (\partial\Omega/\partial z) dz = 0. \quad (107)$$

In deriving more general conditions for the free surface than *Laplace* had done, *Gauss* thus improved the theory. At the close of his paper he recommends the method of *Segner* and *Gay-Lussac*, which *Quincke* has since extensively applied, by measuring the dimensions of large drops of mercury on a horizontal plane, and those of large bubbles of air or other gases, in transparent liquids resting against the under side of a horizontal plate of a substance wetted by the liquid.

7. *Poisson's* Nouvelle théorie de l'action capillaire, Paris, 1831, pp. 1-300.

Poisson's new theory of capillary action is developed with such geometrical elegance, that it must always occupy a prominent place in any survey of the subject. But it is justly remarked that although *Poisson* adopts processes different from those employed by *Laplace*, yet in general the conclusions are identical, except in respect to uniformity of the internal density of the liquid, explained in equations (100) and (101) above. At the close of paragraph 5 above we have indicated reasons for adopting *Laplace's* view that ρ may be taken from under the integral signs in equation (100). *Gauss's* procedure accords with this view also, as we see by his principal equation for Ω above.

Poisson's criticism that *Laplace's* theory makes the constant pressure K very large, whereas it must be in fact very small, is undoubtedly valid, from considerations already pointed out in treating of *Laplace's* theory. Thus *Poisson* reached results in general accord with those of *Laplace*, but did not confirm the great constant pressure K in liquids, and added the claim of a rapid variation of density near the surface, which does not admit of experimental determination.

The theory developed in the present paper, that the wave stress undergoes sudden change at the surface of liquids appears to reconcile these several difficulties; for whilst it assigns to this surface tension the globular form of drops, and the elasticity of the film of soap bubbles, it does not give a great internal pressure for liquids, but only the somewhat feeble surface stress noticed in oscillating drops and elastic films.

In dealing with the *Segner-Young* contribution to the theory of capillarity, 1751-1804, we noted the fact that they successfully explained capillarity by surface tension, and thus it is appropriate for us to draw attention to the rather feeble intensity of the surface tension of various liquids, as determined by *Quincke*, and given briefly in the above table.

For water in air, the surface tension, $T = 81$, by the formula

$$T = hrg\cos\alpha \quad (95)$$

Here α is the angle of contact reckoned from the downward vertical. For water in contact with glass, $\cos\alpha = 1$, and T is found from the radius of the tube r , and observed height of column h . For mercury in air the value of $T = 540$, but in this case $\alpha = 128^\circ 52'$, so that the cosine is negative and the column depressed.

The dyne is the force producing an acceleration of one centimetre per second in a gram mass, and in view of the feebleness of these forces of surface tension, we see why we cannot explain capillarity by such a feeble force, and at the same time admit the enormous constant fluid pressure found by *Laplace's* theory.

8. *Maxwell's* article on capillary action, *Encycl. Brit.* 9th ed., 1875.

In concluding this section it only remains to point out the last great contribution to the whole theory of capillarity, in recent times, the article on capillary action by *Maxwell*, *Encycl. Brit.*, 9th ed., reprinted in *Maxwell's* Scientific Papers, vol. II, pp. 541-591. Though written about half a century ago, it is still the most extensive and accurate survey of the subject yet available. On page 589 he gives a table of *Quincke's* experimental results much more elaborate than that quoted above.

The more recent contributions by Lord *Kelvin*, Lord *Rayleigh*, and other investigators, have added to the extensive literature already cited; but *Quincke's* researches will long remain the chief source of experimental data.

10. New Theory of Cohesion and Adhesion.

(i) Refraction and dispersion of waves at the surface of solids, may produce hardness.

Up to this point we have treated with special attention the cause underlying surface tension and capillarity, because we have felt that if these causes could be definitely assigned, it would not be very difficult to pass over to the related cause of cohesion and adhesion.

In fact adhesion is directly related to capillarity, for when liquids rise in tubes the fluid always wets the tube, so as to adhere to it, and lift the column upward by the force of surface tension. And when the liquid does not rise, but is depressed in the tubes, as in the case of mercury, there is no adhesion, but rather repulsion, or as is commonly said, a greater attraction of the liquid for itself than for the solid. Thus the molecular forces in adhesion are the same as in capillarity; and cohesion is similar to the attraction of liquid particles for one another, except that the cohesive force depends greatly on temperature, and thus becomes much more powerful in solids.

Two centuries ago, in the 3rd edition of the *Optics*, 1721, p. 365, *Newton* discussed the mystery of the molecular forces as follows:

»And how such very hard particles (in solids) which are only laid together and touch only in a few points, can stick together, and that so firmly as they do, without the assistance of something which causes them to be attracted or pressed towards one another, is very difficult to conceive.«

Accordingly, it appears that *Newton* was very much baffled in his efforts to conceive of the cause which underlies cohesion and adhesion, more especially in solids. The difficulty in liquids was no doubt almost equally great, but our treatment of it is already outlined, and we shall therefore deal chiefly with cohesion and adhesion as exhibited by solids.

In the wave-theory we hold that no refraction of the wave front can occur without the expenditure of energy, drawn from the general reservoir of the aether; therefore as waves move more slowly in solids than in free space, there necessarily is wave energy exerted against the solid owing to derangement of the wave front at the boundaries of such masses.

Moreover, the refraction of waves usually is associated with dispersion, or separation of waves, owing to the unequal

refraction. Both of these changes in the wave field involve work done at the boundaries of solid bodies, and the result is wave stresses and reactions which give rise to cohesion¹⁾ and adhesion.

The full development of this theory of cohesion and adhesion involves the complicated problem of wave transformation and separation in a medium 689321600000 times more elastic than air in proportion to its density. This problem is new in science, and as it has not yet been treated exhaustively, we first outline the physical considerations which must be borne in mind.

1. When a ray of light enters a drop of water, with refractive index $n = \frac{4}{3}$, the so-called refractive action is $n^2 - 1 = \frac{7}{9}$. The wave velocity is diminished or accelerated at the boundary by $\frac{1}{3}$; and $\frac{7}{9}$ of the energy is exerted against the surface layer of the drop. This slowing down of the wave speed or its acceleration thus exerts a pressure against the boundary of the drop; for long ago *Maxwell* recognized, (*Treatise on Electricity and Magnetism*, §§ 781-793) that partial stopping of wave motion leads to the exertion of pressure on the surface obstructing the progress of the waves. If waves leave the drop for free space, there is corresponding reaction of the free aether at the boundary, and thus a similar development of central pressure.

2. Moreover, it is evident that in proportion as these wave actions and reactions are sudden and violent at the boundary of a body, so that the refractive action $n^2 - 1$ is large, in the same proportion the related dispersive action also is large. Accordingly, as diamond has the greatest of known refractive indices, $n = 2.49$, and is so powerful in the dispersion of colors as to yield the unapproached lustre which gives the great value to this crystal, it ought theoretically to be the hardest of bodies, and is so found by experiment.

In his »Six Lectures on Light«, second edition, New York, 1886, p. 20, *Tyndall* lucidly explains total reflection, the limiting angle for which in water is $48^\circ 30'$; for flint-glass $38^\circ 41'$; for diamond $23^\circ 41'$; thus rapidly diminishing with increase of the refractive index.

»Thus all the light incident from two complete quadrants, or 180° , in the case of diamond, is condensed into an angular space of $47^\circ 22'$ (twice $23^\circ 41'$) by refraction. Coupled with its great refraction are the great dispersive and great reflective

$$\Omega = \int_0^{\sigma/\lambda} \int_0^\beta \int_0^\delta \int_0^\alpha \int_0^\rho \int_0^\epsilon e^{-\alpha\omega} \epsilon (n^2 - 1) \pi(\sigma/\lambda) \varphi(\beta) \psi(\delta) \chi(x) \theta(\rho e^{-\alpha}) \varpi(\omega) \cdot d(\sigma/\lambda) d\beta d\delta dx d(\rho e^{-\alpha}) d\omega \quad (108)$$

¹⁾ In his »Aether of Space, 1909«, p. 109, Sir *Oliver Lodge* treats of cohesion in a very similar way to that here adopted:

»Why the whole of a rod should follow, when one end is pulled, is a matter requiring explanation; and the only explanation that can be given involves, in some form or other, a continuous medium connecting the discrete and separated particles or atoms of matter.«

»When a steel spring is bent or distorted, what is it that is really strained? Not the atoms — the atoms are only displaced; it is the connecting links that are strained — the connecting medium — the aether. Distortion of a spring is really distortion of the aether. All stresses exist in the aether. Matter can only be moved. Contact does not exist between the atoms of matter as we know them; it is doubtful if a piece of matter ever touches another piece, any more than a comet touches the sun when it appears to rebound from it; but the atoms are connected, as the comet and the sun are connected, by a continuous plenum without break or discontinuity of any kind. Matter acts on matter only through the aether.«

²⁾ Should the other variable elements indicated below increase in about the same proportion as the two well known elements here calculated, the result would be an increase of stress of the order of 8000000 times the value otherwise effective. And as there are sudden discontinuities in the physical state of bodies, as in passing from fluid to solid, owing no doubt to closeness of contact of the molecules of the solid, — assumed to be less than the wave-lengths to which the forces are due — the whole wave-action in the aether seems ample to account for the hardness of the diamond.

powers of diamond; hence the extraordinary radiance of the gem, both as regards white light and prismatic light.«

Tyndall's remark that all the light incident from two complete quadrants, or 180° , in the case of the diamond, is condensed by refraction to an angular space of $47^\circ 22'$, $47^\circ 37'/180^\circ = 1/3.8$, contains the germ of the secret of the most powerful molecular forces, such as those which produce hardness. For just as the rays in a plane angle are thus condensed, so the rays from the solid angle of a whole hemisphere are condensed into $1/3.8$ of their original distribution; so that on any area the concentration of energy increases as the square of 3.8 and becomes 14.44 times greater. As the dispersion is in about the same proportion, the combined effect of refraction and dispersion is magnified some 200 times.²⁾ Considering the tendency to rupture the aether by this sudden discontinuity at the boundary of the diamond, it is not remarkable that the actions and reactions of the more powerful invisible waves give the cohesion underlying the hardness of diamond. It is evident that the hardness of diamond and other crystals, the great tenacity of steel and other wires, depend on wave-action and -reaction at the surface; and therefore the strength of such a solid depends on some such combination as the following:

1. Refractive action, $(n^2 - 1)$, which depends on the density of the solid, σ , and the changing wave-length λ and thus on some unknown function, $\pi(\sigma/\lambda)$;
2. The violence of the incessant bending of the wave-front, for waves coming from all directions, $\varphi(\beta)$;
3. The violence of the incessant dispersion of these incident waves, $\psi(\delta)$;
4. The combination of systematic stresses due to the crystalline arrangement of the atomic planes with the effects of the two latter violent tendencies, thus leading almost to the disruption of the medium, $\chi(x)$;
5. The enormous power of reflection with very slight absorption of energy, at the surface, $\theta(\rho \cdot e^{-\alpha})$;
6. The great central pressure due to the integration of the steady action of the sheath of partially disrupted waves always enveloping the solid, $\varpi(\omega)$.

Accordingly if the condition be imposed that the normal elastic power of the aether is not greater than unity, which is $\epsilon = 689321600000$ times that of our air in proportion to its density, then we shall have (cf. *Todhunter's* Integral Calculus, edition 1910, § 277, p. 262):

But although the nature of the wave function producing solidity and rigidity is thus recognized, yet we cannot at present evaluate the resulting sextuple integral, because the part contributed by each variable is ill defined.

(ii) The assigned cause of the hardness in diamond suggests a similar origin of tenacity.

The theory of the hardness of diamond here outlined will also explain tenacity, or the great breaking strength of such substances as steel¹), which attains maximum power in pianoforte wire.

1. It is a remarkable fact of observation, drawn from experience from the early ages of history, that tenacity is increased through drawing and rolling, by which the metal is given a smoother and more compressed surface. For example, we make strong wire ropes by first drawing the metal into fine wire, each strand being given a compact and compressed surface large compared to the cylindrical content of the solid wire, and then twisting the wire into a rope, which thus becomes not only strong, but also flexible.

2. The fact that in fine wire there is rapid increase of surface compared to the cylindrical content, when the wire is small, shows that the large amount of smooth surface is the essential element of strength, and points to waves in the aether as giving the force of cohesion. The relation of surface to volume in a circular cylinder of length h and radius r is easily found, thus:

$$\begin{array}{l} \text{Volume of cylinder} \quad V = \pi r^2 h \\ \text{Curved surface of cylinder} \quad S = 2\pi r h \end{array} \quad (109)$$

$$\text{Ratio of} \quad S/V = 2\pi r/\pi r^2 = \alpha/r = \eta. \quad (110)$$

Accordingly, as r diminishes the ratio η rapidly increases, according to the curve for a rectangular hyperbola referred to its asymptotes.

3. On account of the finite dimensions of the molecules of the wire, and the finite but greater length of the light waves, it is of course not possible to decrease the radius of the wire below a certain limit, without the metal losing the power of cohesion and breaking. Along with this property, by which a finite radius is required for strength in a metal, goes also the closely related problems of malleability and ductility.

(a) Gold is the most malleable of metals, gold leaf having been reduced to a thickness of $1/300000^{\text{th}}$ of an inch, or $1/11800$ of a millimetre.

(b) Platinum is the most ductile of metals. By coating a platinum wire 0.01 inch in diameter with silver till the thickness of the whole was 0.2 inch, Dr. *Wallaston* drew the cylinder out into a wire as fine as possible, and by boiling with dilute nitric acid, he removed the silver coating and obtained the platinum wire alone with a diameter of approximately $1/10000$ mm nearly the same thickness as the thin gold leaf described in (a) above.

4. The metallic coating used to draw the platinum wire into such fineness was of silver, which is the most perfect of all electrical conductors, and thus the wave-action was

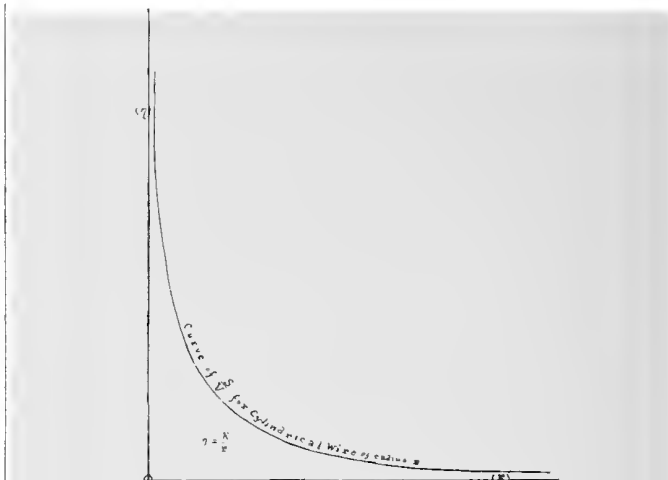


Fig. 18. Curve of the ratio of the surface to volume, in a drawn cylindrical wire of radius r . As it is an observed fact that the strength of a given mass of metal is increased by drawing it into wire, this curve shows that tenacity depends on the relative increase of surface compared to volume, and therefore on wave-action at the surface of the wire. Increase of tenacity, with $\eta = S/V$, equ. (110), begins to fail as short wave-lengths and molecular dimensions are approached.

no doubt very perfectly equilibrated at all times in Dr. *Wallaston's* ductility experiment. As the gold leaf was in similar sheets while being hammered the conditions also were favorable for malleability, without disruption of the molecular forces holding the gold leaf together.

Notwithstanding these favorable conditions it is a little remarkable that gold and platinum, with their very high atomic weights, should prove among the most continuously yielding of metals. This gradual yielding of metals is directly opposed to hardness, which leads to rupture.

Glass threads drawn by Dr. *Boys* have been reduced to a diameter of about $1 : 100000$ of an inch, or three times that of the diameter of the minimum platinum wire above mentioned, with strength however approaching that of steel wire, which shows that surface wave-action probably has increased the strength greatly.

5. It is noticed in modern metallurgy that the pure metals generally are softer than their alloys. Both hardening and increase of strength may be effected, however, by the admixture of a small percentage of certain other metals. Nickel and vanadium are used in the manufacture of hard steel: and such compounds as phosphor bronze, and aluminium bronze, have greatly increased tenacity. We may explain all these effects by the wave-theory, the molecular forces being augmented not merely at the boundary, but throughout the mass. This same reasoning applies also to the internal strength and structure of crystals, such as diamond, quartz and other substances.

¹) Steel is a mechanical mixture of a very fine matrix of carbon in iron, and as diamond is crystallized pure carbon, it would seem that the great strength of steel, over iron, must depend in some way on such wave-transformations as refraction, dispersion, etc., to which the non-conducting carbon contributes at the boundary of the wire. It surely is not accidental that the strength of steel depends on the same element, carbon, which in crystallized form gives diamond its unparalleled hardness.

6. The metals increase in hardness somewhat in the following order: lead, tin, aluminium, gold, silver, platinum, zinc, copper, iron, steel. These results may be explained by the assumption of molecular properties varying from metal to metal, but on the whole depending on the grip of the waves about the atoms and molecules, under their state of condensation, and electrical conductivity or non-conductivity. Lead, for example, is loosely held together, and yields easily to powerful forces. It somewhat resembles pitch, which is a viscous fluid, or solid for quick acting forces, while the lead is an easily yielding solid.

In the same way hardness is measured by the following scale.

- | | |
|--------------|--------------|
| 1. Talc | 6. Feldspar |
| 2. Rock Salt | 7. Quartz |
| 3. Calc Spar | 8. Topaz |
| 4. Fluorspar | 9. Corundum |
| 5. Apatite | 10. Diamond. |

(iii) *Newton's* problem of cohesion may be solved by noticing that waves which have difficulty in passing through between two compact masses will naturally take the path of Least Action around them, and thus force them together.

1. So long as two bodies are not near together the waves from the atoms of each mass, as well as from the rest of the universe, will easily pass between and around the two masses. Each mass will have its own wave field, and they will not sensibly interfere. But when the two bodies are brought very near together, each obstructs the waves from the other, and the wave fields become entangled. When they are brought very near, so as to form a smooth contact, the whole wave action is so much less, when they are pressed tightly together, that nature adopts this method for Least Action, and forces them as solidly together as possible. This gives us a general idea of the cause of cohesion, which so much puzzled *Newton* that he had extreme difficulty in conceiving the cause at work.

2. In order to make the contact effective and powerful, it must be very close indeed, so that the molecules are not whole wave-lengths apart. The fact that observation shows that the contact must be close, appears to point directly to the wave-theory. What explanation other than the wave-theory is possible? The problem is like the hypothesis underlying *Laplace's* theory of capillarity, that the molecular forces become sensible only at insensible distances, which as we have shown, can point to nothing but wave-action.

3. The measurements of *Rücker* show that the ultra-violet waves are of the required order of magnitude, and we know that their working at small distances, in a medium 689321600000 times more elastic than air in proportion to its density, should produce very great power of attraction, since the path of Least Action usually is around the outside of solid masses, and thus they are forced together by reaction of the whole wave field.

This gives us a very tangible conception of the practical working of the wave-theory when applied to molecular forces. We may verify the conclusion here drawn by observations on the dashing of water waves upon two floats anchored so close together that the waves do not pass freely between

them. The result is a full pressure of the waves without, not perfectly balanced by the diminished pressure within, so that the floats are drawn together as if by an attractive force.

4. Now it is very remarkable that nature should be filled with such a multitude of minimal surfaces: raindrops, drops of dew, globules of mercury, iodine, or any chemical liquid which does not adhere to the supporting surface. All melted metals, such as leaden shot, take the same figure, and so also of molten rock of any and every description. Accordingly, globules of liquid, with minimal surfaces, actually are universal in nature. What is the cause of this universal tendency to minimal surfaces? It must be related to the coalescence of contiguous small drops into larger ones, as in the phenomena of rain, accompanied by lightning.

5. It has long been held, first by *Mauvertuis*, *Euler* and *Lagrange*, and subsequently by *Hamilton*, *Jacobi*, *Kelvin*, *Helmholtz*, *Tait*, *Poincaré*, *Larmor*, and many other eminent mathematicians, that nature always follows the principle of Least Action. *Fermat's* principle was of earliest date, and gave the first indication of the more general theorem of Least Action devised by *Mauvertuis* and confirmed by *Euler* and *Lagrange*. It is known that the forces governing the mechanical operations of material systems obey the principle of Least Action, and correspond to the wave-theory of physical forces. Can it be possible that the figures of globules of fluid masses and elastic surfaces would exhibit minimal surfaces, without also depending on waves which are resisted in their progress at the border, and thus transform the liquid into minimal surfaces?

6. In this wave-theory, we find a direct and simple explanation of adhesion, cohesion, capillarity, surface tension, chemical affinity and even of explosive forces. The waves cannot but offer different resistance in their penetrating power when different substances are in contact; and moreover they are refracted unequally in passing through liquid, whence we may explain at once adhesion and capillarity. Cohesion is somewhat different: the particles of solid bodies offer least resistance when the particles are closest together.

7. If the particles are separated appreciably some of the waves pass between them, and on the whole the two separate bodies offer greater resistance to passing waves than would be offered by one mass made by a solid union of the two particles firmly together. This offers a simple theory of the great difficulty discussed by *Newton* in 1721. Surface tension has already been explained in describing the ray of light entering a drop of water; but we may have to include waves both longer and shorter than those of light, to complete the general theory. Experiment shows that chemical affinity is greatly promoted by ultra-violet light, and this confirms the wave-theory of physical forces. Thus, it only remains to say a word about explosive forces, which are related to chemical affinity, and of which no suitable theory has been put forth heretofore.

8. It appears to me that in the molecules of explosive bodies there is a certain resistance to the passing waves, as the atoms are then arranged; but if the atoms mutually are so readjusted as to come closer together suddenly, and re-arranged into a molecule of maximum symmetry and conden-

sation of its parts, there will suddenly be much less resistance to the passing waves. The great energy of the waves always passing through the aether, is thus released or set free by the readjustment of the atoms in the molecule; and this suddenly available energy is so powerful, in view of the aether's enormous elastic power, — which is 689321600000 times that of our air in proportion to its density, and thus much more powerful than our air in any readjustment of the wave field, — that when the release occurs by a sudden readjustment, a violent oscillation of the molecular structure results, — in which disruption and new combination of the oscillating atoms takes place.

9. This new theory derives the store of explosive energy from the elastic power of the aether. This power is shown to exist by the enormous observed speed of the propagation of light and electricity, 300000 km per second. We cannot deny the observed fact of such a velocity for waves in the aether. Accordingly, the enormous elastic power, 689321600000 times greater than that of air in proportion to its density, necessarily follows. And if the universe be filled with waves, of various lengths, from the short waves, most effective in chemical affinity, to the longer waves of light, heat, and radio-telegraphy, it naturally will follow that sudden change in the power of resistance of bodies incident to the rearrangement of the atoms into a new and more compact, less resisting molecular structure, would generate vast stores of energy hitherto latent.

10. This is best illustrated by the new theory of the cause of lightning, a phenomenon which has been equally mysterious and bewildering to natural philosophers. Here is what occurs in lightning:

(a) First, water exists in the atmosphere in the form of invisible vapor. Lowering temperature, usually with currents of colder air, produces a cloud, which is visible, because the light does not pass through it. At first the cloud is made up of very minute particles of water — microscopic in size — but if the cooling and tendency to precipitation continues, the particles of water grow in size, and decrease in number.

(b) When the separate water globules coalesce, into fewer but larger globules, their resistance to passing waves is decreased. And if the region of the earth and atmosphere previously was in electrodynamic equilibrium — the aether waves of this region departing at the same rate that they arrive, so as to give rise to no accumulating aether strain —

3. In AN 5048, p. 165-6, it is shown that the wave function $\Omega(x, y, z, t)$ has the velocity potential Φ :

$$\Phi = \Omega(x, y, z, t) = (1/8\pi^3) \iiint \iiint \iiint e^{A1V^{(-1)}} \Omega(\xi, \eta, \zeta, t) d\xi d\eta d\zeta d\lambda d\mu d\nu$$

$$A = (\xi - x)\lambda + (\eta - y)\mu + (\zeta - z)\nu. \quad (113)$$

4. And *Poisson* has reduced this sextuple integral to the double integral:

$$\Phi = (1/4\pi) \int_0^{\pi} \int_0^{2\pi} F(x + at \cos \theta, y + at \sin \theta \sin \omega, z + at \sin \theta \cos \omega) t \sin \theta d\theta d\omega$$

$$+ (1/4\pi) (\partial/\partial t) \int_0^{\pi} \int_0^{2\pi} \Pi(x + at \cos \theta, y + at \sin \theta \sin \omega, z + at \sin \theta \cos \omega) t \sin \theta d\theta d\omega. \quad (114)$$

5. These integrals are rigorous for the wave disturbances from any point, so long as the movement remains within the liquid sphere, and they will hold true right up to the boundary. In the fourth paper, section 6, (AN 5085) we have extended the integration so as to include the waves from every atom within the boundary of the sphere (r, θ, ω) .

it will experience with the condensation of drops an accumulating stress on the surface of the globules. The waves will flow from the earth and celestial spaces at the old rate, but the resistance to their passage at the surfaces of the enlarged drops is decreased with the condensation of the drops. A positive state of the rain cloud results, and augments rapidly as the rain drops grow.

(c) The result is accumulation of such a strain in the electric medium, or the aether, that lightning develops for restoring the electric equilibrium.

If so terrific a power as lightning can result from the changing electric stress or resistance of the enlarging drops to the waves traversing the universe, it naturally will be easy to imagine that explosive forces and similar atomic powers of incredible magnitude may have their seat in the elastic power of the aether, and the changes in the equilibrium of this medium.

II. Geometrical Conditions fulfilled by an Infinite System of Waves coming from all Directions and passing through a Liquid Sphere under Least Action.

(i) Geometrical conditions of minimum action.

1. We consider a sphere of fluid, whose surface is

$$(x-a)^2 + (y-b)^2 + (z-c)^2 = r^2. \quad (111)$$

The part of a right line intercepted between any two points $p'(x', y', z')$, $p''(x'', y'', z'')$ in the sphere surface, is equal to the length of the chord:

$$\chi = \sqrt{[(x' - x'')^2 + (y' - y'')^2 + (z' - z'')^2]}. \quad (112)$$

Now waves passing through the fluid sphere, after refraction and dispersion at the boundary, follow some of the systems of chords from every point of the surface in every possible direction; so that the paths of minimum action within the surface are along the infinite system of chords drawn from every point of the surface, and therefore doubly infinite in number.

2. For if we suppose waves to originate within the sphere, it is clear that they will be propagated spherically, along these chords, and no deviation from rectilinear motion will occur till the wave front reaches the boundary of the liquid sphere. Refraction and dispersion will take place at the boundary when the wave is going outward, exactly the reverse of what occurs in coming inward; so that from one of these motions the other can be calculated.

$$\begin{aligned} \Phi = & \int_0^r \int_0^\pi \int_0^{2\pi} (\sigma/4\pi) \int_0^\pi \int_0^{2\pi} F[l(x+at \cos \theta) + m(y+at \sin \theta \sin \omega) + n(z+at \sin \theta \cos \omega) - (at+s)] r^2 \sin \theta \, dr \, d\theta \, d\omega \, t \sin \theta \, d\theta \, d\omega \\ & + \int_0^r \int_0^\pi \int_0^{2\pi} (\sigma/4\pi) (\partial/\partial t) \int_0^\pi \int_0^{2\pi} H[l(x+at \cos \theta) + m(y+at \sin \theta \sin \omega) + n(z+at \sin \theta \cos \omega) - (at+s)] \times \\ & \times r^2 \sin \theta \, dr \, d\theta \, d\omega \, t \sin \theta \, d\theta \, d\omega. \quad (115) \end{aligned}$$

6. As the wave disturbances emerging from all atoms will yield a perfect reverse image of those coming in from all directions, it suffices to find the geometrical condition under which the velocity potential yields minimum action. This condition obviously is attained when the mass of fluid is perfectly spherical; for it may be shown that any departure from perfect sphericity yields a resulting action by all the waves greater than the minimum. If the total wave action be given by

$$\Omega = \iiint \Phi \sigma r^2 \sin \theta \, dr \, d\theta \, d\omega \quad (116)$$

then it will follow that for a sphere only is the action a minimum:

$$\delta\Omega = \partial\Omega/\partial x \cdot dx + \partial\Omega/\partial y \cdot dy + \partial\Omega/\partial z \cdot dz = 0. \quad (117)$$

We may reach a similar conclusion also from the wave-theory of gravitation, by noting that the force of gravity is due to waves receding from the centre of mass. The effect of the accumulating aether stress is the central force, which gives a body like our sun a sensibly spherical figure. This conclusion from the wave-theory is confirmed by observation, which shows that the heavenly bodies would be perfectly spherical except for rotations about their axes. The oblateness of the sun is found to be wholly insensible, and the oblatenesses of the different planets correspond severally to their respective rotatory motions.

Accordingly, in the case of immense masses the receding gravitational waves generate the central aether stresses which produce globular figures of the sun and planets; whilst in the case of small liquid drops the globular figures are maintained by the minimum action of the passing waves.

(ii) Geometrical criteria for the theory of minimal surfaces as applied to liquid masses and films.

In our previous discussion we found that in general a minimal surface is a surface of double curvature, such that the fundamental condition fulfilled is that

$$1/R_1 + 1/R_2 = \rho_1 + \rho_2 = 0 \quad (91)$$

where ρ_1 and ρ_2 are the radii of the curvature of the two principal sections at any point of the surface. The radii of curvature are equal but of opposite sign, as shown in such figures as those of a saddle, a mountain pass, the surface of a glove between thumb and forefinger, etc.

The two principal sections lie in different planes, but may be projected as shown in figure 19.

The theory of minimal surfaces involves the treatment of functions of three quantities $F(x, y, z)$ which may be

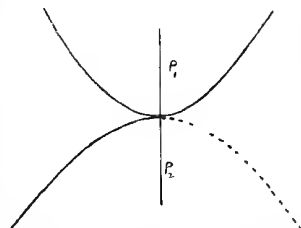


Fig. 19. Sketch of the radii of curvature for a minimal surface, $\rho_1 + \rho_2 = 1/R_1 + 1/R_2 = 0$.

determined as functions of two independent variables u and v , of the general type:

$$u = \int_{t_0}^{t_1} F(x, y, x_1, y_1, dx_1/dt, dy_1/dt) dt \quad (118)$$

where $dx/dt = x_1$, $dy/dt = y_1$, are equations of condition, each involving two variables, as x and y .

For the minimal surfaces, then, we have not a single but a double integral of the form:

$$\Omega = \iint F(x, y, z, \partial x/\partial u, \partial y/\partial u, \partial z/\partial u, \partial x/\partial v, \partial y/\partial v, \partial z/\partial v) \times du \, dv. \quad (119)$$

(cf. Dr. *Hancock's* Lectures on the Calculus of Variations, Cincinnati, 1904, p. 209.)

In the problem of molecular forces now before us we are concerned chiefly with the sphere, which for a given volume has the minimal surface. The problem of the sphere is therefore one in maxima and minima, corresponding to that of the circle, originally due to *Zenodorus*, (150 B. C.), who sought the plane figure with minimum perimeter. A treatment of it will be found in Dr. *Hancock's* Lectures on Maxima and Minima, p. 92. In the same work, p. 75, there is a solution of the problem: To determine the greatest and smallest curvature at a regular point of a surface $F(x, y, z) = 0$.

That the sphere is a minimal surface is fairly obvious without any elaborate mathematical treatment. In the more general surface of double curvature, the fundamental condition $\rho_1 + \rho_2 = 0$ will always hold true. For in the case of twisted surfaces it is obvious that the curvature must be opposite on the two sides; and every point of the surface must be about a centre of curvature lying in the principal planes.

Now imagine a physical surface, like a film of liquid, to depart from the minimal surface; then obviously our condition would be $\rho_1 + \rho_2 = \alpha$, so that $\rho_1 = -\rho_2 + \alpha$. And therefore the curvature in different planes would not be the same on opposite sides at the same point. The result of this condition would be that the film could not be of equal thickness or equal tension in different directions at any point. This obviously would not be a minimal surface; for it could be stretched and somewhat thinned out at the point, without altering the curvature on one side.

In fact the mathematical condition

$$\rho_1 = -\rho_2 + \alpha \quad (120)$$

would imply a swelling in the physical surface, or a sheet of unequal thickness. If this inequality existed, it would gradually augment, under wave action, and the lump of liquid would tend to increase to a drop. But this would disrupt the liquid surface.

Hence the condition of physical stability is

$$\rho_1 + \rho_2 = 0$$

and a liquid sheet fulfilling this condition is stable so long

as the tendency to a drop does not develop under gravitational action on the fluid.

A drop is a load, and may be slightly unsymmetrical, so that it leads to instability; the more it is augmented the more unstable it becomes till the liquid film is disrupted. For in passing the waves tend to make the drop round by everywhere decreasing its surface, and thus they operate to disrupt the film, by drawing in the liquid on all sides. These inferences are easily verified by actual experiments with soap bubbles and other films of soap water containing enough glycerine to make the surfaces elastic.

Now in view of the above reasoning we see why a liquid surface of soap water may stretch and hold taut, as a minimal surface, even when it is a surface of double curvature. It may take the form of a saddle, and yet be perfectly stable, because on the two sides of the film $q_1 + q_2 = 0$, enables the passing waves from all directions to traverse the liquid film with minimum resistance. If, however, $q_1 + q_2 = \alpha$, the integral for the action of the passing waves from all directions is not a minimum; and the principle of least action is violated.

Accordingly we conclude:

1. That minimal surfaces correspond to the principle of least action for all passing waves.

2. Any departure from minimal surfaces renders the wave action greater than the least possible, and therefore is not mathematically admissible, nor will it occur in physical nature.

3. Therefore drops of liquid always take a form as nearly globular as possible; and liquid films follow the mathematical law of minimal surfaces so as to make the physical action of the passing waves a minimum.

4. The instant a liquid film departs mathematically from the minimal form $q_1 + q_2 = 0$, as by the partial development of a drop, the inequality rapidly augments, and the surface is disrupted.

(iii) Examination of the wave-lengths appropriate to the several forces.

From the theory of physical forces resulting from the new theory of the aether it follows that waves of different lengths give rise to different physical effects. In a general way we know that the chemical forces correspond to the ultra-violet region of the spectrum; there also probably will be found the waves producing surface tension, capillarity, cohesion, adhesion, etc. Next in order of increasing wave length comes light, then heat, with the infra-red rays investigated by *Langley*, twenty times longer than the space covered by the visual rays known to *Newton*.

In an earlier section above, we have found the general expression for the potential of the molecular forces:

$$V = \sum_{i=1}^{i=i} m_i \varphi(r) = \sum_{i=1}^{i=i} m_i \int_0^r f(r) dr + \sum_{i=1}^{i=i} m_i \int_r^\infty f(r) dr \quad (121)$$

the second integral of which becomes zero when the distance r exceeds the radius of activity of the molecular forces at work.

Accordingly, we could make a table of wave lengths with their corresponding forces somewhat as follows:

$$V = \sum_{i=1}^{i=i} m_i \int_{\lambda_0}^{\lambda_1} f(r) dr \quad \lambda < r \quad \partial V / \partial r = \text{Molecular forces:} \\ \text{Chemical affinity, Surface tension, Capillarity,} \\ \text{Cohesion, Tenacity, Adhesion.} \\ + \sum_{i=1}^{i=i} m_i \int_{\lambda_1}^{\lambda_2} f(r) dr \quad \left(\begin{matrix} \lambda > \lambda_1 \\ < \lambda_2 \end{matrix} \right) \quad \partial V / \partial r = \text{Light and heat.} \\ + \sum_{i=1}^{i=i} m_i \int_{\lambda_2}^{\lambda_3} f(r) dr \quad \left(\begin{matrix} \lambda > \lambda_2 \\ < \lambda_3 \end{matrix} \right) \quad \partial V / \partial r = \left\{ \begin{matrix} \text{Magnetism, Gravi-} \\ \text{tation, etc.} \end{matrix} \right. \\ + \sum_{i=1}^{i=i} m_i \int_{\lambda_3}^{\lambda_4} f(r) dr \quad \left(\begin{matrix} \lambda > \lambda_3 \\ < \lambda_4 \end{matrix} \right) \quad \partial V / \partial r = \left\{ \begin{matrix} \text{Electrodynamic} \\ \text{action.} \end{matrix} \right. \quad (122)$$

This table gives us an inspiring view of an immense subject, and may enable us to understand the types of waves effective in the various operations of nature. The first region of wave length here outlined, λ_0 to λ_1 , is undoubtedly the region of very short range molecular forces. It could be further subdivided, in the order indicated on the right:

$$V = \sum_{i=1}^{i=i} m_i \int_{\lambda_0}^{\lambda_a} f(r) dr \quad \left(\begin{matrix} \lambda > \lambda_0 \\ < \lambda_a \end{matrix} \right) \quad \partial V / \partial r = \left\{ \begin{matrix} \text{Chemical affinity,} \\ \text{Explosive forces.} \end{matrix} \right. \\ + \sum_{i=1}^{i=i} m_i \int_{\lambda_a}^{\lambda_\beta} f(r) dr \quad \left(\begin{matrix} \lambda > \lambda_a \\ < \lambda_\beta \end{matrix} \right) \quad \partial V / \partial r = \text{Cohesion, Tenacity.} \\ + \sum_{i=1}^{i=i} m_i \int_{\lambda_\beta}^{\lambda_\gamma} f(r) dr \quad \left(\begin{matrix} \lambda > \lambda_\beta \\ < \lambda_\gamma \end{matrix} \right) \quad \partial V / \partial r = \text{Adhesion} \\ + \sum_{i=1}^{i=i} m_i \int_{\lambda_\gamma}^{\lambda_\delta} f(r) dr \quad \left(\begin{matrix} \lambda > \lambda_\gamma \\ < \lambda_\delta \end{matrix} \right) \quad \partial V / \partial r = \left\{ \begin{matrix} \text{Capillarity, Surface} \\ \text{tension} \end{matrix} \right. \quad (123)$$

In a general scheme of this kind, it is obvious that if the forces pointed out be due to waves similar in type but of different lengths, the corresponding actions in many phenomena will somewhat overlap, and be more or less merged together. Thus chemical affinity is a maximum in the ultraviolet spectrum, which is very slightly visible as light. And in the same way the infra-red spectrum investigated by *Langley* is of such immense extent that in all probability the magnetic and gravitational waves will overlap at least part of this region. But these questions must be left to the future, in the hope that greater experience will enable us to illuminate problems which still remain quite obscure. For the present, suffice it to say that magnetic and gravitational waves must be long, otherwise they would be lacking in power of penetration; so that the sun's action on the moon would be almost wholly cut off at the time of lunar eclipses, which is contrary to observation in the lunar fluctuations.

(iv) New theory of acoustic attraction and repulsion: Confirmation of the wave-theory of gravitation.

In the New Theory of the Aether, AN 5044, 5048, 5079, 5085, we have treated of the waves between two bodies and shown that in the process of mutual interpenetration by the independent waves from each centre the medium is thinned out most in the straight line joining the bodies. As the kinetic

exchange tends to keep the aether of uniform density, the tension is thus a maximum in this line, while the increase of stress or pressure is a maximum beyond the two masses. This could be otherwise expressed by saying that under the wave-action some of the aetherons are worked out from between the bodies, and transferred beyond them, as will be readily understood from the double wave field shown in Fig. 8, AN 5048, p. 163.

In order to illuminate this subject still further by well established physical data from known gases, we now ¹⁾ treat very briefly of acoustic attraction and repulsion, which has been experimentally investigated, but not correctly explained by the following authorities.

1. The Philosophical Magazine, for April, 1871, p. 283, where Prof. *Challis* cites the experiment of *Clement* and considers hydrodynamical conditions.

2. The Philosophical Magazine for June, 1871, with experiments on acoustic attraction and repulsion by *Guyot*, *Schellbach*, *Guthrie*, and Sir *W. Thomson* (Lord *Kelvin*).

These experiments, as understood by physicists, have led to the conclusion that the vibrations of an elastic medium attract bodies which are specifically heavier than itself and repel those which are specifically lighter. (cf. *Ganot's* Physics. 14th English edition, by *E. Atkinson*, 1893, p. 274). In proof of this view it is pointed out that a balloon of goldbeater's skin filled with carbonic acid gas is attracted towards the opening of a resonance box, bearing a vibrating tuning fork; while a similar balloon filled with hydrogen gas and tied down by a string is repelled. Experimenters have found that this result always follows, even when the hydrogen balloon is made heavier than air by loading it with wax, or other substances.

This last remark leads me to see in these experiments, not a law based on the relative specific densities of the bodies, but one based on their rate of conductivity of the sound vibrations.

In studying the phenomena of attraction and repulsion, due to electrodynamic action, we are placed at great disadvantage by the enormous speed of such action, which conceals from our view the nature of the process involved. It is therefore well to consider the slower processes which may be more accessible to investigation by laboratory experiments, chiefly in sound.

It is well known that as hydrogen has the greatest molecular velocity of any of the gases, it conducts sound vibrations more rapidly than any other gas. The following data are taken from the table in *Willner's* Experimental-Physik, Leipzig, 1882, Vol. I, p. 804.

Gas	Density	Velocity of Sound in
Air	1	1
Oxygen	1.1056	0.9524
Hydrogen	0.06926	3.8123
Carbonic oxide	0.9678	1.0158
Carbon dioxide	1.5290	0.7812
Ammonia	0.59767	1.2534

¹⁾ This explanation, based on the wave-theory, with the following plates for balloons of carbon dioxide and hydrogen, was developed in the year 1916, but publication has been deferred till the present time.

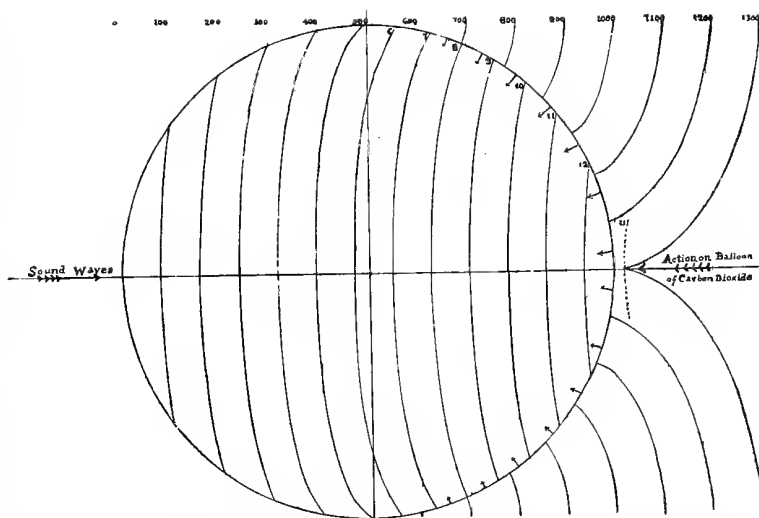


Fig. 20. Illustration of the progress of the wave-front when sound waves advance through the air with velocity 1, and through a balloon containing carbon dioxide, with velocity 0.78. Any phase of the sound wave thus reaches the rear of the balloon by going around through the air quicker than directly through the CO_2 of the balloon, and the reaction on the rear elastic membrane of the balloon impels it towards the source of the sound, which explains the observed acoustic attraction.

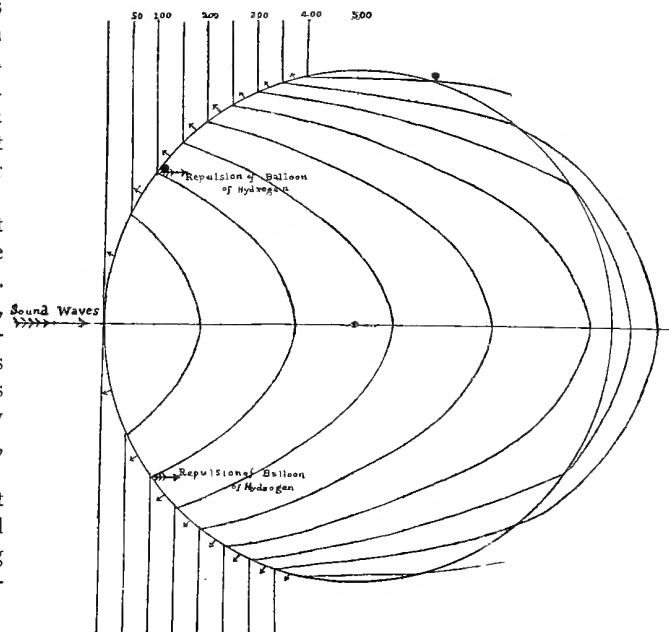


Fig. 21. Illustration of the enormously rapid advance of the sound wave-front in a balloon filled with hydrogen, $V = 3.81$. The internal advance of the sound wave is so rapid that the wave front reverses itself before the centre of the balloon is reached, and the elastic reaction against the surrounding air thus repels the balloon from the source of the sound. This accounts for the observed phenomenon of acoustic repulsion.

It appears from the numbers here given that in the very light gas hydrogen sound has 3.81 times the velocity that it has in air; while ammonia, a gas with relative density of 0.60, has a velocity of 1.25 times that in atmosphere. The facts thus support the view that a balloon filled with ammonia would also be noticeably repelled by the sound waves emitted from a resonance box bearing a vibrating tuning fork.

If this phenomenon of repulsion were due to the smaller average density, it would not persist after the balloon was loaded with wax, or other material, as has been found by observation in the case of hydrogen. It therefore must be due not to the relative lightness of the body floating in the air, but to the great velocity of the sound vibrations in the hydrogen, the waves of which are conducted through the body of the balloon more rapidly than through the air about it.

It is obvious that the rapid advance of the sound waves through the better conducting hydrogen gives a reaction against the surrounding air before this enveloping gas is agitated by the waves coming through the atmosphere alone; the effect of this advance agitation through the hydrogen is an elastic reaction of the hydrogen balloon against the greater part of its as yet undisturbed envelope. It thus rebounds against the inert air, and is repelled from the resonance box, as found by observation.

In the light of this explanation, which is the only one admissible, we readily see also by the above table why a balloon filled with carbon dioxide should be attracted to the resonance box. For the density of carbon dioxide is 1.529, and its conductivity of sound only 0.78 that of air. The sound waves on entering such a balloon will be appreciably outrun by those in the surrounding atmosphere; thus the outside air will give an advance elastic reaction against the enclosed sluggish balloon of carbon dioxide. *

Viewed kinetically it is obvious that some of the lighter and more rapidly moving molecules of the air, under sound agitation, are thus transferred beyond the heavy mass of CO_2 ; and as the air between the balloon and the sounding box is thus somewhat thinned out, the increase of external pressure and internal tension incident to this kinetic transfer of some of the air particles to the space beyond the balloon, causes it to be attracted to the sounding box.

I find on examination that all the other phenomena of acoustic attraction and repulsion, which are reported by the eminent experimenters above named, can be satisfactorily explained in the same way; so that it is natural to infer that we have here a remarkable general law of nature. As the experiments are definite and decisive, it would seem that there is no escape from this conclusion, and the resulting law must therefore be taken as fundamental.

These well established experiments on acoustic attraction and repulsion, in the air, which we can experiment with in our laboratories, confirms our theory of gravitational attraction through the aether, with particles moving 1.57 times faster than light. For in the fourth paper, (AN 5085), we have shown from the confirmation of *Poisson's* researches, how intimate is the connection between the theories of light and sound, as correctly held by that illustrious geometer a century ago.

The aether is of decreasing density in the direction of a central mass such as the sun, and when a body like the earth is also introduced, with decreasing density towards its centre, — thus giving two independent decreases of density incident to the waves from each centre — it follows that the actual density between the bodies is less than if the other body were absent. There is also increase of stress or pressure beyond the bodies. The result is the incessant pulling in the right line between the masses — which we call planetary forces. We could view either body as operating by its wave-action to agitate and expel some of the aetherons from the region between the masses, and increase them beyond so that the density is a minimum along the line sun-earth.

12. General Considerations on the Wave-Theory in Relation to *Planck's* Quantum Theory, with an extension of *Planck's* views, 1913.

(i) Tendency to geometrical forms explained by the wave-theory.

The plausibility of the wave-theory appears from the fact that if we take a solid and heat it, we get a glowing mass with predominant waves of heat, — leaving the action of the shorter waves of the molecular forces weakened, but still largely intact. If we still further increase the heat, the solid fuses into a liquid — the increasing agitation of the long heat waves have so far overcome the shorter waves underlying molecular forces that the molecules become released and the fluid is thus free to flow about. Still higher temperature will vaporize the liquid and convert it into a gas, with particles flying about with high velocities.

Now when we consider such transitions of the state of matter through various temperatures and crucial states, with predominant aether waves of various lengths, what explanation of the discontinuity in physical conditions is so plausible as that afforded by the wave-theory? Rising temperature liquifies and vaporizes all bodies; decreasing temperature and increasing pressure has enabled the experimenter to liquify and solidify all bodies, including the most permanent gases, such as oxygen, hydrogen, helium. The wave-theory is directly involved in all temperature problems, and we have shown how molecular forces depending on short waves develop and become effective when the long heat waves are withdrawn. Is not such a general indication in nature significant of the underlying cause?

It has long been recognized that the raindrops are spherical, but far too little attention has been directed to the question of this exact sphericity of figure, — how it arises and how it is maintained. Molecular forces indeed are the assigned cause of the sphericity, but as nothing is known as to the laws of these forces, or how they act, the current assumptions are admissible only in default of a better explanation. Under the circumstances it becomes advisable to inquire into the degree of sphericity of figure actually maintained, with a view of throwing light on the cause of molecular forces.

1. It is generally agreed that the colors of the rainbow are well separated, except for the overlap of images, due to the finite dimensions of the sun, which renders the spectrum impure. So far as one can see, therefore, the drops

of rain are exceedingly spherical; and no departure from perfect sphericity can be inferred from the observed colors of the rainbow, or from the conical form of that splendid arch of light.

2. Nor is there any evidence indicating noticeable oscillation of figure in the drops which produce the rainbow. Oscillations of figure would render the refraction and reflection irregular and variable; so that the angle of the cone of the rainbow from the anti-solar point would be variable. It is true that the rapidity of the oscillation would render the phenomenon difficult of detection; yet if a great number of drops, enough of them to constitute a considerable fraction of the whole, were incessantly in oscillation, it seems certain that the separation of colors along the conical outline would be blurred, and the rainbow appear as an overlapping hazy arch of light, devoid of distinct colors.

3. Now this hazy arch is not observed in the sky when natural rain is falling. We cannot say that this absence of a noticeably hazy border to the rainbow proves that no drops depart from the true spherical figure; but only that such departure from very perfect sphericity, if they exist, are exceedingly few or of excessively short duration for any individual drop, and thus the corresponding oscillations of figure exert no sensible diffusion of coloration, in comparison with the integral effect of the light from all the spherical drops.

In the Proc. Roy. Soc., May 5, 1879, no. 196, the late Lord *Rayleigh* has devised a means of determining the time of vibration of a dew drop. Lord *Kelvin* found the formula for the period of vibration to be

$$\tau = \frac{1}{4}a^{3/2} \text{ second} \quad (124)$$

where a is the radius of the sphere of water measured in centimetres. For a radius $\frac{1}{4}$ cm the period is $\frac{1}{32}$ second; and hence the table:

r	τ
$\frac{1}{4}$ cm	$\frac{1}{32}$ second.
1	$\frac{1}{4}$ »
2.54	1 »
4	2 »
16	16 »
36	36 »
1407	13200 »

Accordingly, when the drop is one inch in diameter, 2.54 cm, a whole second is required for the vibration. It is only for small drops that the vibration is rapid, and the forces powerful.

Before the time of *Plato* the Greek geometers had noticed the spherical figures of the sun and moon, and inferred a like spherical figure for the earth, from the circular section of the earth's shadow at the time of lunar eclipses. As the orbits of the planets also appeared to be essentially circular, and the Greek natural philosophers noted the tendency of drops of dew, oil, and other liquids to assume the spherical form, which was then held to be a perfect figure, it is now possible to understand *Plato's* doctrine that the deity always geometrizes, — ὁ θεὸς ἀεὶ γεωμετρεῖ.

Apparently this conclusion was not an idle remark, but represented a genuine philosophical induction from the observed order of nature, which we are only beginning to interpret after the lapse of some two thousand three hundred

years. To the modern natural philosophers it will appear as wonderful as it did to the Greeks that nature approximates these very beautiful geometrical figures. Thus the cause of such observed phenomena should engage the attention of the leading geometers of our own age.

In view of the foregoing discussion, it appears that the physical cause of the rainbow is a two-fold one.

1. The exact sphericity of the raindrops, the spherical figures of which are maintained by passing waves shorter than those of light. The cause of these minimal spherical surfaces is now assigned for the first time and shown to accord with the *Weierstrass-Schwarz* mathematical theory of minimal surfaces.

2. The dispersion of the light is due to the spherical figures of the drops with the refraction of the incident light following the law of *Snellius*, as *Descartes* found by actual calculation, 1637. The true theory was originally discovered by *Theodorich*, about 1311 A.D., but his explanation was not published till 1814. Meanwhile it was independently discovered by *Antonius de Dominis*, Archbishop of Spalato, about 1591. *Newton* first developed the complete theory of spectral colors through the decomposition and recomposition of white light, in a series of experiments begun in 1666, and fully published in his Treatise on Optics, 1704.

In view of this development, it is well to dwell on the real physical significance of the rainbow. We should remember that the very existence of this great natural phenomenon implies an infinite variety of waves. Otherwise this splendid bow of color would never span the heavens. Just as the colors in the sky are a perpetual reminder that some 500 trillion waves enter the eye every second, so also do they tacitly imply not merely waves from the region of the visible spectrum, but also invisible waves from the region of the ultra-violet.

It would be in the highest degree improbable that waves come only from the visible spectrum; for the longer heat waves always accompany the sun's light, and are known to come from the red and infra-red regions of the spectrum; and as chemical processes always are going on in nature, and are known to depend on the shorter violet and ultra-violet waves, it follows from the chemical processes of the world alone, that ultra-violet rays also fill the sky, though quite invisible on the blue border of the rainbow.

Accordingly, when we behold the glorious arch of the rainbow, we are at the same time reminded of quadrillions of waves too short to be visible, yet entering the eye every second. They too fill every part of the sky and traverse every drop of rain just as the waves of the visible spectrum enter the correspondingly small pupil of the eye, to the number of about half a quadrillion. Under these circumstances, it is strange that we have not sooner recognized how the waves give the raindrops such mathematically perfect sphericity, and by the resulting dispersion add to the beauty of the world.

(ii) General outline of *Planck's* Quantum Theory, with inference suggested by the wave-theory.

From the wave-theory thus briefly outlined it follows that all the phenomena of the physical universe should depend on the mutual interaction of waves and the corresponding

forces of nature. This relationship is shown in the theory of the correlation of forces, and the doctrine of the conservation of energy, which have become fundamental in modern science. But there are some difficulties to be overcome, and heretofore a method of attacking them has not been developed, even by the most eminent authorities. It seems likely that most of the supposed difficulties of the wave-theory will disappear the moment we attribute the forces of nature to wave action; for then we may use the forces of nature to study the waves by which the forces are produced, and also investigate the forces observed with a view of inferring the type of waves from which they might arise.

Accordingly, after this sketch of the wave-theory, we have now to consider the views announced by Professor *Planck*. In his address as Rector of the University of Berlin, Oct. 15, 1913, reported in the *Revue Scientifique*, Paris, Feb. 14, 1914, *Planck* gives a summary of his chief conclusions, to the effect that neither motion nor physical force is strictly continuous in character, but each of them made up of small jumps or sudden alterations in value. This quantum theory probably is not identical with the wave-theory, yet it has enough elements in common to be worthy of careful examination, on the probability that the two theories may be reconciled by future developments.

Planck's theory is described very briefly in the following account:

»Suppose a mass of water in which violent winds have produced a train of very high waves. After the wind has ceased, the waves still maintain themselves and go from one shore to another. Then takes place a characteristic change. The energy of motion of the longer and larger waves gradually changes, especially when they meet the shore or other solid objects, into that of shorter and smaller waves, until finally the waves become so small as to be quite invisible. This is the well-known change of visible motion into heat, of mass movement into molecular movement.«

»But this process does not go on indefinitely; it finds a natural limit in the size of the atoms. The larger the atoms are, the sooner comes the end of this subdivision of the total energy of movement.«

»Now suppose a similar process with undulations of light and heat; suppose that the rays emitted by a powerfully incandescent body are concentrated into a closed cavity by mirrors and there continually reflected to and fro. Here also will take place a progressive transformation of the radiant energy into shorter and shorter waves. According to classic theory we should expect that the whole energy of the radiation should finally be confined to the ultra-violet part of the spectrum.«

»Now, not the slightest trace of any such phenomenon can be discovered in nature. The transformation reaches, sooner or later, a perfectly clear and well-determined limit, and after this the state of the radiation is stable in all respects.«

»To make this fact agree with the classic theory the most diverse attempts have been made; but it has been shown that the contradiction penetrates too deeply into the roots of the theory to leave them intact. So the only thing to do is to overhaul the foundations of the theory.«

»In the case of the water-waves the subdivision of their energy of motion came to an end because the atoms retained

the energy in a certain way, because each atom represents a determinate quantity of matter, which can move only as a whole. Also in the light and heat radiation, although it is quite immaterial in its nature, there must be certain processes in action that retain the energy in determinate quantities and retain them the more powerfully as the waves are shorter and the vibrations more rapid.«

This outline of *Planck's* theory assures us that the transformation of energy waves into shorter and shorter wave-length would lead one to expect »that the whole energy of the radiation would finally be confined to the ultra-violet part of the spectrum. Now, not the slightest trace of any such phenomenon can be discovered in nature. The transformation reaches, sooner or later, a perfectly clear and well defined limit, and after this the state of the radiation is stable in all respects.«

It should be pointed out that molecular forces furnish evidence of such shorter and shorter waves, at least up to a certain limit hitherto quite unknown. And it is found from the observed thickness of soap bubbles, just before their rupture, that this length corresponds to the wave-length of the ultra-violet spectrum and beyond. Accordingly, it seems to me that *Planck* has not drawn all the admissible conclusions. For if we concede that molecular forces be due to waves, the evidence is that shorter and shorter waves really exist, at least to atomic and perhaps electronic dimensions.

Nature therefore presents to us a book of mysteries which is not yet opened, but securely sealed, as with seven seals. As we have to explain cohesion, adhesion, hardness, tenacity, etc., we cannot yet truthfully say what is the limit of the shortness of the waves, unless this is finally set by the dimensions of the atoms and electrons.

In the last paragraph of the above quotation *Planck* describes the smallness of the masses as fixing limits to the shortness of waves, because such small masses can only move as a whole. He does not show how these elementary quanta of matter vibrating as a whole are represented, but the inference is that no source is able to give out energy till the energy has reached a certain value, by natural sympathy of the vibrating system or otherwise, as in *Helmholtz's* resonators, with which the atoms have many properties in common.

(iii) Discontinuities in the quantum-theory naturally accounted for by the wave-theory.

It is chiefly by the differences of wave-lengths in the integrals for the molecular forces that we explain the different forces of nature. The bolometer-researches of *Langley* on the solar spectrum, showed that the wave-lengths are quite irregularly distributed over the infra-red region. If therefore the operations of heating, at different temperatures t_1 and t_2 should bring into prominence the part played by waves of lengths between λ_1 and λ_2 , it might be possible to account for the discontinuities noted by *Planck*.

For as changing resistance breaks up electrical waves from longer to shorter wave-length, and at the same time heat waves appear from this disintegration, it is very probable that in summing up the effects of waves over a great range of wave-lengths many special phenomena would appear suddenly at certain temperatures. This probable connection between the quantum-theory and the wave-theory seems to make in-

telligible a great body of phenomena involving sudden transition, which heretofore have been quite obscure to the natural philosopher. It is necessary to have some mental picture of the cause of the apparent discontinuity, and at present this can only be supplied by the wave-theory.

Professor *Planck* describes the apparently discontinuous and explosive character of certain natural phenomena as follows:

»In any case the hypothesis of quanta has led to the idea that there are in nature changes that are not continuous, but explosive. I need only remind you that this representation is made acceptable by the discovery and close study of radioactive phenomena. The hypothesis of quanta has so far enabled us to obtain results in better accord with existing measurements of radiation than those of all preceding theories.«

»But there is something further. If it is a point in favor of a new hypothesis that it is verified even in regions to which it was not expected to apply, at the outset, the hypothesis of quanta may surely claim an advantage. I desire to call attention here only to a single striking circumstance. Since we have succeeded in liquifying air, hydrogen and helium, an abundant and new field of experimentation has opened to research in the domain of the lower temperatures, and already a whole series of new and extremely surprising results have come to light.«

»To heat a piece of copper from -250° to -249° , that is, by one degree centigrade, not the same quantity of heat is required as to heat it from 0° to 1° , but about thirty times less. If we started with an initial temperature still lower, we should find that the corresponding quantity of heat was still smaller, without assignable limit. This is directly contrary not only to all customary statements, but also to the requirements of the classic theory, for although we learned more than a century ago to distinguish strictly between temperature and quantity of heat, we have nevertheless been led to the conclusion that even if these magnitudes are not exactly proportional, they vary at least in some parallel way.«

»The hypothesis of quanta has completely cleared up this difficulty, and moreover has furnished another result of high importance, namely, that the forces which provoke heat-vibrations in a solid are precisely the same as those that produce elastic vibrations. We may thus now calculate from the elastic properties of a monatomic body its heat energy at different temperatures a service that the classic theory has never been able to perform.«

The researches heretofore made are too incomplete for us to affirm that these phenomena of quanta can all be explained by the wave-theory; yet the indications of a hitherto unsuspected connection are so plain that the cause underlying the observed phenomena will necessarily become an object of attention in future investigations. Heretofore the phenomena of quanta have appeared as deep mysteries.

(iv) Conclusion to the fifth paper on the new theory of the aether.

From the foregoing comprehensive but necessarily incomplete survey of an extensive subject, it appears that the wave-theory of molecular forces is overwhelmingly indicated by the minimal surfaces pervading nature. The tendency to perfect sphericity of figure is so remarkable a phenomenon

that it can not fail to become an object of research among philosophers, as to why these physical laws exist.

It appears that *Plato* saw in the nearly circular orbits of the planets, and in the spherical figures of the sun and moon and all fluid globules the geometrizing of the Deity — *ὁ θεὸς ἀεὶ γεωμετροῖ.*

But *Newton*, *Clairaut*, and *Laplace* showed that the theory of universal gravitation fully accounts for the figures of the heavenly bodies. And recently it has been recognized, from the writer's *Researches in Cosmogony 1908-10*, that the observed roundness of the orbits of the planets and satellites, which had so profoundly impressed both *Newton* and *Laplace*, is due to the secular action of the nebular resisting medium formerly pervading the solar system.

Thus, to complete the solution of the problem of the Greek philosophers, it remained to account for the perfect sphericity of figure of liquid drops. This production of perfect liquid spheres in nature we have now explained by the wave-theory, which yields minimal surfaces with very remarkable geometrical properties. The proof deduced from the *Archimedean* theorem, Fig. 5, section 4, that spherical drops of liquid are true minimal surfaces, for the whole of the waves traversing the universe in every direction, doubtless will be of more than ordinary interest to geometers and natural philosophers. I am not aware of any previous use of this beautiful theorem, in physical investigations, since the days of *Archimedes*.

In this paper no considerable outline of the wave-theory of chemical affinity, and of explosive forces has been attempted. That is reserved for a sixth paper, in which I hope to deal also with the living forces. These vital processes long have been considered electrical in character, and yet beyond the reach of research so long as molecular forces could not be definitely referred to wave-action. The problems of crystallography likewise are many and promising, and I have left the wave-theory of the hardness of diamond incomplete, yet sufficiently outlined to be suggestive to others.

It only remains to add that *Maxwell*, *Boltzmann*, and other eminent natural philosophers, have taken the molecular forces to vary inversely as the fourth or fifth power of the distance $f(r) = K/r^4$, or $f(r) = K'/r^5$, which will be found to accord well with the wave-theory. According to *Laplace's* hypothesis these forces are sensible only at insensible distances, and thus manifest themselves chiefly in the immediate proximity of physical matter, where the refractions, dispersions, diffractions, interferences, etc. appear separately or conjointly and in unknown intensity.

If, on the average, about two or three of these influences be at work near physical bodies, — the intensity of each being as the inverse square of the distance r , — the compound effect of their joint action would be approximately

$$\varphi(r) = K/r^4, \quad \psi(r) = K'/r^5, \quad \text{or} \quad \chi(r) = K''/r^6. \quad (125)$$

This conclusion accords well with observations, but as the distances at which phenomena are noted are nearly insensible, we must not expect great observational accuracy, nor attach much importance to the theoretical agreement with the wave-theory.

After outlining this new theory of molecular forces, it only remains to call attention to certain definite steps in the

theory of the rainbow, the study of which, under the undulatory theory of light, has now enabled us to assign the cause of molecular forces.

1. About the year 1311 A. D. the first analysis of the colors of the rainbow, with correct explanation of the refractions producing the primary and secondary bows, was made by *Theodorich* (cf. *Venturi*, *Commentarii sopra la storia e le teorie dell'ottica*, Bologna, 1814), who was a contemporary of *Dante*, and thus flourished in the darkest period of the Middle Ages. But *Theodorich's* researches were not published until 1814, — after a delay of 503 years! — so that they first became known early in the 19th century.

2. Meanwhile about the year 1591, the celebrated *Antonius de Dominis*, Archbishop of Spalato, independently discovered and experimentally demonstrated the origin of the colors of the rainbow. In his *Treatise on Optics*, 1704, p. 126, *Newton* says:

»This bow never appears but where it rains in the sunshine, and may be made artificially by spouting up water which may break aloft, and scatter into drops, and fall down like rain. For the sun shining upon these drops certainly causes the bow to appear to a spectator standing in a due position to the rain and sun. Hence it is now agreed upon that this bow is made by refraction of the sun's light in drops of falling rain. This was understood by some of the ancients, and of late more fully discovered and explained by the famous *Antonius de Dominis*, Archbishop of Spalato, in his book *De Radiis Visus et Lucis*, published by his friend *Bartolus* at Venice, in the year 1611, and written about twenty years before. For he teaches there how the interior bow is made in round drops of rain by two refractions of the sun's light, and one reflexion between them, and the exterior by two refractions and two sorts of reflexions between them in each drop of water, and proves his explications by experiments made with a phial full of water, and with globes of glass filled with water, and placed in the sun to make the colours of the two bows appear in them.«

3. It is well known that *Newton's* experiments on colors, with the decomposition and recombination of white light by means of prisms, were begun in 1666, but not published in full until 1704, when the celebrated *Treatise on Optics* appeared. Since *Newton's* day there has been no material change in the theory of the colors of the rainbow.

4. Having had occasion to examine the theory of the rainbow with much attention in the year 1916, I was led to conceive that the waves entering and leaving the drops would exert a pressure towards the centre, and thus to form a new theory of molecular forces depending on wave-action. At length, after several years of research, I have been able to outline a proof that heretofore we have recognized only a small part of the wave secrets of nature.

5. Accordingly, it appears that the study of the rainbow has finally led to the cause of molecular forces, including the phenomenon of lightning, which so long proved terrifying to mankind, and utterly bewildering even to the most learned natural philosophers. The rainbow itself is beautiful, but its wave origin was suggestive of deeper secrets of nature. In fact, if our new theory of molecular forces be admissible,

this great arch of light so splendidly spanning the heavens during rains and thunderstorms now becomes nothing less than a triumphal arch of discovery. By the study of the illumination of this glorious arch we are enabled to penetrate the much deeper mystery of atmospheric electricity and of the lightning, which in all ages has spread fear and terror in those who rejoiced to behold the splendor of the rainbow.

6. Accordingly, if mankind should hereafter be able to view the rainbow, and the lightning so frequently associated with it, in calm reassurance that both phenomena depend on the all-pervading aether and represent the same wave-order in nature, it ought to afford some consolation to philosophers to realize that their researches, beginning with *Theodorich's* pioneer effort in the age of *Dante*, subsequently extended by *Antonius de Dominis*, *Descartes* and *Newton* in the 16th, 17th and 18th centuries, have finally brought to light an even greater secret of the universe. Under the circumstances a torch-bearer of the Greeks, who had brought down the lightning, as the most dazzling flash of the aether of the skies, doubtless would have exclaimed with *Aeschylus*:

Ναρθηκοπλήρωτον δὲ θηρώμαι πυρός
Πηγήν κλοπαίαν, ἢ διδάσκαλος τέχνης
Πάσης βροτοῖς πεφήνε καὶ μέγας πόρος.

Prom. Vinct. 109.

»I brought to earth the spark of heavenly fire,
Concealed at first, and small, but spreading soon
Among the sons of men, and burning on,
Teacher of art and use, and fount of power.«

Very grateful acknowledgements are due to Mr. *W. S. Trankle* for facilitating the completion of this paper.

Starlight on Loutre, Montgomery City, Missouri, 1920 Dec. 10.

T. F. F. See.

1. Postscript. Since finishing the above paper it has occurred to me that the nature of the wave-action in maintaining the oscillations of a globule of liquid might be examined somewhat more critically. When a drop is disturbed from the spherical form its figure oscillates from a prolate to an oblate ellipsoid, or vice versa. Thus it may be worth while to consider these extreme spheroidal forms of the globule.

1. The Prolate Spheroid. The equation of the meridional section is

$$a^2 y^2 + b^2 x^2 = a^2 b^2 \quad (\alpha)$$

which gives

$$y^2 = (b^2/a^2)(a^2 - x^2). \quad (\beta)$$

The differential element of the volume is

$$dv = \pi (b^2/a^2)(a^2 - x^2) dx \quad (\gamma)$$

which by integration gives:

$$v = \pi (b^2/a^2) \int_0^a (a^2 - x^2) dx \quad (\delta)$$

$$= \pi (b^2/a^2) (a^2 x - \frac{1}{3} x^3) + c \quad (\epsilon)$$

If we calculate the volume from the plane passing through the centre, we have for $x = 0$, $v = 0$, and therefore also $c = 0$. Hence between the limits $x = 0$, $x = a$, we have

$$\begin{aligned} \frac{1}{2}v &= \frac{2}{3}\pi b^2 a \\ v &= \frac{4}{3}\pi b^2 a. \end{aligned} \quad (\zeta)$$

As πb^2 is the area of the circle described on the conjugate axis, and $2a$ is the transverse axis, and the volume

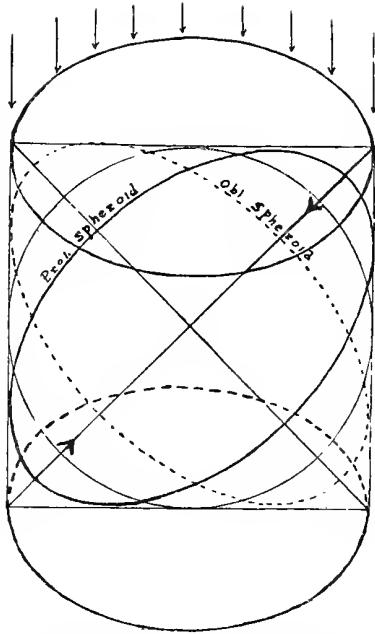


Fig. 22. Theory of wave-action on oscillating drop of liquid, alternately prolate and oblate, the circumscribing cylinder having axis oblique, and being somewhat variable in form and dimensions, which however for the sake of simplicity is not represented in the figure.

of the circumscribed cylinder therefore $2\pi b^2 a$, it follows that the volume of the prolate ellipsoid is to that of the circumscribed cylinder as 2 : 3, which is a remarkable extension of the celebrated theorem of *Archimedes* illustrated above in Fig. 5.

2. The Oblate Spheroid. In this case we have obviously

$$dv = \pi x^2 dy. \tag{\eta}$$

And on substituting for x^2 its value from the equation of the ellipse, namely:

$$x^2 = (a^2/b^2) \cdot (b^2 - y^2) \tag{\theta}$$

we get in like manner:

$$v = \pi (a^2/b^2) \int (b^2 - y^2) dy = \pi (a^2/b^2) (b^2 y - \frac{1}{3} y^3) + c. \tag{\iota}$$

And between the proper limits, this expression for v becomes:

$$v = \frac{4}{3} \pi a^2 b \tag{\kappa}$$

which is another remarkable extension of the celebrated theorem of *Archimedes* illustrated in Fig. 5 above.

If we compare the volumes of the two spheroids here considered, we find:

$$\text{Obl. Spheroid : Prolate Spheroid} = a : b. \tag{\lambda}$$

It thus appears that the volumes of the two spheroids are as their greater and lesser axes respectively. Accordingly, the volumes of the cylinders orthogonally circumscribed about them would also be in the ratio of $a : b$. And the *Archimedeian* theorem on the ratio of the volumes of the spheroids to the orthogonally circumscribed cylinders in each case is $\frac{2}{3}$.

3. Now when we consider a drop of water or other liquid oscillating about its mean figure, which is spherical, we

perceive that there is not only an alteration of figure, from a prolate spheroid to a sphere, and from a sphere to an oblate spheroid, or vice versa, but also that an alteration of volume would be expected to occur except for the incompressibility of the fluid under the slight force of surface tension. The incompressibility of liquids, however, imposes the condition:

$$\text{Obl. Spher.} = \text{Prol. Spher.} = \text{Sphere} \tag{\mu}$$

$$\frac{4}{3} \pi a^2 b = \frac{4}{3} \pi b'^2 a' = \frac{4}{3} \pi r^3$$

or
$$r = \sqrt[3]{a^2 b} = \sqrt[3]{a' b'^2} \tag{\nu}$$

This requires that for an oscillating globule the axes a and b in the two spheroidal forms must take successively appropriate values, yet when the form of the spheroid has alternated, the axes are not identical in the two cases, and should be written as in equation (ν).

4. If we consider the resistance to the waves, due to the fluids in the prolate and oblate spheroids, when the axis of the circumscribing cylinders coincides with the major axis of the prolate and the minor axis of the oblate spheroid, it is evident from the above equations that the *Archimedeian* theorem will hold rigorously true for these two orthogonally coincident axial positions, just as in the case of the sphere treated in Fig. 5 above. In these cases the resistance to the waves due to the fluid spheroids is exactly $\frac{2}{3}$ of that due to the whole cylinder of fluid.

But when the axes of the fluid spheroids are oblique or inclined at any angle to the axis of the circumscribed cylinder, this theorem of the ratio $\frac{2}{3}$ for the resistance of the axes the section of the cylinder is not circular, but really elliptical. And even if the circumscribing cylinder be elliptical, the wave resistance due to the enclosed obliquely tilted spheroids will be less than $\frac{2}{3}$ of that due to the whole cylinder.

(a) The wave pressure at the two ends of the spheroids, parallel to the polar axes, is relatively greater than from the various oblique directions.

(b) Whilst the axes of the spheroids remain fixed in position the sides of the figure are thus forced in or out, as the case may be, till the motion is checked by inertia balancing momentum, as the globule maintains its vibration; and this oscillation, heretofore attributed to unknown molecular forces, is really due to the unequal wave pressure accumulating at the boundary of the fluid in the different directions.

(c) The above figure will convey some impressions of this oscillation in a typical case, but the enclosing cylinder must be conceived as somewhat variable in figure and dimensions. These additional considerations show that the wave-theory may be adapted to the behavior of drops in oscillation as well as to those which have settled down to the figure of equilibrium, which when free from external forces, is that of a sphere.

1921 Feb. 19.

T. F. F. See.

2. Postscript.

Theory of the Flow of Waves in Right Lines through any Conical Space ω , and of the Change of the Double Integral of the Waves over any Closed Surface S , when Reflection occurs within the Enclosed Space¹).

¹) Written about 3 years, but not heretofore published.

In the theory of the brightness of the stellar universe, under an equal distribution of the stars as conceived by *Herschel*, *W. Struve* shows that for a small solid angle ω , the number of stars $d\nu$ included in the cone thus defined between the distances r and $r+dr$ is given by the expression

$$d\nu = k \omega r^2 dr \quad (1)$$

in which k is a constant.

As the total light is determined by the accumulated effect of the stars at their several distances, the whole amount of light received from such a cone will be found by integrating this expression between the limits 0 and ∞ :

$$\begin{aligned} & \sum_{i=1}^{i=i} (1/r_i^2) d\nu_i = \\ & = A = k \omega \int (1/r^2) r^2 dr = k \omega \int dr = k \omega \cdot \infty \quad (2) \end{aligned}$$

In practice this expression is finite and less than the brightness of the sun's disc, and thus either the universe is finite, or an absorption of light by cosmical dust in space is considered probable.

Let λ be the flow of light in straight lines, from a luminous point, under constant wave velocity; then if r be the distance of the luminous point, the intensity, or quantity of light which passes through unit of surface perpendicular to the ray in unit of time, will be proportional to the illumination of steady intensity defined by the equation:

$$I = \lambda/r^2 \quad (3)$$

If the surface illuminated be inclined at an angle θ to the ray, we have for the intensity of the illumination of such a tilted area: $I' = (1/r^2) \lambda \cos \theta$.

In the article *Light*, *Encycl. Brit.*, 9th ed., *Tait* points out that these two intensities are exactly similar to the following expressions: Equation (3) is the expression for the gravitational force exerted by a particle of mass λ on a unit of matter at distance r ; and (4) for the resolved component of this force on a given direction. This is an additional indication that gravitation and light are both due to waves.

Accordingly, if there be any number of separate sources of light, we may employ, for calculation of the effect, an expression exactly analogous to that of the gravitational or electric potential, namely:

$$\begin{aligned} \Omega &= \sum_{i=1}^{i=i} (1/r_i) \lambda_i = \\ &= \iiint [(x-x')^2 + (y-y')^2 + (z-z')^2]^{-1/2} \sigma dx dy dz. \quad (5) \end{aligned}$$

And the differential of this expression with respect to r

$$\begin{aligned} \partial\Omega/\partial r_i &= \sum_{i=1}^{i=i} (1/r_i^2) \lambda_i = \\ &= \iiint [(x-x')^2 + (y-y')^2 + (z-z')^2]^{-1} \sigma dx dy dz \quad (6) \end{aligned}$$

will give the total radiation due to any number of separate sources of light, when the waves are propagated in right lines, in cones composing spheres, separately homogeneous in wave distribution, about the several centres of radiation.

Moreover, if n be the external normal at any point of

a closed surface, we may, as in the fundamental proposition of potentials, take the double integral over the surface:

$$\iint d\Omega/dn \cdot dS = -4\pi \lambda_0 \quad (7)$$

where λ_0 is the sum of the values of the light λ_i from the several sources lying within the surface.

As every source external to the closed surface sends in light which goes out again, and thus leaves the wave-distribution in the cones of space unchanged, while the light from the internal source goes wholly out, we perceive that the amount of light lost through the surface per second for each unit source is 4π , the total area of the unit sphere surrounding the source. Hence we verify the above formula (7), that for all the internal sources the integral is the sum of the several sources of radiation λ_i , and thus equal to $-4\pi \lambda_0$.

Now consider light waves flowing in conical streams from the objects of the material universe in every direction. It is easily seen that the light received from a uniformly illuminated plane surface, when the normal is inclined at the angle θ , is represented by the double integral:

$$A = \iint (1/r^2) \cos \theta dS. \quad (8)$$

It may be shown that for a closed surface, which has no inside source of light, this integral vanishes, because the original wave distribution in the cones of space is unchanged. And for all shells of equal uniform brightness whose edges lie on the same cone its value is constant.

This theorem, that when propagated in right lines, the expression for the light passing through the closed surface vanishes for all external sources, is of the highest significance: it affords an experimentum crucis as to the flow of light from all sources in spherical cones in which the light distribution remains homogeneous — free from refracting or dispersing disturbances — and any other kind of flow gives this integral a finite value different from zero. Hence in general we have

$$\iint d\Omega/dn \cdot dS = \iint (1/r^2) \cos \theta dS = -4\pi \lambda_0 + A. \quad (9)$$

To apply the above theorems to capillarity and other molecular forces, it suffices to enclose the fluid at the point under investigation (x, y, z) , with a spherical surface of convenient radius, so that the waves from external sources are redistributed by refraction, dispersion, etc., within the sphere surface.

(a) We may neglect the collective actions of the waves originating from the particles within the enclosing spherical surface: such aggregate action yields the expression

$$\iint d\Omega/dn \cdot dS = -4\pi \lambda_0. \quad (10)$$

As the enclosed matter, by hypothesis, is not a chief source of radiation, we know that λ_0 is small, and of the order of intensity seen in gravitative forces, which are always very feeble.

(b) Thus we are left to consider the effects of the waves passing through the sphere surface enclosed about the fluid and solid at the point (x, y, z) . These waves are refracted, dispersed, and unequally resisted by the matter in the paths of the cones which make up the surface 4π of the unit sphere. If no refraction, dispersion or resistance occurred, the integral of these passing waves would be zero:

$$\iint (1/r^2) \cos \theta \, dS = 0. \quad (11)$$

But under the refractions, dispersions, retardations, etc., actually occurring along the paths of certain cones, the integral does not vanish, but always reduces to a finite quantity:

$$\iint (1/r^2) \cos \theta \, dS = A \quad (12)$$

This failure of the integral over the closed surface to vanish, implies that the aethereal medium is stressed by the refractions, dispersions, etc., along the paths of certain cones, thus developing forces, which may become quite large in certain cases.

It is upon this integral (12) that the molecular forces depend: and as the integral for the effects of the redistributed waves over the closed surface is not zero, the wave-principle of Least Action always makes the integral for the sum total of the action of the waves along all their actual paths a minimum. Thus the residue A in (12) is made as small as possible.

Accordingly there are physical limitations imposed by nature upon the geometrical conditions underlying *Gauss's* theorems that in the theory of the potential:

1. For an internal point

$$\iint d\Omega/dn \cdot dS = -4\pi \lambda_0$$

2. For an external point

$$\iint (1/r^2) \cos \theta \, dS = 0.$$

1. These celebrated theorems (*Allgemeine Lehrsätze*, § 22, *Gauss's Werke*, Bd. V, p. 224) are based upon rectilinear actions in nature which follow the law of the inverse squares, as specifically pointed out by *Gauss* in his introductory remarks, §§ 1, 2.

2. If, therefore, there be in nature forces due to waves, — which suffer refraction or dispersion when the wave path is through heterogeneous matter, as when a fluid is in contact with a solid or of such shape as to cause refraction or dispersion, — these theorems of *Gauss* cease to hold rigorously true.

3. It is upon such principles that the fluctuations of the moon depend. And in a different way, the stress arising from wave action gives rise to molecular and atomic forces (cf. section 7 above).

1921 July 4.

T. F. F. See.

T. J. J. See. New Theory of the Aether.



Fig. 6. Upper figure, Lightning flash photographed at Kansas City, Missouri, 1915 Aug. 5, 6^h30^m p. m. by Mr. *Donald P. Beard*. Lower figure, an extremely terrific lightning flash photographed at Spokane, Washington, 1914 July 13, 2^h30^m a. m. by *C. R. Lewis*.

T. J. See. New Theory of the Aether.

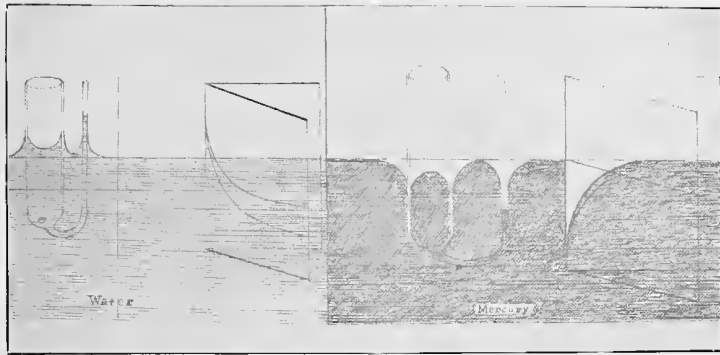


Fig. 9. Illustration of more extraordinary capillary phenomena, for water and mercury.

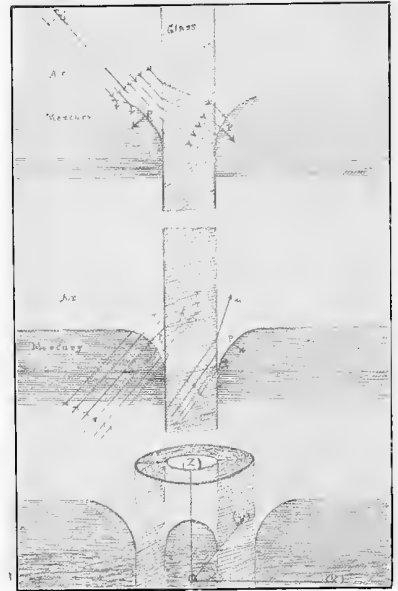


Fig. 13. Illustration of the disturbance of the wave-front when rays pass from air to glass and mercury in contact, giving rise to the observed negative capillary forces.

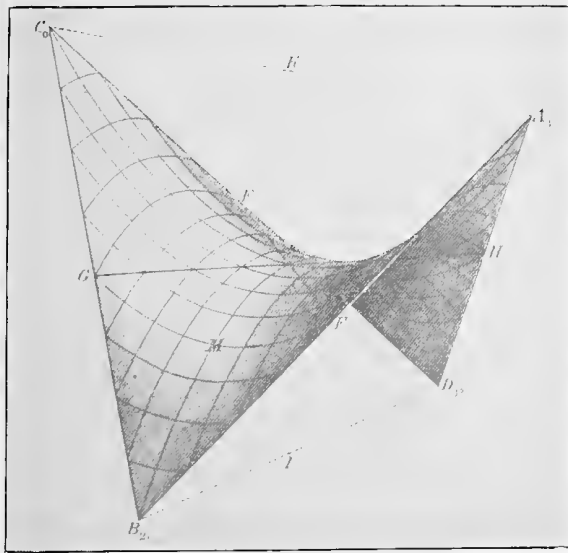


Fig. 14. Prof. Schwarz's illustration of the minimal surface $1/R_1 + 1/R_2 = 0$, with equal but opposite curvature on the two sides.

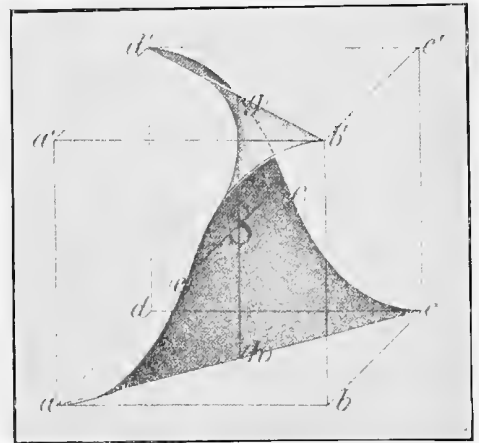
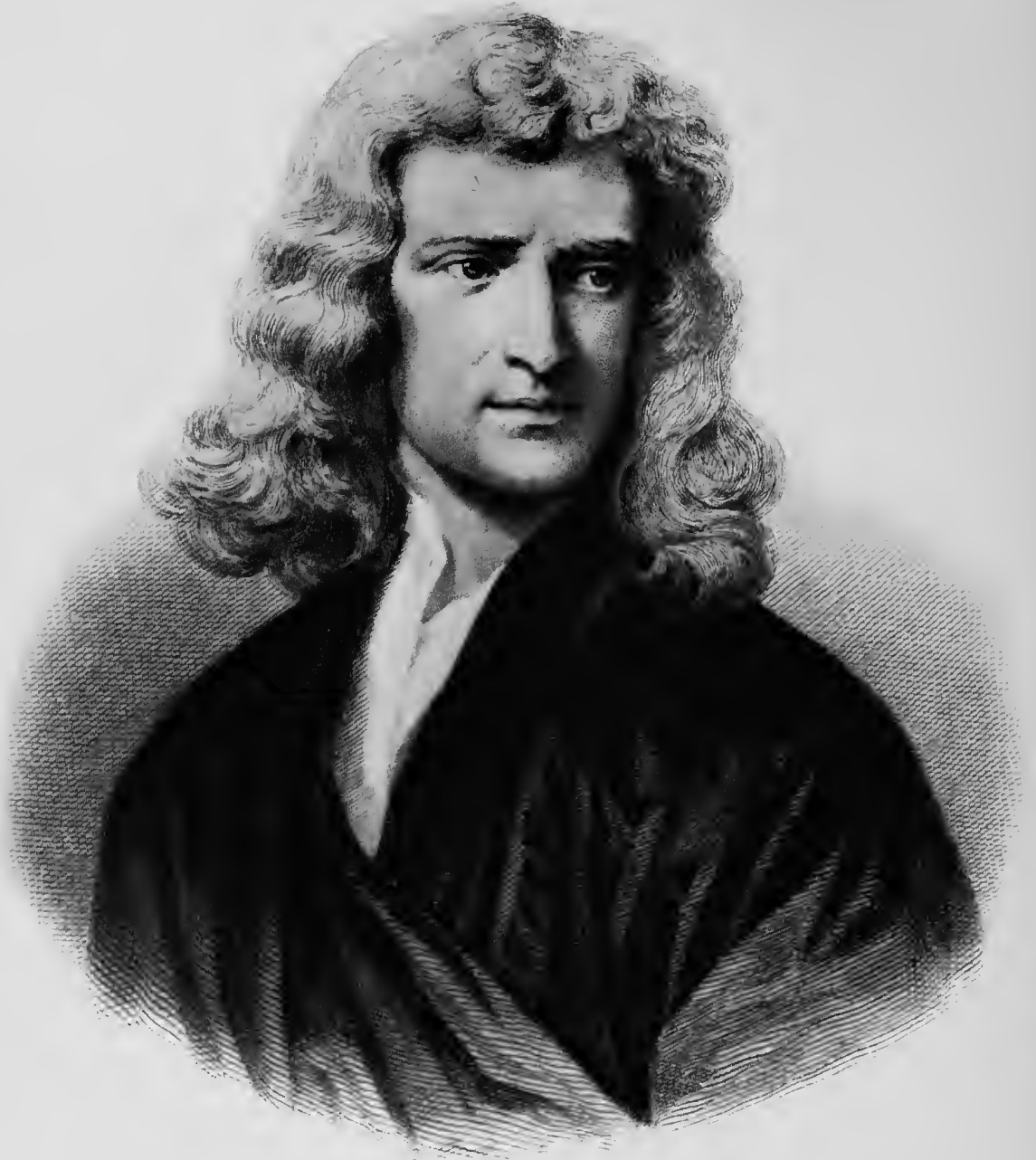


Fig. 15. Prof. Schwarz's illustration of another twisted minimal surface, $1/R_1 + 1/R_2 = 0$.



Is. Newton

"Hypotheses non fingo"

Sir Isaac Newton
1642-1727

Who foresaw the possibility of the new (kinetic) theory of the aether, 1721

New Theory of the Aether. By T. J. J. See.

(Sixth Paper.) (With eleven Plates.)

Part I. The Wave-Theory of Chemical, Explosive, and Vital Forces.

I. The Laws of Nature indicate that Chemical Affinity and Explosive Forces depend on Wave-Action.

General introductory remarks. In the fifth paper on the new theory of the aether (AN 5130) we have treated of the principal molecular forces — such as surface tension (which gives the globular figures to all liquid drops), adhesion, capillarity, cohesion, the tenacity of solids, etc. — but reserved for the sixth paper a more detailed study of the theory of chemical affinity, explosive forces, and the so-called living forces, which depend principally upon chemical action. It has long been believed by chemists that chemical affinity is an electrical phenomenon.¹⁾ Accordingly, if this could be proved it would follow also that explosive forces and the chief vital forces are electrical in character, depending in some way upon the action of waves in the aether.

On account of the great importance of the problem of atomic forces and the profound obscurity in which it has been veiled, we have labored first to make out the nature of the molecular forces. This course was chosen in the hope of finding principles deduced from phenomena under actual measurements of small distances, as in the thickness of soap bubbles, which might enable us to penetrate into the still smaller and more invisible mechanism of the atoms.

Without elaborate argument it would seem fairly obvious that if we could definitely refer such molecular forces as surface tension, capillarity, cohesion, to wave-action, another step in the same chain of reasoning should enable us to grasp the still finer mechanism on which the atomic forces depend.

For experience shows that nature is moderately continuous in her processes; and, judged by the distances at which they act, it is but a step from the molecular forces to the atomic forces. Accordingly the best preparation for a study of the forces operative in the structure of the atoms is the wave-theory of the molecular forces already outlined in the fifth paper. Admitting the probability that the proofs there given of the wave-theory of molecular forces are perhaps yet to be somewhat perfected, we hold nevertheless that so powerful an array of evidence as we have presented justifies our adoption of the wave-theory as a working hypothesis. So powerful an argument drawn from such a variety of phenomena, all mutually confirmatory in character, it seems to me, can only rest upon the basis of substantial physical truth. But in order to strengthen the evidence already adduced we cite the great authority of *Arrhenius*, in the chemical

phenomena of dissociation, Lectures on Theoretical Chemistry University of California, 1904, p. 146:

»In the study of the so-called 'abnormal' vapour densities we have already found that some molecules, for instance those of ammonium chloride, are split up into two (or more) simpler molecules on raising the temperature. This process is called dissociation. The laws of dissociation were first studied by *St. Claire Deville*. Dissociation is a so-called reversible process, i. e. on lowering the temperature the products of dissociation re-combine. A chemical equilibrium exists between the original molecules and the products of their decomposition, and the study of the laws of this equilibrium may be effected by the help of thermodynamics. This study has been very fruitful for theoretical chemistry, and we will, therefore, consider the phenomenon of dissociation a little more in detail.«

»The simplest case of dissociation is that presented by the molecules of iodine, which at low temperatures are composed of two iodine atoms and at higher temperatures are split up into simple atoms, as the molecular weight determinations by *Victor Meyer* (Ber. 1880, 13.394) and *Crafts*, (Compt. rend., 1880, 90.184), have made evident.«

Arrhenius thus distinctly points out that when elements are dissociated, one of the most effective modes of uniting them into molecules made up of more than a single atom is to lower the temperature. In this way, when the longer heat waves are withdrawn, the atomic forces, depending on the shorter waves, become powerful enough to group the atoms into pairs or higher combinations as molecules.

Following the same principles, all the so-called permanent gases have been liquified or solidified under combinations of very high temperatures with very great pressures. Air, oxygen, hydrogen, and finally helium have been reduced to the liquid or solid state, by a process similar to that above outlined by *Arrhenius* as applicable to chemical bodies generally.

In view of these considerations, it is evident, on physical grounds, that the great processes of nature are essentially uniform and continuous. If therefore, we withdraw heat — which is a phenomenon of long wave-action — to enable the atomic forces to assert themselves for the formation of molecules of two or more atoms, it is natural to infer that the cause of the molecular and atomic forces is similar to the heat waves by which they are overcome. It would be remarkable if heat-waves should release forces not due to waves of any kind.

Accordingly, we are led directly to the wave-theory of molecular and atomic forces. And it is very difficult to see how so obvious and simple an argument can be evaded.

¹⁾ Voltaic or dynamic electricity was excited by the force of chemical action in the primitive experiments of *Galvani*, at Bologna, 1790, and their immediate development at Pavia, by *Volta*, who made use of plates of zinc and copper, as in modern batteries.

As *Mossotti* says at the close of the introduction to his celebrated memoir *Sur les forces qui régissent la constitution intérieure des corps*, Turin, 1836:

«C'est un argument qui me paraît mériter beaucoup d'intérêt, parce que la découverte des lois de l'action moléculaire doit conduire les géomètres à construire sur un seul principe la mécanique moléculaire, comme la découverte de la loi de l'attraction universelle les a conduits à ériger sur une seule base le plus beau monument de l'intelligence humaine, la mécanique céleste.»

In alluding thus to *Mossotti's* theory of molecular and atomic forces, published 85 years ago, we think it well to point out that this theory has some similarity to the wave-theory, but also very notable differences which we cannot now go into, except very briefly.

As the particles of material bodies are not in actual contact, *Mossotti* supposes that each is surrounded by an atmosphere of the aethereal medium, which he conceives to be electricity.¹⁾ He assumes that the atoms of the medium repel one another, that the particles of matter also repel one another, but with less intensity; and thus there is a mutual attraction between the particles of matter and the atoms of the medium, under forces which vary inversely as the square of the distance.²⁾

From this theory it follows that when the material molecules of a body are inappreciably near to one another, they mutually repel each other with a force which diminishes rapidly as the infinitely small distances between the molecules augment and at last vanishes. When the molecules are still farther apart, the force becomes attractive. At an intermediary distance the repulsive and attractive forces balance, so that if we try to press the particles nearer the repulsive forces resist our attempt, while if we try to break the body, the attractive forces predominate and hold them together.

The wave-theory presents to our contemplation quite a different picture of the physical world. All forces are attributed to stresses in the aether due to wave-action, and we seek to inquire under what conditions the stresses or forces arise; and we find that boundary conditions exercise the largest influence in changing the velocity and direction of waves, and thus give rise to adhesion, cohesion, capillarity, chemical affinity, and the other molecular and atomic forces.

In his address as rector of the university of Berlin, Oct. 15, 1913, quoted in the fifth paper, section 12 (ii), (AN 5130), Professor *Planck* points out that in the breaking up of the aether waves a limit of smallness or length is finally attained,

¹⁾ «It has long been an hypothesis among philosophers that electricity is the agent which binds the particles of matter together. We are totally ignorant of the nature of electricity, but it is generally supposed to be an aethereal fluid in the highest state of elasticity surrounding every particle of matter» — Mrs. *Somerville*, *Connexion of the physical sciences*, 6th edition, 1842, p. 120.

Sir *Isaac Newton* held somewhat similar views, but could not work out the causes involved to his entire satisfaction; yet he did foresee the possibility of the kinetic theory of the aether, and clearly held that universal gravitation is due to impulses of this subtle aethereal medium. As we now are able definitely to establish the cause of universal gravitation, by following the sagacious suggestions of *Newton* we deem it only just to include the portrait of this most illustrious philosopher as a frontispiece to this sixth paper on the New (Kinetic) Theory of the Aether.

²⁾ «Professor *Mossotti* has recently shown by a very able analysis, that there are strong grounds for believing that not only the molecular forces which unite the particles of material bodies depend on the electric fluid, but that even gravitation itself, which binds world to world and agent which pervades creation.» — Mrs. *Somerville*, *Connexion of the physical sciences*, 6th edition, 1842, p. 121.

It will be noted that in these papers, we have not treated of the repulsive forces of the particles of matter in liquids and solids, as *Mossotti* has attempted to do, except to imply that the resistance to compression probably depends on short wave motions of the same type to which molecular forces are due.

owing chiefly to the finite size of the atoms of matter. Have we not here an indication of the short waves which act to prevent compression of solids?

1. As we have seen in AN 5048, p. 140-41, resistance breaks up long waves into shorter ones. Now if the process of wave disintegration finally stops, as *Planck* says it does, there must be an influence at work to counteract the breaking up of the waves.

2. This can only be the limiting wave lengths corresponding to the dimensions of the atoms. To make the waves shorter would tend to disrupt the aether between the atoms. And as the forces required for the disruption of a medium 68932160000 more elastic than air in proportion to its density, would be nearly infinite in magnitude, vast stresses always are at work between the atoms and molecules, both attractive and repulsive.

3. The central stress yields enormous power of cohesion, and thus the hardness of diamond and the tenacity of steel become intelligible. On the other hand, the finite dimensions of the atoms limit the reduction of the wave lengths, by forces equally powerful, and hence the incompressibility of solids and liquids.

As *Laplace* was careful to point out, these molecular and atomic forces are sensible only at insensible distances, which suggests that wave-action under the enormous elasticity of the aether as the source of the power.

(i) As chemical affinity is shown by laboratory experiments to be promoted and increased by the action of ultra-violet light, this fact of observation must be held to be a proof that it depends of wave-action.

We cite the following experiments as well calculated to illustrate this subject. In each case the interpretation appears to be simple and unique, and thus the experiments are well adapted for disclosing the nature of the chemical changes involved.

(a) Decomposition of chloride of silver or nitrate of silver by light in photography. This is a very familiar phenomenon and has been known since the days of *Daguerre*, *Talbot*, and *Herschel*, who first developed photography over 80 years ago. In this experiment, the chloride of silver, either recently formed or carefully protected from the shorter waves of light, is exposed to the action of common light, which contains the waves of the whole visible spectrum. As is well known a partial decomposition of the silver chloride results from the action of the light; and the action of the short waves is so much more powerful than that of the long waves,

that when a plate has been exposed and is not yet developed or fixed by the action of the hyposulphite of soda we may examine the plate under a light transmitted through red glass, which allows only the longer waves to pass. The hyposulphite of soda dissolves readily chloride, bromide, and iodide of silver, and has been generally used in photography since the days of *Daguerre*, 1840.

By the action of the shorter waves of light on the film containing the salt, $AgCl$, the chlorine is separated and the silver partially precipitated, so that a change of color from white to blue occurs in the film; and as the change over the plate is proportional to the action of the light on that part, photography gives the shades, or aspects of objects about as they appear to the eye in common vision.

The very chemical change which we use in photography we utilize in our vision; but the retina of the eye, being a living film, has its power of reaction renewed by certain natural processes, and only the images are transmitted to the brain, with the chemical changes continually in progress. Thus if chemical action be electrical, it is undoubtedly true, as Sir *Oliver Lodge* remarks, (*Aether of Space*, 1909, p. 25) that »Sight is probably a chemical sense«. Hence the eye is sensitive to aether waves of a certain length, and capable of transmitting their chemical or mechanical effects, in producing images, to the brain.

(b) A considerable variety of chemical solutions are used in photography, but the general effect is always the same, and hence we content ourselves with the simplest outline of the changes, without going into further details. In his thoughtful work on the Correlation and Conservation of Physical Forces, p. 115, (New York, 1883) the English physicist Professor *W. R. Grove*, of the Royal Institution, London, gives the following account of the effects of light upon bodies:

»The effect of light on chemical compounds affords us a striking instance of the extent to which a force, ever active, may be ignored through successive ages of philosophy. If we suppose the walls of a large room covered with photographic apparatus, the small amount of light reflected from the face of a person situated in its centre would simultaneously imprint his portrait on a multitude of recipient surfaces. Were the cameras absent, but the room coated with photographic paper, a change would equally take place in every portion of it, though not a reproduction of form and figure. As other substances not commonly called photographic are known to be affected by light, the list of which might be indefinitely extended, it becomes a curious object of contemplation to consider how far light is daily operating changes in ponderable matter, how far a force, for a long time recognized only in its visual effects, may be constantly producing changes in the earth and atmosphere in addition to the changes it produces in organised structures which are now beginning to be extensively studied. Thus every portion of light may be supposed to write its own history by a change more or less permanent in ponderable matter.«

(ii) The experiments of Sir *Humphrey Davy* in the decomposition of the alkaline earths under the action of electric currents explained by the wave-theory.

A great epoch in the history of experimental chemistry was made by Sir *Humphrey Davy's* decomposition of the

alkaline earths, in the first decade of the 19th century. We shall attempt to show the relationship of these experiments to the wave-theory, and thus make somewhat clearer the nature of the chemical forces, which *Davy* overcame in these celebrated discoveries, by means of the action of the electric current.

When *Davy* began his career, the discovery of the decomposition of chemical substances by voltaic electricity had already begun to excite the interest of men of science; but although *Davy* developed the method most powerfully, and achieved brilliant discoveries, and more than a century has since elapsed, we still have no mechanical or dynamical theory of *Davy's* process of electrolysis.

In the third paper on the new theory of the aether we have proved that an electric current consists in a series of waves, usually quite long in character. Now if such waves be intense, the resulting rapid and violent agitation should obviously be well suited to separating or breaking up the molecules of a compound into its constituent elements. This is exactly what Sir *Humphrey Davy* did.

He had at his command a battery of 400 five inch plates, and one of 40 plates a foot in diameter. With these batteries were conducted his experiments on the alkaline earths, which resulted in the discovery of potassium and sodium.

In 1805 *Davy* began to use also very high temperatures, and in 1806 found that electro-chemical phenomena were explicable by one general law, the acids appearing at the positive, the bases at the negative pole. He generalized his conclusions by stating that hydrogen, the alkalis, earths, metals and certain oxides are attracted by negatively, and repelled by positively electrified metallic surfaces.

He then proceeded to investigate the law of electro-chemical action, and concluded that electro-chemical combinations and decompositions depend on electric attractions and repulsions; and that both »chemical and electrical attractions are produced by the same cause acting in the one case on the particles, in the other on the masses.« The discovery of potassium and sodium was made by electrical decomposition, in October, 1807.

Since we have already shown that an electric current consists of an ordered system of waves of various lengths, we may now be able to throw some new light on the composition and decomposition of bodies.

1. When the long electric waves are powerful and aided by partial breaking up into the shorter waves of heat, the wave agitation of appropriate length may become great enough to eject parts of a compound molecule to such distance that the atomic forces no longer can retain it in stability; in the rapid successions of the oscillations, some of the atoms fly away, anywhere along the line of the electrolysis, but with opposite elements appearing at the poles for the reason set forth in paragraph 6 below.

2. The atoms which are of one type, by their periodicities bearing a certain resonance to the waves, will naturally collect at one pole of the battery; those of very different periodicities and having a different resonance, will naturally gather at the opposite pole, in accordance with observation.

3. It is only when the electric waves, which are ordered in a certain way along the line of the current, become of a

certain intensity, aided by the shorter haphazard agitations called heat, that electrical decompositions can be expected to occur. Otherwise the shorter and more powerful waves which cause chemical forces are predominant.

4. It is to be observed that in electrolysis the electrolyte acts as a conductor, the circuit being completed by the wire connecting the poles. Around the wire the amplitude of the electric waves follow *Biot and Savart's law*

$$I = Ki/r \quad A = VI = V(Ki/r). \quad (1)$$

5. This makes the amplitude greatest next to the wire, and as the poles are terminals of the wire, it naturally follows that decomposition occurs where the wave agitation is a maximum, at the poles of the battery.

6. And as the waves lie flat in the planes through the axis of the wire, the separation will go on according to the rotation in the wave flow — one pole emitting the waves, the other receiving them — and thus the elements are sifted by the movement of the waves, according to poles. In the fifth paper, section 10, we have explained tenacity by increased surface effects due to wave-action at the boundary. Thus we have also solved the problem of cohesion of like elements in electro-plating, heretofore so difficult to natural philosophers.

(iii) Decomposition of water into oxygen and hydrogen gases by the action of an electric current; these elements again united by the action of short waves.

If we put the two poles of a battery arranged to terminate in platinum wire or sheet, into water slightly acidulated with sulphuric acid (H_2SO_4), so as to render the liquid a good conductor; and let the battery act we shall immediately perceive small bubbles of gas accumulating at each pole. When the experiment is arranged as shown in *Regnault's Elements of Chemistry*, (Philadelphia, 1860, p. 110), each pole being inserted in a tube which collects the liberated gas, it is found that the volumes of the gases released by electrolysis are in the ratio of 2 to 1, two volumes of hydrogen to one of oxygen, as shown in the cut.

It is found that the gas disengaged at the positive pole, is oxygen, that at the negative pole hydrogen — the volumes of gas developing in the precise ratio of 2 to 1, as shown in the figure. Thus one volume of oxygen serves for two of hydrogen in the formation of water, H_2O .

If now when the battery has decomposed the water into its two constituent gases, we collect the separated gases in one vessel, without any admixture of air or other foreign gases, the separate molecules of hydrogen and oxygen will be present in just the proportion to form water. And when the gases have become equably diffused, after mixing, an electric spark generated within the vessel as from the wire terminals of a battery, not quite in contact, where the gases are freely mixed, yields the sudden impulse for the union of the atoms of hydrogen with those of oxygen to form water vapor. It collects as drops on the walls of the vessel, and

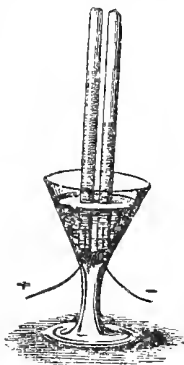


Fig. 1. Decomposition of water into oxygen and hydrogen by the action of an electric current.

trickles down, the amount being exactly equivalent to that decomposed by the original current.

Accordingly, by this experiment we learn that violent long wave agitation due to a current, may produce decomposition of water into its elements hydrogen and oxygen. And when the gases are carefully collected, and mixed, an electric spark, by the action of its short waves may again unite them into water.

If any free hydrogen is present in the atmosphere lightning operates to form from it with free oxygen a small quantity of water vapor. It is supposed that by the combustion of telescopic meteorites, billions of which are burnt up daily in the higher parts of the atmosphere, some free hydrogen is diffused in the air; and the action of lightning thus replenishes to some extent the water lost by permanent absorption in the rocks of the earth's crust. Whether the new water formed by lightning is equal to that lost from our oceans by absorption and crystallisation in the rocks of the earth's crust is not yet known; but it is supposed that during the historical period the two tendencies approximately balance each other, so as to maintain a nearly constant quantity of water on the earth.

(iv) *Priestley's* experiments for producing mercuric oxide (HgO) and the separation of these elements by the use of higher temperature illustrates the wave-theory.

On Aug. 1, 1774, *Priestley* discovered that the red oxide of mercury (HgO) evolved a gas when heated to a considerable temperature. The gas was oxygen and the residue left behind was metallic mercury.

In these celebrated experiments it was found that when metallic mercury in contact with air is heated to a temperature just below its boiling point, it gradually becomes covered with a red scale of mercuric oxide. And when this red scale is collected and subjected to considerably higher temperature, the result is the separation of the oxide into its constituent elements, oxygen gas, and metallic mercury.

Now this experiment in the composition and decomposition of a well known metallic oxide is typical of many oxides, and similar compounds.

1. When heat or molecular wave agitation is applied in not too violent a form, chemical combination results.

2. But when the molecular agitation is made much more extreme, by the use of higher temperatures, the compound is broken up. This is because the chemical affinity, under short wave action, is able to form combinations, when the heat agitation due to the longer waves is not too violent. But the moment the longer wave agitation becomes more extreme, the atomic hold is released, and the elements fly asunder, to form vapors and gases.

It is difficult to imagine a more convincing illustration of the wave-theory than that here presented to our contemplation. The chemical processes appear to be simple, and we can see the combination taking place, by moderate wave agitation, but released by the more violent form of molecular agitation incident to higher temperature.

This rule, for using changes of temperature for effecting chemical combinations and resolutions, has been so widely recognized by chemists that it may be said to be the most general process of that science. When a chemical body is to be broken up, we first try change of temperature. If that

does not succeed, we try the electric current. And frequently we use both high temperature, and the electric current, or some form of electric furnace, as developed about 30 years ago by the celebrated French chemist *Moissan*.

Of late years electro-chemistry has become a distinct branch of practical science, of the greatest importance in the arts, and industry. If the above line of reasoning be admissible, it follows that electro-chemistry depends on wave-action, by which artificial combinations of metals are effected usually under the joint action of a powerful current and a high temperature. The molecular structure of the atoms is so interwoven that when such mixtures as phosphor-bronze, aluminium-bronze, nickel-steel, or vanadium-steel are effected, they are found on cooling to have extraordinary strength, and therefore become extremely useful in the mechanical arts.

(v) Other examples of chemical combinations under the action of spongy platinum, or of ultra-violet light, which has short wave length.

1. It is well known that metallic platinum, especially the black or spongy platinum, condenses gases upon its surface, and furthermore the condensation is attended by the development of heat. This material is celebrated for occluding hydrogen or oxygen; and it has been inferred from the development of heat noted, that the spongy platinum by its cavernous structure acts to cause partial combination of hydrogen and oxygen similar to that noted in flame or ordinary combustion: that the spongy platinum probably does not itself directly produce the chemical combination, but that as the molecules of the gases are absorbed in the cavernous metallic structure, their mutual reactions are complex and condensation of the elements of the gas results. Probably this raises the temperature somewhat, — the result of the confined molecular agitation when the inrush of gases is first effected, — and then the power of absorption of the platinum increases with the rise of temperature.

2. The experiments in thermo-chemistry by *Berthelot* show that heat usually develops in chemical combinations.

It is found that ozone is formed in small quantities when water is decomposed by the electric current. It is formed in the air by lightning discharge, or near a frictional electric machine. In the conversion of oxygen into ozone, the volume of gas contracts by one-third, three molecules of oxygen furnishing two molecules of ozone thus:



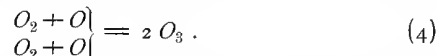
When the ozone is again converted into oxygen, which may be done by heat, — the decomposition at 200° C. being very rapid — the original volume is restored. The use of heat to break up ozone into oxygen, perfect decomposition occurring before 300° C. is reached, shows that the triple molecule O_3 is rent asunder by the long wave agitation due to high temperature.

According to *Berthelot* no less than 29600 units of heat are evolved from 32 grammes of oxygen in the reaction:



And a corresponding amount of energy must be expended in the formation of ozone from ordinary oxygen. The conversion of ozone into oxygen, however, takes place in two

stages: first, the molecule O_3 is converted into $O_2 + O$; and second, the two free atoms of oxygen form two molecules of ozone, thus:



Oxygen has considerable affinity for itself in the form of common oxygen, O_2 , but relatively little for the third atom of oxygen, in the form of ozone. Hence ozone is a great oxidizer. The separation of the atoms of the oxygen molecules from each other involves 29600 heat units for 32 grammes of oxygen; but in the breaking up of ozone O_3 into $O_2 + O$ only a small amount of energy is required.

3. This use of heat for the formation of new bodies was first recommended by *Robert Boyle*, in the *Sceptical Chemist*, 1661. The modern science illustrates this theory by hundreds, yea, thousands of examples, of which we cite merely simple types. But it is only since the epoch of *Lavoisier* that the nature of combustion and the part played by oxygen has been understood.

It follows from the modern doctrine of energy, that if we can determine the heat evolved in combustion or any similar process, we have a numerical measure of the energy which must be expended to effect the corresponding decomposition of the elements previously united. Yet sometimes this energy may be made effective in one way, sometimes in another.

4. As far back as 1775 *Torbern Bergman* of Upsala wrote a dissertation on elective attractions, as he called affinity, and set forth that the compounds formed by the admixture of reagents depended on the sum of their attractions. It was *Lavoisier* (1743-1794), however, who gave a new spirit to chemistry, by devising methods for throwing new light on processes long known, but never before clearly understood. His theory of oxygen was not indeed adopted by *Berthollet* (1748-1822), yet it finally prevailed after the establishment of the mechanical theory of heat.

5. The discovery by *Faraday*, in 1834, that the decompositions effected by the voltaic current indicate the quantity by weight in which the elements combine, or the weights of the atoms according to the atomic theory, at once increased the probability of the hypothesis that the same operations are at work in both chemical and electrical phenomena. Out of this theory of electrolysis grew important developments in electro-chemistry. And when it was shown by *Laurent* that hydrogen may be substituted by an equivalent of chlorine or bromine, and the dualistic theory of positive and negative elements was shaken, *Berzelius* and others tried to reconcile this substitution of an electro-positive for an electro-negative element, by certain modifications of the dualistic theory, some compounds of oxygen as a fourth element being both an oxide and a chloride. The primitive distinctions for simple elements thus become modified for compounds.

(vi) Chemical affinity under wave-action related to explosive forces.

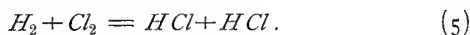
We now consider the chemical action of light and heat, which represent shorter waves than are present in the electric current.

1. It is noted that hydrogen does not spontaneously enter into reaction with any of the elements, though it has

a powerful affinity for some of them, such as oxygen. Accordingly when hydrogen and oxygen are mixed nothing occurs; but if a burning taper or a heated wire be applied, or still better an electric spark, a violent explosion follows, and the gases are united to produce water, $2H_2 + O_2 = 2H_2O$.

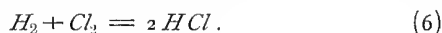
2. As energy is thus given out in the formation of water, it will naturally follow that energy must be expended on water to dissociate it into its constituent gases, whether by violent heat or the wave agitations of an electric current. This composition and decomposition of water thus beautifully illustrates the wave-theory.

3. Again, chlorine gas Cl_2 , and hydrogen gas H_2 , are each biatomic, and without action upon each other in the dark. But if the mixed gases be exposed to a bright light, especially a beam of ultra-violet light, or violently agitated by the passage of an electric spark, the gases unite with explosive violence to form hydrochloric acid. The reaction is shown to be:



Evidently the formation of hydrochloric acid gas is preceded by the separation of the two atoms of the chlorine molecules, and of the two atoms of hydrogen in the hydrogen molecule, from each other; which calls for the expenditure of some energy; then follows a greater evolution of energy in the formation of HCl , or of H_2O in the case of water considered above.

4. The general result is that more energy is given out in the formation of the more stable compounds. The atoms of hydrogen have less affinity for themselves than for chlorine, and the chlorine has less affinity for itself than for hydrogen. Hence under wave agitation the mixed gases undergo the changes shown by the formula:



As soon as this change is started in a few molecules, the agitation thus set up spreads to the whole mass, and all the molecules are transformed into new chemical bodies, — namely water vapor, as described in paragraph 2 above, or hydrochloric acid gas, paragraph 3.

In the wave-theory of physical forces it is believed that the energy exhibited in chemical reactions is drawn from the unlimited storehouse of the aether everywhere pervading the universe. The chemical reactions therefore involve simply an exertion of this unseen power when the atomic rearrangement occurs, and the resistance to the passing waves is suddenly changed. The result is the exertion of unseen and unsuspected forces which frequently are explosive in character and often extremely terrible, as in dynamite, and other forms of nitroglycerine, the tri-nitrotoluenes, and other high explosives.

2. Geometrical Arrangement of the Atoms as conceived by *Regnault* and others for explaining Crystals.

(i) The forces underlying the crystalline forms referred to the aether.

¹⁾ In the outline of the wave-theory of magnetism, and electro-dynamics, AN 5044, p. 73-74, we refer to the collapse or expansion of the medium when the waves interpenetrate. The balance of the kinetic equilibrium of the medium at the same time involves vast exchange of the aetherons. This essential condition of the kinetic equilibrium is there assumed, but it should be borne in mind by those who may be inclined to overlook the foundations of the kinetic theory, which rest on incessant molecular exchange.

It has long been recognized by chemists that the atoms in certain molecules occupy definite relative positions. This is inferred partly from the chemical formulae of the substances, partly from the forms of the corresponding crystals, the study of their symmetry and the isomorphisms, both of special and of general physical properties, as tested by optical and magnetic methods. Indeed the study of crystallography is a very extensive branch of science, and much improvement has become possible of late years, since the Swiss physicist *Laue* began the use of X-rays for exploration of the internal structure of crystals.

This subject is now so extensive that only a general outline of results is permissible in a paper on the aether. We shall give therefore merely a sketch of the method by which the problem is attacked.

In the fifth paper on the new theory of the aether we were enabled to throw light on the powerful refractions, dispersions, and other disturbances experienced by the aether at the boundaries of bodies, by which this medium is placed under extraordinary stress, and we made it probable that the resulting reactions produce the observed hardness and tenacity of bodies.

1. It was shown in the first paper that the aether is 689321600000 more elastic than air in proportion to its density. Accordingly, if the waves traversing the universe be concertedly distributed, by a systematic arrangement of the atoms within the molecules, and of the molecules within crystalline bodies, — such a medium is well calculated to give crystals not only special and geometric forms, but also great hardness and other physical properties which have long caused crystals to be associated with magnetism, as offering extraordinary molecular, optical, magnetic and other physical properties.

2. We have also seen that magnetism depends upon concerted wave-action,¹⁾ and shown the physical and geometrical relationship of the waves to the electric current. And it is evident that if such powerful actions and reactions, which we can control in magnetism and electrodynamics, are due to concerted wave-action; then a corresponding, though differently arranged, stress of the aether should exist about crystals, in view of the atomic arrangement long recognized to exist, and made evident to the senses by *Laue's* X-ray photographs of crystalline structure.

3. We may say that crystals, so far as optical and physical properties are concerned, should present to our contemplation a kind of generalized magnetism. And this we find to be a fact, as shown by the elaborate researches of crystallographers such as *Voigt*, *Laue*, and others. The crystals have various axes of symmetry, and physical, optical and magnetic properties corresponding to the geometrical form of the crystals.

4. It is true that crystals of different substances, with the same geometrical form, have different physical, optical, and magnetic properties. This difference doubtless depends

on the molecules which make up the crystalline structure. Molecules in which the atoms are held together by powerful affinities will naturally give rise to hard crystals; and thus, as some substances have great affinities between their atoms and molecules, strong resistance by the crystalline mass does not surprise us.

5. If the crystal is easily dissolved by heat, we should infer that increased agitation by these long waves tend to throw the atoms and molecules beyond the range of the shorter waves holding the atoms to the molecules, and the molecules to one another, for the make up of the crystal. If the crystal be difficult to dissolve by heat, then the opposite conclusion may be assumed.

6. Accordingly, the study of the physical properties of crystals will throw light on the properties of the molecules, and vice versa. Optical and magnetic properties bear similar relationships, but as yet they are little understood.

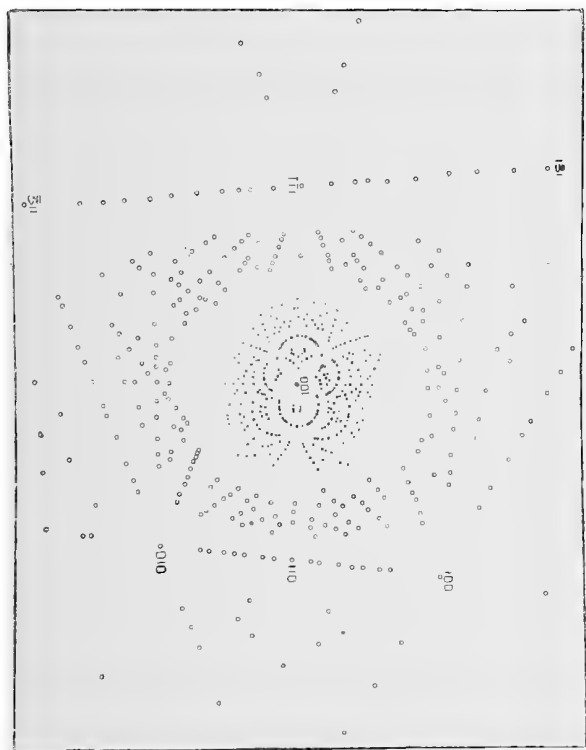


Fig. 2. Illustration of the *Laue* Radiograph of the arrangement of molecular structure in calcite (Iceland-spar), from an article by *R. W. G. Wyckoff*, *Amer. Jour. of Science*, Nov. 1920, p. 321.

(ii) Exhibition of the theory of crystalline structure conceived by *Regnault*.

The celebrated French chemist *Henry Victor Regnault* was one of the most careful and exact investigators of the middle of the 19th century. His *Elements of Chemistry*, in two volumes, (English translation by *Betton*, Philadelphia, 1860), not only is a model treatise on chemistry, but also contains very profound and sagacious remarks on the physical properties of all elements and their compounds, — so that it

lays the foundations of physical chemistry since more fully developed by *Berthelot*, *Moissan*, *Ostwald*, *Van't Hoff*, *Arrhenius* and others.

This is not the place to go into the details of chemical theory, but we may properly reproduce the sagacious outline of crystalline structure conceived by *Regnault*, and since elaborated, from different points of view, by *Voigt* and his followers, and recently confirmed by the photographic X-ray researches of *Laue* and the numerous investigators who have taken up his new methods for exploring crystalline structure.

Regnault begins his theory of crystals by the discussion of divisibility, and shows that however fine the mechanical division may be carried, it falls short of molecular and atomic sizes. In this connection it is well to recall *Newton's* remarks in the *Optics*, 1721, p. 365, »that it is difficult to conceive of the agency by which attraction is produced, when two smooth bodies are in very close contact, yet really touch or approximately touch only in a few points«. In the fifth paper on the new theory of the aether we built up a theory of molecular forces based on wave-action sensible only at insensible distances, because the waves are very minute.

After examining very profoundly the six systems of crystals and working out the numerical relations, often extremely simple, which exist between the faces, axes, and dimensions of the crystals, *Regnault* comes finally to the hypothesis of molecular decrements, (p. 44).

Regnault's reasoning quoted in detail:

»The laws of symmetry which exist between all the crystalline forms of the same substance, are very easily explained by starting with certain hypotheses on the form of the crystalline molecules and their mode of grouping. It is useful to study, at this time, these hypotheses, not only because they give us, as it were, material explanation of these laws, but also because, under their guidance, *Havy* discovered, by induction, the laws of crystallography, which he afterwards verified by measurement. Let us take a mineral substance, as galena, which crystallizes according to the regular system, and assumes many forms of this system. Let us, in the first case, examine a cubic crystal of galena (fig. 3a, plate 1). If we endeavour to fracture it by violence, or by applying a cutting edge, in various directions, we shall soon find that the crystal cleaves, very readily, in three directions parallel to the faces of the cube, whilst it resists all others. The fragments thus detached from the cubic crystal, as well as the remaining nucleus, have all the forms of rectangular parallelepipeds. This mechanical division may be carried very far, for the little fragments may be further divided, and the microscope will show the most minute dust to be composed of rectangular parallelepipeds. We are naturally led, by induction, to infer that the ultimate crystalline particles, that is, those which resist cleavage, will affect the same form. These particles are therefore called integral crystalline molecules, each one of which is formed of a great number of chemical molecules, separable, perchance by other mechanical means, and grouped together by means of forces hitherto unexplained.«

»Let us now take an octahedral crystal of galena (fig. 3b, plate 1). If we endeavour to cleave it in a direction parallel to its faces, we shall not succeed. We obtain, on the contrary,

a very ready cleavage in the direction of planes equally inclined toward the four faces comprising the solid angles of the octahedron. By effecting these successive cleavages at all the solid angles, we shall soon destroy its octahedral form and obtain a nucleus in the form of a rectangular parallelepipedon, which continued cleavage will diminish, but not alter its cubical form. We therefore conclude that the crystalline molecules of the octahedric crystal, as well as those of the cubic crystals, are small rectangular parallelepipedons.«

»Let us select, in the last place, a crystal of galena presenting the form of rhombic dodecahedron (fig. 3c, plate 1). We shall again find that this crystal does not cleave in a direction parallel to its faces. The only natural cleavages are in the direction of planes equally inclined toward the faces of the 4-sided solid angles *A*. If we effect successive cleavages on the six 4-sided solid angles, we shall destroy the faces of the dodecahedron, and obtain nuclei having the form of rectangular parallelepipedons, resembling in appearance and the physical properties of their faces the nuclei we obtained from the cubic and octahedric crystals. We are therefore led to conclude that the crystalline molecules composing the dodecahedric crystal have the same form of rectangular parallelepipedons as those of cubic and octahedric crystals.«

»But what is the ratio of the lengths of the sides of this primitive parallelepipedon? We will observe that the three directions of cleavage which lead to this parallelepipedon present no feature distinguishing them from each other: they are equally easy, and the faces they produce have the same lustre. We are therefore induced to admit that the three dimensions of the parallelepipedon are equal, and that it is consequently a cube. The crystalline particles of galena are therefore cubes, and, if induction has not deceived us, we can reproduce, by the juxtaposition of these small elementary cubes, the cube, the octahedron, the rhombic dodecahedron, and, in short, all the crystalline forms of galena. We are about to show that this can be readily effected.«

«In order to render the fact more apparent, we shall greatly exaggerate the dimensions of the small elementary cubes. This we may do without invalidating the accuracy of the demonstration, for we only consider the tangent planes, the directions of which remain the same, whatever may be the dimensions of the integral crystalline molecules, provided that their forms and mode of grouping be the same. The cubic crystal will be directly formed by the juxtaposition of the elementary cubes. Let us place, on the several faces of the cube *abcdef*, (fig. 4a, plate 2), strata of cubic molecules, arranged as they are in the cubic crystal itself; but suppressing, in each stratum, a row parallel to each side of the face of the cube, so that each new stratum shall contain, on each side, one row less than the preceding. It will be readily seen that we thus obtain the rhombic dodecahedron (fig. 3c, plate 1). Fig. 4a proves this fact: in order not to complicate this figure and destroy its general aspect, we have suppressed the lines which mark the separation of the juxtaposed elementary cubes; but we have indicated them on fig. 4b, plate 2, which represents, on a greater scale, one of the solid angles of the new formation.«

»By supposing the cubic molecules to be infinitely small, the asperities arising from the subtraction of the rows will disappear, and the faces of the dodecahedron will become perfectly plane. We may therefore say, that the rhombic dodecahedron is derived from a cube by the decrement, on the faces of the cube, of a row in length and a row in height.«

(iii) *Regnault's* theory of the removal of rows of elementary particles.

»Let us now suppose that from each new stratum we remove 2, 3, or 4 rows of elementary particles; it is evident that we shall produce, on each face of the cube, 4-sided pyramids, of which the elevations will be $\frac{1}{2}$, $\frac{1}{3}$, or $\frac{1}{4}$ of the axis of the cube, and that we shall obtain the various tetrahedrons (fig. 3d, plate 1) mentioned in the paragraph above. We shall thus have effected a decrement of 1 row in height, and 2, 3, or 4 rows in length.«

»Let us now take a large cubic crystal (fig. 4c), and, starting from the centre of one of its edges, and symmetrically as regards its conformation, remove a molecule from the first upper stratum, 2 from the second, 3 from the third, we shall obtain a tangent truncation of the solid angle of the cube. Repeating the process on each of the angles, we shall have a regular octahedron (fig. 4d) formed by the decrement of a row in length, and a row in height on the angles of the cube.«

»Let us now return to our cube *abcdef* (fig. 4e), and add to its faces additional strata of cubic molecules; but let us make, following the edge *fe*, a decrement of 2 rows in length and 1 in height, and, following the edge *fd*, a decrement of 1 row in length and 2 in height, we shall obtain the pentagonal dodecahedron (fig. 4e). We have omitted in this figure the lines of separation of the small elementary cubes; but these lines are seen in the fig. 4f, which represents, on a larger scale, the anterior portion of fig. 4e. The pentagonal dodecahedron is a hemihedral form, a hemi-tetrahexahedron (Fig. 3d): the other hemihedral forms of the regular system are obtained in the same manner, by unsymmetrical decrements on similar edges.«

»It will be easily seen, without multiplying examples, that we can reproduce, by analogous additions or subtractions, all the figures of the regular system.«

»It can be shown that all the forms of the second system of crystallization may be constructed with crystalline molecules having the figure of a right parallelepipedon, with a square base, but of which the elevation is not equal to the length of the sides of the base; the ratio between this elevation and the sides of the base being always identical in the same substance, but differing in different substances.«

»Let us take a crystal having the form of a right prism with a square base, and add to its base strata of crystalline molecules, with a decrement of a row in length and a row in height in the direction of the sides of the base: we shall obtain a square-based pyramid, of which the elevation will present, to the sides of the base, the same ratio as the homologous lengths of the crystalline molecule. Treating the inferior base of the prism in the same manner, we shall obtain a right square-based prism, terminated by two pointings, which, united by their bases, form a square-based octahedron. Assuming this octahedron as the primitive octahedron of the

substance, its dimension will immediately indicate those of the integral crystalline molecule.«

»We may construct on the same base other 4-sided pyramids by making decrements of 1 row in length, and 2, 3, or 4 rows in height. We shall thus have octahedrons with square bases, more and more acute, of which the elevations will be 2, 3, or 4 times as great as that of the primitive octahedron. If, on the contrary, we make a decrement of only 1 row in height, and 2, 3, or 4 in length we shall obtain octahedrons more and more obtuse, of which the elevations will be $\frac{1}{2}$, $\frac{1}{3}$, or $\frac{1}{4}$ of that of the primitive octahedron. We can therefore construct, with the same integral molecule, an indefinite series of obtuse and acute octahedrons of the same class, but which will all possess this property, that, when referred to the same base, their elevations will be to each other as the very simple numbers $1:2:3:4\cdots$ or $1:\frac{1}{2}:\frac{1}{3}:\frac{1}{4}\cdots$ «

(iv) *Regnault* shows that other forms result in a similar manner.

Regnault next considers a right prism, with a square base, and finally shows that a similar mode of generation is applicable to the hexagonal and even the most complex systems of crystallization.

»Starting from a point in one of its vertical edges, and symmetrically as regards this edge, let us subtract 1 row from the first stratum, 2 from the second, 3 from the third, and so on; in short, let us operate on this prism, as we did upon the cube to obtain the regular octahedron. We shall thus obtain an octahedron which will be the octahedron of the second class of the primitive octahedron, and of which the faces will have the direction of the edges of the latter. By subtracting a row in length and 2, 3, or 4 rows in height, we shall have the series of acute octahedrons of the second class. Lastly, we will obtain a series of obtuse octahedrons of the second class, by subtracting 1 row in height and 2, 3, or 4 rows in length.«

»In the entire, or holohedral forms, of the hexagonal system, we must take the regular 6-sided prism as the integral crystalline molecule. By means of this same prism, we can, by suppressing the decrements according to a certain law, construct the hemihedral forms of the same system. It is, perhaps, more easy to consider these last forms as constituted by integral molecules, hemihedral themselves, and having, for example, the form of the primitive rhombohedron. We shall merely show how scalenohedrons may be derived, in this manner, from the primitive rhombohedron having the same lateral edges. Fig. 4g represents this mode of generation of the scalenohedron (fig. 3e) of carbonate of lime: this scalenohedron has a principal axis treble of that of the primitive rhombohedron having the same lateral edges, and is frequently found in this substance. It is enough to place, on each face of the primitive rhombohedron $abcde$, strata of molecules similar in form to this rhombohedron, by effecting on its lateral edges a decrement of 2 rows in breadth and 1 row in height. The lines of separation of the elementary rhombohedrons are not seen in fig. 4g, but they are clearly exhibited in fig. 4h, which shows, on a larger scale, the upper courses of fig. 4g.«

»If we effect a decrement of 1 row in breadth and 1 in height, we should obtain a scalenohedron which, with the same secondary axes, would have a principal axis double of that of the primitive rhombohedron.

»In the fourth, fifth, and sixth systems of crystallization, the integral molecule will be a parallelepipedon, of which the elements may be determined, from those of the octahedron, chosen as the principal. At one time, the small generating solids will be the integral molecule itself; at others, they will be formed by definite aggregation of these molecules. Fig. 4i is an example of the angular decrement of one of the complex generating solids $abcdefg$. The faces thus formed, either on the edges or on the angles, will have different inclinations, which may be indefinitely varied, by varying the mode of composition of the generative solids themselves: but all these faces will present this common character, that the lengths included by them on the homologous axes will be proportional to whole numbers. This is the general law proved by observation, and to which we have already frequently referred.«

(v) The wave-theory of crystalline structure and forces illustrated by the phenomena exhibited by a grating.

The above reasoning of *Regnault* has been dwelt upon at length, because it seemed simple and well calculated to bring to light the molecular conditions and forces operative in crystalline arrangement.

There is another familiar illustration which may now be used to illuminate the effect of crystalline structure. We refer to the grating. It is to be borne in mind that crystals are productive of the most beautiful exhibitions of optical phenomena. Thus it is desirable to point out the analogy with the grating, by which classified wave arrangement is produced, according to special distribution and wave length, because this, with the molecular structure already described will explain the color phenomena in crystals.

A grating consists of a metallic surface ruled in parallel lines by means of a very fine engine, which will enable the lines to be drawn exactly parallel and on equal distance apart. The finest gratings heretofore made are those constructed by *Rowland* at Baltimore and *Michelson* at Chicago. To carry out this work with the desired accuracy *Rowland* had to produce a very perfect screw, for use in setting the diamond point for making the fine lines, from 10000 to 20000 to the inch.

The grating is thus modeled on the principle of parallel groves, ruled by a fine point. If the metal surface were set up at the proper angle, it would present the aspect of a side of a pyramid as conceived by *Regnault*, for the theory of crystals outlined above. There is thus a close analogy between the grating and its diffraction phenomena, and the structure of a crystal.

Now in the theory of the grating we have first, second, and higher order spectra, and in each spectrum the maximum and minimum for the different wave-lengths are arranged as shown in the accompanying illustrations (fig. 5, p. 67).

1. In the upper illustration, apertures are used instead of reflection from furrows in the grating. The image formed when the lower telescope is directed normally upon the grating gives the »central image«.

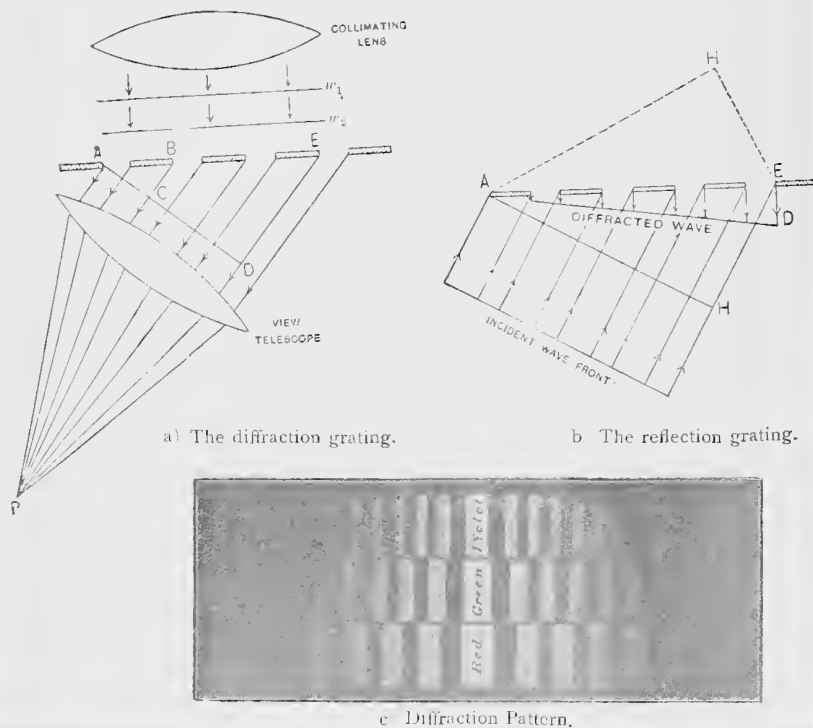


Fig. 5. Illustration of the formation of the diffraction pattern by refraction or by reflection, the wave arrangement of which presents certain analogies with crystalline structure.

2. As the telescope axis P moves to left (or to right) we encounter other secondary maxima of light. The first intense illumination on either side will occur when DE is equal to as many wave lengths as there are spaces on the grating, for then CB will be equal to one wave length, and the light from each aperture will reach the surface AD in precisely the same phase. The light concentrated at P gives the »spectrum of the first order«.

3. On either side, at greater angular distance from the centre, higher orders of spectra occur. The formulae are:

$$\text{For bright band } (a+d) \sin \theta = 2n \lambda / 2$$

$$\text{For dark band } (a+d) \sin \theta = (2n+1) \lambda / 2,$$

where $a+d$ denote the distance between the slits, a being the width of slit, and d of the bar, and n is the order of the spectrum.

4. When the light is not normal to the plane of the grating, but inclined at an angle i , we have the corresponding formulae:

$$(a+d) (\sin \theta + \sin i) = 2n \lambda / 2$$

$$(a+d) (\sin \theta + \sin i) = (2n+1) \lambda / 2.$$

This brief discussion shows that the phenomena of diffraction, reflection and refraction, in a crystal — where

¹⁾ It will be noted that our theory of the hardness of diamond rests largely upon the cause of the tenacity of wire, shown to be traceable to stresses in the sheath of aether about the wire by the equation $\eta = S/V = K/r$, which indicates that the tendency to rupture the aether at the boundary must be the source of the power when the metal is drawn into wire with relatively more surface. If the cause of tenacity in drawn wire is correctly referred to boundary stress in the aether — a conclusion from which I can see no escape, in view of the results of observation agreeing with the above formula — then the cause of the hardness of diamond also follows incontestably. This conclusion is to be taken in connection with the above considerations on the wave oscillations and the resulting forces which resist compression in liquids and solids.

the molecular structure is so arranged as to make the rulings — are extremely complex. It is no wonder that a variety of optical, and physical phenomena develop, and give the crystals many wonderful properties. This necessarily results from the wave-theory.

3. The Wave-Theory explains the Hardness of Diamond and the Growth of Crystals by Accretion along Axes. The Views of *Heddle* and other Crystallographers cited in some detail.

(i) The extraordinary hardness of diamond due to extremely violent wave-refractions and wave-dispersions at the boundary, which tend to disrupt the medium, but thereby result in maximum powers of cohesion for the hardest of known crystalline bodies.

As we examine the problems of crystallography with some care, we first call attention to the extraordinary refraction and dispersion of light in diamond. This violent wave action tends to disrupt the medium at the boundary, but only draws around the crystal such an elastic sheath of stressed aether as to give rise to the extraordinary hardness of the diamond.

In the fifth paper, section 10, we have dealt with this question in some detail, and whilst we have not fully solved the problem, we did separate the elements on which the hardness depends, so as to lay bare the causes

at work. We have there pointed out that in the case of diamond all the light incident from two complete quadrants, or 180° , is condensed by refraction into an angular space of only $47^\circ 22' = 47.37/180^\circ = 1/3.8$. It appears that this enormous concentration of wave energy is the secret of the most powerful molecular forces¹⁾. For on any area of the crystal the concentration of wave energy is as the square of 3.8, or 14.44; and if the dispersive effect be about equally powerful, the combined effect of the refraction and dispersion becomes magnified 200 times.

Now the effect of such extremely violent concentrations and dispersions of wave energy is a tendency to disrupt the medium, but as this cannot be done, owing to the more rapid motion of the aetherons, $\bar{v} = 1/2\pi \cdot V$, the result is the development about the crystal of a stressed envelope or sheath, which binds the diamond like a shell of steel. As the waves go into the diamond the movement is concentrated; as they go out an equally violent reaction, scattering, and diffusion occurs.

From a study of this stressing of the aether about the diamond, we concluded that as the aether is $\epsilon = 689321600000$ more elastic than air in proportion to its density, the tendency to the disruption of such a medium would develop forces

correspondingly larger than would arise in the air. In many physical experiments and natural phenomena, such as cyclones, the power of the air forces are impressively exhibited to our senses. These phenomena leave no doubt as to the possible concentration of power in nature.

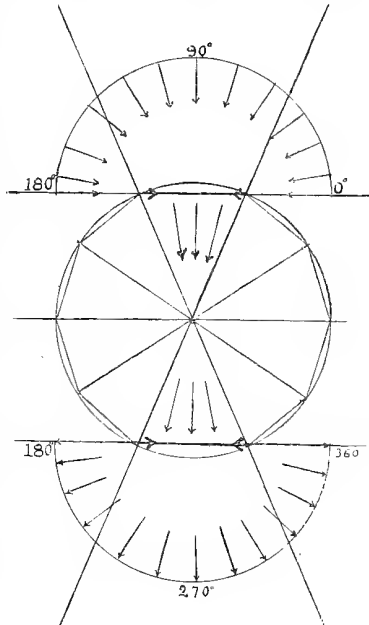
Thus we concluded that the strength of a solid such as diamond would depend on the sextuple integral:

$$\Omega = \int_0^{\sigma/\lambda} \int_0^{\beta} \int_0^{\delta} \int_0^{\alpha} \int_0^{\rho} \int_0^{\omega} \varepsilon \cdot (n^2 - 1) \pi(\sigma/\lambda) \varphi(\beta) \psi(\delta) \chi(\alpha) \theta(\rho \cdot e^{-\alpha}) \varpi(\omega) d(\sigma/\lambda) d\beta d\delta d\alpha d(\rho \cdot e^{-\alpha}) d\omega \quad (7)$$

where the elements involved may be described as follows.

Fig. 6. Stresses in the aether at the boundary, owing to refraction and dispersion of waves by diamond.

1. As the waves enter they are condensed into about 1:14.44 of their former spherical distribution, which is equivalent to an intense contraction of the enclosed aether.
2. When the waves emerge, they undergo an equally powerful spreading out, and this expansion of the wave-front leads to a reaction in the medium also equivalent to a contraction of the envelope about the diamond.
3. Thus whether the waves enter or leave the diamond, there is violent stress in the envelope of aether at the boundary, and when the molecules have crystalline arrangement in a solid, the hardness results.



1. Refractive action, $(n^2 - 1)$, which depends on the density of the solid, σ , and the changing wave-length λ and thus on some unknown function, $\pi(\sigma/\lambda)$;
2. The violence of the incessant bending of the wave-front, for waves coming from all directions, $\varphi(\beta)$;
3. The violence of the incessant dispersion of these incident waves, $\psi(\delta)$;
4. The combination of systematic stresses due to the crystalline arrangement of the atomic planes with the effects of the two latter violent tendencies, thus leading almost to the disruption of the medium, $\chi(\alpha)$;
5. The enormous power of reflection with very slight absorption of energy, at the surface, $\theta(\rho \cdot e^{-\alpha})$;
6. The great central pressure due to the integration of the steady action of the sheath of partially disrupted waves always enveloping the solid, $\varpi(\omega)$.

Accordingly, although we recognize the validity of the above integral, in the present state of our knowledge, we can evaluate it only very approximately. If the other variable elements increase in about the same proportion as the energy in refraction and dispersion, which we can calculate, the result would be an increase of stress of the order of $200 \times 200 \times 200 = 8000000$ times the value otherwise effective. In view of the sudden discontinuities in the physical state of bodies, as in solidification, etc., it seems certain that the wave-theory is ample to account for the hardness of diamond and other crystals, as well as the tenacity of steel and similar substances.

In the Optics, 1721, p. 365, *Newton* pointed out that great power of adhesion is obtained when two solid plane surfaces fit with extreme closeness. In this sixth paper, our line of argument is to show that this same wave-power, based on the enormous elasticity of the aether, operates above all in chemical combinations, where the distances are ultra-microscopic in smallness.

In the case of carbon we have the small molecular weight of 12, and the element moreover crystallizing into diamond, probably under very high pressure, as in the experiments of *Moissan* and others in the production of artificial diamonds, — and thus with such smallness of molecular weight, and crystallization under conditions of the closest possible molecular contact, the resulting solid crystal ought to be the hardest of known substances.

This theory of the hardness of diamond follows at once from *Newton's* remarks, all known experience, and the resulting wave-theory of molecular and atomic forces. In our discussion, to be sure, we usually refer to the refractive index appropriate to light, but this is only for the sake of definiteness. We hold the chief atomic forces to depend on waves shorter than the ultra-violet, and thus the theoretical cohesive power is always much greater than would follow from the theory of light waves of the visual spectrum.

(ii) Views of Professor *M. F. Heddle*, on the growth of crystals by accretion along axes.

In the celebrated article on Mineralogy, *Encycl. Brit.*, 9th ed., Professor *M. F. Heddle* gives an interesting outline of the supposed mode of growth of crystals by dominant accretion along axes. *Heddle's* argument runs thus:

»As regards mere geometric measurement, there are several directions in which axes may with nearly equal advantage be projected. For example, in the cube (fig. 7b, plate 3) they may be drawn from the centres of opposite faces, as lettered *O*; or from opposite solid angles, as lettered *C*; or from the centres of opposite edges, as lettered *D*. There is abundance of evidence that each of these directions must be regarded as lines of dominant accretion of molecules«.

»But the accretion, may be not only dominant but overwhelmingly so in one only of these directions in certain cases, or existent along one set of axes alone in certain others. In a specimen of native silver from Alva in Scotland (fig. 7a), along *O* this is so much the case that the concreting molecules have done little more than delineate the form of an octahedron, and this they have only been able to do by aggregating themselves in lines of minute crystals of the very shape of which they were projecting the skeleton form. Moreover, a polar aggregation at the terminal ends of these octahedral axes is here shown by the amount of concreting and crystallizing material being larger at the terminations of these axes than elsewhere. In the hollow-faced cube again (fig. 7b), an aggregation of molecules in the direction of the lines *D*

and C has filled the edges and solid angles, while none have been deposited along O . This occurs in crystals of salt. In the hollow-faced octahedron again (fig. 7c), there has been no deposition of matter along the line C . Cuprite often shows this form; and it as frequently occurs in hollow-faced dodecahedra, wherein the vacuity is in the direction of D .«

»In the specimen of pyrite from Elba (fig. 7d), a deposition along D and C would ultimately have erected the scaffolding of a hollow cube, in twelve lines of minute combinations of the cube and octahedron. Such directional arrangements may, moreover, not only be intermittent but often alternate. The pyrite from Traversella (fig. 7e) is an illustration of the first. A large pentagonal dodecahedron having been completed, a new accession of material has been attached, not uniformly spread over the pre-existent crystal, to enlarge it, but locally arranged, in equal amount, at the poles of O . But here the special method of the arrangement has determined the formation of a number of small crystals of the same form as that originally projected.«

»An alternation, as it were, in plan is shown in such a crystal of calcite as that in fig. 7f. Here a scalenohedron is seen in the centre of the figure; then a rhombohedron has been perched upon its summit, and lastly both have been sheathed in a six-sided prism with trihedral summits. Different as these three forms are, it is found that they all here stand in a definite position, one to the other; that definite position is the relation which they bear to one of the sets of axes, and this set may be assigned, not only to all the three crystals here combined, but also to all the crystals belonging to the same mineral, wherever occurring. This general applicability constitutes one of the respects in which one special set of axes is, in each of the systems, preferred to the others.«

(iii) Coherence of particles not equal in all directions.

Having indicated by the reasoning of *Regnault* and *Heddle* how crystals are built up by molecular arrangement, embodying various geometrical forms along certain axes, it will not surprise us to learn that the coherence of the particles is not equal in all directions. The contacts of the particles are closer in some directions than in others, and thus the forces depending on wave action yield more readily in some directions than in others. Crystals thus have planes of cleavage, and sometimes may be easily split along these planes, because the contact of the particles is not close, and the coherence of the particles not powerful.

Professor *Heddle's* discussion of this subject is as follows:

»Another respect is the intensity with which the molecules cohere in the different parts of the crystal, as referred to these axes, and the resultant different hardness of certain parts of crystals. It will be afterwards found that this obtains in a very limited manner in the crystals which belong to the first of the following systems, on account of its regularity and sameness as a whole. It may be laid down as a general rule that the edges of crystals are harder than the centres of their faces, and the solid angles harder than the edges. This is markedly the case in the diamond. But, apart from this, there is no distinctive hardness in any one part, side, or end of the crystals of the first system. It is otherwise

with the crystals which fall to be considered in all the other systems. So different is the hardness of the various portions of these, so diverse the appearance of their parts in lustre, colour, polish, etc., so varying the amount of the recoil of these when struck, so unequal their power of conducting heat, so dissimilar their power of resisting the agencies of decay, and so irreconcilable their action upon transmitted light, that we cannot but conclude that the molecules which build them up are packed with greater force, if not in greater number, in certain directions in preference to others. There thus remains no question that these nature-indicated sets of axes are those along which there has been a specially selective or 'polar' arrangement.«

(iv) In crystals, as in wire, the relative increase of surfaces gives maximum hardness.

From the above quotation it will be seen that *Heddle's* views on crystals coincide with those reached in the fifth paper on the new theory of the aether. As we had not examined *Heddle's* article when that paper was finished, we may regard the concurrence of views as remarkable. When *Heddle* says: »It may be laid down as a general rule that the edges of crystals are harder than the centres of their faces, and the solid angles harder than the edges. This is markedly the case in the diamond.« — it almost seems as if he is outlining the wave-theory as treated in the 10th section of the fifth paper.

For it will be remembered that we explained the hardness of diamond and similar bodies as due to wave action at the boundary, where there is enormous and violent refraction and dispersion, with various tendencies to disrupt the aether. And naturally these tendencies to enormous stress in the aether would be a maximum at the edges and corners of crystals, where there is minimal solid content of the crystal in proportion to its surface, so the surface effect is increased as much as possible.

We found from the study of drawn wire that the curve for the relative increase of surface, $\eta = S/V$, defined by the equation:

$$\eta = S/V = k/r \quad (8)$$

shows that the strength of wire will increase with the decrease of the radius of the wire r , so long as the diameter of the wire is not made so small as to approach the diameters of the molecules. From this law of the asymptotic increase of strength, with decreasing r , we justly inferred that wave action at the boundary of the wire must be the secret of the strength of drawn wire.

Now likewise for crystals, in the above general rule, *Heddle* lays it down that the edges and corners offer maximum hardness — evidently because the surface effect is there a maximum.

Hence we have the following remarkable induction relative to laws of nature not heretofore suspected.

1. Wire attains maximum strength or tenacity when so drawn as to make the ratio of the surface to the volume a maximum, as long as molecular dimensions are not approached.

2. Crystals likewise present maximum hardness at edges and corners, where the ratio of the amount of surface to volume is a maximum — just as in the case of drawn wire.

If therefore wave action at the boundary will explain the tenacity of wire, it will also explain the hardness of crystals. Any other conclusion seems wholly excluded. Thus the observed properties of crystals confirm the wave-theory of physical forces.

(v) Study of the crystallization of the diamond, which most strikingly confirms the wave-theory.

Investigation shows that diamond always occurs in crystals belonging to the tesseral or cubical system, usually in the octahedron, or double four-sided pyramid (fig. 8a, plate 4), the rhombic dodecahedron, with twelve faces (fig. 8b); the triakis-octahedron, 3-sided pyramids superposed on the octahedron form (fig. 8c); or hexakis-octahedron, 6-sided pyramids superposed on the octahedron form (fig. 8d).

The crystallography of the diamond is thus remarkable for the symmetry and compactness of the forms taken. Indeed it is noted that the faces of these symmetrical crystals often are curved, and many of the crystals thus become so round as to be almost like spheres, which we may readily understand from the above figures 8b and d.

Now it is remarkable that carbon as an element has extraordinary properties, as follows:

1. In the case of elements other than carbon the number of atoms directly associated together in a molecule of the compounds is very small, probably seldom or never exceeding five.

2. Carbon compounds on the other hand frequently contain a relatively very large number of carbon atoms; and from the behavior of these compounds, it is inferred that the included carbon atoms are in direct association with each other.

3. Whilst none of the remaining elements are known to furnish more than a single stable compound with hydrogen, the number of stable compounds of carbon with hydrogen found by chemists is counted by the hundreds.

4. Wherefore it is concluded that carbon has two distinctive properties: first, that of uniting with itself to an almost unlimited extent, in comparison with other elements; second, that of combining with hydrogen in numerous proportions.

5. Carbon is thus capable of uniting with the same element in a multiplicity of proportions, thereby furnishing a great variety of compounds, which probably exceed in number those of all the remaining elements taken together. Carbon is thus the whole basis of organic chemistry!

6. In view of these remarkable chemical properties it will now be obvious why crystals of carbon take the form nearest approaching that of the sphere. The chemical affinity acts with great equality from all directions, and builds up crystals of the tesseral form, often with curved faces, resembling a sphere.

It is found that the cleavage of diamond is parallel to the face of such crystals as the octahedron: which shows that the hardness of coherence of the atoms is least in the direction normal to the face of the crystal. In this respect diamond is a typical crystal, rather brittle, but the hardest of all known substances.

The high refractive and dispersive power of the diamond has already been dealt with in the 10th section of the fifth

paper. These properties were known over two centuries ago, and Sir *Isaac Newton* himself conjectured that diamond is a substance of peculiar nature. Sir *David Brewster's* discovery that many diamonds show traces of double refraction may be explained by the extreme internal pressure or stress due to the wave action at the boundary, which gives the diamond such extraordinary hardness.

The numerous internal reflections of the light, total when the angle is above $23^{\circ} 41'$, makes the diamond extraordinarily brilliant, and fills the crystal with maximum dispersion of prismatic light, whence the value of the crystal as a gem.

In view of modern studies on radio-activity, it is remarkable that as early as 1664 *Robert Boyle* noticed that when exposed to the light of the sun diamond has the property of shining in the dark, or phosphorescing. This was before the combustibility of diamond was established by the Florentine academicians, 1694-5, by means of a series of experiments with a powerful burning glass, in the presence of *Cosmo III*, Grand Duke of Tuscany. *Lavoisier* found by similar experiments that the chemical product of the combustion was carbon dioxide, CO_2 .

4. The Development of Heat in Chemical Reactions a Proof of the Wave-Theory.

(i) Heat applied to certain mixed atoms will frequently bring about their union: but greater heat leads to instability.

It has long been noticed that when atoms are combining to form new substances, heat is the immediate product of chemical affinity. The invariable rule is that in chemical combination heat is produced. Some half a century ago *Berthelot* devoted great attention to the determination of the heat developed in various combinations, thereby developing thermo-chemistry into an important special branch of that great science.

Berthelot's researches should be studied in his *Essai de mécanique chimique fondée sur la thermo-chimie*, Paris, 1879. The formulae for the energy given up in chemical changes may be written

$$\sum T_0 = \sum (1/2 m v_0^2 - 1/2 m v^2) \quad (9)$$

where v is the velocity attained and v_0 the original velocity.

Here $\sum T_0$ is the work done while the system passes from the first to the second state. If $\sum T_1$ is the work done or energy given up in another transformation, we should have

$$\sum T_1 = \sum (1/2 m v_1^2 - 1/2 m v^2) \quad (10)$$

and therefore for the difference we get

$$\sum 1/2 m v_1^2 - \sum 1/2 m v_0^2 = \sum T_1 - \sum T_0. \quad (11)$$

Accordingly, for any state whatever, we have for a system subjected to no exterior cause, independent of its actual coordinates

$$\sum 1/2 m v_1^2 - \sum T_1 = \sum 1/2 m v_0^2 - \sum T_0 = C \quad (12)$$

where C is the constant quantity which *Rankine* calls the energy of the system.

The general equation of dynamics was given by *Lagrange* in the usual rectangular coordinates:

$$\sum [(X - m \cdot d^2x/dt^2) \delta x + (Y - m \cdot d^2y/dt^2) \delta y + (Z - m \cdot d^2z/dt^2) \delta z] = 0 \quad (13)$$

or in the more common form

$$\sum m(d^2x/dt^2 \cdot \delta x + d^2y/dt^2 \cdot \delta y + d^2z/dt^2 \cdot \delta z) = \sum (X \delta x + Y \delta y + Z \delta z) \quad (14)$$

Now the left member of this equation yields:

$$\begin{aligned} & \sum m(d^2x/dt^2 \cdot \delta x + d^2y/dt^2 \cdot \delta y + d^2z/dt^2 \cdot \delta z) = \\ & = (d/dt) \sum m(dx/dt \cdot \delta x + dy/dt \cdot \delta y + dz/dt \cdot \delta z) - \delta \left\{ \frac{1}{2} \sum m[(dx/dt)^2 + (dy/dt)^2 + (dz/dt)^2] \right\}. \end{aligned} \quad (15)$$

$$\text{When we put } T = \frac{1}{2} \sum m[(dx/dt)^2 + (dy/dt)^2 + (dz/dt)^2] = \frac{1}{2} m v^2 \text{ and } U' = \sum (X \delta x + Y \delta y + Z \delta z) \quad (16)$$

$$\text{we get from (14)} \quad (d/dt) \sum m(dx/dt \cdot \delta x + dy/dt \cdot \delta y + dz/dt \cdot \delta z) = \delta T + U' \quad (17)$$

whence we derive *Hamilton's* principle for a conservative system:

$$\int_{t_0}^{t_1} (\delta T + U') = 0 \quad (18)$$

But molecular and atomic systems undergoing change are not conservative, since invariably there is development of heat due to chemical combination. Parts of the system pass from the free state to the bound state, and in the rapid adjustment of the velocities of the molecules and atoms, there is such rearrangement of their moving wave-fields, that heat is developed. The work done thus naturally has largely the form of aether waves, which tend to diffuse the heat of combination.

Accordingly, in chemical systems the principle of *Hamilton* will not hold, and equation (18) takes the form:

$$\int_{t_0}^{t_1} (\delta T + U') = \Theta \quad (19)$$

where Θ is the number of heat units developed or absorbed by the chemical combinations taking place in the system during the interval $t_1 - t_0$.

If the change of temperature be immense and violent, as by the application of external heat, molecular structures, stable at lower temperature, may become unstable and the combinations break up, because the agitation due to the longer waves predominate over the shorter waves on which chemical affinity mainly depends. This fact confirms the wave-theory.

The following tables include some of the principal results found by the researches of *Berthelot*, *Thomsen* and others. The first table gives the amounts of heat developed on the addition of sodium hydroxide ($2 NaOH Aq, Q Aq$).

Name of Acid	Formula	Units of heat developed in the reaction ($2 NaOH Aq, Q Aq$)
Hydrofluoric	$2 H \cdot Fl$	32540
Sulphuric	$H_2 \cdot SO_4$	31380
Selenic	$H_2 \cdot SeO_4$	30390
Hypophosphorous	$2 (H \cdot PH_2 O_2)$	30320
Sulphurous	$H_2 SO_3$	28970
Metaphosphoric	$2 (H \cdot PO_3)$	28750
Phosphorous	$H_2 \cdot PHO_3$	28370
Oxalic	$H_2 \cdot C_2 O_4$	28280
Hydrochloric	$2 H \cdot Cl$	27480
Hydrobromic	$2 H \cdot Br$	27500
Hydriodic	$2 H \cdot I$	27350
Chloric	$2 H \cdot ClO_3$	27520
Nitric	$2 H \cdot NO_3$	27360

Name of Acid	Formula	Units of heat developed in the reaction ($2 NaOH Aq, Q Aq$)
Dithionic	$H_2 \cdot S_2 O_6$	27070
Selenious	$H_2 \cdot SeO_3$	27020
Chloroplatinic	$H_2 \cdot PtCl_6$	27220
Fluosilicic	$H_2 \cdot SiF_6$	26620
Sulphovinic	$2 (H \cdot SO_4 C_2 H_5)$	26930
Formic	$2 (H \cdot CHO_2)$	26400
Acetic	$2 (H \cdot C_2 H_3 O_2)$	26310
Pyrophosphoric	$\frac{1}{2} (H_4 \cdot P_2 O_7)$	26370
Phosphoric	$H_2 \cdot PO_4 H$	27080
Arsenic	$H_2 \cdot AsO_4 H$	27580
Citric	$\frac{2}{3} (H_3 \cdot C_6 H_5 O_7)$	25470
Tartaric	$H_2 \cdot C_4 H_4 O_6$	25310
Succinic	$H_2 \cdot C_4 H_4 O_4$	24160
Chromic	$H_2 \cdot CrO_4$	24720
Carbonic	$H_2 \cdot CO_3$	20180
Boric	$H_2 \cdot B_2 O_4$	20010
Hypochlorous	$2 (H \cdot OCl)$	19370
Hydrosulphuric	$2 (H \cdot SH)$	15480
Hydrocyanic	$2 (H \cdot CN)$	5530
Stannic	$\frac{1}{2} (H_4 \cdot SnO_4)$	4780
Silicic	$\frac{1}{2} (H_4 \cdot SiO_4)$	2710

This table is from the article *Chemistry*, *Encycl. Brit.*, 9th ed. The explanation of the table by Professor *H. E. Armstrong* is of interest:

»From these tables it will be evident — (1), that when a molecule of sodium hydroxide in aqueous solution enters into reaction with an acid, the heat developed is very nearly proportional to the quantity of acid present until this amounts to 1, $\frac{1}{2}$, $\frac{1}{3}$, or $\frac{1}{4}$ molecule, according as the acid is mono-, di-, tri-, or tetrabasic; but that when the amount of acid added exceeds that requisite to form the normal salt, the different acids behave differently, heat being in some cases developed, and in others absorbed, according to the constitution of the acid; and (2), that mostly when a molecule of an acid in aqueous solution enters into reaction with sodium hydroxide, the amount of heat developed increases almost in proportion to the amount of the latter, and until 1, 2, 3, or 4 molecules are added, according as the acid is mono-, di-, tri-, or tetrabasic; the further addition of sodium hydroxide is not then attended with any considerable development of heat.«

»Very different amounts of heat, it will be observed, are developed on neutralizing the different acids, but there is mostly a remarkable similarity in the results obtained in the case of acids which from chemical evidence are known to be closely allied.«

Professor *Armstrong* then adds a more detailed discussion, which for lack of space we are obliged to omit, proving the general theory here outlined. Several other tables are cited by Professor *Armstrong*, those derived from the chemical investigations of *Thomsen* of Copenhagen being highly important; but the results are too elaborate to be cited here.

The related chemical problem of the number of units of heat developed or absorbed per molecule when salts are dissolved in water could be discussed with profit. And we might go into the problem of atomic heat, with average value of about 6.3; but it involves too much chemical detail for a discussion of the cause underlying physical forces.

It must suffice to point out that the heat developed or absorbed is proof positive of the vast stores of energy drawn upon in the combinations of matter into molecular bodies familiar to chemists. Free or temporarily free atoms are combined into molecules of greater or less stability; and in the commotion incident to the change of state, energy is set free, mainly in the form of heat.

It would be possible to imagine that the energy comes from within the atoms themselves; but such a view has great improbability for three reasons:

1. We cannot conceive how the energy can be stored in the atoms, since it is characteristic of energy to expend itself with very great rapidity.

2. There is no apparent reason why different atoms should have such different energy, in respect to other atoms or molecules, if energy be inherent in matter.

3. This theory would place all the energy in the common matter and leave none in the aether, — which is infinitely improbable, since the aether is perfectly elastic and thus the vehicle of all energy. Therefore it is improbable, almost inconceivable, that energy can really reside in matter as such.

Accordingly, we reach the conclusion that so far from residing in matter, the energy resides in the aether itself, but only exhibits its power in connection with matter, because matter operates to transform the waves, owing to sudden changes of movement at the boundaries. Hence the main function of matter is the transformation of wave energy; and naturally the effects are different with different substances. No other theory will explain the chemical energies evolved in combinations which often are so extremely powerful.

(ii) Heat developed by chemical affinity attributed to transformation of molecular and atomic motion, but when the liberated energy is confined, and new gases formed in the disturbance of the system, their expansive power may give motion to projectiles.

The main distinction between chemical affinity and the physical attraction seen in molecular forces, consists in the fact that the action of chemical affinity is accompanied by chemical changes, whereas purely molecular forces do not change the internal structure of the molecules. Agitation of the molecules generates heat, by the rearrangement of the surrounding wave-field, and when the parts of molecules or atoms are violently agitated and reconnected, as in chemical changes, it is natural that heat should be evolved. This rearrangement of the parts of the molecule, with dissociation and regrouping of atoms, under the wave energies of the universe, thus leads to heat, and lies at the foundation of thermo-

chemistry as developed by *Berthelot*, *Thomsen*, and other modern investigators.

In discussing chemical changes, *W. R. Grove* (Correlation and conservation of forces, p. 153) says:

»It may be a question whether in this case, the force which occasions the motion of the mass is a conversion of the force of chemical affinity, or whether it is not, rather, a liberation of other forces existing in a state of static equilibrium, and having been brought into such state by previous chemical actions; but, at all events, through the medium of electricity chemical affinity may be directly and quantitatively converted into the other modes of force. By chemical affinity, then, we can directly produce electricity; this latter force was, indeed, said by *Davy* to be chemical affinity acting on masses: it appears rather to be chemical affinity acting in a definite direction through a chain of particles; but by no definition can the exact relation of chemical affinity and electricity be expressed; for the latter, however closely related to the former, yet exists where the former does not, as in metallic wire, which when electrified, or conducting electricity, is nevertheless, not chemically altered, or, at least, not known to be chemically altered.«

»*Volta*, the antitype of *Prometheus*, first enabled us definitely to relate the forces of chemistry and electricity. When two dissimilar metals in contact are immersed in a liquid belonging to a certain class, and capable of acting chemically on one of them what is termed a voltaic circuit is formed, and, by the chemical action, that peculiar mode of force called an electric current is generated, which circulates from metal to metal, across the liquid, and through the points of contact.«

»Let us take, as an instance of the conversion of chemical force into electrical, the following, which I made known some years ago. If gold be immersed in hydrochloric acid, no chemical action takes place. If gold be immersed in nitric acid, no chemical action takes place; but mix the two acids, and the immersed gold is chemically attacked and dissolved: this is an ordinary chemical action, the result of a double chemical affinity. In hydrochloric acid, which is composed of chlorine and hydrogen, the affinity of chlorine for gold being less than its affinity for hydrogen no change takes place; but when the nitric acid is added, this latter containing a great quantity of oxygen in a state of feeble combination, the affinity of oxygen for hydrogen opposes that of hydrogen for chlorine, and then the affinity of the latter for gold is enabled to act, the gold combines with the chlorine, and chloride of gold remains in solution in the liquid. Now, in order to exhibit this chemical force in the form of electrical force, instead of mixing the liquids, place them in separate vessels or compartments, but so that they may be in contact, which may be effected by having a porous material, such as unglazed porcelain, amianthus, etc., between them. Immerse in each of these liquids a strip or wire of gold: as long as these pieces of gold remain separated, no chemical or electrical effect takes place; but the instant they are brought into metallic contact, either immediately or by connecting each with the same metallic wire, chemical action takes place — the gold in the hydrochloric acid is dissolved, electrical action also takes place, the nitric acid is deoxidised by the transferred hydrogen, and a current

of electricity may be detected in the metals or connecting metal by the application of a galvanometer or any instrument appropriate for detecting such effect.«

»There are few, if any, chemical actions which cannot be experimentally made to produce electricity: the oxidation of metals, the burning of combustibles, the combination of oxygen and hydrogen etc., may all be made sources of electricity. The common mode in which the electricity of the voltaic battery is generated is by the chemical action of water upon zinc; this action is increased by adding certain acids to the water, which enable it to act more powerfully upon the zinc, or in some cases act themselves upon it; and one of the most powerful chemical actions known, — that of nitric acid upon oxidable metals — is that which produces the most powerful voltaic battery, a combination which I made known in the year 1839; indeed, we may safely say, that when the chemical force is utilised, or not wasted, but all converted into electrical force, the more powerful the chemical action, the more powerful is the electrical action which results.«

Again, in describing the voltaic battery, *Grove* says:

»Now a voltaic battery, which consists usually of alternations of two metals, and a liquid capable of acting chemically upon one of them, has, as we have seen, the power of producing chemical action in a liquid connected with it by metals upon which this liquid is incapable of acting; in such case the constituents of the liquid will be eliminated at the surfaces of the immersed metals, and at a distance one from the other. For example, if the two platinum terminals of a voltaic battery be immersed in water, oxygen will be evolved at one and hydrogen at the other terminal, exactly in the proportions in which they form water; while, to the most minute examination, no action is perceptible in the stratum of liquid. It was known before *Faraday's* time that, while this chemical action was going on in the subjected liquid, a chemical action was going on in the cells of the voltaic battery; but it was scarcely if at all known that the amount of chemical action in the one bore a constant relation to the amount of action in the other. *Faraday* proved that it bore a direct equivalent relation: that is, supposing the battery to be formed of zinc, platinum, and water, the amount of oxygen which united with the zinc in each cell of the battery was exactly equal to the amount evolved at the one platinum terminal, while the hydrogen evolved from each platinum plate of the battery was equal to the hydrogen evolved from the other platinum terminal.«

»Supposing the battery to be charged with hydrochloric acid, instead of water, while the terminals are separated by water, then for every 36 parts by weight of chlorine which united with each plate of zinc, eight parts of oxygen would be evolved from one of the platinum terminals: that is, the weights would be precisely in the same relation which *Dalton* proved to exist in their chemical combining weights. This may be extended to all liquids capable of being decomposed by the voltaic force, thence called electrolytes: and as no voltaic effect is produced by liquids incapable of being thus decomposed, it follows that voltaic action is chemical action taking place at a distance, or transferred through a chain of media, and that the chemical equivalent numbers are the exponents of the amount of voltaic action for corresponding chemical substances.«

»As heat, light, magnetism, or motion, can be produced by the requisite application of the electric current, and as this is definitely produced by chemical action, we get these forces very definitely, though not immediately, produced by chemical action.«

(iii) *Adolphe Wurtz's* theory of chemical affinity.

In his well known History of chemical theory, from the age of *Lavoisier* to the present time, (1869), the celebrated French chemist *Adolphe Wurtz* reached the conclusion that chemical phenomena depend for their cause on the diversity of matter. As stated in the work above cited (translation by *Watts*, London, 1869) pp. 193-194, *Wurtz's* theory is as follows:

»We have seen the progress of ideas following closely on the march of discovery, and arriving, through many variations, at the same fundamental idea, that, namely which consists in seeking the first cause of chemical phenomena in the diversity of matter, each primordial substance being formed of atoms endowed with a certain energy, and with a peculiar aptitude for expending that energy. These two properties of atoms, distinct from one another, render an account of all chemical phenomena, the former measuring their intensity, the latter denoting their manner. Affinity and atomicity are, therefore, the two manifestations of the force which resides in the atoms, and this hypothesis of atoms forms at present the foundation of all our theories, the solid base of our system of chemical knowledge. It gives a striking simplicity to the laws relating to the composition of bodies; it enables us to look into their intimate structure; it intervenes in the interpretation of their properties, reactions, and transformations; and will doubtless at some future time furnish points of support for the science of molecular mechanics.«

»It was, therefore, a grand idea that was originated by *Dalton*, and it may with good reason be asserted, that amongst all the advances that chemical doctrines have made, since the time of *Lavoisier*, this is the most important.«

It thus appears that *Wurtz* attributed all chemical manifestations of force to affinity and atomicity, and held that the support for a science of molecular mechanics must be based thereon. He considered every primordial substance to be »formed of atoms endowed with a certain energy, and with a peculiar aptitude for expending that energy«.

The wave-theory differs from *Wurtz's* view chiefly in attributing all energy to the aether, while the atoms receive, transform, and emit wave energy suitable to their atomic properties and periodicities. This is a simpler conception than *Wurtz's* and it gives to the atoms the properties of resonators, — all energy being inherent in the aether itself, which has an elasticity 689321600000 greater than that of air in proportion to its density.

The phenomena of radio-activity and the kindred phenomena of phosphorescence enable us to see that the wave-theory offers the simplest and most general explanation of radiation, whatever be its form. In 1664, *Boyle* observed that a diamond glows in the dark after having been exposed to the direct action of sunlight. This was probably the earliest observation of the persistence of luminous vibrations after the exciting cause was removed. If the carbon atoms crystallized in diamond may persist in their vibrations it is after all not

such a long step to radio-activity, where the radiation continues almost indefinitely. Thus radium differs from diamond chiefly in the much greater duration of the radiation emitted and the violence of the waves given out. But carbon has an atomic weight of only 12, while radium has an atomic weight of 205, over 17 times greater.

As bearing upon world-radio-active phenomena, we may cite the Aurora Borealis, which occasionally adds to the luminosity of our atmosphere by waves emitted from sunspots, and so transformed in the earth's atmosphere as to give light. On May 14, 1921, we witnessed at Mare Island the most brilliant aurora ever noted in California.¹⁾ At 9^h 30^m p. m., Pacific Standard Time, the auroral streamers extended from the northern horizon to the zenith and beyond; the colors displayed included red, orange, yellow, green, and bluish purple. The streamers showed rapid formation and dissolution, and at about 10 o'clock a canopy of light, like that often reported in Norway and Lapland, formed near the zenith, sixty degrees wide. It afterwards scattered, and appeared as luminous clouds in many parts of the sky.

For many years the aurora has been known to be periodic, and to follow the curve of the sun-spot development. As an unusually large spot was near the central meridian of the sun, this display verifies the electromagnetic wave-theory published by the writer in 1917, and further verified in a paper communicated to the Astronomical Society of France in November, 1918.

From researches covering a very wide field it seems absolutely certain that electrical forces control the physical world, and that both magnetism and gravitation are wave-phenomena, depending on stresses in the aether, a new mathematical-physical theory of which we have developed during the past seven years.

5. The Geometric Basis of the Atomic Arrangement in the Wave-Theory of Molecular Structure also points to the Source of Power in High Explosives.

(i) The resistance of a given molecular structure to passing waves depends upon the atomic arrangement. It may vary between forms which yield maximum to minimum resistance.

In our wave-theory of the hardness and tenacity of bodies, in the fifth paper on the new theory of the aether, we found overwhelming evidence that these properties of bodies, by which they have enormous physical strength, depend on wave transformations and the resulting stresses in the aether at the boundaries of these bodies. Boundary conditions are all-important in fixing the physical properties of gross bodies, because the transformation of waves with the resulting stresses in the aether occur at the boundaries.

Now just as the boundary transformations of waves may generate enormous stresses about and throughout a large body made up of an infinite number of atoms, so also this boundary condition, when reduced to the problem of geometrical figures, may give molecules and atoms properties of greater or less strength and stability.

In fact there is no doubt that there is in general one arrangement which will give minimum stability and another will give maximum stability of the atomic arrangement. It is upon this strength that the stability of the structure of the molecule depends.

In the case of diamond, we have noted that the tendency is to form crystals as nearly spherical as possible; and we have pointed out the probability that the hardness of diamond depends upon the indefinite possibility of combinations of carbon with carbon, just as the multitudinous combinations of carbon with hydrogen give rise to the immense groups of hydrocarbons, and thus form the principal basis of organic chemistry. On this point, dealing with the properties of carbon, we quote the impression of the eminent French chemist *Adolphe Wurtz*, (History of chemical theory, 1869, pp. 159-160):

»Why, indeed, do the atoms of carbon exhibit this singular tendency to accumulate in large numbers in organic molecules? Because they possess the property of combining together, of riveting themselves one to the other. This important property gives to the innumerable compounds of carbon a peculiar stamp, and to organic chemistry its physiognomy, its mode of being. No other element possesses this power in the same degree. Doubtless hydrogen can combine with itself, as recognized by *Gerhardt*; but, as an atom of this body exhausts its combining capacity by its union with a second atom, no other element can be added to this couple, the saturated molecule of which is reduced, as it were, to its simplest expression, being formed of two atoms.«

»The polyatomic elements alone, after having expended part of the combining capacity which resides in them in riveting themselves one to the other, can retain another part to fix other elements. This power is possessed by the atoms of carbon, and likewise by the atoms of oxygen.«

It appears that the geometrical mechanism underlying molecular and atomic forces is somewhat obscure, yet there can be no doubt that different arrangement of the component part may be made so as to give greatly different degrees of compactness and therefore of stability. The subject of the geometrical figures and their possible combinations has been treated of by many authors, beginning with *Kepler's* *Mysterium Cosmographicum*, 1596. Among recent works we shall only allude to two:

1. Growth and Form, by *D'Arcy W. Thompson*, Cambridge University Press, 1917.
2. Fundamentals of the Cosmos, by Colonel *John Millis*, U.S.A., 1918, (Science, Oct. 11, 1918).

The work by *Thompson* has reference to the development of organic bodies, and thus is of interest in biology. The work by *Millis* is of wider application, and involves »a simple geometrical principle and its possible significance in connection with general physical theory.«

The principle stated by *Millis* is that: »In any aggregation of an indefinite number of equal spherical bodies an arrangement giving minimum total volume occupied and perfect symmetry throughout is impossible«. *Millis* recognizes that in every case there is an arrangement giving maximum

¹⁾ This section slightly rewritten on May 16.

condensation and geometrical symmetry, yet the density with the spheres in contact is not a maximum. He summarizes his conclusions thus:

»The only possible arrangement or grouping of equal spheres in contact that gives perfect symmetry as a fixed condition throughout for a group of an indefinite number is the cubical system, and this does not give maximum density; while the only possible arrangement that gives maximum density as a fixed condition throughout such a group is the rhombic dodecahedral, but this does not give universal symmetry. There is no arrangement possible giving both maximum density and universal symmetry.«

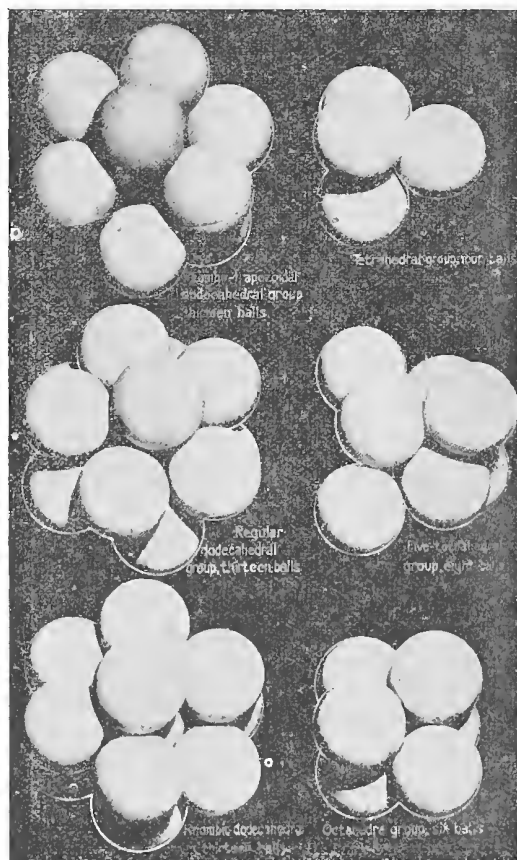


Fig. 9. Forms of arrangement for compact spheres in contact, (*Millis*).

There are other suggestions regarding symmetry and arrangement of forms for spheres or particles of bodies, but we shall not go into them beyond the suggestions conveyed by the illustrations (Fig. 9.) from the paper of Colonel *Millis*.

(ii) The atoms are separated in the molecules like the parts of *Mayer's* floating magnets.

It now remains to point out that in the wave-theory the groupings above represented, and an infinity of other groupings, are possible for the atoms, but the atoms making up the molecule are to be conceived as separated by relatively large

spaces, as in the stable geometrical figures found by *Mayer* for groups of floating magnets.

These floating magnets are illustrated in the figure 10, plate 5, which probably convey to us as good an outline of the molecules or atoms as any known models.

The chief difference we suggest in the model molecule is that in nature we do not have magnets surrounded by polarized groups of waves, but waves filling the universe, and affecting the atoms from every direction, so that the molecule is the symmetrical arrangement of least resistance to the passing waves.

This involves a different cause for the forces known to be at work, but the geometrical forms which result will be very similar; and under certain conditions of temperature or wave agitation the forms are stable. Yet under other conditions there is a rupture of the stability, and the molecule breaks up, with inevitable rearrangement of the atoms or parts, which in their mutual relations may be compared to the parts of *Mayer's* floating magnets.

The picture here given is the simplest and most direct outline of the wave-theory of molecular and atomic structure. When the number of atoms is large a good many geometrical forms may be assumed; but, with diverse properties to the atoms, the combinations frequently are unstable, or stable only within narrow limits, as in the above model floating magnets devised by *Mayer*.

The symmetry of these magnets and their analogy with cross sections of crystals is too obvious to escape the notice of the sagacious observer. In fact *Mayer's* magnets 18a and 18b strikingly resemble the form of crystallization taken by diamond, the purest form of carbon, where the molecular and atomic forces, due to wave-action have unrestricted freedom of operation in arranging the parts to give the best symmetry and maximum hardness.

In contemplating the above figures of *Mayer's* floating magnets, we should remember that all the elements are in one plane — the level surface of the water, — which we may call *xy*. But in the theory of atomic and molecular structure we have to view the atoms or parts of the molecule as lying in tridimensional space, *xyz*. Thus many more geometrical forms are possible for atoms in the structure of the molecule than is shown above in *Mayer's* figures.

(iii) Instability of the geometrical arrangement in molecular structure may lead to rearrangement, under disturbance, and thus the mystery of explosive forces finds explanation in the release of energy due to the elastic power of the aether.

From the theory of molecular and atomic structure here outlined, it follows that very different degrees of stability should exist. In general molecular structure is broken up by excessive heat, because under the agitation of the heat waves, which are of greater length, the atoms are likely to be driven beyond the range of action of the atomic forces due to the shorter waves. Thus heat or electric current may lead to dissociation, and the separation of the elements, as in Sir *Humphrey Davy's* celebrated experiments on the alkaline earths, about 1807.

Now just as heat and the electric current may produce dissociation, by driving the constituent atoms beyond the range of action of the atomic forces, so also when the form of

atomic arrangement is not very stable, a quick disturbance may so derange the geometric figure as to cause molecular collapse of the existing structure of the atoms, and rearrangement into other figures, usually more but sometimes less stable.

This gives us a clue to the secret of explosive forces, which heretofore has challenged the ingenuity of natural philosophers.

If we consider the great body of high explosives, we recall the well known fact that many of them are highly unstable, and will not bear any violent shock.

Thus nitroglycerine is exceedingly unstable, and the same is true of nearly all the latest and most powerful explosives, such as the trinitrotoluenes. In fact, we might almost state as a general principle, that in proportion as an explosive is powerful, and its destructive effect great, in the same proportion is it unstable, so that its stability has to be increased by mixture with an inert substance, as when dynamite is made from nitroglycerine by the addition of silicon material.

Now the only way we can conceive this explosive power to arise is from the aether. It cannot come from the substance of the explosive itself. But if the aether be 689321600000 more elastic than air in proportion to its density, and the universe be filled with waves of all lengths, — then obviously a release of stress, in the rearrangement of structure which gives less resistance to the passing waves, will yield such sources of power as philosophers have seldom dreamed of.

In his familiar lectures on scientific subjects, 1867, pp. 282-286, Sir *John Herschel* recalls this tremendous power of the aether and adds:

»Do what we will — adopt whatever hypothesis we please — there is no escape, in dealing with the phenomena of light, from these gigantic numbers; or from the conception of enormous physical force in perpetual exertion at every point, through all the immensity of space.« . . .

»If free to expand in all directions, it (the aether) would require a bounding envelope of sufficient strength to resist its outward pressure. And to evade this by supposing it infinite in extent, is to solve a difficulty by words without ideas — to take refuge from it in the simple negation of that which constitutes the difficulty. On the other hand, such a 'crystalline orb' or 'firmament' of solid matter conceived as a hollow shell of sufficient strength to sustain the internal tension, and filled with a medium attractively, and not repulsively elastic, might realize (without supposing a solid structure in the contained aether) the condition of transverse vibration.«

This penetrating reasoning of Sir *John Herschel* shows clearly that the power of the aether everywhere about us is great enough, if made effective by molecular rearrangement, to call forth unlimited explosive forces. It is therefore logical to assign explosive forces to the power of the aether — just as we assign the power of the lightning to the release of aether stresses at the boundaries of condensing drops of rain when the aether waves come from every direction in this all-pervading medium.

That which explains the power of the thunderbolt will also explain the power of dynamite, the trinitrotoluenes, and other terrific explosive forces, which so long has challenged the ingenuity of the most eminent natural philosophers. It is impossible to consider the problem of explosive forces,

after a study of the wave-theory of lightning, without reaching the conclusion that the source of power in the two cases is one and the same. And as lightning, with all the destructive power of the thunderbolt, is definitely referred to wave-action incident to the release of aether stress at the surface of rain drops, we must also hold that explosive forces derive their stupendous power from the release of stresses in the aether incident to rearrangement of molecular structure. Hence the instability of all high explosives.

It only remains to point out that as there is yielding and collapse of the molecular structure in an explosion, it follows that such collapse of the original structure will lead to the atoms being carried not only into a state of greater compactness, but also to a rebound from this unnatural state of compression. This is the molecular structural oscillation, under the stress of the passing aether waves, which calls forth the terrific exertion of force witnessed in explosions.

The aether is almost infinitely elastic, and nearly incompressible. Therefore when the stresses incident to the waves binding together the parts of the molecule are released, the yielding carries with it a compression of the disconnected atoms, and in the oscillation the most tremendous forces inevitably are exerted.

It is highly unphilosophical to attribute these explosive forces to the substances themselves. They arise from the aether (*Αἰθήρ*) which *Sophocles* (*Oedipus Coloneus*, 1470) makes the seat of a terrific thunderstorm; and of which *Aeschylus* (*Prom. Vinc.*, 1103-1120) speaks prophetically:

»Yea, now in very deed,
No more in word alone,
The earth shakes to and fro,
And the loud thunder's voice
Bellows hard by, and blaze
The flashing levin-fires;
Such is the storm from Zeus
That comes as working fear,
In terrors manifest.
O Mother venerable!
O Aether! rolling round
The common light of all.«

6. Radio-Activity and Organic Growth and Decay furnishes Direct Evidence of the Wave-Theory.

(i) Radio-active substances are those which transform waves unsuspected and insensible to our perceptions, into others which may be observed, and thus such substances appear to radiate almost unlimited quantities of energy.

The mystery attaching to radio-activity has excited the interest of many ingenious experimenters, and during the past 25 years an extensive literature has been developed dealing with this subject. But notwithstanding the labor and ingenuity of many eminent natural philosophers, it can hardly be said that we yet have any satisfactory theory of radio-activity.

It is recognized that radio-activity involves the expenditure of large amounts of energy; and great emphasis has been laid upon the enormous amount of energy inherent in the atoms of matter. In the article on the Sun, *Encycl. Amer.*, 1904, Professor *Newcomb* dwells on the modification of

Helmholtz's contraction-theory of the sun's heat by the discovery of radio-activity, and says that recent researches show that there is a vast amount of energy inherent in matter, and that its release prolongs the radiation of the sun and stars much beyond the periods formerly calculated. Thus instead of 20 million years of solar radiation, we have energy available for periods to be reckoned in corresponding billions of years. The available energy of the universe has been increased a thousand fold.

It will be noticed that this reasoning places the source of energy in matter, whereas the wave-theory places the source of energy in the aether itself, which fills the universe, and has an elastic power 689321600000 times greater than that of air in proportion to its density. The amount of energy in the aether is unlimited, but only a part of it is available, depending on our material mechanism for converting it into visible energy, as in the electric current generated by a dynamo, or the molecular energy in capillarity, cohesion and in chemical affinity, so powerfully exhibited in explosive forces.

Sir *J. J. Thomson*, Sir *Oliver Lodge*, Sir *Ernest Rutherford* and others have made rough attempts to evaluate the amount of these so-called atomic energies. Conclusions have been reached that the amount of energy in a milligram of radium salt would be capable of doing an enormous amount of mechanical work, such as propelling a large ship involving the expenditure of a vast number of horsepower hours, or months.

But although I differ from these eminent authorities reluctantly, I must add that it appears to me probable, if not certain, that the foundation of their argument is of doubtful validity. Having reached the conclusion that waves exist of all possible length, from many metres or kilometres, down to atomic dimensions; and having found that the waves undergo transformation in passing through certain substances, I have ventured to raise the question whether we may not look upon radio-active substances as those which transform and render sensible to observation waves otherwise unsuspected to pervade the world.

If that idea be admissible, it will follow that the energy noted in radio-activity does not really reside in the atoms which are radio-active, but is merely made manifest by the transformations of waves traversing these atoms.¹⁾ It is probable, perhaps certain, that some atoms have the power of rendering sensible waves which otherwise are insensible. Phosphorescence is a familiar illustration of this tendency. Again we see evidences of a similar tendency when X-rays pass through a thin layer of tungstate of calcium, whereby visual rays are produced in the field traversed by the X-rays, so that the whole field of operations may be explored by the eye.

With the X-rays alone in free space the field is without material resistance and so quiescent that light waves of sufficient intensity to give distinct vision do not arise. Yet when the

X-rays are sent through the field, and finally traverse a layer of tungstate of calcium, objects in the field become illuminated; and we can see distinctly along the path of the X-rays.

The writer's theory of the X-rays is that they are fairly long waves, which thus penetrate various objects. And under the agitation these long waves are either broken up into shorter ones, — corresponding to the visible spectrum, with the ultra-violet part, which gives the photographic power to the X-rays, — or shorter waves are called forth in the atoms all along the line.

We know that atoms are oscillating systems and have a high power of resonance; and this theory of longer waves breaking up into shorter oscillations or calling forth shorter waves, is in accordance with modern researches on the structure and periodicity of the atoms.

If these views be admissible, it will follow that just as calcium tungstate renders the waves in an X-ray field visible to the eye; so also may other radio-active matter in like manner transform invisible waves always pervading the universe into perceptible waves. The waves thus rendered sensible to experiment would give a field of research like that characteristic of radio-active substances.

By way of illustrating this theory of natural wave transformation we may call attention not only to phosphorescence, in organic bodies under decay, and in living objects like the fire-fly and the glow-worm; but also to many phenomena of luminescence in the physical universe, such as the luminous night clouds, which have been especially studied in Germany, the general prevalence of the Aurora Borealis in all latitudes, which *Stipher* has investigated photographically (cf. *Lowell Observ. Bull.*, No. 79, and the author's *Electr. wave-theory of phys. forc.*, vol. 1, 1917, p. 48).

Then again there is similar evidence of luminescence in the nebulae. Many of these objects must be intensely cold, because we can see very faint stars through them; and we know such transparent nebulae can no more retain heat than can the tails of comets, which are known to be at the temperature of space, yet shine with a glow suggestive of phosphorescence, or the Geissler-tube.

As electric discharges in the Geissler-tube may call forth ample light, though no sensible temperature is evolved, and an electric current is recognized to consist of ordered waves, in the aether, we see at once why the tail of a comet might glow in the electro-magnetic field of the sun. The wave-field of the sun is so filled with waves of all possible length that if the particles of a comet's tail had any power of resonance, luminosity ought to develop near perihelion passage.

Now the tails of comets do become enormously brilliant at the nearest approach to the sun; and the luminosity of the tail dies down as the comet recedes away into space. The amplitude of all waves from the sun follows the law:

$$A = k/r \quad (20)$$

¹⁾ In a profound paper "On the absorption of light by coloured media", Sir *John Herschel* has outlined the effects of aether wave motion through material bodies so clearly that we quote it:

"Now, as regards only the general fact of the obstruction and ultimate extinction of light in its passage through gross media, if we compare the corpuscular and undulatory theories, we shall find that the former appeals to our ignorance, the latter to our knowledge, for its explanation of the absorptive phenomena."

The question 'What becomes of light' for *Herschel* is converted into 'What becomes of motion'. "And the answer, on dynamical principles, is, that it continues forever."

and the energy of the waves varies as the square of the amplitude

$$E = A^2 = k^2/r^2. \quad (21)$$

Accordingly the power of the waves to develop luminosity ought to increase and diminish almost directly as the power of the sun's radiation, when the comet approaches and recedes. This conclusion is in general accord with observation. In much the same way the permanent luminosity of the nebulae may depend on the transformation of waves otherwise largely invisible. The evidence of celestial radio-activity is therefore ample, but not exactly of the type noted under experimental conditions in our laboratories.

(ii) Animal and plant growth and decay represent transformations of energy, and thus point to wave-action.

After the foregoing development of the wave-theory this subject is so obvious that an extended argument seems superfluous. We therefore merely call attention to certain leading facts.

1. Animal and plant nutrition go on under the action of chemical affinity and the molecular forces. And if these two types of physical forces be due to wave-action, it will follow that the nutrition due to chemical affinity and molecular forces are also due to wave-action.

2. The processes of nutrition consist in the preparation, for the breaking up of molecules of the food, in order to make the constituent atoms available as building material for the renewal of organic molecules which are undergoing decay, decomposition or combustion by oxidation in the organism. Thus the support of organic life requires a constant renewal of molecular and atomic energy, in the form of food prepared for such nutrition, which gives bodily energy and strength to the animal or plant.

3. In the case of plant life, the material taken in as food is largely inorganic, nitrogenous and other elements from the ground, carried up into the plant structure by the force of capillarity, which is a phenomenon of wave-action. These elements from the earth are borne in the sap, and thus distributed throughout the plant structure. But the plant leaves act as lungs, and absorb certain gases. These lead to the fixation of oxides and potash products in the plant structure. Above all, carbon dioxide (CO_2) taken from the air is effective in building up the organic structure of the plant.

4. The carbon from the CO_2 is built into the plant structure, so as to make fibre, while most of the oxygen is liberated again to return to the air. Thus growing plants purify the air of carbon dioxide. Their growth constitutes a chemical process or reaction, whereby organic structures having carbon as the main body of plant structure are built up, and when dried out may be burned, again producing heat and CO_2 .

5. It is well known that plants cannot live without air and sunlight. The sunlight, in concert with the longer heat waves, aids the chemical changes, whereby inorganic atoms are united and built up into organic molecules. In darkness, as we have often observed, a plant languishes, turns pale and finally dies: the chemical transformations of its life come to a standstill, as decay of organic circulation and nutrition fails. This failure is due to the cutting off of the shorter waves,

upon which chemical transformation mainly depends, so that without light plants cannot grow and flourish.

6. The finished plant structure is largely hydrocarbon, with certain mineral salts and water of nutrition. Cut off the water, and the plant withers, because the circulation and nutrition through capillarity and the chemical transformation by wave-action, in the form of light and heat, all come to an end. In the same way, if we intercept the main flow of capillarity, by cutting off the bark and laying bare the wood of a tree, it will soon die. This process of »deadening« is much used by American farmers when they wish to kill the trees on uncleared land. And now we see that it all depends on intercepting the capillary flow, which is due to wave-action.

7. What applies to trees applies to almost all forms of plant life. Thus we see that if the capillarity, due to wave-action, and the chemical affinity for nutrition, under the action of heat and light waves, be seriously intercepted, the result is essentially fatal. Hence we hold that all vital phenomena in the plant and vegetable world depend on wave-action. This is the deeply mysterious power for renewal so long hidden from our sight, but operating everywhere for the support of life in organic nature.

8. The life of animals is more complex and varied, but the causes underlying its maintenance are in the main the same. The typical animal lives largely on plants, in one form or another. Hence wave-action develops plants, and their digestion or decomposition under various chemical reactions, furnishes food or nutrition, which is made to nourish and support the strength of animal bodies, and all their varied activities.

9. Most of our common animals have animal heat, and hence the chemical combustion of their food is maintained by oxygen breathed in through the lungs. We shall not here treat of fish and other forms of life with low temperature, which have different vital processes, as these are treated of in works on biology. It is evident therefore that animal nutrition depends on wave-action quite as much as plant nutrition. Food is taken into stomachs, and subjected to the chemical reaction of juices, at appropriate temperature, and thus the transformations are connected with wave-action.

10. The longer waves of the world go through animal bodies quite unperceived, and stimulate the shorter waves, on which chemical action depends. Thus our theory of the X-rays being short waves maintained by the action of longer and more penetrating waves (cf. AN 5079, p. 292), finds confirmation in the processes of animal and plant nutrition.

We have been unaccustomed to view the vital processes of the world as due to wave-action; but if molecular and chemical forces depend on the energy of waves in the aether, we shall obviously have to change our old way of thinking.

11. Our new theory of magnetism and electrodynamic action, under which aether waves penetrate all objects, has led a learned thinker, Rev. *Paul Camboué*, S. J., of Tananarive, Madagascar, to suggest that love and other emotional influences in animals, and in man, depend on aether waves emanating from and directed by bodily senses and organs, not unlike the influences of magnetism in inorganic nature. In fact I have held somewhat similar views for some years, including

the conviction that thought is an electric process sustained by waves, and have considered more especially mental and telepathic suggestions as coming under the domain of wave-phenomena¹⁾. The connection of these theories with mental and spiritual and psychic phenomena is obvious, but we leave the development of the subject to those who make a specialty of psychic phenomena.

12. It is of course recognized that bodily senses and organs, by the nature of our nervous system, are largely under the control of the will. But even so, the power of suggestion may be conveyed by wave influences directed by different individuals; and thus a great domain of wave-action is seen in aesthetics and social life, heretofore but little understood.

If one magnet can by the concerted vibrations of its atoms draw those of another piece of metal into harmonious accord, so that the second piece of metal responds to the waves from the first, a similar power of response for the development of emotional harmony may exist in living beings. Here, again, the field for speculation is very great, but we must content ourselves with the physical laws, and leave the applications of the laws to those best qualified to deal with psychic and emotional influences.

It is, however, of some interest to note the immensity of the domains of science opened up by the new theory of the aether. Indeed the unexpected impression now drawn from most obscure subjects will lead us to reflect that the aether is the bearer of light for illuminating the organic as well as the physical world.

(iii) All vital phenomena depend on chemical action and thus on wave-action, which also builds crystals and deposits ores by electrolysis.

Some fifteen years ago Professor *Jacques Loeb*, then at the University of California, but more recently of the Rockefeller Institute for Medical Research, New York, told me that in his judgement all vital processes depend at last analysis on chemical action. He cited the fact that suspension of the supply of material required for nutrition is fatal; and that by varying the supply, and mixing it with various elements, a varied growth results, as shown everywhere by the great variety of organisms and their modification in nature.

Now Professor *Loeb* is perhaps the most eminent experimental biologist in the world. He produced parthenogenesis by the use of solutions containing certain chemical elements on frog eggs; and the frogs thus artificially developed were found to be normal; without the loss of any of their natural animal powers.

Accordingly, the high authority of Professor *Loeb's* opinion in a biological problem ought to be almost decisive that all biological processes depend chiefly and at last analysis on chemical action. But the variety of life and vital phenomena is so great that perhaps we shall consider this conclusion more probable if we note the elements upon which vitality depends:

1. We take life as existing, and shall not go into the discussion handed down through the centuries as to the origin of life. *Arrhenius* and others think the germs of it may have

come to us from other worlds; while some hold that it doubtless originated here by processes at present wholly unknown.

2. Life depends for its maintenance on four chief processes:

(a) Nutrition, or the absorption for chemical assimilation of various elements useful in body building.

(b) Digestive processes, by which the elements are prepared for nutritive processes, making absorption and nutrition easy, so that bodily strength and functions can be maintained.

(c) External chemical elements such as oxygen required for animal heat, and carbon dioxide for plants; which aid the maintenance of life, by maintaining heat, elimination, or body building.

(d) Regulation of chemical action, as these processes go on. And as the chemical action depends on wave-action, we see that the aether waves pervading the world are the chief element in regulating the progress of growth.

3. These four elements are the chief sources of vitality. And if we knew how to sustain the efficiency of these sources of power unimpaired, we should have the means of new vitality. In practice we are reduced to the problem of studying the most advantageous nutrition, improving the processes of elimination, but in some cases electricity may aid medical therapeutics, by the new stimulus thereby afforded by artificial wave action. This last use of electricity has considerably increased in modern medical practice; but the processes of nature are symmetrical, and living beings may have local stimulation more easily than general renewal.

4. In the third paper on electrodynamic action and magnetism, AN 5079, pp. 261-262, we have shown how *Ampère's* original theory of elementary electric currents circulating about the atoms may be reconciled with the wave-theory. In fact the wave-theory and *Ampère's* theory in many respects are identical. And if we conceive waves coming to a body from the atoms of another body, whose atomic planes have a haphazard orientation, the two systems of oscillations, atom for atom, will correspond, as in the theory of gravitational attraction. Each atom is to be conceived to oscillate in such a way that revolving contact occurs between its parts, or the system circulates periodically, the periphery thus giving circulation with the oscillation. The result of the revolving contact or periodic circulation is a wave flat in the atomic equator. Thus *Ampère's* theory of 1822 and the wave-theory are the same.

5. This vibration-theory of atoms is well known in spectrum analysis, and the *Ampère-wave-theory* enables us to interpret it mechanically, in a comparatively simple way. If the waves from the atoms can be maintained unimpaired their electrical vitality is steady as in permanent magnets. But in vital processes the work of nutrition has to go on, because of physical work done by animal organisms; and thereby the vibrational power of the atoms in the physical body may be impaired, partly by clogging the electrical conductivity, and partly by the short circuit and hysteresis effects, with natural waste of electric energy.

¹⁾ In radio-telegraphy our apparatus has to be carefully attuned to give the best receiving and transmitting power. So also in psychic phenomena only those en rapport, in very close psychic accord, may send and receive telepathic messages. The wave-analogy seems very suggestive.

6. Thus vital phenomena depend on wave-action largely in the form of electric energy, — the wave energy of the aether pervading the entire universe. And just as battery action is not perfect and involves a certain amount of waste from physical deterioration — so also vital energy may decline under poor bodily nutrition and waste, which are inseparable from the work of life. A permanent magnet does not deteriorate, because the energy given out equals that received, when the atomic planes remain fixed. Yet in the electrolysis of the world, the electric action is not so unhindered, but constantly modified by chemical affinity due to other elements, as in vital processes, so that conductivity is constantly changing.

7. These remarks throw some light upon the processes of mineralogy and crystallization. Some twenty five years ago I heard that an eminent investigator of crystals had reached the conclusion that they are living organisms, not very unlike certain primitive types of plants and animals. Such a view then seemed very startling, but it now seems plausible if not demonstrated. It is certain that the building of crystals is an electrolytic action due to waves, and made effective when certain solutions are available for facilitating the electrolysis. Wave-action therefore underlies crystal-building just as it does all vital processes.

8. In spite of all our researches on minerals and metallurgical processes, we are still much in the dark as to the origin of ores in veins, and nuggets. Just why silver and gold, nickel and platinum, copper and iron should be deposited as they are in the earth's crust has never been satisfactorily explained. We shall not here go into the question extensively, but it may not be out of place to remark that electrolytic action is the only explanation worth considering.

9. Electrolytic action, in the form of electro-plating, explains the plating of silver on silver, gold on gold, copper on copper. Such electro-plating requires the metallic elements to be in solution, and a current to be maintained capable of effecting the deposits. Now the earth is a vast and varied laboratory, in which the chemical elements are variously mixed, and often dissolved in baths of liquid. And therefore if current action could be maintained it is more than probable that electrolysis analogous to electro-plating would go on; and even if the process be very slow, it would finally give us just such a variety of metallurgical phenomena as we actually observe in nature.

10. In proof of this electrolytic action, under the wave-action pervading the world, we need only cite the collection of gold nuggets in matrixes of quartz, and silver in corresponding characteristic rocks. The conditions which permitted these rocks to form, often with partial crystallization, have also permitted the earth's electrolytic action to deposit the gold and silver, dissolved in the solution of sea water, from the baths of the ocean overlying these rock formations. It is well known that sea water contains practically all elements in solution; and the processes of electro-plating under the wave-action of a current, is the only explanation of mineralogical phenomena suggested by chemical experience. All these phenomena are more closely related to vital phenomena than might at first sight seem probable.

Conclusion of the Wave-Theory of Chemical Forces.

The wave-theory of chemical forces follows from the wave-theory of molecular forces, as will be perceived by those who study this whole series of papers; and it appears that the present argument is not only strong in itself, but also gathers immense power from the argument developed in the preceding wave-theory of the larger physical phenomena. A satisfactory theory of the phenomena of nature will not be viewed with indifference by discerning natural philosophers.

Accordingly, we add merely a few suggestive considerations which may be of interest in the future development of this subject.

(α) *Fourier's* remark that heat travels incessantly equally suggestive in regard to other forms of energy.

It is well known that chemical processes are always at work, but it is well to examine this fact more closely, in hope of confirming the cause underlying this ceaseless law of change. In his celebrated *Théorie analytique de la chaleur*, 1822, *Fourier* exclaims:

»La chaleur pénètre, comme la gravité, toutes les substances de l'univers; ses rayons occupent toutes les parties de l'espace. . . . En effet, le rayon du soleil dans lequel cette planète est incessamment plongée pénètre l'air, la terre et les eaux; ses éléments se divisent, changent de direction dans tous les sens; et, pénétrant dans la masse du globe, ils en élèveraient de plus en plus la température moyenne, si cette chaleur ajoutée n'était pas exactement compensée par celle qui s'échappe en rayons de tous les points de la superficie, et se répand dans les cieux.«

Throughout this great work *Fourier* dwells on the incessant movement of heat, and gives the mathematical laws for this propagation. As heat is now known to be a wave-motion, *Fourier's* argument becomes of general application to the universe.

(β) The wave-theory of the growth of crystals and of metallic deposits of ores and minerals in the crust of the earth naturally follows from the wave-theory of chemical affinity.

The evidence adduced above for this conclusion could be much extended, but we deem it well to leave this discussion to chemists and mineralogists. It only remains to add that if our theory of tenacity be admissible, as shown in the fifth paper, then it follows that the wave-theory of electrolytic processes is beyond dispute. The aether is so stressed at the boundary of solid bodies that not only adhesion occurs, but also cohesion. This suffices to build up solid crystals, and furnish the powerful forces operative in electro-plating and in metallurgical processes.

Whether these world processes yield ores, nuggets, or metallic masses of larger size, I can not doubt that this wonderful process for producing in nature pure crystals, and pure ores, with nuggets of the precious metals, as of gold, silver, and platinum, are due to molecular separation and ordering under wave-action, as in our familiar process of electro-plating.

Considered from the point of view of its history through millions of years, the earth, with all the metals in solution in the sea, is an immense collection or bath of solvent elements, under the electric waves and other oscillations pervading

the universe¹⁾, and exhibited to us daily in the fluctuations of the magnetism, electrical disturbances and earth currents.

(γ) The doctrine of the conservation of energy and of the correlation of forces finds its best support in the wave-theory of physical forces. But this conservation should be understood to apply to all the energies of the universe — mental, spiritual, and subconscious, as well as purely physical. All ordinary vital phenomena must be referred to chemical processes, and thus to wave-action, on which the chemical forces depend. It has long been believed that electrical energy underlies vital phenomena, and now we have endeavoured to give valid physical grounds for this doctrine.

(δ) If our wave-theory of magnetism be admissible, it will follow that each individual carries a mental and spiritual wave-field with him, and hence the 'magnetic power' of certain persons. It is not our purpose to go into psychic or related phenomena, as this must be left to specialists in that large and important field of research. We merely point out that if magnetism and electrodynamic action be referred to waves from atoms, which under certain conditions act in concert, we shall have to admit that each person may be able to exert 'personal magnetism' and emotional influences, depending on waves in the aether, somewhat analogous to physical magnetism.

The subtle psychic influences operating through the all-pervading aether are as yet but imperfectly understood; and until the field is more fully explored we must preserve an open mind, as the first duty in scientific research, which aims not at popularity, but at truth, which endures unto all generations.

Part II.

Discovery of the Cause of Universal Gravitation.

In concluding the new theory of the aether it only remains to draw attention to the discovery and demonstration of the cause of gravitation, which results from this new theory, and the similar researches published during 1917, in volume 1 of the Electrodynamic wave-theory of physical forces. The new theory of the aether affords the necessary and sufficient conditions for a definite proof that wave-action underlies the chief operations of nature.

First, we analyse the facts of planetary observation in accordance with the inductive method which enabled *Kepler* to discover the laws of planetary motion, 1609–1619.

Second, we point out the steps and the physical and geometrical criteria by which *Newton* deduced from these facts of observation the law of attraction for universal gravitation.

Third, the phenomenon of acoustic attraction, for waves of air traveling past a balloon of CO_2 , is simple and easily understood, from measures of velocity in the theory of sound; and thus we naturally apply a similar aether-wave-theory to the observed attraction of universal gravitation. The inductive method, applicable to terrestrial gases which may be experimented upon in our laboratories, thus may be extended to the aether, in which the wave-action of universal gravitation takes place; and the similarity of the wave-processes in the

two cases is so close as to be truly remarkable. It appears from geometrical criteria, that such wave-action alone will explain universal gravitation; and thus we deduce the cause involved, and bring out the necessary and sufficient conditions based on physical and geometrical laws of unquestioned validity.

7. Recognized Geometrical and Physical Criteria Analysed by the Method of *Kepler* and *Newton*. Foundations for the Discovery of the Cause of Universal Gravitation thus incontestably established.

(i) Brief statement of *Kepler's* laws and of *Newton's* deductions therefrom.

It is well known that *Kepler* used the observations of *Tycho Brahe* to deduce the observed laws of the planetary motions; and that *Newton* subsequently deduced the law of gravitation mathematically from the physical facts formulated in *Kepler's* laws. When *Newton* had thus deduced the law of attraction for the force of universal gravitation, he was able in turn to show that *Kepler's* laws follow from the law of this force varying inversely as the square of the distances, and even to correct *Kepler's* third law, which was not quite accurate as originally given, — *Kepler's* form being $t^2 : t'^2 = a^3 : a'^3$, whereas it should read

$$t^2(1+m) : t'^2(1+m') = a^3 : a'^3. \quad (22)$$

After the course of reasoning laid down by *Kepler*, *Newton* derived geometrical criteria, to supplement *Kepler's* physical criteria, which proved both necessary and sufficient to establish rigorously the law of the forces governing the planetary motions. On account of the historical importance of this development, and its bearing on the related problem of the cause of gravitation, which we deduce by an analogous method, we shall examine the reasoning of *Kepler* and *Newton* with some care.

In the work on the Motion of mars, 1609, *Kepler* announced, in substance, the following laws as observed physical facts:

I. The orbit of the planet is an ellipse, with the sun in the focus.

II. The radius vector of the planet drawn to the sun's centre describes equal areas in equal times.

III. And in the work *De Harmonice Mundi*, 1619, the third or harmonic law: The squares of the periodic times of the planets are as the cubes of their mean distances, or $t^2 : t'^2 = a^3 : a'^3$ — the slightly corrected modern form being

$$t^2(1+m) : t'^2(1+m') = a^3 : a'^3. \quad (23)$$

Tycho's observations of mars, and the considerable eccentricity of the orbit of that planet had enabled *Kepler* to reject the traditional Ptolemaic theory of eccentrics, and substitute therefor the theory of planetary motion in an ellipse. So daring an innovation cost *Kepler* great labor, because it involved very tedious calculations. As his work was done before the invention of logarithms, these calculations could not then be abbreviated, as they have been for later investigators. Accordingly, *Kepler* declared that *Napier's* invention of logarithms had trebled the lives of the astronomers.

¹⁾ When we observe the phenomena of nature and note the infinite variety of exquisite colors, some due to absorption, some to refraction and dispersion, and others to interference, we wonder indeed that the wave-theory was not long ago suggested to investigators. Accordingly, if there be those who hesitate to grant the truth of the theory, we need make but one remark: Behold the order of nature, with the infinite varieties of colors in the heavens and in the earth! Has this beautiful order no meaning to those who have eyes to see?

We see therefore that *Kepler's* first law is mainly concerned with getting away from the Ptolemaic hypothesis of eccentrics and epicycles, which the discoveries of *Copernicus* had largely but not entirely swept away.

The second law of *Kepler* has a very different import, namely, the equal areas described in equal times points to a central force acting on the planet and directed to the sun's centre. It is well known and easily demonstrated that however the law of force may vary with the distance, so long as it is central, the areas described by the radius vector will be equal in equal times. This law of areas would hold for any law of attraction,

$$f = k/r^n. \quad (24)$$

If the law should change, as from $n = 1$ to $n = 2$, the areas described would still continue to be equal, but the form of the curve in which the planet moved would undergo a change with the change in the law. Thus when $n = 1$, the curve is an ellipse, with the sun in the centre, but with $n = 2$, the curve is an ellipse with the sun in the focus, corresponding to the planetary motions observed in nature.

Finally, after the second law showed that the force is central and directed to the focus, the third law of *Kepler* enabled *Newton* to deduce the law of this force. *Newton* proved that it must vary inversely as the square of the distance. On the observed facts of *Kepler's* laws no other law of force is admissible.

But in establishing the law of gravitation, (*Principia*, 1686) *Newton* proceeded with his usual caution and philosophical acuteness. For he not only showed that if the planet move in an ellipse with the sun in the focus, the force of attraction will conform to the law of universal gravitation; but also investigated the effect of a slight departure from the law of the inverse squares (cf. AN 5048, pp. 144-153).

Thus if we take

$$f = k^2/r^{2+\nu} \quad (25)$$

where the gravitational exponent is changed by adding ν , a very small quantity, *Newton* pointed out that the result would be a forward motion of the perihelion. Hence already in 1686 he foresaw the possibility of a shifting perihelion, — such as *Leverrier* discovered for the planet mercury in 1859, which has since led to many unprofitable speculations on relativity.

Yet as the observations in *Newton's* time pointed to the fixity of the perihelia (*Principia*, Lib. III, Prop. XIV), this great philosopher believed the law of attraction to be rigorously as the inverse squares. Accordingly, it will be seen that the investigations of *Tycho's* observations led *Kepler* to the laws of planetary motion, as facts of nature; and upon the basis of *Kepler's* laws further geometrical researches led *Newton* directly to the law of universal gravitation. The physical facts of nature being as stated in *Kepler's* laws,

¹) In AN 5079, p. 257, we have shown the inadmissibility of *Gerber's* formula for the potential, which underlies *Einstein's* theory:

$$V = M[r(1 - 1/c \cdot dr/dt)^2]. \quad (\alpha)$$

In the Treatise on electricity and magnetism, 1873, section 856, *Maxwell* has successfully defended the validity of *Weber's* law, of which the potential is

$$V = (k^2 mm'/r) \cdot [1 - 1/c^2 \cdot (dr/dt)^2]. \quad (\beta)$$

The second term gives the effect due to motion in a wave-field, the work of transforming the potential energy changing, like the kinetic energy, with the square of the planet's velocity relative to the sun. If $dr/dt = v$, as in circular orbits, the *Newtonian* law follows; but more generally the velocity in the direction of the radius vector dr/dt yields a term for the effect of the induction, and d^2r/dt^2 gives the term for the change of the induction, under motion in the wave-field. Thus *Weber's* law is the fundamental law of nature, and from (β) we have:

$$f = -\partial V/\partial r = (k^2 mm'/r^2) \cdot [1 - 1/c^2 \cdot (dr/dt)^2 + 2r/c^2 \cdot d^2r/dt^2]. \quad (\gamma)$$

Newton's geometrical criteria were necessary and sufficient to show that the force of attraction obeys the law of the inverse squares, and no other.

During the past three centuries the historical development here traced always has been regarded as the best and most rigorous example of the true processes of scientific discovery. The facts being given, as found by *Kepler* from *Tycho's* observations, the question was: What law of attraction will explain these facts, and is this the only admissible law of attraction?

Newton answered both of these questions in the affirmative, and no one ever has been able successfully to challenge the results of his mathematical researches.

The recent speculations of *Einstein* may be disregarded, because they are totally lacking in physical basis¹). *Newton* based his reasoning on the foundation of facts laid down by *Kepler*, which was as solid as granite; and hence the past three centuries have witnessed an unprecedented development of celestial mechanics. Since the time of *Laplace* the *Newtonian* law has been regularly used as a means of discovery as certain as observation itself.

If we contrast this careful procedure, with correct reasoning on valid premises, and compare its logical results with the reckless course of *Einstein* in proposing to do away with the aether, — as if the planetary forces were not real, — and a medium capable of sustaining stupendous stresses were not necessary for their transmission across space, — we shall perceive that the whole theory of relativity is nothing but a flimsy foundation laid in quicksand. In this whole theory of relativity there is not a trace of substantial physical truth.

(ii) In acoustic attraction the air particles under the wave agitation work out from between the balloon of carbon dioxide and the source of the sound, so that there is tension between, while the pressure is increased behind the balloon. In the same way the aether waves from each of two heavenly bodies expel aetherons from between the masses, thereby generating tension, at the same time increasing the pressure beyond, thus giving rise to the attraction of universal gravitation.

The mechanism of attraction, in the case of acoustic attraction, has been clearly made out in the fifth paper on the new theory of the aether (AN 5130), and we have illustrated this mechanism by means of a chart of the wave front which is so clear and distinct that no doubt can arise as to the nature of the cause assigned. The figure is here repeated, in order that the image of the wave front may be recalled to our minds with entire distinctness (Fig. 12, plate 7).

It is evident that as the sound travels faster in air, $V = 1.00$, than in the balloon filled with CO_2 , $V = 0.78$, the wave agitation in the air will outrun that through the

balloon. Thus for every phase of the waves, the agitations reach the back of the balloon through the air before they arrive straight through that denser and less rapidly conducting medium. The effect is to bend the wave front into oppositely directed eddies behind the balloon, and the incessant advance impulses of the waves, — thus turned out of the ir-rectilinear course, and stopped by the mutual impact of the eddies, — give such agitation or increase of pressure behind that the balloon is shoved forward towards the source of the sound.

As the particles tend to work around behind the balloon, it may be said that the air is thinned out between, when the particles are carried around behind; so that there is tension in the medium between the balloon and the source of the sound. On the other hand the crowding of particles in behind the balloon, by the constant bending of the front as the waves flow steadily around it, and the impulses are destroyed, has the effect of an increase of pressure on the back of the balloon. It is shoved forward by the kinetic energy of these impulses. And thus it may be said that at last we have experimental proof that attraction is due to a vis a tergo — a shove from behind, which is a very old doctrine in natural philosophy, but heretofore not capable of obvious demonstration, in simple phenomena admitting of but one interpretation.

Now in the case of the aether waves receding from two heavenly bodies, it is evident that the waves from each centre will aid in expelling the aetherons from between the masses. In AN 5048, p. 156, we have given the following figure to illustrate the refraction of the sun's gravitation waves in traversing the solid globe of the earth.

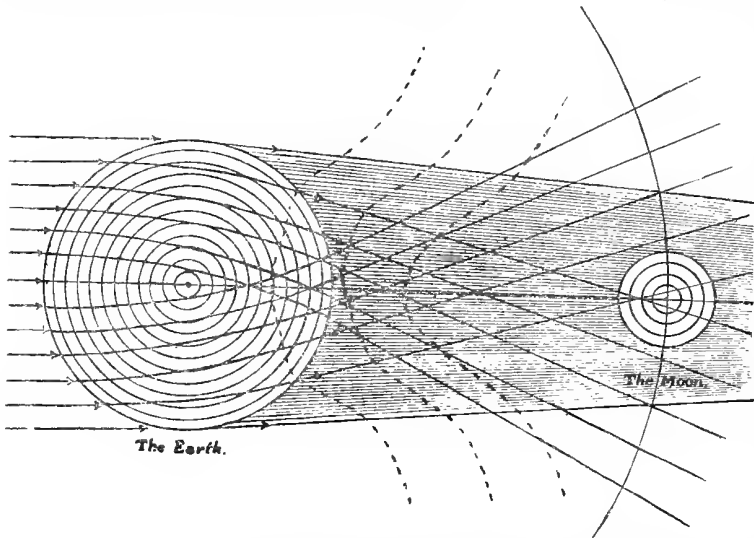


Fig. 13. Illustration of the refraction of the gravitational waves of the sun in passing through the globe of the earth, from the *Electrodynamic wave-theory of physical forces*, vol. 1, 1917, p. 88. The refracted wave-front is here indicated by pointed lines, to complete the analogy with sound, refracted around the balloon filled with CO_2 , and shown in Fig. 12, plate 7.

It will be noticed that the waves from either side are refracted towards the axis of the earth's shadow, just as in the case of the acoustic attraction illustrated above. This is a very remarkable analogy which deserves careful study.

We may easily convince ourselves of the validity of this figure by the following considerations.

1. The refraction of the sun's gravitational waves in passing through the earth, as illustrated above, is postulated on the increase in the density of the layers of the globe as we approach the centre, which is a well established physical fact, — since the surface density is only about 2.55, while the average density for the whole globe, according to the most careful experiments is about 5.50.

2. But quite aside from the increase of density in the layers as we approach the centre, it is well known that in all cases waves travel faster in free space than through any solid mass whatever. Thus the wave front on either side must be refracted towards the axis of the shadow, not only within the globe, but also outside of the earth, very much as in the case of the sound waves about the balloon of carbon dioxide treated above.

Accordingly, we see that the explanation of acoustic attraction affords a tangible explanation of the development of tension between two heavenly bodies, and the increase of pressure beyond them. The air is a kinetic medium, like the aether, only the aether is 689321600000 more elastic in proportion to its density. Hence the aether is capable of exerting tremendous stresses, for governing the motions of the planets.

Finally, it only remains to add that in light the oscillations of the aetherons are in the normal to the wave front, and thus similar to those of sound as held by *Poisson*, 1830, (cf. AN 5085), but the waves are flat only in the planes of their equators, and under haphazard arrangement of the

atomic planes only the part $q = \frac{1}{40}$ in the direction of the radius, while the ratio of A/λ is excessively small, making the longitudinal component evanescent

$$A = q \cdot A/\lambda = 1 : (66420 \cdot 10^6); \quad (26)$$

so that the longitudinal component is utterly insensible to observation. As the displacements of the aetherons are similar to those of the particles of air in sound it follows that the bending of the aether wave-front is similar to that shown in the above diagram of the wave-front for sound waves bending about the carbon dioxide balloon.

In all these aether waves there is true radial displacement of the aetherons, as of the particles of the air, when sound is traveling outwardly from a source; and thus the analogy between sound and gravitation is complete in every respect. Accordingly, we perceive that the aetherons are so worked out from between the two heavenly bodies, that tension exists along the right line connecting them, while beyond them there is increase of pressure, as correctly held in the *Electr. wave-theory of phys. forc.* vol. 1, p. 136.

8. The Inductive Method of Discovery as applied to the Aether leads to Wave-Action as the Sole Cause of Universal Gravitation.
(i) The *Kepler-Newton* method applied to the new theory of the aether.

We have now traced the procedure of *Kepler* and *Newton*

and shown that from certain well established facts of nature they deduced definite laws of the planetary motion, all depending on the attraction of gravitation.

The question now is: Can this *Kepler-Newton* method be applied to the kinetic theory of the aether, to deduce rigorously the cause of universal gravitation?

For as *Newton* made rigorous use of the facts stated in *Kepler's* laws to establish the law of gravitation, it is natural to inquire if the *Kepler-Newton* process can be so extended in the theory of the aether as to enable us to deduce rigorously the cause underlying universal gravitation.

We approach this problem by successive steps as follows:

1. It has been shown in AN 5044, p. 53, that the density of the aether is not uniform throughout space, but increases away from a heavenly body, because the amplitude of the waves receding from any spherical body such as the sun follows the law:

$$A = k/r. \quad (27)$$

2. Accordingly, if the medium be agitated by waves, their amplitudes increase towards the centre inversely as the radius, so that under the agitations of the waves the density decreases towards the centre, and increases as we go outward into space, directly as the radius:

$$\sigma = vr \quad (28)$$

3. The following figure shows the curves for the wave amplitude, which are rectangular hyperbolas referred to their asymptotes.

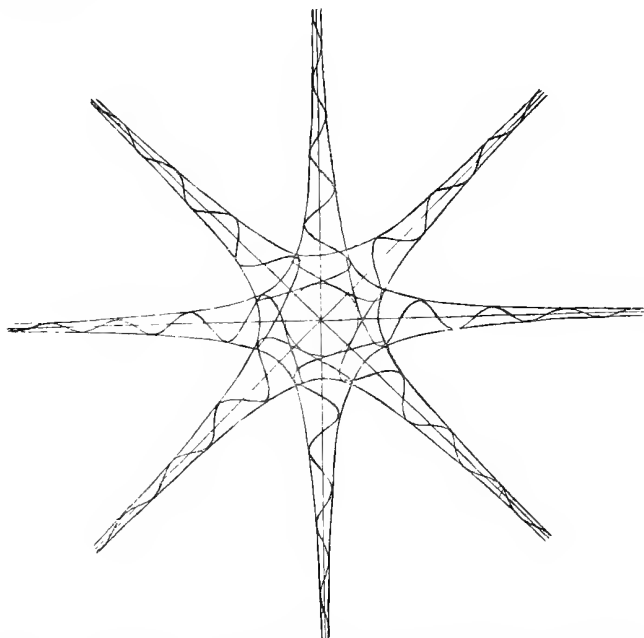


Fig. 14. Diagram showing graphically the increase of amplitude towards the sun, and thus a corresponding decrease of the density of the aether, owing to the asymptotic increase in wave amplitude as we approach the centre.

These curves follow from the nature of wave expansion in tridimensional space, and the asymptotic law of the amplitude thus holds rigorously true.

4. Apparently the only way we can deny the heterogeneity of the aether is to reject this diagram by denying that waves exist; yet this is increasingly difficult because of the following phenomena:

(a) Light and heat waves certainly radiate from the sun, and these waves follow the law shown in the diagram. Thus if the aether were agitated by waves of light and heat alone, it could not be homogeneous, because of the increased amplitude of the waves towards the sun's surface.

(b) It is shown in our theory of magnetism that magnetic forces depend on waves, and obey the law of amplitude indicated above. Thus cosmical magnetism also is a wave-phenomenon, and observation shows that 'magnetic storms' are due to masses of magnetic waves proceeding from the sun, and thus very conspicuous when certain solar areas are uncovered, as by sunspot development.

(c) A paper by Professor *W. Grylls Adams* in the *Phil. Transact. of the Roy. Soc.* for 1892, A, plate 8, seems to show that these magnetic disturbances occur simultaneously throughout the terrestrial globe, as if the disturbances depended on commotions in the sun. These disturbances are accompanied by aurorae and earth currents, which can only be explained by a solar origin.

(d) The connection between sunspots and magnetic storms is shown over a period of two or three centuries, and emphasized by our latest researches with modern data, as by the writer's paper bringing *Wolf's* curves down to 1916, *Bull. of the astron. soc. of France*, November 1918, pp. 397-402.

(e) During the year 1920 much discussion arose in the radio-telegraphic circles of London as to the origin of very delicate but incessant electric commotions sensible to our modern apparatus. In an interview with the public press I expressed the opinion that the reported disturbances depended primarily on commotions in the sun, which caused corresponding oscillations in our terrestrial magnetic field. Within about two weeks of this discussion in America, press dispatches from Paris and London stated that the French and English men of science concurred in the view that these disturbances of our wireless receivers depend principally on the commotions always going on in the sun.

5. Thus we are driven by a great body of knowledge to admit that electrodynamic waves must come to us from the sun.

(a) If so, the aether cannot be homogeneous, but must follow the law of density

$$\sigma = vr \quad (28)$$

because of the increasing amplitudes of these waves towards the sun.

(b) Waves offer the only known explanation of magnetism and electrodynamic actions, with the law of amplitude,

$$A = k/r \quad (27)$$

and the law of force,

$$f = A^2 = k^2/r^2. \quad (29)$$

(c) In the same way the wave-theory explains *Biot* and *Savart's* law, *Ohm's* law, and the mechanical cause underlying the pointing of the needle to the north pole, — whilst no other theory supplies this obvious defect, involving so many electrodynamic phenomena.

(d) *Weber's* electrodynamic law implying waves traveling with the velocity of light, explains the magnetic tides of the earth, whilst no other law meets this rigorous requirement.

6. Accordingly, we see that the wave-field traced in the above diagram gives us an accurate picture of the arrangement of the aether about such a central body as the sun. The density of the aether increases directly as r , when we go outwardly from the centre. It will follow a similar law about a spherical mass such as another star; and hence these curves of wave amplitude may be made to yield valuable criteria. For example the equipotential surfaces about a homogeneous sphere or a heterogeneous sphere made up of concentric layers of uniform density, are sphere surfaces, yet for a second body the wave-fields interpenetrate and the surfaces are changed in a significant way.

(ii) The geometry of the equipotential surfaces based on the law of gravitation points directly to the cause of this great force, and indicates its mode of operation for producing the chief phenomena of nature.

1. Now when we calculate the equipotential surfaces about two equal stars, μ and μ , we find that they have the form shown in fig. 15, plate 8.

Thus it will be seen that the surfaces closed about each centre in a pair of equal stars are not spherical, but actually distorted as shown in the figure. Each body stresses the aether so as to pull the surfaces enclosing the other body into egg-shaped surfaces, set end on, and where the two surfaces join we have an hourglass figure.

2. Thus the disturbing influence generates egg-shaped equipotential surfaces enclosed about either centre, and they have ceased to be spherical, and become so distorted in the direction of the other body that the radius vector is very appreciably longer than when either body acted alone; whereas, beyond, on the side opposite to the other body, the radius vector is shorter than it would be if the other body were absent. In other words the gravitational forces are compounded as shown in the following figure, and the equipotential surfaces thus increasingly separated between the bodies, and drawn nearer together outside of them.

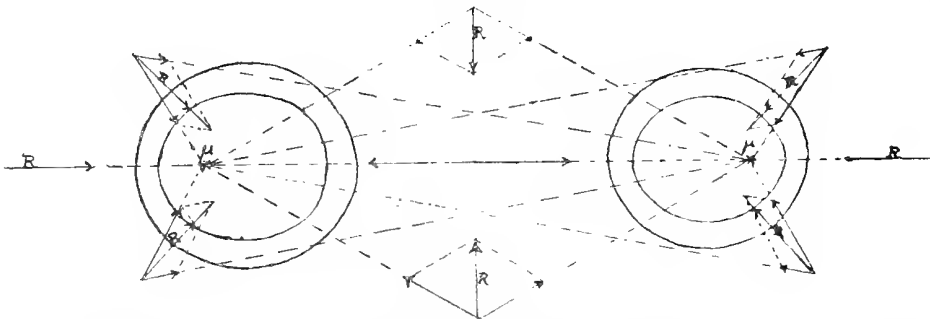


Fig. 16. General theory of the composition of the vectors representing the gravitational forces directed to two equal masses, such as a double star with equal components. It will be noticed that between the masses, the composition largely destroys the oppositely directed separate forces, whereas outside the two masses, the separate forces are but little reduced in composition. The result is that between the bodies the aether is under tension, whereas outside of them it is under increased pressure — both of which tendencies operate to balance the centrifugal force of orbital motion.

3. In general the vector composition gives numerical increase beyond the other body, and numerical decrease between the bodies. Hence we see that:

(α) Between the bodies the successive equipotential surfaces are further apart than they are beyond them.

(β) As the spaces dr indicate the distance we have to traverse for a given change in the force of gravity, which in turn corresponds to a given change in the density of the aether, we perceive that the aether has its density thinned out (or the medium made more homogeneous) between the masses, while the density is somewhat increased beyond them, or rendered more heterogeneous for a given value of dr .

(γ) It thus appears that the waves from each mass operate to expel the aetherons beyond the other mass; so that the medium is put under tension between the bodies, and experiences increase of pressure beyond them.

(δ) The kinetic state of the aether is therefore similar to that of the air under acoustic attraction — there is tension between and increased pressure beyond, which thus generates the central force for holding the planets in their orbits.

(ϵ) In closing this discussion it seems well to record a sagacious remark on gravitation by the late Professor S. W. Burnham, the celebrated discoverer of double stars. It is recalled that the apparent orbit of a binary is an ellipse, and that the radius vector sweeps over equal areas in equal times, as in the case of *Kepler's* law for the planets, which shows that the force is central. It is pointed out that one binary, 42 Comae Berenices, revolves in a plane passing through the sun; and another binary, γ Virginis, has an inclination so small that it may be taken to be zero, so that the real orbit practically coincides with the apparent orbit which we observe; and in this case the central star is in the focus of the ellipse as required by the *Newtonian* law (fig. 18, tab. 9).

(ζ) When such criteria for motion in a plane under central forces directed to the focus of the ellipse were not sufficient to convince an astronomer who visited his office, in 1894, that the law of gravitation is really universal, and he insisted that further proof was desirable — though *Newton* had not required it for the solar system — Professor *Burnham* remarked: »When equal areas are described in equal times, by the radius vector, so that the forces are known to be central, and directed to the focus of the ellipse, is not the discussion about the universality of the law of gravitation like debating whether π , the ratio of the circumference to the diameter of a circle, is the same in Jupiter as it is here?«

(η) This suggested debate was enough to settle the question then and there; and it was agreed that the central force which governs the motions of double stars in their elliptical orbits can be nothing but universal gravitation.

Burnham was remarkable for his practical turn of mind, and for the depth of his understanding of the *Newtonian* natural philosophy, which is especially emphasized in the first and second rules of reasoning:

I. »We are to admit no more causes of natural things than such as are both true and sufficient to explain their appearances.«

II. »Therefore to the same natural effects we must, as far as possible, assign the same causes.«

In the sagacious natural philosophy of *Newton* the phenomenon of refraction is viewed as a simple physical problem, and does not lead to the discussion of such vague and chimerical doctrines as the curvature of space, time-space-manifolds, etc.

9. Rigorous Geometric Analysis confirms the Tension in the Aether between two Stars and increased Stress beyond them, and thus incontestably establishes the Cause of Universal Gravitation.

(i) Geometrical composition of the attraction to two centres from any point in space rigorously confirms the theory of pressure between the stars and the increase of stress or pressure beyond them.

1. Imagine the two stars to be distant r and r' from any point p in space, and let the angle between r and r' be θ . Then by a well known theorem

$$\cos \theta = \frac{(xx' + yy' + zz')}{rr'} \quad (30)$$

the origin of coordinates being at the point p .

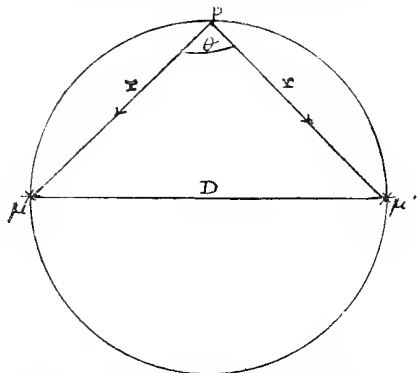


Fig. 17. Geometrical composition of the attraction to two centres investigated, and simplified for points on the circumference of a circle having the two bodies at the extremities of a diameter.

2. If the point p be on the circumference of a circle, having the distance D between the centres of the stars as diameter, the angle θ will be a right angle, and $\cos \theta = 0$. But this condition is special and in general will not hold. If p be beyond the circumference described on D as diameter, $\theta < \pi/2$; if within the circumference, $\theta > \pi/2$.

3. Now whatever be the position of p , we may always compound the attractive forces directed to the two centres according to the parallelogram of forces. Let the two forces be k^2/r^2 , and k'^2/r'^2 ; then by the theorem of the parallelogram we have for the resultant R :

$$R^2 = (k/r)^4 + (k'/r')^4 + 2(k/r)^2(k'/r')^2 \cos \theta \quad (31)$$

$$R = \sqrt{[(k/r)^4 + (k'/r')^4 + 2(k/r)^2(k'/r')^2 \cos \theta]}. \quad (32)$$

4. The angular direction of the resultant will always pass between the two stars. And if $\theta = \alpha + \beta$, the two angles α and β may easily be computed when the magnitude and direction of the forces which make up the two sides, $(k/r)^2$ and $(k'/r')^2$ are given, by the formula

$$\sin \alpha : \sin \beta = (k'/r')^2 : (k/r)^2. \quad (33)$$

These forces may be calculated for any point p distant r and r' from the two stars of masses m and m' , or km and $k'm'$, where k is the *Gaussian* constant.

5. In the case of two equal stars the positions between μ and μ' , within the above circle, make the resultant R less than $\sqrt{[(k/r)^4 + (k'/r')^4]}$, because $\cos \theta$ is negative. For positions outside the above circle, the resultant is relatively larger, because $\cos \theta$ is positive, $\theta < \pi/2$. It attains the maximum relative value in the region outside the two stars, on the line $\mu\mu'$ prolonged; and the minimum relative value between the two stars, on the line $\mu\mu' = D$. This is obvious geometrically from the above figure.

6. The general theory of the composition of forces here set forth shows that the aether is under tension between the two stars, where the geometrical composition tends to a minimum relative value of R . Beyond the two stars, the geometrical composition of forces tends to a relative maximum, and there is greatest increase in the stress of the aether.

The analysis here given explains rigorously the arrangement of the equipotential surfaces about the two equal stars μ and μ' . The above figure shows that the minimum distances between the surfaces are outside the stars, where the stress is increased; and maximum distances are between the stars, where the tension is developed, and the density of the aether increases slowly as we go outward from either star as a centre.

(ii) Tension between two stars and increase of stress beyond them the only possible explanation of gravitation.

1. The law of centrifugal force shows that physically there ought to be tension in the aether between two revolving stars; for the centrifugal force actually is overcome and balanced, which can be done most effectively by tension between, and increase of stress or pressure beyond.

2. By no possibility can a pair of stars revolve without some physical agency operating to give tension between them, so that the stresses in the medium balance the centrifugal force. And we may compute the enormous tension required, in terms of the breaking strength of immense cables of steel, (cf. AN 5044, p. 51).

3. Now the equipotential surfaces show the effects of tension in the aether, since the surfaces are symmetrical in all directions about a single spherical mass, but pulled further apart between two spherical bodies. This distortion of the equipotential surfaces, — which are drawn to correspond to equal changes in the force of gravity, — cannot be explained except on the theory of tension, which gives the aether less increase of density between, for given values of dr , and thus puts the successive surfaces further apart.

4. Since mechanical necessity, calculated from the theory of centrifugal force, thus agrees with the facts of observation in regard to the actual positions of the surfaces, it follows that the cause of the observed distorted form of the surfaces must be tension or stretching of the medium. No other possible cause except tension or pulling, which thins out the aether and makes it tend to contract with stupendous power, will explain the known facts.

5. If we knew the observed forms of the surfaces we could from them predict the tension which yields such dis-

tortion; if we knew the mechanical power of the centrifugal force we could predict the distortion of the equipotential surfaces required to balance the stresses exerted. Both conditions lead to the same result, and no other is possible.

6. If we did not know that the density of the aether increases as we go out from a centre like the sun, we should have to discover it before we could form a correct theory of the equipotential surfaces. Thus the distortion of the surfaces shows the heterogeneity of the aether. And as all known facts are thus reconciled, it follows that no other possible theory of the aether can reconcile the facts of observation except the law for increase of density, as we recede from the centre $\sigma = \nu r$, which Sir *Isaac Newton* suspected in 1721, but could not establish to his satisfaction.

7. If we did not suspect the unsymmetrical wave-fields about the separate masses, and we were required to assign an adequate cause for the increased distances of the surfaces between the two masses, we should have to conclude:

- (a) Between the bodies the equipotential surfaces are relatively separated, by the presence of the second mass.
- (b) Beyond either mass the equipotential surfaces are relatively drawn nearer together.
- (c) These effects are as if they depended on geometrical stresses superposed, but oppositely directed; thus on the plane yz normal to the line $\mu\mu$, and $\mu\mu$ prolonged, we have:

$$W = P + P' = \iint \sigma_s dy dz + \iint \sigma'_s dy dz \quad (34)$$

without the masses;

$$W = P - P' = \iint \sigma_s dy dz - \iint \sigma'_s dy dz \quad (35)$$

between the masses.

8. Therefore, we perceive that the increased distance of the concentric surfaces between the masses, means that we must go a greater distance for a given change in W . Now the aether density increases as we go outward, for a single mass; and in the case of two masses the increase between them is less rapid for given dr , but relatively more rapid externally for both bodies. Hence between the bodies the aether is thinned out by the proximity of the two masses pulling in opposite directions. It is thus under tension, incident to this thinning out. And as the increase in σ is gradual but slower than usual with dr , the concentric surfaces are further apart. In general their figure depends on the masses of the two bodies, whose stresses are here combined.

(iii) Close analogy between density of matter in the earth's crust under isostasy, and density of aether between equipotential surfaces.

(a) In the theory of the equilibrium of the earth's crust, the modern doctrine of isostasy plays a prominent part. If we imagine a solid conical angle $d\omega$, which may be generated by revolving a radius about a fixed small circle, in the surface of a sphere of radius $r = \sqrt{x^2 + y^2 + z^2}$, at constant distance from the centre, the principal theorem of isostasy reduces to the expressions:

$$dm = d\omega \int_r^{r+dr} \int_0^{\theta+d\theta} \int_{\Phi}^{\Phi+d\Phi} \sigma r^2 \sin \theta dr d\theta d\Phi$$

$$= d\omega \int_{r'}^{r'+dr'} \int_{\theta'}^{\theta'+d\theta'} \int_{\Phi'}^{\Phi'+d\Phi'} \sigma' r'^2 \sin \theta' dr' d\theta' d\Phi' \quad (36)$$

the elementary solid angle $d\omega$ of the two cones of matter extending to the centre of the earth being the same in any two elements, $dm = dm'$, between the limits of the radius r to $r+dr$ and r' to $r'+dr'$, corresponding to the depth of isostatic compensation.

(\beta) This theorem was first proposed by *Pratt* about 1850, to account for certain apparent anomalies in the attraction of mountains and plateaus in India, but it has now had extensive use in the researches made by *Hayford* for the U. S. Coast and Geodetic Survey, in respect to the continental mass of the United States, and in *Helmert's* geodetic researches as applied to various parts of our globe. Thus it is well established that isostasy is approximately a fact of observation, and to the depth of isostatic compensation $dm = dm'$. *Hayford* found this depth about 76 miles for the continental United States.

(\gamma) We shall now show that a perfectly analogous theorem holds for the mass of the aether between any two concentric equipotential surfaces drawn about any centre, even when the figures of the equipotential surfaces are disturbed by a neighboring body, as in the case above discussed of two equal stars, with the surfaces distorted between them.

(\delta) Thus let $d\omega$ denote the elementary solid angle arbitrarily fixed upon. Then, as in the above integrals, we have:

$$dm = d\omega \int_r^{r+dr} \int_0^{\theta+d\theta} \int_{\Phi}^{\Phi+d\Phi} \sigma r^2 \sin \theta dr d\theta d\Phi$$

$$= dm' = d\omega \int_{r'}^{r'+dr'} \int_{\theta'}^{\theta'+d\theta'} \int_{\Phi'}^{\Phi'+d\Phi'} \sigma' r'^2 \sin \theta' dr' d\theta' d\Phi' \quad (37)$$

(\epsilon) For we see that when the equipotential surfaces are further apart than usual it means that there is less rapid increase in the density of the aether as we go outward from the centre. In this case the density of the aether increases as we go outward, but least rapidly towards the other body, where the surfaces are farthest apart. In the case of the earth's crust, on the other hand, the density of the matter increases as we go downward, but least rapidly under the mountains and plateaus, owing to the puffing up or intumescence, as Sir *John Herschel* calls it, of the matter just beneath the crust.

(\zeta) Accordingly, it appears that we have a theorem for the aether density quite analogous to that for isostasy in the crust of the globe, but mathematically much more rigorously exact than that of isostasy. The aether theorem

$$d\omega \int_r^{r+dr} \int_0^{\theta+d\theta} \int_{\Phi}^{\Phi+d\Phi} \sigma r^2 \sin \theta dr d\theta d\Phi =$$

$$= d\omega \int_{r'}^{r'+dr'} \int_{\theta'}^{\theta'+d\theta'} \int_{\Phi'}^{\Phi'+d\Phi'} \sigma' r'^2 \sin \theta' dr' d\theta' d\Phi' \quad (38)$$

obviously fulfills rigorously the conservation of energy, since it applies to the aether in the conical space $d\omega$ between two equipotential surfaces concentric about a fixed centre of mass

$$\mu = \iiint \rho dx dy dz \quad (39)$$

yet disturbed by the aether stresses due to another mass

$$\mu' = \iiint \rho' dx' dy' dz'. \quad (40)$$

(*η*) This formulation of the theorem for the rigorous conservation of energy in the aether makes the conclusion incontestable that the aether is under tension between the masses. The increase of stress or pressure beyond the masses, with more rapidly changing density, is equally obvious, since in these parts the space dr required to be traversed is so very small.

(iv) Conclusions drawn from the application of the *Kepler-Newton* method.

The final question now arises: Does not the form of the equipotential surfaces point straight to the cause of gravitation? Is any other interpretation than the one we have given really possible? Obviously not! We have here a criterion which may be applied point by point to the surfaces; and as the surfaces here drawn are found by calculation from the law of gravitation, without regard to the cause involved, yet there is everywhere exact coincidence of the observed facts with the requirements of the wave-theory, it follows exactly as in the *Kepler-Newton* method that one and only one conclusion is possible — namely: gravitation is due to wave-action receding from the two bodies μ and μ .

Accordingly, just as *Kepler's* laws made the rigorous deductions of *Newton* possible, — providing for the necessary and sufficient conditions of valid reasoning, — so also the form and arrangement of the equipotential surfaces about a single spherical mass, and about a pair of equal spherical masses, considered in connection with the spherical expansion of waves in free space, leads incontestably to the cause of universal gravitation. The argument is based on rigorous geometrical criteria, combined with observed physical facts of wave expansion, and it affords the necessary and sufficient conditions to show that this cause and no other can underlie universal gravitation.

In conclusion, it only remains to add that just as *Kepler's* laws, deduced from *Tycho's* observations of the planets, lead inevitably to the *Newtonian* law of gravitation, — so also the observed law of attraction thus found by *Newton* leads incontestably to waves in the aether as the cause of universal gravitation. In the *Principia*, 1686, *Newton* resolves the several attractive forces separately, at whatever distance the bodies are situated, — thus implying that the forces from the bodies of one system penetrate through the bodies of any other neighboring system, — as if the influence were due to waves in the free aether, capable of freely penetrating all parts of space.

In the remarks following the third rule of reasoning in philosophy, *Newton* says (*Principia*, Lib. III):

»Lastly, if it universally appears, by experiments and astronomical observations, that all bodies about the earth gravitate towards the earth, and that in proportion to the quantity of matter which they severally contain; that the moon likewise, according to the quantity of its matter, gravitates towards the earth; that on the other hand, our sea gravitates towards the moon; and all the planets mutually one towards another; and the comets in like manner towards the sun; we must, in consequence of this rule, universally allow that all

bodies whatsoever are endowed with a principle of mutual gravitation.«

Again, in the General Scholium to the *Principia*, (1713), *Newton* adds:

»Hitherto we have explained the phenomena of the heavens and of our sea by the power of gravity, but have not yet assigned the cause of this power. This is certain, that it must proceed from a cause that penetrates to the very centres of the sun and planets, without suffering the least diminution of its force; that operates not according to the quantity of the surfaces of the particles upon which it acts (as mechanical causes use to do), but according to the quantity of the solid matter which they contain, and propagates its virtue on all sides to immense distances, decreasing always in the duplicate proportion of the distances. Gravitation towards the sun is made up out of the gravitations towards the several particles of which the body of the sun is composed; and in receding from the sun decreases accurately in the duplicate proportion of the distances as far as the orb of saturn, as evidently appears from the quiescence of the aphelia of the planets; nay, and even to the remotest aphelia of the comets, if those aphelia are also quiescent. But hitherto I have not been able to discover the cause of these properties of gravity from phenomena, and I frame no hypotheses; for whatever is not deduced from the phenomena is to be called an hypothesis; and hypotheses, whether metaphysical or physical, whether of occult qualities or mechanical, have no place in experimental philosophy. In this philosophy particular propositions are inferred from the phenomena, and afterwards rendered general by induction. Thus it was that the impenetrability, the mobility, and the impulsive force of bodies, and the laws of motion and of gravitation, were discovered. And to us it is enough that gravity does really exist, and act according to the laws which we have explained, and abundantly serves to account for all the motions of the celestial bodies, and of our sea.«

The great penetrating power of gravitation here pointed out, would be naturally explained by the excessive smallness of the aetheron, 1:3620 of the diameter of a hydrogen molecule, and its high velocity, 471000 kms. per second; so that even waves in the aether, if moderately long, could penetrate to the very centres of the sun and planets, as *Newton* says is true of gravitation. *Newton* here expressly declares his inability to discover the cause of gravitation; yet in the authentic Account of Sir *Isaac Newton's* philosophical discoveries, published by his pupil *Colin Maclaurin*, London, 1748, we learn (p. III):

»He (*Newton*) has plainly signified that he thought that those powers arose from the impulses of a subtle aetherial medium that is diffused over the universe, and penetrates the pores of grosser bodies. It appears from his letters to Mr. *Boyle*, that this was his opinion early; and if he did not publish it sooner, it proceeded from hence only, that he found he was not able, from experiment and observation, to give a satisfactory account of this medium, and the manner of its operation, in producing the chief phenomena of nature.«

The impulses of the aetherial medium imagined by *Newton* to be the cause of gravitation are now explained by

wave-action, in accordance with the kinetic theory, which *Newton* had somewhat developed two centuries ago, in the last edition of his *Optics*, 1721. Thus, in the New theory of the aether, and the Electr. wave-theory of phys. forc., we have merely striven to complete the unfinished labors of Sir *Isaac Newton*.

10. Summary of the Chief Results of the New Theory of the Aether.

(i) Although 245 years had elapsed since *Roemer's* discovery of the velocity of light, 1675, a valid theory of the mechanism underlying this enormous velocity was not available until the appearance of the new kinetic theory of the aether, which treats this medium as a monatomic gas, with mean velocity of the aetheron, $\bar{v} = \frac{1}{2}\pi \cdot V$.

In the first paper, (AN 5044), we have pointed out the valid grounds on which the new kinetic theory of the aether mainly rests; and subsequently somewhat strengthened, in the first section of the third paper, (AN 5079), the foundations of this remarkable theory. It is undeniable that all the indications of nature point to a kinetic theory of the aether. And now that it is developed, any other view than that set forth would strike us as too improbable to be given serious consideration.

It can scarcely fail to impress natural philosophers that sound is found by experiment to travel four times faster in hydrogen than in oxygen. And when we connect this relatively rapid speed of sound in hydrogen with the square root of the reciprocal of its relative density, — the density being 16 times less than that of oxygen, — we perceive that the dynamical basis of the high wave velocity in hydrogen results from the *Newtonian* formula:

$$V = V(E/\sigma). \tag{41}$$

This formula at once explains why the speed ought to be four times less in oxygen than in hydrogen, since the density σ occurs in the divisor of the right member under the radical.

Proceeding on the basis of these dependable experiments, which are confirmed by researches on many gases, we necessarily are led to ascribe the high velocity of waves of light and electrodynamic action to the excessively small density of the aether. For if the waves of sound in hydrogen so greatly outrun similar waves in oxygen, owing to the 16-fold greater density of oxygen, it follows that for waves of aether to have a large velocity, the aether must have an excessively small density.

From this conclusion there appears to be absolutely no escape. For the experiments on the velocity of sound in gases are essentially very accurate, and the data well determined, with an excessively small if not insensible uncertainty in the observed results. The ratio of the observed velocity of sound in hydrogen to that in oxygen, with their relative densities, thus becomes of the highest significance, and leads directly to the most fundamental laws of wave phenomena in nature.

In very much the same way, we have found the velocity of light to be 217839 times greater than that of sound in theoretical monatomic hydrogen, (AN 5079), whence it follows that the absolute density of the aether at the earth's surface is

$$\sigma = 1888.15 \cdot 10^{-18}. \tag{42}$$

Accordingly in the third paper, AN 5079, a general method is given for finding the density of the aether at any

point of space, where the absolute or relative force of gravity is known compared to that at the earth's surface.

In view of the considerations here cited it will be obvious that the first step in a valid theory of the aether is to give an explanation of the enormous velocity of wave propagation. No theory except the kinetic theory of the aether, in which the aetherons obey the law:

$$\bar{v} = \frac{1}{2}\pi V \tag{43}$$

will be adequate to explain the enormous velocity of the wave movement.

In the first and third papers, AN 5044, 5079, we have shown that the above law holds for the following gases, when reduced to a monatomic condition:

- | | |
|--------------------------|----------------------------|
| 1. Air | 4. Carbon dioxide, CO_2 |
| 2. Hydrogen | 5. Oxygen |
| 3. Carbon monoxide, CO | 6. Nitrous oxide, NO_2 . |
- (44)

The kinetic theory of the aether must therefore be regarded as well established. Observation indicates that in a monatomic gas the above formula is accurately fulfilled; and as the aether is not known to be capable of any combinations we naturally take its aetheron to have the property of a monatomic gas.

In view of the simplicity and directness of these considerations, it appears to be truly remarkable that nearly two and a half centuries should elapse between *Roemer's* discovery of the velocity of light, and the development of a kinetic theory of this wave-motion, 1920. It must be fairly obvious to natural philosophers that the foremost problem of the aether is the explanation of the enormous velocity of light. And as electrodynamic action and waves in radio-telegraphy take place with the same velocity, the underlying rapid motion of the aetheron is of the deepest interest, and will have the widest applications in all branches of physical science.

(ii) *Einstein* assigns no cause of gravitation, and as he rejects the aether, which is required for conveying stresses across space, his general theory of relativity is misleading.

In the first paper on the new theory of the aether we have explained that *Einstein* rejects the aether entirely. *Michelson* and other eminent authorities have remarked on the inadmissibility of this procedure; and not a few experienced investigators have rejected *Einstein's* general theory of relativity because he has no medium for conveying light, heat and natural forces across space.

The arguments of *Michelson* and others drawn from the theory of light are quite unanswerable. Yet it may be worth while to inquire why, if there be no aether, light and electric waves are transmitted across space with the velocity of $V = 3 \cdot 10^{10}$ cms. If there be no aethereal medium of small density and great elasticity, it would be much more logical to assume that action at a distance is instantaneous. Yet this is contrary to observation.

And although *Einstein* assumes as the basis of his system that »nothing travels faster than light«, he nowhere explains why light should have a finite instead of an infinite velocity.

The wave-theory, on the other hand, lays down no dogma whatever. It takes light and electric waves to travel with the observed velocity, $V = 3 \cdot 10^{10}$ cms., and then inquires what is the mean velocity of the aetheron. By the well established

facts of the kinetic theory of gases, this remarkable theorem is deduced for the aether:

$$\bar{v} = \frac{1}{2}\pi V = 1.57 \cdot 3 \cdot 10^{10} \text{ cms} = 471239 \text{ kms} \quad (45)$$

where V is the wave velocity, and \bar{v} the mean velocity of the aetheron.

It is found that the aetheron moves 10000 times faster than our swiftest planets, and for bodies moving with uniform velocity, as in orbits essentially circular, offers no resistance whatever to the motions of the planets. This corresponds to the known facts of the solar system, which gives no indication of aethereal resistance to the motions of the planets and satellites. If the orbits are sensibly elliptical, there will be alternate acceleration and retardation, but the effect is very slight and in fact insensible to observation.

When two bodies which are magnetic are in relative motion, there is an inductive effect, owing to the change in the wave fields; and this is observed in the earth's magnetism, and found to depend on the sun and moon, as first noted by *Kreil* at Prague, 1841, and afterwards independently discovered by *John Allen Brown*, 1845.

The existence of a semi-diurnal tide in the earth's magnetism obeying the law of the inverse cube of the distance of the moon was fully established by *Brown* and confirmed by *Balfour Stewart* and *Airy*, who pointed out that the tide acted along the line from the Red Sea to Hudson's Bay (the magnetic pole). In AN 5079, p. 268, we have shown that *Lloyd* misinterpreted his equations, in 1858, and the error has been repeated in many later writers. *Lloyd* retained in his analysis of 1858 the angle θ instead of the angle 2θ used in the tide-generating potential. All the phenomena of the earth's magnetism, including the periodicities depending on the heavenly bodies, are fully explained by the wave-theory.

Accordingly, it appears that the wave-theory accounts for the magnetism of the heavenly bodies, and connects cosmical magnetism with universal gravitation, which no previous theory has been able to do.

Einstein's theory, on the other hand, gives no such connection. In fact as *Einstein* even proposed to do away with the aether, he has no mechanism for conveying action across space. Just how empty space is to be conceived as capable of transmitting forces equivalent to the breaking strength of millions of immense cables of steel is not apparent.

Accordingly it is recognized that *Einstein's* reasoning is totally devoid of physical basis. He treats his problem as if it related to pure mathematics, and as if his reasoning were not required to conform to recognized physical conditions. And since he even introduces the curvature of space, to explain a mere phenomenon of refraction, which *Newton* would not have sanctioned, we perceive that the doctrines of *Einstein* are chiefly remarkable for the lack of understanding of the physical universe which they display.

The kinetic theory of the aether perfectly accounts for the phenomenon of aberration, the *Michelson-Morley* experiment, the motion of the perihelion of Mercury, and all other phenomena treated of in the theory of relativity. Accordingly, *Einstein's* theory of relativity is as superfluous as it is misleading. In all his speculations there is not one truth corresponding to the actual phenomena of nature.

(iii) Final table of the physical constants of the aether.

In the course of the development of the new theory of the aether we have been led to a few changes, but the table of constants of the aether given in AN 5044, p. 65-66, still remains essentially correct, except as indicated below.

1. The method for calculating the density of the aether from the constant of solar radiation devised by Lord *Kelvin* in 1854, and modernized in AN 5044, p. 63-64, is now recognized to be defective, owing to the decrease of density of the aether near the earth. For reasons indicated in AN 5079, p. 233-239, we must first find the density of the aether at the earth's surface, and then calculate the density at the surface of the sun and planets, by the processes explained on p. 236-237.

At the earth's surface the density of the aether is found to be

$$\sigma_{3s} = 1888.15 \cdot 10^{-18} \quad (46)$$

while at the sun's surface the density is

$$\sigma_{os} = (1888.15 \cdot 10^{-18} / 219) 41.4868 = 357.6865 \cdot 10^{-18}. \quad (47)$$

Accordingly, the density of the aether at the earth's surface is 4.31 times that given by *Kelvin's* modified method, while at the surface of the sun the density is about 178.84 times that deduced from *Kelvin's* method. We now recognize that *Kelvin's* method is defective and the results given in the first paper, p. 64, are to be superseded by the method for finding the absolute density outlined in AN 5079, p. 236.

2. In the first paper the ratio of amplitude to wave-length was assumed to be $A/\lambda = 1/101.23$, whereas in the fourth paper, AN 5085, it was found to be $A/\lambda = 1:1660508000$ which is equivalent to

$$A/\lambda = 1/101.23 \cdot 1/163045 \quad (48)$$

or over 163000 times smaller than the value first used, which accorded with the experienced judgement of *Kelvin*, *Maxwell* and *Larmor*. Accordingly

$$A\rho = 2\pi/101.23 \cdot 1/163045 = 0.0000003806827; \quad \log(A\rho) = 3.5805632_{-10}. \quad (49)$$

3. The energy per cubic centimetre at the sun's surface is small, owing to the small density of the aether, and the small value of $A\rho$, where $A\rho = 2\pi A/\lambda$, and A/λ is the ratio of the amplitude to the wave-length. The formula for the kinetic energy

$$E = (0.63662) \sigma V^2 (A\rho)^2 \\ = (0.63662) (357.6865 \cdot 10^{-18}) (3 \cdot 10^{10})^2 (0.0000003806827) \\ = 0.0000002968587 \text{ ergs.} \quad (50)$$

This value of the energy at the sun's surface seems very insignificant compared to the value 4.41455 ergs, calculated in the first paper, AN 5044, p. 64; but it follows from the change in density, and above all, the very small amplitude just discussed above, in paragraph 1. Accordingly, great as the changes in our old conceptions are, we believe this new result to be valid, and entitled to adoption in our final results.

4. Greatest tangential stress per square centimetre at the sun's surface: $\sigma V^2 (A\rho) = 0.12252$ dynes. (51)

This value likewise is very small compared to the value 111.1713 dynes found in AN 5044, p. 64; but, as before, the difference is explained by the change in the density and

ratio of amplitude to wave-length, which latter factor is decreased by the divisor 163054.

5. Coefficient of rigidity (or viscosity) of the aether by the formula:

$$\alpha = \sigma V^2 = (357.6865 \cdot 10^{-18})(3 \cdot 10^{10})^2 \quad (52)$$

yields $\alpha_{os} = 321917.8$ at the sun's surface (53)

$$\alpha_{3s} = 7050000 \text{ at the earth's surface.} \quad (54)$$

The rigidity of the aether thus turns out to be much larger than the values found in AN 5044, p. 64, which was only 1800.

6. Density of the aether at the sun's surface:

$$\sigma_{os} = 357.6865 \cdot 10^{-18}. \quad (55)$$

7. At the earth's surface the density of the aether is found to be

$$\sigma_{3s} = 1888.15 \cdot 10^{-18}. \quad (56)$$

At the surfaces of the other planets the absolute densities are as given in the table, in AN 5079, pp. 237-238.

8. Mean velocity of the aetheron

$$\bar{v} = 1.57 V = 47123900000 \text{ cms.} \quad (57)$$

9. The molecular weight of the aetheron, calculated by Maxwell's theorem on the equality of the kinetic energies in all gases

$$\frac{1}{2} m v^2 = \frac{1}{2} m' v'^2 \quad (58)$$

$$w = 12.92 \cdot 10^{-12}, (H = 1). \quad (59)$$

10. Average length of the mean free path, at the sun's surface or at the earth's surface:

$l = 3\alpha_{os}/\sigma\bar{v} = 3\sigma V^2/\sigma\bar{v} = 3V^2/\bar{v} = 57295900000 \text{ cms}$ (60)
the same as in AN 5044, p. 66.

11. Number of corpuscular collisions per second at the sun's surface $= \bar{v}/l = 0.82$, as in AN 5044, p. 66. (61)

12. According to Avogadro's law equal volumes of all gases under the same conditions contain an equal number of molecules. And as hydrogen is 47453880000 times denser than aether, we may equate the masses of two spherical molecules thus:

$$\frac{4}{3}\pi\sigma r^3 = 47453880000 \frac{4}{3}\pi\sigma' r'^3. \quad (62)$$

And if we take the internal densities of the two molecules to be equal, $\sigma = \sigma'$, we have

$$r = \sqrt[3]{47453880000 \cdot r'} = 3620.405 \cdot r' \quad (63)$$

that is, the hydrogen molecule has 3620 times greater radius than the aetheron.

We may form a very useful picture of these relative sizes by imagining the hydrogen molecule magnified to the size of the earth, with mean radius $r = 6370.5 \text{ kms}$. On this scale the aetheron will have a radius of 1.7596 kms, or 1.0934 miles.

Accordingly, if the earth represents a hydrogen molecule, a spherical mountain a little over two miles in diameter (more exactly 11500 feet) would represent an aetheron. This is very nearly the height of Mt. Actna (10872); but as the base of this volcano is very much extended, we must consider the aetheron to correspond only to the central part of the cone, about a mile in radius.

Table for comparing the physical properties of the aether with well known terrestrial gases.

Gas	Mean velocity of molecule	Molecular wt. (H=1)	Coefficient of viscosity α at 0° C.	Mean free path $l = 3\alpha/\sigma\bar{v}$	Collisions per second $c = \bar{v}/l$ - 8 percent, for collision rebound	Radii of molecules calculated by four independent processes, except in the case of the aether ($= 1/3620$ of H)
Aether	47123900000 cms	12.92 · 10 ⁻¹²	7050000	57295900000 cms	0.82	3.701 · 10 ⁻¹²
Air	49800 »	14.43	0.0001724	0.0000059 »	7765 · 10 ⁶	1.86 · 10 ⁻⁸
Hydrogen	185900 »	1	0.0000867	0.0000116 »	14743 · 10 ⁶	1.34 · 10 ⁻⁸
Helium	132113 »	1.98	0.0001889	0.0000171 »	7108 · 10 ⁶	1.11 · 10 ⁻⁸
Oxygen	46100 »	16	0.0001896	0.0000063 »	6732 · 10 ⁶	1.81 · 10 ⁻⁸
Nitrogen	49200 »	14	0.0001660	0.0000057 »	7941 · 10 ⁶	1.90 · 10 ⁻⁸
Argon	41527 »	19.96	0.000210	0.0000063 »	6064 · 10 ⁶	1.81 · 10 ⁻⁸
CO	49700 »	14	0.0001626	0.0000058 »	7901 · 10 ⁶	1.88 · 10 ⁻⁸
CO ₂	39600 »	22	0.0001410	0.0000040 »	9108 · 10 ⁶	2.28 · 10 ⁻⁸
Chlorine	31262 »	35.36	0.0001287	0.0000029 »	9874 · 10 ⁶	2.68 · 10 ⁻⁸
Steam H ₂ O	62000 »	9	0.0000912	0.0000040 »	14260 · 10 ⁶	2.27 · 10 ⁻⁸

11. The Central Forces of Planetary Motion explained by the Wave-Theory.

(i) In the problem of gravitation the force is central, and equal areas are described in equal times.

1. The celebrated laws discovered by Kepler, 1609, 1618, — that the paths of the planets are ellipses, with the sun in their foci; and that the radii vectores of any planet describe equal areas in equal times; and finally, that the squares of their periodic times are as the cubes of the mean distances or major axes — led Newton to the law of universal gravitation:

$$f = k^2 m m' / r^2 \quad (64)$$

Kepler's law that the radius vector describes equal areas in equal times is illustrated by the geometrical figures on

plate 9, for the ellipse, parabola, and hyperbola, and thus applies alike to planets and comets, and also to the double stars.

2. Since it is a fact, that under a central force varying according to any law of distance, equal areas will be described in equal times, Newton correctly concluded that the planets and comets are drawn to the centre of the sun by powerful central forces. And Sir Isaac Newton demonstrated that, with the sun in the focus of the conic section, the law would be that of the inverse squares given above, since shown to hold true in all the actions of universal gravitation.

3. It is well known that Huyghens, Hooke, Wren, Newton and Halley were practical investigators and experimenters, and thus had very clear ideas on the action of central forces.

They recognized fully that curvature of the path of the planet can not take place at every instant of time without the constant action of accelerative forces directed to the focus of the conic section. *Euler, Lagrange, Laplace* and the later illustrious successors of *Newton* have fully confirmed the validity of the *Newtonian* argument; so that no one ever seriously thought of questioning the *Newtonian* dynamics till *Einstein's* misleading speculations began to be developed.

4. Accordingly, the scientific world read with astonishment in the Monthly Notices of the Royal Astronomical Society, (Oct. 1916, 76, p. 702) *De Sitter's* claim that »Gravity is not a force, but a property of space.«

By actual calculations carried out in the first paper we found that the utmost strength of five million million cables of steel, each a foot in diameter, when the steel has the breaking strength of 30 tons to the square inch, are required to curve the path of the moon in its orbit about the earth. And to curve the path of the earth's motion about the sun an eleven inch cable of steel of the same strength, on each square foot of a hemispherical cross section of the earth, would be stretched to its utmost limits by the force of the sun's gravity, constantly acting on our planet for governing its motion. After having made these calculations I had no more doubt that gravity is a real force than had *Wren, Newton* and *Halley* in 1686. As we have shown that the aether has an elasticity 689321600000 times greater than our air in proportion to its density, it is evident from the nature of the triple integral for the potential, that the medium is capable of sustaining these stupendous forces.

5. The action of centrifugal forces in driving bodies from the centre, in the direction of the tangent, and expressed by the formula:

$$f = mv^2/\rho \quad (65)$$

— where v is the velocity and ρ is the radius of curvature — has been fully understood since the time of *Huyghens*, (cf. *De horologio oscillatorio*, 1673) about 250 years ago. As the planets do not recede from the sun, but curve their paths about the centre of the sun, it follows, as *Newton* pointed out, not only that there is a central force incessantly balancing the centrifugal force, but also that it is proportional to mass, and thus gravitation is not a property of space, but of matter, in the focus of the conic section. In the scholium to Proposition IV, Lib. II of the *Principia*, *Newton* says: »By such propositions, Mr. *Huyghens*, in his excellent book, *De horologio oscillatorio*, has compared the force of gravity with the centrifugal forces of the revolving bodies.«

6. In view of the observed phenomena of the heavens it is not possible to depart from this conclusion of *Huyghens* and *Newton*. *Einstein's* theory therefore is unconditionally rejected as wholly contrary to dynamical laws admitting of easy verification. And it remains to consider what other conceptions of gravitation are admissible. We have seen that the gravitational potential introduced by *Laplace*, 1782, has the form:

$$V = M/r = \iiint [(x-x')^2 + (y-y')^2 + (z-z')^2]^{-1/2} \times \sigma dx dy dz. \quad (66)$$

This triple integral corresponds to the summation of the stress in the aether due to the superposition of waves, with amplitude $A = k/r$ from each atom of the attracting mass.

(ii) The geometrical and physical interpretation of the potential leads inevitably to the wave-theory.

We have already pointed out geometrical and physical properties of the medium which lead inevitably to the wave-theory. There is not only evidence of the wave-field about all bodies — whence the forces they exert — but also proof that the wave field travels as the bodies move, and thus carries along the field of force which shows itself near bodies.

1. We conclude therefore that every body has about it an infinitely extended wave field, the amplitudes varying inversely as the distance, $A = k/r$, and the forces inversely as the square of the distances; which corresponds exactly to the known facts of universal gravitation. And since it is shown mathematically that waves in the aether expanding freely in cubical space, would follow the law of amplitude: $A = k/r$, it cannot be accidental that *Laplace's* expression for the potential has this form. On the contrary, it follows that the expression for the potential of gravitation is determined by the amplitudes of the waves receding from each atom; and thus we necessarily are led to the wave-theory of gravitation. For the potential of a mass M is derived from the triple integration of all the elements, $dm = \sigma dx dy dz$, at their appropriate distances, $r = \sqrt{[(x-x')^2 + (y-y')^2 + (z-z')^2]}$; and this corresponds to the amplitude of the wave from any atom, and the mean result to the summation of the stresses due to the separate atoms of the whole mass.

2. Now there must be some simple interpretation of the formula

$$dV = dm/r = [(x-x')^2 + (y-y')^2 + (z-z')^2]^{-1/2} \times \sigma dx dy dz \quad (67)$$

which by integration leads to

$$V = \int dm/r = \iiint [(x-x')^2 + (y-y')^2 + (z-z')^2]^{-1/2} \times \sigma dx dy dz. \quad (68)$$

And as the waves when expanding freely in cubical space follow this same law, the amplitude being $A = k/r$, our interpretation of the potential follows both geometrical and physical laws, and therefore the chances are infinity to one that the wave-theory yields the correct interpretation.

3. The curves for the amplitudes of the waves receding from a centre are as shown in the figure 14, section 8 above. These amplitudes show how the agitation of the waves thins out the density of the medium, towards the centre, and allows it to increase directly as r , so that its final density is inversely as the average wave amplitude, or directly as the distance, which corresponds with the undefined heterogeneity of the aether imagined by *Newton*, 1721.

4. Accordingly, the wave-theory of universal gravitation is indicated by the amplitude of the aether wave freely expanding in cubical space, and by the nature of the observed force of gravitation $f = k^2 m m'/r^2$, which leads to $A = \sqrt{f} = k/r$, or

$$V = M/r = \iiint [(x-x')^2 + (y-y')^2 + (z-z')^2]^{-1/2} \times \sigma dx dy dz. \quad (69)$$

The aether transmits each wave independently of all the rest and the effect of their superposition is a mean state of stress depending on the average wave amplitude, and on the whole mass

$$M = \iiint \sigma dx dy dz \quad (70)$$

which is included under the triple integral in the above formula for the potential.

5. In the fourth paper (AN 5085, p. 448) we have given a diagram of the wave field about a pair of equal stars (reproduced on a larger scale in fig. 19 on plate 10), and shown that at the boundary of the concentric ellipsoids, the whole of the wave stress in the aether due to the two stars is directed along the corresponding system of confocal hyperbolas. Accordingly, if in the diagram we imagine the density of the aether to decrease asymptotically as the two stars are approached, we shall have not only an accurate image of the wave field, but of that stress of the aether towards these centres which is the cause of gravitation. The individual aetherons have a mean velocity $\bar{v} = \frac{1}{2}\pi V = 471239$ kms per second, and thus they press incessantly towards the centres where the density is small, but the amplitude large.

6. It follows therefore that the original conceptions outlined somewhat vaguely by Sir *Isaac Newton* in 1721, but not heretofore considered susceptible of proof, are really true, and now established with all the rigor that may be drawn from modern mathematical and physical research. The law of the wave amplitude about any centre of disturbance admits of verification; and we know that the density of the medium is arranged inversely as the amplitude as the waves recede from that centre. And that such waves do recede from bodies is amply shown by the waves of magnetic phenomena, which follow laws of amplitude similar to those of gravitation.

(iii) The wave-theory of acoustic attraction and repulsion shows that in the aether also the aetherons are so distributed as to be in kinetic equilibrium, and thus under the rapid motions of the aetherons the aether is of decreased density between two bodies.

In the fifth paper on the new theory of the aether (AN 5130) we have applied the wave-theory to acoustic attraction and repulsion, which heretofore has not been satisfactorily explained. As sound is a wave phenomenon, and the velocities of transmission in various media well understood, we were enabled to study the progress of the wave-front in air and in balloons filled with carbon dioxide and hydrogen respectively.

In the case of a carbon dioxide balloon, we found that if the waves travel through the air with the velocity r , the speed through the carbon dioxide will be 0.78 only; and therefore every phase of the wave reaches the opposite side of the balloon through the air in advance of that coming directly through the balloon. The result is a series of advance molecular impulses on the elastic membrane constituting the rear wall of the balloon. The impulses generate slight oscillations in the whole balloon by which a part of the surrounding air thus agitated is transferred gradually to the rear side of the balloon.

As the density of the air is thus decreased on the side next to the source of the sound, and correspondingly increased on the rear side of the balloon, the kinetic equilibrium of the atmospheric medium can only be maintained when the balloon containing CO_2 tends to approach the source of the sound. In other words, the air is worked out somewhat from between the sources of the sound and the balloon, and forced in behind the balloon; so that we have what is called acoustic attraction.

This explanation, without mathematical formulae, is perfectly simple and satisfactory; and we have also treated by the same method, of depicting the progress of the wave-front, the impulses which cause repulsion when the balloon is filled with hydrogen. In this latter case the sound wave travels so fast in hydrogen that it quickly turns its front, and reenters the air on the side next to the source of the sound. Thus repulsion results from accentuation of agitation, the wave motion being so directed that the air is not decreased in elastic pressure on the side next to the source of the sound, but actually increased. The kinetic equilibrium of the atmospheric medium thus requires that the balloon filled with hydrogen be repelled from the source of the sound.

12. The Tension of the Aether is a Maximum along the Right Line connecting the Sun and a Planet, and thus the Wave-Theory conforms to the *Newtonian Theory* of a Central Force directed to the Focus of the Conic Section.

(i) Maximum wave-action in straight lines connecting the bodies μ and μ' .

It has long been remarked by eminent philosophers that the chief forces of nature appear to act in straight lines, as along the radius vector drawn from the centre of a planet to the centre of the sun. And the question naturally arises as to why the stresses in the aether should be thus exerted. We shall show that such rectilinear action in minimum paths necessarily happens when waves are transmitted in an elastic medium like the aether.

But before doing so we shall recall from the first paper, AN 5044, p. 51, that in the case of the moon revolving about the earth, the central force required is equivalent to the full breaking strength of 500000000000 cables of steel one foot in diameter, when the steel has the enormous tenacity of 30 tons to the square inch. In case of the earth revolving about the sun, the curvature of the orbit requires the exertion of a central force equivalent to the full breaking strength of an 11-inch cable of steel of the above tenacity on each square foot of a hemispherical cross section of the earth. Thus to hold the earth in its orbit it would be necessary almost to cover the illuminated hemisphere with a solid forest of steel cables.

Now these stupendous forces are sustained by the elastic medium of the aether, and the mere contemplation of the above tension, which must be balanced, shows the absurdity of the views of *Einstein* and *De Sitter* that »gravity is not a force, but a property of space«. (Monthly Notices 76, 1916, p. 702). In the aether, however, the stresses are not confined to the narrow spaces occupied by the above named cables of steel, but are general throughout this medium, the wave motion being directed from the atoms in the sun and the reaction towards the sun's centre.

It follows from the kinetic theory of the aether that each body carries its wave-field with it, without regard to the wave-field carried by any other body. Accordingly, the wave-fields from the two bodies interpenetrate, and in the arrangement of kinetic equilibrium, the aether density thus becomes a minimum in the right line connecting the two bodies, which is the direction of the stress observed in the

planetary forces. For we have seen that towards either body the density decreases; and along the shortest path, or right line connecting the centres of the bodies, the independent thinning out due to the two wave-fields will be a maximum. The density of the aether is therefore a minimum along the line SE , which connects the sun and earth.

We may look at this problem in a slightly different way as follows: the waves from S tend to thin out the aether to a degree $\sigma = \nu r$, at the distance r ; the waves from E on the other hand yield a density $\sigma' = \nu' r'$ at the distance r' from the centre of E . When the lines r and r' lie in the right line SE they represent the shortest possible connection of any third point with the two chief bodies S and E .

Let us imagine a set of rotating axes, as in the restricted problem of the three bodies (Researches on the evolution of the stellar systems, vol. 2, 1910, chap. 8); then the distances from either centre will be, for motion in the plane of xy :

$$r = V(x^2 + y^2); \quad r' = V[(x-1)^2 + y^2]; \quad s = r + r' \quad (71)$$

Accordingly,

$$\overline{SE^2} = \sigma^2 = r^2 + r'^2 - 2rr' \cos(r, r'). \quad (72)$$

And using the above values for r and r' we have:

$$\sigma = \nu r = \nu V(x^2 + y^2) \quad \sigma' = \nu' r' = \nu' V[(x-1)^2 + y^2] \quad (73)$$

$$\sigma^2 = (\sigma/\nu)^2 + (\sigma'/\nu')^2 - 2(\sigma/\nu)(\sigma'/\nu') \cos(r, r'). \quad (74)$$

Now as SE is a straight line it is the minimum path between the two bodies, and by the equation (73) the minimum density throughout can be fulfilled only when the point $p(x, y)$ lies on the line SE , so that the double integral is a minimum:

$$\begin{aligned} & \delta \iint ds \, d\sigma = \\ & = \delta \iint d\sigma [(\sigma/\nu)^2 + (\sigma'/\nu')^2 - 2(\sigma/\nu)(\sigma'/\nu') \cos(r, r')]^{1/2} = \\ & = \rho \delta \int d\sigma = 0. \end{aligned} \quad (75)$$

For ρ is known to be the minimum path,

$$\delta s = \delta(r + r') = 0 \quad (76)$$

and as σ and σ' increase for any departure of the point $p(x, y)$ from the minimum path ρ corresponding to $\delta s = 0$, it follows from the equation (75) that the condition of minimum for the double integral is

$$\delta \iint ds \, d\sigma = \rho \delta \int d\sigma = 0 \quad (77)$$

which requires the point to lie on the line $SE = \rho$.

The aether therefore has minimum density along the line joining the sun and planet. It is denser on either side of this line, because under the wave actions of the two centres the aetherons are worked out from between the bodies, and increase the pressure or stress beyond them, as correctly held in the Electrodynamical wave-theory of physical forces, vol. 1, 1917.

For two equal masses μ and μ , we have the foregoing figure for the equipotential surfaces:

$$c_i = \mu/r + \mu/r'. \quad (78)$$

And beneath it, for comparison, we have added, in fig. 20, plate 11, the wave-field for two equal stars, thus making a double plate, as explained below. The tendency to form an hour-glass figure, with symmetrical neck between the equal masses is due to the potential or average amplitude of the waves proceeding from either mass. If the masses were unequal,

μ and μ' , where μ'/μ may be any proper fraction whatever, the equation of the surfaces would be:

$$c_i = 1/r + (\mu'/\mu)/r'. \quad (79)$$

And the closed surface around the smaller mass would be contracted in proportion to the size of the mass μ'/μ , but otherwise equipotential surfaces would be of the same general type as the above.

Figure 20 therefore conveys a good impression of the effect of the interpenetration of the wave-fields in decreasing the density of the aether between the masses, and increasing it beyond. Wherever the surfaces are close together there is rapid change in the stress or density; and where they are far apart, there is little change in the density. The change of density is thus least rapid between the bodies where each mass tends to expel some of the aetherons. The result is tremendous tension along the line μ and μ' , with increase of pressure where the surfaces are denser, beyond either mass.

Now tension in the medium between the bodies, and increased pressure beyond them is exactly the mechanical action required to give the central attraction for balancing the centrifugal force of revolving bodies. The wave-theory thus corresponds exactly with the phenomena of nature, and it is impossible to doubt the assigned cause of the stupendous forces which hold the planets in their orbits.

These forces are so immense that nothing but a medium of enormous elasticity would be adequate to sustain the required stress. But since the aether has an elasticity 689321600000 times greater than air in proportion to its density, — an elasticity almost infinite — and moreover the triple integral for the potential shows that the stress increases directly as the mass, we see that all required dynamical conditions are fulfilled, and thus the wave-theory assigns the true cause of universal gravitation.

(ii) Final remarks on the new theory of the aether.

The wave-theory as developed in the new theory of the aether has been found adequate to explain all the forces operating in nature. More stress has been laid upon the explanation of some of these forces than upon others, but this is only by way of illuminating the subjects most obscure and heretofore very bewildering to geometers and natural philosophers.

We need not here dwell on the theory of molecular forces — surface tension, capillarity, cohesion, adhesion, etc. — because we have shown that all these phenomena depend on wave-action. And we have even explained the tenacity and hardness of bodies by the wave stresses in the sheath of aether at the boundaries of bodies.

In the same way chemical affinity and vital forces, depending on chemical processes in connection with capillarity, osmosis, etc., are naturally explained by wave-action. The wave-theory is shown to be identical with *Ampère's* theory, proposed about a century ago to account for magnetism, by the hypothesis of elementary electric currents circulating about the atoms.

Now we see all atoms vibrating and emitting waves which are flat in the planes of their equators. And as this simple theory is useful in magnetism, so also in chemical phenomena

and the processes involved in vital forces, all of which depend on chemical action.

As the power of a galvanic battery depends on chemical changes, it is inevitable that chemical affinity and vital forces should be referred to electric action. In the battery there are groups of vibrating atoms acting in concert and thus the changes go on in an oscillatory character and the current carried along a wire is nothing but a series of waves in the aether, resistance of which develops heat and light.

All chemical actions involve changes of temperature, which is another indication of the electric basis of chemical affinity. The support of animal heat by combustion of hydrocarbons with oxygen is another proof of the same proposition.

One of the most beautiful of the investigations of molecular forces relates to the globular figures of liquid drops, which are minimal surfaces, and easily explained by the wave-theory under least action. Nothing could be more wonderful than the results here brought to light; and the power which may be attained by wave-action is impressively illustrated by the new theory of lightning and of explosive forces.

The wave-theory was partially developed about a century ago by the mathematical analysis of *Fourier* and *Poisson*. As now extended and applied to all classes of physical phenomena, it may justly claim the attention of geometers and natural philosophers; so that the modern investigator can understand the remark of *Plato*: $\delta \Theta ε ο \acute{s} \acute{\alpha} \epsilon \iota \gamma ε ω μ \acute{\epsilon} τ ρ α \iota$.

The conclusion that the Deity always geometrizes is very much like the remark of *Kepler* that, in discovering the geometrical laws of planetary motion, he was only thinking God's thoughts after Him. *Kepler's* researches led to the greatest advance of physical astronomy in his time, and one of the greatest advances of all ages.

In the same way if *Plato's* principle that the Deity always geometrizes — all the forces of nature being due to wave-action, — and geometrical figures such as minimal surfaces therefore resulting from least action of the whole system of waves be applicable to the most varied natural phenomena, as we have endeavoured to show — then we cannot doubt that a great and lasting advance in natural philosophy should follow the development of the wave-theory. The wave-theory will enable the modern geometer to think God's thoughts after Him; for it gives an insight into the true laws of nature, and we are saved from the endless groping in the dark heretofore unavoidable.

Accordingly, we have merely to remark:

1. Waves in the aether following the laws we have explained will account for universal gravitation, — the amplitude $A = k/r$ resulting from unhindered expansion of the waves in free space, and yielding the required law of force established by *Newton*, 1686: $f = A^2 = k^2/r^2$

2. The planetary paths curve incessantly under the action of central forces equivalent to the breaking strength of millions of immense cables of the strongest steel. There must be a medium called the aether capable of sustaining the immense stresses for holding the planets in their orbits.

3. The aether is shown to have an elasticity 689321600000 times greater than that of air in proportion to its density. And as air alone is observed to be given such rotatory motion and stress in the central path of a cyclone as to exert the most

amazing destructive power over all natural objects, we can easily understand how the power of the aether waves may accumulate near great bodies to any required extent through the mere form of the expression for the potential, the waves from the separate atoms being of average wave amplitude k/r , and the whole of the independent effects being superposed in the triple integral:

$$V = M/r = \iiint [(x-x')^2 + (y-y')^2 + (z-z')^2]^{-1/2} \times \sigma dx dy dz. \quad (80)$$

4. The cause here assigned fulfills the required geometrical laws, and is sufficient to explain the accumulated stress in the aether called gravity. No other explanation of gravitation is known, yet one is so urgently required that *Einstein* has been led to mere mathematical abstractions devoid of physical basis. For he denies the existence of an aethereal medium for sustaining the planetary forces. Thus *Einstein's* speculations are of no value, because contrary to physical experiments, which show that centrifugal motion must be balanced by central tension, if we are to have steady orbital motion of the heavenly bodies.

5. The wave-theory postulates aether stresses depending on each atom, with amplitude appropriate to its distance; and the triple integral sums up these effects at any point of space, so that the gravitational potential fulfills *Laplace's* celebrated differential equation for external space:

$$\partial^2 V/\partial x^2 + \partial^2 V/\partial y^2 + \partial^2 V/\partial z^2 = 0. \quad (81)$$

And for points within the mass *Laplace's* equation becomes *Poisson's* celebrated differential equation:

$$\partial^2 V/\partial x^2 + \partial^2 V/\partial y^2 + \partial^2 V/\partial z^2 = -4\pi\sigma. \quad (82)$$

6. Discontinuity in the wave-phenomena at the boundary is also implied in *Poisson's* equation of wave motion:

$$\partial^2 \Phi/\partial t^2 = a^2 (\partial^2 \Phi/\partial x^2 + \partial^2 \Phi/\partial y^2 + \partial^2 \Phi/\partial z^2) \quad (83)$$

of which the *Fourier-Poisson* solution is:

$$\Phi = \Omega(x, y, z, t) = \iiint \iiint \iiint e^{(A+Bht)} V^{-1} \cdot \psi_1(\xi, \eta, \zeta) d\xi d\eta d\zeta d\lambda d\mu d\nu. \quad (84)$$

Since the wave-theory rigorously fulfills all geometrical and physical requirements, and no other tenable hypothesis has been proposed, we hold that it assigns the true cause of universal gravitation.

(iii) Concluding remarks on the cause of gravitation.

1. In 1609 it was established by the researches of *Kepler*, from the planetary observations of *Tycho Brahe*, that the radius vector of a planet drawn to the centre of the sun sweeps over equal areas in equal times.

2. In composing the *Principia*, 1686, Sir *Isaac Newton* showed clearly that *Kepler's* law of areas indicates that the force which gives us the motions of the planets is central; and that it is only the incessant action of this central force which operates to curve the path of the planet at every point of its orbit. This led *Huyghens* and *Newton* to a valid theory of curvilinear motion, and thus marks an epoch in the science of natural philosophy.

3. During the three centuries since the discovery of the law of areas by *Kepler* and its mechanical and physical interpretation by *Newton*, it has been shown by all manner

of researches that this law of areas is a fundamental law of nature. Not only is it verified minutely in the motions of the planets and satellites of the solar system, by the most refined comparisons of theory with the most precise observational criteria which the state of modern astronomy affords; but also by researches on the orbits of nearly 100 visual double stars, and on the motions of an even greater number of spectroscopic binaries.

4. For more than a century the orbits of double stars justly have been regarded as affording the desired objective demonstration of the operation of the law of gravitation in sidereal systems. Having myself calculated about 60 orbits of known double stars and compared the results of gravitational theory with observation over long periods of time, I have not been able to detect the smallest deviation from the *Keplerian* law of areas or the *Newtonian* law of attraction in the motions of these stellar systems.

5. In two cases, indeed, namely: γ Ophiuchi and ζ Herculis, there is some evidence of disturbance of the *Keplerian* law of areas, as if due to a third body not yet detected by telescopic observation. Yet just as in the past history of astronomy, we had two analogous cases in the well known disturbed proper motions of Sirius and Procyon, — the companions of which have since been discovered by *Clark* and *Schaeberle*; — so also in this case the indications point to the triumph of the law of *Newton*. Thus the universality of the law of gravitation continues to be minutely verified by the most refined researches of modern astronomy.

6. In more than two centuries of the most recondite researches of astronomers and geometers not the slightest doubt has arisen that gravitation is a central force accurately directed to the centres of the revolving bodies. In the case of the motion of the moon about the earth, and of the earth about the sun we have calculated the strength of the stupendous cables of steel that would be required to hold these bodies in their orbits. All these calculations are easily verified.

7. The cause of universal gravitation is now definitely traced to wave-action in the aether, which is 689321600000 more elastic than air in proportion to its density. Wave-action directed to the sun in the foci of the conic sections described by the planets and comets alone will explain the central forces which hold these bodies in their orbits. And in stellar systems everywhere we see the same wave-action at work to fulfill *Kepler's* law of areas and *Newton's* law of force directed to the foci of the ellipses described by the stars. Thus we have developed a definite and absolute proof of the cause of gravitation, which is referred to waves in the aether, traveling with the velocity of light.

8. We have found that the geometrical theory of the equipotential surfaces, about two attracting masses, points unmistakably to the cause of gravitation. Vector composition for the forces observed to exist in the gravitational field about two equal stars shows that the aether is under tension between the bodies, and under increased pressure beyond them. Nothing but the wave-theory, with forces directed to the two centres occupied by the stars, will account for the observed form of the equipotential surfaces as shown in figure 15, which originally was drawn by *Thomson* and *Tait* for their celebrated *Treatise on natural philosophy*, 1873, yet unfortunately not

utilized by *Maxwell* in his attempt to explain gravitational stresses (*Treatise on electricity and magnetism*, 1873, chapter V, sections 103-111).

9. As *Maxwell* was misled into the conception of pressure in the direction of gravitational force, and tension at right angles thereto, instead of the reverse arrangement, the mathematical theory of this subject was given an unfortunate start; and the errors thus begun have been handed down by English writers, and the whole scientific world thus misled in a matter essentially simple. Nor is the difficulty diminished, but on the contrary notably increased, by the recent exploitation of the theory of relativity. Perhaps in time the valid dynamical theory of the *Principia* will again restore British science to a position worthy of the country-men of *Newton*.

10. That gravitation is propagated with the velocity of light is a necessary consequence of this wave-theory of physical forces. Under the vision of the physical world thus unfolded to our contemplation, the beauty and order of the universe appears truly remarkable; and we see that the new theory of the aether is a necessary path of exploration in attaining one of those summits near the stars. This sublimest portion of human knowledge still is only partly explored, but in rendering it more accessible to those who have long admired the marvelous geometry of the heavens, we have labored to extend the researches of *Sir Isaac Newton*.

11. It is well known that *Maxwell* was the first natural philosopher to attribute physical forces to stresses in the aetheral medium, but as he had not developed a theory of wave-action, as the mode of propagation for these forces he left the origin of the aether stresses quite obscure, as we see by the discussion in the closing section of his celebrated *Treatise on electricity and magnetism*, 1873.

»We have seen that the mathematical expressions for electrodynamic action led, in the mind of *Gauss*, to the conviction that a theory of the propagation of electric action in time would be found to be the very keystone of electro-dynamics. Now we are unable to conceive of propagation in time, except either as the flight of a material substance through space, or as the propagation of a condition of motion or stress in a medium already existing in space. In the theory of *Neumann*, the mathematical conception called potential, which we are unable to conceive as a material substance, is supposed to be projected from one particle to another, in a manner which is quite independent of a medium, and which, as *Neumann* has himself pointed out, is extremely different from that of the propagation of light. In the theories of *Riemann* and *Betti* it would appear that the action is supposed to be propagated in a manner somewhat more similar to that of light.«

»But in all of these theories the question naturally occurs: If something is transmitted from one particle to another at a distance, what is its condition after it has left the one particle and before it has reached the other? If this something is the potential energy of the two particles, as in *Neumann's* theory, how are we to conceive this energy as existing in a point of space, coinciding neither with the one particle nor with the other? In fact, whenever energy is transmitted from one body to another in time, there must be a medium or substance in which the energy exists after it leaves one

body and before it reaches the other, for energy, as *Torricelli* remarked, is a quintessence of so subtle a nature that it cannot be contained in any vessel except the inmost substance of material things'. Hence all these theories lead to the conception of a medium in which the propagation takes place, and if we admit this medium as an hypothesis, I think it ought to occupy a prominent place in our investigations, and that we ought to endeavour to construct a mental representation of all the details of its action, and this has been my constant aim in this treatise.«

12. Accordingly, *Maxwell* held that we ought to endeavour to construct a mental representation of all the details of the action of the aetherial medium in producing the chief phenomena of nature. In the Electrodynamic wave-theory of physical forces, developed by the writer since 1914, we have attempted to construct this representation, for problems heretofore utterly bewildering to philosophers, and we venture to hope, with no inconsiderable success.

Nevertheless, in spite of our utmost effort, and the unexpected illumination thrown upon some of the greatest problems of transcendental physics, it is of course realized that the new theory of the aether remains in a very considerable degree incomplete.

In conclusion, it is a great pleasure to record the steadfast support lent to these researches by Mrs. *See*, and by Mr. *W. S. Trankle*, who have so loyally seconded our best efforts, which only too often seemed feeble and unequal to so daring an enterprise. It is only by departing from the beaten paths, in the pursuit of a valid theory of the luminiferous aether, that we hope to find the way towards light, more light!

In this sustained effort, which has now extended over seven years, the author's labors often have been relieved by the sympathetic reception accorded the results by several eminent colleagues who have confirmed the steps in this development. Commander *Leonard M. Cox*, Civil Engineer, U.S.N., Captain *Edward L. Beach*, U.S.N., Commandant at Mare Island, and Mr. *Otto von Geldern*, the eminent Civil Engineer, Vice-President of the California Academy of Sciences, San Francisco, have each shown such clear grasp of the new points of view as the work advanced, that it would be difficult to overrate the extent to which their enlightened interest has contributed to the final results.

Starlight on Loutre, Montgomery City, Missouri, 1921 May 6.

T. J. J. See.

Addition. Since concluding the above discussion my attention has been directed to a paper on certain physical experiments described at the General meeting of the American Philosophical Society, Philadelphia, April 19-23, 1921, by Dr. *Chas. F. Brush* of Cleveland, in which different gravitational effects were found for different substances. *Brush's* careful measurements are in marked contrast with those of Baron *Eötvös* of Budapest who found almost no variation of effects for different substances.

In this connection I call attention to the extraordinary negative gravitational measurements made by Professor *Francis E. Nipher* of Washington University, St. Louis, about two years ago. From his careful experiments *Nipher* concluded that the

gravitational property of a body depends upon its state of electric charge, and that up to the present time we know next to nothing of the potential of the earth's magnetic field.

In a postscript to the Third paper, (AN 5079, p. 301-2) I have directed attention to *Majorana's* remarkable experiments at Turin, 1919, showing loss of gravitational power when a body is screened by a layer of mercury.

The three experiments here cited may be interpreted in the light of the wave-theory, but I cannot see any other way of reconciling such unexpected experimental results, which run counter to all the old theories, and yet must be acknowledged as furnishing proof that gravitation is a phenomenon which may be experimentally modified, as by absorption, apparently of wave-action, by electric charges or other physical agency.

Accordingly all these new researches confirm the wave-theory experimentally and open up gravitation to physical investigation and experimentation. But in order to obtain new light on this difficult subject it is necessary to devise experiments which are conclusive.

1921 May 12.

T. J. J. See.

First postscript. In order to establish the error of a new theory it often is sufficient to show that it contradicts a more general and fundamental theory. In the present case we shall adopt in order to demonstrate the error of the *Einstein* theory the doctrine of the conservation of energy as the most general and fundamental principle of modern physical science.

1. Recently, in *Astron. Nachr.* No. 5115, Dr. *Grossmann* of Munich has examined anew the whole question of the motion of the perihelion of Mercury, according to *Newcomb's* work, and finds that the assumed value of $\delta\varpi = +43''$ per century for the observed outstanding difference is not justified. Correcting the result by the equations for the meridian observations, the precision of which *Newcomb* distrusted, and bringing his result into accord with the definitive elements of the sun, by raising it $7''.35$, *Grossmann* concludes that the observed outstanding motion of Mercury's perihelion lies between $29''$ and $38''$, and thus in no case would attain the value of $43''$ demanded by *Einstein*.

In his researches on the observational material, Dr. *Grossmann* takes no account of the theoretical reduction, by *Weber's* Law, $\delta\varpi = +14''.5$, which would make the outstanding motion still smaller, and more out of harmony with the *Einstein* requirements. Thus when tested by the best available data for the motion of Mercury the *Einstein*-theory does not satisfy modern astronomical observations.

2. In the 'Treatise on electricity and magnetism', section 856, *Maxwell* has successfully defended the validity of *Weber's* law, of which the potential is

$$V = k^2 m m' \cdot 1/r \cdot \{1 - (1/c^2)(dr/dt)^2\}. \quad (1)$$

The second term gives the effect due to motion in a wave-field, the work of transforming the potential energy changing like the kinetic energy, with the square of the planet's velocity relatively to the sun. If $dr/dt = 0$, as in circular orbits, the *Newtonian* law follows; but more generally the velocity in the direction of the radius vector dr/dt yields a term for the effect of induction, and d^2r/dt^2 gives the term

for the change of the induction, under motion in the wave-field. Thus *Weber's* law is the fundamental law of nature, and from (1) we have:

$$f = -\partial V/\partial r = k^2 m m' \cdot 1/r^2 \cdot \{1 - (1/c^2) (dr/dt)^2 + (2r/c^2) d^2r/dt^2\} \quad (2)$$

For it is well known in the theory of energy, that a planet may move from perihelion to aphelion, and vice versa, yet the whole energy in the conservative system remains absolutely constant. Thus we always have:

$$T + V = T - Mm/r = C$$

$$\text{or } T + V = \frac{1}{2}m [(dx/dt)^2 + (dy/dt)^2 + (dz/dt)^2] + \frac{1}{2}Mm [(x-x')^2 + (y-y')^2 + (z-z')^2]^{-1/2} = C. \quad (3)$$

As the sun moves, as well as the planet, when the mass of the planet is sensible, we may write the more general expression for the kinetic energy of orbital motion about the centre of gravity of the system:

$$\frac{1}{2}M [mr/(M+m)]^2 \Omega^2 + \frac{1}{2}m [Mr/(M+m)]^2 \Omega^2 = T. \quad (4)$$

In equation (3) the negative term is the potential energy. When kinetic energy changes, in a way depending on v^2 , a corresponding change must occur in V , the potential energy, otherwise the sum of the two energies could not remain constant.

3. The following diagram represents the energy changes in the planetary motion, substantially as given by Professor *Kundt*, in his lectures on physics at the university of Berlin, according to *Helmholtz's* doctrine of the conservation of energy, 1847.

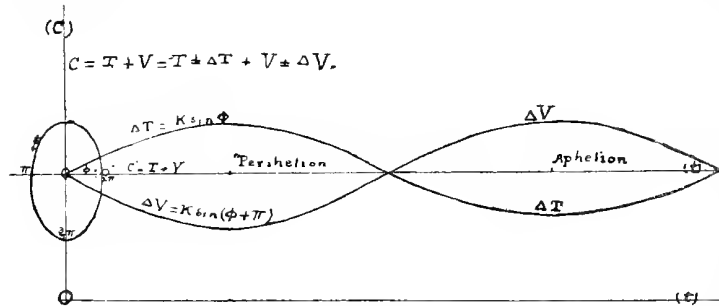


Fig. α.

We see by this diagram that the time flows on continuously as the planet oscillates from perihelion to aphelion, and the curve extends along the axis (t).

Meanwhile when the potential energy is a maximum at aphelion, $V' = V + \Delta V$, the kinetic energy is a minimum, $T' = T - \Delta T$, because ΔT is negative at aphelion, and numerically just equal to ΔV , which is then positive, as shown in the diagram.

At perihelion, on the other hand, the kinetic energy is a maximum, the potential energy a minimum, for corresponding reasons. The diagram, with two superposed sine curves, $\Delta T = K \sin \Phi$, and $\Delta V = K \sin(\Phi + \pi)$, everywhere exactly neutralizing each other, because differing in phase by π , will therefore correctly represent the oscillations of kinetic and potential energy in planetary motion, under a conservative system, free from collisions.

4. Returning now to the *Gerber* formula, in comparison with the *Weber* formula, for the potential, we perceive that the *Weber* formula is correct, while the *Gerber* formula is incorrect. In the work of transformation the potential energy changes like the kinetic energy, with the square of the planet's velocity, relatively to the sun. Unless we admit this to be true we have to deny the conservation of energy; for no other result is possible by the first equation of (3).

Accordingly, the formula for the potential, under *Weber's* law

$$V = k^2 m m' \cdot (1/r) [1 - (1/c^2) (dr/dt)^2] \quad (5)$$

is valid and undeniably admissible. On the other hand, *Gerber's* formula for the potential

$$V = (M/r) \{1/[1 - (1/c) (dr/dt)]^2\} \quad (6)$$

is invalid and wholly inadmissible, because it violates the principle of the conservation of energy.

The *Gerber* formula being thus inadmissible, *Einstein's* theory, built upon it, necessarily falls to the ground. Thus it is definitely disproved, and can no longer be maintained by those who admit the conservation of energy.

5. If we seek to inquire into the nature of the wave-fields about two attracting bodies, we shall need to have recourse to the discussion in part II of the sixth paper on the New Theory of the Aether, where the whole problem is treated in some detail, and illustrated by figures showing the tension between the masses and increase of pressure beyond them. This argument is established by necessary and sufficient conditions. Such wave-fields¹⁾ and nothing else will explain the straight line action of the forces which govern the motions of the planets in their orbits.

It is needless to point out that as the aether is a kinetic medium, the physical basis of all forces, and nothing finer underlies it, it is the source and ultimate reservoir of all energy. Hence we see the physical basis of the conservation of energy. The kinetic theory of the aether thus leads to the conservation of energy, and any result in violation of this great principle must be unreservedly rejected. Accordingly we have a definite demonstration of the erroneous character of the *Einstein*

theory.

1921 Oct. 28.

T. J. J. See.

Second Postscript. Since finishing the body of this paper, in May, I have been impressed with the desirability of obtaining additional light on the forces which sustain the equilibrium of the molecules of an elastic solid. Heretofore this problem has not offered to investigators any very accessible point of attack. On December 10, however, it occurred to me how this problem could be solved, by a method of the required mathematical rigor, which at the same time conforms to the present state of our knowledge of experimental physics.

Hence we add a brief outline of this new method in the hope that it will be of interest to the readers of this series of papers on the new theory of the aether.

By way of extending the argument given in the fifth

¹⁾ Since finishing the sixth paper, I have obtained new and most abundant observational proof that mass movements in the sun do send powerful wave disturbances to the earth, and by the resulting inductions thus produce the aurorae, earth currents and similar disturbances in the earth's wave-field.

paper, AN 5130, p. 330, and in the sixth paper above, equation (7), we notice:

1. The refractive action ($n^2 - 1$) depends on the density of the solid σ , and the changing wave-length λ , and thus on some unknown function $\pi(\sigma/\lambda)$. But in a fixed mass the density varies inversely as the cube of the distance of the molecules, as in the formula for a sphere:

$$m = \frac{4}{3}\pi\sigma r^3 \quad \sigma = \frac{3}{4}m/\pi r^3 = C/r^3. \quad (\alpha)$$

Hence we may take $\pi(\sigma/\lambda)$ as a function of the molecular distance $\Phi_1(r) = C/r^3 = u$.

2. As regards the violence of the incessant bending of the wave-front, for waves coming from all directions, $\varphi(\beta)$, we notice that this effect likewise is a function of the density, and of the elasticity or rigidity, and thus of the atomic distances r ; yet as we do not know the nature of this dependence we simply write for $\varphi(\beta)$ an unknown function $\Phi_2(r) = v$.

3. In reference to the violence of the incessant dis-

$$(n^2 - 1)\pi(\sigma/\lambda)\varphi(\beta)\psi(\delta)\chi(z)\theta(\rho \cdot e^{-a}) = \Phi_1(r) \cdot \Phi_2(r) \cdot \Phi_3(r) \cdot \Phi_4(r) \cdot \Phi_5(r) = u \cdot v \cdot w \cdot u' \cdot v' = U \quad (\beta)$$

The partial differentiation of this function of five variables relative to the three coordinates (x, y, z) yields:

$$\begin{aligned} dU = & (\partial U/\partial u \cdot \partial u/\partial x + \partial U/\partial v \cdot \partial v/\partial x + \partial U/\partial w \cdot \partial w/\partial x + \partial U/\partial u' \cdot \partial u'/\partial x + \partial U/\partial v' \cdot \partial v'/\partial x) dx \\ & + (\partial U/\partial u \cdot \partial u/\partial y + \partial U/\partial v \cdot \partial v/\partial y + \partial U/\partial w \cdot \partial w/\partial y + \partial U/\partial u' \cdot \partial u'/\partial y + \partial U/\partial v' \cdot \partial v'/\partial y) dy \\ & + (\partial U/\partial u \cdot \partial u/\partial z + \partial U/\partial v \cdot \partial v/\partial z + \partial U/\partial w \cdot \partial w/\partial z + \partial U/\partial u' \cdot \partial u'/\partial z + \partial U/\partial v' \cdot \partial v'/\partial z) dz. \end{aligned} \quad (\gamma)$$

7. To effect the required quintuple integration we should have to derive successively d^2U, d^3U, d^4U, d^5U ; and if the last function, or any one of them, was known, we could then, by the reverse process of integration, calculate U , and finally Ω . Unfortunately the finite expressions of these successive differentials are quite unknown; and thus it is useless to develop these differential coefficients.

Apparently the only way we can attack this problem successfully is to deduce the function U , for the action of the molecular forces, direct from the data supplied by the dynamical theory of gases.

This happens to yield an integral expression, the law of molecular repulsion being sensibly $f = \mu/r^5$, and hence we have a tangible mode of approach; and fortunately the theoretical conclusions are confirmed by experiments, which are adopted by the best authorities in the dynamical theory of gases.

8. Accordingly, our mode of integration reduces to

$$\Omega = \iiint \iiint \iiint \varepsilon d^5U dr dr dr dr dr \int \varpi(\omega) d\omega \quad (\delta)$$

$$= U \int \varepsilon \varpi(\omega) d\omega \quad (\epsilon)$$

$$= U \int \left\{ \partial \varepsilon / \partial u \cdot du + \partial \varepsilon / \partial v \cdot dv + \partial \varepsilon / \partial w \cdot dw + \partial \varepsilon / \partial u' \cdot du' + \partial \varepsilon / \partial v' \cdot dv' + \partial \varepsilon / \partial \omega \cdot d\omega \right\} \quad (\zeta)$$

$$= U \int d\varepsilon = U\varepsilon \quad (\eta)$$

where $\varepsilon = 689321600000$ the amount by which the elasticity of the aether exceeds that of the air in proportion to its density.

9. It will be shown below how the function U for the first five integrations may be obtained, in the integral form, corresponding to the repulsive forces actually observed in the theory of gases $f = \mu/r^5$, and the terms giving attraction at greater distances may be added. The sixth integral, for the central pressure due to the integration for the steady action of the enclosing sheath of partially disrupted waves of the aether, leads to the elastic constant of the aether, and thus presents no difficulty.

persion of these incident waves, $\psi(\delta)$, it appears that from the action of diamond on light this effect must depend mainly on the rigidity or hardness, and thus on some function of the radius of atomic action, $\Phi_3(r) = w$.

4. The crystalline arrangement and the forces involved in giving compactness to atoms combined in a way to be most effective, depend also on the atomic distances, or radii of molecular activity, and hence on some function of the distance $\Phi_4(r) = u'$.

5. The power of reflection of waves depends on the smoothness and rigidity of the reflecting mass, and thus on the atomic distances and the forces by which the structure is rendered rigid and impenetrable to the wave agitation. We may take this unknown function as $\Phi_5(r) = v'$.

6. Accordingly, it appears that the first five elements of the integral for Ω , in equation (108) of the fifth paper, or equation (7) above, reduce to

$$(n^2 - 1)\pi(\sigma/\lambda)\varphi(\beta)\psi(\delta)\chi(z)\theta(\rho \cdot e^{-a}) = \Phi_1(r) \cdot \Phi_2(r) \cdot \Phi_3(r) \cdot \Phi_4(r) \cdot \Phi_5(r) = u \cdot v \cdot w \cdot u' \cdot v' = U \quad (\beta)$$

The partial differentiation of this function of five variables relative to the three coordinates (x, y, z) yields:

$$\begin{aligned} dU = & (\partial U/\partial u \cdot \partial u/\partial x + \partial U/\partial v \cdot \partial v/\partial x + \partial U/\partial w \cdot \partial w/\partial x + \partial U/\partial u' \cdot \partial u'/\partial x + \partial U/\partial v' \cdot \partial v'/\partial x) dx \\ & + (\partial U/\partial u \cdot \partial u/\partial y + \partial U/\partial v \cdot \partial v/\partial y + \partial U/\partial w \cdot \partial w/\partial y + \partial U/\partial u' \cdot \partial u'/\partial y + \partial U/\partial v' \cdot \partial v'/\partial y) dy \\ & + (\partial U/\partial u \cdot \partial u/\partial z + \partial U/\partial v \cdot \partial v/\partial z + \partial U/\partial w \cdot \partial w/\partial z + \partial U/\partial u' \cdot \partial u'/\partial z + \partial U/\partial v' \cdot \partial v'/\partial z) dz. \end{aligned} \quad (\gamma)$$

10. In 1866 *Maxwell* concluded from certain researches in the dynamical theory of gases, (*Scientific Papers* 2.32), that in the collisions of molecules the molecular forces, at very short range of action, are repulsive, and vary inversely as the 5th power of the distance, $f = \mu/r^5$. In the present writer's researches on the physical constitution of the sun and planets, (AN 3992, 4053, 4104, 4152), it is shown that gases and solids are closely related, through internal heat developing high elasticity and great effective rigidity, under the enormous pressure to which matter is subjected in the interior of the heavenly bodies.

11. In speaking of the effect of increasing temperature as we descend into the sun's interior, *Newcomb* long ago remarked (*Encycl. Amer.*, article Sun, 1904) that two oppositely directed and very powerful forces were at work: »an inconceivable degree of heat, such that were matter exposed to it on the surface of the earth, it would explode with a violence to which nothing within our experience can be compared«; and on the other hand the tremendous pressure due to the superincumbent layers, confining the matter which otherwise would expand with stupendous explosive violence. Owing to the high effective rigidity acquired by confined gaseous matter — the sun having an average effective rigidity from 2000 to 6000 times that of nickel-steel, — we have a valid point of attack for solids, as we shall now proceed to show in some detail.

12. It was long ago recognized by *Mossotti*, (*Sur les forces qui régissent la constitution intérieure des corps*, Turin, 1836) that at small distances the repulsive forces become more powerful than the attractive forces. Hence, in order to deal satisfactorily with molecular forces, we must have a function composed of several terms which becomes negative at very small distances, positive at greater distances, — all the distances remaining small absolutely, about the order of wave-lengths of light. This function, when integrated relatively

to the distances, should bring into play both attractive and repulsive forces, mutually balancing each other, and thus yielding the rigidity noticed in an elastic solid.

13. We therefore take the molecular forces to be represented by a potential of the form:

$$W = [(h-r)^2 - k/r^2]r_1^4. \quad (\theta)$$

Hence at such small distances the forces become

$$f = \partial W / \partial r = [r - h + k/r^3]r_1^4 \quad (\iota)$$

$$= [r^4 - hr^3 + k]r_1^4 =$$

$$= [(r-r_1)(r-r_2)\{r-(a+ib)\}\{r-(a-ib)\}]r_1^4. \quad (\kappa)$$

14. We are concerned only with very small distances, and therefore we introduce the condition that when $r=r_1=\lambda$, $f=0$; then we have to investigate the biquadratic between the distances r_1 to r_4 :

$$r^4 - hr^3 + k = 0. \quad (\lambda)$$

If any of the roots are real, which we here assume, it can be shown that the equation has two real roots, namely, r_1 , a maximum, at which the attractive forces vanish, $f=0$, and r_2 a smaller value at which the attractive forces are a maximum, as shown by the following diagram. The constant k is to be so adjusted that r_1 falls on the axis (r) making $f=0$. The condition for these two roots is the maximum and minimum of the potential W in (θ) , $\partial W / \partial r = 0$, as in equation (λ) .

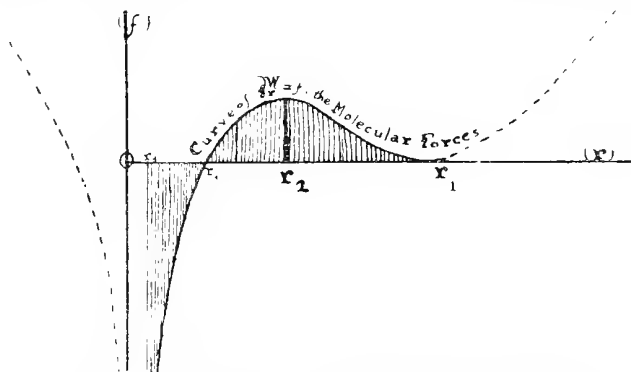


Fig. a. Illustration of the curve of molecular forces $\partial W / \partial r = f$, the unessential parts outside the limits r_1-r_4 being indicated by pointed lines.

15. As a solid body is the result of the equilibrium established between attractive and repulsive forces, we have to get the effect of these equilibrated forces by integrating the equation (ι) between proper limits:

$$f_e = \int_{r_4}^{r_1} \partial W / \partial r \cdot dr + c = \int_{r_4}^{r_1} (r^4 - hr^3 + k) dr + c = 0. \quad (\mu)$$

The nature of this integration is indicated by the above fig. a.

16. This equation (μ) contains the whole theory of the equilibrated forces in a solid body. The integral is

$$f_e = \int_{r_4}^{r_1} \partial W / \partial r \cdot dr + c = [1/5 r^5 - 1/4 h r^4 + k r]r_1^4 + c = 0 \quad (\nu)$$

which is an equation of the fifth degree in r , the variable distance over which the molecular forces act.

The nature of the curve to be integrated in fig. a depends on the value of h , a coefficient of hardness or rigidity. If this constant h is small, but not below a certain limit h_0 , corresponding to fluidity, the body will have slight tenacity, and tend to crumble, like stone, chalk or similar substances. If below h_0 , the body is fluid, and not solid at all.

As h increases above h_0 , we get a series of bodies of increasing hardness, as shown in Fig. b.

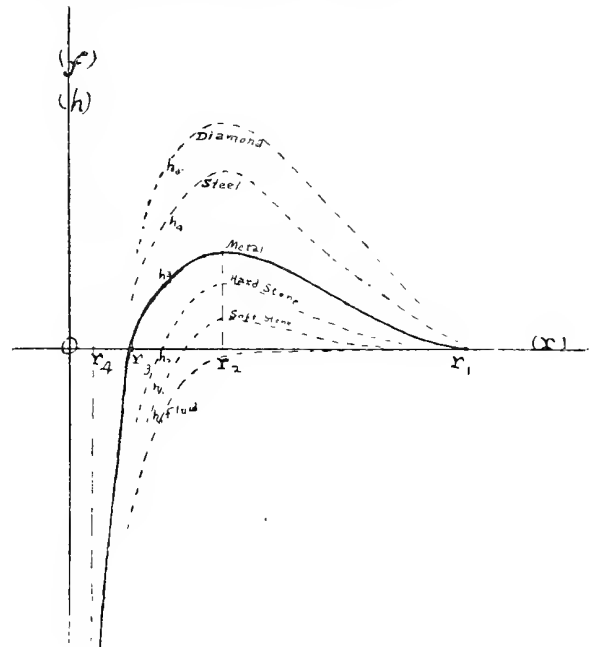


Fig. b.

17. In his celebrated memoir on the dynamical theory of gases, 1866, (Scient. Pap. 2.32) *Maxwell* remarks that the coefficient of rigidity $= p$, the pressure. He designates the elasticity by E and the density by ρ .

«This rigidity, however, cannot be directly observed, because the molecules continually deflect each other from their rectilinear courses, and so equalize the pressure in all directions. The rate at which this equalization takes place is great, but not infinite; and therefore there remains a certain inequality of pressure which constitutes the phenomenon of viscosity.»

«I have found by experiment that the coefficient of viscosity in a given gas is independent of the density, and proportional to the absolute temperature, so that if ET be the viscosity, $ET \sim p/q$.»

«But $E = p$, therefore T , the time of relaxation, varies inversely as the density and is independent of the temperature. Hence the number of collisions producing a given deflection which take place in unit of time is independent of the temperature, that is, of the velocity of the molecules, and is proportional to the number of molecules in unit of volume. If we suppose the molecules hard elastic bodies, the number of collisions of a given kind will be proportional to the velocity, but if we suppose them centres of force, the angle of deflection will be smaller when the velocity is greater; and if the force

is inversely as the fifth power of the distance, the number of deflections of a given kind will be independent of the velocity. Hence I have adopted this law in making my calculations.«

18. The problem of attractive and repulsive forces has been ably discussed by *Boltzmann* (Vorlesungen über Gas-Theorie, 1896, p. 160-161), who concurs in *Maxwell's* reasoning. *Boltzmann* finds his equations much simplified by taking $n = 4$, and then the repulsion between two molecules $f = K/r^{n+1}$, becomes of the inverse 5th power. He adds that his law appears to hold accurately for compound gases, (water vapor, H_2O , carbonic acid, CO_2), but not so satisfactorily for common gases (oxygen, hydrogen, nitrogen). Experience is too limited, he thinks, to make known the exact law in most cases.

»Wir sind daher weit entfernt, behaupten zu wollen, daß sich die Gasmoleküle wirklich wie Massenpunkte verhalten, zwischen denen eine der fünften Potenz der Entfernung verkehrt proportionale Abstoßung wirksam ist. Da es sich hier aber bloß um ein mechanisches Modell handelt, so nehmen wir jenes zuerst von *Maxwell* eingeführte Wirkungsgesetz an, für welches die Rechnung am einfachsten ist.«

In a footnote he adds:

»Auch die Annahme einer der fünften Potenz der Entfernung proportionalen Anziehung gestattet eine ähnliche Vereinfachung der Rechnung (vgl. Wien. Sitzungsber. 89.714, Mai 1884). Doch muß man dann annehmen, daß für Entfernungen, die noch klein gegen die Distanz sind, bei der schon starke Wirkung stattfindet, die Kraft ein anderes Gesetz befolgt, nach welchem die Anziehung endlich bleibt oder in Abstoßung übergeht, weil sonst die Moleküle beim Zusammenstoß sich nicht mehr in endlicher Zeit trennen. Im Texte wollen wir jedoch immer eine der fünften Potenz verkehrt proportionale Abstoßung annehmen.»

The latest researches by *Chapman* and *Feans* (Dynamical theory of gases, 1916, p. 235-237, 256) leave the conclusions of *Maxwell* and *Boltzmann* unchanged, namely, in molecular collision the repulsive force is $f = \mu/r^5$. We are therefore justified in holding that the wave-theory gives rise to both attractive and repulsive forces, which are intelligibly united into a continuous mode of action only by a function of the kind dealt with above.

By means of the above function, however, we have an adequate theory of molecular forces. It accounts for solids of various degrees of hardness, with the other physical properties relating to molecular action and structure.

19. In the above equation (ν) we may divide through by r^5 and obtain

$$\left[\frac{1}{5} - \frac{1}{4} \frac{h}{r} + \frac{k}{r^4} + \frac{c}{r^5} \right]_{r_1}^{r_4} = 0. \quad (\xi)$$

Now the arguments put forth by *Maxwell*, *Boltzmann*, *Feans*, and others that for gases the repulsive forces, when the molecules are in collision, vary as μ/r^5 , would lead us to select the term c/r^5 as that which becomes very large when r is very small — the other terms being relatively insensible at the time of collision. The term k/r^4 would also become large, yet not so large as the last term depending on the inverse 5th power of r .

In order to perceive why there is both attraction and repulsion, we divide (ν) by r^3 only, and then we have:

$$\left[\frac{1}{5} r^2 - \frac{1}{4} h r + \frac{k}{r^2} + \frac{c}{r^3} \right]_{r_1}^{r_4} = 0. \quad (o)$$

This function is positive between r_1 and r_3 , but negative between r_3 and r_4 , as we see by the form of the curve in Fig. a.

The last term of (o) corresponds to the density function in equation (α) above.

20. In my researches on the internal constitution of the heavenly bodies, (AN 3992, 4053, 4104, 4152) I have shown that the sun's matter internally is under tremendous explosive forces, yet held in equilibrium by the gravitational pressure of the outer layers. If the pressure could be relieved, from this matter at the temperature of millions of degrees, it would, (as *Newcomb* remarked in 1904) explode with a violence surpassing that of dynamite or any known substance. Hence in confinement the matter is kept rigid by pressure; and in AN 4104, I have calculated that the average rigidity of the solar matter may be from 2000 to 6000 times that of nickel-steel.

Now the property of rigidity acquired by the sun's matter, as thus confined under tremendous pressure, is analogous to the rigidity of an ordinary solid, — with this difference, that in the ordinary solid heat is largely absent and the molecules thus come so close together that collisions are incessant, under the short waves pervading nature, and the Maxwellian repulsive forces thus arising balance and overcome the attractive forces. These two oppositely directed forces, both very powerful at the small distances, r_1-r_4 , bind the molecules together into a solid, with hardness or rigidity depending on the coefficient h . If we heat a solid, the long heat waves cause the molecules to oscillate beyond the range of action r_1-r_4 , and liquefaction and vaporization takes place.

This transformation of the equation (108) of the fifth paper, equation (ξ) above, makes it conform to the experience of *Maxwell*, *Boltzmann*, *Feans*, and others in the dynamical theory of gases; and as we pass directly from the theory of a gas to that of a solid, by virtue of the researches on the constitution of the sun, we now have a theory of molecular forces which is concrete, and experimentally valid, namely:

$$\Omega = \left[\frac{1}{5} r^5 - \frac{1}{4} h r^4 + k r + c \right]_{r_1}^{r_4} \cdot \varepsilon. \quad (\pi)$$

In virtue of the changes in r , the elastic force of the aether may be positive or negative and has the variation which generates the observed forces, or wave-stresses exerted by the aether upon matter, which usually is most powerful at the boundary owing to the changes of wave-action defined by *Poisson's* equation

$$\partial^2 \Phi / \partial t^2 = a^2 (\partial^2 \Phi / \partial x^2 + \partial^2 \Phi / \partial y^2 + \partial^2 \Phi / \partial z^2),$$

$$\Phi = f(x, y, z, t). \quad (\rho)$$

In conclusion it only remains to add that the present developments in mathematical theory and in physical interpretation, are the outcome of many years of research, in which I have labored to give both a true and a sufficient explanation of the most varied natural phenomena. Doubtless very much remains to be done in the way of improvement, as shown also by the additions as the work progressed; but this refinement could not be entered upon till the first outline of the new theory of the aether was presented in continuous form.

In view of the vast extent of the field of research thus opened up to investigators, may we not hope that others will join in extending the discoveries here merely traversed in briefest outline?

The daring hope originally entertained by *Mossotti*, 1836, of analytically connecting the molecular forces directly with those of universal gravitation was long ago abandoned by investigators, chiefly because, as had been so strongly emphasized by *Laplace*, the molecular forces are sensible only at insensible distances, whereas the gravitational forces act with unbroken continuity over the immensity of the celestial spaces.

Maxwell was equally daring, and more fortunate in his physical conceptions, — when he emphasized the theory of the aether and concluded that all the forces observed in nature are due to stresses in this medium — but the theory of stresses never was completed, owing to the premature death

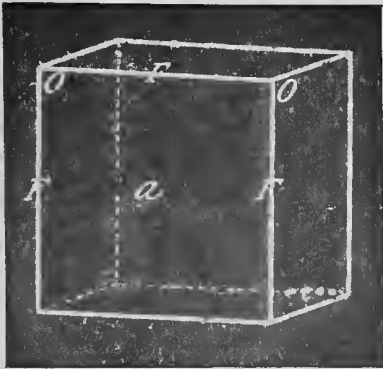
1921 Dec. 10.

of this eminent mathematician at the early age of 48. In fact *Maxwell* had not formulated any *modus operandi* as to how such stresses in the medium could arise, nor had he examined the elastic constant of the aether $\epsilon = 689321600000$.

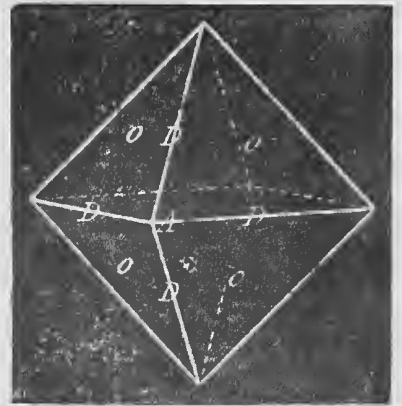
In our new theory of the aether we have examined the character of this medium more critically than *Newton* and *Maxwell* had been able to do, and thus formulated a general theory of physical forces due to wave-action. This reduces the theory of aether-stresses to concrete form, and the procedure has the recommendation of simplicity. It also conforms to the undulatory theory of light and heat, and thus is a necessary step in the doctrine of continuity as applied to the physical universe. The subject is therefore inviting, and will appeal strongly to the geometer as well as the natural philosopher, who may now perceive a new physical basis for the geometrical forms observed in nature.

T. F. F. See.

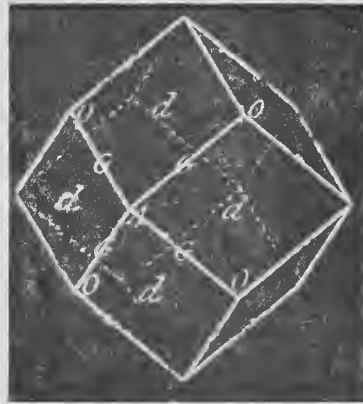
T. J. See. New Theory of the Aether.



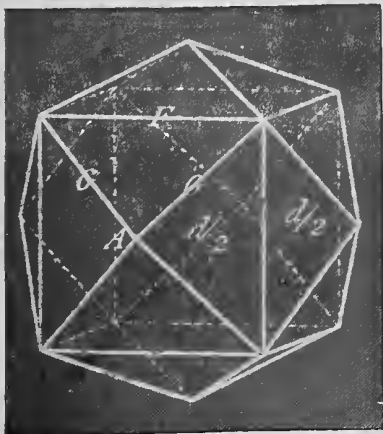
a



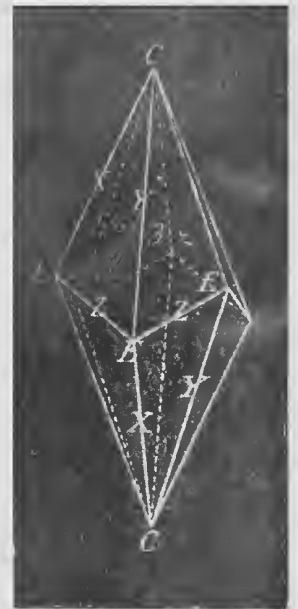
b



c



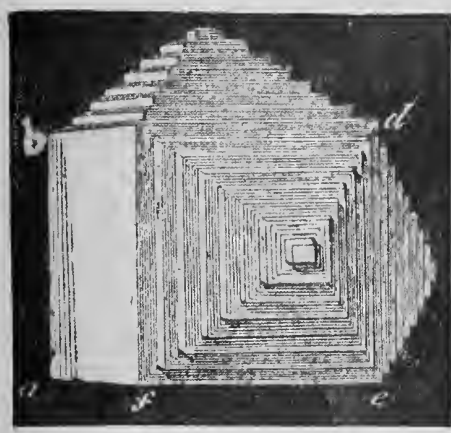
d



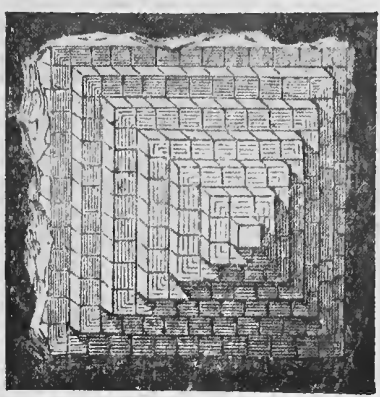
e

Fig. 3. a, b, c, d, e. *Regnault's* theory of the geometrical arrangement by which the atoms give the molecules the property of infinitesimal elements for building up crystals.

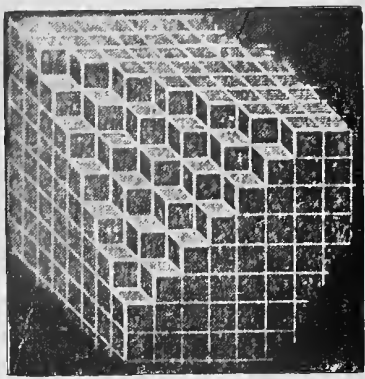
T. J. J. See. New Theory of the Aether.



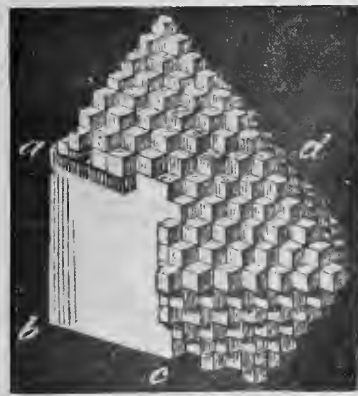
a



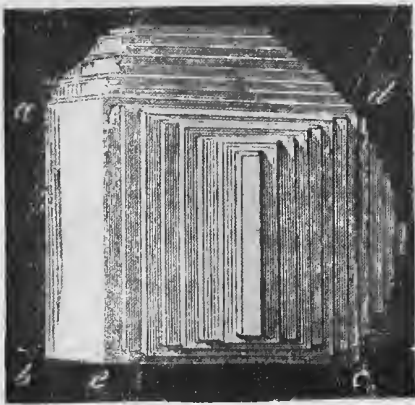
b



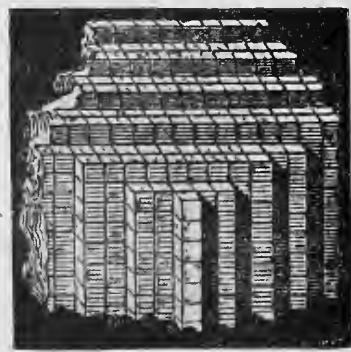
c



d



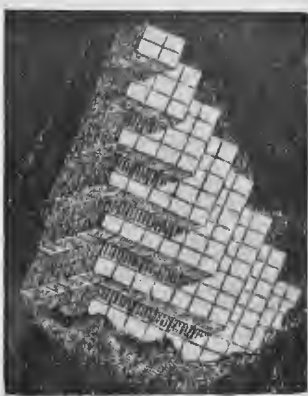
e



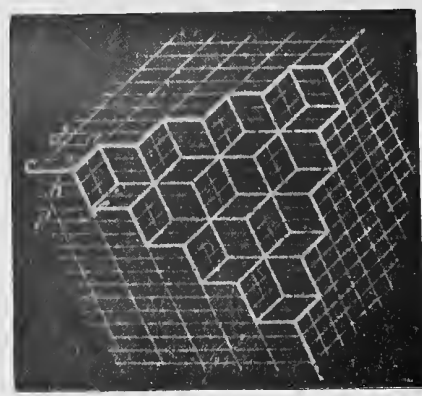
f



g



h



i

T. J. J. See. New Theory of the Aether.

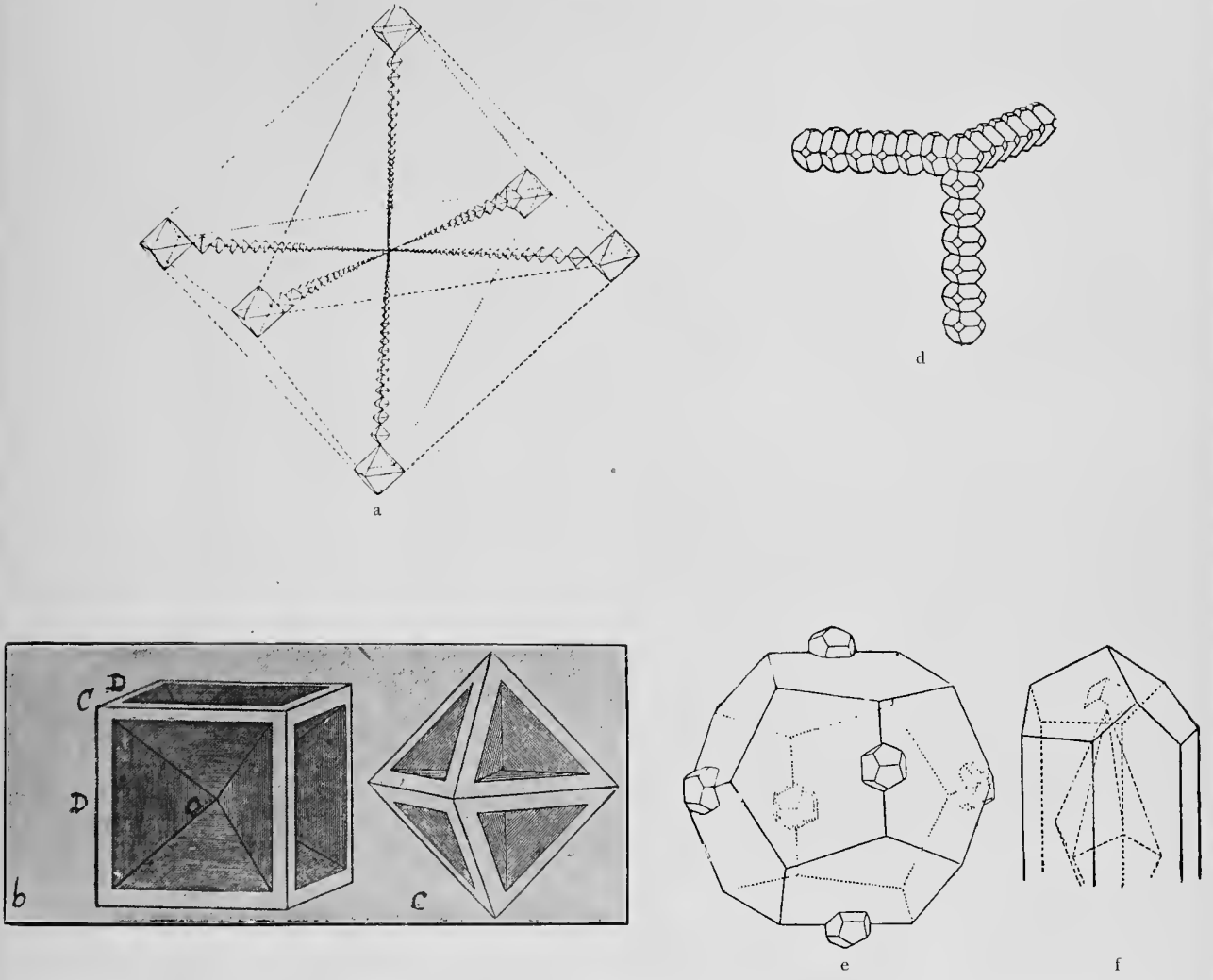
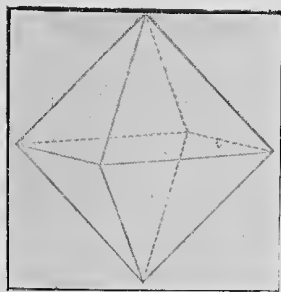
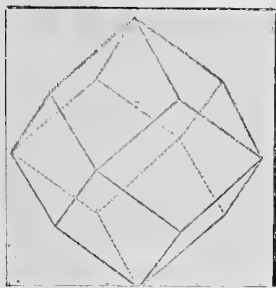


Fig. 7. Construction of crystals by the geometrical arrangement of small elements as described by *Hedde*.

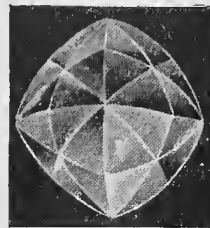
T. J. J. See. New Theory of the Aether.



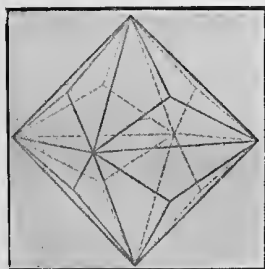
a. The Octahedron.



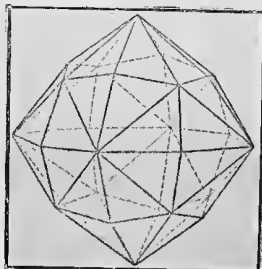
b. Rhombic Dodecahedron.



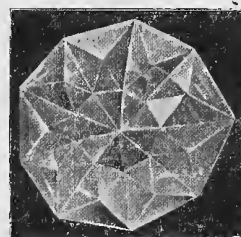
Natural Crystal.



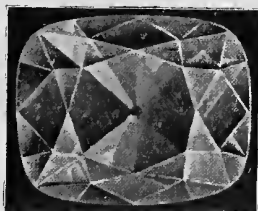
c. Triakis octahedron.



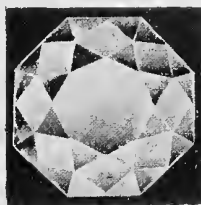
d. Hexakis octahedron.



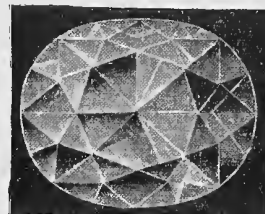
Florentine Crystal.



Star of the South.



The Pasha of Egypt.



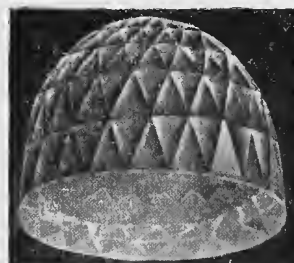
The Kohinur.



The Regent or Pitt.



The Orloff.



The Great Mogul.

Fig. 8. The geometrical forms taken by diamond crystals, with illustrations of the most celebrated diamonds.

T. J. J. See. New Theory of the Aether.

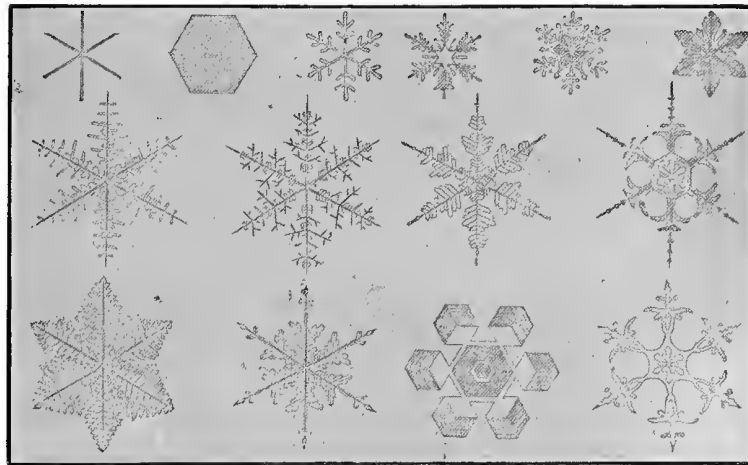
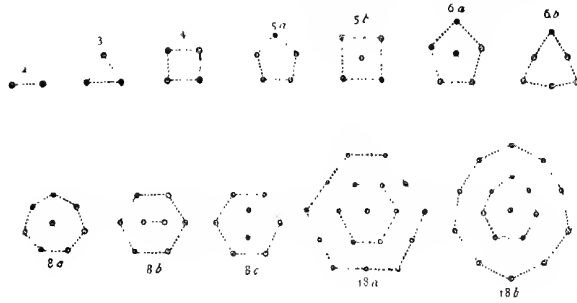


Fig. 10. 1. Mayer's stable forms of groups of floating magnets.
2. Geometrical forms taken by crystals of snow.

T. J. J. See. New Theory of the Aether.

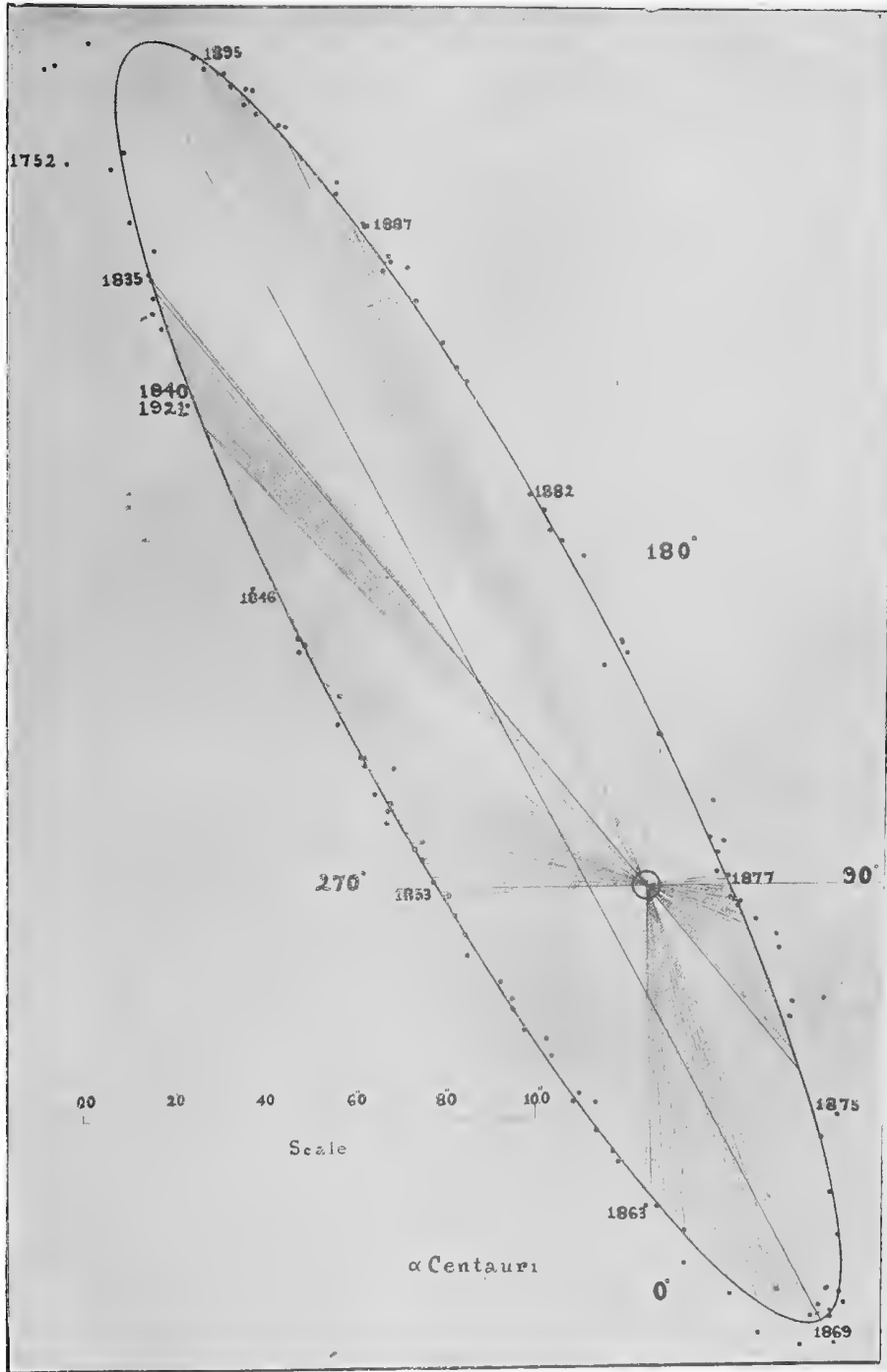


Fig. 11. The apparent orbit of Alpha Centauri, with extremely variable radius vector, yet under the central force of universal gravitation sweeping over equal areas in equal times. (From Researches on the evolution of the stellar systems, vol. I, 1896.)

T. J. I. See. New Theory of the Aether.

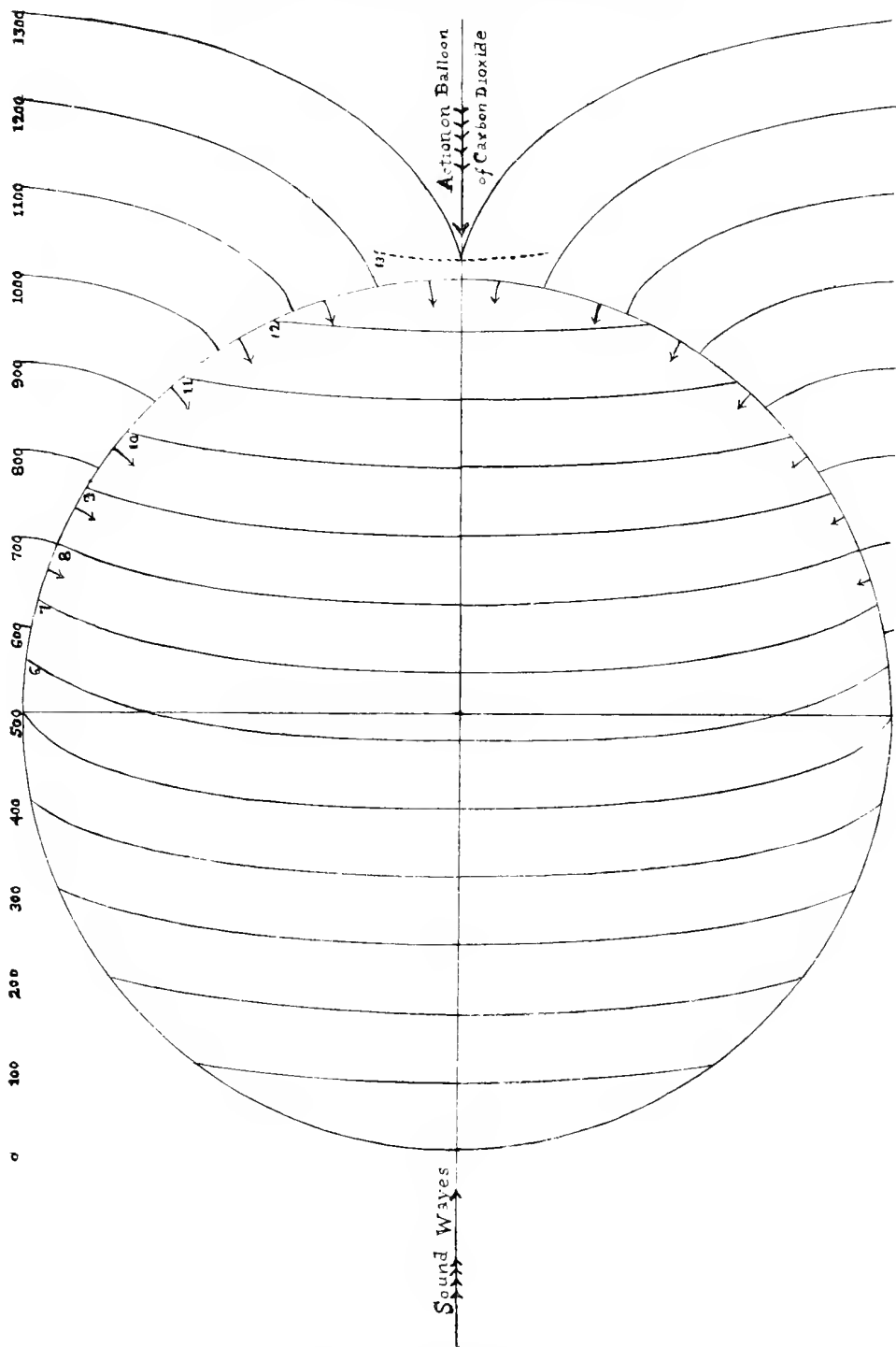


Fig. 12. Graphical illustration of the progress of the wave-front, in the case of sound, propagated through the air and through the carbon dioxide (CO_2) of the balloon. This gives acoustic attraction, owing to the advance wave-motion working some of the air particles out from between the source of the sound and the balloon, and transferring them beyond the balloon, so as to give a vis a tergo, a shove from behind.

T. J. J. See. New Theory of the Aether.

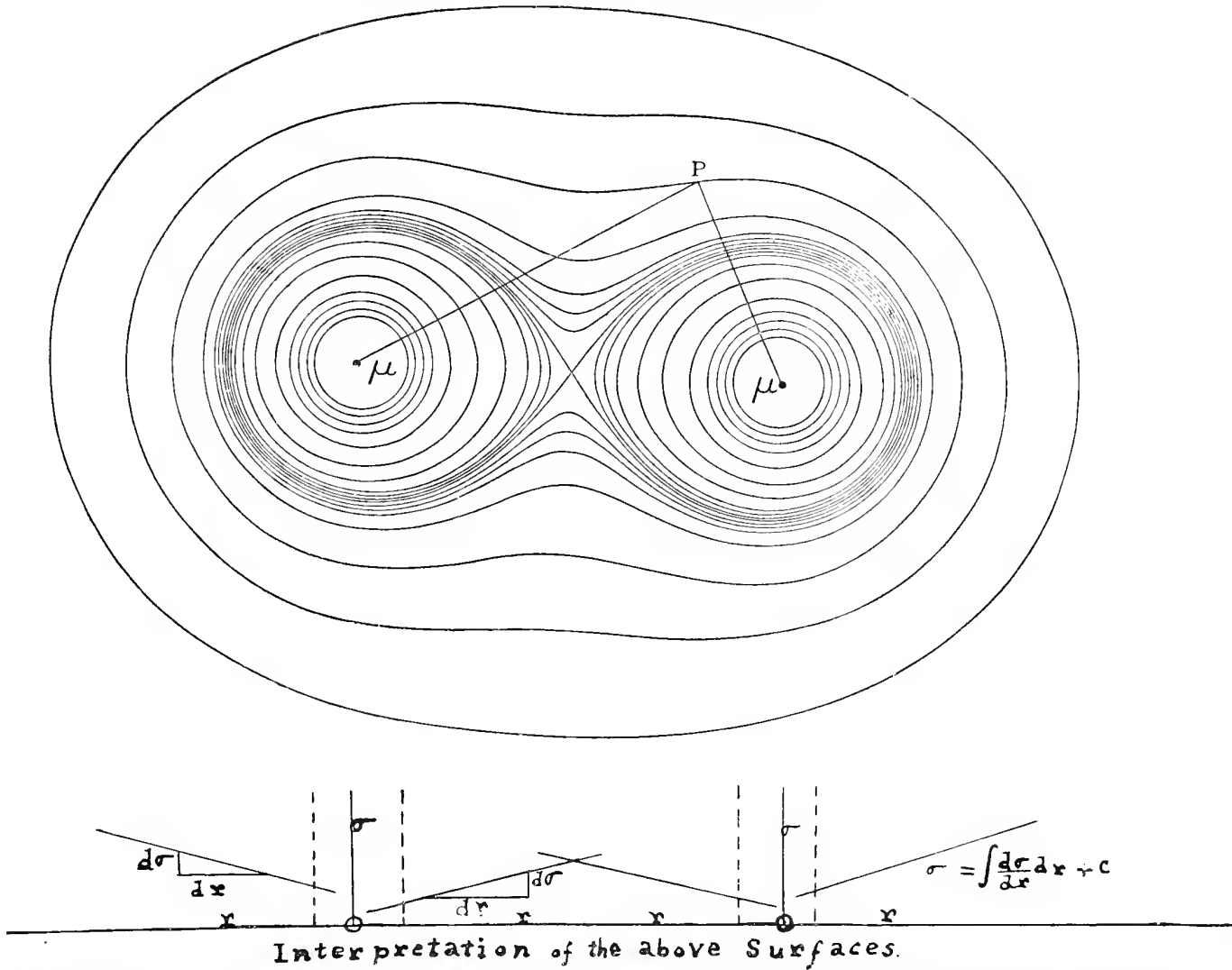


Fig. 15. Diagram of the equipotential surfaces about two equal masses, μ and μ , originally given in *Thomson and Tail's Treatise on Natural Philosophy*, 1st ed. 1873. Without regard to the cause involved this diagram represents the actual surfaces which exist under the potential of gravitation; and in the light of the new theory of the aether we now interpret the meaning of the distortions shown which were first published about half a century ago.

T. J. J. See. New Theory of the Aether.

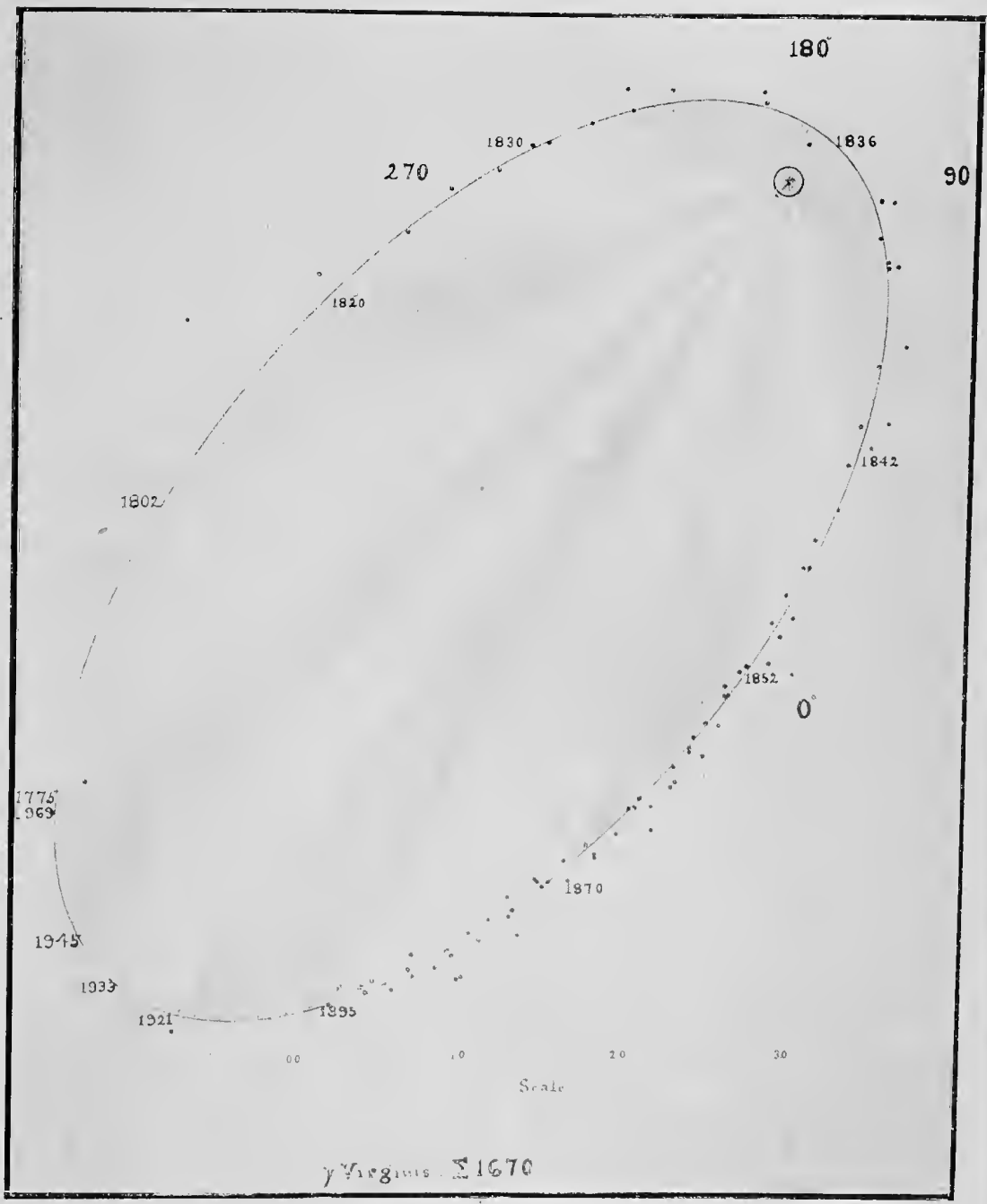
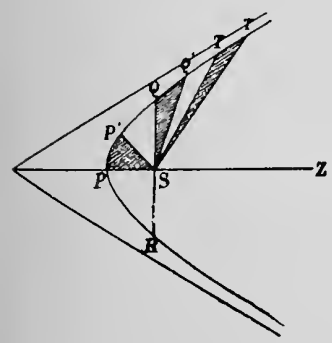
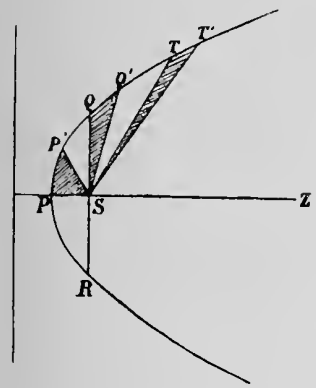
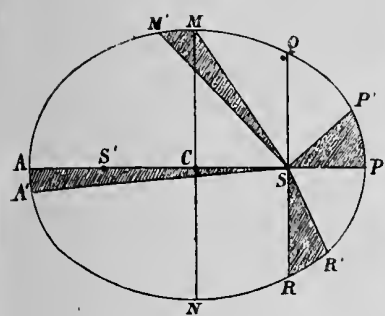


Fig. 18. Geometrical illustrations of the operation of *Kepler's* law of equal areas in equal times for the ellipse, parabola, hyperbola — in which conic sections alone planets and comets may move under the force of gravitation directed to the sun in the focus. On the right, the orbit of γ Virginis, which illustrates *Kepler's* law of areas among the double stars.

T. J. J. See. New Theory of the Aether.

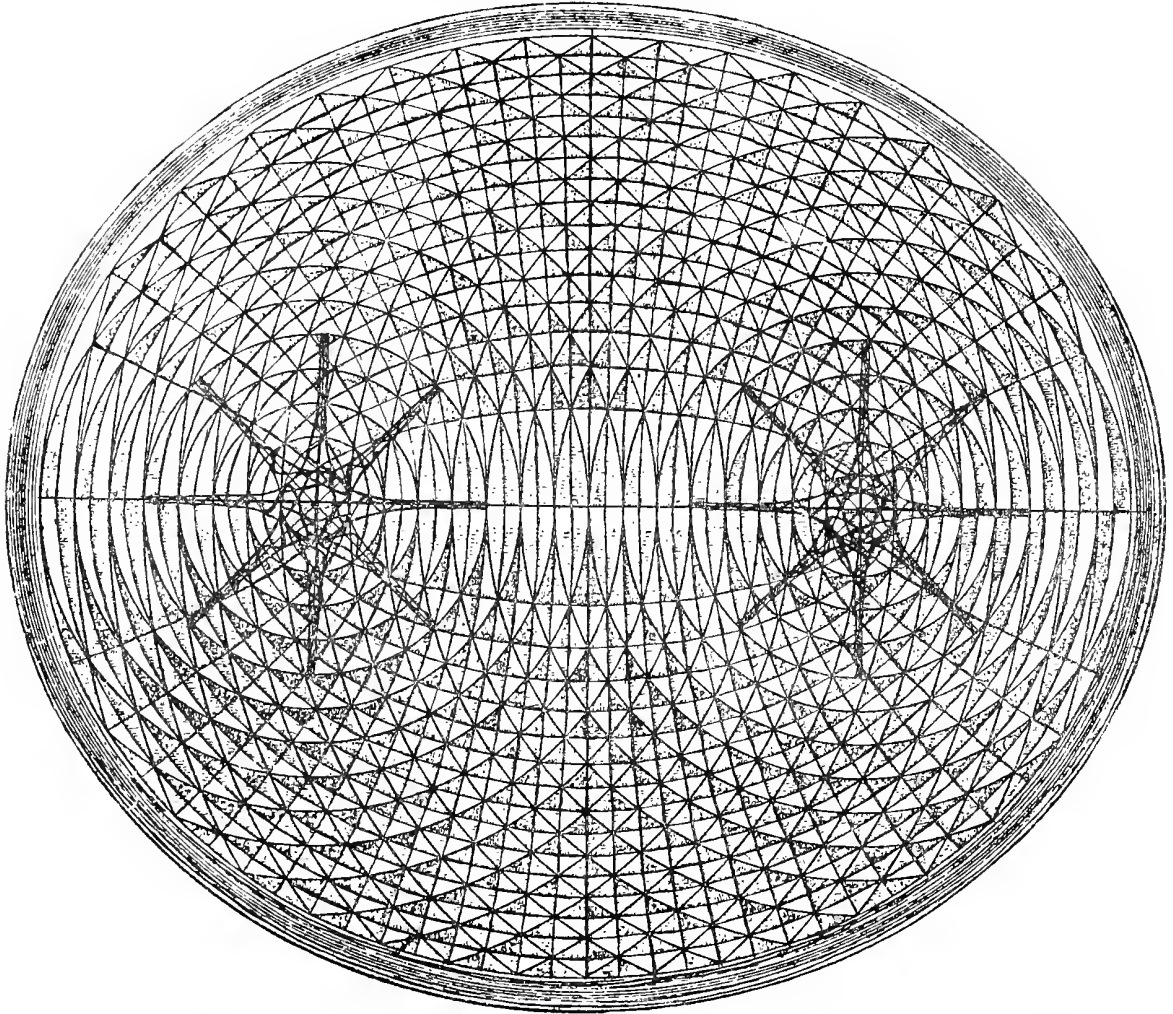


Fig. 19. Geometrical illustration of the wave-field about two equal stars. The wave-amplitudes increase asymptotically towards either body, which renders the aether of variable density $\sigma = \nu r$, while the wave-motion in concentric spheres, when reflected from the surfaces of the confocal ellipsoids, yields stresses along the tangents to the hyperboloids, which intersect the ellipsoids at right angles and with them constitute the system of confocal conics.

In nature the aether waves from the two centres are not reflected by the ellipsoidal surfaces, but proceed onward into infinite space; yet the reaction of the medium gives stresses along the tangents to the hyperboloids exactly the same as if the waves were perfectly reflected by the confocal ellipsoids, and the state of wave-motion rendered perpetual.

T. J. J. See. New Theory of the Aether.

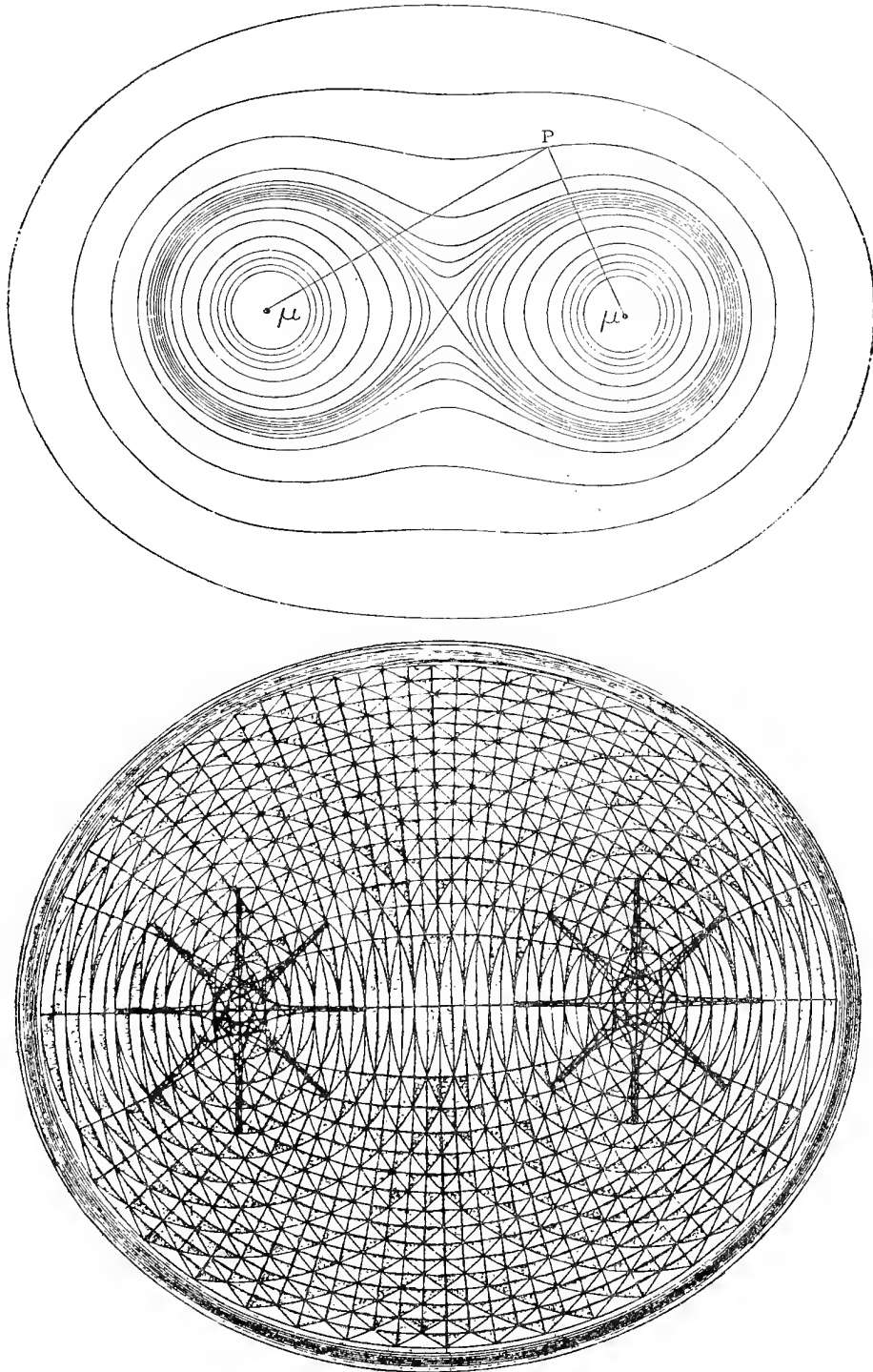


Fig. 20. Double plate showing the aether stresses in the wavefield about two equal stars:
 1. The equipotential surfaces distorted by gravitation to two centres, implying corresponding tension and pressure in the aether.
 2. The double wavefield showing the decrease of density of the aether towards either centre, and the stresses from infinite space acting along the hyperbolas for rendering the state of the medium perpetual.



C. F. Gauss

New Theory of the Aether. By T. J. J. See.

(Seventh Paper.) (With 7 Plates and 2 Portraits.)

I. Discovery of the Cause of Magnetism and of a Remarkable Connection between Magnetism and Universal Gravitation.

(i) Introductory remarks and definitions.

In this seventh paper we demonstrate the cause of magnetism, and outline certain remarkable discoveries in connection therewith, more especially a new physical law now finally established between the magnetism of the earth and terrestrial gravitation. Some of these discoveries have been known to me since 1914, and are recognized in the third paper (AN 5079), and in volume I of the *Electrodynamic Wave-Theory of Physical Forces*, 1917, but the proofs now available are made so much more complete, that it is advisable to re-examine the whole subject somewhat briefly.

The analytical expressions for the accelerating forces under *Newton's* law of gravitation, and under the new law for the total intensity of the earth's magnetic forces, are similar in form, except for the two poles in the case of the magnetic action, each of which is a centre of attraction, exerting its appropriate stress upon the aether in the wave-field of the globe:

$$g = mm'/r^2; \text{ for the sun } G = k^2/r^2, \text{ astron. units; } (1)$$

$$I = \mu\mu'/s^2 + \mu\mu'/s'^2. (2)$$

Here the gravitational masses are m and m' , at the distance r , the radius of the earth, and the acceleration g ; μ is the pole strength of the earth's magnetism, and μ' that of a standard steel bar magnet of weight $1/2$ kilogram, as used by *Gauss* (*Allgemeine Theorie des Erdmagnetismus*, p. 46), I = the total intensity of the earth's magnetism, s = the length of the curved line of magnetic force, obtained by integrating along the curved path ds between the place

of observation o and the pole p , $s = \int_o^p ds$, in the solid globe

of the earth, $s' = \int_o^{p'} ds'$, being the corresponding curved line

of magnetic force to the other pole.

It is recognized that a magnetic bar upon the earth is under a dual system of forces — the gravitational and the magnetic. *Gauss* showed (p. 46) that the pole strength of the earth $\mu = 8464 \cdot 10^{18} \mu'$; and he calculated that on the average, under uniform distribution of these standard steel bar magnets, with parallel axes, each cubic metre of the matter of the globe would have within it an amount of magnetism equivalent to 7.831 of these bars.

The average cubic metre of the earth's matter, with density 5.5, weighs 5500 kilograms; and thus the ratio of the magnetic matter of the globe to the whole of it is:

$$\eta = 3.9155/5500 = 1/1404.674. (3)$$

A more exact value of this constant probably is

$$\eta = 1/1408.12 (4)$$

yet from the considerations indicated in deriving equation (49), it is possible that the value may be as small as $\eta = 1/1414.213$, with the results shown in equation (115) below.

From the above equations (1) and (2) we obtain by division:

$$1/g = \mu\mu'/mm' \cdot (r^2/s^2 + r^2/s'^2). (5)$$

It is shown in the first paper, AN 5044, p. 54, that under tri-dimensional expansion in free space, the wave amplitude $A = k/r$, and that the energy of the waves, from which the forces arise, becomes $f = A^2 = k^2/r^2$, exactly as in the equations (1) and (2) above. The potential is a state of stress of the aether due to the integration for the waves of the several atoms at their respective distances r , s or s' as the case may be.

Thus for gravitation we have:

$$V = \int 1/r \cdot dm = \iiint \sigma [(x-x')^2 + (y-y')^2 + (z-z')^2]^{-1/2} dx dy dz. (6)$$

And for magnetism, having regard to the two poles, we have likewise:

$$\Omega = \int 1/s \cdot d\mu + \int 1/s' \cdot d\mu = \iiint \sigma/s \cdot dx dy dz + \iiint \sigma/s' \cdot dx dy dz. (7)$$

This magnetic potential is subject to the *Gaussian* equation of condition for the whole earth as a magnet:

$$\int d\mu = 0 (8)$$

because, on the two-fluid theory, there must be in the entire mass exactly as much positive as negative magnetism, so that the integral is zero. The wave-theory leads to an identical result.

Accordingly the magnetic forces acting on another magnet of pole strengths μ' , μ' become in the integral form:

$$I = f + f' = \mu\mu'/s^2 + \mu\mu'/s'^2 (9)$$

as in equation (2) above.

For in the wave-theory not only gravitation, but also magnetism is due to the energies of the atomic waves, which yield appropriate forces proportional to the squares of the amplitudes of the vibrations. Now, as found above, the atoms with magnetic properties, due to the concerted way in which they oscillate in parallel planes, are to the whole of the atoms of the earth as 1:1408.12. And therefore the corresponding forces I and g , resulting from the integrals for the magnetic and gravitational masses respectively, must both involve the squares of the amplitudes, since, as shown in AN 5044, this occurs for the gravitational force,

$$g = A^2 = k^2/r^2 = -dV/dr. (10)$$

Moreover, since the complete differentiation of the magnetic potential, by (7), leads to:

Here the two points o and o' are taken to be indefinitely near each other, and thus oo' is tangential to the curve, in the direction of the magnetic force.

Then obviously the sines of the angles γ and δ are inversely as the forces emanating from the corresponding poles, and therefore directly as the squares of the corresponding distances, thus:

$$\sin \gamma / r^2 = \sin \delta / r'^2. \quad (18)$$

But by geometry,

$$\sin \gamma = r \, d\alpha / ds \quad \sin \delta = r' \, d\beta / ds \quad (19)$$

and therefore by substituting in (18) we get:

$$d\alpha / r = d\beta / r'. \quad (20)$$

It is obvious from the figure 1 that

$$r \sin \alpha = r' \sin \beta \quad (21)$$

and on multiplying equation (20) by (21) the product yields

$$\sin \alpha \, d\alpha = \sin \beta \, d\beta$$

which admits of integration in the simple form:

$$\cos \alpha = \cos \beta + C \quad (22)$$

To construct the lines of force by the mechanical means devised by Dr. *Rogee*, let two rulers of equal length revolve around their ends fixed in N and S as centres, while the moveable vertical boundary, taken to be the side of a right triangle ABC , with base on NS prolonged, slides along.

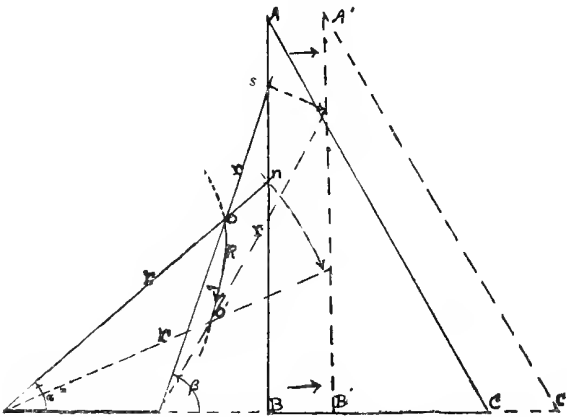


Fig. 2. Dr. *Rogee's* mechanical method for constructing the magnetic lines of force.

The intersection of the rulers resting against the sliding triangle ABC will fulfill the conditions specified in equation (22). For nB is the cosine of α to the radius r , and sB in like manner is the cosine of β to the radius r , and $NS = C$.

Hence the point of a pencil, held at this intersection o , will at once describe a line of the magnetic force, oo' . In the present paper the lines of force for the earth's field have not been drawn by such mechanical magnetic line apparatus, yet the accuracy is sufficient for all purposes here in view, which is chiefly the exposition of valid physical theory.

(iv) The physical nature of the magnetic lines of force investigated by means of an experimentum crucis, which shows that these lines represent the axial rotations of the wave-elements.

1. It is now shown that the stress in the aether along the line of force directed to the pole is due to waves flat in the plane of the equator of the magnet, parallel to which the elements of aether or aetherons rotate, about the lines of force, and thereby generate the tension along these lines which *Faraday* recognized as causing the lines to tend to shorten themselves. Towards the ends of the magnet there is a gradual change in direction of the stress, due to the absence of wave-emitting atoms, all vibrating in concert; and therefore the wave movement turns around and the lines reenter the magnetic poles, as illustrated in the following figure 3 from *Newton's Principia*, 1687, lib. II, section VIII, prop. XLI, theorem XXXII, where the curvature of the waves to a new radius is exhibited after the movement from the centre A passes through the orifice BC .

2. Now in magnetism each atom emits its own waves, and as the motion spreads with increased facility along the axis of the magnet, owing to the increased stress due to waves crowding in that direction, the lines of force are nearly straight at the centre of the magnet, and curve most rapidly around after passing the poles.

This simple view of the dynamics of the magnetic lines of force scarcely seems to require further explanation, as I have treated it briefly in AN 5048, p. 162, in connection with *Dolbear's* experiment, based on an observable mechanical model shown in practice to give the curvature and dynamical properties of the lines of force. Nevertheless the accompanying figure will enable us to see more clearly why the lines have near the ends of the magnet the increased curvature actually observed. The extension of the *Newtonian* figure is authorized by this example in vector composition.

3. Accordingly we shall illustrate the flatness of the lines of force near the centre of the bar magnet, compared to the rapid curvature towards either end, by another figure deduced from that given by *Newton* in the *Principia*, 1687, as follows:

a) Imagine adjacent additional centres of disturbance, $A', A'', A''' \dots$, and $A_1, A_2, A_3 \dots$, all in vertical line with the centre A . And make additional orifices above and below BC , as $B'C', B''C'', B'''C''' \dots, B_1C_1, B_2C_2, B_3C_3 \dots$, through which the wave disturbances may pass.

b) Then the waves in the same phase will everywhere mutually support each other: the disturbing centres being in the same parallel line, the wave fronts will become straightened by the mutual support of the separate independent disturbances.

c) Now imagine the orifices brought closer and closer together, yet maintained as distinct centres of disturbances: we see that beyond the line BC , prolonged in both directions, the wave fronts will become quite straight in the centre, but will curve around rapidly only near the end of the extreme orifice $B'C'$, $B''C''$, above and below respectively. This is exactly what occurs in magnetism: the lines of force curve around conspicuously as we approach the ends of the magnet.

d) The poles, in fact, are the centres of the reacting stress in the medium when agitated by all the atoms vibrating in concert, and emitting waves of the kind here described. The lines of force being axes of rotations for the aetherons, as the waves move along, there is a tendency in these lines to shorten themselves, as in *Dolbear's* experiment; the result is tension along the lines, and as they are of minimum length, they tend to keep straight near the centre of the magnet, and to curve sensibly only near the ends of the bar, just as in the water-wave experiment above described from *Newton's* diagram of 1687.

4. The experiments here described are accurate and can be verified by actual trial for water waves, which are simple and easily understood. They disclose to us the true nature of magnetism, for the following reasons:

a) The results conform to *Dolbear's* experiment, where the dynamical influences at work are easily understood, and admit of but one interpretation.

b) They are verified in the actual movement of water, the waves of which also have tension along their axes and tend to

straighten themselves to a minimum axis $s = \int_0^b ds$ on the principle of Least Action.

5. By actual experiment, 1845, *Faraday* found that the plane of a beam of polarized light was rotated when passed along the line of force, through heavy glass, carbon disulphide and similar substances, and the more rotated the longer the path s . This fact shows clearly that aether waves of the type here described underlie magnetism. They are proved to exist by the practical experiments with water waves, by *Dolbear's* experiment, on tangible models, and by *Faraday's* celebrated experiment on the rotation of the plane of polarization by magnetism.

6. There is one other experiment which equally supports the above conclusion, namely the revolution of a flexible hoop set loosely on an axis, in the apparatus commonly used to show the effects of centrifugal force. When the hoop is spun rapidly about its axis, it becomes of oval shape, bulged out at the equator and drawn in at the poles of rotation, like the figures of the planets which it is used to illustrate.

Now imagine a series of such hoops mounted side by side, and tied together mutually along the axis. Then, when the rotation develops, the whole line of connected hoops will shorten itself, under the centrifugal force, just as in *Faraday's* lines of force. It is impossible to imagine a more convincing proof than that here suggested.

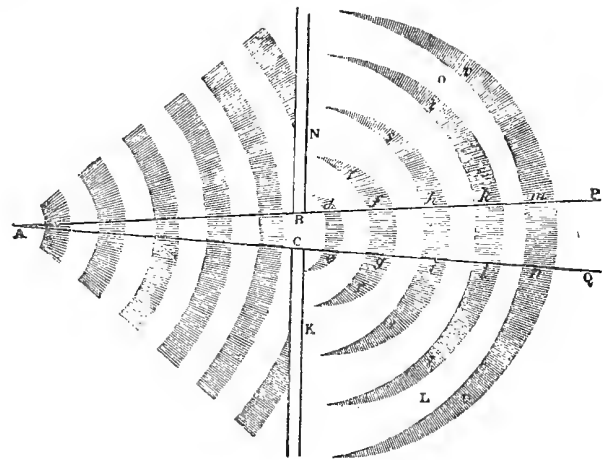


Fig. 3. *Newton's* diagram of the spread of waves to a new radius, after passing through an orifice BC, with *Airy's* illustration of the nature of the wave-motion, below (cf. *Tides and Waves*, 1845).

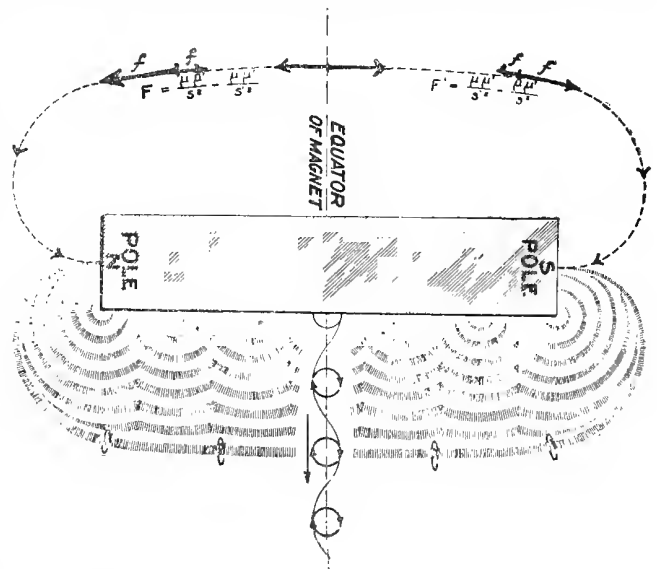
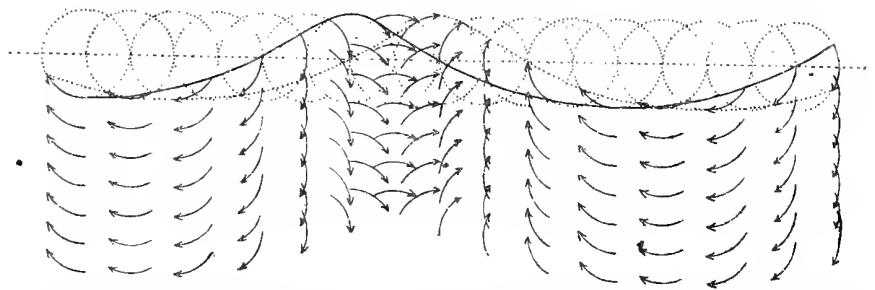


Fig. 4. Illustration of the simultaneous compounding of wave motions from closely adjacent orifices, by extension of *Newton's* theory. As the rotations about the axes are parallel, the tension in each wave disturbance tends to shorten the arc of the whole wave filament, and make the wave front a minimum. We thus get magnetic lines of force nearly straight in the equatorial regions of the magnet, with rapid curvature towards the poles. This diagram, in connection with Fig. 3 above, completely explains the observed phenomena in magnetism, and assures us that the wave theory assigns the true cause of magnetism. Drawn by *T. F. Greathead*.

2. New General Formulae for the Intensity of the Ponderomotive Force in every Part of the Magnetic Field: the New Theory rigorously verified by the Law of *Biot* for a Short Magnet deep in the Interior of the Globe as the Simplest Basis of the Earth's Magnetism, 1816.

(i) Law of the aether stress along the line of magnetic force from pole to pole.

When we have a new theory of any phenomenon in nature nothing is more satisfactory than its expression in the form of a geometrical law which enables us to confirm the mathematical rigor of the theory for every part of space. Thus we need the means for exploring the entire magnetic field, from pole to pole, to see if our harmonic law is everywhere rigorously fulfilled.

If this law is found to be exact throughout the whole field of the magnet, this property of mathematical accuracy alone will constitute an overwhelming argument for the validity of the new theory. Indeed, unless a contradiction can be established, we may safely conclude that the law as formulated is a true law of nature.

1. We begin with the magnetic equator, since in this region the two equal poles are equally remote; and as s and s' are equal, the two terms for the aether stress are equal, and the oppositely directed forces perfectly balanced, thus:

$$I = f + f' = \mu' \int \frac{1}{s^2} \cdot d\mu + \mu' \int \frac{1}{s'^2} \cdot d\mu = \mu\mu'/s^2 + \mu\mu'/s'^2 \quad (23)$$

where μ and μ are the strengths of the poles of the greater magnet (the earth for instance), μ' and μ' the strengths of the poles of the smaller magnet, or needle, which we may regard as suspended by a vertical thread attached to its centre of gravity, while the needle itself assumes the horizontal position.

This fact was first carefully observed by *Humboldt* when he crossed the earth's magnetic equator in northern Peru $7^\circ 1'$ south latitude, $313^\circ 41'$ east longitude, between the silver mining town of Micuipampa and Caxamarca, where the elevation is about 12000 feet (*Cosmos*, vol. 1, *Bohn* translation, p. 177). The true laws of the earth's magnetism are so important that we shall be justified in deriving general formulae and comparing them with the results of observations in both terrestrial hemispheres. What is true of the earth's magnetism is even more rigorously true of a symmetrical magnetic bar, because a good artificial magnet is much more regular and exact in its laws of attraction than the earth, which is made up of many lesser magnets very irregularly arranged into one large globular magnet.

2. As we go towards either pole the force pulling towards the other pole weakens, leaving unbalanced the two terms f and f' , which are oppositely directed, thereby yielding the aether tension I , yet becoming more and more unequal towards the poles.

a) If we go towards the north pole, $f = \mu\mu'/s^2$ increases, because s steadily decreases: on the other hand, f' decreases, because s' quite as steadily increases. Hence in the northern hemisphere the difference of stress will be:

$$F = \mu\mu'/s^2 - \mu\mu'/s'^2 \quad (24)$$

where F is the ponderomotive force pulling the small magnet (with poles μ' and μ') bodily towards the north pole of the large magnet, with poles μ and μ , which may be the earth.

b) If we go towards the south pole, the force f pulling towards the north pole weakens, leaving the pull towards the south pole correspondingly predominant. Hence as $f = \mu\mu'/s^2$ decreases, while $f' = \mu\mu'/s'^2$ increases, we have the corresponding inequality of stress:

$$F' = \mu\mu'/s'^2 - \mu\mu'/s^2. \quad (25)$$

This is therefore the ponderomotive force pulling the small magnet towards the south pole of the large magnet, which may be the earth. In view of these equations, the reader may now advantageously refer again to figure 4 above, which gives a connected representation of all the wave phenomena in the field about a magnet, together with the forces thereby generated. It is well also to refer to the photograph of magnetic action reproduced in plate 2, fig. 1, which places the new theory beyond controversy, because the effects of the ponderomotive forces are rendered directly visible to the eye of the reader. This is the first photograph of the kind ever taken for illustrating the mutual actions of two magnets, the smaller magnets being shown in four leading positions.

3. In view of the above considerations, our harmonic law

$$I/g = \eta^2 r^2 (1/s^2 + 1/s'^2) \quad (26)$$

may be written for the earth's magnetic and gravitational actions in the form:

$$I/g = \mu\mu'/mm' \cdot (r^2/s^2 + r^2/s'^2) = \eta^2 r^2 (1/s^2 + 1/s'^2). \quad (27)$$

Here, in the right member of the equation, we have merely replaced I by the above magnetic expression (23), and for g substituted the familiar gravitational formula, $g = mm'/r^2$. In fact equation (27) may be said to have the following meaning:

The action of the large magnet, such as the uniformly magnetized sphere of the earth, upon the small magnet at the distance of the two poles, from which its stresses are exerted, is to the gravitative action of the earth towards its centre, as

$$\mu\mu'(1/s^2 + 1/s'^2) : (mm'/r^2) = \eta^2 (r^2/s^2 + r^2/s'^2) : 1. \quad (28)$$

Thus at unit distance, $r = 1$, the magnetic force is to the gravitational force as 1 to 1960000, if $\eta = 1/1400$.

In dealing with the actual earth elsewhere, we find from the total intensities at the poles calculated by *Gauss* that the theoretical ratio is slightly different, namely: 1 to 1982802. We need not here inquire into the theoretical sources of this trifling difference, as that would raise too many difficult analytical questions relative to *Gauss*' theory. The difference itself, moreover, is very trifling.

4. Accordingly, if I denote the total force, or aether stress along the line of force, so that $I = \mu\mu'(1/s^2 + 1/s'^2)$, we have for any place on the globe:

$$I/g = \eta^2 r^2 (1/s^2 + 1/s'^2) \quad (29)$$

$$\text{or } [\mu\mu'(1/s^2 + 1/s'^2)] / [mm'/r^2] = \eta^2 (r^2/s^2 + r^2/s'^2). \quad (30)$$

5. This means that the earth's magnetic part acting at the distance to the two foci, s and s' , is to the gravity of the whole mass m , acting at the distance to the centre r , as

$$\eta^2 (r^2/s^2 + r^2/s'^2) : 1 = 1/1960000 \cdot (r^2/s^2 + r^2/s'^2)$$

if $\eta = 1/1400$.

a) As shown above in (23) the stress in the aether along the line of force is perfectly balanced only at the equator, because there $\mu\mu'/s^2 = \mu\mu'/s'^2$. The unbalanced tension along the line of force at any point whatever is equivalent to the effect of each pole pulling unequally on its own end of the needle. The old doctrine of repulsion need not be considered at all.

b) North or south of the equator therefore the stress is unbalanced, because we have:

$$\mu\mu'/s^2 - \mu\mu'/s'^2 = F = \text{ponderomotive force in the northern hemisphere}$$

$$\mu\mu'/s'^2 - \mu\mu'/s^2 = F' = \text{ponderomotive force in the southern hemisphere.}$$

This unbalancing of the stresses in either hemisphere is easily confirmed by observation. A small magnet suspended by a thread easily is seen to be swung bodily and end-on towards the nearest pole. If the proper pole of the suspended magnet be not presented to that of the larger magnet, the smaller magnet will quickly reverse itself, and then swing over, deflecting the thread about its centre visibly from the vertical direction of gravitation, as shown in plate 2, fig. 1.

6. It is the increased power of the term due to the nearer pole, and decreased power of the term due to the opposite pole which throws the aether stress along the line of force out of balance; and this lack of balance gives therefore the difference, or visible ponderomotive forces:

$$F = \mu\mu'/s^2 - \mu\mu'/s'^2, \text{ in the northern hemisphere}$$

$$F' = \mu\mu'/s'^2 - \mu\mu'/s^2, \text{ in the southern hemisphere.} \quad (31)$$

At the poles it is obvious that we shall have:

$$\text{North Pole, } F = \mu\mu'/s^2, \text{ because } \mu\mu'/s'^2 = 0$$

$$\text{South Pole, } F' = \mu\mu'/s'^2, \text{ because } \mu\mu'/s^2 = 0. \quad (32)$$

The results here developed contain the whole theory of the mutual actions of two magnets upon each other. But as such a theory does not exist today in any book in the world, we have felt authorized to explain the new theory in sufficient detail to assure the reader of its entire rigor. The following development by *Biot*, who reached similar results from another point of view, will also prove of interest to the student of this subject.

The problem of magnetism has been so unsatisfactorily treated heretofore that it is highly advisable to examine it from several aspects. Thus *Biot's* formula gives identical results at the two poles, yet no physical cause is assignable from his reasoning why such a result should follow, whilst on the wave-theory of magnetism we have a very tangible physical cause always before our minds, and generating the ponderomotive force exactly as observed in nature.

(ii) Outline of the simple theory of terrestrial magnetism proposed by *Biot* in 1816.

In his *Traité de Physique*, 1816, tome III, p. 139, the celebrated *J. B. Biot* developed an hypothesis which gives

a simple view of the earth's magnetism. It had been somewhat outlined by *Tobias Mayer* of Göttingen about the middle of the 18th century, but *Biot* gave it a form of much greater mathematical elegance and rigor. He imagines a single magnet whose axis passes through the centre of the earth, in a direction perpendicular to the magnetic equator, but of small length compared to the earth's radius.

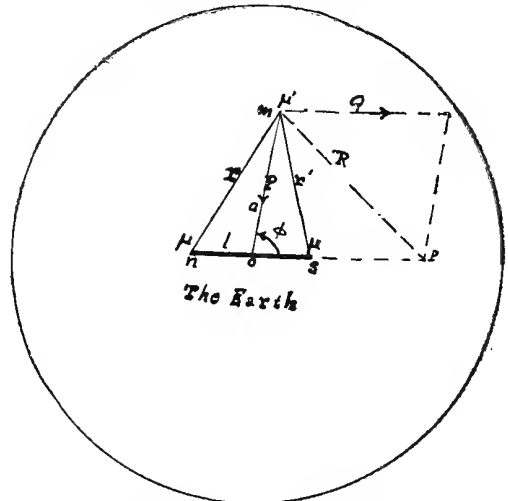


Fig. 5. Illustration of *Biot's* theory of a short magnet near the earth's centre.

In order to give a distinct analysis of *Biot's* theory we derive first the expressions for the force exerted by a bar magnet upon a unit pole, as ordinarily given. Let the line ns denote the distance $2l$ between the two poles of a magnet, each of pole strength μ , acting upon a unit pole at m of strength μ' . If μ' be austral (south seeking), the forces exerted by the poles n and s will become:

$$f = -\mu\mu'/r^2 \quad f' = +\mu\mu'/r'^2. \quad (33)$$

These forces may be resolved into two, namely P in the direction mo , and Q in the direction ns , — the former somewhat small, the latter much larger:

$$P = \mu\mu' a (1/r^3 - 1/r'^3)$$

$$Q = \mu\mu' l (1/r'^3 + 1/r^3). \quad (34)$$

Let $m\hat{p}$ be the direction of the resultant R of the two forces; then as the sides of the triangle $m\hat{o}p$ are proportional to the forces in their directions we have:

$$mo : \hat{o}p = P : Q = a (r^3 - r'^3) : [l(r^3 + r'^3)] \quad (35)$$

$$\hat{o}p = l(r^3 + r'^3)/(r^3 - r'^3). \quad (36)$$

But by trigonometry we have

$$r^2 = a^2 + l^2 + 2al \cos \Phi \quad r'^2 = a^2 + l^2 - 2al \cos \Phi. \quad (37)$$

Now l is taken to be small compared to a , and under these conditions we may expand these expressions in series, neglecting terms of l/a higher than the first.

$$r^{-3} = a^{-3} [1 - 3(l/a) \cos \Phi]$$

$$r'^{-3} = a^{-3} [1 + 3(l/a) \cos \Phi]. \quad (38)$$

Wherefore, by addition and subtraction respectively, we get:

$$r^{-3} + r'^{-3} = 2a^{-3}, \quad r'^{-3} - r^{-3} = 2a^{-3} \cdot 3(l/a) \cos \Phi. \quad (39)$$

Substituting these expressions in (34) above, we find, on putting for $2\mu'$ the magnetic moment $m = 2\mu'$:

$$P = m\mu' \cdot 3 \cos \Phi / a^3, \quad Q = m\mu' / a^3$$

$$P = Q \cdot 3 \cos \Phi. \tag{40}$$

The magnitude of the resultant force R is given by the equation for the composition of the vectors P and Q :

$$R^2 = P^2 + Q^2 - 2PQ \cos \Phi$$

$$= Q^2 [(3 \cos \Phi)^2 + 1 - 2 \cdot 3 \cos \Phi \cos \Phi] \tag{41}$$

whence

$$R = m\mu' / a^3 \cdot (1 + 3 \cos^2 \Phi)^{1/2}. \tag{42}$$

If therefore the point m is on the prolongation of the axis of the magnet, we have: $\Phi = 0^\circ$, and:

$$R = 2 m\mu' / a^3. \tag{43}$$

But if the point m is in the equator, $\Phi = 90^\circ$, and we have:

$$R = m\mu' / a^3. \tag{44}$$

The simple equations (43) and (44) represent *Biot's* celebrated result, that if the earth's magnetism be due to a short magnet in the centre of the globe, the total magnetic force at the poles ought to be exactly twice as great as at the equator.

According to the scale of intensity formerly employed *Humboldt* found that at the magnetic equator, — between Micupampa and Caxamarca, Peru, at an elevation of nearly 12000 feet in the Andes, — the intensity was 1.000; and at the poles *Gauss* calculated the average intensity to be 1.977. This confirms *Biot's* law quite accurately; for half of the mean polar intensity, found by *Gauss's* profound theory, is 0.9885, in perfect accord with the mean of many determinations along the magnetic equator, as shown by the following table:

Sixteen widely separated determinations of the total intensity near the magnetic equator.

Name of Place	Latitude	East Longitude	$I =$ Total Magnetic Intensity
Cape of Good Hope	$-34^\circ 11'$	$18^\circ 26'$	1.014
Mauritius	$-20 \quad 9$	$57 \quad 31$	1.144
Madras	$+13 \quad 4$	$80 \quad 17$	1.031
Otaheite	$-17 \quad 29$	$210 \quad 30$	1.094
Galapagos Islands	$- \quad 0 \quad 50$	$270 \quad 23$	1.069
Magnetic equator near Caxamarca	$- \quad 7 \quad 2$	$281 \quad 12$	1.000
Quito	$\quad \quad 0 \quad 0$	$281 \quad 15$	1.067
Plateau of Antisana	$- \quad 0 \quad 25$	$281 \quad 20$	1.068
Montevideo	$-34 \quad 53$	$303 \quad 47$	1.060
Rio de Janeiro	$-22 \quad 55$	$316 \quad 51$	0.878
Bahia	$-12 \quad 59$	$321 \quad 30$	0.871
Minimum of faint zone east of Brazil	$-19 \quad 59$	$322 \quad 36$	0.706
Pernambuco	$- \quad 8 \quad 4$	$325 \quad 9$	0.914
Porto Praya	$+14 \quad 54$	$336 \quad 30$	1.156
Ascension	$- \quad 7 \quad 56$	$345 \quad 36$	0.873
St. Helena	$-15 \quad 55$	$354 \quad 17$	0.836
Mean value of total intensity		$I_0 =$	0.9863
Half of <i>Gauss's</i> mean value at the poles $1/2 I_c =$			0.9885
Difference		$=$	+0.0022.

3. Detailed Analysis of the Law connecting the Mean Total Intensity of the Magnetism of the earth with Terrestrial Gravitation.

(i) Analysis and application of the harmonic law, $I/g = \eta^2 (r^2/s^2 + r'^2/s'^2)$.

Let I denote the mean total intensity of magnetism at any point of the earth's surface; and let g denote the acceleration of terrestrial gravity, ordinarily taken as 981 cm C. G. S. It is usual to designate the value of the horizontal component of the earth's magnetism by γ , and to express this force in 10^{-5} of a C. G. S.-unit. Thus at Cheltenham, Md., the Magnetic Observatory of the U. S. Coast Survey in 1906 found the value of γ to be 20 (New International Encycl., New York, 1916, vol. 22, article Terrestrial Magnetism, p. 1211; or *L. A. Bauer*, United States Magnetic Tables and Magnetic Charts for 1905, Washington, 1908).

$$\gamma = 0.00020 \text{ C. G. S.}$$

As the magnetic declination for 1906 was $70^\circ 27'$, we find $I = \gamma \sec \theta = 0.00020 \cdot 2.98838 = 0.000597676$ (45) $= 0.0006$, nearly.

But since the declination changes slowly, and also the value of γ varies progressively from year to year, we need not dwell on the higher decimal places; for although accurate values for the Observatory are available, yet other places in the same community would have slightly different values. Thus we use the round number $6 \cdot 10^{-4}$ as representing the mean value of I at Cheltenham for the year 1906.

Accordingly we have by observation:

$$I/g = 6/9810000 = 1/1635000. \tag{46}$$

It is to be observed that at the equator the harmonic law gives the ratio $I\eta^2 = 1/1982802$, and at the mean poles $I\eta^2 = 1/991401$, exactly double the equatorial value, as under *Biot's* law. And similar confirmations of the harmonic law will be found at various stations in middle latitude, so far as the earth's magnetism is regular, in undergoing steady increase towards the poles.

In the applications of the harmonic law

$$I/g = \eta^2 (r^2/s^2 + r'^2/s'^2)$$

it is to be noticed that at the magnetic pole in Boothia Felix the line of magnetic force s' running to the pole in the Antarctic becomes infinite, so that the second term in the above equation vanishes, and we must therefore use only the first term in our calculations.

In like manner, when we apply the formula to the pole in the Antarctic, s becomes infinite, and the first term vanishes, so that only the second term remains for use in calculations.

At the magnetic equator on the other hand, the two terms become of exactly equal value, and the curved lines to the poles attain maximum values $s = \sqrt{2} = 1.4142$, $s' = \sqrt{2} = 1.4142$, so that the sum $r^2/s^2 + r'^2/s'^2 = 1.000$. Also, by observation, each of the equatorial terms is approxi-

mately $1/2$, as we find by actual integration $s = \int_0^{\theta} ds$, $s' = \int_0^{\theta'} ds'$.

Towards the poles, on the other hand, the divisor s or s' of the chief term becomes small, augmenting the intensity

at the poles according to the data of observation and Gauss' theory. The harmonic law therefore is extremely simple, and the force changes steadily, yielding the required increase of intensity towards the poles, and only half of this mean intensity at the equator.

Now it was shown by Gauss (Allgemeine Theorie des Erdmagnetismus, 1838, p. 46), as more fully explained below, that on the average there are in each cubic metre of the earth's matter the equivalent of 7.831 bar magnets each weighing one German pound, all of them weighing 3.9155 kg. And as the density of the earth is taken to be 5.5, the average cubic metre of the earth's matter will weigh 5500 kg. Dividing 3.9155 by 5500, we find from Gauss' figures that:

$$\eta = 3.9155/5500 = 1:1404.674^{\text{th}} \quad (47)$$

part of the earth is magnetic, like the perfectly saturated steel bars used in the Observatory at Göttingen, 1833-38.

These figures imply that the distribution of the bar magnets within the earth is uniform, whereas a more natural hypothesis would be to take the density of the bars to be proportional to the density of the matter in the different spherical shells of which the earth is made up.

On calculating the weight of the average cubic metre of the earth's matter, on this hypothesis, we find it comes out 5524.13 kg, instead of 5500 kg, as previously assumed on the theory of homogeneity. The ratio of increase is 1.004387 to 1. Since the external action of the earth's magnetism was found to correspond to 7.831 standard bars, in the observations used by Gauss, and this observed datum cannot be increased by any alteration of our hypothesis, we can adjust the difference only by taking somewhat fewer bars in each cubic metre, 7.831/1.004387 = 7.7968, in place of 7.831. The result is:

$$\eta = 3.8984/5500 = 1/1410.837. \quad (48)$$

Giving this value a weight of 3, and the above value a weight of 2, we get as our mean result:

$$\eta = 1/1408.372 \quad (49)$$

The result is thus very near the value $\eta = 1:1408.12$ previously indicated, equation (4), and thus we adhere to that value as the most probable.

It should be explained that the curved line of magnetic force, along which magnetic stress towards either pole acts, is to be integrated between the place of observation and the pole properly located in the earth. Here we come to a new property of magnetism as distinguished from gravitation. For gravity acts in straight lines, while magnetism acts in curved lines, along the lines of magnetic force directed to either pole. It is directed along the tangents of these curves towards the nearer pole, and always is positive, as I have found by careful experiments with soft iron, and also with freely suspended small magnetic needles.

The small suspended magnetic needles are magnets, free to turn the appropriate end to the nearer pole; and when so suspended by a thread they behave exactly as soft iron in which magnetism is induced by the waves in the field of the larger magnet. It is easy to find by trial of this simple experiment, that just as soft iron filings when laid upon a glass plate and jarred, will arrange themselves along the magnetic line of force, so also freely suspended

needles will show exactly the same tendency. The ponderomotive force or unbalanced stress in the aether is along the curved paths to the nearest pole.

Hence in considering the earth's magnetism we have to take the integrals:

$$s = \int_0^{\rho} ds = \int_0^{\rho} [1 + (dy/dx)^2 + (dz/dx)^2]^{1/2} dx \quad (50)$$

$$s' = \int_0^{\rho'} ds' = \int_0^{\rho'} [1 + (dy/dx)^2 + (dz/dx)^2]^{1/2} dx$$

as explained above.

In general the curves of the magnetic lines of force in the earth's field are curves of double curvature; so that the rigorous integration of (50) is difficult, because we do not know the equations of the curves by which we might compute dy/dx and dz/dx . Thus we have to consider the curvature

along any path whatever in finding $s = \int_0^{\rho} ds$, $s' = \int_0^{\rho'} ds'$.

In its most general form the equation for the curvature along any path in space has the form

$$1/\rho = [(d^2x/ds^2)^2 + (d^2y/ds^2)^2 + (d^2z/ds^2)^2]^{1/2} \quad (51)$$

where ρ is the variable radius of curvature.

But in our present practical calculations, it suffices to take the curved line s as lying in the plane through the magnetic poles of the earth, which are found to be at depths of 0.766 r for the north pole, and of 0.666 r for the south pole. With these slight restrictions we have calculated the length of s and s' for Cheltenham, Maryland, namely, $s = 0.913r$, $s' = 3.361r$, $(1/s^2 + 1/s'^2) = 1.2114$, whence we find the theoretical ratio to be:

$$I/s = 1.2114/1982802 = 1/1636810. \quad (52)$$

Table of observed values of the total intensity at various places and of the product $I\eta^2 = 1:1960000$, which increases towards the poles:

Place	Latitude	East Longitude	I	$I\eta^2 = 1:1960000$ *)
Spitzbergen	+79° 50'	11° 40'	1.562	1:1254802
Cape of Good Hope	-34 11	18 26	1.014	1:1930940
Hammerfest	+70 40	23 46	1.506	1:1306575
Mauritius	-20 9	57 31	1.144	1:1711300
King George's Sound	-35 2	117 56	1.709	1:1146872
Hobartown	-42 53	147 24	1.817	1:1078700
Sydney	-33 51	151 17	1.685	1:1163205
South magn. pole	-72 35	152 30	2.253	1: 869951
New Zealand	-35 16	174 0	1.591	1:1231930
Otaheite	-17 29	210 30	1.094	1:1791600
San Francisco	+37 49	237 35	1.591	1:1231930
North magn. pole	+73 35	264 21	1.701	1:1152264
Cheltenham Md.	+38 44	283 10	1.738	1:1127400
Conception	-36 42	286 50	1.218	1:1609195
Valparaiso	-33 2	288 19	1.176	1:1666666
Falkland Isl.	-51 32	301 53	1.367	1:1433800
Montevideo	-34 53	303 47	1.060	1:1847313
Rio de Janeiro	-22 55	316 51	0.878	1:2232330
St. Helena	-15 55	354 17	0.836	1:2339105

*) In this table η is taken as 1:1400, but it is not worth while to recompute it.

The close agreement of this ratio with the observed value given in (46) above is so remarkable that the application of the new formula requires no comment. It is evident that the new formulae

$$I/g = (1/1408.12)^2 [(r^2/s^2) + (r^2/s'^2)]$$

$$s = \int_0^p ds \quad s' = \int_0^{p'} ds'$$

will hold for any part of the globe. For what will apply at the equator, at the pole, and at a typical station in middle latitude will apply generally to any part of the earth's surface. But it is evident that we must expect the test to be fulfilled only for the mean value of I , since the calculated action from the distant pole can take no account of local magnetic attractions, which often are of sensible magnitude.

(ii) The magnetic lines of force are paths of least action for the aether stress.

The unexpected result above brought out, that the stress in the aether which gives rise to the magnetic forces, is exerted along the curved line of magnetic force and thus is tangential to the line of force at every point, requires something more than passing notice. Such a result has hardly been considered in the science of dynamics as handed down by the great classic authorities, — such as *Newton, Euler, Lagrange, Laplace, Gauss, Jacobi, Hamilton*. Yet we must remember that these classic authorities were occupied chiefly with gravitational forces, which act in right lines; and if they dealt with other forces occasionally, it was always assumed that the stress from which the forces arise act in right lines, like gravitation. When we come to magnetism, however, the case is different: we have a 'duality of powers', and stresses acting in curved lines.

It is admitted by the most eminent mathematicians, that in the operations of nature the changes take place according to the principle of Least Action. Already *Fermat* had established by rigorous test the fact of action in Least Time for such forces as light:

$$\tau = \int_1^2 v \cdot ds.$$

In later time this geometric condition was generalized for the other forces of nature also.

In applying the above formula (49) to the magnetism of the earth, we notice that as magnetism is a stress, and directed along the line of force, we must assume this curved path to be the path of least action for the operation of the stress in the aether called magnetism. The distance s therefore is a curved path

$$s = \int_0^p ds = \int_0^p [1 + (dy/dx)^2 + (dz/dx)^2]^{1/2} dx$$

$$s' = \int_0^{p'} ds' = \int_0^{p'} [1 + (dy/dx)^2 + (dz/dx)^2]^{1/2} dx$$

where the limits are the place of observation and the nearer pole located at the proper depth in the globe of the earth.

Let us examine into these lines of force, in the hope of finding special cases of straight lines, as at the two surface magnetic poles of the globe, where the direction of the

total intensity of the magnetic force is vertical, and there should be no curvature of this special path either above or below the earth's surface, except for local inequalities of magnetism, which in this general theory of the mean total intensity of the total force is left out of account.

According to *Gauss*, (p. 46), the total intensity of the magnetism at the north pole is:

$$I = 1.701. \quad (53)$$

At the south pole likewise *Gauss* finds:

$$I' = 2.253. \quad (54)$$

Restricting ourselves to the consideration of the mean total force of the magnetic intensity, and disregarding local influences altogether, it is evident that in the region of the poles, the curved line of magnetic force s becomes straight, while $s' = \infty$, and therefore we can write the harmonic law in the form:

$$I/g = 1/1982802 \cdot (r/s)^2 \quad (55)$$

where r is the earth's radius, at which g is determined, and

$s = \int_0^p ds$, also is expressed in units of the earth's radius.

Using the values found by *Gauss*, in (53) and (54) above, we find for the depths of the two poles as more fully discussed hereafter:

$$\begin{aligned} \text{North pole, } s &= 0.766 r \\ \text{South pole, } s' &= 0.666 r. \end{aligned} \quad (56)$$

The results here brought out are quite remarkable. As s at the poles is a straight line, we find that the pole is located much nearer the surface in the southern than in the northern hemisphere. Hence the mean total intensity at the south pole is a maximum, 2.253, while in the northern hemisphere the pole is much deeper down and the total force correspondingly weaker, $I = 1.701$. This very simple deduction throws light upon the asymmetry of the earth's magnetic system, long recognized, but heretofore not understood.

Hence we may be sure that the harmonic law will hold for the entire arc, from the magnetic equator to the magnetic poles. It is certain that the magnetic force or stress from either pole not only varies inversely as the square of the distance s , along the curved line of force, but also renders the pole a true centre of attraction, as so long held in the theory of magnetism. This is what *Airy* calls the »duality of powers«, (*Treatise on Magnetism*, 1870, p. 10).

This confirmation of the law of inverse squares, thus verifies the wave-theory of physical forces. It was noticed by *Faraday* that lines of force tend to shorten themselves, (*Experimental Researches in Electricity*, no. 3269), which led him to the theory of tension along the lines of force. We have explained this mechanical tendency by waves with rotations about the lines of force. Hence these lines of force are minimum paths for the whirling filaments, with tension along then directed to the poles.

(iii) Determination of the depth of the magnetic poles.

1. *Gauss* shows that for the two poles the mean value of the total magnetic force is:

$$I = 1.977. \quad (57)$$

2. To get the depth of the mean pole we have therefore to solve the equation:

$$1/n = 1.977/1982802 = 1/1002935. \quad (58)$$

This is the ratio of magnetic force at the pole to gravity.

3. And we then introduce the factor $1/s^2$, with the condition that when the whole force is exerted from the pole at a certain depth $s < r$, we have the observed ratio indicated in the second number:

$$1/1982802 \cdot (r/s)^2 = 1/1002935 \quad (59)$$

which gives:

$$s = r(1002935/1982802)^{1/2} = 0.71128r \quad (60)$$

4. Accordingly, we find by a very simple process that the pole placed at a depth of $0.71128r$, will generate the increase of force noticed at the pole above the part $1/1982802$, which would correspond to the distance unity, in this case the radius of the earth.

5. Since the intensity of the total magnetic force is observed to increase from the equator to the pole, according to the general law of terrestrial magnetism discovered by *Humboldt* 1799-1804, and first announced by him to the Paris Academy, An XIII, 26th Frimaire (Jan. 16, 1805), in a joint paper with M. *Biot* (Cosmos, vol. I, pp. 179-181, *Bohn* Translation), we naturally attribute this increase of the magnetic force to the smaller distance at which the stress is exerted, by the nearer pole, that to the other pole decreasing correspondingly.

6. It must be remembered that in magnetism the pole is a real centre of attraction, corresponding to the centre of gravity of a heavenly body, for purely gravitational forces; and consequently our reference of magnetic forces must be to the poles by which they are exerted. *Airy* justly says that magnetism is characterized by a »Duality of Powers« (Treatise on Magnetism, 1870, p. 10); hence we must not on that account fail to refer the forces to their appropriate centres. And when we do this all the chief phenomena of terrestrial magnetism may be explained by the laws of attraction for forces varying inversely as the square of the distance, which is another most impressive proof of the connection of gravity with magnetism, and of magnetism with gravitation — both of these forces being due to wave-action, following the same laws, yet exerted along rectilinear and curvilinear paths respectively.

7. Having found the average depth of the mean magnetic poles, it will now be in order to determine the depth of the actual north and south magnetic poles in the solid globe of the earth. At the northern magnetic pole *Gauss'* theory gives the total intensity as

$$I = 1.701$$

wherefore we find

$$1/n = 1.701/1982802 = 1/1165668. \quad (61)$$

And $s = r(1165668/1982802)^{1/2} = 0.76674r \quad (62)$

8. For the actual south pole, we have likewise

$$I' = 2.253$$

$$1/n' = 1/880072 \quad (63)$$

whence $s' = (880072/1982802)^{1/2} = 0.66622r. \quad (64)$

9. The southern magnetic pole is quite appreciably nearer the surface than the northern. In fact the difference in the depth of the two poles amounts to almost exactly one-tenth of the terrestrial radius, or

$$\int_0^s ds - \int_0^{s'} ds' = s - s' = 0.10052r. \quad (65)$$

This is a very remarkable feature of the magnetism of the globe, and so far as I can find out it has scarcely been considered by previous investigators. Yet such a lopsided position of the two magnetic poles, — the southern being one-tenth of a terrestrial radius nearer the Antarctic Continent, — must have some meaning in the physical constitution of our planet.

10. Perhaps the phenomenon of this notable magnetic asymmetry here brought to light is too novel to justify as yet any satisfactory discussion. But we think it worth while to point out that the magnetic asymmetry corresponds closely to the land and water hemispheres, the origin of which I have treated in AN484-445, 1916.

If this coincidence in position is accidental it is quite remarkable. On the other hand, if there be a real physical connection of the pole nearest the earth's surface with the great briny ocean which overlies half the world, we might explain it by the greater conductivity of salt water for the electrical wave-action, on which the magnetism of the earth so essentially depends. Whether such a secular asymmetry of the magnetic system of the earth could develop with the lapse of the billions of years involved in the growth of the earth is a question which must be left to the future researches of natural philosophers.

At any rate I deem it desirable to direct attention to the only known surface cause of such asymmetry, and the singular coincidence in the positions of the two systems — the magnetic system being bodily displaced $0.05r = 200$ miles towards the ocean hemisphere. Whatever conclusions may be developed, these two remarkable asymmetries, — one relating to the ocean and the other to the magnetic system, — are the greatest outstanding physical features of the globe, and their essential coincidence therefore is the more extraordinary. It certainly must appear to philosophers very surprising that such vast outstanding features have received little or no study in the researches heretofore made on the origin of the globe, and the distribution of the magnetism in the two hemispheres.¹⁾

It only remains to add that as the difference of the depths of the magnetic poles from the surface of the earth is 0.10 of the radius or 637.8 kms, about 400 miles, the north pole is displaced downward 318 kms, or 200 miles, while the south pole is displaced upward, towards the Antarctic, by an equal amount. The absolute amount of this displacement thus is very large.

¹⁾ Mr. E. F. Wesley, of *Wheldon* and *Wesley*, London, was able to place in my hands a full set of the great series of memoirs on terrestrial magnetism by General Sir *Edward Sabine*. They had been presented to Sir *John Herschel*, as they successively appeared in the *Philosophical Transactions*, and finally purchased by Mr. *Wesley*, with the *Herschel* library. Without this valuable *Herschel* collection my labors would have encountered increased difficulty.

4. The Harmonic Law affords an Experimentum Crucis as to the Nature of Magnetism.

(i) The aether stress arising under the harmonic law gives forces directed towards the nearer pole.

If we examine the second member of the equation for the harmonic law connecting the total intensity of the earth's magnetism with terrestrial gravitation, namely:

$$I/g = \eta^2 (r^2/s^2 + r'^2/s'^2) \quad (66)$$

we perceive that at the magnetic equator the two terms are exactly equal, while as we approach either pole, the term becomes largest for the pole which is nearest, while the other term vanishes. This equation therefore represents a stress in the aether in the form of an unbalanced tension.

At the magnetic equator the two oppositely directed stresses exactly balance. Accordingly at this place there is no force, because the balanced tension acts in the tangent, and therefore is precisely parallel to the axis of the magnet. Likewise at any other point of the magnetic line of force the tension is in the direction of the tangent, yet on either side of the magnetic equator the term corresponding to the remoter pole decreases, while that directed to the nearer pole increases. And as the stress therefore is no longer exactly balanced, that directed to the nearer pole becomes predominant. It is this outstanding unbalanced stress which appears as a force directed to the nearer pole, along the curved line s or s' as the case may be.

This is the most remarkable physical characteristic of magnetism, and heretofore it has not been well understood. The theory of the action of a magnet upon a unit pole is essentially defective and misleading. For if one pole, say austral, is presented, it tends to move one way along the line of magnetic force; while if the opposite pole, say the boreal, is presented, it tends to move the other way along the magnetic lines of force.

Now in nature there is no such thing as the separation of the two poles. As pointed out in AN 5079, p. 247, one pole cannot exist and act separately, any more than one side of the human body. However short be the pieces into which a magnet is broken, the two poles still persist, even to dust-like or molecular dimensions. Hence the conclusion that magnetism is a property inherent in the molecules or atoms.

About the year 1820 the celebrated French physicist *Ampère* reached the conclusion from the action of galvanic currents in producing artificial magnets that magnetism consisted essentially in the circulation of elementary electric currents about the atoms. A very similar view was taken by *Gauss* (*Allgemeine Theorie des Erdmagnetismus*, 1838, p. 49; *Gauss Werke* 5.168) who reasons as follows:

»In unserer Theorie ist angenommen, daß in jedem meßbaren magnetisierten Teile des Erdkörpers genau eben so viel positives wie negatives Fluidum enthalten sei. Hätten die magnetischen Flüssigkeiten gar keine Realität, sondern wären sie nur ein fingiertes Substitut für galvanische Ströme in den kleinsten Teilen der Erde, so ist jene Gleichheit schon von selbst an die Befugnis zu dieser Substitution geknüpft; legt man hingegen den magnetischen Flüssigkeiten wirkliche Realität bei, so könnte man ohne Ungereimtheit die vollkommene Gleichheit der Quantitäten beider Flüssig-

keiten in Zweifel ziehen. In Beziehung auf einzelne magnetische Körper (natürliche oder künstliche Magnete) ließe sich die Frage, ob in ihnen ein merklicher Überschuß der einen oder der andern Flüssigkeit enthalten sei, oder nicht, leicht durch sehr scharfe Versuche entscheiden, da im erstern Falle ein mit einem solchen Körper belasteter Lotfaden eine Abweichung von der vertikalen Lage zeigen müßte (und zwar in der Richtung des magnetischen Meridians). Wenn dergleichen Versuche, mit vielen künstlichen Magneten in einem von Eisen hinlänglich entfernten Lokale angestellt, niemals die geringste Abweichung zeigen sollten (wie wohl zu vermuten steht), so würde allerdings jene Gleichheit auch für die ganze Erde mit größter Wahrscheinlichkeit anzunehmen sein, immer aber doch die Möglichkeit einiger Ungleichheit noch nicht ganz ausgeschlossen.«

In the *Electr. Wave-Theory of Phys. Forc.*, vol. I, 1917, p. 20, and AN 5079, pp. 261-262, it is clearly shown that *Ampère's* theory of galvanic currents about the atoms, — to which *Gauss* strongly inclines in the above passage, — is identical with the wave-theory. Thus the two theories are one and the same. The existence of electric currents about the atoms implies waves emitted by the atoms which are flat in the planes of their equators. It is waves propagated from the wire bearing a galvanic current that calls forth the magnetic property in iron, steel, nickel or other substances subjected to such action.

Thus by the demonstrated identity of effects the wave-theory has the sanction of *Ampère* and *Gauss*, though it was not developed in their time, nor stated in the way which has developed since the memorable triumph of the undulatory theory under the analysis of *Fourier* and *Poisson*.

(ii) At either pole of the earth, the magnet stands vertical, because the tension to the other pole along the line s or s' vanishes.

By an examination of the above equation (66) we perceive that near the north pole of the earth, the line of force s' running away to the other pole is of infinite length, and the term depending on r^2/s'^2 therefore vanishes. A corresponding result happens at the south pole of our globe, where the term depending on r^2/s^2 disappears, owing to the infinite distance to the north pole along the curved line s .

In fact this property of magnets, by which the lines of the earth's magnetic force at the poles become very straight — corresponding to a very flat field — offers very serious practical difficulty to polar explorers. As far back as Feb. 17, 1841, difficulty was experienced by Sir *James Ross*, when he attempted to judge from the observed dip of $88^\circ 40'$ how far away the southern magnetic pole would be. His observations showed that the direction of the dip from the vertical was only $80'$, ordinarily corresponding to 80 miles, yet he estimated the distance to the pole as about 160 nautical miles — multiplying the normal change of dip by two.

When *Shackleton's* party — Dr. *Mackay*, Professor *David*, Sir *Douglas Mawson* — approached the south magnetic pole in 1909, they found that the dip changed very slowly, — evidently owing to the flatness of the magnetic field — and they were nearly at the end of their vital resources before they came near the region of the pole. On the evening of

Jan. 15, 1909, the dip was observed to be $89^{\circ}48'$, and Sir *Douglas Mawson*, at that time somewhat inexperienced, estimated that the pole was distant only 12 or 13 miles. On Jan. 16, they reached the estimated spot, by forced marches, yet the point of verticity probably was still quite a distance away, for reasons which now seem fairly obvious.

For in 1912, Sir *Douglas Mawson* again sought to reach the pole from Commonwealth Bay, on the other side (Home of the Blizzard, 2 vols., Lippincott, Phil., 1914), and found by measurement that when he was at dip $89^{\circ}43'5$, only $16'5$ from the vertical, the rate of change was so slow that he had to travel three or four nautical miles to effect a change of a single minute in the dip. Thus in this last effort he did not reach the south magnetic pole, but got only within an estimated distance of some 50 or 60 miles of it. Probably it was near *Gauss'* calculated place, two or three times this distance.

It is a curious fact that *Gauss'* calculated position of the pole lies almost half way between the positions attained by *Mawson* in 1909, and 1912, as shown on the map given in plate 3, from *Shackleton's* report on the Geology of the Antarctic. Hence in view of *Mawson's* experience of 1912, when the magnetic field was found to be so very flat that he had to go three or four nautical miles to effect a change in the dip of only a single minute, I believe the southern magnetic pole has not yet been attained by any explorer.

It would appear to be very near the position assigned by *Gauss'* profound theory, namely: $72^{\circ}35'$ south latitude, $152^{\circ}30'$ east longitude. The *Shackleton* party in 1909 got within about 80 miles of this site, and *Mawson* in 1912 was within about 130 miles of it; yet the untraversed south magnetic polar area of elliptical form, with centre near *Gauss'* position, was still at least 160 miles long and about 100 miles wide. The centre of this elliptical area has never yet been explored, and thus *Gauss'* calculated position still is in a veritable Terra Incognita.

Returning now to the above formula for the harmonic law, we see that the lines of magnetic force at the poles become excessively straight and parallel. And hence, just as two parallel lines meet only at infinity, so also the returning branch of a very straight closed line can reach the other pole only by traversing an infinite distance in its circuit.

Accordingly, it is true that at the poles of a magnet the conjugate term in the harmonic law becomes rigorously zero. The magnetic attraction on the vertical needle therefore is wholly downward, and the curved line s or s' to the pole becomes rigorously a right line, as assumed in the foregoing theory, for calculating the depths of the poles below the earth's surface. This mathematical method for locating the depth of the poles in the earth is therefore entirely rigorous; and the only uncertainty which can arise is from some physical modification of magnetic wave action, such as the absorption studied by *Majorana* at Turin, 1919, in his researches on the absorption of gravitation (cf. Phil. Mag., May, 1920).

(iii) Photographic illustration of the directions of the forces exerted in magnetism.

In view of the considerable confusion of thought on the subject now prevalent it is very important to have a convincing demonstration of the true nature of magnetism.

Thus it appears well to illustrate an easy experiment by a photograph admitting of accurate reproduction.

1. We suspend by threads four small magnetic needles, and so space them about the large magnet as shown in fig. 1, plate 2. It will be seen from the photograph that in all cases the magnet exerts a very sensible pull on the small needles. They are therefore bodily drawn away from the vertical as shown in the photograph here reproduced.

2. The statement so often made that a magnet exerts only a directive action on a magnetic needle, therefore, is not generally true. In the case of the earth, with the poles almost infinitely distant, the action is indeed mainly directive; yet there is always a slight bodily pull on the needle, northward in our hemisphere, and southward in the southern hemisphere.

3. With the photograph of the effect of the forces acting on the four needles, herewith reproduced in fig. 1, plate 2, our theory of the nature of magnetism is completely demonstrated. The argument underlying the harmonic law is seen to be a fact. It is impossible to claim that a similar theory ever before was proposed by any other investigator. And as the wave-theory now is definitely proved for the first time it would appear that *Helmholtz* was not far wrong when he said that our failure to discover the cause of magnetism was the disgrace of the 19th century.

4. It seems likely that the cause never could have been discovered by reasoning based on the theory of the action on a unit north pole — a half magnet! when no such thing exists in nature! — and hence I have examined the problem from the ground up. In the unpublished Preliminary Paper which I sent to the Royal Society in 1914, it was shown conclusively that a needle suspended by a thread is bodily attracted to a wire bearing a steady galvanic current, the ponderomotive force being

$$F = \mu' \pi i (1/r + 1/r') \quad (67)$$

as shown in section 12 (ii) below.

The treatises on physics, indeed, give no clear statement as to what happens in this case. They simply evade the difficulty cleverly, and sometimes vaguely. Even *Maxwell* declared in his address on Action at a Distance (Scient. Pap., vol. 2, p. 317), that »the most obvious deduction from this new fact (*Oersted's* experiment) was that the action of the current on the magnet was not a push-and-pull force, but a rotatory force, and accordingly many minds were set a speculating on vortices and streams of aether whirling round the current.«

5. Just before making this amazing announcement, showing that he had never tried the experiment which I carried out in 1914, *Maxwell* in this address said:

»We have now arrived at the great discovery by *Oersted* of the connection between electricity and magnetism. *Oersted* found that an electric current acts on a magnetic pole, but that it neither attracts nor repels it, but causes it to revolve round the current. He expresses this by saying that 'the electric conflict acts in a revolving manner'«

6. Evidently the great *Maxwell* believed that the magnet is not bodily attracted to a wire bearing a current. An error authorized by so eminent an authority as *Maxwell*

The values which I use are slightly different from those employed by *Gauss* eighty four years ago. With my constants the value of N comes out:

$$\begin{aligned} N &= 8454.457 \cdot 10^{18} \\ &= 8454457000000000000000. \end{aligned} \quad (76)$$

To explain the significance of this immense number of magnets for the entire earth, *Gauss* remarks that in order to obtain a substitute for the action of the globe in outer space, we should have to assume, under uniform distribution with parallel magnetic axes, nearly eight such magnets to each cubic metre of the earth's mass (more exactly 7.831).

Such a result, $8.454457 \cdot 10^{21}$ one-pound magnets, everywhere with parallel magnetic axes, is impressive enough an illustration of the magnetism of our globe; yet for the sun the number of such one pound magnets would be enormously greater. In fact the magnetic part of the sun is $1/157$ of the whole, and since the sun is 330000 more massive than the earth, this is equivalent to 2102 times the total mass of our globe.

Accordingly for the sun we should have the higher number:

$$\begin{aligned} N &= 8.454457 \cdot 10^{21} \cdot 2102 = 17.77127 \cdot 10^{24} \\ &= 17771270000000000000000000. \end{aligned} \quad (77)$$

To convey a clear idea of this effect we may imagine our earth to have the property of perfect magnetism. Then if all its particles were reduced to magnetic bars with parallel axes, it would require 2102 such perfect magnetic globes, like this hypothetical substitute for the earth, when uniformly distributed throughout the sun's mass, to give the magnetic field which actually surrounds our sun and acts on the planets as they revolve in their orbits.

Since the solar magnetic field is rendered variable by the outbursts of sunspots, with their increased emission of magnetic waves, we need not be surprised at the earth currents (really eddy currents) 'Magnetic Storms' and Aurorae observed upon our globe.

5. Investigation of the Supposed Motion of the Magnetic Poles in the Earth.

(i) Sir *James Clark Ross*' attempts to reach the south magnetic pole, 1841.

In order to obtain a clear view of the supposed motion of the magnetic poles in the solid globe of the earth, we must first review the locations assigned to the poles by leading explorers at different epochs. We shall then be able to judge if there is evidence of a progressive motion of the poles, and, if so, to fix its character as accurately as possible.

On June 1, 1831, the north magnetic pole was located by Sir *James Ross* in $70^{\circ}5'$ North Latitude, $263^{\circ}14'$ East Longitude, where the dip was observed to be $89^{\circ}59'$. This observation no doubt was as accurate as could be expected, but since the north magnetic pole does not seem to have been located by actual observation at any later period, we have no observational data to enable us to judge of its supposed motion since 1831.

We shall therefore first examine the problem of the supposed motion of the south magnetic pole, where approximate data are furnished by Sir *James Ross*' observations of

1841, and by Sir *Douglas Mawson*'s observations of 1909 and 1912. The south magnetic pole is the more instructive also because of the way *Gauss*' calculated position fits in with the recently observed places.

On February 17, 1841, Sir *James Ross* discovered Cape Gauss, near $76^{\circ}12'$ South Latitude, 164° East Longitude. Here the vertical walls of ice stopped the westward cruise of the *Erebus* and *Terror*; but from measures taken on the ice he observed the dip to be $88^{\circ}40'$, or $80'$ from magnetic verticity, »so that the pole was only 160 miles distant«.

The place of *Ross*' ship is indicated on the accompanying map (plate 3); and as he found the variation there to be $109^{\circ}24'$ east, I have accurately charted his calculated position of the south magnetic pole, at this nearest approach to it. The places commonly assigned to *Ross*' estimate of the place of the pole, frequently are so inexact that it is necessary to exercise caution, to avoid being misled. Thus in the article *Polar Regions*, *Encycl. Brit.*, 9th ed., 1885, vol. 19, p. 330, it is stated that »the south magnetic pole was calculated to be in 76° S. and $145^{\circ}20'$ E., or about 500 miles southwest from the ship's position«. There is no good authority for this statement, and it cannot be correct. The place laid down on the accompanying map is from *Ross*' observations, and he expressly declares that »the pole was only 160 miles distant«.

Ross believed the pole to be in the snow capped mountains, slightly to the north of west from his position, and as the summits were over 10000 feet high, he could behold from the sea the range of mountains in which the pole is placed, and yet he could not reach it, owing to the indefinitely extended vertical walls of ice.

In his account he adds: »The range of mountains in the extreme west, which, if they be of an equal elevation with Mount *Erebus*, were not less than fifty leagues distant (150 nautical miles), and therefore undoubtedly the seat of the southern magnetic pole, was distinguished by the name of His Royal Highness, Prince *Albert*.«

It is worthy of notice that *Ross* seems to have been aware of the flatness of the earth's field, near the magnetic pole; for when the dip is only $80'$ from verticity, he estimates the pole to be distant 160 miles — so that twice as many miles would have to be traversed to produce the required change of dip. This same problem arises with Sir *Douglas Mawson*, 1912, as shown below, but it was not given much attention in the dash for the magnetic pole made Jan. 16, 1909.

(ii) Sir *Douglas Mawson*'s search for the south magnetic pole, 1909.

1. In *Shackleton's Heart of the Antarctic* (2 vols., Lippincott, Phila., 1909) a detailed account is given of the search for the south magnetic pole. The *Shackleton* party seems to have believed that the pole was in rapid movement. Thus on p. 383, they say:

»In the interval between 1841, when these observations were made, and 1902, when the *Discovery Expedition* again located the south magnetic pole, it had moved about two hundred geographical miles to the eastward.«

2. This statement as to the motion of the pole since 1841 must be received with great reserve for the following reasons:

a) On p. 177 it is stated in the record for Jan. 12, 1909, that on carefully analysing the results of the advance copy of the Discovery Expedition Magnetic Report, Mr. *Mawson* decided that »the magnetic pole, instead of moving easterly, as it had done in the interval between *Sabine's* observations in 1841, and the time of the Discovery Expedition in 1902, was likely now to be traveling somewhat to the northwest«. This was of course on the supposition that the pole moves quite rapidly. Such reasoning, however, was not justified, because the pole had never yet been accurately located.

b) On Jan. 15, *Mawson* got a good latitude observation, $72^{\circ}42'$, and twenty minutes before noon found by the dip circle that the dip was $89^{\circ}45'$, so that they had at length approached very near to the south magnetic pole. That evening the dip was again found to be $89^{\circ}48'$, the day's march having been 14 miles. Having calculated that the pole was not over 13 miles away, they rested till early next morning. Thus they made an early start for the spot fixed upon for the pole, $72^{\circ}25'$ South Latitude, $155^{\circ}16'$ East Longitude, and reached it by great effort at 3^h 30^m p. m., — guiding their course by vertical marks erected every two miles or so, as they traveled, the compass now being useless, on account of the great proximity to the pole.

3. Owing to the extreme weariness of the party and their shortage of food they took no further observations, merely raising the British Flag, and taking possession of the plateau about the pole, and retracing their steps with all haste to the little depot where the dip was $89^{\circ}48'$, which they reached at 10^h p. m. (p. 182). On Jan. 15, *Mawson* estimated (p. 180) that »in order to accurately locate the mean position (of the pole) possibly a month of continuous observation would be needed, but that the position he indicated was now as close as he could locate it.«

The dash to the pole place fixed upon by the apparent rapid change in the dip was thus all that was attempted. Apparently they did not even count the number of oscillations of the needle in 10 minutes, which would have given a measure of the total intensity at the pole, and been valuable scientific data. The journey had, however, proved to be much longer than had been expected, which again emphasizes the flatness of the magnetic field near the pole.

In 1841 *Ross* had taken the distance to be two miles to a single minute of change in the dip. By actual journey the *Shackleton* party found the distance there and back at least 500 miles. If we take the single distance at 240 miles on a great circle, the change of 80' in the dip from *Ross'* place in 1841, would imply an average multiplication by three miles for each minute of the change in dip. The distance, however, from *Ross'* place at the sea to the actual pole probably was about 320 miles, which would make the average multiplier of the change of dip four instead of three.

(iii) The expedition to the south magnetic pole, by *Mawson*, *Bage* and *Webb*, from Commonwealth Bay, 1912.

In the Home of the Blizzard (Lippincott, Phila., 1914, 2 vols.) we find a detailed account of the approach to the

south magnetic pole from the other side, the base being in Commonwealth Bay. The following is a brief summary of the chief measurements of dip, and other phenomena noted.

On Nov. 10, 1912, the party started for the south magnetic pole, the journey being mainly to the south, and slightly to the east. On Nov. 20, the dip was $87^{\circ}27'$, requiring a change of 153' to reach the pole; but by Nov. 27, the dip had changed to $88^{\circ}54'$, yet as the change was somewhat sudden it was thought to be »too large«, (p. 287), — perhaps the reading should have been $88^{\circ}24'$. The dip continued to decrease slowly, and on Dec. 3, it was steady at $88^{\circ}30'$ — a result showing that the above value for Nov. 27 was an error.

As the party sped on they seemed to find the dip nearly stationary for a time, $89^{\circ}11'$, — what it had been since leaving the station at 150 miles. Sixty five miles more appeared to yield little change in the dip. On Dec. 17 they passed 70° south latitude — making about 14 miles a day, and the dip was found to be $89^{\circ}25'$. On Dec. 19, the dip was $89^{\circ}35'$, and at 256 miles the altitude of the plateau was 5600 feet, while on Dec. 21, their sledge-meter showed 301 miles.

On page 296 *Bage* describes the difficulties of making accurate observations:

»Magnetic work under these conditions is an extremely uncomfortable operation. Even a light wind will eddy round the break-wind, and it is wind which makes low temperatures formidable. Nearly all the work has to be done with bare fingers or thin instrument-gloves, and the time taken is far greater than in temperate climates, owing to the fingers constantly 'going' and because of the necessity of continually freeing the instrument from the condensed moisture of the breath. Considering that the temperature was -12° F. when he had finished his four hours' work, it may be imagined that *Webb* was ready for his hot tea. The dip proved to be $89^{\circ}43.5'$, that is: sixteen and half minutes from the vertical. The altitude was just over five thousand nine hundred feet, in latitude $70^{\circ}36.5'$ south and longitude $148^{\circ}10'$ east.«

The party was now within 175 miles of where *David*, *Mawson* and *Mackay* had stopped in 1909. They had to turn back after getting within 16.5 of the 90° dip at the pole. *Bage's* diary says:

»We have now been exactly six weeks on the tramp and somehow feel rather sad at turning back, even though it has not been quite a Sunday school picnic all along. It is a great disappointment not to see a dip of 90° , but the time is too short with this 'climate'. It was higher than we expected to get, after the unsatisfactory dips obtained near the two-hundred-mile depot. The rate of increase since that spot has been fairly uniform and indicates that 90° might be reached in another fifty to sixty miles, if the same rate held, and that means at least another week. It's no good thinking about it, for 'orders are orders'. We 'll have our work cut out to get back as it is. Twenty-five days till we are overdue. Certainly we have twenty-three days' food, eight days' with us, ten days' at two hundred miles, and five days' at sixty-seven miles; so with luck we should not go hungry, but *Webb* wants to get five more full sets of dips if possible on the way back, and this means two and a half days.«

This southward journey of *Mawson's* party from Commonwealth Bay is full of instruction, like that of the *Shackleton* party from Ross Sea in 1909. In both explorations the observers found the pole with 90° dip was much further away than they had at first expected. This was due to the extreme flatness of the magnetic field near the pole.

(iv) True place of the south magnetic pole probably is within 30 miles of the position calculated by *Gauss*, 1838.

After some study of the effect of the increasing flatness of the magnetic field, as we near the pole, I have ventured to construct a table of distances from the pole, with changing rate of increase for a given increment of dip ($\Delta\theta = 3'$) towards the magnetic pole.

This table may not be complete, but it is very instructive, as affording a simple means of harmonizing the conflicting estimates of the observers who have tried to locate the pole from opposite sides. It seems to show that the true pole is very near the point located by *Gauss* in 1838, and almost certainly not over 30 miles away.

Number of circle about magnetic pole i	Differences of dip from the pole $\Delta\theta_i - \Delta\theta_{i+1}$	$m_i =$ multiplier for 1' of dip to give equivalent distance in naut. miles.	$m_i(\Delta\theta_i - \Delta\theta_{i+1}) =$ radial width of circles in naut. miles.
1	16'5 - 12'	4	18
2	12 - 9	5	15
3	9 - 6	6	18
4	6 - 3	7	21
5	3 - 0	8	24

$$\sum_{i=1}^{i=5} m_i(\Delta\theta_i - \Delta\theta_{i+1}) = 96 \text{ miles}$$

Estimated total distance of *Mawson's* party in 1912 from pole = 106 miles
 Estimated distance of *Shackleton's* party of 1909 from pole = 70 miles.

In fact it is about 70 miles northwest of the furthest point reached by *Shackleton's* party in 1909, and about 105 miles southeast of where *Mawson's* party halted in 1912. The star on the map shows where we locate the south magnetic pole, after a careful study of all the evidence furnished by the parties of *Shackleton* and *Mawson*.

This very accurate confirmation of the position of the south magnetic pole indicated by *Gauss* in 1838, is well calculated to impress us with the rigor of the method of calculation used by that great mathematician. Observation has not yet been able to improve on the results of the mathematical calculations made before any explorer had visited the Antarctic Continent!

Gauss' method rests on 24 constants, and thus requires measures of the three independent magnetic elements of dip, declination and total intensity, at eight places of observation. The method does not require observations in the southern hemisphere, yet the more symmetrically the stations are distributed about the earth the better. Above all, great accuracy is required in the magnetic measurements, and as *Gauss* was a great master in this line of research, very little improvement has ever been made on his original constants of 1838.

(v) Is there any evidence of the motion of the earth's magnetic poles?

This is a question which has been long debated, yet from the above analysis of the evidence it would seem as if motion is not definitely proved. Before making the above careful analysis of the records I had inclined to the impression of a counter-clockwise rotation of the south magnetic pole, about the *Gaussian* position (M) of the Maximum Magnetic Moment for the earth. But in this early survey of the data I had relied upon the pole being not over 160 miles from the position of *Ross's* ship *Erebus*, Feb. 17, 1841. We have seen above that *Ross* held the pole to be distant only 160 miles, yet in so doing he took the multiplier for converting changes of dip into nautical miles to be only 2, whereas the above table based upon *Mawson's* observational experience showed that the average multiplier for *Ross's* distance should have been at least 3, perhaps 4.

We find in the records of *Shackleton's* party, 1909, abundant evidence of a current view that the magnetic pole is near the coast, and even moving eastward! As they travel inland they are surprised at the slowness of the change of dip, and conclude that it has suddenly moved westward. As a matter of fact they had not sufficiently allowed for the flatness of the field very near the pole. And these errors of reckoning were not only current among the explorers, but are also repeated in the article *Terrestrial Magnetism*, *Encycl. Brit.*, 11th ed., by such a scientific authority as Dr. *Charles Chree*, director of the Kew Observatory.

Dr. *Chree* points out that *Sabine's* Chart (1841) gave for the south magnetic pole 73° 30' South Latitude, 147° 30' East Longitude. He says Professor *J. C. Adams* in his researches reached the coordinates 73° 40' S., and 147° 7' E. *Chree* then gives the following table as a summary of the chief data.

(A) Southern Cross Expedition,	72° 40' S.,	152° 30' E.
(B) The Voyage of the »Discovery»,		
1902-3	72 51 S.,	156 25 E.
(C) <i>Shackleton's</i> Expedition, 1908-9	72 25 S.,	155 16 E.

In conclusion Dr. *Chree* thinks »there is at least moderate probability that a considerable movement towards the north-east has taken place during the last seventy years.«

Unfortunately for Dr. *Chree's* argument we see from the foregoing investigation that there is not the slightest evidence of any such motion. If any motion at all is shown, it is to the westward. For *Gauss'* theoretical determination of the position of the pole is our only trustworthy guide. It is valid for the epoch 1830, and the observational work of 1909 and 1912 show the pole still so very near *Gauss'* original position that we cannot be sure that any motion at all has occurred in the intervening 80 years. The star (*) on the map is the most probable place indicated by the available observations, yet being only about 3' from the pole of *Gauss* or 25 miles, we can not safely conclude that any motion at all has occurred. Under the most favorable conditions *Gauss'* calculated place may be uncertain by 2'; and at least 1' of uncertainty always exists in the observations of 1909 and 1912, because of the difficulty in setting and reading the dip circle accurately while traveling in so severe a climate.

If the southern magnetic pole gives little or no evidence of motion in 80 years, it would be natural to hold that the north magnetic pole is correspondingly fixed. Unfortunately the observational evidence is even more incomplete than that for the south pole. When only 30 years of age Sir *James Ross* was in the icefields with his uncle Sir *John Ross*, and as they could only move some eight miles in two years, yet they were near the north magnetic pole, the young man in sheer desperation finally got ashore and having found the dip to be $89^{\circ} 59'$ located the pole June 1, 1831, at

$$70^{\circ} 5' 17'' \text{ N, } 263^{\circ} 13' 15'' \text{ E.}$$

So far as I can learn no other explorer ever was able to reach the north magnetic pole. The Norwegian expedition of 1905-07, under *Roald Amundsen*, was to search for this spot, but although he traversed the Northwest Passage and came to San Francisco, with his vessel, and I conversed with him at Mare Island, I never heard of his being near the north magnetic pole. Probably the ice blocked the way in the channels to the south, as it did with the *Rosses* in 1831, and *Amundsen* had to steer a more northerly course. Accordingly it appears that Sir *James Ross* alone attained the north magnetic pole or got within 10 miles of it. The only other indications of value are drawn from *Gauss'* theory; but even here a contradiction arises, probably from a systematic bias at some unknown source.

For *Gauss* himself calculated the north magnetic pole to be at $73^{\circ} 35' \text{ N, } 264^{\circ} 21' \text{ E}$. Longitude, which was $3^{\circ} 5'$ from *Ross'* observed latitude. This considerable difference proved puzzling to *Gauss*, who says, (p. 44):

»Nach *Ross's* Beobachtung fällt der nördliche magnetische Pol um $3^{\circ} 30'$ südlicher als nach unserer Rechnung, und letztere gibt, wie aus unsrer Vergleichungstafel ersichtlich ist, eine um $1^{\circ} 12'$ fehlerhafte Richtung der magnetischen Kraft an jenem Platze. Beim südlichen magnetischen Pole wird man eine bedeutend größere Verschiebung zu erwarten haben. Da in Hobarttown, als dem demselben am nächsten liegenden Beobachtungsorte, die berechnete Inklination, ohne Rücksicht auf das Zeichen, von der Rechnung um $3^{\circ} 38'$ zu klein angegeben wird, insofern man sich auf die Beobachtungen verlassen kann, so wird der wirkliche südliche magnetische Pol wahrscheinlich bedeutend nördlicher liegen als ihn unsere Rechnung angibt, und möchte derselbe etwa in der Gegend von 66° Breite und 146° Länge zu suchen sein.«

Accordingly it appears that in view of the observed difference at the north magnetic pole, *Gauss* was in doubt of the accuracy of the calculated place of the south magnetic pole; yet observations over 70 years later verified the true place of the south pole to be very near that assigned by the great mathematician.

As Dr. *Chree* has recently discussed the problem of the motion of the north magnetic pole from another point of view, we shall quote his summary in the *Encycl. Brit.*, article *Terrestrial Magnetism*, 11th ed., 1911, page 382:

»Table XLV, Axis and Moment of First Order *Gaussian* Coefficients.

Epoch	Authority	N. Lat.	W. Long.	M/R^3 in cgs. units.
1650	<i>H. Fritsche</i>	$82^{\circ} 50'$	$42^{\circ} 55'$	0.3260
1836	»	78 27	63 35	0.3260
1845	<i>F. C. Adams</i>	78 44	64 20	0.3282
1880	»	78 24	68 4	0.3234
1885	<i>Neumayer, Peterson, Bauer</i>	78 3	67 3	0.3230
1885	<i>Neumayer, Schmidt</i>	78 34	68 31	0.3230

»49. The first order *Gaussian* constants have a simple physical meaning. The terms containing them represent the potential arising from the uniform magnetization of a sphere parallel to a fixed axis, the moment M of the spherical magnet being given by

$$M = R^3 [(g_1^0)^2 + (g_1^1)^2 + (h_1^1)^2]^{1/2}$$

where R is the earth's radius. The position of the north end of the axis of this uniform magnetization and the values of M/R^3 derived from the more important determinations of the *Gaussian* constants are given in Table XLV. The data for 1650 are of somewhat doubtful value. If they were as reliable as the others, one would feel greater confidence in the reality of the apparent movement of the north end of the axis from east to west. The table also suggests a slight diminution in M since 1845, but it is open to doubt whether the apparent change exceeds the probable error in the calculated values.«

Accordingly, it thus appears that Dr. *Chree* is very doubtful of the supposed motion of the north magnetic pole to the westward.

Yet reasoning on the basis of the observed secular motion of the magnetic meridians, *Airy* remarks in his *Treatise on Magnetism*, 1870, p. 53:

»The system of magnetic meridians has undergone considerable changes in the times of modern accurate science. The southern point of Africa received from the Portuguese voyagers in the fifteenth century the name of *L'Agulhas* (the needle), because the direction of the compass-needle, or the local magnetic meridian, coincided there with the geographical meridian: it now makes with it an angle of about 30° . In the sixteenth century, the compass-needle in Britain pointed east of north: it now points from 20° to 30° (in different parts of the British isles) west of north. At the present time, a change of the opposite character is going on: in 1819 the westerly declination at Greenwich was about $24^{\circ} 23'$, which was probably its maximum; in the last thirty years it has diminished from $23^{\circ} 5'$ to 20° , nearly. It is believed that the magnetic poles are rotating around the geographical poles from east to west.«

Great and impressive as are the surface changes here pointed out by *Airy*, it can scarcely be held that any regular cyclical motion of the magnetic poles are in progress. This could not be so and leave either pole fixed in its place, as we have shown is true of the south magnetic pole. Nor, on the other hand, can we adopt the hypothesis of motion and assign to the south magnetic pole a cycle of oscillation enabling it to present the same position in 1910 as 1830. We are thus forced to admit the most extensive secular motions of the magnetic meridians, yet compelled at the same

time to deny any sensible motion of the magnetic poles in the solid globe of the earth.

The only way we could account for such a motion of the magnetic meridians without motion of the poles would be to assign the meridional shifts to superficial effects, perhaps due to Eddy-Currents in the globe, like those disturbances which manifest themselves chiefly in Earth Currents and Aurorae, and depend on the action of the sun and moon as explained hereafter. Perhaps the periodicity of the secular changes and their differences in local surface areas of the globe, could be explained by the mutual interactions of the various segments of the earth under the incessant magnetic disturbances of the heavenly bodies, especially the sun and moon.

Under the influence of cosmically induced eddy currents, depending on the sun and moon, and the sunspot cycle with its suddenly varying magnetic field, there could arise not only the uncompensated electric disturbances, and their varying dissipation, with auroral displays in the atmosphere of the higher latitudes, but also, from the way these disturbances are reflected and compensated within a globe so heterogeneous as our earth, a mass of progressive secular oscillations in the magnetic field near the surface. This is the most probable explanation of the secular changes in the earth's magnetism: for we must not regard our globe as one homogeneous mass, but a series of masses acting on each other mutually, and all under changing action depending on the sun, moon and sunspot cycles.

6. Theory of the Earth's Magnetic Moment, with Gauss' Explanation of his Method of Calculation.

(i) The constant part of the earth's magnetism depends on internal causes, and its potential may be developed in a convergent series of spherical harmonics.

It has long been recognized that the earth's magnetism may be separated into two parts:

1. A constant part, depending on internal causes, namely plane magnetic waves emitted from the atoms so lined up as to have their equatorial planes parallel to a common plane.

2. A periodic part, depending on fluctuating magnetic disturbances due to the sun, moon, and sunspot changes.

Let H denote the horizontal component of the magnetic force at any point of the earth's field; then the force usually is resolved into the components:

$$\begin{aligned} \text{Towards the north, } X &= H \cos \delta = -1/r \cdot \partial \Omega / \partial u \\ \text{Towards the west, } Y &= H \sin \delta = -1/(r \sin u) \cdot \partial \Omega / \partial \lambda \\ \text{Vertically downward, } Z &= H \operatorname{tg} \delta = \partial \Omega / \partial r \end{aligned} \quad (78)$$

where δ = the magnetic declination; θ = angle of the dip; and Ω = the potential due to the earth's field at a point of polar distance u and longitude λ , distant r from the centre of the globe.

If α , β , γ be the components of the magnetic force at any point (x, y, z) , we shall have

$$\begin{aligned} \Omega &= - \int \frac{1}{\rho} \cdot d\mu \\ \rho &= \{r^2 - 2r r_0 [\cos u \cos u_0 + \sin u \sin u_0 \cos(\lambda - \lambda_0)] + \\ &\quad + r_0^2\}^{1/2} \end{aligned} \quad (79)$$

$$\begin{aligned} \Omega &= - \int_{-\infty}^{x,y,z} (\alpha dx + \beta dy + \gamma dz) = \\ &= \int_{-\infty}^{x,y,z} (\partial \Omega / \partial x \cdot dx + \partial \Omega / \partial y \cdot dy + \partial \Omega / \partial z \cdot dz) \end{aligned} \quad (80)$$

in which Ω fulfills Laplace's equation for every point of free space:

$$\partial^2 \Omega / \partial x^2 + \partial^2 \Omega / \partial y^2 + \partial^2 \Omega / \partial z^2 = 0$$

or in polar coordinates (r, u, λ) :

$$\begin{aligned} \frac{1}{r^2} \cdot \partial(r^2 \cdot \partial \Omega / \partial r) / \partial r + \frac{1}{r^2 \sin u} \cdot \partial(\sin u \cdot \partial \Omega / \partial u) / \partial u + \\ + \frac{1}{r^2 \sin^2 u} \cdot \partial^2 \Omega / \partial \lambda^2 = 0. \end{aligned} \quad (81)$$

Therefore the potential of the earth's field may be expanded in convergent series of the form:

$$\Omega = (S_1/r^2 + S_2/r^3 + S_3/r^4 + \dots) + S'_0 + S'_1 r + S'_2 r^2 + S'_3 r^3 + \dots \quad (82)$$

in which $S_1, S_2, S_3 \dots S'_0, S'_1, S'_2, S'_3 \dots$ are surface harmonics of the degree indicated by the subscripts.

Since the surface harmonic S_n can be expanded in the form

$$S_n = \sum P_n^m(\cos u) (A_{n,m} \cos m \lambda + B_{n,m} \sin m \lambda) \quad (83)$$

we have

$$\begin{aligned} \Omega = \sum_{n=0}^{\infty} \sum_{m=0}^{m=n} \{ P_n^m(\cos u) (A_{n,m} \cos m \lambda + B_{n,m} \sin m \lambda) \\ + r^n P_n^m(\cos u) (A_{n,m} \cos m \lambda + B_{n,m} \sin m \lambda) \} \end{aligned} \quad (84)$$

The latter series, depending on periodic planetary influences outside of the earth, usually is separated from the other, because it is very small, and in fact was not included in Gauss' theory for the non-periodic part of the earth's magnetism. Thus we have for the principal development of the magnetic potential:

$$\begin{aligned} \Omega = S_1/r^2 + S_2/r^3 + S_3/r^4 + \dots \\ = \sum_{n=1}^{\infty} \sum_{m=0}^{m=n} \left\{ \frac{P_n^m(\cos u)}{r^{n+1}} (A_{n,m} \cos m \lambda + B_{n,m} \sin m \lambda) \right\} \end{aligned} \quad (85)$$

If we ignore all the harmonics beyond the first, we obtain:

$$\begin{aligned} \Omega = 1/r^2 \cdot \{ A_{1,0} P_1(\cos u) + P_1^1(\cos u) \times \\ \times (A_{1,1} \cos \lambda + B_{1,1} \sin \lambda) \} \end{aligned} \quad (86)$$

$$\begin{aligned} = 1/r^2 \cdot \{ 0.3157 \cos u + \sin u \times \\ \times (0.0248 \cos \lambda - 0.0603 \sin \lambda) \}. \end{aligned} \quad (87)$$

This last expression is a biaxial harmonic of order unity, (cf. *J. H. Jeans*, *Mathematical Theory of Electricity and Magnetism*, 3rd ed., 1915, p. 403), and is easily shown to be equal to $0.3224 \cos \chi$, where χ is the angular distance of the point (u, λ) from the pole of a uniformly magnetized sphere with axis through

$$\begin{aligned} \text{Lat. } 78^\circ 20' \text{ N., and Long. } 67^\circ 17' \text{ W.} \\ u = 11^\circ 40' \quad , \quad \lambda = 292^\circ 43' \end{aligned} \quad (88)$$

as discussed by *Chree*, near the end of section 5 above.

Accordingly the potential is

$$\Omega = 0.3224 \cos \chi / r^2 \quad (89)$$

which is the potential of a uniformly magnetized sphere having as direction of magnetization the radius through the point

defined in equation (88). It is sometimes defined as equivalent to the potential of a single magnetic particle of appropriate magnetic mass at the centre of the earth, yet with the axis of the magnetic particle pointing in this same direction.

(ii) The calculation of the magnetic moment of a magnet explained more in detail.

In all the older theories it was recognized that in a magnet we have to imagine as much negative as positive magnetism, so that, as *Gauss* expressed it $\int d\mu = 0$, when the integral is extended throughout the whole body. We shall now examine the basis of this reasoning.

Let μ be a small quantity of magnetism, f the resultant magnetic force at the point (x, y, z) , then the magnetic force exerted on a quantity μ of magnetism concentrated there is μf . Now for a whole magnet $\int d\mu = 0$, and in order to fulfill this condition for the opposite magnetisms we have:

$$\Sigma\mu = -\Sigma\mu'. \quad (90)$$

Let N be the centre of mass of the positive, S the centre of mass of the negative magnetism characteristic of the two poles of the magnet; then obviously the coordinates of N and S are:

$$\begin{aligned} \bar{x} &= \Sigma\mu x / \Sigma\mu, & \bar{y} &= \Sigma\mu y / \Sigma\mu, & \bar{z} &= \Sigma\mu z / \Sigma\mu; \\ \bar{x}' &= \Sigma\mu' x' / \Sigma\mu', & \bar{y}' &= \Sigma\mu' y' / \Sigma\mu', & \bar{z}' &= \Sigma\mu' z' / \Sigma\mu'. \end{aligned} \quad (91)$$

Now if l be the distance between N and S , whose coordinates are given in (91), we have:

$$l = [(\bar{x} - \bar{x}')^2 + (\bar{y} - \bar{y}')^2 + (\bar{z} - \bar{z}')^2]^{1/2}. \quad (92)$$

Then, there is a certain constant in the theory of a magnet, known as the magnetic moment, which we shall call K :

$$K = l\Sigma\mu = -l\Sigma\mu'. \quad (93)$$

The magnetic moment therefore is equal to the product of the length between the two poles by the amount of magnetism at either pole. If the magnet be placed in a uniform field, and the axis of the line NS makes the angle χ with the strength f , a directed magnitude defining the field, the whole couple becomes:

$$f \cdot (\Sigma\mu^{1/2} l - \Sigma\mu'^{1/2} l) \sin \chi = f \Sigma\mu l \sin \chi. \quad (94)$$

It follows from the definition in (93) that the magnetic moment is a positive magnitude $K = l\Sigma\mu$, and since $l = NS$, the pole is the centre of mass of the magnetic forces, just as the centre of oscillation gives the centre of gravity for the gravitative forces at work in the motion of a compound pendulum, of length l .

Now let ξ, η, ζ be the direction cosines of the magnetic axis of any element $dv = dx dy dz$ of a magnet, and \mathcal{F} such a quantity that $\mathcal{F} dv$ is the magnetic moment of the element: then \mathcal{F} is the intensity of magnetization, at the point (x, y, z) , where the element $dv = dx dy dz$ is taken, and we have

$$\mathcal{F}\xi = A \quad \mathcal{F}\eta = B \quad \mathcal{F}\zeta = C \quad (95)$$

\mathcal{F} being a vector or directed magnitude, tangential to the line of magnetization, and A, B, C the ideal equivalent magnets with axes parallel to the coordinate axes.

If p, q, r be the direction cosines of the axis of the whole magnet, we have

$$\begin{aligned} p &= (\Sigma\mu x / \Sigma\mu - \Sigma\mu' x' / \Sigma\mu') \cdot 1/l = \Sigma[l\mu \cdot (x - x') / l] / (l \Sigma\mu) \\ &= \Sigma \delta K \xi / K = \Sigma \mathcal{F} \xi dv / K = \Sigma A dv / K. \end{aligned} \quad (96)$$

Upon integration for the volume $dv = dx dy dz$, we may therefore write:

$$\begin{aligned} K &= 1/p \cdot \iiint A dx dy dz = 1/q \cdot \iiint B dx dy dz \\ &= 1/r \cdot \iiint C dx dy dz. \end{aligned} \quad (97)$$

The condition that K should be a maximum for a body like the earth evidently is that $R = (A^2 + B^2 + C^2)^{1/2}$ should be a maximum. Hence we rotate the axes to such a position that $\delta R = 0$, or

$$\delta K = \delta \iiint (A^2 + B^2 + C^2)^{1/2} dx dy dz = 0 \quad (98)$$

as explained in the following calculation.

(iii) *Gauss'* calculation of the magnetic moment of the earth.

In the 31st section of his *Allgemeine Theorie Gauss* proceeds to calculate the magnetic moment of the earth. He first remarks that it would be a misconception to attribute any significance to the mere surface location of the poles, or the chord joining them, if one were to call this line the magnetic axis of the earth.

»The one way«, says *Gauss*, »in which we can give the conception of the magnetic axis of a body a general validity is that set forth in article 5 of the »Intensitas Vis Magneticae«, according to which we understand a straight line, in respect to which the moment of the free magnetism contained in the body is a maximum. To determine the position of the magnetic axis of the earth in this sense and at the same time the moment of the earth's magnetism in respect to the same, as already remarked above in art. 17, we require only a knowledge of the terms of the first order. According to our elements in art. 26, we have:

$$\begin{aligned} P' &= +925.782 \cos u + 89.024 \sin u \cos \lambda + \\ &\quad - 178.744 \sin u \sin \lambda \end{aligned} \quad (99)$$

in which $-925.782 R^3, -89.024 R^3, +178.744 R^3$ are the moments of the earth's magnetism in respect to the earth's axis, and the two earth-radii for the longitude 0° and 90° . By the earth's axis we are to understand the direction to the north pole, and the negative sign of the corresponding moment indicates that the magnetic axis makes an obtuse angle with it, that the magnetic north pole is turned to the south. The direction of the magnetic axis resulting from this is parallel to the diameter of the earth at $77^\circ 50'$ north latitude, $296^\circ 29'$ longitude (east), $77^\circ 50'$ south latitude, $116^\circ 29'$ longitude (east), and the magnetic moment in respect to the same $= 947.08 R^3$.

»In respect to this last result, we are to remember, that our elements are based upon a unit of intensity which is a thousandth part of that commonly used. In order to make the reduction to the absolute unit established in the *Intensitas Vis Magneticae*, we remark that in the latter the horizontal intensity of Göttingen, 1834, July 19, was found $= 1.7748$, from which with the inclination $68^\circ 1'$ the total intensity $= 4.7414$ follows, whereas by the above unit this was taken to be $= 1357$. The reduction factor is therefore $= 0.0034941$, and consequently the magnetic moment of the earth in absolute units

$$= 3.3092 R^3. \quad (100)$$

»In this absolute unit for the terrestrial magnetic force the millimetre is taken as the unit of length, and therefore R must also be expressed in millimetres, whereby — since the ellipticity of the earth is entirely neglected — it is sufficient to consider R as the radius of a circle whose circumference amounts to 40000 million millimetres. According to this, the above magnetic moment is expressed by a number whose logarithm = 29.93136 or by 853800 quadrillions. According to the same absolute unit the magnetic moment of one of the sensitive magnetic bars experimented upon in 1832 (*Intensitas*, Art. 21) is = 100877000; and the magnetic moment of the earth is therefore 8464 trillion times larger.«

»Therefore 8464 trillion such magnetic bars, with parallel axes, would be required to replace the magnetic action of the earth in outer space; which in a uniform distribution throughout the whole bodily space of the earth would amount to nearly eight bars (more exactly 7.831) to each cubic metre.«

(iv) The fractional part of the earth which is magnetic found to be $\eta = 1/1404.674$.

The above analysis discloses how *Gauss* reached his celebrated result, that 7.831 parallel saturated steel bar magnets, each weighing one German pound, all of them 3.9155 kilograms, would be required in each cubic metre of the earth's mass to give externally the magnetic field actually observed at the surface of our globe.

After arriving at this striking practical result *Gauss* continues:

»When so stated, this result still retains its meaning even if we do not consider the earth a real magnet, but would ascribe terrestrial magnetism merely to purely galvanic streams in the earth. If, however, we consider the earth a real magnet, we are compelled to ascribe to each part of the same, which is one eighth cubic metre in size, on the average at least¹⁾, a magnetization quite as powerful as that bar contains, — a result indeed which will be unexpected by the physicist.«

In section 17 *Gauss* gives the following explanation of the analysis by which the above value of V is calculated:

»We choose r for the distance to the centre of the earth, and u for the angle which r makes with the northern part of the earth's axis, while λ denotes the angle of the plane through r and the earth's axis and a fixed meridian, reckoned positive to the east. Let V be a function developed in a series proceeding according to powers of r , which we give the following form:

$$V = R^2 P^0 / r + R^3 P^1 / r^2 + R^4 P^2 / r^3 + R^5 P^3 / r^4 + \text{etc.} \quad (101)$$

The coefficients P^0, P^1, P^2 , etc., are here functions of u and λ ; in order to discern how they depend on the internal distribution of the magnetic fluid in the interior of the earth, let $d\mu$ be an element of this magnetic fluid, q its distance from O , and for $d\mu$ let r_0, u_0, λ_0 , denote the same which r, u, λ , are for O . We have therefore expanded

$$V = - \int 1/q \cdot d\mu \quad (102)$$

through all $d\mu$. Furthermore

$$q = \{r^2 - 2rr_0 [\cos u \cos u_0 + \sin u \sin u_0 \cos(\lambda - \lambda_0)] + r_0^2\}^{1/2} \quad (103)$$

and if we develop $1/q$ in a series:

$$1/q = 1/r \cdot (T^0 + T^1 r_0 / r + T^2 r_0^2 / r^2 + \text{etc.}) \quad (104)$$

we have

$$R^2 P^0 = - \int T^0 d\mu, \\ R^3 P^1 = - \int T^1 r_0 d\mu, \quad R^4 P^2 = - \int T^2 r_0^2 d\mu. \quad (105)$$

»Since $T^0 = 1$, it will follow by means of the fundamental assumption, that the mass of the positive and negative fluid in each measurable part of its conductor, and therefore in the whole earth, is equally large, or that

$$\int d\mu = 0, \\ P^0 = 0; \quad (106)$$

or the first term of our series for V falls away. We see further, that P^1 has the form

$$R^3 P^1 = \alpha \cos u + \beta \sin u \cos \lambda + \gamma \sin u \sin \lambda \\ \alpha = - \int r_0 \cos u_0 d\mu \\ \beta = - \int r_0 \sin u_0 \cos \lambda_0 d\mu \\ \gamma = - \int r_0 \sin u_0 \sin \lambda_0 d\mu. \quad (107)$$

»Thus, according to the explanation in Art. 5 of the *Intensitas Vis Magneticae*, $-\alpha, -\beta, -\gamma$ are the moments of the terrestrial magnetism in respect to three rectangular axes, of which the first is the earth's axis, the second and third are the equatorial radii for the longitude 0° and 90° .«

»The general formulae for all coefficients of the series for $1/q$ we may assume as known; for our purpose it is merely necessary to remark that in respect to u and λ the coefficients are rational integral functions of $\cos u, \sin u \cos \lambda, \sin u \sin \lambda$, and T'' of the second order, T''' of the third order, etc. The same holds therefore also for the coefficients P^2, P^3 , etc. The series for $1/q$ and for V converge, so long as r is not smaller than R , or rather, not smaller than the radius of a sphere which encloses the whole of the magnetic parts of the earth.«

We have already remarked that in his treatment of magnetism, *Gauss* takes the action to be in right lines, whereas in nature the lines of magnetic force are curved. The corrections for this defect will be considered hereafter.

The above is the process of reasoning by which *Gauss* derives 7.831 parallel bar magnets each weighing a German pound, all of them 3.9155 kg for each cubic metre of the globe of the average weight = 5500 kg, and hence the mass component with the properties of a vector which I was led to deduce becomes

$$\eta = 3.9155 / 5500 = 1/1404.674. \quad (108)$$

Hence taking account of *Laplace's* law of density, we get the value finally adopted, namely:

$$\eta = 1/1408.12.$$

(v) Calculation of the fractional part of the earth which is magnetic, on the simple hypothesis that on the average the magnetism in the different spherical shells is proportional to the density of the matter in these shells.

Profound as is the analysis underlying *Gauss's* theory of the earth's magnetism, there remains in the theory one

¹⁾ »Insofar as we are not obliged to assume, in all magnetic parts of the earth, parallel magnetic axes throughout. The more such parallelism fails, the stronger must be the average magnetization of the parts, in order to bring forth the total magnetic moment.«

unnecessary element of weakness, which can be removed; and as the correction conforms to *Gauss'* mathematical criteria, yet brings the analysis of the theory down to a better physical basis, it is worthy of careful attention.

In section 32 of the *Allgemeine Theorie Gauss* says that the manner of the actual distribution of the magnetic fluid in the earth remains necessarily indeterminate; and then proceeds to point out that instead of any arbitrary distribution of the magnetic fluid within, we may always substitute a superficial distribution of magnetism which will give exactly the same effect in external space. This results from *Poisson's* theorem on the volume and surface distribution of magnetism (*Memoires de l'Institut* tome 5, 1822). Wherefore *Gauss* concludes that a given action in external space may result from an indefinite number of different distributions of the magnetic fluid within.

From a purely mathematical point of view, this theorem is valid, yet from a physical point of view it fails entirely, because we know that in magnetism, as in gravitation, the forces acting around attracting bodies, depend on the matter within them, not upon their surfaces, or any mere mathematical abstraction.

Thus the one fatal weakness of the Theory of Relativity arose from the absurd claim that »Gravity is not a force, but a property of space« (*de Sitter*, MN 76, 1916, p. 702). Such a view is wholly untenable, because the force of gravity is proportional to the mass, and acts in right lines towards it: therefore gravity is a force depending on matter, and directly proportional to the amount of it gathered into the central attracting body, and in no sense is a property of space. Physically such claims are absurd!

In the same way, we know very well that magnetism depends on the atoms within the magnet, which have magnetic properties. For example, leaving out of account a slight change due to mere form of the bar, if we double the number of such atoms, by taking a magnet of double the mass, we practically double the intensity of the magnetic force in the field about it. Thus magnetism depends upon matter: it is a physical force!

From these considerations we see that whilst the mathematical possibility exists of a given action in external space resulting from many different mathematical distributions of the magnetism within, there is no such physical possibility. And as magnetism is a physical phenomenon, we are restricted in our choices of magnetic distribution to those which are consistent with the possible distribution of the matter. This leads to the physical theory that the magnetism of the earth depends on the density of the concentric spherical shells of which the globe is made up.

Accordingly, in the preceding section we have developed a criterion for reducing *Gauss'* infinite number of possible solutions for the distribution of the magnetism within the earth to a unique solution, with the density of the magnetic fluid everywhere proportional to the density of the matter within the earth. As *Gauss* took the distribution of the magnetism to be uniform in the evaluation above given, 7.831 one-pound bar magnets to each cubic metre of matter, whatever be its density, it seems advisable to consider the effect of the increase of density towards the centre, and

relative decrease of density near the surface, according to *Laplace's* law.

The magnetic moment found by *Gauss* can be adapted to this condition by the following process of calculation. The integral for the mass in any spherical layer of the globe of radius q is (cf. AN 3992, p. 127):

$$\int_a^b dm = 4\pi \int_a^b q^2 d\sigma_0 \cdot \sin(qx) \cdot qx \quad x = q/r$$

$$dq = r dx \quad (109)$$

And the total mass M

$$M = (4\pi r^3 \sigma_0 / q) \int_0^x \sin(qx) dx$$

$$= (4\pi r^3 \sigma_0 / q^3) \cdot \{ \sin(qx) - qx \cos(qx) \} \quad (110)$$

where x is the fraction of the earth's radius, $x = q/r$.

In our present problem it suffices to use a numerical ratio

$$N = [1 / (\sigma_1 r^3)] \sum_{i=0}^{i=1} \sigma_i (r_i^3 - r_{i-1}^3) \quad (111)$$

where the volumes of the shells $\frac{4}{3}\pi (r_i^3 - r_{i-1}^3)$ are easily calculated, and the density σ_i is already determined (c. f. AN 3992).

For it is not known that *Laplace's* law is rigorously true, and owing to the improvements which may ultimately be possible in the elements of *Gauss'* theory; attempts at extreme refinement are not justifiable. Accordingly we use the following table:

r_i	σ_i	$\frac{1}{2}(\sigma_i + \sigma_{i-1})$	$r_i^3 - r_{i-1}^3$	$\frac{1}{2}(\sigma_i + \sigma_{i-1}) \cdot (r_i^3 - r_{i-1}^3)$
10	2.55	3.15	271	853.66
9	3.75	4.37	217	948.29
8	4.99	5.60	169	946.40
7	6.21	6.80	127	863.60
6	7.38	7.92	91	720.72
5	8.46	8.93	61	544.73
4	9.40	9.76	37	361.12
3	10.12	10.43	19	198.17
2	10.74	10.90	7	76.30
1	11.07	11.14	1	11.14
0	11.215			

$$\sum_{i=0}^{i=10} = 5524.13$$

As the mean density of the earth is $\sigma_1 = 5.5$, $r = 10$, we have $\sigma_1 r^3 = 5500$; and the numerical reduction factor is

$$N = 5524.13 / 5500 = 1.004387 \quad (112)$$

Dividing the value 7.831 by this number we find that the average number of one-pound magnets required to produce the observed magnetism of the earth, if they were everywhere so distributed as to be proportional to the density of the matter, is

$$7.831 / 1.004387 = 7.7968 \quad (113)$$

The fractional part of the earth's mass which would be magnetic, under the hypothesis that the density of the magnets is everywhere proportional to the density of the matter, thus proves to be, as in equation (48):

$$\eta = 1 / 1410.837 \quad (114)$$

Hence for the reasons assigned in deriving (49) we use $\eta = 1 / 1408.12$.

As the connection between magnetism and gravitation was discovered from an extension of the researches of Gauss, we have, for the sake of uniformity, adhered closely to his constants. Yet it may be that at some future time values slightly different from those now in use may come to be preferred. For example, if $\eta = 1/1414.213 = 1/\sqrt{2000000}$, which involves only a slight change, then we should have:

$$I/g = 1/2000000, \text{ at the magnetic equator,} \quad (115)$$

$$I/g = 1/1000000, \text{ at the poles.}$$

These round numbers are accurate enough for all practical purposes, and are easily remembered. They conform rigorously to Biot's law of 1816, which represents the larger phenomena of the earth's magnetism disclosed by Humboldt's law of 1804. The harmonic law, it should be noted, gives a physical basis for the laws of Humboldt and Biot, which heretofore has been wanting, and thus will prove extremely useful to investigators.

7. Outlines of Gauss' General Theory of the Earth's Magnetism.

We have seen, that Gauss takes r to denote the distance of any element of magnetism $d\mu$ from the centre of the earth, while u denotes the angle between r and the earth's north polar axis, and λ the angle, (reckoned positive to the east), between the plane containing r and the earth's axis and a fixed meridian. Thus let r_0, u_0, λ_0 be coordinates of the element $d\mu$ in the globe, r, u, λ those of a point considered as lying anywhere in space: then the radius vector connecting them is defined by the relation

$$q^2 = r^2 - 2rr_0 [\cos u \cos u_0 + \sin u \sin u_0 \cos(\lambda - \lambda_0)] + r_0^2. \quad (116)$$

And for the potential we have the integral:

$$\Omega = - \int \{r^2 - 2rr_0 [\cos u \cos u_0 + \sin u \sin u_0 \cos(\lambda - \lambda_0)] + r_0^2\}^{-1/2} d\mu \quad (117)$$

for the elements of magnetism $d\mu$ throughout the globe. This expression for Ω may be expanded into a converging series of solid spherical harmonics, involving sines and cosines of u and λ , and the ratio between the radius of the earth (R) and that of the external point (r).

We shall now enter at some length into Gauss' Allgemeine Theorie des Erdmagnetismus, 1838, because without this outline of Gauss' work, it will be difficult to interpret his results or to recognize their bearing upon the present problem of the law connecting magnetism with gravitation.

In the measurement of magnetic fluid Gauss takes as unit the quantity of boreal fluid, which, acting on a similar quantity of the same kind of fluid, at assumed unit distance, exerts a moving force equal to unity. If μ be the mass of fluid, at the distance q , the magnetic force exerted is taken to be:

$$f = \pm \mu/q^2 \quad (118)$$

repulsive or attractive, in the direction of the line q , according as μ is positive or negative.

Putting $d\mu$ for the mass of the magnetic fluid in any differential element dx, dy, dz , we have:

$$\Omega = - \int I/q \cdot d\mu = - \iiint I/q \cdot \sigma dx dy dz \quad (119)$$

and the components of the earth's total magnetic force I , making the angle θ with any plane become:

$$\xi = \partial\Omega/\partial x \quad \eta = \partial\Omega/\partial y \quad \zeta = \partial\Omega/\partial z$$

$$I = [\xi^2 + \eta^2 + \zeta^2]^{1/2}$$

$$d\Omega = \partial\Omega/\partial x \cdot dx + \partial\Omega/\partial y \cdot dy + \partial\Omega/\partial z \cdot dz$$

$$= \xi dx + \eta dy + \zeta dz = I \cos \theta ds. \quad (120)$$

Accordingly, the basis of the general theory is the equations:

$$X = -1/R \cdot \partial\Omega/\partial u$$

$$Y = -1/(R \sin u) \cdot \partial\Omega/\partial \lambda$$

$$Z = -\partial\Omega/\partial R. \quad (121)$$

Then it follows that the magnetic potential Ω may be expanded:

$$\Omega = R(P_0 \cdot R/r + P_1 \cdot R^2/r^2 + P_2 \cdot R^3/r^3 + P_3 \cdot R^4/r^4 + \dots). \quad (122)$$

The functions P_0, P_1, P_2 etc. are spherical surface harmonics, of degree indicated by the subscripts, depending on the angles u and λ , which will be more fully explained below.

If therefore we extend the integration through all elements of the magnetic fluid, we shall have:

$$\Omega = - \int I/q \cdot d\mu$$

$$= - \int \{r^2 - 2rr_0 [\cos u \cos u_0 + \sin u \sin u_0 \cos(\lambda - \lambda_0)] + r_0^2\}^{-1/2} \cdot d\mu \quad (123)$$

where

$$q^2 = r^2 - 2rr_0 \cos(r, r_0) + r_0^2$$

$$\cos(r, r_0) = \cos u \cos u_0 + \sin u \sin u_0 \cos(\lambda - \lambda_0) \quad (124)$$

and thus

$$\Omega = \int_0^r \int_0^\pi \int_0^{2\pi} \{r^2 - 2rr_0 [\cos u \cos u_0 + \sin u \sin u_0 \cos(\lambda - \lambda_0)] + r_0^2\}^{-1/2} \cdot \sigma dr \cdot r \sin u du \cdot r \sin u d\lambda. \quad (125)$$

As the development of this function depends on $1/q$, we may put:

$$1/q = 1/r \cdot (T_0 + T_1 \cdot r_0/r + T_2 \cdot r_0^2/r^2 + T_3 \cdot r_0^3/r^3 + \dots) \quad (126)$$

Wherefore, since $\Omega = - \int I/q \cdot d\mu$, we have from equations (122), (123), (126)

$$P_0 \cdot R^2/r + P_1 \cdot R^3/r^2 + P_2 \cdot R^4/r^3 + \dots = - \{1/r \cdot \int T_0 d\mu + 1/r^2 \cdot \int T_1 r_0 d\mu + 1/r^3 \cdot \int T_2 r_0^2 d\mu + \dots\} \quad (127)$$

Equating like powers of r in this identify, we have:

$$P_0 R^2 = - \int T_0 d\mu \quad P_3 R^5 = - \int T_3 r_0^3 d\mu$$

$$P_1 R^3 = - \int T_1 r_0 d\mu \quad P_4 R^6 = - \int T_4 r_0^4 d\mu \quad (128)$$

$$P_2 R^4 = - \int T_2 r_0^2 d\mu \quad \text{etc.}$$

By Gauss' fundamental assumption the mass of positive and negative magnetic fluid in every part of the earth is of equal magnitude, and thus also in the whole globe; so that we have

$$\int d\mu = 0. \quad (129)$$

Therefore, since the function $T_0 = 1$, the equation $P_0 = -1/R^2 \cdot \int T_0 d\mu$, leads to the result

$$P_0 = 0. \quad (130)$$

And the series becomes

$$P_1 \cdot R^3/r^2 + P_2 \cdot R^4/r^3 + P_3 \cdot R^5/r^4 + P_4 \cdot R^6/r^5 + \dots =$$

$$= - \{1/r^2 \cdot \int T_1 r_0 d\mu + 1/r^3 \cdot \int T_2 r_0^2 d\mu + 1/r^4 \cdot \int T_3 r_0^3 d\mu + \dots\} \quad (131)$$

$$P_1 R^3 = - \int T_1 r_0 d\mu \quad P_2 R^4 = - \int T_2 r_0^2 d\mu$$

$$P_3 R^5 = - \int T_3 r_0^3 d\mu \quad P_4 R^6 = - \int T_4 r_0^4 d\mu \quad (132)$$

The first equation yields:

$$P_1 R^3 = -\int T_1 r_0 d\mu = \alpha \cos u + \beta \sin u \cos \lambda + \gamma \sin u \sin \lambda$$

$$\begin{aligned} \text{where} \quad \alpha &= -\int r_0 \cos u_0 d\mu \\ \beta &= -\int r_0 \sin u_0 \cos \lambda_0 d\mu \\ \gamma &= -\int r_0 \sin u_0 \sin \lambda_0 d\mu. \end{aligned} \quad (133)$$

The coefficients $-\alpha$, $-\beta$, $-\gamma$ are explained by *Gauss*, in § 15 of his investigation *Intensitas Vis Magneticae*, as moments of the earth's magnetism, in respect to the three rectangular coordinate axes; the first being in respect to the earth's axis, and the two latter in respect to equatorial radii for longitudes $\lambda_0 = 0^\circ$, $\lambda_0 = 90^\circ$.

$$r \cdot \partial^2(r \Omega) / \partial r^2 + \partial^2 \Omega / \partial u^2 + \text{ctg } u \cdot \partial \Omega / \partial u + 1 / \sin^2 u \cdot \partial^2 \Omega / \partial \lambda^2 = 0. \quad (135)$$

The former expressions for the components of the magnetic force now become

$$\text{north,} \quad X = -1/r \cdot \partial \Omega / \partial u = -R^3/r^3 \{ \partial P_1 / \partial u + R/r \cdot \partial P_2 / \partial u + R^2/r^2 \cdot \partial P_3 / \partial u + \dots \} \quad (136)$$

$$\text{west,} \quad Y = -1/(r \sin u) \cdot \partial \Omega / \partial \lambda = -R^3/(r^3 \sin u) \cdot \{ \partial P_1 / \partial \lambda + R/r \cdot \partial P_2 / \partial \lambda + R^2/r^2 \cdot \partial P_3 / \partial \lambda + \dots \} \quad (137)$$

$$\text{downward,} \quad Z = -\partial \Omega / \partial r = R^3/r^3 \cdot \{ 2P_1 + 3R P_2/r + 4R^2 P_3/r^2 + \dots \}. \quad (138)$$

For points at the surface of the earth, $r = R$, and these expressions may be written

$$X = -\{ \partial P_1 / \partial u + \partial P_2 / \partial u + \partial P_3 / \partial u + \dots \} \quad (139)$$

$$Y = -1/\sin u \cdot \{ \partial P_1 / \partial \lambda + \partial P_2 / \partial \lambda + \partial P_3 / \partial \lambda + \dots \} \quad (140)$$

$$Z = 2P_1 + 3P_2 + 4P_3 + \dots \quad (141)$$

After deriving these expressions *Gauss* remarks that if we combine with these equations the well known theorem that every function of λ and u which has a definite finite value for all values of λ from 0° to 360° , and for u from 0° to 180° , can be developed in a series of the form $P_0 + P_1 + P_2 + P_3 + \dots$ etc;

of which the general term P_n satisfies *Laplace's* differential equation, that such a development is possible in only one definite way. Proceeding in this way *Gauss* is led to four theorems of which the following is the most remarkable:

1. The knowledge of the value of Ω in all points of the earth's surface suffices for deriving the general expression of Ω for the whole infinite space external to the earth's surface, and thereby the determination of the forces X , Y , Z , not only on the earth's surface, but also for the whole infinite space outside of it. To this end it suffices to develop Ω/R in a series, as shown hereafter.

The coefficient P_n satisfies the partial differential equation

$$n(n+1)P_n + \partial^2 P_n / \partial u^2 + \text{ctg } u \cdot \partial P_n / \partial u + 1/\sin^2 u \cdot \partial^2 P_n / \partial \lambda^2 = 0. \quad (142)$$

If we designate by $P_{n,m}$ the following function of u only:

$$P_{n,m} = \left\{ \cos^{n-m} u - \frac{(n-m)(n-m-1)}{2(2n-1)} \cos^{n-m-2} u + \frac{(n-m)(n-m-1)(n-m-2)(n-m-3)}{2 \cdot 4(2n-1)(2n-3)} \cos^{n-m-4} u - \text{etc.} \right\} \sin^m u \quad (143)$$

it follows that P_n has the form of an aggregate of $2n+1$ parts, as follows:

$$P_n = g_{n,0} P_{n,0} + (g_{n,1} \cos \lambda + h_{n,1} \sin \lambda) P_{n,1} + (g_{n,2} \cos 2\lambda + h_{n,2} \sin 2\lambda) P_{n,2} + \dots + (g_{n,n} \cos n\lambda + h_{n,n} \sin n\lambda) P_{n,n} \quad (144)$$

where $g_{n,0}$, $g_{n,1}$, $h_{n,1}$, $g_{n,2}$, $h_{n,2}$, etc., are definite numerical coefficients, of which the table calculated by *Gauss* is given below.

From this general formula it follows that P_1 has 3 indeterminate coefficients, P_2 has 5; P_3 , 7; P_4 , 9; the full expressions being:

$$\begin{aligned} P_1 &= g_{1,0} + (g_{1,1} \cos \lambda + h_{1,1} \sin \lambda) P_{1,1} \\ P_2 &= g_{2,0} P_{2,0} + (g_{2,1} \cos \lambda + h_{2,1} \sin \lambda) P_{2,1} + (g_{2,2} \cos 2\lambda + h_{2,2} \sin 2\lambda) P_{2,2} \\ P_3 &= g_{3,0} P_{3,0} + (g_{3,1} \cos \lambda + h_{3,1} \sin \lambda) P_{3,1} + (g_{3,2} \cos 2\lambda + h_{3,2} \sin 2\lambda) P_{3,2} + (g_{3,3} \cos 3\lambda + h_{3,3} \sin 3\lambda) P_{3,3} \\ P_4 &= g_{4,0} P_{4,0} + (g_{4,1} \cos \lambda + h_{4,1} \sin \lambda) P_{4,1} + (g_{4,2} \cos 2\lambda + h_{4,2} \sin 2\lambda) P_{4,2} + (g_{4,3} \cos 3\lambda + h_{4,3} \sin 3\lambda) P_{4,3} + \\ &\quad + (g_{4,4} \cos 4\lambda + h_{4,4} \sin 4\lambda) P_{4,4}. \end{aligned} \quad (145)$$

Already, in section 22, p. 26, *Gauss* has considered the probable distribution of the magnetism of the globe in respect to the radius, remarking that the series would converge rapidly if it is concentrated towards the centre, but less rapidly if more diffuse and irregular in its distribution. He then adds, as shown above, that the coefficient P_1 has three coefficients; P_2 , five; P_3 , seven; P_4 , nine — making 24 constants for the

In the expansion of $1/\rho$, we need only remark that as respects u and λ , the coefficients are rational integral functions of $\cos u$, $\sin u \cos \lambda$, $\sin u \sin \lambda$; in the case of T_2 , they are of the second order; in the case of T_3 of the third order, etc. The same rule holds for P_2 , P_3 , etc.

The series for $1/\rho$, and Ω converge so long as r is not smaller than R , or the observed point is external to the surface of the earth, in which the magnetic fluid acts to develop magnetism.

The function of the magnetic potential Ω for the point O satisfies *Laplace's* equation:

$$\partial^2 \Omega / \partial x^2 + \partial^2 \Omega / \partial y^2 + \partial^2 \Omega / \partial z^2 = 0 \quad (134)$$

which may also be transformed into the spherical coordinates:

$$r \cdot \partial^2(r \Omega) / \partial r^2 + \partial^2 \Omega / \partial u^2 + \text{ctg } u \cdot \partial \Omega / \partial u + 1 / \sin^2 u \cdot \partial^2 \Omega / \partial \lambda^2 = 0. \quad (135)$$

$$\text{north,} \quad X = -1/r \cdot \partial \Omega / \partial u = -R^3/r^3 \{ \partial P_1 / \partial u + R/r \cdot \partial P_2 / \partial u + R^2/r^2 \cdot \partial P_3 / \partial u + \dots \} \quad (136)$$

$$\text{west,} \quad Y = -1/(r \sin u) \cdot \partial \Omega / \partial \lambda = -R^3/(r^3 \sin u) \cdot \{ \partial P_1 / \partial \lambda + R/r \cdot \partial P_2 / \partial \lambda + R^2/r^2 \cdot \partial P_3 / \partial \lambda + \dots \} \quad (137)$$

$$\text{downward,} \quad Z = -\partial \Omega / \partial r = R^3/r^3 \cdot \{ 2P_1 + 3R P_2/r + 4R^2 P_3/r^2 + \dots \}. \quad (138)$$

For points at the surface of the earth, $r = R$, and these expressions may be written

$$X = -\{ \partial P_1 / \partial u + \partial P_2 / \partial u + \partial P_3 / \partial u + \dots \} \quad (139)$$

$$Y = -1/\sin u \cdot \{ \partial P_1 / \partial \lambda + \partial P_2 / \partial \lambda + \partial P_3 / \partial \lambda + \dots \} \quad (140)$$

$$Z = 2P_1 + 3P_2 + 4P_3 + \dots \quad (141)$$

After deriving these expressions *Gauss* remarks that if we combine with these equations the well known theorem that every function of λ and u which has a definite finite value for all values of λ from 0° to 360° , and for u from 0° to 180° , can be developed in a series of the form $P_0 + P_1 + P_2 + P_3 + \dots$ etc;

of which the general term P_n satisfies *Laplace's* differential equation, that such a development is possible in only one definite way. Proceeding in this way *Gauss* is led to four theorems of which the following is the most remarkable:

1. The knowledge of the value of Ω in all points of the earth's surface suffices for deriving the general expression of Ω for the whole infinite space external to the earth's surface, and thereby the determination of the forces X , Y , Z , not only on the earth's surface, but also for the whole infinite space outside of it. To this end it suffices to develop Ω/R in a series, as shown hereafter.

The coefficient P_n satisfies the partial differential equation

$$n(n+1)P_n + \partial^2 P_n / \partial u^2 + \text{ctg } u \cdot \partial P_n / \partial u + 1/\sin^2 u \cdot \partial^2 P_n / \partial \lambda^2 = 0. \quad (142)$$

If we designate by $P_{n,m}$ the following function of u only:

$$P_{n,m} = \left\{ \cos^{n-m} u - \frac{(n-m)(n-m-1)}{2(2n-1)} \cos^{n-m-2} u + \frac{(n-m)(n-m-1)(n-m-2)(n-m-3)}{2 \cdot 4(2n-1)(2n-3)} \cos^{n-m-4} u - \text{etc.} \right\} \sin^m u \quad (143)$$

it follows that P_n has the form of an aggregate of $2n+1$ parts, as follows:

$$P_n = g_{n,0} P_{n,0} + (g_{n,1} \cos \lambda + h_{n,1} \sin \lambda) P_{n,1} + (g_{n,2} \cos 2\lambda + h_{n,2} \sin 2\lambda) P_{n,2} + \dots + (g_{n,n} \cos n\lambda + h_{n,n} \sin n\lambda) P_{n,n} \quad (144)$$

where $g_{n,0}$, $g_{n,1}$, $h_{n,1}$, $g_{n,2}$, $h_{n,2}$, etc., are definite numerical coefficients, of which the table calculated by *Gauss* is given below.

From this general formula it follows that P_1 has 3 indeterminate coefficients, P_2 has 5; P_3 , 7; P_4 , 9; the full expressions being:

$$\begin{aligned} P_1 &= g_{1,0} + (g_{1,1} \cos \lambda + h_{1,1} \sin \lambda) P_{1,1} \\ P_2 &= g_{2,0} P_{2,0} + (g_{2,1} \cos \lambda + h_{2,1} \sin \lambda) P_{2,1} + (g_{2,2} \cos 2\lambda + h_{2,2} \sin 2\lambda) P_{2,2} \\ P_3 &= g_{3,0} P_{3,0} + (g_{3,1} \cos \lambda + h_{3,1} \sin \lambda) P_{3,1} + (g_{3,2} \cos 2\lambda + h_{3,2} \sin 2\lambda) P_{3,2} + (g_{3,3} \cos 3\lambda + h_{3,3} \sin 3\lambda) P_{3,3} \\ P_4 &= g_{4,0} P_{4,0} + (g_{4,1} \cos \lambda + h_{4,1} \sin \lambda) P_{4,1} + (g_{4,2} \cos 2\lambda + h_{4,2} \sin 2\lambda) P_{4,2} + (g_{4,3} \cos 3\lambda + h_{4,3} \sin 3\lambda) P_{4,3} + \\ &\quad + (g_{4,4} \cos 4\lambda + h_{4,4} \sin 4\lambda) P_{4,4}. \end{aligned} \quad (145)$$

first four terms of the series. As each complete observation of X , Y , Z gives three constants, he adds that exact observations at eight places would be theoretically sufficient to determine all the coefficients for the general theory of the earth's magnetism. But in practice a larger number of observations are necessary; and he reduces his equations to the following form for points on parallel circles of latitude:

$$X = k + k' \cos \lambda + K' \sin \lambda + k'' \cos 2\lambda + K'' \sin 2\lambda + k''' \cos 3\lambda + K''' \sin 3\lambda + \text{etc.} \quad (146)$$

$$Y = l + l' \cos \lambda + L' \sin \lambda + l'' \cos 2\lambda + L'' \sin 2\lambda + l''' \cos 3\lambda + L''' \sin 3\lambda + \text{etc.} \quad (147)$$

$$Z = m + m' \cos \lambda + M' \sin \lambda + m'' \cos 2\lambda + M'' \sin 2\lambda + m''' \cos 3\lambda + M''' \sin 3\lambda + \text{etc.} \quad (148)$$

Here it is assumed that the eight points, separated by convenient arcs, lie upon a great circle; and *Gauss* notes that there will be as many values of $k, l, m, k', \text{etc.}$, as there are parallel circles adapted to this treatment. On each circle, according to theory $l = 0$, and from the values of l found by calculation we have a measure of the inadmissibility of the numbers adopted in the theory of any parallel.

The above expressions give for the coefficients the following equations:

$$k = -g_{1,0} \cdot dP_{1,0}/du - g_{2,0} \cdot dP_{2,0}/du + g_{3,0} \cdot dP_{3,0}/du + \text{etc.} \quad (149)$$

$$m = 2g_{1,0} P_{1,0} + 3g_{2,0} P_{2,0} + 4g_{3,0} P_{3,0} + \text{etc.}$$

the number being twice as great as that of the number of parallel circles. On substituting in $dP_{1,0}/du, dP_{2,0}/du, \text{etc.}$, and in $P_{1,0}, P_{2,0}, \text{etc.}$, the numerical values of u , the coefficients $g_{1,0}, g_{2,0}, g_{3,0}, \text{etc.}$, may be determined by the method of least squares.

In the same way we have for the determination of the coefficients $g_{1,1}, g_{2,1}, g_{3,1}, \text{etc.}$:

$$-k' = g_{1,1} \cdot dP_{1,1}/du + g_{2,1} \cdot dP_{2,1}/du + g_{3,1} \cdot dP_{3,1}/du + \text{etc.} \quad (150)$$

$$L' = g_{1,1} \cdot P_{1,1}/\sin u + g_{2,1} \cdot P_{2,1}/\sin u + g_{3,1} \cdot P_{3,1}/\sin u + \text{etc.}$$

$$m' = 2g_{1,1} P_{1,1} + 3g_{2,1} P_{2,1} + 4g_{3,1} P_{3,1} + \text{etc.}$$

the number of which is three times that of the parallel circles.

And likewise for the coefficients $h_{1,1}, h_{1,2}, h_{1,3}, \text{etc.}$:

$$-K' = h_{1,1} \cdot dP_{1,1}/du + h_{2,1} \cdot dP_{2,1}/du + h_{3,1} \cdot dP_{3,1}/du + \text{etc.} \quad (151)$$

$$-l' = h_{1,1} \cdot P_{1,1}/\sin u + h_{2,1} \cdot P_{2,1}/\sin u + h_{3,1} \cdot P_{3,1}/\sin u + \text{etc.}$$

$$M' = 2h_{1,1} P_{1,1} + 3h_{2,1} P_{2,1} + 4h_{3,1} P_{3,1} + \text{etc.}$$

In like manner we have for the determination of $g_{2,2}, g_{3,2}, g_{4,2}, \text{and } h_{2,2}, h_{3,2}, h_{4,2}, \text{the following equations:}$

$$-k'' = g_{2,2} \cdot dP_{2,2}/du + g_{3,2} \cdot dP_{3,2}/du + g_{4,2} \cdot dP_{4,2}/du + \text{etc.} \quad (152)$$

$$L'' = 2g_{2,2} \cdot P_{2,2}/\sin u + 2g_{3,2} \cdot P_{3,2}/\sin u + 2g_{4,2} \cdot P_{4,2}/\sin u + \text{etc.}$$

$$m'' = 3g_{2,2} P_{2,2} + 4g_{3,2} P_{3,2} + 5g_{4,2} P_{4,2} + \text{etc.}$$

$$-K'' = h_{2,2} \cdot dP_{2,2}/du + h_{3,2} \cdot dP_{3,2}/du + h_{4,2} \cdot dP_{4,2}/du + \text{etc.}$$

$$-l'' = h_{2,2} \cdot P_{2,2}/\sin u + h_{3,2} \cdot P_{3,2}/\sin u + h_{4,2} \cdot P_{4,2}/\sin u + \text{etc.}$$

$$M'' = 3h_{2,2} P_{2,2} + 4h_{3,2} P_{3,2} + 5h_{4,2} P_{4,2} + \text{etc.}$$

And so on, to higher orders of terms, as far as required.

Selecting the best data available in his time *Gauss* found for the 24 largest coefficients of g and h the following tabular values:

$g_{1,0} = +925.782$	$g_{2,2} = +0.493$
$g_{2,0} = -22.059$	$g_{3,2} = -73.193$
$g_{3,0} = -18.868$	$g_{4,2} = -45.791$
$g_{4,0} = -108.855$	$h_{2,2} = -39.010$
$g_{1,1} = +89.024$	$h_{3,2} = -22.766$
$g_{2,1} = -144.913$	$h_{4,2} = +42.573$
$g_{3,1} = +122.936$	$g_{3,3} = +1.396$
$g_{4,1} = -152.589$	$g_{4,3} = +19.774$
$h_{1,1} = -178.744$	$h_{3,3} = -18.750$
$h_{2,1} = -6.030$	$h_{4,3} = -0.178$
$h_{3,1} = +47.794$	$g_{4,4} = +4.127$
$h_{4,1} = +64.112$	$h_{4,4} = +3.175$

(153)

Gauss considers these coefficients as the Elements of the theory of the earth's magnetism; and thence collects his results into the following formula, putting for brevity e in place of $\cos u$, and f in place of $\sin u$:

$$\begin{aligned} \Omega/R = & -1.977 + 937.103e + 71.245e^2 - 18.868e^3 - 108.855e^4 \\ & + (64.437 - 79.518e + 122.936e^2 + 152.589e^3)f \cos \lambda \\ & + (-188.303 - 33.507e + 47.794e^2 + 64.112e^3)f \sin \lambda \\ & + (7.035 - 73.193e - 45.791e^2)f^2 \cos 2\lambda \\ & + (-45.092 - 22.766e - 42.573e^2)f^2 \sin 2\lambda \\ & + (1.396 + 19.774e)f^3 \cos 3\lambda \\ & + (-18.750 - 0.178e)f^3 \sin 3\lambda \\ & + 4.127f^4 \cos 4\lambda + 3.175f^4 \sin 4\lambda. \end{aligned} \quad (154)$$

For the magnetic poles of the globe *Gauss* finds:

1. North pole: North latitude $73^\circ 35'$
East longitude $264^\circ 21'$ from Greenwich
Total intensity $l = 1.701$, in ordinary units
 $\Omega/R = +895.86$. (155)
2. South pole: South latitude $72^\circ 35'$
East longitude $152^\circ 30'$
Total intensity $l' = 2.253$
 $\Omega/R = -1030.24$. (156)

Gauss remarks that Sir *James Ross* found the north magnetic pole $3^\circ 30'$ further south than is given by this calculation; and that at the south pole the deviation between theory and observation may be yet more considerable, owing to certain defects in the observations at Hobartown. He thinks the south magnetic pole probably lies appreciably further north than is given by the above calculation, and assigns south latitude 66° and east longitude 146° as its probable location.

It will be seen from the differences shown in the following table that *Gauss'* elements are comparatively very exact. In order to give to the mind a connected view of them, *Gauss* induced Dr. *Goldschmidt* to represent his results graphically. The excellence of the agreement is also shown by comparing these calculated charts with the recently observed charts.

Owing to the great importance of a correct understanding of the high accuracy of *Gauss'* theory, in the present investigation for connecting the magnetism of the earth with terrestrial gravitation, we reproduce a slightly modified form of *Gauss'* table for comparing his theory with observations throughout the globe. The table as here given has been condensed as much as possible, yet it is so impressive that it cannot fail to interest the modern reader.

Table of Gauss' theory as compared with observations, 1838.

Nr.	Place of Observation	Latitude	East Longitude	Total Magnetic Intensity			Decl. $\delta_0 - \delta_c$	Incl. or Dip $\theta_0 - \theta_c$
				I_0	I_c	$I_0 - I_c$		
1	Spitzbergen	+79° 50'	11° 40'	1.562	1.599	-0.037	-1°32	-0°83
2	Hammerfest	+70 40	23 46	1.506	1.545	-0.039	-1.55	-0.07
3	Jakutsk	+62 1	129 45	1.697	1.661	+0.036	+5.75	-0.30
4	Porotowsk	+62 1	131 50	1.721	1.658	+0.063	+4.70	-0.45
5	Nochinsk	+61 57	134 57	1.713	1.653	+0.060	+2.23	-0.58
6	Tschernoljes	+61 31	136 23	1.700	1.648	+0.052	+3.50	-0.66
7	Petersburg	+59 56	30 19	1.410	1.469	-0.059	-0.05	+0.63
8	Christiania	+59 54	10 44	1.419	1.456	-0.037	-0.08	+0.05
9	Ochotsk	+59 21	143 11	1.615	1.621	-0.006	+2.60	-0.92
10	Tobolsk	+58 11	68 16	1.557	1.575	-0.018	-3.17	+0.80
11	Tigil River	+58 1	158 15	1.577	1.583	-0.006	+0.23	-1.45
12	Sitka	+57 3	224 35	1.731	1.697	+0.034	+0.43	-0.65
13	Tara	+56 54	74 4	1.575	1.586	-0.011	-1.87	+0.70
14	Catherinenburg	+56 51	68 34	1.523	1.535	-0.012	-0.97	+0.87
15	Tomsk	+56 30	85 9	1.619	1.613	+0.006	-1.22	+0.37
16	Nishny Nowgorod	+56 19	43 57	1.442	1.469	-0.027	-1.62	+1.53
17	Krasnojarsk	+56 1	92 57	1.657	1.638	+0.019	-0.85	+0.60
18	Kasan	+55 48	49 7	1.433	1.477	-0.044	-1.25	+1.20
19	Moscow	+55 46	37 37	1.404	1.446	-0.042	-1.40	+2.20
20	Königsberg	+54 43	20 30	1.365	1.410	-0.045	-0.88	+2.12
21	Barnaul	+53 20	83 56	1.605	1.591	+0.014	-0.42	+0.33
22	Uststretensk	+53 20	121 51	1.656	1.609	+0.047	+2.87	-0.35
23	Gorbizkoi	+53 6	119 9	1.660	1.611	+0.049	+1.82	-0.17
24	Petropaulowsk	+53 0	158 40	1.489	1.521	-0.032	-0.53	-1.68
25	Uriupina	+52 47	120 4	1.667	1.612	+0.055	+2.80	-0.40
26	Berlin	+52 30	13 24	1.367	1.391	-0.024	-1.43	+1.37
27	Pogromnoi	+52 30	111 3	1.640	1.616	+0.024	+0.93	-0.28
28	Irkuzk	+52 17	104 47	1.647	1.616	+0.031	+0.82	-0.05
29	Stretensk	+52 15	117 40	1.649	1.606	+0.043	+1.97	-0.28
30	Stepnoi	+52 10	106 21	1.663	1.615	+0.048	+0.73	-0.03
31	Tschitanskoi	+52 1	113 27	1.668	1.609	+0.059	+1.22	-0.23
32	Nertschinsk City	+51 56	116 31	1.635	1.604	+0.031	+2.18	-0.53
33	Werchneudinsk	+51 50	107 46	1.657	1.612	+0.045	+1.03	+0.18
34	Orenburg	+51 45	55 6	1.432	1.461	-0.029	-0.57	+1.50
35	Argunskoi	+51 23	119 56	1.655	1.595	+0.060	+2.37	-0.27
36	Göttingen	+51 32	9 56	1.357	1.388	-0.031	-1.83	+1.22
37	London	+51 31	359 50	1.372	1.410	-0.038	-1.62	+0.38
38	Nertschinsk Bergw.	+51 19	119 37	1.617	1.593	+0.024	+2.77	-0.43
39	Tschindant	+50 34	115 32	1.650	1.592	+0.058	+1.66	-0.05
40	Charazaiska	+50 29	104 44	1.643	1.599	+0.044	-0.30	+0.18
41	Zuruchaitu	+50 23	119 3	1.626	1.584	+0.042	+1.88	+0.02
42	Troizkosawsk	+50 21	106 45	1.642	1.597	+0.045	+1.37	-0.32
43	Abagaitujewskoi	+49 35	117 50	1.583	1.577	+0.006	+1.77	-0.75
44	Altanskoi	+49 28	111 30	1.619	1.585	+0.034	-1.07	-0.43
45	Mendschinskoi	+49 26	108 55	1.630	1.587	+0.043	+1.13	-0.28
46	Paris	+48 52	2 21	1.348	1.389	-0.041	-2.03	+0.65
47	Chunzal	+48 13	106 27	1.612	1.574	+0.038	+0.40	-0.22
48	Urga	+47 55	106 42	1.583	1.571	+0.012	+0.17	-0.35
49	Astrachan	+46 20	48 0	1.334	1.358	-0.024	-0.47	+2.98
50	Chologur	+46 0	110 34	1.580	1.545	+0.035	+1.15	-0.62
51	Ergi	+45 32	111 25	1.559	1.539	+0.020	+1.22	-0.60
52	Milan	+45 28	9 9	1.294	1.331	-0.037	-2.38	+1.58
53	Sendschi	+44 45	110 26	1.530	1.529	+0.001	+0.83	-0.55
54	Batchay	+44 21	112 55	1.553	1.520	+0.033	+0.72	-0.47
55	Scharabudurguna	+43 13	114 6	1.538	1.502	+0.036	+0.23	-0.48

Nr.	Place of Observation	Latitude	East Longitude	Total Magnetic Intensity			Decl. $\delta_o - \delta_c$	Incl. or Dip $\theta_o - \theta_c$
				I_o	I_c	$I_o - I_c$		
56	Naples	+40° 52'	14° 6'	1.271	1.271	0.000	-3°55	+2°45
57	Chalghan	+40 49	114 58	1.459	1.465	-0.006	+0.52	-0.57
58	Pekin	+39 54	116 26	1.453	1.448	+0.005	+0.83	-0.90
59	Terceira	+38 39	332 47	1.457	1.469	-0.012	-0.98	-0.47
60	San Francisco	+37 49	237 35	1.591	1.592	-0.001	+1.45	-1.60
61	Port Praya	+14 54	336 30	1.156	1.168	-0.012	+0.22	+0.20
62	Madras	+13 4	80 17	1.031	1.038	-0.007	-	+2.63
63	Galapagos Islands	- 0 50	270 23	1.069	1.085	-0.016	-0.55	-3.92
64	Ascension	- 7 56	345 36	0.873	0.813	+0.060	-1.12	-3.88
65	Pernambuco	- 8 4	325 9	0.914	0.909	+0.005	-0.07	+0.18
66	Bahia	-12 59	321 30	0.871	0.883	-0.012	+1.10	+1.42
67	St. Helena	-15 55	354 17	0.836	0.811	+0.025	-1.45	-3.15
68	Otaheite	-17 29	210 30	1.094	1.113	-0.019	-2.15	-3.00
69	Mauritius	-20 9	57 31	1.144	1.060	+0.084	+0.15	+0.12
70	Rio de Janeiro	-22 55	316 51	0.878	0.879	-0.001	-0.95	+1.32
71	Valparaiso	-33 2	288 19	1.176	1.094	+0.082	-1.55	-1.18
72	Sydney	-33 51	151 17	1.685	1.667	+0.018	-2.55	-4.63
73	Cape of Good Hope	-34 11	18 26	1.014	0.981	+0.033	+1.10	-1.52
74	Monte Video	-34 53	303 47	1.060	1.022	+0.038	-0.62	-0.10
75	K. George's Sound	-35 2	117 56	1.709	1.658	+0.051	+0.40	-2.03
76	New Zealand	-35 16	174 0	1.591	1.616	-0.025	-2.83	-4.77
77	Concepcion	-36 42	286 50	1.218	1.147	+0.071	-2.08	-1.40
78	Blanco Bay	-38 57	298 1	1.113	1.103	+0.010	-2.05	+0.12
79	Valdivia	-39 53	286 31	1.238	1.145	+0.093	-1.28	-0.57
80	Chiloe	-41 51	286 4	1.313	1.227	+0.086	-1.06	-1.20
81	Hobarttown	-42 53	147 24	1.817	1.894	-0.077	-5.25	-3.63
82	Port Low	-43 48	285 58	1.326	1.257	+0.069	-2.27	-1.27
83	Port Desire	-47 45	294 5	1.359	1.263	+0.096	-3.33	-1.35
84	R. Santa Cruz	-50 7	291 36	1.425	1.321	+0.104	-2.52	-1.45
85	Falkland Islands	-51 32	301 53	1.367	1.276	+0.091	-3.73	-0.65

8. The Mutual Potential Energy and the Mutual Action of Two Magnetic Systems: How the Result is modified by the Magnetic Law of Stress exerted in Curved Lines drawn to the Poles.

(i) The mutual potential energy of two magnetic systems.

1. Imagine a magnet of infinitely small dimensions, like the particles into which a magnet may be broken without losing its physical properties. Suppose the length to be dl , with direction cosines α, β, γ ; then if Ω_1 and Ω_2 be the values of the potential Ω at the negative and positive poles respectively, we shall have for the potential energy of this small magnet:

$$d\mu dl \cdot d\Omega/dl = m \cdot \partial\Omega/\partial l \quad (157)$$

$m = \text{moment of the magnet.}$

On putting $dv = dx dy dz$ for the magnetized element we get: $m \cdot \partial\Omega/\partial l = I(\alpha \cdot \partial\Omega/\partial x + \beta \cdot \partial\Omega/\partial y + \gamma \cdot \partial\Omega/\partial z) dx dy dz$ (158) where $I = \text{total intensity along the line of magnetization.}$

By triple integration for all the elements of the system, in a field of potential Ω , on putting $I\alpha = A, I\beta = B, I\gamma = C$, we get:

$$\Omega = \int \int \int \frac{\{A(\xi-x) + B(\eta-y) + C(\zeta-z)\}}{\{(\xi-x)^2 + (\eta-y)^2 + (\zeta-z)^2\}^{3/2}} dx dy dz. \quad (162)$$

$$W = \iiint \int I(\alpha \cdot \partial/\partial x + \beta \cdot \partial/\partial y + \gamma \cdot \partial/\partial z) (1/D) dx dy dz$$

$$= \iiint \int (A \cdot \partial\Omega/\partial x + B \cdot \partial\Omega/\partial y + C \cdot \partial\Omega/\partial z) dx dy dz \quad (159)$$

$$D = [(\xi-x)^2 + (\eta-y)^2 + (\zeta-z)^2]^{1/2}$$

the distance D corresponding to the point $P(\xi, \eta, \zeta)$.

Here the integration is supposed to be extended throughout the magnetized masses acted upon. Accordingly, if $I', \alpha', \beta', \gamma', x', y', z'$ or A', B', C' refer to the acting system, we get for the potential Ω :

$$\Omega = \iiint \int I'(\alpha' \cdot \partial/\partial x' + \beta' \cdot \partial/\partial y' + \gamma' \cdot \partial/\partial z') (1/D) dx' dy' dz' \quad (160)$$

where $D = [(\xi-x)^2 + (\eta-y)^2 + (\zeta-z)^2]^{1/2}$ (161)

as in (159), and thus D is the distance of the point $P(\xi, \eta, \zeta)$.

At any point $P(\xi, \eta, \zeta)$ an infinitely small magnet $A dx dy dz$ situated at $p(x, y, z)$, having its axis parallel to the axis of x , has the component of the potential $A(\xi-x)/D^3$; and as the other components are symmetrical, we get for the potential of the whole magnet, by the integration of the sum of these components, an expression equivalent to (160):

Now from (159) and (160) we get for the mutual potential energy of the two magnetic systems:

$$W = \int \int \int \int \int \int \frac{(\alpha \cdot \partial/\partial x + \beta \cdot \partial/\partial y + \gamma \cdot \partial/\partial z) (\alpha' \cdot \partial/\partial x' + \beta' \cdot \partial/\partial y' + \gamma' \cdot \partial/\partial z') I I'}{[(\xi - x)^2 + (\eta - y)^2 + (\zeta - z)^2]^{3/2}} dx dy dz dx' dy' dz'. \quad (163)$$

The functions A, B, C vanish in free space, where there is no magnetized matter, and therefore we may use these functions in the sextuple integral with the understanding that they are zero everywhere where space is devoid of matter. The limits thus become infinite, and we get:

$$W = \int \int \int \int \int \int \frac{(A \cdot \partial\Omega/\partial x + B \cdot \partial\Omega/\partial y + C \cdot \partial\Omega/\partial z) (A' \cdot \partial\Omega'/\partial x' + B' \cdot \partial\Omega'/\partial y' + C' \cdot \partial\Omega'/\partial z')}{[(\xi - x)^2 + (\eta - y)^2 + (\zeta - z)^2]^{3/2}} dx dy dz dx' dy' dz'. \quad (164)$$

Integrating by parts, and noticing that the surface integral at infinity vanishes, we get simply:

$$W = \int \int \int \int \int \int (A \cdot \partial\Omega/\partial x + B \cdot \partial\Omega/\partial y + C \cdot \partial\Omega/\partial z) dx dy dz. \quad (165)$$

$$= - \int \int \int \int \int \int (\partial A/\partial x + \partial B/\partial y + \partial C/\partial z) dx dy dz. \quad (166)$$

Here it is assumed that A, B, C vary continuously, but as these functions undergo at the surface such rapid variation as to amount to discontinuity; and thus a finite portion of the integral will arise from an infinitely thin stratum near the surface, as in the *Poisson* formula for surface density μ_0 and volume density μ (*Mémoires de l'Institut*, tome V, 1821):

$$W = \int \int \int \Omega \mu_0 dS + \int \int \int \int \Omega \mu dx dy dz. \quad (167)$$

Let therefore Ω' be the potential of the magnet acted upon; then, taking account of the discontinuous change at the surface 4π about the system, we get

$$\partial^2\Omega'/\partial x'^2 + \partial^2\Omega'/\partial y'^2 + \partial^2\Omega'/\partial z'^2 = 4\pi (\partial A/\partial x + \partial B/\partial y + \partial C/\partial z). \quad (168)$$

And on multiplying by $\Omega dv = \Omega dx dy dz$ and integrating, we have by (166):

$$W = -1/4\pi \cdot \int \int \int \int \int \int (\partial^2\Omega'/\partial x'^2 + \partial^2\Omega'/\partial y'^2 + \partial^2\Omega'/\partial z'^2) dx dy dz \quad (169)$$

$$= 1/4\pi \cdot \int \int \int \int \int \int (\partial\Omega'/\partial x \cdot \partial\Omega'/\partial x + \partial\Omega'/\partial y \cdot \partial\Omega'/\partial y + \partial\Omega'/\partial z \cdot \partial\Omega'/\partial z) dx dy dz \quad (170)$$

$$= +1/4\pi \cdot \int \int \int \int \int \int R R' \cos \chi \cdot dx dy dz \quad (171)$$

(cf. Sir *W. Thomson*, Reprint of Papers on Electricity and Magnetism, p. 433).

In this last formula R and R' are the resultant forces at any point of space due to the acting and acted upon systems respectively, and χ is the angle between the directions of these resultant forces.

Having now derived very general expressions for the mutual potential and mutual action of two magnets, or magnetic systems, of any form or distribution in space, we are obliged to consider carefully how far the underlying hypotheses conform to the true laws of nature. It has been assumed by *Gauss*, *Airy*, *Thomson*, *Maxwell*, *Crystall* and other recent investigators:

(I.) The attraction or repulsion according as the poles are unlike or like, between two quantities μ and μ' of magnetism, supposed concentrated in two points at distance r apart is represented by the force:

$$f = \pm \mu \mu' / r^2. \quad (172)$$

(II.) This force in the mutual action of two elements of magnetism is taken to be in the straight line r , joining the elements μ and μ' .

This hypothesis of rectilinear action almost presumes that magnetism is similar to gravitation, whereas it is shown in the present paper that magnetic stress is exerted in the curved lines of force typical of magnetism. It is necessary therefore to examine the foundation of the classic theory of magnetism with particular care.

(III.) The classic theory supposes that the unit quantity of magnetism is so chosen that two units of positive magnetism at unit distance apart repel each other with unit force. This definition, underlying the magnetic system of units, gives for the dimensions of a quantity of magnetism, in the magnetic system of units:

$$\mu = L^{3/2} M^{1/2} T^{-1}. \quad (173)$$

(IV.) The strength of a magnetic field, or the resultant magnetic force at a point in the field, is defined to be the force exerted upon a unit of positive magnetism supposed concentrated at the point. So that in general, if R be the resultant magnetic force at the point, the magnetic force exerted on a quantity μ of magnetism concentrated there becomes μR , just as in the case of gravity, where the force is $m g$.

(ii) How the action is modified by the law of magnetic stress acting tangentially in the curved lines of force directed to the two poles.

We have seen abundant proof that the law:

$$I/g = \eta^2 (r^2/s^2 + r'^2/s'^2) \quad s = \int_0^p ds \quad s' = \int_0^{p'} ds' \quad (174)$$

represents the connection between magnetism and gravitation.

In every possible situation on the earth's surface we found that in general we have to consider the modification of theory due to the increase in the path of action from

$$r \text{ to } r + dr.$$

To make the reasoning general, and avoid confusion, we shall put: $s = q + Aq = q(1 + Aq/q)$ (175)

where q is the rectilinear path chosen by *Gauss* in his *Allgemeine Theorie des Erdmagnetismus*, 1838. This path q within the earth may be increased by as much as 40 per cent at the equator, so that Aq is finite, not infinitely small.

Now expressions for magnetism involve the inverse second power, and therefore we are concerned with:

$$s^2 = \rho^2 + 2\rho \Delta\rho + (\Delta\rho)^2$$

where $\rho^2 = r^2 - 2r r_0 [\cos u \cos u_0 + \sin u \sin u_0 \cos(\lambda - \lambda_0)] + r_0^2$. (176)

Any expression for the force used by Gauss, as $\Omega = -\int \frac{1}{\rho} \cdot d\mu$

$$= -\int \{r^2 - 2r r_0 [\cos u \cos u_0 + \sin u \sin u_0 \cos(\lambda - \lambda_0)] + r_0^2\}^{-1/2} \cdot d\mu$$
 (177)

will therefore be much more complex.

We may put the above expansion in the following form: $(\rho + \Delta\rho)^2 = \rho^2 (1 + \Delta\rho/\rho)^2 = \rho^2 [1 + 2\Delta\rho/\rho + (\Delta\rho)^2/\rho^2]$. (178)

And then we have $\mu/[\rho(1 + \Delta\rho/\rho)]^2 = (\mu/\rho^2) [1 + \Delta\rho/\rho]^{-2}$ (179)

$$= (\mu/\rho^2) \{1 - 2\Delta\rho/\rho + 3(\Delta\rho/\rho)^2 - 4(\Delta\rho/\rho)^3 + 5(\Delta\rho/\rho)^4 - \dots\}$$
 (180)

This series converges with sufficient rapidity, except when $\Delta\rho$ is very large, as in the region of the terrestrial equator. It is evident that beyond the first term, the sum of the terms

$$S = \sum_{v=1}^{n-1} \frac{n(n-1)(n-2)\dots(n-v)}{1 \cdot 2 \cdot 3 \cdot 4 \cdot \dots \cdot v} \cdot \left(\frac{\Delta\rho}{\rho}\right)^v$$
 (181)

is negative, because the first term of (179) is smaller than μ/ρ^2 , under the integral (177) used by Gauss.

Accordingly as

$$\mu/[\rho^2(1 + \Delta\rho/\rho)^2] < \mu/\rho^2; \text{ and therefore}$$

$$\int \frac{1}{\rho^2} \cdot d\mu > \int \frac{1}{[\rho^2(1 + \Delta\rho/\rho)^2]} \cdot d\mu$$
 (182)

we may form a table for the earth, using the value $s = \rho(1 + \Delta\rho/\rho)$ in the different latitudes. Thus the table will give the means of integration by quadrature for the average value in the case of our globe. In this way we may find out how much $s > \rho$, as used by Gauss.

Approximate Table for the Increase of the Amount of Magnetism in the Globe, under Curved Line Action compared to the Straight Line Action assumed by Gauss:

i = Number of Zone in Quadrant of Globe from the Pole	u_i = Angular Distance of Limit of Zone	s/ρ = $(1 + \Delta\rho/\rho)$	s^2/ρ^2 = $(1 + \Delta\rho/\rho)^2$	$s^2/\rho^2 \cdot 2\pi (\cos u_i - \cos u_{i+1})$ = Integral for the Zones of the Sphere by the ratio of the Forces s^2/ρ^2 acting on them
0	0	1.000	1.000
1	10	1.028	1.056	0.1008
2	20	1.042	1.085	0.3074
3	30	1.050	1.102	0.5103
4	40	1.060	1.123	0.7056
5	50	1.075	1.155	0.8940
6	60	1.096	1.201	1.0801
7	70	1.120	1.254	1.2449
8	80	1.300	1.690	1.7882
9	90	1.414	2.000	2.1815

Mean Value = 1.120 | 1.266 | $\Sigma = 8.8129$
 Mean for equal elements of the Solid Angle $\omega = \Sigma/2\pi = 1.4026$.

From the table it appears:

1. The mean ratio of the mere increase of distance s/ρ is 1.12, while the mean ratio of the squared distances s^2/ρ^2 required in the divisor of the integral for the forces is 1.266. This means that zone for zone of the conical space about the pole there would be an increase in the calculated amount of the magnetism, — observation, under Gauss' defective hypothesis of rectilinear action, yielding only $1/1.266 = 0.80$, nearly. Thus an increase of 25 percent is required, to overcome the effect of the defect in the underlying hypothesis.

2. But instead of taking zone for zone, we should integrate the zones of the sphere by the ratio of the forces s^2/ρ^2 acting on them, as given in the last column of the above table, which yields a mean for equal elements of all the solid angles, $\omega = 1.4026$. That is, solid angle for solid angle, throughout the hemisphere, the effect of the curved line action rises to about 1.4; so that $1/1.4 = 0.71$ is the calculated part of the magnetism existing in nature, the increase required for defect in hypothesis being about 40 percent, $29/71 = 0.40$.

3. Although the above table is approximate only, — including merely the effect of the changes in s , for one hemisphere, the changes in s' for the other hemisphere being left out of account, — it is evident that the final result will not very greatly exceed the ratio here estimated. It will not, I feel sure, exceed 50 percent; yet this change shows how profoundly all our conceptions of magnetism must be modified, to take account of nature's actions in curved lines compared to the straight lines heretofore employed by physical theorists.

4. The above conclusion that the ratio of increase will not exceed 50 percent rests on a study of the nature of the integrals:

$$I = f + f' = \mu' \iiint \frac{\sigma}{s^2} \cdot dx dy dz + \mu'' \iiint \frac{\sigma'}{s'^2} \cdot dx dy dz = \mu\mu'/s^2 + \mu\mu''/s'^2$$

the two terms f and f' being equal at the equator, but each of them falling off rapidly and soon becoming relatively small terms in the opposite hemisphere.

The results of our calculations are given in the accompanying table. It will be seen that the general effect of using s in place of ρ is to weaken the attractive force everywhere. And as Gauss' results follow from the constant use of a path of action which is too short, yet the observed forces were the forces he actually used, we must conclude that the amount of magnetism in the earth very appreciably exceeds that calculated by Gauss.

After some examination of this problem, we conclude from the study of the earth's magnetism, that for such a spherical magnet as the earth, the average increase of $s = \rho(1 + \Delta\rho/\rho)$, the second term being the excess of s over rectilinear action, is about:

$$s = \rho(1 + 0.12/\rho)$$
 (183)

And therefore in the integral

$$\int \frac{1}{s} \cdot d\mu = \int \frac{1}{[\rho^2(1 + \Delta\rho/\rho)^2]} \cdot d\mu$$
 (184)

the evaluated sum is decreased in the ratio of 1.00 to 1.26. Consequently we find that the amount of magnetism in the globe is about 26 percent greater than observations indicate

in virtue of curved line action, zone for zone; and, solid angle for solid angle, at least 40 percent, perhaps 50 percent.

The general theory of curved line action here developed is entirely new in science. It has not been used in any previous work. Thus in *Crystall's* great article on Magnetism, *Encycl. Brit.*, 9th ed., p. 227, it is stated that the force between two quantities of magnetism is $f = \mu\mu'/r^2$, and »is in the line joining the two points«.

The whole theory of magnetism heretofore in use is based on the theory of rectilinear action, as in *Gauss' Allgemeine Theorie des Erdmagnetismus*, § 3, p. 7, where we read:

»Zur Abmessung der magnetischen Flüssigkeiten legen wir, wie in der Schrift *Intensitas vis magneticae* etc. diejenige Quantität nördlichen Fluidums als positive Einheit zu Grunde, welche auf eine ebenso große Quantität desselben Fluidums in der zur Einheit angenommenen Entfernung eine bewegende Kraft ausübt, die der zur Einheit angenommenen gleich ist. Wenn wir von der magnetischen Kraft, welche in irgend einem Punkte des Raumes, als Wirkung von anderswo befindlichem magnetischem Fluidum, schlechthin sprechen, so ist darunter immer die bewegende Kraft verstanden, welche daselbst auf die Einheit des positiven magnetischen Fluidums ausgeübt wird. In diesem Sinne übt folglich die in einem Punkt konzentriert gedachte magnetische Flüssigkeit μ in der Entfernung q die magnetische Kraft μ/q^2 aus, und zwar abstoßend oder anziehend in der Richtung der geraden Linie q , je nachdem μ positiv oder negativ ist. Bezeichnet man durch a, b, c die Koordinaten von μ in Beziehung auf drei unter rechten Winkeln einander schneidende Achsen; durch x, y, z die Koordinaten des Punktes, wo die Kraft ausgeübt wird, sodaß

$$q = [(x-a)^2 + (y-b)^2 + (z-c)^2]^{1/2}$$

und zerlegt die Kraft den Koordinatenachsen parallel, so sind die Komponenten

$$\mu(x-a)/q^3, \quad \mu(y-b)/q^3, \quad \mu(z-c)/q^3,$$

welche, wie man leicht sieht, den partiellen Differentialquotienten von $-\mu/q$ nach x, y und z gleich sind.«

We have cited the foundations of *Gauss' theory* in some detail, not only to show that he takes the force $f = \mu/q^2$ and reckons q rectilinear, »in der Richtung der geraden Linie q «, positive or negative according to the sign of μ ; but also to exhibit the *Gaussian resolution* of the component forces, which is of exactly the same form as in the case of gravitation.

Before coming definitely to the decision that a fundamental error of the kind here described has come down in the classical theory of magnetism, as developed by *Gauss* and other high authorities, I took pains to experiment very carefully as follows:

(a) When iron filings were sprinkled on a plate of glass over the poles of a powerful small magnet, they showed unmistakably the tendency to move towards the poles along the curved lines of force, not straight to the poles.

(b) When soft iron paper fasteners were attached to threads for exploring the field, they showed the same motion — the pulling being in the tangent to the line of force.

(c) Yet not content with such indications, I went to the trouble to test the field carefully, again and again, when the small compass needle was tied to a silk thread for exploring the magnetic field. Upon actual trial it was found that the

deflection of the needle against gravity, predicted by the formula for the ponderomotive force:

$$F = mg \operatorname{tg} \chi = \mu\mu'/s^2 - \mu\mu'/s'^2, \text{ (northern hemisphere) (185)}$$

where m = gravitational mass of the smaller magnet, was due visibly and undeniably to a force along the tangent to the line of force. By moving the suspended needle from one position to another, where the lines of force curve rapidly, it could be seen distinctly that the deflection is always in the tangent to the magnetic line of force. The observation is not difficult. The evidence is perfectly unmistakable!

Conclusions.

1. From the experiments here described it follows incontestably that the laws of magnetic attraction and repulsion are not quite so simple as we have supposed. Instead of an attraction or repulsion along the straight line r , we must imagine these stresses exerted along the shortest lines of force

$$s = q + Aq = \int_0^q ds, \quad s' = \int_0^{q'} ds'.$$

2. The aether stress along the line of force of minimum length is the maximum tension for the attracted magnetic needle. The resultant is directed to the nearer pole, around the curve, but it changes direction at the equator, and in the other hemisphere is therefore directed to the other pole.

3. The lines of force, as *Faraday* noticed, tend to shorten themselves, and thus are under tension. The tension is greatest nearest the poles, which act as true centres of attraction, yet the stress always acts in curved lines, because there is another pole in the distance to which the other end of the line of force returns.

4. Since the lines of force are vortical filaments of aether in rapid rotation, owing to the wave-action constituting magnetism, — the resultant rotation at any point being in the plane normal to the line of force, — we perceive that the tension in the line of force will always pull the suspended magnetic needle towards the nearer pole of the larger magnet. The chief forces are centred in the opposite ends of the suspended needle, the opposite poles of the needle being pulled to opposite poles of the large magnet.

5. At the equator the action on the two ends of the suspended needle are equal: in other positions the forces are unequal, with the increased attraction towards the nearer pole predominant.

a) There is always a slight bodily deflection of the suspended needle towards the larger magnet — the vortical filament of the aether along the line of force acting like a stretched rope.

b) But near either pole, the stress along the line of force is so much more predominant, that we notice chiefly the attraction towards the pole.

6. As observation confirms the theory of tension along the magnetic lines of force, we perceive that these observations, showing stresses as described above, also confirm and definitely establish wave-action as the cause of magnetism. This explanation is not only sufficient; it is also necessary — the only possible one! Hence in finding the law of magnetic action in curved lines of force, we have discovered the true cause of magnetism!

9. The Feebleness of Gravitation Compared to Electric and Magnetic Forces: Velocity of the Propagation of Universal Gravitation.

(i) Estimates of the feebleness of gravitation.

The force of universal gravitation is so nearly insensible, for small masses, as to lead to the belief that this chief force of nature is a residual effect, in which only a small component of the elastic power of the aether is exerted. By virtue of the stupendous masses of the heavenly bodies, however, this residual component attains gigantic magnitude between the planets and the sun, or between the members of a pair of double stars, as they revolve in their orbits, — the actual stress becoming a maximum and thus often enormous at periastron passage.

a) Thus in the Connexion of the Physical Sciences, 9th ed., 1858, p. 426, Mrs. *Somerville* remarks:

»Gravitation is a feeble force, vastly inferior to electric action, chemical affinity and cohesion; yet, as far as human knowledge extends, the intensity of gravitation has never varied within the limits of the solar system.«

The latter part of this argument is modified by observations and experiments made within the past twenty years; but the remark on the feebleness of gravitation is eminently appropriate, and today more noteworthy than in former times, when gravitation was less investigated by natural philosophers.

b) In the article Gravitation, *Encycl. Brit.*, 9th ed., 1875, *Ball* points out that on the average the attraction of a magnet is millions of times more powerful than gravitational attraction. This general remark is of such great interest that we propose to test it by actual calculation, as follows. So far as I know this calculation is new, at least I have never met with it in the writings of any modern investigator.

c) It appears by the U. S. Coast Survey observations at the Magnetic Observatory, Cheltenham, Maryland, that in 1906, the horizontal component of the earth's magnetism was $\gamma = 0.00020$ c. g. s., while the inclination or dip was $\theta = 70^\circ 27'$. Now we may take gravity as 981 cm c. g. s., and therefore the horizontal component of the earth's magnetism is to that of gravitational acceleration as:

$$\gamma/g = 2/9810000 = 1/4905000. \quad (186)$$

But $\cos 70^\circ 27' = 0.3347 = 1/3$ very nearly, and thus we have for the ratio of the total intensity at Cheltenham to gravity, 1906, the equation:

$$I/g = \gamma \sec \theta / g = 1/1635000. \quad (187)$$

This is the same result at which we arrived in equation (46) above.

d) It is shown in *Gauss' Allgemeine Theorie des Erdmagnetismus*, 1838, that at the two poles the average intensity of the earth's magnetism is 1.977, or nearly 2, while at the magnetic equator it reduces to 1 approximately. We therefore have the general theorem, that for the region between the magnetic equator and the magnetic poles the intensity of the earth's magnetism lies between the limits given in equation (115):

$$I/g = 1/2000000, \text{ and } I/g = 1/1000000. \quad (188)$$

Accordingly the above value at Cheltenham is typical of the larger part of the globe. The above remarks of Mrs. *Somerville* and Prof. *Ball* are therefore very appropriate.

e) In 1894, Prof. *C. V. Boys* determined the constant of gravitation or the attraction of a mass of a gram at a distance of a centimetre in a second,

$$\Gamma = 0.000000666 = 10^{-10} \cdot 666 \text{ c. g. s.} \quad (189)$$

$= 1/(1501 \cdot 10^4)$ dyne, or practically one-fifteen millionth of a dyne.

As the dyne is roughly the weight of a milligram, it was remarked by Prof. *G. M. Minchin* of Oxford (*Treatise on Statics*, 1886, vol. II, p. 251), »how extremely small a magnitude is the constant of gravitation«. This opinion of the feebleness of gravitation has been generally held by investigators since the days of *Newton*; in fact the force was so very small that it was a long time before experimental measurements of the deflections due to gravitation became possible.

In 1774 *Maskelyne* succeeded in detecting the deflection of the vertical by the attraction of Mt. Shehallien in Scotland, from which he deduced a mean density of the earth of 4.71. In 1798 *Cavendish* first used the method of the Torsion Balance, and obtained the value 5.48, which is very near the modern value, 5.50.

In view of the extreme feebleness of gravitation, the accurate determination of the gravitation constant is one of the most difficult experiments in the whole range of physical science.

(ii) Revision of *Maxwell's* calculation of the stress in the aether incident to gravitation.

In his researches on the stresses in the aether required to produce electric, magnetic or gravitational forces, *Maxwell* derives the following formula (*Treatise on Electricity and Magnetism*, 1873, sect. 643; *Minchin's Treatise on Statics*, vol. II, 1886, p. 451):

$$B = R^2/8\pi\Gamma. \quad (190)$$

where Γ is the gravitation constant, $\Gamma = 666 \cdot 10^{-10}$ c. g. s., as above explained, and $R = 981$ cm, is the acceleration of gravity at the earth's surface.

The calculation is as follows:

$\log R = 981 = 2.9916690$	$\log 8 = 0.9030900$
$\log(R^2) = 5.9833380$	$\log \pi = 0.4971499$
$\log 10^{10} = 10.0000000$	$\log 666 = 2.8234742$
$\log(10^{10} \cdot R^2) = 15.9833380$	$\log(8\pi 666) = 4.2237141$
$\log(8\pi 666) = 4.2237141$	
$\log(10^{10} \cdot R^2/8\pi 666) = 11.7596239$, c. g. s.	
$\log(981000) = 5.9916690$	
$\log B = 5.7679549$ kg per sq cm	
$B = 586077.3$ kg per sq cm.	(191)

In *Maxwell's* calculation of this stress an error of a decimal place occurs, as is easily shown. He gives the stress as 37000 tons weight per square inch, namely:

$$B' = 37000 \cdot 2240 = 82880000 \text{ pounds per sq inch.}$$

$$\begin{aligned} \log(82880000) &= 7.9184497 \\ \log(6.4516 \cdot 2.2046213) &= 1.1530014 \\ \log B' &= 6.7654483 \end{aligned}$$

$$B' = 5827040 \text{ kg per sq cm.} \quad (192)$$

But above we found $B = 586077.3$ kg per sq cm, which is almost exactly one tenth of *Maxwell's* value.

If we recall that *Maxwell* used a slightly different value of Γ from that cited above, it seems certain that he misplaced the decimal point in his reduction.

In pounds per square inch this may be made even more obvious, thus:

$$B = 8335974, \text{ (See)} \quad (193)$$

$$B' = 82880000, \text{ (Maxwell)}$$

which exhibits very distinctly the misplacement of the decimal point in *Maxwell's* calculation.

(iii) Table of stresses in the aether at the surfaces of the sun and planets, and at the orbits of the eight principal planets of the solar system.

The following table contains data of much interest, as revealing to us the actual state of the aether at critical points of the solar system.

Table of the aether stresses for the sun and planets.

Name	i	g_i (in cm)	$B_i = g_i^2/8\pi\Gamma = \text{Stress}$ (in kg per sq cm)	S_i Stress in units of the tensile strength of steel, 30 tons to the sq in. = 4.7246 metric tons per sq cm	At the Planetary Orbits	
					g_i	Stress = $B_i = g_i^2/8\pi\Gamma$ (in kg per sq cm)
Sun	0	27301.6	453934400.0	96085.0	cm	—
Mercury	1	188.0	21524.5	4.55	3.947	9.4821
Venus	2	875.37	466660.0	98.77	1.13035	0.77811
The Earth	3	981.0	586077.3	124.05	0.59141	0.21301
Mars	4	377.14	86621.0	18.33	0.25474	0.039519
Jupiter	5	2621.7	4185843.0	885.96	0.021848	0.00029070
Saturn	6	1144.2	797298.0	168.75	0.006499650	0.000025728
Uranus	7	1304.0	822568.3	174.10	0.0016057	0.000015703
Neptune	8	1464.6	1306336.0	276.50	0.00065404	0.0000026051

And as R'^2 occurs in the above equation, we find that the gravitational stress at the earth's surface, namely 586077 kilograms per square centimetre, must be divided by the enormous number $(1635000)^2 = 2673225000000$, yielding only the utterly insensible stress of 0.00000021924 kilograms per square centimetre. This stress is in the direction of the total magnetic intensity. And as the dip is largely vertical in the chief places of the northern hemisphere, it is not remarkable that the earth's northward pull on a suspended magnetic needle is practically insensible, as found by observers since the days of *Norman*, 1576.

The experimental detection of any modification of weight by magnetization, or even a bodily deflection of a suspended magnetic needle from the vertical, is therefore very difficult in the magnetic field of the earth, where the stresses are so feeble compared to the enormous stress due to gravitation.

(iv) Definite proof that gravitation is propagated with the velocity of light deduced from the connection established between magnetism and gravitation.

1. We have now shown that so far as the magnetism of our globe is regular a definite connection exists between the mean total force of terrestrial magnetism in any latitude and the accelerative force of gravitation at the earth's surface, through the equation:

$$I/g = \eta^2 (r^2/s^2 + r'^2/s'^2) = (1/1408.12)^2 (r^2/s^2 + r'^2/s'^2) \quad (14)$$

It will be seen that the aether stress is very great near the surfaces of the larger planets, and especially near the solar surface. This stress varies as the square of the force of gravity, and thus augments rapidly near a large dense mass, where the acceleration of gravity becomes very large. Such a result is in no way remarkable, but on the contrary, to be expected by any one familiar with the wave-process for generating the physical forces pervading nature.

It would be easy to calculate the magnetic stresses by the corresponding formula:

$$B' = R'^2/8\pi\Gamma$$

where R' is the magnetic acceleration expressed in units of some known gravitational acceleration. Thus to compare the stress due to the magnetic field of the earth with gravity at the earth's surface we use the ratio above found, for such a typical station as Cheltenham, namely:

$$R' = I/g = 1/1635000.$$

where r = radius of the earth, and s is expressed in the same unit, the integration for the path $s = \int_0^p ds$ being taken along the line of the magnetic force from the place of observation o to the pole p , and $s' = \int_0^{p'}$ to the other pole p' .

2. It follows from this line of argument:

a) That artificial magnets are produced by the concerted wave-action of electric currents, in coils of wire such as *Ampère* first wound about the bars being magnetized — the atoms having their equators lined up parallel to the equator, or plane perpendicular to the bar's axis at its centre.

b) The magnetic force is due to stress in the aether, under vortical rotation of the aetherons about the lines of force, as the magnetic waves travel outward with the velocity of light. This magnetic force being due to a state of stress in the aether is propagated across space with the same velocity as the electrodynamic waves generating the magnet, which has been found by many careful experimenters to be identical with the speed of light, — 300000 km per second.

3. Now if a real connection exists between terrestrial magnetism and gravitation at the surface at the earth, as shown in this paper, — 1/1408 part of the atoms being

lined up in parallel planes, and giving the attraction directed to the two poles; the rest, 1407/1408, of them lying haphazard, with their planes tilted at all possible angles, and giving only a mean stress towards the centre of the whole mass — then, it will follow that gravitation necessarily is transmitted with the velocity of light. For this velocity certainly is true of the waves generating magnetism, and as magnetism is definitely connected with gravitation, this latter force must of necessity be transmitted across space with the same velocity, namely, $V = 3 \cdot 10^{10}$ cm.

4. The investigation of the connection between the magnetism of the earth and terrestrial gravity now shown to exist, is therefore of the deepest interest, because it furnishes a definite proof that the universal gravitation, which governs the motions of the planets in their orbits, is transmitted with the velocity of light. This is another proof that gravitation is due to wave-action in the aether, because the velocity of transmission deduced from the connection with magnetism corresponds to such waves.

In the Baltimore Lectures, 1904, Appendix F, (reprinted from the Proc. Roy. Soc., vol. 8, June, 1856; Phil. Mag., March, 1857) Lord Kelvin treats of Faraday's discovery, 1845, of the rotation of a beam of polarized light when it is passed through heavy glass, carbon disulphide, etc. along the path of a magnetic line of force. This discovery is fundamental in magnetism, and by all competent authorities ranked among the most wonderful of Faraday's discoveries.

Yet although over three fourths of a century have now elapsed since Faraday's discovery, the only investigators who have studied it from the dynamical point of view are Kelvin, 1856; Maxwell, 1873; and the present writer, 1917. The work of Kelvin and Maxwell was incomplete, yet extremely suggestive. In fact, since their investigations led to the explanation of the cause of magnetism outlined by me in 1917, and that cause is now definitely demonstrated, it is well to recall the reasoning of both Kelvin and Maxwell.

Kelvin inferred that »the magnetic influence on light discovered by Faraday depends on the direction of motion of moving particles«, and that »Faraday's optical discovery affords a demonstration of the reality of Ampère's explanation of the ultimate nature of magnetism« — corresponding to the wave-theory.

After discussing Rankine's hypothesis of molecular vortices, which he had himself developed at length, Kelvin finally concludes: »I think we have good evidence for the opinion that some phenomenon of rotation is going on in the magnetic field, that this rotation is performed by a great number of very small portions of matter, each rotating on its own axis, this axis being parallel to the direction of the magnetic force, and that the rotations of these different vortices are made to depend on one another by means of some kind of mechanism connecting them.« This is Kelvin's early description of what is now the wave-theory.

10. The Degree of Accuracy of the Law of the Inverse Squares for Gravitation and for Magnetism respectively.

(i) The accuracy of the law of the inverse squares for gravitation.

In AN 5048, p. 144-154, we have examined the degree of rigor which may be assigned the Newtonian law of the inverse squares, and found that whilst the law certainly is very accurate, yet the exponent is not accurate beyond the ten-millionth, or seventh decimal place.

(a) In the Astronomical Journal, vol. 14, 1894, p. 49, Prof. A. Hall considered the admissible change of exponent to account for the motion of Mercury's perihelion. After weighing the evidence carefully Hall adopted the modified law:

$$f = mm' / r^{2.00000016}. \quad (194)$$

This places the uncertainty in the seventh decimal place of the exponent; and it is impossible for us to deny the admissibility of such a change. For the whole matter was subsequently reviewed by Newcomb, (Astronomical Constants, 1895, p. 118) who adopted the same form of law, but carried the development to higher decimal places:

$$f = mm' / r^{2.0000001574}. \quad (195)$$

In my own examination of this question, AN 5048, p. 148, I find that when account is taken of Weber's law, with the small terms resulting from the propagation in time, the most probable exponent does not exceed the following:

$$f = mm' / r^{2.0000001046}. \quad (196)$$

Since the author prepared the second paper on the New Theory of the Aether, AN 5048, Dr. Grossmann of Munich, has very carefully tested the outstanding difference of $43''$ in the motion of Mercury's perihelion found by Newcomb, 1881, and finds, (AN 5115) that the true outstanding difference very probably lies between $29''$ and $38''$, but in no case will attain $43''$ per century, as so long assumed.

Now as the smaller terms in Weber's law amount to $+14.5$ for the motion of Mercury, it follows that with Grossmann's results the difference to be accounted for would be between $+14.5$ and $+23.5$ per century. This leads to residuals smaller than was used to get my exponent 2.0000001046, which was $[d\varpi]_{00} = +28.44$ (AN 5048, p. 148). And hence with Grossmann's outstanding motion, and Weber's law (this latter is necessary in any case), the exponent would be less than 2.0000001046, — the exact amount depending on the adopted centennial difference $[d\varpi]_{00}$ taken by me at $+28.44$.

Making fair allowances for the obvious uncertainty in this outstanding difference, I think it certain that the ten-millionth place of the exponent probably is accurate, namely:

$$f = mm' / r^{2+\nu}, \quad \nu = 0.0000001 \quad (197)$$

but the hundred-millionth place is in doubt by at least 3 units, so that:

$$\nu = 0.00000010 \pm 0.00000003. \quad (198)$$

The uncertainty in this exponent therefore is of the order of three one-hundred-millionths, and it is not easy to see how we can reach a conclusion authorizing a smaller value of this uncertainty.

Now in his address to the British Association in Australia, 1914, p. 316, Prof. E. W. Brown, of Yale University, estimates that the exponent in the law of gravitation does not differ from 2 by a fraction greater than $1:400000000 = 0.000000025$ — which is at least ten times smaller than the uncertainty indicated above. Brown's premises are open to grave objections, in that he assumed the Newtonian law to be quite rigorous, and adopted an oblateness of the earth of about $1:294$,

which is not admissible, (AN 5048, pp. 149-150), because in AN 5103-5104, I have shown that the most probable oblateness of the earth is 1 : 298.3.

The estimated higher accuracy of the law of attraction adopted by *Brown* therefore is not justified by the existing state of our knowledge. In fact the fluctuations of the moon continue to be so troublesome that calculations on the motion of the perigee do not give as exact a criterion for the exponent in the law of attraction as we formerly believed.

All we can do at the present time is to say that the exponent does not differ from 2 by more than about one-twenty-millionth of the whole, or 0.0000001, while the uncertainty is about three in the hundred millionth place, or ± 0.0000003 .

It follows from this line of reasoning that the law of gravitation is established with very great accuracy. It is by far the most exact of all the laws of nature, because astronomical observations extend over long ages, and the precision of the observations is very high for about two centuries. In the case of eclipses of the sun and moon the records are fairly complete for 3000 years, and thus they serve to check astronomical calculations back to the time of the Babylonians.

(ii) The accuracy of the law of the inverse squares for magnetism.

In the year 1914, I made a careful estimate of the accuracy assignable to the law of gravitational attraction in *Newton's* time, and found that it was of the order of one unit in the ten-thousandth place of the exponent, thus, $n = 2.0001 \pm 0.0001$.

It follows from the formulae for the calculation of the motion of the perihelion (cf. *Tisserand's Mécanique Céleste*, tome 1, p. 50), that the exponent 2.001 would give a displacement of a planet's perihelion amounting to $\delta\varpi = 648''$ in a single revolution. In the same way the exponent 2.0001 would yield a displacement of $64.8''$, a little over 1', which is about as high an order of accuracy as was attainable in *Newton's* time.

If now we turn to the law of magnetic attraction, we find a similar history of progress. In the time of *Newton* the law of magnetic attraction had not been determined, nor even surmised with any degree of probability. Accordingly, *John Michell* of Cambridge, England, in 1750, first showed roughly that the law of the inverse squares probably holds for magnetic attraction. This law was much more rigorously established by the French physicist *Coulomb*, in 1785, by means of delicate experiments with the torsion balance; and it has since been generally received as a true law of nature, so that we have $f = \mu\mu'/r^2$.

The general theory of magnetic attraction was subsequently improved by *Hansteen*, of Copenhagen (*Magnetismus der Erde*, 1819). Yet it is to *Gauss*, above all others, that we owe the real test of the law of magnetic attraction; for this great mathematician made a successful effort to fix the law of nature with a degree of rigor comparable to that of universal gravitation in the time of *Newton*.

Gauss carried out a series of end-on observations with bar magnets in which the density of the magnetism for either half of the bar was assumed to have the form:

$$f = \lambda x^n. \quad (199)$$

Gauss took the force due to an element of positive magnetism $d\mu$, at the distance D , to have the general form, (*Intensitas Vis Magneticae*, etc., 1833, § 21):

$$f = d\mu/D^n \quad (200)$$

where n may be any number whatever.

As the result of a long series of delicate experiments, on a magnetized needle, by means of fixed magnets about a foot long and weighing about one pound, he found that while various values of n may be almost equally well adopted for special cases; yet when the distance between the two magnets is sufficiently great, compared to the linear dimensions of either, — ultimately taken as more than four times as great, in the experiments finally devised by *Gauss*, — the best results indicated that the true value is $n = 2$.

If the deflexions in the end-on experiments were denoted by Φ , and in the broadside-on experiments by Φ' , the positions of the deflecting magnet are given by the general expressions:

$$\begin{aligned} \text{tg } \Phi &= L_1 r^{-(n+1)} + L_2 r^{-(n+2)} + \dots + L_i r^{-(n+i)} \\ \text{tg } \Phi' &= L'_1 r^{-(n+1)} + L'_2 r^{-(n+2)} + \dots + L'_i r^{-(n+i)} \end{aligned} \quad (201)$$

where $L_1/L'_1 = n$.

His observations, however, required but few terms of the series, and were satisfied by the approximate formulae:

$$\begin{aligned} \text{tg } \Phi &= 0.086870 r^{-3} - 0.002185 r^{-5} \\ \text{tg } \Phi' &= 0.043435 r^{-3} + 0.002449 r^{-5}. \end{aligned} \quad (202)$$

If r be the distance between the centres of the magnets, measured in metres, and Φ_o , Φ'_o , and Φ_c , Φ'_c be the observed and calculated values, respectively, the experiments of *Gauss*, lead to the following table of results:

r	Φ_o	$\Phi_o - \Phi_c$	Φ'_o	$\Phi'_o - \Phi'_c$
1.1 m			$1^\circ 57' 24.8''$	$+2.8''$
1.2			1 29 40.5	-6.0
1.3	$2^\circ 13' 51.2''$	$+0.8''$	1 10 19.3	$+6.0$
1.4	1 47 28.6	$+4.5$	0 55 58.9	$+0.2$
1.5	1 27 19.1	-9.6	0 45 14.3	-6.6
1.6	1 12 7.6	-3.3	0 37 12.2	-3.2
1.7	1 0 9.9	-5.0	0 30 57.9	-1.2
1.8	0 50 52.5	$+4.2$	0 25 59.5	-3.4
1.9	0 43 21.8	$+7.8$	0 22 9.2	$+2.6$
2.0	0 37 16.2	$+10.6$	0 19 1.6	$+5.9$
2.1	0 32 4.6	$+0.9$	0 16 24.7	$+4.9$
2.5	0 18 51.9	-10.2	0 9 36.1	-2.5
3.0	0 11 0.7	-1.1	0 5 33.7	-0.2
3.5	0 6 56.9	-0.2	0 3 28.9	-1.0
4.0	0 4 35.9	-3.7	0 2 22.2	$+1.7$

Those who have studied this subject carefully have found in the above table a double proof of the law of the inverse squares:

1. The fact that $\text{tg } \Phi$ and $\text{tg } \Phi'$ can be so accurately expressed by only the first two terms of the infinite series in (201).

2. The fact that the coefficient of the first term in $\text{tg } \Phi$, namely 0.086870, is exactly double that in $\text{tg } \Phi'$, which is 0.043435.

As a result of the great generality of this analytical theory, together with the novelty of the experimental method, for treating the law of force at great distances, where minor

imperfections in the magnets would be minimized, and the refinement of the observations made by *Gauss*, the law of the inverse squares has been regarded as definitely settled by his researches. Accordingly, it seems certain that the exponent in the expression for the law of magnetic attraction is 2, with a probable uncertainty of not more than one unit in the ten-thousandth place:

$$n = 2 \pm \nu \quad \nu < 0.0001 \quad (203)$$

or

$$n = 2.0000 \pm 0.0001.$$

Therefore, it appears probable that the exponent in the law of force in magnetic attraction is known to within about a thousandth part of the accuracy attainable in the refined theories of the heavenly motions developed by the labors of astronomers in the two centuries following the memorable epoch of *Newton*.

The law of magnetic attraction is therefore exceedingly accurate, and with modern apparatus, the refinement doubtless could be carried still further; but it would serve little purpose in the present state of science, as the true law of nature already is plainly indicated.

For it appears from the above analysis of the leading facts that the exponent in the law of magnetic attraction has about the value $n = 2.0001$, essentially identical with the accuracy $n = 2.0001$ attained in the test of the law of gravitation embodied in the *Principia* by *Newton*, 1687. If this degree of accuracy appeared satisfactory to *Newton*, in the case of gravitation, the accuracy attained by *Gauss* for magnetic attraction leaves very little to be desired.

II. Explanation of the Periodic and Secular Changes in the Earth's Magnetism, including the Cause of the Earth Currents, 'Magnetic Storms', and Aurorae.

In the theory of magnetism a considerable group of errors have been handed down by tradition. Although some of them have been refuted several years ago, they still continue to find place in even the latest treatises. It is therefore necessary to dwell at some length on these errors, in the hope of giving increased currency to valid views on this subject.

(i) Correction of the error in *Lloyd's* analysis of 1858: Direct magnetic action of the sun and moon established by *Lloyd's* observations.

In the *Philosophical Magazine* for March, 1858, Dr. *Humphrey Lloyd*, for many years professor of natural philosophy, and afterwards provost of Trinity College, Dublin, has a learned paper entitled: »On the direct magnetic influence of a distant luminary upon the diurnal variations of the magnetic force at the earth's surface«, which was afterwards reprinted in *Lloyd's* Treatise on Magnetism, (Longmans, Green & Co., London, 1874, p. 233-239).

We shall review *Lloyd's* paper briefly in order to point out the error of analysis which vitiates the conclusions drawn from it. These unjustifiable conclusions have been widely circulated in other works, such as the *Mathematical Theory of Electricity and Magnetism* (3rd ed., 1916) by Dr. *J. H. Feans*, now secretary of the Royal Society, and are detrimental to the progress of physical science.

Dr. *Lloyd* begins his discussion with the following interesting introductory remarks:

»It has been usual to ascribe the ordinary diurnal variations of the terrestrial magnetic force to solar heat, either operating directly upon the magnetism of the earth, or generating thermo-electric currents in its crust. The credit of these hypotheses has been somewhat weakened by the discovery of a variation which is certainly independent of any such cause, namely, the lunar variation of the three magnetic elements; while at the same time new laws of the solar diurnal change have been established, which are deemed to be incompatible with the supposition of a thermic agency. There has been, accordingly, a tendency of late to recur to the hypothesis that the sun and moon are themselves endued with magnetism, whether inherent or induced; and it is therefore of some importance to determine the effects which such bodies would produce at the earth's surface, and to compare them with those actually observed.«

»I have endeavoured, in what follows, to solve this question, on the assumption that the supposed magnetism of these luminaries is inherent. The result will show the insufficiency of the hypothesis to explain the phenomena; and will therefore bring us one step nearer to their explanation, by the removal of one of their supposed causes.«

He then derives the usual expressions for the total forces X, Y, Z , exerted by a needle delicately suspended about its centre of gravity upon a distant magnetic element m supposed to be in the heavens:

$$\begin{aligned} X &= (Mm/a^3) [2\cos\alpha + 3(b/a)\cos\beta + 3(c/a)\cos\gamma] \\ Y &= (Mm/a^3) [-\cos\beta + 3(b/a)\cos\alpha] \\ Z &= (Mm/a^3) [-\cos\gamma + 3(c/a)\cos\alpha]. \end{aligned} \quad (204)$$

Here M is an integral, which we need not explain, a, b, c are the coordinates of the distant magnetic element m , and α, β, γ the angles made by the axis of the suspended terrestrial magnet with the coordinate axes.

Lloyd then proceeds to substitute in these expressions, saying: »If D denote the distance of the centre of the magnet from the centre of the earth, r the earth's radius, λ the latitude of the point (a, b, c) on its surface, and θ the angle contained by the meridian passing through it with that containing the acting magnet,

$$a = D - r \cos\lambda \cos\theta \quad b = r \cos\lambda \sin\theta \quad c = r \sin\lambda. \quad (205)$$

He thus makes the coordinates a, b, c to depend on the hour angle θ , and thus tacitly restricts all changes to the period of the diurnal movement. His analysis is so framed as to exclude the possibility of a semi-diurnal movement of the suspended needle. Yet he proceeds to examine the effect of his analysis, finally adding the following conclusions:

»1. That the effect of a distant magnetic body on each of the three elements of the earth's magnetic force consists of two parts, one of which is constant throughout the day, while the other varies with the hour-angle of the luminary.«

»2. Each of these parts varies inversely as the cube of the distance of the magnetic body.«

»3. The variable part will give rise to a diurnal inequality, having one maximum and one minimum in the day, and subject to the condition:

$$A_0 + A_{\theta+\pi} = 0.$$

»The third of these laws does not hold, with respect either to the solar-diurnal or to the lunar-diurnal variation. Thus, in the solar-diurnal variation of the declination, the changes of position of the magnet throughout the night are comparatively small, and do not correspond, with change of sign only (as required by the foregoing law), to those which take place at the homonymous hours of the day. The phenomena of the lunar-diurnal variation are even more opposed to the foregoing law, the variation having two maxima and two minima of nearly equal magnitude in the twenty-four lunar hours, and its values at homonymous hours having for the most part the same sign. Hence the phenomena of the diurnal variation are not caused by the direct magnetic action of the sun and moon.«

This is one of the most curious specimens of deceptive reasoning which I have ever met with in physical science. If *Lloyd* had used the angle 2θ instead of θ , in the polar expressions for the coordinates a, b, c , so that $a = D - r \cos \lambda \cos 2\theta$ $b = r \cos \lambda \sin 2\theta$ $c = r \sin \lambda$ (206) it is evident that the disturbing action resulting would have had a semi-diurnal period, in accordance with magnetic observations, and with gravitational action in the theory of the tides of our seas.

In the theory of our ocean tides, the angle 2θ is used to represent the semi-diurnal forces acting on the sea (cf. *Darwin's* article Tides, *Encycl. Brit.*). The reader is also referred to the discussion in AN 5079, pp. 267-270, where *Darwin's* figure of the semi-diurnal movement of a pendulum will be found useful, in interpreting the following magnetic observations by *Lloyd* himself:

Lunar inequality of the easterly force (η) at Dublin (*Lloyd*, p. 197).

Lunar hours	η = easterly force summer lunations	η = easterly force winter lunations	year
-12	-0.19	-0.09	-0.14
-10	-0.21	-0.08	-0.15
-8	-0.06	+0.02	-0.02
-6	+0.09	+0.09	+0.09
-4	+0.12	+0.13	+0.13
-2	+0.08	-0.01	+0.03
0	-0.06	-0.09	-0.08
+2	-0.04	-0.07	-0.05
+4	+0.05	-0.02	+0.01
+6	+0.17	+0.08	+0.12
+8	+0.06	+0.07	+0.07
+10	0.00	-0.05	-0.03

Lunar inequality of the northerly force (ξ) at Dublin (*Lloyd*, p. 199).

Lunar hours	ξ = northerly force summer lunations	ξ = northerly force winter lunations	year
-12	-0.06	+0.01	-0.03
-10	-0.01	+0.02	+0.01
-8	+0.08	+0.07	+0.07
-6	+0.04	+0.05	+0.04
-4	-0.02	0.00	-0.01
-2	-0.03	+0.04	+0.01
0	-0.01	+0.02	+0.01
+2	0.00	+0.05	+0.08
+4	+0.08	-0.03	+0.03
+6	-0.01	-0.03	-0.02
+8	-0.10	-0.12	-0.11
+10	-0.08	-0.07	-0.08

Lunar inequality of the vertical force (ζ) at Dublin (*Lloyd*, p. 200).

Lunar hours	ζ = vertical force	Lunar hours	ζ = vertical force
-12	+0.05	0	+0.02
-10	+0.00	+2	+0.02
-8	0.00	+4	-0.01
-6	-0.02	+6	-0.06
-4	-0.07	+8	-0.01
-2	+0.10	+10	+0.01

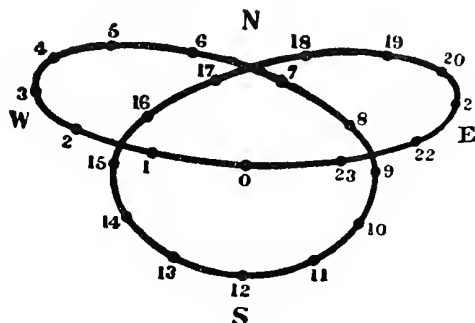


Fig. 6. *Darwin's* diagram of the semi-diurnal motion of a pendulum, with the hours indicated, latitude 30° .

(ii) Discovery of the magnetic tide by *Kreil* at Prague, 1841, and by *J. A. Brown* independently, 1845: *Remarks of Airy*.

The discovery by *Kreil*, 1841, that there is a true tide in the earth's magnetism, depending on the moon, has long been recognized, and need not be fully discussed here. It suffices to refer to *Stewart's* elaborate discussion of Terrestrial Magnetism in the article *Meteorology*, *Encycl. Brit.*, 9th ed.

The existence of this true magnetic tide depending on the moon, was independently discovered by *J. A. Brown*, 1845, and fully confirmed by the elaborate magnetic researches of *Sabine*. The fact of the magnetic tide therefore has been known for about eighty years; yet it has never been explained except by the new theory of magnetism here set forth, and depending on the equations for the ponderomotive forces:

$$F = \mu\mu'/s^2 - \mu\mu'/s'^2, \quad F' = \mu\mu'/s'^2 - \mu\mu'/s^2. \quad (207)$$

When attention was directed to the effect of the changing distance of the moon from the earth, both *Sabine* and *Brown* found the observed changes greater for perigee than for apogee. In fact when *Brown* made an exact analysis of the mean ratio of the apogee effect to the perigee effect, he found it to be as 1 to 1.24 nearly. Examining into the cause of this difference he noticed that the distance of the half orbit near apogee is to that near perigee very nearly as 1.07 to 1.

Brown then adds that tidal forces vary as the cube of the distances, and the cube of 1.07 is 1.23 nearly. As this inference from analytical theory thus agrees very perfectly with observations, he was left in no doubt as to the reality of the suspected tide in the earth's magnetism depending on the moon.

Although a true tide in the earth's magnetism has been known for over 80 years, it is a singular fact that investigators have had great difficulty in interpreting the meaning of these tides. We believe that most of the difficulty has arisen from traditional errors in the theory of magnetism itself, as we shall now proceed to explain.

It appears that among all his eminent contemporaries *Airy* alone — probably as the result of his great work on *Tides and Waves*, — was able to interpret the magnetic tides of the earth correctly. In his *Treatise on Magnetism*, 1870, p. 206, *Airy* recognized »a true lunar tide in magnetism, occurring twice in the lunar day, and showing magnetic attraction backward and forward in the line from the Red Sea to Hudson's Bay«.

In view of the cause of magnetism set forth in the present paper it would be difficult to overrate this analysis of *Airy*. First, he assigned to a magnet a »Duality of Powers«, — an attraction towards the two centres known as the poles — and second, he says distinctly that the force of the earth's magnetism directed to the north pole near Hudson's Bay is variable along the line of the magnetic meridian directed through Western Europe to the Red Sea.

In our new theory of the ponderomotive forces of the earth's field, we found the formulae:

$$F = \mu\mu'/s^2 - \mu\mu'/s'^2, \quad F' = \mu\mu'/s'^2 - \mu\mu'/s^2. \quad (207)$$

Now if under the radiation of the moon or sun any action is exerted upon the earth to change the relative intensity of either pole, the forces F and F' will vary correspondingly. Under these circumstances the ponderomotive forces cannot possibly remain constant; and the result necessarily is a true lunar magnetic tide occurring twice daily, according to which ever pole temporarily is most powerful, thus showing magnetic attraction backward and forward in the line from the Red Sea to the north magnetic pole near Hudson's Bay.

In the case of the sun the changes of the earth's magnetic field due to heat and the magnetic waves in the earth's illuminated hemisphere are so very considerable that the phenomena are somewhat involved. In the case of the moon's action the effects are simpler, though much feebler.

Airy adds that the lunar magnetic forces are considerably less than those which follow the law of solar hours; the mean diurnal solar inequality being about $1/600$ of the horizontal force, while the lunar is only $1/12000$. Thus the solar influence is approximately 20 times more powerful than that due to the moon. This result need cause no surprise in view of the recently measured high intensity of the sun's magnetism.

(iii) The cause of Earth Currents, 'Magnetic Storms', and the Aurorae.

The explanations of the Aurora Borealis heretofore put forth are artificial, incomplete or unsatisfactory. They all involve something unusual, or out of the ordinary, and therefore must be rejected as inconsistent with the simplicity of the laws of nature.

We propose to develop the magnetic wave-theory of the Aurora, and shall endeavor to show that this phenomenon may be easily understood as soon as we approach the problem from the right point of view.

1. About 1850 it was shown by *Lamont*, *Wolf*, *Gautier* and *Sabine* that there is some extraordinary dependence of the amplitude of the magnetic disturbances, or 'Magnetic Storms', of our globe upon sunspots. The amplitudes of the magnetic disturbances follow the same law as the sunspots, in a cycle of about 11 years.

2. But although this periodic magnetic connection has been known now over 70 years, and we might properly have attributed high magnetic power to the sun, yet we could not make out the mode of operation of the magnetic forces, even after the Mount Wilson observers, about 1908, had obtained a better and more direct proof of the intense magnetism of the sun's globe.

3. We pause therefore to unfold a clear view of the disturbance known as an electric current when it is developed in a dynamo of the simplest type. In AN 5079, plate 6, we have explained in some detail the wave field about a wire bearing a current. In the accompanying fig. 7, therefore, we

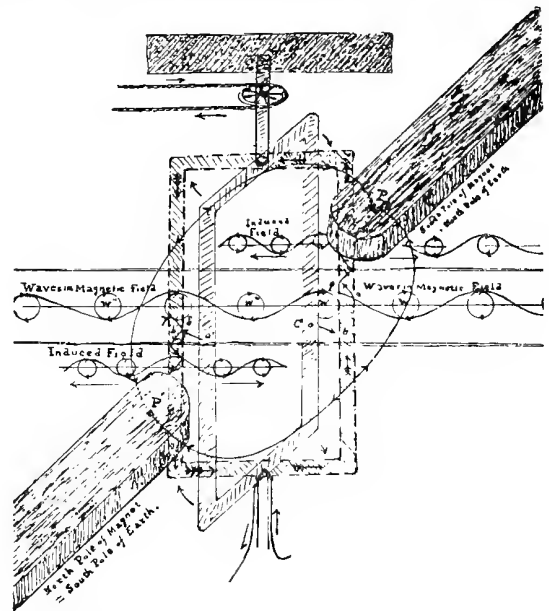


Fig. 7. Generation of electric current by relative motion in a wave-field.

show in the middle section of the figure the nature of the waves of the magnetic field. The waves are to be conceived as traveling in every direction with the velocity of light. What, then, will happen when a loop of wire — which may be viewed as a section of an armature or core — revolves in such a wave field?

4. We know that induction takes place, so that a current tends to be generated and will flow steadily in one direction if the wave-disturbance is properly led off in a wire forming a closed circuit. To get a clear view of this induction process, we need only note that as the wire has both inductance and capacity, any motion of the wire in the wave-field, or any motion of the wave-field relatively to the wire, will produce the induction required to develop the current. By the motion of the wire, or of the wave-field relatively to the wire, the electric equilibrium in the wire is disturbed, as when it moves between the magnetic poles P and P' .

5. Suppose, for example, the copper wire C to move from a to b . At such a point as a the equilibrium of the aether will be disturbed. Under the action of the vortices in the external free aether, those within the wire will tend

to be forced upward, owing to the approach of the wire towards the whirl w . At the point β , on the other hand, the wire recedes from the whirl w' , and owing to the enormous elasticity of the aether a suction effect will result, by virtue of which the aether in the wire at β will also tend to be forced upward. Thus, owing to these relative motions, the disturbances at α and β combine to produce a wave disturbance upward in the wire as shown, which is similar to that given in AN 5079, Tafel 6, for a current.

6. But as a current requires a circuit, we must next consider what is the effect of the motion of the wire on the opposite side, $\alpha' \beta'$. At the point γ the disturbance of the aether due to the vortex w'' , will be downward, for reasons similar to those assigned above. At δ , on the other hand, the wire is receding from the vortex w'' , and under the high elasticity of the aether, the resulting suction effect will be such as to also direct the disturbance downward. Thus at both γ and δ there is a combination of downward disturbances; and therefore a tendency to develop the electric oscillations or current shown in the diagram, and recognized as a current in AN 5079, Tafel 6.

7. This combination of electric oscillations tending upward on the right, and downward on the left of the wire loop, is the basis of the induced current discovered by *Faraday* in 1831. The rule about »cutting the lines of force« is a very good rule of thumb for artisans and mechanics; but it gives no intelligent view of what actually goes on. Thus we have outlined the process from the point of view of the highly elastic medium the aether is known to be.

8. And we have explained how the relative motion of the wire in respect to the magnetic field filled with vortices must necessarily create about the wire the wave-field called a current. The magnetic vortices, being elements of the magnetic waves, may be conceived as moving with the velocity of light in free space; yet as they are perpetually renewed in situ, they act as if they were stationary relatively to the magnetic poles upon which they depend.

9. As we pointed out above, any motion of the fixed wave-field, or any marked variation of the wave-field, in respect to the wires, will give rise to electric disturbances which might be made the basis of an electric current, if properly led off and directed. We have now to draw attention to the well known fact that the sun's magnetic wave field is quite variable. The magnetic wave disturbances are much worse when sunspots are present than when these spots are absent. As the spots are known to be vortices of highly magnetized matter, we see that the magnetic waves coming from these local areas of the solar surface are the immediate cause of the »Magnetic Storms«. This connection is abundantly established by the researches of astronomers during the past 75 years.

10. In the *Phil. Trans.*, vol. 166, p. 387, *John Allen Broun* found from magnetic phenomena that there was a period of recurrence in the magnetic disturbances of about 26 days, — the period of the solar rotation, — and expressed the belief that certain zones or areas of the solar surface might exert a potent influence on the state of the earth's magnetism during several rotations. In 1904, (MN 65,

pp. 2 and 538), *E. W. Maunder* reached similar conclusions, without knowledge of *Broun's* earlier work. *Maunder* made the period to be 27.28 days, coinciding with the sun's rotation relatively to the observer upon the earth. Mr. *Maunder* regarded his results as demonstrating that the larger magnetic disturbances of the earth originate in the sun; and considered the action as propagated along narrow well defined streams, having their bases in active areas of sunspots, yet possibly preceding and outliving the spots themselves.

11. *Young's* observations of the violent magnetic tremors near the time of the total solar eclipse in Colorado, 1872, are well known, but as his account is instructive we quote it briefly:

»On August 3, 1872, the chromosphere in the neighborhood of a sun-spot, which was just coming into view around the edge of the sun, was greatly disturbed on several occasions during the forenoon. Jets of luminous matter of intense brilliance were projected, and the dark lines of the spectrum were reversed by hundreds for a few minutes at a time. There were three especially notable paroxysms at 8^h45^m, 10^h30^m, and 11^h50^m a. m. local time. At dinner the photographer of the party, who was determining the magnetic constants of our station, told me, without knowing anything about my observations, that he had been obliged to give up work, his magnet having swung clear off the scale. Two days later the spot had come around the edge of the limb.«

Young's observations extended over the next two days, and when he afterwards wrote to *Airy* and *Perry* in England, he was surprised to find from their photographs that the needles at Greenwich und Stonyhurst had shown violent tremors, just like that noted in Colorado, and at the same instant of Greenwich mean time, within 10 minutes, — the time in Colorado not having been noted with any great precision.

12. The accompanying Plate 7 of simultaneous magnetic disturbances throughout the world, reduced to Greenwich time, is from a paper by Prof. *W. G. Adams*, in the *Phil. Trans.*, for 1892, A, Plate 8. After examining this record, it is useless to extend our present argument any further.

But whilst the relationship of Sunspots to 'Magnetic Storms', Earth Currents, Aurorae, is long recognized from well defined phenomena of periodicity, the nature of the undoubted connection continues so very obscure that we must carry the examination a little further.

In his *Treatise on Magnetism*, 1870, p. 204 *Airy* says:

»The periods of great disturbance sometimes occupy a portion of a single day, sometimes several days in succession: they are familiarly known by the name of 'magnetic storms'. They are not connected with thunder-storms or any other known disturbance of the atmosphere; but they are invariably connected with exhibitions of Aurora Borealis, and with spontaneous galvanic currents in the ordinary telegraph wires: and this connection is found to be so certain that, upon remarking the display of one of the three classes of phenomena, we can at once assert that the other two are observable (the Aurora Borealis sometimes not visible here, but certainly visible in a more northern latitude).«

Conclusions as to the Cause of the Earth Currents, 'Magnetic Storms', Aurora Borealis and Aurora Australis.

1. From the above argument it follows that the sun's magnetic wave-field is variable, owing to the changes associated with the sunspot development. Variability in the sun's magnetic wave field leads to variability in the inductive actions of these waves upon the earth; and as our globe has both inductance and capacity, the result is electric disturbances adjusting themselves within the globe, which is a heterogeneous mass three fourths covered by sea, and surrounded by an atmosphere well suited to Geißler tube discharges.

2. It is easily shown by experiments on land, especially near the sea, that very considerable differences of electric potential always exists in the ground, and is in constant dissipation and adjustment. The solid heterogeneous earth, sea and sky are under perpetual adjustment of the equilibrium of their respective wave-fields; and as the inductions due to the sun are variable, we see that there will arise a true magnetic tide pulling backward and forward from the Red Sea to Hudson's Bay, whenever the solar inductions take place in such a way as to change the two poles of the globe of the earth or of the sun. If these changes are rapid and violent we frequently have a form of lightning in the upper atmosphere:

$$F = \mu\mu'/s^2 - \mu\mu'/s'^2, \text{ Aurora Borealis.} \quad (208)$$

$$F' = \mu\mu'/s'^2 - \mu\mu'/s^2, \text{ Aurora Australis.} \quad (209)$$

3. These simple considerations perfectly explain the earth currents, and the 'magnetic storms', and we may dismiss these two classes of phenomena as now referred to their true cause. For the sun is variable in its action, owing to spot development and rotation, and thus has variable poles, μ und μ' , while the earth also rotates steadily; yet its poles μ' and μ'' are variable, because the changing light hemispheres are successively subjected to an extremely variable induction by the sun's action. Accordingly the earth currents and 'magnetic storms' immediately follow from the above formulae.

4. As for the aurora, it was remarked by *Halley* in the *Phil. Trans.*, for 1714-1716 (vol. XXIX, no. 341), that this brilliant northern light is a magnetic phenomenon. Perhaps *Halley* was influenced in his conclusions, as more modern investigators have been, by the observed fact that the streamers of the aurora are parallel to the lines of force of the earth's magnetic field. The argument from the parallelism of the streamers to the magnetic lines of force and from the periodicity of the aurora coinciding with that of the 'magnetic storms', earth currents and sunspot development is all that is required to show that the aurora depends upon electric discharges in our atmosphere. The streamers take on faint luminosity along the lines of magnetic force, because the magnetic state of the earth is varying, under the irregular inductive action of the sun, which operates most directly upon the light hemisphere; yet as the night hemisphere of the earth is magnetically a part of the earth's entire system, the dissipation of uncompensated magnetic wave-energy is likely to become visible chiefly by night.

5. In *Lowell Observatory Bulletin* no. 79, June to November, 1916, Dr. *Slipher* has shown that the aurora usually is present in the sky near the horizon, even by daylight. This

is because the air near the horizon is of greatest depth, and thus on the photographic plate the persistence of the auroral rays may become visible in spite of its invisibility to the eye. In high latitudes, especially about the cold poles of our globe, the atmospheric electric potential of the air tends to fall, as *Exner* showed, on the average fifteen times more rapidly than in the equatorial regions of our globe. Thus in cold regions the rapid fall of the electric potential offers an easy release for wave stress in the air when the particles of cirrus and similar clouds are undergoing rapid condensation. Thus electric discharges at great height do not take the form of lightning directed to the earth, but of faintly luminous streamers.

6. Now if we consider the new theory of lightning and of surface tension given in the fifth paper, AN 5130, we perceive that liquid drops, or even globules of ice suspended in a frozen cirrus cloud, under the influence of the earth's magnetic field, would not have the aether stress at the surface exerted with perfect symmetry, but there would be a north and south polarity in the globules, owing to the unsteadiness in the earth's magnetic forces. If this stress yielded to a slight electric rupture, under the wave impulses of the earth's magnetism, the release of energy would generate an agitation yielding luminous streamers in the direction of the magnetic lines of force, as in the aurora. Since the magnetic stress is greatest to the north, the rays often would start there and flash southward, which explains the auroral streamers perfectly, without the introduction of any arbitrary hypothesis. So simple a theory leaves nothing to be desired; without strain it explains all the auroral phenomena of the two terrestrial hemispheres.

7. The folded ribbon bands so often seen in the aurora are perspective shadow effects, produced mainly by alternations of luminous and non-luminous clouds, somewhat analogous to the beams, with truncated columnar aspect, often seen in the sky at sunset or sunrise; yet just as the sources of the auroral light are more hidden than in the case of the sun, so the auroral truncated bands or folded curtains thus are more mysterious than what we see produced by the sun's visible illumination.

8. During the brilliant aurora observed at Mare Island, California, May 14, 1921, I saw the streamers forming very distinctly in several parts of the sky where the clouds were just forming and dissolving. When a faint cloud became visible, yet was not luminous, I found, by watching, that it often would soon exhibit faint streamers running parallel to the earth's magnetic lines.

Thus I am convinced that the light energy of the aurora is wave-energy, which in lower clouds frequently takes the form of lightning directed to the earth; but in the region of the cirrus, where the air is very rare, is released by slight oscillatory changes in the earth's magnetic forces. The aurora is a kind of sheet lightning of the upper atmosphere, and therefore the luminous streamers take the direction of the lines of force in the earth's magnetic field. To this extent *Halley's* bold conjecture of 1714 is correct. A more detailed account of the brilliant aurora observed May 14, 1921, will be found in AN 5140, p. 81.

(iv) The secular changes in the earth's magnetism.

It only remains to consider the secular changes of the earth's magnetism. Here, unfortunately, we are on uncertain

ground, owing to the absence of any well defined criteria to show the cause at work.

1. It was stated by *Airy* that the magnetic north pole probably is revolving around the geographical pole; but after a critical survey of the known data for the south magnetic pole, in section 5 above, we are unable to find definite evidence of any shifting whatever of the earth's magnetic poles. And as the poles appear to be fixed, — if we judge by that in the Antarctic, for which the observed data are most complete — we have been obliged to conclude that the surface secular changes in the earth's magnetism depend mainly on induction effects due chiefly to the sun, as in *Arago's* rotation experiment of 1825.

2. Since the sun is a strongly magnetized body, there would arise in our globe some eddy currents of considerable intensity; and as the eddy currents for astronomical reasons would recur with approximate regularity in the same direction, for a long time, over considerable areas, it is likely that a very considerable secular change in the magnetic forces near the surface would gradually result. This is the only tangible explanation of the secular changes known to me.

It has the element of simplicity in its favor, and we know that considerable differences of electric potential do really exist in regions very near each other: therefore it seems probable that an adjustment of the planes of the atomic equators would gradually occur so as to shift the direction of the magnetic lines in the same direction; then, later, by mutual reaction upon other masses, the oscillation might go in the other direction.

3. But as the »magnetic domains« of the earth are very unequal in size and intensity, it is probable that the secular changes would be slow and ill-conformed to one uniform rule. The fact is that they are quite confused, some clockwise, others counter-clockwise. Hence this about corresponds to the observed secular changes in the earth's magnetism. Great as these changes become with the lapse of centuries, they evidently do not belong to the poles, which apparently are not shifting. We can only explain the secular changes by the theory of comparatively shallow *Arago* eddy currents. To this hypothesis there is not the slightest objection, yet we must derive the secular changes wholly from observation.

12. Magnetic Attraction depends on a Duality of Powers, and is therefore directed along Curved Lines towards Two Poles, while Gravitational Attraction is directed straight towards a Single Centre of Gravity: Simplicity of the General Laws of Nature.

(i) The connection and the difference between magnetism and gravitation.

It is now clearly shown that magnetism depends on a duality of powers, and therefore the mutual attraction between two magnets is directed along curved lines, according to the formulæ for the ponderomotive force:

$$F = \mu\mu'/s^2 - \mu\mu'/s'^2 \quad F' = \mu\mu'/s'^2 - \mu\mu'/s^2. \quad (210)$$

In this respect magnetism is totally unlike the simpler stress of gravitation resulting from the haphazard arrangement of the atomic planes, yet yielding a single force directed in a right line towards the centre of gravity:

1. Gravitational attraction

$$f = mm'/r^2. \quad (211)$$

2. Magnetic total intensity, or aether stress

$$I = \mu\mu'/s^2 + \mu\mu'/s'^2. \quad (212)$$

It is justly remarked that for a full century investigators have fought shy of searching for the cause of magnetism. The result was so unsatisfactory to physical science that in the later years of his life *Helmholtz* is said to have remarked that our failure to discover the cause of magnetism was the disgrace of the 19th century. Certainly the need for such research has long been felt as a most urgent desideratum of science, and yet little or no progress was made, owing to the confused state of the subject.

Now that a way is opened for referring all the chief forces of nature to wave-action in the aether, we must be careful not to allow attention to be diverted from so fruitful a line of inquiry. There need be, for example, no discussion of the irregularities of the earth's magnetism; we have known of these irregularities all along, but had not perceived the harmonic law connecting the earth's total magnetic force with terrestrial gravitation.

The new method has enabled us to reach the harmonic law:

$$I/g = \eta^2 (r^2/s^2 + r'^2/s'^2) \quad \eta = 1/1408.12 \quad (213)$$

thus accurately connecting the total intensity of magnetism with gravity throughout the globe. It has enabled us to calculate the total quantity of magnetism in the sun, and to connect the total force of this magnetism at the sun's surface with the known force of solar gravitation by a similar equation

$$I_0/g_0 = \eta_0^2 (r_0^2/s_0^2 + r_0'^2/s_0'^2) \quad \eta = 1/157. \quad (214)$$

Such a law evidently is in the highest sense a true law of nature. Indeed it has all the generality of the law of gravitation itself. The new law can be applied wherever the intensity of the magnetization is known in units of that observed in the earth or in the sun.

Obviously a similar equation will hold for Jupiter, Saturn or Mars, yet up to this time we have no observed data for fixing the intensity of the magnetization in Jupiter, Saturn or Mars compared to that in the earth or sun. However, just as *Kepler's* law of planetary motion about the sun: $a^3 : a'^3 = t^2 (M+m) : t'^2 (M+m')$ $M = 1$, usually, (215) was generalized for the planets and double stars of mass $M_1 + m_1$, in the form:

$$(M+m) : (M_1 + m_1) = a^3/t^2 : a_1^3/t_1^2 \quad (216)$$

so also at the surface of any cosmical body the law connecting magnetism with gravitation becomes:

$$I_v/g_v = \eta_v^2 (r_v^2/s_v^2 + r_v'^2/s_v'^2). \quad (217)$$

It seems probable that the magnetization in a body like Jupiter someday may be determined by observation. Even now we may approximate the magnetic component η_j . For since the mass of this great planet lies between that of the sun and earth, we should expect η for Jupiter to lie between 1/1408 and 1/157, thus

$$1/157 > \eta_j > 1/1408. \quad (218)$$

And similar reasoning would apply to Saturn, Uranus, and Neptune. In the case of Mars, on the other hand, we should expect the magnetization to be less intense than in the case of the earth; so that we should have

$$1/1408 > \eta_M. \quad (219)$$

And as the mass of Mars is only about 0.1 of the earth's mass, it would not be unexpected if the magnetization of that small planet should prove to be approximately:

$$\eta_M = 1/14080, \text{ or } \eta_M = 1/12000. \quad (220)$$

The magnetization of Venus, by similarity of causes, probably would be comparable with the earth's, and thus very nearly the same as our well determined value $\eta = 1/1408$. Thus the problem of cosmical magnetism takes on new interest in all directions.

There are too many questions as yet unexplored for us to dare to hope to solve all of them in a perfectly simple manner; yet when a way is once opened for a solution, there will eventually appear the investigator who will traverse this unexplored path, just as has happened in extending the dominion of the law of gravitation over the unexpected celestial phenomena discovered since the time of *Newton*.

It is remarkable that at last we have reached a great law of nature connecting magnetism with gravitation, in spite of the remarkable difference in the two forces; and that we are able to refer both of these forces of nature to wave-action in the aether. By this harmonic law geometrically connecting the haphazard wave-action in gravitation, which has the force directed towards a single centre, with the systematic wave-action in magnetism, yielding a duality of powers, or forces directed to two centres, the argument for the cause assigned to either force separately is vastly strengthened.

If for example, the probability be very great in favor of either hypothesis separately, so that the chance of any other result practically vanishes, as happens when the limits α and β are indefinitely near together, in the probability integrals:

$$\int_{\alpha}^{\beta} e^{-h^2 x^2} \cdot dx = 1/n, \quad \int_{\alpha'}^{\beta'} e^{-h'^2 x'^2} \cdot dx' = 1/n', \quad (221)$$

$$C \int_{-\infty}^{+\infty} e^{-h^2 x^2} \cdot dx = 1$$

n and n' being very large numbers. And if the two causes at work, as now happens, are connected by the verified harmonic law, then the probability of the compound event, or common cause, for both of the phenomena of magnetism and gravitation being jointly due to wave-action, becomes the reciprocal of the product of these probabilities, when each one has infinitely narrow limits, namely:

$$P = \int_{\alpha}^{\beta} e^{-h^2 x^2} \cdot dx \int_{\alpha'}^{\beta'} e^{-h'^2 x'^2} \cdot dx' = \left[\frac{1}{n} \cdot \frac{1}{n'} \right] = 1/\infty^2. \quad (222)$$

Thus the probability becomes an infinity of the second order, like all the points in an infinite plane to one, that if wave-action underlies either magnetism or gravitation, the same cause underlies both classes of phenomena.

Now the processes involved in gravitation are not directly perceptible to our senses, and thus somewhat obscure. It is not so, however, with the cause of magnetism, — which is

profoundly illuminated by *Faraday's* experiment of 1845, on the rotation of a beam of polarized light, and by a whole train of phenomena in magneto-optics; by the great body of phenomena in electro-dynamics; and finally by the vast array of phenomena in wave motion, especially collected together in figure 4 of this paper, and the six preceding papers on the New Theory of the Aether.

The complete accord of all these magneto-optical phenomena with the undulatory theory in general thus yields another independent probability:

$$p = \int_{\alpha''}^{\beta''} e^{-h''^2 x''^2} \cdot dx'' = 1/n'' \quad (223)$$

And the reciprocal of the compound probability of all these causes

$$Pp = \int_{\alpha}^{\beta} e^{-h^2 x^2} \cdot dx \int_{\alpha'}^{\beta'} e^{-h'^2 x'^2} \cdot dx' \int_{\alpha''}^{\beta''} e^{-h''^2 x''^2} \cdot dx'' =$$

$$= \left[\frac{1}{n} \cdot \frac{1}{n'} \cdot \frac{1}{n''} \right] = 1/\infty^3 \quad (224)$$

when the limits of the integrals are narrowed indefinitely, therefore is the chance which supports the wave-theory. Accordingly, the ratio of all the points in infinite space to one represents the probability that magnetism and universal gravitation are due to the common cause of wave-actions in the aether.

(ii) Defects in the theory of magnetism handed down by tradition from the days of *Robert Norman*, 1576; *Gilbert*, 1600; and *Euler*, 1744.

In the Third Paper, AN 5079, p. 244-247, we have given a brief notice of the defective theory adopted by *Euler*, 1744, who regarded the aether as circulating through the axis of a magnet from the south to the north pole, like the blood flowing through the arteries in one direction only, thus returning to the south pole through free space, along the magnetic lines of force. Figure 3, Tafel 4, AN 5079, illustrates *Euler's* theory according to be original diagrams of his *Opuscula*, vol. III, Berlin, 1744, plate 1.

The principles thus adopted by *Euler* gave an unfortunate bias to thought in magnetism, and although in later treatises they are somewhat modified so as to conform to modern thought, yet the whole trend of the reasoning in this subject has continued to be on an unsound basis. The usual habit of describing the *Eulerian* circuit from the north to the south pole as »the path of a unit north pole«, is criticised in AN 5079, p. 247 as »unscientific and a very imperfect makeshift«, — the mildest criticism, consistent with truth, which could be made.

But prior to *Euler's* time certain defects were current which had been handed down from the days of *Robert Norman*, 1576:

1. That magnetization does not change the weight of a body; that by the action of the magnetic forces there is no tendency to a motion of translation.

2. Hence the earth's magnetic action is directive only, being due to a couple.

None of these claims are strictly true, because one magnet exerts upon another the following ponderomotive forces

for the northern and southern hemispheres respectively:

$$F = \mu\mu'/s^2 - \mu\mu'/s'^2; \quad F' = \mu\mu'/s'^2 - \mu\mu'/s^2. \quad (225)$$

And thus the earth does exert upon a magnet, suspended by a thread through its centre of gravity, a slight deflecting effect; yet it is difficult to observe it experimentally, owing to the force of gravitation exceeding the magnetic force in a ratio of about 1000000 to 2000000 times.

At the earth's magnetic poles, a piece of steel suddenly converted into a magnetic needle would be under two forces: (a) ordinary gravitation, (b) terrestrial magnetism, having a strength of about $1/1000000$ of gravitation. As both forces work in the same vertical direction it seems certain that the magnetized steel would weight a little more after magnetization than before, though the change of weight would be small.

We may safely reach this conclusion by observing that if a steel needle or piece of soft iron is suspended by a thread over the pole of a strong steel magnet, the downward pull on the thread is certainly greater in this position above the magnet, than when the strong steel magnet is removed. I have often tried the experiment, and found the effect very noticeable. What is true of a magnetized needle suspended above a magnet therefore is true of a magnetized piece of steel at the earth's magnetic poles. For the downward pull due purely to gravity would be slightly increased by the purely magnetic action of our globe.

The defect in *Norman's* reasoning, in regard to the earth's magnetic action being directive only, need not be discussed at length, because we have seen that the ponderomotive force does really exist, and vary from place to place; yet the change from place to place is slow, owing to the size of the earth, and the great length of the curved lines s and s' .

It only remains to recall a diagram originally given in *Gilbert's* work *De Magnete*, 1600, as follows.

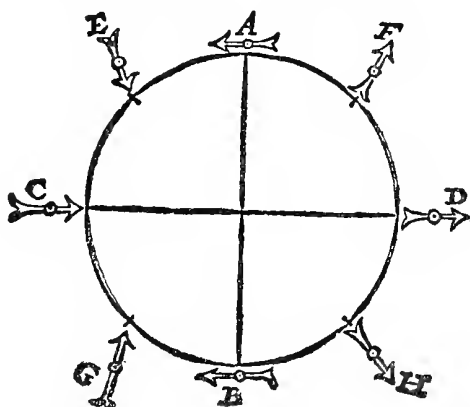


Fig. 8. Diagram from *Gilbert's De Magnete*, 1600, showing the directions taken by the south-seeking pole of a magnetic needle at various places on the earth. This appears to have been the precursor of *Euler's* defective theory of 1744, (AN 5079, Tafel 4, Fig. 3.) that the aether flows in at the south pole, and out at the north pole, circulating like the blood in the arteries in one direction only.

This figure is from *Mottelay's* excellent English translation of *Gilbert's* work, John Wiley & Sons, New York, 1893, p. 282. The points C and D here correspond with *Euler's*

Bd. 217.

south pole and north pole, A and B , and thus it may be that *Euler's* diagram of 1744 had its inspiration in an earlier diagram of *Gilbert*, 1600.

Accordingly the defects in the traditional theory of magnetism doubtless arose originally from the way the south-seeking pole points when brought to the earth's poles. It represents this pointing phenomenon faithfully, but gives us no idea of the correct theory of magnetism, as now expressed by the formulae for the ponderomotive force in the observed mutual action of two magnets.

In AN 5079, p. 247, we have called attention to *Maxwell's* indistinct reasoning, in his address on Action at a Distance, respecting the push and pull forces between a magnetic needle and a wire bearing a current, as in *Oersted's* experiment. Thus it only remains to formulate an expression for the ponderomotive force by which the magnetic needle is drawn to the wire, as follows:

$$F = \mu \alpha i / r + \mu \alpha i / r \quad (226)$$

where μ and μ' are the strengths of the two poles of the magnetic needle, α is a constant, i the strength of the current, and r the shortest radial distance of the poles from the axis of the wire.

Biot and *Savart's* law of 1820 (AN 5079, p. 255), corresponds to the above form of expression; and as the needle acts as if the magnetism were centred in its poles, this extraordinarily simple formula results for the ponderomotive action of a current in a straight wire upon a magnetic needle with poles at the distance r . If the distance of the two poles from the axis of the wire be unequal, r and r' , the formula becomes very slightly more complex:

$$F = \mu \alpha i / r + \mu \alpha i / r' = \mu \alpha i (1/r + 1/r'). \quad (227)$$

Experiments made by me in 1914, show that these ponderomotive forces are real, and very sensible to observation. If the needle be out of its position of equilibrium, it tends to turn around, as in *Oersted's* experiment. If reversed from its natural position, there would of course be a change of sign in F , and repulsion would result; but from the point of view of the wave-theory, the case of attraction is far more interesting.

(iii) Results of recent investigations in regard to the cause of magnetism and gravitation.

a) Views of *Airy*: In his *Treatise on Magnetism*, 1870, *Airy* expresses himself thus:

»In ordinary observation, magnetism is scarcely known except as existing in iron and especially in steel, and as related in some obscure manner to the earth. But there is reason to believe that it is one of the most extensively diffused agents in nature. It can be traced not only in iron but also in every substance into which iron (one of the most widely spread substances in nature) enters in composition. It is found in nickel and other substances, and even in some gases. Wherever a galvanic current exists in nature, whether produced by chemical action or appearing in the thermo-electric form as originating from the effects of heat at the place of union of different substances, magnetic effects can be elicited. On the larger scale it is certain that the whole earth acts as a combination of magnets, and there is reason to think that the sun and the moon also act as magnets«.

Yet after developing a comprehensive treatise written with his usual masterly ability, and making great use and high commendation of the researches of *Gauss*, *Airy* concludes his work (p. 220) with the following somewhat melancholy remark:

»On the whole, we must express our opinion, that the general cause of the earth's magnetism still remains one of the mysteries of cosmical physics.«

b) Views of *Maxwell*: We shall now examine *Maxwell's* views on magnetism and gravitation. In the celebrated article on Attraction, (*Scient. Pap.*, vol. II, p. 488) *Maxwell* reasons as follows:

»*Faraday* showed that the transmission of electric and magnetic forces is accompanied by phenomena occurring in every part of the intervening medium. He traced the lines of force through the medium; and he ascribed to them a tendency to shorten themselves and to separate from their neighbors, thus introducing the idea of stress in the medium in a different form from that suggested by *Newton*: for, whereas *Newton's* stress was a hydrostatic pressure in every direction, *Faraday's* is a tension along the lines of force, combined with a pressure in all normal directions. By showing that the plane of polarisation of a ray of light passing through a transparent medium in the direction of the magnetic force is made to rotate, *Faraday* not only demonstrated the action of magnetism on light, but by using light to reveal the state of magnetisation of the medium he 'illuminated', to use his own phrase, 'the lines of magnetic force'«.

»From this phenomenon *Thomson* afterwards proved, by strict dynamical reasoning, that the transmission of magnetic force is associated with a rotatory motion of the small parts of the medium. He showed, at the same time, how the centrifugal force due to this motion would account for magnetic attraction.«

»A theory of this kind is worked out in greater detail in *Clerk Maxwell's* Treatise on Electricity and Magnetism. It is there shown that, if we assume that the medium is in a state of stress, consisting of tension along the lines of force, and pressure in all directions at right angles to the lines of force, the tension and the pressure being equal in numerical value and proportional to the square of the intensity of the field at the given point, the observed electrostatic and electromagnetic forces will be completely accounted for.«

»The next step is to account for this state of stress in the medium. In the case of electromagnetic force we avail ourselves of *Thomson's* deduction from *Faraday's* discovery stated above. We assume that the small parts of the medium are rotating about axes parallel to the lines of force. The centrifugal force due to this rotation produces the excess of pressure perpendicular to the lines of force. The explanation of electrostatic stress is less satisfactory, but there can be no doubt that a path is now open by which we may trace to the action of a medium all forces which, like the electric and magnetic forces, vary inversely as the square of the distance, and are attractive between bodies of different names, and repulsive between bodies of the same names.«

»The force of gravitation is also inversely as the square of the distance, but it differs from the electric and magnetic

forces in this respect, that the bodies between which it acts cannot be divided into two opposite kinds, one positive and the other negative, but are in respect of gravitation all of the same kind, and that the force between them is in every case attractive. To account for such a force by means of stress in an intervening medium, on the plan adopted for electric and magnetic forces, we must assume a stress of an opposite kind from that already mentioned. We must suppose that there is a pressure in the direction of the lines of force, combined with a tension in all directions at right angles to the lines of force. Such a state of stress would, no doubt, account for the observed effects of gravitation. We have not, however, been able hitherto to imagine any physical cause for such a state of stress.«

It has been shown in AN 5048, pp. 162-164, that this last view of *Maxwell*, assigning a pressure in the direction of the gravitational force, is erroneous. We treat of his calculations of stress in some detail section 9 (ii) above, and correct a numerical error which has stood about half a century. It thus suffices to add that what *Maxwell* could not solve was even more bewildering to *Lord Kelvin*, *Helmholtz*, and other investigators.

And as light could not be shed on magnetism, it need not surprise us that the mystery of the cause underlying gravitation has remained complete. In a learned paper in the *Proc. R. Soc.*, vol. 54, 1893, p. 457, Prof. *Larmor* concludes by saying that: »The cause of the phenomenon of gravitation has hitherto remained perfectly inscrutable«.

c) Views of *Lord Kelvin*. In the introduction to the English edition of *Hertz's* *Electric Waves*, 1893 (pp. xii-xiii), *Lord Kelvin* expressed himself as follows regarding *Faraday's* researches:

»But before his death, in 1867, he had succeeded in inspiring the rising generation of the scientific world with something approaching to faith that electric force is transmitted by a medium called ether, of which, as had been believed by the whole scientific world for forty years, light and radiant heat are transverse vibrations. *Faraday* himself did not rest with this theory for electricity alone. The very last time I saw him at work in the Royal Institution in an underground cellar, which he had chosen for freedom from disturbance; and he was arranging experiments to test the time of propagation of magnetic force from an electromagnet through a distance of many yards of air to a fine steel needle polished to reflect light; but no results came from those experiments. About the same time or soon afterward, certainly not long before the end of his working time, he was engaged (I believe at the shot tower near Waterloo Bridge on the Surrey side) in efforts to discover relations between gravity and magnetism, which also led to no result.«

»Absolutely nothing has hitherto been done for gravity either by experiment or observation towards deciding between *Newton* and *Bernoulli*, as to the question of its propagation through a medium, and up to the present time we have no light, even so much as to point a way for investigation in that direction. But for electricity and magnetism *Faraday's* anticipations and *Clerk Maxwell's* splendidly developed theory have been established on the sure basis of experiment by

Hertz's work, of which his own interesting account is now presented to the English reader by his translator, Prof. *D. E. Jones*. It is interesting to know, as *Hertz* explains in his introduction, and it is very important in respect to the experimental demonstration of magnetic waves to which he was led, that he began his electric researches in a problem happily put before him thirteen years ago by Prof. *v. Helmholtz*, of which the object was to find by experiment some relation between electromagnetic forces and dielectric polarisation of insulators, without, in the first place, any idea of discovering a progressive propagation of this force through space. «

This citation is important for showing the great *Faraday's* conviction of a connection between magnetism and gravitation, and also for showing the significance of *Hertz's* researches on forces due to waves propagated through the aether.

Absolute Continuity among the Forces of Nature.

If after two centuries of effort, from the time of *Newton* and *Bernoulli*, such great mystery still hung over this question of the connection between gravitation and electrodynamic action, under electric and magnetic forces, as viewed by the comprehensive and experienced mind of Lord *Kelvin*, still more imperative was it the writer's duty to develop the connection between magnetism and gravitation. Yet this was much more difficult than it might seem at first sight.

1. In Dr. *K. F. Bottlinger's* Inaugural Dissertation at the university of Munich, 1912, it is stated that *Einstein* had been so unsuccessful in his attempt to connect gravitation with electrodynamic action that he had quite turned away from it. Out of this *Einstein* failure grew the much discussed but false doctrine of Relativity. It was prematurely exploited in England, by the Royal societies and by scientific journals, which have since regretted the record of this ill-advised course.

2. Now that gravitation is directly connected with magnetism, and magnetism itself an electrodynamic phenomenon, it follows incontestably that universal gravitation also is an electrodynamic force. Accordingly it is evident that the present successful breaking down of the complete isolation which so long separated gravitation from the other forces of the universe is a step of no ordinary significance.

3. *Faraday* had the right idea, based on the doctrine of continuity for all the forces of nature, 1866, as above described by Lord *Kelvin*. But in *Faraday's* day the Royal Society of London would give no heed to his views, any more than they would to the similar views set forth in my Preliminary Paper of 1914, which were regarded favorably by such an authority as the late Lord *Rayleigh*. Thus, owing to the lack of vision of the referees of the Royal Society, *Faraday's* correct ideas were smothered for half a century, and never could have triumphed but for my good fortune in getting the work completed and published in these papers on the New Theory of the Aether. In deference to the revered memory of *Newton*, one would have thought that if the referees of the Royal Society could not lead in this work of discovery, they certainly would encourage such effort on the part of others for illuminating the cause of gravitation.

4. But in view of their utter failure, it appears that the same weakness of management exists now, as in 1686, when they evaded the publication of *Newton's* Principia, and com-

pelled *Halley* to print it at his private expense. Let the simple record of fact — that they discouraged *Newton*, 1686; *Faraday*, 1866; myself, 1914-16; and in 1916-19, actually championed Relativity against the *Newtonian* Philosophy — tell the story of the Royal Society, whether the organization ever is effective in promoting the highest discoveries, such as *Newton* would approve.

The Philosophical Transactions during the last 50 years has perhaps a dozen learned mathematical memoirs on electricity and magnetism, especially on *Maxwell's* equations for the electromagnetic field, yet not one of the authors discloses the smallest knowledge of the fundamental errors in the theory of magnetism handed down from the days of *Gilbert*, 1600, and *Euler*, 1744, though one or two recent authors discuss the hypothetical Magneton, which has no real existence. Hence as they made no progress towards the cause of magnetism, we have recently had what Dr. *Whewell* calls a stationary period in physical science.

(iv) General considerations on the highest laws of nature.

It is one of the great merits of Sir *Isaac Newton's* law of universal gravitation:

$$f = mm'/r^2 \quad (228)$$

that it is extremely simple, and at the same time of the utmost generality. Accordingly 235 years after the publication of the Principia (1687), we find that the *Newtonian* law still accounts perfectly for the observed motions of the celestial bodies, except as modified by the addition of the small terms in *Weber's* law of 1846, which take account of the induction and change of the induction, under wave-action propagated across space with the velocity of light.

A favorite motto from *Shakespeare's* King Lear, scene II, was adopted by *Gauss*, in physical science:

»Thou, nature, art my goddess; to thy laws my services are bound;«

and the rule for very perfect productions:

»Pauca sed matura.«

Thus judged by the experience of this great mathematician, the chief object of the explorer of nature is the discovery of general and universal laws which are highly perfect and admit of no exceptions. Accordingly we notice the analytical similarity of the laws of magnetic intensity to the *Newtonian* law of gravitation: $I = f + f' = \mu\mu'/s^2 + \mu\mu'/s'^2$ (229)

$$g = mm'/r^2 \quad (228)$$

$$F = \mu\mu'/s^2 - \mu\mu'/s'^2, \quad F' = \mu\mu'/s'^2 - \mu\mu'/s^2. \quad (230)$$

The first force is directed to two poles, usually at unequal distances, s and s' , along the curved lines of the magnetic force, while the second force is directed to a single centre, the centre of gravity of the whole mass. There is therefore a great similarity in the above laws, yet the difference inevitably resulting from rectilinear attraction towards a single centre, and the duality of powers resulting from stresses directed towards two centres or poles, along curved lines.

As magnetism is characterized by polarity, while gravitation shows an utter lack of polarity, and depends wholly on a mean central action only, one cannot doubt that the above laws of nature are ultimate.

The very simplicity of the law of magnetic attraction, and its close analogy with the *Newtonian* expression for gravitation, shows that the fundamental law of magnetism may be expected to withstand the ravages of time, just as the law of gravitation has done for over two centuries.

Perhaps the above formulae are typical of the highest laws of nature. Magnets exert magnetic attraction only through the mutual action of their poles; the forces are therefore directed to these poles, and follow extremely simple laws, although the action is conveyed along curved lines.

In the case of gravitation, on the other hand, the forces result from the integrations of the actions of the several atoms at their respective distances, yet practically this mean action reduces to a single force directed to the centre of gravity of the mass, at least for spheres and spheroids differing but little from spheres.

We perceive, therefore, as the result of experience, that the great laws of nature are extremely simple, and of the utmost generality in their character. When these qualities are not assured by any announced law, it is to be suspected that what may be called a law of nature is not ultimate, but at best only a first approximation, and sometimes wholly erroneous, without being even approximately true.

The formulae of Relativity¹⁾ obviously fall in the class of rejected laws. The theory is too complex, vague and chimerical to represent any permanent advance in physical science.

It is justly remarked that it has all the weakness of the Ptolemaic system of astronomy, without the extenuating circumstance, applicable to *Ptolemy's* complex system, that it arose in a primitive age, when knowledge of the heavens was not yet subjected to the Experimentum Crucis of an exact test. Moreover, Relativity was born of complexity, not of simplicity; it involves so much misapplication of mathematics, without physical basis, — such as the so-called four-dimensional time-space manifolds, curvature of space, geodesic curves, etc. — that an experienced natural philosopher cannot defend it. Thus the doctrine of Relativity has not enlightened, but rather confused the scientific world. Out of all this mass of discussion not one clear truth has emerged, except perhaps the warning to beware of doctrines which pride themselves on their complexity.

The law for the ponderomotive force which two magnets exert on each other, given in equation (230) above, is equally remarkable for its simplicity and its generality. There can be no doubt whatever that this law is ultimate. It is easily

verified by experiment, and follows at once from the law of magnetic intensity given above in equation (229).

It frequently is said that the successors of *Kepler* and *Newton* have been so much occupied with the verification of the laws of these great masters, under the complex conditions of the actual universe, that the more recent investigators seldom have been able to add to the laws of nature. Undoubtedly it is a disadvantage to be so much bewildered by a multitude of secondary phenomena that we lose sight of the significant outstanding features of any problem.

No doubt the modern students of magnetism have been bewildered with refinements, and thus were unable to discover the errors in the foundations of the theory of magnetism handed down by traditions dating from 1576, 1600 and 1744. When such fundamental errors of principle are involved in our theories, the mere refinement of measurement will add little to our stock of physical knowledge. Before real progress can be expected the erroneous theory must be unconditionally thrown overboard, and a new start made, on the basis of true laws of nature, which may be recognized, chiefly by their simplicity.

Often we must turn our eyes away from great masses of observations, lest the simplicity of general laws be lost sight of in a hopeless mass of bewildering detail. The investigator often is in the position of the explorer who cannot see the general character of the forest on account of the trees which crowd too close about him. Thus in the present investigation I have depended much less upon the magnetic observations of the past 75 years, than upon the general results already known to *Humboldt* and *Gauss*. As it was the data of their arbitrary scale of intensities, for the earth's magnetism, which enabled me to reach the general laws here given, I have retained their scale in the maps and diagrams of this paper. The multiplier given by *Sabine* for converting these numbers into the absolute scale is 7.57.

And since it was a somewhat hidden diamond accidentally dropped by *Gauss* amidst his profound calculations on the amount of magnetism in the earth, that finally enabled me to work out and verify the connection between the magnetism of the earth and terrestrial gravitation²⁾, I gratefully crown the great mathematician with a laurel wreath, by selecting his portrait for the frontispiece to this concluding paper on the New Theory of the Aether.

¹⁾ Ever since completing the first paper, AN 5044, Jan. 14, 1920, the present writer has recognized clearly the fallacy of the *Einstein* Theory of Relativity. Valid mathematical and physical reasons for the rejection of the whole theory are given in AN 5044, and in AN 5048, the latter paper dated Febr. 19, 1920. It is gratifying to notice that Prof. *Paul Painlevé* and Prof. *Emile Picard*, perpetual secretary, in important communications to the Paris Academy of Sciences, Oct. 24, 1921, have confirmed my conclusions from somewhat different points of view. Both of these eminent mathematicians reject the doctrines of *Einstein*, and support the *Newtonian* mechanics. As they had received copies of the successive papers on the New Theory of the Aether, their announced support of the *Newtonian* doctrines in natural philosophy is not surprising. Under the kinetic theory of the Aether any other position is wholly untenable, but they did well to give public notice of the danger into which many unwary societies and investigators had fallen.

²⁾ In an article, written for Popular Astronomy, about 1894, it was stated by Prof. *Asaph Hall* that in his time *Laplace* had done more for astronomy than all the Universities of Europe combined. In the same way it is evident that *Gauss* did more for terrestrial magnetism than all other authorities of every age combined, and henceforth his work takes on vastly increased significance, from the connection now established between magnetism and universal gravitation. Since 235 years have elapsed since the publication of *Newton's* Principia, and yet no real progress was made towards solving the problem of the cause of gravitation, or showing that gravitation is an electrodynamic phenomenon, we think it very improbable that a solution could be effected without the results given by *Gauss's* method, as further developed in the present paper.

And since *Faraday's* attempts at experimental proof of a connection between magnetism and gravitation failed, yet the present analytical method of attacking the problem succeeded, by virtue of *Gauss's* theory, I look upon *Gauss's* theory as one of the most precious products of the human intellect. For when every other resource failed, *Gauss's* theory admitted of analytical development which enabled us to solve the greatest outstanding physical problem of the centuries!

As the genius of *Gauss* incidentally brought out the results which gave the fractional part of the earth that is magnetic, and thereby made it possible to connect the magnetism of the globe with terrestrial gravitation, thus breaking down the hitherto inscrutable isolation of the chief force of nature, we may exclaim of *Gauss*, even more appropriately than *Fourier* could of *Laplace*:

»It is the great mathematician whose memory we celebrate.«

By a fortunate circumstance it turns out that *Humboldt* was not only the life-long friend and cooperator with *Gauss* in establishing the study of terrestrial magnetism upon a scientific basis, but also the idol of my youth, the perpetual inspiration to a career of discovery. These early impressions were of the greatest influence during my student days at the university of Berlin, so that I very frequently visited *Humboldt's* country place at Tegel. Who knows what influence these associations have had in leading me to a rigorous proof of the connection between magnetism and terrestrial gravitation, since these researches were begun in 1914, and such a connection definitely indicated to the Royal Society of London?

Humboldt regarded his discovery of the law of the increase of the earth's total magnetic intensity from the equator towards the poles as the most important result of his American voyage of discovery, 1798–1804. Accordingly, in veneration of the memory of this great man¹⁾, I cite his own account of the discovery of this great law (*Cosmos*, *Bohn* Translation, vol. I, pp. 179–181):

»The following is the history of the discovery of the law that the intensity of the force increases (in general) with the magnetic latitude. When I was anxious to attach myself in 1798 to the expedition of captain *Baudin*, who intended to circumnavigate the globe, I was requested by *Borda*, who took a warm interest in the success of my project, to examine the oscillations of a vertical needle in the magnetic meridian in different latitudes in each hemisphere, in order to determine whether the intensity of the force was the same, or whether it varied in different places. During my travels in the tropical regions of America I paid much attention to this subject. I observed that the same needle which in the space of ten minutes made 245 oscillations in Paris, 246 in the Havana, and 242 in Mexico, performed only 216 oscillations during the same period at San Carlos del Rio Negro, (1°53' north lat. and 80°40' west long. from Paris), on the magnetic equator i. e. the line in which the inclination = 0, in Peru (7°1' south lat. and 80°54' west long. from Paris) only 211; while at Lima (12°2' south lat.) the number rose to 219. I found in the years intervening between 1799 and 1803, that the whole force, if we assume it at 1.0000 on

the magnetic equator in the Peruvian Andes, between Miquipampa and Caxamarca, may be expressed at Paris by 1.3482, in Mexico by 1.3155, in San Carlos del Rio Negro by 1.0480, and in Lima by 1.0773. When I developed this law of the variable intensity of terrestrial magnetic force, and supported it by the numerical value of observations instituted in 104 different places, in a Memoir read before the Paris Institute, on the 26th Frimaire, An XIII, (of which the mathematical portion was contributed by M. *Biot*), the facts were regarded as altogether new. It was only after the reading of the paper, as *Biot* expressly states (*Lametherie*, Journal de Physique, t. 59, p. 446, note 2), and as I have repeated in the Relation historique, t. 1, p. 262, note 1, that Mr. *de Rossel* communicated to *Biot* his oscillation experiments made six years earlier (between 1791 and 1794) in Van Diemen's Land, in Java, and in Amboina. These experiments gave evidence of the same law of decreasing force in the Indian Archipelago. It must, I think, be supposed that this excellent man, when he wrote his work, was not aware of the regularity of the augmentation and diminution of the intensity, as before the reading of my paper he never mentioned this (certainly not unimportant) physical law to any of our mutual friends, *Laplace*, *Delambre*, *Prony* or *Biot*. It was not till 1808, four years after my return from America, that the observations made by M. *de Rossel* were published in the Voyage de L'Entrecasteaux, t. 2, pp. 287, 291, 321, 480, and 644. Up to the present day it is still usual, in all the tables of magnetic intensity which have been published in Germany (*Hansteen*, Magnet. der Erde, 1819, p. 71; *Gauss*, Beob. des Magnet. Vereins, 1838, p. 36–39; *Erman*, Physikal. Beob., 1841, p. 529–579), in England (*Sabine*, Report on Magnet. Intensity, 1838, p. 43–62; Contributions to Terrestrial Magnetism, 1843), and in France (*Becquerel*, Traité d'Electr. et de Magnét., t. 7, p. 354–367), to reduce the oscillations observed in any part of the earth to the standard of force which I found on the magnetic equator in Northern Peru; so that, according to the unit thus arbitrarily assumed, the intensity of the magnetic force at Paris is put down as 1.348. The observations made by *Lamanon* in the unfortunate expedition of La Pérouse, during the stay at Teneriffe (1785), and on the voyage to Macao (1787), are still older than those of admiral *Rossel*. They were sent to the Academy of Sciences, and it is known that they were in the possession of *Condorcet* in the July of 1787 (*Becquerel*, t. 7, p. 320); but notwithstanding the most careful search, they are not now to be found. From a copy of a very important letter of *Lamanon*, now in the possession of captain *Duperrey*, which was addressed to the then perpetual secretary of the Academy of Sciences, but was omitted in the narrative of the Voyage de La Pérouse, it is stated 'that the attractive force of the magnet is less in the tropics than when we approach the

¹⁾ *Humboldt's* extensive and varied researches on the magnetism of the earth extended over more than 60 years. In addition to his own notable series of observations, especially during the travels in America, 1799–1804, and the expedition to Central Asia, 1829, he secured the cooperation of the Russian and British Governments for the establishment of chains of magnetic observatories throughout the northern and southern hemispheres, 1830–1840, and by *Ross* in the Antarctic, 1841. He always cooperated with *Gauss* and *Weber*, and thus aided the observational foundation of *Gauss's* Allgemeine Theorie des Erdmagnetismus, 1838.

After eight years of researches in the wave-theory of physical forces, and the frequent use of *Humboldt's* *Cosmos* for exactly forty years, the present author finally was enabled to establish between cosmical magnetism and universal gravitation the remarkable general law of nature: $I|g = \eta^2 (r^2|s^2 + r'^2|s'^2)$. Hence the addition of his portrait to this concluding paper on the New Theory of the Aether may be dedicated to the revered memory of *Humboldt*.

poles, and that the magnetic intensity deduced from the number of oscillations of the needle of the inclination-compass varies and increases with the latitude'. If the Academicians, while they continued to expect the return of the unfortunate La Pérouse, had felt themselves justified, in the course of 1787, in publishing a truth which had been independently discovered by no less than three different travellers, the theory of terrestrial magnetism would have been extended by the knowledge of a new class of observations, dating eighteen years earlier than they now do. This simple statement of facts may probably justify the observations contained in the third volume of my *Relation historique* (p. 615): — 'The observations on the variation of terrestrial magnetism, to which I have devoted myself for thirty-two years, by means of instruments, which admit of comparison with one another, in America, Europe and Asia, embrace an area extending over 188 degrees of longitude, from the frontier of Chinese Dzungarie to the west of the South Sea bathing the coasts of Mexico and Peru, and reaching from 60° north lat. to 12° south lat. I regard the discovery of the law of the decrement of magnetic force from the pole to the equator, as the most important result of my American voyage'. Although not absolutely certain it is very probable that *Condorcet* read *Lamaison's* letter of July, 1787, at a meeting of the Paris Academy of Sciences; and such a simple reading I regard as a sufficient act of publication. (*Annuaire du Bureau des Longitudes*, 1842, p. 463). The first recognition of the law belongs, therefore, beyond all question, to the companion of La Pérouse; but long disregarded or forgotten, the knowledge of the law that the intensity of the magnetic force of the earth varied with the latitude, did not, I conceive, acquire an existence in science until the publication of my observations from 1798 to 1804. The object and the length of this note will not be indifferent to those who are familiar with the recent history of magnetism, and the doubts that have been started in connection with it, and who, from their own experience, are aware that we are apt to attach some value to that which has cost us the uninterrupted labour of five years under the pressure of a tropical climate, and of perilous mountain expeditions.«

Starlight on Loutre, Montgomery City, Missouri, May 8, 1922.

In conclusion it may be recalled that *Gauss* was much bewildered by the phenomenon of the Northern Light, adding (p. 50): »Die rätselhaften Erscheinungen des Nordlichts, bei welchem allem Anscheine nach Elektrizität in Bewegung eine Hauptrolle spielt« — »the puzzling appearance of the Northern Light, in which according to all appearances electricity in motion plays a leading part«. He adds that it will not do to deny the possibility of such electric currents, but it will be interesting to investigate how such electric currents would arise from the magnetic actions at the surface of the earth.

In the above paper we have not overlooked this recommendation of the great mathematician. On the contrary the new theory of molecular forces (AN 5130) yields so direct and simple an explanation for this harmless discharge of electric energy from the changing globules in the comparatively rare air of the cirrus clouds that the explanation fulfills all known physical conditions by assimilating the aurora to a kind of lightning of the upper atmosphere, which frequently is easily set off in delicate streamers by unusually violent disturbances of the earth's magnetism.

As it has taken eight long years to finish the work recommended by *Gauss*, 84 years ago, I think we may appropriately exclaim with the Poet *Oliver Wendell Holmes*:

»When darkness hid the starry skies
In war's long winter night,
One ray still cheered our straining eyes,
The far-off Northern Light!«
(*Holmes' Poems*, America to Russia, p. 199).

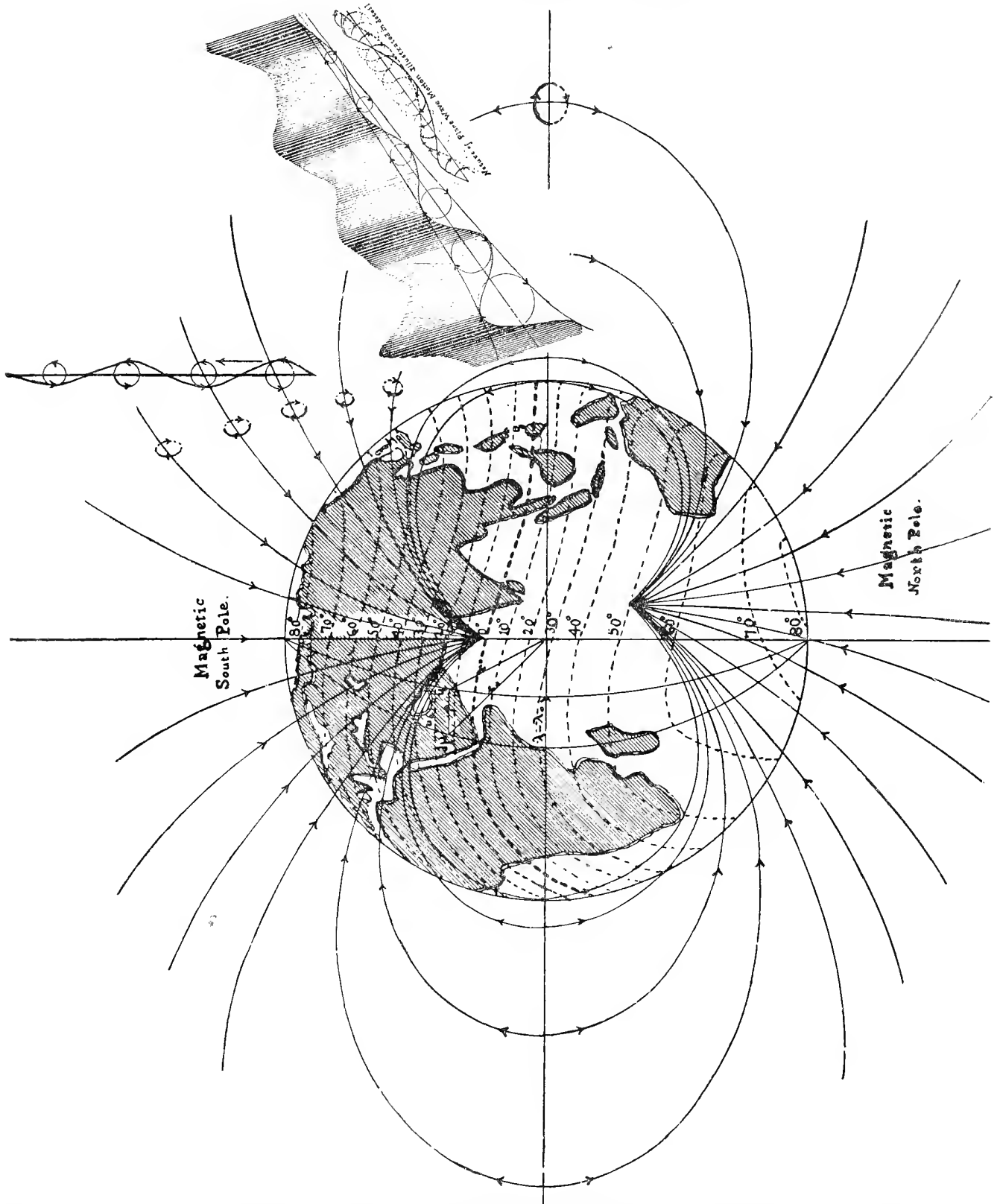
Very grateful acknowledgements are due to two eminent civil engineers, — Captain *Leonard M. Cox*, U. S. N., of Mare Island, and Mr. *Otto von Geldern* of San Francisco; to my friend Mr. *A. E. Axlund*, a very skillful draftsman who has aided in the preparation of the plates; to my associate Mr. *W. S. Trankle*, for contributing greatly to the early completion of the paper; and, above all others, to Mrs. *See*, for an unwavering faith that the hour for the triumph of light over darkness would finally come.

T. F. F. See.



Alexander von Humboldt, Aged 80.

T. J. J. See. New Theory of the Aether.



General view of the wave-field about the earth, showing the unequal depths of the poles in the solid globe, due to the shift of the whole magnetic system towards the Ocean-Hemisphere, by 0.05 of the radius, or 200 miles. This explains the increased total intensity of the earth's magnetism in the southern hemisphere, which is the greatest outstanding phenomenon in the magnetism of the globe, and not heretofore investigated.



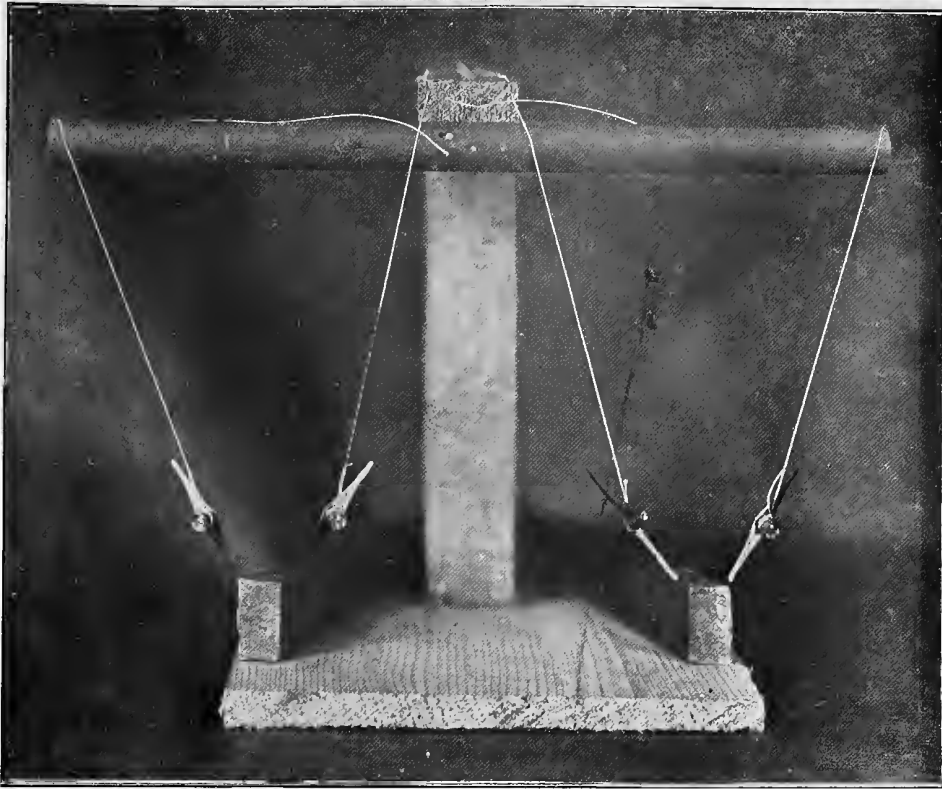


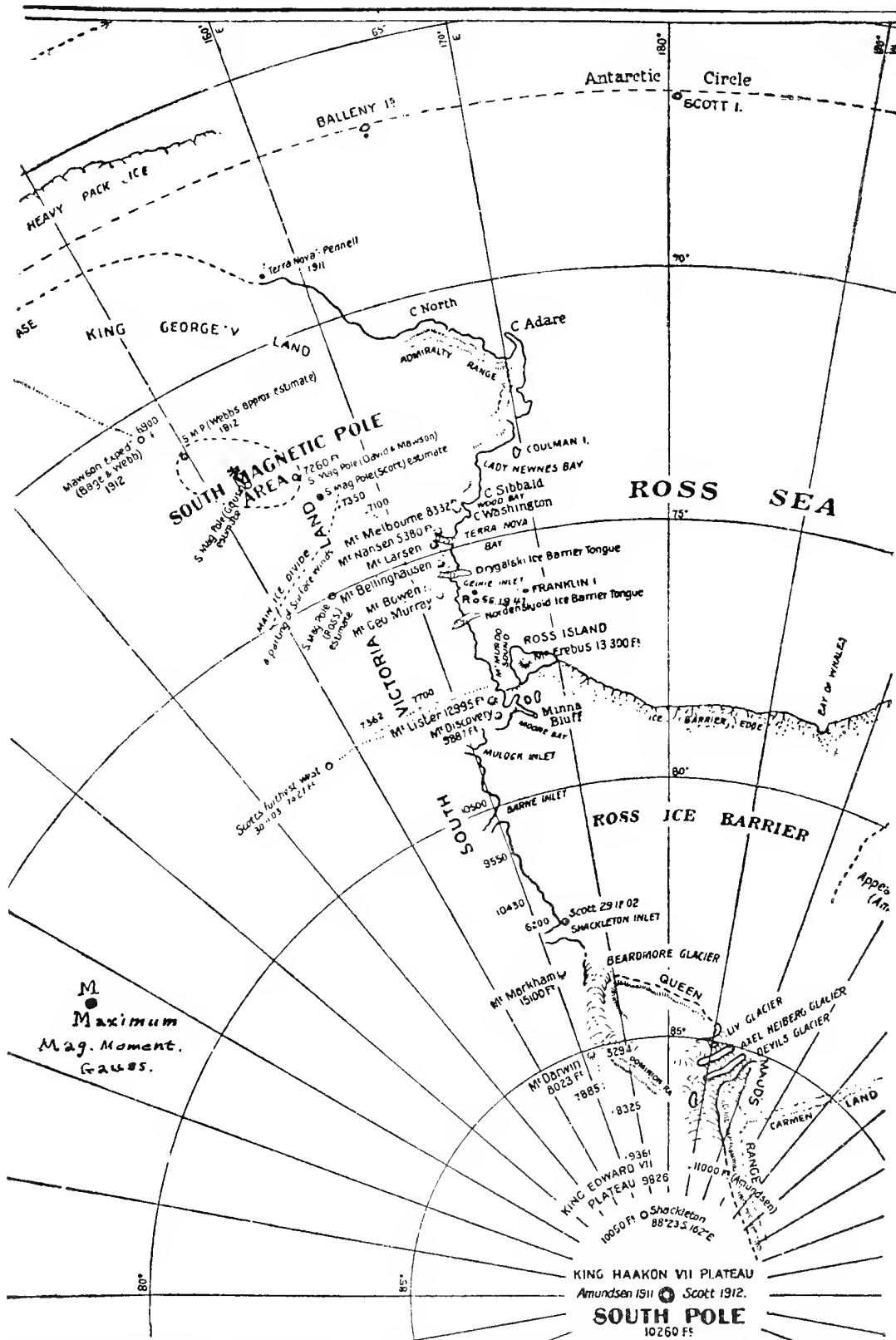
Fig. 1. Photograph of four small magnetic needles, suspended by threads, near a larger strong magnet, which pulls them over bodily to the adjacent poles, and thereby indicates unmistakably the nature of the ponderomotive force. This photograph discloses the true nature of magnetism, and sweeps away the false principles which have come down from the time of *Gilbert*, 1600, and *Euler*, 1744.



Fig. 2. A typical view of the Aurora Borealis, showing extensive curtain, with ribbon folds at the lower border, and stars visible through the illumination. An aurora of this general aspect was observed by the author at Madison, Wisconsin, Sept. 29, 1895. The brilliant aurora observed at Mare Island, California, May 14, 1921, had less of the well defined curtain, but more of the delicate streamers, and they appeared and disappeared wherever certain thin clouds became visible in the sky. This proves that the aurora is a kind of lightning of the upper atmosphere, the unstable aether stress on the surfaces of the drops escaping as an electric discharge, under the decreased resistance of the rare air, by the mere disturbances of the earth's magnetism, yet this lightning never reaches the surface of the earth like that of the lower

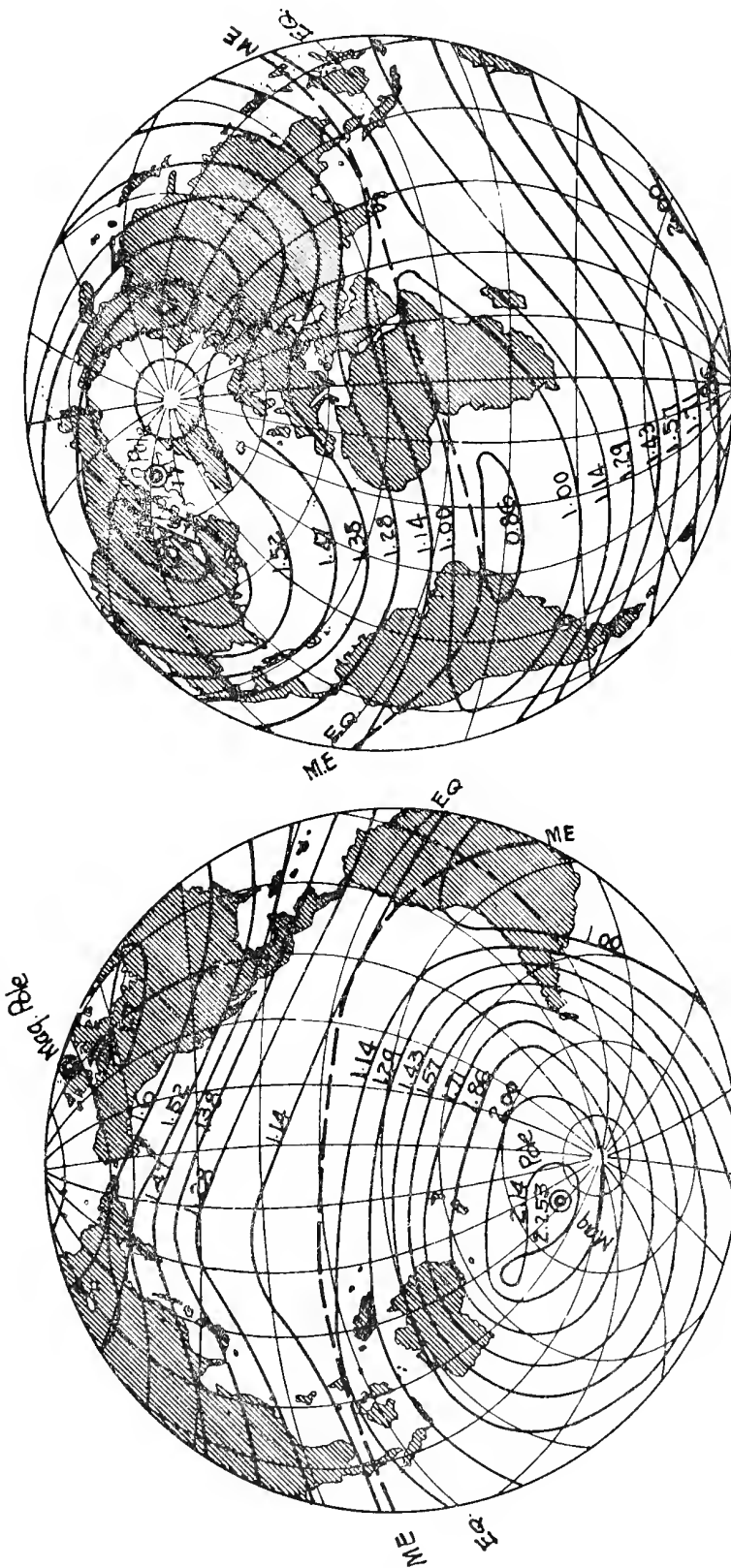


T. J. J. See. New Theory of the Aether.



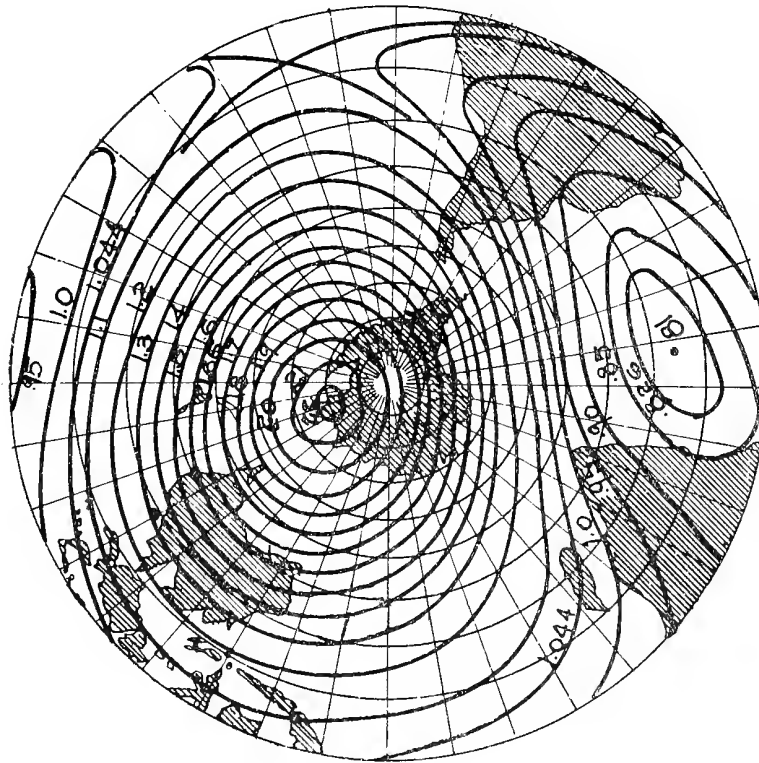
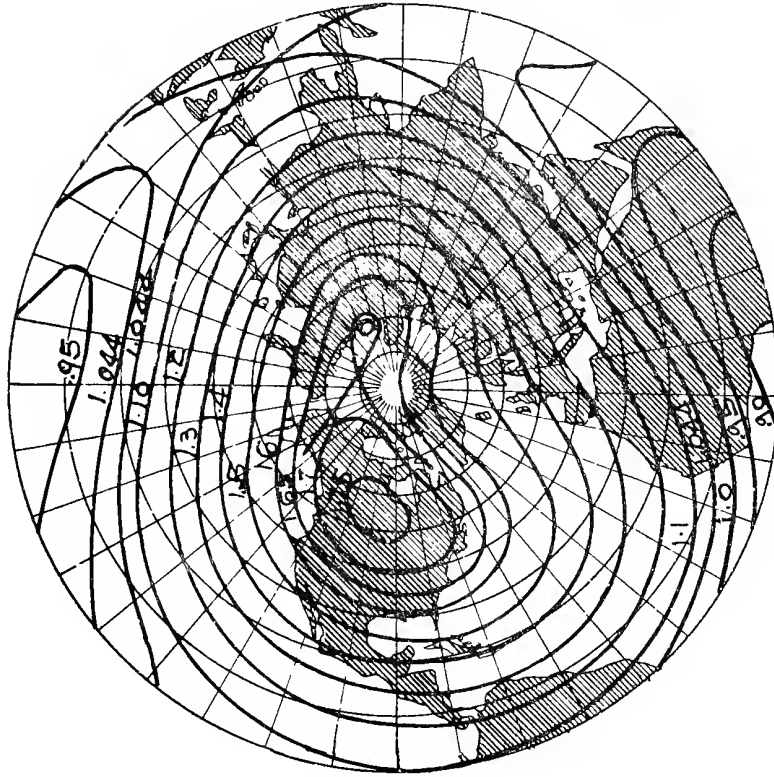
General map of the region of the south magnetic pole, and of the journeys over the ice by *Mawson* from Ross Sea, 1909, and from the other side, 1912. The most probable position of the magnetic pole is shown to be at the star (*), so very near the position assigned by *Gauss' Theory*, 1838, that no certain evidence of motion exists, although 70 years elapsed between *Gauss' calculations* just prior to *Ross' observations*, 1841, and the *Shackleton-Mawson explorations*, 1909-1912.

T. J. J. See. New Theory of the Aether.



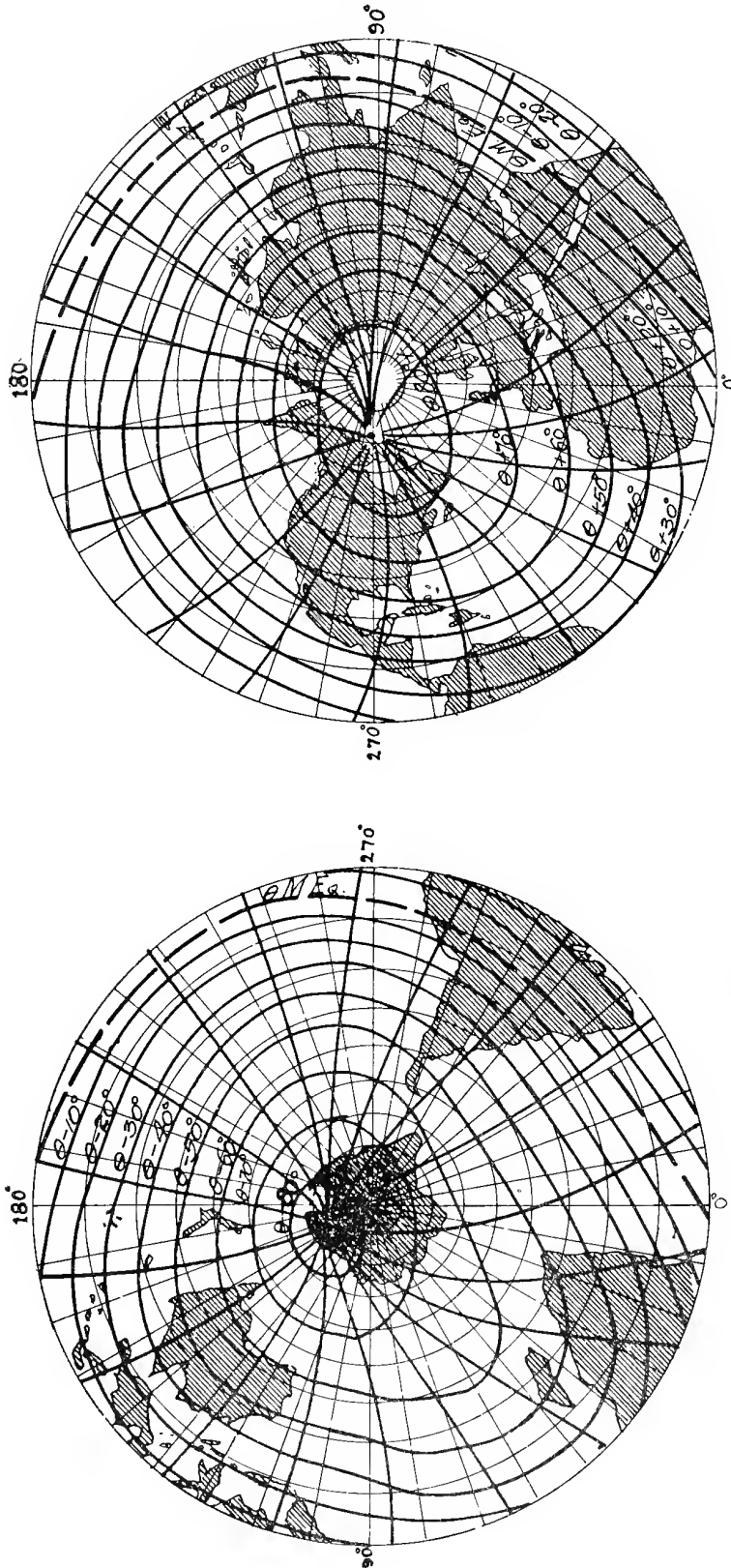
Isodynamic lines of the total intensity of the earth's magnetism, for the equatorial regions. The scale of intensity used is that employed by Humboldt and Gauss, yet we may pass to the absolute scale by multiplying these numbers by 7.57 (*Sabine*).

T. J. J. See. New Theory of the Aether.



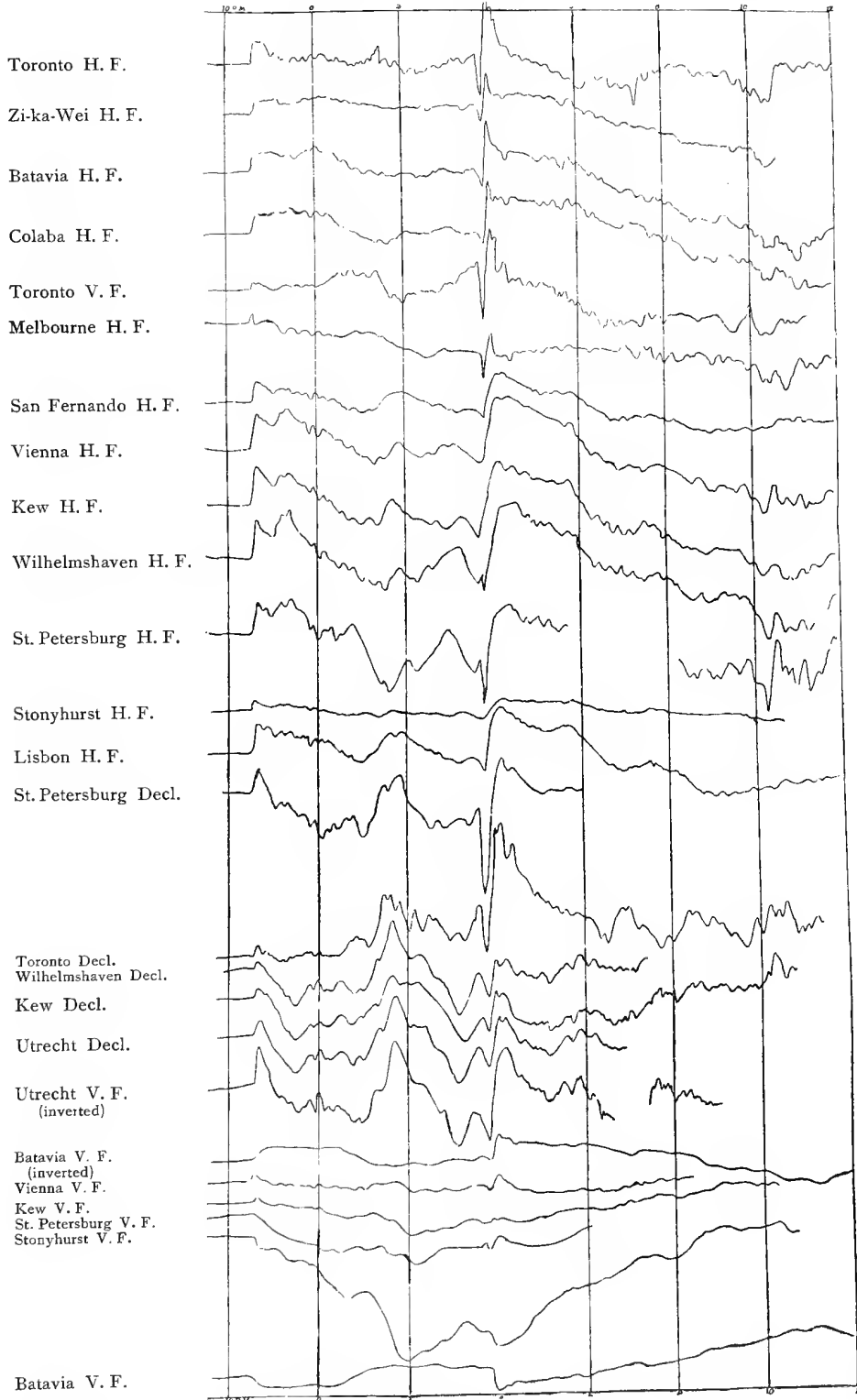
Isodynamic lines for the polar regions of the earth, showing the decreased total intensity in the northern hemisphere which indicates a depth of 0.766 *r* for this pole, while the south pole has a depth of only 0.666 *r*.

T. J. J. See. New Theory of the Aehter.



View of the two poles, showing lines of equal dip, and the considerable curvature of the magnetic meridians, which becomes very sensible near the poles.

T. J. J. See. New Theory of the Aether.



Professor *W. Grylls Adams*' record of simultaneous disturbances of the magnetic needle throughout the world, in the great 'Magnetic Storm' of June 25, 1885.



lope.

lope,
id.

e two
given
e two
duced
which
globe

t »one
so to
omical
sibility
ere is
quality
pheres.
state
trudes
mean
d with
fluid.»
odesist
sphere
in the
could
ensity,
of the
s. Soc.,
ons of
have
e most

ciently
ich an
till lie
be con-
ne out-
of the
minent

ecure
amical
chap II,
at sim-
e Tides

in 1909

chte der

Tafel 8.



Determination of the Physical Cause

which has established the Unsymmetrical Equilibrium of the Earth's Solid Nucleus in the Fluid Envelope, and thereby produced the well-defined Land and Water Hemispheres of the Terrestrial Spheroid.

By *T. F. F. See*.

(With three plates.)

I. Introductory Remarks. It was justly observed by *Herschel* (Outlines of Astronomy, 10. ed., 1869, § 284), that the terrestrial hemisphere having Falmouth, England, as a pole includes nearly all the lands of the globe, while the opposite hemisphere, with pole in New Zealand, is almost wholly covered by the sea.

This fundamental division of the Earth into a well defined land and ocean hemisphere is the most remarkable fact connected with the physical constitution of the globe, and would long since have received the careful attention of philosophers but for the apparent hopelessness of discovering the cause on which it depends.

The first explorers to comprehend the extent of the ocean were the early navigators who extended the voyages of discovery begun by *Columbus* in 1492. As the outcome of their explorations it gradually dawned on the early navigators that one hemisphere of the Earth is almost wholly covered by the ocean, while in the other the area covered by the sea about equals the combined lands of the globe. Thus the idea that the Earth's surface is about three fourths sea and one fourth land early became familiar to geographers and astronomers.

Accordingly the fact of the existence of an ocean hemisphere was known to navigators and geographical explorers long before any explanation of it was attempted by natural philosophers. When *Newton* established the law of gravitation, for explaining the principal phenomena of the physical universe, 1686, and incidentally made out the cause of the tides of the sea, he was well acquainted with the distribution of the ocean; but there is no record of any attention being given by him to the problem of the significance of the land and ocean hemispheres.

Laplace followed closely in *Newton's* footsteps, and endeavored to finish the work which that great master had left untouched. And thus it was the great French geometer who first studied profoundly the problem of the equilibrium of the sea, and proved by mathematical analysis that the equilibrium generally is stable when the density of the overlying fluid is less than the average of the solid globe of the Earth on which it rests, but unstable if these conditions of density are reversed.

In the fifth volume of the *Méc. cél.* *Laplace* has considered the equations for the motions of the heavenly bodies

depending on certain inequalities of the land in the two terrestrial hemispheres; but he does not seem to have given any attention to the cause of the difference in these two hemispheres or how it arose, beyond the theorems deduced from his researches on the stability of the sea, from which it tacitly follows that the distribution of density in the globe is unsymmetrical.

In the passage above cited *Herschel* remarks that »one result of maritime discovery on the great scale, is, so to speak, massive enough to call for mention as an astronomical feature. Astronomically speaking, the fact of this divisibility of the globe into an oceanic and terrestrial hemisphere is important, as demonstrative of a want of absolute equality in the density of the solid material of the two hemispheres. Considering the whole mass of land and water in a state of equilibrium, it is evident that the half which protrudes must of necessity be buoyant; not, of course, that we mean to assert it to be lighter than water, but, as compared with the whole globe, in a less degree heavier than the fluid.»

It was also clearly recognized by the English geodesist *J. H. Pratt* half a century ago that the ocean hemisphere is due to an unsymmetrical distribution of density in the Earth; but as he did not anticipate that any progress could be made, in locating the depth of these inequalities of density, the recent progress in the subject has grown out of the earthquake researches of the writer, (*Proc., Am. Philos. Soc., Philadelphia, 1906-1913*) and the newer investigations of geodesists, especially *Hayford*¹⁾ and *Helmert*²⁾, who have established *Pratt's* doctrine of isostasy as one of the most important laws of the Earth's crust.

It would be difficult for me to acknowledge sufficiently my indebtedness to the writings of *Pratt*, without which an adequate theory of the ocean hemisphere might still lie hopelessly beyond our reach. If the present theory be considered at all satisfactory, the writer would ascribe the outcome mainly to the profit he derived from the study of the ingenious methods and suggestions put forth by this eminent geodesist.

II. General Analysis of the Forces which secure the Stability of the Ocean. Although this dynamical problem was first treated by *Laplace* (*Méc. cél.*, liv. IV chap II, §§ 13-14), yet the development has been somewhat simplified by more modern writers, such as *Airy* (Article Tides

¹⁾ The figure of the Earth and isostasy from measurements in the United States, 1909. Also Supplementary investigations in 1909 of the figure of the Earth and isostasy, 1910.

²⁾ Die Erfahrungsgrundlagen der Lehre vom Allgemeinen Gleichgewichtszustande der Massen der Erdkruste. Sitzungsberichte der Kgl. Preussischen Akad. der Wissenschaften, XX, 1912.

and Waves, Encycl. Metr., 1845, § 123, pp. 279-280) and Darwin (Article Tides, Encycl. Brit., 9th ed., § 19). It seems advisable to describe the general character of the forces which establish the equilibrium of the sea so as to give greater lucidity to the argument of the present paper.

Let us imagine a solid globe of average density σ_1 covered by a layer of fluid of density σ ; and suppose $\sigma_1 - \sigma$ is a positive quantity, or that the nucleus has a density greater than the fluid by which it is covered, so that the equilibrium once established will be stable. Then imagine the fluid layer to be displaced sidwise, so that forces of restitution will be developed.

The force of gravitation acting on any part of the water distant r' from the centre of the water and r from the centre of the solid nucleus is $\frac{4}{3}\pi\sigma r'$ towards the centre of the fluid sphere, and $\frac{4}{3}\pi(\sigma_1 - \sigma)r$ towards the centre of the nucleus. For the matter of the two spheres may be regarded as interpenetrating, the density of the solid nucleus thus reducing to the difference of the two densities $\sigma_1 - \sigma$, and each sphere attracting towards its centre of figure.

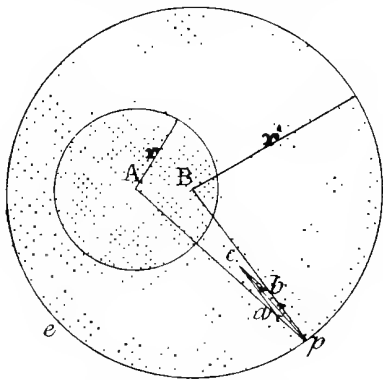


Fig. 1. Stable equilibrium of Sea.

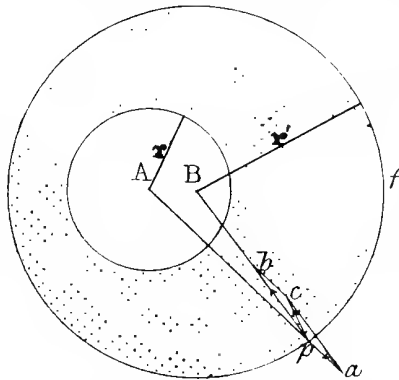


Fig. 2. Unstable equilibrium of Sea.

In both cases the combined attraction of nucleus and fluid envelope is represented in magnitude and direction by pc .

Now if $\sigma_1 - \sigma$ is positive, as is true of the earth and sea, where $\sigma_1 - \sigma = 4.50$, there is a force tending to carry the water from places where it is deeper to places where it is shallower, as shown in the accompanying figure, which is a modification of that in Airy's work on Tides and Waves, plate I: and thus the distribution of the water over the nucleus tends to become symmetrical. Accordingly, when $\sigma_1 - \sigma$ is positive, and the equilibrium is arbitrarily disturbed, the forces of restitution restore the original condition, and the equilibrium is stable.

If, however, $\sigma_1 - \sigma$ is negative, or the nucleus lighter than the fluid surrounding it, the force of restitution becomes negative, and tends to carry the water from where it is shallower to where it is deeper, and the sidwise displacement of the nucleus augments.

Therefore the equilibrium of a layer of fluid distributed over a nucleus lighter than itself is unstable. Hence, as Lord Kelvin remarks (Treat. on Natural Philosophy, § 816), when the nucleus is lighter than the ocean, it will float in the ocean with part of the surface dry. This would be true, for example, if our existing sea were converted into quick-

silver, density 13.5, and $\sigma - \sigma_1 = 8$, so that the fluid would have much greater attraction for itself than for the solid globe, and it would thus gather into a rather small meniscus on one side, and not spread around the Earth as our actual oceans do.

To give the general mathematical conditions of equilibrium, suppose the fluid layer be disturbed, so that its equation is

$$r = a(1 + S_i) \tag{1}$$

where S_i is a surface harmonic of degree i ; then it is easily shown that the potential due to this deformation is

$$\frac{4\pi\sigma}{2i+1} \cdot \frac{a^{i+3}}{r^{i+1}} \cdot S_i \tag{2}$$

and the whole potential is

$$U = \frac{4\pi\sigma_1 a^3}{3r} + \frac{4\pi\sigma}{2i+1} \cdot \frac{a^{i+3}}{r^{i+1}} \cdot S_i \tag{3}$$

(Cf. Thomson & Tait's Treat. on Nat. Phil., §§ 815-816).

If, therefore, $\sigma/(2i+1)$ is greater than $\frac{1}{3}\sigma_1$, the potential of the forces due to deformation is greater than that due to the nucleus; and as such a deformation tends to increase itself by mutual attraction, it follows that the forces will augment the deformation. Accordingly, when

$$\sigma = \frac{1}{3}(2i+1)\sigma_1 \tag{4}$$

all the deformations up to the i^{th} are unstable, but the $i+1^{\text{th}}$ is stable.

Poincaré has treated of this problem of stability, of a fluid mass in equilibrium, by methods of great generality, in the Acta Math., 7, §§ 3, 4, 1885, to which the reader is referred for further development of the subject.

For our present purposes, in dealing with the equilibrium of the ocean, it suffices that $\sigma_1 - \sigma$ be positive, or the fluid lighter than the nucleus which it covers. When this condition is fulfilled, deformations of any order

give rise to positive forces of restitution, and the equilibrium is stable.

Hence, however the ocean may be disturbed, as by storms or earthquakes, its equilibrium is stable, and after a series of oscillations the fluid quickly returns to its proper spheroidal figure about the nucleus on which it rests.

III. To find the physical cause of the observed distribution of the sea over the earth, we may apply the methods of geodesy for calculating the effects of local attraction.

It would not be difficult to devise direct methods for calculating the attraction of a given arbitrary distribution of matter in altering the sea level, and thus changing the distribution of the sea over the globe. But as our object is practical, it seems better to work from methods of investigation already satisfactorily established by the researches of geodesists.

The following method of treatment by Pratt (Treatise on attractions, Laplace's functions, and the figure of the Earth, 4. ed., 1871) is well known; and it suffices to explain the symbols and their geometrical significance.

About any place on the surface as pole, suppose a number of great circles be drawn about the Earth regarded as a sphere, each making with the next the angle β , which thus divide the surface into a series of lunes. Then from the same pole describe a series of small circles at angular distances α and $\alpha + \varphi$, thus dividing the earth's surface into a series of four sided compartments. To determine the law for the drawing of the small circles, it suffices to calculate the attraction of a fixed mass of matter, at uniform height throughout, standing on one of these compartments, upon the assumed pole in the horizontal direction.

If we take α and $\alpha + \varphi$ for the angular distance from the place of the two circles bounding the compartment; h for the height of the mass; θ for the angular distances along the surface of an elementary vertical prism of the mass; a the radius of the Earth; ψ the angle which the plane of θ makes with the plane of the mid-line of the lune, in which latter plane the resultant attraction acts. Then it may be shown that an elementary prism with base area $a^2 \sin \theta d\theta d\psi$ at the distance $2a \sin^{1/2} \theta$ exerts an attraction along the chord θ equal to

$$dA = \frac{\sigma a^2 h \sin \theta d\theta d\psi}{4 a^2 \sin^2 1/2 \theta} \quad (5)$$

Along the tangent to the mid-line of the lune the attraction is easily shown to be

$$dA = \frac{\sigma h \sin \theta \cos 1/2 \theta d\theta d\psi \cos \psi}{4 \sin^2 1/2 \theta} \quad (6)$$

and on putting $\sin \theta = 2 \sin 1/2 \theta \cos 1/2 \theta$, this reduces to

$$dA = \frac{\sigma h \cos^2 1/2 \theta d\theta d\psi \cos \psi}{2 \sin 1/2 \theta} \quad (7)$$

Integrating now for the attraction of the whole mass, we have

$$\left. \begin{aligned} A &= \frac{1}{2} \sigma h \int_{\alpha}^{\alpha+\varphi} \int_{-1/2\beta}^{+1/2\beta} \frac{\cos^2 1/2 \theta}{\sin 1/2 \theta} d\theta \cos \psi d\psi \\ &= \sigma h \sin 1/2 \beta \int_{\alpha}^{\alpha+\varphi} \frac{\cos^2 1/2 \theta}{\sin 1/2 \theta} d\theta \end{aligned} \right\} (8)$$

The law of dissection for the compartments made by the circles is so chosen as to simplify the expression for the attraction, which is thus reduced to the form

$$A = 4 \sigma h \sin 1/2 \beta \sin 1/4 \varphi \cos^2(1/2 \alpha + 1/4 \varphi) / \sin(1/2 \alpha + 1/4 \varphi) = \frac{4}{21} \sigma h \sin 1/2 \beta \quad (9)$$

The transcendental expression

$$\sin 1/4 \varphi \cos^2(1/2 \alpha + 1/4 \varphi) / \sin(1/2 \alpha + 1/4 \varphi) = \frac{1}{21} \quad (10)$$

is solved by means of tables, and it is shown that

$$\varphi / (\alpha + \varphi) = \frac{1}{11} \{ 1 + 0.000055 (\alpha + \varphi)^2 \} \quad (11)$$

The very simple expression (9) may be reduced to numbers as follows: Put $\sigma = 2.55$, and $a = 4000$ miles; then, since the acceleration of gravity $g = \frac{4}{3} \pi \sigma_1 a^3 / a^2 = \frac{4}{3} \pi \sigma_1 a$, σ_1 being the mean density, we may take for the acceleration due to the attracting mass

$$g = \frac{4}{3} \pi a \sigma (5.50 / 2.55) \quad (12)$$

Hence the attraction of the mass in any compartment becomes

$$\begin{aligned} A &= \left(\frac{4}{21} \cdot \frac{3}{4\pi} \cdot \frac{2.55}{5.50} \cdot \frac{h}{a} \sin 1/2 \beta \right) g \\ &= 0.0000527072 h \sin 1/2 \beta \cdot g \end{aligned} \quad (13)$$

h being expressed in parts of a mile. If we use 3958.8, the mean radius of the Earth adopted by *Clark*, we shall find the above constant increased in the ratio of 4000/3958.8, and we have

$$A = 0.0000532557 h \sin 1/2 \beta \cdot g \quad (14)$$

but for most purposes the difference is unimportant.

The following is a brief explanation of the method for finding the horizontal attraction of a thin hemi-spherico-spheroidal meniscus of matter lying on the Earth's surface upon a point on the surface. In the figure (3), suppose MAN to be the meniscus, with pole at A ; and let P be the attracted point; and let the meniscus be divided into lunes from P to C , and the lunes into compartments. If Q be the mid-point of one of the compartments which lies in the meniscus, and the angles be as shown in the figure, then we have to consider the quadrantal triangle ABC of which $AB = 90^\circ$. The required formula is $\cos C$

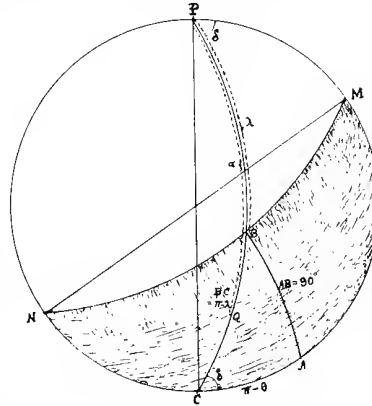


Fig. 3. Diagram illustrating the calculation of the effect of the solidification of the ocean hemisphere.

$\cos C = -\text{ctg} a \text{ctg} b$, or in our present symbols, since $b = \pi - \theta$, $a = \pi - \lambda$

$$\cos \delta = -\text{ctg}(\pi - \lambda) \text{ctg}(\pi - \theta) \quad (15)$$

and this reduces to

$$\text{ctg} \lambda = -\text{tg} \theta \cos \delta \quad (16)$$

Let n be the number of compartments between B and C , the numerical value of λ determining the value of n . If P is 180° from the pole of the meniscus at A , the horizontal attraction will be zero; and accordingly it suffices to take P at 150° , 135° , 120° , and 90° from the pole A . The values of δ , λ and n , calculated by *Pratt*, are given in the following table:

δ	Values of θ								The whole Lune
	150°		135°		120°		90°		
	λ	n	λ	n	λ	n	λ	n	
15°	$60^\circ 51'$	4	$46^\circ 0'$	6	$30^\circ 52'$	10	180°		The whole Lune
45	67 48	3	54 44	5	39 14	8	180		
75	81 30	2	75 29	3	66 21	4	180		
105	98 30	1	104 31	1	113 39	0	180		
135	112 12	1	125 16	0	140 46	0	180		
165	119 9	0	134 0	0	149 8	0	180		

If t be the thickness of the shell at Q and h at the pole A , the law of decrease for an ellipse of small ellipticity such as the sections of the terrestrial spheroid, obviously is

$$t = h(1 - \sin^2 A Q) = h \cos^2 A Q \quad (17)$$

$$= h(\cos \theta \cos \alpha + \sin \theta \sin \alpha \cos \delta)^2 \quad (18)$$

Resolving the horizontal attraction of any lune along the tangent PT , we have by what precedes

$$\frac{4}{21} \sigma \sin 15^\circ \cos \delta \Sigma t = 0.0493 \sigma \cos \delta \Sigma t \quad (19)$$

$$\begin{aligned}
&= 0.0493 \sigma h \cos \delta \Sigma (\cos \theta \cos \alpha + \sin \theta \sin \alpha \cos \delta)^2 \\
&= 0.02465 \sigma h \cos \delta \Sigma \{ 2 \cos^2 \theta - (\cos^2 \theta - \sin^2 \theta \cos^2 \delta) (1 - \cos 2\alpha) + \sin 2\theta \cos \delta \sin 2\alpha \} \\
&= 0.02465 \sigma h \cos \delta \{ 2n \cos^2 \theta - (\cos^2 \theta - \sin^2 \theta \cos^2 \delta) \Sigma (1 - \cos 2\alpha) + \sin 2\theta \cos \delta \Sigma \sin 2\alpha \}. \quad (20)
\end{aligned}$$

When any value of θ is chosen, the table last given above shows how many (n) compartments there will be for each lune; and the corresponding values of α , or the distance of the midpoints of the compartments from P , are to be found from the first of the above tables.

The values of $1 - \cos 2\alpha$ and $\sin 2\alpha$ must be written down, and added together; and when substituted in the formula will give the horizontal attractions for each of them in turn. The sum of these several attractions is the final attraction for the position of P . As a result of calculation for the horizontal attraction of a slender hemispheroidal meniscus of matter at the Earth's surface on points 90° , 120° , 135° , 150° and 180° , the following values result:

$$\begin{array}{l}
90^\circ \quad A_1 = 0.1115 (h/a)g \\
120^\circ \quad A_2 = 0.0381 (h/a)g \\
135^\circ \quad A_3 = 0.0219 (h/a)g
\end{array}
\left|
\begin{array}{l}
150^\circ \quad A_4 = 0.0129 (h/a)g \\
180^\circ \quad A_5 = 0 (h/a)g = 0
\end{array}
\right. \quad (21)$$

The density used in these coefficients is 2.55, instead of 2.75 used by *Pratt*.

If θ be the distance of any point in the further hemisphere from the pole of the meniscus, the above quantities, by the use of indeterminate coefficients, lead to the following formula, the density of 2.75 used by *Pratt* again being reduced to 2.55.

$$A_h = (0.1341 \sin \theta + 0.0888 \sin 2\theta + 0.0226 \sin 3\theta) (h/a)g \quad (22)$$

which will give the attraction at any point in the hemisphere opposite to the meniscus. To find the tangential attraction of a hemispherical shell of uniform thickness upon any point in the surface of the whole sphere is a simple problem of the same kind. Making the calculations for the points 91° (a little away from the base of the meniscus), 120° , 135° , 150° , 180° , from the pole of the shell, we get:

$$\begin{array}{l}
91^\circ \quad A_1 = 1.2750 (h/a)g \\
120^\circ \quad A_2 = 0.1776 (h/a)g \\
135^\circ \quad A_3 = 0.1046 (h/a)g
\end{array}
\left|
\begin{array}{l}
150^\circ \quad A_4 = 0.0790 (h/a)g \\
180^\circ \quad A_5 = 0 (h/a)g = 0
\end{array}
\right. \quad (23)$$

And the following formula will serve generally for other points in the hemisphere opposite to the hemi-spherical shell. Horizontal attraction

$$A_h = (2.0450 \sin \theta + 1.8399 \sin 2\theta + 0.7053 \sin 3\theta) (h/a)g \quad (24)$$

If we take a hemispheroidal meniscus of thickness h at its edge, and no thickness at the pole, the attraction will be found by subtracting the results in (22) from those in (24). Thus we get

$$A_h = (1.9109 \sin \theta + 1.7511 \sin 2\theta + 0.6827 \sin 3\theta) (h/a)g \quad (25)$$

IV. Application of the geodetic method for finding how much higher the sea level stands on the shores of Great Britain than it would if the ocean in the New Zealand hemisphere were to become land, other things remaining as at present.

This is the same as finding the effect of the deficiency of matter in the ocean hemisphere in producing horizontal local attraction in the opposite hemisphere.

(1). Consider the New Zealand Ocean of the form

of a hemispheroidal meniscus, of thickness h at the pole. Then, by the preceding formula we have

$$A_h = (0.1341 \sin \theta + 0.0888 \sin 2\theta + 0.0226 \sin 3\theta) (h/a) (\sigma/2.55) g \quad (26)$$

σ being the deficiency of density in the ocean. Now the North and South Atlantic acts as a canal to the ocean hemisphere; hence the elevation of the sea-level at New Zealand is

$$H = \int_{1/2\pi}^{\theta} (W/g) da\theta = (\sigma h/2.55) \left\{ -0.1341 \cos \theta + \right. \\
\left. -0.0444 \cos 2\theta - 0.0075 \cos 3\theta - 0.0444 \right\}. \quad (27)$$

The density of sea-water is 1.028, and $\sigma = 2.55 - 1.028 = 1.52$, and the elevation of the sea level

$$\begin{aligned}
H &= -0.596 h (0.0444 + 0.1341 \cos \theta \\
&\quad + 0.0444 \cos 2\theta + 0.0075 \cos 3\theta) \\
&= 0.596 h (0.1413 - 0.0888), \text{ at Great Britain,} \\
&= 0.596 h \cdot 0.0525 = 0.03129 h \text{ mile,} \\
&= 330.4 \text{ feet, if } h = 2 \text{ miles.}
\end{aligned} \quad (28)$$

(2). Suppose the ocean in the New Zealand hemisphere to be of the form of a meniscus, the thickness at the pole being zero, and at the edge h . Then by formula (25) we get

$$\begin{aligned}
H &= -0.596 (1.9109 \cos \theta + 0.8755 \cos 2\theta \\
&\quad + 0.2276 \cos 3\theta + 0.8755) h \\
&= 0.596 (2.1385 - 1.7510) h \\
&= 0.23095 h = 2592.642 \text{ feet}
\end{aligned} \quad (29)$$

(3). Suppose the ocean be regarded as uniformly deep; then by formula (24) we have

$$\begin{aligned}
H &= -0.596 (2.0450 \cos \theta + 0.9200 \cos 2\theta \\
&\quad + 0.2351 \cos 3\theta + 0.9200) h \\
&= 0.596 (2.2801 - 1.8400) h \\
&= 0.2623 h = 2769.888 \text{ feet for } h = 2 \text{ miles.}
\end{aligned} \quad (30)$$

The average of three methods is

$$1/3 (330.4 + 2592.6 + 2769.9) = 1/3 5692.9 = 1897.6 \text{ feet.}$$

It is estimated that the land of the water hemisphere amounts to four percent of the surface of the globe, while the land of the land hemisphere is about 24 percent, making the total water of the globe 72 percent, and of land 28.

Four percent of the Earth's surface is eight percent of the water hemisphere. If we wish to allow for this land, we may reduce 1898 feet by eight percent, or 152 feet, leaving for the effect of the solidification of the water hemisphere 1746 feet. This is the amount by which the level of the sea would be lowered about England if the ocean hemisphere about New Zealand were converted into average rock of the crust of the globe.

V. Calculation of the amount of the intumescence of the land hemisphere.

When allowance is made for Australia, the southern point of South America, and the islands of the East Indies,

lands which are almost symmetrically distributed about the New Zealand pole, we find that the solidification of the ocean hemisphere would lower the level of the sea in England by 1746 feet. If the fluid were molten rock of density 2.55, instead of water of density 1.00, the equivalent meniscus would have a thickness of $\frac{1746}{2.55} = 685$ feet = $\frac{1}{7.7}$ mile. Thus the conversion of the ocean hemisphere into land would lower the level of the sea about England by 1746 feet, and the equivalent meniscus of crust, of density 2.55, has a thickness at the pole of 685 feet.

As respects the attraction of the Earth, this change of level corresponds to a vacant space of this thickness beneath the land hemisphere, with pole at Falmouth, England, and we may imagine the vacancy to be just beneath the crust, if the shell be conceived to be of homogeneous density and otherwise supported, as by walls of perfect rigidity. This gives the key to the problem of the land hemisphere of the globe.

If we take the shell of isostatic compensation to have a thickness of 74 miles (*Hayford*), and deduct 20 miles for the outer solid crust, we shall have for the quasi-fluid substratum a depth of 54 miles. But it seems certain that the intumescence is chiefly in the upper part of this layer, because earthquake shocks are known to proceed from a depth not exceeding about 40 miles, though expansive changes might extend to greater depth. If we allow normal density to the lower layer of 20 miles, the thickness being the same as that of the solid crust above, we shall have 34 miles for the total thickness of the layer of intumescence.

A total intumescence of $\frac{1}{7.7}$ mile, when distributed over a layer 34 miles thick, would reduce the amount of the intumescence to $\frac{1}{262}$ part. In other words, a reduction in the density of the layer 34 miles deep of such a nature that the average density is decreased by $\frac{1}{262}$ part would fill up the vacancy calculated to have a thickness of 685 feet in the problem of the solidification of the ocean.

Accordingly, if the matter under the land hemisphere had its average density decreased by $\frac{1}{255}$ part, so that the earthquake and mountain forming layer which may be estimated to have a thickness of 33 miles, will have an average density of 2.54, the elevation of 685 feet would be accounted for, without any additional mass in the crust of the land hemisphere.

The land hemisphere is about half water, and *Geikie* estimates (*Text-book of Geology*, 4. ed., p. 49) the average elevation of the lands of the globe at 2411 feet. But the oceans of the land hemisphere are taken to have an average depth of about 12000 feet, and as the land areas alone have been raised, it is clear that 685 feet for a hemisphere would correspond to 1370 feet for a half-hemisphere, which is the total land area.

In the »Realm of Nature«, by *H. R. Mill*, 1905, p. 188, it is shown that, according to *Murray's* data on the ocean depths, the mean sphere level is at a depth of 10000 feet below the present sea-level, so that the enclosing concentric spheroid would leave the earth half land and half sea. This level should probably be chosen for estimates of the intumescence of the earth; for by a remarkable coincidence the volume of all the elevations projecting above this mean sphere

level is exactly equal to the volume of all the depressions extending below it.

Now suppose the upper two miles of sea water to be removed, or temporarily left out of consideration. Imagine the present land areas first reduced to a dead level, as by erosion, and then elevated a mile above mean sphere level, and the water below mean sphere level correspondingly withdrawn, so as to depress the sea about the land an additional mile, owing to the postulated elevation and resulting change in the Earth's attraction. Then imagine the total volumes of the sea restored, and the result will represent a simple outline of how the existing state of our globe came about.

For in the uplift of the continental masses, they will carry up their borders to some extent; and in the withdrawal of the sea to increase the depth in the ocean hemisphere, by about three quarters of a mile at New Zealand, owing to the change in the Earth's attraction, the bases of the continents and islands will be still more uncovered, as the surface of the surrounding sea falls about a mile around England, and nearly half a mile about the continents nearer the Equator of the land hemisphere.

With this explanation of the effect of the upheaval of the land and the withdrawal of the ocean from its lower layers, we may now imagine the upper layers of the sea two miles deep again superposed; and then we see that by the filling up of the sea and raising the level everywhere about 2 miles, the Earth would appear as we know it — about one fourth land, and three fourths sea, — with a land and water hemisphere well defined.

To find the amount of the intumescence required by the above reasoning, we notice that an elevation of the land by a mile will be satisfied by a layer beneath it $\frac{1}{33}$ of the thickness of the substratum. If it be thought that the thickness should be a mile plus the 2411 feet which *Geikie* takes for the average height of all the lands of the globe, the intumescence would be less than $\frac{3}{2} \cdot \frac{1}{33}$, or $\frac{1}{22}$. A reduction of the density by $\frac{1}{33}$ would make that of the intumescent layer 2.47 instead of 2.55 in the overlying crust; and if we use $\frac{1}{22}$, the density of the layer beneath the crust becomes 2.44. These results satisfactorily explain the notable deficiencies of matter beneath the plateaus and mountains found by geodetic researches.

In his communication to the Berlin Academy of Nov. 2, 1911, p. 332, *Helmert* points out that the orographic forms of land and sea are compensated isostatically within a few hundred metres (bis auf wenige hundert Meter); that is to say, if the isostatic compensation in the crust and substratum is not complete, it is so within a few hundred metres. This is a point of some importance in the theory of mountain formation. For in a discussion of the subject between Professor *H. F. Ried* of Johns Hopkins University and the present writer, at the annual General Meeting of the American Philosophical Society, April 19, 1911, *Ried* conceded the validity of the new theory of mountain formation if the conditions of isostasy could be satisfied. Although *Helmert's* results were not yet public, I had sufficiently studied the question to be able to assure that isostasy was not mathematically exact, but to be taken as perfect only within limits of some hundreds, and in rare cases, thousands, of feet.

In other words, the expulsion of lava of smaller specific gravity from beneath the sea and its injection under the land for the uplift of mountains and plateaus was not inconsistent with the doctrine of isostasy as now developed. For a layer of such matter hundreds or even thousands of feet thick, if the density be appropriate, would not contradict the observed isostatic compensation of the globe. And now *Helmert* has confirmed, by his great experience and authority, the views put forth by the present writer in April, 1911.

It is scarcely necessary to add that both *Helmert's* views and my own are satisfactorily confirmed by the present investigation of the equilibrium of the globe between the land and water hemispheres, and it is shown that the intumescence of the matter beneath the crust varies between sufficiently wide limits to account for all the problems of local attraction which may arise in any part of the Terrestrial Globe.

VI. Explanation of the tapering of the terrestrial land masses towards the South.

In *Suess' »Face of the Earth«*, and many other works on Geology and Geography, the fact is noted that all the great land masses of the globe are widest on the North, and taper to points towards the South. This tendency is so marked as to cause many authorities to conclude that it is a law characteristic of the Earth's mode of development. But we believe a little consideration will show that this supposed law is due principally to the great depth of the Southern Ocean, and the gradual withdrawal of the water to that hemisphere.

Let us see what cause may have contributed to broaden the continents at their northern ends and render them tapering at the South. We have reason to conclude that the land began to group in one hemisphere by chance, and then the tendency grew more pronounced, by the extension of the process under the influence of the leakage of the oceans and the injection of lighter material under the continents. As the land hemisphere culminates in middle north latitude, the extension in longitude of such continents as Europe and Asia occasions no surprise; but it should be remembered that the Indian Ocean was formerly connected with the Mediterranean, and for this reason Africa also should be broad on the North.

In North America we have a typical continent widest at the North and tapering to the South; and South America follows the same law. This tendency to broaden at the North and narrow at the South is augmented by the withdrawal of the ocean to the southern hemisphere. If the ocean were so distributed as to be of less depth to the South and greater depth to the North, this tendency would largely disappear. Thus large areas in the centre and northern part of North America, the Amazon and La Plata valleys, nearly the whole of Europe, and Siberia, would sink beneath the waves; and the continents would present a totally different aspect. Not only would the extension in the east and west direction at the North be curtailed, but the extension to the South in some cases would be increased. If the Southern Ocean at New Zealand were lowered by a mile it seems certain that South America would take on the Falkland Islands, and become

broad at the South, while Australia would be considerably extended eastward, and Africa southward and eastward, so that it probably would take on Madagascar.

In this hypothetical draining of the water to the North, Northern India would be submerged, and the peninsula cut off from the mainland, and thus another tapering point taken from Asia; because the plains of Deccan would then be an island, and other large islands might appear to the South in the Indian Ocean.

As the sea now is, only the higher ridges extending to the South from Asia rise above the waves; and as the ocean almost completely covers the Southern Hemisphere, India and the Malay peninsula necessarily assume the tapering form. This aspect depends chiefly on the deepening sea to the South, and is largely a consequence of the depth of the water in the ocean hemisphere.

The supposed law for the Earth is partly the effect of the direct uplift of the land above the sea through the earthquake processes, and partly the result of the withdrawal of the sea to the ocean hemisphere. Both causes have contributed to the observed tendency, but it assuredly is not based on any mechanical process of nature except the accidental distribution of the outline and depth of the sea.

It should be noticed that the distribution of the World Ridge about the Ocean hemisphere would not be changed by the above mentioned depression of the level of the sea by one mile at New Zealand. The World Ridge thus is a visible proof of the process of elevation going on about the greatest of the oceans.

VII. The intumescence of the substrata beneath the mountains, plateaus and continents the physical cause of the appearance of dry land upon the Earth, and the essential condition in the development of the higher forms of life.

It is instructive to reflect on the consequences of this investigation on the theories of the evolutionary history of our planet. The emergence of dry land was a necessary condition for the development of the higher forms of life; and without the appearance of the dry land, none of the higher forms of life could have developed, which is also well known from the established laws of Biology.

The present investigation gives us a definite cause for the appearance of the dry land, and presents a mental picture of how the continents of the globe came to emerge from the sea.

Prior to the writer's researches on earthquakes and mountain formation, begun in 1906, it had been uniformly assumed by all previous writers that the ocean bottom is water tight, and that leakage through the solid rock of the crust of the globe 20 miles thick did not take place. Now we have proved by a connected and mutually confirmatory series of researches not only that ocean leakage really takes place, but also that it is the sole cause which has made possible the appearance of dry land upon the Earth. Let it be noticed:

1. That geodetic research, as outlined in the second part of this paper, shows that a shell of isostatic compensation really exists; and the interior nucleus below a depth of some 80 miles presents no irregularities of density which

could cause any part of the globe to float above the surrounding oceans.

2. The irregularities of density causing the continents to emerge from the sea are confined wholly to the isostatic shell, and due wholly to the effects of the leakage of the oceans, and the resulting intumescence under the areas now constituting dry land.

3. If the ocean bottoms had been water tight, as assumed by previous writers, we should have had a planet without continents and without any of the higher forms of life.

4. If there exists elsewhere in the universe other planets with oceans which do not leak, these worlds will never attain a development comparable to that known to us; yet the universality of the porosity of matter is so well established that we may at once dismiss the idea of such defective development in other worlds. Wherever oceans of appreciable depth exist they will leak and develop mountains and continents, with life somewhat analogous to that found upon the Earth.

We are thus reminded of the importance of correct premises in all philosophic reasoning. So long as the false premise of the contraction of the Earth was admitted, we could make no progress towards explaining the origin of the mountains and plateaus; and earthquakes were denied any organic function in the development of our globe. With water-tight ocean bottoms, the uplift of the mountains, and plateaus about the sea, with earthquakes, sea waves, and active volcanoes blowing out vast quantities of steam and pumice, remained a profound enigma. Nor could any reason be assigned why lighter material should underly the mountains and cause them to exert a feeble attraction. Isostasy was equally mysterious, and so little confidence was entertained that we would discover the cause of the unsymmetrical equilibrium of the globe between the land and water hemispheres, that *Pratt* pronounced such speculation useless, while *Darwin* considered the hidden inequalities of density as necessarily unknown. (cf XI and XV below.)

In this connection attention should be called to the philosophical reasoning of *Herschel*, in his *Physical Geography*, 1867, pp. 9 and 14: »The fact (of the land and ocean hemisphere) is instructive, as it proves the force by which the continents are sustained to be one of tumefaction, inasmuch as it indicates a situation of the centre of gravity of the total mass of the Earth somewhat eccentric relatively to that of the general external surface — the eccentricity lying in the direction of our antipodes; and is therefore a proof of the comparative lightness of the materials of the terrestrial hemisphere.«

VIII. Recent researches in geodesy and geogony indicate that notwithstanding surface irregularities the external shell of the terrestrial spheroid may be regarded as an ellipsoidal homoeoid.

The results of recent researches in geodesy, more especially those made by *Hayford* and *Tittman* of the United States Coast Survey, and by *Helmert* in Germany, cited on pag. 337, have confirmed the discovery of the physical cause which has produced the apparent inequalities noticed in the Earth's crust, but now proved not to extend to any considerable depth.

If the mass of the Earth be M , and the element of its mass

$$dm = \sigma dx dy dz \tag{31}$$

then the expressions for the forces acting on a unit mass whose coordinates are (x', y', z') becomes

$$\left. \begin{aligned} -\frac{dV}{dx} = X &= \iiint \frac{x' - x}{r^3} \sigma dx dy dz \\ -\frac{dV}{dy} = Y &= \iiint \frac{y' - y}{r^3} \sigma dx dy dz \\ -\frac{dV}{dz} = Z &= \iiint \frac{z' - z}{r^3} \sigma dx dy dz \\ r &= \sqrt{[(x' - x)^2 + (y' - y)^2 + (z' - z)^2]} \end{aligned} \right\} \tag{32}$$

the potential function being

$$V = \iiint \frac{\sigma dx dy dz}{r} \tag{33}$$

If in spherical coordinates we take the angle φ for the longitude, θ for the polar distance, and r for the radius of the sphere, the expressions required in the transformation are:

$$\left. \begin{aligned} x' - x &= r \sin \theta \cos \varphi \\ y' - y &= r \sin \theta \sin \varphi \\ z' - z &= r \cos \theta \\ dm &= \sigma dx dy dz = \sigma r dr d\theta r \sin \theta d\varphi \end{aligned} \right\} \tag{34}$$

The element of the potential due to this differential element is $(1/r) \sigma r^2 \sin \theta dr d\theta d\varphi$; and the potential function becomes

$$V = \frac{1}{4\pi} \int_0^{2\pi} d\varphi \int_0^\pi \sin \theta d\theta \int_0^r \sigma r dr \tag{35}$$

If we make use of the equations (31) and (34), in (32), we obtain the expressions for the resolved forces in spherical coordinates:

$$\left. \begin{aligned} -\frac{dV}{dx} = X &= \int_0^{2\pi} \cos \varphi d\varphi \int_0^\pi \sin^2 \theta d\theta \int_0^r \sigma dr \\ -\frac{dV}{dy} = Y &= \int_0^{2\pi} \sin \varphi d\varphi \int_0^\pi \sin^2 \theta d\theta \int_0^r \sigma dr \\ -\frac{dV}{dz} = Z &= \int_0^{2\pi} d\varphi \int_0^\pi \cos \theta \sin \theta d\theta \int_0^r \sigma dr \end{aligned} \right\} \tag{36}$$

The forces arising from a spheroidal shell will be identical with these, except that the limits of the integral relative to r should be from r_1 to r rather than 0 to r , r_1 being the distance from the centre of gravity of the spheroid to the inner surface of the shell.

If ϵ be the oblateness of the terrestrial spheroid, e the eccentricity of a meridional section, then we have

$$\epsilon = a - a\sqrt{1 - e^2} \quad \text{or} \quad (\epsilon/a) = 1 - \sqrt{1 - e^2} = \epsilon$$

when the oblateness is expressed in units of the semi-axis major; and hence we have $e = \sqrt{1 - (1 - \epsilon)^2}$.

If we take $\epsilon = 1 : 297.7$ (cf. *Researches on the Evolution of the Stellar Systems*, Vol. II, p. 441), then it is easy

to prove (cf. *Pratt*, Figure of the Earth, 4. ed., p. 9) that these forces reduce to the form:

$$\left. \begin{aligned} -\frac{dV}{dx} &= X = -2\pi\sigma x' \left[\frac{V(1-\epsilon^2)}{\epsilon^3} \sin^{-1}\epsilon - \frac{1-\epsilon^2}{\epsilon^2} \right] \\ -\frac{dV}{dy} &= Y = -2\pi\sigma y' \left[\frac{V(1-\epsilon^2)}{\epsilon^3} \sin^{-1}\epsilon - \frac{1-\epsilon^2}{\epsilon^2} \right] \\ -\frac{dV}{dz} &= Z = -4\pi\sigma z' \left[\frac{1}{\epsilon^2} - \frac{V(1-\epsilon^2)}{\epsilon^2} \sin^{-1}\epsilon \right] \end{aligned} \right\} (37)$$

The equation to the mean external surface of the terrestrial spheroid, so adjusted in dimensions as to include its solid and liquid parts, may be written

$$(x^2 + y^2)/a^2 + z^2/c^2 = 1. \quad (38)$$

And for the internal surface of the shell determined by the depth of isostatic compensation found by geodetic research, likewise

$$(x_1^2 + y_1^2)/a^2 + z_1^2/c^2 = 1. \quad (39)$$

It is especially worthy of remark that the physical properties of an ellipsoidal homoeoid simplifies the theory of the Earth's attraction.

We notice that the matter included between these two concentric spheroidal surfaces constitutes a spheroidal shell having essentially the property of an ellipsoidal homoeoid, and exerts no attraction on a point within.

For as the thickness of the shell of isostatic compensation is found by geodesists to have a depth of less than 80 miles, or less than $1/50$ of the radius, it is quite thin; and, barring surface inequalities, which are compensated by corresponding variations in the density beneath, the internal and external surfaces may be taken as concentric, similar, and similarly placed, and thus the shell of isostatic compensation is a true spheroidal homoeoid, and has the well known geometrical properties of ellipsoidal homoeoids.

The details of the researches of geodesists by which the existence of such an isostatic shell is established are described below, but we may remark that the true spheroidal homoeoid has the following well known properties:

1. The potential function

$$V = \frac{1}{4\pi} \int_0^{2\pi} d\varphi \int_0^{\pi} \sin\theta d\theta \int_{r_1}^r \sigma r dr \quad (40)$$

satisfies, for all external points, the equation of *Laplace*

$$d^2V/dx^2 + d^2V/dy^2 + d^2V/dz^2 = 0. \quad (41)$$

2. And for all points between the two surfaces of the shell, whatever be the density, it satisfies *Poisson's* equation

$$d^2V/dx^2 + d^2V/dy^2 + d^2V/dz^2 = -4\pi\sigma. \quad (42)$$

3. For all points within the cavity enclosed by the shell, if the density is a function of the radius only, the value of the potential function is constant, as appears from the equation (40); the first and second differentials thus vanish, and *Laplace's* equation may be said to hold within as well as without the shell.

As regards our actual Earth, it is true that the potential arising from the matter of the isostatic shell is slightly modified

by the surface irregularities, with underlying variations of density, and thus does not depend wholly on r , but also involves θ and φ ; yet since isostatic compensation is found to be a fact, the defect thus arising is not of the second, but only of the third order of small quantities. Accordingly it is too minute to be considered in our present investigation, and probably can never be detected by any kind of observations that may be instituted at the surface of the Earth.

This conception of the external shell of the terrestrial spheroid as an ellipsoidal homoeoid greatly simplifies the theory of the attraction of the Earth; for it is sufficient to divide the whole spheroid into two parts:

1. The isostatic shell, including external irregularities of surface and corresponding internal variations of density so arranged as to be mutually compensatory, giving complete isostatic compensation, or equal pressure on the enclosed nucleus at every point.

2. The nucleus, composed of concentric spheroidal shells of uniform density and exhibiting in these shells neither variations of density nor inequalities of the bounding surfaces, because, under the uniform pressure operating everywhere in the successive layers, the density is a function of the mean radius only.

Reasons will be assigned below to show that this ideal arrangement of the terrestrial spheroid is fulfilled with remarkable accuracy, so that it may be regarded as essentially a law of nature, equally applicable to other planets covered by oceans and producing similar surface inequalities to those found upon the Earth.

The polar section of the terrestrial spheroid on plate 10 shows to scale the shell of isostatic compensation, the depth of the sea and the height of mountains and plateaus.

IX. The stability of the rotatory motion and equilibrium of the earth and sea, under the earthquake processes which have led to the gradual development of the continents.

We may here inquire very briefly how the motion of the Earth about its centre of gravity is rendered stable, so as to secure continuity in the phenomena of geological history. Researches in geology show that the sea and land have always occupied their present relative situations, though with many changes in the contours of the sea at different periods, due to elevations and depressions of the land, under the earthquake forces depending on the leakage of the ocean bottom and the formation of steam beneath the earth's crust. In the long run the continents have grown from the interior outward, while the oceans have contracted their borders; so that more and more land has finally emerged from the sea, and at length the ocean withdrew mainly to the southern hemisphere.

The importance of an analysis of the motion of the Earth about its centre of gravity is such that it is advisable to develop it briefly, before considering the changes taking place in the globe itself.

If as before we put (x', y', z') for the coordinates of the attracted point, and then we have

$$V = \iiint \frac{\sigma dx dy dz}{\sqrt{[(x'-x)^2 + (y'-y)^2 + (z'-z)^2]}} \quad (43)$$

$$\left. \begin{aligned} -\frac{\partial V}{\partial x} &= X = \iiint \frac{\sigma(x'-x) dx dy dz}{[(x'-x)^2+(y'+y)^2+(z'-z)^2]^{3/2}} \\ -\frac{\partial V}{\partial y} &= Y = \iiint \frac{\sigma(y'-y) dx dy dz}{[(x'-x)^2+(y'+y)^2+(z'-z)^2]^{3/2}} \\ -\frac{\partial V}{\partial z} &= Z = \iiint \frac{\sigma(z'-z) dx dy dz}{[(x'-x)^2+(y'+y)^2+(z'-z)^2]^{3/2}} \end{aligned} \right\} (44)$$

The radius vector to the point (x', y', z') is r , and the direction cosines $\lambda = x'/r$, $\mu = y'/r$, $\nu = z'/r$, or $x' = \lambda r$, $y' = \mu r$, $z' = \nu r$. If we expand the radical of (43) according to inverse powers of r (cf. *Tisserand's Méc. cé.* 2.319) we get by using the direction cosines

$$\begin{aligned} V &= \frac{1}{r} \iiint \sigma dx dy dz + \frac{1}{r^2} \left\{ \lambda \iiint \sigma x dx dy dz + \mu \iiint \sigma y dx dy dz + \nu \iiint \sigma z dx dy dz \right\} \\ &+ \frac{1}{2r^3} \left\{ (3\lambda^2 - 1) \iiint \sigma x^2 dx dy dz + (3\mu^2 - 1) \iiint \sigma y^2 dx dy dz + (3\nu^2 - 1) \iiint \sigma z^2 dx dy dz \right\} \\ &+ \frac{3}{r^3} \left\{ \lambda \mu \iiint \sigma xy dx dy dz + \mu \nu \iiint \sigma yz dx dy dz + \nu \lambda \iiint \sigma zx dx dy dz \right\} + \dots \end{aligned} \quad (45)$$

Now if M denotes the mass of the Earth, ϵ the oblateness, a the equatorial radius, and φ the ratio of the centrifugal force to gravity at the equator; we have the well known expression for the potential of the Earth, θ being the polar distance of the attracted point on the surface. $V = M/r + (\epsilon - 1/2 \varphi) (1/3 - \cos^2 \theta) M a^2 / r^3$. (46)

Comparing these two expressions for V , and equating the coefficients of like powers of $1/r$, $1/r^2$, $1/r^3$ we obtain

$$M = \iiint \sigma dx dy dz; \quad \iiint \sigma x dx dy dz = 0; \quad \iiint \sigma y dx dy dz = 0; \quad \iiint \sigma z dx dy dz = 0. \quad (47)$$

$$\begin{aligned} 1/2 (3\lambda^2 - 1) \iiint \sigma x^2 dx dy dz + 1/2 (3\mu^2 - 1) \iiint \sigma y^2 dx dy dz + 1/2 (3\nu^2 - 1) \iiint \sigma z^2 dx dy dz + \\ + 3\lambda \mu \iiint \sigma xy dx dy dz + 3\mu \nu \iiint \sigma yz dx dy dz + 3\nu \lambda \iiint \sigma zx dx dy dz = (\epsilon - 1/2 \varphi) (1/3 - \cos^2 \theta) M a^2 \end{aligned} \quad (48)$$

The equation (47) shows that the centre of gravity is at the centre of the spheroid of revolution, and that the mass is a centrobaric body. (Cf. *Thomson and Tait, Treatise on Nat. Phil.* I.2, § 535.)

The equation (48) may be simplified by noticing that the direction cosines λ , μ , ν always fulfill the condition

$\lambda^2 + \mu^2 + \nu^2 = 1$, and hence by introducing this condition, and putting for 1 this value, the coefficients of the two members respectively take the form $(\lambda^2 - 1/2 \mu^2 - 1/2 \nu^2)$, and $\{1/3 \lambda^2 + 1/3 \mu^2 + (1/3 \nu^2 - \cos^2 \theta)\} = 1/3 \lambda^2 + 1/3 \mu^2 - 2/3 \nu^2$, since $\cos \theta = \nu$. Hence, on equating the terms depending on the several coefficients $\lambda \mu$, $\mu \nu$, $\nu \lambda$, λ^2 , μ^2 , ν^2 we have

$$\left. \begin{aligned} \iiint \sigma xy dx dy dz = 0; \quad \iiint \sigma yz dx dy dz = 0; \quad \iiint \sigma zx dx dy dz = 0. \\ \iiint \sigma x^2 dx dy dz - 1/2 \iiint \sigma y^2 dx dy dz - 1/2 \iiint \sigma z^2 dx dy dz = 1/3 (\epsilon - 1/2 \varphi) M a^2 \\ \iiint \sigma y^2 dx dy dz - 1/2 \iiint \sigma z^2 dx dy dz - 1/2 \iiint \sigma x^2 dx dy dz = 1/3 (\epsilon - 1/2 \varphi) M a^2 \\ \iiint \sigma z^2 dx dy dz - 1/2 \iiint \sigma x^2 dx dy dz - 1/2 \iiint \sigma y^2 dx dy dz = -2/3 (\epsilon - 1/2 \varphi) M a^2. \end{aligned} \right\} (50)$$

The equations (49) show that the axes OX , OY , OZ are principal axes, and this however the body revolves, provided only that the centre of gravity is kept at O .

The first two of equations (50) give the relation

$$\iiint \sigma x^2 dx dy dz = \iiint \sigma y^2 dx dy dz. \quad (51)$$

This means simply that the moments of inertia of the Earth about the axes OX , and OY in the plane of the equator are identical, which ought to be true of such a spheroid of revolution. If we subtract the third from the first of (50), we obtain, in the usual notation for the moments of inertia, $C - A = \iiint \sigma x^2 dx dy dz - \iiint \sigma z^2 dx dy dz = 2/3 (\epsilon - 1/2 \varphi) M a^2$. (52)

The moment of inertia C , about the polar axis OZ , is the largest, and a maximum of all the possible axes of the spheroid, and since the equator is the plane of maximum areas it is evident that uniform or steady rotation about such an axis is stable, and no upheaval depending on mutual actions within the Earth can disturb it. Hence no upheaval depending on the internal forces of a highly rigid globe can displace the pole from its mean position except by very small oscillations.

This problem was given some attention by *Laplace* a century ago (*Méc. cé.* 2.5, p. 365, und 5.2, p. 19-24). It has been examined more in detail by *Darwin*, in a paper on Possible geological changes due to a shifting of the Earth's axis of rotation reprinted in *Darwin's Scientific Papers*, Vol. III, p. 1-36.

X. The Earth retains its primitive axis of rotation and the motion about the centre of gravity is very steady.

In view of the above principles, as more fully elaborated by *Darwin* in the investigation just cited, it is obvious that the upheavals of the Earth's crust which have eventually given us the continents and larger islands of the globe have not involved any large displacement of the pole from its primitive position. For the forces have operated with exceeding slowness, and the uplifts have resulted from just such slight disturbances as we now witness in earthquakes. In the parts of the *Méc. cé.* above cited 5.365 and 9.19-24) *Laplace* had deduced the stability of motion for a solid globe, such as the Earth is now known to be, and also showed that the overlying sea would adjust itself in a stable layer about the globe; and could not be disturbed except by slight oscillations due to such influences as earthquakes, which have

thus elevated the mountains and plateaus and finally given us the continents and islands.

The cumulative effect of these changes in the course of immeasurable time has been the elevation of a group of continents so situated that they constitute the land hemisphere of the globe, while the other is almost wholly covered by the sea. Both the emergence of the land from the sea, and the withdrawal of the ocean to the water hemisphere has been extremely gradual. Very probably this withdrawal of the sea to the ocean hemisphere will explain a considerable part of the lowering of the strand line noticed by *Suess* in his great work on the Face of the Earth as characteristic of nearly all countries.

We say only a considerable part is due to the withdrawal of the sea to the other hemisphere — because much of it is due to the bodily uplift of the continents by the earthquake process, as set forth in my paper »Further Researches, etc.«, Proc. Am. Phil. Soc., Phila., 1908. In fact the elevation of the continents and the withdrawal of the sea to the opposite hemisphere has gone on simultaneously, and the two movements have finally given us a land and water hemisphere such as we now observe.

In considering these changes, however, it is important to notice that the geometrical centre of the interior surface of the isostatic shell of the globe exactly coincides with the centre of the solid nucleus within. The isostatic shell is of slightly irregular figure only on its external surface, owing to the effects of ocean leakage; but according to the geodetic researches of *Hayford* and *Helmert* the elevations and depressions with variations of density beneath do not extend deeper than 76 miles. The earth therefore rotates about the common centre of gravity of both shell and nucleus; and the elevations of the continents and the withdrawal of the sea to the opposite hemisphere has not involved any permanent changes in the motion of the earth about its centre of gravity.

Under the theory of the isostatic shell there are no inequalities of attraction in the two terrestrial hemispheres depending on the unequal distribution of the land, as imagined by *Laplace*, Méc. cél. 5, and thus the motions of the heavenly bodies are not disturbed by the unsymmetrical equilibrium of the solid nucleus in the fluid envelope.

The differential equations for the mutual action of all elements of the mass,

$$\left. \begin{aligned} \iiint \left\{ x \frac{d^2 y}{dt^2} - y \frac{d^2 x}{dt^2} \right\} \sigma dx dy dz &= 0 \\ \iiint \left\{ y \frac{d^2 z}{dt^2} - z \frac{d^2 y}{dt^2} \right\} \sigma dx dy dz &= 0 \\ \iiint \left\{ z \frac{d^2 x}{dt^2} - x \frac{d^2 z}{dt^2} \right\} \sigma dx dy dz &= 0 \end{aligned} \right\} (53)$$

with the corresponding integrals,

$$\left. \begin{aligned} \iiint \left\{ x \frac{dy}{dt} - y \frac{dx}{dt} \right\} \sigma dx dy dz &= K \\ \iiint \left\{ y \frac{dz}{dt} - z \frac{dy}{dt} \right\} \sigma dx dy dz &= K' \\ \iiint \left\{ z \frac{dx}{dt} - x \frac{dz}{dt} \right\} \sigma dx dy dz &= K'' \end{aligned} \right\} (54)$$

have always held true. And thus the rotation of the earth about the centre of gravity is very steady, and subject to none but very minute changes depending on the relative motions of parts of its mass.

As the Earth is now definitely known to have originated independently, at a great distance from the Sun, and subsequently to have built up its mass by accretion as it neared that central mass, and revolved in an orbit becoming ever smaller and smaller and rounder and rounder, owing to the secular action of the nebular resisting medium, we realize that the primitive history of our planet was entirely different from what was long believed by *Laplace* and his followers.

The old traditional views have now been entirely abandoned, and we see that the rotation of the globe was acquired by insensible degrees as it neared the Sun and gradually increased its mass. The atmosphere was at length developed, and the oceans precipitated upon the encrusted planet. The details of this early history are not yet established, but the geological evidence is conclusive that the primitive oceans covered the entire Earth.

In A. N. 181.365, and Researches, Vol. II, 1910, I have shown that the Moon is really a captured planet, and that the Earth's rotation period never was short, as imagined by Lord *Kelvin* and *Darwin*. Thus the evidence is conclusive that no appreciable readjustment in the figure of our planet has ever taken place. The stability of the figure of the globe and the very gradual changes in the state of the sea have thus secured the most perfect conditions for the development of organic life; and the great continuity shown in geological history therefore is not remarkable, but has necessarily resulted from the steady processes operative in the formation of the Earth.

XI. Origin of the older and development of the more recent investigations: Misleading conclusion of Lord *Kelvin* and *Darwin* that the existence of dry land proves the Earth is not a figure of equilibrium appropriate to its diurnal rotation.

In the Méc. cél., Liv. IV, Chapter II, §§ 13-14, *Laplace* has given careful attention to the problem of the equilibrium of the sea, and shown that it generally is stable when the density of the overlying fluid is less than the average of the solid globe of the Earth on which it rests, but unstable if these conditions of density are reversed. In accordance with these results, *Darwin* notes in the article Tides, Encycl. Brit., 9. ed., that »Sir *William Thomson* has remarked (*Thomson* and *Tait*, Nat. Phil., § 816) if the nucleus is lighter than the ocean, it will float in the ocean with part of the surface dry«.

Notwithstanding the clearness of this reasoning, along the lines originally laid down by *Laplace*, there are important errors in the writings of Lord *Kelvin* and *Darwin*, to which attention should be called. Thus in the Treatise on Natural Philosophy, 1883, I. 2, 424, the following statement occurs:

»We have in § 797 been occupied with the results of observations giving the form of ellipsoid which most nearly satisfies geodetic and gravitational experiments, but the existence of dry land proves that the Earth's surface is not

a figure of equilibrium appropriate to the diurnal rotation. Hence the interior of the Earth must be in a state of stress, and as the land does not sink in, nor the sea bed rise up, the materials of which the Earth is made must be strong enough to bear the stress. We are thus led to inquire how the stresses are distributed in the Earth's mass, and what are the magnitudes of the stresses.«

Lord *Kelvin* then refers to the work of *Darwin*, included in a paper published in *Phil. Trans., R. Soc.* 173, 1882, reprinted in *Darwin's Scientific Papers* 2.460-514, entitled: »On the stresses caused in the interior of the Earth by the weight of continents and mountains.«

Darwin begins the summary of this paper by saying: »The existence of dry land proves that the Earth's surface is not a figure of equilibrium appropriate for the diurnal rotation.« Then follow remarks like the above quoted from Lord *Kelvin*. On page 513 of the *Scient. Pap.* 2 *Darwin* concludes: »It is well known that the Earth may be divided into two hemispheres, one of which consists almost entirely of land, and the other of sea. If the South of England be taken as the pole of a hemisphere, it will be found that almost the whole of the land, excepting Australia, lies in that hemisphere, whilst the antipodal hemisphere consists almost entirely of sea. This proves that the centre of gravity of the Earth's mass is more remote from England than the centre of the figure of the solid globe.« *Darwin* then remarks that such a displacement without true deformation is expressed by a surface harmonic of the first order; but the problem is meaningless, as shown by considering the surface forces due to deformation of a homogeneous sphere. He adds that in the case of the Earth such an inequality does exist, »and thus the force referred to must be counterbalanced somehow. The balance can only be maintained by inequalities of density, which are necessarily unknown. The problem therefore apparently eludes mathematical treatment.«

Like the conclusions reached by *Pratt*, and more fully discussed in XV, below, this last impression of *Darwin* is altogether too hopeless. The earlier statement that »the existence of dry land proves that the Earth is not a figure of equilibrium appropriate to the diurnal rotation«, seems to be vitiated by an error of principle, or by some unstated premise which is inadmissible. In any case the reasoning is inconsistent with the claim that »The balance of forces can only be maintained by inequalities of density which are necessarily unknown« since these inequalities of density do not involve the question of rotation.

On this latter point it is sufficient to observe that, if the dry land appeared at the equator or geographical poles, there might be some foundation for the claim that the land's emergence from the sea depends on the rotational speed of the globe; but as the land hemisphere obviously culminates in the middle north latitude, while the corresponding region of the southern hemisphere is covered by an ocean two miles deep, there obviously is not the least connection between the existence of land and the rotation of the globe. As is shown in the present paper, the appearance of dry land depends on the existence of lighter material beneath it, and such a grouping of the several continents as will enable them conjointly to emerge from the ocean.

Thus it appears that the primitive grouping of the lands of the globe for the development of the continents was a matter of chance; but once they were started, the forces continued to be directed from the adjacent oceans for their uplift, till the present arrangement of a land hemisphere with interlocking oceans resulted, while the waters of the globe withdrew more and more to the ocean hemisphere.

The only way I can account for these errors in the reasoning of *Kelvin* and *Darwin* is by supposing that as both of them had been occupied with the hypothetical more rapid rotation of the Earth in former times, resulting from *Darwin's* work on the origin of the Moon, they unconsciously allowed that cause to be introduced into a problem where there is nothing to suggest it, and definite reasons can now be assigned to the contrary. It may also be noted that the results brought out in the present paper, based on the theory of isostasy, as confirmed by geodetic research, negative *Darwin's* conclusions as to stresses in the deep interior of the Earth; for the stresses resulting from inequalities in the isostatic shell would be confined essentially to that shell, and thus *Darwin's* reasoning on stresses in the deep interior of the globe is vitiated by a false premise, which perhaps could not have been anticipated by anyone prior to the recent geodetic confirmation of the existence of this shell.

In A. N. 181.365, and *Researches*, Vol. II, I have proved that the moon can only be regarded as a captured planet; and in the *Proceedings of the Am. Phil. Soc.*, No. 204, April-June, 1912, will be found my »*Dynamical Theory of the Globular Clusters*«, showing that the principle of formation in the distance with subsequent drawing together under universal gravitation is a fundamental law in the development of all types of systems throughout the sidereal universe. Accordingly, in view of this law of nature, any other origin of the Moon than that of capture is quite out of the question.

These researches in cosmogony thus throw important light on the constitution of the terrestrial globe; and the deceptive point of view adopted in the earlier researches of *Kelvin* and *Darwin* probably is responsible for the errors into which they fell when they connected the appearance of dry land with the diurnal rotation of the Earth.

Nearly seventy years ago *Herschel* (*Outlines of Astr.*, § 284) and *Airy* (*Tides and Waves*, Sec. 123; and *Phil. Trans.*, 1855, p. 101) were considering the unsymmetrical equilibrium of the Earth as covered by the sea, and also the results of the geodetic observations made in India by *Everest*, 1847, showing a large deflection of the plumb line due to the local attractions of the Himalaya Mountains. They were also familiar with the subsequent investigations by *J. H. Pratt* for determining the effects of the Himalaya Mountains and Indian Ocean on the direction of gravity (*Pratt*, *Fig. of the Earth*, § 93).

Herschel held that the unsymmetrical equilibrium of the Earth gave indications of a tumefaction or puffing up of the land, though he made no calculation as to the amount of the tumefaction, or its location in respect to depth beneath the Earth's surface. From his remarks in the article *Tides and Waves*, it may be inferred that *Airy* probably held similar general views on the equilibrium of the globe, but was somewhat more definite with respect to the problem of

local attractions, and worked out the mathematical theory with sufficient care to show that the geodetic observations in India could be explained by a layer of material slightly lighter than the crust just beneath the base of the Himalaya Mountains. (Phil. Trans., 1855, p. 101.)

Geodesists have never lost sight of the ideas outlined by these eminent mathematicians, and more recently their researches have been greatly facilitated by precise pendulum measurements of the intensity of gravity in many of the chief continents of the globe. But although these early suggestions have never been abandoned, they do not appear to have taken such definite shape as to enable any previous writer to formulate the cause of the suspected internal arrangement of the density of the Earth, prior to the development of the »New Theory of Earthquakes and Mountain Formation« in 1906, and more fully described in »Further Researches, etc.« (Proceedings of Am. Phil. Soc., 1908, pp. 264-267).

XII. The earlier theory of *Airy*, 1855, that light material underlies the mountains.

In his paper »On the computation of the effect of the attraction of mountain masses, as disturbing the apparent astronomical latitude of stations in geodetic surveys«, Phil. Trans., 1855, pp. 101-104, *Airy* commends *Pratt's* paper on the attraction of the Himalayas, Phil. Trans., 1855, pp. 53-100, and says he was greatly surprised to find the disturbing effect of the mountains as calculated from the theory of gravitation greater than what is observed in geodetic measurement. He then proceeds to show that *Pratt's* results ought to have been expected, and are of high importance in every investigation in geodesy.

Airy says the theory that the Earth once was fluid is held by most physicists, but the fluidity may be very imperfect, and in fact mere viscosity. He then proceeds to show that the state of the Earth's crust lying upon lava may be compared with perfect correctness to the state of a raft of timber floating upon water, some logs floating higher than others, because more deeply immersed in the water. Whilst *Airy* adopts the theory that the crust is floating in equilibrium, he remarks that »in our entire ignorance of the modus operandi of the forces which have raised submarine strata to the tops of high mountains, we can not insist on this as absolutely true«. His idea is that »the diminution of attractive matter below (the mountains), produced by the substitution of light crust for heavy lava, will be sensibly equal to the increase of attractive matter above«.

Such were the considerations which led *Airy* to suggest that the material just beneath the mountains may be relatively deficient in density. In *Airy's* view this might result from the mountains being left aloft as the Earth contracted its volume, or from a superabundance of lighter matter beneath producing the upheaval actually observed. On the hypothesis that the deficiency in density is just beneath the crust of the globe, *Airy* has explained how this defect due to lighter matter might counteract the attractive effect of the elevated masses on the plumb-line.

Upon the supposition that the mountains may have drawn their mass from the regions below *Pratt* has calculated the modifying effect on the plumb-line in the Phil.

Trans. for 1858-59; and included the chief results in the Fig. of the Earth, pp. 87-94.

By actual researches on the local attractions found in the trigonometric survey of India, by *Everest* and others, *Pratt* found these local disturbances of the plumb-line to be as large as 28". The deviations generally exceeded 7" and were so large as to induce *Everest* to abandon his original principal terminal station at Takal Khera.

At the time these investigations were in progress *Pratt* believed the crust of the Earth to be thick, in accordance with certain researches of *Hopkins* and *Thomson* (Lord *Kelvin*), and therefore would not admit the validity of *Airy's* premises. *Pratt* therefore extended his investigations to take account of the deficiency of matter in the Indian Ocean compared to rock; and showed that the deficiency in the attraction of this southern ocean must be very considerable in its effects on the plumb-line, along the great arc of India.

In order to be free from any special hypothesis as to the thickness of the crust, *Pratt* made a third application of his method for dealing with local attractions and proved that a slight though widespread deficiency or excess in the density beneath the surface might anywhere produce local attractions as important as any that was caused by the mountains on the North or the ocean to the South of India. He concluded that in the unknown regions below we have unlimited resource upon which to draw for explaining the anomalies of local attraction observed at the surface. Much additional light has been thrown upon these conclusions by recent geodetic researches; but we need only allude to *Hayford's* investigation showing that the depth of isostatic compensation for the continental United States does not exceed 76 miles, and is thus a layer about three or four times the thickness of the Earth's crust.

XIII. Recent earthquake investigations prove that the Earth's crust is thin, and may be taken to have a thickness of 20 miles.

As intimated above, it was formerly held by eminent physicists such as *Hopkins*, *Thomson*, *Pratt*, and others that the Earth's crust is of much greater thickness than geologists had all along believed. This arose from certain researches of *Thomson* on the rigidity of the Earth, which were afterwards extended by *Darwin*, tending to show that the globe of the Earth is solid throughout.

In view of the claims of these eminent physicists many geologists finally gave up the view that the Earth has a thin crust resting on a layer of liquid matter. But in the writer's memoirs on earthquakes and mountain formation, Proc. Am. Phil. Soc., 1906-08, it was proved that, although the matter of the interior of the Earth is rendered solid and rigid by the great pressure to which it is subjected, yet there is a quasi-fluid or plastic layer just beneath the crust of the globe, and bodily movement in this layer actually takes place in world-shaking earthquakes, as when lava is transferred from under the sea and pushed under the land. Thus the views of the older geologists were restored, and the claims of the physicists definitely disproved.

In general modern seismological observations show that earthquakes are due to shocks proceeding from a depth of

about 20 miles; and therefore are due to strains arising in the layer just beneath the crust of the globe. In my researches it is shown that these strains are due to the leakage of the oceans, producing accumulation of steam and increasing pressure in the plastic layer just beneath the crust. The strain slowly accumulates and finally becomes so great that the crust moves along a fault line; and then a readjustment occurs in the layer of lava just beneath the crust. As the steam accumulates under the ocean but not under the land, the lava layer tends to spread mainly towards the land; and the result is that the crust is uplifted into a wall parallel to the sea coast, as in the typical case of the Andes in South America.

Recent earthquake researches thus mark a very definite advance in our knowledge of the thickness of the crust of the Earth. Not only is the crust thin, as *Airy* assumed in 1855, but the lava beneath this crust actually moves in earthquakes; and in the relief of the strain along the path of least resistance pushes up mountain ranges essentially parallel to the sea shore.

XIV. The geodetic researches of *Helmert*, based on the deep sea gravity measured by *Hecker*, confirm the doctrine of isostacy.

In the Sitzungsberichte of the Berlin Ac., XX, 1912, will be found an important paper communicated by *Helmert*, Nov. 2, 1911. The deep sea measures of gravity were made by *Hecker*, 1901-10, and confirm the doctrine of isostacy first formulated by *Pratt* about half a century ago. *Hecker's* journeys included voyages from Hamburg to Rio Janeiro, Rio Janeiro to Lisbon, Bremerhaven to Melbourne, Sydney to San Francisco, and San Francisco to Yokohama the observations being made with the most approved modern pendulum apparatus, and thoroughly discussed by *Helmert* and his associates of the Royal Geodetic Institute at Potsdam.

Helmert remarks that the important observations by English officers at Moré in the Himalayas, altitude of 4696 metres, which enabled *Basevi* in 1871 to make out decisive defects in the attraction of gravity, already had fore-runners during the 18th century, in *Bouguer's* observations about Quito, at the base of Chimborazo, the similar results thus arising having led *Laplace* (*Méc. cél.* 5.2, 56) to refer them to defects of density beneath the mountain masses. But the observations taken within the last 30 years are much more decisive and thoroughly done. *Helmert* treats of the deep sea observations of *Hecker* in a careful and systematic manner, and reaches the following results for the disturbance of mean gravity on the open ocean in comparison with that on continental land:

Pacific Ocean	— 0.040 cm ± 0.026 cm
Indian Ocean	+ 0.031 » ± 0.100 »
Atlantic Ocean	+ 0.018 » ± 0.038 »

which are combined into — 0.019 cm ± 0.021 cm.

Helmert remarks that the amount — 0.020 cm is easily accounted for by the *Pratt-Hayford* hypothesis of isostacy; and he adds that the mean result of three oceans agrees well together, and the mean error is sufficiently small — corresponding to a layer of rock 200 metres thick by which the mass of the Earth's crust on continental land is distinguished from that of the ocean. This disturbance by which

gravity is too great over the deep sea in comparison with that on continental land is independent of any hypothesis; and simply shows that the orographic form taken by the land has only a small influence on the acceleration of gravity; and thus in general isostacy exists.

Helmert then enters upon the consideration of the depth of isostatic compensation, taking *Hayford's* working hypothesis of 120 kilometres as the basis, and finds that the disturbances of gravity are to be explained partly by the orographic form of the land, and partly by imperfections in the conditions of equilibrium, the agreement with the doctrine of isostacy in the United States having been found by *Hayford* very satisfactory. He adds that the future must determine whether there is along coasts generally a deviation from the *Pratt-Hayford* distribution of mass.

Helmert finally examines *Hayford's* calculations, for the depth of 76 miles, as that of isostatic compensation in the United States, and concludes that his inference is not entirely conclusive, owing to failure to take into consideration the depth of the sea. If we reckon from the base of the sea that the mean height of the continent is about 6000 metres, we should find 400 metres as the thickness of the remaining disturbing layer of matter. However that may be, *Helmert* concludes, the orographic form of the continental land and sea is compensated isostatically within a few hundred metres — as was found by *Hayford* from the variations of gravity in the United States.

XV. The early geodetic researches of *Everest*, *Pratt* and *Airy* confirmed by the recent researches of *Hayford* and *Tittman* in the United States and of *Burrard* in India.

We have seen that as far back as 1847 *Everest* observed that the attraction of the Himalaya Mountains produced a very considerable deviation of the plumb-line at many of the Indian stations; and that *Pratt* and *Airy* confirmed this observational conclusion by mathematical researches based on the theory of gravitation. A photographic view of the Himalaya Mountains from Phalut, at the culmination of the Range, in Mt. Kinchinjunga, near Mt. Everest, supplied by Colonel Sidney G. Burrard, F. R. S., Surveyor General of India, is given in Plate 8. This lofty snow covered range led to the general law of density in the Earth's crust and the theory of isostacy. *Pratt* took account of the feeble attraction of the Indian Ocean, on the South, as well as the attraction of the Himalaya Mountains on the North; and reached the following conclusions:

»The density of the crust beneath the mountains must be less than that below the plains, and still less than that below the ocean bed.« (*Pratt*, Fig. of the Earth, p. 201.) Again, in article 215, *Pratt* concludes: »There is no doubt that the solid parts of the Earth's crust beneath the Pacific Ocean must be denser than in the corresponding parts on the opposite side, otherwise the ocean would flow away to the other parts of the Earth. The following reasoning will explain this: Suppose the Earth to be a sphere. Through any point on it suppose a surface drawn separating a thin portion on the right hand and through the same point a similar surface separating a like portion on the left. The sphere consists, then, of three parts, the middle portion being of a symmetrical form and attracting the point in the direction of the radius, and the two

slender slices attracting it equally to the right and left of that radius. If one of these slices became fluid and of less density than the other, its attraction would be overcome by that of the other, and the fluid would be drawn away to the other parts of the sphere. It does not follow that the whole of the fluid would be drawn over. The above process would go on until the surface of the fluid at the circumference of the slice had become so inclined as to be at right angles to the direction of the resultant attraction of the whole mass, solid and fluid. If, however, a narrow channel were cut through this circumference (which would otherwise act as an embankment) the whole of the water would be drawn off.«

»Now in the case of the Earth there is a channel opening a passage from the New Zealand hemisphere into the opposite one, viz: the North and South Atlantic, and yet the ocean remains in that hemisphere. There must, therefore, be some excess of matter in the solid parts of the Earth between the Pacific Ocean and the Earth's centre which retains the water in its place. This effect may be produced in an infinite variety of ways; and therefore, without data, it is useless to speculate regarding the arrangement of matter which actually exists in the solid parts below.«

This subject is by no means so hopeless as is implied in the last remark of *Pratt*; for if the modern theory of mountain formation has shown that lighter material is pushed under the mountains and plateaus, the unsymmetrical arrangement of matter due to the light material under the World Ridge ¹⁾ will fully explain the observed land and water hemispheres of the globe. When the continents first began to emerge from the sea, the elevation of the higher points of the land hemisphere above the sea may have been ever so slight; but the lack of symmetry between the two hemispheres has steadily increased, till we have truly a land and a water hemisphere as now observed.

The important researches of *Hayford* are sufficiently set forth in a report to the Washington Academy of Sciences and published in the Proceedings for May 18, 1906. His work rests on *Clarke's* Standard Spheroid for 1866, which was found best suited to the area covered by the United States. The residuals are least for a depth of 71 miles as that of isostatic compensation.

Hayford's work rests on 765 series of astronomical observations at 89 stations in the United States, and is thus the most extensive yet made by geodesists. But *Burrard's* unfinished researches in India essentially conform to the conclusions reached by the American investigators; and all the modern geodetic researches confirm the earlier conclusions of *Pratt* and *Airy*, so that what was formerly an hypothesis is now an established fact.

With *Tittman's* approval, *Hayford's* results were announced as follows:

»The evidence shows clearly and decisively that the assumption of complete isostatic compensation within the depth of 71 miles is a comparatively close approximation to

the truth, that the assumption of extreme rigidity is far from the truth — that the United States is not maintained in its position above the sea level by the rigidity of the Earth, but is, in the main, buoyed up, floated, upon underlying material of deficient density.«

»The conclusions just stated were based upon the 507 residuals considered as one group. The residuals have been examined in separate groups of 25, each group covering a small region. Not a single group of 25 contradicts the conclusion just stated.«

»It is certain that for the United States and adjacent regions including oceans, the isostatic compensation is more than two-thirds complete — perhaps much more.«

»The departure from perfect compensation may be, in some regions, in the direction of over-compensation rather than under-compensation, but in either case the departure from perfect compensation is less than one third.«

»In terms of stresses, it is safe to say that these geodetic observations prove that the actual stresses in and about the United States have been so reduced by isostatic adjustment that they are less than one-tenth as great as they would be if the continent were maintained in its elevated position, and the ocean floor maintained in its depressed position, by the rigidity of the Earth.«

The latest geodetic researches of *Burrard* (Professional Paper No. 12, Survey of India) support the conclusions of *Pratt* and *Hayford* that isostasy exists, but the data derived by *Hayford* for the United States require modification before they can be applied to India and the elevated regions of the Himalayas. In view of the immensity of the Himalaya uplifts this variation of the theory of isostasy is not altogether surprising, but doubtless should have been anticipated.

XVI. Concluded physical cause of the unsymmetrical equilibrium of the Earth between the land and water hemispheres, with remarks on the bearing of these results on other sciences.

From the theory of the equilibrium of the globe between the land and water hemispheres here outlined, it follows that the development of the ocean hemisphere is of comparatively late development in the geological history of the Earth. Thus almost the whole of this unsymmetrical arrangement may be ascribed to the period embraced in the formation of the sedimentary rocks.

The concluded intumescence of the layer beneath the land areas conforms to the theory of plastic flow just beneath the Earth's crust, under earthquake forces. The views set forth in A. N. 167.113, 169.321, 171.369, 173.373, and Researches, Vol. II, that under planetary pressure all matter is porous, and the elements may readily interpenetrate, when subjected to such enormous forces, also appear to be confirmed. Accordingly, although matter in the interior of the Earth would become gaseous if in a free state, it has in confinement the property of a highly rigid solid. Thus the

¹⁾ In vol. IV of his Collected Mathematical Works, pp. 419-452, Dr. *G. W. Hill* has an important and too little known memoir on Dynamic Geodesy, in which are developed extremely general expressions for the force of gravity throughout the world. He introduces the fiction of a small sphere of negative mass, in one side of the globe, just beneath the crust; and by varying the decrease in density thus produced obtains a series of approximations of remarkable accuracy. Dr. *Hill's* mathematical formulæ and results are therefore consistent with the present physical theory, and confirm the need of such a general theory of the Earth's attraction.

pressure is the sole cause of the effective rigidity of planets like the Earth, as I first pointed out to the editor of Nature in a letter published during the year 1905.

Accordingly, our present knowledge of the increase of pressure and rigidity as we descend into the interior of the globe, does not leave us »in such complete ignorance as to the manner in which the equilibrium of the solid parts of the Earth is maintained«, as *Darwin* believed in 1882 (cf. *Darwin's* Scient. Pap. 2.514). On the contrary, the stable equilibrium of the globe necessarily results from the law of universal gravitation to which its parts are subjected, and by which the matter, though it would be gaseous if free, is given in confinement the property of an elastic solid, with an average rigidity surpassing that of steel.

The celebrated researches of Lord *Kelvin* and *Darwin*, by which our knowledge was first extended along this line are so important that they will deserve to be remembered in the remotest ages.

The view that the great Southern Ocean has become deeper in recent geological time is of no small interest in connection with various problems of geology and paleontology. For example, it throws an interesting light on *Ch. Darwin's* Theory of Coral Islands, and on *A. R. Wallace's* speculations on a possible former land connection between the Malay Peninsula and Australia.

Darwin found such evidence of widespread subsidence as to lead him to the view that a very large area of the Southern Ocean was becoming more and more deeply submerged. An increase in the accumulation of the water on this side of the globe, however, would explain the phenomena noted quite as well as actual subsidence of the ocean bed, which is now excluded by other considerations, especially those based on the rigidity of the Earth and the acknowledged absence of actual shrinkage.

In the same way this increase in the depth of the

Starlight on Loutre, Montgomery City, Missouri, 1915 July 6.

ocean might sever the former land connections between the Malay Peninsula and Australia, as imagined by *Wallace*. Thus the lines of research here traced will prove useful for various investigations in geology and paleontology, as well as in biology. In fact all the sciences which deal with the evolution of the Earth will be improved by the new lines of investigation here sketched; and the improvement thus suggested affords an impressive illustration of the vast developments yet to be made in all the physical and natural sciences.

It seems probable that the previous lack of definite lines of progress for coordinating all the known phenomena of the globe, which might have been expected as a legitimate outcome of the vast extension of such sciences as geology, paleontology, geodesy, seismology, and physics of the Earth, during the past two centuries, has produced on the modern mind a somewhat hopeless and bewildering effect, not unlike that noted by some historians of astronomy as characteristic of the stationary period of the Middle Ages (cf. *Whewell's* History of the Inductive Sciences, I, Book IV). And thus there arose a growing demand for the discovery of the physical cause of the land and ocean hemispheres of the terrestrial globe; yet the attempts at a solution of the problem seemed hopeless, prior to the researches on earthquakes and mountain formation 1906-13, and on isostatic compensation, 1909-11.

It is scarcely necessary to point out that these results illustrate somewhat impressively the importance of an independent attitude of mind, as well as the value of a comprehensive vision in the study of the sciences. Apparently this quality of independence, and the power for comparing together the most remote phenomena and the most diverse objects, and the physical causes by which they may be produced, alone makes possible substantial progress in discovery of the highest order.

T. F. F. Sec.

T. J. J. See. Physical cause of the unsymmetrical equilibrium of the Earth's solid nucleus in the fluid envelope.



Fig. a. Map showing the World Ridge (from F77's Complete Geography).
(The high mountains and great plateaus everywhere face the outside.)

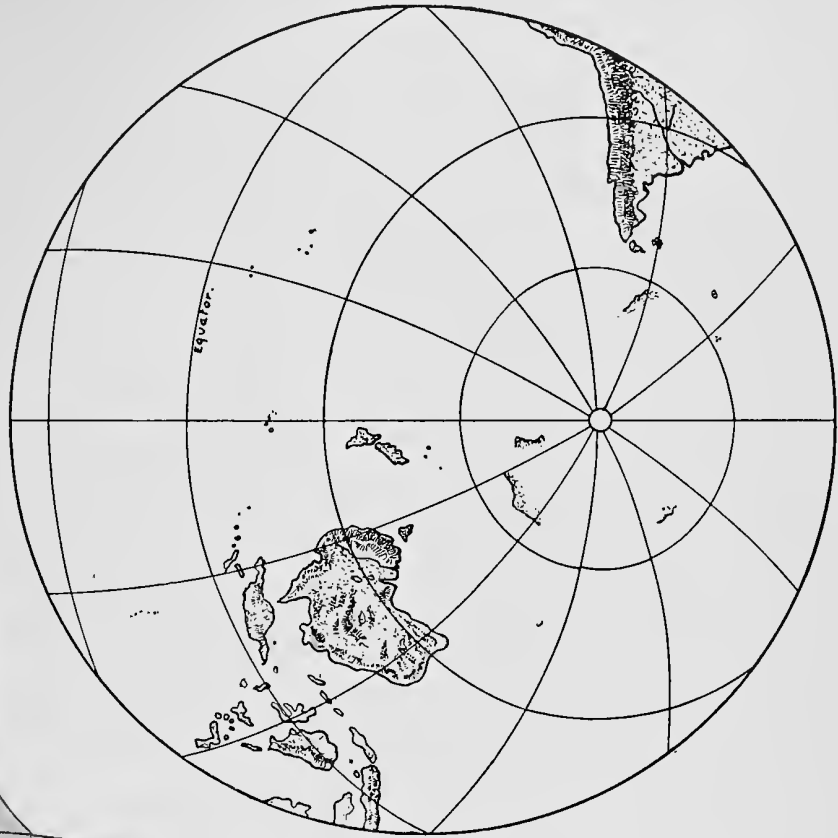
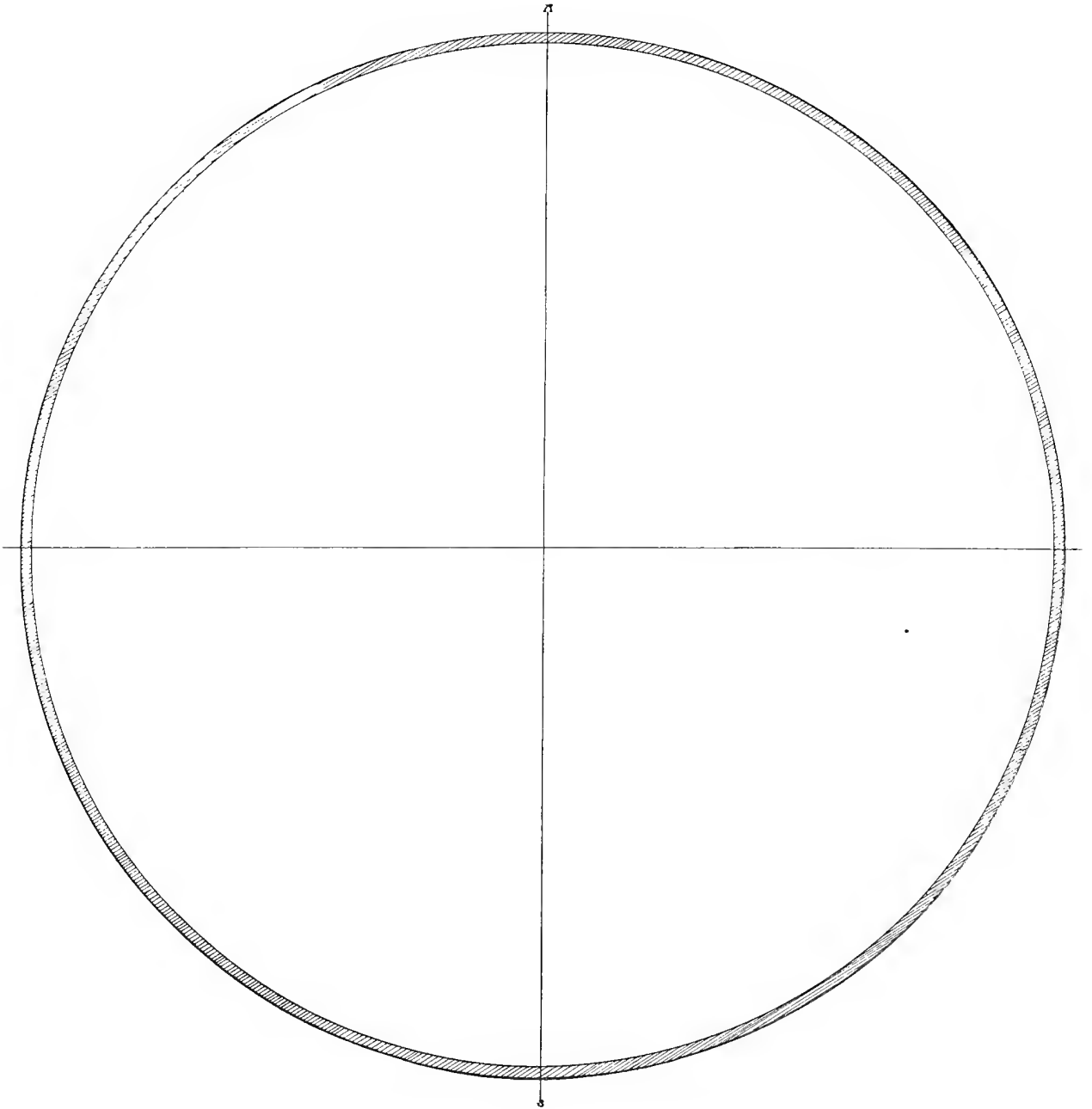


Fig. b. Water hemisphere, which has the World Ridge around it.

Illustrations of the land and water hemispheres of the terrestrial globe.

T.J.J. See. Physical cause of the unsymmetrical equilibrium of the Earth's solid nucleus in the fluid envelope.



Polar section of the terrestrial spheroid through the meridian of Central India.

Researches on the Figure of the Earth, with Definitive Determination of the Oblateness, and Complete Tables of the Corresponding Terrestrial Spheroid. By *T. J. J. See*.

(With a plate and two tables.)

I. Historical Statement of the Problem of the Figure of the Earth.

The determination of the figure and dimensions of the earth is the recognized problem of geodesy, and many approximate solutions of it have been effected within the past three centuries. The governments of the leading nations of the world have long maintained extensive and highly organized geodetic surveys for the accurate measurement of arcs of the meridian and of longitude; and so many arcs have now been measured by geodetic operations that the linear dimensions of the earth are known to a high degree of accuracy.

According to Dr. *O. H. Tittmann*, who has had over 40 years experience in geodesy and for about 15 years was Superintendent of the U. S. Coast and Geodetic Survey, the best value of the earth's equatorial radius is *Helmert's* value of 1903, — which was communicated to Professor *Newcomb* for his researches on the motion of the moon — namely 6378000 m. This round number is preferred, because there still is an uncertainty in the length of the earth's equatorial radius of at least 250 metres; yet the accuracy attained in the diameter of the earth already approaches 1 part in 25000, which is a notable triumph of the science of geodesy!

But the determination of the exact geometrical figure of the earth is a much more difficult problem than the measurement of its radius or equatorial diameter. And as the spheroidal figure of the earth gives rise to sensible perturbations of the motion of the moon, both in latitude and in longitude, which admit of accurate evaluation from the observations of the moon, the question of the geometrical figure of the earth becomes also fundamentally a great problem of astronomy. Thus in the determination of the figure and dimensions of the earth the sciences of geodesy and astronomy occupy common ground, and it is difficult to separate the science of the measurement of the earth from the science of the heavens.

In establishing the law of universal gravitation, 1687, Sir *Isaac Newton* correctly concluded that the mean figure of the earth is that of an oblate spheroid of revolution, with oblateness considerably less than 1 : 230, (*Principia*, Lib. III, Prop. 19), which corresponds to the hypothesis of homogeneity.

Already in 1751 the measurements of arcs of latitude in Peru and in France led *La Condamine* to an oblateness which is near the modern value 1 : 303.6, (cf. *Mesure des trois premiers degrés du méridien dans l'hémisphère austral*, Paris, 1751, p. 259). In 1785 *Lalande* reached the value 1 : 300, and in 1789 *Legendre* found the most probable oblateness to be 1 : 305.

In 1802 *Bürg* discussed the lunar perturbations due to the lack of sphericity of the earth's figure, and found coefficients leading to the oblateness 1 : 305.05, (*Mécanique*

Céleste, Tome III, Liv. VII, Chap. 4 no. 21). This value was largely used by *Laplace*, but in 1825 he adopted the round figure 1 : 306, drawn from the combined researches of *Bürg*, *Bouvard* and *Burckhardt* on several thousand Greenwich observations of the moon (cf. *Mécanique Céleste*, Tome V, Liv. XI, Chap. 1, no. 1).

Bessel's profound researches in geodesy (A. N. Bd. 14, 1837), with a general method for utilizing all observations, led him to deduce corrections for the calculation of the distance from Barcelona to Formentera (AN 19.116). By combining all the best arcs known in 1841 he obtained the oblateness 1 : 299.1528 (AN 438), which long remained classic, and has been but little improved upon to this day, (cf. *Bessel's* *Abhandlungen*, Bd. 3). Thus in the *Encyclopedia Metropolitana*, 1849, Sir *George Airy* carefully discusses the theory of the figure of the earth, first outlined in 1830, and finally adopts his earlier oblateness of 1 : 299.33, which does not differ sensibly from *Bessel's* classical value of 1841.

In *Clarke's* spheroid of 1878 (*Phil. Mag.*, 5th Series, vol. VI, p. 86) a larger value of the oblateness is found, 1 : 293.465; and although it has been extensively used in England and America, it is now abandoned as certainly less accurate than *Bessel's* classic value of 1841. For during the past 30 years the U. S. Coast and Geodetic Survey has made extensive series of pendulum observations; and a full discussion of the results by Dr. *Wm. Bowie* (*Investigations of Gravity and Isostasy*, U. S. Coast and Geodetic Survey, Special Publication, no. 40, 1917, p. 134) leads to the value 1 : 297.4.

This value of the flattening of the earth's mean figure differs very little from other values derived from geodetic data in the United States and elsewhere. For example in 1909 *Hayford* had obtained the value 1 : 297.0. Likewise Professor *Helmert*, in 1901, had found the value 1 : 298.2, but in 1915 increased the oblateness to 1 : 296.7 ± 0.4. Dr. *Bowie*, on the other hand, had reached the value 1 : 298.0 in 1912, but in 1917 adopted 1 : 297.4 as an improvement on his earlier result.

The recent progress of *Helmert* and of the American investigators may be tabulated as follows:

Name	Date	$\epsilon = \text{Obl.}$	$\epsilon =$	Mean
<i>Helmert</i>	1884	1 : 298.54	= 0.00334965	} = 0.00335784 = 1 : 297.810
»	1901	1 : 298.2	= 0.00335345	
»	1915	1 : 296.7	= 0.00337041	
<i>Hayford</i>	1909	1 : 297.0	= 0.00336704	} = 0.00336174 = 1 : 297.465
<i>Bowie</i>	1912	1 : 298.0	= 0.00335570	
»	1917	1 : 297.4	= 0.00336247	

Giving *Helmert's* value a weight of 2, *Hayford* and *Bowie's* value a weight of 1, in accordance with their geodetic experience, we obtain for the weighted mean of these several results: $\epsilon = 0.00335914 = 1 : 297.695$. (1)

The first of *Helmert's* values of 1884 is based on 1:297.8, derived from the lunar perturbations depending on the figure of the earth, and on 1:299.26 derived from pendulum observations. Accordingly it will be seen that there is a very good agreement between the results of *Helmert* and those found by the American investigators; yet both results, except the value of *Helmert*, 1884, rest mainly on pendulum observations.

There are several other methods, however, of finding the ellipticity of the earth's figure, which have been quite thoroughly discussed by *Helmert*, and subsequently by *Tisserand*, *Mécanique Céleste*, Tome II, 1891, pages 368-369, where we find the following sagacious summary:

»Réflexions générales et conclusions. — L'examen des valeurs obtenues pour l'aplatissement de la Terre par diverses méthodes et avec des données numériques de sources différentes montre qu'on n'en est pas encore arrivé au point de pouvoir affirmer que l'aplatissement 1/293.5 de *M. Clarke* doit être préféré à l'une des valeurs 1/299.26, 1/297.8 auxquelles est parvenu *M. Helmert*. On remarquera d'ailleurs que les erreurs probables des dénominateurs de ces dernières sont de 1 ou de 2 unités. La théorie de *Clairaut* néglige du reste les quantités du second ordre et ne permet pas de distinguer entre l'ellipticité et l'aplatissement, de sorte qu'on ne peut pas prétendre à déterminer le dénominateur en question à moins d'une unité près. (*M. O. Callandrea* a étendu la théorie de *Clairaut*, en tenant compte des termes du carré de l'aplatissement, dans un important mémoire: Sur la théorie de la figure des planètes, *Annales de l'Observatoire de Paris*, t. XIX).«

»Il s'agirait donc de savoir si l'aplatissement 1/298 ou 1/299 doit, dès à présent, être remplacé par 1/293 ou 1/294. Nous ne pensons pas que la chose puisse être regardée comme démontrée. Cela entraînerait, comme on l'a vu, des conséquences assez graves, car il y aurait contradiction entre l'aplatissement 1/293 et la valeur numérique de la constante $(A-C)/A$ fournie par la théorie de la précession. Il n'en est plus ainsi quand on adopte 1/297 ou un aplatissement plus petit. *M. Roche*, regardant la contradiction comme bien établie, en avait conclu que l'intérieur de la Terre doit être solide (*Mémoire sur l'état intérieur du globe terrestre*, Paris, 1881). Cette conclusion, qui serait d'une importance capitale pour la Géologie, ne peut donc pas encore être considérée comme certaine. Nous reviendrons plus loin sur ce sujet.«

Accordingly it thus appears, from an extensive survey of the subject made 30 years ago, that *Tisserand* reached the conclusion that the only values to be seriously considered were *Helmert's* values, 1:299.26 to 1:297.8, the latter from the observations of the moon, and the former from pendulum observations.

After these able discussions by *Helmert* and *Tisserand*, it is surprising that Professor *E. W. Brown*, in his researches on the lunar theory, should prefer the large value 1:294, apparently because it gave an outstanding motion of the lunar perigee of only +3", (cf. AN 5048, p. 150). He even considers favorably the still larger value 1:293.7, because this would get rid of the outstanding motion of the lunar perigee, without modifying the Newtonian Law.

Just why no modification of the Newtonian Law should be considered so desirable, in view of the recent English predilection for *Einstein's* theory, — which so unjustifiably alters the form of *Newton's* law as to violate the homogeneity of the fundamental equation of the potential of a sphere — is not apparent.

What I mean here is this: In the third paper on the new theory of the aether (AN 5079) I have shown that *Einstein's* reasoning proceeds on *Gerber's* formula for the potential,

$$U = M/r(1 - 1/c \cdot dr/dt)^2 \quad (2)$$

which violates the ordinary potential of a sphere, just as we should do in the dimensional equation of the velocity, $V = L/T$, by unwarrantedly introducing the factor γ^2 in the divisor thus:

$$V = L/T\gamma^2 \quad (3)$$

which is not authorized by any recognized canon of physical science.

Brown's procedure, on the one hand, shows a somewhat ultra conservative attitude, while the British followers of *Einstein*, on the other, exhibit a course as reckless as it is disrespectful to the traditional veneration naturally attaching to *Newton's* law. It seems to me that neither of these extreme courses can be justified.

There is of course no objection to modifying the Newtonian law, provided any known physical cause can be assigned for the change, such as wave-action, thus converting this law into *Weber's* law of 1846, which I have dealt with in AN 5048, p. 149-150. Moreover, *Majorana's* experiments at Turin, 1919, lend observational support to this course, and the validity of some slight modification cannot well be denied. Nevertheless, in our researches on the physical universe, it is always desirable to go slow in modifying laws which have proved accurate and historically serviceable: thus changes should be admitted only in the face of convincing evidence.

2. Determination of the Ellipticity of the Terrestrial Spheroid by means of the Equation for the Coefficient of the Moon's Inequality in Latitude depending on the Figure of the Earth.

The determination of the exact analytical expression for the law of universal gravitation leads to a problem of successive approximations. And the search for a solution might be entirely in vain but for the highly rigorous geometrical conditions fulfilled by the motions of certain bodies of the solar system, and the resulting accuracy with which it is possible to detect a small deviation from the assumed form of the law of attraction. Among the motions best adapted for disclosing a departure from the law of *Newton*, we must reckon the nearly fixed elliptical paths described by the planets about the sun, and the rapidly varying Keplerian ellipse described by the moon about the centre of gravity of the earth.

The moon's motion, however, is disturbed not only by the action of the sun and planets but also by the action of the oblateness of the figure of the earth; and to throw any light on the observed inequalities in the moon's motion, it is necessary to separate these two causes, — the celestial from the terrestrial — and to evaluate them independently and with great accuracy. As geometers for over two cen-

tures have given great attention to the motion of the moon, it happens fortunately that analysis has enabled them to determine with great accuracy the effect of the different forces acting upon the moon.

It is found that just as the action of the oblate figure of the earth produces sensible inequalities in the motion of the moon, both in latitude and in longitude, so also the observed amounts of these inequalities, when carefully separated from the other perturbations of the moon's motion, become established data which enable us to determine the exact degree of the oblateness of the earth's figure. The lunar perturbations best suited to this purpose are the monthly inequality in latitude depending on the figure of the earth, and the progression of the lunar perigee in longitude, a part of which also depends on the oblateness of the terrestrial spheroid. The 18.6 year inequality in longitude, having a coefficient of $7''.1176$, is treated of independently in section 3 below.

The observational determination of the exact amount of the earth's oblateness therefore presents a most difficult problem. After reviewing the causes operating to exclude a definite and accurate result, *Tisserand* remarks (*Traité de Mécanique Céleste*, Tome II, p. 366): »On peut voir par ce qui précède combien la détermination de la figure de la terre devient délicate et difficile, soit qu'on parte des opérations géodésiques ou des mesures du pendule, quand on veut tenir compte des irrégularités de la surface et de la croûte terrestre.«

It will be the aim of the present paper to determine the ellipticity of the terrestrial spheroid with the highest accuracy now obtainable. It concludes certain investigations which were developed in 1904, but heretofore not published in detail. The approximate mean result then given in AN 3992 as 1 : 297.7 is now put in final form and rendered more exact.

This celestial method of finding the oblateness of the earth was preferred by *Laplace*, and is given great prominence in his lunar theory, which appeared in the third volume of the *Mécanique Céleste*, 1802. It leads to a mean result free from the influence of local irregularities of gravity such as arise from mountains or irregularities of crust, and thus prove troublesome in the researches of geodesy.

By means of a very great number of observations of the moon extending over a long interval, *Bürg*, a celebrated calculator of Vienna, at *Laplace's* request, carefully determined the coefficient of the lunar inequality in latitude, and fixed the value at $-8''$; from which *Laplace* deduced an oblateness of $1/304.6$.

The related method based on the inequality in longitude, extending over a revolution of the moon's nodes, in 18.6 years, and likewise depending on the ellipticity of the figure of the earth, — for which *Bürg* found the coefficient to be $6''.8$ from a great number of *Maskelyne's* observations, — led *Laplace* to an oblateness of $1/305.05$. This great geometer regarded the near coincidence of the two values as an indication of the high accuracy of the two astronomical methods.

»Thus, the moon«, says *Laplace*, »by the observation of her motions, renders sensible to modern astronomy the

ellipticity of the earth, whose roundness was made known to the early astronomers by her eclipses«. — »The two preceding inequalities deserve every attention of observers; because they have the advantage over geodetical measures in giving the oblateness of the earth, in a manner which is less dependent on the irregularities of its figure«.

Laplace did not fully grasp the fluctuations of the moon's motion, since established by *Newcomb* and first explained by me in 1916, and thus he somewhat overrated the accuracy of the second method, as pointed out below, Section 3.

With this explanation of the importance of the lunar methods, we remark that the inequality in latitude depending on the figure of the earth, has the analytical form (cf. *Pratt's Figure of the Earth*, 4th edition, p. 148)

$$\Delta h = -na/h \cdot A \sin(nt + \epsilon) \quad (4)$$

$$= -n\alpha^2/2ha^2 \cdot (\epsilon - 1/2\varphi) \sin 2\omega \sin(nt + \epsilon) \quad (5)$$

where h is the regression of the moon's node, $\varphi = 0.00346768$ is *Helmert's* value of the ratio of the centrifugal force to the force of gravity at the terrestrial equator; α = earth's mean equatorial radius, 6378000 meters; a = moon's mean distance, the ratio α/a = sine of the moon's equatorial horizontal parallax, taken as $P_C = 57' 2''.39$, $\log \sin P_C = (8.2198844 - 10)$, and the obliquity of the ecliptic for 1900.00, $\omega = 23^\circ 27' 8''.26$ (*Newcomb*, *Astronomical Constants*, 1895, p. 196), and, for the same epoch, the mean motion of the moon

$$n = 17325593''.8484 \quad (6)$$

in a Julian year.

Hansen has carefully determined the coefficient of this lunar inequality in latitude from extensive series of observations, and fixed the value at $8''.382$. (*Darlegung der theoretischen Berechnung der in den Mondtafeln angewandten Störungen*, t. I, p. 457-471 and t. II, p. 273-322). Previously to *Hansen's* researches *Bürg* had fixed the value at $8''$, and in his *Cours d'Astronomie*, t. II, p. 316, *Faye* has reached the value $8''.59$. The mean of *Bürg's* and of *Faye's* value is $8''.295$ which differs from *Hansen's* value by $0''.087$, a comparatively small quantity.

Tisserand remarks (*Mécanique Céleste*, t. II, p. 368) that the difference of $0''.2$ between the values found by *Faye* and *Hansen* shows that the determination of this coefficient from the observations of the moon is a delicate matter. The difference is less important, however, since the mean of *Bürg's* value, which *Laplace* estimated so highly, and of *Faye's* is within $0''.087$ of that found by the pains-taking labor of *Hansen*, $8''.382$.

Accordingly it appears that we may adhere to *Hansen's* value with great confidence. Our formula for the ellipticity of the earth thus becomes:

$$\epsilon = 8''.382 \cdot 2h/[n \sin^2 P_C \sin 2\omega (206264''.8)] + 0.00173384 \quad (7)$$

where $0.00173384 = \varphi/2$ found by *Helmert* as indicated above.

We use the above values, and recall that the mean regression of the node h , in units of the moon's mean motion in a Julian year, is found by calculation to be:

$$h/n = 27.32166/(365.2563582 \cdot 18.5996) \\ = 0.004021663 \quad (8)$$

wherefore $\log(h/n) = (7.6044057 - 10)$. (9)

Thus we find:

$$\begin{aligned} \sin P_C &= 8.2198844_{-10} \\ \sin^2 P_C &= 6.4397688_{-10} \\ \sin 2\omega &= 9.8634520_{-10} \\ \log(\sin^2 P_C \sin 2\omega) &= 6.3032208_{-10}. \end{aligned} \quad (10)$$

Accordingly,

$$\log[(2h/n)(8^{\circ}38'22.06264''8)] = 3.5143583_{-10} \quad (11)$$

and

$$\begin{aligned} &3.5143583_{-10} \\ &6.3032208_{-10} \\ \hline \log(\varepsilon - \varphi/2) &= 7.2111375_{-10} \end{aligned} \quad (12)$$

$$\varepsilon - \varphi/2 = 0.0016260634.$$

Therefore, $\varepsilon - \varphi/2 = 0.0016260634$
 $+ \varphi/2 = 0.0017338400$

or

$$\begin{aligned} \varepsilon &= 0.0033599034 \\ \varepsilon &= 1/297.63. \end{aligned} \quad (13)$$

Tisserand adds (*Mécanique Céleste*, t. II, p. 368), that *Helmert* stops at a value of $1/297.8 \pm 2.2$ as the result of the observations of the moon.

The oblateness above reached is not far from *Helmert's* value, but I would make the probable error smaller than that given by *Helmert*, owing to the superior accuracy of *Hansen's* work, and the greater weight to be attributed to his researches.

If we use *Bürg's* value of the coefficient, $8''$ instead of the $8''.382$ found by *Hansen*, we obtain

$$\varepsilon = 0.00328580 = 1/304.34 \quad (14)$$

and with *Faye's* coefficient, $8''.59$, we obtain the larger value

$$\varepsilon = 0.00340025 = 1/294.103. \quad (15)$$

The mean of these two values, resulting from the coefficients of *Bürg* and *Faye*, is found to be:

$$\varepsilon = 0.0033430 = 1/299.13 \quad (16)$$

which agrees almost exactly with the oblateness found by *Bessel* from a discussion of all geodetic measurements in 1841, (AN 438), namely:

$$\varepsilon = 1/299.1528. \quad (17)$$

As it seems illogical to wholly ignore the work of *Bürg* and *Faye*, we combine the three results, with the system of weights assigned below:

<i>Hansen</i>	$\varepsilon = 0.0033599$	wt. = 10
<i>Bürg</i>	0.0032858	5
<i>Faye</i>	0.0034002	5

$$\text{weighted mean, } \varepsilon = 0.0033515 = 1/298.37. \quad (18)$$

This result utilizes all the results obtained from the moon's inequality in latitude, depending on the figure of the earth. It is remarkable that it agrees almost exactly with *Helmert's* earlier value (1903) for the oblateness of the earth, obtained from gravity determinations, namely,

$$\varepsilon = 1/298.3 \quad (19)$$

to which Prof. *E. W. Brown* has called attention in his address to the British Association in Australia, 1914, p. 317. It also conforms closely to my value of 1904, namely:

$$\varepsilon = 1/297.7 \quad (20)$$

AN 3992, and to the value $1/297$ adopted by the Directors of the Nautical Almanacs in 1911.

The oblateness of the earth thus obtained by assigning moderate weights to the three determinations ought to have an uncertainty in the divisor of not more than one unit. The coincidence of this value with *Helmert's* independent result found from gravity determinations, is quite remarkable, and renders it the more probable that no considerable error due to accidental or constant causes can exist in this weighted mean ellipticity deduced from the lunar inequality in latitude.

Nevertheless, in the above-mentioned address on the moon's motion, Prof. *E. W. Brown* expresses the view that the lunar inequality in latitude is not satisfactory for the determination of the oblateness of the earth, because the coefficient of the inequality is entangled with the obliquity of the ecliptic. The obliquity, however, is known with great precision for several centuries prior to the present epoch, and even to the age of the Greeks, with a degree of accuracy surpassing that derivable from the observations the ancients have transmitted to us. Thus the obliquity has no degree of uncertainty which can sensibly vitiate the oblateness of the earth deduced from the lunar inequality in latitude: and after an examination of this criticism, we must hold it to be not well founded. It is surprising that Prof. *Brown* was not more careful in pronouncing against one of the most accurate of all our available methods, which was correctly appraised by *Laplace* in 1802, and more recently has enabled *Helmert* to reach a value of the oblateness $\varepsilon = 1/297.8$ extremely near the truth.

Brown contends finally that the observations on the lunar parallax, between Greenwich and the Cape of Good Hope, and the observed motion of the moon's node and perigee, are best satisfied by an oblateness of about $1:294$. And he holds that this value should have been adopted in the conference of almanac directors. In the course of the present paper we shall examine into the validity of this claim: it suffices here to say that it is inadmissible, partly because it assumes that the Newtonian Law should not be modified by a slight change in the exponent, as shown in AN 5048, p. 148.

3. Discussion of *Laplace's* Theoretical Method for determining the Ellipticity of the Terrestrial Spheroid by Means of the 18.6-Year Inequality in Longitude depending on the Regression of the Moon's nodes.

From the observations used for the construction of his lunar tables, 1755, *Tobias Mayer* found indications of an inequality in longitude in some way depending on the revolution of the moon's node. In his memoir on the secular acceleration of the moon, 1772, *Lagrange* was the first to entertain the idea of introducing the oblateness of the earth into the differential equations of the motion of the moon, but neglected it, — supposing insensible the inequalities which contain the factor I , the inclination of the moon's orbit, — and thus he missed the inequality in longitude depending on the oblateness of the earth.

Twenty seven years later, 1799, while calculating the terms which escaped the analysis of *Lagrange*, *Laplace* discovered the physical cause of the inequality pointed out by

Mayer, and easily explained the nature of the perturbations in longitude. But *Laplace* discovered also the inequality in latitude Δh , which *Bürg* and *Burckhardt* subsequently confirmed by the discussion of observations, and which we have already discussed in relation to the ellipticity of the earth.

The principal inequality in longitude depending on the figure of the earth has the form:

$$\begin{aligned} \Delta L &= -(19/4n/h) (\varepsilon - 1/2\varphi) I \sin^2 P_C \sin 2\omega \sin \Omega \\ &= -C \sin \Omega \end{aligned} \quad (21)$$

where Ω is the longitude of the moon's node, and the other symbols are the same as were described before.

Using the values previously introduced, namely:

$$\begin{aligned} \log \sin^2 P_C &= 6.4397688_{-10} & \log(n/h) &= 2.3955943 \\ \log \sin 2\omega &= 9.8634520_{-10} & \log(19/4) &= 0.6766936 \end{aligned}$$

we find with $I = 5^\circ 8' 43''.35 = 18523''.35$ (22)

$$\varepsilon = 0.00335233 = 1:298.3$$

$$\text{by actual calculation } C = 7''.1176. \quad (23)$$

Accordingly the theoretical value of this inequality in the moon's longitude is

$$\Delta L = +7''.1176 \sin \Omega. \quad (24)$$

In volume II of his *Mécanique Céleste*, p. 367, *Tisserand* reaches a value of the coefficient larger than this; for in volume III, p. 148, he deduces the value:

$$\delta L = +7''.626 \sin \Omega \quad (25)$$

the retrograding node Ω giving this change to a plus sign in the coefficient.

It is pointed out by *Laplace* (*Mécanique Céleste*, Liv. VII, Chap. IV, § 24) that *Mason* found the value $7''.7$ for this coefficient by observation, while *Bürg* subsequently obtained the value $6''.8$. The simple mean of these two values is $7''.25$, near the new theoretical value calculated above. If we give *Mason's* value a weight of 1 and *Bürg's* value a weight of 2, the mean will be $7''.10$, which is still nearer the above calculated value, and yields:

$$\varepsilon = 1:298.6572 = 0.003348321. \quad (26)$$

But it should be pointed out that none of the older methods for obtaining this coefficient by observation can be rigorously depended on, owing to the fluctuations established by *Newcomb* in 1909, and theoretically explained by me in accordance with *Newton's* law, 1916, (cf. AN 5048, pp. 153-160). I have shown that there are three terms in the moon's mean longitude with periods of 18.0293, 61.7006, and 277.590 years, respectively; and as the corresponding coefficients are $1''$, $3''$, and $13''$, there would result slow changes in the moon's mean longitude, which would render the older discussions somewhat defective, yet on the average giving a result approximately correct.

It is noteworthy that in Chap. V, Lib. VII, of the *Mécanique Céleste*, 1802, *Laplace* believed in the existence of fluctuations in the moon's mean motion. He introduces the subject by saying: »We have remarked that the moon's mean motion, deduced from a comparison of the observations of *Flamsteed* and *Bradley*, is sensibly greater than that which results from the observations of *Bradley*, compared with those of *Maskelyne*; moreover, the observations made within fifteen or twenty years indicate, in this motion, a still greater diminution. This seems to prove, that there is, in the theory of the moon's motion, one or more inequalities of a long period;

and, it is important to ascertain the law which regulates any such inequality. If we examine the lunar theory, with the most scrupulous attention, we shall find, that the action of the planets produces nothing of this kind.«

In his commentary to the translation of the *Mécanique Céleste*, from which the above is quoted, *Bowditch* points out that *D'Alembert* proposed to introduce an inequality of long period, before *Laplace* discovered the cause of the moon's secular acceleration, 1787. And in spite of this discovery the irregularities of the motion in longitude continued to engage the attention of astronomers like *Laplace*, *Burckhardt*, *Bürg*, *Plana*, and *Carlini*. *Laplace* subsequently recurs to the inequality of long period which appears to exist in the moon's motion, in the fifth volume of the *Mécanique Céleste*, but speaks with less confidence of the existence of this inequality. And in the last edition of the *Système du Monde*, published only a short time before his death, he omits mention of it altogether. This would seem to show that *Laplace* was at least partially aware of the fluctuations of the moon's motion, afterwards established by *Newcomb*, 1869-1909, and of which the present writer discovered the physical cause, 1916 (cf. *Electr. Wave-Theory of Phys. Forces*, vol. I, 1917).

From the above discussion of the inequality in the moon's longitude depending on the figure of the earth, it follows that to evaluate the coefficient by observation, the fluctuations must be known accurately for the period of the observations. In the present state of science the laws of the fluctuations have been established indeed, but not yet used in calculation; and thus the corresponding method of finding the ellipticity of the earth is not quite rigorously applied in the deduction of the older coefficients of *Bürg* and *Mason*. Nevertheless, as the fluctuations change very gradually, the mean values derived by *Bürg* and *Mason* from observations extending over a long period of years should give coefficients which are essentially accurate.

Accordingly, just as *Laplace* believed, the method ultimately is one of great promise; and since he obtained an ellipticity of $1/304.6$, from *Bürg's* coefficient, the use of *Mason's* value ($7''.7$) properly weighted still further improves the accuracy.

4. The Determination of the Ellipticity of the Strata, under *Laplace's* Law of Density, gives also the Ellipticity of the Earth's Surface; and the Fluid Theory, postulated by *Clairaut*, 1743, is confirmed by the Modern *Pratt-Helmert-Hayford* Theory of Isostasy.

Under *Laplace's* law of density, — which assumes the law of the compressibility of the earth's matter to be that the increase of the square of the density is proportional to the increase of the pressure, or $d\sigma = \alpha \sigma d\sigma$, — we have throughout the globe: $\sigma = \sigma_0 \cdot \sin qx / qx$. (27)

It is shown also that the ellipticity of a stratum of uniform density is defined by the equation:

$$\varepsilon = \frac{5}{2} \varphi \cdot [1 - 3z/(q^2 \alpha^2)] / (3 - z - q^2 \alpha^2 / z) \quad (28)$$

where $q\alpha$ is the part of the radius appropriate to the stratum in question, $z = 1 - q\alpha / \text{tg } q\alpha$, and $\varphi = 0.00346768$, as before.

It is shown in AN 3992, that $q\alpha = 2.52896$, = $144^\circ 53' 55''.2$; and hence we find for the ellipticity of the earth's surface:

$$\begin{aligned}
 \log q\alpha &= 0.4029420 \\
 \log \operatorname{tg} q\alpha &= \frac{9.8468605_{-10n}}{0.5560815n} \\
 -q\alpha/\operatorname{tg} q\alpha &= \frac{3.598168}{1} \\
 z &= 4.598168 \\
 \log (q\alpha)^2 &= 0.8058840 \\
 \log z &= 0.6625849 \\
 \log (q\alpha)^2/z &= 0.1432991 \\
 -(q\alpha)^2/z &= -1.3909104 \\
 -z &= -4.598168 \\
 -z - (q\alpha)^2/z &= -5.9890784 \\
 &+ 3 \\
 3 - z - (q\alpha)^2/z &= -2.9890784.
 \end{aligned} \tag{29}$$

$$\begin{aligned}
 3z &= 13.794504 \\
 \log 3z &= 1.1397060 \\
 \log (q\alpha)^2 &= \frac{0.8058840}{0.3338220} \\
 -3z/(q\alpha)^2 &= -2.15686 \\
 1 - 3z/(q\alpha)^2 &= -1.15686 \\
 \log \{1 - 3z/(q\alpha)^2\} &= 0.0632809n \\
 \log \{3 - z - (q\alpha)^2/z\} &= 0.4755373n \\
 \log \left\{ \frac{1 - 3z/(q\alpha)^2}{3 - z - (q\alpha)^2/z} \right\} &= 9.5877436_{-10} \\
 \log \left(\frac{5}{2} \varphi \right) &= \frac{7.9379752_{-10}}{7.5257188_{-10}}
 \end{aligned} \tag{30}$$

By equation (28) we have $\log \varepsilon = 7.5257188_{-10}$.

Therefore $\varepsilon = 0.0033552 = 1/298.045$. (31)

Accordingly, on *Clairaut's* fluid-theory, 1743, (cf. *Tisserand's Mécanique Céleste*, Tome II, p. 211), as now confirmed by modern geodesy, we conclude from the above data, which appear to be the best obtainable, that the ellipticity of the surface of the terrestrial spheroid is 1 : 298.045.

Over half a century ago it was shown by *Pratt* to be highly probable that the density of the matter just beneath the surface of the earth is so arranged as to give equal mass in equal cones having their common vertices at the center of the earth. This doctrine of isostasy applies especially to the inequalities of the earth's surface, and has been recently confirmed by *Hayford's* investigations of the gravitational and geodetic measurements made by the U. S. Coast Survey.

In his latter years *Helmert* recognized the fact of isostasy in the arrangement of the crust of the globe, and thus *Clairaut's* fluid-theory is fully confirmed by modern geodesy. Accordingly it is made the basis also of my paper on the Physical Cause of the Land and Ocean Hemispheres of the Earth (AN 202 Nr. 4844-5, May 1916). We have therefore finally confirmed the arrangement of the globe as a heterogeneous mass of fluid in equilibrium, as originally postulated by *Clairaut* in 1743; and used by *Laplace* as the basis of his law of density, which made it possible to integrate *Clairaut's* differential equations for the equilibrium of a fluid mass (cf. *Tisserand's Mécanique Céleste*, Tome II, Chap. XV, p. 232).

It is shown that if the earth's internal density follows a law $\sigma = \Phi(a)$ (32)

where a is the radius of a shell, and ε its ellipticity, the law of *Laplace*, which *Legendre* was the first to propose, leads to the equations:

$$\varepsilon = F\zeta \quad \zeta = y/\int_0^a \sigma a^2 da \tag{33}$$

$$d^2y/da^2 = (a^2 \cdot d\sigma/da) / \int_0^a \sigma a^2 da + 6/a^2 y. \tag{34}$$

This equation takes on a simple aspect when we suppose that the law of density will be such that we may always write,

$$a^2 \cdot d\sigma/da / \int_0^a \sigma a^2 da + m^2 = 0 \tag{35}$$

where m denotes a constant, $m = \sqrt{6/a}$.

On clearing of fractions and differentiating this last equation, we get:

$$a^2 \cdot d^2\sigma/da^2 + 2a \cdot d\sigma/da + m^2 \sigma a^2 = 0 \tag{36}$$

which may be put in the form:

$$d^2\sigma a/da^2 + m^2 \sigma a = 0. \tag{37}$$

By integration we obtain:

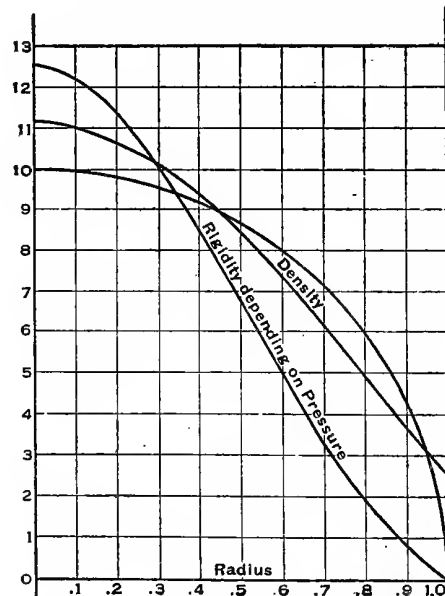
$$\sigma a = Q \sin qa + R \cos qa \tag{38}$$

and as the density should be finite at the centre, where $a = 0$, we conclude that $R = 0$, and our general equation for the density reduces to the form (cf. AN 167.122):

$$\sigma = Q \sin qa/a = \sigma_0 \cdot \sin qx/qx. \tag{39}$$

This is *Laplace's* celebrated law of density, and when applied to the earth the data of the law is illustrated by the following table and curve (cf. AN 3992):

Fig. 2. Curves of Pressure and Density within the Earth, according to *Laplace's* Law.



The Earth:
Scale of Rigidity 1 div. = 250000 Atmospheres.
4 divisions = Rigidity of Nickel Steel.

Radius r	σ ($\sigma_1 = 5.50$)	ϖ (Pressure in Atmospheres)
1.0	2.55	1
0.9	3.75	198760
0.8	4.99	483691
0.7	6.21	842921
0.6	7.38	1260966
0.5	8.46	1710730
0.4	9.40	2152114
0.3	10.12	2521620
0.2	10.74	2861507
0.1	11.07	3050870
0.0	11.215	3135727

On calculating the ellipticities of the strata towards the center of the earth, we find them to decrease as *Laplace* has shown should be the case (*Mécanique Céleste*, Lib. III, Chap. IV, § 30), while the density increases. The following table exhibits the results of our calculations.

r	qa in arc	qa in radians	σ	ε	ε
1.0	144° 53' 55".2	2.528960	2.55	1.000	= 1:298.30
0.9	130 24 31.7	2.276064	3.75	0.9487	= 1:314.44
0.8	115 55 8.2	2.023168	4.99	0.9090	= 1:328.16
0.7	101 25 44.7	1.770272	6.21	0.8778	= 1:339.83
0.6	86 56 21.2	1.517376	7.38	0.8532	= 1:349.62
0.5	72 26 57.7	1.264480	8.46	0.8338	= 1:357.76
0.4	57 57 34.2	1.011584	9.40	0.8193	= 1:364.09
0.3	43 28 10.7	0.758688	10.12	0.8084	= 1:369.53
0.2	28 58 47.2	0.505792	10.74	0.8014	= 1:372.22
0.1	14 29 23.7	0.252896	11.07	0.7981	= 1:373.76
0.0	0 0 0.0	0.000000	11.215	0.7970	= 1:374.28

5. Determination of the Mean Ellipticity of the Earth's Surface by Means of the Observed Value of the Precession of the Equinoxes, and an Integration for the Mechanical Ellipticity of the Earth, the Integrals for $(C-A)/C$ being deduced from the Application of *Laplace's* Law of Density.

It is shown in the theory of a spheroid, to which *Laplace's* law of density is applicable, that we may represent the surface of the globe by an equation of the form:

$$r = r_0 [1 + \varepsilon (1/3 - \cos^2 \theta)] \tag{40}$$

Then, we shall have for the larger moment of inertia, which is that about the polar axis, and usually denoted by C :

$$C = 2 \int_0^{r_0} \int_0^{1/2\pi} \int_0^{2\pi} \sigma r^2 \sin \theta \, dr \, d\theta \, d\Phi \cdot r^2 \sin^2 \theta \tag{41}$$

$$= 2 \int_0^{r_0} \int_0^{1/2\pi} \int_0^{2\pi} \sigma r_0^4 [1 + \varepsilon (1/3 - \cos^2 \theta)]^4 \sin^3 \theta \, dr_0 \, d\theta \, d\Phi \tag{42}$$

For the smaller moment of inertia, about an axis in the equator of the terrestrial spheroid, we have in like manner:

$$A = 2 \int_0^{r_0} \int_0^{1/2\pi} \int_0^{2\pi} \sigma r_0^4 [1 + \varepsilon (1/3 - \cos^2 \theta)]^4 \times \sin \theta (1 - \sin^2 \theta \sin^2 \Phi) \, dr_0 \, d\theta \, d\Phi \tag{43}$$

Accordingly the triple integral for the mechanical ellipticity of the earth has the form:

$$\frac{C-A}{C} = \int_0^{r_0} \int_0^{1/2\pi} \int_0^{2\pi} \sigma r_0^4 [1 + \varepsilon (1/3 - \cos^2 \theta)]^4 \times \{(\sin^2 \theta \cos^2 \Phi - 1) / \sin^2 \theta\} \, dr_0 \, d\theta \, d\Phi \tag{44}$$

And it is shown that the integral of this becomes:

$$(C-A)/C = z/[2 + (1 - 6/q^2 a^2)] \cdot (\varepsilon^{-1/2} \varphi) \tag{45}$$

where $\varphi = 0.00346768$, and $qa = 2.52896$, $z = 4.598168$, as before.

This leads to the following value for the mechanical ellipticity of the earth:

$$(C-A)/C = 0.00325766 = 1/306.97 \tag{46}$$

It may be noticed that this so called mechanical ellipticity of the earth (cf. *Newcomb*, *Astronomical Constants*, 1895, p. 195) is considerably smaller than the ellipticity of the layer constituting the surface of our globe. The physical reason for this is that in the above integral (43) we take account of the product of the mass of each shell into the ellipticity of that stratum of the globe, so that the final result is an average value. And as the ellipticity of the strata decreases towards the center, while the density increases, as shown by the table at the close of the last section, it follows that the mechanical ellipticity is an average for the entire earth, and thus too small for the surface layer. The integral of the mass of each stratum, multiplied by its appropriate ellipticity, yields a varying product, and when these are summed up, as the integration is extended throughout the mass, the resulting mean value necessarily is too small.

Now the solar annual precession is given by the formula (*Airy*, *Mathematical Tracts*, 4th ed., p. 218):

$$(\partial r / \partial t)_\odot = (C-A)/C \cdot 9(60)^2 \cos \omega / 366.2563582 \tag{47}$$

Reducing this to numbers with the above value of the mechanical ellipticity, $(C-A)/C$, we obtain for the annual solar precession:

$$(\partial r / \partial t)_\odot = 15''.86253 \tag{48}$$

In like manner the lunar annual precession is:

$$\begin{aligned} (\partial r / \partial t)_\ominus &= (C-A)/C \times \\ &\times \frac{9(60)^2 \cdot 366.2563582 \cos \omega (1 - 3/2 \sin^2 I)}{(27.32166)^2 \cdot 81.45} = 34''.4378 \end{aligned} \tag{49}$$

Accordingly, for the combined luni-solar precession, we have the sum of these two values:

$$(\partial r / \partial t)_\oplus + (\partial r / \partial t)_\ominus = 34''.4378 + 15''.8625 = 50''.3003 \tag{50}$$

From the discussion of observations of many stars, *Newcomb* found the value of the actual precession to be only slightly different from that obtained by *Bessel* in 1818, namely 50''.248 (1900). *Newcomb's* value for 1900 is:

$$dr/dt = 50''.25 \tag{51}$$

The difference between the theoretical value 50''.30 as above calculated and the *Bessel-Newcomb* observed precession is therefore only +0''.05, which is so very small as to be near the limit of uncertainty in our value of the precession as derived from observations of the fixed stars.

It follows therefore that *Laplace's* law of density within the earth gives a value of the mechanical ellipticity which represents the precession quite perfectly. The group of constants could be so adjusted as to obliterate this small difference, but as it is uncertain where the changes should be made, we deem it best to allow the above value to stand, without further change.

Pratt remarks that the argument for *Laplace's* law of density, deduced from these calculations, is not very strong. As the terrestrial strata have small ellipticity, the law of density conceivably might be varied from that of *Laplace*, and yet lead to about the same agreement when the integration for $(C-A)/C$ is extended to the mass of the whole earth. But as *Laplace's* law gives a close agreement for the ellipticity of the surface with those found by pendulum observations and by elaborate geodetic measurements of arcs of the meridian, it is improbable that the law of density should be materially changed. We must therefore regard *Laplace's* law as essentially a law of nature.

In AN 3992, 4053, 4104, we have adduced strong physical arguments to show that the increase of density towards the centers of the heavenly bodies is due to the enormous pressure to which their gaseous or semi-solid matter is subjected. It is shown that the enormous rigidity of the heavenly bodies is due solely to the pressure.

Professor *E. Wiechert* and others have formerly assumed for the earth an iron nucleus, covered with a superstructure of rock; but of late, the author's argument that the increase of density downward is due solely to the enormous increase of pressure seems to be very generally accepted. Hence the differential equation $d\omega = \kappa \sigma d\sigma$, underlying *Laplace's* law, may be regarded as verified by an induction based on the study of all the principal solid bodies of the solar system.

It follows therefore that the close agreement of the theoretical with the observed value of the precession points to an ellipticity of the external surface of the globe of $1 : 298.3$.

6. Determination of the Ellipticity of the Earth's Surface by Means of Pendulum Observations of the Force of Gravity, and of *Clairaut's* Theorem.

The potential of the earth's mass may be expressed in the form:

$$V = M/r + (\epsilon - 1/2\varphi) (Ma^2/r^3) (1/3 - \cos^2\theta). \quad (52)$$

The second term varies with the polar distance θ , which is the complement of the latitude. Accordingly the gravity in any latitude was found by *Clairaut*, in his *Théorie de la Figure de la Terre*, 1743, to vary according to the following law: $g = G \{1 + (5/2 - \epsilon) \sin^2\Phi\}$.

This formula for the variation of gravity with the latitude is known as *Clairaut's* Theorem.

By means of pendulum observations a great many determinations of the relative force of gravity have been made in all parts of the world. These give a good determination of the ellipticity of the earth. The following are the most important results:

1. *Helmert's* determination, 1903, based on all the available measures of gravity, taking account of the term of second order in $\sin^2\Phi$, where Φ is the latitude:

$$\epsilon = 1/298.30. \quad (54)$$

This value was furnished to Prof. *Newcomb* for his *Lunar Researches*, vol. II, 1912, and was long believed to be *Helmert's* final word on the subject. As far back, however, as 1884, *Helmert*, from pendulum observations, had reached the value:

$$\epsilon = 1/(299.26 \pm 1.26). \quad (55)$$

This rested on a very complete calculation in which account is taken of a term of second order in $\sin^2\Phi$, where Φ is the latitude (*Tisserand's Mécanique Céleste*, Tome II, p. 366). Accordingly, his more recent calculation of the ellipticity, for Prof. *Newcomb's* *Lunar Researches*, was in fact an improvement on the value of 1884, yet it included the results of 20 years of later measurements of the force of gravity by means of the more refined pendulum observations of recent times.

In his address to the British Association in Australia, 1914, p. 317, Prof. *E. W. Brown* therefore accepts *Helmert's* value of $1 : 298.30$, from the whole series of pendulum observations, as the concluded value by that method; and it probably will be a long time before any material improvement on this result will be possible.

This value of the ellipticity of the earth has great inherent probability, both because of the refinement of the measures of gravity, and their wide distribution over the globe, in both latitude and longitude, and also because of the thoroughness with which *Helmert* has systematically treated all the accumulated observational material during the past 50 years. It has in our time the same relative weight with *Bessel's* classical value $\epsilon = 1/299.15$ (56) determined from the sagacious discussion of all the geodetic observations of arcs of the meridian available to the investigator in the middle of the 19th century.

It is somewhat remarkable that as far back as 1904, the present writer reached an ellipticity of the earth, from all the available methods of finding this element, according exactly with *Helmert's* value, but without knowledge of his result. The value of 1904 was:

$$\epsilon = 1/(298.30 \pm 1.00). \quad (57)$$

And I calculated formulae and elaborate tables for the resulting spheroid. On receiving other data, probably from Prof. *E. W. Brown*, I altered the concluded ellipticity a little, and published merely the approximate result, in AN 167.125, namely:

$$\epsilon = 1/297.7.$$

Accordingly, it appears that my value of the oblateness of the earth, 1904, and *Helmert's* value of 1903, are in exact agreement; and although *Helmert* subsequently increased his value to $1 : 296.7$, as shown above in Section I, my definitive value for the oblateness, 1921, based on all available data remains quite unchanged, namely

$$\epsilon = 1 : 298.3. \quad (58)$$

7. Determination of the Ellipticity of the Terrestrial Spheroid from Geodetic Measurements of Arcs of the Meridian.

This method is the one originally proposed by the Alexandrian astronomer *Eratosthenes*, about 230 B. C., and in modern times gradually perfected with the development of geodesy. It is therefore very old, and was generally considered the logical method prior to the discovery of the widely prevalent minor variations of the force of gravity due to local disturbing influences. But even with irregular gravitational attractions disturbing the local direction of the vertical, the method is still very valuable, because it rests on direct measurement of the length of the arc of the meridian.

If Φ_1 and Φ_2 be the astronomical latitudes of the terminals of the arc in question, and ρ the radius of curvature of the meridian for the mean latitude $\frac{1}{2}(\Phi_1 + \Phi_2)$ and a the equatorial axis, we have for the length of the arc the integral:

$$s = \int_{\Phi_1}^{\Phi_2} \rho d\Phi = a \int_{\Phi_1}^{\Phi_2} (1 - e^2)(1 - e^2 \sin^2 \Phi)^{-3/2} d\Phi. \quad (59)$$

And if we put for the ratio of the polar to the equatorial axis $b/a = (1-n)/(1+n)$, we may write $n = (a-b)/(a+b) = 1/595.6 \cdot a$, in the case of the earth, and thus

$$s = b \int_{\Phi_1}^{\Phi_2} (1+n)(1-n^2)(1+2n \cos 2\Phi + n^2)^{-3/2} d\Phi. \quad (60)$$

When the measurements are extensive, over a long and fairly homogeneous arc, as in a level country, the local disturbances are largely eliminated, as mutually destroying one another. Yet there may be some disturbing gravitational causes introduced, due to systematic local attractions exerting an uncompensated influence on the vertical. Besides, there are errors of observation incident to the imperfections of the geodetic instruments, and thus also affecting the adjustment of the triangulation of the meridian. And for these and other reasons it is possible that the pendulum observations of gravity may give a more accurate value of the ellipticity of the earth than that of geodetic measurements of arcs of the meridian.

Nevertheless, the geodetic method has advantages, and the following are the chief results:

1. *Airy*, from an able discussion of the figure of the earth, *Encycl. Metr.*, ed. 1831, and ed. 1849,

$$\epsilon = 1/299.33. \quad (61)$$

This result was reached by a judicious selection of arcs along the meridian only; those in mountainous countries also being excluded, to avoid undue effects of local gravitational disturbances. *Airy* weighed carefully the relative accuracy of the earlier and later geodetic measurements, and thus obtained an ellipticity of great accuracy.

2. *Bessel's* classical determination of the ellipticity of the figure of the earth, 1841, AN 19 Nr. 438:

$$\epsilon = 1/299.1528. \quad (62)$$

This celebrated result is based upon an elaborate discussion of the most reliable measurements of arcs of the meridian. The final spheroid is so adjusted to the entire system of observations, by a least square solution of the equations, as to give minimum errors of observation. *Bessel's* discussion has always been considered a masterpiece, and no criticism of serious purport has ever been made against it.

3. *Clarke's* spheroid of 1878,

$$\epsilon = 1/293.465. \quad (63)$$

This value by *Clarke* is comparatively recent, but it differs materially from *Bessel's*, and has not been much used on the continent of Europe, where the leading authorities have preferred *Bessel's* determination of the ellipticity. *Clarke's* result has, however, been considerably used in England, and provisionally by the United States Coast and Geodetic Survey.

4. *Tittmann's* Coast Survey result, 1904, in which the

American geodetic work is combined with the results of the various series of triangulations in other parts of the world:

$$\epsilon = 1/300.7. \quad (64)$$

In regard to several other determinations of the ellipticity of the earth, by geodetic methods, it only remains to add that they are of secondary importance compared to the four principal results here cited. For example, in his *Figure of the Earth*, 4th ed., 1871, p. 177, *Pratt* made a determination of the ellipticity of the terrestrial spheroid, taking account of local attractions. From the three long arcs considered *Pratt* found the ellipticity to be

$$\epsilon = 1/295.2. \quad (65)$$

Pratt also made certain criticisms of *Bessel's* formulae, but Colonel *Clarke* did not consider the criticism justified; and in his *Article Earth, Encycl. Britt.*, 9th ed., p. 605, *Clarke* says of *Pratt's* attack on *Bessel's* equations: »certainly *Bessel* was right, and the objection is groundless«.

It only remains therefore to find the best mean value obtainable from the above four chief results. After careful consideration we adopt the following weights for the different independent determinations, all of which are valuable:

Name	Date	Ellipticity	weight.
<i>Airy</i>	1831	0.003340794	5
<i>Bessel</i>	1841	0.003342774	5
<i>Clarke</i>	1878	0.003407614	3
<i>Tittmann</i>	1904	0.003325573	6
Weighted Mean		$\epsilon = 0.003347059$	
		$\epsilon = 1/298.767$	(66)

It only remains to point out certain features of the arc method which seem worthy of the attention of geodesists. In the U. S. Coast Survey Report, 1898-99, App. No. 3, Frontispiece, we find the accompanying Map of the Geodetic Operations for the Measurement of the Earth, Fig. 1 Plate 1. The only important extensions of the arcs here laid down, in the 20 years since this map was published, are in the region of South Africa, where Sir *David Gill's* arc amounted to 22° of latitude, in 1903, and slight arcs of 2°5' in the equatorial region of Africa, 1908, with a similar short arc in Egypt, Cairo to Assiut (cf. *The Observatory*, Dec. 1920, pp. 421-422).

The most striking feature of Figure 1, which is a map of the world's geodetic surveys, is the inequality between the operations made in the two terrestrial hemispheres — nearly all the measurements being in the northern hemisphere, where most of the land lies, and the greater and more enterprising nations are developed.

This great deficiency of long arcs in the southern terrestrial hemisphere is thus a fundamental weakness in the geodetic method, but the weakness is largely if not entirely compensated for by the following circumstances:

1. It is stated by Col. *H. G. Lyons*, at the London discussion of geophysical subjects, Nov. 5, 1920, (cf. *The Observatory*, Dec. 1920, p. 422), that Dr. *Bahn's* researches, in the *Beiträge zur Geophysik*, show that in the South African Arc »the combined errors resulting from triangulation and base measurement are only about 1 in 90000, or 28 metres in 2600 kilometres. The curvature, as a whole, agrees well

with that of the *Clarke* spheroid of 1880, but the radius of curvature for the southern portion is less than for the arc as a whole.«

If this analysis be dependable, it means that the ellipticity of the spheroid in South Africa is less than that indicated by *Clarke's* spheroid, and thus more nearly accordant with our value $\epsilon = 1:298.3$, which is a satisfactory confirmation of the new spheroid derived from the latest geodetic surveys.

2. In the dynamical theory of the land and water hemispheres of our globe, given in AN 4844-45, May 1916, it is shown that theoretically there ought not to be any sensible difference in the figures of the two terrestrial hemispheres. When *Laplace* therefore concluded, in the fifth volume of the *Mécanique Céleste*, that there are slight inequalities in the motion of the moon depending on certain inequalities of land in the two terrestrial hemispheres, he did not take account of isostasy, and the resulting perfect hydrostatic equilibrium of the two hemispheres.

For in AN 4845, p. 355, I have shown that under the theory of the isostatic shell, now recognized to exist, there are no inequalities of attraction in the two terrestrial hemispheres, depending on the unequal distribution of the land; and thus the motions of the heavenly bodies are not disturbed, as *Laplace* imagined, by the unsymmetrical equilibrium of the solid nucleus in the fluid envelope of our globe.

3. These two results accord well with the views of the late Professor Sir *G. G. Stokes*, (Cambridge and Dublin Math. Journal, vol. IV, p. 210), which in part are as follows:

»It may be well to consider the degree of evidence afforded by the figure of the earth in favour of the hypothesis of the earth's original fluidity.«

»In the first place it is remarkable that the surface of the earth is so nearly a surface of equilibrium. The elevation of the land above the level of the sea is extremely trifling compared with the breadth of the continents. The surface of the sea must of course necessarily be a surface of equilibrium, but still it is remarkable that the sea is spread so uniformly over the surface of the earth. There is reason to think that the depth of the sea does not exceed a very few miles on the average. Were a roundish solid taken at random, and a quantity of water poured on it, and allowed to settle under the action of the gravitation of the solid, the probability is that the depth of the water would present no sort of uniformity, and would be in some places very great. Nevertheless the circumstance that the surface of the earth is so nearly a surface of equilibrium might be attributed to the constant degradation of the original elevations during the lapse of ages.«

»In the second place, it is found that the surface is very nearly an oblate spheroid, having for its axis the axis of rotation. That the surface should on the whole be protuberant about the equator is nothing remarkable, because even were the matter of which the earth is composed arranged symmetrically about the centre, a surface of equilibrium would still be protuberant in consequence of the centrifugal force; and were matter to accumulate at the equator by degradation, the ellipticity of the surface of equilibrium would be increased

by the attraction of this matter. Nevertheless the ellipticity of the earth is much greater than the ellipticity ($1/2 \varphi$) due to the centrifugal force alone, and even greater than the ellipticity which would exist were the earth composed of a sphere touching the surface at the poles, and consisting of concentric spherical strata of equal density and of a spherico-spheroidal shell having the density of the rocks and clay at the surface (or $1 \div 420$ nearly). This being the case, the regularity of the surface is no doubt remarkable; and this regularity is accounted for on the hypothesis of original fluidity.«

»The near coincidence between the numerical values of the ellipticity of the terrestrial spheroid obtained independently from the motion of the moon, from the pendulum, by the aid of *Clairaut's* theorem, and from direct measures of arcs, affords no additional evidence whatever in favour of the hypothesis of original fluidity, being a direct consequence of the law of universal gravitation. These results (that every equatoreal axis and the axis of rotation are principal axes) would follow as a consequence of the hypothesis of original fluidity.«

»The phenomena of precession and nutation introduce a new element to our consideration, namely, the moment of inertia of the earth about an equatoreal axis. The observation of these phenomena enables us to determine the numerical value of the (moment of inertia) if we suppose ϵ known otherwise. Now, independently of any hypothesis as to original fluidity, it is probable that the earth consists approximately of spherical strata of equal density. Any material deviation from this arrangement could hardly fail to produce an irregularity in the variation of gravity, and consequently in the form of the surface, since we know that the surface is one of equilibrium. Hence we may assume when not directly considering the ellipticity, that the density is a function of the distance from the centre.«

»Now the preceding results will not be sensibly affected by giving to the nearly spherical strata of equal density one form or another, but the form of the surface will be materially affected. The surface in fact might not be spheroidal at all, or if spheroidal, the ellipticity might range between tolerably wide limits. But according to the hypothesis of original fluidity the surface ought to be spheroidal, and the ellipticity ought to have a certain numerical value depending upon the law of density. If then there exists a law of density, not in itself improbable a priori, which satisfies the required conditions respecting the mean and superficial densities, and which gives to the ellipticity and to the annual precession numerical values nearly agreeing with their observed values, we may regard this law not only as in all probability representing approximately the distribution of matter within the earth, but also as furnishing, by its accordance with observation, a certain degree of evidence in favour of the hypothesis of original fluidity. The law of density usually considered in the theory of the figure of the earth is a law of this kind.«

This reasoning of *Stokes* is so well thought out that we have quoted it in full. Since the time of *Stokes' paper*, 1849, very notable progress has been made in our theory of the connection between solid and fluid bodies. In the *Mémoires des Savants Étrangers, Acad. des Scienc. de Paris*,

(Tomes 18, 20, 1868, 1870) *Tresca* and *St. Venant* published the results of their experiments made about half a century ago, on the flow of metals and other solid bodies when subjected to very great forces. It was found that under very great forces the division between solid and fluid bodies quite disappears, and that solids yield like wax and adapt themselves to equilibrium forms.

Lord *Kelvin*, Sir *George Darwin*, and the present writer (cf. AN 3992, 4104, 4152) have since confirmed the conclusion that whatever their constitution the planetary bodies behave as fluid under the tremendous pressures and high temperatures operating in their interior. Thus the stars, sun and planets take on true figures of equilibrium appropriate to the mutual gravitation of their particles and the centrifugal force of rotation; and any other figure of the surfaces of these masses is inconceivable. The doctrine of isostasy, since developed in geodesy, points in the same direction, and simplifies very greatly our theory of the earth's attraction (cf. AN 4844-45).

Accordingly, the favorable circumstances described in the above three arguments, for the perfect figure of equilibrium of the earth, render the geodetic method for finding the oblateness by the measurement of arcs of the meridian one of great accuracy, in spite of the inequality of the geodetic operations hitherto made in the two terrestrial hemispheres. Thus in a definitive determination of the figure of the earth, it is obvious that the method of geodesy should have adequate weight, not inferior to that based on pendulum observations of the relative force of gravity.

8. Definitive Determination of the Oblateness of the Terrestrial Spheroid Based upon a Weighted Mean of the Results indicated by the Separate Methods for finding the Figure of the Earth.

The chief results arrived at in the foregoing investigation are summarized in the following survey of independent weighted means, by the four methods which give a definite determination of the ellipticity of the terrestrial spheroid.

1. The ellipticity indicated by the lunar inequality in latitude, weighted mean of the coefficients found by *Bürg*, *Faye* and *Hansen*, equation (18) in section 2 above:

$$\epsilon = 1 : 298.37 = 0.0033515 \text{ wt. } 5.$$

2. The ellipticity derived from two separate sources shown to be quite independent, yet in remarkably good agreement:

(a) 18.6-year lunar inequality in longitude, depending on the revolution of the moon's nodes, weighted mean of *Bürg* and *Mason's* coefficients (7^o10), $\epsilon = 1 : 298.6572 = 0.00334832$, equation (26) above.

(b) *Laplace's* law of density, which rests on *Clairaut's* fluid-theory, recently verified by the geodetic fact of isostasy — the constants of *Laplace's* law (cf. AN 3992, 1904) having been derived from experimental determination of the density of the rocks composing the crust of the globe (2.55). The method thus yields for the surface stratum $\epsilon = 1 : 298.045 = 0.00335520$, equation (31) above. The mean of (a) and (b) therefore gives:

$$\epsilon = 1 : 298.351 = 0.00335176 \text{ wt. } 5.$$

3. The ellipticity found from pendulum observations of the force of gravity, weighted mean of the results of *Helmert*, *Hayford* and *Bowie*, equation (1) above:

$$\epsilon = 1 : 297.695 = 0.00335914 \text{ wt. } 10.$$

4. The ellipticity indicated by the geodetic measurement of arcs of the meridian and of longitude, weighted mean of the results of the geodetic researches of *Airy*, *Bessel*, *Clarke*, *Tittmann*, equation (66) above:

$$\epsilon = 1 : 298.767 = 0.003347059 \text{ wt. } 10.$$

Weighted mean of these four independent methods:

$$\epsilon = 1 : 298.2751 = 0.003352610 \text{ wt. } 30 \\ \pm 0.1388 \pm 0.000001559.$$

The probable error of this general mean ellipticity of the terrestrial spheroid has been calculated by the well known formula (cf. *Merriman's* Textbook of the Method of Least Squares, New York and London, 1897, p. 75):

$$r_0 = 0.6745 \sqrt{\{\Sigma p v^2 / [(n-1) \Sigma p]\}} \quad (67)$$

where p represents the weights assigned the several independent results, and $n-1 = 3$, n being the number of independent determinations.

It was observed by *Laplace*, in his celebrated *Théorie Analytique des Probabilités*, 1807, that the theory of probability is nothing but common sense reduced to calculation. And *Gauss* based his development of the method on the axiom established by experience that the most probable value of a quantity which is observed directly several times, with equal care, is the arithmetical mean of the measurements. And if the separate observations have unequal weights, the above formula takes account of the weights assigned by the best judgement available.

Now in the above determination of the most probable oblateness of the earth we cannot observe this quantity directly, but must deduce it by calculation from independent methods of observation, the calculations themselves being free from error. The theory of probability and the method of least squares is thus applicable to the determination of the figure of the earth, and gives us a dependable criterion for the degree of precision attained.

Finding the most probable value of an element from a varied series of observations is equivalent to determining the centre of gravity of the given observations, so that the whole body of phenomena will be best represented. This condition is fulfilled by the weighted mean, which makes the sum of the squares of the outstanding residuals a minimum. In the present problem the weights have been assigned from the following considerations:

1. As to the first method, for reasons fully pointed out by *Laplace* in 1802, the ellipticity indicated by the lunar inequality in latitude must be given considerable weight, since it leads to a mean figure of the earth uninfluenced by local peculiarities, such as mountains, plateaus and other irregularities of the earth's crust. Moreover, the accuracy of the method depending on the lunar inequality in latitude is confirmed by the independent researches of *Bürg*, *Hansen* and *Faye*; and the observations are not materially vitiated by the fluctuations in the moon's mean longitude, which have occasioned so much inconvenience to recent investigators in the lunar theory.

2. The second method, depending on the 18.6-year lunar inequality in longitude, combined with the surface ellipticity resulting from *Laplace's* law, under *Clairaut's* fluid-theory, is sufficiently set forth in the above table. In confirmation of its validity we note that *Pratt's* theory of isostasy, in the constitution of the crust of the earth, has been confirmed by the recent researches of *Helmert*, *Hayford* and *Bowie*, and to a considerable extent by the results reached by Colonel *Burrard* in India, near the mighty range of the Himalayas, where the contrasts between the elevations and depressions of the continental crust are the greatest in the world. Thus it is obvious that the *Clairaut-Laplace-Pratt* fluid-theory of the earth's constitution is verified by the most extensive geodetic observations and researches of our time.

3. The ellipticity found from determinations of the force of gravity, by means of the pendulum observations, as used by *Helmert*, and subsequently by the U. S. Coast Survey, obviously must be given great weight. Accordingly, we assign the result of this method a weight equal to that of the two foregoing methods combined.

4. And on account of the importance of the actual measurements of arcs of the meridian and of longitude in geodesy, it will be generally felt that equal weight should be given to the mean ellipticity indicated by geodetic operations. As the best method of combining the observations, on the various arcs of the globe depends on geodetic experience and sound practical judgement, it seemed best to use the results of the chief investigators since 1830, without attempting new reductions of the original data. An attempt at new reductions would raise many troublesome questions, without yielding any corresponding advantages, where the ground already has been covered by investigators of great eminence. This may be easily understood from the discordance of *Clarke's* oblateness 1:293.465, 1878, with those of *Airy*, 1830, and *Bessel*, 1841, 1:299.15, which *Tittmann* has brought out by his value 1:300.7, 1904, — an approximate restoration of *Bessel's* value after a lapse of more than 60 years! Accordingly, it is best to leave the discussion of purely geodetic operations to geodesists; and hence the admissibility of the weights assigned to the result reached by *Airy*, *Bessel*, *Clarke*, *Tittmann*, probably will be generally acknowledged.

Sir *George Darwin's* conception of the matter of the globe as plastic and yielding under the tremendous forces to which it is subjected by gravity is also confirmed by the present author's researches on the physical constitution of the earth, sun, and planets, (AN 3992, 4053, 4104). And as these modern inquiries into the internal constitution of the globe support the conclusions drawn from geodetic researches on the earth's surface by *Helmert*, *Hayford*, and *Burrard*, we justly conclude that the fluid-theory of the earth is fully verified. *Laplace's* law of density, and the hypothesis $d\omega = k\sigma d\sigma$ introduced by this great geometer for the integration of *Clairaut's* differential equations of the

equilibrium of such a heterogeneous fluid mass, thus represents essentially a law of nature.

The ellipticity of the terrestrial spheroid now found from the discussion of all the available methods thus becomes with the highest accuracy now obtainable:

$$\epsilon = 1/(298.30 \pm 0.30). \quad (68)$$

The uncertainty in this divisor is taken at a little over twice the probable error in the above summary, so that it probably does not exceed ± 0.30 . Accordingly it appears that the ellipticity of the earth is determined to a degree of precision of about one part in a thousand. In view of the immensity of the terrestrial globe and the entangled local influences which vitiate our efforts to determine its true figure with great accuracy¹), this result must be regarded as a scientific triumph of no mean order. It reflects the highest credit on a long series of patient observers, in many lines of investigation, whose combined researches extend over nearly three centuries.

The amount of the compression at either pole of the terrestrial globe is approximately 21 kilometres; and as the uncertainty in our value is estimated at one-thousandth of the whole amount, we see that the outstanding error is reduced to a residue of the order of 21.4 metres, or about 65 feet.

A result so helpful to physical science can hardly fail to be gratifying to geometers, since it exhibits the steady narrowing of the limits of error in the delicate and difficult problem of the measurement of the exact figure of the earth.

9. Dynamical Theory of the Figure of the Earth.

Let X, Y, Z be the components of the attractive force of gravity, parallel to the coordinate axes, acting on a fluid particle of the earth's mass; then if σ be the density and ω the pressure at the point considered, we have

$$\begin{aligned} d\omega &= \sigma(Xdx + Ydy + Zdz) \\ &= \sigma(\partial V/\partial x \cdot dx + \partial V/\partial y \cdot dy + \partial V/\partial z \cdot dz) \end{aligned} \quad (69)$$

which becomes zero at the free surface, or

$$d\omega = \sigma dV = \sigma(Xdx + Ydy + Zdz) = 0. \quad (70)$$

This equation implies that the resultant of the forces is normal to the surface at every point. In a homogeneous mass the expression (69) is the differential equation for all surfaces of equal pressure. If the mass is heterogeneous, we have the complete differential:

$$Xdx + Ydy + Zdz = \partial V/\partial x \cdot dx + \partial V/\partial y \cdot dy + \partial V/\partial z \cdot dz. \quad (71)$$

When the mass has uniform velocity of rotation, the effect of the centrifugal force must be introduced, as it acts on each particle with a force proportional to the distance from the axis of rotation. Thus the corresponding part of

$$Xdx + Ydy + Zdz = d\Omega \quad (72)$$

is a complete differential of $\Omega = f(x, y, z)$.

The equilibrium condition is that

$$d\omega = \sigma d\Omega \quad (73)$$

¹) That the equatorial radius of the earth should be known to 1 part in 25000, and thus 25 times more accurately than the oblateness of the geometrical figure, is not remarkable, when we consider that one quantity is measured directly, in the observed length of a degree, while the other is a differential effect which must be calculated from small residuals, either terrestrial or celestial.

be a complete differential. That is, σ must be a function of Ω or of ϖ , and thus also ϖ a function of Ω . Accordingly,

$$d\Omega = \partial\Omega/\partial x \cdot dx + \partial\Omega/\partial y \cdot dy + \partial\Omega/\partial z \cdot dz = 0 \quad (74)$$

is the differential equation of surfaces of equal pressure and density.

Let e denote the eccentricity of the meridian, so that when $\varepsilon = 1:298.3$, $e = 0.08181332$; then if the equation for the ellipsoid be

$$x^2/[c^2(1+e^2)] + y^2/[c^2(1+e^2)] + z^2/c^2 = 1 \quad (75)$$

the attraction upon the particle $dm = \sigma dx dy dz$ has for its components

$$X = Ax \quad Y = Ay \quad Z = Cz \quad (76)$$

$$\begin{aligned} A &= 2\pi\sigma[(1+e^2)e^{-3}\operatorname{arctg}e - 1/e^2] \\ C &= 4\pi\sigma[(1+e^2)e^{-2} - (1+e^2)e^{-3}\operatorname{arctg}e]. \end{aligned} \quad (77)$$

To take account of the centrifugal force due to rotation, we introduce the appropriate components $-x\omega^2$, $-y\omega^2$, 0 ; and then the condition of the fluid equilibrium becomes:

$$(A - \omega^2)x dx + (A - \omega^2)y dy + Cz dz = 0. \quad (78)$$

By integration this yields:

$$(A - \omega^2)(x^2 + y^2) + Cz^2 = K \quad (79)$$

where K is the constant of integration.

$$\begin{aligned} H = V &= \iiint \sigma [r^2 - 2r(x' \cos \Phi' \cos \lambda' + y' \cos \Phi' \sin \lambda' + z' \sin \Phi') + r'^2]^{-1/2} dx' dy' dz' + (2\pi^2/T^2) r^2 \cos^2 \Phi' \\ \partial V/\partial r &= -g [\cos \Phi \cos \Phi' \cos(\lambda - \lambda') + \sin \Phi \sin \Phi'] \\ 1/r \cdot \partial V/\partial \Phi' &= -g [-\cos \Phi \sin \Phi' \cos(\lambda - \lambda') + \sin \Phi \cos \Phi'] \end{aligned} \quad (83)$$

As the geocentric coordinates r , Φ , λ , are not determined directly by observation, they must be eliminated, by the simplest available process.

The differences between the geographical and geocentric longitude $\lambda - \lambda'$ probably nowhere exceeds a minute of arc, and hence we may put $\cos(\lambda - \lambda') = 1$. And in the development of the first part of V , under the above triple integral, it is known that the terms involving λ' have very small coefficients. In these therefore we may substitute λ for λ' , and after λ' is thus made to disappear, we get:

$$\begin{aligned} H = V &= \iiint \sigma [r^2 - 2r(x' \cos \Phi' \cos \lambda + y' \cos \Phi' \sin \lambda + z' \sin \Phi') + r'^2]^{-1/2} dx' dy' dz' + (2\pi^2/T^2) r^2 \cos^2 \Phi' \\ \partial V/\partial r &= -g \cos(\Phi - \Phi') \quad 1/r \cdot \partial V/\partial \Phi' = -g \sin(\Phi - \Phi') \quad 1/r \cdot \sec \Phi' \partial V/\partial \lambda' = 0. \end{aligned} \quad (84)$$

We may apply Laplace's method of expanding V in a series of spherical functions which to Y_4 yields:

$$\begin{aligned} V &= M/r + Y_2/r^3 + Y_3/r^4 + Y_4/r^5 + (2\pi^2/T^2) r^2 \cos^2 \Phi' = H \\ \partial V/\partial r &= M/r^2 + 3Y_2/r^4 + 4Y_3/r^5 + 5Y_4/r^6 - (4\pi^2/T^2) r \cos^2 \Phi' = g \cos(\Phi' - \Phi) \\ 1/r \cdot \partial V/\partial \Phi' &= 1/r^4 \cdot \partial Y_2/\partial \Phi' + 1/r^5 \cdot \partial Y_3/\partial \Phi' + 1/r^6 \cdot \partial Y_4/\partial \Phi' - (4\pi^2/T^2) r \sin \Phi' \cos \Phi' = g \sin(\Phi' - \Phi). \end{aligned} \quad (85)$$

In order to eliminate r and Φ' from these equations, we square both members of the first and divide by M . We observe that in this elimination the squares and product of Y_3 and Y_4 and their product by $(2\pi^2/T^2) r^2 \cos^2 \Phi'$ may be neglected as insensible. Thus we get:

$$\begin{aligned} M/r^2 + 2Y_2/r^4 + 2Y_3/r^5 + 2Y_4/r^6 + (2\pi^2/T^2) r \cos^2 \Phi' &= \\ H^2/M - 1/M \cdot Y_3^2/r^6 - (4\pi^2/MT^2) Y_2 \cos^2 \Phi'/r - (4\pi^4/MT^4) r^4 \cos^4 \Phi'. \end{aligned} \quad (86)$$

On subtracting this from the second equation of (85), we find

$$\begin{aligned} H^2/M + Y_2/r^4 + 2Y_3/r^5 + 3Y_4/r^6 = \\ g \cos(\Phi' - \Phi) + (8\pi^2/T^2) r \cos^2 \Phi' + 1/M \cdot Y_2^2/r^6 + (4\pi^2/MT^2) Y_2 \cos^2 \Phi'/r + (4\pi^4/MT^4) r^4 \cos^4 \Phi'. \end{aligned} \quad (87)$$

The last term of the right member is of the order of the square of the compression, and thus very minute, but it ought not to be omitted in very precise determinations, (cf. *G. W. Hill's Collected Mathematical Works*, vol. II, p. 305).

In this equation it will be noticed that wherever the variables r and Φ' occur, they are multiplied by quantities which are at least of the order of smallness of the compression. Thus it suffices to eliminate them by formulae which are only approximately exact.

If T be the duration of the earth's axial rotation, and σ the density at any point $p(x, y, z)$, and V the potential of gravity, with the centrifugal force included, we shall have:

$$\begin{aligned} V = \iiint \sigma [(x-x')^2 + (y-y')^2 + (z-z')^2]^{-1/2} dx' dy' dz' \\ + (2\pi^2/T^2)(x^2 + y^2). \end{aligned} \quad (80)$$

The triple integral is to be extended to all points of the earth's mass, after which the variables x', y', z' of the moveable point $p(x', y', z')$ disappears; and V becomes a function of x, y, z , which, equated to a constant, gives the general equation to the level surfaces.

If we put Φ' and λ' for the geocentric latitude and longitude respectively, we have

$$\begin{aligned} x &= r \cos \Phi' \cos \lambda' \\ y &= r \cos \Phi' \sin \lambda' \\ z &= r \sin \Phi'. \end{aligned} \quad (81)$$

And then our four equations for the component forces based on the geographical latitude and longitude, are:

$$\begin{aligned} H &= V \\ g \cos \Phi \cos \lambda &= -\partial V/\partial x \\ g \cos \Phi \sin \lambda &= -\partial V/\partial y \\ g \sin \Phi &= -\partial V/\partial z. \end{aligned} \quad (82)$$

These will become, by substituting polar coordinates:

and logarithm of the radius of the spheroid, in the reduction of observations to the centre of the earth:

$$\begin{aligned} \Phi - \Phi' &= 692^{\circ}6265 \sin 2\Phi - 1^{\circ}1629 \sin 4\Phi \\ \log(r/a) &= 9.9992727 + 0.0007291 \cos 2\Phi \\ &\quad - 0.0000018 \cos 4\Phi. \end{aligned} \tag{88}$$

And the radius of curvature of the meridian in any latitude may be calculated from the formula:

$$\rho = a(1 - e^2)(1 - e^2 \sin^2 \Phi)^{-3/2}. \tag{89}$$

But for many purposes, it is better to express these properties of the terrestrial spheroid by means of general formulae which are applicable to all latitudes and equally useful in astronomy and geodesy. The theory of the derivation of these formulae must be sought in works on the theory of the figure of the earth. The coefficients given below have been checked by equations of condition, and their rigorous accuracy may be depended on.

10. Derivation of the Elements of the New Terrestrial Spheroid.

The elements of the terrestrial spheroid here adopted rest on the equatorial radius $a = 6378000.00$ metres, concluded by *Helmert* from all his researches up to 1903.

In the formulae indicated below, ρ is the radius of curvature of the spheroidal surface in the plane of the meridian, ρ' the radius of curvature of the spheroidal surface in the plane perpendicular to the meridian, D the length of a degree in the plane of the meridian, D' the length of a degree in a plane perpendicular to the meridian. Accordingly, we have the following:

Concluded Elements of the Terrestrial Spheroid.

$$\begin{aligned} a &= 6378000 \pm 250 \text{ metres} \\ b &= 6356618.84 \pm 250 \text{ metres} \\ \epsilon &= (a-b)/a = 1 : 298.30 = 0.00335233 \\ &\quad \pm 0.30' \pm 0.00000335 \\ \rho &= 6367315.33 - 32072.50 \cos 2\Phi + 66.17 \cos 4\Phi \text{ m} \\ \rho' &= 6388713.00 - 10727.00 \cos 2\Phi + 14.00 \cos 4\Phi \text{ m} \\ D &= 111128.67 - 559.37 \cos 2\Phi + 2.76 \cos 4\Phi \text{ m} \\ D' &= 111410.46 \cos \Phi - 93.48 \cos 3\Phi + 0.12 \cos 5\Phi \text{ m.} \\ \Phi - \Phi' &= 692^{\circ}6265 \sin 2\Phi - 1^{\circ}1629 \sin 4\Phi \\ \log(r/a) &= 9.9992727 + 0.0007291 \cos 2\Phi \\ &\quad - 0.0000018 \cos 4\Phi. \end{aligned} \tag{90}$$

Each of the formulae here adopted has been controlled by equations of condition of great accuracy. For example, the equation for the radius of curvature ρ in the plane of the meridian leads to three equations of condition:

$$\begin{aligned} \rho_1 &= \rho_0 - A \cos 2\Phi_1 + B \cos 4\Phi_1 \\ &= \rho_0 - A + B \quad \Phi_1 = 0^\circ \\ \rho_2 &= \rho_0 - A \cos 2\Phi_2 + B \cos 4\Phi_2 \\ &= \rho_0 - \frac{1}{2}A - \frac{1}{2}B \quad \Phi_2 = 30^\circ \\ \rho_3 &= \rho_0 - A \cos 2\Phi_3 + B \cos 4\Phi_3 \\ &= \rho_0 + A + B \quad \Phi_3 = 90^\circ. \end{aligned} \tag{91}$$

By combining the first and third of these equations, and then the second and the third, we obtain successively:

$$\begin{aligned} \rho_1 + \rho_3 &= 2\rho_0 + 2B & \rho_1 - \rho_3 &= -2A \\ \text{whence } A &= \frac{1}{2}(\rho_3 - \rho_1), & B &= \frac{1}{2}(\rho_1 + \rho_3 - 2\rho_0) \\ \text{and} & & & \\ 2\rho_0 &= 2\rho_2 + A + B & \rho_0 &= \rho_3 - A - B \\ \text{whence } \rho_0 &= \frac{1}{3}(2\rho_2 + \rho_3). \end{aligned} \tag{92}$$

To obtain exact numerical values for these radii of curvature, at the equator, $\Phi_1 = 0^\circ$, latitude $\Phi_2 = 30^\circ$, and at the pole, $\Phi_3 = 90^\circ$, we use the well known formula:

$$\rho = a(1 - e^2)(1 - e^2 \sin^2 \Phi)^{-3/2} \tag{93}$$

and thus we find:

$$\begin{aligned} \rho_1 &= 6335309.00 \text{ metres} \\ \rho_2 &= 6351246.00 \text{ } \\ \rho_3 &= 6399454.00 \text{ } \end{aligned} \tag{94}$$

Hence $\rho_0 = 6367315.33$ metres $\tag{95}$
 $A = 32072.5$ metres $B = 66.17$ metres. $\tag{96}$

Therefore the radius of curvature in plane of the meridian at any latitude Φ becomes:

$$\rho = 6367315.33 - 32072.50 \cos 2\Phi + 66.17 \cos 4\Phi \text{ m.} \tag{97}$$

And the derivation of the other equations is similar. Thus for the equation in D , we first compute by means of the elliptical integral treated below, the length of a degree of three arcs of the meridian:

at the equator, $\Phi_1 = 0^\circ$ to $\Phi_2 = 1^\circ$ $D_1 = 110572.06$ metres $\tag{98}$
 at latitude, $\Phi_2 = 30^\circ$ $D_2 = 110847.60$ »
 at the pole, $\Phi_3 = 90^\circ$ $D_3 = 111690.80$ »

And then we have similar equations of condition:

$$\begin{aligned} D_1 &= D_0 - A + B \\ D_2 &= D_0 - \frac{1}{2}A - \frac{1}{2}B \\ D_3 &= D_0 + A + B \end{aligned} \tag{99}$$

whence $D_0 = \frac{1}{3}(2D_2 + D_3) = 111128.67$ m $\tag{100}$
 $A = 559.37$ m $B = 2.76$ m. $\tag{101}$

And therefore

$$D = 111128.67 - 559.37 \cos 2\Phi + 2.76 \cos 4\Phi \text{ m.} \tag{102}$$

The length of a degree of the elliptic arc of the meridian has been computed by the formula:

$$\begin{aligned} s &= \int_{\Phi_1}^{\Phi_2} \rho \, d\Phi = a \int_{\Phi_1}^{\Phi_2} (1 - e^2)(1 - e^2 \sin^2 \Phi)^{-3/2} \, d\Phi = \\ &= b \int_{\Phi_1}^{\Phi_2} (1+n)(1-n^2)(1+2n \cos 2\Phi + n^2)^{-3/2} \, d\Phi \end{aligned} \tag{103}$$

where $a/b = (1+n)/(1-n)$, so that $n = 1 : 595.6$.

This elliptic integral of the second class yields the series:

$$s/b = (1+n+5/4n^2)\alpha_0 - (3n+3n^2)\alpha_1 + (15/8n^2)\alpha_2. \tag{104}$$

The functions of n yield the following values:

$$\begin{aligned} (1+n+5/4n^2) &= 1.001682500 \\ (3n+3n^2) &= 0.00504540 \\ (15/8n^2) &= 0.000001843. \end{aligned} \tag{105}$$

For the trigonometric functions $\alpha_0, \alpha_1, \alpha_2, \Phi = 0^\circ, \Phi = 1^\circ$ we have:

$$\begin{aligned} \alpha_0 &= \Phi_2 - \Phi_1, \log(3600/206264.8) = 8.2418774_{-10} \\ \alpha_1 &= \sin(\Phi_2 - \Phi_1) \cos(\Phi_2 + \Phi_1) \\ \alpha_2 &= \sin 2(\Phi_2 - \Phi_1) \cos 2(\Phi_2 + \Phi_1). \end{aligned} \tag{106}$$

And for the three terms of (104) we find:

$$\begin{aligned} I &= +0.01748265 \\ II &= -0.00008804 \\ III &= +0.0000018 \\ \Sigma &= +0.01739479. \end{aligned} \tag{107}$$

Hence for the length of the meridian arc of 1° on either side of the equator, we obtain:

$$s = \int_{\Phi_1}^{\Phi_2} \rho d\Phi = a \int_{\Phi_1}^{\Phi_2} (1 - e^2) (1 - e^2 \sin^2 \Phi)^{-3/2} d\Phi = b \int_{\Phi_1}^{\Phi_2} (1+n) (1-n^2) (1+2n \cos 2\Phi + n^2)^{-3/2} d\Phi = \\ = b(0.01739479) = 110572.06 \text{ metres.} \quad (108)$$

In the calculation of D_2 , corresponding to 30° , we have to take Φ between the limits $\Phi_1 = 29^\circ.5$, $\Phi_2 = 30^\circ.5$; and to get D_3 at the pole $\Phi = 90^\circ$, we take Φ between the limits $\Phi_1 = 89^\circ.5$ and $\Phi_2 = 90^\circ.5$, with the results indicated in the above equation (99).

In concluding this paper on the figure of the earth, it only remains to point out the circumstances from which it arose, and which have delayed its completion and publication for seventeen years.

1. Although the last 40 years have been productive of many researches which bear on the figure of the earth, these researches as a rule have been pursued in isolation, and almost wholly without regard to other modes of treatment of the same problem; and when brought to a conclusion and prepared for publication, the discussion of the figure of the earth usually has proceeded from the point of view of a single method only. Thus the public mind has become somewhat bewildered if not confused by the numerous results obtained from isolated points of view, and apparently lost hope of a substantial improvement of our knowledge based on the utmost use of all available methods taken together. Such an integration of all the results of the separate investigations alone can give the definitive determination of the figure of the earth which our age demands.

2. Perhaps these remarks on scattered results do not apply to the discussions carried out 30 or 40 years ago by such eminent investigators as *Helmert* and *Tisserand*, whose surveys of the available data were comprehensive and well balanced by the use of all methods then available; yet the very intervals of 30 or 40 years which have elapsed since their comprehensive researches render newer determinations desirable, just as the production in this period also furnished new data for this purpose, — especially along the line of pendulum observations and the measurement of arcs of the meridian. When I began to treat of the figure of the earth, seventeen years ago, it was from the immediate necessity of obtaining a reliable approximate value $1:297.7$, (AN 3992), which accords closely with the value $1:297$ adopted by the directors of the nautical almanacs in 1911.

3. Thus with the approximate value attained in 1904, the whole of my discussion was reserved for a later and fuller treatment. And as many observations have been added to the data of the subject in the last 17 years, while on the other hand the confusion continues, — and even injures

science by the use of such inadmissible values as $1:294$ by Prof. *E. W. Brown* in his *New Lunar Theory and Tables of the Motion of the Moon*, 1920, — it has seemed to me important that further delay should not occur in publishing the paper on the concluded definitive figure of the earth.

4. For it should be remembered that the figure of the earth enters into a great many sciences, — as Astronomy, Mechanics, Dynamics, Physics, Geodesy, Geography — and therefore the best data of our age should again be made accessible to these varied groups of investigators. This seems the more important since no all-around treatment of the subject at all convincing has appeared within the 30 years since the publication of the second volume of *Tisserand's Mécanique Céleste*.

5. Moreover since *Tisserand's* learned discussion, though very well balanced and comprehensive, left the limits of the oblateness of the earth somewhat wide, as if his data were not decisive, whereas they really were quite conclusive, I naturally have labored to narrow as much as is allowable the limits of uncertainty by the use of the data of the past 30 years. Of all the men recently active in science, *Helmert* was best qualified to make an authoritative review of the subject, but our hopes along this line are now cut short by the recent lamented death of this illustrious geodesist.

6. Fortunately all the new data point very definitely to the value now adopted, which was in fact also recommended to *Newcomb* by *Helmert* in 1903, because of the indications drawn from the great body of the older data. It appears likely to be some time before any further sensible refinement in the oblateness of the earth will be possible; yet the accuracy already attained is so great that we may be less concerned for the slight improvements which may be made by future investigators.

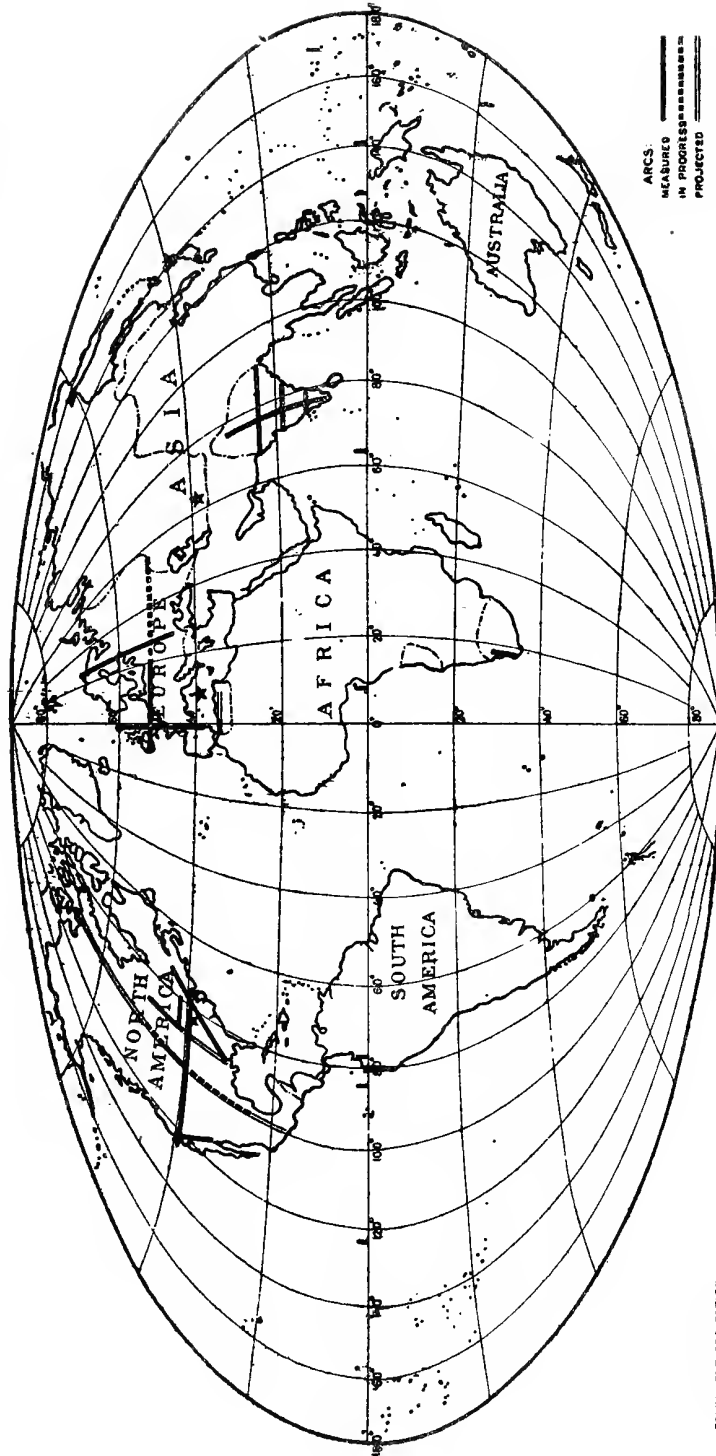
The author acknowledges gratefully the aid uniformly extended in this, as in other investigations, by his associates Mr. *L. Tiernan*, and Mr. *W. S. Trankle*, and above all by Mrs. *See*, without which it would not have been possible to bring these long delayed researches on the figure of the earth to a satisfactory conclusion.

Starlight on Loutre, Montgomery City, Mo., 1921 Jan. 14.

T. J. J. See.

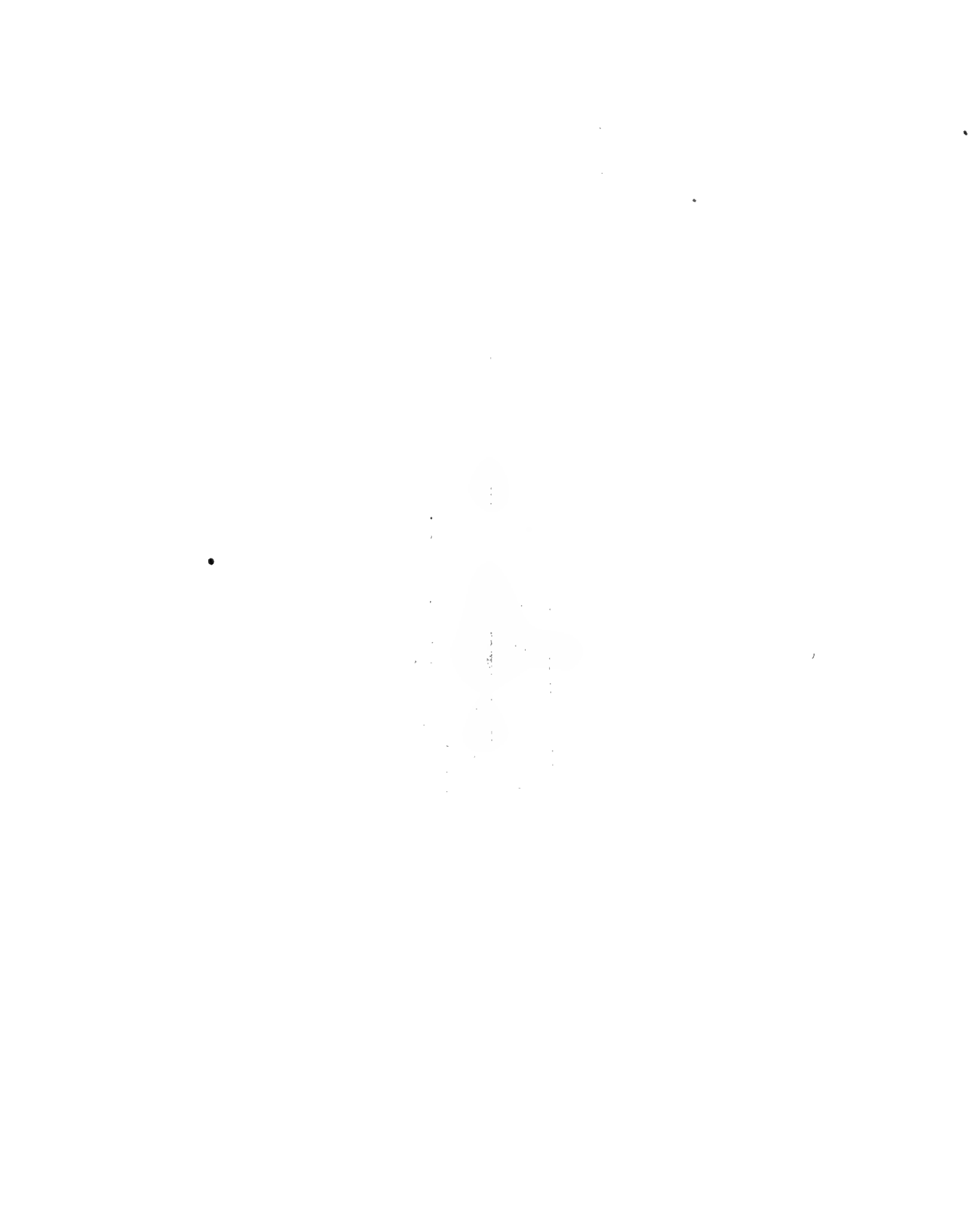


Fig. 1. Map of the World showing the Location of the Principal Geodetic Operations, which are chiefly in the Northern Hemisphere.



EQUIVALENT PROJECTION

GEODETTIC OPERATIONS FOR THE MEASUREMENT OF THE EARTH



Tables of the Differences of the Astronomical and Geocentric Latitude, ϕ and of the change of the Logarithm of the Earth's Radius, $\log(r/a)$, with th

Φ = Geographical Latitude, Φ' = Geocentric Latitude, (r/a) = Radius of the Earth in units of th

Φ	$\Phi - \Phi'$	Diff.	$\log(r/a)$	Diff.	Φ	$\Phi - \Phi'$	Diff.	$\log(r/a)$	Diff.	Φ	$\Phi - \Phi'$	Diff.	$\log(r/a)$	Diff.	
1°	0' 24.09	24.09	9.999		35°	0' 10.50	1.40	9.999		45°	0' 11.32	0.02	9.999		
2	0 48.15	24.06	9997	3	10	51.49	1.38	5196	40	10	32.63	0.00	2746	43	
3	1 12.15	24.00	9961	14	20	52.85	1.36	5156	40	20	32.61	0.02	2704	42	
4	1 36.07	23.92	9931	22	30	54.18	1.33	5116	40	30	32.57	0.04	2661	43	
5	1 59.87	23.80	9892	30	40	55.49	1.31	5076	40	40	32.51	0.06	2619	42	
6	2 23.53	23.66	9844	39	50	56.78	1.29	5036	40	50	32.42	0.09	2576	43	
7	2 47.02	23.49	9787	48	0	58.04	1.26	4996	40	0	32.31	0.11	2534	42	
8	3 10.30	23.28	9721	57	10	59.28	1.24	4956	40	10	32.18	0.13	2491	43	
9	3 33.35	23.05	9647	66	20	60.50	1.22	4915	41	20	32.02	0.16	2449	42	
10	3 56.14	22.79	9565	74	30	61.70	1.20	4875	41	30	31.83	0.19	2407	42	
11	4 18.64	22.50	9475	82	40	62.88	1.18	4834	41	40	31.61	0.22	2364	43	
12	4 40.85	22.21	9377	90	50	64.04	1.16	4794	41	50	31.37	0.24	2322	42	
13	5 2.70	21.85	9270	98	0	65.18	1.14	4753	41	0	31.10	0.27	2280	42	
14	5 24.20	21.50	9155	107	10	66.30	1.12	4712	41	10	30.81	0.29	2237	43	
15	5 45.31	21.11	9033	115	20	67.40	1.10	4672	41	20	30.50	0.31	2195	42	
16	6 5.99	20.68	8903	122	30	68.47	1.07	4631	41	30	30.17	0.33	2153	42	
17	6 26.23	20.24	8766	130	40	69.51	1.04	4590	41	40	29.82	0.35	2111	42	
18	6 46.01	19.78	8621	137	50	70.52	1.01	4549	41	50	29.45	0.37	2068	43	
19	7 5.30	19.29	8469	145	0	71.51	0.99	4508	41	0	29.07	0.38	2026	42	
20	7 24.07	18.77	8310	152	10	72.48	0.97	4467	41	10	28.66	0.41	1984	42	
21	7 42.30	18.23	8144	159	20	73.43	0.95	4426	41	20	28.22	0.44	1942	42	
22	7 59.98	17.68	7972	166	30	74.36	0.93	4385	41	30	27.75	0.47	1900	42	
23	8 17.07	17.09	7794	172	40	75.27	0.91	4344	41	40	27.26	0.49	1858	42	
24	8 33.56	16.49	7609	178	50	76.16	0.89	4302	42	50	26.75	0.51	1816	42	
25	8 49.44	15.88	7418	185	0	77.02	0.86	4260	42	0	26.21	0.54	1774	42	
26	9 4.67	15.23	7222	191	10	77.86	0.84	4219	41	10	25.65	0.56	1732	42	
27	9 19.24	14.57	7020	196	20	78.68	0.82	4177	42	20	25.06	0.59	1690	42	
28	9 33.14	13.90	6813	199	30	79.47	0.79	4136	41	30	24.45	0.61	1647	43	
29	9 46.34	13.20	6600	202	40	80.24	0.77	4094	42	40	23.82	0.63	1605	42	
30	0' 58.83	12.49	6382	213	50	80.99	0.75	4053	41	50	23.17	0.65	1563	42	
10	10 0.84	2.01	6345	218	0	81.71	0.72	4011	42	0	22.50	0.67	1521	42	
20	2.83	1.99	6308	37	10	82.40	0.69	3969	42	10	21.80	0.70	1480	41	
30	4.80	1.97	6272	37	20	83.08	0.68	3927	42	20	21.08	0.72	1438	42	
40	6.75	1.95	6235	36	30	83.74	0.66	3886	41	30	20.33	0.75	1396	42	
50	8.68	1.93	6198	37	40	84.37	0.63	3844	42	40	19.56	0.77	1354	42	
31	10 10.59	1.91	6161	37	50	84.98	0.61	3802	42	50	18.77	0.79	1312	42	
10	12.48	1.89	6123	38	0	85.57	0.59	3760	42	0	17.96	0.81	1270	42	
20	14.35	1.87	6086	38	10	86.13	0.56	3718	42	10	17.13	0.83	1229	41	
30	16.20	1.85	6049	37	20	86.67	0.54	3676	42	20	16.28	0.85	1187	42	
40	18.02	1.82	6011	37	30	87.18	0.51	3634	42	30	15.40	0.88	1146	41	
50	19.83	1.81	5973	38	40	87.67	0.49	3592	42	40	14.49	0.91	1104	42	
32	10 21.61	1.78	5936	38	50	88.14	0.47	3550	42	50	13.56	0.93	1063	41	
10	23.38	1.77	5898	38	0	88.59	0.45	3508	42	0	12.60	0.96	1022	41	
20	25.12	1.74	5860	38	10	89.02	0.43	3466	42	10	11.62	0.98	980	42	
30	26.84	1.72	5821	38	20	89.42	0.40	3424	42	20	10.62	1.00	939	41	
40	28.54	1.70	5783	38	30	89.80	0.38	3382	42	30	9.60	1.02	898	41	
50	30.22	1.68	5744	38	40	90.15	0.35	3339	43	40	8.56	1.04	857	41	
33	10 31.88	1.66	5706	38	50	90.48	0.33	3297	42	50	7.50	1.06	815	42	
10	33.52	1.64	5667	38	0	90.79	0.31	3255	42	0	6.41	1.09	774	41	
20	35.14	1.62	5628	39	10	91.07	0.28	3213	42	10	5.30	1.11	733	41	
30	36.74	1.60	5589	39	20	91.33	0.26	3170	43	20	4.17	1.13	693	40	
40	38.31	1.57	5550	39	30	91.57	0.24	3128	42	30	3.02	1.15	652	41	
50	39.86	1.55	5511	39	40	91.79	0.22	3086	42	40	1.84	1.18	611	41	
34	10 41.38	1.52	5472	39	50	91.98	0.19	3043	43	50	0.64	1.20	571	40	
10	42.89	1.51	5433	39	0	92.14	0.16	3001	42	0	59.41	1.23	530	41	
20	44.38	1.49	5393	39	10	92.28	0.14	2959	42	10	58.16	1.25	489	41	
30	45.85	1.47	5354	40	20	92.40	0.12	2916	43	20	56.89	1.27	449	40	
40	47.29	1.44	5315	39	30	92.50	0.10	2874	42	30	55.60	1.29	409	40	
50	48.71	1.42	5275	39	40	92.57	0.07	2831	43	40	54.29	1.31	368	41	
35	10 50.11	1.40	5236	39	50	92.61	0.04	2789	42	50	52.95	1.34	328	40	
					45	0	92.63	0.02	2746	43	55	51.59	1.36	288	40

Cause
 served in
 Can any
 the three
 on cause?
 et a long
 re theory
 343) and
 al planets
 us to re-
 formation
 e precipi-
 equatorial
 rn.
 velop the
 to have
 r system.
 l actions
 the sun.
 t planets
 Saturn,
 4
 2
 5
 9
 use of the
 ar system
 piter and
W. Hill
 (1)
 ; to 2', so
 -5 n' be-
 (2)
 rm in the
 (3)
 ie divisor

e Latitude.

e Equatorial Radius a .

Φ	$\Phi - \Phi'$	Diff.	Log (r/a)	Diff.
			9.99	
55° 0'	10' 51.759	1.36	90248	40
10	50.21	1.38	90208	40
20	48.81	1.40	90169	39
30	47.39	1.42	90129	40
40	45.95	1.44	90089	40
50	44.49	1.46	90050	39
56° 0'	10' 43.00	1.49	90010	40
10	41.49	1.51	89971	39
20	39.96	1.53	89932	39
30	38.41	1.55	89892	40
40	36.83	1.58	89853	39
50	35.23	1.60	89814	39
57° 0'	10' 33.61	1.62	89775	39
10	31.97	1.64	89736	39
20	30.31	1.66	89697	39
30	28.63	1.68	89659	38
40	26.93	1.70	89620	39
50	25.20	1.73	89582	38
58° 0'	10' 23.45	1.75	89543	39
10	21.68	1.77	89505	38
20	19.89	1.79	89467	38
30	18.08	1.81	89429	38
40	16.25	1.83	89391	38
50	14.40	1.85	89353	38
59° 0'	10' 12.52	1.88	89315	38
10	10.63	1.89	89278	37
20	8.71	1.92	89240	38
30	6.77	1.94	89203	37
40	4.81	1.96	89166	37
50	2.83	1.98	89128	38
60° 0'	10' 0.84	1.99	89091	37
61	9 48.42	12.42	88872	219
62	9 35.29	13.13	88658	214
63	9 21.45	13.84	88448	210
64	9 6.92	14.53	88243	205
65	8 51.73	15.19	88044	199
66	8 35.88	15.85	87851	193
67	8 19.40	16.48	87664	187
68	8 2.30	17.10	87482	182
69	7 44.61	17.69	87308	174
70	7 26.36	18.25	87140	168
71	7 7.55	18.81	86979	161
72	6 48.22	19.33	86823	156
73	6 28.39	19.83	86676	147
74	6 8.08	20.31	86537	139
75	5 47.32	20.76	86405	132
76	5 26.13	21.19	86281	124
77	5 4.54	21.59	86164	117
78	4 42.58	21.96	86055	109
79	4 20.26	22.32	85955	100
80	3 57.64	22.62	85863	92
81	3 34.72	22.92	85779	84
82	3 11.53	23.19	85704	75
83	2 48.11	23.42	85638	66
84	2 24.46	23.65	85580	58
85	2 0.67	23.79	85531	49
86	1 36.74	23.93	85491	40
87	1 12.66	24.08	85459	32
88	0 48.48	24.18	85437	22
89	0 24.25	24.23	85423	14

s of Curvature:

the Plane perpendicular to the Meridian;
in the Plane of the Meridian,
perpendicular to the Meridian.

D	$\rho =$ metres	$\rho' =$ metres	$D =$ metres	$D' =$ metres
	6367315.33	6388713.00	111128.67	
5°	- 66.17	- 14.00	- 2.76	78845.10
6	+ 1053.30	+ 360.40	+ 16.77	77461.79
7	+ 2171.73	+ 734.42	+ 36.28	76054.34
8	+ 3287.77	+ 1107.59	+ 55.76	74623.73
9	+ 4400.02	+ 1479.45	+ 75.19	73170.18
0	+ 5507.01	+ 1849.57	+ 94.54	71694.17
1	+ 6607.80	+ 2217.48	+ 113.77	70196.15
2	+ 7700.62	+ 2582.74	+ 132.86	68676.52
3	+ 8784.27	+ 2944.89	+ 151.83	67135.76
4	+ 9857.42	+ 3303.51	+ 170.61	65574.34
5	+ 10918.75	+ 3658.13	+ 189.19	63992.72
6	+ 11966.97	+ 4008.33	+ 207.54	62391.42
7	+ 13000.78	+ 4353.69	+ 225.65	60770.86
8	+ 14018.92	+ 4693.79	+ 243.50	59131.56
9	+ 15020.13	+ 5028.19	+ 261.05	57474.03
0	+ 16003.17	+ 5356.50	+ 278.28	55798.77
1	+ 16966.83	+ 5678.31	+ 295.19	54106.27
2	+ 17909.93	+ 5993.22	+ 311.74	52397.10
3	+ 18831.29	+ 6300.84	+ 327.91	50673.00
4	+ 19729.79	+ 6601.31	+ 343.69	48930.67
5	+ 20604.31	+ 6892.75	+ 359.05	47174.48
6	+ 21453.77	+ 7176.30	+ 374.01	45403.62
7	+ 22277.12	+ 7451.11	+ 388.45	43618.92
8	+ 23073.34	+ 7716.84	+ 402.45	41820.61
9	+ 23841.43	+ 7973.18	+ 415.95	40009.37
0	+ 24580.45	+ 8219.79	+ 428.95	38185.69
1	+ 25289.48	+ 8455.79	+ 441.43	36350.22
2	+ 25967.64	+ 8682.65	+ 453.36	34503.50
3	+ 26614.10	+ 8898.33	+ 464.74	32646.03
4	+ 27228.03	+ 9103.13	+ 475.55	30778.47
5	+ 27808.68	+ 9296.85	+ 485.77	28901.36
6	+ 28355.33	+ 9479.21	+ 495.40	27015.30
7	+ 28867.31	+ 9649.99	+ 504.42	25120.86
8	+ 29343.97	+ 9808.97	+ 512.82	23218.58
9	+ 29784.70	+ 9955.97	+ 520.59	21309.13
0	+ 30188.99	+ 10090.81	+ 527.71	19393.06
1	+ 30556.29	+ 10213.32	+ 534.18	17470.97
2	+ 30886.17	+ 10323.33	+ 540.00	15543.44
3	+ 31178.23	+ 10420.72	+ 545.16	13611.09
4	+ 31432.13	+ 10505.37	+ 549.63	11674.52
5	+ 31647.57	+ 10577.18	+ 553.43	9734.60
6	+ 31823.99	+ 10635.99	+ 556.54	7791.08
7	+ 31961.52	+ 10681.93	+ 558.97	5845.42
8	+ 32059.91	+ 10714.80	+ 560.70	3897.96
9	+ 32118.98	+ 10734.31	+ 561.78	1949.27
0	+ 32138.67	+ 10741.00	+ 562.15	0000.00

Discovery of the Cause of the Sunspots, and of their 11-year Periodicity, and of the Cause of the Cepheid, Geminid, and Cluster Variable Stars. By T. J. J. See.

[With 9 Plates.]

I. Introductory Remarks on the Problem of Sunspots and their 11-year Periodicity, and on the Elements, Conjunctions and Oppositions of Jupiter and Saturn.

The year 1610 is especially notable in the history of astronomy from *Galileo's* invention of the telescope and his almost immediate discovery of conspicuous spots on the sun. In the scholastic philosophy then current the sun appeared so glorious, that *Dante* had made it the abode of the saints, while under *Aristotle's* original doctrines it was held to be perfect and therefore free from all physical defects; and thus the solar spots noticed by *Galileo* soon became objects of much philosophic attention and of violent controversy. Hence it happens that our records of these spots run back 311 years, and during much of this period the observers have left us reliable and fairly continuous observations.

But although in this interval of ten generations of astronomers the combined mass of the observations accumulated is enormous, it is a somewhat embarrassing fact that science still is unable to give us an adequate physical theory of the origin of the spots or of the celebrated 11-year periodicity discovered by *Schwabe* of Dessau in 1843. For in a special article on the Sun, *New International Encycl.*, New York, 1916, Prof. *Hale*, Director of the Mt. Wilson Solar Observatory, expressly remarks: »The cause of this periodicity is unknown.«

It always has seemed to me very unfortunate that although the observational record accumulates century after century, no substantial progress is made in the physical theory of the sun. Now there naturally will be different views of what criteria a valid physical theory should meet, and where the accumulated mass of observations is so enormous as is true of the solar records, it would not be surprising if some division of opinion should arise from outstanding details. Yet if the great body of solar phenomena clearly conforms to the theory, it will have the presumption of truth, and become the stronger the more fully it meets a geometrically rigorous test which may serve as an experimentum crucis.

Accordingly, having been somewhat occupied with the problem of the cause of sunspots since 1917, when the dynamical theory here outlined first took definite form, and having recently developed certain exact criteria which appear to be absolutely decisive, I would not be justified in longer delaying the publication of the results at which I have arrived.

It is evident that solar phenomena do not stand alone, but are closely related to other processes recognized to be going on in the solar system. Thus both Jupiter and Saturn have been found to have very sensible equatorial accelerations,

analogous to the swifter rotation of the spots observed in the gaseous photosphere near the sun's equator. Can any one doubt that these three similar phenomena, on the three largest bodies of our solar system, depend on a common cause?

And what can this common cause be? To get a long range view of this subject we may recall the capture theory of satellites developed in 1909, (AN 4308, 4341, 4343) and the resulting theory of the rotations of the principal planets (AN 4358). This development of 1909 enables us to recognize that the processes which operated in the formation of the solar system still are at work, and thus the precipitation of meteors upon these bodies leads to the equatorial accelerations noticed on the sun, Jupiter and Saturn.

And all we are required to do is to develop the dynamical theory now recognized to be valid and to have its roots firmly set in the foundations of the solar system. This will lead us to a critical study of the mutual actions of Jupiter and Saturn, in precipitating meteors upon the sun. And thus we cite first the elements of these great planets as given in *Hill's* New Theory of Jupiter and Saturn, Collected math. works of *G. W. Hill* 3.19.

Elements of Jupiter and Saturn.

Epoch 1850 Jan. 0.0 m. t. Greenw.

$L = 159^{\circ} 56' 26''.60$	$L' = 14^{\circ} 49' 34''.04$
$\pi = 11 56 9.33$	$\pi' = 90 6 46.22$
$\theta = 98 56 19.79$	$\theta' = 112 20 49.05$
$i = 1 18 42.10$	$i' = 2 29 40.19$
$e = 0.04824277$	$e' = 0.05605688$
$n = 109256''.55563$	$n' = 43996''.07844$
$m = 1/1047.870$	$m' = 1/3501.6$

Since *Laplace's* discovery of the physical cause of the great inequality, 1785, it has been generally recognized that the most important planetary perturbations of the solar system are those depending on the mutual actions of Jupiter and Saturn. The mean motions were found by Dr. *G. W. Hill* to be:

$$n = 109256''.62552 \quad n' = 43996''.21506 \quad (1)$$

And as these motions are nearly in the ratio of 5 to 2, so as to be almost commensurable, the argument $2n - 5n'$ becomes a very small quantity, namely:

$$2n - 5n' = -1467''.82426. \quad (2)$$

Accordingly, by the double integration, the term in the mean longitude,

$$\delta L = k \iint dR/d\varepsilon \cdot d\varepsilon \cdot dt \quad (3)$$

becomes quite large, owing to the smallness of the divisor $(in - i'n')^2$, thus:

$$\delta L = k i P \sin \{(i n - i' n') t + n - n' + Q\} / (i n - i' n')^2 \quad (4)$$

(cf. *Laplace*, *Méc. Cél.*, lib. II, chap. VII, § 54, chap. VIII, § 65).

Laplace shows that the great inequality thus arising extends over a period of about 918 years. In the first half of this period, or 459 years, Jupiter is accelerated, (at the maximum about $21'$), while Saturn is retarded, (at the maximum about $49'$); but in the second period of 459 years, the changes in the mean motions are reversed, Jupiter being retarded, and Saturn accelerated, by corresponding amounts.

The conjunctions of Jupiter and Saturn occur at points of their orbits differing in longitude by about 120° , near the points $0^\circ, 240^\circ, 120^\circ$, as shown in the following diagram, which indicates also the shift of the line of conjunctions, in the recurrence near the same point, after about 60-year periods, — the successive subscripts to the letters \mathcal{F} and \mathcal{S} , showing where the conjunctions recur.

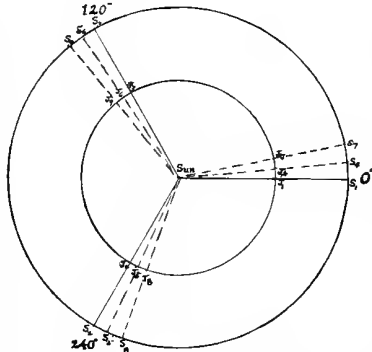


Fig. 1. Diagram of the shifting conjunctions of Jupiter and Saturn, for illustrating *Laplace's* discovery of the cause of the great inequality, 1785.

This figure and the above analysis of the relations of the mean motions will make known to us a series of periodic impulses arising from the mutual actions of our two greatest planets, and profoundly effecting the other bodies of the solar system. In particular, it is easy to see that if there be meteor swarms, with their perihelia near the sun's surface, and their aphelia near Jupiter and Saturn respectively, their paths will be subjected to considerable periodic disturbances at intervals of about 20 years, with secondary maxima in half this period, yet the whole period of meteoric downpour depending on Jupiter's sidereal revolution in 11.86 years, and thus compounding into a shorter cycle of average length 11.18 years, which is the well known sunspot cycle.

Accordingly, we propose to investigate the effect of the mutual actions of Jupiter and Saturn in precipitating meteors upon the sun, in the hope of finding this average observed period, and also of assigning the cause of the variation between the observed lower limit of about 8 and the upper limit of some 14 years.

If the average period of 11.18 years can be found from dynamical theory, and the lower and upper limits likewise assigned, in substantial accordance with the observed minimum and maximum of duration noticed during the past 311 years, — involving some 28 cycles, since *Galileo's* invention of the telescope in 1610, — the presumption will be very strong that we have found the true physical cause underlying these remarkable appearances.

No phenomena in nature have been better established than the periodic fluctuations in the frequency of sunspots, and none have proved more utterly bewildering to natural philosophers, when they have attempted to assign the cause.

For notwithstanding the abundance of observational material, we have remained hopelessly in the dark as to the cause underlying these perplexing phenomena. The sagacious investigator is therefore justified in departing from traditions which lead only to failure. It is not by pursuing these beaten paths that we shall find the hidden laws of nature.

Taking the motion in a Julian year to be as indicated in equation (1) above, we find the difference in the mean motions to be $n - n' = 65260''.41046$, which will amount to a whole circumference in a period of

$$\tau = 1296000'' / 65260''.41046 = 19.8589 \text{ Julian years.} \quad (5)$$

This is the average period between the conjunctions of Jupiter and Saturn; and half of it, or

$$\frac{1}{2}\tau = 9.92945 \text{ Julian years} \quad (6)$$

will give the average period between conjunctions and oppositions with the sun.

Now by the American Ephemeris for 1921, we find that Jupiter and Saturn will be in conjunction in heliocentric longitude $\lambda = 177^\circ 0$, at the epoch t_1 ,

$$t_1 = 1921 \text{ August } 22.5775 \text{ Gr. m. t.} \quad (7)$$

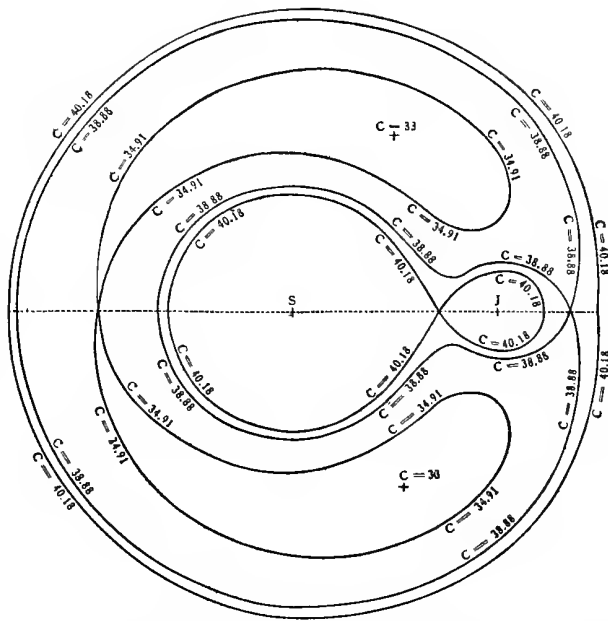
According to the mean period in equation (5) the conjunction of 1901 should have occurred on Oct. 12.5, but from the data of the Berliner Jahrbuch for 1901, we find that the two planets actually were in line at the epoch $t = 1901$ Sept. 29.64.

This indicates that a difference of 12 or 13 days may arise from the relative positions and forms of the orbits. If we disregard this slight change, as unimportant for our present purposes, we find that in 1881 the conjunction should have occurred on Dec. 3, and at each 20-year period earlier the date moves forward by 51.537 days. In about 140 years the conjunctions will occur at all seasons of our calendar. Thus the conjunction of 1941 will occur on July 1.0, and in 1961 on May 10.5.

2. Periodic Impulses for the Precipitation of Maximum Multitudes of Meteors upon the Sun under the combined actions of Jupiter and Saturn.

It is well known from the researches on *Jacobi's* integral for the restricted problem of three bodies (cf. my *Researches on the Evolution of the Stellar Systems*, vol. II, 1910, p. 170), that we have an hour-glass shaped space about the sun and a planet such as Jupiter. In his celebrated memoir on Periodic Orbits, *Acta Math.* 1898, Sir *George Darwin* calculated these surfaces for a planetary mass Jove having one-tenth of the solar mass. This planetary mass is relatively about 100 times that of our actual Jupiter, and the closed surface about that planet therefore is about ten times too large in linear dimensions. Yet such enlargement of the scale enables us to see the nature of the closed surface about the planet more distinctly, and as the other relations are unchanged, we shall make use of *Darwin's* figure, as follows.

It is shown that a meteoric body may pass from the region controlled by the sun, through the neck of the hour-glass, to that under the control of the planet, and, under some conditions, collisions occur.



Figur 2. Section of the *Hill* surfaces in the plane of the orbit of Jupiter, restricted problem of three bodies, giving curves of zero velocity in the case, where the planet has one-tenth of the sun's mass (*Darwin*). The inner curve represents the hour-glass shaped space, with narrow neck, through which the meteorite may move and drop down nearer the sun or planet, till it becomes captured by one of the larger bodies.

Since the surfaces of zero velocities in the motion of Jove about the sun are based on the theory of rotating axes, having the mean motion of Jupiter, we perceive that in its motion about the sun the revolving planet always carries this hour-glass space with it.

In the same way, if Saturn carry a similar hour-glass space with that planet, we perceive that a larger outer set of surfaces will be periodically superposed upon the inner surfaces belonging to Jupiter. And as the two planets carry these surfaces with them, the result is a compounding of the effects near longitudes 0° , 240° and 120° , as shown in figure 3 on following page, where the outer lines relate to the surfaces about Saturn.

From the mere contemplation of this figure it is obvious that the system of three bodies — the sun, Jupiter, and Saturn — is subjected to a somewhat profound disturbance in a period of 19.8589 years; and a secondary maximum of disturbance in half this period, 9.92945 years, when Jupiter and Saturn are in opposition, in the positions of the pointed lines. The first opposition line would correspond to S_3 at 120° for Saturn, on the line $\mathcal{F}_{3/2} S_3$, and to $\mathcal{F}_{3/2}$ at 300° for Jupiter. The second conjunction will be with Jupiter and Saturn in the positions \mathcal{F}_2 and S_2 at 240° . The next opposition would be with Saturn at S_1 and Jupiter at $\mathcal{F}_{3/2}$; then a conjunction of Jupiter and Saturn at $\mathcal{F}_3 S_3$; and finally with Saturn at S_2 and Jupiter at $\mathcal{F}_{1/2}$ in opposition; after which the cycle repeats itself indefinitely, except for the slow shift of the lines of conjunction-opposition in 918 years as already explained.

Outlines of the Dynamical Theory of the Precipitation of Meteors for the Sunspot Periodicity.

In order to test the theory of sunspot periodicity depending on meteor swarms of long period, we shall consider the dynamics of a system made up of a sun and planet, such as Jupiter; and we shall suppose that Jupiter revolves in a circular orbit. Then we may introduce the system of rotating axes, and by the use of *Jacobi's* integral, we have the divisions of space found for the restricted problem of three bodies, as illustrated in the foregoing figure.

A particle of cosmical dust introduced into such a system, with small relative velocity, has its motion defined by the *Hill* surfaces here drawn. If its constant of relative energy is fixed, or variable between certain limits, its possible motion is thereby determined. If the velocity be greater than corresponds to the system, the body may pass on through it without stopping or changing its path materially. In the present problem we shall suppose the motion to be confined to the hour-glass space about S and \mathcal{F} , and ignore the remoter parts of the figure. In this case the periodic paths may pass about S or \mathcal{F} or about both of these centres conjointly; yet the periodic orbit rotates with the planet Jupiter in a period of 11.86 years.

Next consider a particle pursuing a non periodic but perturbed orbit, descending near the sun, and at aphelion passing near Jupiter, somewhat like that of *Lexell's* celebrated comet of 1770. The transformations of the orbit of *Lexell's* comet are well known (cf. *Researches on the Evolution of the Stellar Systems*, vol. II, 1910, p. 196). Dr. *Poor* has carefully traced those of comet 1889 V, and many similar transformations in the restricted problem of three bodies have been worked out by *Darwin*, *Strömgen* and other contemporary mathematicians. We need not go into the infinite details of such problems, but will simply take such transformations as facts; yet the reader should be referred to Sir *George Darwin's* researches on periodic orbits (*Scient. Papers*, vol. IV, 1911).

Accordingly, it follows that if there be swarms of meteorites passing near Jupiter and the sun, and thus not pursuing rotating orbits, they may be so transformed by encounters with the planet as to bring about collisions of many of these particles with the sun's globe. In general their motions would be direct, and their paths would be confined very largely to the plane of Jupiter's orbit, just as are the orbits of the periodic comets and the asteroids, which in the course of ages undoubtedly have been thrown within Jupiter's orbit by successive transformations.

In view of the multitude of comets and asteroids gathered in by Jupiter, it is probable that every point of Jupiter's orbit would have its quota of particles descending near the sun. *Darwin* showed in his address to the British Association in South Africa, 1905, how such a particle may revolve a long time, yet many of them are finally absorbed in the sun or Jupiter.

»As it grazes past Jove or the sun it may often but just escape a catastrophe, but a time will come at length when it runs its chances too fine and comes into actual collision. The individual career of the stone is then ended

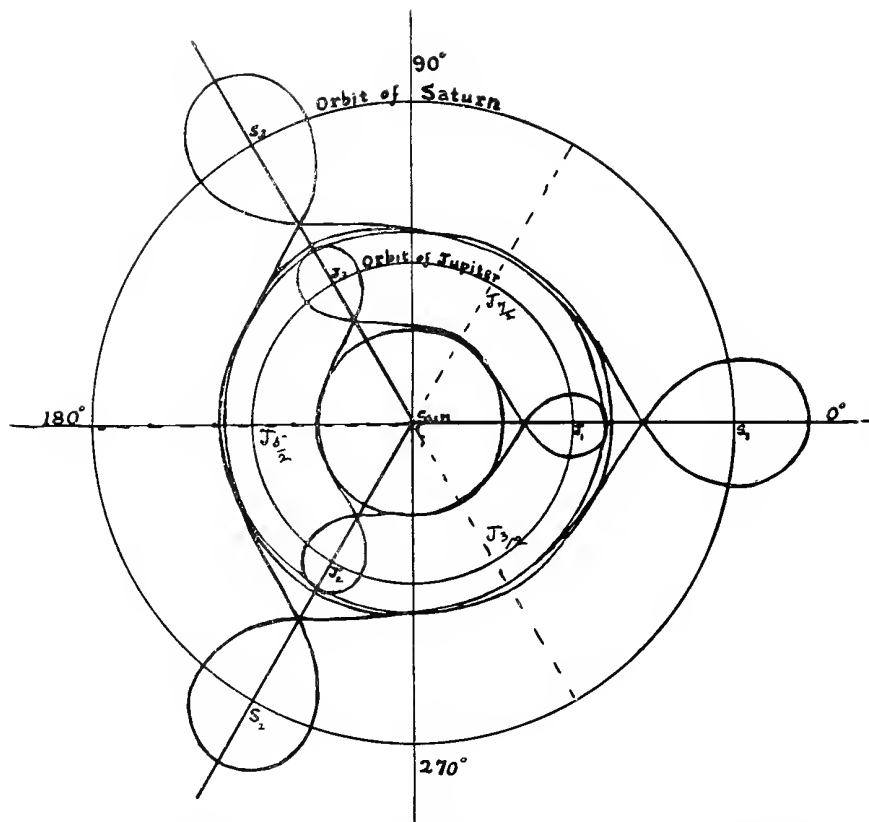


Fig. 3. Section of the limiting *Hill* surfaces, of hour-glass form, connecting the closed spaces about the planets with that about the sun. The scale of the space about Jupiter is magnified 10 times, that about Saturn 18.3 times; and the two sets of surfaces superposed as at the conjunctions of the two planets.

by absorption and of course by far the greater chance is that it will find its Nirvana by absorption in the sun. «

The modern researches of *Poincaré*, *Darwin*, *Strömgren* and others have now established this collision theory on the firmest basis; and thus we assume that the reader is familiar with the chief conclusion of modern mathematicians.

Now if so much is established by the researches of geometers, in respect to the precipitation of the Jovian meteor particles into the sun, it follows that similar reasoning will apply to the independent system of particles passing near the sun and Saturn. For just as Jupiter has an immense mass, rapid rotation, and captured satellites, as shown by the retrograde revolutions, of the outer members of the system; so also has Saturn large mass, rapid rotation and also captured satellites — showing that this great outer planet has played almost as great a part in the development of our system as has Jupiter himself. We may therefore assume meteoric swarms to touch all points of Saturn's orbit, and often pass also near the orbit of Jupiter in their circuits about the sun.

The reader should be referred especially to a paper by the author in AN 4307, on the Physical Cause which has produced the small obliquity of Jupiter (cf. *Researches . . .*, vol. II, 1910, p. 393-397). It is there shown that if Saturn's

mass could be trebled, so as to become equal to Jupiter's, the increase of the Saturnian mass would be accompanied by a destruction of the obliquity, — so that instead of 27° as at present, it would become less than three degrees. This throws important light on Jupiter's small obliquity — it has been destroyed in building up the planet by the capture and absorption of millions of meteors moving near the plane of the planetary orbit.

But of course in building up Jupiter and destroying his original obliquity, the sun has been built up also. In fact the precipitation of meteors upon the larger bodies of the solar system has been going on from the earliest ages. And it is this process of sweeping up cosmical dust which has built up the planets. It is definitely established from valid dynamical laws that they never were parts of the sun, as supposed by *Laplace*, but have been formed in the distance by the accretion of smaller masses, and gradually drawn to the centres about which they now revolve, while the original eccentricities of their orbits have been gradually destroyed by the secular action of the nebular resisting medium formerly pervading our solar system.

The conjunction of Jupiter and Saturn previously described occur at average intervals of 19.8589 years. Midway between these conjunctions there occur oppositions, in average period of 9.92945 years; which is shorter than the average sunspot period.

Thus whilst Jupiter's own period of 11.86 years is somewhat in excess of the observed value, the conjunction or opposition with Saturn is shorter than the sunspot period, which usually is given as 11.18 years.

Is it dynamically possible that the observed period of 11.18 years may depend on the superposition and composition of orbital motions in these periods of 9.92945 and 11.86 years?

If so, the mystery of the sunspot periodicity would be solved. A question of such importance deserves the most careful examination in the light of the modern theories of dynamics. But before forming a judgement on this critical problem, we may advantageously examine certain oscillatory phenomena of the earth's surface, more especially the tides of our oceans, which in practice combine a free and forced oscillation of different periods.

It is pointed out by *Darwin* and other authorities on tides, that the equilibrium figure of our actual ocean is subjected to forces which tend to change its shape in a lunar day, $24^h 51^m$. But the oceans are too shallow to respond to such rapid oscillation, and the tide-wave therefore travels westward more slowly than the forces by which the disturbance is generated. Hence the tide-wave is retarded in its progress around the earth by the friction incident to the small depth of the sea.

Accordingly the disturbance of our actual sea is repeated at the average interval of a lunar day, and the wave thus generated travels around the world in about two days. The tide-wave forcibly generated by the moon's attraction has its period of free oscillation nearly doubled by the shallowness of the sea; where as if the sea were about 13 miles deep it would keep pace with the moon in its westward movement.

It follows that the resultant oscillation of the ocean must be the summation of a series of partial waves, generated at successive intervals of time, yet constantly falling behind the moon, and the integration of the partial waves, which yields the aggregate wave, being the same at each instant, (in an ocean or canal of uniform depth), this aggregate wave must travel westward at the rate of a thousand miles an hour (cf. *Darwin*, Tides, Encyc. Brit., 9th ed., p. 354). It follows therefore that the period of an oscillating system may be altered by composition, as under resonance influence, when there are such periodic impulses at work to change or modify the oscillation time. And in any given case the final result will depend on the composition of the superposed periodic forces to which the whole system is subjected.

3. The Effect of Two Forced Oscillations, in Different Periods, when the Number of Free Bodies is Infinite, is an effective Composition according to the Weights of the two Impulses, or the Spheres of Activity of the two Disturbing Planets.

The principle here stated is analogous to the celebrated theorem adopted by *Laplace* in his theory of the tidal oscillations (*Méc. Cél.*, vol. II), that the state of any system subject to periodic impulses must be periodic like the forces to which it is subjected. Accordingly, we need only apply the principle to the problem now under consideration.

Jupiter is the largest planet of our solar system, with mass $3500/1047.35 = 3.34177$ times that of Saturn; and thus if forced oscillations of meteor swarms arise depending on the actions of these two great planets, it is natural to expect that the impress of Jupiter's action depending on his sidereal revolution will be considerably the more powerful of these periodic phenomena.

Now meteors are moving about the sun in elongated orbits, with aphelia near the orbits of Jupiter and Saturn, and under the mutual actions of these two great planets their paths are so sensibly perturbed that a considerable mass of them are brought into collision with the sun. If the meteors traveled in a straight line ellipse about the sun's centre, the period for the Saturnian meteors would be 10.416 years, and for the Jovian meteors 4.1958 years. In practice, however, both of these periods would be somewhat lengthened, the exact amount depending on the distance of the perihelion, and whether the aphelion is beyond or within the orbit of the great planet in question. All these various cases will occur in nature.

We have next to consider the relative extent of the spheres of influence carried by the two planets Jupiter and Saturn in their motions about the sun. The gravitational actions are given by the expressions:

$$\begin{aligned} f &= k^2 m / r^2 &= \text{Jupiter's action} \\ f' &= k^2 m' / r'^2 &= \text{Saturn's action} \end{aligned} \quad (8)$$

where k^2 is the Gaussian constant.

To compare these actions at all distances it suffices to note that Jupiter's mass exceeds that of Saturn in the ratio 3.34177 to 1. Hence the actions will be equal at distances in the ratio of the square roots of these numbers, or 1.82805 to 1; for obviously whatever be r and r' , we may always write $r = 1.82805 r'$, and have the valid equation:

$$3.34177 / (1.82805 r)^2 = 1 / r'^2 \quad (9)$$

Accordingly, in order to make the Jovian action always equal to that of Saturn, we have to take Jupiter's action at a distance $r = 1.82805 r'$. These spheres of influence as drawn to scale are as indicated in the following figure 4; but the volumes are as the cubes, $(1.828)^3$ to 1, so that Jupiter's sphere exceeds Saturn's 6.108 to 1.

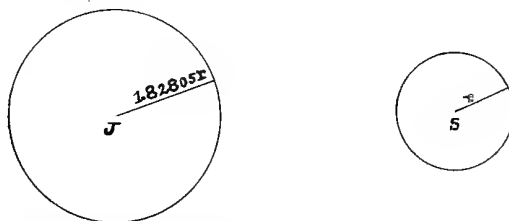


Fig. 4. Illustration of the radii of the relative spheres of influence of Jupiter and Saturn, which give the relative weight of these planets in fixing the resulting periodicity of the meteoric downpour.

It thus appears that the volume of Jupiter's sphere of activity is 6.108 times that of Saturn's. But in order to get the dynamical effect on meteors traversing these spheres of influence, we have to consider the velocities of the meteors when near Jupiter and Saturn respectively. This will enable us to estimate the relative lengths of time in which they are subjected to these disturbing influences, and the precipitative effects in throwing them upon the sun.

Now at Jupiter and Saturn respectively the sun's gravity is in the ratio of $(9.54)^2 : (5.20)^2 = 3.36$. And hence the moving meteors, under this stronger central action at Jupiter's orbit, will be in his larger sphere of influence, or under greater force, a longer duration of time, proportional to $6.108/3.36 = 1.82$ nearly.

By comparing the parabolic velocities at the orbits of Jupiter and Saturn respectively (cf. *AN* 3992, p. 136), we find them to be 8.0941 km and 4.4148 km respectively. This yields the ratio of 1.83. Accordingly, by the above reasoning we find that, Jupiter's relative perturbative efficiency over Saturn's, in their mutual actions on meteors, whether moving with moderate or very great (parabolic) velocity, and thus not subject to appreciable change, is in the ratio of 1.828 to 1.

Dynamically this means that whatever distance be taken as the unit of distance, and of action, Jupiters sphere of influence and his efficiency, always is 1.82805 times greater than Saturn's. In other words, if there be two periods based on meteor swarm precipitation, — namely 11.86172 years, which is Jupiter's sidereal period, and 9.92945 years, which

is the average period in which Saturn passes Jupiter's radius vector in the reverse direction at conjunction or at opposition — we must get their mean period by combining them with different weights as follows:

$$\begin{array}{r} 11.86172 \quad \text{wt. } 1.82805 \\ 9.92945 \quad \quad \quad 1 \\ \hline \end{array}$$

$$\text{Mean period } T_c = 11.17846 \text{ years.} \quad (10)$$

Let us now examine for a moment the observational period of the sunspot cycle as found by the best authorities. These periods are as follows:

1. *R. Wolf*, 1852-1877, by the various observations since 1610, AN 35.369, and Mem. R. A. S., vol. 43, 1877, p. 202.

$$T = 11^y 111 \pm 2.030 \pm 0.307.$$

In this result 2.030 years is a periodic oscillation, and 0.307 the uncertainty in the determination of the period.

2. *Faye*, 1878, from a careful discussion of *Schwabe's* observations under *Faye's* criterion, CR 86.911, July 30, 1877.

$$T = 11^y 20.$$

3. *Spoerer*, 1881, by a discussion of the accumulated observations since 1732, AN 97.102.

$$T = 11^y 31.$$

4. *Newcomb*, 1900, from a discussion of the accumulated data since the time of *Galileo*, ApJ 13, Jan. 1901.

$$T = 11^y 13.$$

Each of these determinations has high and special merit, and if we take the simple mean, which gives them equal weight, we get

$$T_o = 11^y 187 \pm 0.062; \quad (11)$$

and hence the difference from the above calculated period is only

$$T_o - T_c = 0^y 009 \quad (12)$$

or about 3.3 days. This difference is so extraordinarily small as to be remarkable — only one seventh of the probable error in the above value of T_o .

In his memoir of 1877, *Wolf* remarks that *Schwabe* himself, the discoverer of the sunspot cycle, had later adopted the period of 11.11 years (AN 1521). And the same is true of later investigators, — they all agree that the period is slightly over 11 years.

Accordingly, it appears that we can only view the above results as establishing the true cause of the sunspot cycle; and naturally the theoretical mean period is preferable to that derived from observations. Thus the true mean period of the sunspot cycle is 11.178 years.

The accompanying diagrams, plate 3, fig. a, of the sunspot cycles observed since 1831 are from *Wolf's* memoir of 1875 in the memoirs of the Royal Astronomical Society for 1877. It will be noticed that the curves are not of equal heights, nor the periods of equal lengths; but that the different cycles show notable variations both in height of curve and period of duration.

This problem will be examined in more detail hereafter, and we shall endeavor to assign the cause for the oscillation of the period in length, and for the variation of the amplitude or vertical height. At present we merely point out two salient features:

1. An indication of double periodicity, in about 89 years, 4 high maxima followed by 4 low maxima, as from 1834 to 1923, or from 1745 to 1834.

2. The persistence of the tendency to a secondary maximum, which is especially well shown in *Wolf's* curve from 1831 to 1875.

Explanation of the Sunspot Curves here adopted.

1. It is evident that the modern observations of the sun kept up during the last half century at Greenwich, Potsdam, Zürich, and other observatories, on a uniform basis, and thus giving comparable data decade after decade, are vastly preferable to the older observations. Yet we find fairly satisfactory data back to the beginning of *Schwabe's* records in 1826; and we may even go back half a century further, to 1776, without passing out of the era of modern observers.

2. It is stated in Miss *Clerke's* History of Astronomy during the 19th Century, 4th ed., 1902, p. 53, that »for 164 years, then, after *Galileo* first levelled his telescope at the setting sun, next to nothing was learned as its nature«; and that beyond the time of rotation of the sun on its axis, which was immediately deduced by *Galileo* and *Fabricius*, there was no development or increase of precision for five generations of astronomers.

3. The turning point for renewed solar observations seems to have been reached when Prof. *Alexander Wilson* of the University of Glasgow, in November, 1769, noticed a great sunspot and followed it so systematically as to deduce the celebrated Wilsonian theory that the solar spots are depressions in the photosphere. In 1774 *Wilson* proved his theory by geometrical evidence then considered satisfactory, (Phil. Trans. 1774, part 1, p. 7-11). In the same epoch other notable solar observers appeared:

(1) *J. E. Bode*, Gedanken über die Natur der Sonne und die Entstehung ihrer Flecken, Berlin, 1776.

(2) *J. H. Schroeter*, Beobachtungen über die Sonnenfackeln und Sonnenflecken, Erfurt, 1789.

(3) Sir *Wm. Herschel*, On the Nature and Constitution of the Sun and Fixed Stars, (Phil. Trans. 1795, p. 46); and Observations tending to investigate the Nature of the Sun, in Order to find the Causes of its Variable Emission of Light and Heat, (Phil. Trans. 1801, p. 265-334):

(4) *Lalande* and his associates at Paris also were active in all lines of observations, and from the Mém. de l'Acad. d. Sc., 1776, (pub. 1779), we find that the solar spots had enough attention for *Lalande* to develop the eruptive theory first outlined by *Derham* in 1711.

4. If we contrast this considerable development of systematic solar observations during the last third of the 18th century with the almost total lack of good observations in the century and a half preceding 1770, we shall find reason to reject the assumption sometimes made that the sunspot curves of frequency prior to 1770 can be depended upon. This no doubt is the tacit reason why *Rudolf Wolf* and other investigators of sunspot curves often terminate these curves at 1770. In his memoir of 1875, *Wolf* indeed extends his curves back to 1745; and in a recent extensive examination of this subject by Prof. *A. Wolfer* of the Zürich Observatory the curves are carried back to 1749. (cf. Die Häufigkeit der Sonnenflecken in den Jahren 1749-1901, *Wolf*, Astron. Mitteilungen no. 93, and Monthly Weather

Review, Washington, April 1902; and a later summary to 1920, Monthly Weather Review, Aug. 1920).

5. In the paper of August, 1920, *Wolf* finds from his profound studies on the 11-year periodicity of sunspots, 1610 to 1920, that a revision of the mean period now changes the value from 11.12 to 11.2 years. *Wolf*'s new value thus agrees perfectly with my theoretical value 11.178, found above from the motion of Jupiter and Saturn, and the observed value resulting from the work of *Wolf*, *Spoerer*, *Faye* and *Newcomb*, 11.187, which I had deduced before I received the papers so kindly furnished by Prof. *Wolf*.

6. We now turn to *Wolf*'s sunspot frequency curves, 1745-1798, and notice that in his latest work, *Wolf* has reduced *Wolf*'s maximum of 1788 to about 86 percent of the height given it by *Wolf* in his memoir of 1875. After some study of this question I am led to think this curve ought to come down to 0.7 of the height given it by *Wolf*. This would make the maximum of 1788 a low maximum. On the other hand, I would raise the *Wolf* maxima of 1760 by about 40 percent, and that of 1750 by about 50 percent, as shown by the pointed lines in the diagrams of *Wolf*'s curves revised, Plate 3 (b).

7. My reasons for going further than Prof. *Wolf* does in this concluded revision of *Wolf*'s curves are the following:

(a) The observers from 1745 to 1770 were few in number and desultory in attention to the observation of the spots which actually existed on the sun. The chances are therefore that a great percentage of the spots escaped notice.

(b) On the other hand in the period of the French Revolution, 1784 to 1798, — when all Europe and especially France was under an exhalation of intellectual activity, — it is probable that many relatively minute sunspots were noticed, and the number thus unduly increased. Hence to make the record from 1745 to 1798 of any scientific value we must depress the maximum of 1788 and elevate the maxima of 1750 and 1760, as here indicated.

(c) This revision of *Wolf*'s curves would make the 4 maxima 1745-1785 all high, and of comparatively short period, 10 years each, which accords with the tendency noticed in the later and more reliable records of our own time.

(d) After careful reflection I am of the opinion that no known fact stands in the way of this revision, while on the other hand it brings the 18th century sunspot record into harmony with that since 1834, which is the best and most accurate of all. Incidentally it confirms the great sunspot saros in 88.9 years, which is founded upon the numerical relations of cycles recognized to exist, the writer's theoretical period of 11.178 years being independently found by Prof. *Wolf* as 11.2 years in his latest work.

8. In conclusion, the author acknowledges his great indebtedness to Prof. *A. Wolf*, for invaluable data, including his very latest results; and to Sir *Frank W. Dyson*, Astronomer Royal, who kindly furnished the latest Greenwich sunspot and magnetic records. It is to the continuous observations maintained at Greenwich and the systematic classification and reduction kept up at Zürich that we mainly owe our present knowledge of sunspots and their 11-year periodicity. Such records will always be of the highest usefulness to the investigator.

4. The Calculation from the Motion of Jupiter of the Theoretical Sunspot Saros in 88.9 Years confirmed by the Observed Periodicity in about 90 years.

From a study of the sunspot cycle, in relation to Jupiter's orbital motion, made on Aug. 12, 1921, I was able to derive the Great Theoretical Saros, or Restitution Period, in which the sunspots should recur, and to confirm the theory by a careful comparison with *Wolf*'s researches on the observed periodicity since 1745. This theoretical periodicity was found to correspond to 88.9 years, and was derived by the following process of calculation.

1. We have seen that the theoretical period of the sunspot cycle is 11.178 years, while the mean observed period found by *Wolf*, *Faye*, *Spoerer* and *Newcomb* was 11.187 years, which differs only 0.009 from the above theoretical period. The difference between the theoretical and observed period is insensible, so that we naturally prefer the theoretical period of 11.178 years.

2. Now Jupiter's sidereal revolution occurs in 11.86172 years; and thus the sunspot cycle is 0.68372 year shorter than the planet's revolution. The sunspot cycle is therefore displaced 22°0201 in respect to Jupiter's orbit, in a sidereal revolution of the planet, as shown by the following equation:

$$n : n_1 = 1/11.86172 : 1/11.178 = 360^\circ : x \quad (13)$$

$$x = 382^\circ 0201$$

$$x - 360^\circ = 22^\circ 0201; \quad (14)$$

or dividing 22°0201 by 11.86172, we have 1°8564 per annum.

3. But each sidereal revolution of Jupiter finds the conjunction-opposition line displaced according to the proportion:

$$n : n_2 = 1/11.86172 : 1/9.92945 = 360^\circ : x \quad (15)$$

$$x = 430^\circ 0559$$

$$x - 360^\circ = 70^\circ 0559; \quad (16)$$

whence, dividing 70°0559 by 11.86172, we have for the motion per annum 5°90605.

4. And now the difference in these motions, 5°90605 — 1°8564 = 4°04965, is the amount by which the conjunction-opposition line gains upon the sunspot cycle in a year. The periodicity resulting from this displacement is therefore

$$\tau = 360^\circ / 4^\circ 04965 = 88.89657 \text{ years} \quad (17)$$

which is equal to 7.952816 sunspot cycles.

Accordingly, in slightly less than 8 sunspot cycles, the observed cycles of the phenomena should be repeated as a kind of sunspot saros. If the sunspot phenomena were made up of 4 high maxima, and 4 low maxima, which is very nearly the case, the whole of the phenomena should become periodic after about 88.9 years. With the cycle fixed at 11.178, we find the eight periods to amount to 89.424 years, which corresponds very closely to the above saros period.

5. Now let us examine *Wolf*'s curves of the sunspot cycles from 1745 to 1921, — a period of 176 years, very nearly two of the above theoretical cycles, $2 \times 88.9 = 177.8$ years, — for which the observations are most trustworthy. It is to be understood that since *Wolf*'s death in 1893, his curves have been continued by his successors, so that the

data of the last 28 years are dependable. The periods of the frequency curves of the accompanying chart since 1745 probably are free from serious defect of any kind.

6. First, we notice that in the whole interval of 176 years, since 1745, there appears to be two great divisions in the spot phenomena:

(a) A marked period of three low maxima, 1798-1834 = 36 years; and a similar marked period of four low maxima, 1877-1921 = 44 years.

(b) Each of these groups of low maxima were preceded by series of high maxima. That of 1745-1798 = 53 years, apparently contained five maxima, with average period of 10.6 years; and that from 1834 to 1877 = 43 years contained four well defined high maxima of average period 10.75 years each. As the old records are less satisfactory than modern ones, we cannot be too certain of minor details; for example one high maximum, most likely that of 1785-1798, might really be a low maximum, which would balance the distribution more perfectly.

7. As the beginning and end of these periods is somewhat indistinct, we must not expect too perfect an agreement in the minor details; yet in a general way there is very perfect agreement in the observations showing two groups of high series, and two groups of low series of the sunspot cycles. These are the larger and more outstanding features of the observed phenomena; and thus the records since 1745 certainly point to two great periods of solar activity, of about 89 years each. Can such a record be the result of chance, or does it depend on the theoretical Jovian cycle above discussed?

8. To judge intelligently of this problem, we notice that each of the lows in the groups of the cycles comes along in proper succession: that is, they are all together, each of the lows of the low groups being placed with the other low groups; and each of the highs of the high groups being placed with the other high groups of its series. Thus there is no mixing of the highs and lows, but each class of these phenomena is well separated, and stands out conspicuously by itself.

9. Now if this arrangement or order of development depended on chance, the probability of this orderly recurrence would be excessively small. As 16 spot cycles are involved, we should have to consider the probability of a chance event depending on either of two possibilities, each equally probably. Hence we should have:

$$P = (1/2)^{16} = 1 : 65536. \quad (18)$$

The improbability of this orderly arrangement being due purely to chance is so obvious that further argument probably is not required in this connection, — though additional considerations may be adduced as follows, which render the above divisor very much larger yet.

10. We may consider the chance of each low being in elevation of the same order as the other lows. This would be $P' = (1/2)^4 = 1/64$; and the chance of each high being of the same order as the other highs, which is $P'' = (1/2)^4 = 1/64$. The chance of the compound probability is therefore $P_c = PP'P'' = 1/65536 \cdot 1/64 \cdot 1/64 = 1/268435456$ (19)

11. Moreover, we should consider the chance of the lows occurring when the moveable epoch of the sunspot saros is on the side of Jupiter's orbit corresponding to minimum meteorites; and the highs occurring when this epoch of the sunspot saros is on the side of Jupiter's orbit corresponding to maximum comet orbits, or maximum meteors. This again leads to a compound probability almost infinitely small:

$$P_c = PP'P''P''' = 1/65536 \cdot 1/268435456 = 1/17592186044416 \quad (20)$$

12. It is needless to extend these calculations any further, since a compound probability of 17 trillions to 1, that the arrangement is not due to chance may be regarded as a certainty.

Accordingly, we conclude that the great saros or theoretical periodicity in 88.9 years — found from the relations of the cycles 11.178 and 9.92945 years to Jupiter's sidereal revolution in 11.86172 years — is strikingly confirmed by the sunspot records of the past 176 years. The observations point to the theory in such a way that not the least doubt can remain as to reality of the connection.

It is true, therefore, that there is a great periodicity or saros in the spot cycles, extending over about 89 years, yet heretofore not recognized, because we did not see the connection with Jupiter's motion, and the process by which the meteors were precipitated upon the sun, and the larger features of the spot phenomena recurring after the lapse of so great a period.

Accordingly, it only remains to write the formula for the length of the sunspot cycle:

$$II_i = II_0 - III_0 (\sigma_0/\sigma_\mu) \sin[\beta - \alpha(t - t_0)] \quad (21)$$

$$II_i = 11.178 - 2.05 (\sigma_0/\sigma_\mu) \sin[177^\circ - 4^\circ.04965(t - t_0)], \quad (22)$$

$$t_0 = 1921.64224$$

Here the variable term 2.05 years is the »oscillation« found by *Wolf* (Mem. R. A. S. 1877, p. 202) from the observations between 1610 and 1870, and σ_0 is the mean density and σ_μ represents the average variable density of the meteors in the different parts of Jupiter's orbit successively described in the motion of that great planet about the sun.

It will be found that this formula is capable of representing the lengths of the sunspot cycles with remarkable accuracy, and that the highs and lows are indicated by the factor (σ_0/σ_μ) , in the variable term having the period of 88.9 years, with four highs and about 4 lows, as above explained. The amplitudes A_i of the successive cycles depend on the density of the meteors, and thus on the reciprocal expression:

$$A_i = \sigma_\mu/\sigma_0 \quad (23)$$

For it is an observed fact that the highs are somewhat shorter in period than the lows, the former having length say 10.7, and the latter extending to about 12.0 years. The highs therefore are deficient in length by 0.50, and the lows exceed the average length by about 0.83.

It thus appears that to some extent there is a process of partial compensation in the sunspot phenomena. When the amplitudes are greater the periods are somewhat shorter than the average; and when the amplitudes are smaller the

periods are considerably longer than the average period. Perfect compensation probably is not to be expected here, yet this tendency towards partial compensation is clearly indicated by the observed phenomena and may not be rejected without doing violence to the observations. Such processes of partial compensations are frequently met with, and may be said to be a general tendency in nature.

Finally it is to be noticed that even if perfect compensation on the two sides of Jupiter's orbit be attainable, and a good agreement in the individual cycles could be predicted from our formula, under legitimate variation of the arbitrary constants, yet there is little assurance or probability of this concordance being permanent, owing to the changing perturbative influences affecting the meteors, and the unknown distribution or density of these swarms in the different parts of their orbits. Accordingly, if there is a general accordance between theory and observation it is all we can expect; and that we now have certainly attained, in much greater perfection than any one heretofore has dared to hope for.

5. A Method for making the Spot Frequency Curve an Experimentum Crucis for the Discovery of the Cause of Sunspots and of Cepheid and Cluster Variable Stars.

1. If we have a series of recurring phenomena, but do not know the underlying cause to which they are due, yet can trace the curve of these phenomena in an accurate and dependable way, we may proceed to infer the hidden cause involved from other periodic phenomena showing similar frequency curves, if it is allowable to suppose that the two causes may be of like nature, as indicated by the frequency curves of the phenomena.

1) In the propagation of a simple unresisted wave along a canal of uniform width and depth, we have for the uniform motion of the disturbance, under the accelerating forces X and Y :

$$X = \Phi(x, t) = \chi(vt - x) = A(e^{my} + e^{-my}) \cos(nt - mx - B) \quad (a)$$

$$Y = - \int_{y=0}^{y=y} dX/dx \cdot dx = -A(e^{my} - e^{-my}) \sin(nt - mx - B) \quad (b)$$

which satisfy the differential equations: $dX/dx + dY/dy = 0$ $d^2X/dx^2 + d^2Y/dy^2 = 0$ $X = \Phi(y + x\sqrt{-1}) + \Psi(y - x\sqrt{-1})$ (c)

But under resistance the equations of wave motion in a canal are more complicated, just as the theory of disturbed planetary motion is more complex than the simple theory of undisturbed motion. In general our equations have the form:

$$d^2X/dt^2 = F + d/dx \left[-gK - \int_{y=\eta}^{y=h} d^2Y/dt^2 \cdot dt \right], \text{ equation of equal fluid pressure} \quad (d)$$

$$Y = \Xi d\eta/dx - \int_{y=\eta}^{y=y} dX/dx \cdot dx, \text{ equation of continuity} \quad (e)$$

where $\Xi =$ the value of X at the bottom of the canal, and $d\eta/dx =$ tangent of the inclination of this sloping bottom to the horizon. These two equations contain the whole theory of the motion of fluids in canals of uniform width, but of uniform or variable depth, when the motion is taken to be entirely longitudinal and vertical.

If in this oscillatory motion of the fluid about a mean position, which is called a wave, we put:

$$X = a \cos(mvt - mx) \quad (f)$$

we get
and

$$dX/dx = ma \sin(mvt - mx) \quad (g)$$

$$d^2X/dx^2 = -m^2 a \cos(mvt - mx).$$

These expressions satisfy the differential equation of wave-motion,

$$d^2X/dt^2 - v^2 d^2X/dx^2 = 0 \quad (h)$$

and, by double integration, accurate to a second approximation, lead to the solution:

$$X = \Phi(vt - x) + \Psi(vt + x) - \frac{3}{16} a^2 m^2 (vt + x) \cos(2mvt - 2mvx) \quad (i)$$

which is easily transformed to give the elevation of the water above mean level, as cited above (cf. *Airy*, Tides and Waves, p. 286-300).

2. Now in the case of the sunspots, the observations during the 311 years since *Galileo's* invention of the telescope and discovery of these spots, do indeed give us reliable frequency curves; yet the underlying cause is left utterly obscure, because no one appears to have applied successfully the above principle. Perhaps the difficulty was increased, because we did not anticipate that it would be possible to find curves in other periodic phenomena so accurately similar to the sunspot curve as to constitute an experimentum crucis; yet on Aug. 19, 1921, such an identity of curves was discovered by the writer and shown to be so rigorously applicable as a crucial test, that the chances are infinity to one that it reveals the true cause of sunspots. Heretofore the nature of these phenomena has been so completely hidden from our view that the cause involved has proved utterly bewildering to natural philosophers.

3. The accompanying curves (Plates 4 and 5) for the form of the tide wave in a river or shallow canal of uniform width and depth are from *Airy's* celebrated article on Tides and Waves, *Encyc. Metr.*, 1845. To explain them it suffices to say that the upper curve Nr. 9, shows the theoretical form of the surface of the water in a shallow river, as the tide wave advances from the sea, to the 1st station; then up the river, to the 2nd, 3rd and 4th stations. It will be noticed that the wave front becomes steeper, owing to resistance; thus the form of the wave is slowly modified, and it finally breaks up by the development of a secondary wave in the rear of the chief wave. The formula¹⁾ for the elevation of the water is:

$$H = -bk \sin(mvt - mx') + \frac{3}{4} b^2 kmx' \sin(2mvt - 2mx'). \quad (24)$$

The first term of this expression is a sine curve and holds for the elevation when the displacement of the particle

is small in comparison with the depth of the water; but the second term is of a different type, since the multiplier x' is outside of the periodic function, as in the integrations for the secular variations of the elements of the planetary orbits (cf. *Méc. Cél.*, Liv. II, Chap. V, §§ 40-42). This latter expression for the elevation of the water may be conceived to be a secondary wave, infinitely small at first, but whose magnitude increases continually as x' increases, or the disturbance travels along the canal, with the increase of the time t .

4. When the tide wave leaves the sea, at the first station, the second term is insensible, and the motion harmonic, in the curve of sines; but as the disturbance travels up the canal, the secondary wave grows, as shown in *Airy's* curves, which of course exaggerate the effects, to render them visible to the eye of the reader. In our actual seas the vertical motion is of course very small compared to the horizontal motion, and this exaggeration of the vertical component is necessary in the diagram.

Now if at any station along the river we record the passing elevation of water, as by a tide-gauge, we get the next lower series of figures, nos. 10, 11, 12, 13. We can easily see that this is a reversal of the above form of the surface; for a tide-gauge is made by fixing a marking pencil on a sheet of paper, moving uniformly in the contrary direction to the advance of the wave up the river, as shown by the arrow on the right, upper part of Plate 4. Thus as the pencil is held fast, and the paper on a cylinder revolves beneath it, to the left, the tidal curve due to the change in the level of the water, with the periods shown, is recorded, the record being the exact reverse of the above form of the tide-wave.

5. It is the tidal curve of resisted wave motion which especially interests us in the theory of the sunspots; for it gives an exact and very wonderful reproduction of the curve of frequency, or form of the sunspot cycle, as found by *Schwabe*, *R. Wolf*, *Faye*, *Spoerer*, *Newcomb* and other investigators. Let the following typical sketches serve to remind us of the steep slope on the left, the high maximum, with more gradual slope and distinct indication of secondary maximum on the right.

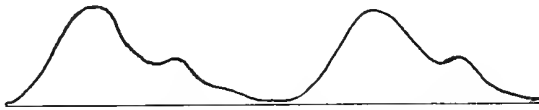


Fig. 5. Typical forms of the curve of frequency of sunspots.

These curves are typical of the records found from the laborious researches of *Wolf*, which covered the whole period from 1610 to 1875, and were extended till *Wolf's* death in 1893, since which time *Wolf's* records have been kept up with great and commendable continuity. Thus our curves run from 1610 to 1921, but different portions of the record have been made by different investigators.

6. From the above simple argument it follows that the sunspot cycle obeys the mathematical law of a wave movement advancing against resistance, as shown by the actual records of oceanic tides in shallow rivers. These

forms of tides and the reversed tidal curves have been treated by *Airy* in the ablest manner, and illustrated by many figures which now become of extreme interest in connection with the sunspot cycle. As the forms of the sunspot frequency curve and the tidal curve are absolutely identical in every detail, we are forced to admit that the sunspot frequency depends on a movement in the sun analogous to a tide, but resisted by other parts of the sun's body in which such motion does not exist.

7. The next question naturally is: What kind of solar tide can this be? Obviously it is nothing but the periodic forward rush of the equatorial acceleration, produced by the sudden downpour of meteors against the equatorial regions of the photosphere, under the combined precipitative action of Jupiter and Saturn, yet not occurring in the polar regions, and therefore this equatorial tide in the solar photosphere is resisted by the slower rotation in higher latitudes — just as the tidal waves entering the river Severn are resisted by its banks, as so well and fully illustrated by *Airy* in his great work on tides and waves. Accordingly this resistance of the equatorial rush or photospheric tide at the solar equator is the true cause of the form of the curve of the sunspot frequency. On this point there is not the slightest doubt to those who know the geometrical properties of curves shown to be of identical type.

8. It would be possible to build up an argument from the theory of probability, showing that the chances are infinity to one that this is the correct and only admissible interpretation of the identity of form between the tidal curve of resisted wave motion and the curve of spot frequency. The incontestable nature of such an argument is obvious. By no possibility could the two curves have identically the same form throughout their courses — involving the analogous ordering of an infinite number of points or neighboring elements of curvature — without both curves representing resisted tidal wave motions.

9. It only remains to add that when *Schwabe* began to record sunspots in 1826, he acted unconsciously as a tide-gauge. The spots are the solar analogue of the height of the water in the tidal river; and *Schwabe* by noting the number of spots with the uniform flight of time made a useful gauge of the disturbances in the equatorial regions of the sun. Thus *Schwabe's* method was very simple, yet extremely effective, since it gave an accurate register of the ebb and flow of spots, and therefore of the resistance to the current movements at the sun's equator due to the downpour of meteors under the combined actions of Jupiter and Saturn.

10. As soon as I had perceived the cause thus underlying the curve of sunspot frequency, Aug. 19, 1921, I had the good fortune to be able to submit the argument to the critical judgement of commander *L. M. Cox*, U. S. N., the eminent civil engineer at Mare Island, who concurred at once in the view that the proof is overwhelming. It was not without the concurrence of several other trusted and sagacious thinkers — Capt. *E. L. Beach*, U. S. N., Commandant, Mr. *A. E. Axland*, Mr. *L. Tiernan*, Mr. *W. S. Trankle*, and especially Mrs. *See* — that I was induced to announce

the discovery by the cablegrams of Aug. 20-22, to the *Astronomische Nachrichten*, and the *Astronomische Gesellschaft* at the Potsdam meeting.

For upon reflection it was evident that whatever cause regulates the sunspot curve of frequency — the whole flow of spots — must necessarily regulate the origin of the individual spots. Therefore there could be no doubt whatever of the discovery of the cause of the sunspots. They could be due to nothing but the cause here assigned, and all other causes are wholly and forever excluded from consideration.

11. We have therefore no hesitation in introducing into astronomy the tidal curve of resisted wave motion as of great importance in the science of the heavens. The doubly periodic function

$$H = -bk \sin(mvt - mx') + \frac{3}{4}b^2k^2m^2x' \sin(2mvt - 2mx') \quad (25)$$

as here interpreted, gives us the true clue to the long standing mystery of the sunspot frequency curve.

And not only will this development enable us to understand great masses of phenomena in the solar system, but also others equally or more bewildering in the sidereal universe. It is well known that the two great classes of variable stars heretofore utterly bewildering to investigators are the Cepheids including Geminids and the Cluster variables, the latter numbering thousands, and discovered chiefly by Professor *Solon I. Bailey*.

As Dr. *Harlow Shapley* has used the Cepheid and Cluster variables to find an indirect correlation method for measuring the distance of the globular clusters, — ranging in distance from 7000 to 240000 light-years — it is evident that we must explain the forms of the Cepheid light curves, and also the light curves of the cluster variables, in order to be sure that they come under the causes assigned by the theory of resisted wave motion.

12. The accompanying figures, Plates 6, 7, will make this theory sufficiently obvious. The resemblance of the light curves of the Cepheids to the sunspot frequency curve has been emphasized by several writers, but especially by Miss *Clerke's* *The System of the Stars*, 1905, from whose excellent work the typical illustrations here used are taken.

The propriety of applying the theory of the tidal curves of resisted wave motion to these variables is at once obvious, if we turn to *Airy's* figures Nr. 53 and 59, Plate 5.

(a) These tidal curves of the resisted waves at Newnham and Weymouth respectively are so exactly similar to the light curves of certain typical Cluster variables found by *Bailey*, that one could not wish for a more perfect geometrical correspondence. The rapid rise to high maximum, more gradual decline, and long dead level track constituting the minimum, are very notable features, and will strongly commend the theory of a resisted tide-wave to the investigator of variable star phenomena throughout the sidereal universe.

(b) It might be possible to ascribe the light curves of cluster variables of this type largely to mere surface conflagration incident to the downpour of meteors, since the rapid rise in brilliancy and slower decline, under cooling, could thus be accounted for. The objection to the purely

conflagration theory is that it would separate the cluster variables from other variables, with secondary maxima. Nature will not allow such discontinuity.

(c) Thus whilst the conflagration of meteors occurs, there are also currents and inequalities of level set up in the photospheres of the stars; and the resulting thermal and gravitational oscillations are closely associated and obey the same wave laws, — though usually in slightly different periods, as we see by the results cited below from Lord *Kelvin*, eq. (32), *Ritter*, eq. (49) and (50), and *Moulton*, *ApJ* 29 — and therefore the changes, with the whole of the phenomena of light variation, obey the curves of resisted tide waves. This is the substance of the new theory, and it is applicable alike to the sunspots and to the periodic fluctuations of starlight shown by the light curves of Cepheid, Geminid and Cluster variables.

(d) It only remains to point out that in the case of the Cluster variables the secondary maximum on the descending slope of the light curve, is either missing or nearly insensible. It is important to know how to interpret this deficiency, and a clear light is shed on the mystery by extending the researches on the theoretical form of the tide-wave in a shallow river, to second approximation given in *Airy's* figure Nr. 9. If this curve be continued to the 6th or 8th station, it is evident that the secondary wave will break away more distinctly from the chief wave — the secondary wave becoming steeper in front, and allowing the chief wave to be followed by a long dead level track, just such as we find in the light curves of Cluster variables.

(e) Accordingly we conclude that if enough time were to elapse before the next meteoric downpour, under the orbital revolution of the satellite, the secondary wave would duly appear. But the forced oscillation under orbital motion in say half a day gives a pulsation so rapid that the thermal and gravitational disturbance, due to meteoric downpour at their equators, has no time to show an effect of sensible resistance by disrupting the pulsation into two oscillations. There is not time for sensible resistance effects to follow as a separate wave; hence the secondary maximum in the light curves are largely or entirely lacking, because too soon overtaken and swallowed up in the succeeding forced oscillation depending on orbital motion, which is of much greater magnitude. The fact that the resisted wave theory overcomes this great mystery in Cluster variables shows how secure is the physical foundation underlying the theory. Thus all the chief phenomena of Cepheid and Cluster variables are accounted for in a manner much simpler than any investigator heretofore has dared to anticipate.

6. Brief Notice of the Cepheids, Geminids and Cluster Variables: Explanation of why the Sunspot Frequency and Stellar Light Curves follow the Law of the Tidal Curve of a Resisted Wave.

1. The following table from Miss *Clerke's* *Problems of Astrophysics*, London, 1903, p. 324, will convey to the reader a very good idea of the periods, and extent of the light changes in a dozen typical Cepheid variables.

Name	Limits of change	Period
R Muscae	6.6 to 7.4 mag.	0 ^d 21 ^h 10 ^m
R Triang. Austr.	6.6 » 8.0 »	3 9 20
ST Cygni	6.6 » 7.4 »	3 20 10
T Vulpeculae	5.5 » 6.5 »	4 10 28
Y Sagittarii	5.8 » 6.6 »	5 18 33
U Sagittarii	7.0 » 8.3 »	6 17 46
X Sagittarii	4.0 » 6.0 »	7 2 50
W Sagittarii	4.8 » 5.8 »	7 14 16
S Sagittae	5.6 » 6.4 »	8 9 7
X Cygni	6.4 » 7.7 »	16 9 15
W Virginis	8.7 » 10.4 »	17 6 30
T Monocerotis	5.8 » 8.2 »	27 0 18

The system of δ Cephei, from which this class of variables is named, fluctuates in brightness between 3.7 and 4.9 magnitude, in a period of 5^d 8^h 47^m 39^s, of which 1^d 14^h 36^m yield the increase of light, while the remaining interval, 3^d 18^h 11^m, is devoted to the decline in brightness, with secondary maximum at 3 days from the minimum. The secondary maximum is therefore slightly less than 0.6 of the whole oscillation from the minimum, and the whole series of changes is well shown by the accompanying light curve (s. Plate 6a).

2. The accompanying table of eight Geminid variables, also from Miss *Clerke's* Problems of Astrophysics, p. 331, will sufficiently illustrate the light changes in these systems.

Name	Limits of change	Period
R ² Centauri	7.4 to 7.8 mag.	0 ^d 7 ^h 16 ^m
S Antliae	6.7 » 7.3 »	0 7 47
U Pegasi	9.3 » 9.9 »	0 9 0
24 ω Centauri	13.4 » 14.0 »	0 11 5
V Puppis	4.1 » 4.9 »	0 17 27
U Vulpeculae	6.9 » 7.6 »	8 0 4
δ Serpentis	5.0 » 5.7 »	8 17 17
β Lyrae	3.4 » 4.5 »	12 21 47

This class of variables is named after ζ Geminorum, discovered by *Schmidt* in 1847 (AN 624). It was soon afterwards found by *Belopolsky* and *Campbell* that the light variations are associated with orbital motion in 10^d 4^h, as if the system were so tilted that its orbital plane lie nearly but not quite in our visual ray. One component is invisible, yet the observed minima are not due to its intervention, — since their epochs do not correspond to spectroscopically determined conjunctions.

In the case of the Geminids the periods are fairly short and the light curves rise and fall almost as symmetrically as a sine curve: thus the resisted wave effect does not develop into any prominence, since the tendency to secondary maxima are nearly insensible. In the case of U Vulpeculae and V Puppis, however, the tendency to secondary maxima is more pronounced, as shown by the »humped« decline (s. Plate 6b).

3. While making photographic comparisons of certain Globular clusters in 1895, *Bailey* discovered the most numerous of all the types of variable stars — the so-called Cluster variables. Over 500 have been found in certain clusters, and more than a thousand in the Magellanic clouds (Harv. Circ. 82, 96, 100).

Their periods generally are remarkably short — decidedly less than one day. The following brief table will give an idea of the nature of these cluster variables (*Clerke's* System of the Stars, 1905, p. 379):

Name	RA. 1900	Decl. 1900	Range in mag.	Period in days	Rem.
No. 8 ω Centauri	13 ^h 20 ^m 8	-46° 57'	12 ^m 8-14 ^m 3	0.52	1
No. 7 Messier 5	15 13.5	+ 27 27	13.5-14.9	0.50	2
S Arae	17 51.5	-49 25	9.5-10.8	0.45	3
Y Lyrae	18 34.2	+43 52	11.3-12.3	0.51	4
XX Cygni	20 1.3	+58 40	10.7-11.6	0.13	5
UY Cygni	20 52.3	+30 3	9.6-10.4	0.5	6

Remarks: 1. One of 128 variable components of the great southern cluster. Nearly constant minimum of 6^h duration. — 2. Situated in the globular cluster in Libra. Minimum lasts 0.4 of total period. — 3. Rises to maximum in 1^h 10^m. — 4. Increase of light effected in 1^h 30^m. — 5. Discovered by Mrs. *Ceraski* in 1904. — 6. Rise completed in 1^h 53^m.

The Cluster variables are characterized by a swift rise to maximum, and a prolonged halt of change at minimum. Hence the minima are more or less dead level tracks, and this low light phase is about half of the whole period. The brightness then blazes up rapidly and after passing the maximum, declines much more slowly. The light curves of these stars show distinctly the backward slope of the tidal curve of a resisted wave. Yet the time of the whole change is so short that secondary maxima do not become sensible (s. Plate 7).

After thus briefly showing the applicability of the theory of the tidal curve of a resisted wave to the Cepheid, Geminid, and Cluster variables, it may perhaps be appropriate to give a short notice of how this advance in astronomical geometry became possible.

4. Having been occupied with the problem of the sunspot periodicity since early in July, 1921, I finally resolved on Aug. 18, to search diligently in all available mathematical and physical treatises for the geometrical form of the typical curve of sunspot frequency, which, if it could be found, would enable one to predict the normal development of spot phenomena, with confidence and rigorous accuracy. This daring adventure might not succeed, but at least the experiment was worth trying, in the hope of finding the mathematical and physical law underlying the spot development.

(a) On Aug. 18, I turned to the elaborate tables of Spherical Harmonic Functions, with curves for illustration, given in *Thomson* and *Tait's* celebrated Treatise on Natural philosophy, ed. 1883, sections 782-784; and after some examination, settled upon the functions $\Theta_6^{(5)}$, $\Theta_7^{(6)}$ as being of all the graphs there given the one most like the form of the sunspot cycle. The resemblance was not perfect and after some disappointment, I put that treatise aside, to look into certain wave forms resulting from *Fourier's* analysis of wave-motion, and illustrated by curves in *Riemann's* Partielle Differentialgleichungen, *Hattendorff's* edition, 1882, p. 59, 159, 161. The two latter wave figures, based on the transcendental equation

$$\varphi \cos \varphi + \psi \sin \varphi = 0 \quad (26)$$

which in an oscillating periodic function of great interest, seemed likely to be most applicable, but after a brief examination I had to drop the work until the following day.

(b) On Aug. 19, I made a careful sketch of the Harmonic Functions $\Theta_6^{(5)}$ and $\Theta_7^{(6)}$, here reproduced, s. Plate 8 Fig. 6, but found the resemblance to the sunspot curve not sufficiently close to justify the adoption of these curves. Thus I put aside the harmonic curves altogether and turned to the *Fourier* wave curves treated by *Riemann*, p. 159, 161.

On tracing the curves reduced in the vertical ordinate by the factor $1/4$ I found that although these reversed wave curves rose more rapidly than they fell, and in general form were like the sunspot frequency curves, yet they did not have a secondary maximum on the downward slope, as indicated so frequently in the solar records. Hence whilst I did not despair of progress I deemed it prudent to extend the search for other curves, in the hope of finding a more exact type for the sunspot frequency curve.

(c) Having been so long engaged upon the wave-theory of physical forces, (1914-1921), in completing the *New Theory of the Aether*, 1921, nothing was more natural than to turn to *Airy's* great work on *Tides and Waves*, 1845. Remembering his analysis of the theory of long waves as resisted in shallow canals (Art. 201) with the figure reproduced in the *Second Paper on the New Theory of the Aether*, AN 5048, p. 141-2, I turned to that illustration, and immediately recognized the exact form required for the sunspot curve. In a few minutes the problem was perfectly solved and the further the examination of the tidal curves was extended the more incontestable the proof of the identity became. The rest of the discussion is given above, and any one may now form his own judgement both as to the logical character of the search for curves which would be useful in the geometry of the heavens, and as to results of that search in finding curves of the deepest interest to the investigator of the physical universe.

5. It only remains to add that in view of the evidence for the sun's curve of spot frequency cited above and confirmed by the light curves of Cepheid, Geminid and Cluster variables, we have no alternative but to give up any idea that the effect of meteoric downpour upon the sun or a star would follow the simple law of the well known curve of sines, of which the equation is:

$$y = a \sin(2\pi x/\lambda + \alpha) = a \sin(2\pi/\lambda) (Vt - x) = a \sin(2\pi/\lambda) (mVt - mx). \quad (27)$$

In practice the disturbance would be a disintegrating oscillation or broken wave; and hence we must frankly admit that all the physical oscillations of matter in nature are accompanied by resistance. The tendency of this friction is a gradual modification of the chief wave, and, if kept up long enough, a disruption into another of shorter length but greater amplitude; and the formation of a secondary wave, as shown by the second term of the expression for a tidal curve of a resisted wave:

$$H = -bk \sin(mvt - mx') + \frac{3}{4} b^2 k m x' \sin(2mvt - 2mx'). \quad (28)$$

This curve with two maxima represents a modification which in time develops into double periodicity, or a move-

ment developing into two unequal oscillations. Therefore it is more complicated than the above simple curve of sines, with single periodicity — just as motion in the ellipse, investigated by the Greek geometer *Apollonius* of Perga in his great work on conic sections (250 B. C.), and introduced by *Kepler* in 1609 for the motions of the planets, is more complicated than simple motion in a circle.

Up to *Kepler's* time circular motion had been used by astronomers, since the days of *Hipparchus* and *Ptolemy*; and it required a heroic effort on *Kepler's* part to get rid of this usage of eighteen centuries. For it must be remembered that the Greek geometers and natural philosophers regarded the circle as a perfect figure, and hence it was held that the celestial motions necessarily are circular.

6. If α, β be the coordinates of the centre of the circle, the equation of the path of the eccentric referred to the origin, distant $\mathcal{A} = \sqrt{\alpha^2 + \beta^2}$, becomes:

$$\begin{aligned} (x - \alpha)^2 + (y - \beta)^2 &= r^2 \\ x &= r \cos \omega + \alpha \\ y &= r \sin \omega + \beta. \end{aligned} \quad (29)$$

The radius vector ρ and polar angle θ , in reference to any point as origin may be obtained, by a roundabout process; and this usage was kept up till *Kepler* introduced the simpler theory of motion in the ellipse, of which the polar equation is:

$$r = a(1 - e^2)/(1 + e \cos v). \quad (30)$$

Here the radius vector is given, and the true anomaly v is easily found by the solution of *Kepler's* equation.

7. Increased geometrical rigor, as well as a better basis for physical action, followed *Kepler's* innovation of 1609. For it was upon *Kepler's* laws of planetary motion, — which placed the sun in the focus of the ellipse, with the radius vector describing equal areas in equal times, and made the squares of the periodic times to vary as the cubes of the mean distances, — that *Newton* established the law of universal gravitation, 1686:

$$f = mm'/r^2. \quad (31)$$

With these explanatory remarks on the progress of past ages, it must be borne in mind that in our present problem of sunspots and variable stars, we introduce the theory of the tidal curve of a resisted wave with the following understanding:

(a) Under the law of gravitation and the doctrine of the conservation of energy, we hold that the downpour of meteorites generates the energy of light and heat radiated away by the disturbed heavenly body. As the meteors fall, their gravitational energy generates a disturbance in the photosphere, which upsets both the hydraulic and radiative equilibrium, whether on the sun or stars; and the first result is a photospheric outburst, with rush of flaming fluid — the magnitude of the disturbance depending on the amount of meteors precipitated, the intensity of gravity, the star's velocity of rotation, surface temperature, etc.

(b) The hydraulic and radiative equilibrium being thus upset, there will follow with time, a gradual reaction or subsidence, to be followed by a secondary wave of disturbance like the first, but of feebler intensity.

8. (α) The problem of the gravitational oscillation of spheres has been treated by Lord *Kelvin* in the Phil. Trans. for 1863; and the period found to be very short, except in case of masses of small density, which are thus subjected to feeble forces, — the time of oscillation being inversely as the square root of the density. *Kelvin's* time for the gravitation oscillation of the sun is found to be:

$$T = 3^h 8^m. \quad (32)$$

(β) In his *Anwendungen der Mechanischen Wärme-Theorie auf kosmologische Probleme*, Leipzig, 1882, *Ritter* finds that when the sun's thermal equilibrium is disturbed the period of the oscillation is $T = 2.422$ days. No change of *Ritter's* constants will alter this result materially; so that we know the time of the thermal oscillation is only a few days.

(γ) In the *Astrophysical Journal* for May, 1909, *F. R. Moulton* reached a period of thermal oscillation for the sun of only a few days, — and thus substantially in accord with *Ritter's* work of 1882. These results hold for expansions and contractions of the globe represented by a harmonic of the second order, which in view of the high effective rigidity of the sun (AN 4104) is an excellent approximation to the truth.

9. Now we dismiss all such gravitational and thermal oscillations as are here described in paragraphs α , β , γ , as inapplicable to the sun and variable stars; and consider only what will happen as the secondary wave or tidal current of the equatorial disturbance develops on the sun or a star, under the effect of frictional resistance to the original rush of the flaming fluid. It is for this readjustment of the equatorial flow under friction that we introduce the curve of the resisted tide wave — the double or secondary oscillation being due to the effects of friction and reaction, as in the observed progress of the tide waves noticed upon the earth.

10. When the current is set up at the equator of a sun or star by a meteoric downpour, there is generated¹⁾ besides the outburst of light and heat, a forward rush of the photospheric fluid. Now a river, as we know in practical hydraulics, runs swifter and at greater elevation in the centre of the channel, where the fluid is deepest. Owing to the tendency to maintain the hydrodynamical condition implied in the equation of continuity, (cf. *Airy*, *Tides and Waves*, Art. 72, or *Darwin*, *Art. Tides*, *Encyc. Brit.*, 9th ed., § 11. eq. 481):

$$du \gamma \sin \theta / d\theta + \gamma \sin \theta \cdot dv / d\varpi + w \sin \theta = 0 \quad (33)$$

the rushing column of liquid in the centre tends to drag along the fluid near the banks of the river, and thus by suction the level of the fluid is elevated in the rapidly moving centre of the channel.

11. Now in the same way a rapidly moving current set up in the photosphere, at the equator of the sun or of a star, by the downpour of meteors, tends to carry the fluid

in the higher latitudes along with it, by the suction of friction, — the hydrodynamical conditions specified in the equation of continuity still holding approximately true. Moreover, by the increased centrifugal force given to the equatorial current by the meteoric downpour, there is additional suction towards the swifter current at the equator. Hence the level of the spherical or spheroidal photosphere is slightly raised at the equator; and the level of the fluid in higher latitude undergoes a slight adjustment as the surface fluid moves slightly towards the equatorial region.

Hence in time the shallow surface current is checked by friction at the sides, and from the layers beneath, which revolve less rapidly: the result is a revulsion and readjustment of level in all latitudes, as when the resisted tide wave in our rivers breaks up. This subsiding oscillation calls forth a secondary movement or rush of fluid like the first; but much feebler, and thus arises the secondary maximum in the curves of the sun and stars. Such readjustment in the surface layers of our sun are also implied in *Spoerer's* law of sunspots, which we have shown confirm the theory in every respect.

The views here expressed on the sun's equatorial photospheric currents and their reactions, apply of course to the stars throughout the sidereal heavens, — though the time of reaction will vary from star to star, according to physical conditions. In view of the extreme fluidity of the stars, at the high temperature of their photospheres, it is evident that the period of modification for the formation of a secondary wave, as in the resisted wave noticed upon the earth, will not be very short, except where the frictional effects are very great.

12. In the case of the sunspots, for example, the period to the secondary maximum is some six years, — half of the periodic time of the chief disturbing planet. In the case of a variable like η Aquilae the secondary maximum follows in about four days, about two-thirds of the period of the companion shown by the spectrograph to revolve in some $6\frac{1}{2}$ days. If the period be very short — say less than half a day — it seems certain that secondary maxima cannot develop, for lack of time of decay; and this inference is confirmed by the general absence of secondary maxima in Cluster variables.

As Commander *Leonard M. Cox* was kind enough to confirm the early results at which I arrived, on Aug. 19-22, I may be pardoned for quoting some passages from a letter in which he gives the conclusions of a practical worker in the hydraulics of rivers and channels.

»My dear Dr. See:

»I am so profoundly impressed with your remarkable discovery of the cause and periodicity of sunspots and of the Cepheid and Cluster variable stars, that I am impelled to express, in my feeble way, my appreciation of the achievement.« . . .

¹⁾ In the present paper we have scarcely alluded to the elliptic tide which in fact is a periodic change of oblateness of figure depending on the revolution of the companion in its orbit: yet we assume that the reader is familiar with this variation of tidal forces, and the resulting equatorial and polar rush of the flaming fluid. This change of oblateness under the tidal forces producing the elliptic tide would give rise to some change of brightness, but not the great blazing up of light actually noticed in the case of many variables. Hence the chief effects are ascribed to the meteoric downpour, yet the subordinate effects of the elliptic tide are not overlooked in our reasoning, but recognized to exist without special discussion.

»I am particularly impressed with the use of the geometrical theory of terrestrial wave motion, as in the case of the tides — which are of so much interest to engineers. Apparently you have rejected the complicated and used the simple and obvious — though not obvious until you pointed the way. In this, you remind me of *Kepler's* innovation (in 1609, I think) in boldly rejecting the clumsy theory of eccentrics as handed down by *Ptolemy*, for the simple and perfect theory of elliptical motion with the sun in the focus of the ellipse.«

»As I recall the development and application of geometry to the heavens, not many species of curves are used even now — chiefly the conic sections. Your introduction of the tidal curve of a resisted wave, and your development of a general equation describing it, makes a new doubly periodic function applicable to the most intricate and varied of celestial phenomena. Undoubtedly we shall have occasion to observe indications of this resisted wave motion throughout the solar system as well as in the globular clusters and other portions of the sidereal universe.«

»Since the cluster variables are used for calculating the distance of the clusters, recently found to be removed from the earth hundreds of thousands of light years, this application of the tidal curve of a resisted wave seems destined to become as useful in astronomy as the theory of elliptical motion introduced by *Kepler* the year before *Galileo* invented the telescope and discovered the sunspots from which your new discovery arises.«

»It will always be a source of pride to me that, despite my inability always to follow you on the lofty plane of your work, you have done me the honor of including me among the few to whom you first communicated your discovery. I shall not attempt to express my gratitude, for the reason that personal considerations seem out of place in connection with such a momentous addition to the knowledge of man.«

7. Explanation of the Binary Character of the Formula for the Length of the Sunspot Cycle, with the resulting Secondary Periodic Oscillation affecting the Duration, and itself Variable with the Amplitude.

It will be noticed that our formula for the length of the sunspot cycle, given in section 5 above, has the binary form, and thus the secondary term may become positive or negative, through the changes of sign in the expression

$$\sin[\beta - \alpha(t - t_0)]. \quad (21)$$

Hence a word of explanation is desirable in justification of the form adopted.

Already in 1875 *Wolf* found the period, — during the whole interval from 1610 to 1870.6 — about 261 years — to be so clearly modified by a secondary term which might become either positive or negative, that this eminent investigator adopted the designation »oscillation« for this secondary term, which was to be added to the mean term of period 11.11 years (Mem. R. A. S., 1877).

Such a secondary oscillation, for modifying the mean sunspot period, is simply a fact of observation shown in the records from the age of *Galileo*; and therefore we are

authorized to use it, yet at the same time we shall endeavor to explain how it arises from the eccentric distribution of the orbits of comets and meteors about Jupiter's orbit.

1. The distribution of comet orbits in *Sivastian's* diagram of 1893 (s. plate 1) resembles the positive and negative character in the sine function, — nearly all the orbits being between longitudes 90° and 270° , while the lack of orbits between 270° through 360° to 90° corresponds to the negative value of the sine between 180° and 360° .

2. Thus by taking the average density for the mean value we may introduce the sine function to represent the density of the orbits; and with the axes arranged as here described, we find that by taking the average density of the orbits for the zero of our function, the variable density of the orbits from 0° through 360° will correspond very accurately to the sine function.

3. So much for the law of distribution of the orbits of comets about the orbit of Jupiter. The question remains what the density of the meteors will be in the different parts of the planetary orbit. Here again we may take σ_0 for the average density of the meteors throughout the planetary orbit, and σ_μ for the average density of the meteors in the part of the orbit being described; the ratio σ_0/σ_μ will vary somewhat as the distance function r/a in the theory of elliptic motion, and thus will not become negative in any part of the orbit. The factor σ_0/σ_μ will give therefore the variable amplitude required.

4. In his memoir of 1877 (Mem. R. A. S., 1877), *Wolf* noticed that the variation in length of the sunspot cycle could properly be regarded as an »oscillation«, and his mean values from all his series of observations 1610–1870, turns out to be:

$$\begin{array}{l} 1610.8 \\ 1734.0 \end{array} \left. \begin{array}{l} \text{Oscillation} \\ \text{Minima, } \Delta\pi = \pm 2.711 \end{array} \right\} (34)$$

$$\begin{array}{l} 1615.5 \\ 1837.7 \end{array} \left. \begin{array}{l} \text{Maxima, } \Delta\pi = \pm 2.706 \\ \text{Minima, } \Delta\pi = \pm 1.54 \end{array} \right\}$$

$$\begin{array}{l} 1745.0 \\ 1867.2 \\ 1750.3 \\ 1870.6 \end{array} \left. \begin{array}{l} \text{Maxima, } \Delta\pi = \pm 2.52 \\ \text{Mean value } \Delta\pi = \pm 2.0575 \end{array} \right\} (35)$$

5. Hence we may take the oscillation or variable part of the period as 2.05 years, and by introducing the law of the sine above described, our formula would become

$$\pi_i = 11.1178 - 2.05(\sigma_0/\sigma_\mu) \sin[\beta - \alpha(t - t_0)] \quad (36)$$

$$= 11.1178 - 2.05(\sigma_0/\sigma_\mu) \sin[177^\circ - 4^\circ 04965(t - t_0)] \quad (37)$$

$$t_0 = 1921 \text{ Aug. } 22.5775$$

where $\beta = 177^\circ =$ heliocentric longitude of Jupiter, Aug. 22, 1921, and the oscillation is adjusted to give four high maxima during the next 44 years.

6. Now it is found by the sunspot records that when the amplitudes of the cycle are large, or the maxima are high, the period is materially shorter than the mean; and when the amplitudes are low, or the maxima are low, the periods are considerably longer than the mean. Thus there is a

tendency to compensation in length for lack of height, as in many other phenomena of nature.

This is an additional reason for the form of the above equations, where the amplitude

$$A_i = \sigma_0 / \sigma_{\mu}. \quad (38)$$

7. The amplitudes A_i are therefore large on the side of the orbit $\lambda = 90^\circ$ to $\lambda = 270^\circ$, as shown in the figure. On this side of Jupiter's orbit the meteors are dense, and the effect of their downpour is therefore intense.

It appears that the combined actions of Jupiter and Saturn, when the phase line representing the appulse with Saturn enters the region of dense orbits, are nearly twenty years preparing for the precipitation of meteors upon the sun, probably in rearranging the meteor paths relatively to the planetary orbits. The effect is thus delayed, as if to let orbital motions develop. The eccentricities of the meteor orbits no doubt are readjusted¹⁾, so that increasing numbers of meteors pass very near the sun.

8. But as the effect, when once developed, runs on for a like period before it is exhausted, we see that the solar phenomena are prolonged after the phase line of Jupiter and Saturn has passed on, and entered into the region of rare meteors. Thus our formula for the oscillation has the form written above, and is justified by experience.

This theory enables us to predict that the sunspot cycle beginning next year will have high maxima, and after 44 years the low maxima will again return. Such is the plain indication of the past 176 years, and we cannot depart from it without doing violence to the observations.

9. In practical mechanics it is well known that if a wheel roll upon an eccentric, such as an elliptical cylinder, with axis through the focus of the ellipse, the centre of gravity of the wheel will oscillate relatively to the axis, in the period of the movement around this centre, as in the theory of planetary motion.

The oscillation of the radius vector is given by the formula for elliptic motion:

$$(r/a) = (1 - e^2) / (1 + e \cos v). \quad (39)$$

And the component of this central displacement, depending on the true anomaly v (which in our problem might increase or decrease the precipitation of meteors upon the sun, owing to the asymmetry of the orbital arrangement) is easily seen to be:

$$(r/a) \sin v = [(1 - e^2) / (1 + e \cos v)] \sin v. \quad (40)$$

The magnitude of these eccentricity effects depends upon the eccentricity of the meteor orbits, (usually very great), and upon the asymmetry of the ensemble of cometary orbits, which appears to be very pronounced. Hence it is not remarkable, but perfectly inevitable that in the sunspot cycle there should exist a double oscillation, — that is, an oscillation variable both in period and amplitude, as in the above formulae (39) and (40), where v and (r/a) oscillate, and the resolved component may reach large proportions, in view of the eccentricities and asymmetry involved.

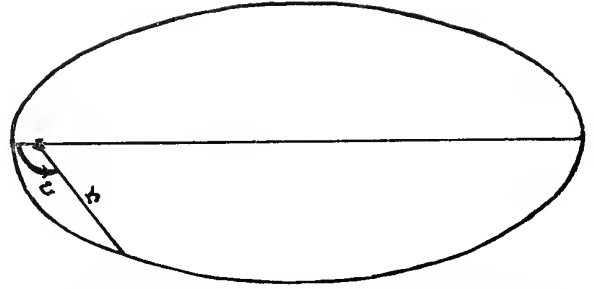


Fig. 8. Illustration of the effect of elliptic motion, which gives the secondary term of the sunspot period depending on $\sin[\beta - \alpha(t - t_0)]$ also a variable amplitude.

Accordingly, if the reasoning here outlined be admissible, it will follow that the sunspot cycle does not depend on two separate periods of $4\sqrt{62} + 6\sqrt{51} = 11.13$ years, as *Newcomb* concluded in his paper »On the Period of the Solar Spots«, *Ap. J.* 13.1, January, 1901. In view of the impossibility of such long periods arising from internal causes, it is difficult to recognize any physical or geometrical ground for the view that our sunspot cycle depends on two shorter periods each several years in length. The only possible physical basis for *Newcomb's* theory would be the downpour of meteors from Jupiter's system, yet having perihelia near the sun; but here the periods would lie between 4.2 and 5.3 years, and thus do not correspond to *Newcomb's* hypothetical component periods.

It remains to point out clearly a series of false premises heretofore very widely current, and which have added to the disorder of our thinking on sunspot phenomena.

1. It has been very usual to ascribe certain meteorological phenomena to the influence of sunspots; but any attempt to prove the truth of this assumption has met with insurmountable difficulty, and added to the confusion of the subject.

2. Below in section 10 we set forth the conclusions which seem to follow from accurate calculation, yet even here it is necessary to be on our guard against misinterpretation of the present theory.

3. For example, the sunspots are now held to be an indirect effect of the repulsive forces forming the corona and of the circulation and readjustment within the solar atmosphere, due to the periodic downpour of meteors precipitated by the actions of Jupiter and Saturn; and thus the spots are comparatively, if not entirely, harmless in their effects upon climatology and other terrestrial weather conditions, — unless the »Magnetic Storms« associated with the spots have some influence not yet recognized. This latter possibility still exists, but we do not elaborate it in the present paper.

4. It is a very different question when we come to consider the seasonal elevation of terrestrial temperature by the downpour of meteors, which appears to occur at intervals of 9.92945 years, — thus giving us with the equatorial expansion of the corona, terrible decennial droughts. If our

¹⁾ Compare *Herschel's* tabulation of the effects of the disturbing force, given below near the end of section 12, for details of these adjustments.

theory be admissible, these droughts do not follow either the sunspot cycle, or Jupiter's orbital motion.

5. In Section 4 above we deal with the shift of the epochs of the several cycles in respect to one another.

(a) The droughts appear to occur about every ten years, yet there is a shifting of their epoch amounting to 51.5 days in 19.8589 years, or about 25.8 days every ten years, so that relatively to our calendar, the seasons of the decennial droughts will circulate around the 12 months of the year in about 140 years.

(b) The drought cycle depending on meteoric downpour and the action of Jupiter and Saturn shifts in respect to the average sunspot cycle in 11.178 years, according to the formula:

$$n_1 : n_3 = 1/11.178 : 1/9.92945 = 360^\circ : x \quad (41)$$

$$x = 405^\circ.267$$

$$x - 360^\circ = 45^\circ.267 \quad (42)$$

(c) Accordingly in about 8 drought cycles, of 9.92945 years each, (about 79 years), the epoch will be displaced through a whole circumference, relatively to the mean sunspot cycle, and the phases may begin over again.

6. It is therefore vain for us to search for a fixed relationship between the drought cycle and the sunspot cycle. No such relationship exists, and the search merely adds to our bewilderment. In the same way we show, in section 4 above, how the epoch of the mean sunspot cycle circulates in respect to Jupiter's sidereal motion in his orbit. Thus it happens that in time the sunspot maxima and minima occur with Jupiter in every conceivable relative position: the shift is $22^\circ.0201$ each Jovian revolution, or $1^\circ.8564$ per annum, thus completing the circulation through 360° in slightly less than 200 years.

7. In view of the considerations here brought to light, it is important on the one hand to avoid hasty deductions which can have no basis in cyclic or dynamical theory, and on the other not to abandon hope of real progress in a subject heretofore unduly confused. If a few firm foundations of fact can be established, and harmonized in our theory of sunspot phenomena, the clearing up of the rest will present less difficulty. Accordingly, in this paper we aim to develop a theory based on carefully ascertained facts, and which may unfold to us the true laws of nature.

8. If the dynamical theory at first sight seems strange, it is only because it is unfamiliar, — not having been thought out by any previous investigator. When its obviousness is once pointed out many will wonder that it had not occurred to some of the eminent astronomers heretofore occupied with the deeper problems of solar physics. The road to new light is not along the familiar beaten paths; and thus I have not hesitated to follow where the light leads.

¹⁾ Since preparing the above discussion, largely as given in my *Researches*, vol. 2, 1910, I have been surprised to find that *Newton*, *Halley* and *Flamsteed*, in 1694, were earnestly occupied with the problem of the acceleration of orbital motion due to increase of the central mass. In *Brewster's Life of Newton*, 1855, vol. 2, p. 170, we have the following letter from *Flamsteed* to *Newton*:

"Yesterday at London, I had a great deal of talk with Mr. *Halley* about the moon's motion. He affirmed the moon's motion to have been swifter in the time of *Albategnius* than at present, and that the cause of it was by reason that the bulk of the planets continually increased. I gave him the hearing, and at last told him that his notion was yours, he answered, in truth you helped him with that."

This passage is very remarkable, and so far as I know it is the earliest discussion of the subject except what is given in *Newton's Principia*. *Flamsteed* says he told *Halley* that the argument was *Newton's*, and *Halley* admitted that *Newton* had helped him with it.

8. Calculation of the Amount of Meteoric Matter falling into the Sun.

In the *Researches on the Evolution of the Stellar Systems*, vol. 2, 1910, p. 320, the writer has shown how to calculate the amount of the meteoric matter falling into the sun, from the observed secular acceleration of the earth's motion, which may be found from researches on total eclipses of the sun noticed by the Greeks.

The formula for the secular acceleration of the earth depending on the increase of the sun's mass is found to be:

$$\Delta L_1^0 = \frac{328714}{328715} \frac{3H}{R_0} \left(1 + \frac{\rho^2}{R_0^2}\right) \frac{k}{a^{3/2}} t^2 \quad (A) \quad (43)$$

where ρ is the mean radius of the earth, $\rho = 6370000000$ mm; R_0 is the radius of the sun, $R_0 = 696098000000$ mm; $k/a^{3/2}$ is the mean motion of the earth in a Julian century $= 129600000''$, the combined mass of the sun and earth being unity; and H is the thickness of the layer of cosmical dust of the mean density of the earth falling upon the sun from regions of celestial space beyond the terrestrial orbit, and thus effecting secular changes in the earth's motion.

Now since

$$1 + \rho^2/R_0^2 = 1.0001$$

which differs but little from unity, we get by the above equation (A)

$$\Delta L_1^0 = 38880000/698098000000 \cdot H t^2 = 0.0005584 H t^2 \quad (B) \quad (44)$$

If we take $H = 1000$ mm, and use the factor 1.0001, we obtain

$$\Delta L_1^0 = 0.5590 t^2 \quad (C) \quad (45)$$

This is the amount of the secular acceleration¹⁾ of the earth's motion, arising from the fall of a layer of matter of the mean density of our globe, 5.5, upon the sun's surface in a Julian century. This falling of matter on the sun produces the principal secular change in the earth's motion.

But there are small changes due to tangential resistance in the curved cylindrical space swept over by the earth in its motion about the sun, which is found to be given by the equation

$$\Delta L_2^0 = 9/2 \cdot (k/a^{3/2}) (h t^2/\rho) = 0.0916 t^2 \quad (D) \quad (46)$$

And, lastly, there is a retardation of the earth's rotation by the downfall of miscellaneous directed cosmical dust upon our globe, and by tidal friction. In the same *Researches*, vol. 2, 1910, pp. 317-321, we have shown that these two secular effects upon the earth's rotation, and affecting the apparent secular motion of the sun, may be reduced to the expression

$$\Delta L_3^0 = 0.0650 t^2 \quad (E) \quad (47)$$

All these three terms are plus, and they lead to an apparent secular acceleration of the sun in a century amounting to:

$$\sum_{i=1}^3 ALi^0 = \begin{Bmatrix} +0.5590 t^2 \\ +0.0916 t^2 \\ +0.0650 t^2 \end{Bmatrix} = +0.7156 t^2 \quad (F) \quad (48)$$

This reasoning is founded on a meteoric layer of dust at the earth's surface of thickness $h = 1$ mm in a century, density $= 5.5$.

The researches of Dr. *P. H. Cowell*, on ancient eclipses, made some 15 years ago, and Dr. *Fotheringham's* recent extension of these researches, as reported in the Monthly Notices, indicate that the probable amount of the earth's secular acceleration may be as great as 1".43 per century, which would correspond to a downfall of meteoric dust upon the sun of thickness 2000 mm, and upon the earth of thickness $h = 2$ mm each of density 5.5, which is not excluded by any known observational phenomenon.

In a letter written to the Royal Society, in 1749, *Euler* expressed the conviction that the motions of the planets are accelerated, and that the earth once was beyond the present orbit of Saturn. This was an early indication of the view developed in recent times that the planets are steadily nearing the sun, chiefly from the secular increase of the sun's mass under the downfall of meteorites upon its surface.

The above calculation is accurate and dependable, and as the researches of *Cowell*, *Fotheringham* and others on ancient eclipses of the sun, show that a secular acceleration of the earth really exists, it is natural to attribute this secular change in the major axis of the earth's orbit mainly to an increase of the sun's mass by the downpour of meteorites upon the surface of the sun.

Quite recently there was a report of a paper to the Roy. Astron. Soc. in the Observatory (May, 1920, p. 178) stating that no cause was known adequate to account for the earth's reported secular acceleration. In reply to this comment (Observatory, Aug., 1920, pp. 287-8) I called attention to calculations like the above, given in my Researches vol. 2, 1910, pp. 319-321; where upon Mr. *Harold Jeffreys* acknowledged the adequacy of the assigned cause for explaining the real secular acceleration of our planet indicated by ancient solar eclipses, particularly that of 128 B.C., total at the Hellespont, and supposed to have been observed by *Hipparchus*.

Accordingly, the cause assigned seems adequate, and founded upon the downpour of meteors upon the sun, which is known to be at work; and thus we are justified in adopting the above explanation as true and sufficient to explain all the known phenomena. It seems therefore justifiable to hold that in this case we have brought to light the true cause of the earth's secular acceleration¹⁾.

This implies an increase in the sun's mass by nearly twice that of the moon in a century, yet as the moon is

only 1:27000000th of the solar mass, such a secular augmentation of the central mass is by no means improbable. The only question remaining therefore is whether the increase of mass goes on uniformly, or by gusts, varying in intensity like the observed showers of rain. It would seem that the downpour cannot possibly be uniform.

It is quite remarkable, as pointed out by Sir *John Herschel* (Outlines, 10th ed., 1869, § 325), that as far back as 1852 (Compt. Rend., Aug. 20, 1852, and AN 806, 833), the celebrated Father *Secchi* made careful measurements of the intensity of the thermal radiation of different parts of the solar surface, finding the heat emitted at the centre of the disc nearly twice that at the borders, and moreover that the equatorial region of the sun is somewhat hotter than the polar regions.

This early result of *Secchi* coincides with the requirements of the meteoric theory, and, as *Secchi's* work always is accurate, it may even be considered as an observational confirmation of the postulated meteoric downpour. What other cause except falling meteorites could heat the equatorial regions to a temperature beyond that of the polar regions? Obviously no other cause is known. And as the sun has a recognized very noticeable equatorial acceleration of the photospheric surface at the equator, over that in higher latitude, where the spot zones appear, we infer that the equatorial acceleration is due to the whirl of cosmical dust continually colliding with the sun's surface, and thus imparting to it an increase of momentum, owing to the meteorites having a direct motion of revolution like those of the planets.

The tangential velocity at the sun's surface would be 617 kms. (cf. AN 3992, p. 136), and thus a small mass, by this great velocity, would contribute considerably to the augmentation of the sun's equatorial momentum. Such secular downpour of meteorites would thus maintain the sun's equatorial acceleration against decay by friction; and also maintain a higher temperature in the region of greatest impact, since probably nine-tenths or more probably 95 percent of the meteors would have direct motion, like the planets, by whose disturbing action they are precipitated upon the sun's disc.

By this reasoning, it will be noticed, we give a direct and simple explanation of the sun's equatorial acceleration, which is accounted for by principles operating also to give the equatorial accelerations observed in Jupiter and Saturn, and confirmed by the direct motion of all their inner satellites, and of Saturn's rings. The vortex of dust here assumed to be precipitating upon the solar surface is therefore definitely known to exist, and to have a direct motion like the acceleration observed in the sun's equatorial regions.

The greater temperature observed at the sun's equator in 1852 by *Secchi*, has therefore the highest probability. But it does not follow that such inequality in temperature would

¹⁾ Several recent British writers persist in the antiquated habit of regarding the apparent secular acceleration of the sun and moon indicated by observation as due chiefly to a retardation of the earth's rotation, holding that only a small part of it is real. This was the view current half a century ago, as in the speculations of *Delanoy* and *Adams*, and in *Thomson* and *Tait's* Treatise on Natural Philosophy, 1873, which underlies *Darwin's* researches on the origin of the moon, 1880.

Such views were justifiable enough before the development of the Capture Theory of Satellites (AN 4341, 4343); but since that development — with definite proof that the sun and planets have acquired their rotations by the collisions of meteors against their equators (AN 4307), and that tidal friction is everywhere vastly overshadowed by the acceleration of rotation due to the downpour of meteors against the surfaces — the persistence of this antiquated mode of reasoning is entirely out of place, as inconsistent with recent progress in cosmogony (cf. Researches on the Evolution of the Stellar Systems, vol. 2, 1910, p. 293-326).

lead to spot development in higher latitudes till the circulatory system somewhat adjusted itself, which probably would be a process of four or five years.

9. All other Explanations of the Earth's Secular Acceleration, except the Downpour of Meteorites upon the Sun, excluded. No Cause within the Sun can give Rise to the Sunspot Cycle, nor produce a Sensible Change in Solar Radiation. Sir *John Herschel's* Cyclonic Theory of Sunspots, 1847, still more Appropriate under the Periodic Conflagration of Meteorites.

It is important to emphasize the indisputable fact that the theory of a considerable downpour of meteorites upon the sun offers the only known explanation of the earth's observed secular acceleration. Thus we have the definite fact of the secular acceleration of the earth's motion, — which is confirmed by the researches of *Cowell, Fotheringham*, and other investigators of ancient solar eclipses, and only one cause adequate to explain this acceleration.

Our solution of the problem of the earth's acceleration is therefore unique: there is one solution and only one, just as in the case of a linear equation with one unknown quantity. Such a problem, with unique solution, is most welcome to the investigator; for not the least uncertainty attaches to the result, and thus the solution illuminates a great secret of nature.

And not only is the unique solution of the secular acceleration of the earth found to be satisfactory mathematically, but also physically. It is especially welcome, as having no inherent improbability; for we know that billions of meteors daily fall upon the earth (cf. observations by the writer in AN 3618, and Researches, vol. 2, 1910, p. 300), and hence we hold that these same bodies must therefore also fall upon the sun, in vastly greater quantities. The sun naturally draws in great quantities of small bodies and thus builds up its mass.

If we come to examine the causes within the sun which could give rise to a periodic disturbance or oscillation of that globe depending upon the equilibrium of gravitational or thermal forces we shall find that any such supposed cause cannot be admitted, owing to the absence of known physical agency adequate to produce and especially to prolong the oscillation. Internal causes at most would explain an oscillation having a period of a few days — but not a sunspot cycle of 11.18 years, which is at least four thousand times the duration of any admissible internal disturbance.

In his well known *Anwendungen der Mechanischen Wärme-Theorie auf kosmologische Probleme*, Leipzig, 1882, *Ritter* investigates the duration of the pulsation of the sun. Taking the ratio of the specific heat of the gas under constant pressure to that under constant volume to have the value $k = 1.41$, as in ordinary biatomic gases, *Ritter* finds (p. 69), that the duration of the double pulsation would be

$$T = 20928 \text{ seconds} = 5.812 \text{ hours} = 0.2422 \text{ day. (49)}$$

If the sphere of gas were expanded to fill Neptune's orbit and the density equally distributed, the time would be 340 years. Thus the only way to get a long period for the thermal oscillation is to have a very expanded mass

subjected to forces which become very feeble, in the reactions of the parts of the mass upon itself. Now, such a very expanded state does not correspond to the sun's actual condition, and is therefore excluded.

If $k = 1.66$, as in monatomic gases, *Ritter's* formula for the sun's double pulsation period would reduce to:

$$T = 2\pi r^{3/2} / ((3k-4)Ng)^{1/2} = 10046^s = 3 \text{ hours, nearly (50)}$$

where $r = 688000000 \text{ m}$; $k = 1.66$, $N = 27.435$ and $g = 9.81 \text{ m}$.

Accordingly, whatever be k , whether the gases be biatomic or monatomic, the duration of the double oscillation at most will be only a few hours. It is not possible to prolong the pulsation into days without adopting assumptions unwarranted by experience.

In 1909 *Moulton* also made a thorough investigation of the pulsation period of the sun (ApJ 29, May, 1909): but although his details were different from those reached by *Ritter*, he concurred in the above conclusion that the sun's pulsation period is very short. It could not be made to exceed a day without doing violence to physical experience, and departing from every indication of probability.

Accordingly, we reach the incontestable conclusion that no oscillation depending on thermal or gravitational causes within the sun could arise of longer duration than a day. The average sunspot cycle is at least 4000 times longer than this theoretical oscillation period; and thus by no physical possibility can the sunspot fluctuation depend on an internal oscillation of the sun's mass.

It follows, therefore, that the long duration of the sunspot cycle compels us to look beyond the sun's interior for the causes which underly this periodic fluctuation in the sun's condition. No thermal or gravitational cause within the sun can possibly generate a cycle of 11.18 years duration, because the forces at work are very powerful, and the period of their reaction on the sun's mass very short, a day or less, and thus less than $1/4000^{\text{th}}$ of the sunspot cycle.

In turning away from the sun's body to the surrounding heavens, for the cause of the sunspot fluctuation, nothing appeals so directly to our common sense as the mutual reactions of Jupiter and Saturn, which come into conjunction-opposition in 9.2945 years, while Jupiter himself revolves in 11.86172 years, and has an unsymmetrical or lopsided distribution of cometary orbits about his sidereal path.

Ever since the researches of *Adams, Leverrier, Schiaparelli, Newton* and *Alexander Herschel* on the November meteors, and other meteoric swarms, and the comets with which they are connected, which researches were carried out in the middle sixties of last century, — we have referred meteors to cometary origin. And thus we must hold that not only are the cometary paths distributed unsymmetrically about Jupiter's orbit, but also the corresponding meteor swarms. Thus with the meteor swarms arranged in a lopsided, or unsymmetrical form, the cycle of the downpour of meteors upon the sun will depend upon Jupiter's sidereal revolution as well as on the conjunction-opposition with Saturn. Accordingly we reach the theory above developed, and every other explanation is excluded.

Sir *John Herschel's* Cyclonic Theory of Sunspots, 1847.

1. Those who read Sir *John Herschel's* lucid account of sunspot distribution in the two zones north and south of the solar equator (Results of Observations at the Cape of Good Hope, 1847, p. 433) cannot fail to be impressed with the argument there adduced for the cyclonic theory of sunspots, afterwards confirmed observationally by *Secchi* and *Faye*, and in recent times often illustrated by our photographs of the sunspots.

»Now, whatever be the physical cause of the spots,« says *Herschel*, »one thing is certain, that they have an intimate connection with the rotation of the sun upon its axis. The absence of spots in the polar regions of the sun, and their confinement to two zones extending to about 35° latitude on either side, with an intermediate equatorial belt much more rarely visited by spots, is a fact notorious in their history, and which at once refers their cause to fluid circulations, modified, if not produced, by that rotation, by reasoning of the very same kind whereby we connect our own system of trade and anti-trade winds with the earth's rotation. Having given any exciting cause for the circulation of the atmospheric fluids from the poles to the equator, and back again, or vice versa, the effect of rotation will necessarily be to modify these currents as our trade winds and monsoons are modified, and to dispose all their meteorological phenomena on a great scale which accompany them as their visible manifestations, in zones parallel to the equator, with a calm equatorial zone interposed. It only remains, therefore,

to inquire whether any such cause of circulation can be found in the economy of the sun, so far as we know and can understand it?«

2. In section 424 *Herschel* continues:

»Recurring now to the question whether any probable or possible cause can be assigned, from what we know of the sun's economy, capable of giving rise to circulatory movements to and from its poles, in the fluids which cover its surface and having at the same time a dependency on its rotation; it may be observed that if any physical difference in the constitution or circumstances of its polar and equatorial regions tend to repress the escape of heat in the one and to favor it in the other of these regions, the effect will be the same as if those regions were unequally heated from without, and all the phenomena of trade winds, mutatis mutandis, must arise.«

3. Here it may be observed that the downfall of meteors upon the sun's equator not only represses the escape of the sun's internal heat, but also adds greatly to the temperature of the surface layer of the photosphere. *Herschel* then proceeds to reason that the sun is surrounded by an atmosphere of considerable thickness, as an aliquot part of the sun's radius, and with the ellipticity of the layers increasing outwardly, in accordance with the known laws of dynamics, (cf. *Laplace*, Méc. Cél., Lib. III, Chap. IV, § 30). The thickness of the atmospheric layers, density for density, must differ between the equator and the poles. He concludes that this elliptical layer about the sun, with increased obstruction to the equatorial radiation, should maintain the equatorial and polar regions at different temperatures, and by the interchange thus produce the spots. If this difference of temperature would be maintained by mere difference of radiation, due to greater thickness in the elliptical layer at the solar equator, how much more certainly would such an effective blanketing of the heat at the equator arise from the downpour of meteors? The blanketing of the equatorial zone is shown to be a fact by the observed acceleration of the earth's motion, made known by the researches on ancient eclipses.

The exchanges of solar atmospheric circulation between equator and poles should be accompanied by vorticose motions, in very full agreement with observation, not only in the case of terrestrial tornadoes, but also of sunspots, which appear to be filled in by the collapse of their sides, the penumbra generally closing in upon the spot and disappearing after it.

4. Such is *Herschel's* cyclonic theory of sunspots. It rests on a very secure dynamical basis, as respects the effects of rotation, but the premise postulating an atmosphere thick enough to constitute a considerable part of the sun's radius, and decreasing in depth towards the poles, is the weak link in the chain of reasoning. For the sun's atmosphere is known to constitute a very thin layer of gases, with the density falling off rapidly as we ascend, (cf. AN 4053), and all internal disturbances dying out rapidly owing to the intensity of the gravitative action as explained in AN 4053.

Zonal obstruction of the sun's radiation therefore would not give rise to long period disturbances in the

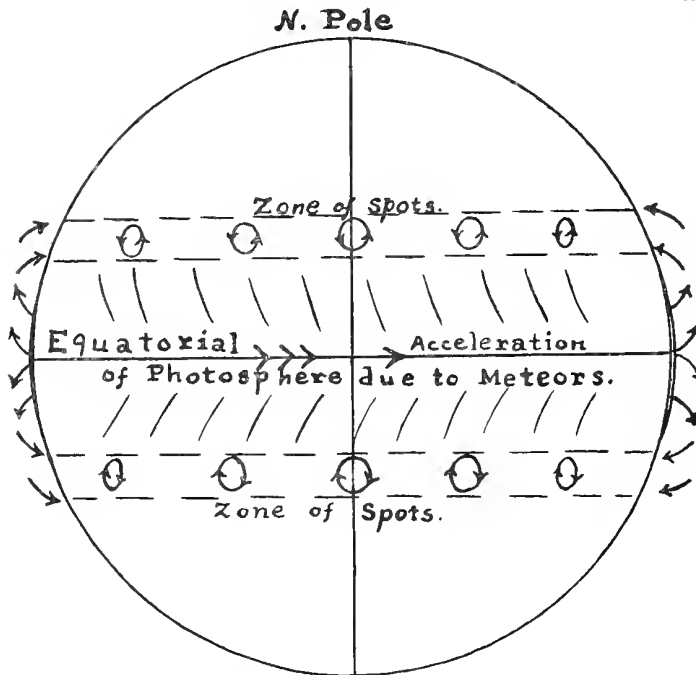


Fig. 9. Illustration of the circulatory system of the sun's photosphere and corona. The meteoric downpour yields the acceleration of spots observed at the equator, while the resulting expulsion of dust, falling in higher heliographic latitude, produces the zones of spots on either side, with *Spoerer's* law of drift in the observed sunspot period.

atmospheric circulation, unless this obstruction was superposed periodically, by an external cause, such as the downpour of meteors, acting at fixed intervals corresponding to the tardy return of the appulse with Jupiter and Saturn, and giving sunspots in cycles of 11 years' duration.

5. *Herschel's* Results at the Cape appeared in 1847, but his theory of sunspots doubtless was prepared some years earlier, and probably without knowledge of *Schwabe's* discovery of a sunspot periodicity in 1843. Thus *Herschel's* cyclonic theory took no account of the problem of periodicity, which is much more difficult to solve than might be supposed at first sight. For several investigators long ago considered the possibility of the sun being an oscillating gaseous globe, but all of them have found the theoretical periods much too short to be compared with the immense 11-year cycle noticed for sunspots (cf. section 6, paragraph 8, α , β , γ above).

10. Somewhat Violent Variations of the Sun's Radiations indicated by World Famines and by other Large Features of Terrestrial Meteorology.

Up to the present time our studies in solar radiation have extended over short periods, in recent times, or else are long range studies based upon the records of snow and ice in Europe during the winters of various years in the period since the Middle Ages. Thus in the Smithsonian Report for 1857, pp. 339-345, there is a very philosophical summary of the evidence for secular changes of the sun's intensity of radiation. Though *Wolf* and other high authorities are cited, no decision is reached, and it is doubtful if the record is continuous enough to enable a modern investigator to pursue the subject to a definite result.

Lord *Kelvin* and some other authorities, including *Fourier*, in his celebrated *Théorie Analytique de la Chaleur*, have considered the distribution of plants and animals in the classic period as affording comparatively good evidence that no considerable change in the sun's radiation has taken place since the Greek and Roman writers *Aristotle*, *Theophrastus* and *Pliny* described the flora and fauna best known 2000 years ago.

It would seem that the records of antiquity exclude the possibility of very great secular change, since the distribution in modern times confirms that recorded by the Greek and Roman naturalists. But up to the present time there are only general indications of the secular constancy of the solar radiation, whilst decennial variations have not been investigated at all, and we can affirm nothing, except that in his recent measurements *Abbot* found the so-called »solar constant« to be 1.93 (small) calories per second, and variable by as much as 5 or even 10 percent within a single week.

That very sensible and comparatively sudden changes do occur from time to time in the sun's radiation is indicated by our common sense, and by the consensus of opinion of mankind. Yet this result heretofore has not found definite scientific expression, chiefly because it was not suspected nor sought for in the larger aspects of terrestrial meteorology.

So long as we look only at the changing multitude of details of climate, in particular countries, and not at the condition of the globe as a whole, we naturally do not suspect violent variations in the sun's radiation.

But the moment we venture to depart from traditional teaching, and begin to think for ourselves, we discover abundant evidence of changes in the solar radiation which are sensible throughout the terrestrial globe. They may even prove fatal, through the effects of unusual heat and drought, to a considerable portion of mankind¹).

We shall therefore examine this question on its merits. No great problem could be more worthy of the meditation of philosophers who aim at the discovery of the laws of the universe.

From Plate Ia, *Sivasian's* Diagram of the Comet Family of Jupiter, 1893, we notice that the next opposition in 1931 along the line $\mathcal{F}_{9/2} S_3$, in Plate Ib, will be in a somewhat sparser region of comet orbits; whilst the conjunction of 1941 will be in heliocentric longitude $\lambda = 57^\circ$, a region much sparser in meteors, according to the indications of the cometary orbits. Hence we should expect the season of 1941 to be considerably less violently hot than 1921, which is a record breaker for violence of temperature, and disastrous droughts in nearly all the leading countries of the world.

The conjunction of 1961 will again become violent, from the downfall of meteors and the development of excessive heat; but in 1981 the effects will be even worse, — being a repetition of the record breaking heat of 1921. Yet the heat will occur in our winter, corresponding to summer in the southern hemisphere, as in 1861, when in fact the conjunction fell on Feb. 20, 1862. And as the southern terrestrial hemisphere is so largely covered with water, the effect of the heat upon the earth may be very much less important than in 1921, when the conjunction occurred in August, with the sun as directly as possible over the land hemisphere of the globe.

In 1802, July 26, there were conditions for great heat development similar to that of 1921. Sir *William Herschel* (*Phil. Trans.* 1801, pp. 265-318) was then studying solar effects upon the earth, and considered the general aspects of terrestrial meteorology to depend largely upon the sun's condition. »The influence of this eminent body« says *Herschel*, p. 265, »on the globe we inhabit, is so great, and so widely diffused, that it becomes almost a duty for us to study the operations which are carried on upon the solar surface«. »A constant observation of the sun with this view (i. e. determining the radiation) and a proper information respecting the general mildness or severity of the seasons, in all parts of the world, may bring this theory to perfection or refute it, if it be not well founded.«

Even today, after the lapse of 120 years, our data are very incomplete, yet may afford some indications of the truth.

¹) In the Literary Digest of Aug. 6, and Aug. 13, 1921, it is stated that no rain has fallen in the wheat belt of Russia, along the Wolga, from Samara to Perm, since March. After a drought of six months vegetation is parched, the ground cracked open to great depths, forest trees dying and millions of people fleeing west in the greatest distress ever known in Russian history.

The summer heat and drought of 1901 was so terrible that in large regions of the Mississippi valley a considerable fraction of the forest trees perished. The season of 1881 was similar, but perhaps less severe all over the globe. In 1901 the normal conjunction was due on Nov. 5, and in 1881 on Dec. 31. These hot waves therefore were nearer the winter season than in the season of 1921, where the conjunction occurred on August 22.

Russia is a very large and uniform country much like the Mississippi valley, and the Russian annals of 1891 make the famine from drought in that year very notable. The drought and heat in America was less pronounced, yet widespread, and severe. The year 1891, it will be noticed, corresponds to the opposition of Jupiter and Saturn $\mathcal{J}_{91} S_1$, Plate 1 b, when a very considerable meteoric downfall may have occurred.

The only observational record in partial conflict with this inference, is some observations by *Frost* at Potsdam in 1892 (cf. AN 3105-6, and *Astronomy & Astrophysics*, I I . 720). Yet it may be observed that *Frost's* work was directed chiefly to the determination of the absorption of the solar atmosphere, at the sun's limb, while the relative temperature of different parts of the disc was a secondary problem, and given only casual attention.

Accordingly, whilst the observations were held to indicate the practical uniformity of the heat radiation from all parts of the solar disc, we must accept such a conclusion with great reserve, both because the observations were insufficient, and because contrary to *Secchi's* careful work of 1852. Moreover, *Frost's* work was done nearly a year after the great Russian drought and famine of 1891, and thus somewhat late for detecting the effect of meteoric downpour a year or more previous to the observations.

A complete search of past records is much beyond the scope of the present paper. We can only say the indications point strongly to the theory here developed, and no contradiction of its conclusions is known, nor do we believe any can be established by the most painstaking and impartial research.

Thus we turn to the season of 1921, and ask ourselves for a summary of the evidence that the heat has been unusual.

1. There has been excessive heat throughout the interior and nearly all parts of the United States, and Canada, as well as Mexico. Recognition of this unusual torridity has found expression in a thousand ways; and it is remarked not only that the heat is great and unabated, but accompanied by conditions which preclude rain — so that great droughts have occurred. Thus the crops in Mexico are officially reported to be greatly injured by the excessive drought. What occurs in the tropical and semitropical land of Mexico, is true of the temperate zone of the interior United States and Canada. The great heat is everywhere associated with excessive and long-continued drought, — so that not only are corn and other crops greatly injured, — the cotton crop being the smallest since 1888 — but even large numbers of forest trees have been killed by the violence of the heat.

2. Up to August 1, England has had a drought of over 100 days, and the most terrible heat ever known. Attempts to produce rain about London by throwing great quantities of explosives high into the air, about the middle of July, failed to produce a drop of moisture. The *Manchester Guardian* of July 1, reports that the iron locks of Monument Bridge in the ship canals at Hull had become bound from the excessive heat, and that pouring water on them had failed to cool them enough to release the locks, so that the ships continue tied up and unable to move.

3. France has had this summer the most terrible heat recorded within half a century, with almost no rain for four or five months; so that all the French rivers are low and stagnant, and the ship canals unable to operate. At Paris the summer has been almost unbearable, so that the forests at Fontainebleau were dried out and have partly perished by accidental fires, while at Bordeaux the heat and drought have been equally bad. No appreciable rain has fallen for five months, and the vineyards, gardens and fields of the country are parched, so that the forests are everywhere endangered.

4. In Spain and Italy the conditions of extreme heat and dryness correspond to those in France. At Milan, Venice, Florence, the heat was extreme, while at Rome the summer heat has been so excessive that for the first time within the memory of the oldest inhabitant, relief against the torrid climate has had to be sought in discarding the coat at all dances given by the Roman aristocracy. The significance of this record is sufficient to show the extreme heat all over Italy.

5. In Germany the summer heat and dryness has been excessive. Reports show that whilst the early grain crops escaped without great injury, the late crops, such as potatoes, will be largely burnt up, and will result in a serious food shortage. The forest trees in the Tiergarten, the largest park in Berlin, are losing their leaves so rapidly under the drought, at the end of July, that already they have to be cleaned up and carried away; whereas such fall of the leaves usually does not occur till late in September or October. Thus even the forests of Germany, Switzerland, Bohemia, Austria, and Hungary have suffered badly before mid-summer. In the burning of a large hotel at Villars, Switzerland, Aug. 1, even the trees took fire and acted as torches for spreading the conflagration, so that they had to be felled by the troops. Such a record of drought throughout Europe is quite unprecedented since exact observations began to be made 300 years ago.

6. When we come to Russia, the story is even more distressing. The immense and fertile valley of the Wolga, from Samara to Perm, is burnt up by the heat, with long-continued and excessive drought; and in the province of Samara, millions of people, without reserves of food, or prospects for this year, have abandoned their homes and are fleeing in the hope of escaping starvation from lack of food and water. So great an exodus of whole peoples has not been known since the Middle Ages. Great alarm is felt in Germany, Poland and Rumania at the Russian migration. A wave of relief was felt in Central Europe when the United

States government took steps to relieve the distress of the fleeing Russian refugees¹⁾).

7. In the case of China, Manchuria, and parts of Siberia, the story is similar. Millions of the Chinese and Northern Mongolians are fleeing from the excessive heat and drought which have laid waste their provinces. No such desperate migration has been observed in China since the Middle Ages; and it is impossible to foresee the extent of the affliction in vast areas, which usually are fertile and prosperous regions, supporting in comfort immense populations of industrious people. In fact reports from Shanghai show that the drought has greatly afflicted not only China, but the whole of Asia.

8. In India the intense heat and drought have done immense damage, and by raising the prices of wheat added to the unrest and agitation of the population which is of such grave concern to the authorities of the British Empire. What is true of India is equally true of Syria and Mesopotamia, and especially Siberia. In Japan, the grain, fruit and the rice fields have suffered greatly from the unusual torrid heat, so that the whole Orient has suffered from the terrible summer heat of 1921. The Literary Digest of Aug. 13 summarizes the Russian famine situation by the alarming heading: »The Third Horseman rides in Russia«.

Accordingly, it appears from this brief survey that whether we consider conditions in California — where prunes and other stone fruit are rotting from the torrid heat reflected from the pit in the core, or any other part of the world — the story is everywhere the same: an unprecedented state of heat and drought, which is not to be explained by local terrestrial conditions, but must be assigned to an elevation in the temperature of the equatorial regions of the sun itself.

There is no other possible explanation of an effect so worldwide²⁾ and so unprecedented in the annals of the human race. And not a single objection to such an explanation can be offered. Science up to the present has no records to contradict an explanation sanctioned by our common sense, and by the consensus of the climatic evidence of the globe.

A sensible secular acceleration of the earth has been recognized as probable for about 15 years; and in 1909 I showed that the fall of meteors upon the sun is the only possible explanation of the secular acceleration of the earth indicated by the researches of astronomers on ancient eclipses of the sun. The amount of matter thus precipitated upon the sun may be double that of our lunar mass in a

¹⁾ A press report from London by Sir *Hall Caine*, Sept. 13, 1921, shows that the above description of the disaster in Russia is not overdrawn. Sir *Hall* quotes the British Prime Minister's statement, made in August, in the House of Commons: »In the Russian famine we are witnessing the most terrible devastation which has afflicted the world for centuries«; and himself goes further, declaring, from the evidence furnished by distinguished Russians of all parties in various countries of Europe, that the calamity is the worst which has afflicted the human family since the Flood.

Only a part of the calamity, however, is due to the drought — the rest being due to the war, revolution and subsequent demoralization. Sir *Hall Caine*, who personally witnessed the famine and cholera in Russia in 1891, exclaims: »Yet what was the famine of 1891 compared with the present catastrophe? My Russian friends tell me the population affected is not fewer than 40000000, and that from 15000000 to 20000000 of these are homeless, friendless and foodless, and are on the roads«. (Note added Sept. 13, 1921).

²⁾ The description of the drought in Russia, *Literary Digest* of Aug. 6, says that the drought is world-wide, and thus not confined to Russia, though there attaining the most disastrous proportions. A press dispatch from Spitzbergen, Aug. 5, 1921, says: »The heat wave at last has struck Lapland and the Polar regions. With the thermometer at 86 degrees (Fahrenheit), the Eskimos have thrown away their fur garments and are organizing bathing parties.«

»For most of the Eskimos, this bath will be the event of a lifetime, perhaps never to be repeated. The game and reindeers are suffering terribly.«

century. The chances are infinity to one that it does not fall steadily, but comes down in gusts, — at the time of the conjunctions and oppositions of Jupiter and Saturn, as we have explained above. Accordingly, the theory here developed accords with all known phenomena, and not a single legitimate objection to it can be raised.

The Physical Cause of the Persistence of Excessive Droughts, as in 1921.

The unprecedented drought of 1921 is of world-wide character, profoundly affecting all the principal nations of the northern terrestrial hemisphere; and thus it is well to inquire into the physical cause of this condition, and its long persistence over the larger part of the terrestrial globe. The cause can not be local, but is evidently general throughout the length and breadth of the earth; yet it depends not on ordinary influences, — but on a hidden physical law of such a kind as not to be suspected by meteorologists, and thus apparently it has escaped detection by investigators.

1. We have seen that there is every reason to believe that the heat of the sun has been suddenly increased by the meteors falling upon that globe, under the combined precipitative actions of Jupiter and Saturn. Let us assume as probable such an increase in the solar radiation; and then consider what will follow. Is there any physical law of the molecular motions of the gases of the atmosphere not heretofore suspected to exist?

2. When the weather is very hot, a very large percentage of the water vapor in the atmosphere, say $1/n^{\text{th}}$ part — where n may equal any number as 3, 4, 5, 6, 7, and so on, — is separated out from the lower layers of the atmosphere and driven to regions of the air higher than usual, by virtue of the great heat and the smaller molecular weight of the water vapor, and its 1.27 times greater molecular velocity.

3. For the air has molecular weight as follows:

Nitrogen	14	parts	3
Oxygen	16		1

Mean molecular wt. = 29.

In the case of water vapor we have for the vapor of H_2O :

Hydrogen	1	parts	2
Oxygen	16		1

Molecular wt. = 18.

4. It thus appears that water vapor is 11 units less heavy than air (29), which is a difference of 38 percent. And as the mean molecular velocity is governed by the molecular weight, according to the formula of Maxwell:

$$\frac{1}{2}m_1 v_1^2 = \frac{1}{2}m_2 v_2^2 \quad (51)$$

or

$$9v_1^2 = (14.5)v_2^2 \quad (52)$$

we find

$$v_1 = \sqrt{(14.5/9)} \cdot v_2 = 1.27 v_2 \quad (53)$$

5. Accordingly, as the molecular velocity of water vapor is 1.27 times that of the air, the water vapor, under intense and continued heat, tends to rise above the air of corresponding temperature and pressure. Hence the water vapor forms a relatively greater part of the upper part of the higher atmosphere, while in the lower atmosphere there is a deficiency of moisture, due to the heat driving out the swifter molecules of water vapor.

6. Now the lower air contains most of the dust particles, which by acting as nuclei of condensation, may develop drops, and give rise to rain. And when the weather is very hot, with the water vapor tending in greater percentage upward, a difficulty arises in the saturation of the atmosphere. Thus the formation of rain is increasingly difficult.

7. Under the great and persistent heat of a drought, upon a large inland area, the water vapor passes more and more to a level relatively free from dust; and even if a lowering of temperature occurred at this height, the droplets, on descending to lower level, would again vaporize, and again ascend to greater height. Hence the cirrus clouds so prevalent in dry seasons!

8. This explanation appears to afford a solution of the increased difficulty in developing rain during prolonged droughts. It has long been a saying that the dryer it gets, the more difficult it is to rain; so that dryness adds to the prolongation of the drought, and the spell is not broken until there is change of temperature and shift of air currents with the season, in the larger world movements of the atmosphere.

9. Accordingly, the present (Aug., 1921) world-wide drought may last till late in the summer or autumn. And all the phenomena would indicate that the abnormal solar radiation had thrown the terrestrial atmospheric elements

out of equilibrium early in the season of 1921. And there seems no possibility of general relief till the whole atmosphere is stirred up by the larger current movements incident to the sun's rapid change in declination, about the autumnal equinox.

10. We have examined many treatises on meteorology¹⁾, and consulted several eminent meteorologists, without finding any record of the above separation process as applied to the lighter vapor of water. It depends on the physical laws of molecular diffusion, and apparently has not been studied in dealing with terrestrial meteorology. The cause at work is definite, and well defined, but would produce a notable effect only under persistent high temperature; and thus the effects would become notable chiefly in the summer with the sun at maximum elevation.

11. If in addition to summer altitude, the radiative power of the sun be increased, as by meteors falling into it and developing an immense equatorial extension of the corona, under the actions of Jupiter and Saturn, then the disturbance of the rainmaking power of the world would be enormous. This cause appears to be adequate to account for the unprecedented drought of 1921; and so far as we know no other cause can be assigned, which is at all adequate to account for so great a disturbance in the normal equilibrium of the terrestrial meteorological elements.

12. It is true that the cause here assigned depends on unequal molecular diffusion; but this is a definite cause operating on an immense scale²⁾, in the gigantic laboratory of the earth's atmosphere, under direct solar radiation. To deny an accumulative effect of such a process is to deny well known physical laws of molecular diffusion. And to ignore the drought as due to unusual causes is to deny the plainest evidence of our senses, and the most authentic reports of the recent extreme desiccation of the larger part of the terrestrial globe.

11. The Observed Periods, Distribution, Nature and Cause of Sunspots.

(i) The sunspot periods found by *Wolf* and later investigators.

In the *Memoirs R. A. S.* 43, 1875, *Wolf* gives the following useful table, to which the later periods have been added from the best available authorities.

¹⁾ Since the above discussion was written I have found that in his *Meteorology*, 1861, (p. 51-52), Sir *John Herschel* takes account of the diffusive power of water vapor which he says is lighter than air in the ratio of 0.6235 to 1. "It is the lightest of all known vapours, and, with exception of hydrogen and ammonia, the lightest of gases. In consequence, as soon as generated, it tends to rise in the air by its buoyancy, and in so doing, carries up with it much of the air with which it is intermixed, disengaging itself no doubt from it, in its upward progress, to become entangled, however, with fresh particles, which again it carries upward, to abandon them for others. In this way, not only is its upward diffusion far more rapid than its horizontal, but in its struggle upwards it tends to produce an ascensional movement in the air itself, and thus to act as a powerful agent in the production of wind."

²⁾ In his *Elements of Meteorology*, 1902, p. 143, Prof. *W. M. Davis* gives a table of pressures, weights of vapor and saturated air:

Temp.	Vapor Pressure mm	Vapor weight cu. met. grams	Sat. Air weight cu. met. kilogr.
-30° C.	0.38	0.44	1.45
0	4.57	4.87	1.30
+30	31.51	30.08	1.15
+40	54.87	50.67	1.11

Davis adds: "It is important to notice that the increase of capacity is much faster at high temperatures than at low temperatures, — which would make the higher air able to hold but a small amount of vapor, owing to its low temperature. Yet as the amount of the upper air is indefinitely great, I do not doubt the escape of water vapor into it, as shown also by the cirrus clouds so prevalent in droughts, yet yielding no rain."

Première Série		Seconde Série					
Minima		Maxima		Minima		Maxima	
1610.8	8.2	1615.5	10.5	1745.0	11.0	1750.3	11.6
1619.0	15.0	1626.0	13.5	1755.2	10.2	1761.5	11.2
1634.0	11.0	1639.5	9.5	1766.5	9.0	1769.7	8.7
1645.0	10.0	1649.0	11.0	1775.5	9.2	1778.4	9.7
1655.0	11.0	1660.0	15.0	1784.7	13.6	1788.1	16.1
1666.0	13.5	1675.0	10.0	1798.3	12.3	1804.2	12.2
1679.5	10.0	1685.0	8.0	1810.6	12.7	1816.4	13.5
1689.5	8.5	1693.0	12.5	1823.3	10.6	1829.9	7.3
1698.0	14.0	1705.5	12.7	1833.9	9.6	1837.2	10.9
1712.0	11.5	1718.2	9.3	1843.5	12.5	1848.1	12.0
1723.5	10.5	1727.5	11.2	1856.0	11.2	1860.1	10.5
1734.0		1738.7		1867.2		1870.6	
11.20 ± 2.11		11.20 ± 2.06		11.11 ± 1.54		10.94 ± 2.52	
± 0.64		± 0.63		± 0.47		± 0.76	

Minima	Diff.	Maxima	Diff.
1878.0	10.8	1870.6	13.2
1889.5	11.5	1883.8	9.2
1901.5	12.0	1893.0	12.0
1912.8	11.3	1905.0	12.6
(1923.0)	(10.2)	1917.6	

It will be seen that the periods vary from 8.0 to 15 or 16 years, and that frequently there are associated together two periods of about 8 years each, 9 years each, or 10 years each, while if we turn to periods longer than the 11.18 year cycle, we frequently find two periods of 15-13, 14-12, 13-11 years, which must be considered very favorable to the Jupiter and Saturn meteoric theory above outlined. Owing to the variation of the meteoric density σ_{μ} in our formulae, we could obtain any desired length by admissible changes in this constant, but we have preferred not to attempt any minute agreement in the present state of this subject.

(ii) The distribution of the sunspots in latitude shows that they do not depend directly on the downpour of meteors. *Spoerer's* law of decreasing latitude explained.

In section 9 above we have cited the cyclonic theory of sunspots developed by Sir *John Herschel*, 1847, and we again invite attention to *Herschel's* reasoning.

The distribution of sunspots, in two chief zones on either side of the equator, as indicated in the following figure, shows that the spots do not depend directly upon the downfall of meteors. The spot development must be an indirect effect; for if they were a direct effect they ought to be more prevalent at the solar equator than anywhere else, which is contrary to observation.

This diagram shows the distribution of 1386 spots, distributed in heliographic latitude as shown on the left. The part of the figure on the right relates to the protuberances, which are seen to be more frequent near the equatorial regions.

It is a leading doctrine of the meteoric theory as here developed that with the downfall of the meteors chiefly at the equator, the increase of heat is developed there.

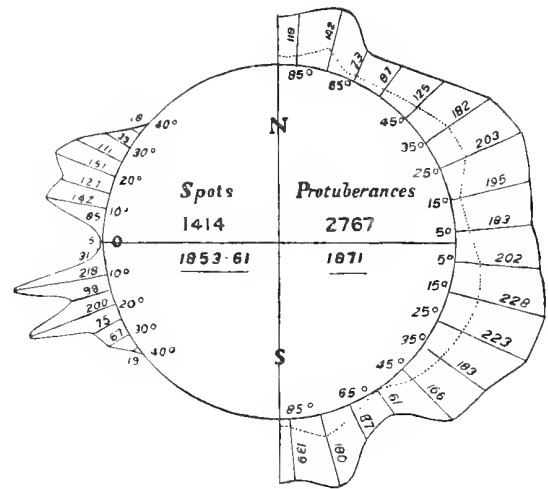


Fig. 11. *Carrington's* illustration of the distribution of sunspots in heliographic latitude.

1. Hence it follows that the equator would be under the greatest radiation pressure, and this should give great prominence to the expulsion of dust for building up the corona in the equatorial regions, about the time of sunspot minimum.

2. It is well known that the corona is most widely extended in the equatorial parts of the sun's disc, usually with a prong on either side of the equator, as if there were some differential pressure towards the poles, yet the outer parts of the corona are arranged as if rendered luminous by the sun's magnetic field with wave-rotations along the lines of force from the poles.

3. If the heated equatorial region be not very wide, this differential effect would arise as the fine dust is carried upward under the increased radiation pressure of the heat and light at the equator.

4. Since the dust driven away from the solar surface thus would have an under drift towards the poles, as it falls back to the sun, there would be two consequences:

(a) As the cooling matter descended on the solar surface in higher latitude, the internal hydrostatic equilibrium of the solar globe would develop a slight surface flow from the higher to the lower latitudes. For if the most matter is expelled under the radiation pressure in the equatorial regions the deficiency naturally would be made good by a surface drift towards the equatorial regions, as in the celebrated law discovered by *Spoerer*.

(b) The corona and protuberances would be relatively prominent in the equatorial regions of the sun, owing to the superior temperature and radiation pressure operative in that region, near sunspot minima, when most of the meteors are falling, and for some time afterwards.

5. *Spoerer's* law is illustrated by the following double figure from *Young's* work on the sun, 1902, p. 157, in which the heavy lines represent *Spoerer's* law of spot drift from higher to lower latitude, while the dotted line represents *Wolf's* sunspot curves, 1855-1880.

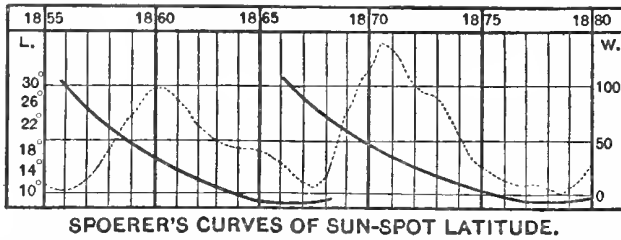


Fig. 12. Illustration of *Spoerer's* law of drift of spots from high to low heliographic latitude with the progress of the sunspot cycle.

6. It will be seen that the drift of the spots in latitude found by *Spoerer* corresponds exactly with the theory above outlined. The theory would thus appear to have vastly increased probability; for *Young* says that *Spoerer's* law is of »great theoretical importance«, yet so far as we are aware no previous explanation of it has been given, while the explanation based on the meteoric downpour appears to be perfect.

(iii) The tendency of the spots to form vortices recognized by *Secchi*, 1857, and *Faye*, 1877; and now explained by the meteoric theory.

As far back as the fifties and sixties of last century *Secchi* was a diligent student of the sun, and at this early date he noticed the tendencies of the spots to have a vortical or whirling motion. *Secchi's* drawings of vortical sunspots found their way into many handbooks of astronomy during the latter half of the 19th century.

At a somewhat later period *Faye* became a great student of the sun, and he too recognized the vortical tendencies in the spots on either side of the solar equator. In a special article on the sun, *Newcomb's* Popular Astronomy, 1878, p. 281, *Faye* says:

»These whirlpools, which tend to equalize the difference of velocity just spoken of (between the equator and higher latitudes), follow the currents of the photosphere in the same way that whirlpools and whirlwinds, tornadoes, and cyclones of our atmosphere follow the upper currents in which they originate. Like these they are descending, as I have proved (against the meteorologists) by a special study of these terrestrial phenomena. They carry down into the depths of the solar mass the cooler materials of the upper layers, formed principally of hydrogen, and thus produce in their centre a decided extinction of light and heat as long as the gyratory movement continues. Finally, the hydrogen set free at the base of the whirlpool becomes reheated at this great depth, and rises up tumultuously around the whirlpool, forming irregular jets which appear above the chromosphere. These jets constitute the protuberances.«

»The whirlpools of the sun, like those on the earth, are of all dimensions, from the scarcely visible pores to the enormous spots which we see from time to time. They have, like those of the earth, a marked tendency first to increase, and then to break up, and thus form a row of spots extending along the same parallel.«

Not very much more than *Faye* has here indicated is known about the vortical character of the spots today, though

the use of photography gives us accurate records which may be preserved for permanent study, and therefore are valuable.

The accompanying Plate 9, 3a gives *Secchi's* drawing of the great rotating spot of April and May, 1858; and by comparison with 3b, a photograph of a solar vortex recently taken at the Mt. Wilson Solar Observatory, under the direction of Prof. *Hale*, we see that the progress during the past 60 years is not so great as many persons have supposed.

By this short sketch it appears that although the detailed study of solar spots has enormously increased of late years, the students of the sun have not been able to enrich science by a general improvement of theory, by which we may understand clearly the scheme of the sun's activity.

Already in 1878 a similar remark was made by *Newcomb*, Popular Astronomy, p. 257, where he says:

»It is remarkable that modern science has shown us more mysteries in the sun than it has explained: so that we find ourselves farther than before from a satisfactory explanation of solar phenomena.«

Such a conclusion still applies, after 43 years of modern photographic effort. For although a vast mass of details have been accumulated, no hope heretofore has been held out of our being able to interpret them into a connected whole. It is for these reasons that we outline the simple consequences of the meteoric theory.

Nearly all the phenomena of the sun are shown to be related, and to follow from a few simple principles. A new theory of the sun's activity is an urgent desideratum of science, but in the present paper we merely sketch briefly the foundations of such a theory.

(iv) Calculation of the heat due to colliding meteors at the solar equator.

It is easy to calculate the heat due to collision of meteors against the solar surface. If m be the mass of the meteor, and v its velocity, which we may take to be the parabolic velocity, the energy of the collision will be:

$$E = \frac{1}{2}mv^2 \quad (54)$$

But to get the exact effect we have to deduct the effect of the sun's rotation, with equatorial velocity $v_0 = 2$ km per sec. Now if we take the parabolic velocity of the colliding meteor to be $v = 617$ km per second (cf. AN 3992, p. 136), the energy imparted to the surface of the sun's equator becomes,

$$E = \frac{1}{2}m(v^2 - v_0^2) = \frac{1}{2}m(380689 - 4). \quad (55)$$

And thus we see at once that a very small mass may impart relatively great energy to the sun's equator, because of the enormous velocity of the impinging meteors. Nearly all the orbits of the meteors have direct motion, like the planets by which they are precipitated, and thus the collisions are predominantly tangential.

We have seen that the sun's mass is about 27 000 000 times that of our moon, yet twice this amount of matter may fall into the sun in a century, or 9 sunspot cycles. Hence in a single sunspot cycle the mass of the meteors may exceed a fifth of the moon's mass, or 1 : 112 500 000th of the sun's mass.

As this is a very small fraction of the sun's mass, we must not expect it to appreciably accelerate the sun's rotation. But it may easily prevent the extinction of the observed acceleration of the outer layer of the equatorial region with surface drift like that known to exist.

As the equator is given an increase of momentum proportional to the meteoric downfall:

$$dH = m/M \cdot (v - v_0) = m/M \cdot (617 - 2) \quad (56)$$

we see that the equatorial layer tends to be accelerated by over 600 times its present velocity. Now as the falling mass m is small, compared to the total solar mass M , the only effect is to accelerate the surface layer.

From our researches on the motion of rivers, we know that the current motion is deepest in the centre, and dies out towards the banks, owing to friction. In the same way we may be sure that the acceleration or current in the solar surface is deepest and swiftest at the equator, and dies down gradually on either side. But in any case the accelerating current at the sun's equator is not of any considerable depth, owing to the tremendous increase of pressure as we descend into the sun (cf. AN 4053, 4104, 4152, and Researches on the Evolution of the Stellar Systems, vol. II, 1910, pp. 451, 541).

Accordingly, as there is elevation of temperature at the solar equator, and greater relative motion, we see that an effort at adjustment always is in progress. The vortical motion of the spots, with clockwise rotation in the southern hemisphere, and counter-clockwise rotation in the northern hemisphere therefore arises, and the explanation of it presents no difficulty of any kind.

The whirling of the spots originates from this differential motion, and the spots themselves arise from the descent of cooler matter, originally driven out from the equatorial heat zone, and tending to fall back in higher latitude. Hence the spots obey *Spoerer's* law of development, as before remarked.

But as the elevation of the sun's temperature at the equator under meteoric downpour is gradual, and the downpour decreases only gradually, the adjustment between the equatorial and polar regions is also gradual and may extend over several years. The heating up is comparatively rapid, but the cooling down more leisurely, while the drift under *Spoerer's* law is slow, owing to the feebleness of the forces under which adjustment is gradually accomplished.

12. The Periodicity of the Coronal Extension naturally conforms to the Sunspot Cycle.

(i) The variability of the coronal extension.

Within the last 40 years it has been established by the observation of total eclipses of the sun, that the corona is not always of the same form and extent, but that the appearance of the corona is variable with the sunspot cycle. It would thus not be difficult to trace the details of the growth of this doctrine since 1870, but we may refer the reader to the account in Miss *Clerke's* History of Astronomy, 1902, pp. 174-176.

The theory of a variable form for the corona has come into use gradually, and has at last been concurred

in by nearly all investigators, though our photographic data in proof of the fact is based upon the scant records of the few moments of total solar eclipses.

The fact appears to be fairly well established that the extent of the corona is variable, with the sunspot cycle. It is found that at the minimum the corona has the longest equatorial extensions, and when the spots are numerous the corona appears to be most fully developed above the spot zones, offering to the eye a rudely quadrilateral contour. On each side of the equator there are great luminous sheaves of the coronal light, curving together, and away from the pole on the outside, as if arranged somewhat along the lines of the sun's magnetic field. No doubt the magnetic field and the electrical forces operating about the sun have a good deal to do in arranging the visibility of the lines of the corona; for the polar streamers are distinct and follow the lines of force of a spherical magnet, as I have proved by careful comparison.

As far back as the Colorado eclipse of 1878, Prof. *Cleveland Abbe* reached the conclusion that the coronal light was due to streams of meteors rushing towards or from perihelion, and many others concur in the view that the solar neighborhood is crowded by swarms of such small bodies.

But since *Arrhenius's* study of the solar corona, Lick Observatory Bulletin, Nr. 58, 1904, it has been held that under light pressure the fine matter of the corona is actually expelled from the sun itself. Some of the fine dust driven away by radiation pressure falls back, while other parts of it float quietly in the coronal field, and still other parts of the dust are so fine as to recede to great distance or escape from the sun's control entirely.

Accordingly, we concur in the general opinion that the coronal matter is supplied from the solar surface by the varying pressure of the sun's radiation; and as the temperature of the equatorial regions exceeds that of the polar regions during the maximum of the meteoric downpour, which corresponds to the minimum of spots, there is a variable state of the corona, depending on the sunspot or meteoric cycle. In the early period, when the meteors are falling thickest, and later as the spots are being generated, the equatorial extension of the corona is notable. In the later periods of spot decline, just before the rapid growth of meteoric downfall, the outline figure of the corona appears to be nearly circular. The details of this theory have yet to be studied, but it conforms generally to the existing state of our knowledge, and is believed to rest on a substantial foundation.

(ii) 'Magnetic storms' or the variation of terrestrial magnetism, with the spot development, due to the magnetic areas about the spots being then most effective.

Ever since *Lamont* (Annalen der Phys. 84.580) discovered the change in the range of magnetic variation in $10\frac{1}{3}$ years, 1851, it has been recognized that the variation in the amplitude of the magnetic declination follows the curve of *Wolf's* sunspot cycle so closely as to show that the two phenomena — sunspots and magnetic storms — are immediately and directly related.

The question is: How and why are the magnetic storms related to spot development? We may answer this as follows:

1. In the Bulletin de la Soc. Astr. de France, Nov., 1918, I have explained the magnetic effect by supposing the surface openings of the spots to allow the underlying magnetic waves to escape more easily than usual. Thus when the surface is agitated by spot development, we have abundance of 'magnetic storms', and vice versa.

2. But if the spots be really due to the descent of cooler matter upon the solar surface as is implied in the theory now set forth — the zones on either side of the equator being fixed by the higher temperature at the equator, with the corresponding expulsion of dust and drift towards the polar regions, with the beginning of spot growth in higher latitude, as indicated by *Spoerer's* law — then it will follow that, as the cooler matter settles upon the photospheric surface, it looks dark by contrast, gives out less heat and light, and thus takes on more fully magnetic properties appropriate to the sun as a whole, because the iron and other vapors in the spots are cooled enough to become magnetic. Under this view the spot areas are simply better radiators of the magnetic waves. At present either view seems admissible, but time must decide which is preferable.

Accordingly, there is no difficulty in accounting for the growth of 'magnetic storms' with the progress of the spot development; yet certain discriminations are needed before we can fix on the theory of the magnetism of spots which is most admissible. This problem is difficult, yet soluble by separating the secondary effects of spot growth from the causes out of which it grows.

In 1877 *Faye* called attention to the frequently observed outbursts of hydrogen protuberances about spots as due to this volatile element being carried down into the nucleus, where the temperature is high, — whence a rapid expansion, with outburst of hydrogen, calcium and other protuberances occur. The details of spot operations thus admit of satisfactory explanation, and it is believed that no serious difficulty remains outstanding. This is remarkable in view of the bewilderment heretofore prevalent, and increasing with the accumulation of the vast masses of solar data now available.

(iii) Remarks on the incompleteness of *Sivaslian's* diagram for the dependence of the sunspot cycle, with coronal fluctuation, on the meteors connected with Jupiter and Saturn.

It is important to inquire why the sunspot cycle depends on a composition between the sidereal revolution of Jupiter in 11.86172 years and the retrograde revolution of the conjunction-opposition line with Saturn in 9.92945 years. The best answer to this inquiry is the preceding diagram of Jupiter's family of comets, made by *A. G. Sivaslian* in 1893.

This diagram is not complete, as was supposed by *Sivaslian*, in 1893, but today has to be supplemented by the orbits of the following comets, and several others.

	Period.
1896 V (Giacobini)	9.00 years
1896 VII (Perrine)	6.67
1905 II (Borrelly)	7.30
1906 IV (Kopff)	6.67
1906 VI (Metcalfe)	6.89

Accordingly, it follows that *Sivaslian's* diagram of 1893 is incomplete, yet the relation of Jupiter to his family of comets is sufficiently developed to show that the comets are quite unsymmetrically distributed about the Jovian orbit. Most of the orbits are gathered together and symmetrically arranged about the Jovian Aphelion, whereas about the perihelion, in longitude 12° , almost no orbits will be found. This remarkable asymmetry of distribution is not yet explained, and it may be a long time before we know the cause on which it depends. But the fact is certain, and moreover, adding a few more orbits to the diagram will not change the distribution of the cometary paths, to alter the dependence on Jupiter's position in his orbit, or the sidereal revolution.

The above figure, Plate 1, will sufficiently illustrate the theory of a meteoric swarm under the action of Jupiter and Saturn. We must suppose Jupiter's orbit everywhere crossed by meteor paths, just as in the well known case of periodic comets. The swarms on the average revolve direct, in a period of from 4.5 to 4.8 years. Saturn's meteoric swarms may have a period of 11.125 years, as imagined by *Schuster*. The reaction of Jupiter upon his own meteors, and upon those connected with Saturn's orbit will give relative impulses in periods of 9.92945 years, and in 11.86172 years respectively, which may be compounded as before described.

All kinds of detailed transformations of the meteor paths will result. We are concerned here only with average effects, and dynamically these evidently will attain maxima in periods depending on combinations of 9.92945 years and 11.86172 years, which latter is the period of Jupiter's sidereal revolution. As Saturn's motion is retrograde relatively to Jupiter, the longer period will be shortened to an intermediate period, between 9.92945 and 11.86172 years, yielding an adjustment in accordance with the principle of least action.

But although the maximum dynamical impulse occurs at conjunctions and oppositions of Jupiter and Saturn, and the outburst of solar heat should then take place, — as in 1881, 1901, 1921, which were years of terrific heat — yet the sunspots, being an indirect effect of the equatorial acceleration and the heat then given to the sun, may not attain maximum prominence till 4 or 5 years have elapsed in the cooling and adjustment of the sun's surface layers in different latitudes. We shall not go into this problem in more detail at present.

We now observe from Plate 1 that if the conjunction of 1921, Aug. 22.57756 G. M. T., the heliocentric longitude $\lambda = 177^\circ$, be taken as the initial position $S_1 \mathcal{F}_1$, in our figures, it will be evident we are now in the densest cluster of comet orbits and meteor swarms. Hence we should expect a tremendous increase recently in the precipitation of meteors upon the sun. Is this the source of the terrible heat developed during the summer of 1921 in all the leading countries of the world? The recent weather reports accord with this view, and thus emphatically support the theory of meteoric downfall; but we have already examined the weather reports somewhat fully in section 10 above, and need not here extend the discussion.

1. Hence it follows that just as the arrangement of the cometary orbits depends on the sidereal revolution of Jupiter, so also the meteor swarms shown to be produced by the disintegration of comets must also depend on the sidereal revolution of this great planet.

2. We do not know the reason for this dependence on the sidereal position, but from the observed positions of the cometary orbits, the fact appears to be certain. Nothing could be more clearly demonstrated by the above diagrams.

3. It is to be noticed also that as Jupiter has very few comet orbits near his perihelion, in longitude 12° , but very many near his aphelion, a presumption exists that a similar law of distribution will hold for the paths of the meteor swarms, which are invisible.

4. Accordingly, when Jupiter is in conjunction with Saturn, near aphelion, Aug. 22, 1921, there ought to be great derangement of the meteor swarm paths by the mutual actions of these two great planets. If this throws down swarms of meteors upon the sun, there ought to be maximum development of heat, as during the terribly hot summer of 1921.

5. The details of the mutual actions of these great planets upon the meteor swarms is sufficiently illustrated by the Plate 1. Jupiter will so shorten the radius vector of the meteors belonging to the Saturnian system as to bring billions of them into collision with the sun; and Saturn will react correspondingly on the Jovian swarms. Hence a maximum downpour of meteors may be expected.

6. The conjunction of 1901-1961 in longitude 297° is less favorably situated for the downpour of meteors, as we see by comparing the two diagrams. The conjunction of 1881-1941 in longitude 57° , will be still less favorably situated; and we should not expect such terrific precipitation of meteors upon the sun at these conjunctions.

These diagrams facilitate the study of the dependence of the meteor swarms upon Jupiter's sidereal revolution. And as the conjunction-opposition line for Jupiter and Saturn revolves retrograde, in a period of 9.92945 years, while Jupiter revolves direct in a period of 11.86172 years, we see that the sunspot cycle, if dependent on the interactions of these great planets, should recur in less than 11.86 years, but have a period greater than 9.93 years.

It is shown in section 4 above that the combination of these periods leads to the average value of 11.18 years, in exact agreement with the observed duration of the sunspot cycle, 11.18 years. Moreover, the periods will be irregular, varying from about 8.0 years to 14.0 years, in the way we have already explained.

It is difficult to imagine a more satisfactory proof than that here adduced of the cause of the sunspot cycle, and its mysterious variation. The exact agreement as to periods here given, and their direct deduction from the retrograding motion of the conjunction-opposition line in respect to Jupiter's sidereal revolution leaves nothing to be desired.

(iv) The previous researches on meteor swarms by Sir *John Herschel*, *Lockyer*, *Schuster* and *Turner* did not lead to the observed period of the sunspot cycle, 11.18 years.

1. It is well known that Sir *John Herschel* was the first to suggest that the sunspot periodicity depends on the downfall of meteors upon the solar surface. (*Outlines of Astronomy*, 10th ed., 1869, Arts. 900-905a). It does not appear that *Herschel* worked out the theory in any considerable detail, but rather adopted Sir *W. Thompson's* theory of meteoric matter falling into the sun to keep up its heat.

When this theory was revived by Sir *Norman Lockyer*, the objection dating from *Herschel's* time, seemed more formidable than at first seemed probable. Meteors falling on the solar surface, for example, would not be distributed with especial density in northern and southern heliographic latitude where the maxima of the spot zones are located. Accordingly, certain fundamental difficulties of the meteoric theory were not overcome by *Herschel* or by *Lockyer*; and the difficulty still persists, unless overcome by the meteoric theory of the present writer, which we believe will be found to be true.

2. In later times the problems of sunspot periodicity has been extensively studied by *Schuster* and *Turner*¹⁾; but in spite of their extensive labors it can hardly be said that any satisfactory conclusion was arrived at.

Newcomb's conclusion that there are two periods of $4.62 + 6.51$ years = 11.13 years is also far from convincing. He holds that these are the uniform cycles underlying the periodic variation of sunspot activity; but is so bewildered by the cause involved that he adds: »Whether the cause of this cycle is to be sought in something external to the sun; or within it . . . , we have at present no way of deciding.»

Now to ascertain what would happen under the mutual action of the two planets, we consider as before first the *Hill-surfaces* about the planet and the sun, and the rotating orbits resulting therefrom. It will not be difficult to infer the shifting of orbits which will take place when the orbits of the particles are not periodic and do not rotate with Jupiter and Saturn, but extend from either planet to perihelia near the sun.

(a) When the orbits are rotating, like the *Hill-surfaces*, which either planet carries about itself and the sun, it is evident that just as the surfaces may be superposed in conjunction or opposition, so also may the orbits be superposed. The outcome of this superposition is indicated by the figures.

(b) We conclude that in conjunction Saturn operates to decrease the perihelion distance of many particles near the sun, mainly within the Jovian control; and likewise, Jupiter operates to increase the perihelion distance of many particles mainly under the control of Saturn. In opposition the perturbative tendencies at work are exactly the reverse, but other particles in paths normal to the planetary line are precipitated upon the sun. If the two planetary orbits were exactly circular the two tendencies would be equal, for equal planetary actions; and the sun will have about equal masses of meteorites precipitated upon its equatorial regions, in periods less than 11.86 years, but greater than 9.93 years.

¹⁾ MN 64.543 (1904).

(c) *Herschel's* table of the effects of the tangential disturbing force.

Direction of Motion in Orbit	Situation in Orbit	Action of Tangential Force	Eccentricity
Indifferent	About Aphelion	Accelerating P	Decreases
»	» »	Retarding P	Increases
»	» »	Accelerating P	Increases
»	» »	Retarding P	Decreases

Effects of the normal disturbing force.

Direction of Motion in Orbit	Situation in Orbit	Action of Normal Force	Eccentricity
Approaching S	Anywhere	Inwards	Increases
» »	»	Outwards	Decreases
Receding from S	»	Inwards	Decreases
» » »	»	Outwards	Increases

3. Passing therefore to the non-periodic orbits traversed by swarms of meteorites, such as may be assumed to have accompanied *Lexell's* comet of 1770, in a period of $5\frac{1}{2}$ years, we conclude:

(a) The Jovian meteorites might revolve in periods varying from 4.2 years to 5.3 years, the average period for such masses in orbits smaller than that of *Lexell's* comet being about 4.76 years, like the periodicity found by *Schuster* for the sunspots, Phil. Trans. 1906.

(b) The meteoric swarms depending on Saturn would revolve in periods varying from about 10.4 years to 11.85 years, — the latter period corresponding to a limit beyond Saturn's orbit. This would give an average period of 11.125 years, as concluded by *Schuster* from observed sunspots by periodogram methods, Phil. Trans. 1906.

(c) *Schuster* also inferred a periodicity of 8.344 years, which corresponds very nearly to the mid-region between Jupiter and Saturn, $a = 8.231$, where many meteor swarms may be collected by an action of Saturn, analogous to that of Jupiter in gathering the asteroids within his orbit.

Thus Saturn's mean distance is 9.54, and Jupiter's 5.20, giving a central zone at 7.37; but the above zone for *Schuster's* periodicity 8.344 years, $2a = 8.231$, is a little further out, 1.31 units within the orbit of Saturn. Now it is known that Thule, one of the remotest asteroids, has a distance 4.30, and thus lies 0.90 unit within Jupiter's orbit. The situation of a zone of cosmical dust 1.3 within the orbit of Saturn may therefore be safely assumed from the established arrangement of the asteroids within Jupiter's orbit. The periodicities found by *Schuster*, namely:

$\frac{1}{3} \cdot 33.375 = 11.125$ years, $2a = 9.972$ units, Saturn = 9.54
 $\frac{1}{4} \cdot 33.375 = 8.344$ » $2a = 8.231$ units
 $\frac{1}{7} \cdot 33.375 = 4.768$ » $2a = 5.664$ units, Jupiter = 5.20
 appear to correspond to the three zones here considered, namely the path of Saturn, the stable zone within Saturn's orbit, and to the orbit of Jupiter.

Now the orbits of Jupiter and Saturn are zones of perturbations, owing to the actions of these planets, while the stable zone between is a catch-basin, for the dust of our system in process of transformation. The particles are hurled into and away from the orbits, and also into and

away from the zone between them. These three zones are therefore the ones which should precipitate meteoric showers onto the sun's equatorial region, to produce the secular acceleration, and disturb the atmosphere so as to form clouds or spots in the readjustment between the equatorial and polar regions.

Summary and Conclusion.

We have seen how difficult, if not impossible, it has been to make progress in solar and stellar physics under the old theories handed down for the last half century. Thus already in 1878 *Newcomb* could say that the sun had developed a great many more problems than the solar physicists had been able to solve. This criticism of solar physics still holds today, in spite of the vast masses of data recently accumulated by photographic and spectroscopic research. The investigators literally are lost in the multitudinous and confusing character of their data: they are in the unfortunate position of the explorer who could not see the forest on account of the trees — because all general and collected view of nature is lost sight of.

The vast importance of the unsolved problems of solar and stellar physics may be inferred from the number of observatories recently devoted to the study of the sun. This number amounts to about one half of the larger observatories of the world. And in 1904 there was founded near Pasadena, California, the Mt. Wilson Solar Observatory of the Carnegie Institution of Washington, on which now at least two million dollars have been spent, and of which the maintainance involves an annual expenditure of \$ 186 000 — three times that of any other large observatory on the globe.

Such expensive equipment, with vast annual outlay of funds for the maintainance of solar and stellar research, is ample testimony to the importance of the problems treated of in this paper. It may be noted that the directors of these observatories have dwelt upon the importance of cooperation, in the solution of leading problems of astrophysics. Accordingly, in view of the simple connected view now obtained of several great problems, which have defied successful treatment for nearly a century, we may anticipate a zealous interest on the part of our solar and astrophysical observatories in extending and improving on the promising researches here outlined.

If the meteoric downpour upon the sun now going on is shown to depend on the perturbative actions of Jupiter and Saturn, the knowledge of sound theory thus gained, when confirmed by time and increased experience, may prove to be a source of safety for vast populations against world-wide drought and famine, such as are now witnessed in Russia and China, and threaten other parts of the continents of Asia, Central and Western Europe, and North America.

About 140 years from now, 2061 A. D., a very similar situation of maximum danger will recur to the inhabitants of the northern terrestrial hemisphere, from the conjunctions of the great planets Jupiter and Saturn in the middle of the summer. But lesser dangers will recur in 1941 and 1961, as explained above, — after which the danger to the northern hemisphere will decrease somewhat, owing to the conjunctions corresponding to the winter season, and thus threatening chiefly the inhabitants of the southern terrestrial hemisphere, which is largely covered by the ocean, and less likely to be adversely affected.

By the extension of these researches it may be possible for future astronomers to foretell these dangers in time to avert world drought disasters to large populations, such as we have witnessed in 1921. If this could be done with confidence, so as to give opportunity in years of plenty to provide for years of famine, incident to drought, millions of people would be saved from suffering and destruction by this humanitarian service of science. Thus in time the researches here outlined may add not a little to the safety and stability of the nations of the earth.

It always is very difficult to be sure that we have correctly connected the details of a great multitude of phenomena in the simplest and most direct way. But as simplicity is a powerful argument for truth, when we come to search for the fundamental laws of nature, the indications are that the meteoric theory here advanced alone meets the modern requirements of solar and cosmical physics. Certainly no simpler theory could be proposed, and it is difficult to imagine any valid objection to explanations which appeal so strongly to our common sense, and to the direct evidence of our senses.

When we consider the sun and the Cepheid, Geminid and Cluster variable stars in their larger aspects, we naturally ask whether the theory advanced will account for the chief phenomena of their observed changes. If so, the more of these phenomena we can bring under the theory, the greater the probability that it is correct.

For in the final confirmation of any new development, it always is a great element of satisfaction to find that the adopted theory is supported by arguments drawn from several independent sources, so that the indications all are mutually accordant.

In the investigation now concluded it appears by the records at hand that as far back as 1917 I became so fully convinced that the sunspot cycle depends upon meteors thrown upon the sun by the combined actions of Jupiter and Saturn, that I then drew up a considerable outline of the dynamical theory of this precipitation of meteors, and

hung certain sketches of it over my desk, to remind me that the subject should be resumed as soon as the new theory of the aether was concluded (June 15, 1921).

Accordingly, early in July, 1921, the work was energetically resumed, and as the summer already was one of unprecedented heat, I became convinced, as stated in a press announcement issued July 8, that an unusual number of meteors had recently fallen upon the sun. This explained the extraordinary summer heat in accordance with a cause known to be at work, from the observed secular acceleration of the earth's motion, as confirmed by the researches of *Cowell* and *Fotheringham* on ancient eclipses.

The ability to calculate the exact length of the mean sunspot cycle from the sidereal revolution of Jupiter (11.86172 years) compounded with retrograde appulse with Saturn (in 9.92945 years) was another very striking proof of the dynamical theory depending on the meteoric downpour under the combined actions of these two great planets, as was also the great sunspot saros in 88.9 years.

But final and absolutely overwhelming proof became possible only on Aug. 19, when I discovered that the form of the sunspot frequency curve was that of the tidal curve of a resisted wave. Such a gravitational and thermal tide at the sun's equator would result from the meteoric downpour, and hence the argument was seen to be absolutely complete; and as each part of the argument supported the other, and thus it hung together consistently as a whole, the result was announced by the cablegram of Aug. 20, to be followed by the cablegram of Aug. 22, when the results had been fully applied to the Cepheid, Geminid and Cluster variables.

Nothing could be simpler or more general than the present theory of the generation of surface tides rushing forward about the equators of the stars, and by the neighboring resistance to this movement, yielding curves of light, corresponding to the tidal curves of resisted waves, as observed in the canals and rivers connected with the oceans covering the terrestrial globe. Thus the tidal theory, — begun by *Newton*, 1686, extended and improved by *Laplace's* use of more rigorous dynamical principles, and made eminently practical by the researches of *Airy* on tides and waves, 1845, — unfolds a penetrating vision of the most stupendous operations of the sidereal universe.

We are enabled to understand the cause of sunspots, by the form of the curve of frequency, where the period is somewhat long, and the movement shows a secondary maximum under the sensible resistance of the equatorial rush by other portions of the photosphere in higher latitude and at greater depth.

To understand the break in the tidal curve of a resisted wave, as applied to the sun and stars, we notice the well known fact that a river flows fastest, with the water at greatest elevation, in the central deeper parts of the channel. Now this central elevation of level corresponds to the equators of the sun and stars; and hence we perceive that as the equatorial current is resisted, the equatorial level of the photosphere readjusts itself, by a revulsion of

the flaming fluid towards the poles, and a secondary oscillation follows, by reaction of the globe upon itself, yielding a flow like the first equatorial accelerated current, but feebler. These simple considerations, verified by recognized facts and experiments in terrestrial hydraulics, show that the tidal curve of a resisted wave gives an exact representation of the currents at the equators of the sun and stars as set in motion by the meteoric downpour.

And we may apply this discovery at once to the body of the Cepheid and Geminid variable stars, in which the light curve has the same form as the curve of sunspot frequency.

In the case of the sunspots we do not observe the variation of the sun's light — though indeed it does actually vary, — but the frequency of the spots, a secondary phenomenon proportional to the variations of the sun's light. Up to the present time our imperfect experimental measurements do not disclose to us the sun's light curve; yet we know from the variable stars that the type of this variation in radiation is similar to that of the Cepheid variables.

Accordingly, in the absence of direct records of the sun's light curve, we may use the curve of spot frequency, which will have the correct form, but a considerable retardation of phase, owing to the fact that the spots are an indirect effect of the downpour of the meteors upon the sun's equatorial belt.

Again, in the case of the Cluster-variables discovered by *Bailey*, we find the periods to be of the order of a half day or less, which is too short an interval to bring about any visible secondary maximum, due to break of the tidal rush under the effect of resistance; and thus *Bailey's* Cluster-variables are practically devoid of sensible secondary maxima in their light curves.

Without the present theory we could not have foreseen the cause of this omission of the secondary maximum; but in the light of it, we see how inevitable the omission is, and how very useful the theory is in dealing with the thousands of stars undergoing regular pulsations of light, though situated in globular clusters so remote that the radiation takes from 7000 to 240000 light-years to reach the earth.

Obviously the regularity of the pulsation is due to the orbital motion of a satellite about the Cluster-variable; yet the downpour of meteors thereby precipitated, chiefly owing to the considerable eccentricity of the satellite orbit, is the direct cause of the rapid increase of the star's light, as shown by the steep ascending slope of the light curve.

These remarks remind one that there is a new »Astronomy of the Invisible«, more general than that made known eighty years ago through *Bessel's* celebrated researches on the proper motions of Sirius and Procyon. The difference between the two developments consists largely in the fact that the tidal movements in the stars will be forever invisible, while the companions of Sirius and Procyon have been optically discovered. Yet as the light curves admit of direct comparison with the sunspot frequency curve and

the tidal curves recorded in our rivers, we see the cause at work as plainly as if it were observed with the telescope.

It is fortunate that we have very perfect frequency curves for the sunspots, and very similar light curves in such stars as η Aquilae. In view of the perfect geometric conformity of the curves with each other and with the tidal curve of resisted wave-motion, it is absolutely impossible to doubt that the cause at work in the two cases is identical. In the case of the sun the orbital motion of Jupiter is slow, and the meteoric downpour therefore somewhat gradual and prolonged; in the case of η Aquilae the period of the meteoric downpour is much shorter, yet long enough for the gravitational and thermal tidal wave at the equator of the star to break, partially subside, and, by reaction, form a distinct secondary maximum.

All these considerations show the exalted nature of the tidal theory as a means of future discovery. The applications of the theory in the terrestrial phenomena of the oceanic tides heretofore made by *Newton*, *Laplace* and *Airy* are small compared to those which will be made in the immensity of space. By the study of the associated gravitational and thermal pulsations, — visible through the fluctuations of starlight in the globular clusters and other remote objects of the sidereal universe, — we have a means of exploration of transcendent interest to the geometer and natural philosopher.

Here are sidereal systems of the highest order, composed of many thousands of giant stars, yet removed from us by perhaps a quarter of a million light-years, and thus by perspective condensed into a very small angular space on the back ground of the heavens, while from the mere effect of this distance these giant stars are so faint as to appear on our photographic plates as extremely delicate points of light. Nevertheless their starlight is found to undergo regular periodic fluctuations which admit of accurate measurement.

From the light curves thus defined, the geometer perceives that the gravitational and thermal oscillations going on in these remote sidereal systems, though forever beyond the range of direct telescopic exploration, are undeniably similar to the tidal oscillations familiar to *Newton*, *Laplace*, *Airy* and *Darwin* in the oceans and rivers of our terrestrial globe, and duly recorded since the age of *Galileo* in the curves of sunspots investigated by *Schwabe*, *Wolf*, *Spoerer*, *Faye*, *Newcomb* and other astronomers.

The possibilities opened up by these unexpected but verified lines of research are as gratifying as they are limitless, and seem to me beyond mortals wonderful! They present to us an impressive picture of the continuity and unbroken order of nature; and again emphasize *Newton's* doctrine that the laws found to hold true upon the earth are to be extended to the heavens and applied to the solar system and sidereal systems throughout the immensity of space.

In the author's paper on the Dynamical Theory of the Globular Clusters etc., (*Proc. Am. Philos. Soc.*, 1912), it is pointed out that the globular clusters have been built up by the downpour of meteoric matter upon the component stars. Thus the prediction made nine years ago is now proved by some of the most impressive phenomena yet brought to light

in the sidereal systems of high order first studied by Sir *William Herschel*.

For over forty years the explorations of this unrivaled man made known the immensity and profundity of the star-depths. He wondered especially at the nature of the globular clusters, scattered along the path of the clustering stream of the Milky Way; and did not fail to notice that the symmetrical accumulation of brightness, increasing to a perfect blaze of starlight towards the centre, is a proof of the globular form of these dense masses of stars.

To the wonders perceived by *Herschel*, *Bailey* has added the amazing discovery of hundreds of variables in the interior of the globular clusters; and *Shapley* has recently supplemented the record with a systematic determination of the distances of these splendid systems.

It was justly pointed out by *Fourier*, in his historical eulogy on the author of the *Mécanique Céleste* (June 15, 1829), that the successors of *Herschel* and *Laplace* would witness the accomplishment of the great phenomena whose laws these celebrated astronomers discovered. At remote epochs the spectacle of the heavens will be changed, yet nothing can diminish the glory of the inventor who alone is able to assign the cause of natural phenomena.

If therefore we are able to assign to resisted wave action the wonderful periodic fluctuations of the starlight of the individual variables noticed in *Herschel's* glorious globular clusters, we shall bring to light a geometrical law which will verify the prediction of *Fourier*, whose rigorous analysis, involving sextuple integration between infinite limits, alone is adequate to deal with the general theory of wave motion.

It is a most impressive fact that the present theory explains:

1. The sun's equatorial acceleration, and the preservation of this acceleration from age to age.
2. The periodicity of the corona, with its great equatorial extension near the time of sunspot minimum, when the principal gust of the meteoric downpour occurs.
3. *Spoerer's* law of progress for spot distribution, the development beginning in high heliographic latitude and moving towards the equator with the advance of the sunspot cycle.
4. The mean period of the sunspot cycle, in 11.178 years, which can be calculated more accurately from the motions of Jupiter and Saturn than it can be found by the direct observation of spots after records extending over 311 years, from their discovery by *Galileo*, in 1610.
5. The form of the curve of frequency of sunspots, which by comparison with the curves in *Airy's* great treatise

On Tides and Waves, 1845, is shown to be identical with that of the tidal curve of a resisted wave.

6. The light curves of thousands of variable stars, which are explained also by the theory of gravitational and thermal waves under resistance.

7. The secondary maxima in the curve of frequency of sunspots and in the light curves of variable stars, which heretofore have proved utterly bewildering to astronomers and geometers.

8. The connection between the sunspot frequency curve and the light curves of variable stars — both types of curves being geometrically identical and depending on the modified oscillation incident to the resistance to wave motion.

9. The secular acceleration of the earth established by researches on ancient eclipses, showing that the sun's mass increases, and thus confirming the theory of a meteoric downpour.

10. The direction of the rotations of the spots in the zones north and south of the solar equator.

11. The Great Saros or theoretical restitution period in 88.9 years, which is confirmed by the sunspot curves of *Wolf* and other investigators during the past 176 years.

12. World-wide meteorological disturbances, with decennial droughts due to the increase of solar radiation, as witnessed for the greater part of a century and especially illustrated by the excessive heat experienced in all countries during the summer of 1921.

In the *New Theory of the Aether*, recently published, we have referred all the physical forces of the universe to wave-action in the aether. And now we find that free and forced waves in matter, fluid and thermal oscillations in the photospheres of the stars, depending on the gravitational action of other bodies, play a much greater part in the phenomena of the universe than we have heretofore believed. Accordingly, this general wave-theory of the universe follows from the original development begun by *Newton*, for the tides of our sea and the sound waves of the air, and cannot fail to give us the deepest insight into the laws of nature.

The prompt and generous recognition lent to this investigation by several friends deserves the author's grateful remembrance, and thus he mentions especially Captain *Edward L. Beach*, U. S. N., Commandant at Mare Island, and Commander *L. M. Cox*, U. S. N., the eminent civil engineer; besides his associates Mr. *L. Tiernan*, Mr. *W. S. Trankle*, and above all Mrs. *See*, as contributing to the early completion of these researches.

Starlight on Loutre, Montgomery City, Missouri, 1921 Aug. 22.

T. J. J. See.

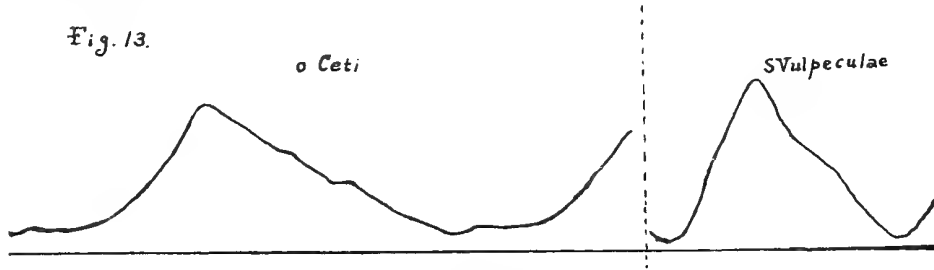
Discovery of the Cause of the Mira Variable Stars.

Postscript:

1. The day I mailed this paper to the editor, (Sept. 21, 1921) I received AN 5116 and 5117, containing important articles on variable stars by *Heiskanen* and *Ludendorff*. *Heiskanen* gives a well defined curve of S Vulpeculae, AN 5116, p. 63, which shows clearly that this star has a rapid rise, followed by a much more gradual decline, with distinct secondary maximum, and therefore depends on the

same cause as the Cepheid-variables, namely: meteoric showers on the photosphere, undergoing gravitation and thermal oscillations like the tidal curve of a resisted wave.

2. I had neglected to treat of the Mira stars, because I had not seen a good light curve of Omicron Ceti. Here it is, and the record tells the same story as in the case of S Vulpeculae, namely: gravitation and thermal oscillations following the tidal curve of a resisted wave.



The rapid rise to maximum, more gradual decline to minimum, with distinct secondary maximum about half way along the downward slope assimilates Mira not only to δ Cephei, as *Ludendorff* imagines, but also to the curve of the sunspot frequency much more distinctly than we have heretofore dared to believe.

3. No doubt the Mira stars generally will be found to have similar connections and to depend on the very cause here outlined. It is no objection to the meteoric theory that the periods, and amplitudes are somewhat variable, in the Mira stars; because we see above what happens in the case of our sun, with an »oscillation« in the spot period, and similar causes no doubt will operate among the stars generally. When the periods are very regular, as in some of the cluster variables, the orbital motion of the companion is so powerful as to be the chief influence, and an »oscillation« in the period is eliminated.

4. It is well known that the spectral changes of Mira show atmospheric ignition, as if the absorbing gases of the photosphere were aflame from the downpour of meteors, with internal disturbances incident to this conflagration and tidal rush of the flaming fluid. The star does not exhibit

orbital motion, but neither does our sun, owing to the smallness of the masses of Jupiter and Saturn. Thus Mira probably has comparatively small bodies active in precipitating the meteors, and the combinations of two or more of them will explain the »oscillations« in the period as well as the ignition of the star's photosphere.

5. It is interesting to note that the earliest observations of Mira by *David Fabricius* at Resterhave, East Frisia, were made in August, 1596, and thus just 325 years ago. This seems a long period to wait for an explanation of any celestial phenomenon, yet if the explanation is valid, the compensation is to be found in the establishment of a true law of nature.

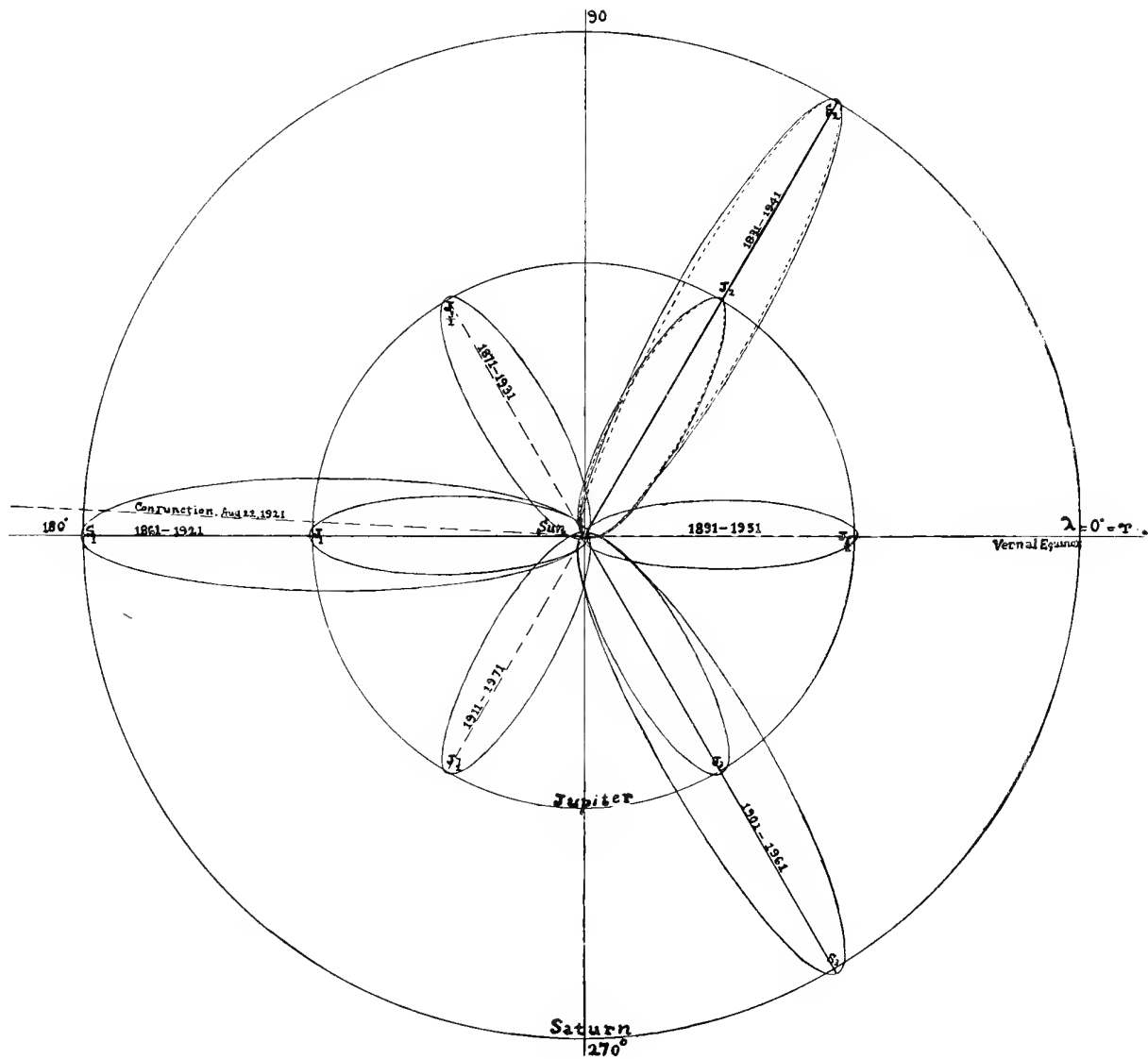
6. Finally, attention may be called to the desirability of giving the light curves in the form shown above, Figure 13. In the absence of this form, the physical meaning of the fluctuation of the star light is difficult to recognize; but with this unsymmetrical oscillation and secondary maximum exhibited to the eye, the tidal curve of a resisted wave becomes as obvious as in the light curve of δ Cephei, or the curve of sunspot frequency.

1921 Sept. 22.

T. F. F. See.



Sunspots and their Periodicity.



b

Diagram illustrating the conjunctions and oppositions of Jupiter and Saturn, with the years when abnormal terrestrial heat and drought may be expected, from the precipitation of meteors upon the sun.

T. J. J. See. Cause of the Sunspots and their Periodicity.

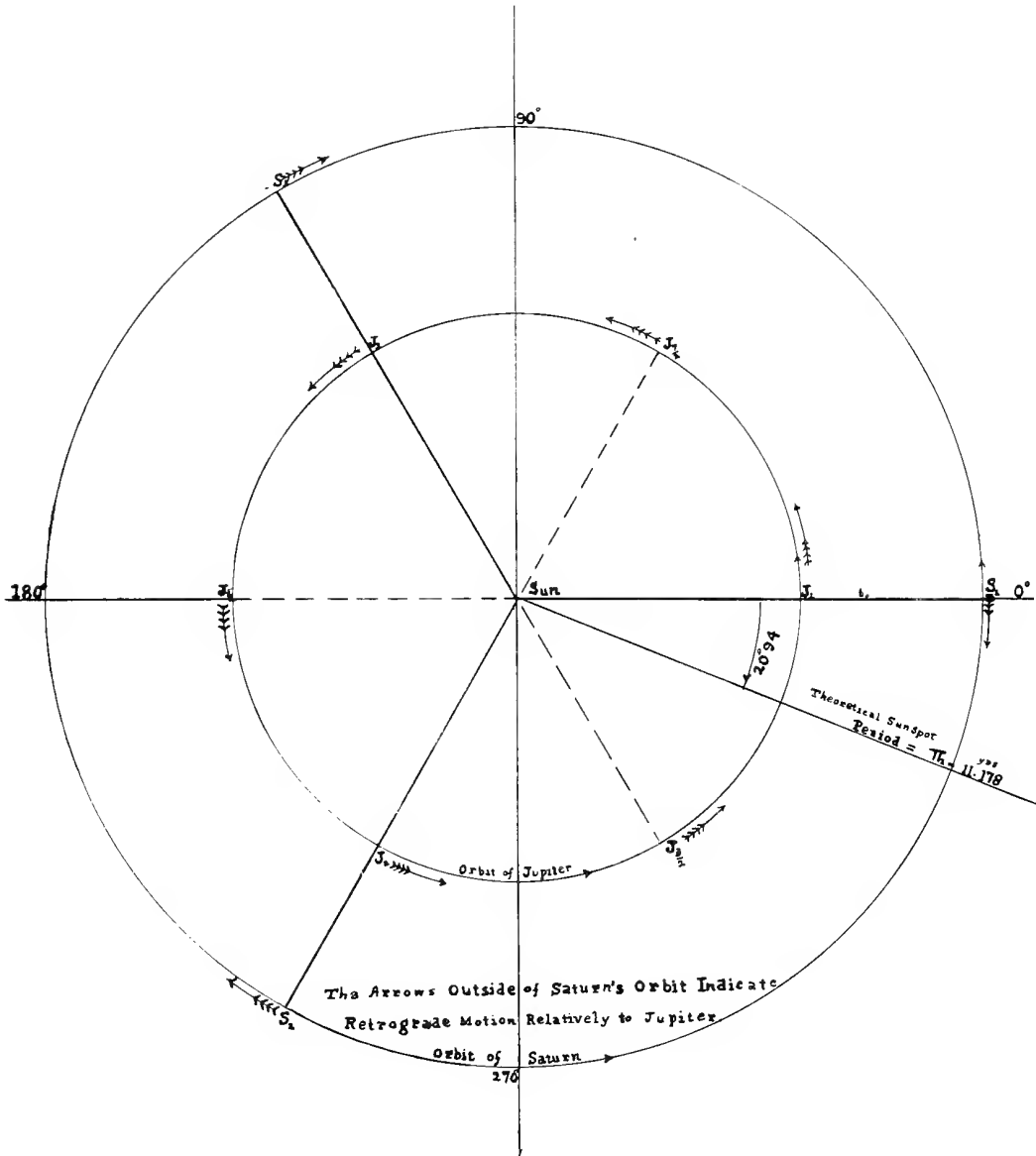
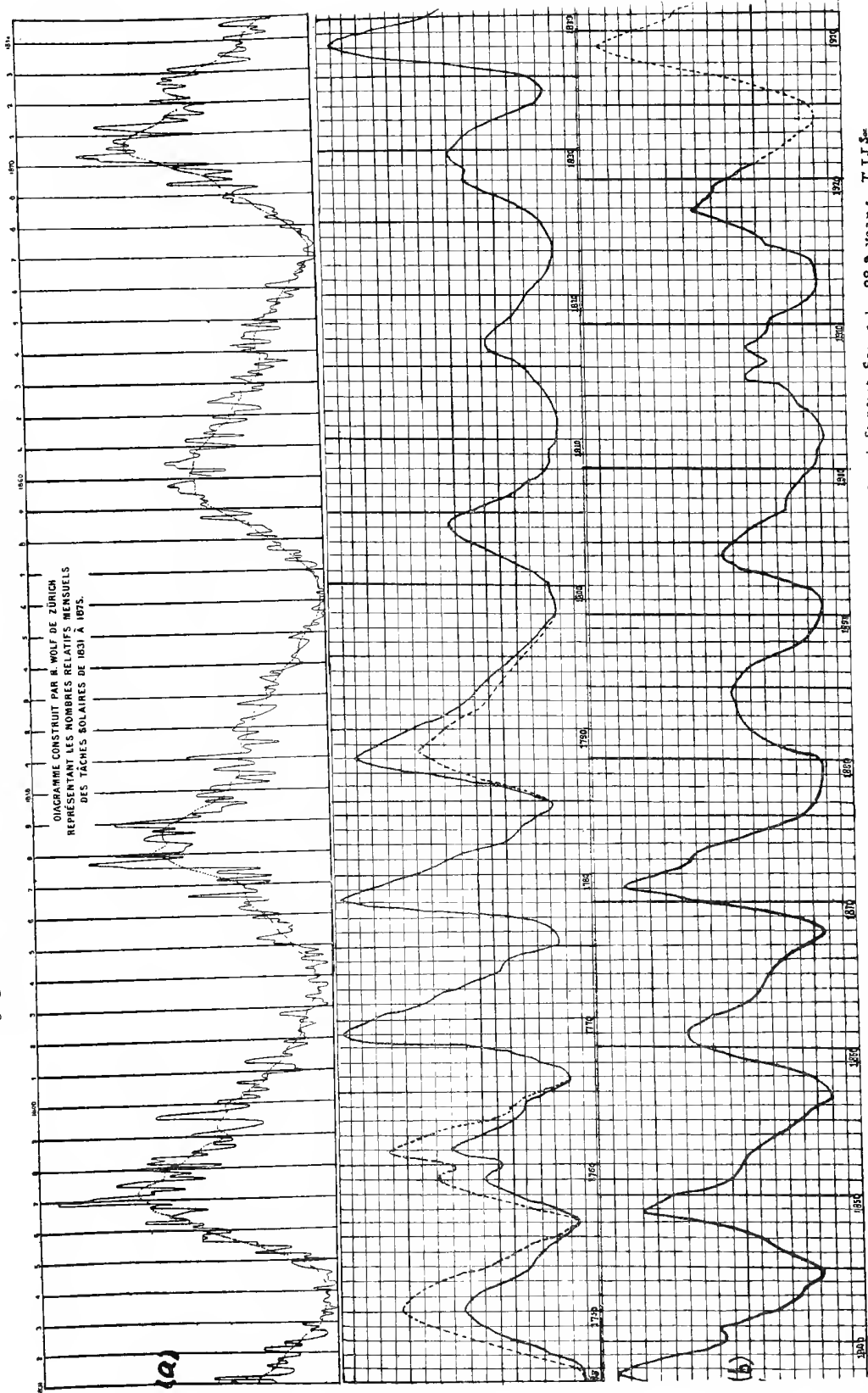
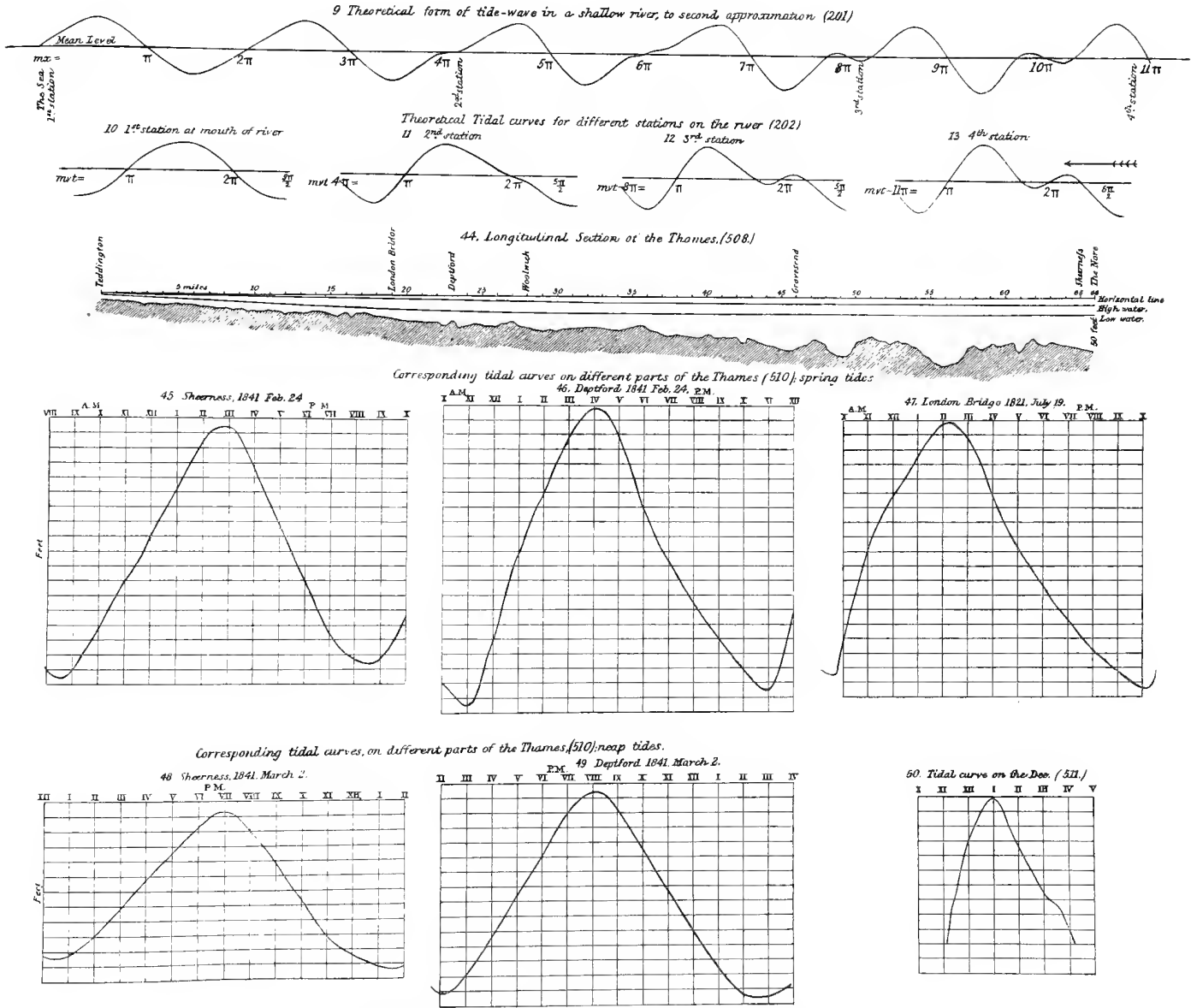


Diagram illustrating the relative motion of Jupiter and Saturn, and the theoretical method for calculating the sunspot period of 11.178 years.

T. J. J. Sec. Cause of the Sunspots and their Periodicity.



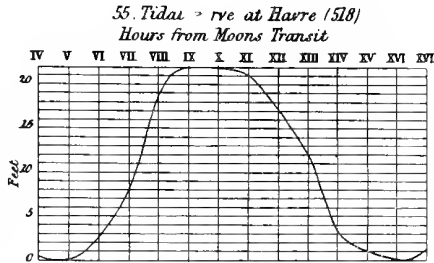
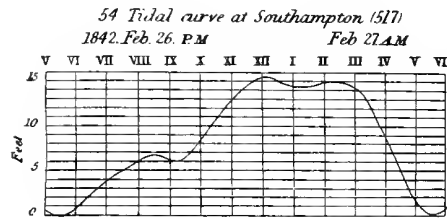
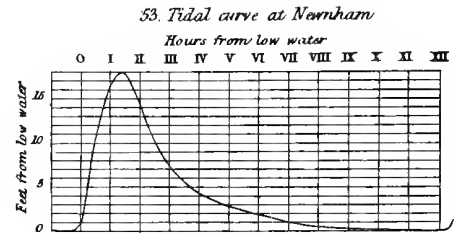
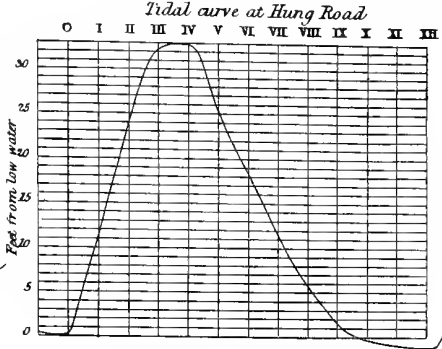
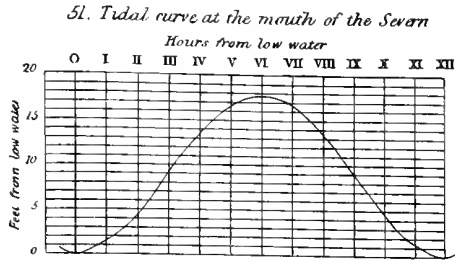
T. J. J. See. Cause of the Sunspots and their Periodicity.



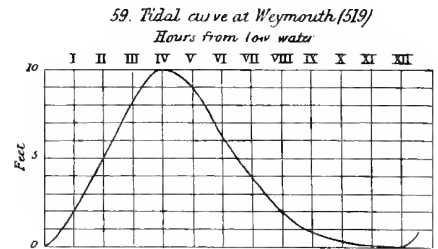
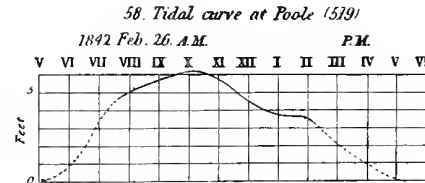
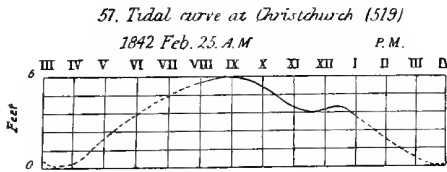
Airy's illustrations of the effects of resistance upon the motion of waves, and of the tide waves in the river Thames.

T. J. J. See. Cause of the Sunspots and their Periodicity.

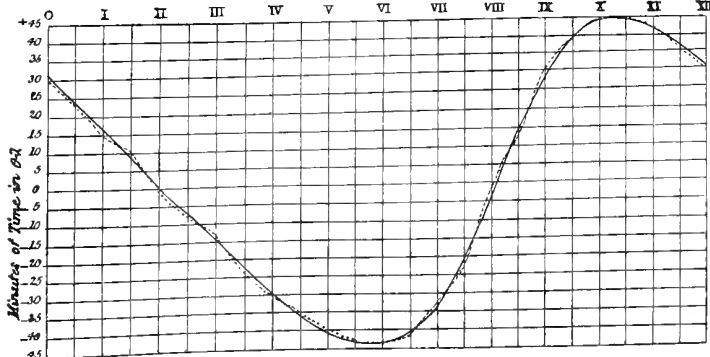
Corresponding tidal curves on different parts of the Severn (515)



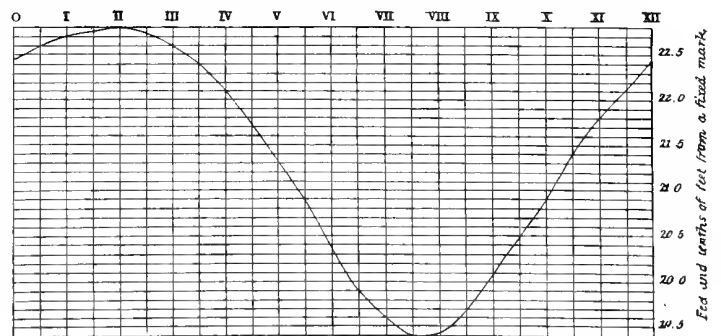
56. Chart of the coast from Weymouth to Portsmouth (519)



61. Semimenstrual inequality of Time of High Water ($\theta-\lambda$) for London (547)
Computed Observed
Solar Hours of Moon's Transit

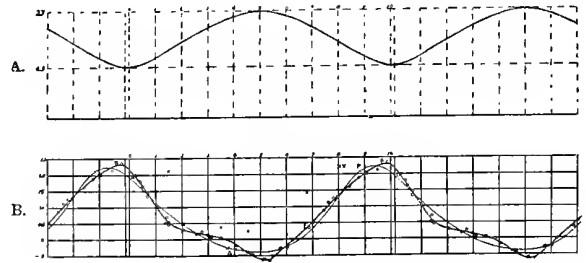
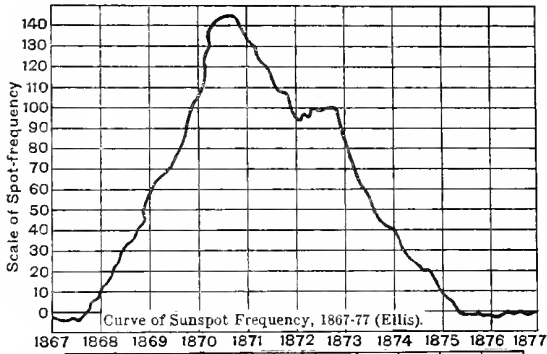
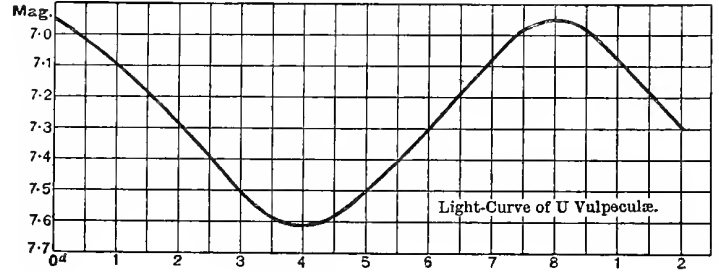
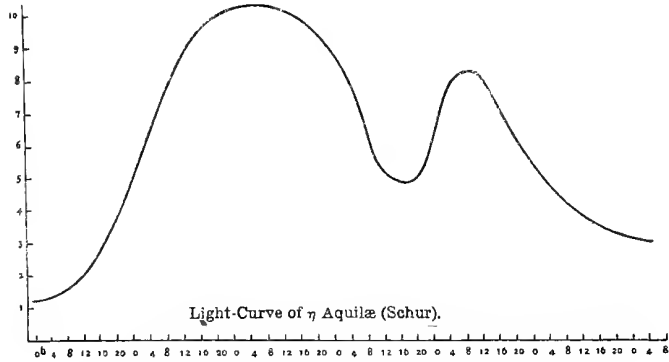


62. Observed semimenstrual inequality of Height of High Water for London (549)
Solar Hours of Moon's Transit

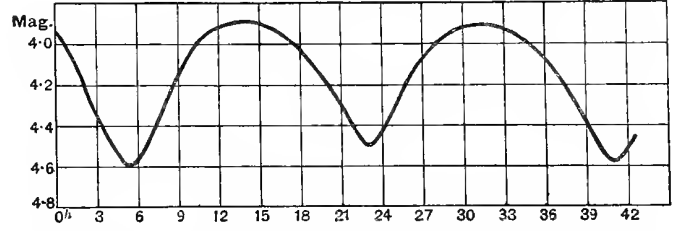
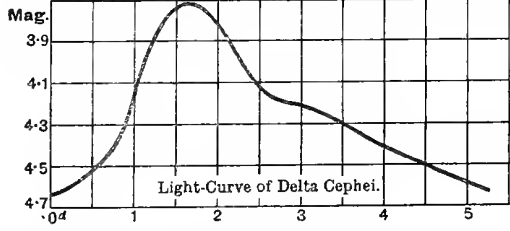


Airy's illustrations of the tidal curves in the river Severn, and near the Isle of Wight.

T. J. J. See. Cause of the Sunspots and their Periodicity.



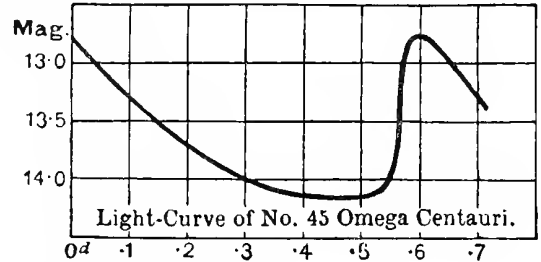
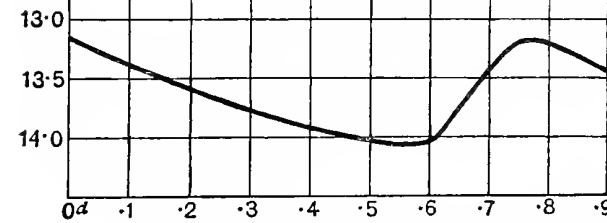
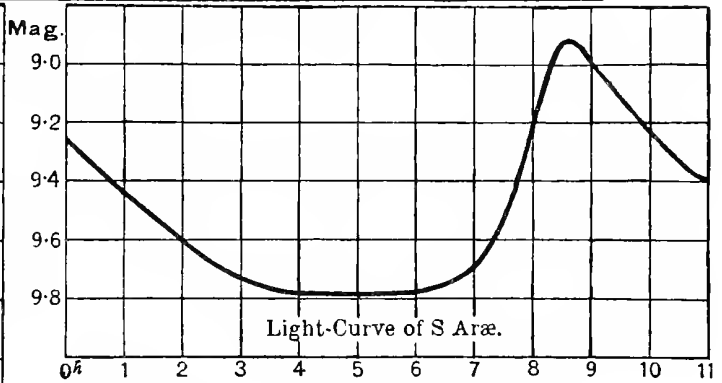
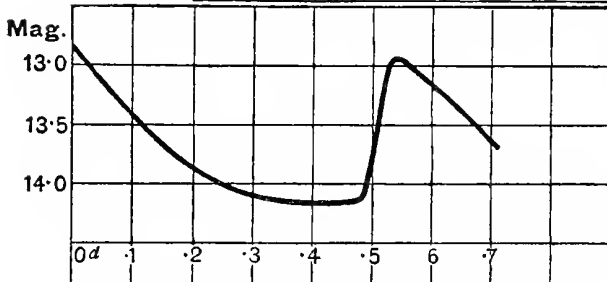
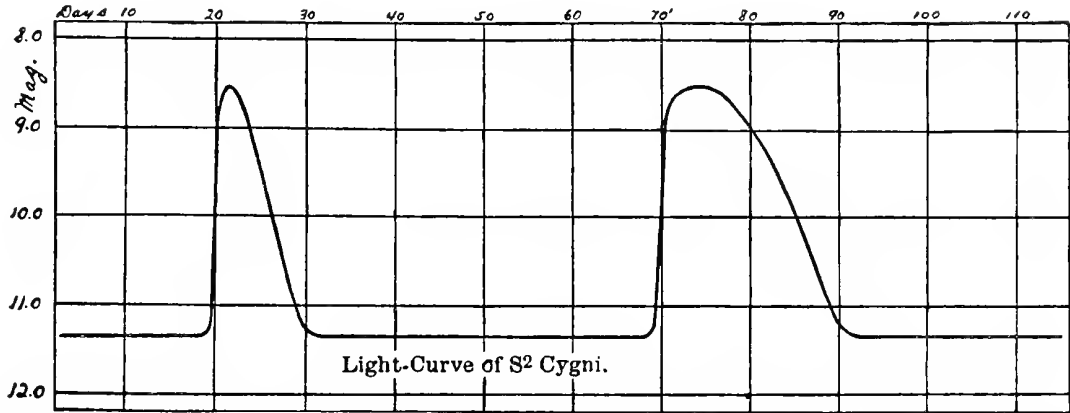
Curves representing the Variations (A) in Light, (B) in Radial Velocity of ζ Geminorum (Campbell).



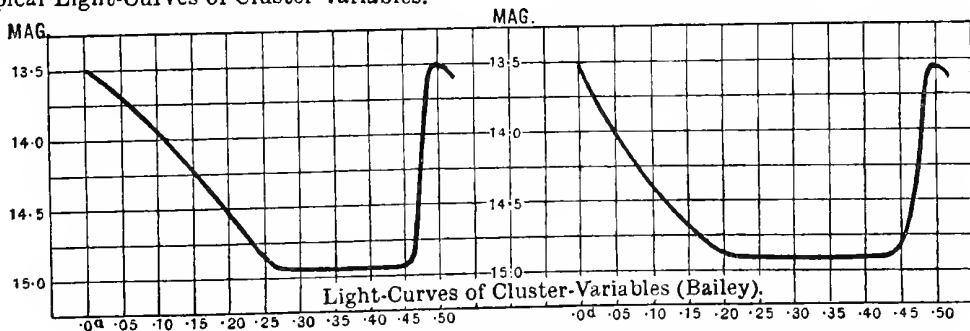
a. Illustrations of the light curves of the variable stars η Aquilæ and δ Cephei, in comparison with the sunspot curve (1867-77) as found by Ellis of the Royal Observatory, Greenwich.

b. Light curves of the Geminid-variables U Vulpeculæ, ζ Geminorum, and V Puppis.

T. J. J. See. Cause of the Sunspots and their Periodicity.



Typical Light-Curve of Cluster Variables.



Light curves of Cluster-variables, and of SS Cygni, and S Arae, which are essentially similar.

T. J. J. See. Cause of the Sunspots and their Periodicity.

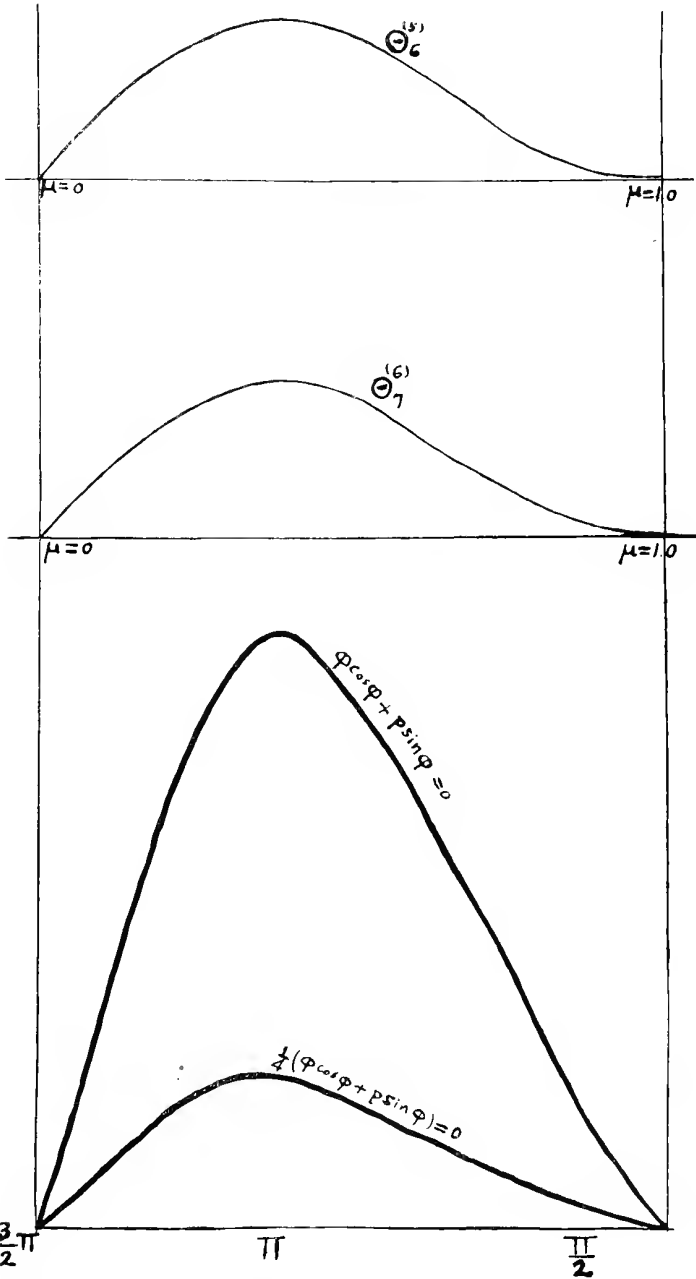


Fig. 6. Illustrations of the types of curves examined by the author before adopting the tidal curve of a resisted wave as representing the order of nature.

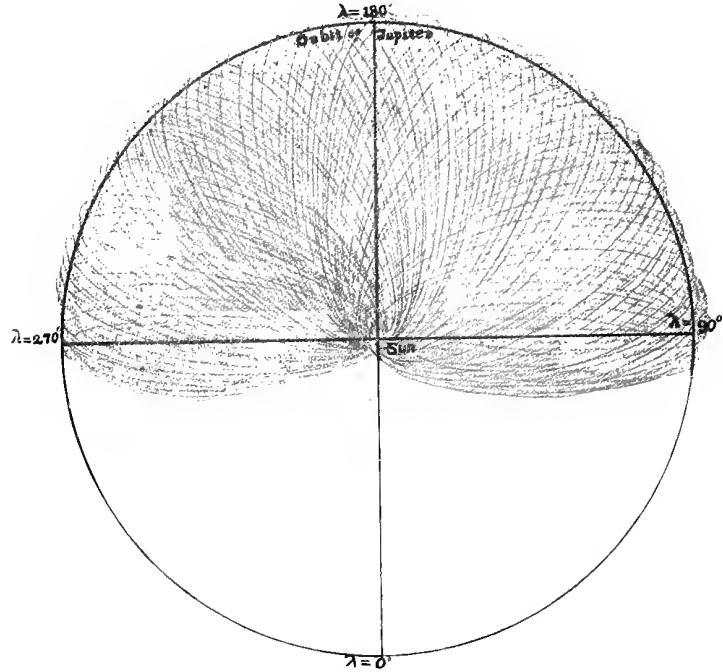


Fig. 7. Illustration of the unsymmetrical distribution of comet orbits and meteoric swarms about Jupiter's orbit, which authorizes the use of the term $\Delta\pi(\sigma_0/\sigma_1)\sin[\beta-\alpha(t-t_0)]$ in the formula for the sunspot periodicity.

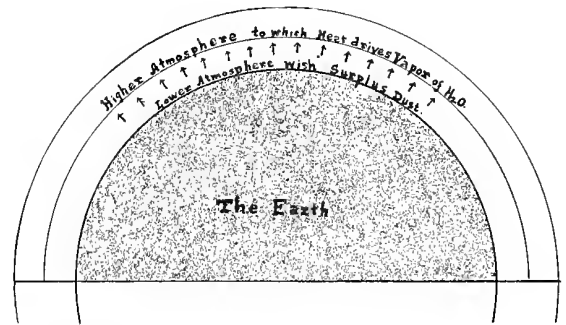
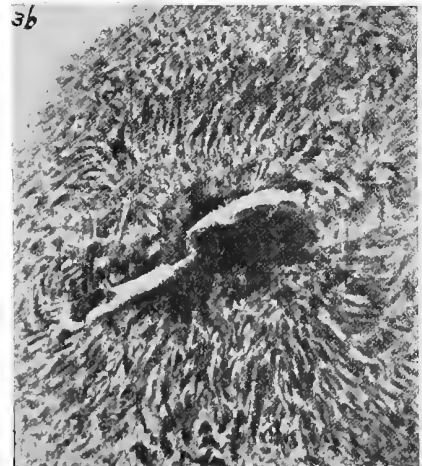
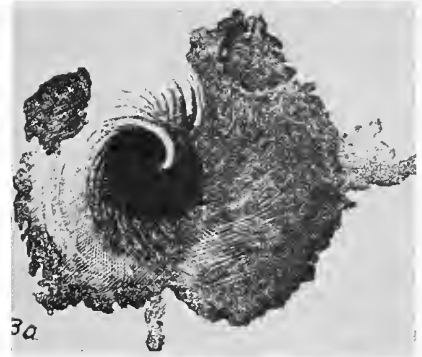
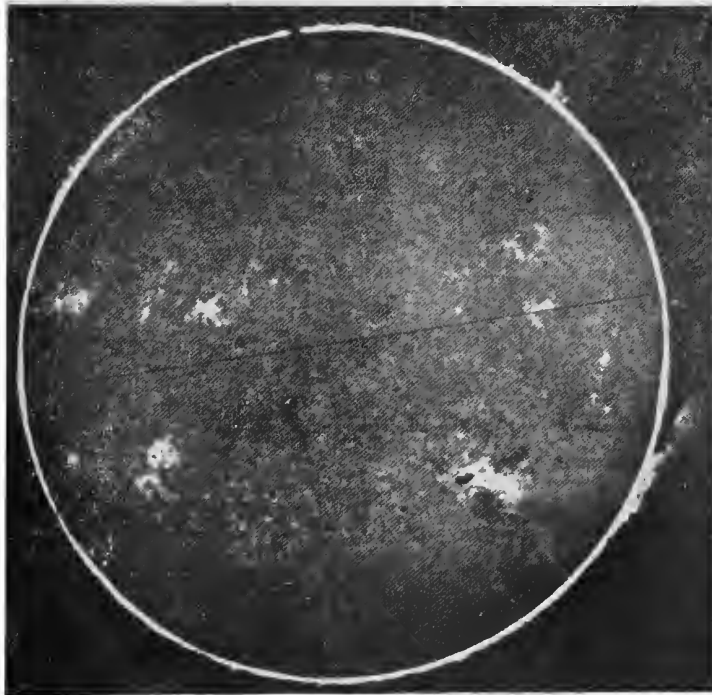
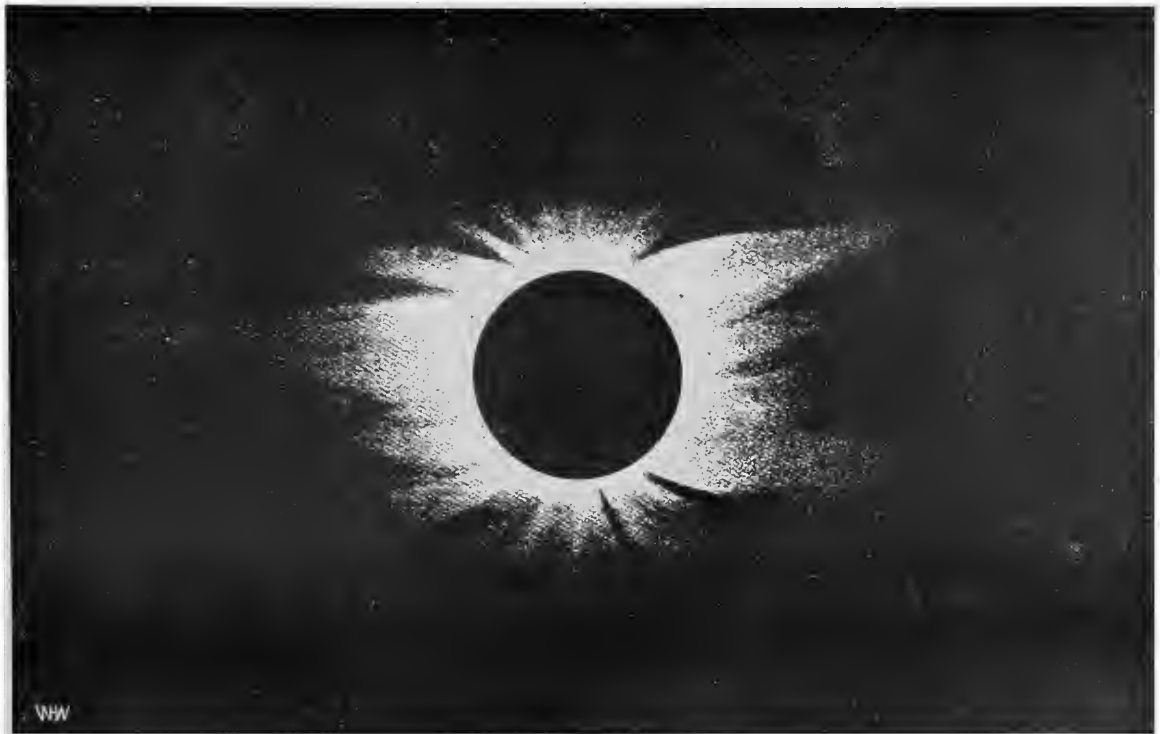


Fig. 10. Illustration of the escape of water vapor, molecular weight 18, to the higher regions of the atmosphere, which is relatively so free from dust, and condensation therefore so difficult, that when a drought in a large inland country once becomes established, it is apt to be prolonged till the larger seasonal changes produce such commotion in the earth's atmosphere as to bring on rain.

T. J. J. See. Cause of the Sunspots and their Periodicity.



1. The corona during the total solar eclipse of May 28, 1900, drawn by *W. H. Wesley* from photographs by *E. W. Maunder*. This was near the spot minimum of 1901.5, and the corona therefore already much extended at the equator under the increasing downpour of meteors.
2. Composite photograph of sun's disc and limb, taken by *W. J. S. Lockyer*, 1904, July 19.
3. (a) The great cyclonic spot of May 5, 1858, drawn by *Secchi*; and (b) a stereoscopic view of solar atmosphere above a group of Sunspots, Aug. 7, 1915, by *Hale*.

