

Observation During 2004 of Periodic Fringe-Shifts in an Adialeiptometric Stationary Michelson-Morley Experiment

Contents

1. The evidence for a constant speed of light in 1900	70
2. The MM experiment: a huge blunder?	73
2.1. Was the MM experiment negative?	73
2.2. Effect of solar motion upon the velocity of the laboratory	75
2.3. Effect of solar motion upon the interference fringe-shift	77
2.4. Analysis of solar motion in Michelson, MM, and Miller works	79
3. Our adialeiptometric experiment at CIF	80
3.1. Design of our experiment	80
3.2. Description of our experimental setup	81
3.3. Expected fringe-shifts	81
3.4. Operational tests	82
3.5. Data recollection and raw data	83
4. Analysis of data	85
4.1. Environmental effects	85
4.2. Typical corrected fringe-shift curves.	86
4.3. Solar velocities consistent with observations.	87
5. Closing remarks	87

Abstract

Adialeiptometry means unceasing or continuous measurements. We have carried out continuous measurements with a stationary Michelson-Morley interferometer at our CIF laboratory in Bogota (Colombia) for almost two years from the end of 2003 to June 2005. The paper reports the results for year 2004, during which we identified large periodical fringe-shifts, after correcting for environmental variables. To provide a context for the new experimental results presented in this paper, we start by discussing the meaning of speed of light at the time of Einstein, and present next the evidence then available for its constancy. We argue that the evidence provided by the original MM experiment and its repetitions is not as strong as usually believed, thus justifying a new experiment that corrects for the main weaknesses uncovered. The observed periodical variations are consistent with the predicted curves using a constant speed of light in a preferred frame, that adds vectorially to the laboratory velocity using Galilean addition. The solar motion that explains our observations is similar to other modern estimates of solar velocity.

1. The evidence for a constant speed of light in 1900

To provide a context for the new experimental re-

sults presented in this paper, we start by discussing the meaning of speed of light at the time of Einstein, and present next the evidence then available for its constancy. Section 2 argues that the evidence provided by the MM experiment and its repetitions is not as

strong as usually believed, thus making it reasonable to carry out a new experiment, described in section 3, that corrects for the main weaknesses uncovered. Section 4 summarizes our main empirical results, and section 5 closes the paper.

Einstein's special theory of relativity (STR) is based on two assumptions: the postulate of relativity, and the postulate that the speed of light is independent of the state of motion of the observer. The first postulate is a philosophical principle that nearly everybody accepts in one form or another; for instance, the principle of Galilean relativity is firmly entrenched in classical mechanics. Contrariwise, the second postulate has empirical nature and constitutes a testable assertion. The obvious question arises: was there any empirical evidence at the turn of the 20th century for the second postulate? As discussed in the following, the importance of the negative interpretation of the famous Michelson-Morley (MM henceforth) experiment [1] is that it constituted the main *direct* evidence to support the second postulate; on the contrary, any positive result in a MM-type experiment would falsify the postulate.

In the spirit of Newtonian mechanics, that was the dominant paradigm in 1900, let us consider that motion is relative to a preferred frame of reference Σ , and that time is universal, in the sense that all observers in the universe may agree on a common scale. Let us determine the speed of light in the laboratory. A photon¹ moves in straight line (defined by the light path itself) from a light source at A to a photon detector at B, stationary in the laboratory and located at a distance D measured with rod sticks. If the time of flight from A to B is t_{AB} , the one-way speed of light over the line segment AB is

$$c_{AB} = \frac{D}{t_{AB}} \quad (1)$$

The speed defined by eq. (1) is, of course, an average over the segment AB, and has the familiar meaning of everyday language. For any lay person it is extremely surprising to realize that the one-way speed of light was unknown during Einstein lifetime, and still is unknown today! Although various suggestions to measure the one-way speed of light have been proposed over the years [2–5], to our knowledge, no successful experiments with B stationary in the laboratory have been carried out, let alone with B in motion. That is, when detector B moves with respect to the laboratory along the light path, up to date there is no empirical evidence indicating whether the one-way speed of light varies, or does not.

The difficulty to determine the one-way speed of light entirely resides in the measurement of t_{AB} , which

¹Our analysis is done in the Newtonian context, from a modern vintage point. Then, ether is not mentioned, and light is treated as a particle. The wave-particle duality appears in interference phenomena.

is the difference between the time at B when the photon arrives, and the time at A when the photon is emitted. There are two aspects: (i) Then on-existence of clocks with a resolution high enough to measure the extremely short time intervals involved in a laboratory experiment, and (ii) The difficulty to synchronize the two clocks at A and B.

All the classical experiments to determine the speed of light in the laboratory (Fizeau, Foucault, Michelson [6,7]) measured c_2 the average speed of light along a two-way straight line from A to B, and back to A, defined by

$$c_2 = \frac{2D}{t_{AB} + t_{BA}} \Rightarrow \frac{2}{c_2} = \frac{1}{c_{AB}} + \frac{1}{c_{BA}} \quad (2)$$

Table 1 summarizes the values at the beginning of 20th century for the speed of electromagnetic radiation, in *free space* according to textbooks [8,p.847]. Note, however, that experiments have never been made in “free space”, whatever it is; the majority of values correspond to the measurement of c_2 for light propagating in air in our terrestrial laboratory, which moves with some unknown velocity $V(t)$ relative to Σ . The speed for light propagating in a vacuum in our terrestrial laboratory is calculated by adding a correction based on the index of refraction in air, which is a function of air density. The latter depends of air composition (mainly humidity), and ambient pressure and temperature at the moment of the measurement. For instance, Michelson based his correction on *mean*² pressure and temperature [7, p.2, footnote 2], and added the *same* correction of 67 km/s to all his speeds in air during the 1924 and 1926 experiments, undoubtedly made under different ambient conditions [7, p.2, 4, 5,9, 10, 11]. By the way, this cavalier procedure to obtain the vacuum speed casts some doubts on the correctness of the small uncertainty of 4 km/s quoted by Michelson for his 1926 experiments [7, p.12], and shown in table 1.

In the experiments of table 1 the positions of the mirror at B and the detector at A do not change with respect to the laboratory, so that they do not give clues on how the motion of the observer with respect to the laboratory would affect the value of the two-way speed of light. Regarding the motion of the laboratory with respect to the preferred frame, the earth's orbital speed around the sun is about 30 km/s, smaller than the uncertainty of 30 to 60 km/s, that was attainable by the end of the 19th century (see table 1). Hence, the measurements available in 1905 for the two-way speed of light could not possibly uncover any effect arising from the orbital motion of the observer.

However, if the high resolution of 4 km/s quoted by

²Michelson does not specify what is “mean” in this context. Is “mean” the average during the summer months at the time of the observations, or is it the diurnal average during the summer months, or is it the 24-hour daily average over the summer months, or is it the 24-hour daily average over the whole year...?

Table 1. The two-way speed of electromagnetic radiation in terrestrial laboratories [8], speed and uncertainty in km/s

Date	Experimenter	Method	Speed	Uncertainty
1849	Fizeau (France)	Toothed wheel	313,300	-
1862	Foucault (France)	Rotating mirror	298,000	500
1876	Cornu (France)	Toothed wheel	299,990	200
1880	Michelson (USA)	Rotating mirror	299,910	50
1883	Newcomb (UK)	Rotating mirror	299,860	30
1883	Michelson (USA)	Rotating mirror	299,853	60
1906	Rosa-Dorsey (USA)	Electromagnetic theory	299,781	10
1923	Mercier (France)	Standing waves	299,782	15
1924	Michelson (USA) [6,7]	Rotating mirror	299,802	30
1926	Michelson (USA) [7]	Rotating mirror	299,796	4

Michelson for his 1926 experiment is correct, such experimental set up was capable of uncovering the variations in c_2 due to the diurnal variation of the projection of $\mathbf{V}(t)$ along AB (arising from rotation of earth), and due to the annual variation of $\mathbf{V}(t)$ resulting from the orbital motion of earth. In an experiment designed with this objective in mind, observations should be made at different times of the day during the whole year, so that the possible diurnal and annual periodicities may be identified (see section 2.2). Michelson's observations were carried out during the 1926 summer only, so that the effect of velocity could not possibly be observed. Nonetheless, for a different reason, Michelson noted that he wanted to repeat the experiment in December 1926 [7, p.12].

There existed since the end of the 19th century a procedure to determine differences in the two-way speed of light. Indeed, Michelson invented his interferometer in 1881[9] to compare c_2 (1), the two way-speed of light along arm 1, to c_2 (2), the two way-speed of light along arm 2. The interferometer was improved for the 1887 MM experiment [1]. According to MM's *negative or null interpretation*, they did not observe any difference between c_2 (1) and c_2 (2), hence they concluded that the two-way speed of light in our moving terrestrial laboratory is constant along any direction. Next section 2 discusses whether the MM experiment was properly designed to observe what MM wanted, the relevant issue in this section being whether Einstein was aware of the null interpretation of the MM experiment while developing his ideas about the second postulate.

Einstein occasionally made the statement that he did not know the results of the MM experiment before 1905: "When I asked him [Einstein] how he had learned of the Michelson-Morley experiment, he told me that he had become aware of it through the writings of H. A. Lorentz, but only after 1905 had it come to his attention! 'Otherwise,' he said, 'I would have mentioned it in my paper'" emphasis in the original [10, p.48]. This

recollection by Einstein is contrary to the most recent documental evidence contained in Einstein's Love Letters [11, 12], showing that Einstein was aware of the MM experiment before 1905 both indirectly and directly, as follows:

Indirect knowledge of MM experiment. Einstein read the work of Lorentz by the end of 1901 and the beginning of 1902, as attested by letter 48 dated in Schaffhausen (Switzerland) on 28 December 1901 where Einstein writes to Mileva: "I want to get down to business now and read what Lorentz and Drude have written about electrodynamics of moving bodies" [12, p.72]. These books were the 1895 theory of Lorentz [13], and the 1900 optics book by Drude [14]. The empirical basis for Lorentz' work was the "negative" interpretation of the MM experiment. Indeed, Lorentz was closely following Michelson's work right from the beginning and send him a correction to the 1881 experiment [9] that was acknowledged by MM in the 1887 paper [1, p.451]. Evidently, Lorentz continued quite worried about Michelson's "negative" results, as attested by a letter to Lord Rayleigh on 18 August 1892; Lorentz asked: "Can there be some point in the theory of Mr. Michelson's experiment which has as yet been overlooked?" [15, p.32]. In addition, Einstein learnt about Lorentz work, and its physical basis, through Drude's book. The English translation of this book says in the introduction to chapter VIII [14, p.457]: "The assumption which will be adopted here is that the ether always remain completely at rest. Upon this basis H. A. Lorentz [13] has developed a complete and elegant theory. It is essentially this theory which is here presented emphasis in the original.

Direct knowledge of MM experiment. In the same chapter VIII, Drude explicitly discusses the empirical evidence, including Michelson's 1881 experiment in great detail [14, p. 478-481], and the 1887 MM experiment in less detail [14, p.481-482], i.e., from Drude's work Einstein learnt about the constancy of the two-way velocity of light in January 1902. But Einstein had

previous information on the same subject. In letter 11 dated in Milan around 28 September 1899 Einstein says: “I read a very interesting paper by Wien from 1898 on this subject” [12,p.15]. Wien’s paper [16] describes 13 experiments related to the detection of the motion of earth relative to the ether.

The MM experiment is in the list of 10 experiments with negative results [12, p.85]. The explicit text is: “If the ether is at rest, then the time a light ray needs to travel back and forth between two glass plates must change if the plates are moving [with velocity v]. The change depends on the quantity $v^2 A^2$ [A is the reciprocal of the speed of light], but should be observable by the application of interferometry. The negative result is incompatible with the assumption of an ether at rest. This assumption can only be maintained by means of the hypothesis that the linear dimensions of rigid bodies are altered by motion through the resting ether in the same ratio, so as to compensate for the lengthening³ of the path of the light ray” [11, p.46]. Hence, Einstein read about the “negative” interpretation of the MM experiment as least as early as September 1899.

The foregoing new evidence casts serious doubts on the conventional view propounded by Holton [17, 18] that the role of the MM experiment was minor in the genesis of STR. It is clear that Einstein knew at least since 1899 that, according to the experimental evidence, the two-way speed of light was independent of direction, and that such a fact necessitated some appropriate physical explanation.

This being so, one may be tempted to say with Edwards [19, p.485] that the second postulate should be amended to explicitly state that the constancy of light assumed by Einstein refers to the two-way speed of light; if that were the case, the second postulate would contain no information about the one-way speed of light. However, given Einstein’s concern for economy of thought, it is more likely that Einstein was thinking in his second postulate about the one-way speed of light. In that case it holds that $c_{AB} = c_{BA}$, and eq. (2) would immediately imply that the two-way speed is $c_2 = c_{AB}$ the same for any orientation of the segment AB. In both interpretations, the second postulate may be falsified if the two-way speed of light depends of direction, that is, if a MM experiment yields positive results. Notice that to falsify the second postulate there is no need to measure the one-way speed, thus making moot the conventionalist stance that it is impossible to measure it [20].

Einstein was deeply aware that a positive result in a MM experiment would destroy his theory. Regarding Miller’s work (briefly discussed in next section), Einstein wrote: “the existence of a not trivial positive effect would affect very deeply the fundament of theoretical physics as it is presently accepted” [21, p.2283].

³We ask: Is it shortening rather than lengthening?

2. The MM experiment: a huge blunder?

In retrospect, it is very surprising that Michelson’s work regarding the MM experiment was not closely scrutinized in his epoch, especially for the very deep implications it had. It is well known that both Lord Kelvin and Lord Rayleigh urged Michelson to repeat the 1881 experiment [15, p.25], and that in 1900 Kelvin urged Morley and Miller for a repetition of the 1887 MM experiment [15, p.33; 22, p.208]. The uneasiness of Lorentz is reflected in his 1892 letter to Rayleigh quoted above [15, p.32]. Towards 1900 there were several minor criticisms to some aspects of the setup of the MM experiment, that we have listed elsewhere [23, 24], but the only significant critical appraisal of the whole process was done by Hicks in 1902 [25]. The most disturbing aspect, however, is Miller’s claim [22] that the MM experiment was always positive. We turn now to that subject and to two new criticisms that we have recently advanced [24, 26].

2.1. Was the MM experiment negative?

Firstly, it must be noted that MM did not obtain a zero shift of the reference fringe, as flatly expressed in both relativistic and classical mechanics textbooks, without any caveats whatsoever. Rather, they found that “the relative velocity of the earth and the ether is probably less than one sixth the earth’s orbital velocity, and certainly less than one fourth” [1, p.458]. This means that according to their data reduction process they found a motion of earth relative to the preferred frame that certainly was less than 7.5 km/s, and probably less than 5 km/s. These values are no doubt smaller than their incorrectly expected 30 km/s (see section 2.2), but certainly they were not zero.

It is most striking that the 1887 MM paper [1] contains no analysis of experimental error, which was roughly done for the 1881 experiment [9]; even the straight forward statistical error analysis is missing. Consequently, there are no error bars in their famous figure 6 [1, p.458] upon which MM based the conclusion quoted in previous paragraph. Moreover, figure 6 is obtained from the data listed in two tables of the original paper [1, p.457] by an additional reduction process that is unexplained by MM; this weakness in the MM paper went unnoticed until quite recently [27]. We have calculated elsewhere [24, 26] the statistical error associated with the whole reduction process. The very large error bars preempt the conclusions drawn by MM. On the contrary, one may argue that the observations are compatible with MM’s original expectation of 30 km/s.

Additionally, we also revisited all the original MM-type experiments up to 1930, and we found that all of

them presented small, but non-zero fringe-shifts [23]. Such small fringe-shifts were interpreted as negligible by the experimenters, and therefore in support of the STR. Miller [22] was the only author that interpreted his results as positive fringe-shifts.

Michelson left Cleveland in 1899. From 1902 to his retirement in 1906, Morley teamed up with Miller to repeat the experiments with more sensitive interferometer shaving light-paths of 32 m, about three times the path of the 1887 MM apparatus [22, p.208-217]. Observations were made in August 1902 and June 1903 consisting of 505 turns of a wood apparatus, and with a steel interferometer in July 1904 (260 turns) and July, October, November 1905 (230 turns). Morley and Miller obtained *positive* effects between 7 and 10 km/s shown in figure 4 of Miller's final paper [22, p.207]. Miller also recalculated the original 1887 MM results, applying a linear correction suggested by Hicks for thermal shift [25], and obtained "*a velocity of 8.8 km/s for the noon observations and 8.0 km/s for the evening observations*" [22, p.207], similar to Morley-Miller results.

It may be noted that the Morley-Miller experiments involved 995 turns of the interferometer in the period 1902-1905, while the MM experiment only consisted of 36 turns of the apparatus in the period July 8-12, 1887. It is quite astonishing that the scientific community accepted the negative interpretation of the latter, and rejected the positive interpretation of Morley-Miller, based on 30 times more data. Technological design of the experiment, and its environmental control were similar in both cases.

Miller resumed alone the interferometer experiments in 1921. During 1921 and 1924 he made observations at Mount Wilson involving 1,181 turns of the interferometer, during 1922-1924 he took data in Cleveland involving 1,146 turns of the apparatus, and again at Mount Wilson in April 1, August 1, and September 15, 1925 and February 8, 1926 Miller performed 6,402 turns of the interferometer. Once again, Miller observed positive results between 9.3 to 11.2 km/s, and additionally uncovered an annual periodicity in the variation of light-speed [22, p.217-230].

By the time that Miller completed his analysis of data around 1930, Einstein's STR was firmly entrenched and his results were received with great skepticism. Shankland and collaborators [28] analyzed Miller's work in 1955; they acknowledged that Miller's velocity variations were not random, but surprisingly concluded that Miller's periodical changes were caused by thermal (presumably periodical) variations. Miller had passed away in 1941 and could not defend himself, but this particular issue was empirically checked many years before by Miller during the 1922-1924 tests. From his tests Miller had already concluded that thermal variations could not possibly lead to the periodical effects that he had observed [22, p.220]. For further arguments in support of Miller's claims see De

Meo' revision of Miller's work [29].

Since the 1990's, there has been a renewed interest in Miller's work; several authors independently consider that Miller's results are real and not mere experimental artifacts [23,29-35]. In particular, Allais [32,34] has uncovered new annual periodicities in Miller's data. Then, if Miller's results represent real variations of the speed of light caused by the motion of the laboratory, what is the origin of the small amplitude of the variations (hence, the small laboratory velocity) observed by MM and by Miller? This is the remaining puzzle in the whole history. In our earlier work [35, pp. 192-193; 36, pp. 474-475] the clue has been offered: the MM and the Miller experiments were designed to measure fractions of wavelength, larger variations were recalibrated away. To solve this problem, we analyze in next section 2.2 the effect of solar motion upon the readings in any interferometer.

For completeness, let us note that the vast majority of the physics community does not take seriously Miller's claims. They argue that after 1930 the MM experiment has been repeated many times using modern technology, and that the results have always been in accordance with the original MM experiment. A precision is required here. Starting with the Kennedy-Thorndike (KT) experiment [37], the data reduction process suffered a change. Up to this turning point, the fringe-shifts were analyzed in an effort to detect variations that would lead to a measurement of different velocities of light along the two arms of the interferometer. About that time a consensus emerged that the (presumably) null-results of the MM experiments could be interpreted as empirical proof of the length-contraction predicted by STR. For instance Robertson [38, p.380] stated: "*No significant difference in times was found, and since the original experiment and its repetitions were carried out at various orientations and at various times of the year, we would seem justified in interpreting this null-result as [independence of direction]*". It is amazing that Robertson completely ignored in 1949 the results of Miller's experiments that were published in the same journal in 1933.

The experimental setup in the KT experiment is very similar to previous MM experiments (except for the length of the arms which is not the same⁴), but the analysis of data is quite different. In the KT experiment, it is assumed that the length of the arms of the interferometer are shorter than the physical value,

⁴For most authors this is a very important difference; in our opinion it is negligible. The reason being that in the MM experiment the length of arm 1 equals the length of arm 2 up to macroscopic accuracy (at best, some tenths of millimeters). This accuracy is meaningless relative to the variations of tenths of a wave-length of visible light that are involved in the shift of an interference pattern. On the other hand, if the lengths of the arms are adjusted to the same length using the interference pattern itself, then we are begging the question because we are using as a standard of length the same ruler whose variation we are trying to measure.

according to the Lorentz length-contraction; hence, light apparently takes a shorter time to travel along the shortened arms. The observed fringe-shift (null, or otherwise) is then interpreted as a measure of time dilation with respect to the difference of apparent travel times along the two shortened arms. Since the observed data are subject to various manipulations during the interpretation of a KT experiment, it is quite difficult to assert from the data reported in the open literature whether a particular KT experiment exhibited fringe-shift relative to absolute space, or not.

As an example consider the excellent, and often quoted, experiment by Brilliet and Hall (BH henceforth), who started their paper stating that: “*Our conventional postulate that space is isotropic represents an idealization of the null experiments of Michelson and Morley*” [39, p.549]. Note that BH talked of an “idealization”, and did not claim that their experiment was exactly the same as MM experiment; indeed, a couple of paragraphs below BH explicitly compared their results to the experiment of Jaseja and co-workers using infrared masers [40]. The latter belongs to a group of experiments headed by Prof. Townes on the isotropy of space [40-42]. Cedarholm and Townes explicitly state that “*the experiment is more closely related to the Kennedy-Thorndike experiment than to that of Michelson and Morley*” [42, p.1351, first column]. Other contemporary experiments either belong to the KT class [43], or have built-in corrections, whose interpretation is not clear-cut [44]. A recent paper even suggests that the theory behind resonant cavity experiments (as the BH experiment) may be more complicated than expected [45].

2.2. Effect of solar motion upon the velocity of the laboratory

The absolute velocity of earth’s center of mass $\mathbf{V}(t)$ is the vector addition of $\mathbf{V}_0(t)$, the orbital motion of the center of mass of earth around the sun, plus \mathbf{V}_s the solar system motion:

$$\mathbf{V}(t) = \mathbf{V}_s + \mathbf{V}_0(t) \quad (3)$$

Miller used the same conceptual model for his analysis of the 1925-26 observations, he even built a mechanical model [22, p.22]. Of course, solar motion is formed by the velocity with respect to the center of mass of our galaxy, plus the motion of our galaxy with respect to Σ . For the observation periods of a few years relevant to this paper, \mathbf{V}_s is assumed to be constant.

For the calculations, let us adopt celestial equatorial coordinates (see any book on practical astronomy [46, 47]) with the celestial equator contained in the Z-X plane and the celestial northern pole along the Y-axis. To calculate orbital velocity $\mathbf{V}_0(t)$ the following approximate model is used: (i) the earth moves circularly on the plane of the ecliptic, (ii) the orbital period is 365.25 solar days, (iii) the tangential speed

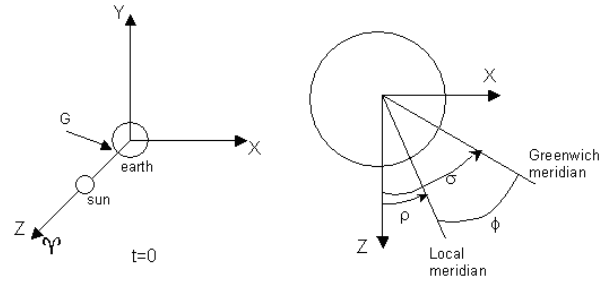

Fig. 1. Equatorial system of coordinates attached to absolute space. The Z-axis points towards the first point of Aries, which is a fixed point in space, on the date of the vernal equinox. At left, the earth as seen from the celestial north ernpole. At arbitrary time t a plane containing the Greenwich meridian makes angle σ with the plane defined by the Y-Z axes. An observer at longitude ϕ is rotated through an angle ρ relative to the Y-Z plane.

V_0 is 29.8 km/s; (iv) the origin of time is noon of March 21 every leap year. It is assumed that at $t = 0$ an observer G on the Equator (latitude $\lambda = 0$) at the Greenwich meridian (longitude $\phi = 0$) sees the Z-axis

The observer G rotates counterclockwise on the Z-X plane with a period $T = 365.25/366.25 = 0.99727$ solar days. At any arbitrary time t (in solar days) observer G has rotated through an azimuth angle σ relative to the Z-axis given by

$$\sigma = 360^\circ \text{ mod}[t, T] \quad (4)$$

The angle σ is shown in figure 1, and is a good proxy for sidereal time. As an aid to reckon daily fringe-shifts, the number of days elapsed until the first day of each month since the beginning of a 4-year cycle starting March 21, 2000 is included as Annex 1.

As usual, local civil time t^* (in solar hours) may be converted to universal time t (also in solar hours) by using

$$t = t^* - \frac{24\phi_{TimeZone}}{360} \quad (5)$$

where $\phi_{TimeZone}$ is the nominal longitude for the international time zone, positive (negative) to the east (west) of the Greenwich meridian. For the calculations used in this paper: $\phi_{TimeZone} = -75^\circ$ for Bogota (Colombia) and Cleveland (Ohio), and $\phi_{TimeZone} = -120^\circ$ for Mount Wilson (California).

In the spherical coordinates associated with the equatorial celestial coordinates shown in figure 2, solar velocity \mathbf{V}_s is described by magnitude V_s , right ascension angle α and declination angle δ so that

$$\begin{aligned} V_X^S &= V_S \cos \delta \sin \alpha, \\ V_Y^S &= V_S \sin \delta, \\ V_Z^S &= V_S \cos \delta \cos \alpha \end{aligned} \quad (6)$$

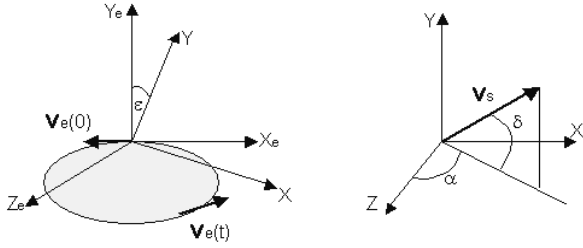

Fig. 2. The earth moves on a circular orbit with speed V_0 on the plane of the ecliptic defined by the Z_e - X_e axes. The equatorial system of coordinates XYZ is rotated through an angle ε with respect to the ecliptic; the directions of the Z and Z_e axes coincide. At left, solar velocity \mathbf{V}_s in spherical coordinates (V_s, α, δ) in the equatorial system of coordinates.

To calculate the orbital motion of the earth around the sun, ecliptic coordinates are used with the plane of ecliptic contained in the Z_e - X_e plane. The Z_e -axis has the same orientation as the equatorial Z -axis: towards the first point of Aries (see figure 2). At $t = 0$ the orbital velocity of earth is $\mathbf{V}_e(t=0) = -V_0 \mathbf{i}_e$. Since the motion of earth is counter-clockwise, at any time t the orbital velocity in ecliptic coordinates is

$$\mathbf{V}_e(t) = V_0(-\mathbf{i}_e \cos \omega_0 t + \mathbf{k}_e \sin \omega_0 t) \quad (7)$$

where $\mathbf{i}_e, \mathbf{j}_e, \mathbf{k}_e$ are the unit vectors along the X_e, Y_e, Z_e -axes and the angular orbital speed is $\omega_0 = 2\pi$ radians/365.25 solar days. The inclination of the plane of the ecliptic relative to the equatorial coordinates is $\varepsilon = 23.44^\circ$, so that orbital velocity $\mathbf{V}_0(t)$ in celestial equatorial coordinates is obtained by rotating the system around the Z_e -axis to get:

$$\begin{aligned} \mathbf{V}_0(t) &= R_\varepsilon \mathbf{V}_e(t) \\ &= V_0(-\mathbf{i} \cos \omega_0 t \cos \varepsilon - \mathbf{j} \cos \omega_0 t \sin \varepsilon + \mathbf{k} \sin \omega_0 t) \end{aligned} \quad (8)$$

where R_ε is the rotation matrix from ecliptic to equatorial coordinates (see table 2). In equatorial coordinates, the velocity of the earth is then

$$\begin{aligned} \mathbf{V}(t) &= \mathbf{i}(V_s \cos \delta \sin \alpha - V_0 \cos \omega_0 t \cos \varepsilon) \\ &\quad + \mathbf{j}(V_s \sin \delta - V_0 \cos \omega_0 t \sin \varepsilon) \\ &\quad + \mathbf{k}(V_s \cos \alpha + V_0 \sin \omega_0 t) \\ &= \mathbf{i}V_X + \mathbf{j}V_Y + \mathbf{k}V_Z \end{aligned} \quad (9)$$

The rotation of the earth around her axis does not contribute, of course, to the velocity of her center of mass relative to Σ , and the contribution of earth's rotational velocity to the total speed of a laboratory on the surface of earth is certainly negligible. However, earth's rotational motion has an extremely significant effect on the magnitude and direction of the projection of $\mathbf{V}(t)$ on the plane of the interferometer, effect

that has been often overlooked by other investigators. Consider a laboratory located on the surface of the earth at latitude λ (positive north of the equator) and longitude ϕ (positive east of Greenwich), and let a measurement be performed at local civil time t^* (in hours). At t^* the plane defined by the local meridian and the axis of rotation of earth makes angle ρ with the plane defined by the Z - Y equatorial axes:

$$\rho = \sigma + \phi \quad (10)$$

A rotation of coordinates R_ρ around the Y -axis through ρ aligns the Z -axis with the local meridian (see figure 1). A further rotation of coordinates R_λ around the X -axis through angle λ directs the Z -axis towards the local zenith. In this way the local horizon system of Cartesian coordinates is obtained with the X -axis oriented to the local east (E), the Y -axis oriented to the local north (N) and the Z -axis oriented to the zenith ($U = \text{up}$).

In local horizon coordinates the absolute velocity of the center of mass of earth is then

$$\mathbf{V}_L(t) = V_E \mathbf{e}_E + V_N \mathbf{e}_N + V_U \mathbf{e}_U = R_\lambda R_\rho \mathbf{V}(t) \quad (11)$$

where \mathbf{e} is the unit vector along each direction, and the rotation matrices $R_\lambda R_\rho$ are defined in table 2. Substituting (9) into (11) we explicitly get

$$\begin{aligned} V_E &= V_X \cos \rho - V_Z \sin \rho \\ V_N &= -(V_X \sin \rho + V_Z \cos \rho) \sin \lambda + V_Y \cos \lambda \\ V_U &= (V_X \sin \rho + V_Z \cos \rho) \cos \lambda + V_Y \sin \lambda \end{aligned} \quad (12)$$

The absolute velocity of the solar system is not known with certainty. On the contrary, the experiment reported in this paper could be used to obtain its value [36]. Table 3 presents the values of solar velocity used by Michelson in the design of his experiments in 1881 and 1887 (items 1 and 2). Items 3 and 4 are the two values derived by Miller from his observations in the 1920's. Item 5 is the solar velocity obtained by Marinov in the late 1970's in an experiment with two rotating coupled interferometers [48]. Finally, item 6 is the velocity of earth relative to background radiation, obtained by means other than interferometric experiments [49].

For two of the scenarios above, figure 3 presents the variation of terrestrial motion in Cleveland, Ohio ($\phi = 81^\circ - 39'W, \lambda = 41^\circ - 30'N$) during 8 July 1887, which was the first day of the MM experiment. It may be seen that at the time of the experiment (noon and 6 p.m.) the speed towards the east was much larger than the 30 km/s incorrectly expected by MM, and the speed towards the north was not zero as incorrectly expected by MM. On the contrary, both components of velocity are in general much larger than 30 km/s. These two facts immediately imply that the MM experiment was incorrectly designed. This is a novel and deep failure in the MM experiment, that we recently recognized

Table 2. Rotation matrices used in the calculations

R_ε			R_ρ			R_λ		
$\cos\varepsilon$	$-\sin\varepsilon$	0	$\cos\rho$	0	$-\sin\rho$	1	0	0
$\sin\varepsilon$	$\cos\varepsilon$	0	0	1	0	0	$\cos\lambda$	$-\sin\lambda$
0	0	1	$\sin\rho$	0	$\cos\rho$	0	$\sin\lambda$	$\cos\lambda$

Table 3. Some estimates of solar velocity

Item	Name	Description	$V_S, km/s$	α	δ
1	Michelson1881[9]	Estimate in 1881	30	18 hr	+26°
2	MM1887 [1])	Solar speed ignored (1887)	0	X	X
3	Miller1[22,p.231]	Initial evaluation (1928)	200	17hr – 30min	+65°
4	Miller2[22,p.234]	Recalculation in 1932	208	4hr – 54min	-70° – 33'
5	Marinov [48]	Rotating interferometers	303 ± 20	14.28 ± 0.33hr	-23° ± 4°
6	SGM [49]	Background radiation	390 ± 60	11.0 ± 0.6hr	+6° ± 10°

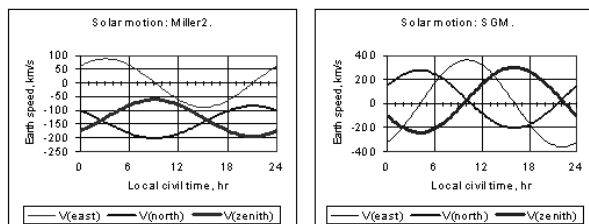

Fig. 3. Components of terrestrial motion in Cleveland (Ohio) on 8 July 1887, the first day of the MM experiment for two scenarios of solar motion in table 3 (see text): item 4 = Miller2, and item 6 =SGM. The Cartesian components of the velocity of the laboratory present large diurnal variations, whose shape depends of solar velocity.

[24], after being unnoticed for more than 120 years. This subject is expounded in next section 2.3.

Figure 3 also shows that at noon and 6 p.m. the magnitude of each speed is rapidly varying. Hence, during the duration of a session of the MM experiment (say, between 30 and 60 minutes) there is a significant change on the eastern and northern components of speed. This immediately implies that the initial fringe-shift at position 0 is not the same as the final fringe-shift at position 16⁵, despite the fact that at both

⁵MM rotated the interferometer in 22.5° steps with respect to a local direction, say the east. Arm 1 to the east is position 0, arm 1 at 22.5° relative to the east is position 1, and so on.

positions the apparatus has the same orientation with respect to the laboratory. This additional fringe-shift at position 16 is a cumulative process that steadily grows during the 6 turns of the MM interferometer. The overall result is the monotonous drift present in MM data [1], which did not merit any comment from MM but was recognized by Hicks [25], who ascribed it to “thermal effects”. On the contrary, in our opinion, the change in the position of the reference fringe at position 16 is a signature of absolute motion, which accounts, at least partially, for the observed monotonic drift [35, 36].

2.3. Effect of solar motion upon the interference fringe-shift

The MM experiment was designed in the context of Maxwell’s theory. For our purposes, the basic assumption is that the speed of light is a constant c with respect to the preferred frame Σ , independently of the direction of propagation, and of the velocity of the emitter. Regarding the latter, there exist alternative theories where the motion of the source affects the speed of light [50]; the evidence in favor of independence of c with respect to the motion of the source has been provided by astronomical observations (for instance, De Sitter observation of twin stars) and by laboratory experiments [51]. For a revision of evidence see [52]. For the time being, we simply assume that c

Position 16 is a full turn.

is independent of the motion of the source. Also, from the isotropy assumption, it follows that c may be interpreted as a one-way velocity. For an observer at rest in Σ , the two-way velocity eq. (2) has exactly the same value c .

An observer in motion with respect to Σ will measure a different speed according to Galilean velocity addition. In a Michelson interferometer light propagates along two different directions (arms 1 and 2) orthogonal to each other. For an apparatus on the surface of earth the time-dependent components of the terrestrial velocity V_E , V_N , V_U define the response of the interferometer. For instance, a vertical stationary interferometer with one arm oriented along the WE axis, and the other perpendicular to the local horizontal plane is controlled by V_E and V_U . More relevant to the analysis in this paper is a stationary horizontal interferometer with arm 1 oriented from west to east, and arm 2 oriented from south to north, where components V_E and V_N control the operation of the apparatus.

Consider a stationary interferometer with L_1 the length of arm 1 oriented WE, and L_2 the length of arm 2 oriented SN, and let T_j be the two-way time of transit of a light-ray along arm $j=1,2$ of the interferometer. Then, the difference in the time of transit as given by the time-delay of the light signal is

$$\Delta T = T_1 - T_2 = \frac{L\beta_I^2 \cos 2\gamma}{c(1 - \beta_I^2)} + \frac{\Delta L(4 - \beta_I^2)}{c(1 - \beta_I^2)} \quad (13)$$

where

$$\Delta L = \frac{L_1 - L_2}{2}, \quad L = \frac{L_1 + L_2}{2}, \quad \beta_1 = \frac{V_I}{c} \quad (14)$$

and the projection of earth's absolute velocity upon the plane of the interferometer is $V_I(t)$ given by

$$V_I = \sqrt{V_N^2 + V_E^2} \quad (15)$$

$$\tan \gamma = \frac{V_N}{V_E} \quad (16)$$

Eq. (13) is also applicable to asymmetric interferometers with different arm lengths; the equation may also be used for error analysis. If the interferometer arms are identical, and if V_I is small, then eq. (13) reduces to

$$\Delta T = \frac{L\beta_I^2 \cos 2\gamma}{c} \quad (17)$$

In a rotating interferometer eq. (17) becomes

$$\Delta T = \frac{L\beta_I^2 \cos 2(\theta - \gamma)}{c} \quad (18)$$

where θ is the angle between arm 1 and WE axis. The conventional expression used by MM for the interpretation of their experiment is a particular case of eq. (18) with $V_N = 0$, and $\gamma = 0$. From figures 3

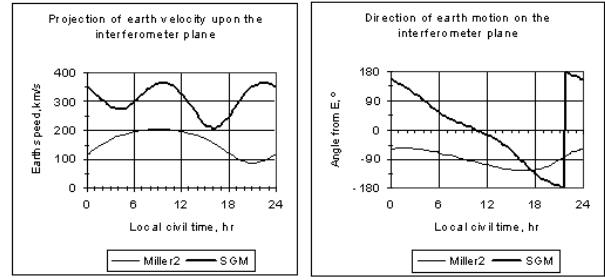

Fig. 4. Components of terrestrial motion in Cleveland (Ohio) on 8 July 1887, the first day of the MM experiment, for two scenarios of solar motion in table 3 (see text): item 4 = Miller2, and item 6 =SGM. The projection of earth motion on the plane of the interferometer depicts large diurnal variations, whose shape depends of the actual value of solar velocity. The magnitude V_I is at left, and the azimuth ϕ is at the right side.

and 4, the latter condition is utterly wrong, as noted at the end of previous section 2.2. In a previous paper [23], the leading author has already discussed this systematic error in the analysis of all MM-type experiments.

As usual, the fringe-shift F is proportional to the time delay, so that in the MM rotating interferometer

$$F = \nu \Delta T = \frac{L\beta_I^2 \cos 2(\theta - \gamma)}{\Lambda} \quad (19)$$

where ν and Λ are the frequency and wave-length of the light used in the interferometer. As shown in figure 4, calculated for 8 July 1887 with the same solar velocities used in figure 3, both V_I and γ depend of the time of day and epoch within a year. For the Miller2 solar velocity, V_I at noon and 6 p.m. respectively are 197 and 122 km/s, whereas for the SGM solar velocity these values are 330 and 248 km/s. All of them are much larger than the 30 km/s used by MM to calculate their expectations.

MM compared the fringe-shift for $\theta = 0$ with the fringe-shift for $\theta = 90^\circ$,

$$\Delta F = F(0) - F(90^\circ) = \frac{2L\beta_I^2 \cos 2\gamma}{\Lambda} \quad (20)$$

Table 4 shows the absolute value of fringe shift ΔF to be expected in a MM experiment for the various scenarios of solar velocity in table 3.

In general, fringe-shifts of several wave-lengths are to be expected, rather than the small 0.4 fringe-shift predicted by MM. Notice also the strong dependence of the time of day. However, as is well known, the MM experiment and subsequent repetitions, including Miller's, was designed to read only fractions of wavelength, completely ignoring the integer number of fringes. Consequently, the amplitude observed in experiments is much lower than it should

Table 4. Expected fringe-shifts for the MM experiment on 8 July 1887

Solar velocity	Michelson81	MM87	Miller1	Miller2	Marinov	SGM
Noon	0.08	0.37	14.3	13.1	21.5	40.4
6 p.m.	0.10	0.20	6.4	2.8	18.7	0.8

be, and the estimate of velocity from eq. (20) is lower than it should. In a recent paper we have simulated the response of the MM interferometer, assuming the SGM solar velocity, when only fractions of fringe are read [24]. The apparent fringe-shift amplitude under the incorrect data gathering procedure only amounts to 3.2% of the amplitude that would be observed if the whole fringe-shift were measured, thus explaining the consistently low values of laboratory velocity obtained in all MM-type experiments.

2.4. Analysis of solar motion in Michelson, MM, and Miller works

For completeness and fairness, we briefly review in this subsection the analysis of solar motion performed in the early experiments. In 1881, while at Helmholtz laboratory in Berlin, Michelson invented his interferometer and performed his first experiment. Regarding solar motion he stated [9, p.124-125]: “At this time of the year, early in April, the *earth’s motion in its orbit coincides roughly in longitude with the estimated direction of the solar system – namely, toward the constellation Hercules. The direction of this motion is inclined at angle of about 26° to the plane of the equator, and at this time of the year the tangent of the earth’s motion in its orbit makes an angle of 23.5° with the plane of the equator; hence we may say the resultant would lie within 25° of the equator. The nearer the two components are in magnitude to each other, the more nearly would their resultant coincide with the plane of the equator. In this case, if the apparatus be so placed that the arms point north and east at noon, the arm pointing east would coincide with the resultant motion, and the other would be at right angles*” Therefrom Michelson estimated the ensuing fringe-shift. This solar motion of 30 km/s was included in table 3 above as MM1881.

In the same paper Michelson also considered the possibility that “*the proper motion of the sun is small compared to the earth’s motion*” [9, p.125], and estimated the corresponding fringe-shift. He considered both scenarios equally likely because we went on to take “*the mean of these two numbers as the most probable*” [9, p.120]. It is noteworthy that Michelson did not

consider the other logically possible alternative: that the speed of the sun could be larger—or, much larger— than earth’s orbital velocity (as it is, according to current knowledge). Perhaps, the logically possible alternative was not a physically possible alternative in Michelson’s age...

In the 1887 MM experiment, for unknown reasons the emphasis was on orbital motion only: “*In what precedes, only the orbital motion of the earth is considered. If this is combined with the motion of the solar system, concerning which but little is known with certainty, the result would have to be modified*” [1, page458]. Since this is the best known paper, most writers believe that in a MM experiment orbital velocity is the only relevant motion, for instance Lodge [53, page 854]. For completeness, a null solar motion is entered in table 3 as MM1887. In the experiments carried out by Morley and Miller from 1902 to 1905 [22, 54], solar motion was assumed very much as Michelson did in 1881. The magnitude of terrestrial motion was about 33.5 km/s [54, p.684], which resulted of a “*combination of the diurnal and annual motions of the earth, together with the presumed motion of the solar system toward the constellation Hercules with a velocity of 19km/s. On the dates chosen for the observations there were two times of the day when the resultant of these motions would lie in the plane of the interferometer, about 11:30 A.M. and 9:00 P.M.*” [55,p.353], emphasis added; see also [22, p.210].

Miller did not notice that the solar motion used by Michelson, MM and himself contained a significant weakness until 1925; this recognition was prompted by a detailed calculation of expected outcomes [56], very similar to our calculation in section 2.2 above. In his words: “*At the end of the year 1924, when a solution seemed impossible, a complete calculation of the then expected effects, for each month of the year, was made for the first time*” [55, p. 356-357], emphasis added. Miller then understood that “*the well-known motion of the solar system towards the constellation Hercules, with a velocity of 19 km/s, is only a relative motion of the sun with regard to the group of nearby stars and it may give no information as to the motion of the group as a whole*” emphasis in the original [22, p.223]. Then, for his large and final series of experi-

ments during 1925-26, Miller introduced a *new experimental design*: continuous rotation of the interferometer day and night without assuming any azimuth for V_I . The analysis of his results led him to obtain the two estimates of solar velocity labelled Miller1 and Miller2 in table 3 above.

Miller's experimental design introduced a new concept in the design of experiments that has not been duly emphasized: continuous repetition of an experiment, under constant conditions with respect to the laboratory, for long periods of time. The goal is to uncover small effects that are missed by the conventional design, for instance, the effect of the velocity of earth with respect to absolute space. To describe this class of experiments we hereby propose a new word: *adialeiptometry*, from the Greek words $\alpha\delta\iota\alpha\lambda\epsilon\iota\pi\tau\omicron\sigma$ and $\mu\epsilon\tau\rho\upsilon\nu$ meaning unceasing, or continuous, measurement. Other examples of adialeiptometry are Buffo's daily observation of a Foucault pendulum during 8 years in the 1940's and 1950's [57], Allais observation of a paraconical pendulum during several months day and night in the 1950's [31], our ongoing research with paraconical pendulums, and our research with the stationary interferometer reported elsewhere [35,58], and in the present paper.

Summarizing section 2, the MM experiment can not be interpreted as a demonstration that the two-way speed of light is independent of the observer. Indeed, under the incorrect data gathering procedure used by MM and by Miller the result was not null. If MM and Miller had used the correct procedure of measuring the total shift (integer fringes plus fraction of a fringe), they should have obtained a much larger amplitude, and hence a much larger velocity of the laboratory.⁶ In addition, MM did not provide error analysis for their results; the missing statistical error bars are quite large and do not permit a negative conclusion, as MM did. Furthermore, the fact that there is one experiment (Miller's) that apparently contradicts the predictions of STR warrants, in our opinion, a repetition of the experiment using modern technology.

3. Our adialeiptometric experiment at CIF

3.1. Design of our experiment

From the foregoing discussion one concludes that a correct design of a MM experiment should be based on the identification of a large number of fringe-shifts

⁶To obtain the velocities listed as Miller1 and Miller2 in table 3 above, Miller introduced a correction factor of about 20 to convert observed velocity into final velocity [22, table V, p.235]. He obtained this value from an analysis of the observed direction of earth's motion. Our claim is that if Miller had measured integer fringe-shifts, then final velocity would have resulted, without any ad hoc correction.

during one rotation of the interferometer. A possible approach towards this end is to make many observations during one rotation, say every 1° . The experimenter should be reasonably certain that in passing from an arbitrary position θ of the interferometer to the next, say $\theta + 1^\circ$, the reference fringe has moved less than 1 fringe. In the few turns of the MM experiment [1] and in the many repetitions by Miller [22], measurements were made every 22.5° so that it was completely impossible to know how many fringes the reference fringe had moved. They rotated the interferometer from θ to $\theta + 22.5^\circ$ and observed that the reference fringe was at a different position and naively concluded that the fringe had moved through less than one fringe! In many of the famous repetitions of the experiment, like those by Kennedy [59] and by Illingworth [60], the situation was even worse: the experimenter determined the initial position of the reference fringe and then rotated the apparatus through 90° . Obviously, nobody knows how many fringes shifted past the fiducial marker during such a massive rotation of the apparatus. However, *without hesitation and without evidence*, all experimenters up to date have *interpreted* that their reference fringe moved less than one wavelength!

Another weakness in the design of the original MM experiment is implicit in Miller's writings [22, p.228]: "*these observations have involved the taking of over 200,000 readings of the positions of the interference fringes, requiring that the observer should walk in a small circle, in the dark, while making the readings, a distance of about 160 miles*". Sir Oliver Lodge, an acid critic of Miller, noted with irony that "*it is rather surprising that the readings were made by a peripatetic observer, with the instrument in constant and not very slow rotation... one would have thought that a stoppage of the frame and a reading of the fringes by a seated observer in many azimuths, would have been more satisfactory*" [53, page 854, second column], emphasis added.

Our experimental design solves the two weaknesses noted in previous two paragraphs. A *stationary* interferometer performs a slow rotation at the earth's angular speed, and can be read by a seated observer (a video camera connected to a computer) at short intervals of time. During the setup process the first semester of 2002, we started with measurements every 15 minutes, which amount to rotations of the interferometer through 3.75° . The interference pattern from one observation to the next showed differences that could be appreciated by the naked eye. We tried shorter time intervals, until finding that observations taken every 2 minutes appeared identical to the naked eye. Thus, the initial experiments in 2002 were manually made at 2 minute intervals [35]. Starting in 2003 we implemented an automatic system for data gathering, and have used ever since 1 minute intervals. In this way we are reasonably certain that, if a shift of the

reference fringe does exist, it is smaller than one wavelength.⁷ During 1 minute the earth rotates through 0.25° , which means that the spatial resolution of our experiment is $22.5/0.25 = 90$ times better than MM setup.

3.2. Description of our experimental setup

As previously described [58], a symmetric Michelson interferometer was mounted on top of a reinforced concrete anti-vibration table 4.48 m long, 2.57 m wide, 0.32 m thick, that weighs 13.5 metric ton; the height of table relative to the floor is 0.77 m. The table is placed inside a room with dark walls, and polystyrene thermal insulation in the former windows, located in the ground floor of the CIF institute (Centro Internacional de Fisica =International Center of Physics), housed at the campus of National University in Bogota, Colombia, located at $\phi = 74^\circ - 05' W$, $\lambda = 4^\circ - 38' N$, and 2,556 m altitude above mean sea level.

The light source is green ($\lambda = 532$ nm) produced by a Nd: YAG diode pumped laser, model DPY 325/425II, manufactured by Adlas (Germany), whose maximum output power is 200 mW. The laser light propagates along the West-East direction, the apparatus being located at the SW corner of the interferometer, on top of a metal supporting plate ($35 \times 35 \times 5$ cm), fastened to the main concrete table. The laser's power supply is placed outside the anti-vibration table. The horizontality of the laser beam was checked with a precision level (0.1 mm in 1 m).

The light beam splitter is a prism (equivalent to the semi-transparent mirror in the original MM setup), located on top of another independent metallic supporting board ($81 \times 81 \times 5$ cm), attached to the main concrete table. The mirrors are placed on top of small brass tables (10×10 cm), with legs of adjustable height fastened directly to the concrete table, and placed at the end of each arm. The length of each interferometer arm is given by the distance from the center of the beam splitter to the face of each the east and north mirror, $L_1 = L_2 = 2.044$ m as measured with a metallic tape⁸.

The interference pattern is observed with a Sony video camera focused upon a small frost glass screen (6×4 cm) placed about 1 mm in front of the camera lens; the glass screen is 20 cm south from the beam splitter. The camera is oriented along the S-N direc-

⁷A rigorous critic may note another possibility. The variations in the fringe-shift may be so fast that they cannot be observed by the eye. The video camera, however, has a temporal resolution higher than the eye and did not show any instabilities in the interference pattern. Additionally, during 2005 we also took some series of observations every 15 seconds; the interference patterns were similar from one observation to the next. Hence, we stay reasonably certain in our claim that fringe-shifts between successive observations are smaller than 1 wavelength.

⁸Macroscopic length measured with an accuracy of 0.5mm.

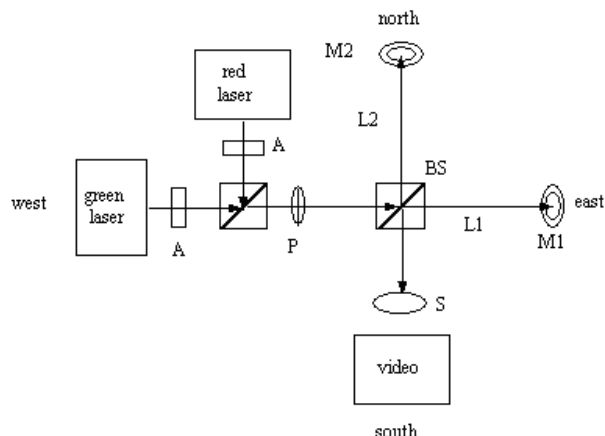

Fig. 5. Diagram of our experimental setup. $L_1 = L_2 = 2044$ mm, A = intensity absorber, BS = beam-splitter, M1 and M2 = end mirrors, P = polarizer, S = frost glass screen. Only one laser is on at a given time. To decrease effects due to air motion, the optical trajectory is enclosed inside a plastic tubing (approximately 3 cm diameter). To stabilize the air temperature, the tubing is surrounded by polystyrene insulation (approximately 5 cm thick). The beam splitter is also covered with thermal insulation fabricated of the same material. The small tables supporting the mirrors are also surrounded by polystyrene insulation; additionally, there is another layer of thermal insulating material mounted on wood. This second level of protection is intended to decrease effects due to vibration of the mirrors induced by sonic vibration of the air (i.e. to control noise from the street, and from low-flying airplanes). Additionally, there are cloth curtains surrounding the main concrete table along the south and west sides, to avoid noise vibrations from a main street (outside the campus) that is about 100 m away.

tion, and is placed on the south border of the concrete table. The video signal is sent by a 1m cable to a computer placed in the same room, but outside the concrete anti-vibration table. Figure 5 is a diagram of the experimental setup.

Each end mirror has two screws for vertical and horizontal adjustment. They are used to obtain an interference pattern containing some 7 fringes, each fringe has a width of 1 to 2 mm. The interference pattern is very stable, and remains the same over weeks. The laser has a built-in stability control; occasionally, after being in operation for more than 30 hr, the laser entered into recalibration mode. The measurements were then ended, and resumed when the laser was back into stable mode.

3.3. Expected fringe-shifts

The fringe-shifts to be expected in our interferometer can be calculated from eq. (17). To compare observations taken in different sessions we follow the usual

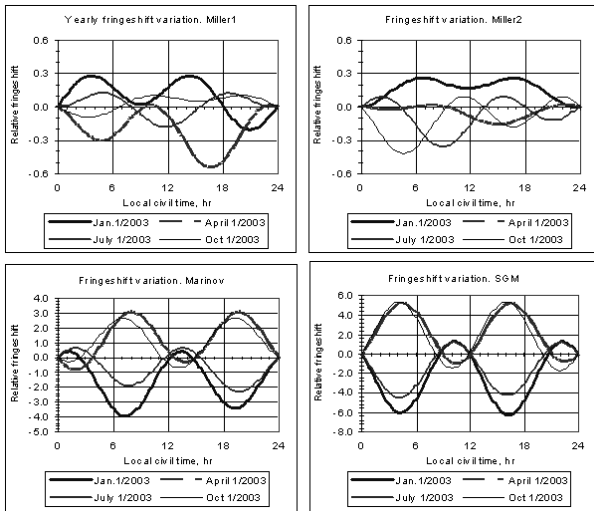

Fig. 6. Prediction of fringe-shifts at our CIF laboratory in Bogota (Colombia) for four scenarios of solar velocity, at four epochs during the year. Note the large variations in the shape of the curves, and their amplitudes, as a function of solar velocity. For further discussion see the text.

procedure of comparing against an arbitrary reference value, that, for the MM experiment, was the reading at the initial position of the interferometer. Since our interferometer is stationary let us take midnight (mn) as the reference position, so that the relative fringe-shift ΔF is given by

$$\Delta F = F(t) - F(\text{midnight}) = \frac{L}{\Lambda} (\beta_T^2 \cos 2\gamma - \beta_T^2(\text{mn}) \cos 2\gamma(\text{mn})) \quad (21)$$

As discussed in section 2, the shape of the curve ΔF versus local time of day t^* will depend of the actual value of solar velocity, which is unknown. Figure 6 shows the expected response of our interferometer for four scenarios of solar velocity in table 3: Miller1, Miller2, Marinov, SGM.

For a given solar velocity there are variations over the year. The shape of the curve may depict significant variations over the year, as in the case of Miller1 and Miller2, where the direction of solar motion is more or less perpendicular to the equatorial plane. If solar motion is nearly parallel to the equatorial plane, as in Marinov's and SGM's scenarios, the shape of the curve remains constant over the year, with the position of the minima shifting according to civil time. However, as shown in figure 7, the position of minima remains more or less stationary in sidereal time. The magnitude of solar velocity in the four scenarios is about the same, ranging from 200 to 390 km/s. The expected amplitude of fringe-shift shows a much larger variation, which is of fractions of wavelength in the case of Miller's estimates, to several fringes in the

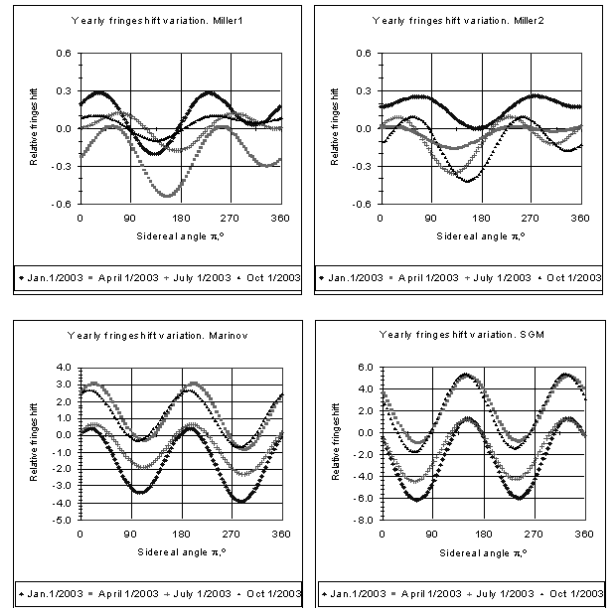

Fig. 7. Prediction of fringe-shifts at our CIF laboratory in Bogota (Colombia) for four scenarios of solar velocity, at four epochs during the year, in terms of sidereal angle σ , which is a proxy for sidereal time. Despite the large differences in the shape of the curves, the minima are concentrated in a small region (compare to figure 6 in terms of local civil time). The variations in position are larger for large declinations of solar velocity (Miller1, Miller2).

other two scenarios. These differences are caused, of course, by the different directions of solar motion. As argued elsewhere [36], the shape of the relative fringe-shift curve ΔF versus t^* may be used to obtain solar velocity. Section 4 describes the preliminary results of that exercise.

3.4. Operational tests

The design and setup of the experiment was carried over the year 2002. As mentioned in 3.1, the interval of measurement was chosen during the first semester of 2002 to assure that the interference pattern is almost identical from one measurement to the next. During that period we also checked for the possible existence of periodic vibrations in the concrete table and/or the video camera support. For this, we measured acceleration with an apparatus capable of discriminating 0.001g (where $g = 9.77m/s^2$ is the local gravitational acceleration); measurements were performed at different times of the day, and in particular during the evening rush hour (17:00 to 20:00), when heavy trucks and low-flying airplanes can be heard passing by. Accelerations along two horizontal directions (W-E and S-N) and along a direction normal to the concrete table were checked. Acceleration readings do not show periodic behavior, and the amplitude is at the noise

level (0.001g).

The interference pattern itself is extremely sensitive to ambient noise. However, only about five readings were lost during several weeks of tests. The reason for the high success rate is that the concrete table returns to rest within a few seconds after entering in vibration by, say, the passage of a heavy truck. The only perturbing external influence that completely destroyed the interference pattern during intervals of one to two minutes was the operation of an air compressor in a nearby laboratory. This is most likely due to the excitation of resonance modes in the damping system of the table. When the compressor was operating, we did not measure. Fortunately, the compressor was moved by the end of 2002 from that particular place.

We used two thermal sensors to check the thermal stability of the air around the interferometer. One of them was located next to the beam splitter, on top of the supporting table. The other one was located inside the laser beam enclosure, alternatively on the W-E and S-N arms. Most of the time, temperature is constant, within $\pm 0.2^\circ\text{C}$ (sensor sensitivity). Occasionally, during a 24-hour run there is one change of temperature either of $+0.4^\circ\text{C}$, or -0.4°C . Humidity and illumination were also checked during the experimental sessions. Illumination is constant because the room is always dark, but humidity is variable and is more or less periodic, with variations associated with solar motion. Hence, the effect of humidity must be corrected from our data (see section 4).

During the setup period it was also noted that the most difficult time to perform stable measurements was about the peak of the evening rush hour (18:00 to 19:30). To avoid the noisy environment during the week, it was decided to carry out our observations during weekends and holidays, as indeed done during 2003. Analysis of data from 2003 did not show peculiarities in the Friday evening data (when the interferometer started operation) [61], so that by the end of 2004 we started collection of data collection also during weekdays.

During October 2002 the temperature in the room housing the interferometer was continuously changed using four electrical oil-heaters. A variation in the room air temperature over a couple of degrees Celsius produced a severe change of the shape of interference patterns, which would make completely meaningless any experiment. Since November 2002, all measurements are made without any heating.

To check whether the observed variations in the fringe-shifts could possibly be ascribed to intrinsic periodic oscillations of the laser equipment we installed an alternative source of light: a conventional He-Ne laser manufactured by a Belgian company, also shown in figure 5. Consecutive series of data were taken with the green laser and the red laser in the period November 2002-October 2003. As reported elsewhere, the interference patterns taken with both lasers exhibit the

same cyclic behavior [58, 61]. Hence, the observed periodicities are not due to intrinsic cyclic variations of the light source.

After observing periodic behavior of the interference pattern during a whole year, both with the green and red lasers, it was also checked whether such behavior could be induced by periodic variations of the power supplied to the laser sources. This was done in November 2003. Large variations of voltage were imposed to the laser apparatuses that did not produce proportional effects on the interference patterns [61]. Hence, it may be concluded that the periodic oscillations in the fringe-shifts are not due to the daily voltage drops during the hours of high electricity consumption.

The analysis of the 2003 data suggests some instability in the laser apparatus during several hours immediately after turning the laser on [61]. Hence, from mid 2004 it was decided to use the green laser only, without ever turning it off after an experimental session.

3.5. Data recollection and raw data

A video camera permanently observes the image of the interference pattern on the frost glass screen (figure 5). This color image is captured every minute and stored in the computer using software developed by the Owaha Group of the Department of Systems Engineering of National University, for a total of 1440 images produced each day. Since each experimental session lasts several days, several thousand images in TIF format (about 300k each) are collected in each run. Each image is labeled with the date and civil time at the moment that the image was stored. Although the whole image is not required for our data reduction, we are keeping them all as evidence of our work, and for possible future re-analysis. The images obtained up to June 2005 occupy 306 CDs.

In the period 14 December 2002-18 October 2003 we took 30 runs with the green laser and 16 runs with the red laser. After being convinced that the periodicities were not instrumental artifacts, we decided to use only one laser. The green laser apparatus was exclusively used from 18 October 2003 to 10 June 2005; about 60 experimental runs were carried during this period, of which 41 series correspond to year 2004. During the year 2005 several runs of more than 10 days were taken. The laser was continuously powered from October 2004 to June 2005, when it entered a recalibration mode that did not reset itself; observations were stopped at that time.

Since 13 January 2003 onwards, during each experimental run we also registered temperature, humidity and light intensity at the end of each arm using small sensors manufactured by Hobo (USA); the sensors are located inside the wooden box enclosing the end mirrors. Temperature inside the eastern mirror enclosure varies at most 0.2°C during a weekend, but

Table 5. Correlation coefficients R between data from different sensors

Series	T(east mirror) vs. T(north mirror)	T(concrete table) vs. T(east mirror)	T(concrete table) vs. T(north mirror)	H(east mirror) vs. T(north mirror)
1	0.69	0.53	0.49	0.94
2	0.62	0.00	0.00	0.96
3	0.69	0.45	0.28	0.91
4	0.17	0.01	0.09	0.95
5	0.63	0.00	0.00	0.82
6	0.67	0.46	0.31	0.94
7	0.40	0.48	0.39	0.86
8	0.24	0.00	0.00	0.97
9	0.45	0.30	0.38	0.89
10	0.47	0.00	0.00	0.83
mean	0.50 ± 0.20	0.21 ± 0.27	0.15 ± 0.25	0.90 ± 0.06

temperature variations inside the northern mirror enclosure are somewhat larger; this effect is most likely due to variations in temperature outside the building (which are very large in Bogota) that are communicated through a former window covered with polystyrene, that is close to that end of the interferometer. Temperature of the concrete table immediately below the optical path of the WE arm is also recorded; its value is constant almost all time. Table 5 shows the coefficients of correlation between temperature T and relative humidity H at the eastern and northern mirrors, for 10 typical series during 2004 (one per month, the actual dates for each series is in figure 10). As expected, humidity is highly correlated, but temperature is not, due to the influence of external ambient temperature through the former window near the northern mirror. The zero correlation between mirror temperature and table temperature is produced by a completely constant temperature of the concrete table during the whole duration of the run. The average values in last line of table 5 were calculated for all 41 series taken during 204.

After collecting the images, the next step is to obtain the position of a fringe as function of time; this is done off-line using a computer program written by one of us [61]. A digital profile of each image is obtained across a thin two-dimensional window placed upon the

image. The position (in pixels) of this window is the same during a given run. The light intensity in the image is converted to a scale between 0 (= dark) to 255 (= bright). In the digital profile a minimum value is a dark fringe, while a maximum value corresponds to a bright fringe; our analysis is based on the position of dark fringes in the image taken at local time t^* . The position of a certain dark fringe is followed in all consecutive images taken during a given run. This process immediately produces fringe position in pixels versus local civil time. To increase the robustness of our measurement, we calculated the average fringe-shift of two or three consecutive fringes in each image, relative to the first image in a run. The average fringe-shift versus local civil time, obtained by the computer program without direct human intervention, constitutes the empirical output from an observational run. Figure 8 is a typical example of a run with the green laser during the period from 02 to 08 September 2003. The periodical behavior of the fringe-shifts is evident, and is similar to the expected curves shown in figure 6. **Figure 8 is labeled “raw data” in the sense that no corrections have been applied to the data so far; the input to our analysis, which strictly is the raw data, is formed by the images of the interference patterns.**

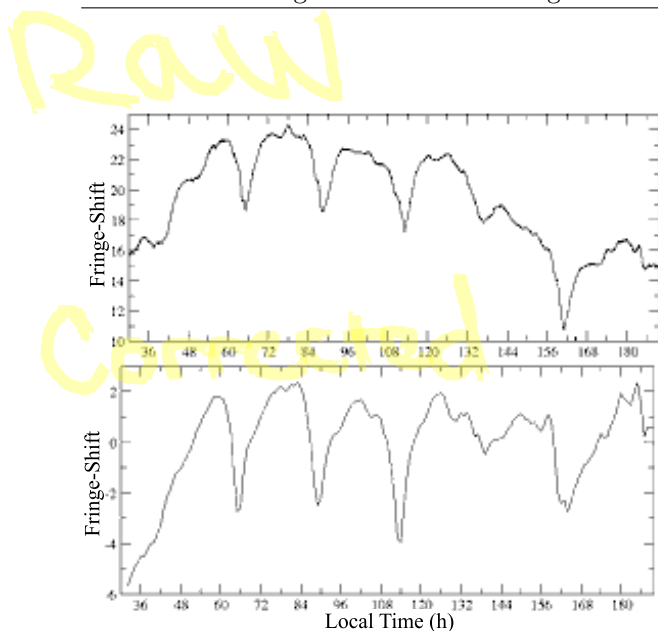

Fig. 8. Fringe-shift versus local time, as observed in the period 02 to 08 September 2003 with the green laser. Above: raw data, below: fringe-shift corrected for ambient humidity and pressure. The lower graph shows a residual curve with a periodicity similar to the original curve, with a smaller amplitude, and well defined minima.

4. Analysis of data

4.1. Environmental effects

As noted in section 3.4, environmental humidity of air varies periodically according to the daily rotation of earth, and the magnitude of fringe-shift also varies in a similar manner. If the variation in the fringe-shifts is *caused* by the humidity variations, then the humidity effect, and any other causative periodical effect, must be subtracted from the “raw data” curve. However, it may happen that humidity and fringe-shift are not causally related, and that the correlation may be due to the existence of a common cause. In that case, a subtraction of the humidity component would amount to elimination of the effect that we are searching for. Finally, it may happen that a part of the fringe-shift variation is caused by environmental effects, and the remaining variation by the common cause directly; in that case a stochastic correction totally eliminating the correlation between fringe-shift and the environmental variables amounts to an over-correction, leading to a residual curve whose amplitude is smaller than it should be.

The influence of ambient temperature and pressure upon the index of refraction of air was already known to Michelson, who corrected for such effect in his measurements of the speed of light [7], but did not consider them in the interference experiments [1,9]. With

regard to the index of refraction, Michelson’s decision was correct. Indeed, using a modern semi-empirical equation [62], we have estimated the effect of variations of temperature, pressure and humidity upon our interferometer [61, ch.3], to find that the fringe-shifts induced by changes in the index of refraction are much lower than the resolution of our experiment.

Ambient temperature was mentioned by Michelson as a significant source of experimental error in his 1881 experiment [9], but was ignored in the analysis of the 1887 MM experiment [1]. In his analysis of the MM experiment, Hicks [25] suggested that the monotonic drift of fringe-shifts was due to a thermal effect. Miller recognized the importance of temperature and built apparatuses in different materials, hence, with different coefficients of thermal expansion. Additionally, Miller tried to control for temperature variations, and checked whether it was possible to obtain periodical effects on the fringe-shifts from temperature variations in the interferometer room [22]. In a re-analysis of Miller’s work, Shankland and collaborators attributed Miller’s periodical fringe-shifts to periodical thermal variations [28]. Even the recent Stanford experiment — carried out at a temperature close to absolute zero with an extremely tight control of temperature variation (within $10^{-5}K$, according to the authors [63]) — attributed the observed periodical frequency-shifts to mechanical effects induced by temperature! However, although the influence of temperature is usually recognized, no effort is done to eliminate such temperature effect during the data reduction process.

As mentioned above, variation in the index of refraction along the optical path produces a negligible fringe-shift [61], so that the most important effect of temperature is thermal expansion and contraction of the interferometer, thus changing the values of L_1 and L_2 . To decrease the variations in optical length, our experiment is set upon a concrete table that has a low coefficient of thermal expansion. However, the supports for the mirrors, which are fixed directly to the concrete, are fabricated in brass, so that thermal effects due to expansion of the metallic parts must be expected. Theoretical calculation of such expansion would require a detailed knowledge of the distribution of temperature, which is not available.

In view of such difficulties, during the analysis of the data taken during 2003 [61], it was decided to implement a stochastic correction for the effect of the three environmental parameters: relative humidity (H), pressure (P), and temperature (T). The correlation between fringe-shift F and each parameter is found for each series. A linear regression is then obtained between F , and, say, H . This gives the maximum value of fringe-shift that could be attributed to the environmental variable H . If this value is subtracted from the raw data, a corrected fringe-shift F^* is obtained that is not correlated any longer to H . The same procedure is now applied to the other two envi-

ronmental variables P and T, using in each case the most recently corrected F^* .

Due to limitations in the storage of data at the sensors, H and T are taken at intervals that vary from 1 to 5 minutes, depending upon the duration of the run. The correction calculated in previous paragraph is thus applied to the average fringe-shift during the appropriate interval. For pressure we did not have a micro-barometer with the required accuracy. During 2003 we used for the stochastic correction the data collected hourly at the Eldorado International Airport, some 15 km away from the National University campus. So that, for the pressure correction, we had to average the fringe-shifts over one-hour periods, thus decreasing the temporal resolution [61]. For the analysis in the present paper we rather used synthetic monthly pressure curves derived from 20 year averages taken at a meteorological station on the campus of National University [64]. In this way the averaging of fringe-shifts is done over equal intervals for the 3 parameters H, P, and T.

The largest corrections are produced by H and P. After correcting for H and P (in that order), the curve F^* has a low correlation with H shown in the second column of table 6 and no correlation with P, but the correlation with T is still large, as shown in the third column of table 6. After applying the correction for temperature, its correlation with T disappears, but the correlations with H and P slightly increase as shown in columns 4 and 5 of table 6. The averages shown in last row of the table are calculated over the 41 runs taken in 2004. We also explored the application of the corrections in a different order, say P,H,T; the residual correlations are somewhat larger but still very low.

The lower graph in figure 8 is a typical example of the residual curve after correction for H and P. Note that, although the amplitude is decreased, the periodicity is enhanced by the correction process. However, the amplitude of the final residual curve amounts to several fringes. As shown in last column of Table 6, the final curves have a low correlation to the environmental variables, which means that the procedure used here for eliminating environmental effects was successful.

However, as implicitly noted at the beginning of this section, and recalling that variations in the index of refraction can not explain the large observed fringe-shifts, there remains a fundamental question: what is the physical mechanism that may explain the large effect of humidity and pressure upon fringe-shift. For this reason, in the following we show both the corrected curves and the raw curves.

4.2. Typical corrected fringe-shift curves.

From the 41 experimental runs during 2004, we have

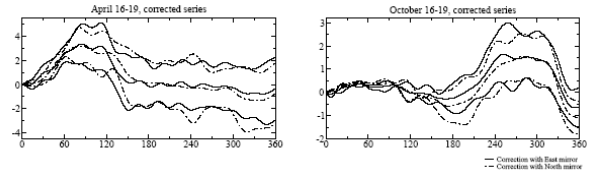

Fig. 9. Average fringe-shift curve for April (left) and October (right), corrected for H and T as measured at the eastern mirror (continuous line) and northern mirror (dashed line). The months were chosen for having a very low correlation between the temperatures at the two mirrors. The shapes of the corrected curves are similar, independently of the correction process. The one-sigma error band is shown in all cases.

selected a long run (several days) about the middle of each month as typical of that particular month;⁹ the dates of the runs are indicated in table 7 and figure 10. Each run is divided into 24 sidereal hours periods, and the fringe-shift at each midnight is taken as a reference for that particular day; this means that the relative fringe-shift at midnight is always zero. The relative fringe-shifts at other times of the day are averaged over the several days in the run. Figure 9 shows the average fringe-shift curve for the month of April, corrected for H and T as measured at the eastern mirror, compared in the same graph to the curves corrected with data taken at the northern mirror. Both corrected curves have the same general shape, thus hinting to an underlying physical process that cannot be removed by the environmental correction. As seen in table 5 (series 4), temperature at the northern mirror was not correlated in April to temperature measured at the eastern mirror. The right-hand-side of figure 9 shows the same curves for the month of October 2004 (series 8 in table 5). Once again, the temperatures at the eastern and northern mirrors are not correlated, while the corrected curves are quite similar, thus hinting again to the existence of an underlying physical mechanism different from the mere environmental variations. The one sigma statistical error bands are also shown in the figure.

Since the shapes of the corrected curves are similar using the values of H and T measured at either the eastern or the northern mirror, in the following we concentrate on the curves with the corrections based on the eastern mirror. Figure 10 shows the corrected curves for the 10 months analyzed in 2004, with the one-sigma error bands. The error only contains the statistical variation over the several days that form the series. Other experimental and/or data reduction errors are not included; for instance, the error arising from the fact that pressure correction was based on

⁹Two months are missing during a period of distress (May and June) induced by the robbery of the video camera by the end of April 2004.

Table 6. Correlation coefficients R of intermediate and final series, after correction with data taken by sensors located at east mirror

Series	Series corrected with H and P		Final series corrected with H,P and T	
No.	Correlation with H	Correlation with T	Correlation with H	Correlation with P
1	-0.01	-0.19	+0.12	-0.01
2	+0.01	-0.25	+0.09	-0.07
3	-0.01	-0.74	+0.18	-0.06
4	-0.10	-0.01	-0.10	+0.00
5	-0.01	-0.64	-0.11	-0.06
6	-0.03	-0.64	+0.11	+0.03
7	+0.04	-0.11	-0.03	-0.01
8	+0.00	-0.31	-0.12	-0.05
9	+0.01	-0.29	+0.03	-0.05
10	-0.11	-0.39	+0.15	-0.12
mean	0.00 ± 0.09	-0.26 ± 0.29	0.00 ± 0.12	-0.04 ± 0.09

a synthetic curve rather than on observed pressures. Note that the error band contracts at some points. The amplitude of the residual curves is of several fringes, while the position of the minima varies over the year.

Some of the sessions are identified by the date followed by the letters INV; some explanation is required. When the fringes move to the right (or up, depending upon the interference pattern), the computer program arbitrarily defines that sense as an increase of the position of the fringe-curves; however, it could be a decrease in position. This is due to the orientation of the reflecting mirrors, that are modified during the process of calibration of the interferometer.¹⁰ Then, the empirical curves may be plotted with the sign assigned by the computer, or with the opposite sign; the latter produces an inversion of the curves, denoted by the letters INV. The curves (direct, or inverted) were selected for consistency with our theoretical expectations.

4.3. Solar velocities consistent with observations.

We turn now to a preliminary analysis of possible solar velocities consistent with our empirical observations. The main features of the fringe-shift curves are the position of the two minima in terms of angle σ in degrees (\circ), and the amplitude A in fringes, understood as the difference between the maximum and minimum values of the curve. Table 7 shows the amplitudes for the original and corrected curves, the latter information is also contained in figure 10. In general, the environmental correction decreases the amplitude of the fringe-shift curve. The most interesting feature of the corrected curves is the variation of amplitude

during the year. During the four months from July to October 2004 the amplitude is much smaller than in the rest of the year, which is, of course, confirmed by the partial averages shown in table 7. At first sight this empirical observation is counter-intuitive, however, some reflection indicates that this result must be induced by the direction of solar motion.

By direct numerical calculation in a simple computer program written in Excel, it is found that when the right ascension of solar motion is in the range 170° to 190° the observed ordering of amplitudes is reproduced. When right ascension is outside this range, the ordering of amplitudes is completely different, for instance, amplitudes during July-October may be the highest. The second half of table 7 shows the amplitudes calculated for two solar velocities, namely: $V1 = 350$ km/s, $\alpha = 175^\circ$, $\delta = -50^\circ$, and $V2 = 300$ km/s, $\alpha = 185^\circ$, $\delta = -50^\circ$. As expected, the value of the amplitude of the fringe-shift is directly linked to the value of solar speed.

The fringe-shift curves calculated with V2 are shown in figure 10. It may be seen that there is a reasonable agreement with the observations, with the theoretical curves within the one-sigma error band in most cases. From the previous qualitative analysis it may be said that the solar motion consistent with our observations may be in the range 300 to 360 km/s, with right ascension from 170° to 190° , and declination between -45° and -55° . No additional quantitative analysis is presented at this stage. This matter will be pursued together with the analysis of the data taken during 2005, that we are currently advancing.

5. Closing remarks

Following Miller's pioneering efforts, we have carried out an adialeptometric experiment using a sta-

¹⁰As noted long ago by Hicks [25], this is the same mechanism that produce increasing or decreasing trends during the original MM experiment.

Table 7. Amplitudes of the fringe-shift curves in year 2004

No.	Session Dates	Original	Corrected		Calculated V1		Calculated V2	
		A, fringes	A, fringes	Partial Average	A, fringes	Partial average	A, Fringes	Partial average
1	Jan19-27	4.0	3.0	3.7	3.1	2.8	2.5	2.2
2	Feb13-16	5.0	4.2		3.0		2.3	
3	Mar19-23	6.3	3.5		2.6		2.0	
4	Apr16-19	5.1	4.1		2.4		1.8	
5	Jul19-24	3.2	2.7	2.2	2.1	2.5	1.5	1.8
6	Aug13-17	2.4	1.6		2.3		1.6	
7	Sep10-13	1.9	1.3		2.6		1.8	
8	Oct16-19	3.6	2.3		2.9		2.1	
9	Nov18-21	3.5	3.9	4.4	3.2	3.2	2.4	2.4
10	Dec17-23	5.4	4.8		3.3		2.5	

tionary Michelson-Morley interferometer at our CIF laboratory in Bogota (Colombia) for almost two years from the end of 2003 to June 2005; the present paper reports the results for year 2004. After correcting for environmental variables, we identified large fringe-shifts, whose period most likely is a sidereal day. To provide a context for the new experimental results presented in this paper, we started by discussing the meaning of speed of light at the time of Einstein, and presented next the evidence then available for its constancy. It was argued that the evidence provided by the original MM experiment and its various repetitions is not as strong as usually believed, thus justifying our new experiment, where we tried to correct for the main weaknesses uncovered.

The fringe-shift curves observed in Bogota are consistent with the predicted curves using a constant speed of light in a preferred frame, that adds vectorially to the laboratory velocity using Galilean addition. From the qualitative analysis performed so far, it may be said that the solar motion that explains our observations is in the range 300 to 360 km/s, with right ascension from 170° to 190°, and declination between -45° and -55°. This value is similar to other modern estimates of solar velocity (recall table 3), for instance Smoot and his team [49] found a solar speed of 390 ± 60 km/s, in the direction $\alpha = 165^\circ \pm 9^\circ$, $\delta = +6^\circ \pm 10^\circ$, while Marinov [48] obtained 303 ± 20 km/s, $\alpha = 214^\circ \pm 5^\circ$, $\delta = -23^\circ \pm 4^\circ$. The declination is the controlling factor for the relative depth of the two minima in the fringe-shift curves. The value consistent with our curves seems to point towards the southern celestial pole, as in Miller's observations, and seems larger than the value of either SGM or Marinov.

Finally, it is noted that the recent experiment by the Stanford group [63] amounts to a vertical interferometer. As already pointed out elsewhere [58], the Stanford curves are very similar to our own raw curves, for instance figure 8, but they were interpreted as caused

by thermal effects. It is noted that the Stanford group tried to interpret (without success) the variation of their parameters in terms of the annual orbital motion of earth. As noted in section 4, and as can be gathered from figure 10, the shape of the fringe-shift curves does not follow a simple sequence. Then, if a curve is fitted to each monthly fringe-shift curve (as done by the Stanford group) the parameters of the fitting curve do not follow a simple pattern, as incorrectly expected in that paper.

Acknowledgements

This experiment was carried out at the Centro Internacional de Física (CIF) in Bogota, using optical and laser equipment kindly provided by Prof. Dr. Eduardo Posada, Director of CIF; J. Garcia and I. Lopez, members of CIF's staff, designed and built the accelerometer. The data acquisition system was furnished by the principal investigator; Munch Engineering (USA) provided funds for the sensors, and Thomas Goodey (England) provided a new video camera (to replace the original one stolen in April 2004).

For the manual observation of the interferometer during 2002, the authors counted with the help of N. F. Munera, P. R. Gis, C. Carrillo, G. Carrillo and R. Rojas; the latter also manufactured the polystyrene thermal insulation around the interferometer. The software for the automatic data gathering was developed by Professor M. G. Forero and his students C. Gomez and D. Vejar of Owaha Group, Faculty of Engineering, National University. The Faculty of Sciences and the Department of Physics of National University at Bogota have allowed the three authors to use a minor percentage of their working time to carry out this experiment and for advancing the theoretical research. Discussions with our colleagues V. Tapia, R. Amezcua and Y. Mejia are gratefully acknowledged.

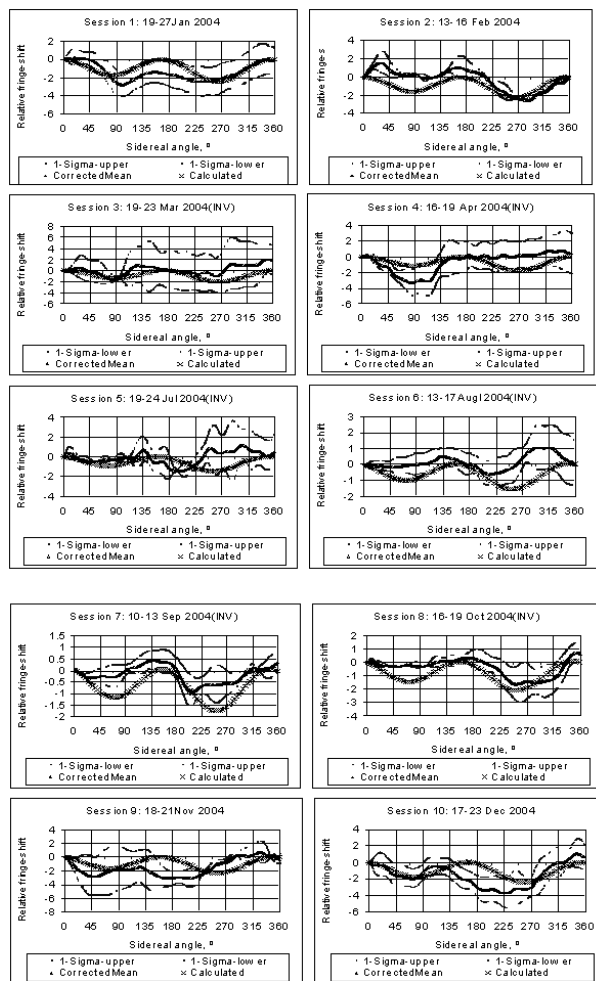

Fig. 10. Fringe-shift curves corrected for environmental variables for the 10 months observed in 2004. Note the variation of amplitude during the year (somewhat concealed by the different vertical scales). The one-sigma error band is the standard deviation calculated for the number of days in the series. The theoretical fringe-shift, shown by the crosses, was calculated for a solar motion of 300 km/s in the direction $\alpha = 185^\circ$ and $\delta = -50^\circ$.

Manuscript received May 12, 2006

References

[1] A.A. Michelson and E.W. Morley, “On the relative motion of the earth and the luminiferous ether”, *Am. J. Sci. Series 3*, 34 (203) 333-345 (Nov. 1887), and *Philosophical Magazine* (London), Series 5, 24 (151) 449-463 (Dec. 1887).

[2] C.B. Chiu, J.P. Hsu, and T.N. Sherry, “Prediction of variation of the speed of light measured by stable clocks”, *Phys. Rev. D* 16 (8) 2420-2423 (1977).

[3] Shing-Fai Fung and K.C. Hsieh, “Is the isotropy of the speed of light a convention?”, *Am. J. Phys.* 48 (8) 654-657 (1980).

[4] C. Nissim-Sabat, “Can one measure the one-way velocity of light?”, *Am. J. Phys.* 50 (6) 533-536 (1982).

[5] J.P. Wesley, “Proposed tachometer for absolute velocity”, *Phys. Essays* 2, 334 (1989), and *Advanced Fundamental Physics*, Benjamin Wesley, Blumberg, Germany (1991).

[6] A.A. Michelson, “Preliminary experiments on the velocity of light”, *The Astrophysical Journal* 60, 256-261 (1924).

[7] A.A. Michelson and F. Pearson, “Measurement of the velocity of light between Mount Wilson and Mount San Antonio”, *The Astrophysical Journal* 65 (1) 1-22 (1927).

[8] D. Halliday and R. Resnick, *Physics for Students of Science and Engineering*, Wiley, New York (1960).

[9] A.A. Michelson, “The relative motion of the earth and the luminiferous ether”, *Am. J. Sci. Series 3*, 22, 120-129 (1881).

[10] R.S. Shankland, “Conversations with Albert Einstein”, *Am. J. Phys.* 31 (1) 47-57 (1963).

[11] J. Stachel, “Einstein and the ether drift experiments”, *Physics Today* 40 (5) 45-47 (1987).

[12] J. Renn and R. Schulmann (editors), S. Smith (translator), *Albert Einstein-Mileva Maric, The Love Letters*, Princeton University Press, Princeton (1992) 107 pp.

[13] H.A. Lorentz, *Versuch einer Theorie der elektrischen und optischen Erscheinungen in bewegten Körpern*, Brill, Leiden (1895).

[14] P. Drude, *Lehrbuch der Optik*, Hirzel, Leipzig (1900). English translation as *The Theory of Optics* (1902), unabridged republication by Dover Publications, New York (1959).

[15] R.S. Shankland, “Michelson-Morley experiment”, *Am. J. Phys.* 32 (1) 16-35 (1964).

[16] W. Wien, “Ueber die fragen, welche die translatorische Bewegung des Lichtaethers betreffen”, *Annalen der Physik und Chemie* 65 (3) 1-17 (1898).

[17] G. Holton, “Einstein, Michelson, and the ‘crucial’ experiment”, *Isis* 60 (2) 133-197 (1969).

[18] G. Holton, “Einstein and the ‘crucial’ experiment”, *Am. J. Phys.* 37 (10) 968-982 (1969).

- [19] W.F. Edwards, "Special relativity in anisotropic space", *Am. J. Phys.* 31 (7) 482-489 (1963).
- [20] B. Townsend, "The special theory of relativity and the one-way speed of light", *Am. J. Phys.* 51 (12) 1092-1096 (1983).
- [21] R.S. Shankland, "Michelson's role in the development of relativity", *Applied Optics* 12 (10) 2280-2287 (1973).
- [22] D.C. Miller, "The ether-drift experiment and the determination of the absolute motion of the earth", *Revs. Mod. Phys.* 5, 203-242 (1933).
- [23] H.A. Munera, "Michelson-Morley experiments revisited: systematic errors, consistency among different experiments, and compatibility with absolute space", *Apeiron* 5 (1-2) 371-376 (1998).
- [24] H.A. Munera, "The evidence for Lorentz-contraction at the turn of the 20th century: Nonexistent", 77-92 in V.V. Dvoeglazov (ed), *Einstein and Poincare: the Physical Vacuum*, Apeiron Press, Montreal (2005).
- [25] W.M. Hicks, "On the Michelson-Morley experiment relating to the drift of the aether", *Philos. Mag. Series 6*, 3 9-42 and 256 (1902).
- [26] H.A. Munera, "The missing statistical analysis in the original 1887 Michelson-Morley experiment" presented at ICPE2005 International Conference on Physics Education: World View on Physics Education 2005: Focusing on Change, New Delhi, India (21-26 August 2005).
- [27] M.A. Handschy, "Re-examination of the 1887 Michelson-Morley experiment", *Am. J. Phys.* 50 (11) 987-990 (1982).
- [28] R.S. Shankland, S. W. McCuskey, F. C. Leone, and G. Kuerti, "New analysis of the interferometric observations of Dayton C. Miller", *Revs. Mod. Phys.* 27 (2) 167-178 (1955).
- [29] J. De Meo, "Dayton Miller's ether drift experiments: A fresh look", *Pulse of the Planet* 5, 114-130 (2002).
- [30] J.-P. Vigièr, "Relativistic interpretation (with non-zero photon mass) of the small ether drift velocity detected by Michelson, Morley and Miller", *Apeiron* 4 (2-3) 71-76 (1997).
- [31] M. Allais, *L'Anisotropie de L'Espace*, Editions Clement Juglar, Paris (1997) 757 pp.
- [32] M. Allais, "The experiments of Dayton C. Miller (1925-1926) and the theory of relativity", *21st Century* 11 (1) 26-33 (1998).
- [33] L. Hecht, "Optical theory in the 19th century and the truth about Michelson-Morley-Miller", *21st Century* 11 (1) 35-50 (1998).
- [34] M. Allais, "Des regularites tres significatives dans les observations interferometriques de Dayton C. Miller 1925-1926", *Compt. Rend. Acad. Sci.(Paris), Serie II*, 327, 1405-1410 (1999); "Nouvelles regularites tres significatives dans les observations interferometriques de Dayton C. Miller 1925-1926", *Compt. Rend. Acad. Sci.(Paris), Serie II*, 327, 1411-1419 (1999); and, "L'origine des regularites constatees dans les observations interferometriques de Dayton C. Miller 1925-1926: variations de temperature ou anisotropie de l'espace", *Compt. Rend. Acad. Sci. (Paris) serie IV*, 1, 1205-1210 (2000).
- [35] H.A. Munera, E. Alfonso, and G. Arenas, "Empirical verification of the existence of large fringe-shifts in the original Michelson-Morley and Miller experiments, and a novel interpretation of its origin", *Journal of New Energy* 6 (4) 185-209 (2002).
- [36] H.A. Munera, "The effect of solar motion upon the fringe-shifts in a Michelson-Morley interferometer a la Miller", *Annales de la Fondation Louis de Broglie* 27 (3) 463-484 (2002).
- [37] R.J. Kennedy and E. M. Thorndike, "Experimental establishment of the relativity of time", *Phys. Rev.* 42, 400-418 (1932).
- [38] H.P. Robertson, "Postulate versus observation in the special theory of relativity", *Revs. Mod. Phys.* 21 (3) 378-382 (1949).
- [39] A. Brillat and J. L. Hall, "Improved laser test of the isotropy of space", *Phys. Rev. Lett.* 42 (9) 549-552 (1979).
- [40] T. S. Jaseja, A. Javan, J. Murray, and C.H. Townes, "Test of special relativity or of the isotropy of space by use of infrared masers", *Phys. Rev.* 133 (5A) A1221-A1225 (1964).
- [41] J.P. Cedarholm, G. F. Bland, B.L. Havens, and C.H. Townes, "New experimental test of special relativity", *Phys. Rev. Lett.* 9, 342-343 (1958).
- [42] J.P. Cedarholm and C.H. Townes, "A new experimental test of special relativity", *Nature* 184, 1350-1351 (1959).
- [43] J. Muller and M.H. Soffel, "A Kennedy-Thorndike experiment using LLR data", *Phys. Lett. A* 198, 71-73 (1995).
- [44] P. Wolf and G. Petit, "Satellite test of special relativity using the global positioning system", *Phys. Rev. A* 56 (6) 4405-4409 (1997).

- [45] C. Lammerzahn and M.P. Haugan, "On the interpretation of Michelson-Morley experiments", *Phys. Lett. A* 282, 223-229 (2001).
- [46] D. H. DeVorkin, *Practical Astronomy*, Smithsonian Institution Press, Washington and London (1986) 109 pp.
- [47] P. Duffett-Smith, *Practical Astronomy With Your Calculator*, 3rd. Edition, Cambridge University Press (1988) 185 pp.
- [48] S. Marinov, "Measurement of the laboratory's absolute velocity", *Gen. Rel. and Grav.* 12 (1) 57-66 (1980).
- [49] G.F. Smoot, M. V. Gorenstein and R.A. Muller, "Detection of anisotropy in the cosmic blackbody radiation", *Phys. Rev. Lett.* 39 (14) 898-901 (1977).
- [50] W. Ritz, "Recherches critiques sur l'électrodynamique generale", *Annales de Chimie et de Physique*, series 8, 13, 145-275 (1908).
- [51] Q. Majorana, "Experimental demonstration of the constancy of velocity of the light emitted by a moving source", *Philos. Mag. Series 6*, 37, 145-150 (1919).
- [52] J.G. Fox, "Evidence against emission theories", *Am. J. Phys.* 33 (1) 1-17 (1965).
- [53] O. Lodge, "On Prof. Miller's ether-drift experiments", *Nature* 117 (2955) 854 (June 19, 1926).
- [54] E.W. Morley and D.C. Miller, "An experiment to detect the Fitzgerald-Lorentz effect", *Philos. Mag. Series 6*, 9, 680-685 (1905).
- [55] A.A. Michelson, "Conference on the Michelson-Morley experiment held at the Mount Wilson Observatory, Pasadena, California, February 4 and 5, 1927", *Astrophysical Journal* 68 (5) 342-345 (1928); H.A. Lorentz, *Ibidem* 345-351; D. C. Miller, *Ibidem* 352-367; R.J. Kennedy, *Ibidem* 367-373; E. R. Hedrick, *Ibidem* 374-385; P.S. Epstein, *Ibidem* 385-389; Discussion, *Ibidem* 389-402.
- [56] J.J. Nassau and P.M. Morse, "A study of solar motion by harmonic analysis", *Astrophysical Journal* 65 (2) 73-85 (1927).
- [57] G. Buffo, "Proposición y fundamentos para un nuevo enunciado sismológico" (Foundations for a novel sismological principle), published in *Los Principios*, Cordoba, Argentine (1958). Reprinted as an appendix, pages 160-184, in G. Diaz-Daniele and K. Rodriguez-Sinder, *Guido Buffo y El Templo del Pendulo*, Editorial El Pais, Santa Cruz, Bolivia (without date, in the 1990's).
- [58] H.A. Munera, J.E. Alfonso, and G. Arenas, "Preliminary observations with a stationary Michelson-Morley interferometer close to the equator", *Journal of New Energy* 7 (3) 101-105 (2003).
- [59] R.J. Kennedy, "A refinement of the Michelson-Morley experiment", *Proceedings National Academy of Sciences* 12, 621-629 (1926).
- [60] K.K. Illingworth, "A repetition of the Michelson Morley experiment using Kennedy's refinement", *Phys. Rev.* 30, 692-696 (1927).
- [61] D. Hernandez-Deckers, *Reduccion de datos del experimento con interferometro estacionario de Michelson-Morley-Miller (Data reduction in the Michelson-Morley-Miller experiment with stationary interferometer)*, Thesis for a B.Sc. in Physics, National University, Bogota, Colombia (2005) 77 pp.
- [62] R.K. Leach, *Calibration, traceability and uncertainty issues in surface texture metrology*, Centre for Basic Thermal and Length Metrology, Middlesex, UK (1999).
- [63] J.A. Lipa, J.A. Nissen, S. Wang, D.A. Stricker, and D. Avaloff, "A new limit on signals of Lorentz violation in electrodynamics", *Phys. Rev. Lett.* 90, 060403 (2003).
- [64] J.A. Eslava, *Regimen de la presión atmosférica en Colombia (Regime of atmospheric pressure in Colombia)*, Academia Colombiana de Ciencias Exactas, Físicas y Naturales, No. 8, Bogota, Colombia (1995).

Annex 1. Four year cycle used for the calculations, σ = Sidereal angle at noon GMT

Date	t,	Sidereal	Date	t,	Sidereal
2000-01	days	angle $\sigma,^\circ$	2001-02	days	angle $\sigma,^\circ$
Mar 21, 00	0	0.0	Mar 21, 01	365	359.8
Apr 1, 00	11	10.8	Apr 1, 01	376	10.6
May 1, 00	41	40.4	May 1, 01	406	40.2
Jun 1, 00	72	71.0	Jun 1, 01	437	70.7
Jul 1, 00	102	100.5	Jul 1, 01	467	100.3
Aug 1, 00	133	131.1	Aug 1, 01	498	130.8
Sep 1, 00	164	161.6	Sep 1, 01	529	161.4
Oct 1, 00	194	191.2	Oct 1, 01	559	191.0
Nov 1, 00	225	221.8	Nov 1, 01	590	221.5
Dec 1, 00	255	251.3	Dec 1, 01	620	251.1
Jan 1, 01	286	281.9	Jan 1, 02	651	281.6
Feb 1, 01	317	312.4	Feb 1, 02	682	312.2
Mar 1, 01	345	340.0	Mar 1, 02	710	339.8
Mar 21, 01	365	359.8	Mar 21, 02	730	359.5

Date	t,	Sidereal	Date	t,	Sidereal
2002-03	days	angle $\sigma,^\circ$	2003-04	days	angle $\sigma,^\circ$
Mar 21, 02	730	359.5	Mar 21, 03	1095	359.3
Apr 1, 02	741	10.3	Apr 1, 03	1106	10.1
May 1, 02	771	39.9	May 1, 03	1136	39.7
Jun 1, 02	802	70.5	Jun 1, 03	1167	70.2
Jul 1, 02	832	100.0	Jul 1, 03	1197	99.8
Aug 1, 02	863	130.6	Aug 1, 03	1228	130.3
Sep 1, 02	894	161.2	Sep 1, 03	1259	160.9
Oct 1, 02	924	190.7	Oct 1, 03	1289	190.5
Nov 1, 02	955	221.3	Nov 1, 03	1320	221.0
Dec 1, 02	985	250.8	Dec 1, 03	1350	250.6
Jan 1, 03	1016	281.4	Jan 1, 04	1381	281.2
Feb 1, 03	1047	312.0	Feb 1, 04	1412	311.7
Mar 1, 03	1075	339.5	Mar 1, 04	1441	340.3
Mar 21, 03	1095	359.3	Mar 21, 04	1461	0.0