

C l a s s i c a l
M E C H A N I C S
T H I R D E D I T I O N

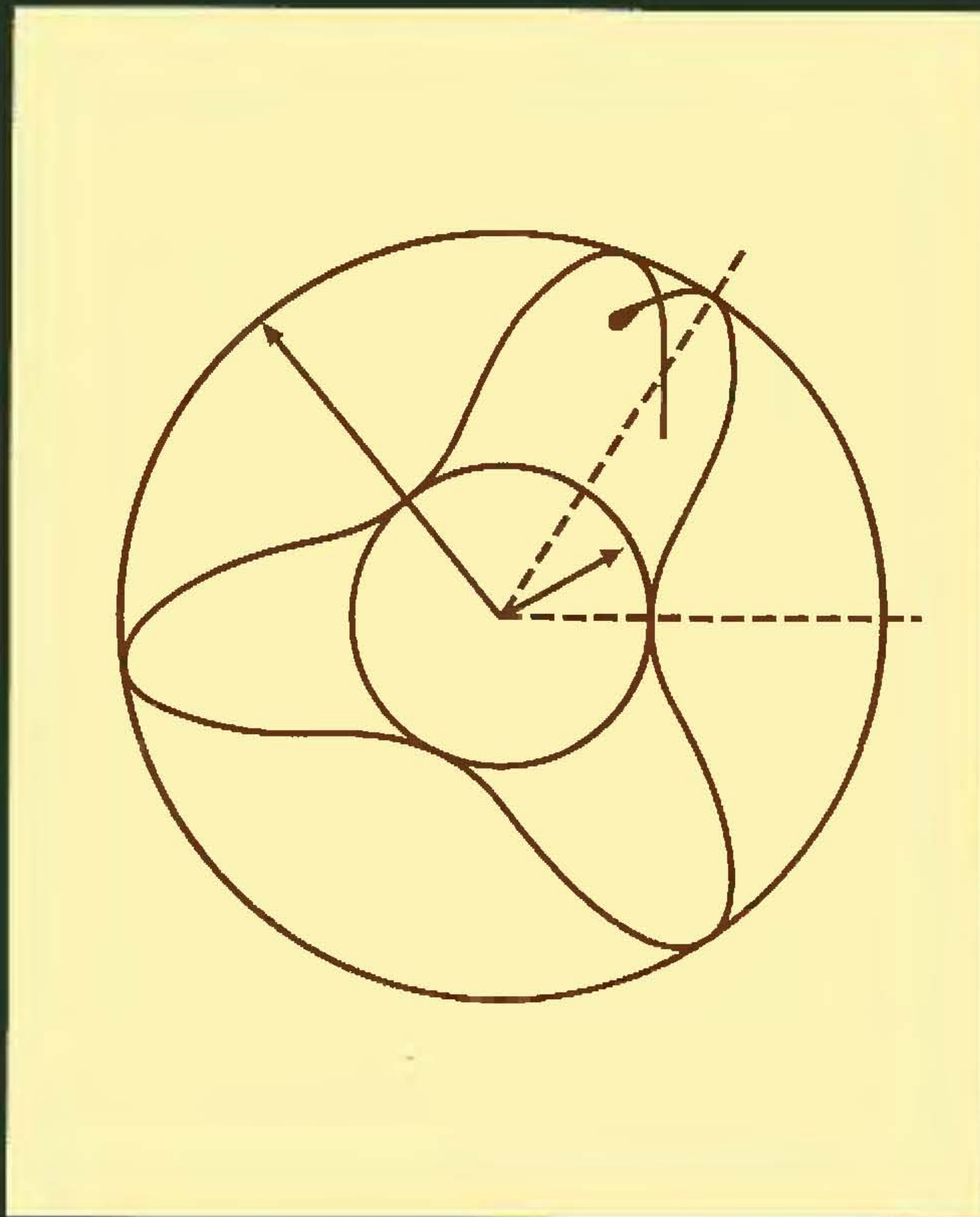

G o l d s t e i n
P o o l e & S a f k o

CLASSICAL MECHANICS

THIRD EDITION

Herbert Goldstein

Columbia University

Charles Poole

University of South Carolina

John Safko

University of South Carolina

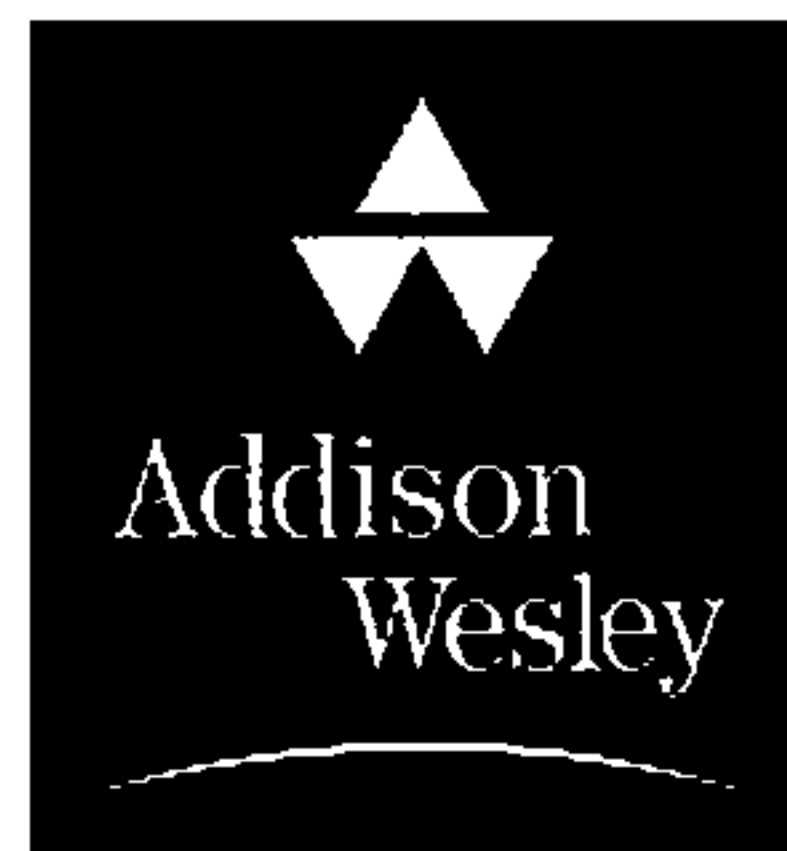

San Francisco Boston New York
Capetown Hong Kong London Madrid Mexico City
Montreal Munich Paris Singapore Sydney Tokyo Toronto

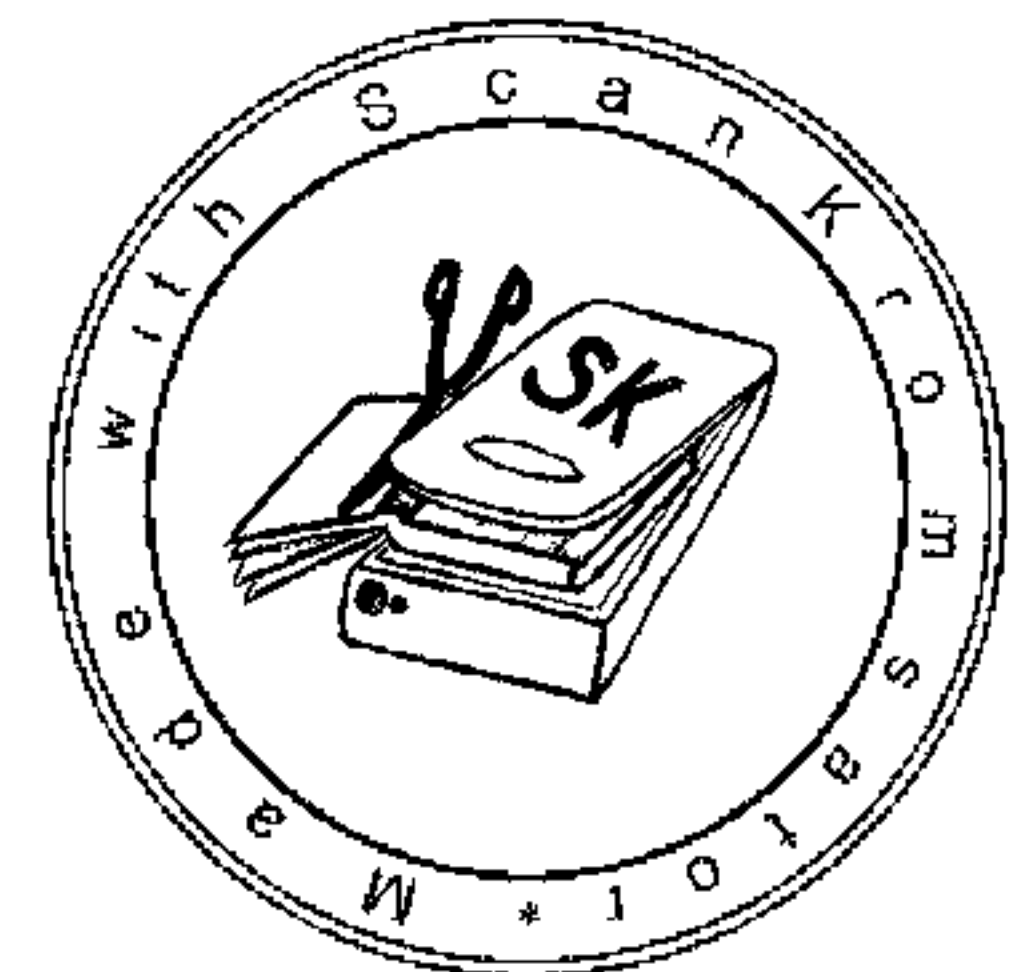

Contents

1 ■ Survey of the Elementary Principles	1
1.1 Mechanics of a Particle	1
1.2 Mechanics of a System of Particles	5
1.3 Constraints	12
1.4 D'Alembert's Principle and Lagrange's Equations	16
1.5 Velocity-Dependent Potentials and the Dissipation Function	22
1.6 Simple Applications of the Lagrangian Formulation	24
2 ■ Variational Principles and Lagrange's Equations	34
2.1 Hamilton's Principle	34
2.2 Some Techniques of the Calculus of Variations	36
2.3 Derivation of Lagrange's Equations from Hamilton's Principle	44
2.4 Extension of Hamilton's Principle to Nonholonomic Systems	45
2.5 Advantages of a Variational Principle Formulation	51
2.6 Conservation Theorems and Symmetry Properties	54
2.7 Energy Function and the Conservation of Energy	60
3 ■ The Central Force Problem	70
3.1 Reduction to the Equivalent One-Body Problem	70
3.2 The Equations of Motion and First Integrals	72
3.3 The Equivalent One-Dimensional Problem, and Classification of Orbits	76
3.4 The Virial Theorem	83
3.5 The Differential Equation for the Orbit, and Integrable Power-Law Potentials	86
3.6 Conditions for Closed Orbits (Bertrand's Theorem)	89
3.7 The Kepler Problem: Inverse-Square Law of Force	92
3.8 The Motion in Time in the Kepler Problem	98
3.9 The Laplace–Runge–Lenz Vector	102
3.10 Scattering in a Central Force Field	106
3.11 Transformation of the Scattering Problem to Laboratory Coordinates	114
3.12 The Three-Body Problem	121

4 ■ The Kinematics of Rigid Body Motion	134
4.1 The Independent Coordinates of a Rigid Body	134
4.2 Orthogonal Transformations	139
4.3 Formal Properties of the Transformation Matrix	144
4.4 The Euler Angles	150
4.5 The Cayley–Klein Parameters and Related Quantities	154
4.6 Euler’s Theorem on the Motion of a Rigid Body	155
4.7 Finite Rotations	161
4.8 Infinitesimal Rotations	163
4.9 Rate of Change of a Vector	171
4.10 The Coriolis Effect	174
5 ■ The Rigid Body Equations of Motion	184
5.1 Angular Momentum and Kinetic Energy of Motion about a Point	184
5.2 Tensors	188
5.3 The Inertia Tensor and the Moment of Inertia	191
5.4 The Eigenvalues of the Inertia Tensor and the Principal Axis Transformation	195
5.5 Solving Rigid Body Problems and the Euler Equations of Motion	198
5.6 Torque-free Motion of a Rigid Body	200
5.7 The Heavy Symmetrical Top with One Point Fixed	208
5.8 Precession of the Equinoxes and of Satellite Orbits	223
5.9 Precession of Systems of Charges in a Magnetic Field	230
6 ■ Oscillations	238
6.1 Formulation of the Problem	238
6.2 The Eigenvalue Equation and the Principal Axis Transformation	241
6.3 Frequencies of Free Vibration, and Normal Coordinates	250
6.4 Free Vibrations of a Linear Triatomic Molecule	253
6.5 Forced Vibrations and the Effect of Dissipative Forces	259
6.6 Beyond Small Oscillations: The Damped Driven Pendulum and the Josephson Junction	265
7 ■ The Classical Mechanics of the Special Theory of Relativity	276
7.1 Basic Postulates of the Special Theory	277
7.2 Lorentz Transformations	280
7.3 Velocity Addition and Thomas Precession	282
7.4 Vectors and the Metric Tensor	286

7.5	1-Forms and Tensors	289	
7.6	Forces in the Special Theory; Electromagnetism	297	
7.7	Relativistic Kinematics of Collisions and Many-Particle Systems	300	
7.8	Relativistic Angular Momentum	309	
7.9	The Lagrangian Formulation of Relativistic Mechanics	312	
7.10	Covariant Lagrangian Formulations	318	
7.11	Introduction to the General Theory of Relativity	324	
8	■ The Hamilton Equations of Motion		334
8.1	Legendre Transformations and the Hamilton Equations of Motion	334	
8.2	Cyclic Coordinates and Conservation Theorems	343	
8.3	Routh's Procedure	347	
8.4	The Hamiltonian Formulation of Relativistic Mechanics	349	
8.5	Derivation of Hamilton's Equations from a Variational Principle	353	
8.6	The Principle of Least Action	356	
9	■ Canonical Transformations		368
9.1	The Equations of Canonical Transformation	368	
9.2	Examples of Canonical Transformations	375	
9.3	The Harmonic Oscillator	377	
9.4	The Symplectic Approach to Canonical Transformations	381	
9.5	Poisson Brackets and Other Canonical Invariants	388	
9.6	Equations of Motion, Infinitesimal Canonical Transformations, and Conservation Theorems in the Poisson Bracket Formulation	396	
9.7	The Angular Momentum Poisson Bracket Relations	408	
9.8	Symmetry Groups of Mechanical Systems	412	
9.9	Liouville's Theorem	419	
10	■ Hamilton–Jacobi Theory and Action-Angle Variables		430
10.1	The Hamilton–Jacobi Equation for Hamilton's Principal Function	430	
10.2	The Harmonic Oscillator Problem as an Example of the Hamilton–Jacobi Method	434	
10.3	The Hamilton–Jacobi Equation for Hamilton's Characteristic Function	440	
10.4	Separation of Variables in the Hamilton–Jacobi Equation	444	
10.5	Ignorable Coordinates and the Kepler Problem	445	
10.6	Action-angle Variables in Systems of One Degree of Freedom	452	

10.7	Action-Angle Variables for Completely Separable Systems	457
10.8	The Kepler Problem in Action-angle Variables	466
11	■ Classical Chaos	483
11.1	Periodic Motion	484
11.2	Perturbations and the Kolmogorov–Arnold–Moser Theorem	487
11.3	Attractors	489
11.4	Chaotic Trajectories and Liapunov Exponents	491
11.5	Poincaré Maps	494
11.6	Hénon–Heiles Hamiltonian	496
11.7	Bifurcations, Driven-damped Harmonic Oscillator, and Parametric Resonance	505
11.8	The Logistic Equation	509
11.9	Fractals and Dimensionality	516
12	■ Canonical Perturbation Theory	526
12.1	Introduction	526
12.2	Time-dependent Perturbation Theory	527
12.3	Illustrations of Time-dependent Perturbation Theory	533
12.4	Time-independent Perturbation Theory	541
12.5	Adiabatic Invariants	549
13	■ Introduction to the Lagrangian and Hamiltonian Formulations for Continuous Systems and Fields	558
13.1	The Transition from a Discrete to a Continuous System	558
13.2	The Lagrangian Formulation for Continuous Systems	561
13.3	The Stress-energy Tensor and Conservation Theorems	566
13.4	Hamiltonian Formulation	572
13.5	Relativistic Field Theory	577
13.6	Examples of Relativistic Field Theories	583
13.7	Noether’s Theorem	589
Appendix A	■ Euler Angles in Alternate Conventions and Cayley–Klein Parameters	601
Appendix B	■ Groups and Algebras	605
	Selected Bibliography	617
	Author Index	623
	Subject Index	625

Preface to the Third Edition

The first edition of this text appeared in 1950, and it was so well received that it went through a second printing the very next year. Throughout the next three decades it maintained its position as the acknowledged standard text for the introductory Classical Mechanics course in graduate level physics curricula throughout the United States, and in many other countries around the world. Some major institutions also used it for senior level undergraduate Mechanics. Thirty years later, in 1980, a second edition appeared which was “a through-going revision of the first edition.” The preface to the second edition contains the following statement: “I have tried to retain, as much as possible, the advantages of the first edition while taking into account the developments of the subject itself, its position in the curriculum, and its applications to other fields.” This is the philosophy which has guided the preparation of this third edition twenty more years later.

The second edition introduced one additional chapter on Perturbation Theory, and changed the ordering of the chapter on Small Oscillations. In addition it added a significant amount of new material which increased the number of pages by about 68%. This third edition adds still one more new chapter on Nonlinear Dynamics or Chaos, but counterbalances this by reducing the amount of material in several of the other chapters, by shortening the space allocated to appendices, by considerably reducing the bibliography, and by omitting the long lists of symbols. Thus the third edition is comparable in size to the second.

In the chapter on relativity we have abandoned the complex Minkowski space in favor of the now standard real metric. Two of the authors prefer the complex metric because of its pedagogical advantages (HG) and because it fits in well with Clifford Algebra formulations of Physics (CPP), but the desire to prepare students who can easily move forward into other areas of theory such as field theory and general relativity dominated over personal preferences. Some modern notation such as 1-forms, mapping and the wedge product is introduced in this chapter.

The chapter on Chaos is a necessary addition because of the current interest in nonlinear dynamics which has begun to play a significant role in applications of classical dynamics. The majority of classical mechanics problems and applications in the real world include nonlinearities, and it is important for the student to have a grasp of the complexities involved, and of the new properties that can emerge. It is also important to realize the role of fractal dimensionality in chaos.

New sections have been added and others combined or eliminated here and there throughout the book, with the omissions to a great extent motivated by the desire not to extend the overall length beyond that of the second edition. A section

was added on the Euler and Lagrange exact solutions to the three body problem. In several places phase space plots and Lissajous figures were appended to illustrate solutions. The damped driven pendulum was discussed as an example that explains the workings of Josephson junctions. The symplectic approach was clarified by writing out some of the matrices. The harmonic oscillator was treated with anisotropy, and also in polar coordinates. The last chapter on continua and fields was formulated in the modern notation introduced in the relativity chapter. The significances of the special unitary group in two dimensions $SU(2)$ and the special orthogonal group in three dimensions $SO(3)$ were presented in more up-to-date notation, and an appendix was added on groups and algebras. Special tables were introduced to clarify properties of ellipses, vectors, vector fields and 1-forms, canonical transformations, and the relationships between the spacetime and symplectic approaches.

Several of the new features and approaches in this third edition had been mentioned as possibilities in the preface to the second edition, such as properties of group theory, tensors in non-Euclidean spaces, and “new mathematics” of theoretical physics such as manifolds. The reference to “One area omitted that deserves special attention—nonlinear oscillation and associated stability questions” now constitutes the subject matter of our new Chapter 11 “Classical Chaos.” We debated whether to place this new chapter after Perturbation theory where it fits more logically, or before Perturbation theory where it is more likely to be covered in class, and we chose the latter. The referees who reviewed our manuscript were evenly divided on this question.

The mathematical level of the present edition is about the same as that of the first two editions. Some of the mathematical physics, such as the discussions of hermitean and unitary matrices, was omitted because it pertains much more to quantum mechanics than it does to classical mechanics, and little used notations like dyadics were curtailed. Space devoted to power law potentials, Cayley-Klein parameters, Routh’s procedure, time independent perturbation theory, and the stress-energy tensor was reduced. In some cases reference was made to the second edition for more details. The problems at the end of the chapters were divided into “derivations” and “exercises,” and some new ones were added.

The authors are especially indebted to Michael A. Unseren and Forrest M. Hoffman of the Oak Ridge National laboratory for their 1993 compilation of errata in the second edition that they made available on the Internet. It is hoped that not too many new errors have slipped into this present revision. We wish to thank the students who used this text in courses with us, and made a number of useful suggestions that were incorporated into the manuscript. Professors Thomas Sayetta and the late Mike Schuette made helpful comments on the Chaos chapter, and Professors Joseph Johnson and James Knight helped to clarify our ideas on Lie Algebras. The following professors reviewed the manuscript and made many helpful suggestions for improvements: Yoram Alhassid, Yale University; Dave Ellis, University of Toledo; John Gruber, San Jose State; Thomas Handler, University of Tennessee; Daniel Hong, Lehigh University; Kara Keeter, Idaho State University; Carolyn Lee; Yannick Meurice, University of Iowa; Daniel

Marlow, Princeton University; Julian Noble, University of Virginia; Muhammad Numan, Indiana University of Pennsylvania; Steve Ruden, University of California, Irvine; Jack Semura, Portland State University; Tammy Ann Smecker-Hane, University of California, Irvine; Daniel Stump, Michigan State University; Robert Wald, University of Chicago; Doug Wells, Idaho State University.

It has indeed been an honor for two of us (CPP and JLS) to collaborate as co-authors of this third edition of such a classic book fifty years after its first appearance. We have admired this text since we first studied Classical Mechanics from the first edition in our graduate student days (CPP in 1953 and JLS in 1960), and each of us used the first and second editions in our teaching throughout the years. Professor Goldstein is to be commended for having written and later enhanced such an outstanding contribution to the classic Physics literature.

Above all we register our appreciation and acknowledgement in the words of Psalm 19,1:

Οἱ οὐρανοὶ διηγούνται δόξαν Θεοῦ

*Flushing, New York
Columbia, South Carolina
Columbia, South Carolina
July, 2000*

HERBERT GOLDSTEIN
CHARLES P. POOLE, JR.
JOHN L. SAFKO

CHAPTER

1

Survey of the Elementary Principles

The motion of material bodies formed the subject of some of the earliest research pursued by the pioneers of physics. From their efforts there has evolved a vast field known as analytical mechanics or dynamics, or simply, mechanics. In the present century the term “classical mechanics” has come into wide use to denote this branch of physics in contradistinction to the newer physical theories, especially quantum mechanics. We shall follow this usage, interpreting the name to include the type of mechanics arising out of the special theory of relativity. It is the purpose of this book to develop the structure of classical mechanics and to outline some of its applications of present-day interest in pure physics. Basic to any presentation of mechanics are a number of fundamental physical concepts, such as space, time, simultaneity, mass, and force. For the most part, however, these concepts will not be analyzed critically here; rather, they will be assumed as undefined terms whose meanings are familiar to the reader.

1.1 ■ MECHANICS OF A PARTICLE

Let \mathbf{r} be the radius vector of a particle from some given origin and \mathbf{v} its vector velocity:

$$\mathbf{v} = \frac{d\mathbf{r}}{dt}. \quad (1.1)$$

The *linear momentum* \mathbf{p} of the particle is defined as the product of the particle mass and its velocity:

$$\mathbf{p} = m\mathbf{v}. \quad (1.2)$$

In consequence of interactions with external objects and fields, the particle may experience forces of various types, e.g., gravitational or electrodynamic; the vector sum of these forces exerted on the particle is the total force \mathbf{F} . The mechanics of the particle is contained in *Newton's second law of motion*, which states that there exist frames of reference in which the motion of the particle is described by the differential equation

$$\mathbf{F} = \frac{d\mathbf{p}}{dt} \equiv \dot{\mathbf{p}}, \quad (1.3)$$

or

$$\mathbf{F} = \frac{d}{dt}(m\mathbf{v}). \quad (1.4)$$

In most instances, the mass of the particle is constant and Eq. (1.4) reduces to

$$\mathbf{F} = m \frac{d\mathbf{v}}{dt} = m\mathbf{a}, \quad (1.5)$$

where \mathbf{a} is the vector acceleration of the particle defined by

$$\mathbf{a} = \frac{d^2\mathbf{r}}{dt^2}. \quad (1.6)$$

The equation of motion is thus a differential equation of second order, assuming \mathbf{F} does not depend on higher-order derivatives.

A reference frame in which Eq. (1.3) is valid is called an *inertial* or *Galilean system*. Even within classical mechanics the notion of an inertial system is something of an idealization. In practice, however, it is usually feasible to set up a coordinate system that comes as close to the desired properties as may be required. For many purposes, a reference frame fixed in Earth (the “laboratory system”) is a sufficient approximation to an inertial system, while for some astronomical purposes it may be necessary to construct an inertial system by reference to distant galaxies.

Many of the important conclusions of mechanics can be expressed in the form of conservation theorems, which indicate under what conditions various mechanical quantities are constant in time. Equation (1.3) directly furnishes the first of these, the

Conservation Theorem for the Linear Momentum of a Particle: If the total force, \mathbf{F} , is zero, then $\dot{\mathbf{p}} = 0$ and the linear momentum, \mathbf{p} , is conserved.

The angular momentum of the particle about point O , denoted by \mathbf{L} , is defined as

$$\mathbf{L} = \mathbf{r} \times \mathbf{p}, \quad (1.7)$$

where \mathbf{r} is the radius vector from O to the particle. Notice that the order of the factors is important. We now define the *moment of force* or *torque* about O as

$$\mathbf{N} = \mathbf{r} \times \mathbf{F}. \quad (1.8)$$

The equation analogous to (1.3) for \mathbf{N} is obtained by forming the cross product of \mathbf{r} with Eq. (1.4):

$$\mathbf{r} \times \mathbf{F} = \mathbf{N} = \mathbf{r} \times \frac{d}{dt}(m\mathbf{v}). \quad (1.9)$$

Equation (1.9) can be written in a different form by using the vector identity:

$$\frac{d}{dt}(\mathbf{r} \times m\mathbf{v}) = \mathbf{v} \times m\mathbf{v} + \mathbf{r} \times \frac{d}{dt}(m\mathbf{v}), \quad (1.10)$$

where the first term on the right obviously vanishes. In consequence of this identity, Eq. (1.9) takes the form

$$\mathbf{N} = \frac{d}{dt}(\mathbf{r} \times m\mathbf{v}) = \frac{d\mathbf{L}}{dt} \equiv \dot{\mathbf{L}}. \quad (1.11)$$

Note that both \mathbf{N} and \mathbf{L} depend on the point O , about which the moments are taken.

As was the case for Eq. (1.3), the torque equation, (1.11), also yields an immediate conservation theorem, this time the

Conservation Theorem for the Angular Momentum of a Particle: If the total torque, \mathbf{N} , is zero then $\dot{\mathbf{L}} = 0$, and the angular momentum \mathbf{L} is conserved.

Next consider the work done by the external force \mathbf{F} upon the particle in going from point 1 to point 2. By definition, this work is

$$W_{12} = \int_1^2 \mathbf{F} \cdot d\mathbf{s}. \quad (1.12)$$

For constant mass (as will be assumed from now on unless otherwise specified), the integral in Eq. (1.12) reduces to

$$\int \mathbf{F} \cdot d\mathbf{s} = m \int \frac{d\mathbf{v}}{dt} \cdot \mathbf{v} dt = \frac{m}{2} \int \frac{d}{dt}(v^2) dt,$$

and therefore

$$W_{12} = \frac{m}{2}(v_2^2 - v_1^2). \quad (1.13)$$

The scalar quantity $mv^2/2$ is called the kinetic energy of the particle and is denoted by T , so that the work done is equal to the change in the kinetic energy:

$$W_{12} = T_2 - T_1. \quad (1.14)$$

If the force field is such that the work W_{12} is the same for any physically possible path between points 1 and 2, then the force (and the system) is said to be *conservative*. An alternative description of a conservative system is obtained by imagining the particle being taken from point 1 to point 2 by one possible path and then being returned to point 1 by another path. The independence of W_{12} on the particular path implies that the work done around such a closed circuit is zero, i.e.

$$\oint \mathbf{F} \cdot d\mathbf{s} = 0. \quad (1.15)$$

Physically it is clear that a system cannot be conservative if friction or other dissipation forces are present, because $F \cdot ds$ due to friction is always positive and the integral cannot vanish.

By a well-known theorem of vector analysis, a necessary and sufficient condition that the work, W_{12} , be independent of the physical path taken by the particle is that \mathbf{F} be the gradient of some scalar function of position:

$$\mathbf{F} = -\nabla V(\mathbf{r}), \quad (1.16)$$

where V is called the *potential*, or *potential energy*. The existence of V can be inferred intuitively by a simple argument. If W_{12} is independent of the path of integration between the end points 1 and 2, it should be possible to express W_{12} as the change in a quantity that depends only upon the positions of the end points. This quantity may be designated by $-V$, so that for a differential path length we have the relation

$$\mathbf{F} \cdot d\mathbf{s} = -dV$$

or

$$F_s = -\frac{\partial V}{\partial s},$$

which is equivalent to Eq. (1.16). Note that in Eq. (1.16) we can add to V any quantity constant in space, without affecting the results. Hence *the zero level of V is arbitrary*.

For a conservative system, the work done by the forces is

$$W_{12} = V_1 - V_2. \quad (1.17)$$

Combining Eq. (1.17) with Eq. (1.14), we have the result

$$T_1 + V_1 = T_2 + V_2, \quad (1.18)$$

which states in symbols the

Energy Conservation Theorem for a Particle: If the forces acting on a particle are conservative, then the total energy of the particle, $T + V$, is conserved.

The force applied to a particle may in some circumstances be given by the gradient of a scalar function that depends explicitly on both the position of the particle and the time. However, the work done on the particle when it travels a distance ds ,

$$\mathbf{F} \cdot d\mathbf{s} = -\frac{\partial V}{\partial s} ds,$$

is then no longer the total change in $-V$ during the displacement, since V also changes explicitly with time as the particle moves. Hence, the work done as the

particle goes from point 1 to point 2 is no longer the difference in the function V between those points. While a total energy $T + V$ may still be defined, it is not conserved during the course of the particle's motion.

1.2 ■ MECHANICS OF A SYSTEM OF PARTICLES

In generalizing the ideas of the previous section to systems of many particles, we must distinguish between the *external forces* acting on the particles due to sources outside the system, and *internal forces* on, say, some particle i due to all other particles in the system. Thus, the equation of motion (Newton's second law) for the i th particle is written as

$$\sum_j \mathbf{F}_{ji} + \mathbf{F}_i^{(e)} = \dot{\mathbf{p}}_i, \quad (1.19)$$

where $\mathbf{F}_i^{(e)}$ stands for an external force, and \mathbf{F}_{ji} is the internal force on the i th particle due to the j th particle (\mathbf{F}_{ii} , naturally, is zero). We shall assume that the \mathbf{F}_{ij} (like the $\mathbf{F}_i^{(e)}$) obey Newton's third law of motion in its original form: that the forces two particles exert on each other are equal and opposite. This assumption (which does not hold for all types of forces) is sometimes referred to as the *weak law of action and reaction*.

Summed over all particles, Eq. (1.19) takes the form

$$\frac{d^2}{dt^2} \sum_i m_i \mathbf{r}_i = \sum_i \mathbf{F}_i^{(e)} + \sum_{\substack{i,j \\ i \neq j}} \mathbf{F}_{ji}. \quad (1.20)$$

The first sum on the right is simply the total external force $\mathbf{F}^{(e)}$, while the second term vanishes, since the law of action and reaction states that each pair $\mathbf{F}_{ij} + \mathbf{F}_{ji}$ is zero. To reduce the left-hand side, we define a vector \mathbf{R} as the average of the radii vectors of the particles, weighted in proportion to their mass:

$$\mathbf{R} = \frac{\sum m_i \mathbf{r}_i}{\sum m_i} = \frac{\sum m_i \mathbf{r}_i}{M}. \quad (1.21)$$

The vector \mathbf{R} defines a point known as the *center of mass*, or more loosely as the center of gravity, of the system (cf. Fig. 1.1). With this definition, (1.20) reduces to

$$M \frac{d^2 \mathbf{R}}{dt^2} = \sum_i \mathbf{F}_i^{(e)} \equiv \mathbf{F}^{(e)}, \quad (1.22)$$

which states that the center of mass moves as if the total external force were acting on the entire mass of the system concentrated at the center of mass. Purely internal forces, if they obey Newton's third law, therefore have no effect on the

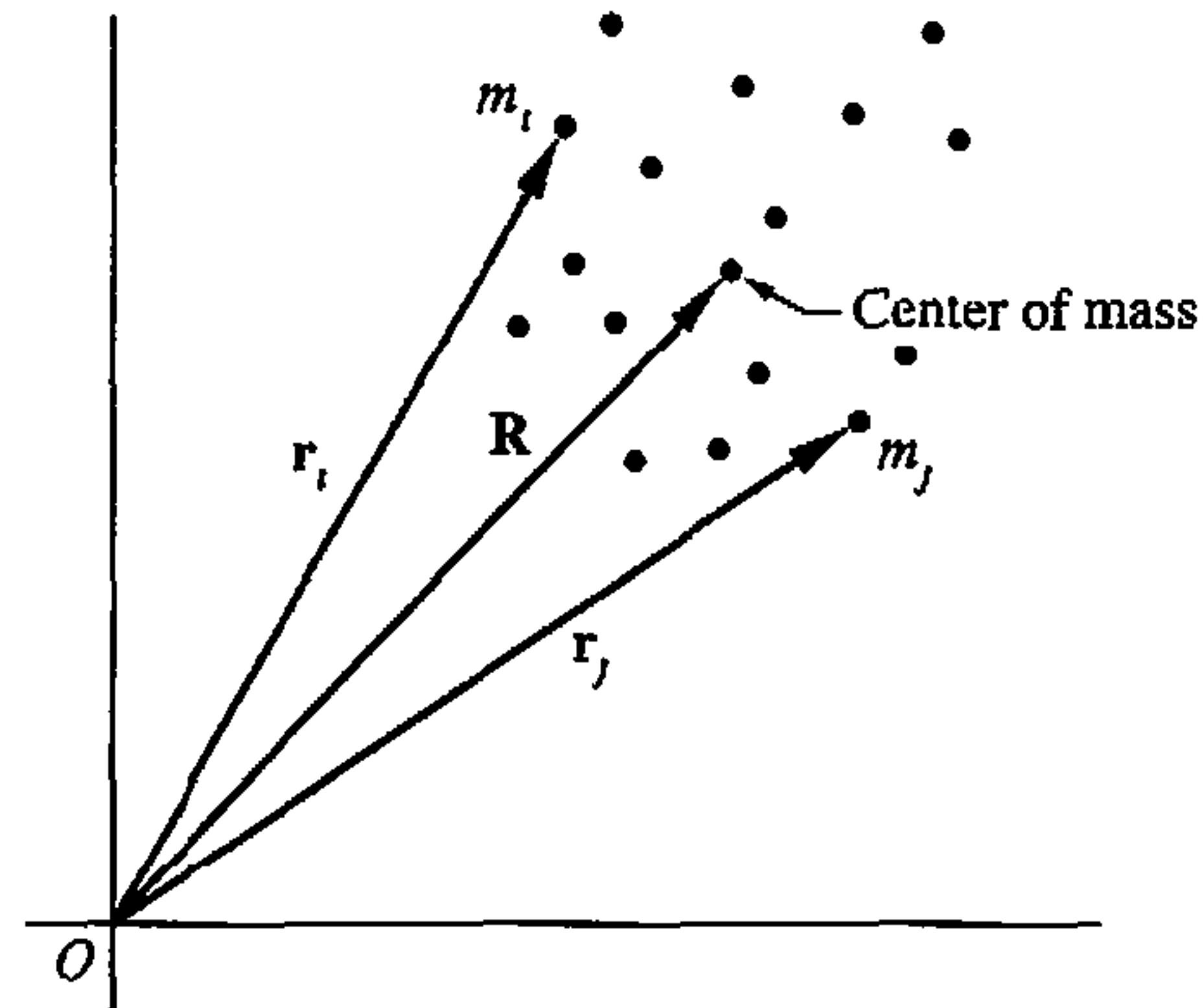

FIGURE 1.1 The center of mass of a system of particles.

motion of the center of mass. An oft-quoted example is the motion of an exploding shell—the center of mass of the fragments traveling as if the shell were still in a single piece (neglecting air resistance). The same principle is involved in jet and rocket propulsion. In order that the motion of the center of mass be unaffected, the ejection of the exhaust gases at high velocity must be counterbalanced by the forward motion of the vehicle at a slower velocity.

By Eq. (1.21) the total linear momentum of the system,

$$\mathbf{P} = \sum m_i \frac{d\mathbf{r}_i}{dt} = M \frac{d\mathbf{R}}{dt}, \quad (1.23)$$

is the total mass of the system times the velocity of the center of mass. Consequently, the equation of motion for the center of mass, (1.23), can be restated as the

Conservation Theorem for the Linear Momentum of a System of Particles: If the total external force is zero, the total linear momentum is conserved.

We obtain the total angular momentum of the system by forming the cross product $\mathbf{r}_i \times \mathbf{p}_i$ and summing over i . If this operation is performed in Eq. (1.19), there results, with the aid of the identity, Eq. (1.10),

$$\sum_i (\mathbf{r}_i \times \dot{\mathbf{p}}_i) = \sum_i \frac{d}{dt} (\mathbf{r}_i \times \mathbf{p}_i) = \dot{\mathbf{L}} = \sum_i \mathbf{r}_i \times \mathbf{F}_i^{(e)} + \sum_{\substack{i,j \\ i \neq j}} \mathbf{r}_i \times \mathbf{F}_{ji}. \quad (1.24)$$

The last term on the right in (1.24) can be considered a sum of the pairs of the form

$$\mathbf{r}_i \times \mathbf{F}_{ji} + \mathbf{r}_j \times \mathbf{F}_{ij} = (\mathbf{r}_i - \mathbf{r}_j) \times \mathbf{F}_{ji}, \quad (1.25)$$

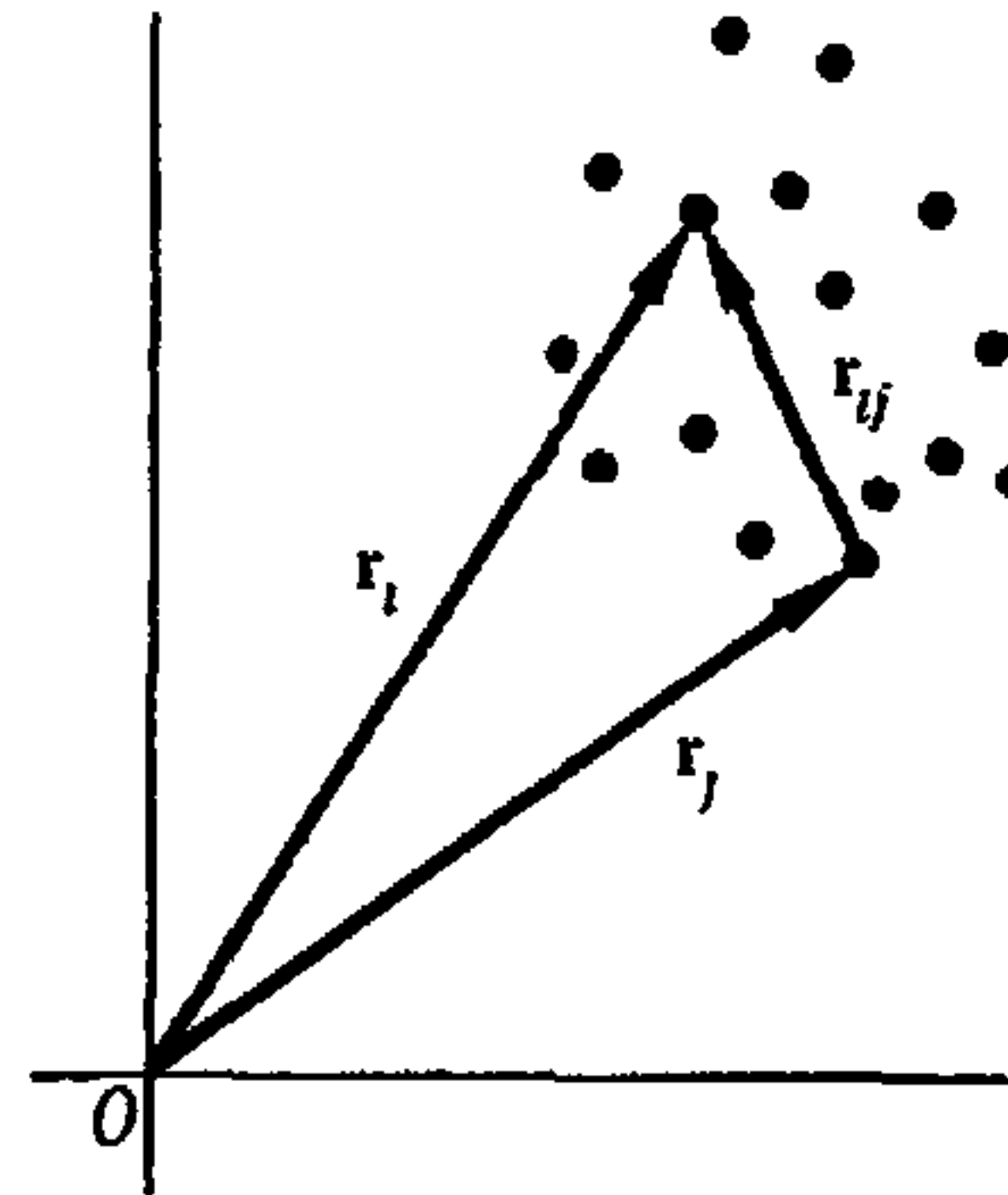

FIGURE 1.2 The vector r_{ij} between the i th and j th particles.

using the equality of action and reaction. But $\mathbf{r}_i - \mathbf{r}_j$ is identical with the vector \mathbf{r}_{ij} from j to i (cf. Fig. 1.2), so that the right-hand side of Eq. (1.25) can be written as

$$\mathbf{r}_{ij} \times \mathbf{F}_{ji}.$$

If the internal forces between two particles, in addition to being equal and opposite, also lie along the line joining the particles—a condition known as the *strong law of action and reaction*—then all of these cross products vanish. The sum over pairs is zero under this assumption and Eq. (1.24) may be written in the form

$$\frac{d\mathbf{L}}{dt} = \mathbf{N}^{(e)}. \quad (1.26)$$

The time derivative of the total angular momentum is thus equal to the moment of the external force about the given point. Corresponding to Eq. (1.26) is the

Conservation Theorem for Total Angular Momentum: \mathbf{L} is constant in time if the applied (external) torque is zero.

(It is perhaps worthwhile to emphasize that this is a *vector* theorem; i.e., L_z will be conserved if $N_z^{(e)}$ is zero, even if $N_x^{(e)}$ and $N_y^{(e)}$ are not zero.)

Note that the conservation of linear momentum in the absence of applied forces assumes that the weak law of action and reaction is valid for the internal forces. The conservation of the total angular momentum of the system in the absence of applied torques requires the validity of the strong law of action and reaction—that the internal forces in addition be *central*. Many of the familiar physical forces, such as that of gravity, satisfy the strong form of the law. But it is possible to find forces for which action and reaction are equal even though the forces are not central (see below). In a system involving moving charges, the forces between the charges predicted by the Biot-Savart law may indeed violate both forms of

the action and reaction law.* Equations (1.23) and (1.26), and their corresponding conservation theorems, are not applicable in such cases, at least in the form given here. Usually it is then possible to find some generalization of \mathbf{P} or \mathbf{L} that is conserved. Thus, in an isolated system of moving charges it is the sum of the mechanical angular momentum and the electromagnetic “angular momentum” of the field that is conserved.

Equation (1.23) states that the total linear momentum of the system is the same as if the entire mass were concentrated at the center of mass and moving with it. The analogous theorem for angular momentum is more complicated. With the origin O as reference point, the total angular momentum of the system is

$$\mathbf{L} = \sum_i \mathbf{r}_i \times \mathbf{p}_i.$$

Let \mathbf{R} be the radius vector from O to the center of mass, and let \mathbf{r}'_i be the radius vector from the center of mass to the i th particle. Then we have (cf. Fig. 1.3)

$$\mathbf{r}_i = \mathbf{r}'_i + \mathbf{R} \quad (1.27)$$

and

$$\mathbf{v}_i = \mathbf{v}'_i + \mathbf{v}$$

where

$$\mathbf{v} = \frac{d\mathbf{R}}{dt}$$

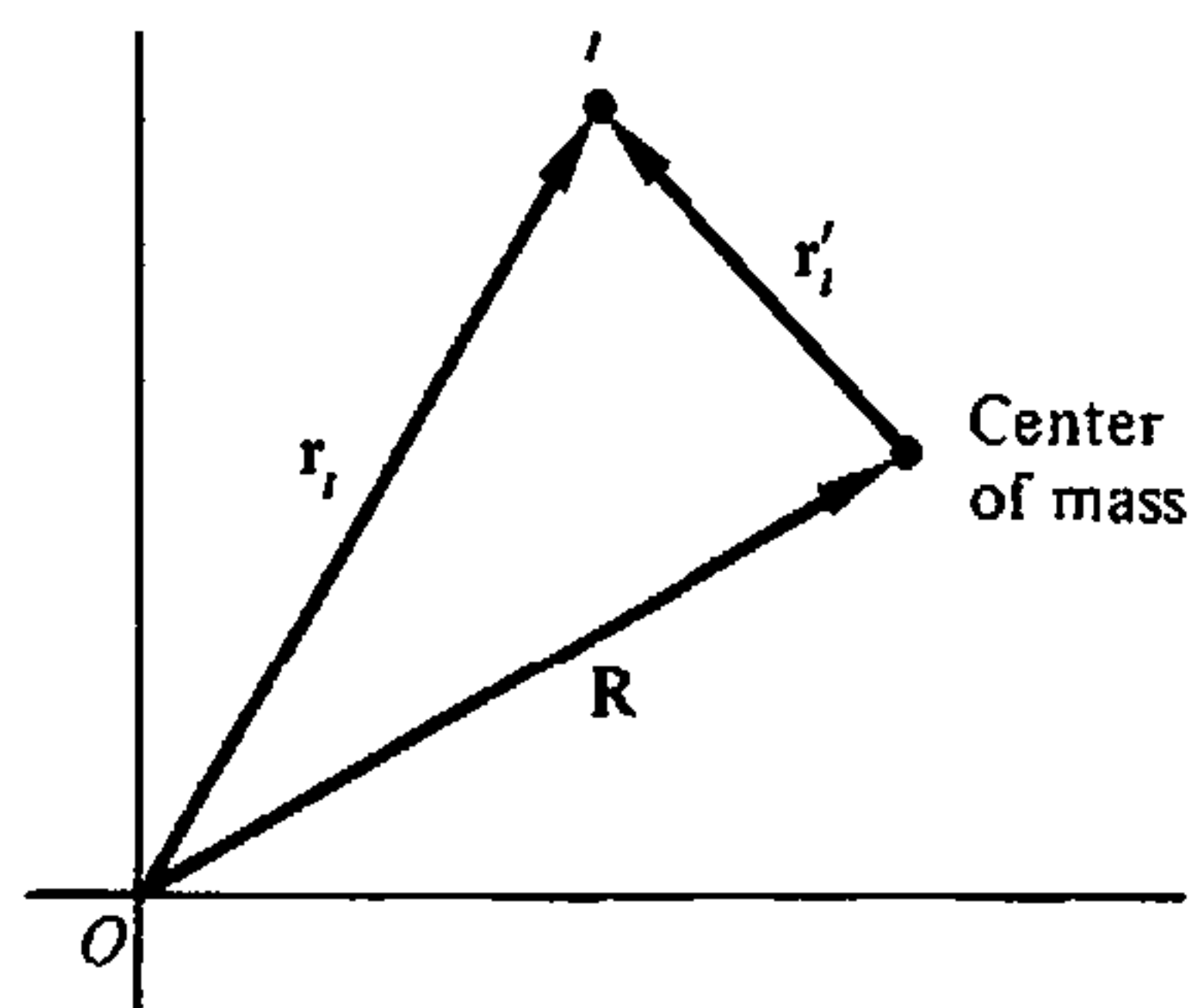

FIGURE 1.3 The vectors involved in the shift of reference point for the angular momentum.

*If two charges are moving uniformly with parallel velocity vectors that are not perpendicular to the line joining the charges, then the net mutual forces are equal and opposite but do not lie along the vector between the charges. Consider, further, two charges moving (instantaneously) so as to “cross the T,” i.e., one charge moving directly at the other, which in turn is moving at right angles to the first. Then the second charge exerts a nonvanishing magnetic force on the first, without experiencing any magnetic reaction force at that instant.

is the velocity of the center of mass relative to O , and

$$\mathbf{v}'_i = \frac{d\mathbf{r}'_i}{dt}$$

is the velocity of the i th particle relative to the center of mass of the system. Using Eq. (1.27), the total angular momentum takes on the form

$$\mathbf{L} = \sum_i \mathbf{R} \times m_i \mathbf{v} + \sum_i \mathbf{r}'_i \times m_i \mathbf{v}'_i + \left(\sum_i m_i \mathbf{r}'_i \right) \times \mathbf{v} + \mathbf{R} \times \frac{d}{dt} \sum_i m_i \mathbf{r}'_i.$$

The last two terms in this expression vanish, for both contain the factor $\sum m_i \mathbf{r}'_i$, which, it will be recognized, defines the radius vector of the center of mass in the very coordinate system whose origin is the center of mass and is therefore a null vector. Rewriting the remaining terms, the total angular momentum about O is

$$\mathbf{L} = \mathbf{R} \times M\mathbf{v} + \sum_i \mathbf{r}'_i \times \mathbf{p}'_i. \quad (1.28)$$

In words, Eq. (1.28) says that the total angular momentum about a point O is the angular momentum of motion concentrated at the center of mass, plus the angular momentum of motion about the center of mass. The form of Eq. (1.28) emphasizes that in general \mathbf{L} depends on the origin O , through the vector \mathbf{R} . Only if the center of mass is at rest with respect to O will the angular momentum be independent of the point of reference. In this case, the first term in (1.28) vanishes, and \mathbf{L} always reduces to the angular momentum taken about the center of mass.

Finally, let us consider the energy equation. As in the case of a single particle, we calculate the work done by all forces in moving the system from an initial configuration 1, to a final configuration 2:

$$W_{12} = \sum_i \int_1^2 \mathbf{F}_i \cdot d\mathbf{s}_i = \sum_i \int_1^2 \mathbf{F}_i^{(e)} \cdot d\mathbf{s}_i + \sum_{\substack{i,j \\ i \neq j}} \int_1^2 \mathbf{F}_{ji} \cdot d\mathbf{s}_i. \quad (1.29)$$

Again, the equations of motion can be used to reduce the integrals to

$$\sum_i \int_1^2 \mathbf{F}_i \cdot d\mathbf{s} = \sum_i \int_1^2 m_i \dot{\mathbf{v}}_i \cdot \mathbf{v}_i dt = \sum_i \int_1^2 d \left(\frac{1}{2} m_i v_i^2 \right).$$

Hence, the work done can still be written as the difference of the final and initial kinetic energies:

$$W_{12} = T_2 - T_1,$$

where T , the total kinetic energy of the system, is

$$T = \frac{1}{2} \sum_i m_i v_i^2. \quad (1.30)$$

Making use of the transformations to center-of-mass coordinates, given in Eq. (1.27), we may also write T as

$$\begin{aligned} T &= \frac{1}{2} \sum_i m_i (\mathbf{v} + \mathbf{v}'_i) \cdot (\mathbf{v} + \mathbf{v}'_i) \\ &= \frac{1}{2} \sum_i m_i v^2 + \frac{1}{2} \sum_i m_i v_i'^2 + \mathbf{v} \cdot \frac{d}{dt} \left(\sum_i m_i \mathbf{r}'_i \right), \end{aligned}$$

and by the reasoning already employed in calculating the angular momentum, the last term vanishes, leaving

$$T = \frac{1}{2} M v^2 + \frac{1}{2} \sum_i m_i v_i'^2 \quad (1.31)$$

The kinetic energy, like the angular momentum, thus also consists of two parts: the kinetic energy obtained if all the mass were concentrated at the center of mass, plus the kinetic energy of motion about the center of mass.

Consider now the right-hand side of Eq. (1.29). In the special case that the external forces are derivable in terms of the gradient of a potential, the first term can be written as

$$\sum_i \int_1^2 \mathbf{F}_i^{(e)} \cdot d\mathbf{s}_i = - \sum_i \int_1^2 \nabla_i V_i \cdot d\mathbf{s}_i = - \sum_i V_i \Big|_1^2,$$

where the subscript i on the del operator indicates that the derivatives are with respect to the components of \mathbf{r}_i . If the internal forces are also conservative, then the mutual forces between the i th and j th particles, \mathbf{F}_{ij} and \mathbf{F}_{ji} , can be obtained from a potential function V_{ij} . To satisfy the strong law of action and reaction, V_{ij} can be a function only of the distance between the particles:

$$V_{ij} = V_{ij}(|\mathbf{r}_i - \mathbf{r}_j|). \quad (1.32)$$

The two forces are then automatically equal and opposite,

$$\mathbf{F}_{ji} = -\nabla_i V_{ij} = +\nabla_j V_{ij} = -\mathbf{F}_{ij}, \quad (1.33)$$

and lie along the line joining the two particles,

$$\nabla V_{ij}(|\mathbf{r}_i - \mathbf{r}_j|) = (\mathbf{r}_i - \mathbf{r}_j) f, \quad (1.34)$$

where f is some scalar function. If V_{ij} were also a function of the difference of some other pair of vectors associated with the particles, such as their velocities or (to step into the domain of modern physics) their intrinsic "spin" angular momenta, then the forces would still be equal and opposite, but would not necessarily lie along the direction between the particles.

When the forces are all conservative, the second term in Eq. (1.29) can be rewritten as a sum over *pairs* of particles, the terms for each pair being of the form

$$- \int_1^2 (\nabla_i V_{ij} \cdot ds_i + \nabla_j V_{ij} \cdot ds_j).$$

If the difference vector $\mathbf{r}_i - \mathbf{r}_j$ is denoted by \mathbf{r}_{ij} , and if ∇_{ij} stands for the gradient with respect to \mathbf{r}_{ij} , then

$$\nabla_i V_{ij} = \nabla_{ij} V_{ij} = -\nabla_j V_{ij},$$

and

$$ds_i - ds_j = d\mathbf{r}_i - d\mathbf{r}_j = d\mathbf{r}_{ij},$$

so that the term for the ij pair has the form

$$- \int \nabla_{ij} V_{ij} \cdot d\mathbf{r}_{ij}.$$

The total work arising from internal forces then reduces to

$$-\frac{1}{2} \sum_{\substack{i,j \\ i \neq j}} \int_1^2 \nabla_{ij} V_{ij} \cdot d\mathbf{r}_{ij} = -\frac{1}{2} \sum_{\substack{i,j \\ i \neq j}} V_{ij} \Big|_1^2. \quad (1.35)$$

The factor $\frac{1}{2}$ appears in Eq. (1.35) because in summing over *both* i and j each member of a given pair is included twice, first in the i summation and then in the j summation.

From these considerations, it is clear that if the external and internal forces are both derivable from potentials it is possible to define a *total potential energy*, V , of the system,

$$V = \sum_i V_i + \frac{1}{2} \sum_{\substack{i,j \\ i \neq j}} V_{ij}. \quad (1.36)$$

such that the total energy $T + V$ is conserved, the analog of the conservation theorem (1.18) for a single particle.

The second term on the right in Eq. (1.36) will be called the internal potential energy of the system. In general, it need not be zero and, more important, it may vary as the system changes with time. Only for the particular class of systems known as *rigid bodies* will the internal potential always be constant. Formally, a rigid body can be defined as a system of particles in which the distances r_{ij} are fixed and cannot vary with time. In such case, the vectors $d\mathbf{r}_{ij}$ can only be perpendicular to the corresponding \mathbf{r}_{ij} , and therefore to the \mathbf{F}_{ij} . Therefore, in a rigid body the *internal forces do no work*, and the internal potential must remain

constant. Since the total potential is in any case uncertain to within an additive constant, an unvarying internal potential can be completely disregarded in discussing the motion of the system.

1.3 ■ CONSTRAINTS

From the previous sections one might obtain the impression that all problems in mechanics have been reduced to solving the set of differential equations (1.19):

$$m_i \ddot{\mathbf{r}}_i = \mathbf{F}_i^{(e)} - \sum_j \mathbf{F}_{ji}.$$

One merely substitutes the various forces acting upon the particles of the system, turns the mathematical crank, and grinds out the answers! Even from a purely physical standpoint, however, this view is oversimplified. For example, it may be necessary to take into account the *constraints* that limit the motion of the system. We have already met one type of system involving constraints, namely rigid bodies, where the constraints on the motions of the particles keep the distances r_{ij} unchanged. Other examples of constrained systems can easily be furnished. The beads of an abacus are constrained to one-dimensional motion by the supporting wires. Gas molecules within a container are constrained by the walls of the vessel to move only *inside* the container. A particle placed on the surface of a solid sphere is subject to the constraint that it can move only on the surface or in the region exterior to the sphere.

Constraints may be classified in various ways, and we shall use the following system. If the conditions of constraint can be expressed as equations connecting the coordinates of the particles (and possibly the time) having the form

$$f(\mathbf{r}_1, \mathbf{r}_2, \mathbf{r}_3, \dots, t) = 0, \quad (1.37)$$

then the constraints are said to be *holonomic*. Perhaps the simplest example of holonomic constraints is the rigid body, where the constraints are expressed by equations of the form

$$(\mathbf{r}_i - \mathbf{r}_j)^2 - c_{ij}^2 = 0.$$

A particle constrained to move along any curve or on a given surface is another obvious example of a holonomic constraint, with the equations defining the curve or surface acting as the equations of a constraint.

Constraints not expressible in this fashion are called *nonholonomic*. The walls of a gas container constitute a nonholonomic constraint. The constraint involved in the example of a particle placed on the surface of a sphere is also nonholonomic, for it can be expressed as an inequality

$$r^2 - a^2 \geq 0$$

(where a is the radius of the sphere), which is not in the form of (1.37). Thus, in a gravitational field a particle placed on the top of the sphere will slide down the surface part of the way but will eventually fall off.

Constraints are further classified according to whether the equations of constraint contain the time as an explicit variable (rheonomous) or are not explicitly dependent on time (scleronomous). A bead sliding on a rigid curved wire fixed in space is obviously subject to a scleronomous constraint; if the wire is moving in some prescribed fashion, the constraint is rheonomous. Note that if the wire moves, say, as a reaction to the bead's motion, then the time dependence of the constraint enters in the equation of the constraint only through the coordinates of the curved wire (which are now part of the system coordinates). The overall constraint is then scleronomous.

Constraints introduce two types of difficulties in the solution of mechanical problems. First, the coordinates r_i are no longer all independent, since they are connected by the equations of constraint; hence the equations of motion (1.19) are not all independent. Second, the forces of constraint, e.g., the force that the wire exerts on the bead (or the wall on the gas particle), is not furnished a priori. They are among the unknowns of the problem and must be obtained from the solution we seek. Indeed, imposing constraints on the system is simply another method of stating that there are forces present in the problem that cannot be specified directly but are known rather in terms of their effect on the motion of the system.

In the case of holonomic constraints, the first difficulty is solved by the introduction of *generalized coordinates*. So far we have been thinking implicitly in terms of Cartesian coordinates. A system of N particles, free from constraints, has $3N$ independent coordinates or *degrees of freedom*. If there exist holonomic constraints, expressed in k equations in the form (1.37), then we may use these equations to eliminate k of the $3N$ coordinates, and we are left with $3N - k$ independent coordinates, and the system is said to have $3N - k$ degrees of freedom. This elimination of the dependent coordinates can be expressed in another way, by the introduction of new, $3N - k$, independent variables $q_1, q_2, \dots, q_{3N-k}$ in terms of which the old coordinates $\mathbf{r}_1, \mathbf{r}_2, \dots, \mathbf{r}_N$ are expressed by equations of the form

$$\begin{aligned}\mathbf{r} &= \mathbf{r}_1(q_1, q_2, \dots, q_{3N-k}, t) \\ &\vdots \\ \mathbf{r}_N &= \mathbf{r}_N(q_1, q_2, \dots, q_{3N-k}, t)\end{aligned}\tag{1.38}$$

containing the constraints in them implicitly. These are *transformation* equations from the set of (\mathbf{r}_i) variables to the (q_i) set, or alternatively Eqs. (1.38) can be considered as parametric representations of the (\mathbf{r}_i) variables. It is always assumed that we can also transform back from the (q_i) to the (\mathbf{r}_i) set, i.e., that Eqs. (1.38) combined with the k equations of constraint can be inverted to obtain any q_i as a function of the (\mathbf{r}_i) variable and time.

Usually the generalized coordinates, q_l , unlike the Cartesian coordinates, will not divide into convenient groups of three that can be associated together to form vectors. Thus, in the case of a particle constrained to move *on* the surface of a sphere, the two angles expressing position on the sphere, say latitude and longitude, are obvious possible generalized coordinates. Or, in the example of a double pendulum moving in a plane (two particles connected by an inextensible light rod and suspended by a similar rod fastened to one of the particles), satisfactory generalized coordinates are the two angles θ_1, θ_2 . (Cf. Fig. 1.4.) Generalized coordinates, in the sense of coordinates other than Cartesian, are often useful in systems without constraints. Thus, in the problem of a particle moving in an external central force field ($V = V(r)$), there is no constraint involved, but it is clearly more convenient to use spherical polar coordinates than Cartesian coordinates. Do not, however, think of generalized coordinates in terms of conventional orthogonal position coordinates. All sorts of quantities may be impressed to serve as generalized coordinates. Thus, the amplitudes in a Fourier expansion of \mathbf{r}_j may be used as generalized coordinates, or we may find it convenient to employ quantities with the dimensions of energy or angular momentum.

If the constraint is nonholonomic, the equations expressing the constraint cannot be used to eliminate the dependent coordinates. An oft-quoted example of a nonholonomic constraint is that of an object rolling on a rough surface without slipping. The coordinates used to describe the system will generally involve angular coordinates to specify the orientation of the body, plus a set of coordinates describing the location of the point of contact on the surface. The constraint of "rolling" connects these two sets of coordinates; they are not independent. A change in the position of the point of contact inevitably means a change in its orientation. Yet we cannot reduce the number of coordinates, for the "rolling" condition is not expressible as an equation between the coordinates, in the manner of (1.37). Rather, it is a condition on the *velocities* (i.e., the point of contact is stationary), a differential condition that can be given in an integrated form only *after* the problem is solved.

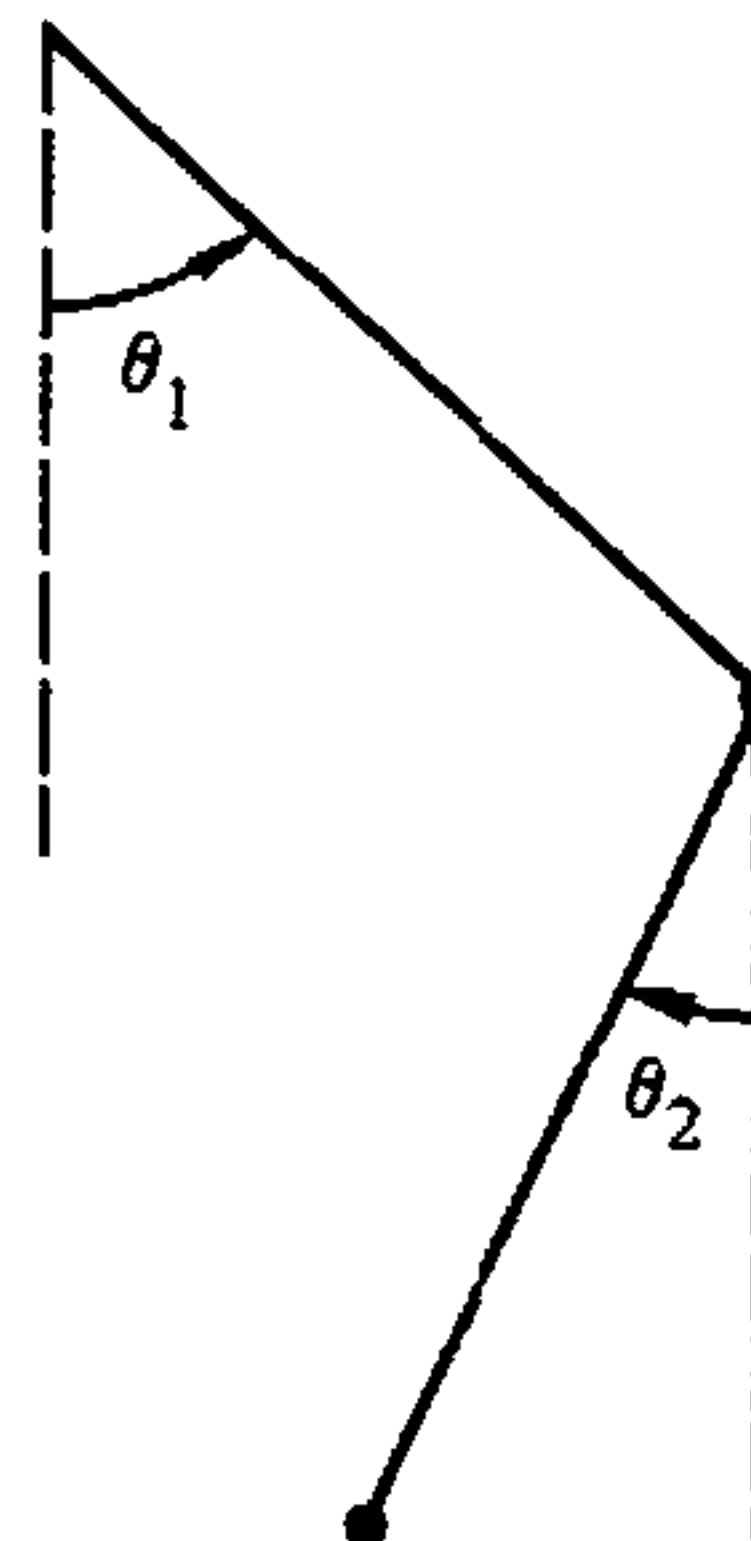

FIGURE 1.4 Double pendulum.

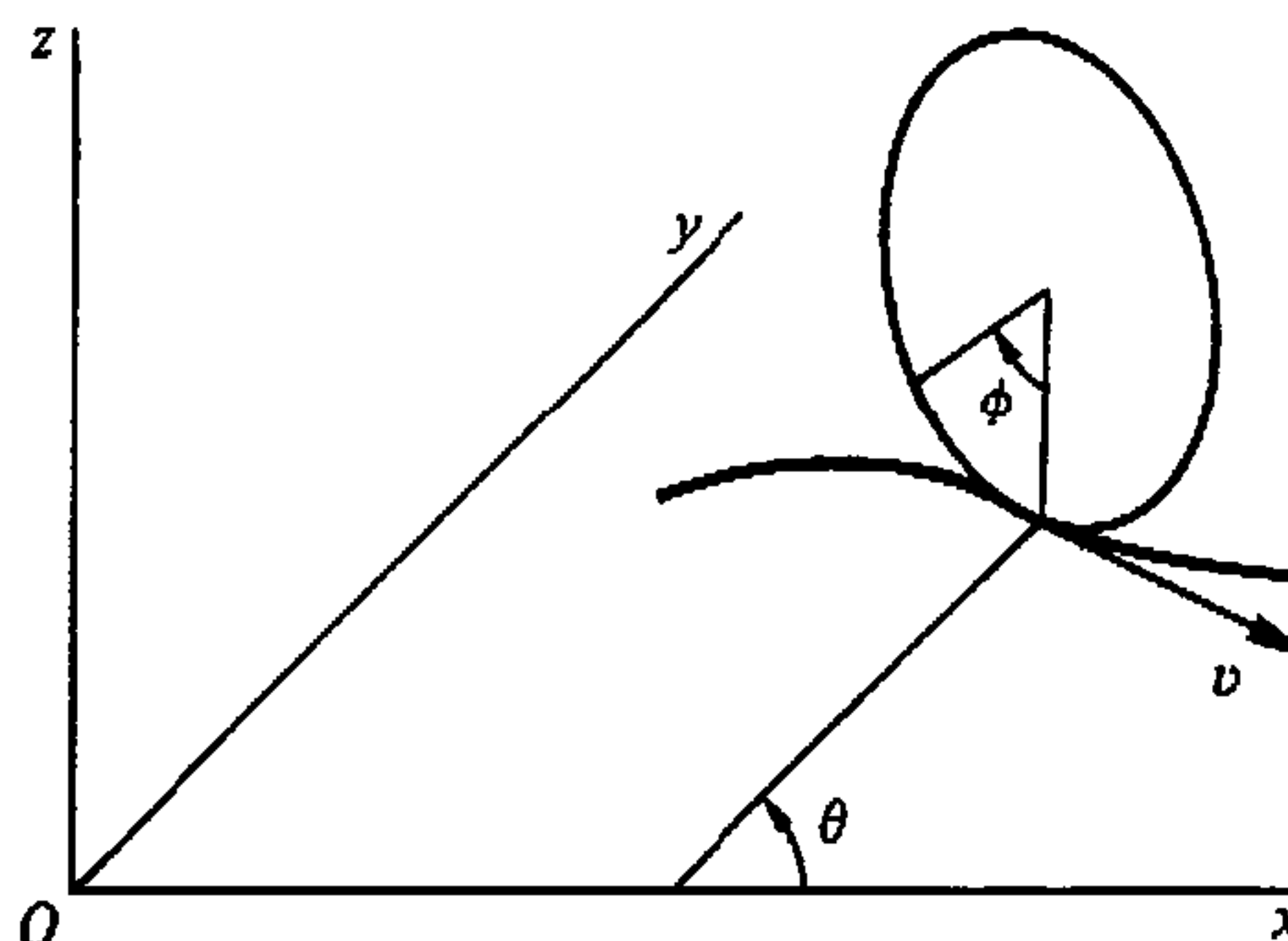

FIGURE 1.5 Vertical disk rolling on a horizontal plane.

A simple case will illustrate the point. Consider a disk rolling on the horizontal xy plane constrained to move so that the plane of the disk is always vertical. The coordinates used to describe the motion might be the x, y coordinates of the center of the disk, an angle of rotation ϕ about the axis of the disk, and an angle θ between the axis of the disk and say, the x axis (cf. Fig 1.5). As a result of the constraint the velocity of the center of the disk, v , has a magnitude proportional to $\dot{\phi}$,

$$v = a\dot{\phi},$$

where a is the radius of the disk, and its direction is perpendicular to the axis of the disk:

$$\begin{aligned}\dot{x} &= v \sin \theta \\ \dot{y} &= -v \cos \theta.\end{aligned}$$

Combining these conditions, we have two *differential* equations of constraint:

$$\begin{aligned}dx - a \sin \theta d\phi &= 0, \\ dy + a \cos \theta d\phi &= 0.\end{aligned}\tag{1.39}$$

Neither of Eqs. (1.39) can be integrated without in fact solving the problem; i.e., we cannot find an integrating factor $f(x, y, \theta, \phi)$ that will turn either of the equations into perfect differentials (cf. Derivation 4).^{*} Hence, the constraints cannot be reduced to the form of Eq. (1.37) and are therefore nonholonomic. Physically we can see that there can be no direct functional relation between ϕ and the other coordinates x, y , and θ by noting that at any point on its path the disk can be

^{*}In principle, an integrating factor can always be found for a first-order differential equation of constraint in systems involving only two coordinates and such constraints are therefore holonomic. A familiar example is the two-dimensional motion of a circle rolling on an inclined plane.

made to roll around in a circle tangent to the path and of arbitrary radius. At the end of the process, x , y , and θ have been returned to their original values, but ϕ has changed by an amount depending on the radius of the circle.

Nonintegrable *differential* constraints of the form of Eqs. (1.39) are of course not the only type of nonholonomic constraints. The constraint conditions may involve higher-order derivatives, or may appear in the form of inequalities, as we have seen.

Partly because the dependent coordinates can be eliminated, problems involving holonomic constraints are always amenable to a formal solution. But there is no general way to attack nonholonomic examples. True, if the constraint is nonintegrable, the differential equations of constraint can be introduced into the problem along with the differential equations of motion, and the dependent equations eliminated, in effect, by the method of Lagrange multipliers.

We shall return to this method at a later point. However, the more vicious cases of nonholonomic constraint must be tackled individually, and consequently in the development of the more formal aspects of classical mechanics, it is almost invariably assumed that any constraint, if present, is holonomic. This restriction does not greatly limit the applicability of the theory, despite the fact that many of the constraints encountered in everyday life are nonholonomic. The reason is that the entire concept of constraints imposed in the system through the medium of wires or surfaces or walls is particularly appropriate only in macroscopic or large-scale problems. But today physicists are more interested in atomic and nuclear problems. On this scale all objects, both in and out of the system, consist alike of molecules, atoms, or smaller particles, exerting definite forces, and the notion of constraint becomes artificial and rarely appears. Constraints are then used only as mathematical idealizations to the actual physical case or as classical approximations to a quantum-mechanical property, e.g., rigid body rotations for "spin." Such constraints are always holonomic and fit smoothly into the framework of the theory.

To surmount the second difficulty, namely, that the forces of constraint are unknown a priori, we should like to so formulate the mechanics that the forces of constraint disappear. We need then deal only with the known applied forces. A hint as to the procedure to be followed is provided by the fact that in a particular system with constraints i.e. a rigid body, the work done by internal forces (which are here the forces of constraint) vanishes. We shall follow up this clue in the ensuing sections and generalize the ideas contained in it.

1.4 ■ D'ALEMBERT'S PRINCIPLE AND LAGRANGE'S EQUATIONS

A virtual (infinitesimal) displacement of a system refers to a change in the configuration of the system as the result of any arbitrary infinitesimal change of the coordinates δr_i , *consistent with the forces and constraints imposed on the system at the given instant t* . The displacement is called virtual to distinguish it from an actual displacement of the system occurring in a time interval dt , during which

the forces and constraints may be changing. Suppose the system is in equilibrium; i.e., the total force on each particle vanishes, $\mathbf{F}_i = 0$. Then clearly the dot product $\mathbf{F}_i \cdot \delta \mathbf{r}_i$, which is the virtual work of the force \mathbf{F}_i in the displacement $\delta \mathbf{r}_i$, also vanishes. The sum of these vanishing products over all particles must likewise be zero:

$$\sum_i \mathbf{F}_i \cdot \delta \mathbf{r}_i = 0. \quad (1.40)$$

As yet nothing has been said that has any new physical content. Decompose \mathbf{F}_i into the applied force, $\mathbf{F}_i^{(a)}$, and the force of constraint, \mathbf{f}_i ,

$$\mathbf{F}_i = \mathbf{F}_i^{(a)} + \mathbf{f}_i. \quad (1.41)$$

so that Eq. (1.40) becomes

$$\sum_i \mathbf{F}_i^{(a)} \cdot \delta \mathbf{r}_i + \sum_i \mathbf{f}_i \cdot \delta \mathbf{r}_i = 0 \quad (1.42)$$

We now restrict ourselves to systems for which *the net virtual work of the forces of constraint is zero*. We have seen that this condition holds true for rigid bodies and it is valid for a large number of other constraints. Thus, if a particle is constrained to move on a surface, the force of constraint is perpendicular to the surface, while the virtual displacement must be tangent to it, and hence the virtual work vanishes. This is no longer true if sliding friction forces are present, and we must exclude such systems from our formulation. The restriction is not unduly hampering, since the friction is essentially a macroscopic phenomenon. On the other hand, the forces of rolling friction do not violate this condition, since the forces act on a point that is momentarily at rest and can do no work in an infinitesimal displacement consistent with the rolling constraint. Note that if a particle is constrained to a surface that is itself moving in time, the force of constraint is instantaneously perpendicular to the surface and the work during a virtual displacement is still zero even though the work during an actual displacement in the time dt does not necessarily vanish.

We therefore have as the condition for equilibrium of a system that the virtual work of the *applied forces* vanishes:

$$\sum_i \mathbf{F}_i^{(a)} \cdot \delta \mathbf{r}_i = 0. \quad (1.43)$$

Equation (1.43) is often called the *principle of virtual work*. Note that the coefficients of $\delta \mathbf{r}_i$ can no longer be set equal to zero; i.e., in general $\mathbf{F}_i^{(a)} \neq 0$, since the $\delta \mathbf{r}_i$ are not completely independent but are connected by the constraints. In order to equate the coefficients to zero, we must transform the principle into a form involving the virtual displacements of the q_i , which are independent. Equation (1.43) satisfies our needs in that it does not contain the \mathbf{f}_i , but it deals only with statics; we want a condition involving the general motion of the system.

To obtain such a principle, we use a device first thought of by James Bernoulli and developed by D'Alembert. The equation of motion,

$$\mathbf{F}_i = \dot{\mathbf{p}}_i,$$

can be written as

$$\mathbf{F}_i - \dot{\mathbf{p}}_i = 0,$$

which states that the particles in the system will be in equilibrium under a force equal to the actual force plus a "reversed effective force" $-\dot{\mathbf{p}}_i$. Instead of (1.40), we can immediately write

$$\sum_i (\mathbf{F}_i - \dot{\mathbf{p}}_i) \cdot \delta \mathbf{r}_i = 0, \quad (1.44)$$

and, making the same resolution into applied forces and forces of constraint, there results

$$\sum_i (\mathbf{F}_i^{(a)} - \dot{\mathbf{p}}_i) \cdot \delta \mathbf{r}_i + \sum_i \mathbf{f}_i \cdot \delta \mathbf{r}_i = 0.$$

We again restrict ourselves to systems for which the virtual work of the forces of constraint vanishes and therefore obtain

$$\sum_i (\mathbf{F}_i^{(a)} - \dot{\mathbf{p}}_i) \cdot \delta \mathbf{r}_i = 0, \quad (1.45)$$

which is often called *D'Alembert's principle*. We have achieved our aim, in that the forces of constraint no longer appear, and the superscript ^(a) can now be dropped without ambiguity. It is still not in a useful form to furnish equations of motion for the system. We must now transform the principle into an expression involving virtual displacements of the generalized coordinates, which are then independent of each other (for holonomic constraints), so that the coefficients of the δq_i can be set separately equal to zero.

The translation from \mathbf{r}_i to q_j language starts from the transformation equations (1.38),

$$\mathbf{r}_i = \mathbf{r}_i(q_1, q_2, \dots, q_n, t) \quad (1.45')$$

(assuming n independent coordinates), and is carried out by means of the usual "chain rules" of the calculus of partial differentiation. Thus, \mathbf{v}_i is expressed in terms of the \dot{q}_k by the formula

$$\mathbf{v}_i \equiv \frac{d\mathbf{r}_i}{dt} = \sum_k \frac{\partial \mathbf{r}_i}{\partial q_k} \dot{q}_k + \frac{\partial \mathbf{r}_i}{\partial t}. \quad (1.46)$$

Similarly, the arbitrary virtual displacement $\delta \mathbf{r}_i$ can be connected with the virtual displacements δq_j by

$$\delta \mathbf{r}_i = \sum_j \frac{\partial \mathbf{r}_i}{\partial q_j} \delta q_j \quad (1.47)$$

Note that no variation of time, δt , is involved here, since a virtual displacement by definition considers only displacements of the coordinates. (Only then is the virtual displacement perpendicular to the force of constraint if the constraint itself is changing in time.)

In terms of the generalized coordinates, the virtual work of the \mathbf{F}_i becomes

$$\begin{aligned} \sum_i \mathbf{F}_i \cdot \delta \mathbf{r}_i &= \sum_{i,j} \mathbf{F}_i \cdot \frac{\partial \mathbf{r}_i}{\partial q_j} \delta q_j \\ &= \sum_j Q_j \delta q_j, \end{aligned} \quad (1.48)$$

where the Q_j are called the components of the *generalized force*, defined as

$$Q_j = \sum_i \mathbf{F}_i \cdot \frac{\partial \mathbf{r}_i}{\partial q_j}. \quad (1.49)$$

Note that just as the q 's need not have the dimensions of length, so the Q 's do not necessarily have the dimensions of force, but $Q_j \delta q_j$ must always have the dimensions of work. For example, Q_j might be a torque N_j and dq_j a differential angle $d\theta_j$, which makes $N_j d\theta_j$ a differential of work.

We turn now to the other other term involved in Eq. (1.45), which may be written as

$$\sum_i \dot{\mathbf{p}}_i \cdot \delta \mathbf{r}_i = \sum_i m_i \ddot{\mathbf{r}}_i \cdot \delta \mathbf{r}_i.$$

Expressing $\delta \mathbf{r}_i$ by (1.47), this becomes

$$\sum_{i,j} m_i \ddot{\mathbf{r}}_i \cdot \frac{\partial \mathbf{r}_i}{\partial q_j} \delta q_j.$$

Consider now the relation

$$\sum_i m_i \ddot{\mathbf{r}}_i \cdot \frac{\partial \mathbf{r}_i}{\partial q_j} = \sum_i \left[\frac{d}{dt} \left(m_i \dot{\mathbf{r}}_i \cdot \frac{\partial \mathbf{r}_i}{\partial q_j} \right) - m_i \dot{\mathbf{r}}_i \cdot \frac{d}{dt} \left(\frac{\partial \mathbf{r}_i}{\partial q_j} \right) \right]. \quad (1.50)$$

In the last term of Eq. (1.50) we can interchange the differentiation with respect to t and q_j , for, in analogy to (1.46),

$$\frac{d}{dt} \left(\frac{\partial \mathbf{r}_i}{\partial q_j} \right) = \frac{\partial \dot{\mathbf{r}}_i}{\partial q_j} = \sum_k \frac{\partial^2 \mathbf{r}_i}{\partial q_j \partial q_k} \dot{q}_k + \frac{\partial^2 \mathbf{r}_i}{\partial q_j \partial t} - \frac{\partial \mathbf{v}_i}{\partial q_j},$$

by Eq. (1.46). Further, we also see from Eq. (1.46) that

$$\frac{\partial \mathbf{v}_i}{\partial \dot{q}_j} = \frac{\partial \mathbf{r}_i}{\partial q_j}. \quad (1.51)$$

Substitution of these changes in (1.50) leads to the result that

$$\sum_i m_i \ddot{\mathbf{r}}_i \cdot \frac{\partial \mathbf{r}_i}{\partial q_j} = \sum_i \left[\frac{d}{dt} \left(m_i \mathbf{v}_i \cdot \frac{\partial \mathbf{v}_i}{\partial \dot{q}_j} \right) - m_i \mathbf{v}_i \cdot \frac{\partial \mathbf{v}_i}{\partial q_j} \right],$$

and the second term on the left-hand side of Eq. (1.45) can be expanded into

$$\sum_j \left\{ \frac{d}{dt} \left[\frac{\partial}{\partial \dot{q}_j} \left(\sum_i \frac{1}{2} m_i v_i^2 \right) \right] - \frac{\partial}{\partial q_j} \left(\sum_i \frac{1}{2} m_i v_i^2 \right) - Q_j \right\} \delta q_j.$$

Identifying $\sum_i \frac{1}{2} m_i v_i^2$ with the system kinetic energy T , D'Alembert's principle (cf. Eq. (1.45)) becomes

$$\sum \left\{ \left[\frac{d}{dt} \left(\frac{\partial T}{\partial \dot{q}_j} \right) - \frac{\partial T}{\partial q_j} \right] - Q_j \right\} \delta q_j = 0. \quad (1.52)$$

Note that in a system of Cartesian coordinates the partial derivative of T with respect to q_j vanishes. Thus, speaking in the language of differential geometry, this term arises from the curvature of the coordinates q_j . In polar coordinates, e.g., it is in the partial derivative of T with respect to an angle coordinate that the centripetal acceleration term appears.

Thus far, no restriction has been made on the nature of the constraints other than that they be workless in a virtual displacement. The variables q_j can be any set of coordinates used to describe the motion of the system. If, however, the constraints are holonomic, then it is possible to find sets of independent coordinates q_j that contain the constraint conditions implicitly in the transformation equations (1.38). Any virtual displacement δq_j is then independent of δq_k , and therefore the only way for (1.52) to hold is for the individual coefficients to vanish:

$$\frac{d}{dt} \left(\frac{\partial T}{\partial \dot{q}_j} \right) - \frac{\partial T}{\partial q_j} - Q_j. \quad (1.53)$$

There are n such equations in all.

When the forces are derivable from a scalar potential function V ,

$$\mathbf{F}_i = -\nabla_i V.$$

Then the generalized forces can be written as

$$Q_j = \sum_i \mathbf{F}_i \cdot \frac{\partial \mathbf{r}_i}{\partial q_j} = - \sum_i \nabla_i V \cdot \frac{\partial \mathbf{r}_i}{\partial q_j},$$

which is exactly the same expression for the partial derivative of a function $-V(\mathbf{r}_1, \mathbf{r}_2, \dots, \mathbf{r}_N, t)$ with respect to q_j :

$$Q_j = - \frac{\partial V}{\partial q_j}. \quad (1.54)$$

Equations (1.53) can then be rewritten as

$$\frac{d}{dt} \left(\frac{\partial T}{\partial \dot{q}_j} \right) - \frac{\partial (T - V)}{\partial q_j} = 0. \quad (1.55)$$

The equations of motion in the form (1.55) are not necessarily restricted to conservative systems, only if V is not an explicit function of time is the system conservative (cf. p. 4). As here defined, the potential V does not depend on the generalized velocities. Hence, we can include a term in V in the partial derivative with respect to \dot{q}_j :

$$\frac{d}{dt} \left(\frac{\partial (T - V)}{\partial \dot{q}_j} \right) - \frac{\partial (T - V)}{\partial q_j} = 0.$$

Or, defining a new function, the *Lagrangian* L , as

$$L = T - V, \quad (1.56)$$

the Eqs. (1.53) become

$$\frac{d}{dt} \left(\frac{\partial L}{\partial \dot{q}_j} \right) - \frac{\partial L}{\partial q_j} = 0, \quad (1.57)$$

expressions referred to as "Lagrange's equations."

Note that for a particular set of equations of motion there is no unique choice of Lagrangian such that Eqs. (1.57) lead to the equations of motion in the given generalized coordinates. Thus, in Derivations 8 and 10 it is shown that if $L(q, \dot{q}, t)$ is an approximate Lagrangian and $F(q, t)$ is *any* differentiable function of the generalized coordinates and time, then

$$L'(q, \dot{q}, t) = L(q, \dot{q}, t) + \frac{dF}{dt} \quad (1.57')$$

is a Lagrangian also resulting in the same equations of motion. It is also often possible to find alternative Lagrangians beside those constructed by this prescription (see Exercise 20). While Eq. (1.56) is always a suitable way to construct a Lagrangian for a conservative system, it does not provide the *only* Lagrangian suitable for the given system.

1.5 ■ VELOCITY-DEPENDENT POTENTIALS AND THE DISSIPATION FUNCTION

Lagrange's equations can be put in the form (1.57) even if there is no potential function, V , in the usual sense, providing the generalized forces are obtained from a function $U(q_j, \dot{q}_j)$ by the prescription

$$Q_j = -\frac{\partial U}{\partial q_j} + \frac{d}{dt} \left(\frac{\partial U}{\partial \dot{q}_j} \right). \quad (1.58)$$

In such case, Eqs. (1.57) still follow from Eqs. (1.53) with the Lagrangian given by

$$L = T - U. \quad (1.59)$$

Here U may be called a "generalized potential," or "velocity-dependent potential." The possibility of using such a "potential" is not academic; it applies to one very important type of force field, namely, the electromagnetic forces on moving charges. Considering its importance, a digression on this subject is well worthwhile.

Consider an electric charge, q , of mass m moving at a velocity, \mathbf{v} , in an otherwise charge-free region containing both an electric field, \mathbf{E} , and a magnetic field, \mathbf{B} , which may depend upon time and position. The charge experiences a force, called the Lorentz force, given by

$$\mathbf{F} = q[\mathbf{E} + (\mathbf{v} \times \mathbf{B})]. \quad (1.60)$$

Both $\mathbf{E}(t, x, y, z)$ and $\mathbf{B}(t, x, y, z)$ are continuous functions of time and position derivable from a scalar potential $\phi(t, x, y, z)$ and a vector potential $\mathbf{A}(t, x, y, z)$ by

$$\mathbf{E} = -\nabla\phi - \frac{\partial \mathbf{A}}{\partial t} \quad (1.61a)$$

and

$$\mathbf{B} = \nabla \times \mathbf{A}. \quad (1.61b)$$

The force on the charge can be derived from the following velocity-dependent potential energy

$$U = q\phi - q\mathbf{A} \cdot \mathbf{v}, \quad (1.62)$$

so the Lagrangian, $L = T - U$, is

$$L = \frac{1}{2}mv^2 - q\phi + q\mathbf{A} \cdot \mathbf{v}. \quad (1.63)$$

Considering just the x -component of Lagrange's equations gives

$$m\ddot{x} = q \left(v_x \frac{\partial A_x}{\partial x} + v_y \frac{\partial A_y}{\partial x} + v_z \frac{\partial A_z}{\partial x} \right) - q \left(\frac{\partial \phi}{\partial x} + \frac{dA_x}{dt} \right). \quad (1.64)$$

The total time derivative of A_x is related to the particle time derivative through

$$\begin{aligned} \frac{dA_x}{dt} &= \frac{\partial A_x}{\partial t} + \mathbf{v} \cdot \nabla A_x \\ &= \frac{\partial A_x}{\partial t} + v_x \frac{\partial A_x}{\partial x} + v_y \frac{\partial A_x}{\partial y} + v_z \frac{\partial A_x}{\partial z}. \end{aligned} \quad (1.65)$$

Equation (1.61b) gives

$$(\mathbf{v} \times \mathbf{B})_x = v_y \left(\frac{\partial A_y}{\partial x} - \frac{\partial A_x}{\partial y} \right) + v_z \left(\frac{\partial A_z}{\partial x} - \frac{\partial A_x}{\partial z} \right).$$

Combining these expressions gives the equation of motion in the x -direction

$$m\ddot{x} = q [\mathbf{E}_x + (\mathbf{v} \times \mathbf{B})_x]. \quad (1.66)$$

On a component-by-component comparison, Eqs. (1.66) and (1.60) are identical, showing that the Lorentz force equation is derivable from Eqs. (1.61) and (1.62).

Note that if not all the forces acting on the system are derivable from a potential, then Lagrange's equations can always be written in the form

$$\frac{d}{dt} \left(\frac{\partial L}{\partial \dot{q}_j} \right) - \frac{\partial L}{\partial q_j} = Q_j,$$

where L contains the potential of the conservative forces as before, and Q_j represents the forces *not* arising from a potential. Such a situation often occurs when frictional forces are present. It frequently happens that the frictional force is proportional to the velocity of the particle, so that its x -component has the form

$$F_{f,x} = -k_x v_x.$$

Frictional forces of this type may be derived in terms of a function \mathcal{F} , known as *Rayleigh's dissipation function*, and defined as

$$\mathcal{F} = \frac{1}{2} \sum_i (k_x v_{ix}^2 + k_y v_{iy}^2 + k_z v_{iz}^2), \quad (1.67)$$

where the summation is over the particles of the system. From this definition it is clear that

$$F_{f,x} = -\frac{\partial \mathcal{F}}{\partial v_x}.$$

or, symbolically,

$$\mathbf{F}_f = -\nabla_v \mathcal{F}. \quad (1.68)$$

We can also give a physical interpretation to the dissipation function. The work done *by* the system *against* friction is

$$dW_f = -\mathbf{F}_f \cdot d\mathbf{r} = -\mathbf{F}_f \cdot \mathbf{v} dt = (k_x v_x^2 + k_y v_y^2 - k_z v_z^2) dt.$$

Hence, $2\mathcal{F}$ is the rate of energy dissipation due to friction. The component of the generalized force resulting from the force of friction is then given by

$$\begin{aligned} Q_j &= \sum_i \mathbf{F}_{f_i} \cdot \frac{\partial \mathbf{r}_i}{\partial q_j} = - \sum \nabla_v \mathcal{F} \cdot \frac{\partial \mathbf{r}_i}{\partial q_j} \\ &= - \sum \nabla_v \mathcal{F} \cdot \frac{\partial \dot{\mathbf{r}}_i}{\partial \dot{q}_j}, \quad \text{by (1.51),} \\ &= - \frac{\partial \mathcal{F}}{\partial \dot{q}_j}. \end{aligned} \quad (1.69)$$

An example is Stokes' law, whereby a sphere of radius a moving at a speed v , in a medium of viscosity η experiences the frictional drag force $\mathbf{F}_f = 6\pi\eta a\mathbf{v}$. The Lagrange equations with dissipation become

$$\frac{d}{dt} \left(\frac{\partial L}{\partial \dot{q}_j} \right) - \frac{\partial L}{\partial q_j} + \frac{\partial \mathcal{F}}{\partial \dot{q}_j} = 0, \quad (1.70)$$

so that two scalar functions, L and \mathcal{F} , must be specified to obtain the equations of motion.

1.6 ■ SIMPLE APPLICATIONS OF THE LAGRANGIAN FORMULATION

The previous sections show that for systems where we can define a Lagrangian, i.e., holonomic systems with applied forces derivable from an ordinary or generalized potential and workless constraints, we have a very convenient way of setting up the equations of motion. We were led to the Lagrangian formulation by the desire to eliminate the forces of constraint from the equations of motion, and in achieving this goal we have obtained many other benefits. In setting up the original form of the equations of motion, Eqs. (1.19), it is necessary to work with many *vector* forces and accelerations. With the Lagrangian method we only deal with two *scalar* functions, T and V , which greatly simplifies the problem.

A straightforward routine procedure can now be established for all problems of mechanics to which the Lagrangian formulation is applicable. We have only to write T and V in generalized coordinates, form L from them, and substitute in (1.57) to obtain the equations of motion. The needed transformation of T and V from Cartesian coordinates to generalized coordinates is obtained by applying the

transformation equations (1.38) and (1.45'). Thus, T is given in general by

$$T = \sum_i \frac{1}{2} m_i v_i^2 = \sum_i \frac{1}{2} m_i \left(\sum_j \frac{\partial \mathbf{r}_i}{\partial q_j} \dot{q}_j + \frac{\partial \mathbf{r}_i}{\partial t} \right)^2.$$

It is clear that on carrying out the expansion, the expression for T in generalized coordinates will have the form

$$T = M_0 + \sum_j M_j \dot{q}_j + \frac{1}{2} \sum_{j,k} M_{jk} \dot{q}_j \dot{q}_k, \quad (1.71)$$

where M_0 , M_j , M_{jk} are definite functions of the \mathbf{r} 's and t and hence of the q 's and t . In fact, a comparison shows that

$$\begin{aligned} M_0 &= \sum_i \frac{1}{2} m_i \left(\frac{\partial \mathbf{r}_i}{\partial t} \right)^2, \\ M_j &= \sum_i m_i \frac{\partial \mathbf{r}_i}{\partial t} \cdot \frac{\partial \mathbf{r}_i}{\partial q_j}, \end{aligned} \quad (1.72)$$

and

$$M_{jk} = \sum_i m_i \frac{\partial \mathbf{r}_i}{\partial q_j} \cdot \frac{\partial \mathbf{r}_i}{\partial q_k}.$$

Thus, the kinetic energy of a system can always be written as the sum of three homogeneous functions of the generalized velocities,

$$T = T_0 + T_1 + T_2, \quad (1.73)$$

where T_0 is independent of the generalized velocities, T_1 is linear in the velocities, and T_2 is quadratic in the velocities. If the transformation equations do not contain the time explicitly, as may occur when the constraints are independent of time (scleronomous), then only the last term in Eq. (1.71) is nonvanishing, and T is always a homogeneous quadratic form in the generalized velocities.

Let us now consider simple examples of this procedure:

1. Single particle in space
 - (a) Cartesian coordinates
 - (b) Plane polar coordinates
2. Atwood's machine
3. Time-dependent constraint—bead sliding on rotating wire

1. (a) *Motion of one particle: using Cartesian coordinates.* The generalized forces needed in Eq. (1.53) are obviously F_x , F_y , and F_z . Then

$$T = \frac{1}{2}m(\dot{x}^2 + \dot{y}^2 + \dot{z}^2),$$

$$\frac{\partial T}{\partial x} = \frac{\partial T}{\partial y} = \frac{\partial T}{\partial z} = 0,$$

$$\frac{\partial T}{\partial \dot{x}} = m\dot{x}, \quad \frac{\partial T}{\partial \dot{y}} = m\dot{y}, \quad \frac{\partial T}{\partial \dot{z}} = m\dot{z},$$

and the equations of motion are

$$\frac{d}{dt}(m\dot{x}) = F_x, \quad \frac{d}{dt}(m\dot{y}) = F_y, \quad \frac{d}{dt}(m\dot{z}) = F_z. \quad (1.74)$$

We are thus led back to the original Newton's equations of motion.

(b) *Motion of one particle: using plane polar coordinates.* Here we must express T in terms of \dot{r} and $\dot{\theta}$. The equations of transformation, i.e., Eqs. (1.38), in this case are simply

$$x = r \cos \theta$$

$$y = r \sin \theta.$$

By analogy to (1.46), the velocities are given by

$$\dot{x} = \dot{r} \cos \theta - r\dot{\theta} \sin \theta,$$

$$\dot{y} = \dot{r} \sin \theta + r\dot{\theta} \cos \theta.$$

The kinetic energy $T = \frac{1}{2}m(\dot{x}^2 + \dot{y}^2)$ then reduces formally to

$$T = \frac{1}{2}m[\dot{r}^2 + (r\dot{\theta})^2]. \quad (1.75)$$

An alternative derivation of Eq. (1.75) is obtained by recognizing that the plane polar components of the velocity are \dot{r} along \mathbf{r} , and $r\dot{\theta}$ along the direction perpendicular to r , denoted by the unit vector \mathbf{n} . Hence, the square of the velocity expressed in polar coordinates is simply $\dot{r}^2 + (r\dot{\theta})^2$. With the aid of the expression

$$d\mathbf{r} = \hat{\mathbf{r}} dr + r\hat{\boldsymbol{\theta}} d\theta + \hat{\mathbf{k}} dz$$

for the differential position vector, $d\mathbf{r}$, in cylindrical coordinates, where $\hat{\mathbf{r}}$ and $\hat{\boldsymbol{\theta}}$ are unit vectors in the \mathbf{r} and $\boldsymbol{\theta}$ -directions, respectively, the components of the generalized force can be obtained from the definition, Eq. (1.49),

$$Q_r = \mathbf{F} \cdot \frac{\partial \mathbf{r}}{\partial r} = \mathbf{F} \cdot \hat{\mathbf{r}} = F_r,$$

$$Q_\theta = \mathbf{F} \cdot \frac{\partial \mathbf{r}}{\partial \theta} = \mathbf{F} \cdot r\hat{\boldsymbol{\theta}} = rF_\theta,$$

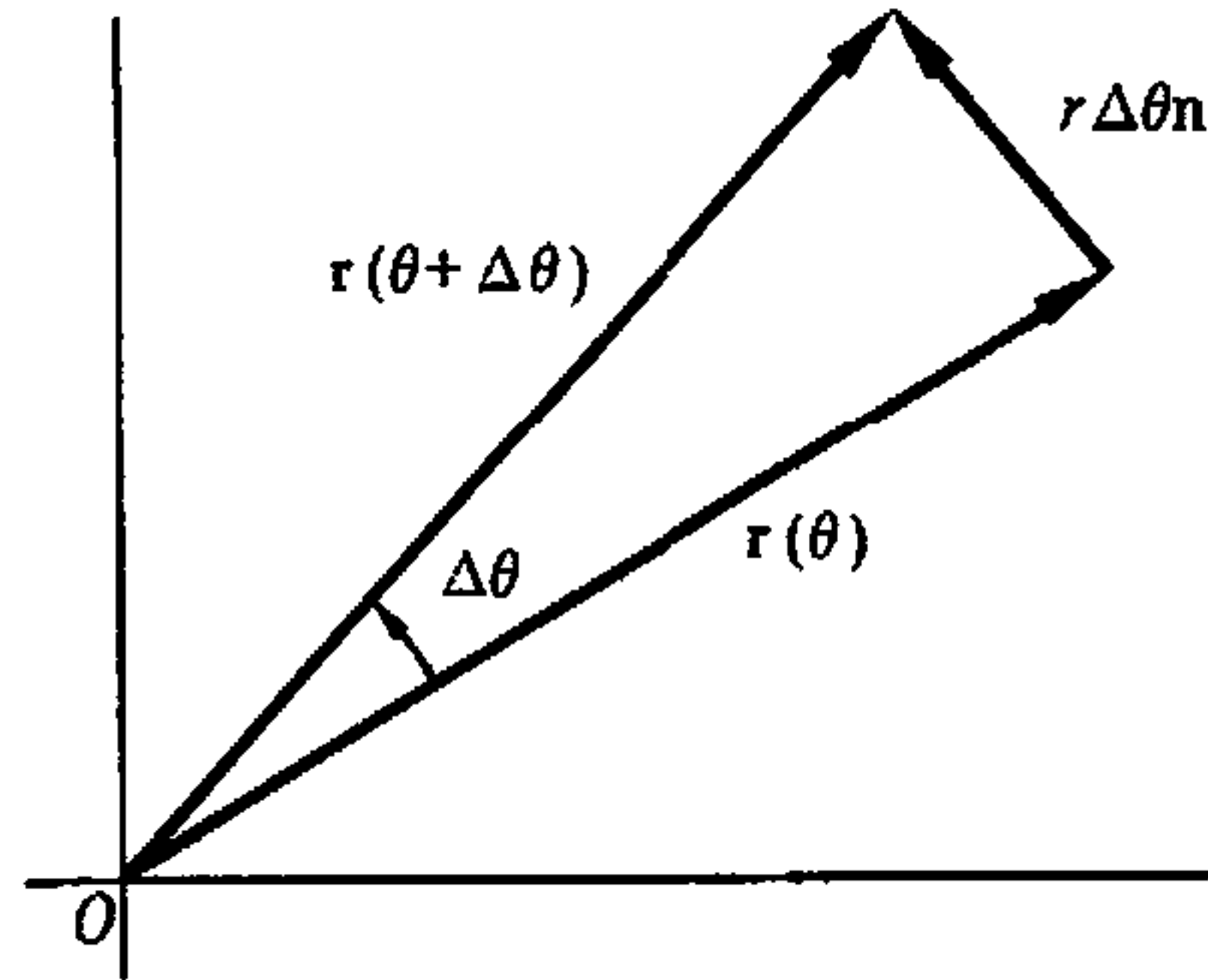
FIGURE 1.6 Derivative of r with respect to θ .

since the derivative of \mathbf{r} with respect to θ is, by the definition of a derivative, a vector in the direction of $\hat{\theta}$ (cf. Fig. 1.6). There are two generalized coordinates, and therefore two Lagrange equations. The derivatives occurring in the r equation are

$$\frac{\partial T}{\partial r} = mr\dot{\theta}^2, \quad \frac{\partial T}{\partial \dot{r}} = m\dot{r}, \quad \frac{d}{dt} \left(\frac{\partial T}{\partial \dot{r}} \right) = m\ddot{r},$$

and the equation itself is

$$m\ddot{r} - mr\dot{\theta}^2 = F_r,$$

the second term being the centripetal acceleration term. For the θ equation, we have the derivatives

$$\frac{\partial T}{\partial \theta} = 0, \quad \frac{\partial L}{\partial \dot{\theta}} = mr^2\dot{\theta}, \quad \frac{d}{dt} (mr^2\dot{\theta}) = mr^2\ddot{\theta} + 2mr\dot{r}\dot{\theta},$$

so that the equation becomes

$$\frac{d}{dt} (mr^2\dot{\theta}) = mr^2\ddot{\theta} + 2mr\dot{r}\dot{\theta} = rF_\theta.$$

Note that the left side of the equation is just the time derivative of the angular momentum, and the right side is exactly the applied torque, so that we have simply rederived the torque equation (1.26), where $L = mr^2\dot{\theta}$ and $N^{(\ell)} = rF_\theta$.

2. *Atwood's machine*—(See Fig. 1.7) an example of a conservative system with holonomic, scleronomous constraint (the pulley is assumed frictionless and massless). Clearly there is only one independent coordinate x , the position of the other weight being determined by the constraint that the length of the rope between them is l . The potential energy is

$$V = -M_1gx - M_2g(l - x),$$

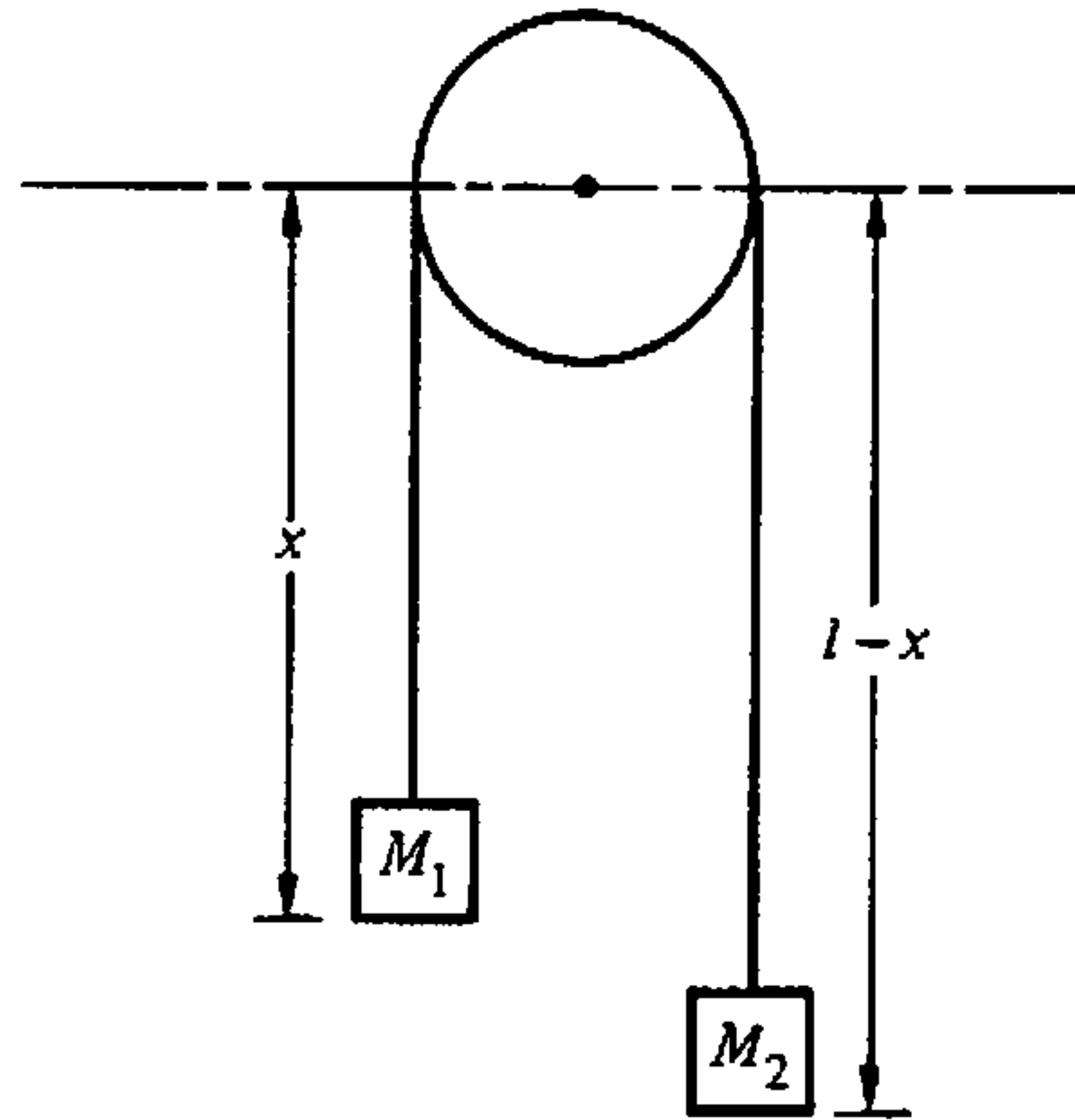

FIGURE 1.7 Atwood's machine.

while the kinetic energy is

$$T = \frac{1}{2} (M_1 + M_2) \dot{x}^2.$$

Combining the two, the Lagrangian has the form

$$L = T - V = \frac{1}{2} (M_1 + M_2) \dot{x}^2 + M_1 g x + M_2 g (l - x).$$

There is only one equation of motion, involving the derivatives

$$\begin{aligned} \frac{\delta L}{\delta x} &= (M_1 - M_2) g, \\ \frac{\partial L}{\partial \dot{x}} &= (M_1 + M_2) \dot{x}, \end{aligned}$$

so that we have

$$(M_1 + M_2) \ddot{x} = (M_1 - M_2) g,$$

or

$$\ddot{x} = \frac{M_1 - M_2}{M_1 + M_2} g,$$

which is the familiar result obtained by more elementary means. This trivial problem emphasizes that the forces of constraint—here the tension in the rope—appear nowhere in the Lagrangian formulation. By the same token, neither can the tension in the rope be found directly by the Lagrangian method.

3. *A bead (or ring) sliding on a uniformly rotating wire in a force-free space.* The wire is straight, and is rotated uniformly about some fixed axis perpendicular to the wire. This example has been chosen as a simple illustration of a constraint

being time dependent, with the rotation axis along z and the wire in the xy plane. The transformation equations explicitly contain the time.

$$x = r \cos \omega t, \quad (\omega = \text{angular velocity of rotation})$$

$$y = r \sin \omega t. \quad (r = \text{distance along wire from rotation axis})$$

While we could then find T (here the same as L) by the same procedure used to obtain (1.71), it is simpler to take over (1.75) directly, expressing the constraint by the relation $\dot{\theta} = \omega$:

$$T = \frac{1}{2}m (\dot{r}^2 + r^2\omega^2).$$

Note that T is not a homogeneous quadratic function of the generalized velocities, since there is now an additional term not involving \dot{r} . The equation of motion is then

$$m\ddot{r} = mr\omega^2 = 0$$

or

$$\ddot{r} = r\omega^2,$$

which is the familiar simple harmonic oscillator equation with a change of sign. The solution $r = e^{\omega t}$ shows that the bead moves exponentially outward because of the centripetal acceleration. Again, the method cannot furnish the force of constraint that keeps the bead on the wire. Equation (1.26) with the angular momentum, $\mathbf{L} = mr^2\omega^2 e^{\omega t}$, provides the force $\mathbf{F} = \mathbf{N}/r$, which produces the constraint force, $F = mr\omega^2 e^{\omega t}$, acting perpendicular to the wire and the axis of rotation.

DERIVATIONS

1. Show that for a single particle with constant mass the equation of motion implies the following differential equation for the kinetic energy:

$$\frac{dT}{dt} = \mathbf{F} \cdot \mathbf{v},$$

while if the mass varies with time the corresponding equation is

$$\frac{d(mT)}{dt} = \mathbf{F} \cdot \mathbf{p}.$$

2. Prove that the magnitude R of the position vector for the center of mass from an arbitrary origin is given by the equation

$$M^2 R^2 = M \sum_i m_i r_i^2 - \frac{1}{2} \sum_{i,j} m_i m_j r_{ij}^2.$$

3. Suppose a system of two particles is known to obey the equations of motion, Eqs. (1.22) and (1.26). From the equations of the motion of the individual particles show that the internal forces between particles satisfy both the weak and the strong laws of action and reaction. The argument may be generalized to a system with arbitrary number of particles, thus proving the converse of the arguments leading to Eqs. (1.22) and (1.26).
4. The equations of constraint for the rolling disk, Eqs. (1.39), are special cases of general linear differential equations of constraint of the form

$$\sum_{i=1}^n g_i(x_1, \dots, x_n) dx_i = 0.$$

A constraint condition of this type is holonomic only if an integrating function $f(x_1, \dots, x_n)$ can be found that turns it into an exact differential. Clearly the function must be such that

$$\frac{\partial (fg_i)}{\partial x_j} = \frac{\partial (fg_j)}{\partial x_i}$$

for all $i \neq j$. Show that no such integrating factor can be found for either of Eqs. (1.39).

5. Two wheels of radius a are mounted on the ends of a common axle of length b such that the wheels rotate independently. The whole combination rolls without slipping on a plane. Show that there are two nonholonomic equations of constraint,

$$\begin{aligned} \cos \theta dx + \sin \theta dy &= 0 \\ \sin \theta dx - \cos \theta dv &= \frac{1}{2}a(d\phi + d\phi'), \end{aligned}$$

(where θ , ϕ , and ϕ' have meanings similar to those in the problem of a single vertical disk, and (x, y) are the coordinates of a point on the axle midway between the two wheels) and one holonomic equation of constraint,

$$\theta = C - \frac{a}{b}(\phi - \phi').$$

where C is a constant.

6. A particle moves in the xy plane under the constraint that its velocity vector is always directed towards a point on the x axis whose abscissa is some given function of time $f(t)$. Show that for $f(t)$ differentiable, but otherwise arbitrary, the constraint is nonholonomic.
7. Show that Lagrange's equations in the form of Eqs. (1.53) can also be written as

$$\frac{\partial \dot{T}}{\partial \dot{q}_j} - 2 \frac{\partial T}{\partial q_j} = Q_j.$$

These are sometimes known as the *Nielsen* form of the Lagrange equations.

8. If L is a Lagrangian for a system of n degrees of freedom satisfying Lagrange's equations, show by direct substitution that

$$L' = L + \frac{dF(q_1, \dots, q_n, t)}{dt}$$

also satisfies Lagrange's equations where F is any arbitrary, but differentiable, function of its arguments.

9. The electromagnetic field is invariant under a gauge transformation of the scalar and vector potential given by

$$\begin{aligned} A &\rightarrow A + \nabla\psi(\mathbf{r}, t), \\ \phi &\rightarrow \phi - \frac{1}{c} \frac{\partial\psi}{\partial t}, \end{aligned}$$

where ψ is arbitrary (but differentiable). What effect does this gauge transformation have on the Lagrangian of a particle moving in the electromagnetic field? Is the motion affected?

10. Let q_1, \dots, q_n be a set of independent generalized coordinates for a system of n degrees of freedom, with a Lagrangian $L(q, \dot{q}, t)$. Suppose we transform to another set of independent coordinates s_1, \dots, s_n by means of transformation equations

$$q_i = q_i(s_1, \dots, s_n, t), \quad i = 1, \dots, n.$$

(Such a transformation is called a *point transformation*.) Show that if the Lagrangian function is expressed as a function of s_j, \dot{s}_j , and t through the equations of transformation, then L satisfies Lagrange's equations with respect to the s coordinates:

$$\frac{d}{dt} \left(\frac{\partial L}{\partial \dot{s}_j} \right) - \frac{\partial L}{\partial s_j} = 0.$$

In other words, the form of Lagrange's equations is invariant under a point transformation.

EXERCISES

11. Consider a uniform thin disk that rolls without slipping on a horizontal plane. A horizontal force is applied to the center of the disk and in a direction parallel to the plane of the disk.
- Derive Lagrange's equations and find the generalized force.
 - Discuss the motion if the force is not applied parallel to the plane of the disk.
12. The *escape velocity* of a particle on Earth is the minimum velocity required at Earth's surface in order that the particle can escape from Earth's gravitational field. Neglecting the resistance of the atmosphere, the system is conservative. From the conservation theorem for potential plus kinetic energy show that the escape velocity for Earth, ignoring the presence of the Moon, is 11.2 km/s.
13. Rockets are propelled by the momentum reaction of the exhaust gases expelled from the tail. Since these gases arise from the reaction of the fuels carried in the rocket, the mass of the rocket is not constant, but decreases as the fuel is expended. Show that the equation of motion for a rocket projected vertically upward in a uniform gravitational

field, neglecting atmospheric friction, is

$$m \frac{dv}{dt} = -v' \frac{dm}{dt} - mg,$$

where m is the mass of the rocket and v' is the velocity of the escaping gases relative to the rocket. Integrate this equation to obtain v as a function of m , assuming a constant time rate of loss of mass. Show, for a rocket starting initially from rest, with v' equal to 2.1 m/s and a mass loss per second equal to 1/60th of the initial mass, that in order to reach the escape velocity the ratio of the weight of the fuel to the weight of the empty rocket must be almost 300!

14. Two points of mass m are joined by a rigid weightless rod of length l , the center of which is constrained to move on a circle of radius a . Express the kinetic energy in generalized coordinates.
15. A point particle moves in space under the influence of a force derivable from a generalized potential of the form

$$U(\mathbf{r}, \mathbf{v}) = V(r) + \boldsymbol{\sigma} \cdot \mathbf{L},$$

where \mathbf{r} is the radius vector from a fixed point, \mathbf{L} is the angular momentum about that point, and $\boldsymbol{\sigma}$ is a fixed vector in space.

- (a) Find the components of the force on the particle in both Cartesian and spherical polar coordinates, on the basis of Eq. (1.58).
- (b) Show that the components in the two coordinate systems are related to each other as in Eq. (1.49).
- (c) Obtain the equations of motion in spherical polar coordinates.
16. A particle moves in a plane under the influence of a force, acting toward a center of force, whose magnitude is

$$F = \frac{1}{r^2} \left(1 - \frac{\dot{r}^2 - 2\ddot{r}r}{c^2} \right),$$

where r is the distance of the particle to the center of force. Find the generalized potential that will result in such a force, and from that the Lagrangian for the motion in a plane. (The expression for F represents the force between two charges in Weber's electrodynamics.)

17. A nucleus, originally at rest, decays radioactively by emitting an electron of momentum 1.73 MeV/c, and at right angles to the direction of the electron a neutrino with momentum 1.00 MeV/c. (The MeV, million electron volt, is a unit of energy used in modern physics, equal to 1.60×10^{-13} J. Correspondingly, MeV/c is a unit of linear momentum equal to 5.34×10^{-22} kg·m/s.) In what direction does the nucleus recoil? What is its momentum in MeV/c? If the mass of the residual nucleus is 3.90×10^{-25} kg what is its kinetic energy, in electron volts?
18. A Lagrangian for a particular physical system can be written as

$$L' = \frac{m}{2} (a\dot{x}^2 + 2b\dot{x}\dot{y} + c\dot{y}^2) - \frac{K}{2} (ax^2 + 2bxy + cy^2),$$

where a , b , and c are arbitrary constants but subject to the condition that $b^2 - ac \neq 0$.

What are the equations of motion? Examine particularly the two cases $a = 0 = c$ and $b = 0, c = -a$. What is the physical system described by the above Lagrangian? Show that the usual Lagrangian for this system as defined by Eq. (1.57') is related to L' by a point transformation (cf. Derivation 10). What is the significance of the condition on the value of $b^2 - ac$?

19. Obtain the Lagrange equations of motion for a spherical pendulum, i.e., a mass point suspended by a rigid weightless rod.
20. A particle of mass m moves in one dimension such that it has the Lagrangian

$$L = \frac{m^2 \dot{x}^4}{12} + m x^2 V(x) - V_2(x),$$

where V is some differentiable function of x . Find the equation of motion for $x(t)$ and describe the physical nature of the system on the basis of this equation

21. Two mass points of mass m_1 and m_2 are connected by a string passing through a hole in a smooth table so that m_1 rests on the table surface and m_2 hangs suspended. Assuming m_2 moves only in a vertical line, what are the generalized coordinates for the system? Write the Lagrange equations for the system and, if possible, discuss the physical significance any of them might have. Reduce the problem to a single second-order differential equation and obtain a first integral of the equation. What is its physical significance? (Consider the motion only until m_1 reaches the hole.)
22. Obtain the Lagrangian and equations of motion for the double pendulum illustrated in Fig. 1.4, where the lengths of the pendula are l_1 and l_2 with corresponding masses m_1 and m_2 .
23. Obtain the equation of motion for a particle falling vertically under the influence of gravity when frictional forces obtainable from a dissipation function $\frac{1}{2} k v^2$ are present. Integrate the equation to obtain the velocity as a function of time and show that the maximum possible velocity for a fall from rest is $v = mg/k$.
24. A spring of rest length L_0 (no tension) is connected to a support at one end and has a mass M attached at the other. Neglect the mass of the spring, the dimension of the mass M , and assume that the motion is confined to a vertical plane. Also, assume that the spring only stretches without bending but it can swing in the plane.
- (a) Using the angular displacement of the mass from the vertical and the length that the string has stretched from its rest length (hanging with the mass m), find Lagrange's equations.
- (b) Solve these equations for small stretching and angular displacements.
- (c) Solve the equations in part (a) to the next order in both stretching and angular displacement. This part is amenable to hand calculations. Using some reasonable assumptions about the spring constant, the mass, and the rest length, discuss the motion. Is a resonance likely under the assumptions stated in the problem?
- (d) (For analytic computer programs.) Consider the spring to have a total mass $m \ll M$. Neglecting the bending of the spring, set up Lagrange's equations correctly to first order in m and the angular and linear displacements.
- (e) (For numerical computer analysis.) Make sets of reasonable assumptions of the constants in part (a) and make a single plot of the two coordinates as functions of time.

CHAPTER

2

Variational Principles and Lagrange's Equations

2.1 ■ HAMILTON'S PRINCIPLE

The derivation of Lagrange's equations presented in Chapter 1 started from a consideration of the instantaneous state of the system and small virtual displacements about the instantaneous state, i.e., from a "differential principle" such as D'Alembert's principle. It is also possible to obtain Lagrange's equations from a principle that considers the entire motion of the system between times t_1 and t_2 , and small virtual variations of this motion from the actual motion. A principle of this nature is known as an "integral principle."

Before presenting the integral principle, the meaning attached to the phrase "motion of the system between times t_1 and t_2 " must first be stated in more precise language. The instantaneous configuration of a system is described by the values of the n generalized coordinates q_1, \dots, q_n , and corresponds to a particular point in a Cartesian hyperspace where the q 's form the n coordinate axes. This n -dimensional space is therefore known as configuration space. As time goes on, the state of the system changes and the system point moves in configuration space tracing out a curve, described as "the path of motion of the system." The "motion of the system," as used above, then refers to the motion of the system point along this path in *configuration space*. Time can be considered formally as a parameter of the curve; to each point on the path there is associated one or more values of the time. Note that configuration space has no necessary connection with the physical three-dimensional space, just as the generalized coordinates are not necessarily position coordinates. The path of motion in configuration space has no resemblance to the path in space of any actual particle; each point on the path represents the *entire* system configuration at some given instant of time.

The integral *Hamilton's principle* describes the motion of those mechanical systems for which all forces (except the forces of constraint) are derivable from a generalized scalar potential that may be a function of the coordinates, velocities, and time. Such systems will be denoted as *monogenic*. Where the potential is an explicit function of position coordinates only, then a monogenic system is also conservative (cf. Section 1.2).

For monogenic systems, Hamilton's principle can be stated as

The motion of the system from time t_1 to time t_2 is such that the line integral (called the action or the action integral),

$$I = \int_{t_1}^{t_2} L dt, \quad (2.1)$$

where $L = T - V$, has a stationary value for the actual path of the motion.

That is, out of all possible paths by which the system point could travel from its position at time t_1 to its position at time t_2 , it will actually travel along that path for which the value of the integral (2.1) is stationary. By the term "stationary value" for a line integral, we mean that the integral along the given path has the same value to within first-order infinitesimals as that along all neighboring paths (i.e., those that differ from it by infinitesimal displacements). (Cf. Fig. 2.1.) The notion of a stationary value for a line integral thus corresponds in ordinary function theory to the vanishing of the first derivative.

We can summarize Hamilton's principle by saying that the motion is such that the *variation* of the line integral I for fixed t_1 and t_2 is zero:

$$\delta I = \delta \int_{t_1}^{t_2} L(q_1, \dots, q_n, \dot{q}_1, \dots, \dot{q}_n, t) dt = 0. \quad (2.2)$$

Where the system constraints are holonomic, Hamilton's principle, Eq. (2.2), is both a necessary and sufficient condition for Lagrange's equations, Eqs. (1.57). Thus, it can be shown that Hamilton's principle follows directly from Lagrange's equations. Instead, however, we shall prove the converse, namely, that Lagrange's equations follow from Hamilton's principle, as being the more important theorem. That Hamilton's principle is a sufficient condition for deriving the equations of motion enables us to construct the mechanics of monogenic systems from Hamilton's principle as the basic postulate rather than Newton's laws of motion. Such a formulation has advantages; e.g., since the integral I is obviously invariant to the system of generalized coordinates used to express L , the equations of motion must always have the Lagrangian form no matter how the generalized coordinates

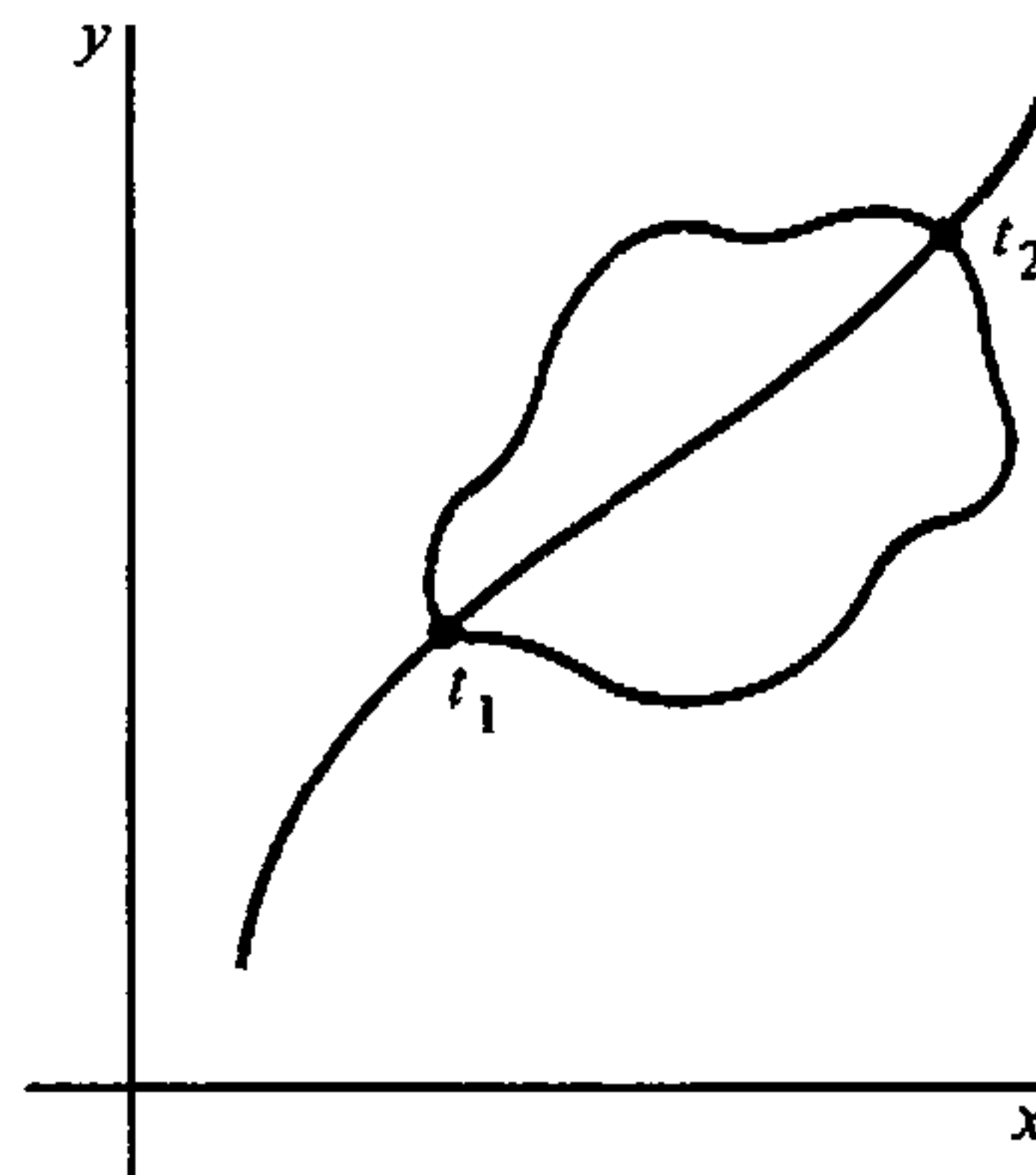

FIGURE 2.1 Path of the system point in configuration space.

are transformed. More important, the formulation in terms of a variational principle is the route that is generally followed when we try to describe apparently nonmechanical systems in the mathematical clothes of classical mechanics, as in the theory of fields.

2.2 ■ SOME TECHNIQUES OF THE CALCULUS OF VARIATIONS

Before demonstrating that Lagrange's equations do follow from (2.2), we must first examine the methods of the calculus of variations, for a chief problem of this calculus is to find the curve for which some given line integral has a stationary value.

Consider first the problem in an essentially one-dimensional form: We have a function $f(y, \dot{y}, x)$ defined on a path $y = y(x)$ between two values x_1 and x_2 , where \dot{y} is the derivative of y with respect to x . We wish to find a particular path $y(x)$ such that the line integral J of the function f between x_1 and x_2 ,

$$\dot{y} \equiv \frac{dy}{dx},$$

$$J = \int_{x_1}^{x_2} f(y, \dot{y}, x) dx, \quad (2.3)$$

has a stationary value relative to paths differing infinitesimally from the correct function $y(x)$. The variable x here plays the role of the parameter t , and we consider only such varied paths for which $y(x_1) = y_1$, $y(x_2) = y_2$. (Cf. Fig. 2.2.) Note that Fig. 2.2 does *not* represent configuration space. In the one-dimensional configuration space, both the correct and varied paths are the segment of the straight line connecting y_1 and y_2 ; the paths differ only in the functional relation between y and x . The problem is one-dimensional, y is a function of x not a coordinate.

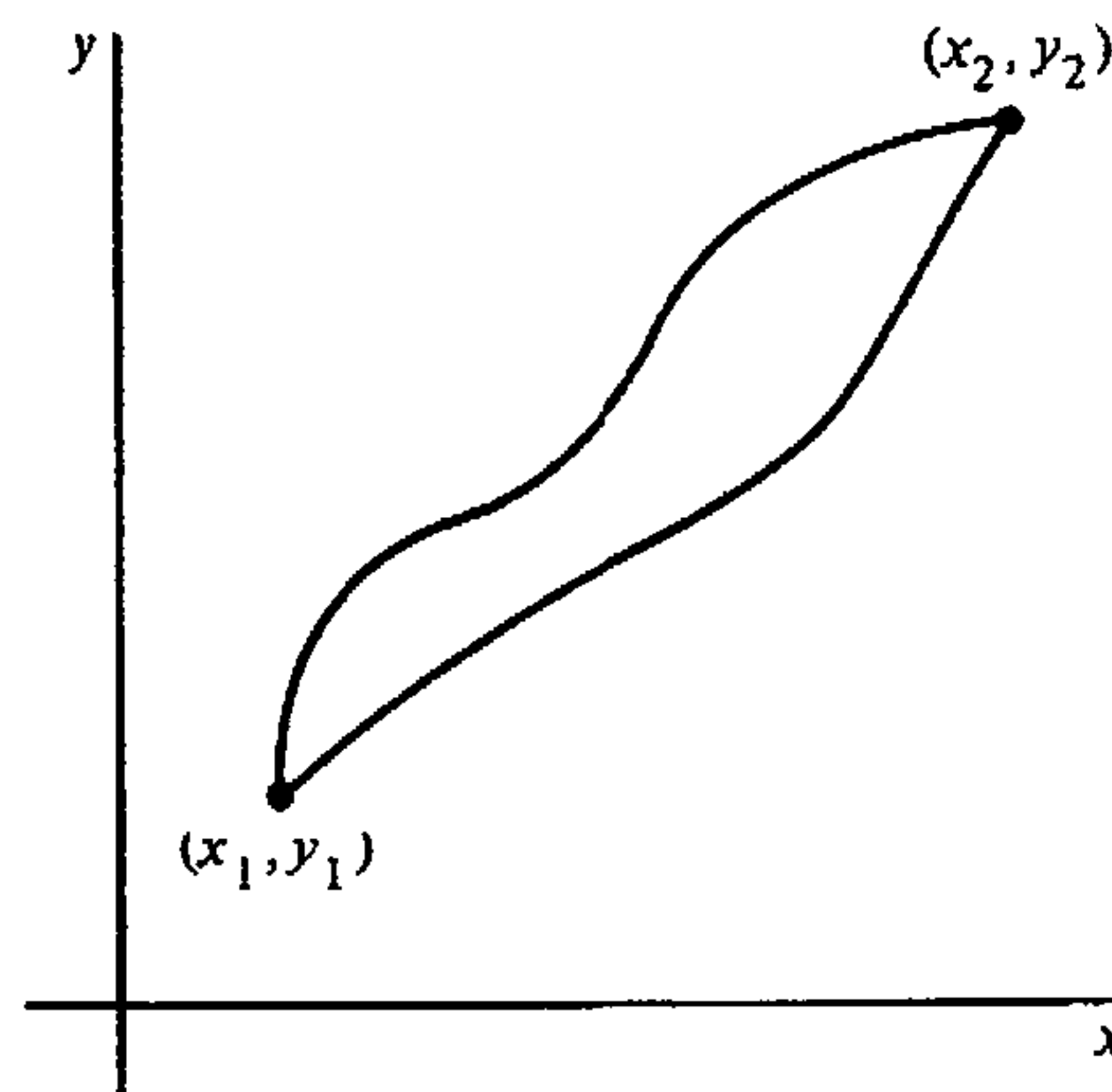

FIGURE 2.2 Varied paths of the function of $y(x)$ in the one-dimensional extremum problem.

We put the problem in a form that enables us to use the familiar apparatus of the differential calculus for finding the stationary points of a function. Since J must have a stationary value for the correct path relative to *any* neighboring path, the variation must be zero relative to *some* particular set of neighboring paths labeled by an infinitesimal parameter α . Such a set of paths might be denoted by $y(x, \alpha)$, with $y(x, 0)$ representing the correct path. For example, if we select any function $\eta(x)$ that vanishes at $x = x_1$ and $x = x_2$, then a possible set of varied paths is given by

$$y(x, \alpha) = y(x, 0) + \alpha\eta(x). \quad (2.4)$$

For simplicity, it is assumed that both the correct path $y(x)$ and the auxiliary function $\eta(x)$ are well-behaved functions—continuous and nonsingular between x_1 and x_2 , with continuous first and second derivatives in the same interval. For any such parametric family of curves, J in Eq. (2.3) is also a function of α :

$$J(\alpha) = \int_{x_1}^{x_2} f(y(x, \alpha), \dot{y}(x, \alpha), x) dx. \quad (2.5)$$

and the condition for obtaining a stationary point is the familiar one that

$$\left(\frac{dJ}{d\alpha}\right)_{\alpha=0} = 0. \quad (2.6)$$

By the usual methods of differentiating under the integral sign, we find that

$$\frac{dJ}{d\alpha} = \int_{x_1}^{x_2} \left(\frac{\partial f}{\partial y} \frac{\partial y}{\partial \alpha} + \frac{\partial f}{\partial \dot{y}} \frac{\partial \dot{y}}{\partial \alpha} \right) dx. \quad (2.7)$$

Consider the second of these integrals.

$$\int_{x_1}^{x_2} \frac{\partial f}{\partial \dot{y}} \frac{\partial \dot{y}}{\partial \alpha} dx = \int_{x_1}^{x_2} \frac{\partial f}{\partial \dot{y}} \frac{\partial^2 y}{\partial x \partial \alpha} dx.$$

Integrating by parts, the integral becomes

$$\int_{x_1}^{x_2} \frac{\partial f}{\partial \dot{y}} \frac{\partial^2 y}{\partial x \partial \alpha} dx = \frac{\partial f}{\partial \dot{y}} \frac{\partial y}{\partial \alpha} \Big|_{x_1}^{x_2} - \int_{x_1}^{x_2} \frac{d}{dx} \left(\frac{\partial f}{\partial \dot{y}} \right) \frac{\partial y}{\partial \alpha} dx. \quad (2.8)$$

The conditions on all the varied curves are that they pass through the points (x_1, y_1) , (x_2, y_2) , and hence the partial derivative of y with respect to α at x_1 and x_2 must vanish. Therefore, the first term of (2.8) vanishes and Eq. (2.7) reduces to

$$\frac{dJ}{d\alpha} = \int_{x_1}^{x_2} \left(\frac{\partial f}{\partial y} - \frac{d}{dx} \frac{\partial f}{\partial \dot{y}} \right) \frac{\partial y}{\partial \alpha} dx.$$

The condition for a stationary value, Eq. (2.6), is therefore equivalent to the equation

$$\int_{x_1}^{x_2} \left(\frac{\partial f}{\partial y} - \frac{d}{dx} \frac{\partial f}{\partial \dot{y}} \right) \left(\frac{\partial y}{\partial \alpha} \right)_0 dx = 0. \quad (2.9)$$

Now, the partial derivative of y with respect to α occurring in Eq. (2.9) is a function of x that is arbitrary except for continuity and end point conditions. For example, for the particular parametric family of varied paths given by Eq. (2.4), it is the arbitrary function $\eta(x)$. We can therefore apply to Eq. (2.9) the so-called "fundamental lemma" of the calculus of variations, which says if

$$\int_{x_1}^{x_2} M(x)\eta(x) dx = 0 \quad (2.10)$$

for all arbitrary functions $\eta(x)$ continuous through the second derivative, then $M(x)$ must identically vanish in the interval (x_1, x_2) . While a formal mathematical proof of the lemma can be found in texts on the calculus of variations, the validity of the lemma is easily seen intuitively. We can imagine constructing a function η that is positive in the immediate vicinity of any chosen point in the interval and zero everywhere else. Equation (2.10) can then hold only if $M(x)$ vanishes at that (arbitrarily) chosen point, which shows M must be zero throughout the interval. From Eq. (2.9) and the fundamental lemma, it therefore follows that J can have a stationary value only if

$$\frac{\partial f}{\partial y} - \frac{d}{dx} \left(\frac{\partial f}{\partial \dot{y}} \right) = 0. \quad (2.11)$$

The differential quantity,

$$\left(\frac{\partial y}{\partial \alpha} \right)_0 d\alpha \equiv \delta y, \quad (2.12)$$

represents the infinitesimal departure of the varied path from the correct path $y(x)$ at the point x and thus corresponds to the virtual displacement introduced in Chapter 1 (hence the notation δy). Similarly, the infinitesimal variation of J about the correct path can be designated

$$\left(\frac{dJ}{d\alpha} \right)_0 d\alpha \equiv \delta J. \quad (2.13)$$

The assertion that J is stationary for the correct path can thus be written

$$\delta J = \int_{x_1}^{x_2} \left(\frac{\partial f}{\partial y} - \frac{d}{dx} \frac{\partial f}{\partial \dot{y}} \right) \delta y dx = 0,$$

requiring that $y(x)$ satisfy the differential equation (2.11). The δ -notation, introduced through Eqs. (2.12) and (2.13), may be used as a convenient shorthand for treating the variation of integrals, remembering always that it stands for the manipulation of parametric families of varied paths such as Eq. (2.4).

Some simple examples of the application of Eq. (2.11) (which clearly resembles a Lagrange equation) may now be considered:

1. *Shortest distance between two points in a plane.* An element of length in a plane is

$$ds = \sqrt{dx^2 + dy^2}$$

and the total length of any curve going between points 1 and 2 is

$$I = \int_1^2 ds = \int_{x_1}^{x_2} \sqrt{1 + \left(\frac{dy}{dx}\right)^2} dx.$$

The condition that the curve be the shortest path is that I be a minimum. This is an example of the extremum problem as expressed by Eq. (2.3), with

$$f = \sqrt{1 + \dot{y}^2}.$$

Substituting in (2.11) with

$$\frac{\partial f}{\partial y} = 0, \quad \frac{\partial f}{\partial \dot{y}} = \frac{\dot{y}}{\sqrt{1 + \dot{y}^2}},$$

we have

$$\frac{d}{dx} \left(\frac{\dot{y}}{\sqrt{1 + \dot{y}^2}} \right) = 0$$

or

$$\frac{\dot{y}}{\sqrt{1 + \dot{y}^2}} = c,$$

where c is constant. This solution can be valid only if

$$\dot{y} = a,$$

where a is a constant related to c by

$$a = \frac{c}{\sqrt{1 - c^2}}.$$

But this is clearly the equation of a straight line,

$$y = ax + b,$$

where b is another constant of integration. Strictly speaking, the straight line has only been proved to be an extremum path, but for this problem it is obviously also a minimum. The constants of integration, a and b , are determined by the condition that the curve pass through the two end points, (x_1, y_1) , (x_2, y_2) .

In a similar fashion we can obtain the shortest distance between two points on a sphere, by setting up the arc length on the surface of the sphere in terms of the angle coordinates of position on the sphere. In general, curves that give the shortest distance between two points on a given surface are called the *geodesics* of the surface.

2. *Minimum surface of revolution.* Suppose we form a surface of revolution by taking some curve passing between two fixed end points (x_1, y_1) and (x_2, y_2) defining the xy plane, and revolving it about the y axis (cf. Fig. 2.3a). The problem then is to find that curve for which the surface area is a minimum. The area of a strip of the surface is $2\pi x ds = 2\pi x \sqrt{1 + \dot{y}^2} dx$, and the total area is

$$2\pi \int_1^2 x \sqrt{1 + \dot{y}^2} dx.$$

The extremum of this integral is again given by (2.11) where

$$f = x \sqrt{1 + \dot{y}^2}$$

and

$$\frac{\partial f}{\partial y} = 0, \quad \frac{\partial f}{\partial \dot{y}} = \frac{x \dot{y}}{\sqrt{1 + \dot{y}^2}}.$$

Equation (2.11) becomes in this case

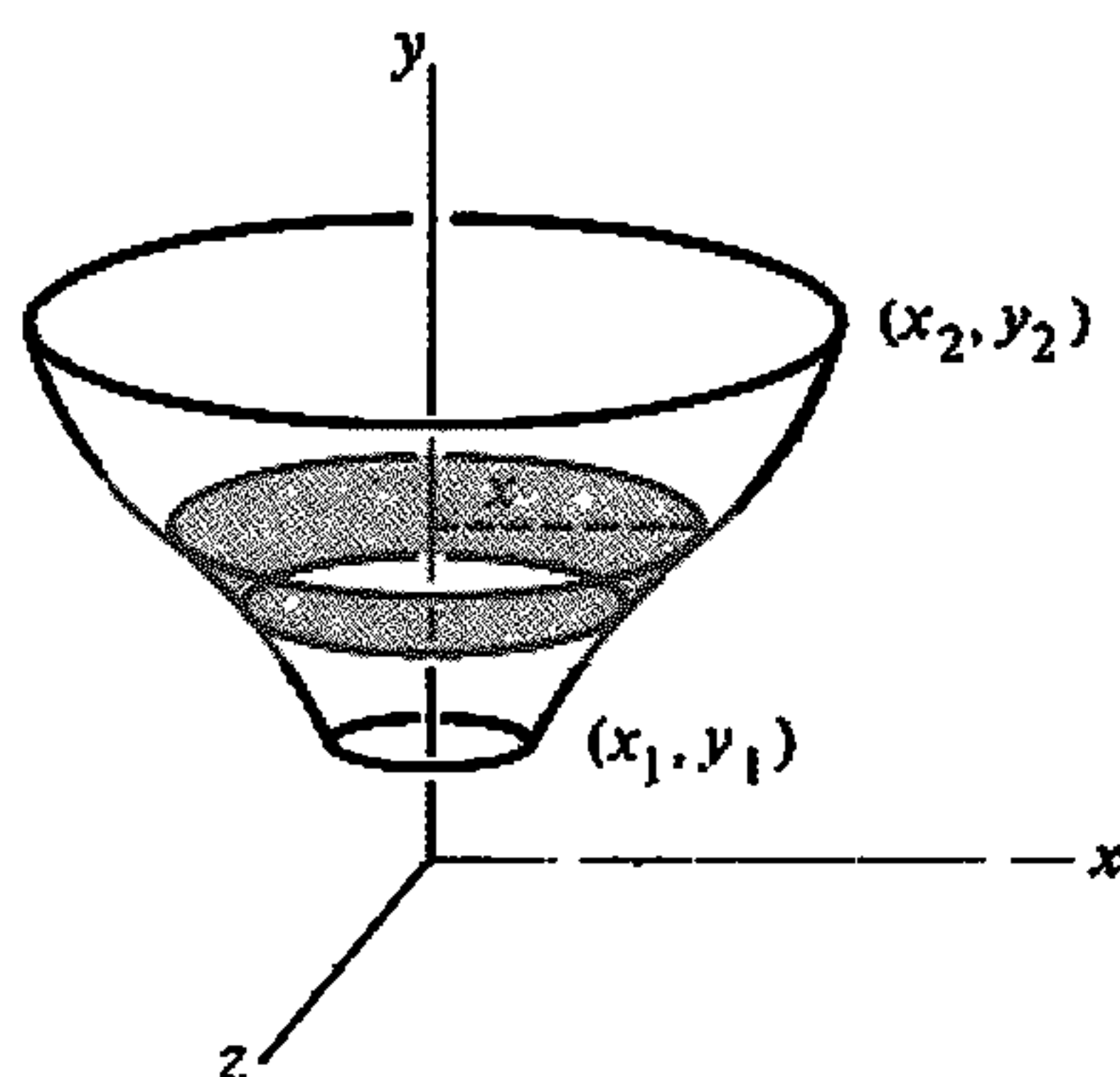

FIGURE 2.3a Minimum surface of revolution. Note that this figure is drawn for y_1 and y_2 having the same sign relative to the rotation axis. This is not assumed in the general solution.

$$\frac{d}{dx} \left(\frac{x\dot{y}}{\sqrt{1+\dot{y}^2}} \right) = 0$$

or

$$\frac{x\dot{y}}{\sqrt{1+\dot{y}^2}} = a,$$

where a is some constant of integration clearly smaller than the minimum value of x . Squaring the above equation and factoring terms, we have

$$\dot{y}^2(x^2 - a^2) = a^2,$$

or solving,

$$\frac{dy}{dx} = \frac{a}{\sqrt{x^2 - a^2}}.$$

The general solution of this differential equation, in light of the nature of a , is

$$y = a \int \frac{dx}{\sqrt{x^2 - a^2}} + b = a \operatorname{arc} \cosh \frac{x}{a} + b$$

or

$$x = a \cosh \frac{y - b}{a},$$

which is the equation of a catenary. Again the two constants of integration, a and b , are determined in principle by the requirements that the curve pass through the two given end points, as shown in Fig. 2.3b.

Curves satisfying the preceding equation all scale as x/a and y/a with one independent parameter b/a . This suggests that when the solutions are examined in detail they turn out to be a great deal more complicated than these considera-

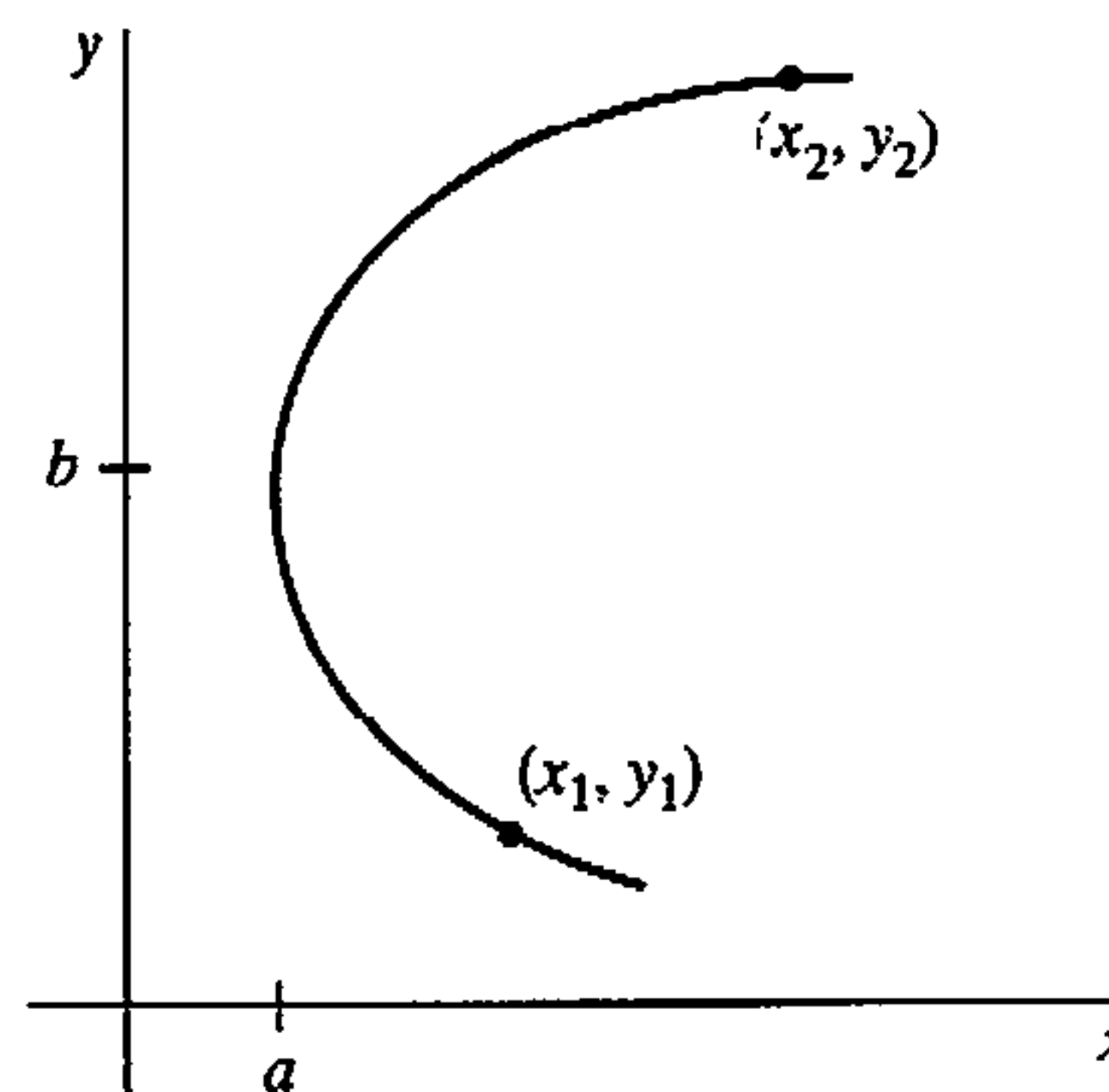

FIGURE 2.3b General catenary solution for minimum surface of revolution.

tions suggest. For some pairs of end points, unique constants of integration a and b can be found. But for other end points, it is possible to draw two different catenary curves through the end points, while for additional cases no possible values can be found for a and b . Further, recall that Eq. (2.11) represents a condition for finding curves $y(x)$ continuous through the second derivative that render the integral stationary. The catenary solutions therefore do not always represent minimum values, but may represent "inflection points" where the length of the curve is stationary but not minimum.

For certain combinations of end points (an example is x_1 and x_2 both positive and both much smaller than $y_2 - y_1$), the absolute minimum in the surface of revolution is provided (cf. Exercise 8) by a curve composed of straight line segments—from the first end point parallel to the x axis until the y axis is reached, then along the y axis until the point $(0, y_2)$ and then out in a straight line to the second end point corresponding to the area $\pi(x_1^2 + x_2^2)$. This curve results when $a = 0$, forcing either $x = 0$ or $y = \text{constant}$. Since this curve has discontinuous first derivatives, we should not expect to find it as a solution to Eq. (2.11).

This example is valuable in emphasizing the restrictions that surround the derivation and the meaning of the stationary condition. Exercises 7 and 8 examine the conditions for the pathological behavior for a symmetric example. More information can be found in many texts on the calculus of variations.

3. *The brachistochrone problem.* (See Fig. 2.4a.) This well-known problem is to find the curve joining two points, along which a particle falling from rest under the influence of gravity travels from the higher to the lower point in the least time.

If v is the speed along the curve, then the time required to fall an arc length ds is ds/v , and the problem is to find a minimum of the integral

$$t_{12} = \int^2 \frac{ds}{v}.$$

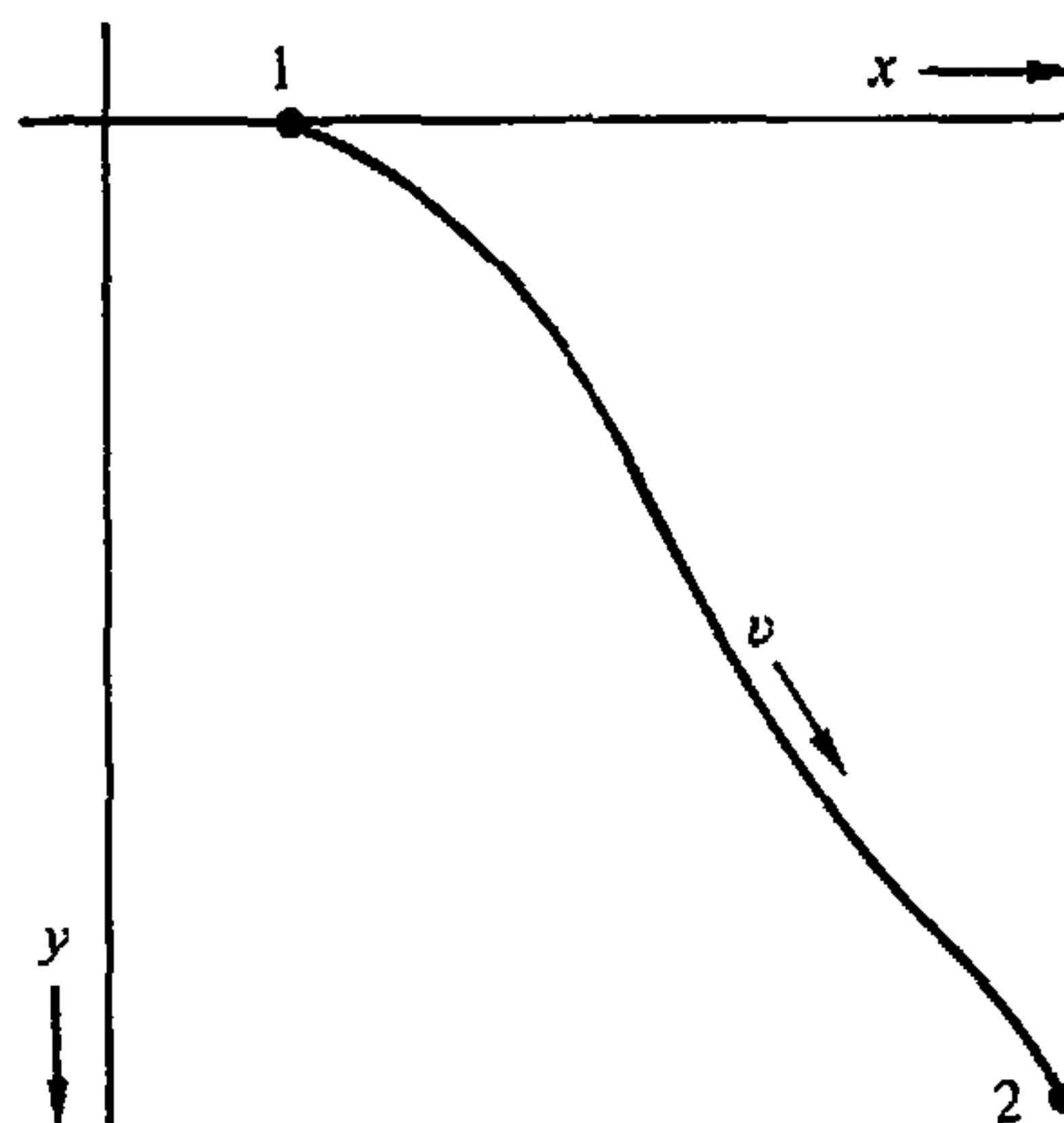

FIGURE 2.4a The brachistochrone problem.

If y is measured down from the initial point of release, the conservation theorem for the energy of the particle can be written as

$$\frac{1}{2}mv^2 = mgy$$

or

$$v = \sqrt{2gy}.$$

Then the expression for t_{12} becomes

$$t_{12} = \int_1^2 \frac{\sqrt{1 + \dot{y}^2}}{\sqrt{2gy}} dx,$$

and f is identified as

$$f = \sqrt{\frac{1 + \dot{y}^2}{2gy}}.$$

The integration of Eq. (2.11) with this form for f is straightforward and is left as an exercise.

The solution in terms of its one parameter, a , given by

$$\frac{y}{a} = 1 - \cos \left[\frac{x + \sqrt{y(2a - y)}}{a} \right],$$

is sketched in Fig. 2.4b for the first cycle ($0 \leq x \leq 2\pi a$) and the beginning of the second cycle. Three cases of solutions are indicated. A power-series expansion of the solution for the limit $y \ll a$ gives

$$y = \frac{x^2}{2}a.$$

The brachistochrone problem is famous in the history of mathematics, for it was the analysis of this problem by John Bernoulli that led to the formal foundation of the calculus of variations.

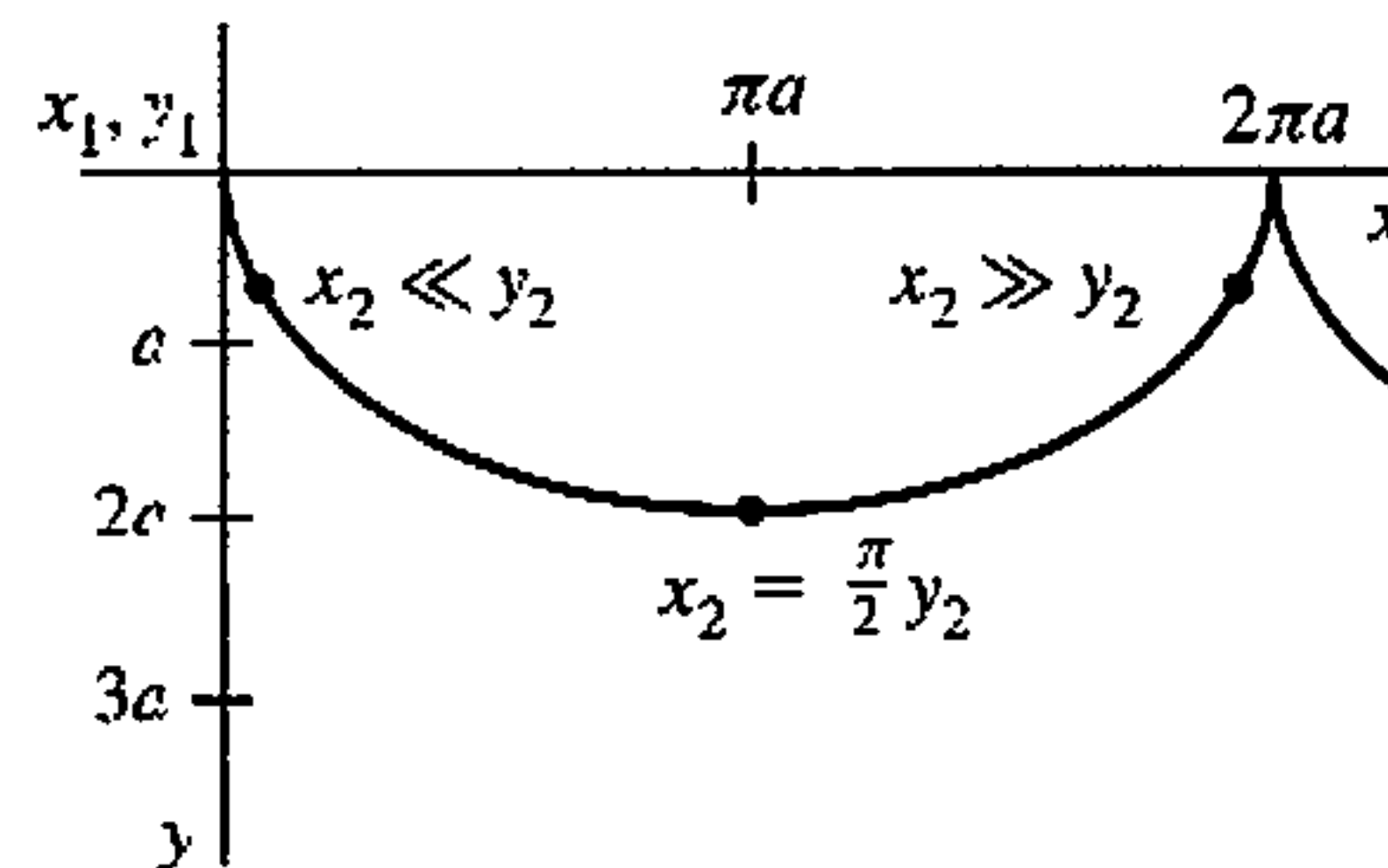

FIGURE 2.4b Catenary solution to the brachistochrone problem showing positions on the curve for the three cases $x_2 \ll y_2$, $x_2 = \frac{\pi}{2} y_2$, and $x_2 \gg y_2$

2.3 ■ DERIVATION OF LAGRANGE'S EQUATIONS FROM HAMILTON'S PRINCIPLE

The fundamental problem of the calculus of variations is easily generalized to the case where f is a function of many independent variables y_i , and their derivatives \dot{y}_i . (Of course, all these quantities are considered as functions of the parametric variable x .) Then a variation of the integral J ,

$$\delta J = \delta \int_1^2 f(y_1(x); y_2(x), \dots, \dot{y}_1(x); \dot{y}_2(x), \dots, x) dx, \quad (2.14)$$

is obtained, as before, by considering J as a function of parameter α that labels a possible set of curves $y_1(x, \alpha)$. Thus, we may introduce α by setting

$$\begin{aligned} y_1(x, \alpha) &= y_1(x, 0) + \alpha \eta_1(x), \\ y_2(x, \alpha) &= y_2(x, 0) + \alpha \eta_2(x), \\ &\vdots \quad \quad \quad \vdots \quad \quad \quad \vdots \end{aligned} \quad (2.15)$$

where $y_1(x, 0)$, $y_2(x, 0)$, etc., are the solutions of the extremum problem (to be obtained) and η_1 , η_2 , etc., are independent functions of x that vanish at the end points and that are continuous through the second derivative, but otherwise are completely arbitrary.

The calculation proceeds as before. The variation of J is given in terms of

$$\frac{\partial J}{\partial \alpha} d\alpha = \int_1^2 \sum_i \left(\frac{\partial f}{\partial y_i} \frac{\partial y_i}{\partial \alpha} d\alpha + \frac{\partial f}{\partial \dot{y}_i} \frac{\partial \dot{y}_i}{\partial \alpha} d\alpha \right) dx. \quad (2.16)$$

Again we integrate by parts the integral involved in the second sum of Eq. (2.16):

$$\int_1^2 \frac{\partial f}{\partial \dot{y}_i} \frac{\partial^2 y_i}{\partial \alpha \partial x} dx = \left. \frac{\partial f}{\partial \dot{y}_i} \frac{\partial y_i}{\partial \alpha} \right|_1^2 - \int_1^2 \frac{\partial y_i}{\partial \alpha} \frac{d}{dx} \left(\frac{\partial f}{\partial \dot{y}_i} \right) dx,$$

where the first term vanishes because all curves pass through the fixed end points. Substituting in (2.16), δJ becomes

$$\delta J = \int_1^2 \sum_i \left(\frac{\partial f}{\partial y_i} - \frac{d}{dx} \frac{\partial f}{\partial \dot{y}_i} \right) \delta y_i dx, \quad (2.17)$$

where, in analogy with (2.12), the variation δy_i is

$$\delta y_i = \left(\frac{\partial y_i}{\partial \alpha} \right)_0 d\alpha.$$

Since the y variables are independent, the variations δy_i are independent (e.g., the functions $\eta_i(x)$ will be independent of each other). Hence, by an obvious extension of the fundamental lemma (cf. Eq. (2.10)), the condition that δJ is zero

requires that the coefficients of the δy_i separately vanish:

$$\frac{\partial f}{\partial y_i} - \frac{d}{dx} \frac{\partial f}{\partial \dot{y}_i} = 0, \quad i = 1, 2, \dots, n. \quad (2.18)$$

Equations (2.18) represent the appropriate generalization of (2.11) to several variables and are known as the *Euler-Lagrange differential equations*. Their solutions represent curves for which the variation of an integral of the form given in (2.14) vanishes. Further generalizations of the fundamental variational problem are easily possible. Thus, we can take f as a function of higher derivatives \ddot{y} , \dot{y} , etc., leading to equations different from (2.18). Or we can extend it to cases where there are several parameters x_j and the integral is then multiple, with f also involving as variables derivatives of y_i with respect to each of the parameters x_j . Finally, it is possible to consider variations in which the end points are *not* held fixed.

For present purposes, what we have derived here suffices, for the integral in Hamilton's principle,

$$I = \int_1^2 L(q_i, \dot{q}_i, t) dt, \quad (2.19)$$

has just the form stipulated in (2.14) with the transformation

$$\begin{aligned} x &\rightarrow t \\ y_i &\rightarrow q_i \\ f(y_i, \dot{y}_i, x) &\rightarrow L(q_i, \dot{q}_i, t). \end{aligned}$$

In deriving Eqs. (2.18), we assumed that the y_i variables are independent. The corresponding condition in connection with Hamilton's principle is that the generalized coordinates q_i be independent, which requires that the constraints be holonomic. The Euler-Lagrange equations corresponding to the integral I then become the Lagrange equations of motion,

$$\frac{d}{dt} \frac{\partial L}{\partial \dot{q}_i} - \frac{\partial L}{\partial q_i} = 0, \quad i = 1, 2, \dots, n,$$

and we have accomplished our original aim, to show that Lagrange's equations follow from Hamilton's principle—for monogenic systems with holonomic constraints.

2.4 ■ EXTENSION OF HAMILTON'S PRINCIPLE TO NONHOLONOMIC SYSTEMS

It is possible to extend Hamilton's principle, at least in a formal sense, to cover certain types of nonholonomic systems. In deriving Lagrange's equations from

either Hamilton's or D'Alembert's principle, the requirement of holonomic constraints does not appear until the last step, when the variations q_i are considered as independent of each other. With nonholonomic systems the generalized coordinates are not independent of each other, and it is not possible to reduce them further by means of equations of constraint of the form $f(q_1, q_2, \dots, q_n, t) = 0$. Hence, it is no longer true that the q_i 's are all independent.

Another difference that must be considered in treating the variational principle is the manner in which the varied paths are constructed. In the discussion of Section 2.2, we pointed out that δy (or δq) represents a virtual displacement from a point on the actual path to some point on the neighboring varied path. But, with independent coordinates it is the final varied path that is significant, not how it is constructed. When the coordinates are not independent, but subject to constraint relations, it becomes important whether the varied path is or is not constructed by displacements consistent with the constraints. Virtual displacements, in particular, may or may not satisfy the constraints.

It appears that a reasonably straightforward treatment of nonholonomic systems by a variational principle is possible only when the equations of constraint can be put in the form

$$f_\alpha(q_1, \dots, q_n; \dot{q}_1, \dots, \dot{q}_n) = 0, \quad (2.20)$$

when this can be done the constraints are called semi-holonomic. The index α indicates that there may be more than one such equation. We will assume there are m equations in all, i.e., $\alpha = 1, 2, \dots, m$. Equation (2.20) commonly appears in the restricted form

$$\sum_k a_{ik} dq_k + a_{it} dt = 0. \quad (2.20')$$

We might expect that the varied paths, or equivalently, the displacements constructing the varied path, should satisfy the constraints of Eq. (2.20). However, it has been proven that no such varied path can be constructed unless Eqs. (2.20) are integrable, in which case the constraints are actually holonomic. A variational principle leading to the correct equations of motion can nonetheless be obtained when the varied paths are constructed from the actual motion by virtual displacements.

The procedure for eliminating these extra virtual displacements is the method of *Lagrange undetermined multipliers*. If Eqs. (2.20) hold, then it is also true that

$$\sum_{\alpha=1}^m \lambda_\alpha f_\alpha = 0, \quad (2.21)$$

where the λ_α , $\alpha = 1, 2, \dots, m$, are some undetermined quantities, functions in general of the coordinates and of the time t . In addition, Hamilton's principle,

$$\delta \int_{t_1}^{t_2} L dt = 0, \quad (2.2)$$

is assumed to hold for this semiholonomic system. Following the development of Section 2.3, Hamilton's principle then implies that

$$\int_1^2 dt \sum_k \left(\frac{\partial L}{\partial q_k} - \frac{d}{dt} \frac{\partial L}{\partial \dot{q}_k} \right) \delta q_k = 0. \quad (2.22)$$

The variation cannot be taken as before since the q_k are not independent; however, combining (2.21) with (2.2) gives

$$\delta \int_{t_1}^{t_2} \left(L + \sum_{\alpha=1}^m \lambda_{\alpha} f_{\alpha} \right) dt = 0 \quad (2.23)$$

The variation can now be performed with the $n \delta q_i$ and $m \lambda_{\alpha}$ for $m+n$ independent variables. For the simplifying assumption that $\lambda_{\alpha} = \lambda_{\alpha}(t)$, the resulting equations from δq_i become*

$$\frac{d}{dt} \left(\frac{\partial L}{\partial \dot{q}_k} \right) - \frac{\partial L}{\partial q_k} = Q_k, \quad (2.24)$$

where

$$Q_k = \sum_{\alpha=1}^m \left\{ \lambda_{\alpha} \left[\frac{\partial f_{\alpha}}{\partial q_k} - \frac{d}{dt} \left(\frac{\partial f_{\alpha}}{\partial \dot{q}_k} \right) \right] - \frac{d\lambda_{\alpha}}{dt} \frac{\partial f_{\alpha}}{\partial \dot{q}_k} \right\}, \quad (2.25)$$

while the $\delta \lambda_{\alpha}$ give the equations of constraint (2.20). Equations (2.24) and (2.20) together constitute $n+m$ equations for $n+m$ unknowns. The system can now be interpreted as an $m+n$ holonomic system with generalized forces Q_k . The generalization to $\lambda_{\alpha} = \lambda_{\alpha}(q_1, \dots, q_n; \dot{q}_1, \dots, \dot{q}_n; t)$ is straightforward.

As an example, let us consider a particle whose Lagrangian is

$$L = \frac{1}{2}m(\dot{x}^2 + \dot{y}^2 + \dot{z}^2) - V(x, y, z) \quad (2.26)$$

subject to the constraint

$$f(\dot{x}, \dot{y}, y) = \dot{x}\dot{y} + ky = 0 \quad (2.27)$$

with k a constant. The resulting equations of motion are

$$m\ddot{x} + \lambda\ddot{y} + \dot{\lambda}\dot{y} + \frac{\partial V}{\partial x} = 0, \quad (2.28)$$

$$m\ddot{y} + \lambda\ddot{x} - k\lambda + \dot{\lambda}\dot{x} + \frac{\partial V}{\partial y} = 0, \quad (2.29)$$

$$m\ddot{z} + \frac{\partial V}{\partial z} = 0, \quad (2.30)$$

*J. Ray, *Amer. J. Phys.* **34** (406–8), 1996.

and the equation of constraint, (2.20), becomes

$$\dot{y}\dot{x} + ky = 0.$$

In this process we have obtained more information than was originally sought. Not only do we get the q_k 's we set out to find, but we also get $m\lambda_l$'s. What is the physical significance of the λ_l 's? Suppose we remove the constraints on the system, but instead apply external forces Q'_k in such a manner as to keep the motion of the system unchanged. The equations of motion likewise remain the same. Clearly these extra applied forces must be equal to the forces of constraint, for they are the forces applied to the system so as to satisfy the condition of constraint. Under the influence of these forces Q'_k , the equations of motion are

$$\frac{d}{dt} \frac{\partial L}{\partial \dot{q}_k} - \frac{\partial L}{\partial q_k} = Q'_k. \quad (2.31)$$

But these must be identical with Eqs. (2.24). Hence, we can identify (2.25) with Q'_k , the generalized forces of constraint. In this type of problem we really do not eliminate the forces of constraint from the formulation. They are supplied as part of the answer.

Although it is not obvious, the version of Hamilton's principle adopted here for semiholonomic systems also requires that the constraints do no work in virtual displacements. This can be most easily seen by rewriting Hamilton's principle in the form

$$\delta \int_{t_1}^{t_2} L dt = \delta \int_{t_1}^{t_2} T dt - \delta \int_{t_1}^{t_2} U dt = 0. \quad (2.32)$$

If the variation of the integral over the generalized potential is carried out by the procedures of Section 2.3, the principle takes the form

$$\delta \int_{t_1}^{t_2} T dt = \int_{t_1}^{t_2} \sum_k \left[\frac{\partial U}{\partial q_k} - \frac{d}{dt} \left(\frac{\partial U}{\partial \dot{q}_k} \right) \right] \delta q_k dt; \quad (2.33)$$

or, by Eq. (1.58),

$$\delta \int_{t_1}^{t_2} T dt = - \int_{t_1}^{t_2} \sum_k Q_k \delta q_k dt. \quad (2.34)$$

In this dress, Hamilton's principle says that the difference in the time integral of the kinetic energy between two neighboring paths is equal to the negative of the time integral of the work done in the virtual displacements between the paths. The work involved is that done only by the forces derivable from the generalized potential. The same Hamilton's principle holds for both holonomic and semiholonomic systems, it must be required that the additional forces of semiholonomic constraints do no work in the displacements δq_k . This restriction parallels the earlier condition that the virtual work of the forces of holonomic constraint also be

zero (cf. Section 1.4). In practice, the restriction presents little handicap to the applications, as many problems in which the semiholonomic formalism is used relate to rolling without slipping, where the constraints are obviously workless.

Note that Eq. (2.20) is not the most general type of nonholonomic constraint; e.g., it does not include equations of constraint in the form of inequalities. On the other hand, it does include holonomic constraints. A holonomic equation of constraint,

$$f(q_1, q_2, q_3, \dots, q_n, t) = 0, \quad (2.35)$$

is equivalent to (2.20) with no dependence on \dot{q}_k . Thus, the Lagrange multiplier method can be used also for holonomic constraints when (1) it is inconvenient to reduce all the q 's to independent coordinates or (2) we might wish to obtain the forces of constraint.

As another example of the method, let us consider the following somewhat trivial illustration—a hoop rolling, without slipping, down an inclined plane. In this example, the constraint of “rolling” is actually holonomic, but this fact will be immaterial to our discussion. On the other hand, the holonomic constraint that the hoop be on the inclined plane will be contained implicitly in our choice of generalized coordinates.

The two generalized coordinates are x , θ , as in Fig. 2.5, and the equation of rolling constraint is

$$r d\theta = dx.$$

The kinetic energy can be resolved into kinetic energy of motion of the center of mass plus the kinetic energy of motion about the center of mass:

$$T = \frac{1}{2}M\dot{x}^2 + \frac{1}{2}Mr^2\dot{\theta}^2.$$

The potential energy is

$$V = Mg(l - x) \sin \phi,$$

where l is the length of the inclined plane and the Lagrangian is

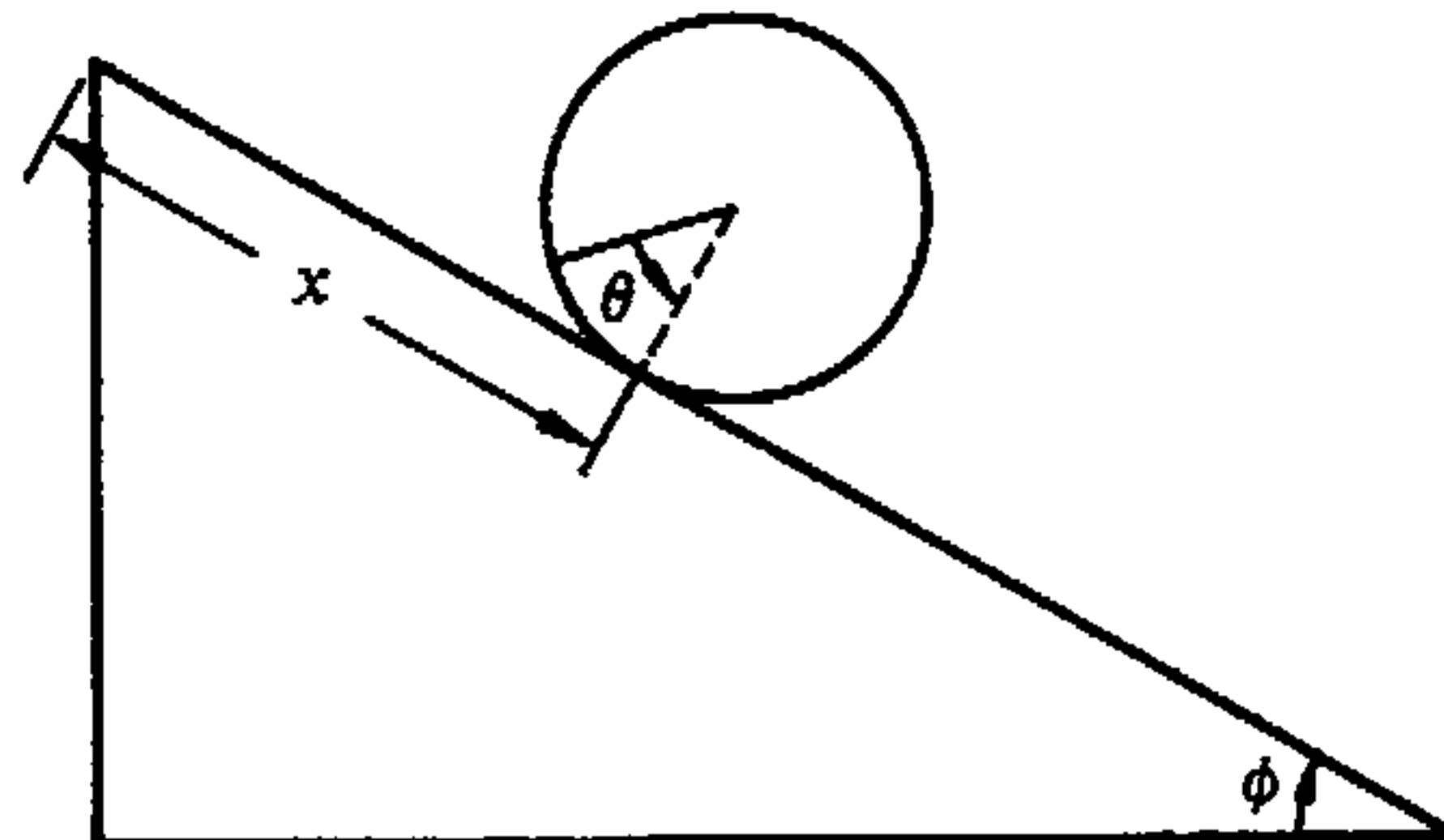

FIGURE 2.5 A hoop rolling down an inclined plane.

$$\begin{aligned}
 L &= T - V \\
 &= \frac{M\dot{x}^2}{2} + \frac{Mr^2\dot{\theta}^2}{2} - Mg(l - x)\sin\phi.
 \end{aligned} \tag{2.36}$$

Since there is one equation of constraint, only one Lagrange multiplier λ is needed. The coefficients appearing in the constraint equation are:

$$\begin{aligned}
 a_\theta &= r, \\
 a_x &= -1.
 \end{aligned}$$

The two Lagrange equations therefore are

$$M\ddot{x} - Mg\sin\phi + \lambda = 0, \tag{2.37}$$

$$Mr^2\ddot{\theta} - \lambda r = 0, \tag{2.38}$$

which along with the equation of constraint,

$$r\dot{\theta} = \dot{x}, \tag{2.39}$$

constitutes three equations for three unknowns, θ , x , λ .

Differentiating (2.39) with respect to time, we have

$$r\ddot{\theta} = \ddot{x}.$$

Hence, from (2.38)

$$M\ddot{x} = \lambda,$$

and (2.37) becomes

$$\ddot{x} = \frac{g\sin\phi}{2}.$$

along with

$$\lambda = \frac{Mg\sin\phi}{2}$$

and

$$\ddot{\theta} = \frac{g\sin\phi}{2r}.$$

Thus, the hoop rolls down the incline with only one-half the acceleration it would have slipping down a frictionless plane, and the friction force of constraint is $\lambda = Mg\sin\phi/2$.

2.5 ■ ADVANTAGES OF A VARIATIONAL PRINCIPLE FORMULATION

Although we can extend the original formulation of Hamilton's principle (2.2) to include some nonholonomic constraints, in practice this formulation of mechanics is most useful when a Lagrangian of independent coordinates can be set up for the system. The variational principle formulation has been justly described as "elegant," for in the compact Hamilton's principle is contained all of the mechanics of holonomic systems with forces derivable from potentials. The principle has the further merit that it involves only physical quantities that can be defined without reference to a particular set of generalized coordinates, namely, the kinetic and potential energies. The formulation is therefore automatically invariant with respect to the choice of coordinates for the system.

From the variational Hamilton's principle, it is also obvious why the Lagrangian is always uncertain to a total time derivative of any function of the coordinates and time, as mentioned at the end of Section 1.4. The time integral of such a total derivative between points 1 and 2 depends only on the values of the arbitrary function at the end points. As the variation at the end points is zero, the addition of the arbitrary time derivative to the Lagrangian does not affect the variational behavior of the integral.

Another advantage is that the Lagrangian formulation can be easily extended to describe systems that are not normally considered in dynamics—such as the elastic field, the electromagnetic field, and field properties of elementary particles. Some of these generalizations will be considered later, but as three simple examples of its application outside the usual framework of mechanics, let us consider the cases of an RL circuit, an LC circuit, and coupled circuits.

We consider the physical system of a battery of voltage V in series with an inductance L and a resistance of value R and choose the electric charge q as the dynamical variable. The inductor acts as the kinetic energy term since the inductive effect depends upon the time rate of change of the charge. The resistor provides a dissipative term and the potential energy is qV . The dynamic terms in Lagrange's equation with dissipation (1.70) are

$$T = \frac{1}{2}L\dot{q}^2, \quad \mathcal{F} = \frac{1}{2}R\dot{q}^2,$$

and potential energy = qV . The equation of motion is

$$V = L\ddot{q} + R\dot{q} = L\dot{I} + RI. \quad (2.40)$$

where $I = \dot{q}$ is the electric current. A solution for a battery connected to the circuit at time $t = 0$ is

$$I = I_0(1 - e^{-Rt/L}),$$

where $I_0 = V/R$ is the final steady-state current flow.

The mechanical analog for this is a sphere of radius a and effective mass m' falling in a viscous fluid of constant density and viscosity η under the force of

gravity. The effective mass is the difference between the actual mass and the mass of the displaced fluid, and the direction of motion is along the y axis. For this system,

$$T = \frac{1}{2}m'\dot{y}^2, \quad \mathcal{F} = 3\pi\eta a\dot{y}^2,$$

and potential energy $= m'gy$, where the frictional drag force, $F_f = 6\pi\eta ay$, called Stokes' law, was given at the end of Section 1.5.

The equation of motion is given by Lagrange's equations (1.70) as

$$m'g = m'\ddot{y} + 6\pi\eta a\dot{y}.$$

Using $v = \dot{y}$, the solution (if the motion starts from rest at $t = 0$), is

$$v = v_0(1 - e^{-t/\tau})$$

where $\tau = m'/(6\pi\eta a)$ is a measure of the time it takes for the sphere to reach $1/e$ of its terminal speed of $v_0 = m'g/6\pi\eta a$.

Another example from electrical circuits is an inductance, L , in series with a capacitance, C . The capacitor acts as a source of potential energy given by q^2/C where q is the electric charge. The Lagrangian produces the equation of motion,

$$L\ddot{q} + \frac{q}{C} = 0, \quad (2.41)$$

which has the solution

$$q = q_0 \cos \omega_0 t,$$

where q_0 is the charge stored in the capacitor at $t = 0$, and the assumption is that no charge is flowing at $t = 0$. The quantity

$$\omega_0 = \frac{1}{\sqrt{LC}}$$

is the resonant frequency of the system.

The mechanical analog of this system is the simple harmonic oscillator described by the Lagrangian $L = \frac{1}{2}m\dot{x}^2 - \frac{1}{2}kx^2$, which gives an equation of motion,

$$m\ddot{x} + kx = 0,$$

whose solution for the same boundary conditions is

$$x = x_0 \cos \omega_0 t \quad \text{with} \quad \omega_0 = \sqrt{k/m}.$$

These two examples show that an inductance is an inertial term, the electrical analog of mass. Resistance is the analog of Stokes' law type of frictional drag, and the capacitance term $1/C$ represents a Hooke's law spring constant. With this

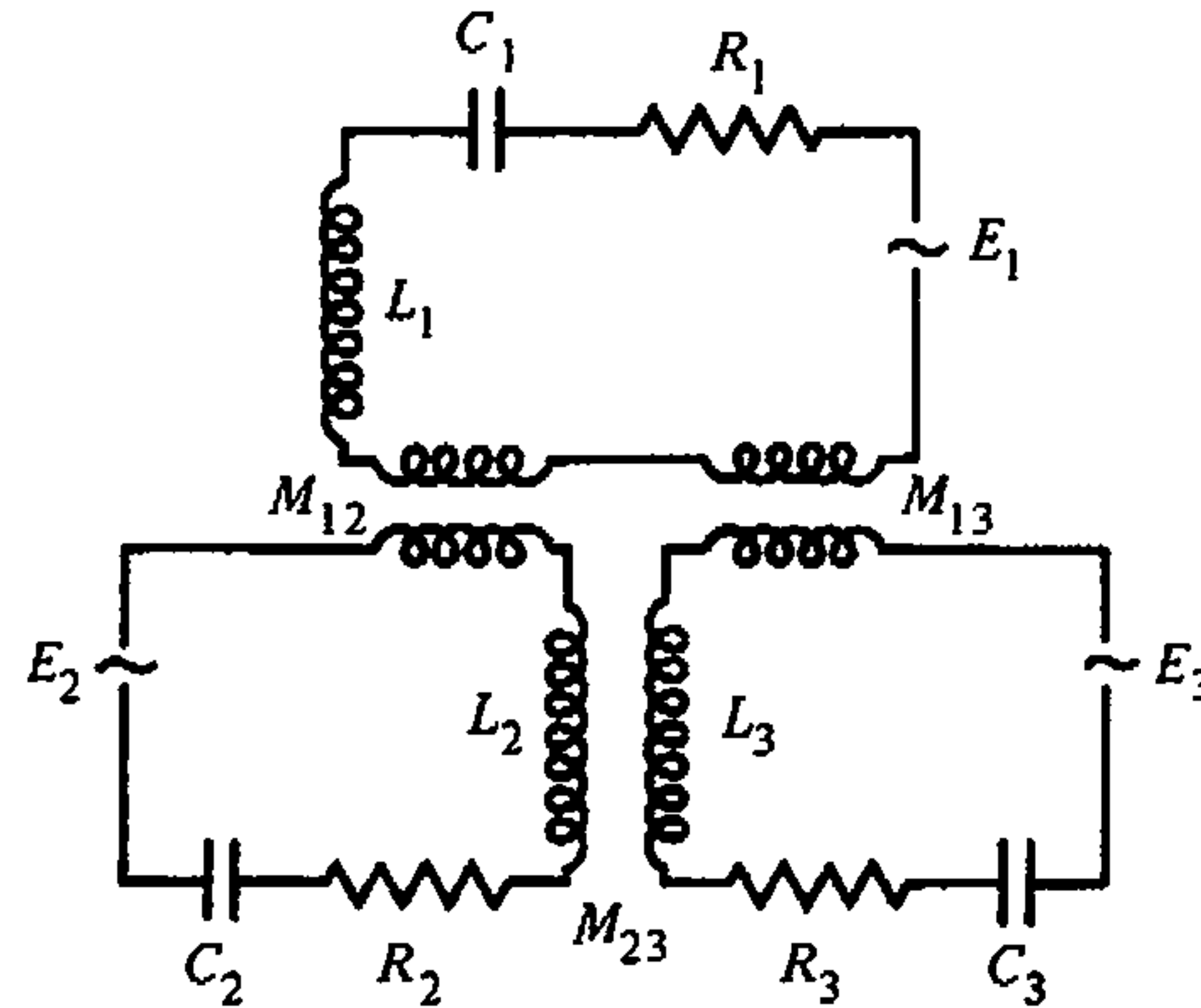

FIGURE 2.6 A system of coupled circuits to which the Lagrangian formulation can be applied.

background, a system of coupled electrical circuits of the type shown in Fig. 2.6 has a Lagrangian of the form

$$L = \frac{1}{2} \sum_j L_j \dot{q}_j^2 + \frac{1}{2} \sum_{\substack{jk \\ j \neq k}} M_{jk} \dot{q}_j \dot{q}_k - \sum_j \frac{q_j^2}{2C_j} + \sum_j e_j(t) q_j,$$

and a dissipation function

$$\mathcal{F} = \frac{1}{2} \sum_j R_j \dot{q}_j^2.$$

where the mutual inductance terms, $M_{jk} \dot{q}_j \dot{q}_k$, are added to take into account the coupling between inductors. The Lagrange equations are

$$L_j \frac{d^2 q_j}{dt^2} + \sum_{\substack{k \\ j \neq k}} M_{jk} \frac{d^2 q_k}{dt^2} + R_j \frac{dq_j}{dt} + \frac{q_j}{C_j} = E_j(t). \quad (2.42)$$

where the $E_j(t)$ terms are the external emf's.

This description of two different physical systems by Lagrangians of the same form means that all the results and techniques devised for investigating one of the systems can be taken over immediately and applied to the other. In this particular case, the study of the behavior of electrical circuits has been pursued intensely and some special techniques have been developed; these can be directly applied to the corresponding mechanical systems. Much work has been done in formulating equivalent electrical problems for mechanical or acoustical systems, and vice versa. Terms hitherto reserved for electrical circuits (reactance, susceptance, etc.) are now commonly found in treatises on the theory of vibrations of mechanical systems.

Additionally, one type of generalization of mechanics is due to a subtler form of equivalence. We have seen that the Lagrangian and Hamilton's principle together form a compact invariant way of obtaining the mechanical equations of motion. This possibility is not reserved for mechanics only; in almost every field of physics variational principles can be used to express the "equations of motion," whether they be Newton's equations, Maxwell's equations, or the Schrödinger equation. Consequently, when a variational principle is used as the basis of the formulation, all such fields will exhibit, at least to some degree, a *structural analogy*. When the results of experiments show the need for altering the physical content in the theory of one field, this degree of analogy has often indicated how similar alterations may be carried out in other fields. Thus, the experiments performed early in this century showed the need for quantization of both electromagnetic radiation and elementary particles. The methods of quantization, however, were first developed for particle mechanics, starting essentially from the Lagrangian formulation of classical mechanics. By describing the electromagnetic field by a Lagrangian and corresponding Hamilton's variational principle, it is possible to carry over the methods of particle quantization to construct a quantum electrodynamics (cf. Sections 13.5 and 13.6).

2.6 ■ CONSERVATION THEOREMS AND SYMMETRY PROPERTIES

Thus far, we have been concerned primarily with obtaining the equations of motion, but little has been said about how to solve them for a particular problem once they are obtained. In general, this is a question of mathematics. A system of n degrees of freedom will have n differential equations that are second order in time. The solution of each equation will require two integrations resulting, all told, in $2n$ constants of integration. In a specific problem these constants will be determined by the initial conditions, i.e., the initial values of the nq_j 's and the $n\dot{q}_j$'s. Sometimes the equations of motion will be integrable in terms of known functions, but not always. In fact, the majority of problems are not completely integrable. However, even when complete solutions cannot be obtained, it is often possible to extract a large amount of information about the physical nature of the system motion. Indeed, such information may be of greater interest to the physicist than the complete solution for the generalized coordinates as a function of time. It is important, therefore, to see how much can be stated about the motion of a given system without requiring a complete integration of the problem.*

In many problems a number of first integrals of the equations of motion can be obtained immediately; by this we mean relations of the type

$$f(q_1, q_2, \dots, \dot{q}_1, \dot{q}_2, \dots, t) = \text{constant}, \quad (2.43)$$

*In this and succeeding sections it will be assumed, unless otherwise specified, the system is such that its motion is completely described by a Hamilton's principle of the form (2.2).

which are first-order differential equations. These first integrals are of interest because they tell us something physically about the system. They include, in fact, the conservation laws obtained in Chapter 1.

Let us consider as an example a system of mass points under the influence of forces derived from potentials dependent on position only. Then

$$\begin{aligned}\frac{\partial L}{\partial \dot{x}_i} &\equiv \frac{\partial T}{\partial \dot{x}_i} - \frac{\partial V}{\partial \dot{x}_i} = \frac{\partial T}{\partial \dot{x}_i} = \frac{\partial}{\partial \dot{x}_i} \sum \frac{1}{2} m_i (\dot{x}_i^2 + \dot{y}_i^2 + \dot{z}_i^2) \\ &= m_i \dot{x}_i = p_{ix},\end{aligned}$$

which is the x component of the linear momentum associated with the i th particle. This result suggests an obvious extension to the concept of momentum. The generalized momentum associated with the coordinate q_j shall be defined as

$$p_j = \frac{\partial L}{\partial \dot{q}_j}. \quad (2.44)$$

The terms *canonical momentum* and *conjugate momentum* are often also used for p_j . Notice that if q_j is not a Cartesian coordinate, p_j does not necessarily have the dimensions of a linear momentum. Further, if there is a velocity-dependent potential, then even with a Cartesian coordinate q_j the associated *generalized momentum* will not be identical with the usual *mechanical momentum*. Thus, in the case of a group of particles in an electromagnetic field, the Lagrangian is (cf. 1.63)

$$L = \sum_i \frac{1}{2} m_i \dot{\mathbf{r}}_i^2 - \sum_i q_i \phi(x_i) + \sum_i q_i \mathbf{A}(x_i) \cdot \dot{\mathbf{r}}_i$$

(q_i here denotes charge) and the generalized momentum conjugate to x_i is

$$p_{ix} = \frac{\partial L}{\partial \dot{x}_i} = m_i \dot{x}_i + q_i A_x, \quad (2.45)$$

i.e., mechanical momentum plus an additional term.

If the Lagrangian of a system does not contain a given coordinate q_j (although it may contain the corresponding velocity \dot{q}_j), then the coordinate is said to be *cyclic* or *ignorable*. This definition is not universal, but it is the customary one and will be used here. The Lagrange equation of motion,

$$\frac{d}{dt} \frac{\partial L}{\partial \dot{q}_j} - \frac{\partial L}{\partial q_j} = 0,$$

reduces, for a cyclic coordinate, to

$$\frac{d}{dt} \frac{\partial L}{\partial \dot{q}_j} = 0$$

or

$$\frac{dp_j}{dt} = 0,$$

which mean that

$$p_j = \text{constant.} \quad (2.46)$$

Hence, we can state as a general conservation theorem that *the generalized momentum conjugate to a cyclic coordinate is conserved.*

Note that the derivation of Eq. (2.46) assumes that q_j is a generalized coordinate; one that is linearly independent of all the other coordinates. When equations of constraint exist, all the coordinates are not linearly independent. For example, the angular coordinate θ is not present in the Lagrangian of a hoop rolling without slipping in a horizontal plane that was previously discussed, but the angle appears in the constraint equations $rd\theta = dx$. As a result, the angular momentum, $p_\theta = mr^2\dot{\theta}$, is not a constant of the motion.

Equation (2.46) constitutes a first integral of the form (2.43) for the equations of motion. It can be used formally to eliminate the cyclic coordinate from the problem, which can then be solved entirely in terms of the remaining generalized coordinates. Briefly, the procedure, originated by Routh, consists in modifying the Lagrangian so that it is no longer a function of the generalized velocity corresponding to the cyclic coordinate, but instead involves only its conjugate momentum. The advantage in so doing is that p_j can then be considered one of the constants of integration, and the remaining integrations involve only the non-cyclic coordinates. We shall defer a detailed discussion of Routh's method until the Hamiltonian formulation (to which it is closely related) is treated.

Note that the conditions for the conservation of generalized momenta are more general than the two momentum conservation theorems previously derived. For example, they furnish a conservation theorem for a case in which the law of action and reaction is violated, namely, when electromagnetic forces are present. Suppose we have a single particle in a field in which neither ϕ nor \mathbf{A} depends on x . Then x nowhere appears in L and is therefore cyclic. The corresponding canonical momentum p_x must therefore be conserved. From (1.63) this momentum now has the form

$$p_x = m\dot{x} + qA_x = \text{constant.} \quad (2.47)$$

In this case, it is not the mechanical linear momentum $m\dot{x}$ that is conserved but rather its sum with qA_x .^{*} Nevertheless, it should still be true that the conservation theorems of Chapter 1 are contained within the general rule for cyclic coordinates; with proper restrictions (2.46) should reduce to the theorems of Section 1.2.

^{*}It can be shown from classical electrodynamics that under these conditions, i.e., neither \mathbf{A} nor ϕ depending on x , that qA_x is exactly the x -component of the electromagnetic linear momentum of the field associated with the charge q .

We first consider a generalized coordinate q_j , for which a change dq_j represents a translation of the system as a whole in some given direction. An example would be one of the Cartesian coordinates of the center of mass of the system. Then clearly q_j cannot appear in T , for velocities are not affected by a shift in the origin, and therefore the partial derivative of T with respect to q_j must be zero. Further, we will assume conservative systems for which V is not a function of the velocities, so as to eliminate such complications as electromagnetic forces. The Lagrange equation of motion for a coordinate so defined then reduces to

$$\frac{d}{dt} \frac{\partial T}{\partial \dot{q}_j} \equiv \dot{p}_j = -\frac{\partial V}{\partial q_j} \equiv Q_j. \quad (2.48)$$

We will now show that (2.48) is the equation of motion for the total linear momentum, i.e., that Q_j represents the component of the total force along the direction of translation of q_j , and p_j is the component of the total linear momentum along this direction. In general, the generalized force Q_j is given by Eq. (1.49):

$$Q_j = \sum_i \mathbf{F}_i \cdot \frac{\partial \mathbf{r}_i}{\partial q_j}.$$

Since dq_j corresponds to a translation of the system along some axis, the vectors $\mathbf{r}_i(q_j)$ and $\mathbf{r}_i(q_j + dq_j)$ are related as shown in Fig. 2.7. By the definition of a derivative, we have

$$\frac{\partial \mathbf{r}_i}{\partial q_j} = \lim_{dq_j \rightarrow 0} \frac{\mathbf{r}_i(q_j + dq_j) - \mathbf{r}_i(q_j)}{dq_j} = \frac{dq_j}{dq_j} \mathbf{n} = \mathbf{n}, \quad (2.49)$$

where \mathbf{n} is the unit vector along the direction of the translation. Hence,

$$Q_j = \sum \mathbf{F}_i \cdot \mathbf{n} = \mathbf{n} \cdot \mathbf{F},$$

which (as was stated) is the component of the total force in the direction of \mathbf{n} . To prove the other half of the statement, note that with the kinetic energy in the form

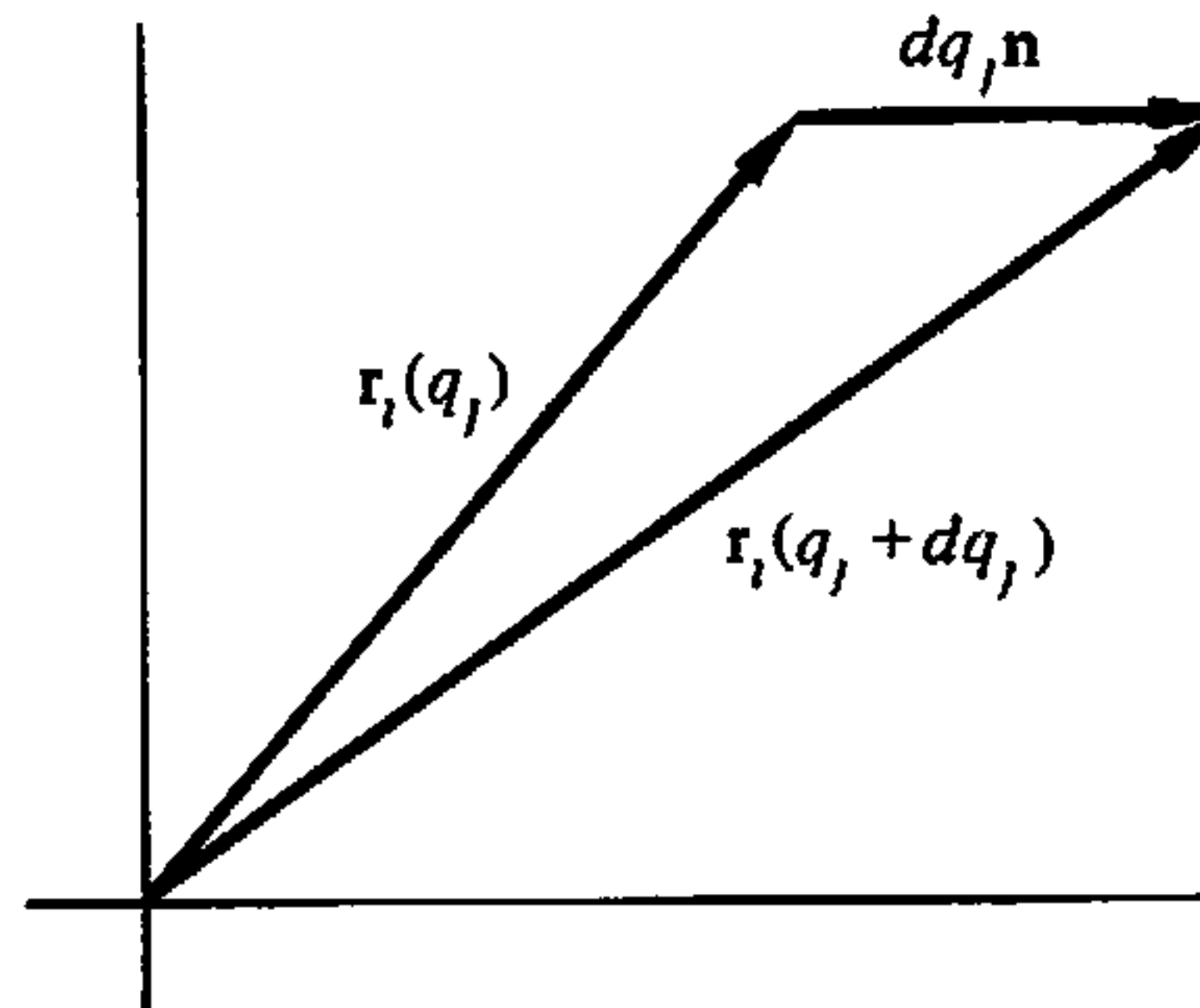

FIGURE 2.7 Change in a position vector under translation of the system.

$$T = \frac{1}{2} \sum m_i \dot{\mathbf{r}}_i^2,$$

the conjugate momentum is

$$\begin{aligned} p_J &= \frac{\partial T}{\partial \dot{q}_J} = \sum_i m_i \dot{\mathbf{r}}_i \cdot \frac{\partial \dot{\mathbf{r}}_i}{\partial \dot{q}_J} \\ &= \sum_i m_i \mathbf{v}_i \cdot \frac{\partial \mathbf{r}_i}{\partial q_J}, \end{aligned}$$

using Eq. (1.51). Then from Eq. (2.49)

$$p_J = \mathbf{n} \cdot \sum_i m_i \mathbf{v}_i,$$

which again, as predicted, is the component of the total system linear momentum along \mathbf{n} .

Suppose now that the translation coordinate q_J that we have been discussing is cyclic. Then q_J cannot appear in V and therefore

$$-\frac{\partial V}{\partial q_J} \equiv Q_J = 0.$$

But this is simply the familiar conservation theorem for linear momentum—that if a given component of the total applied force vanishes, the corresponding component of the linear momentum is conserved.

In a similar fashion, it can be shown that if a cyclic coordinate q_J is such that dq_J corresponds to a rotation of the system of particles around some axis, then the conservation of its conjugate momentum corresponds to conservation of an angular momentum. By the same argument used above, T cannot contain q_J , for a rotation of the coordinate system cannot affect the magnitude of the velocities. Hence, the partial derivative of T with respect to q_J must again be zero, and since V is independent of \dot{q}_J , we once more get Eq. (2.48). But now we wish to show that with q_J a rotation coordinate the generalized force is the component of the total applied torque about the axis of rotation, and p_J is the component of the total angular momentum along the same axis.

The generalized force Q_J is again given by

$$Q_J = \sum_i \mathbf{F}_i \cdot \frac{\partial \mathbf{r}_i}{\partial q_J},$$

only the derivative now has a different meaning. Here the change in q_J must correspond to an infinitesimal rotation of the vector \mathbf{r}_i , keeping the magnitude of the vector constant. From Fig. 2.8, the magnitude of the derivative can easily be obtained:

$$|d\mathbf{r}_i| = r_i \sin \theta dq_J$$

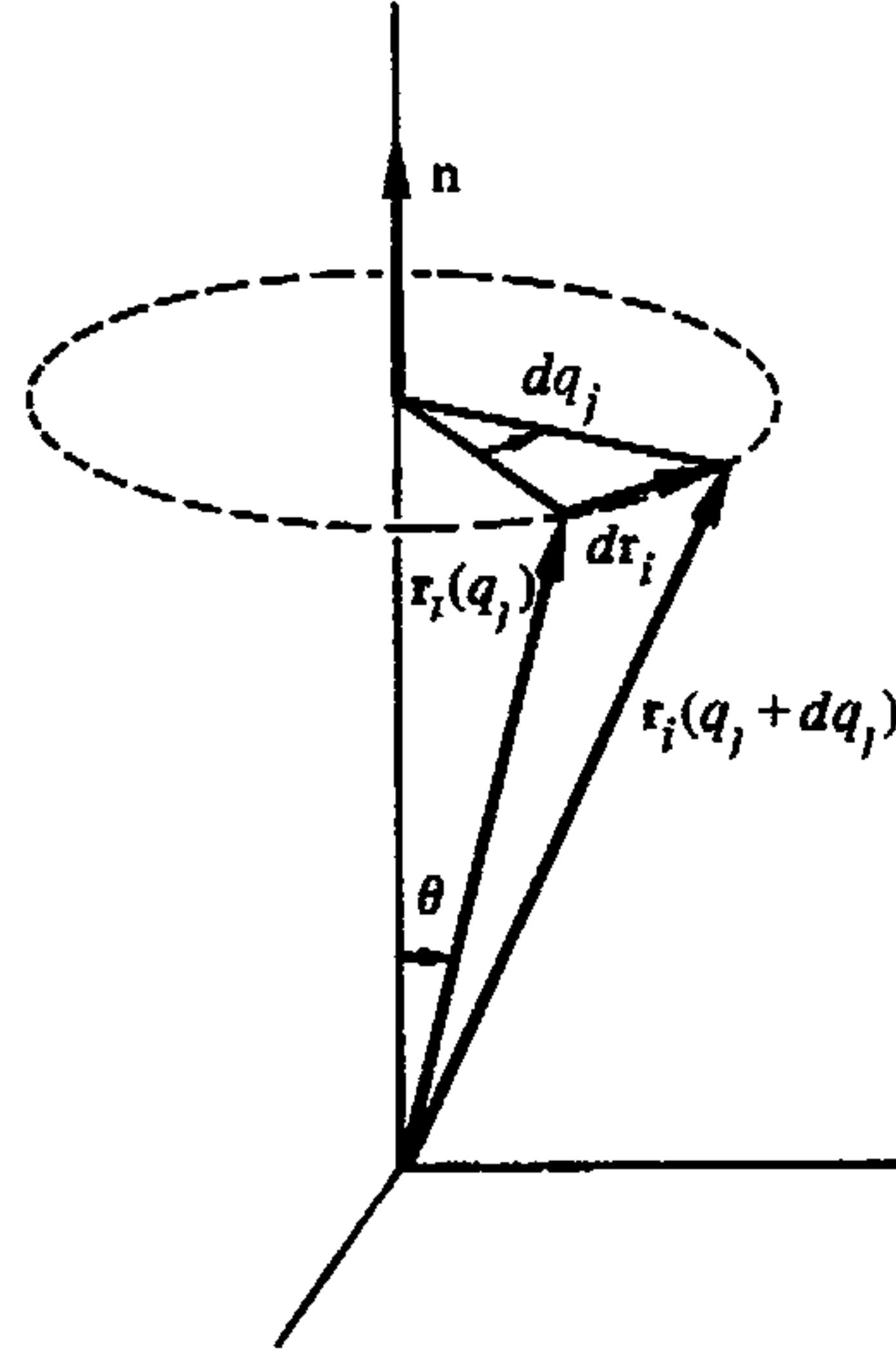

FIGURE 2.8 Change of a position vector under rotation of the system.

and

$$\left| \frac{\partial \mathbf{r}_i}{\partial q_j} \right| = r_i \sin \theta,$$

and its direction is perpendicular to both \mathbf{r}_i and \mathbf{n} . Clearly, the derivative can be written in vector form as

$$\frac{\partial \mathbf{r}_i}{\partial q_j} = \mathbf{n} \times \mathbf{r}_i. \quad (2.50)$$

With this result, the generalized force becomes

$$\begin{aligned} Q_j &= \sum_i \mathbf{F}_i \cdot \mathbf{n} \times \mathbf{r}_i \\ &= \sum_i \mathbf{n} \cdot \mathbf{r}_i \times \mathbf{F}_i, \end{aligned}$$

reducing to

$$Q_j = \mathbf{n} \cdot \sum_i \mathbf{N}_i = \mathbf{n} \cdot \mathbf{N},$$

which proves the first part. A similar manipulation of p_j with the aid of Eq. (2.50) provides proof of the second part of the statement:

$$p_j = \frac{\partial T}{\partial \dot{q}_j} = \sum_i m_i \mathbf{v}_i \cdot \frac{\partial \mathbf{r}_i}{\partial \dot{q}_j} = \sum_i \mathbf{n} \cdot \mathbf{r}_i \times m_i \mathbf{v}_i = \mathbf{n} \cdot \sum_i \mathbf{L}_i = \mathbf{n} \cdot \mathbf{L}.$$

Summarizing these results, we see that if the rotation coordinate q_j is cyclic, then Q_j , which is the component of the applied torque along \mathbf{n} , vanishes, and the component of \mathbf{L} along \mathbf{n} is constant. Here we have recovered the angular momentum conservation theorem out of the general conservation theorem relating to cyclic coordinates.

The significance of cyclic translation or rotation coordinates in relation to the properties of the system deserves some comment at this point. If a generalized coordinate corresponding to a displacement is cyclic, it means that a translation of the system, as if rigid, has no effect on the problem. In other words, if the system is *invariant* under translation along a given direction, the corresponding linear momentum is conserved. Similarly, the fact that a generalized rotation coordinate is cyclic (and therefore the conjugate angular momentum conserved) indicates that the system is invariant under rotation about the given axis. Thus, the momentum conservation theorems are closely connected with the *symmetry properties* of the system. If the system is spherically symmetric, we can say without further ado that all components of angular momentum are conserved. Or, if the system is symmetric only about the z axis, then only L_z will be conserved, and so on for the other axes. These symmetry considerations can often be used with relatively complicated problems to determine by inspection whether certain constants of the motion exist. (cf. Noether's theorem—Sec. 13.7.)

Suppose, for example, the system consists of a set of mass points moving in a potential field generated by fixed sources uniformly distributed on an infinite plane, say, the $z = 0$ plane. (The sources might be a mass distribution if the forces were gravitational, or a charge distribution for electrostatic forces.) Then the symmetry of the problem is such that the Lagrangian is invariant under a translation of the system of particles in the x - or y -directions (but not in the z -direction) and also under a rotation about the z axis. It immediately follows that the x - and y -components of the total linear momentum, P_x and P_y , are constants of the motion along with L_z , the z -component of the total angular momentum. However, if the sources were restricted only to the half plane, $x \geq 0$, then the symmetry for translation along the x axis and for rotation about the z axis would be destroyed. In that case, P_x and L_z could not be conserved, but P_y would remain a constant of the motion. We will encounter the connections between the constants of motion and the symmetry properties of the system several times in the following chapters.

2.7 ■ ENERGY FUNCTION AND THE CONSERVATION OF ENERGY

Another conservation theorem we should expect to obtain in the Lagrangian formulation is the conservation of total energy for systems where the forces are derivable from potentials dependent only upon position. Indeed, it is possible to demonstrate a conservation theorem for which conservation of total energy represents only a special case. Consider a general Lagrangian, which will be a function of the coordinates q_j and the velocities \dot{q}_j and may also depend explicitly on the time. (The explicit time dependence may arise from the time variation of external

potentials, or from time-dependent constraints.) Then the total time derivative of L is

$$\frac{dL}{dt} = \sum_J \frac{\partial L}{\partial q_J} \frac{dq_J}{dt} + \sum_J \frac{\partial L}{\partial \dot{q}_J} \frac{d\dot{q}_J}{dt} + \frac{\partial L}{\partial t}. \quad (2.51)$$

From Lagrange's equations,

$$\frac{\partial L}{\partial q_J} = \frac{d}{dt} \left(\frac{\partial L}{\partial \dot{q}_J} \right),$$

and (2.51) can be rewritten as

$$\frac{dL}{dt} = \sum_J \frac{d}{dt} \left(\frac{\partial L}{\partial \dot{q}_J} \right) \dot{q}_J + \sum_J \frac{\partial L}{\partial \dot{q}_J} \frac{d\dot{q}_J}{dt} + \frac{\partial L}{\partial t}$$

or

$$\frac{dL}{dt} = \sum_J \frac{d}{dt} \left(\dot{q}_J \frac{\partial L}{\partial \dot{q}_J} \right) + \frac{\partial L}{\partial t}.$$

It therefore follows that

$$\frac{d}{dt} \left(\sum_J \dot{q}_J \frac{\partial L}{\partial \dot{q}_J} - L \right) + \frac{\partial L}{\partial t} = 0. \quad (2.52)$$

The quantity in parentheses is oftentimes called the *energy function** and will be denoted by h :

$$h(q_1, \dots, q_n; \dot{q}_1, \dots, \dot{q}_n; t) = \sum_J \dot{q}_J \frac{\partial L}{\partial \dot{q}_J} - L, \quad (2.53)$$

and Eq. (2.52) can be looked on as giving the total time derivative of h :

$$\frac{dh}{dt} = -\frac{\partial L}{\partial t}. \quad (2.54)$$

If the Lagrangian is not an explicit function of time, i.e., if t does not appear in L explicitly but only implicitly through the time variation of q and \dot{q} , then Eq. (2.54) says that h is conserved. It is one of the first integrals of the motion and is sometimes referred to as Jacobi's integral.[†]

*The energy function h is identical in value with the Hamiltonian H (See Chapter 8) It is given a different name and symbol here to emphasize that h is considered a function of n independent variables q_j and their time derivatives \dot{q}_j (along with the time), whereas the Hamiltonian will be treated as a function of $2n$ independent variables, q_j, p_j (and possibly the time)

[†]This designation is most often confined to a first integral in the restricted three-body problem. However, the integral there is merely a special case of the energy function h , and there is some historical precedent to apply the name Jacobi integral to the more general situation

Under certain circumstances, the function h is the total energy of the system. To determine what these circumstances are, we recall that the total kinetic energy of a system can always be written as

$$T = T_0 + T_1 + T_2, \quad (1.73)$$

where T_0 is a function of the generalized coordinates only, $T_1(q, \dot{q})$ is linear in the generalized velocities, and $T_2(q, \dot{q})$ is a quadratic function of the \dot{q} 's. For a very wide range of systems and sets of generalized coordinates, the Lagrangian can be similarly decomposed as regards its functional behavior in the \dot{q} variables:

$$L(q, \dot{q}, t) = L_0(q, t) + L_1(q, \dot{q}, t) + L_2(q, \dot{q}, t). \quad (2.55)$$

Here L_2 is a homogeneous function of the second degree (not merely quadratic) in \dot{q} , while L_1 is homogeneous of the first degree in \dot{q} . There is no reason intrinsic to mechanics that requires the Lagrangian to conform to Eq. (2.55), but in fact it does for most problems of interest. The Lagrangian clearly has this form when the forces are derivable from a potential not involving the velocities. Even with the velocity-dependent potentials, we note that the Lagrangian for a charged particle in an electromagnetic field, Eq. (1.63), satisfies Eq. (2.55). Now, recall that Euler's theorem states that if f is a homogeneous function of degree n in the variables x_i , then

$$\sum_i x_i \frac{\partial f}{\partial x_i} = nf. \quad (2.56)$$

Applied to the function h , Eq. (2.53), for the Lagrangians of the form (2.55), this theorem implies that

$$h = 2L_2 + L_1 - L = L_2 - L_0. \quad (2.57)$$

If the transformation equations defining the generalized coordinates, Eqs. (1.38), do not involve the time explicitly, then by Eqs. (1.73) $T = T_2$. If, further, the potential does not depend on the generalized velocities, then $L_2 = T$ and $L_0 = -V$, so that

$$h = T + V = E, \quad (2.58)$$

and the energy function is indeed the total energy. Under these circumstances, if V does not involve the time explicitly, neither will L . Thus, by Eq. (2.54), h (which is here the total energy), will be conserved.

Note that the conditions for conservation of h are in principle quite distinct from those that identify h as the total energy. We can have a set of generalized coordinates such that in a particular problem h is conserved but is not the total energy. On the other hand, h can be the total energy, in the form $T + V$, but not be conserved. Also note that whereas the Lagrangian is uniquely fixed for each

system by the prescription

$$L = T - U$$

independent of the choice of generalized coordinates, the energy function h depends in magnitude and functional form on the specific set of generalized coordinates. For one and the same system, various energy functions h of different physical content can be generated depending on how the generalized coordinates are chosen.

The most common case that occurs in classical mechanics is one in which the kinetic energy terms are all of the form $m\dot{q}_i^2/2$ or $p_i^2/2m$ and the potential energy depends only upon the coordinates. For these conditions, the energy function is both conserved and is also the total energy.

Finally, note that where the system is not conservative, but there are frictional forces derivable from a dissipation function \mathcal{F} , it can be easily shown that \mathcal{F} is related to the decay rate of h . When the equations of motion are given by Eq. (1.70), including dissipation, then Eq. (2.52) has the form

$$\frac{dh}{dt} + \frac{\partial L}{\partial t} = \sum_j \frac{\partial \mathcal{F}}{\partial \dot{q}_j} \dot{q}_j.$$

By the definition of \mathcal{F} , Eq. (1.67), it is a homogeneous function of the \dot{q} 's of degree 2. Hence, applying Euler's theorem again, we have

$$\frac{dh}{dt} = -2\mathcal{F} - \frac{\partial L}{\partial t}. \quad (2.59)$$

If L is not an explicit function of time, *and* the system is such that h is the same as the energy, then Eq. (2.59) says that $2\mathcal{F}$ is the rate of energy dissipation,

$$\frac{dE}{dt} = -2\mathcal{F}, \quad (2.60)$$

a statement proved above (cf. Sec. 1.5) in less general circumstances.

DERIVATIONS

1. Complete the solution of the brachistochrone problem begun in Section 2.2 and show that the desired curve is a cycloid with a cusp at the initial point at which the particle is released. Show also that if the particle is projected with an initial kinetic energy $\frac{1}{2}mv_0^2$ that the brachistochrone is still a cycloid passing through the two points with a cusp at a height z above the initial point given by $v_0^2 = 2gz$.
2. Show that if the potential in the Lagrangian contains velocity-dependent terms, the canonical momentum corresponding to a coordinate of rotation θ of the entire system

is no longer the mechanical angular momentum L_θ but is given by

$$p_\theta = L_\theta - \sum_i \mathbf{n} \cdot \mathbf{r}_i \times \nabla_{\mathbf{v}_i} U,$$

where $\nabla_{\mathbf{v}}$ is the gradient operator in which the derivatives are with respect to the velocity components and \mathbf{n} is a unit vector in the direction of rotation. If the forces are electromagnetic in character, the canonical momentum is therefore

$$p_\theta = L_\theta + \sum_i \mathbf{n} \cdot \mathbf{r}_i \times \frac{q_i}{c} \mathbf{A}_i.$$

3. Prove that the shortest distance between two points in space is a straight line.
4. Show that the geodesics of a spherical surface are great circles, i.e., circles whose centers lie at the center of the sphere.

EXERCISES

5. A particle is subjected to the potential $V(x) = -Fx$, where F is a constant. The particle travels from $x = 0$ to $x = a$ in a time interval t_0 . Assume the motion of the particle can be expressed in the form $x(t) = A + Bt + Ct^2$. Find the values of A , B , and C such that the action is a minimum.
6. Find the Euler–Lagrange equation describing the brachistochrone curve for a particle moving *inside* a spherical Earth of uniform mass density. Obtain a first integral for this differential equation by analogy to the Jacobi integral h . With the help of this integral, show that the desired curve is a hypocycloid (the curve described by a point on a circle rolling on the inside of a larger circle). Obtain an expression for the time of travel along the brachistochrone between two points on Earth's surface. How long would it take to go from New York to Los Angeles (assumed to be 4800 km apart on the surface) along a brachistochrone tunnel (assuming no friction) and how far below the surface would the deepest point of the tunnel be?
7. In Example 2 of Section 2.1 we considered the problem of the minimum surface of revolution. Examine the symmetric case $x_1 = x_2$, $y_2 = -y_1 > 0$, and express the condition for the parameter a as a transcendental equation in terms of the dimensionless quantities $k = x_2/a$, and $\alpha = y_2/x_2$. Show that for α greater than a certain value α_0 two values of k are possible, for $\alpha = \alpha_0$ only one value of k is possible, while if $\alpha < \alpha_0$ no real value of k (or a) can be found, so that no catenary solution exists in this region. Find the value of α_0 , numerically if necessary.
8. The broken-segment solution described in the text (cf. p. 42), in which the area of revolution is only that of the end circles of radius y_1 and y_2 , respectively, is known as the *Goldschmidt solution*. For the symmetric situation discussed in Exercise 7, obtain an expression for the ratio of the area generated by the catenary solutions to that given by the Goldschmidt solution. Your result should be a function only of the parameters k and α . Show that for sufficiently large values of α at least one of the catenaries gives an area below that of the Goldschmidt solution. On the other hand, show that if $\alpha = \alpha_0$, the Goldschmidt solution gives a lower area than the catenary.

9. A chain or rope of indefinite length passes freely over pulleys at heights y_1 and y_2 above the plane surface of Earth, with a horizontal distance $x_2 - x_1$ between them. If the chain or rope has a uniform linear mass density, show that the problem of finding the curve assumed between the pulleys is identical with that of the problem of minimum surface of revolution. (The transition to the Goldschmidt solution as the heights y_1 and y_2 are changed makes for a striking lecture demonstration. See Exercise 8.)
10. Suppose it is known experimentally that a particle fell a given distance y_0 in a time $t_0 = \sqrt{2y_0/g}$, but the times of fall for distances other than y_0 is not known. Suppose further that the Lagrangian for the problem is known, but that instead of solving the equation of motion for y as a function of t , it is guessed that the functional form is

$$y = at + bt^2.$$

If the constants a and b are adjusted always so that the time to fall y_0 is correctly given by t_0 , show directly that the integral

$$\int_0^{t_0} L dt$$

is an extremum for real values of the coefficients only when $a = 0$ and $b = g/2$.

11. When two billiard balls collide, the instantaneous forces between them are very large but act only in an infinitesimal time Δt , in such a manner that the quantity

$$\int_{\Delta t} F dt$$

remains finite. Such forces are described as *impulsive* forces, and the integral over Δt is known as the *impulse* of the force. Show that if impulsive forces are present Lagrange's equations may be transformed into

$$\left(\frac{\partial L}{\partial \dot{q}_j}\right)_f - \left(\frac{\partial L}{\partial \dot{q}_j}\right)_i = S_j,$$

where the subscripts i and f refer to the state of the system before and after the impulse, S_j is the impulse of the generalized impulsive force corresponding to q_j , and L is the Lagrangian including all the nonimpulsive forces.

12. The term *generalized mechanics* has come to designate a variety of classical mechanics in which the Lagrangian contains time derivatives of q_i higher than the first. Problems for which $x = f(x, \dot{x}, \ddot{x}, t)$ have been referred to as "jerky" mechanics. Such equations of motion have interesting applications in chaos theory (cf. Chapter 11). By applying the methods of the calculus of variations, show that if there is a Lagrangian of the form $L(q_i, \dot{q}_i, \ddot{q}_i, t)$, and Hamilton's principle holds with the zero variation of both q_i and \dot{q}_i at the end points, then the corresponding Euler-Lagrange equations are

$$\frac{d^2}{dt^2} \left(\frac{\partial L}{\partial \ddot{q}_i}\right) - \frac{d}{dt} \left(\frac{\partial L}{\partial \dot{q}_i}\right) + \frac{\partial L}{\partial q_i} = 0, \quad i = 1, 2, \dots, n.$$

Apply this result to the Lagrangian

$$L = -\frac{m}{2}q\ddot{q} - \frac{k}{2}q^2.$$

Do you recognize the equations of motion?

13. A heavy particle is placed at the top of a vertical hoop. Calculate the reaction of the hoop on the particle by means of the Lagrange's undetermined multipliers and Lagrange's equations. Find the height at which the particle falls off.
14. A uniform hoop of mass m and radius r rolls without slipping on a fixed cylinder of radius R as shown in the figure. The only external force is that of gravity. If the smaller cylinder starts rolling from rest on top of the bigger cylinder, use the method of Lagrange multipliers to find the point at which the hoop falls off the cylinder.

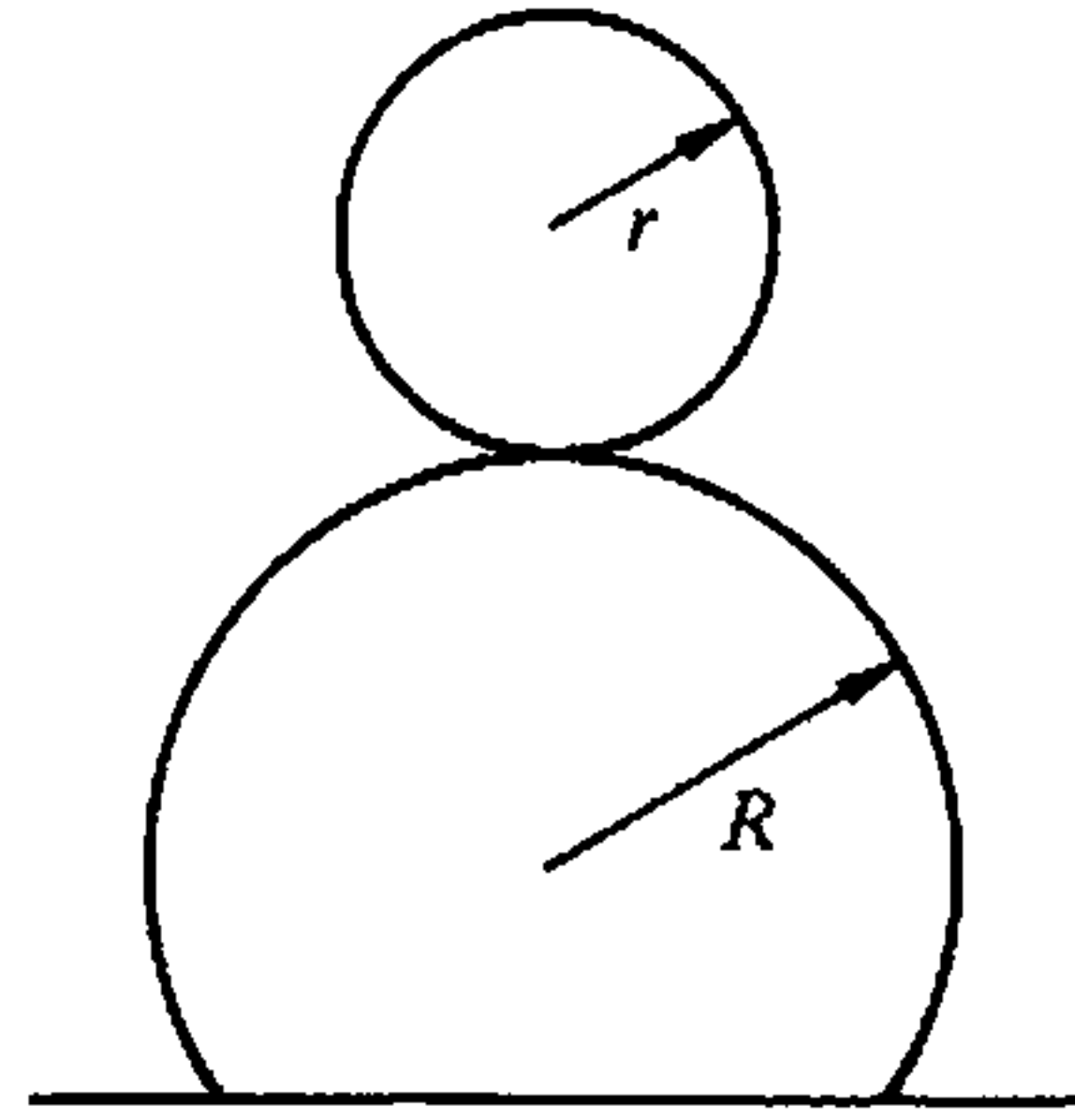

15. A form of the Wheatstone impedance bridge has, in addition to the usual four resistances, an inductance in one arm and a capacitance in the opposite arm. Set up L and \mathcal{F} for the unbalanced bridge, with the charges in the elements as coordinates. Using the Kirchhoff junction conditions as constraints on the currents, obtain the Lagrange equations of motion, and show that eliminating the λ 's reduces these to the usual network equations.
16. In certain situations, particularly one-dimensional systems, it is possible to incorporate frictional effects without introducing the dissipation function. As an example, find the equations of motion for the Lagrangian

$$L = e^{\gamma t} \left(\frac{m\dot{q}^2}{2} - \frac{kq^2}{2} \right).$$

How would you describe the system? Are there any constants of motion? Suppose a point transformation is made of the form

$$s = e^{\gamma t} q.$$

What is the effective Lagrangian in terms of s ? Find the equation of motion for s . What do these results say about the conserved quantities for the system?

17. It sometimes occurs that the generalized coordinates appear separately in the kinetic energy and the potential energy in such a manner that T and V may be written in the form

$$T = \sum_i f_i(q_i) \dot{q}_i^2 \quad \text{and} \quad V = \sum_i V_i(q_i)$$

Show that Lagrange's equations then separate, and that the problem can always be reduced to quadratures.

18. A point mass is constrained to move on a massless hoop of radius a fixed in a vertical plane that rotates about its vertical symmetry axis with constant angular speed ω . Obtain the Lagrange equations of motion assuming the only external forces arise from gravity. What are the constants of motion? Show that if ω is greater than a critical value ω_0 , there can be a solution in which the particle remains stationary on the hoop at a point other than at the bottom, but that if $\omega < \omega_0$, the only stationary point for the particle is at the bottom of the hoop. What is the value of ω_0 ?
19. A particle moves without friction in a conservative field of force produced by various mass distributions. In each instance, the force generated by a volume element of the distribution is derived from a potential that is proportional to the mass of the volume element and is a function only of the scalar distance from the volume element. For the following fixed, homogeneous mass distributions, state the conserved quantities in the motion of the particle:
- The mass is uniformly distributed in the plane $z = 0$.
 - The mass is uniformly distributed in the half-plane $z = 0, y > 0$.
 - The mass is uniformly distributed in a circular cylinder of infinite length, with axis along the z axis.
 - The mass is uniformly distributed in a circular cylinder of finite length, with axis along the z axis.
 - The mass is uniformly distributed in a right cylinder of elliptical cross section and infinite length, with axis along the z axis.
 - The mass is uniformly distributed in a dumbbell whose axis is oriented along the z axis.
 - The mass is in the form of a uniform wire wound in the geometry of an infinite helical solenoid, with axis along the z axis.
20. A particle of mass m slides without friction on a wedge of angle α and mass M that can move without friction on a smooth horizontal surface, as shown in the figure. Treating the constraint of the particle on the wedge by the method of Lagrange multipliers, find the equations of motion for the particle and wedge. Also obtain an expression for the forces of constraint. Calculate the work done in time t by the forces of constraint acting on the particle and on the wedge. What are the constants of motion for the system? Contrast the results you have found with the situation when the wedge is fixed. [*Suggestion:* For the particle you may either use a Cartesian coordinate system with y vertical, or one with y normal to the wedge or, even more instructively, do it in both systems.]

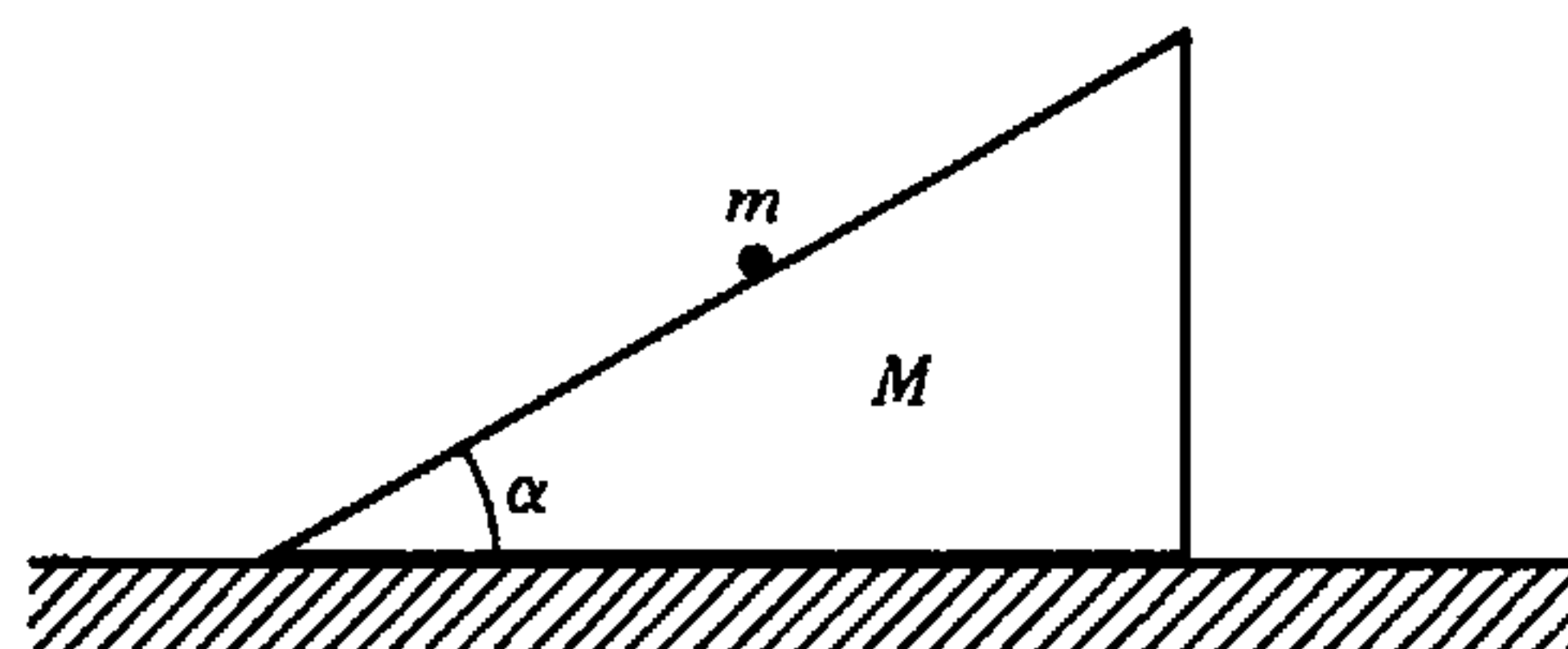

21. A carriage runs along rails on a rigid beam, as shown in the figure below. The carriage is attached to one end of a spring of equilibrium length r_0 and force constant k , whose other end is fixed on the beam. On the carriage, another set of rails is perpendicular to the first along which a particle of mass m moves, held by a spring fixed on the beam, of force constant k and zero equilibrium length. Beam, rails, springs, and carriage are assumed to have zero mass. The whole system is forced to move in a plane about the point of attachment of the first spring, with a constant angular speed ω . The length of the second spring is at all times considered small compared to r_0 .
- (a) What is the energy of the system? Is it conserved?
- (b) Using generalized coordinates in the laboratory system, what is the Jacobi integral for the system? Is it conserved?
- (c) In terms of the generalized coordinates relative to a system rotating with the angular speed ω , what is the Lagrangian? What is the Jacobi integral? Is it conserved? Discuss the relationship between the two Jacobi integrals.

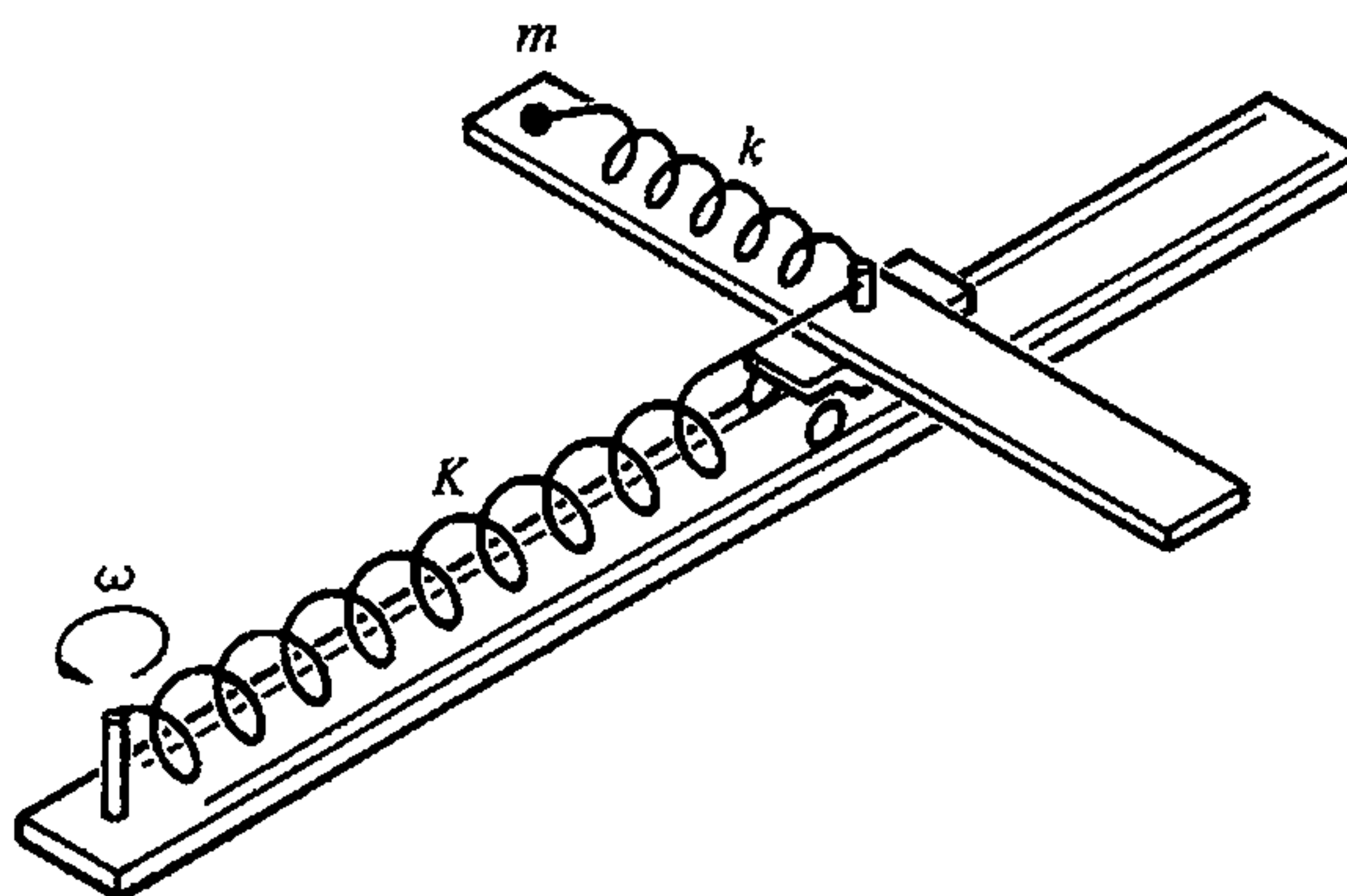

22. Suppose a particle moves in space subject to a conservative potential $V(\mathbf{r})$ but is constrained to always move on a surface whose equation is $\sigma(\mathbf{r}, t) = 0$. (The explicit dependence on t indicates that the surface may be moving.) The instantaneous force of constraint is taken as always perpendicular to the surface. Show analytically that the energy of the particle is not conserved if the surface moves in time. What physically is the reason for nonconservation of the energy under this circumstance?
23. Consider two particles of masses m_1 and m_2 . Let m_1 be confined to move on a circle of radius a in the $z = 0$ plane, centered at $x = y = 0$. Let m_2 be confined to move on a circle of radius b in the $z = c$ plane, centered at $x = y = 0$. A light (massless) spring of spring constant k is attached between the two particles.
- (a) Find the Lagrangian for the system.
- (b) Solve the problem using Lagrange multipliers and give a physical interpretation for each multiplier.
24. The one-dimensional harmonic oscillator has the Lagrangian $L = m\dot{x}^2/2 - kx^2/2$. Suppose you did not know the solution to the motion, but realized that the motion must be periodic and therefore could be described by a Fourier series of the form

$$x(t) = \sum_{j=0} a_j \cos j\omega t,$$

(taking $t = 0$ at a turning point) where ω is the (unknown) angular frequency of the motion. This representation for $x(t)$ defines a many-parameter path for the system point in configuration space. Consider the action integral I for two points, t_1 and t_2 separated by the period $T = 2\pi/\omega$. Show that with this form for the system path, I is an extremum for nonvanishing x only if $a_j = 0$, for $j \neq 1$, and only if $\omega^2 = k/m$.

25. A disk of radius R rolls without slipping inside the stationary parabola $y = ax^2$. Find the equations of constraint. What condition allows the disk to roll so that it touches the parabola at one and only one point independent of its position?
26. A particle of mass m is suspended by a massless spring of length L . It hangs, without initial motion, in a gravitational field of strength g . It is struck by an impulsive horizontal blow, which introduces an angular velocity ω . If ω is sufficiently small, it is obvious that the mass moves as a simple pendulum. If ω is sufficiently large, the mass will rotate about the support. Use a Lagrange multiplier to determine the conditions under which the string becomes slack at some point in the motion.

CHAPTER 3

The Central Force Problem

In this chapter we shall discuss the problem of two bodies moving under the influence of a mutual central force as an application of the Lagrangian formulation. Not all the problems of central force motion are integrable in terms of well-known functions. However, we shall attempt to explore the problem as thoroughly as is possible with the tools already developed. In the last section of this chapter we consider some of the complications that follow by the presence of a third body.

3.1 ■ REDUCTION TO THE EQUIVALENT ONE-BODY PROBLEM

Consider a monogenic system of two mass points, m_1 and m_2 (cf. Fig. 3.1), where the only forces are those due to an interaction potential U . We will assume at first that U is any function of the vector between the two particles, $\mathbf{r}_2 - \mathbf{r}_1$, or of their relative velocity, $\dot{\mathbf{r}}_2 - \dot{\mathbf{r}}_1$, or of any higher derivatives of $\mathbf{r}_2 - \mathbf{r}_1$. Such a system has six degrees of freedom and hence six independent generalized coordinates. We choose these to be the three components of the radius vector to the center of mass, \mathbf{R} , plus the three components of the difference vector $\mathbf{r} = \mathbf{r}_2 - \mathbf{r}_1$. The Lagrangian will then have the form

$$L = T(\dot{\mathbf{R}}, \dot{\mathbf{r}}) - U(\mathbf{r}, \dot{\mathbf{r}}, \dots). \quad (3.1)$$

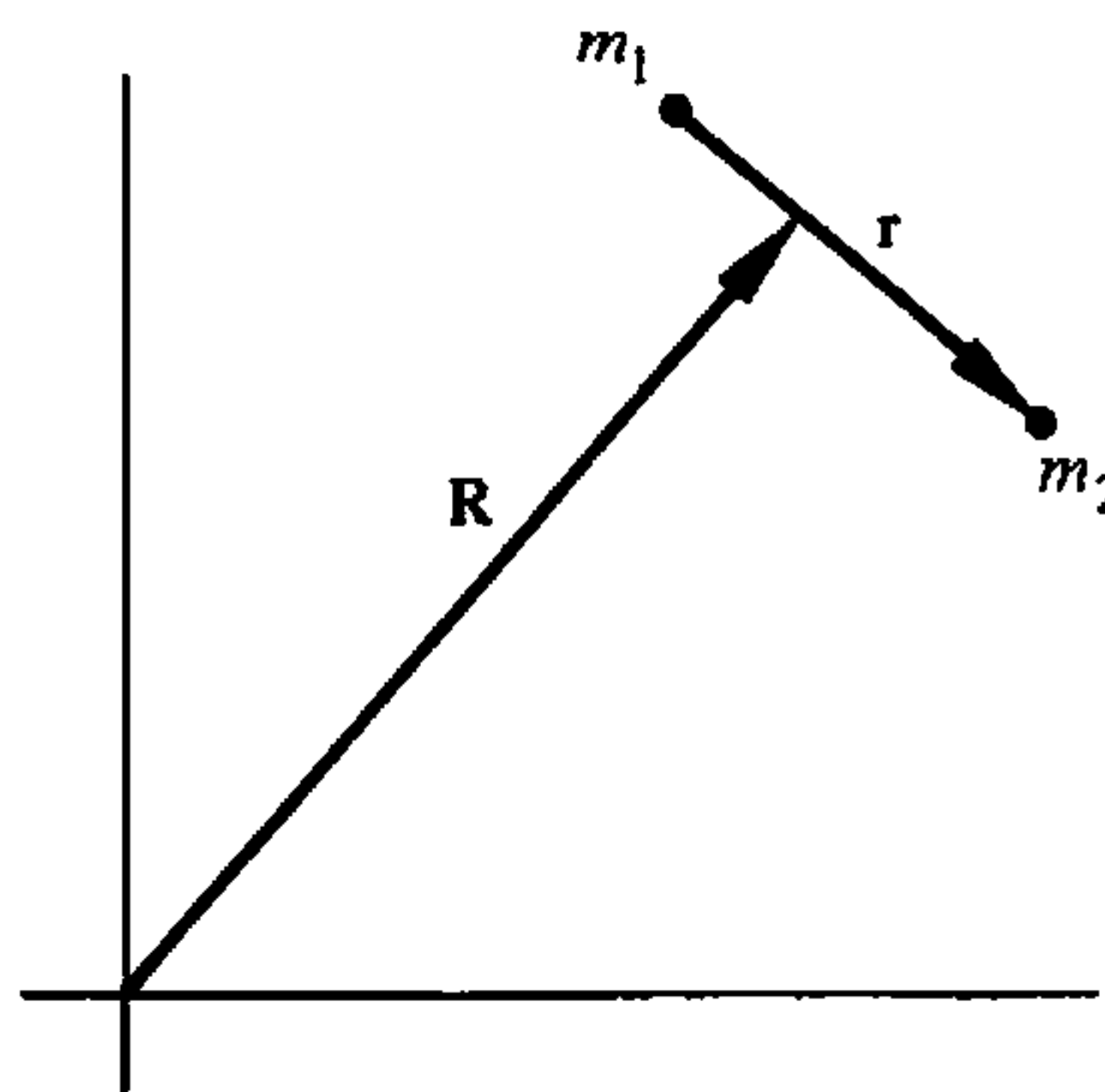

FIGURE 3.1 Coordinates for the two-body problem.

The kinetic energy T can be written as the sum of the kinetic energy of the motion of the center of mass, plus the kinetic energy of motion about the center of mass, T' :

$$T = \frac{1}{2} (m_1 + m_2) \dot{\mathbf{R}}^2 + T'$$

with

$$T' = \frac{1}{2} m_1 \dot{\mathbf{r}}_1'^2 + \frac{1}{2} m_2 \dot{\mathbf{r}}_2'^2.$$

Here \mathbf{r}'_1 and \mathbf{r}'_2 are the radii vectors of the two particles relative to the center of mass and are related to \mathbf{r} by

$$\begin{aligned} \mathbf{r}'_1 &= -\frac{m_2}{m_1 + m_2} \mathbf{r}, \\ \mathbf{r}'_2 &= \frac{m_1}{m_1 + m_2} \mathbf{r} \end{aligned} \quad (3.2)$$

Expressed in terms of \mathbf{r} by means of Eq. (3.2), T' takes on the form

$$T' = \frac{1}{2} \frac{m_1 m_2}{m_1 + m_2} \dot{\mathbf{r}}^2$$

and the total Lagrangian (3.1) is

$$L = \frac{m_1 + m_2}{2} \dot{\mathbf{R}}^2 + \frac{1}{2} \frac{m_1 m_2}{m_1 + m_2} \dot{\mathbf{r}}^2 - U(\mathbf{r}, \dot{\mathbf{r}}, \dots). \quad (3.3)$$

It is seen that the three coordinates \mathbf{R} are cyclic, so that the center of mass is either at rest or moving uniformly. None of the equations of motion for \mathbf{r} will contain terms involving \mathbf{R} or $\dot{\mathbf{R}}$. Consequently, the process of integration is particularly simple here. We merely drop the first term from the Lagrangian in all subsequent discussion.

The rest of the Lagrangian is exactly what would be expected if we had a fixed center of force with a single particle at a distance \mathbf{r} from it, having a mass

$$\mu = \frac{m_1 m_2}{m_1 + m_2}, \quad (3.4)$$

where μ is known as the *reduced mass*. Frequently, Eq. (3.4) is written in the form

$$\frac{1}{\mu} = \frac{1}{m_1} + \frac{1}{m_2}. \quad (3.5)$$

Thus, the central force motion of two bodies about their center of mass can always be reduced to an equivalent one-body problem.

3.2 ■ THE EQUATIONS OF MOTION AND FIRST INTEGRALS

We now restrict ourselves to conservative central forces, where the potential is $V(r)$, a function of r only, so that the force is always along \mathbf{r} . By the results of the preceding section, we need only consider the problem of a single particle of reduced mass m moving about a fixed center of force, which will be taken as the origin of the coordinate system. Since potential energy involves only the radial distance, the problem has spherical symmetry; i.e., any rotation, about any fixed axis, can have no effect on the solution. Hence, an angle coordinate representing rotation about a fixed axis must be cyclic. These symmetry properties result in a considerable simplification in the problem.

Since the problem is spherically symmetric, the total angular momentum vector,

$$\mathbf{L} = \mathbf{r} \times \mathbf{p},$$

is conserved. It therefore follows that \mathbf{r} is always perpendicular to the fixed direction of \mathbf{L} in space. This can be true only if \mathbf{r} always lies in a plane whose normal is parallel to \mathbf{L} . While this reasoning breaks down if \mathbf{L} is zero, the motion in that case must be along a straight line going through the center of force, for $\mathbf{L} = 0$ requires \mathbf{r} to be parallel to $\dot{\mathbf{r}}$, which can be satisfied only in straight-line motion.* Thus, central force motion is always motion in a plane.

Now, the motion of a single particle in space is described by three coordinates; in spherical polar coordinates these are the azimuth angle θ , the zenith angle (or colatitude) ψ , and the radial distance r . By choosing the polar axis to be in the direction of \mathbf{L} , the motion is always in the plane perpendicular to the polar axis. The coordinate ψ then has only the constant value $\pi/2$ and can be dropped from the subsequent discussion. The conservation of the angular momentum vector furnishes three independent constants of motion (corresponding to the three Cartesian components). In effect, two of these, expressing the constant *direction* of the angular momentum, have been used to reduce the problem from three to two degrees of freedom. The third of these constants, corresponding to the conservation of the magnitude of \mathbf{L} , remains still at our disposal in completing the solution.

Expressed now in plane polar coordinates, the Lagrangian is

$$\begin{aligned} L &= T - V \\ &= \frac{1}{2}m(\dot{r}^2 + r^2\dot{\theta}^2) - V(r). \end{aligned} \quad (3.6)$$

As was foreseen, θ is a cyclic coordinate, whose corresponding canonical momentum is the angular momentum of the system:

$$p_{\theta} = \frac{\partial L}{\partial \dot{\theta}} = mr^2\dot{\theta}.$$

*Formally $\dot{\mathbf{r}} = \dot{r}\mathbf{n}_r + r\dot{\theta}\mathbf{n}_{\theta}$, hence $\mathbf{r} \times \dot{\mathbf{r}} = 0$ requires $\dot{\theta} = 0$.

One of the two equations of motion is then simply

$$\dot{p}_\theta = \frac{d}{dt} (mr^2\dot{\theta}) = 0. \quad (3.7)$$

with the immediate integral

$$mr^2\dot{\theta} = l. \quad (3.8)$$

where l is the constant magnitude of the angular momentum. From (3.7) it also follows that

$$\frac{d}{dt} \left(\frac{1}{2} r^2 \dot{\theta} \right) = 0. \quad (3.9)$$

The factor $\frac{1}{2}$ is inserted because $\frac{1}{2} r^2 \dot{\theta}$ is just the *areal velocity*—the area swept out by the radius vector per unit time. This interpretation follows from Fig. 3.2, the differential area swept out in time dt being

$$dA = \frac{1}{2} r (r d\theta),$$

and hence

$$\frac{dA}{dt} = \frac{1}{2} r^2 \frac{d\theta}{dt}.$$

The conservation of angular momentum is thus equivalent to saying the areal velocity is constant. Here we have the proof of the well-known Kepler's second law of planetary motion: The radius vector sweeps out equal areas in equal times. It should be emphasized however that the conservation of the areal velocity is a general property of central force motion and is not restricted to an inverse-square law of force.

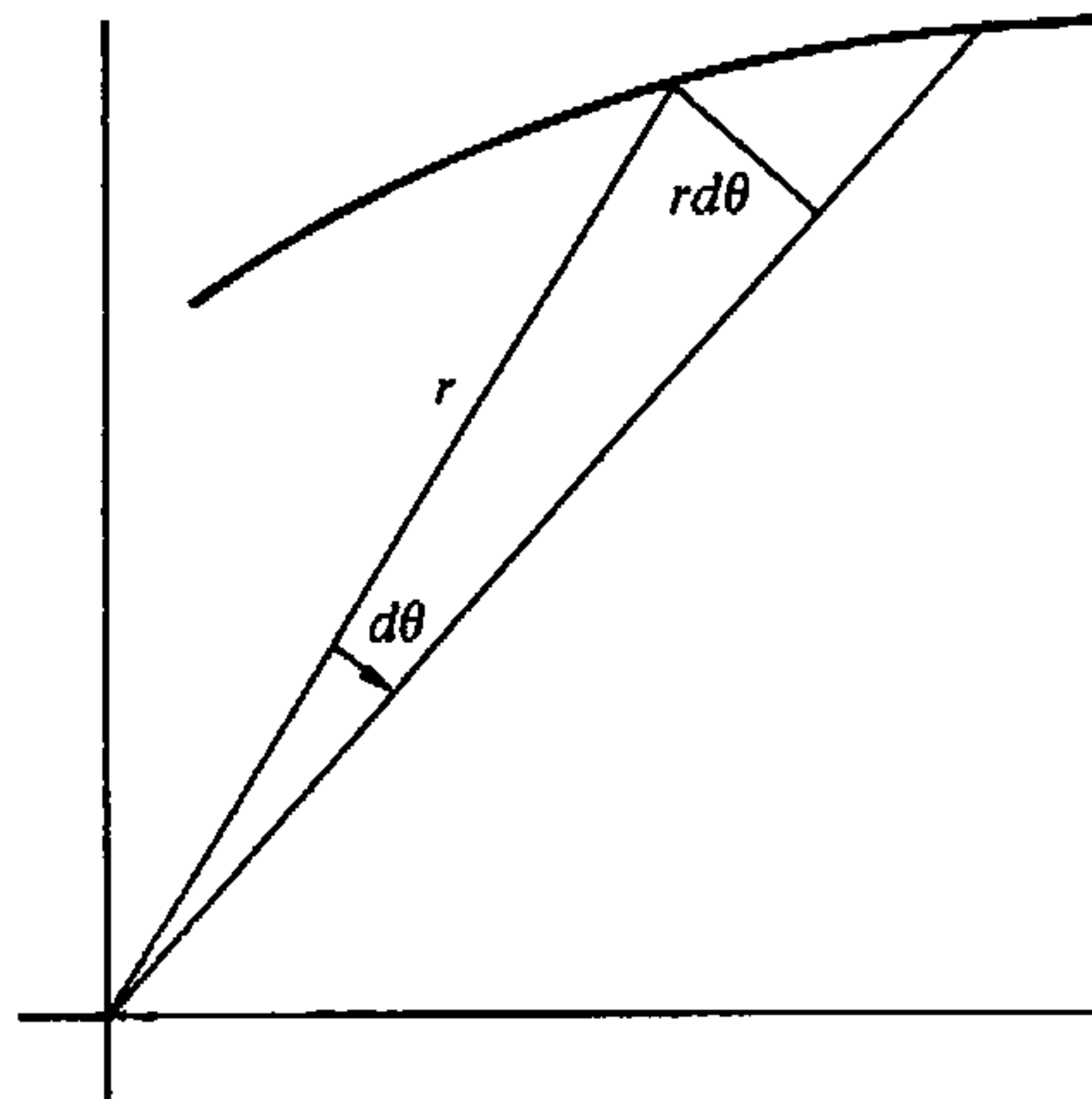

FIGURE 3.2 The area swept out by the radius vector in a time dt .

The remaining Lagrange equation, for the coordinate r , is

$$\frac{d}{dt}(m\dot{r}) - mr\dot{\theta}^2 + \frac{\partial V}{\partial r} = 0. \quad (3.10)$$

Designating the value of the force along \mathbf{r} , $-\partial V/\partial r$, by $f(r)$ the equation can be rewritten as

$$m\ddot{r} - mr\dot{\theta}^2 = f(r). \quad (3.11)$$

By making use of the first integral, Eq. (3.8), $\dot{\theta}$ can be eliminated from the equation of motion, yielding a second-order differential equation involving r only:

$$m\ddot{r} - \frac{l^2}{mr^3} = f(r). \quad (3.12)$$

There is another first integral of motion available, namely the total energy, since the forces are conservative. On the basis of the general energy conservation theorem, we can immediately state that a constant of the motion is

$$E = \frac{1}{2}m(\dot{r}^2 + r^2\dot{\theta}^2) + V(r), \quad (3.13)$$

where E is the energy of the system. Alternatively, this first integral could be derived again directly from the equations of motion (3.7) and (3.12). The latter can be written as

$$m\ddot{r} = -\frac{d}{dr} \left(V + \frac{1}{2} \frac{l^2}{mr^2} \right). \quad (3.14)$$

If both sides of Eq. (3.14) are multiplied by \dot{r} the left side becomes

$$m\ddot{r}\dot{r} = \frac{d}{dt} \left(\frac{1}{2}m\dot{r}^2 \right).$$

The right side similarly can be written as a total time derivative, for if $g(r)$ is any function of r , then the total time derivative of g has the form

$$\frac{d}{dt}g(r) = \frac{dg}{dr} \frac{dr}{dt}.$$

Hence, Eq. (3.14) is equivalent to

$$\frac{d}{dt} \left(\frac{1}{2}m\dot{r}^2 \right) = -\frac{d}{dt} \left(V + \frac{1}{2} \frac{l^2}{mr^2} \right)$$

or

$$\frac{d}{dt} \left(\frac{1}{2}m\dot{r}^2 + \frac{1}{2} \frac{l^2}{mr^2} + V \right) = 0,$$

and therefore

$$\frac{1}{2}m\dot{r}^2 + \frac{1}{2}\frac{l^2}{mr^2} + V = \text{constant.} \quad (3.15)$$

Equation (3.15) is the statement of the conservation of total energy, for by using (3.8) for l , the middle term can be written

$$\frac{1}{2}\frac{l^2}{mr^2} = \frac{1}{2mr^2}m^2r^4\dot{\theta}^2 = \frac{mr^2\dot{\theta}^2}{2}.$$

and (3.15) reduces to (3.13).

These first two integrals give us in effect two of the quadratures necessary to complete the problem. As there are two variables, r and θ , a total of four integrations are needed to solve the equations of motion. The first two integrations have left the Lagrange equations as two first-order equations (3.8) and (3.15); the two remaining integrations can be accomplished (formally) in a variety of ways. Perhaps the simplest procedure starts from Eq. (3.15). Solving for \dot{r} , we have

$$\dot{r} = \sqrt{\frac{2}{m} \left(E - V - \frac{l^2}{2mr^2} \right)}, \quad (3.16)$$

or

$$dt = \frac{dr}{\sqrt{\frac{2}{m} \left(E - V - \frac{l^2}{2mr^2} \right)}}. \quad (3.17)$$

At time $t = 0$, let r have the initial value r_0 . Then the integral of both sides of the equation from the initial state to the state at time t takes the form

$$t = \int_{r_0}^r \frac{dr}{\sqrt{\frac{2}{m} \left(E - V - \frac{l^2}{2mr^2} \right)}}. \quad (3.18)$$

As it stands, Eq. (3.18) gives t as a function of r and the constants of integration E , l , and r_0 . However, it may be inverted, at least formally, to give r as a function of t and the constants. Once the solution for r is found, the solution θ follows immediately from Eq. (3.8), which can be written as

$$d\theta = \frac{l dt}{mr^2}. \quad (3.19)$$

If the initial value of θ is θ_0 , then the integral of (3.19) is simply

$$\theta = l \int_0^t \frac{dt}{mr^2(t)} + \theta_0. \quad (3.20)$$

Equations (3.18) and (3.20) are the two remaining integrations, and formally the problem has been reduced to quadratures, with four constants of integration E , l , r_0 , θ_0 . These constants are not the only ones that can be considered. We might equally as well have taken r_0 , θ_0 , \dot{r}_0 , $\dot{\theta}_0$, but of course E and l can always be determined in terms of this set. For many applications, however, the set containing the energy and angular momentum is the natural one. In quantum mechanics, such constants as the initial values of r and θ , or of \dot{r} and $\dot{\theta}$, become meaningless, but we can still talk in terms of the system energy or of the system angular momentum. Indeed, two salient differences between classical and quantum mechanics appear in the properties of E and l in the two theories. In order to discuss the transition to quantum theories, it is therefore important that the classical description of the system be in terms of its energy and angular momentum.

3.3 ■ THE EQUIVALENT ONE-DIMENSIONAL PROBLEM, AND CLASSIFICATION OF ORBITS

Although we have solved the one-dimensional problem formally, practically speaking the integrals (3.18) and (3.20) are usually quite unmanageable, and in any specific case it is often more convenient to perform the integration in some other fashion. But before obtaining the solution for any specific force laws, let us see what can be learned about the motion in the general case, using only the equations of motion and the conservation theorems, without requiring explicit solutions.

For example, with a system of known energy and angular momentum, the magnitude and direction of the velocity of the particle can be immediately determined in terms of the distance r . The magnitude v follows at once from the conservation of energy in the form

$$E = \frac{1}{2}mv^2 + V(r)$$

or

$$v = \sqrt{\frac{2}{m}(E - V(r))}. \quad (3.21)$$

The radial velocity—the component of $\dot{\mathbf{r}}$ along the radius vector—has been given in Eq. (3.16). Combined with the magnitude v , this is sufficient information to furnish the direction of the velocity.* These results, and much more, can also be obtained from consideration of an equivalent one-dimensional problem.

The equation of motion in r , with $\dot{\theta}$ expressed in terms of l , Eq. (3.12), involves only r and its derivatives. It is the same equation as would be obtained for a

*Alternatively, the conservation of angular momentum furnishes $\dot{\theta}$, the angular velocity, and this together with \dot{r} gives both the magnitude and direction of $\dot{\mathbf{r}}$.

fictitious one-dimensional problem in which a particle of mass m is subject to a force

$$f' = f + \frac{l^2}{mr^3}. \quad (3.22)$$

The significance of the additional term is clear if it is written as $mr\dot{\theta}^2 = mv_{\theta}^2/r$, which is the familiar centrifugal force. An equivalent statement can be obtained from the conservation theorem for energy. By Eq. (3.15) the motion of the particle in r is that of a one-dimensional problem with a fictitious potential energy:

$$V' = V + \frac{1}{2} \frac{l^2}{mr^2}. \quad (3.22')$$

As a check, note that

$$f' = -\frac{\partial V'}{\partial r} = f(r) + \frac{l^2}{mr^3},$$

which agrees with Eq. (3.22). The energy conservation theorem (3.15) can thus also be written as

$$E = V' + \frac{1}{2} m\dot{r}^2. \quad (3.15')$$

As an illustration of this method of examining the motion, consider a plot of V' against r for the specific case of an attractive inverse-square law of force:

$$f = -\frac{k}{r^2}.$$

(For positive k , the minus sign ensures that the force is *toward* the center of force.) The potential energy for this force is

$$V = -\frac{k}{r},$$

and the corresponding fictitious potential is

$$V' = -\frac{k}{r} + \frac{l^2}{2mr^2}.$$

Such a plot is shown in Fig. 3.3; the two dashed lines represent the separate components

$$-\frac{k}{r} \quad \text{and} \quad \frac{l^2}{2mr^2},$$

and the solid line is the sum V' .

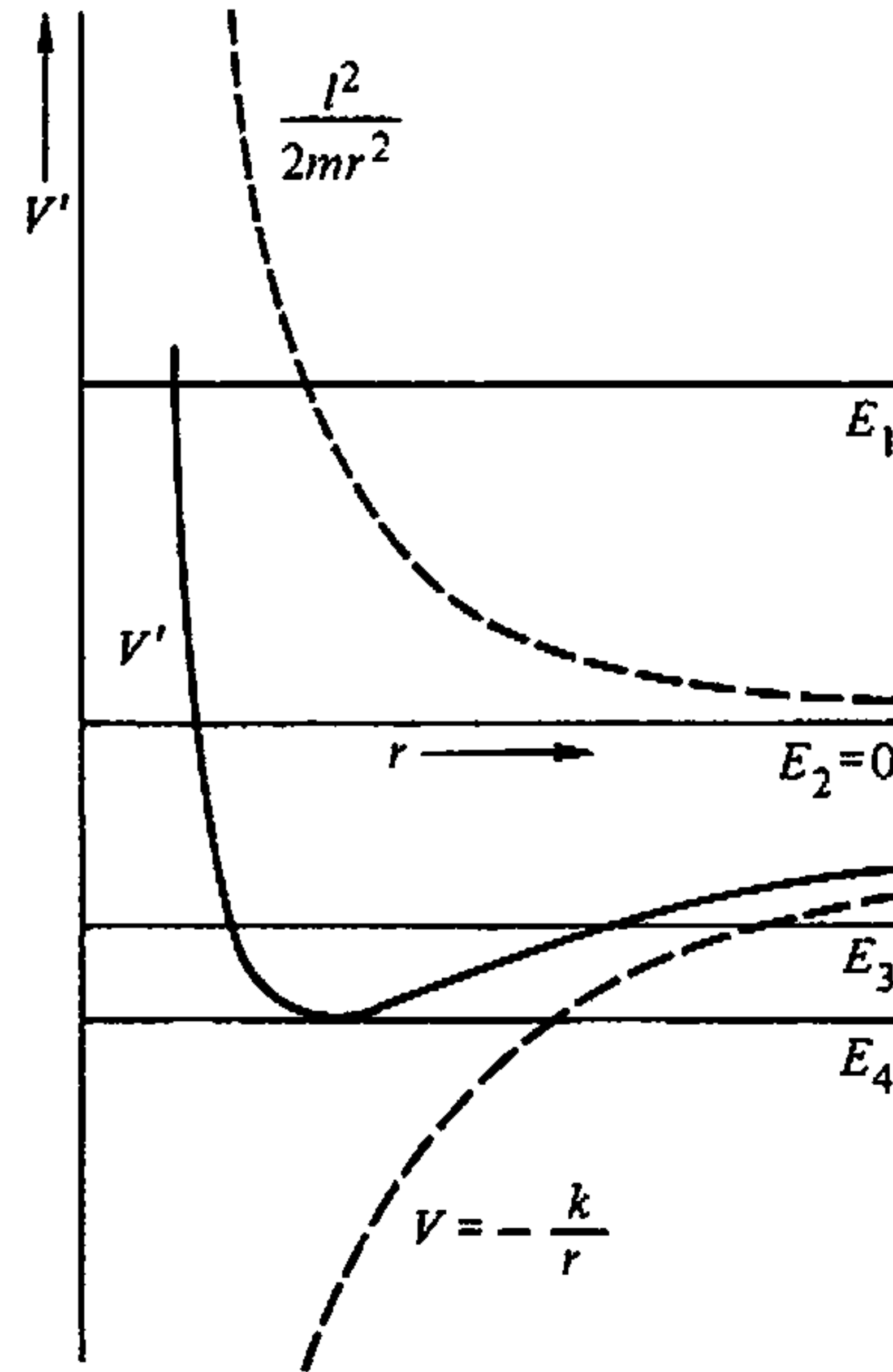

FIGURE 3.3 The equivalent one-dimensional potential for attractive inverse-square law of force.

Let us consider now the motion of a particle having the energy E_1 , as shown in Figs. 3.3 and 3.4. Clearly this particle can never come closer than r_1 (cf. Fig. 3.4). Otherwise with $r < r_1$, V' exceeds E_1 and by Eq. (3.15') the kinetic energy would have to be negative, corresponding to an imaginary velocity! On the other hand, there is no upper limit to the possible value of r , so the orbit is not bounded. A particle will come in from infinity, strike the "repulsive centrifugal barrier," be repelled, and travel back out to infinity (cf. Fig. 3.5). The distance between E and V' is $\frac{1}{2}m\dot{r}^2$, i.e., proportional to the square of the radial velocity, and becomes zero, naturally, at the *turning point* r_1 . At the same time, the distance between E and V on the plot is the kinetic energy $\frac{1}{2}mv^2$ at the given value of r . Hence, the distance between the V and V' curves is $\frac{1}{2}mr^2\dot{\theta}^2$. These curves therefore supply the magnitude of the particle velocity and its components for any distance r , at the given energy and angular momentum. This information is sufficient to produce an approximate picture of the form of the orbit.

For the energy $E_2 = 0$ (cf. Fig. 3.3), a roughly similar picture of the orbit behavior is obtained. But for any lower energy, such as E_3 indicated in Fig. 3.6, we have a different story. In addition to a lower bound r_1 , there is also a maximum value r_2 that cannot be exceeded by r with positive kinetic energy. The motion is then "bounded," and there are two turning points, r_1 and r_2 , also known as *apsidal distances*. This does not necessarily mean that the orbits are closed. All that can be said is that they are bounded, contained between two circles of radius r_1 and r_2 with turning points always lying on the circles (cf. Fig. 3.7).

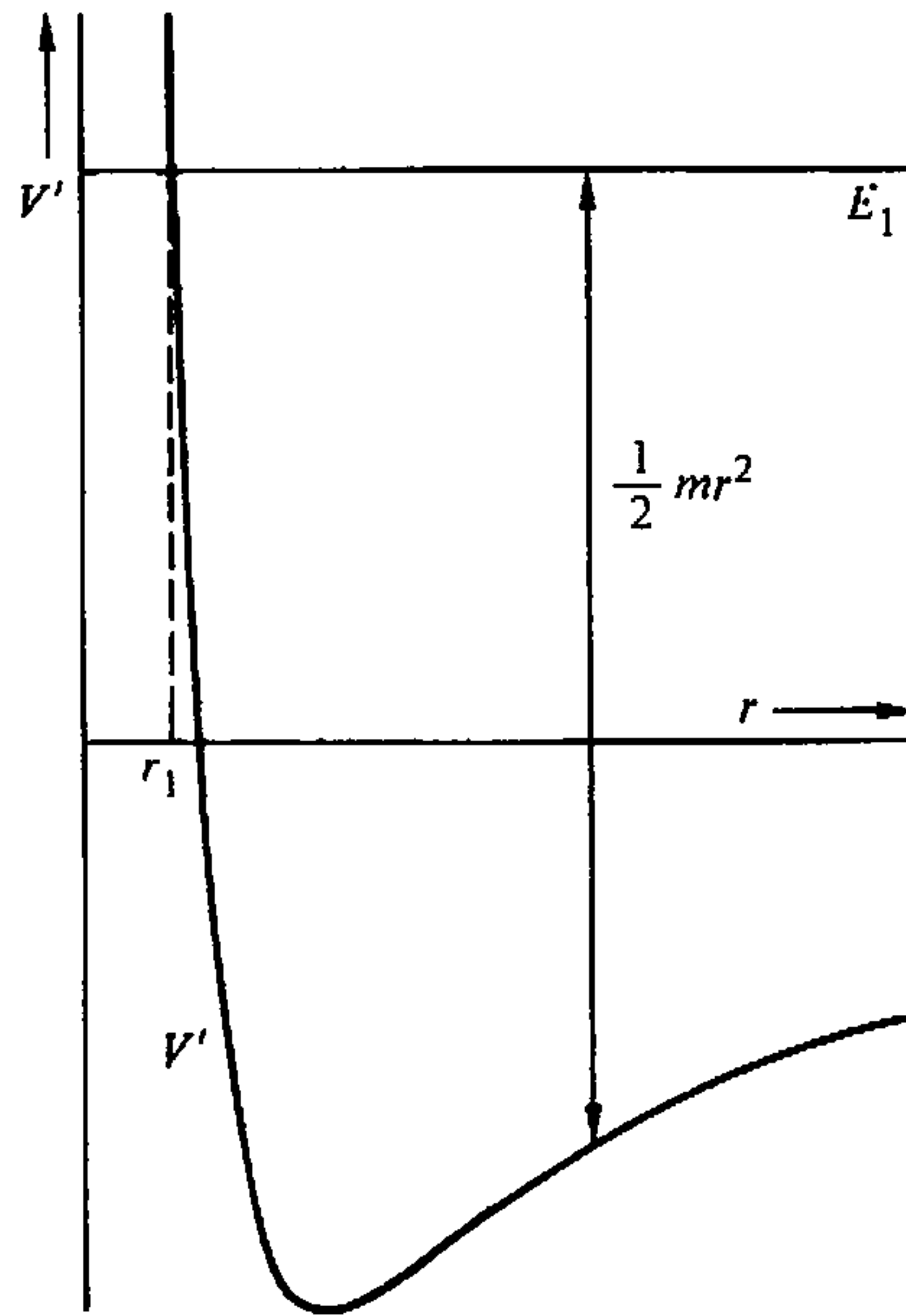

FIGURE 3.4 Unbounded motion at positive energies for inverse-square law of force.

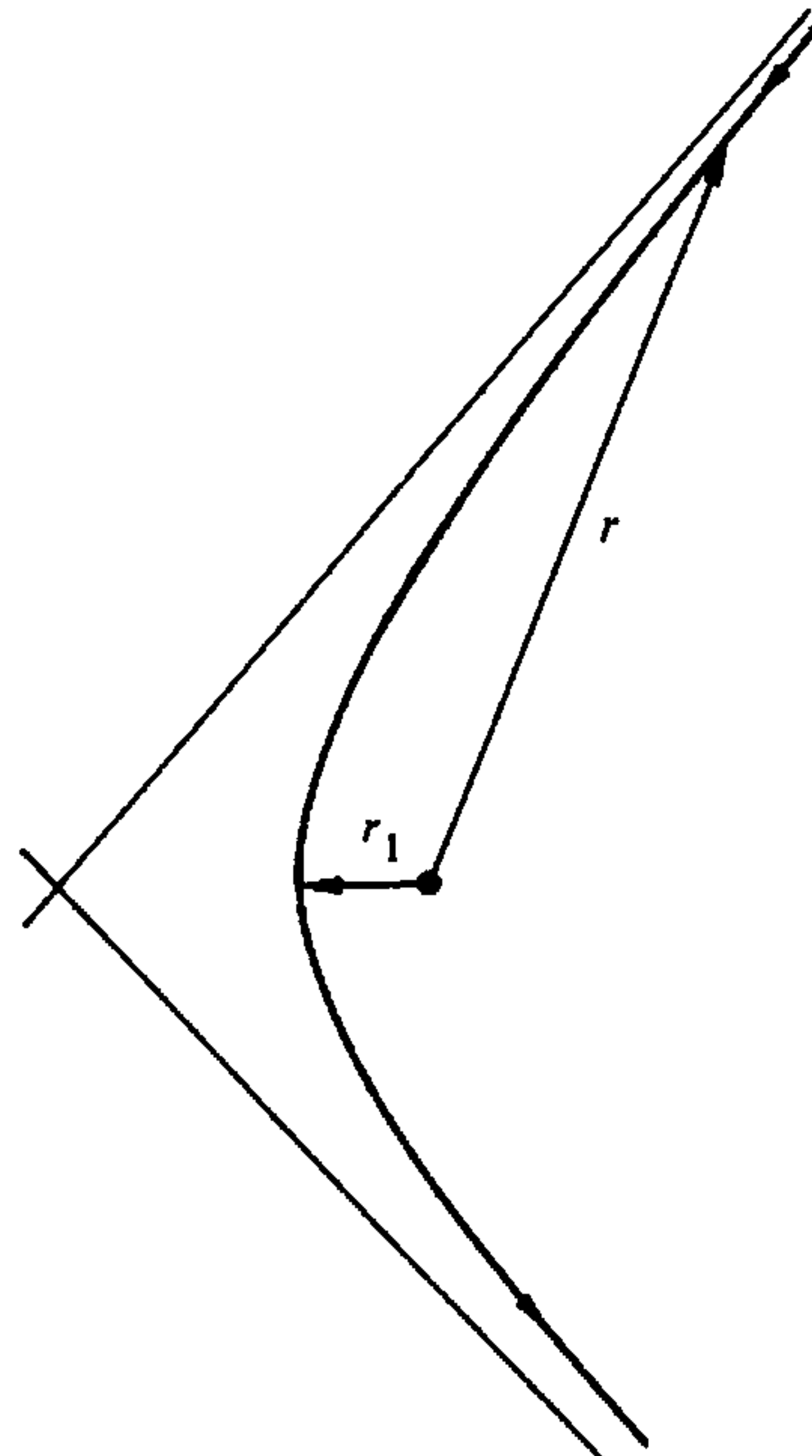

FIGURE 3.5 The orbit for E_1 corresponding to unbounded motion.

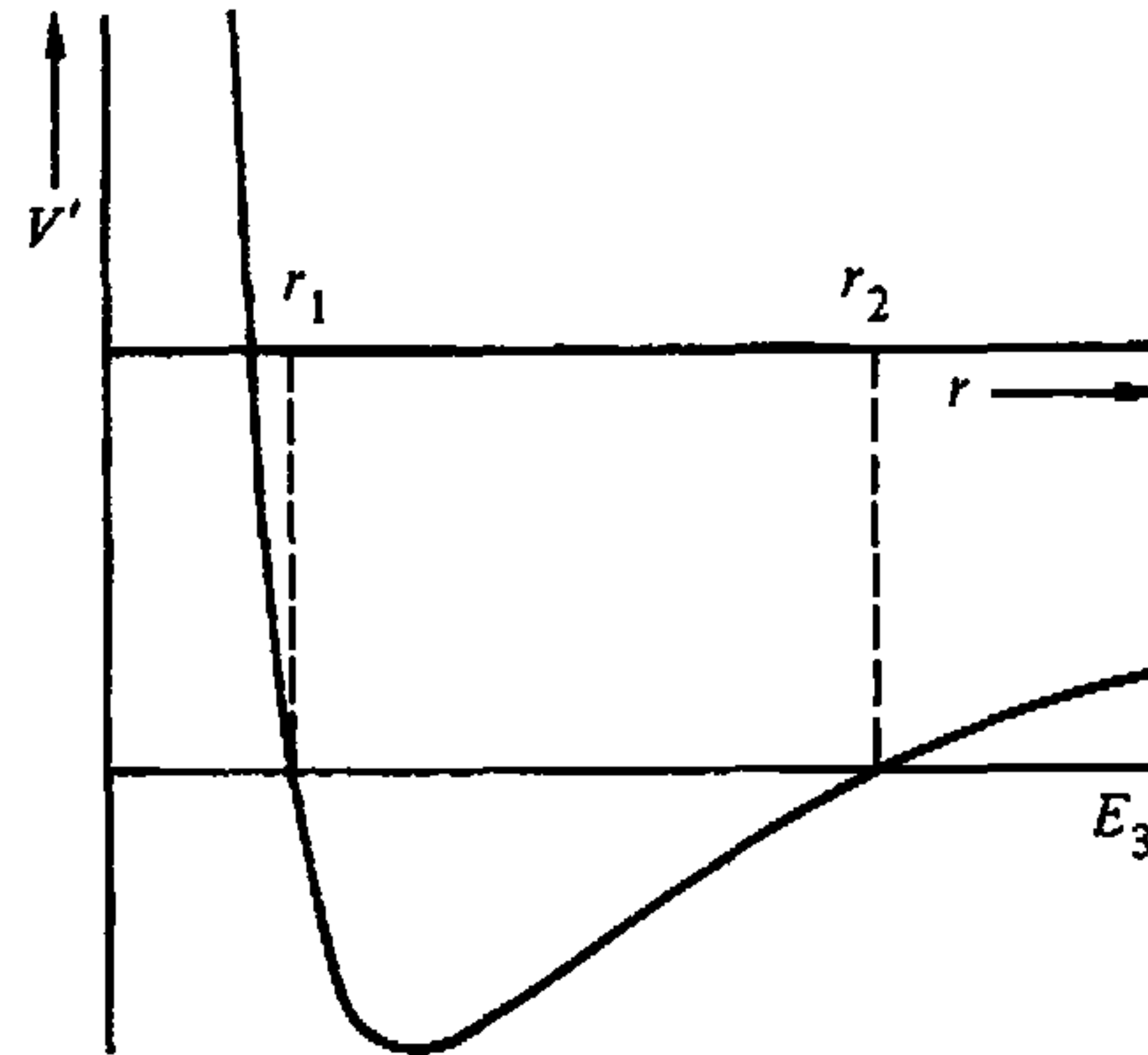

FIGURE 3.6 The equivalent one-dimensional potential for inverse-square law of force, illustrating bounded motion at negative energies.

If the energy is E_4 at the minimum of the fictitious potential as shown in Fig. 3.8, then the two bounds coincide. In such case, motion is possible at only one radius; $\dot{r} = 0$, and the orbit is a circle. Remembering that the effective “force” is the negative of the slope of the V' curve, the requirement for circular orbits is simply that f' be zero, or

$$f(r) = -\frac{l^2}{mr^3} = -mr\dot{\theta}^2.$$

We have here the familiar elementary condition for a circular orbit, that the applied force be equal and opposite to the “reversed effective force” of centripetal

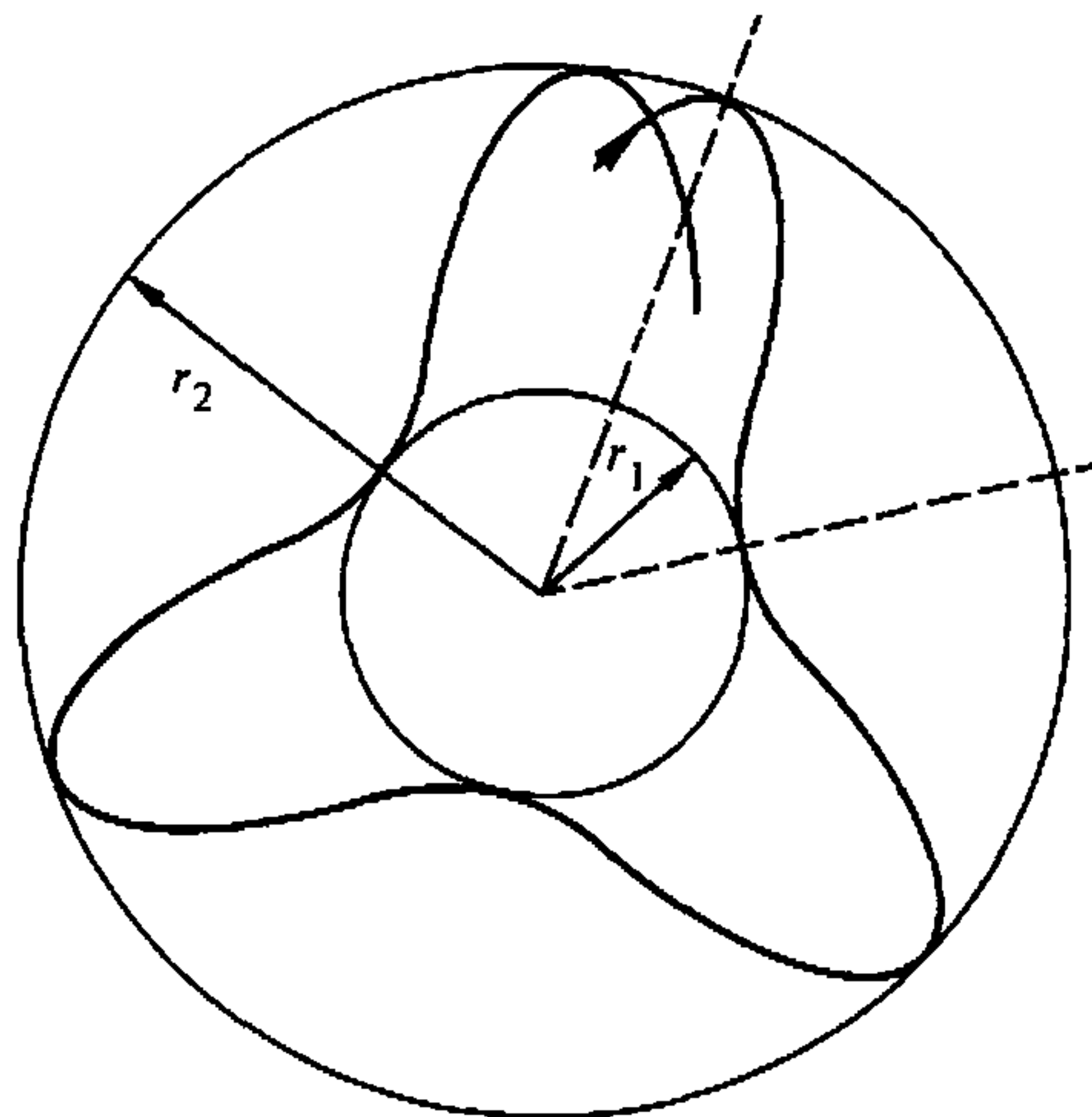

FIGURE 3.7 The nature of the orbits for bounded motion.

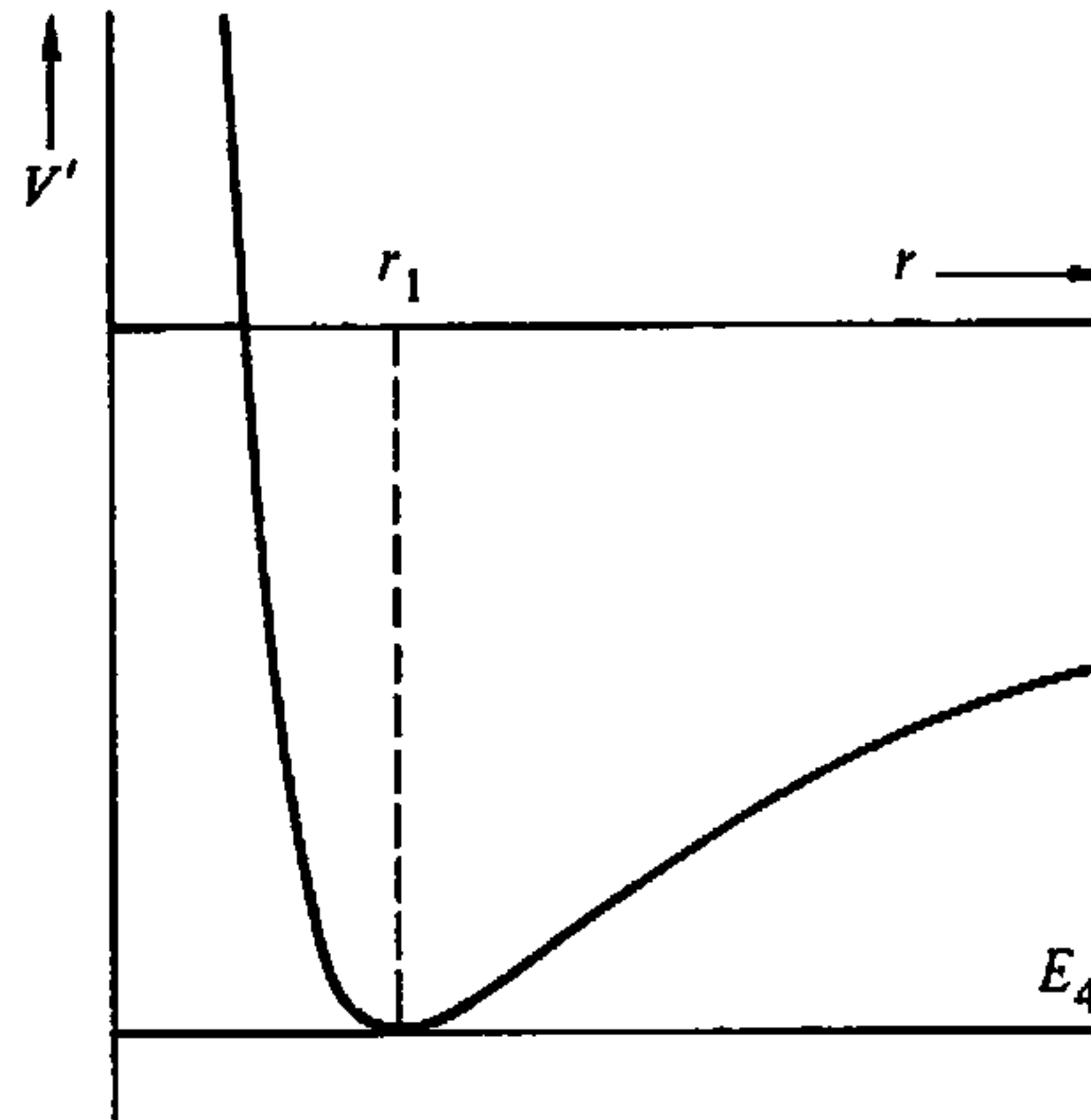

FIGURE 3.8 The equivalent one-dimensional potential of inverse-square law of force, illustrating the condition for circular orbits.

acceleration.* The properties of circular orbits and the conditions for them will be studied in greater detail in Section 3.6.

Note that all of this discussion of the orbits for various energies has been at one value of the angular momentum. Changing l changes the quantitative details of the V' curve, but it does not affect the general classification of the types of orbits.

For the attractive inverse-square law of force discussed above, we shall see that the orbit for E_1 is a hyperbola, for E_2 a parabola, and for E_3 an ellipse. With other forces the orbits may not have such simple forms. However, the same general qualitative division into open, bounded, and circular orbits will be true for any attractive potential that (1) falls off slower than $1/r^2$ as $r \rightarrow \infty$, and (2) becomes infinite slower than $1/r^2$ as $r \rightarrow 0$. The first condition ensures that the potential predominates over the centrifugal term for large r , while the second condition is such that for small r it is the centrifugal term that is important.

The qualitative nature of the motion will be altered if the potential does not satisfy these requirements, but we may still use the method of the equivalent potential to examine features of the orbits. As an example, let us consider the attractive potential

$$V(r) = -\frac{a}{r^3}, \quad \text{with} \quad f = -\frac{3a}{r^4}.$$

The energy diagram is then as shown in Fig. 3.9. For an energy E , there are two possible types of motion, depending upon the initial value of r . If r_0 is less than r_1 the motion will be bounded, r will always remain less than r_1 , and the particle will pass through the center of force. If r is initially greater than r_2 , then it will

*The case $E < E_4$ does not correspond to physically possible motion, for then \dot{r}^2 would have to be negative, or \dot{r} imaginary.

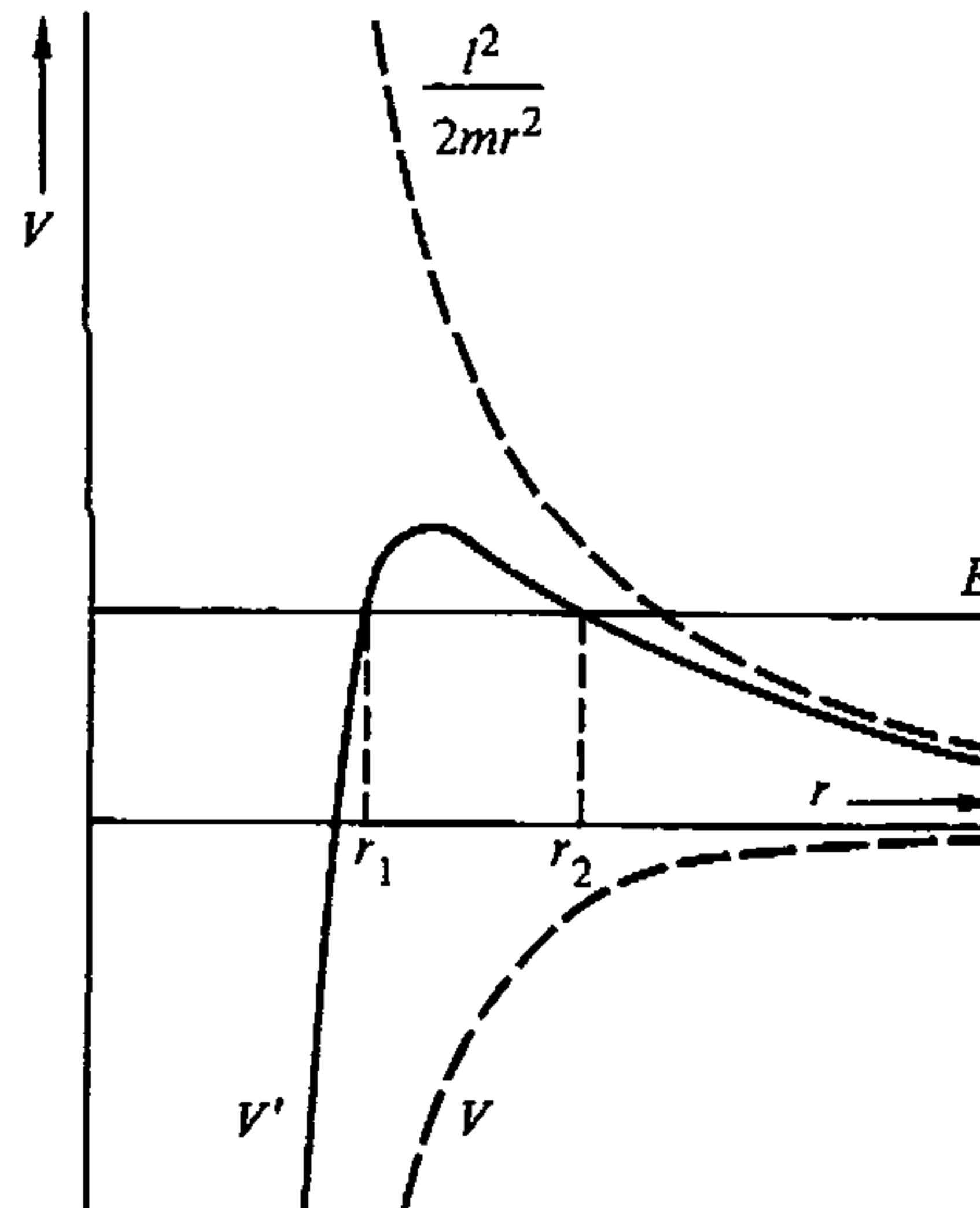

FIGURE 3.9 The equivalent one-dimensional potential for an attractive inverse-fourth law of force

always remain so; the motion is unbounded, and the particle can never get inside the “potential” hole. The initial condition $r_1 < r_0 < r_2$ is again not physically possible.

Another interesting example of the method occurs for a linear restoring force (isotropic harmonic oscillator):

$$f = -kr, \quad V = \frac{1}{2}kr^2.$$

For zero angular momentum, corresponding to motion along a straight line, $V' = V$ and the situation is as shown in Fig. 3.10. For any positive energy the motion is bounded and, as we know, simple harmonic. If $l \neq 0$, we have the state of affairs shown in Fig. 3.11. The motion then is always bounded for all physically possible

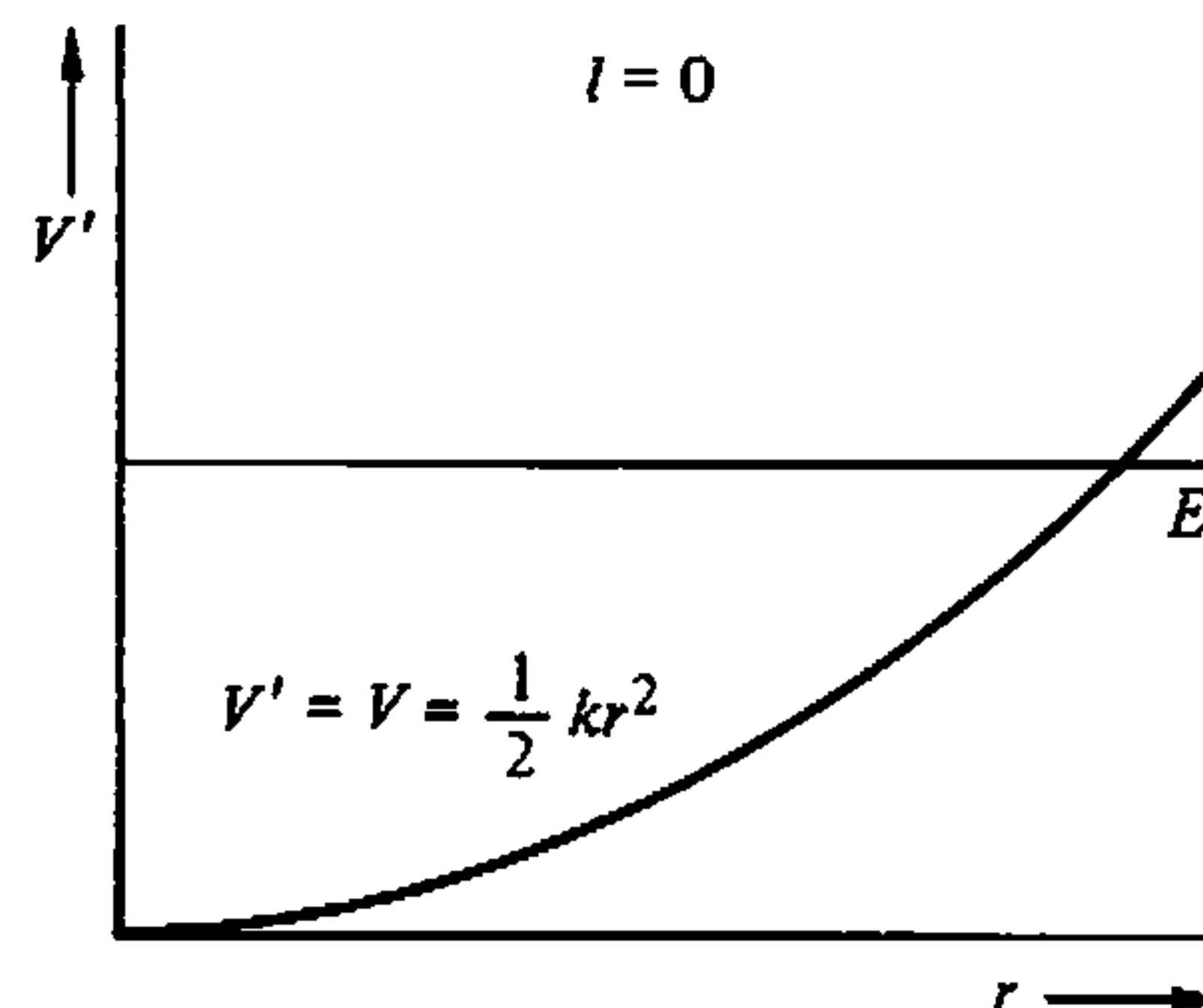

FIGURE 3.10 Effective potential for zero angular momentum.

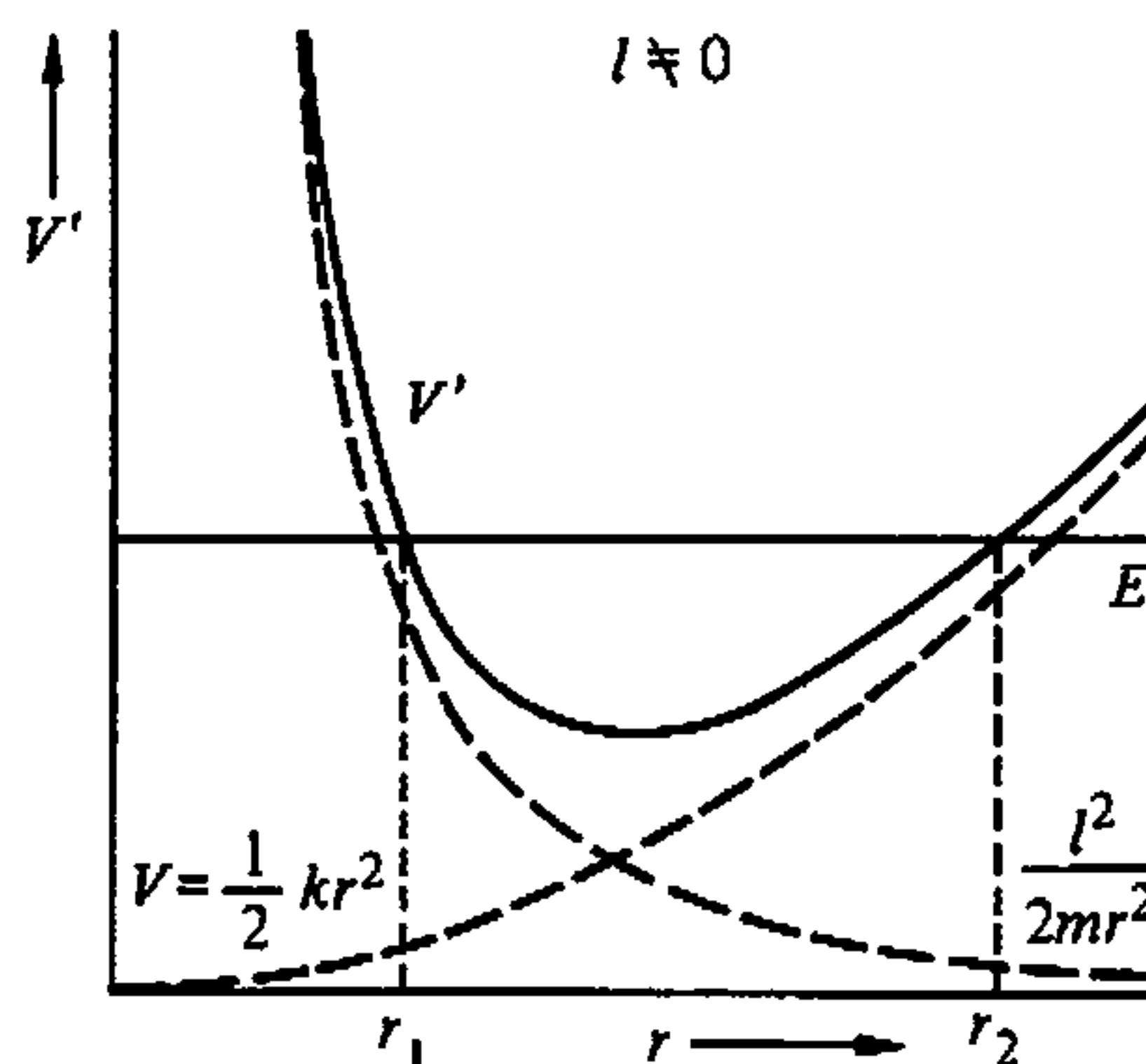

FIGURE 3.11 The equivalent one-dimensional potential for a linear restoring force.

energies and does not pass through the center of force. In this particular case, it is easily seen that the orbit is elliptic, for if $\mathbf{f} = -k\mathbf{r}$, the x - and y -components of the force are

$$f_x = -kx, \quad f_y = -ky.$$

The total motion is thus the resultant of two simple harmonic oscillations at right angles, and of the same frequency, which in general leads to an elliptic orbit.

A well-known example is the spherical pendulum for small amplitudes. The familiar Lissajous figures are obtained as the composition of two sinusoidal oscillations at right angles where the ratio of the frequencies is a rational number. For two oscillations at the same frequency, the figure is a straight line when the oscillations are in phase, a circle when they are 90° out of phase, and an elliptic shape otherwise. Thus, central force motion under a linear restoring force therefore provides the simplest of the Lissajous figures.

3.4 ■ THE VIRIAL THEOREM

Another property of central force motion can be derived as a special case of a general theorem valid for a large variety of systems—the *virial theorem*. It differs in character from the theorems previously discussed in being *statistical* in nature; i.e., it is concerned with the time averages of various mechanical quantities.

Consider a general system of mass points with position vectors \mathbf{r}_i and applied forces \mathbf{F}_i (including any forces of constraint). The fundamental equations of motion are then

$$\dot{\mathbf{p}}_i = \mathbf{F}_i. \quad (1.3)$$

We are interested in the quantity

$$G = \sum_i \mathbf{p}_i \cdot \mathbf{r}_i,$$

where the summation is over all particles in the system. The total time derivative of this quantity is

$$\frac{dG}{dt} = \sum_i \dot{\mathbf{r}}_i \cdot \mathbf{p}_i + \sum_i \dot{\mathbf{p}}_i \cdot \mathbf{r}_i. \quad (3.23)$$

The first term can be transformed to

$$\sum_i \dot{\mathbf{r}}_i \cdot \mathbf{p}_i = \sum_i m_i \dot{\mathbf{r}}_i \cdot \dot{\mathbf{r}}_i = \sum_i m_i v_i^2 = 2T,$$

while the second term by (1.3) is

$$\sum_i \dot{\mathbf{p}}_i \cdot \mathbf{r}_i = \sum_i \mathbf{F}_i \cdot \mathbf{r}_i.$$

Equation (3.23) therefore reduces to

$$\frac{d}{dt} \sum_i \mathbf{p}_i \cdot \mathbf{r}_i = 2T + \sum_i \mathbf{F}_i \cdot \mathbf{r}_i. \quad (3.24)$$

The time average of Eq. (3.24) over a time interval τ is obtained by integrating both sides with respect to t from 0 to τ , and dividing by τ :

$$\frac{1}{\tau} \int_0^\tau \frac{dG}{dt} dt \equiv \overline{\frac{dG}{dt}} = \overline{2T} + \overline{\sum_i \mathbf{F}_i \cdot \mathbf{r}_i}$$

or

$$\overline{2T} + \overline{\sum_i \mathbf{F}_i \cdot \mathbf{r}_i} = \frac{1}{\tau} [G(\tau) - G(0)]. \quad (3.25)$$

If the motion is periodic, i.e., all coordinates repeat after a certain time, and if τ is chosen to be the period, then the right-hand side of (3.25) vanishes. A similar conclusion can be reached even if the motion is not periodic, provided that the coordinates and velocities for all particles remain finite so that there is an upper bound to G . By choosing τ sufficiently long, the right-hand side of Eq. (3.25) can be made as small as desired. In both cases, it then follows that

$$\overline{T} = -\frac{1}{2} \overline{\sum_i \mathbf{F}_i \cdot \mathbf{r}_i}. \quad (3.26)$$

Equation (3.26) is known as the *virial theorem*, and the right-hand side is called the *virial of Clausius*. In this form the theorem is important in the kinetic theory

of gases since it can be used to derive ideal gas law for perfect gases by means of the following brief argument.

We consider a gas consisting of N atoms confined within a container of volume V . The gas is further assumed to be at a Kelvin temperature T (not to be confused with the symbol for kinetic energy). Then by the equipartition theorem of kinetic theory, the average kinetic energy of each atom is given by $\frac{3}{2}k_B T$, k_B being the Boltzmann constant, a relation that in effect is the definition of temperature. The left-hand side of Eq. (3.26) is therefore

$$\frac{3}{2}Nk_B T.$$

On the right-hand side of Eq. (3.26), the forces \mathbf{F}_i include both the forces of interaction between atoms and the forces of constraint on the system. A perfect gas is defined as one for which the forces of interaction contribute negligibly to the virial. This occurs, e.g., if the gas is so tenuous that collisions between atoms occur rarely, compared to collisions with the walls of the container. It is these walls that constitute the constraint on the system, and the forces of constraint, \mathbf{F}_c , are localized at the wall and come into existence whenever a gas atom collides with the wall. The sum on the right-hand side of Eq. (3.26) can therefore be replaced in the average by an integral over the surface of the container. The force of constraint represents the reaction of the wall to the collision forces exerted by the atoms on the wall, i.e., to the pressure P . With the usual outward convention for the unit vector \mathbf{n} in the direction of the normal to the surface, we can therefore write

$$d\mathbf{F}_i = -P\mathbf{n}dA,$$

or

$$\frac{1}{2} \sum_i \mathbf{F}_i \cdot \mathbf{r}_i = -\frac{P}{2} \int \mathbf{n} \cdot \mathbf{r} dA.$$

But, by Gauss's theorem,

$$\int \mathbf{n} \cdot \mathbf{r} dA = \int \nabla \cdot \mathbf{r} dV = 3V.$$

The virial theorem, Eq. (3.26), for the system representing a perfect gas can therefore be written

$$\frac{3}{2}Nk_B T = \frac{3}{2}PV,$$

which, cancelling the common factor of $\frac{3}{2}$ on both sides, is the familiar ideal gas law. Where the interparticle forces contribute to the virial, the perfect gas law of course no longer holds. The virial theorem is then the principal tool, in classical kinetic theory, for calculating the equation of state corresponding to such imperfect gases.

We can further show that if the forces \mathbf{F}_i are the sum of nonfrictional forces \mathbf{F}'_i and frictional forces \mathbf{f}_i proportional to the velocity, then the virial depends only on the \mathbf{F}'_i ; there is no contribution from the \mathbf{f}_i . Of course, the motion of the system must not be allowed to die down as a result of the frictional forces. Energy must constantly be pumped into the system to maintain the motion; otherwise *all* time averages would vanish as τ increases indefinitely (cf. Derivation 1.)

If the forces are derivable from a potential, then the theorem becomes

$$\bar{T} = \frac{1}{2} \overline{\sum_i \nabla V \cdot \mathbf{r}_i}, \quad (3.27)$$

and for a single particle moving under a central force it reduces to

$$\bar{T} = \frac{1}{2} \overline{\frac{\partial V}{\partial r} r}. \quad (3.28)$$

If V is a power-law function of r ,

$$V = ar^{n+1},$$

where the exponent is chosen so that the force law goes as r^n , then

$$\frac{\partial V}{\partial r} r = (n+1)V,$$

and Eq. (3.28) becomes

$$\bar{T} = \frac{n+1}{2} \bar{V}. \quad (3.29)$$

By an application of Euler's theorem for homogeneous functions (cf. p. 62), it is clear that Eq. (3.29) also holds whenever V is a homogeneous function in r of degree $n+1$. For the further special case of inverse-square law forces, n is -2 , and the virial theorem takes on a well-known form:

$$\bar{T} = -\frac{1}{2} \bar{V}. \quad (3.30)$$

3.5 ■ THE DIFFERENTIAL EQUATION FOR THE ORBIT, AND INTEGRABLE POWER-LAW POTENTIALS

In treating specific details of actual central force problems, a change in the orientation of our discussion is desirable. Hitherto solving a problem has meant finding r and θ as functions of time with E , l , etc., as constants of integration. But most often what we really seek is the equation of the orbit, i.e., the dependence of r upon θ , eliminating the parameter t . For central force problems, the elimination is particularly simple, since t occurs in the equations of motion only as a variable of differentiation. Indeed, one equation of motion, (3.8), simply provides a definite

relation between a differential change dt and the corresponding change $d\theta$:

$$l dt = mr^2 d\theta. \quad (3.31)$$

The corresponding relation between derivatives with respect to t and θ is

$$\frac{d}{dt} = \frac{l}{mr^2} \frac{d}{d\theta}. \quad (3.32)$$

These relations may be used to convert the equation of motion (3.12) or (3.16) to a differential equation for the orbit. A substitution into Eq. (3.12) gives a second-order differential equation, while a substitution into Eq. (3.17) gives a simpler first-order differential equation.

The substitution into Eq. (3.12) yields

$$\frac{1}{r^2} \frac{d}{d\theta} \left(\frac{1}{mr^2} \frac{dr}{d\theta} \right) - \frac{l^2}{mr^3} = f(r), \quad (3.33)$$

which upon substituting $u = 1/r$ and expressing the results in terms of the potential gives

$$\frac{d^2u}{d\theta^2} + u = -\frac{m}{l^2} \frac{d}{du} V \left(\frac{1}{u} \right). \quad (3.34)$$

The preceding equation is such that the resulting orbit is symmetric about two adjacent turning points. To prove this statement, note that if the orbit is symmetrical it should be possible to reflect it about the direction of the turning angle without producing any change. If the coordinates are chosen so that the turning point occurs for $\theta = 0$, then the reflection can be effected mathematically by substituting $-\theta$ for θ . The differential equation for the orbit, (3.34), is obviously invariant under such a substitution. Further the initial conditions, here

$$u = u(0), \quad \left(\frac{du}{d\theta} \right)_0 = 0, \quad \text{for } \theta = 0,$$

will likewise be unaffected. Hence, the orbit equation must be the same whether expressed in terms of θ or $-\theta$, which is the desired conclusion. *The orbit is therefore invariant under reflection about the apsidal vectors.* In effect, this means that the complete orbit can be traced if the portion of the orbit between any two turning points is known. Reflection of the given portion about one of the apsidal vectors produces a neighboring stretch of the orbit, and this process can be repeated indefinitely until the rest of the orbit is completed, as illustrated in Fig. 3.12.

For any particular force law, the actual equation of the orbit can be obtained by eliminating t from the solution (3.17) by means of (3.31), resulting in

$$d\theta = \frac{l dr}{mr^2 \sqrt{\frac{2}{m} \left(E - V(r) - \frac{l^2}{2mr^2} \right)}}. \quad (3.35)$$

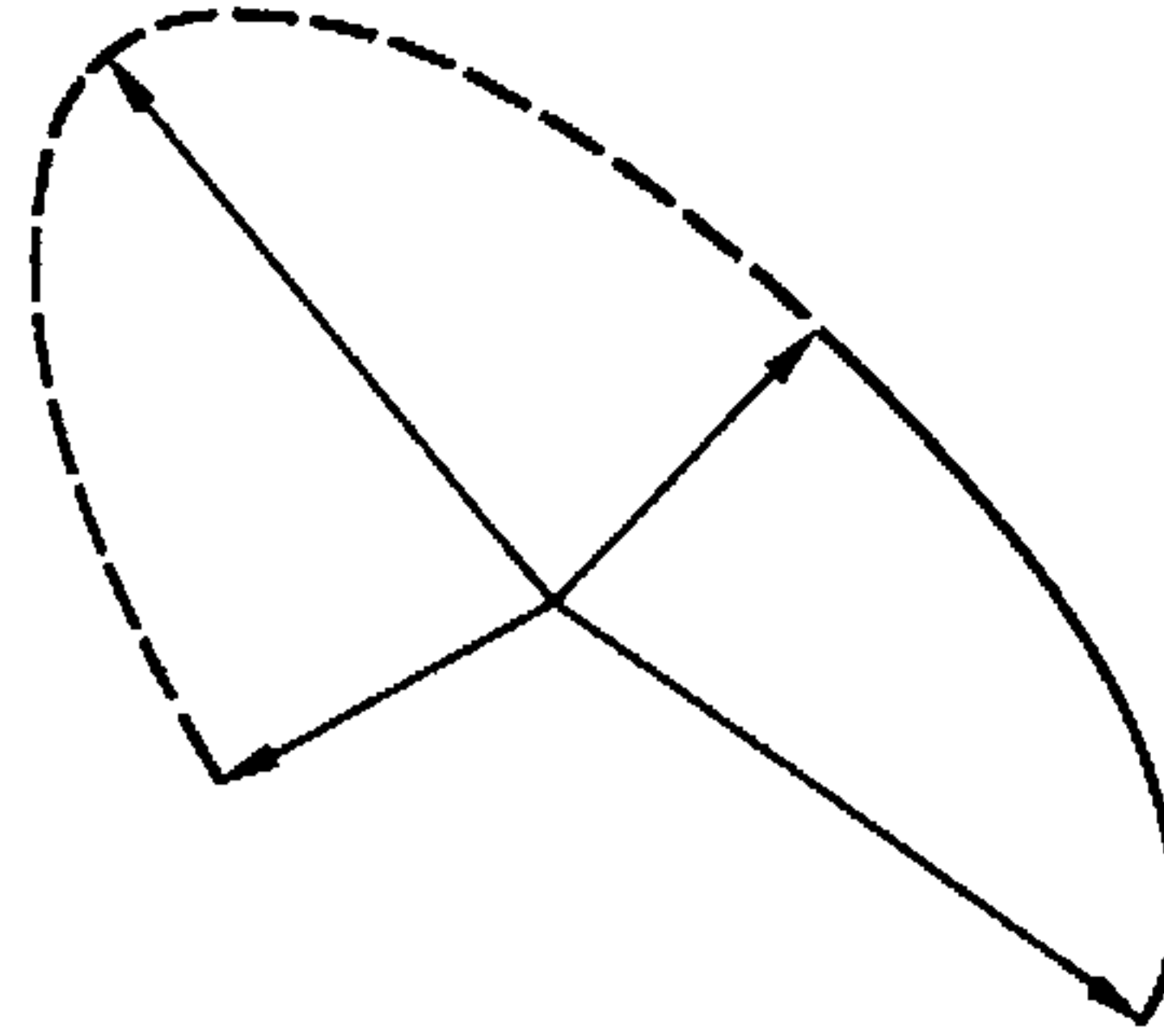

FIGURE 3.12 Extension of the orbit by reflection of a portion about the apsidal vectors.

With slight rearrangements, the integral of (3.35) is

$$\theta = \int_{r_0}^r \frac{dr}{r^2 \sqrt{\frac{2mE}{l^2} - \frac{2mV}{l^2} - \frac{1}{r^2}}} + \theta_0, \quad (3.36)$$

or, if the variable of integration is changed to $u = 1/r$,

$$\theta = \theta_0 - \int_{u_0}^u \frac{du}{\sqrt{\frac{2mE}{l^2} - \frac{2mV}{l^2} - u^2}}. \quad (3.37)$$

As in the case of the equation of motion, Eq. (3.37), while solving the problem formally, is not always a practicable solution, because the integral often cannot be expressed in terms of well-known functions. In fact, only certain types of force laws have been investigated. The most important are the power-law functions of r ,

$$V = ar^{n+1} \quad (3.38)$$

so that the force varies at the n th power of r .^{*} With this potential, (3.37) becomes

$$\theta = \theta_0 - \int_{u_0}^u \frac{du}{\sqrt{\frac{2mE}{l^2} - \frac{2ma}{l^2} u^{-n-1} - u^2}}. \quad (3.39)$$

This again is integrable in terms of simple functions only in certain cases. The particular power-law exponents for which the results can be expressed in terms of trigonometric functions are

$$n = 1, -2, -3.$$

^{*}The case $n = -1$ is to be excluded from the discussion. In the potential (3.38), it corresponds to a constant potential, i.e., no force at all. It is an equally anomalous case if the exponent is used in the force law directly, since a force varying as r^{-1} corresponds to a logarithmic potential, which is not a power law at all. A logarithmic potential is unusual for motion about a point, it is more characteristic of a *line* source. Further details of these cases are given in the second edition of this text.

The results of the integral for

$$n = 5, 3, 0, -4, -5, -7$$

can be expressed in terms of elliptic functions. These are all the possibilities for an integer exponent where the formal integrations are expressed in terms of simple well-known functions. Some fractional exponents can be shown to lead to elliptic functions, and many other exponents can be expressed in terms of the hypergeometric function. The trigonometric and elliptical functions are special cases of generalized hypergeometric function integrals. Equation (3.39) can of course be numerically integrated for any nonpathological potential, but this is beyond the scope of the text.

3.6 ■ CONDITIONS FOR CLOSED ORBITS (BERTRAND'S THEOREM)

We have not yet extracted all the information that can be obtained from the equivalent one-dimensional problem or from the orbit equation without explicitly solving for the motion. In particular, it is possible to derive a powerful and thought-provoking theorem on the types of attractive central forces that lead to *closed orbits*, i.e., orbits in which the particle eventually retraces its own footsteps.

Conditions have already been described for one kind of closed orbit, namely a circle about the center of force. For any given l , this will occur if the equivalent potential $V'(r)$ has a minimum or maximum at some distance r_0 and if the energy E is just equal to $V'(r_0)$. The requirement that V' have an extremum is equivalent to the vanishing of f' at r_0 , leading to the condition derived previously (cf. Section 3.3).

$$f(r_0) = -\frac{l^2}{mr_0^3}, \quad (3.40)$$

which says the force must be attractive for circular orbits to be possible. In addition, the energy of the particle must be given by

$$E = V(r_0) + \frac{l^2}{2mr_0^2}, \quad (3.41)$$

which, by Eq. (3.15), corresponds to the requirement that for a circular orbit \dot{r} is zero. Equations (3.40) and (3.41) are both elementary and familiar. Between them they imply that for any attractive central force it is possible to have a circular orbit at some arbitrary radius r_0 , provided the angular momentum l is given by Eq. (3.40) and the particle energy by Eq. (3.41).

The character of the circular orbit depends on whether the extremum of V' is a minimum, as in Fig. 3.8, or a maximum, as in Fig. 3.9. If the energy is slightly above that required for a circular orbit at the given value of l , then for a minimum in V' the motion, though no longer circular, will still be bounded. However, if

V' exhibits a maximum, then the slightest raising of E above the circular value, Eq. (3.34), results in motion that is unbounded, with the particle moving both through the center of force and out to infinity for the potential shown in Fig. 3.9. Borrowing the terminology from the case of static equilibrium, the circular orbit arising in Fig. 3.8 is said to be *stable*; that in Fig. 3.9 is *unstable*. The stability of the circular orbit is thus determined by the sign of the second derivative of V' at the radius of the circle, being stable for positive second derivative (V' concave up) and unstable for V' concave down. A stable orbit therefore occurs if

$$\frac{\partial^2 V'}{\partial r^2} \Big|_{r=r_0} = -\frac{\partial f}{\partial r} \Big|_{r=r_0} + \frac{3l^2}{mr_0^4} > 0. \quad (3.42)$$

Using Eq. (3.40), this condition can be written

$$\frac{\partial f}{\partial r} \Big|_{r=r_0} < -\frac{3f(r_0)}{r_0}, \quad (3.43)$$

or

$$\frac{d \ln f}{d \ln r} \Big|_{r=r_0} > -3 \quad (3.43')$$

where $f(r_0)/r_0$ is assumed to be negative and given by dividing Eq. (3.40) by r_0 . If the force behaves like a power law of r in the vicinity of the circular radius r_0 ,

$$f = -kr^n,$$

then the stability condition, Eq. (3.43), becomes

$$-knr^{n-1} < 3kr^{n-1}$$

or

$$n > -3, \quad (3.44)$$

where k is assumed to be positive. A power-law attractive potential varying more slowly than $1/r^2$ is thus capable of stable circular orbits for all values of r_0 .

If the circular orbit is stable, then a small increase in the particle energy above the value for a circular orbit results in only a slight variation of r about r_0 . It can be easily shown that for such small deviations from the circularity conditions, the particle executes a simple harmonic motion in $u (\equiv 1/r)$ about u_0 :

$$u = u_0 + a \cos \beta \theta. \quad (3.45)$$

Here a is an amplitude that depends upon the deviation of the energy from the value for circular orbits, and β is a quantity arising from a Taylor series expansion

of the force law $f(r)$ about the circular orbit radius r_0 . Direct substitution into the force law gives

$$\beta^2 = 3 + \frac{r}{f} \frac{df}{dr} \Big|_{r=r_0}. \quad (3.46)$$

As the radius vector of the particle sweeps completely around the plane, u goes through β cycles of its oscillation (cf. Fig. 3.13). If β is a rational number, the ratio of two integers, p/q , then after q revolutions of the radius vector the orbit would begin to retrace itself so that the orbit is *closed*.

At each r_0 such that the inequality in Eq. (3.43) is satisfied, it is possible to establish a stable circular orbit by giving the particle an initial energy and angular momentum prescribed by Eqs. (3.40) and (3.41). The question naturally arises as to what form the force law must take in order that the slightly perturbed orbit about any of these circular orbits should be closed. It is clear that under these conditions β must not only be a rational number, it must also be the *same* rational number at all distances that a circular orbit is possible. Otherwise, since β can take on only discrete values, the number of oscillatory periods would change discontinuously with r_0 , and indeed the orbits could not be closed at the discontinuity. With β^2 everywhere constant, the defining equation for β^2 , Eq. (3.46), becomes in effect a differential equation for the force law f in terms of the independent variable r_0 .

We can indeed consider Eq. (3.46) to be written in terms of r if we keep in mind that the equation is valid only over the ranges in r for which stable circular orbits are possible. A slight rearrangement of Eq. (3.46) leads to the equation

$$\frac{d \ln f}{d \ln r} = \beta^2 - 3, \quad (3.47)$$

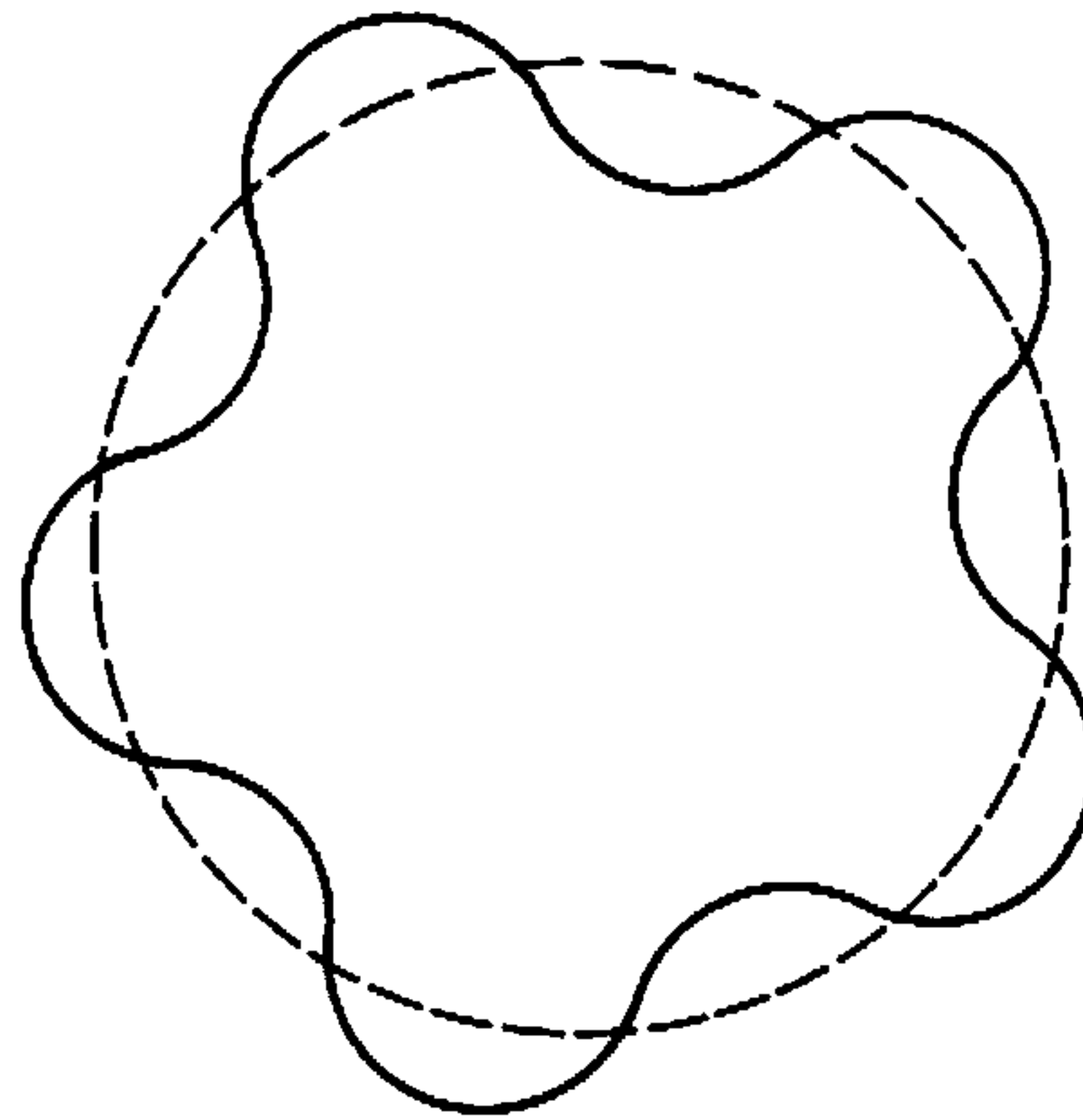

FIGURE 3.13 Orbit for motion in a central force deviating slightly from a circular orbit for $\beta = 5$.

which can be immediately integrated to give a force law:

$$f(r) = -\frac{k}{r^{3-\beta^2}}. \quad (3.48)$$

All force laws of this form, with β a rational number, lead to closed stable orbits for initial conditions that differ only *slightly* from conditions defining a circular orbit. Included within the possibilities allowed by Eq. (3.48) are some familiar forces such as the inverse-square law ($\beta \equiv 1$), but of course many other behaviors, such as $f = -kr^{-2/9}$ ($\beta = \frac{5}{3}$), are also permitted.

Suppose the initial conditions deviate more than slightly from the requirements for circular orbits; will these same force laws still give circular orbits? The question can be answered directly by keeping an additional term in the Taylor series expansion of the force law and solving the resultant orbit equation.

J. Bertrand solved this problem in 1873 and found that for more than first-order deviations from circularity, the orbits are closed only for $\beta^2 = 1$ and $\beta^2 = 4$. The first of these values of β^2 , by Eq. (3.48), leads to the familiar attractive inverse-square law; the second is an attractive force proportional to the radial distance—Hooke's law! These force laws, and only these, could possibly produce closed orbits for any arbitrary combination of l and E ($E < 0$), and in fact we know from direct solution of the orbit equation that they do. Hence, we have Bertrand's theorem: *The only central forces that result in closed orbits for all bound particles are the inverse-square law and Hooke's law.*

This is a remarkable result, well worth the tedious algebra required. It is a commonplace astronomical observation that bound celestial objects move in orbits that are in first approximation closed. For the most part, the small deviations from a closed orbit are traceable to perturbations such as the presence of other bodies. The prevalence of closed orbits holds true whether we consider only the solar system, or look to the many examples of true binary stars that have been observed. Now, Hooke's law is a most unrealistic force law to hold at all distances, for it implies a force increasing indefinitely to infinity. Thus, the existence of closed orbits for a wide range of initial conditions by itself leads to the conclusion that the gravitational force varies as the inverse-square of the distance.

We can phrase this conclusion in a slightly different manner, one that is of somewhat more significance in modern physics. The orbital motion in a plane can be looked on as compounded of two oscillatory motions, one in r and one in θ with the same period. The *character of orbits in a gravitational field fixes the form of the force law*. Later on we shall encounter other formulations of the relation between degeneracy and the nature of the potential.

3.7 ■ THE KEPLER PROBLEM: INVERSE-SQUARE LAW OF FORCE

The inverse-square law is the most important of all the central force laws, and it deserves detailed treatment. For this case, the force and potential can be written

as

$$f = -\frac{k}{r^2} \quad V = -\frac{k}{r}. \quad (3.49)$$

There are several ways to integrate the equation for the orbit, the simplest being to substitute (3.49) in the differential equation for the orbit (3.33). Another approach is to start with Eq. (3.39) with n set equal to -2 for the gravitational force

$$\theta = \theta' - \int \frac{du}{\sqrt{\frac{2mE}{l^2} + \frac{2mku}{l^2} - u^2}}, \quad (3.50)$$

where the integral is now taken as indefinite. The quantity θ' appearing in (3.50) is a constant of integration determined by the initial conditions and will not necessarily be the same as the initial angle θ_0 at time $t = 0$. The indefinite integral is of the standard form,

$$\int \frac{dx}{\sqrt{\alpha + \beta x + \gamma x^2}} = \frac{1}{\sqrt{-\gamma}} \arccos \frac{\beta + 2\gamma x}{\sqrt{q}}, \quad (3.51)$$

where

$$q = \beta^2 - 4\alpha\gamma.$$

To apply this to (3.50), we must set

$$\alpha = \frac{2mE}{l^2}, \quad \beta = \frac{2mk}{l^2} \quad \gamma = -1, \quad (3.52)$$

and the discriminant q is therefore

$$q = \left(\frac{2mk}{l^2}\right)^2 \left(1 + \frac{2El^2}{mk^2}\right). \quad (3.53)$$

With these substitutes, Eq. (3.50) becomes

$$\theta = \theta' - \arccos \frac{\frac{l^2 u}{mk} - 1}{\sqrt{1 + \frac{2El^2}{mk^2}}}. \quad (3.54)$$

Finally, by solving for $u, \equiv 1/r$, the equation of the orbit is found to be

$$\frac{1}{r} = \frac{mk}{l^2} \left(1 + \sqrt{1 + \frac{2El^2}{mk^2}} \cos(\theta - \theta')\right). \quad (3.55)$$

The constant of integration θ' can now be identified from Eq. (3.55) as one of the turning angles of the orbit. Note that only three of the four constants of integration appear in the orbit equation; this is always a characteristic property of the orbit. In

effect, the fourth constant locates the initial position of the particle on the orbit. If we are interested solely in the orbit equation, this information is clearly irrelevant and hence does not appear in the answer. Of course, the missing constant has to be supplied if we wish to complete the solution by finding r and θ as functions of time. Thus, if we choose to integrate the conservation theorem for angular momentum,

$$mr^2 d\theta = l dt,$$

by means of (3.55), we must additionally specify the initial angle θ_0 .

Now, the general equation of a conic with one focus at the origin is

$$\frac{1}{r} = C[1 + e \cos(\theta - \theta')], \quad (3.56)$$

where e is the eccentricity of the conic section. By comparison with Eq. (3.55), it follows that the orbit is always a conic section, with the eccentricity

$$e = \sqrt{1 + \frac{2El^2}{mk^2}}. \quad (3.57)$$

The nature of the orbit depends upon the magnitude of e according to the following scheme:

$e > 1,$	$E > 0:$	hyperbola,
$e = 1,$	$E = 0:$	parabola,
$e < 1,$	$E < 0:$	ellipse,
$e = 0,$	$E = -\frac{mk^2}{2l^2}:$	circle.

This classification agrees with the qualitative discussion of the orbits on the energy diagram of the equivalent one-dimensional potential V' . The condition for circular motion appears here in a somewhat different form, but it can easily be derived as a consequence of the previous conditions for circularity. For a circular orbit, T and V are constant in time, and from the virial theorem

$$E \equiv T + V = -\frac{V}{2} + V = \frac{V}{2}.$$

Hence

$$E = -\frac{k}{2r_0}. \quad (3.58)$$

But from Eq. (3.41), the statement of equilibrium between the central force and the "effective force," we can write

$$\frac{k}{r_0^2} = \frac{l^2}{mr_0^3},$$

or

$$r_0 = \frac{l^2}{mk}. \quad (3.59)$$

With this formula for the orbital radius, Eq. (3.58) becomes

$$E = -\frac{mk^2}{2l^2},$$

the above condition for circular motion.

In the case of elliptic orbits, it can be shown the major axis depends solely upon the energy, a theorem of considerable importance in the Bohr theory of the atom. The semimajor axis is one-half the sum of the two apsidal distances r_1 and r_2 (cf. Fig. 3.6). By definition, the radial velocity is zero at these points, and the conservation of energy implies that the apsidal distances are therefore the roots of the equation (cf. Eq. (3.15))

$$E - \frac{l^2}{2mr^2} + \frac{k}{r} = 0,$$

or

$$r^2 + \frac{k}{E}r - \frac{l^2}{2mE} = 0. \quad (3.60)$$

Now, the coefficient of the linear term in a quadratic equation is the negative of the sum of the roots. Hence, the semimajor axis is given by

$$a = \frac{r_1 + r_2}{2} = -\frac{k}{2E}. \quad (3.61)$$

Note that in the circular limit, Eq. (3.61) agrees with Eq. (3.58). In terms of the semimajor axis, the eccentricity of the ellipse can be written

$$e = \sqrt{1 - \frac{l^2}{mka}}, \quad (3.62)$$

(a relation we will have use for in a later chapter). Further, from Eq. (3.62) we have the expression

$$\frac{l^2}{mk} = a(1 - e^2), \quad (3.63)$$

in terms of which the elliptical orbit equation (3.55) can be written

$$r = \frac{a(1 - e^2)}{1 + e \cos(\theta - \theta')}. \quad (3.64)$$

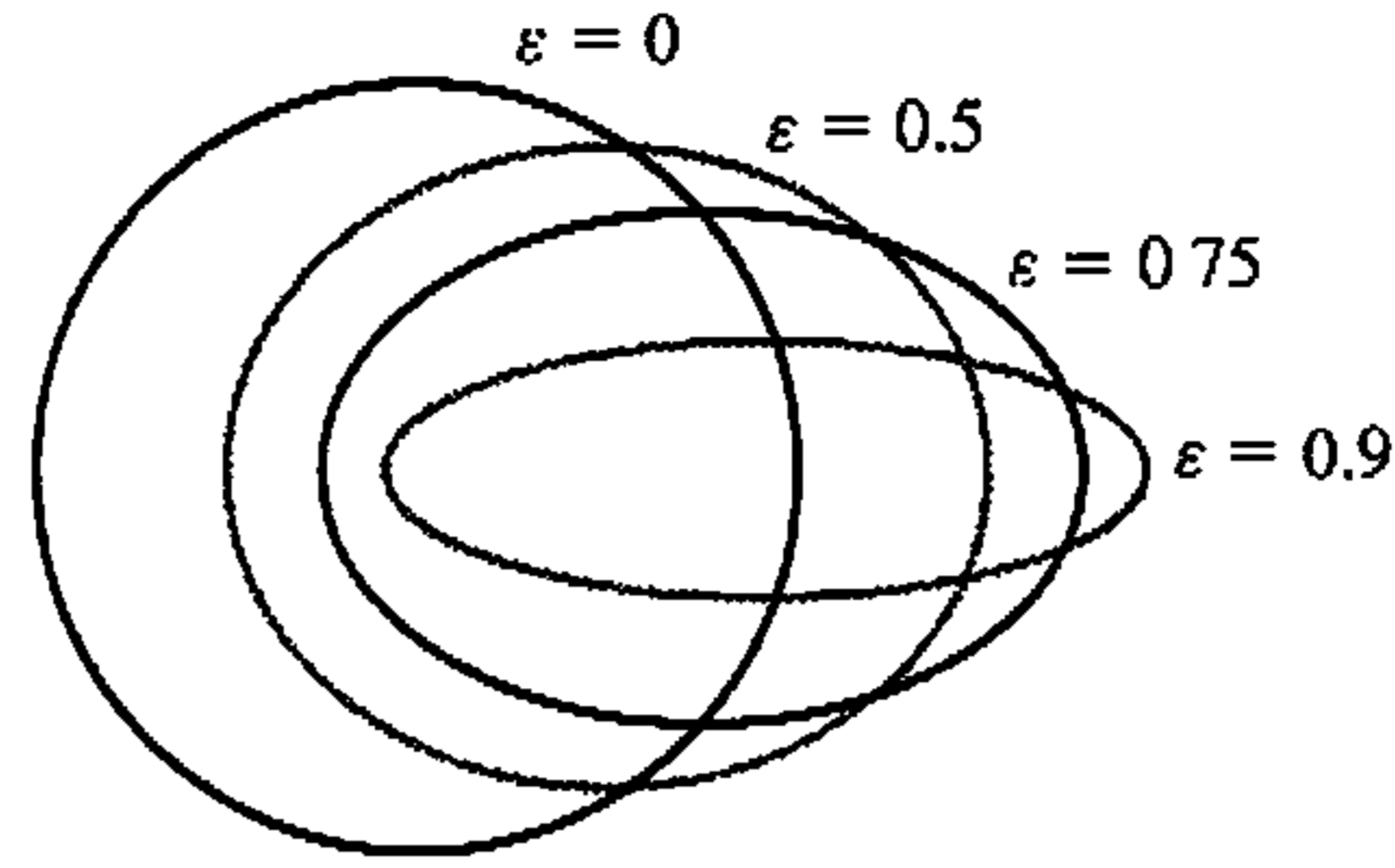

FIGURE 3.14 Ellipses with the same major axes and eccentricities from 0.0 to 0.9.

From Eq. (3.64), it follows that the two apsidal distances (which occur when $\theta - \theta'$ is 0 and π , respectively) are equal to $a(1 - e)$ and $a(1 + e)$, as is to be expected from the properties of an ellipse.

Figure 3.14 shows sketches of four elliptical orbits with the same major axis a , and hence the same energy, but with eccentricities $\varepsilon = 0.0, 0.5, 0.75$, and 0.9 . Figure 3.15 shows how r_1 and r_2 depend on the eccentricity ε .

The velocity vector \mathbf{v}_{\parallel} of the particle along the elliptical path can be resolved into a radial component $v_r = \dot{r} = p_r/m$ plus an angular component $v_{\theta} = r\dot{\theta} = l/mr$

$$\mathbf{v}_{\parallel} = v_r \hat{\mathbf{r}} + v_{\theta} \hat{\boldsymbol{\theta}}.$$

The radial component with the magnitude $v_r = \varepsilon v_0 \sin \theta / (1 - \varepsilon^2)$ vanishes at the two apsidal distances, while v_{θ} attains its maximum value at perihelion and its minimum at aphelion. Table 3.1 lists angular velocity values at the apsidal distances for several eccentricities. Figure 3.16 presents plots of the radial velocity component v_r versus the radius vector \mathbf{r} for the half cycle when v_r points outward, i.e., it is positive. During the remaining half cycle v_r is nega-

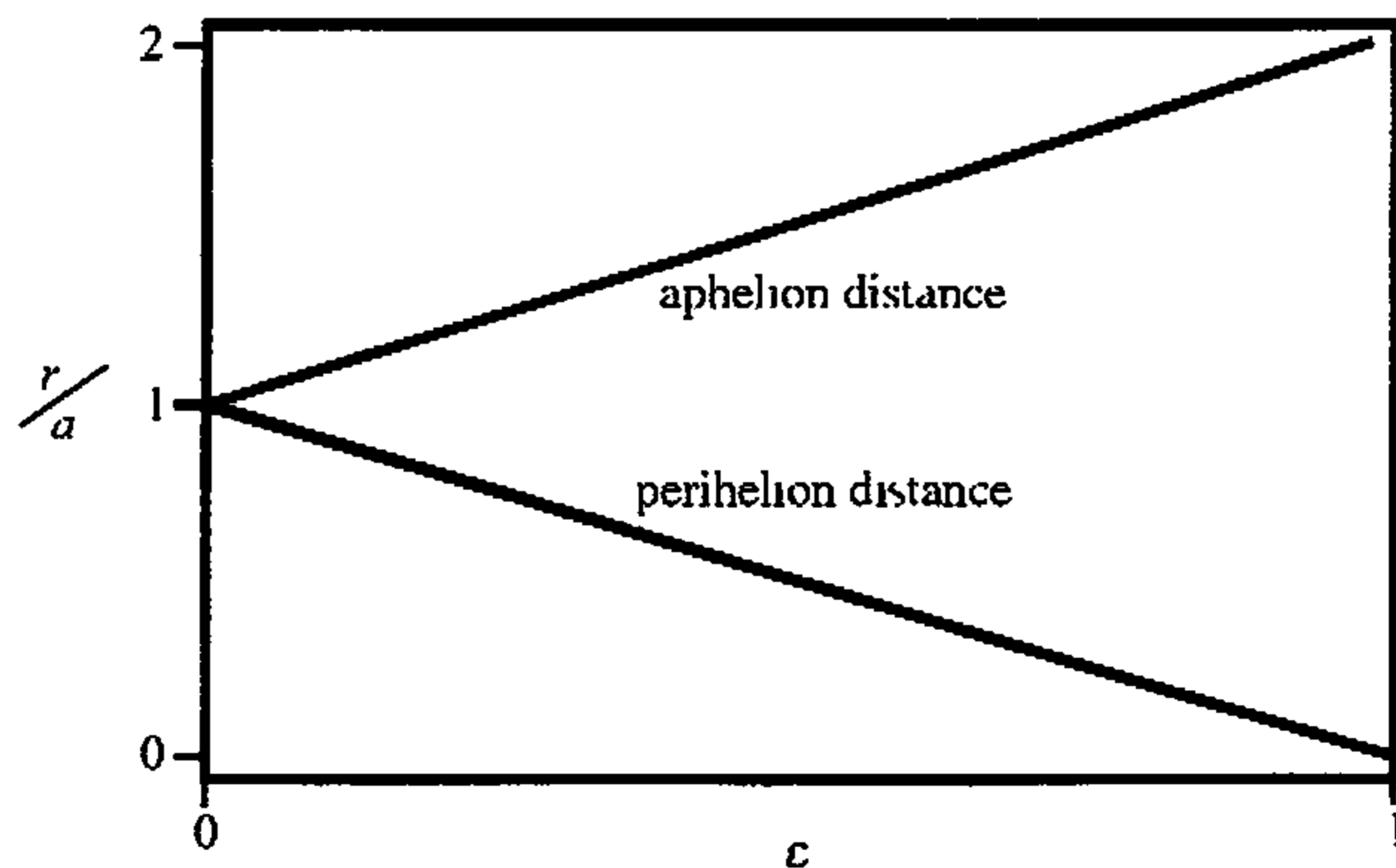

FIGURE 3.15 Dependence of normalized apsidal distances r_1 (lower line) and r_2 (upper line) on the eccentricity ε .

TABLE 3.1 Normalized angular speeds $\dot{\theta}$ and $v_{\theta} = r\dot{\theta}$ at perihelion (r_1) and aphelion (r_2), respectively, in Keplerian orbits of various eccentricities (ε). The normalized radial distances at perihelion and aphelion are listed in columns 2 and 3, respectively. The normalization is with respect to motion in a circle with the radius a and the angular momentum $l = mav_0 = ma^2\dot{\theta}_0$.

Eccentricity	Perihelion	Aphelion	Angular speed		Linear angular speed	
	r_1/a	r_2/a	$\dot{\theta}_1/\dot{\theta}_0$	$\dot{\theta}_2/\dot{\theta}_0$	$v_{\theta 1}/v_0$	$v_{\theta 2}/v_0$
ε	$1 - \varepsilon$	$1 + \varepsilon$	$\frac{1}{(1 - \varepsilon)^2}$	$\frac{1}{(1 + \varepsilon)^2}$	$\frac{1}{1 - \varepsilon}$	$\frac{1}{1 + \varepsilon}$
0	1	1	1	1	1	1
0.1	0.9	1.1	1.234	0.826	1.111	0.909
0.3	0.7	1.3	2.041	0.592	1.429	0.769
0.5	0.5	1.5	4.000	0.444	2.000	0.667
0.7	0.3	1.7	11.111	0.346	3.333	0.588
0.9	0.1	1.9	100.000	0.277	10.000	0.526

tive, and the plot of Fig. 3.16 repeats itself for the negative range below $v_r = 0$ (not shown). Figure 3.17 shows analogous plots of the angular velocity component v_{θ} versus the angle θ . In these plots and in the table the velocities are normalized relative to the quantities v_0 and $\dot{\theta}_0$ obtained from the expressions $l = mr^2\dot{\theta} = mrv_{\theta} = ma^2\dot{\theta}_0 = mav_0$ for the conservation of angular momentum in the elliptic orbits of semimajor axis a , and in the circle of radius a .

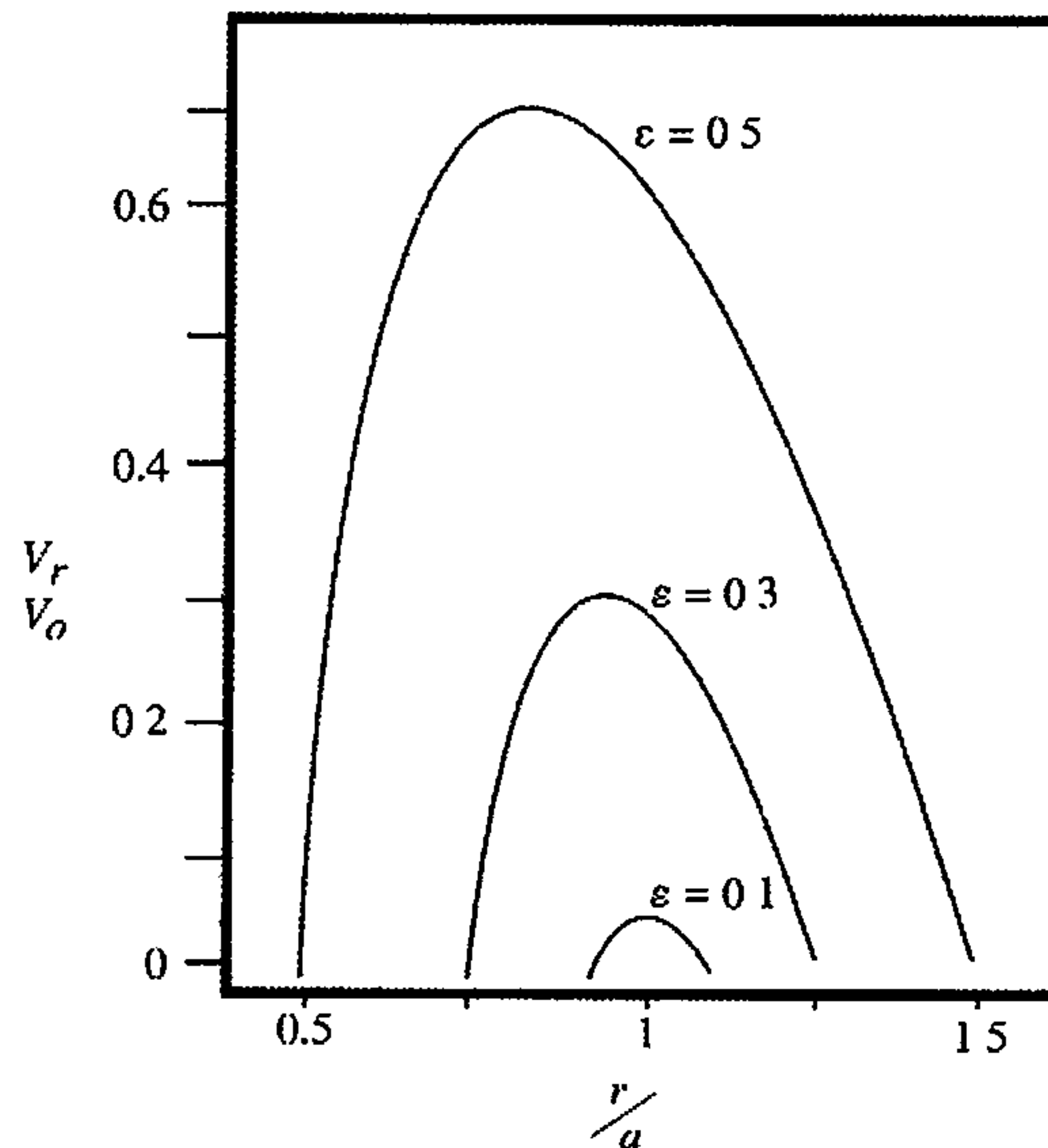

FIGURE 3.16 Normalized radial velocity, v_r , versus r for three values of the eccentricity ε .

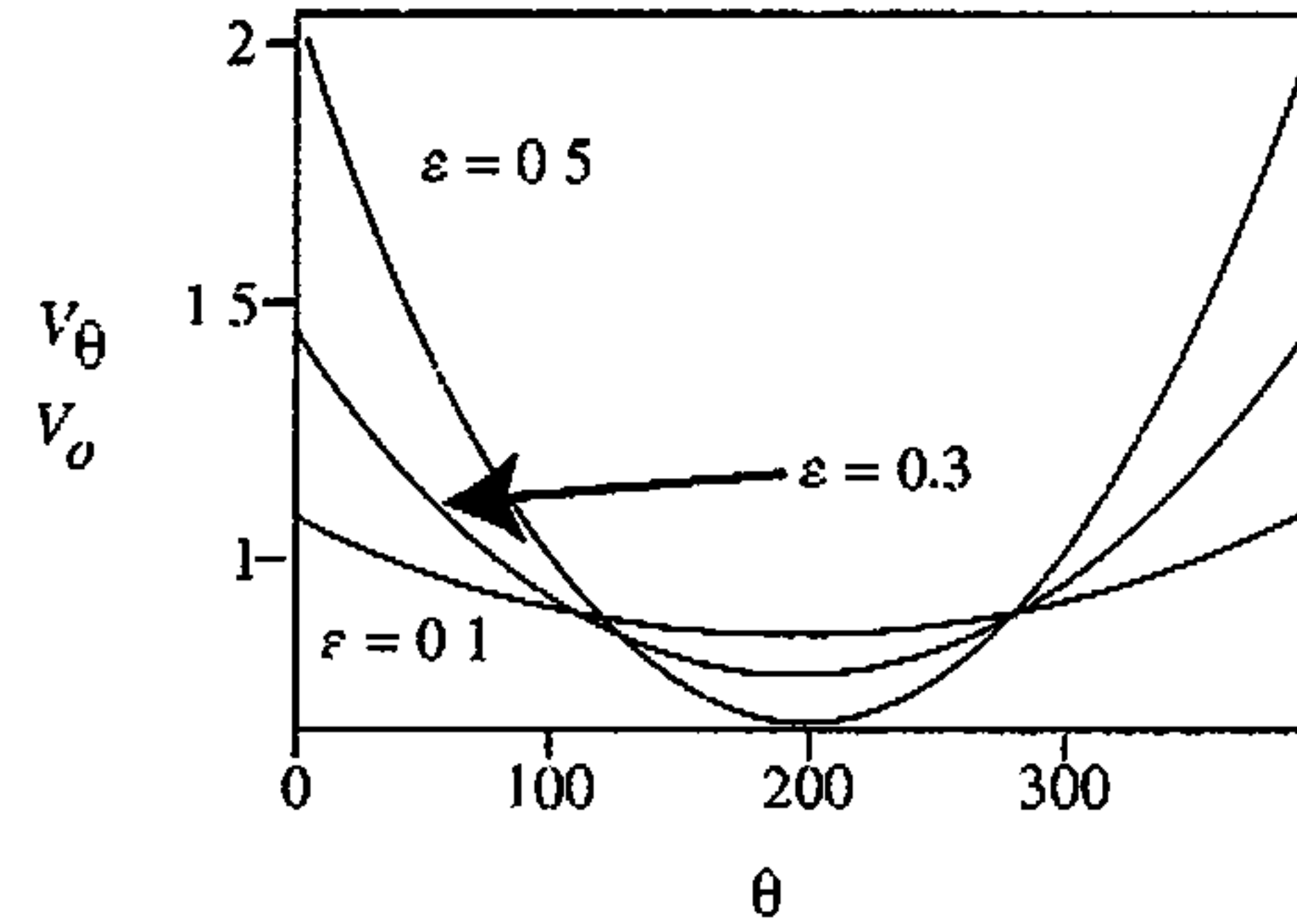

FIGURE 3.17 Normalized orbital velocity, v_θ , versus θ for three values of the eccentricity ε .

3.8 ■ THE MOTION IN TIME IN THE KEPLER PROBLEM

The orbital equation for motion in a central inverse-square force law can thus be solved in a fairly straightforward manner with results that can be stated in simple closed expressions. Describing the motion of the particle in time as it traverses the orbit is however a much more involved matter. In principle, the relation between the radial distance of the particle r and the time (relative to some starting point) is given by Eq. (3.18), which here takes on the form

$$t = \sqrt{\frac{m}{2}} \int_{r_0}^r \frac{dr}{\sqrt{\frac{k}{r} - \frac{l^2}{2mr^2} + E}}. \quad (3.65)$$

Similarly, the polar angle θ and the time are connected through the conservation of angular momentum,

$$dt = \frac{mr^2}{l} d\theta,$$

which combined with the orbit equation (3.51) leads to

$$t = \frac{l^3}{mk^2} \int_{\theta_0}^{\theta} \frac{d\theta}{[1 + e \cos(\theta - \theta')]^2}. \quad (3.66)$$

Either of these integrals can be carried out in terms of elementary functions. However, the relations are very complex, and their inversions to give r or θ as functions of t pose formidable problems, especially when one wants the high precision needed for astronomical observations.

To illustrate some of these involvements, let us consider the situation for parabolic motion ($e = 1$), where the integrations can be most simply carried out. It is customary to measure the plane polar angle from the radius vector at

the point of closest approach—a point most usually designated as the *perihelion*.^{*} This convention corresponds to setting θ' in the orbit equation (3.51) equal to zero. Correspondingly, time is measured from the moment, T , of perihelion passage. Using the trigonometric identity

$$1 + \cos \theta = 2 \cos^2 \frac{\theta}{2},$$

Eq. (3.66) then reduces for parabolic motion to the form

$$t = \frac{l^3}{4mk^2} \int_0^\theta \sec^4 \frac{\theta}{2} d\theta.$$

The integration is easily performed by a change of variable to $x = \tan(\theta/2)$, leading to the integral

$$t = \frac{l^3}{2mk^2} \int_0^{\tan(\theta/2)} (1 + x^2) dx,$$

or

$$t = \frac{l^3}{2mk^2} \left(\tan \frac{\theta}{2} + \frac{1}{3} \tan^3 \frac{\theta}{2} \right). \quad (3.67)$$

In this equation, $-\pi < \theta < \pi$, where for $t \rightarrow -\infty$ the particle starts approaching from infinitely far away located at $\theta = -\pi$. The time $t = 0$ corresponds to $\theta = 0$, where the particle is at perihelion. Finally $t \rightarrow +\infty$ corresponds to $\theta \rightarrow \pi$ as the particle moves infinitely far away. This is a straightforward relation for t as a function of θ ; inversion to obtain θ at a given time requires solving a cubic equation for $\tan(\theta/2)$, then finding the corresponding arctan. The radial distance at a given time is given through the orbital equation.

For elliptical motion, Eq. (3.65) is most conveniently integrated through an auxiliary variable ψ , denoted as the *eccentric anomaly*,^{*} and defined by the relation

$$r = a(1 - e \cos \psi). \quad (3.68)$$

By comparison with the orbit equation, (3.64), it is clear that ψ also covers the interval 0 to 2π as θ goes through a complete revolution, and that the perihelion occurs at $\psi = 0$ (where $\theta = 0$ by convention) and the aphelion at $\psi = \pi = \theta$.

^{*}Literally, the term should be restricted to orbits around the Sun, while the more general term should be *periapsis*. However, it has become customary to use perihelion no matter where the center of force is. Even for space craft orbiting the Moon, official descriptions of the orbital parameters refer to perihelion where pericyynthion would be the pedantic term.

^{*}Medieval astronomers expected the angular motion to be constant. The angle calculated by multiplying this average angular velocity ($2\pi/\text{period}$) by the time since the last perihelion passage was called the mean anomaly. From the mean anomaly the eccentric anomaly could be calculated and then used to calculate the true anomaly. The angle θ is called the true anomaly just as it was in medieval astronomy.

Expressing E and ℓ in terms of a , e , and k , Eq. (3.65) can be rewritten for elliptic motion as

$$t = -\sqrt{\frac{m}{2k}} \int_{r_0}^r \frac{r dr}{\sqrt{r - \frac{r^2}{2a} - \frac{a(1-e^2)}{2}}}, \quad (3.69)$$

where, by the convention on the starting time, r_0 is the perihelion distance. Substitution of r in terms of ψ from Eq. (3.68) reduces this integral, after some algebra, to the simple form

$$t = \sqrt{\frac{ma^3}{k}} \int_0^\psi (1 - e \cos \psi) d\psi. \quad (3.70)$$

First, we may note that Eq. (3.70) provides an expression for the period, τ , of elliptical motion, if the integral is carried over the full range in ψ of 2π :

$$\tau = 2\pi a^{3/2} \sqrt{\frac{m}{k}}. \quad (3.71)$$

This important result can also be obtained directly from the properties of an ellipse. From the conservation of angular momentum, the areal velocity is constant and is given by

$$\frac{dA}{dt} = \frac{1}{2} r^2 \dot{\theta} = \frac{l}{2m}. \quad (3.72)$$

The area of the orbit, A , is to be found by integrating (3.72) over a complete period τ :

$$\int_0^\tau \frac{dA}{dt} dt = A = \frac{l\tau}{2m}.$$

Now, the area of an ellipse is

$$A = \pi ab,$$

where, by the definition of eccentricity, the semiminor axis b is related to a according to the formula

$$b = a\sqrt{1 - e^2}.$$

By (3.62), the semiminor axis can also be written as

$$b = a^{1/2} \sqrt{\frac{l^2}{mk}},$$

and the period is therefore

$$\tau = \frac{2m}{l} \pi a^{3/2} \sqrt{\frac{l^2}{mk}} = 2\pi a^{3/2} \sqrt{\frac{m}{k}},$$

as was found previously. Equation (3.71) states that, other things being equal, the square of the period is proportional to the cube of the major axis, and this conclusion is often referred to as the third of Kepler's laws.* Actually, Kepler was concerned with the specific problem of planetary motion in the gravitational field of the Sun. A more precise statement of this third law would therefore be: *The square of the periods of the various planets are proportional to the cube of their major axes.* In this form, the law is only approximately true. Recall that the motion of a planet about the Sun is a two-body problem and m in (3.71) must be replaced by the reduced mass: (cf. Eq. (3.4))

$$\mu = \frac{m_1 m_2}{m_1 + m_2},$$

where m_1 may be taken as referring to the planet and m_2 to the Sun. Further, the gravitational law of attraction is

$$f = -G \frac{m_1 m_2}{r^2},$$

so that the constant k is

$$k = G m_1 m_2. \quad (3.73)$$

Under these conditions, (3.71) becomes

$$\tau = \frac{2\pi a^{3/2}}{\sqrt{G(m_1 + m_2)}} \approx \frac{2\pi a^{3/2}}{\sqrt{G m_2}}, \quad (3.74)$$

if we neglect the mass of the planet compared to the Sun. It is the approximate version of Eq. (3.74) that is Kepler's third law, for it states that τ is proportional to $a^{3/2}$, with the same constant of proportionality for all planets. However, the planetary mass m_1 is not always completely negligible compared to the Sun's; for example, Jupiter has a mass of about 0.1% of the mass of the Sun. On the other hand, Kepler's third law is rigorously true for the electron orbits in the Bohr atom, since μ and k are then the same for all orbits in a given atom.

To return to the general problem of the position in time for an elliptic orbit, we may rewrite Eq. (3.70) slightly by introducing the frequency of revolution ω as

*Kepler's three laws of planetary motion, published around 1610, were the result of his pioneering analysis of planetary observations and laid the groundwork for Newton's great advances. The second law, the conservation of areal velocity, is a general theorem for central force motion, as has been noted previously. However, the first—that the planets move in elliptical orbits about the Sun at one focus—and the third are restricted specifically to the inverse-square law of force.

$$\omega = \frac{2\pi}{\tau} = \sqrt{\frac{k}{ma^3}}. \quad (3.75)$$

The integration in Eq. (3.70) is of course easily performed, resulting in the relation

$$\omega t = \psi - e \sin \psi, \quad (3.76)$$

known as *Kepler's equation*. The quantity ωt goes through the range 0 to 2π , along with ψ and θ , in the course of a complete orbital revolution and is therefore also denoted as an anomaly, specifically the *mean anomaly*.

To find the position in orbit at a given time t , Kepler's equation, (3.76), would first be inverted to obtain the corresponding eccentric anomaly ψ . Equation (3.68) then yields the radial distance, while the polar angle θ can be expressed in terms of ψ by comparing the defining equation (3.68) with the orbit equation (3.64):

$$1 + e \cos \theta = \frac{1 - e^2}{1 - e \cos \psi}.$$

With a little algebraic manipulation, this can be simplified, to

$$\cos \theta = \frac{\cos \psi - e}{1 - e \cos \psi}. \quad (3.77)$$

By successively adding and subtracting both sides of Eq. (3.77) from unity and taking the ratio of the resulting two equations, we are led to the alternative form

$$\tan \frac{\theta}{2} = \sqrt{\frac{1+e}{1-e}} \tan \frac{\psi}{2}. \quad (3.78)$$

Either Eq. (3.77) or (3.78) thus provides θ , once ψ is known. The solution of the transcendental Kepler's equation (3.76) to give the value of ψ corresponding to a given time is a problem that has attracted the attention of many famous mathematicians ever since Kepler posed the question early in the seventeenth century. Newton, for example, contributed what today would be called an analog solution. Indeed, it can be claimed that the practical need to solve Kepler's equation to accuracies of a second of arc over the whole range of eccentricity fathered many of the developments in numerical mathematics in the eighteenth and nineteenth centuries. A few of the more than 100 methods of solution developed in the pre-computer era are considered in the exercises to this chapter.

3.9 ■ THE LAPLACE–RUNGE–LENZ VECTOR

The Kepler problem is also distinguished by the existence of an additional conserved vector besides the angular momentum. For a general central force, New-

ton's second law of motion can be written vectorially as

$$\dot{\mathbf{p}} = f(r) \frac{\mathbf{r}}{r}. \quad (3.79)$$

The cross product of $\dot{\mathbf{p}}$ with the constant angular momentum vector \mathbf{L} therefore can be expanded as

$$\begin{aligned} \dot{\mathbf{p}} \times \mathbf{L} &= \frac{mf(r)}{r} [\mathbf{r} \times (\mathbf{r} \times \dot{\mathbf{r}})] \\ &= \frac{mf(r)}{r} [\mathbf{r}(\mathbf{r} \cdot \dot{\mathbf{r}}) - r^2 \dot{\mathbf{r}}]. \end{aligned} \quad (3.80)$$

Equation (3.80) can be further simplified by noting that

$$\mathbf{r} \cdot \dot{\mathbf{r}} = \frac{1}{2} \frac{d}{dt} (\mathbf{r} \cdot \mathbf{r}) = r\dot{r}$$

(or, in less formal terms, the component of the velocity in the radial direction is \dot{r}). As \mathbf{L} is constant, Eq. (3.80) can then be rewritten, after a little manipulation, as

$$\frac{d}{dt} (\mathbf{p} \times \mathbf{L}) = -mf(r)r^2 \left(\frac{\dot{\mathbf{r}}}{r} - \frac{\mathbf{r}\dot{r}}{r^2} \right).$$

or

$$\frac{d}{dt} (\mathbf{p} \times \mathbf{L}) = -mf(r)r^2 \frac{d}{dt} \left(\frac{\mathbf{r}}{r} \right). \quad (3.81)$$

Without specifying the form of $f(r)$, we can go no further. But Eq. (3.81) can be immediately integrated if $f(r)$ is inversely proportional to r^2 —the Kepler problem. Writing $f(r)$ in the form prescribed by Eq. (3.49), Eq. (3.81) then becomes

$$\frac{d}{dt} (\mathbf{p} \times \mathbf{L}) = \frac{d}{dt} \left(\frac{mkr}{r} \right),$$

which says that for the Kepler problem there exists a *conserved vector* \mathbf{A} defined by

$$\mathbf{A} = \mathbf{p} \times \mathbf{L} - mk \frac{\mathbf{r}}{r}. \quad (3.82)$$

The relationships between the three vectors in Eq. (3.82) and the conservation of \mathbf{A} are illustrated in Fig. 3.18, which shows the three vectors at different positions in the orbit. In recent times, the vector \mathbf{A} has become known amongst physicists as the Runge–Lenz vector, but priority belongs to Laplace.

From the definition of \mathbf{A} , we can easily see that

$$\mathbf{A} \cdot \mathbf{L} = 0, \quad (3.83)$$

since \mathbf{L} is perpendicular to $\mathbf{p} \times \mathbf{L}$ and \mathbf{r} is perpendicular to $\mathbf{L} = \mathbf{r} \times \mathbf{p}$. It follows from this orthogonality of \mathbf{A} to \mathbf{L} that \mathbf{A} must be some fixed vector in the plane of

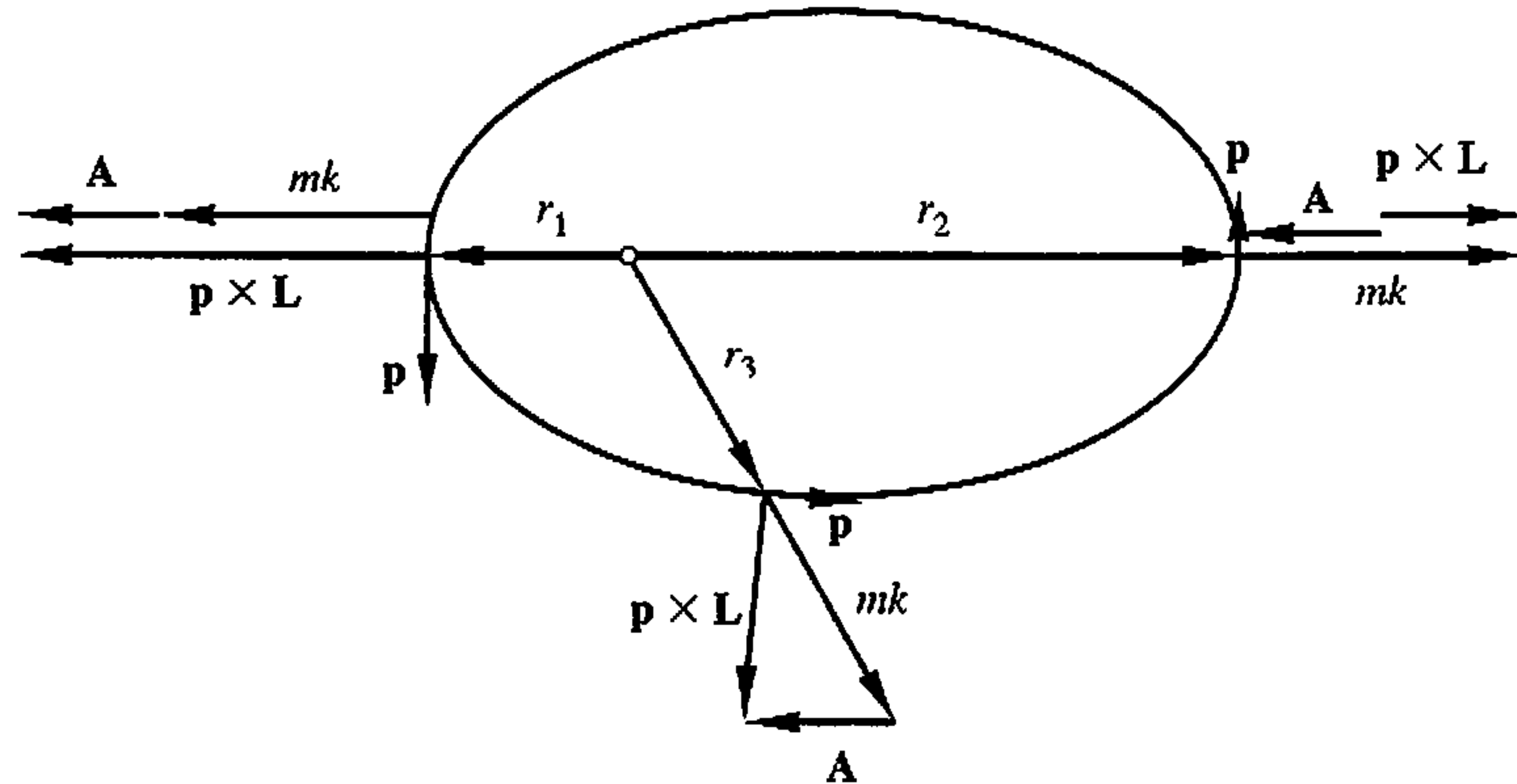

FIGURE 3.18 The vectors \mathbf{p} , \mathbf{L} , and \mathbf{A} at three positions in a Keplerian orbit. At perihelion (extreme left) $|\mathbf{p} \times \mathbf{L}| = mk(1+e)$ and at aphelion (extreme right) $|\mathbf{p} \times \mathbf{L}| = mk(1-e)$. The vector \mathbf{A} always points in the same direction with a magnitude mke .

the orbit. If θ is used to denote the angle between \mathbf{r} and the fixed direction of \mathbf{A} , then the dot product of \mathbf{r} and \mathbf{A} is given by

$$\mathbf{A} \cdot \mathbf{r} = Ar \cos \theta = \mathbf{r} \cdot (\mathbf{p} \times \mathbf{L}) - mkr. \quad (3.84)$$

Now, by permutation of the terms in the triple dot product, we have

$$\mathbf{r} \cdot (\mathbf{p} \times \mathbf{L}) = \mathbf{L} \cdot (\mathbf{r} \times \mathbf{p}) = l^2,$$

so that Eq. (3.84) becomes

$$Ar \cos \theta = l^2 - mkr,$$

or

$$\frac{l}{r} = \frac{mk}{l^2} \left(1 + \frac{A}{mk} \cos \theta \right). \quad (3.85)$$

The Laplace–Runge–Lenz vector thus provides still another way of deriving the orbit equation for the Kepler problem! Comparing Eq. (3.85) with the orbit equation in the form of Eq. (3.55) shows that \mathbf{A} is in the direction of the radius vector to the perihelion point on the orbit, and has a magnitude

$$A = mke. \quad (3.86)$$

For the Kepler problem we have thus identified two vector constants of the motion \mathbf{L} and \mathbf{A} , and a scalar E . Since a vector must have all three independent components, this corresponds to seven conserved quantities in all. Now, a system such as this with three degrees of freedom has six independent constants of the motion, corresponding, say to the three components of both the initial position

and the initial velocity of the particle. Further, the constants of the motion we have found are all algebraic functions of \mathbf{r} and \mathbf{p} that describe the orbit as a whole (orientation in space, eccentricity, etc.); none of these seven conserved quantities relate to where the particle is located in the orbit at the initial time. Since one constant of the motion must relate to this information, say in the form of T , the time of the perihelion passage, there can be only five independent constants of the motion describing the size, shape, and orientation of the orbit. We can therefore conclude that not all of the quantities making up \mathbf{L} , \mathbf{A} , and E can be independent; there must in fact be two relations connecting these quantities. One such relation has already been obtained as the orthogonality of \mathbf{A} and \mathbf{L} , Eq. (3.83). The other follows from Eq. (3.86) when the eccentricity is expressed in terms of E and l from Eq. (3.57), leading to

$$A^2 = m^2 k^2 + 2mEl^2, \quad (3.87)$$

thus confirming that there are only five *independent* constants out of the seven.

The angular momentum vector and the energy alone contain only four independent constants of the motion: The Laplace–Runge–Lenz vector thus adds one more. It is natural to ask why there should not exist for any general central force law some conserved quantity that together with \mathbf{L} and E serves to define the orbit in a manner similar to the Laplace–Runge–Lenz vector for the special case of the Kepler problem. The answer seems to be that such conserved quantities can in fact be constructed, but that they are in general rather peculiar functions of the motion. The constants of the motion relating to the orbit between them define the orbit, i.e., lead to the orbit equation giving r as a function of θ . We have seen that in general orbits for central force motion are not closed; the arguments of Section 3.6 show that closed orbits imply rather stringent conditions on the form of the force law. It is a property of nonclosed orbits that the curve will eventually pass through any arbitrary (r, θ) point that lies between the bounds of the turning points of r . Intuitively this can be seen from the nonclosed nature of the orbit; as θ goes around a full cycle, the particle must never retrace its footsteps on any previous orbit. Thus, the orbit equation is such that r is a multivalued function of θ (modulo 2π); in fact, it is an *infinite-valued function* of θ . The corresponding conserved quantity additional to \mathbf{L} and E defining the orbit must similarly involve an infinite-valued function of the particle motion. Suppose the r variable is periodic with angular frequency ω_r and the angular coordinate θ is periodic with angular frequency ω_θ . If these two frequencies have a ratio (ω_r/ω_θ) that is an integer or integer fraction, periods are said to be *commensurate*. Commensurate orbits are closed with the orbiting mass continually retracing its path. When $\omega_\theta > \omega_r$ the orbit will spiral about the origin as the distance varies between the apsidal (maximum and minimum) values, closing only if the frequencies are commensurate. If, as in the Kepler problem, $\omega_r = \omega_\theta$, the periods are said to be *degenerate*. If the orbits are degenerate there exists an additional conserved quantity that is an algebraic function of \mathbf{r} and \mathbf{p} , such as the Runge–Lenz vector.

From these arguments we would expect a simple analog of such a vector to exist for the case of a Hooke's law force, where, as we have seen, the orbits are

also degenerate. This is indeed the case, except that the natural way to formulate the constant of the motion leads not to a vector but to a tensor of the second rank (cf. Section 7.5). Thus, the existence of an additional constant or integral of the motion, beyond E and L , that is a simple algebraic function of the motion is sufficient to indicate that the motion is degenerate and the bounded orbits are closed.

3.10 ■ SCATTERING IN A CENTRAL FORCE FIELD

Historically, the interest in central forces arose out of the astronomical problems of planetary motion. There is no reason, however, why central force motion must be thought of only in terms of such problems; mention has already been made of the orbits in the Bohr atom. Another field that can be investigated in terms of classical mechanics is the *scattering* of particles by central force fields. Of course, if the particles are on the atomic scale, it must be expected that the specific results of a classical treatment will often be incorrect physically, for quantum effects are usually large in such regions. Nevertheless, many classical predictions remain valid to a good approximation. More important, the procedures for *describing* scattering phenomena are the same whether the mechanics is classical or quantum; we can learn to speak the language equally as well on the basis of classical physics.

In its one-body formulation, the scattering problem is concerned with the scattering of particles by a *center of force*. We consider a uniform beam of particles—whether electrons, or α -particles, or planets is irrelevant—all of the same mass and energy incident upon a center of force. It will be assumed that the force falls off to zero for very large distances. The incident beam is characterized by specifying its *intensity* I (also called flux density), which gives the number of particles crossing unit area normal to the beam in unit time. As a particle approaches the center of force, it will be either attracted or repelled, and its orbit will deviate from the incident straight-line trajectory. After passing the center of force, the force acting on the particle will eventually diminish so that the orbit once again approaches a straight line. In general, the final direction of motion is not the same as the incident direction, and the particle is said to be scattered. The *cross section for scattering in a given direction*, $\sigma(\Omega)$, is defined by

$$\sigma(\Omega) d\Omega = \frac{\text{number of particles scattered into solid angle } d\Omega \text{ per unit time}}{\text{incident intensity}}, \quad (3.88)$$

where $d\Omega$ is an element of solid angle in the direction Ω . Often $\sigma(\Omega)$ is also designated as the *differential scattering cross section*. With central forces there must be complete symmetry around the axis of the incident beam; hence the element of solid angle can be written

$$d\Omega = 2\pi \sin \Theta d\Theta, \quad (3.89)$$

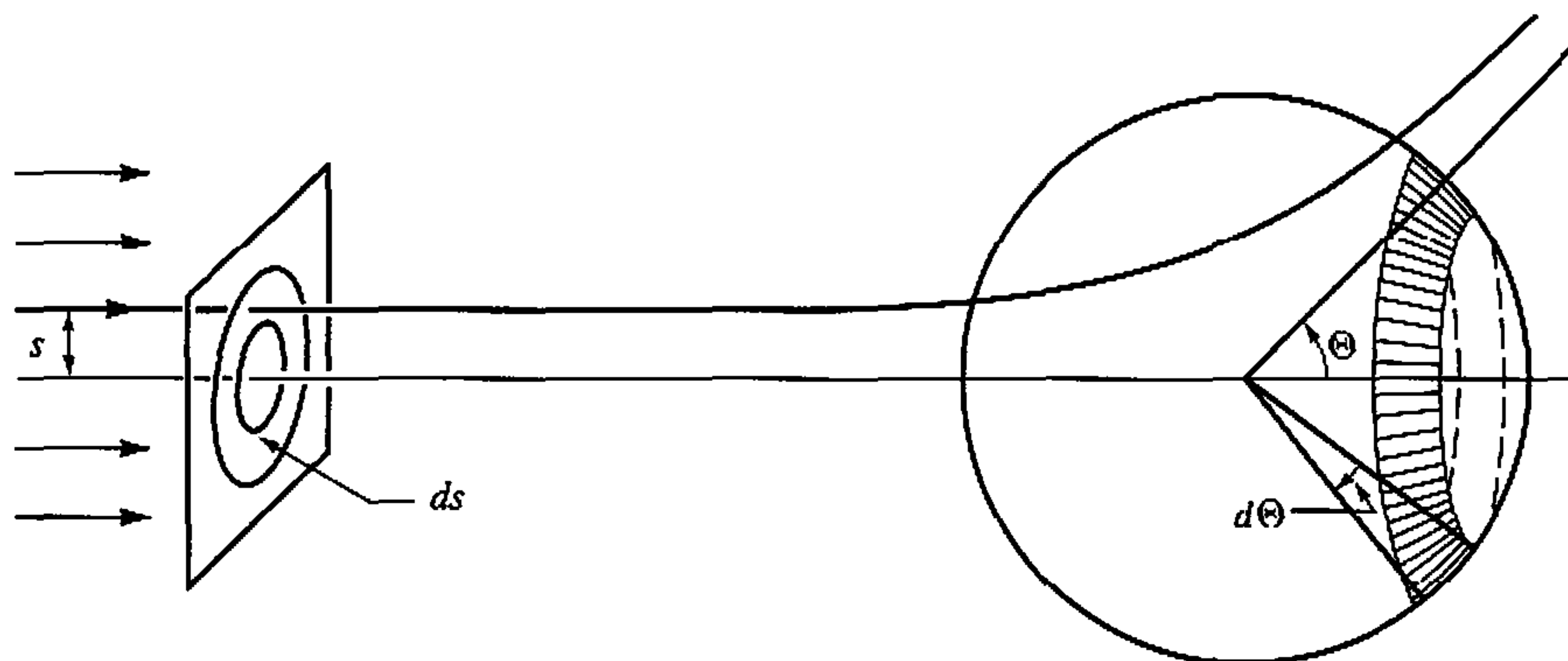

FIGURE 3.19 Scattering of an incident beam of particles by a center of force.

where Θ is the angle between the scattered and incident directions, known as the *scattering angle* (cf. Fig. 3.19, where repulsive scattering is illustrated). Note that the name “cross section” is deserved in that $\sigma(\Omega)$ has the dimensions of an area.

For any given particle the constants of the orbit, and hence the amount of scattering, are determined by its energy and angular momentum. It is convenient to express the angular momentum in terms of the energy and a quantity known as the *impact parameter*, s , defined as the perpendicular distance between the center of force and the incident velocity. If v_0 is the incident speed of the particle, then

$$l = mv_0s = s\sqrt{2mE}. \quad (3.90)$$

Once E and s are fixed, the angle of scattering Θ is then determined uniquely.* For the moment, it will be assumed that different values of s cannot lead to the same scattering angle. Therefore, the number of particles scattered into a solid angle $d\Omega$ lying between Θ and $\Theta + d\Theta$ must be equal to the number of the incident particles with impact parameter lying between the corresponding s and $s + ds$:

$$2\pi l s |ds| = 2\pi \sigma(\Theta) l \sin \Theta |d\Theta|. \quad (3.91)$$

Absolute value signs are introduced in Eq. (3.91) because numbers of particles must of course always be positive, while s and Θ often vary in opposite directions. If s is considered as a function of the energy and the corresponding scattering angle,

$$s = s(\Theta, E), \quad (3.92)$$

*It is at this point in the formulation that classical and quantum mechanics part company. Indeed, it is fundamentally characteristic of quantum mechanics that we cannot unequivocally predict the trajectory of any particular particle. We can only give probabilities for scattering in various directions.

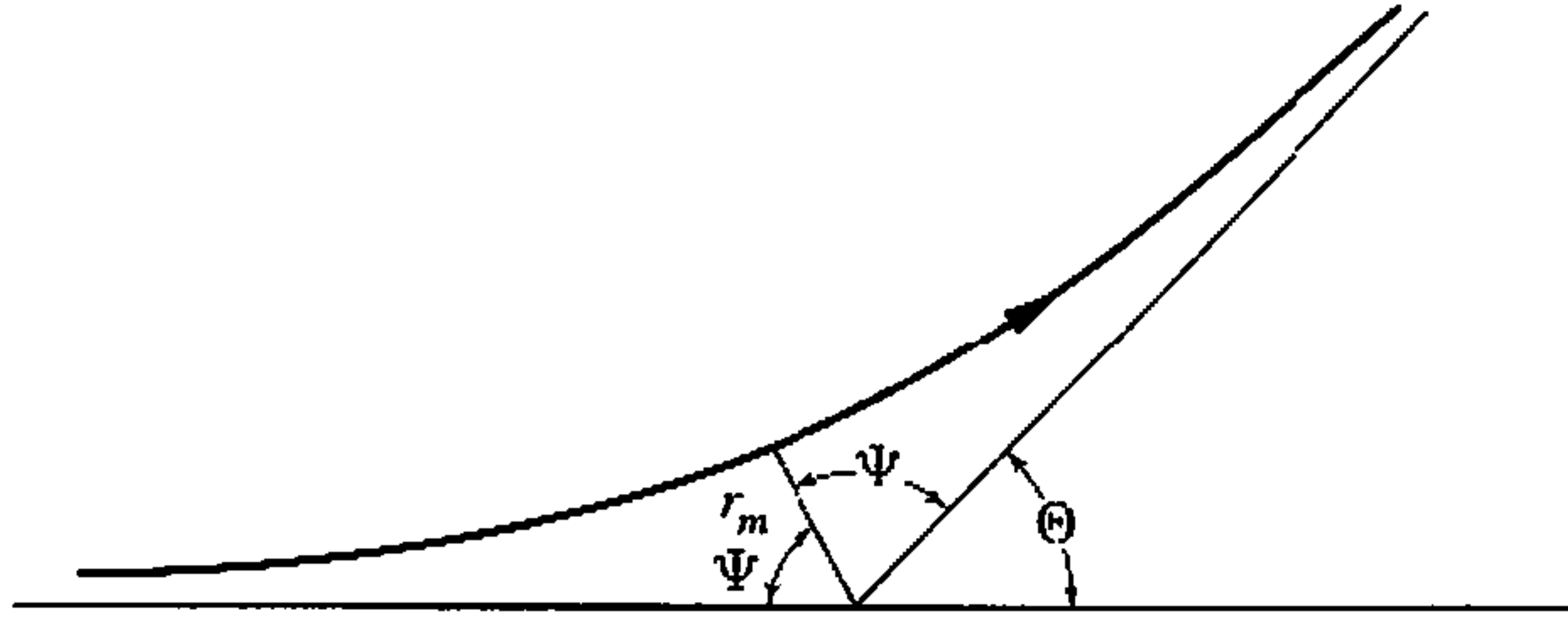

FIGURE 3.20 Relation of orbit parameters and scattering angle in an example of repulsive scattering.

then the dependence of the differential cross section on Θ is given by

$$\sigma(\Theta) = \frac{s}{\sin \Theta} \left| \frac{ds}{d\Theta} \right|. \quad (3.93)$$

A formal expression for the scattering angle Θ as a function of s can be directly obtained from the orbit equation, Eq. (3.36). Again, for simplicity, we will consider the case of purely repulsive scattering (cf. Fig. 3.20). As the orbit must be symmetric about the direction of the periastris, the scattering angle is given by

$$\Theta = \pi - 2\Psi, \quad (3.94)$$

where Ψ is the angle between the direction of the incoming asymptote and the periastris (closest approach) direction. In turn, Ψ can be obtained from Eq. (3.36) by setting $r_0 = \infty$ when $\theta_0 = \pi$ (the incoming direction), whence $\theta = \pi - \Psi$ when $r = r_m$, the distance of closest approach. A trivial rearrangement then leads to

$$\Psi = \int_{r_m}^{\infty} \frac{dr}{r^2 \sqrt{\frac{2mE}{l^2} - \frac{2mV}{l^2} - \frac{1}{r^2}}}. \quad (3.95)$$

Expressing l in terms of the impact parameter s (Eq. (3.90)), the resultant expression for $\Theta(s)$ is

$$\Theta(s) = \pi - 2 \int_{r_m}^{\infty} \frac{s dr}{r \sqrt{r^2 \left(1 - \frac{V(r)}{E}\right) - s^2}}. \quad (3.96)$$

or, changing r to $1/u$

$$\Theta(s) = \pi - 2 \int_0^{u_m} \frac{s du}{\sqrt{1 - \frac{V(u)}{E} - s^2 u^2}}. \quad (3.97)$$

Equations (3.96) and (3.97) are rarely used except for direct numerical computation of the scattering angle. However, when an analytic expression is available for the orbits, the relation between Θ and s can often be obtained almost by inspection. An historically important illustration of such a procedure is the repulsive scattering of charged particles by a Coulomb field. The scattering force field is that produced by a fixed charge $-Ze$ acting on the incident particles having a charge $-Z'e$ so that the force can be written as

$$f = \frac{ZZ'e^2}{r^2},$$

i.e., a repulsive inverse-square law. The results of Section 3.7 can be taken over here with no more change than writing the force constant as

$$k = -ZZ'e^2. \quad (3.98)$$

The energy E is greater than zero, and the orbit is a hyperbola with the eccentricity given by*

$$\epsilon = \sqrt{1 + \frac{2El^2}{m(ZZ'e^2)^2}} = \sqrt{1 + \left(\frac{2Es}{ZZ'e}\right)^2}, \quad (3.99)$$

where use has been made of Eq. (3.90). If θ' in Eq. (3.55) is chosen to be π , periapsis corresponds to $\theta = 0$ and the orbit equation becomes

$$\frac{1}{r} = \frac{mZZ'e}{l^2}(\epsilon \cos \theta - 1). \quad (3.100)$$

This hyperbolic orbit equation has the same form as the elliptic orbit equation (3.56) except for a change in sign. The direction of the incoming asymptote, Ψ , is then determined by the condition $r \rightarrow \infty$:

$$\cos \Psi = \frac{1}{\epsilon}$$

or, by Eq. (3.94),

$$\sin \frac{\Theta}{2} = \frac{1}{\epsilon}.$$

Hence,

$$\cot^2 \frac{\Theta}{2} = \epsilon^2 - 1,$$

and using Eq. (3.99)

*To avoid confusion with the electron charge e , the eccentricity will temporarily be denoted by ϵ .

$$\cot \frac{\Theta}{2} = \frac{2Es}{ZZ'e}$$

The desired functional relationship between the impact parameter and the scattering angle is therefore

$$s = \frac{ZZ'e^2}{2E} \cot \frac{\Theta}{2}, \quad (3.101)$$

so that on carrying through the manipulation required by Eq. (3.93), we find that $\sigma(\Theta)$ is given by

$$\sigma(\Theta) = \frac{1}{4} \left(\frac{ZZ'e^2}{2E} \right)^2 \csc^4 \frac{\Theta}{2}. \quad (3.102)$$

Equation (3.102) gives the famous Rutherford scattering cross section, originally derived by Rutherford for the scattering of α particles by atomic nuclei. Quantum mechanics in the nonrelativistic limit yields a cross section identical with this classical result.

In atomic physics, the concept of a *total scattering cross section* σ_T , defined as

$$\sigma_T = \int_{4\pi} \sigma(\Omega) d\Omega = 2\pi \int_0^\pi \sigma(\Theta) \sin \Theta d\Theta.$$

is of considerable importance. However, if we attempt to calculate the total cross section for Coulomb scattering by substituting Eq. (3.102) in this definition, we obtain an infinite result! The physical reason behind this behavior is not difficult to discern. From its definition the total cross section is the number of particles scattered in all directions per unit time for unit incident intensity. Now, the Coulomb field is an example of a “long-range” force; its effects extend to infinity. The very small deflections occur only for particles with very large impact parameters. Hence, all particles in an incident beam of infinite lateral extent will be scattered to some extent and must be included in the total scattering cross section. It is therefore clear that the infinite value for σ_T is not peculiar to the Coulomb field; it occurs in classical mechanics whenever the scattering field is different from zero at all distances, no matter how large.* Only if the force field “cuts off,” i.e., is zero beyond a certain distance, will the scattering cross section be finite. Physically, such a cut-off occurs for the Coulomb field of a nucleus as a result of the presence of the atomic electrons, which “screen” the nucleus and effectively cancel its charge outside the atom.

* σ_T is also infinite for the Coulomb field in quantum mechanics, since it has been stated that Eq. (3.102) remains valid there. However, not all “long-range” forces give rise to infinite total cross sections in quantum mechanics. It turns out that all potentials that fall off faster at larger distances than $1/r^2$ produce a finite quantum-mechanical total scattering cross section.

In Rutherford scattering, the scattering angle Θ is a smooth monotonic function of the impact parameter s . From Eq. (3.101) we see that as s decreases from infinity, Θ increases monotonically from zero, reaching the value π as s goes to zero. However, other types of behavior are possible in classical systems, requiring some modification in the prescription, Eq. (3.93), for the classical cross section. For example, with a repulsive potential and particle energy qualitatively of the nature shown in Fig. 3.21(a), it is easy to see physically that the curve of Θ versus s may behave as indicated in Fig. 3.21(b). Thus, with very large values of the impact parameter, as noted above, the particle always remains at large radial distances from the center of force and suffers only minor deflection. At the other extreme, for $s = 0$, the particle travels in a straight line into the center of force, and if the energy is greater than the maximum of the potential, it will continue on through the center without being scattered at all. Hence, for both limits in s , the scattering angle goes to zero. For some intermediate value of s , the scattering angle must pass through a maximum Θ_m . When $\Theta < \Theta_m$, there will be *two* values of s that can give rise to the same scattering angle. Each will contribute to the scattering cross section at that angle, and Eq. (3.93) should accordingly be modified to the form

$$\sigma(\Theta) = \sum_i \frac{s_i}{\sin \Theta} \left| \frac{ds}{d\Theta} \right|_i, \quad (3.103)$$

where for $\Theta \neq \Theta_m$ the index i takes on the values 1 and 2. Here the subscript i distinguishes the various values of s giving rise to the same value of Θ .

Of particular interest is the cross section at the maximum angle of scattering Θ_m . As the derivative of Θ with respect to s vanishes at this angle, it follows from Eq. (3.93) or (3.103) that the cross section must become infinite at $\Theta \rightarrow \Theta_m$. But for all larger angles the cross section is zero, since the scattering angle cannot exceed Θ_m . The phenomenon of the infinite rise of the cross section followed by abrupt disappearance is very similar to what occurs in the geometrical optics of the scattering of sunlight by raindrops. On the basis of this similarity, the phenomenon is called *rainbow scattering*.

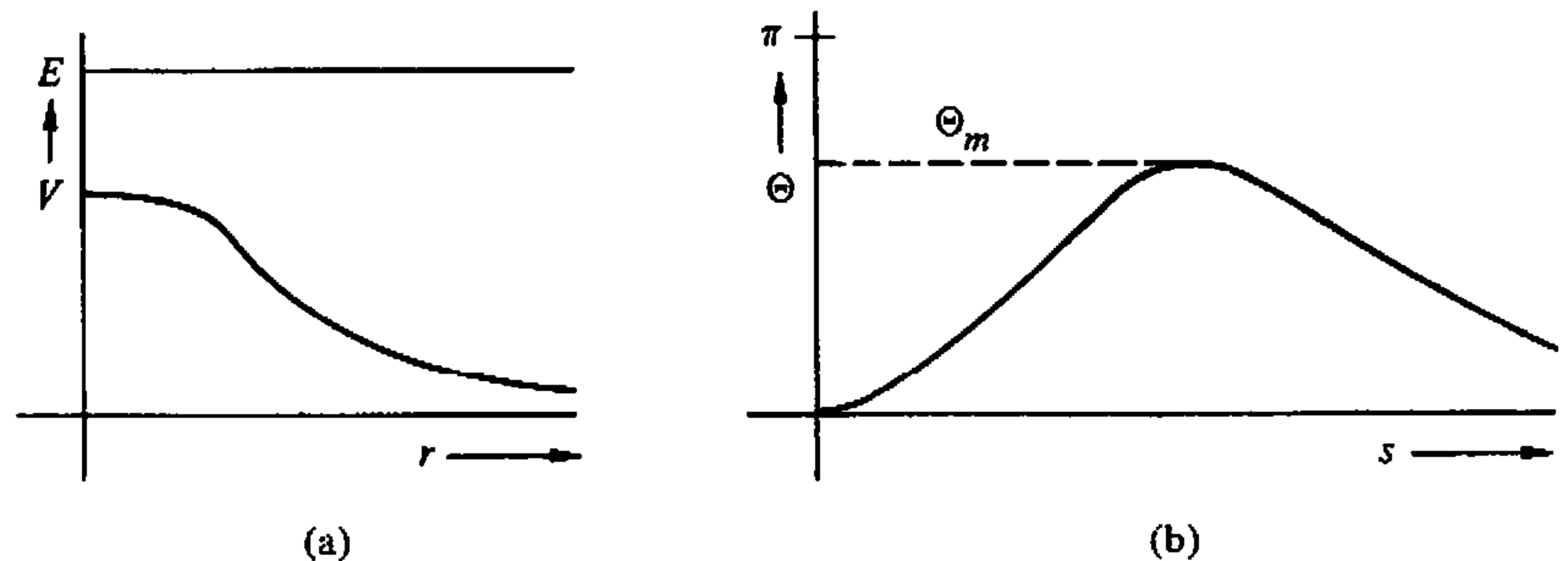

FIGURE 3.21 Repulsive nonsingular scattering potential and double-valued curve of scattering angle Θ versus impact parameter s_0 for sufficiently high energy.

So far, the examples have been for purely repulsive scattering. If the scattering involves attractive forces, further complications may arise. The effect of attraction will be to pull the particle in toward the center instead of the repulsive deflection outward shown in Fig. 3.20. In consequence, the angle Ψ between the incoming direction and the periapsis direction may be greater than $\pi/2$, and the scattering angle as given by Eq. (3.94) is then negative. This in itself is no great difficulty as clearly it is the magnitude of Θ that is involved in finding the cross section. But, under circumstances Θ as calculated by Eq. (3.96) may be greater than 2π . That is, the particle undergoing scattering may circle the center of force for one or more revolutions before going off finally in the scattered direction.

To see how this may occur physically, consider a scattering potential shown as the $s = 0$ curve in Fig. 3.22. It is typical of the intermolecular potentials assumed in many kinetic theory problems—an attractive potential at large distances falling off more rapidly than $1/r^2$, with a rapidly rising repulsive potential at small distances. The other curves in Fig. 3.22 show the effective one-dimensional potential $V'(r)$, Eq. (3.22'), for various values of the impact parameter s (equivalently various values of l). Since the repulsive centrifugal barrier dominates at large r for all values of $s > 0$, the equivalent potential for small s will exhibit a hump.

Now let us consider an incoming particle with impact parameter s_1 and at the energy E_1 corresponding to the maximum of the hump. As noted in Section 3.3, the difference between E_1 and $V'(r)$ is proportional to the square of the radial velocity at that distance. When the incoming particle reaches r_1 , the location of the maximum in V' , the radial velocity is zero. Indeed, recall from the discussion

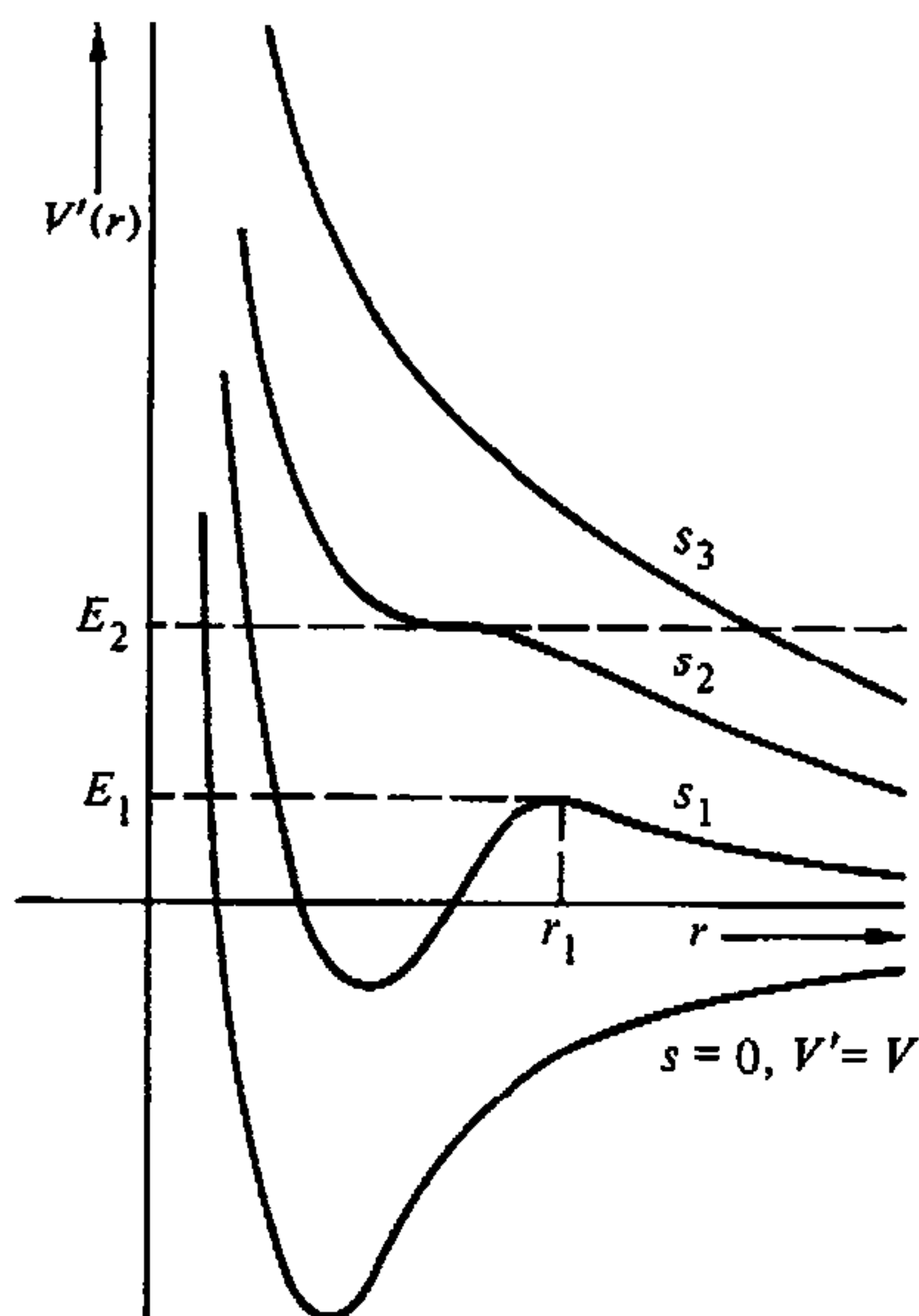

FIGURE 3.22 A combined attractive and repulsive scattering potential, and the corresponding equivalent one-dimensional potential at several values of the impact parameter s .

in Section 3.6 that we have here the conditions for an unstable circular orbit at the distance r_1 . In the absence of any perturbation, the incoming particle with parameters E_1 and s_1 , once having reached r , would circle around the center of force indefinitely at that distance without ever emerging! For the same impact parameter but at an energy E slightly higher than E_1 , no true circular orbit would be established. However, when the particle is in the immediate vicinity of r_1 the radial speed would be very small, and the particle would spend a disproportionately large time in the neighbourhood of the hump. The angular velocity, $\dot{\theta}$, meanwhile would not be affected by the existence of a maximum, being given at r , by (3.90)

$$\dot{\theta} = \frac{l}{mr^2} = \frac{s_1}{r_1^2} \sqrt{\frac{2E}{m}}.$$

Thus, in the time it takes the particle to get through the region of the hump, the angular velocity may have carried the particle through angles larger than 2π or even multiples thereof. In such instances, the classical scattering is said to exhibit *orbiting* or *spiraling*.

As the impact parameter is increased, the well and hump in the equivalent potential V' tend to flatten out, until at some parameter s_2 there is only a point of inflection in V' at an energy E_2 (cf. Fig. 3.22). For particle energies above E_2 , there will no longer be orbiting. But the combined effects of the attractive and repulsive components of the effective potential can lead even in such cases to zero deflection for some finite value of the impact parameter. At large energies and small impact parameters, the major scattering effects are caused by the strongly repulsive potentials at small distances, and the scattering qualitatively resembles the behavior of Rutherford scattering.

We have seen that the scattered particle may be deflected by more than π when orbiting takes place. On the other hand, the observed scattering angle in the laboratory lies between 0 and π . It is therefore helpful in such ambiguous cases to distinguish between a *deflection angle* Φ , as calculated by the right-hand sides of Eqs. (3.96) or (3.97), and the observed scattering angle Θ . For given Φ , the angle Θ is to be determined from the relation

$$\Theta = \pm\Phi - 2m\pi, \quad m \text{ a positive integer.}$$

The sign and the value of m are to be chosen so that Θ lies between 0 and π . The sum in Eq. (3.103) then covers all values of Φ leading to the same Θ . Figure 3.23 shows curves of Θ versus s for the potential of Fig. 3.22 at two different energies. The orbiting that takes place for $E = E_1$ shows up as a singularity in the curve at $s = s_1$. When $E > E_2$, orbiting no longer takes place, but there is a rainbow effect at $\Theta = -\Phi'$ (although there is a nonvanishing cross section at higher scattering angles). Note that Θ vanishes at $s = s_3$, which means from Eq. (3.93) that the cross section becomes infinite in the forward direction through the vanishing of $\sin \Theta$. The cross section can similarly become infinite in the backward direction

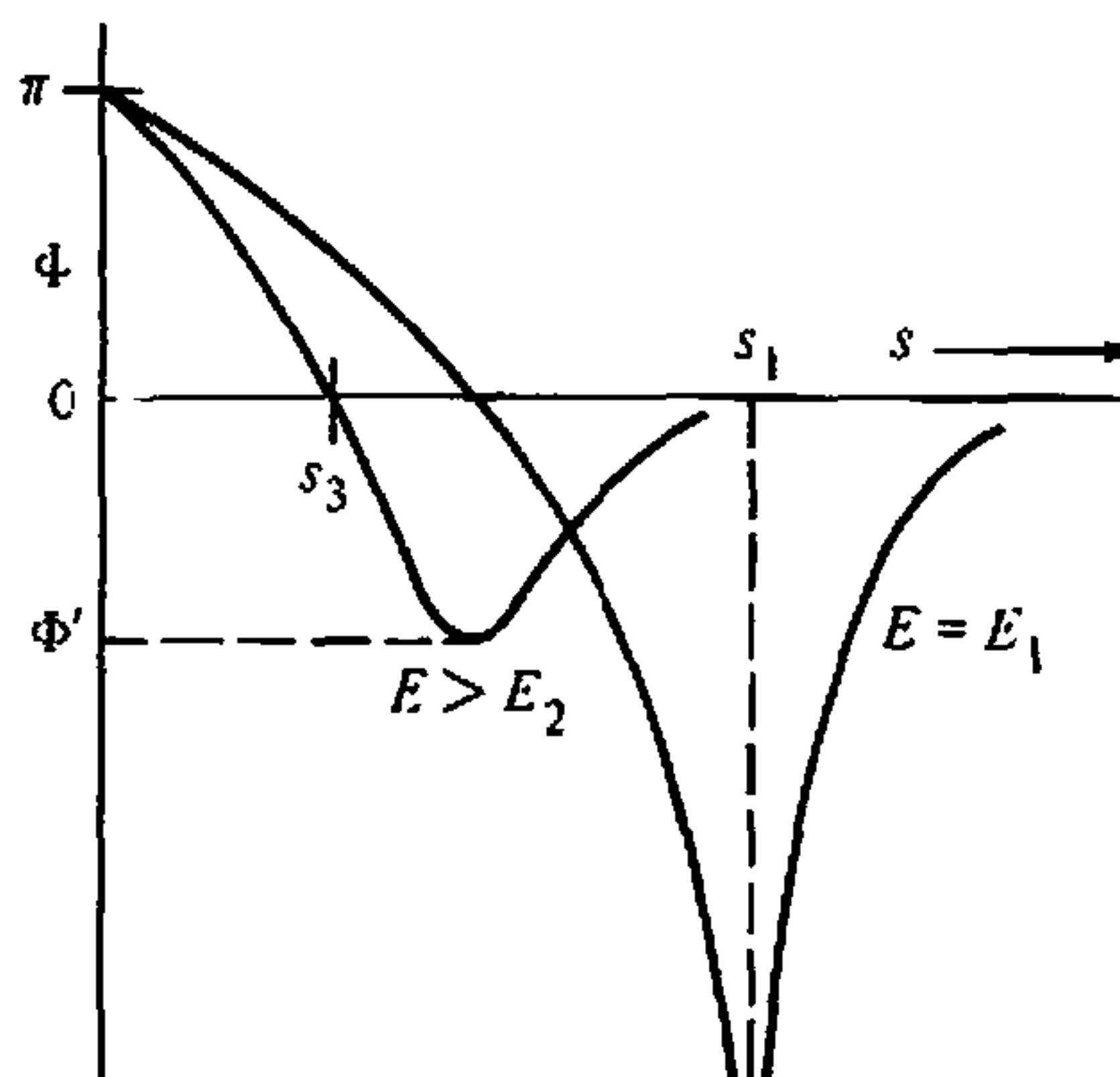

FIGURE 3.23 Curves of deflection angle Φ versus s , for the potential of Fig. 3.22 at two different energies.

providing

$$s \left| \frac{ds}{d\Theta} \right|$$

remains finite at $\Theta = \pi$. These infinities in the forward or backward scattering angles are referred to as *glory scattering*, again in analogy to the corresponding phenomenon in meteorological optics.*

A more general treatment would involve quantum corrections, but in some instances quantum effects are small, as in the scattering of low-energy ions in crystal lattices, and the classical calculations are directly useful. Even when quantum-mechanical corrections are important, it often suffices to use an approximation method (the “semiclassical” approximation) for which a knowledge of the classical trajectory is required. For almost all potentials of practical interest, it is impossible to find an analytic form for the orbit, and Eq. (3.96) (or variant forms) is either approximated for particular regions of s or integrated numerically.

3.11 ■ TRANSFORMATION OF THE SCATTERING PROBLEM TO LABORATORY COORDINATES

In the previous section we were concerned with the one-body problem of the scattering of a particle by a fixed center of force. In practice, the scattering always involved two bodies; e.g., in Rutherford scattering we have the α particle and the atomic nucleus. The second particle, m_2 , is not fixed but recoils from its initial position as a result of the scattering. Since it has been shown that any two-body

*The backward glory is familiar to airplane travelers as the ring of light observed to encircle the shadow of the plane projected on clouds underneath

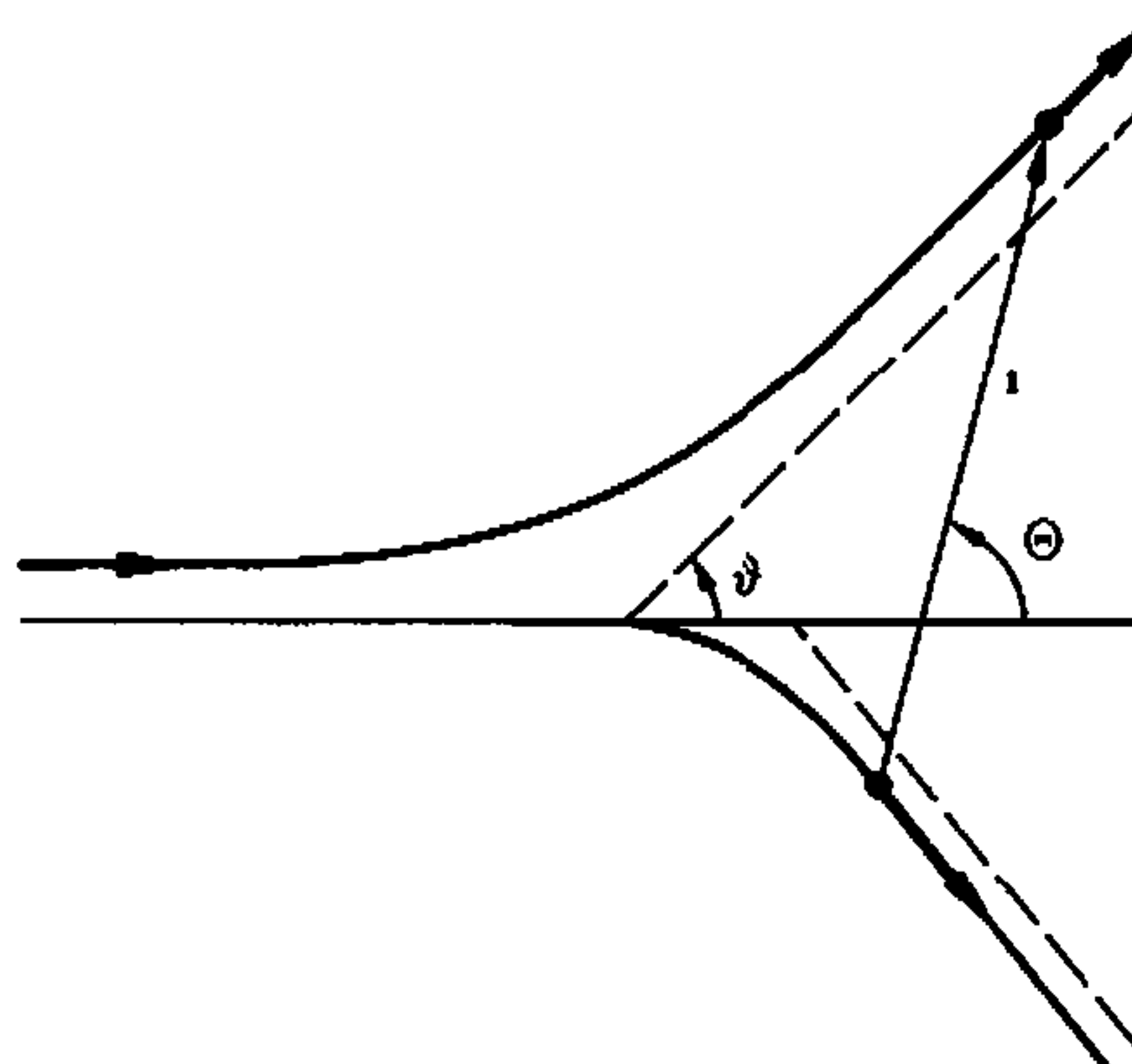

FIGURE 3.24 Scattering of two particles as viewed in the laboratory system.

central force problem can be reduced to a one-body problem, it might be thought that the only change is to replace m by the reduced mass μ . However, the matter is not quite that simple. The scattering angle actually measured in the laboratory, which we shall denote by ϑ , is the angle between the final and incident directions of the scattered particle in laboratory coordinates.[†] On the other hand, the angle Θ calculated from the equivalent one-body problem is the angle between the final and initial directions of the relative vector between the two particles in the center of mass coordinates. These two angles, θ and Θ , would be the same only if the second particle remains stationary through the scattering process. In general, however, the second particle, though initially at rest, is itself set in motion by the mutual force between the two particles, and, as is indicated in Fig. 3.24, the two angles then have different values. The equivalent one-body problem thus does not directly furnish the scattering angle as measured in the laboratory coordinate system.

The relationship between the scattering angles Θ and ϑ can be determined by examining how the scattering takes place in a coordinate system moving with the center of mass of both particles. In such a system the total linear momentum is zero, of course, and the two particles always move with equal and opposite momenta. Figure 3.25 illustrates the appearance of the scattering process to an observer in the center of mass system. Before the scattering, the particles are moving directly toward each other; after, they are moving directly away from each other. The angle between the initial and final directions of the relative vector, Θ , must therefore be the same as the scattering angle of either particle in the center-of-mass system. The connection between the two scattering angles Θ and ϑ can thus be obtained by considering the transformation between the center-of-mass system and the laboratory system.

[†]The scattering angle ϑ must not be confused with the angle coordinate θ of the relative vector, \mathbf{r} , between the two particles

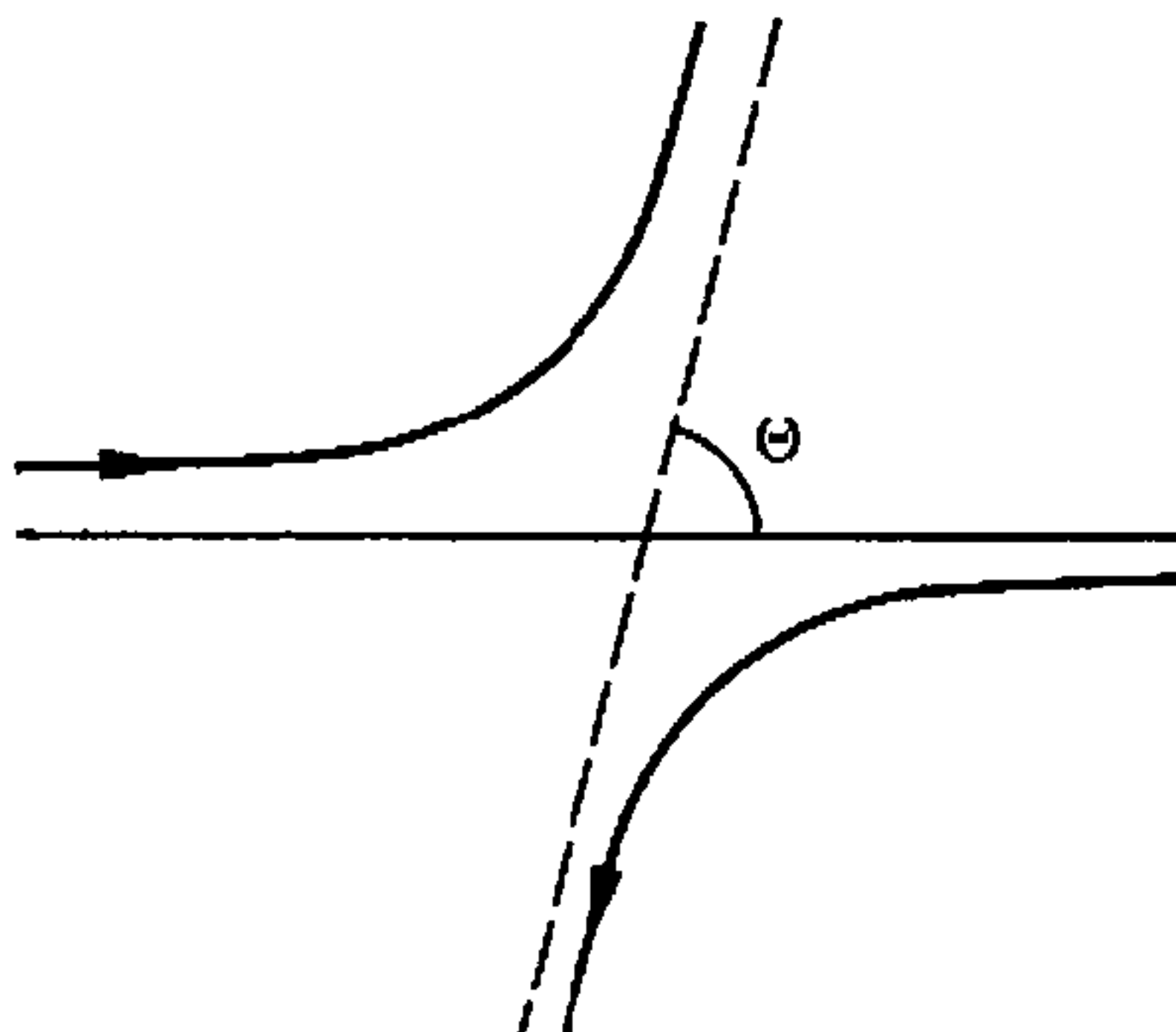

FIGURE 3.25 Scattering of two particles as viewed in the center of mass system.

It is convenient here to use the terminology of Section 3.1, with slight modifications:

- \mathbf{r}_1 and \mathbf{v}_1 are the position and velocity, after scattering, of the incident particle, m_1 , in the laboratory system,
- \mathbf{r}'_1 and \mathbf{v}'_1 are the position and velocity, after scattering, of particle m_1 in the center of mass system, and
- \mathbf{R} and \mathbf{V} are the position and (constant) velocity in the center of mass in the laboratory system.

At any instant, by definition

$$\mathbf{r}_1 = \mathbf{R} + \mathbf{r}'_1,$$

and consequently

$$\mathbf{v}_1 = \mathbf{V} + \mathbf{v}'_1. \quad (3.104)$$

Figure 3.26 graphically portrays this vector relation evaluated *after* the scattering has taken place; at which time \mathbf{v}_1 and \mathbf{v}'_1 make the angles ϑ and Θ , respectively,

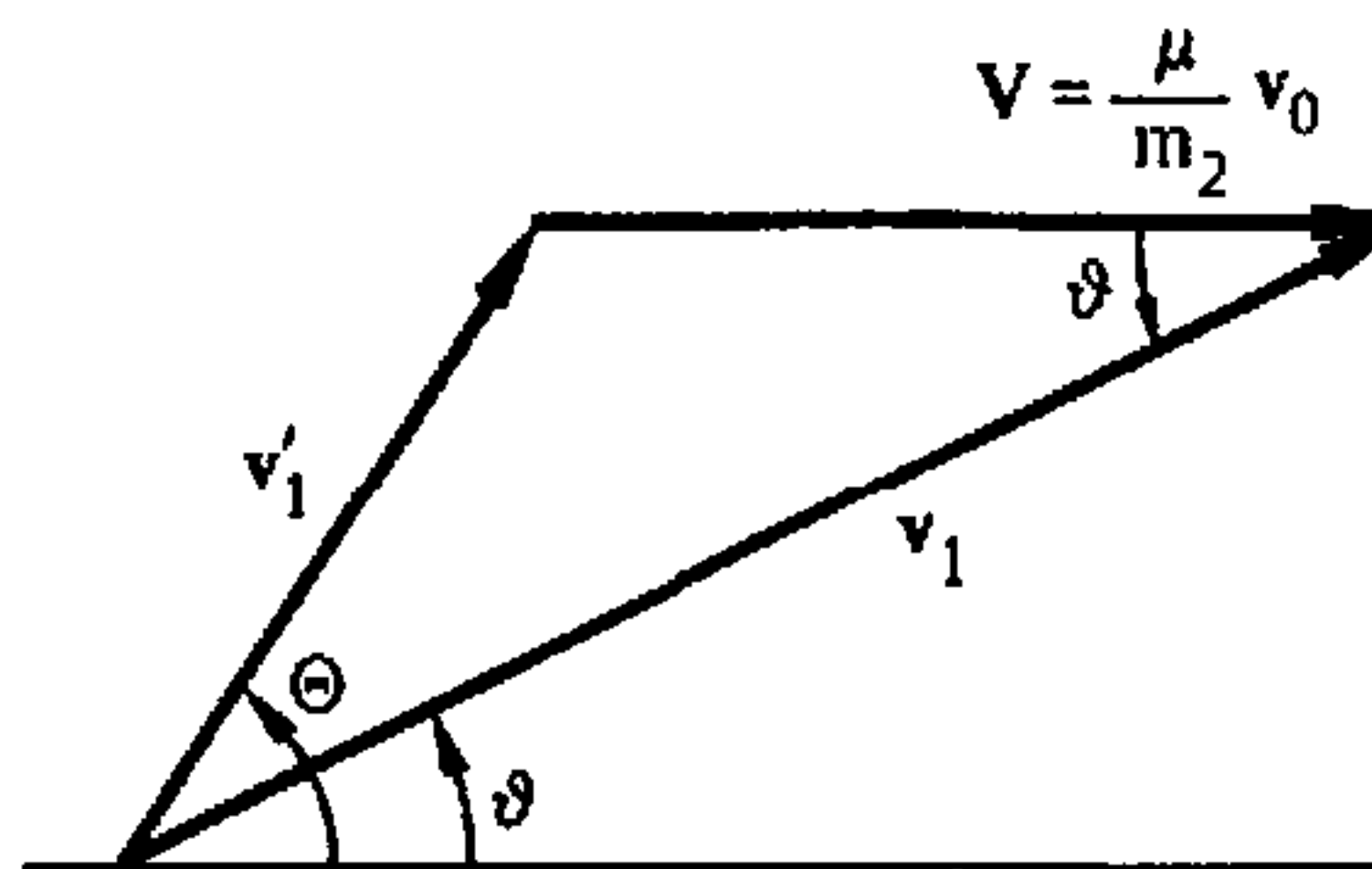

FIGURE 3.26 The relations between the velocities in the center of mass and laboratory coordinates.

with the vector \mathbf{V} lying along the initial direction. Since the target is initially stationary in the laboratory system, the incident velocity of particle 1 in that system, \mathbf{v}_0 , is the same as the initial relative velocity of the particles. By conservation of total linear momentum, the constant velocity of the center of mass is therefore given by

$$(m_1 + m_2)\mathbf{V} = m_1\mathbf{v}_0,$$

or

$$\mathbf{V} = \frac{\mu}{m_2}\mathbf{v}_0, \quad (3.105)$$

where $\mu = m_1 m_2 / (m_1 + m_2)$. From Fig. 3.26, it is readily seen that

$$v_1 \sin \vartheta = v'_1 \sin \Theta$$

and

$$v_1 \cos \vartheta = v'_1 \cos \Theta + V. \quad (3.106)$$

The ratio of these two equations gives a relation between ϑ and Θ :

$$\tan \vartheta = \frac{\sin \Theta}{\cos \Theta + \rho}, \quad (3.107)$$

where ρ is defined as

$$\rho \equiv \frac{\mu}{m_2} \frac{v_0}{v'_1}. \quad (3.108)$$

An alternative relation can be obtained by expressing v_1 in terms of the other speeds through the cosine law as applied to the triangle of Fig. 3.26:

$$v_1^2 = v'^2_1 + V^2 + 2v'_1 V \cos \Theta. \quad (3.109)$$

When this is used to eliminate v_1 from Eq. (3.106) and V is expressed in terms of v_0 by Eq. (3.105), we find

$$\cos \vartheta = \frac{\cos \Theta + \rho}{\sqrt{1 + 2\rho \cos \Theta + \rho^2}}. \quad (3.110)$$

Both these relations still involve a ratio of speeds through ρ . By the definition of center of mass, the speed of particle 1 in the center-of-mass system, v'_1 , is connected with the relative speed v after the collision, by the equation (cf. Eq. (3.2)), where $v = |\dot{\mathbf{r}}|$:

$$v'_1 = \frac{\mu}{m_1} v.$$

Hence, ρ can also be written as

$$\rho = \frac{m_1 v_0}{m_2 v}, \quad (3.108')$$

where v , it should be emphasized, is the relative speed *after* the collision. When the collision is *elastic*, the total kinetic energy of the two particles remains unaltered and v must equal v_0 so that ρ is simply

$$\rho = \frac{m_1}{m_2}, \quad (\text{elastic collision}) \quad (3.111)$$

independent of energies or speeds. If the collision is *inelastic*, the total kinetic energy of the two particles is altered (e.g., some of the kinetic energy goes into the form of internal excitation energy of the target). Since the total energy is conserved and momentum is conserved, the energy change resulting from the collision can be expressed as

$$\frac{\mu v^2}{2} = \frac{\mu v_0^2}{2} + Q. \quad (3.112)$$

The so-called Q value of the inelastic collision is clearly negative in magnitude, but the sign convention is chosen to conform to that used in general for atomic and nuclear reactions. From Eq. (3.112) the ratio of relative speeds before and after collision can be written

$$\frac{v}{v_0} = \sqrt{1 + \frac{m_1 + m_2}{m_2} \frac{Q}{E}}, \quad (3.113)$$

where $E = \frac{1}{2} m v_0^2$ is the energy of the incoming particle (in the laboratory system). Thus, for inelastic scattering ρ becomes

$$\rho = \frac{m_1}{m_2 \sqrt{1 + \frac{m_1 + m_2}{m_2} \frac{Q}{E}}}. \quad (\text{inelastic scattering}) \quad (3.114)$$

Not only are the scattering angles ϑ and Θ in general different in magnitude, but the values of the differential scattering cross section depend upon which of the two angles is used as the argument of σ . The connection between the two functional forms is obtained from the observation that in a particular experiment the number of particles scattered into a given element of solid angle must be the same whether we measure the event in terms of ϑ or Θ . As an equation, this statement can be written

$$2\pi I \sigma(\Theta) \sin \Theta |d\Theta| = 2\pi I \sigma'(\vartheta) \sin \vartheta |d\vartheta|,$$

or

$$\sigma'(\vartheta) = \sigma(\Theta) \frac{\sin \Theta}{\sin \vartheta} \left| \frac{d\Theta}{d\vartheta} \right| = \sigma(\Theta) \left| \frac{d(\cos \Theta)}{d(\cos \vartheta)} \right|, \quad (3.115)$$

where $\sigma'(\vartheta)$ is the differential scattering cross section expressed in terms of the scattering angle in the laboratory system. The derivative can easily be evaluated from Eq. (3.110), leading to the result

$$\sigma'(\vartheta) = \sigma(\Theta) \frac{(1 + 2\rho \cos \Theta + \rho^2)^{3/2}}{1 + \rho \cos \Theta}. \quad (3.116)$$

Note that $\sigma(\Theta)$ is *not* the cross section an observer would measure in the center-of-mass system. Both $\sigma(\Theta)$ and $\sigma'(\vartheta)$ are cross sections measured in the laboratory system; they are merely expressed in terms of different coordinates. An observer fixed in the center-of-mass system would see a different flux density of incident particles from that measured in the laboratory system, and this transformation of flux density would have to be included if (for some reason) we wanted to relate the cross sections as measured in the two different systems.

The two scattering angles have a particularly simple relation for elastic scattering when the two masses of particles are equal. It then follows that $\rho = 1$, and from Eq. (3.110) we have

$$\cos \vartheta = \sqrt{\frac{1 + \cos \Theta}{2}} = \cos \frac{\Theta}{2},$$

or

$$\vartheta = \frac{\Theta}{2}, \quad (\rho = 1).$$

Thus, with equal masses, scattering angles greater than 90° cannot occur in the laboratory system; all the scattering is in the forward hemisphere. Correspondingly, the scattering cross section is given in terms of Θ from Eq. (3.116) as

$$\sigma'(\vartheta) = 4 \cos \vartheta \cdot \sigma(\Theta), \quad \vartheta \leq \frac{\pi}{2}, \quad (\rho = 1).$$

Even when the scattering is isotropic in terms of Θ , i.e., $\sigma(\Theta)$ is constant, independent of Θ , then the cross section in terms of ϑ varies as the cosine of the angle! When, however, the scattering mass m_2 is very large compared to the incident particle mass m_1 and the scattering is elastic, then from Eq. (3.111) $\rho \approx 0$, so $\sigma'(\vartheta) \approx \sigma(\Theta)$ from Eq. (3.116).

We have seen that even in elastic collisions, where the total kinetic energy remains constant, a collision with an initially stationary target results in a transfer of kinetic energy to the target with a corresponding decrease in the kinetic energy of the incident particle. In other words, the collision *slows down* the incident

particle. The degree of slowing down can be obtained from Eq. (3.109) if v_1' and V are expressed in terms of v_0 by Eqs. (3.108) and (3.105), respectively:

$$\frac{v_1^2}{v_0^2} = \left(\frac{\mu}{m_2 \rho} \right)^2 (1 + 2\rho \cos \Theta + \rho^2) \quad (3.117)$$

For elastic collisions $\rho = m_1/m_2$, and Eq. (3.117) can be simplified to

$$\frac{E_1}{E_0} = \frac{1 + 2\rho \cos \Theta + \rho^2}{(1 + \rho)^2}, \quad (\text{elastic collision}) \quad (3.117')$$

where E_0 is the initial kinetic energy of the incident particle in the laboratory system and E_1 the corresponding energy after scattering. When the particles are of equal mass, this relation becomes

$$\frac{E_1}{E_0} = \frac{1 + \cos \Theta}{2} = \cos \vartheta.$$

Thus, at the maximum scattering angle ($\Theta = \pi$, $\vartheta = \pi/2$), the incident particle loses all its energy and is completely stopped in the laboratory system.

This transfer of kinetic energy by scattering is, of course, the principle behind the "moderator" in a thermal neutron reactor. Fast neutrons produced by fission make successive elastic scatterings until their kinetic energy is reduced to thermal energies, where they are more liable to cause fission than to be captured. Clearly the best moderators will be the light elements, ideally hydrogen ($\rho = 1$). For a nuclear reactor, hydrogen is practical only when contained as part of a mixture or compound, such as water. Other light elements useful for their moderating properties include deuterium, of mass 2, and carbon, of mass 12. Hydrogen, as present in paraffin, water, or plastics, is frequently used in the laboratory to slow down neutrons.

Despite their current useful applications, these calculations of the transformation from laboratory to center of mass coordinates, and of the transfer of kinetic energy, are not particularly "modern" or "quantum" in nature. Nor is the classical mechanics involved particularly advanced or difficult. All that has been used, essentially, is the conservation of momentum and energy. Indeed, similar calculations may be found in freshman textbooks, usually in terms of elastic collisions between, say, billiard balls. But it is their elementary nature that results in the widespread validity of these calculations. So long as momentum is conserved (and this will be true in quantum mechanics) and the Q value is known, the details of the scattering process are irrelevant. In effect, the vicinity of the scattering particle is a "black box," and we are concerned only with what goes in and what comes out. It matters not at all whether the phenomena occurring inside the box are "classical" or "quantum." Consequently, the formulae of this section may be used in the experimental analysis of phenomena essentially quantum in nature, as for example, neutron-proton scattering, so long as the energies are low enough that relativistic effects may be neglected. (See Section 7.7 for a discussion of the relativistic treatment of the kinematics of collisions.)

3.12 ■ THE THREE-BODY PROBLEM

Thus far, we have treated integrable problems in which the equations of motion can be integrated to give a closed-form solution. For the two-body case of the inverse-square law, we found solutions involving motion in elliptic, parabolic, and hyperbolic orbits, the former of which constitute closed orbits. Solutions can also be found for some additional power laws of the form $V(r) = ar^n$. Nevertheless, for almost all other possible central force potentials, the equations of motion cannot be integrated. When one more mass is added, the situation becomes much more complex. Even for inverse-square law forces, this three-body Kepler-type problem has no known general solution. In the present section we shall examine some simple examples of what happens when this third mass is added.

The Newtonian three-body problem involves three masses m_1 , m_2 , and m_3 at the respective positions \mathbf{r}_1 , \mathbf{r}_2 , and \mathbf{r}_3 , interacting with each other via gravitational forces. We assume that the position vectors \mathbf{r}_1 , \mathbf{r}_2 , and \mathbf{r}_3 are expressed in the center of mass system. It is easy to write the equation of motion of the first mass since by Newton's second law $m_1\ddot{\mathbf{r}}_1$ equals the gravitational forces that the other two masses exert on m_1 :

$$\ddot{\mathbf{r}}_1 = -Gm_2 \frac{\mathbf{r}_1 - \mathbf{r}_2}{|\mathbf{r}_1 - \mathbf{r}_2|^3} - Gm_3 \frac{\mathbf{r}_1 - \mathbf{r}_3}{|\mathbf{r}_1 - \mathbf{r}_3|^3} \quad (3.118)$$

and analogously for the other two masses. If we make use of the relative-position vectors defined by

$$\mathbf{s}_i = \mathbf{r}_j - \mathbf{r}_k \quad (3.119)$$

in Fig. 3.27, then clearly

$$\mathbf{s}_1 + \mathbf{s}_2 + \mathbf{s}_3 = 0. \quad (3.120)$$

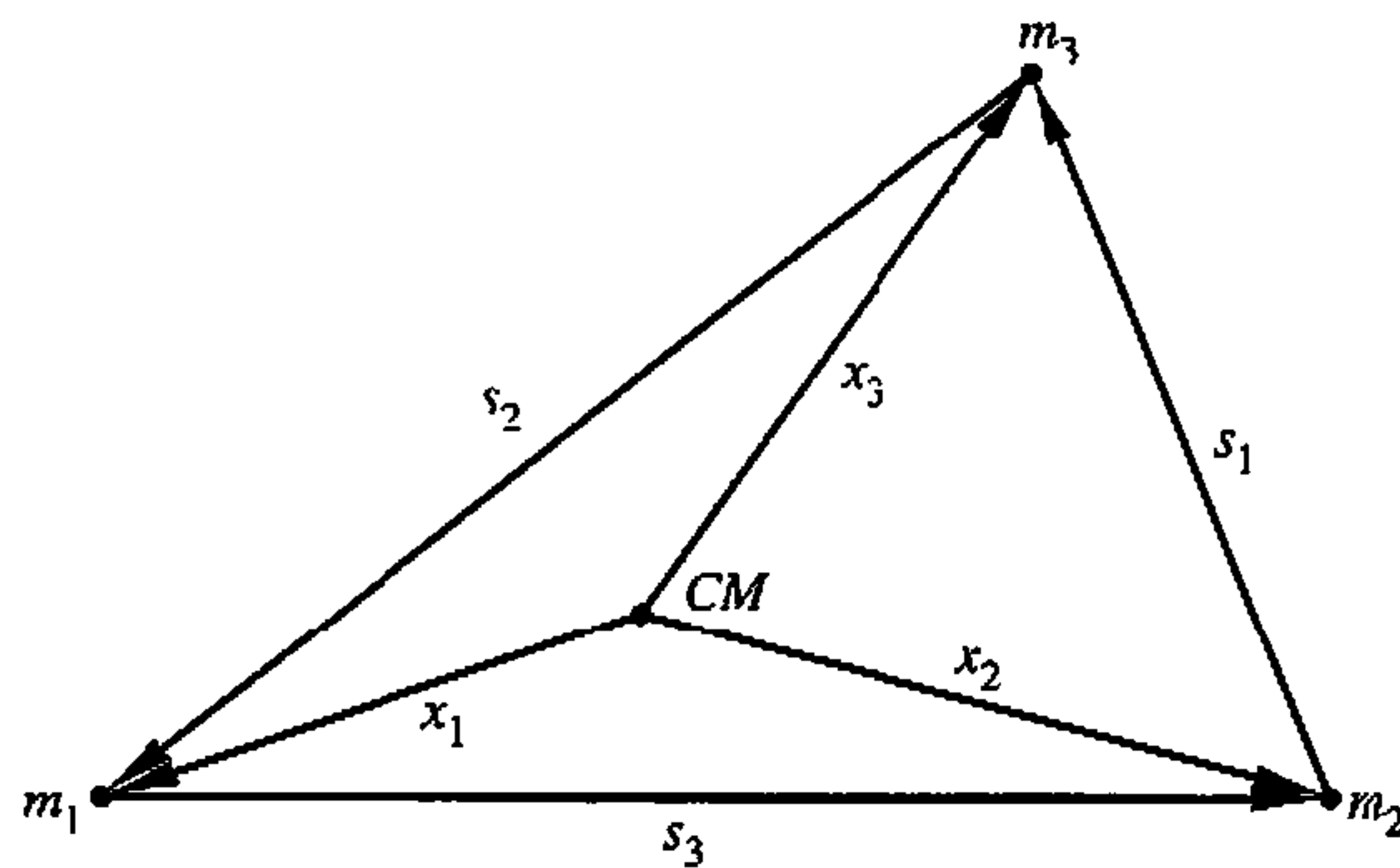

FIGURE 3.27 Position vectors $\mathbf{s}_i = \mathbf{r}_j - \mathbf{r}_k$ for the three-body problem. Adapted from Hestenes, *New Foundations for Classical Mechanics*, 1999, Fig. 5.1.

After a little algebra, the equations of motion assume the symmetrical form

$$\ddot{\mathbf{s}}_i = -mG \frac{\mathbf{s}_i}{s_i^3} + m_i \mathbf{G} \quad (3.121)$$

where $i = 1, 2, 3$, the quantity m is the sum of the three masses

$$m = m_1 + m_2 + m_3 \quad (3.122)$$

and the vector \mathbf{G} is given by

$$\mathbf{G} = G \left(\frac{\mathbf{s}_1}{s_1^3} + \frac{\mathbf{s}_2}{s_2^3} + \frac{\mathbf{s}_3}{s_3^3} \right). \quad (3.123)$$

The three coupled equations in the symmetrical form, (3.121), cannot be solved in general, but they do provide solutions to the three-body problem for some simple cases.

There is a solution due to Euler in which mass m_2 always lies on the straight line between the other two masses so that $\mathbf{r}_1, \mathbf{r}_2, \mathbf{r}_3, \mathbf{s}_1, \mathbf{s}_2, \mathbf{s}_3$, and \mathbf{G} are all collinear. Figure 3.28 shows Euler's negative-energy (i.e., bound-state) solution for the mass ratio $m_1 < m_2 < m_3$ in which the masses move along confocal ellipses with the same period τ . During each period, the masses pass through both a perihelion configuration, in which they lie close together along the axis of the ellipses, and an aphelion configuration, in which they lie along this same axis but far apart. The aphelion positions in the orbits are indicated in Figure 3.28.

If the vector $\mathbf{G} = 0$, the equations of motion decouple, and Eq. (3.121) reduces to the two-body form of the Kepler problem,

$$\ddot{\mathbf{s}}_i = -mG \frac{\mathbf{s}_i}{s_i^3}, \quad (3.124)$$

with each mass moving along an elliptical orbit lying in the same plane with the same focal point and the same period. This decoupling occurs when the three

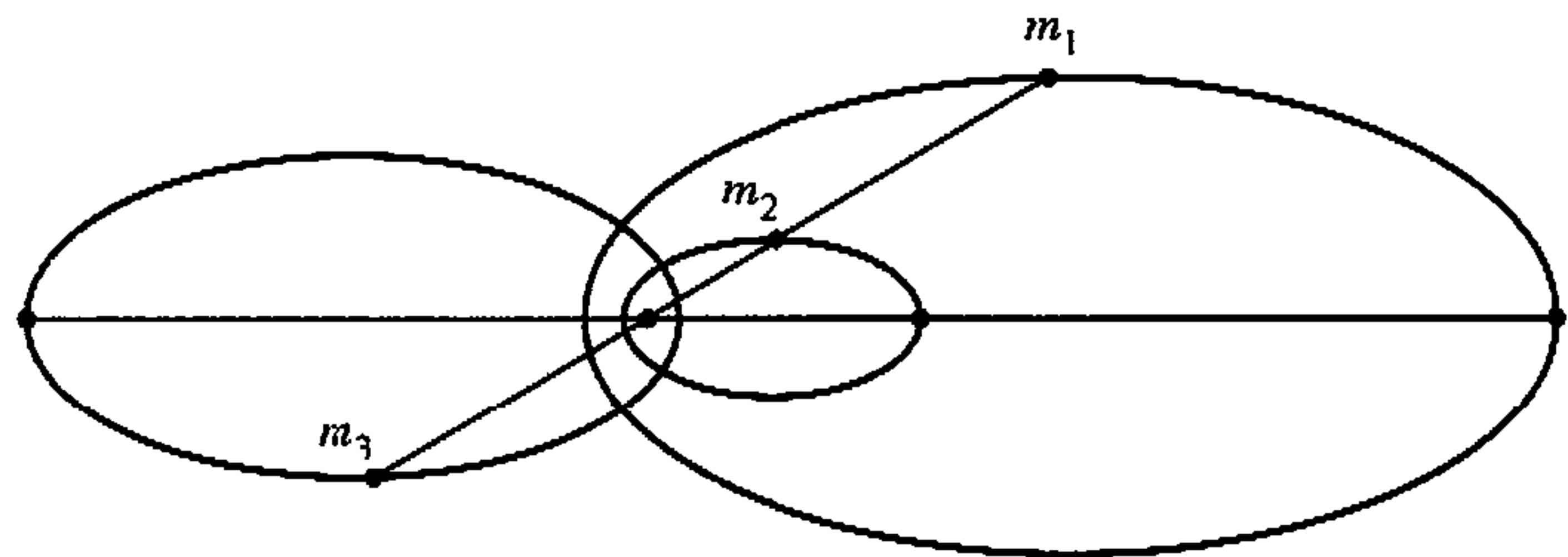

FIGURE 3.28 Euler's collinear solution to the three-body problem for the mass ratio $m_1 < m_2 < m_3$. Three of the dots show aphelion positions. Adapted from Hestenes, *New Foundations for Classical Mechanics*, 1999, Fig. 5.2

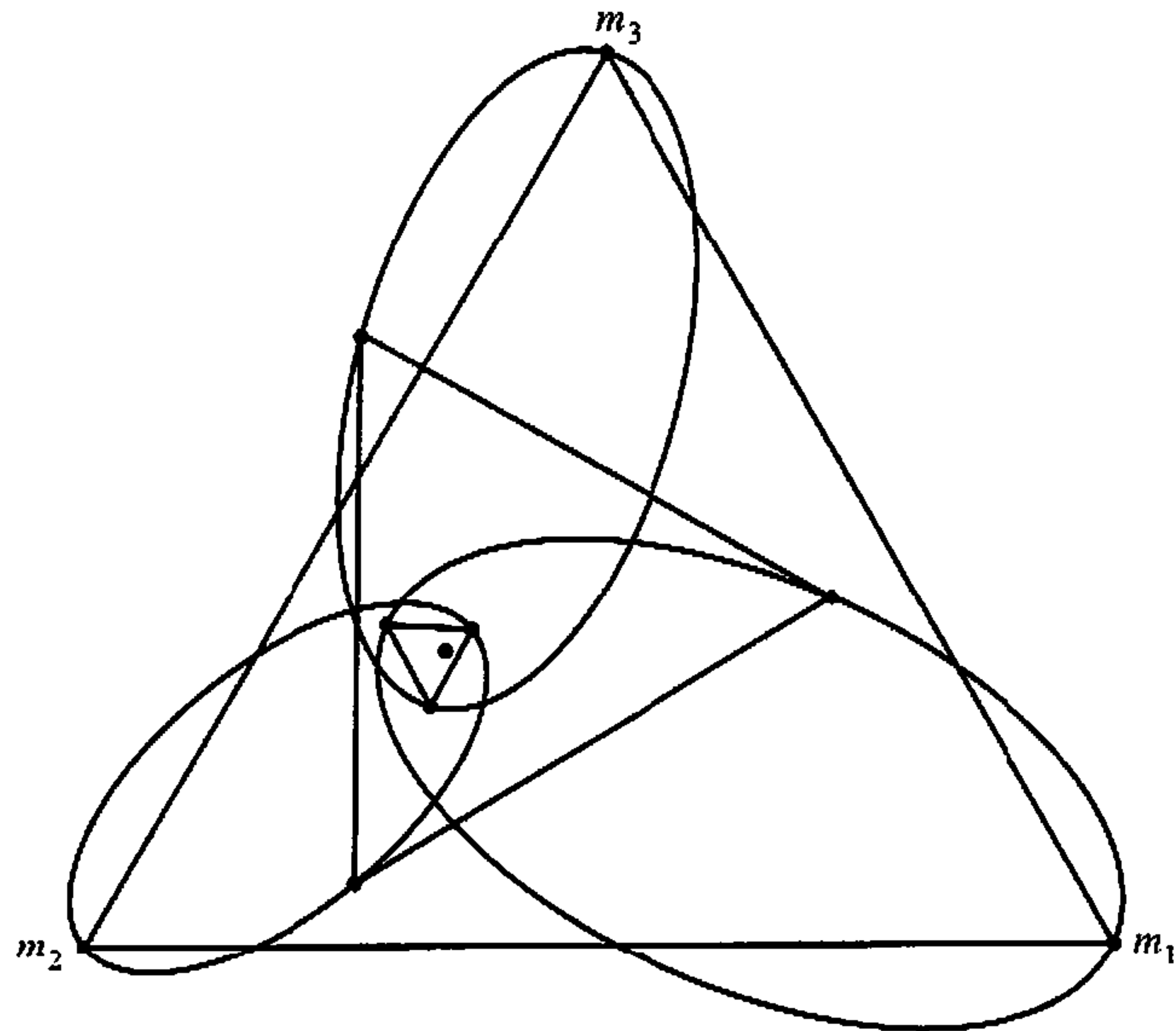

FIGURE 3.29 Lagrange's equilateral triangle solution to the three-body problem for the mass ratio $m_1 < m_2 < m_3$. Adapted from Hestenes, *New Foundations for Classical Mechanics*, 1999, Fig. 53.

masses are at the vertices of an equilateral triangle. As the motion proceeds, the equations remain uncoupled so the equilateral triangle condition continues to be satisfied, but the triangle changes in size and orientation. Figure 3.29 presents Lagrange's elliptic solution case with the same mass ratio as before, $m_1 < m_2 < m_3$. The figure shows the configuration when the masses are close together, each at its respective perihelion point, and also indicates the analogous aphelion arrangement.

Various asymptotic solutions have been worked out for the three-body problem. For example, if the total energy is positive, then all three masses can move away from each other, or one can escape, carrying away most of the energy, and leave the other two behind in elliptic orbits. If the energy is negative, one can escape and leave the other two in a bound state, or all three can move in bound orbits.

The restricted three-body problem is one in which two of the masses are large and bound, and the third is small and merely perturbs the motion of the other two. Examples are a spacecraft in orbit between Earth and the Moon, or the perturbation of the Sun on the Moon's orbit. In the spacecraft case, the first approach is to assume that the Earth and Moon move in their unperturbed orbits, and the satellite interacts with them through their respective inverse-square gravitational forces. We should also note that satellites orbiting Earth at altitudes of 90 miles or 150 kilometers have their orbits perturbed by Earth's nonspherical mass distribution.

A complicating factor in the restricted three-body problem is the distribution of gravitational potential energy in the vicinity of the Earth–Moon system. Close to Earth, we experience a gravitational force directed toward Earth, and close to the Moon, the force is directed toward the Moon. This means that the equipotentials, or curves of constant gravitational energy, are closed curves that encircle the Earth, (m_1) and Moon, (m_2), respectively, as shown in Fig. 3.30. In contrast to this, far from the Earth and Moon, the equipotentials encircle the Earth–Moon pair, as shown in the figure. At some point, called Lagrange point L_2 , along the horizontal line in the figure between the Earth and Moon, the attraction to the two bodies is equal in magnitude and opposite in direction so the force experienced by a small mass placed there is zero. In other words, L_2 is a local potential minimum along this line. More precisely, this point is a saddle point: because the potential energy is a minimum only along the Earth–Moon axis, and decreases in directions perpendicular to this axis. Two other Lagrange points, L_1 and L_3 , along this same axis between the Earth and Moon are located at the transition points between orbits that encircle the Earth and the Moon individually, and orbits that encircle the

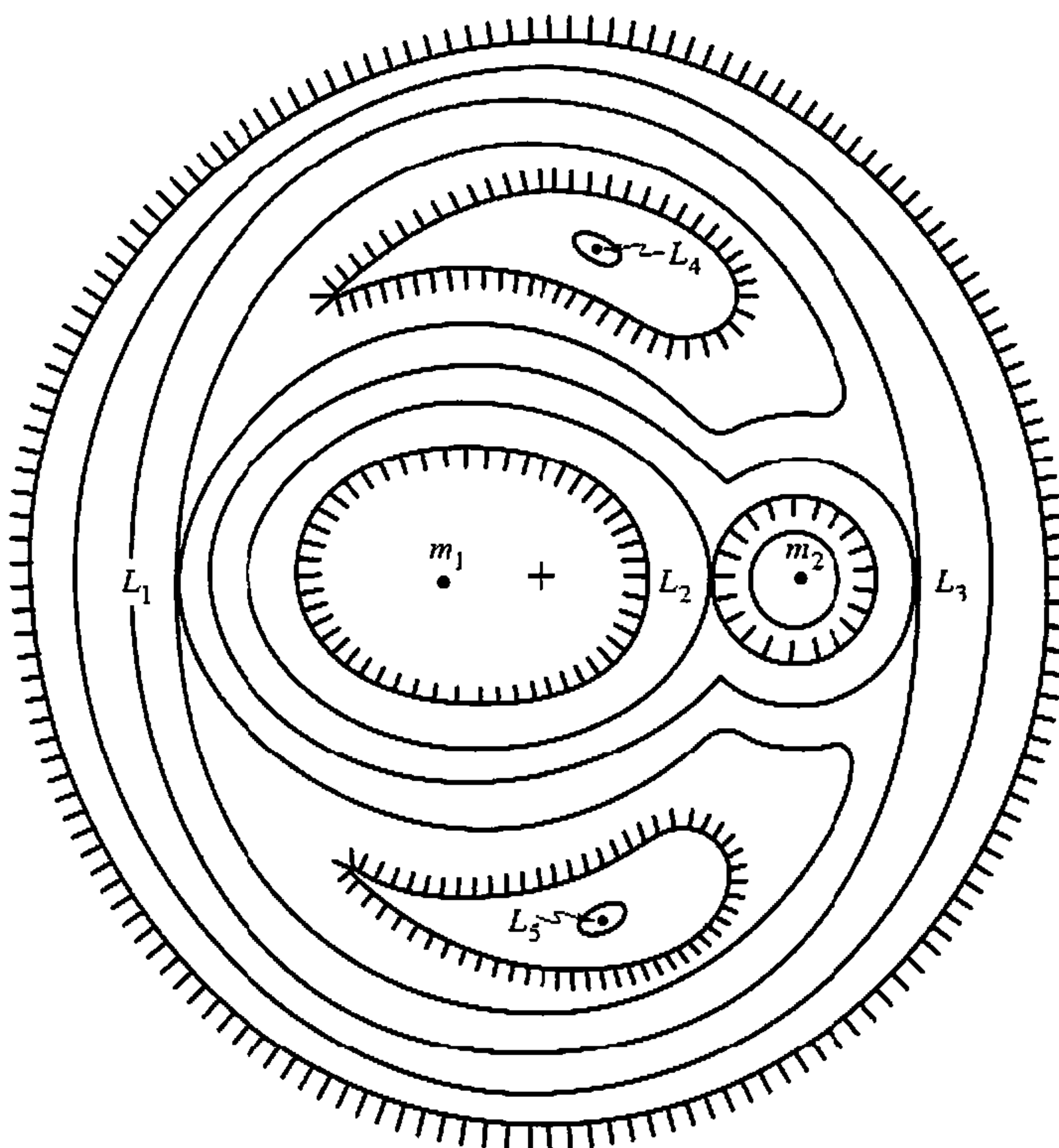

FIGURE 3.30 Contour map of equipotential curves of two masses $m_1 > m_2$ plotted in a reference system rotating with the two masses around each other. From Hestenes, *New Foundations for Classical Mechanics*, 1986, Fig. 5.5.

two together as a pair. These are also saddle points. The fourth and fifth Lagrange points, L_4 and L_5 , which are not collinear with the other three, correspond to local minima in the gravitational potential energy. Masses in the vicinity of these two points experience a force of attraction toward them, and can find themselves in stable elliptical-shaped orbits around them.

We can verify the preceding statements by considering the solutions found in Sections 3.7 and 3.8 for two massive bodies in the center-of-mass frame and asking if there are locations where a small test body will remain at rest relative to the two bodies. By a test body we mean one whose mass is sufficiently small that we can neglect its effect on the motions of the other two bodies. For simplicity, we will limit our attention to the restricted case where the bodies undergo circular motion about the center of mass. The Lagrangian for the motion of the test mass, m , can be written, in general, as

$$L = \frac{1}{2}m(\dot{r}^2 + r^2\dot{\theta}^2) - V(r, \theta, t), \quad (3.125)$$

where $V(r, \theta, t)$ is the time-dependent potential due to the two massive bodies.

As a consequence of the circular motion, the radius vector, \mathbf{r} , between the two bodies is of constant length and rotates with a constant frequency, ω , in the inertial frame. If we go to a coordinate system rotating at the frequency, the two massive bodies appear to be at rest and we can write the Lagrangian in terms of the rotating system by using $\theta' = \theta + \omega t$ as the transformation to the rotating frame. Thus, the Lagrangian in the rotating coordinates can be written in terms of the cylindrical coordinates, ρ , $\theta = \theta' - \omega t$, and z , with ρ being the distance from the center of mass and θ the counterclockwise angle from the line joining the two masses shown in Fig. 3.30. So

$$L = \frac{1}{2}m(\dot{\rho}^2 + \rho^2(\dot{\theta}' - \omega)^2 + \dot{z}^2) - V'(\rho, \theta, z), \quad (3.126)$$

or

$$L = \frac{1}{2}m(\dot{\rho}^2 + \rho^2\dot{\theta}'^2 + \dot{z}^2) - \left(m\omega\rho^2\dot{\theta}' - \frac{1}{2}m\rho^2\omega^2 + V'(\rho, \theta, z)\right). \quad (3.127)$$

The fifth and sixth terms are the potentials for the Coriolis effect (cf. Section 4.10) and the centrifugal effect, respectively.

The procedure then is to find the Lagrange equations and look for solutions with the conditions that $\dot{\rho} = \dot{z} = \dot{\theta}' = 0$. The solutions are the five Lagrange points shown in Fig. 3.30. Stability can be determined by investigating the effects of small displacements from these positions using the methods discussed in Chapters 6 and 12. Only L_4 and L_5 are stable.

Even though the L_2 point is not stable against displacements along the line between the masses, it has been useful for studies of the Sun. The L_2 between the Earth and Sun is the approximate location in the 1990s for the solar and heliospheric observatory, SOHO, which orbits the L_2 point in a plane perpendicular to

the Earth–Sun line. The satellite cannot be exactly at the L_2 point, or we could not receive its transmissions against the bright Sun. Small steering rockets correct for the slow drift toward, or away from, L_2 .

DERIVATIONS

1. Consider a system in which the total forces acting on the particles consist of conservative forces \mathbf{F}'_i and frictional forces \mathbf{f}_i proportional to the velocity. Show that for such a system the virial theorem holds in the form

$$\bar{T} = -\frac{1}{2} \overline{\sum_i \mathbf{F}'_i \cdot \mathbf{r}_i},$$

providing the motion reaches a steady state and is not allowed to die down as a result of the frictional forces.

2. By expanding $e \sin \psi$ in a Fourier series in ωt , show that Kepler's equation has the formal solution

$$\psi = \omega t + \sum_{n=1}^{\infty} \frac{2}{n} J_n(ne) \sin \omega t,$$

where J_n is the Bessel function of order n . For small argument, the Bessel function can be approximated in a power series of the argument. Accordingly, from this result derive the first few terms in the expansion of ψ in powers of e .

3. If the difference $\psi - \omega t$ is represented by ρ , Kepler's equation can be written

$$\rho = e \sin(\omega t + \rho).$$

Successive approximations to ρ can be obtained by expanding $\sin \rho$ in a Taylor series in ρ , and then replacing ρ by its expression given by Kepler's equation. Show that the first approximation by ρ is ρ_1 , given by

$$\tan \rho_1 = \frac{e \sin \omega t}{1 - e \cos \omega t},$$

and that the next approximation is found from

$$\sin(\rho_2 - \rho_1) = -e^3 \sin(\omega t + \rho_1)(1 + e \cos \omega t),$$

an expression that is accurate through terms of order e^4 .

4. Show that for repulsive scattering, Eq. (3.96) for the angle of scattering as a function of the impact parameter, s , can be rewritten as

$$\Theta = \pi - 4s \int_0^1 \frac{\rho d\rho}{\sqrt{r_m^2 \left(1 - \frac{V}{E}\right) - s^2(1 - \rho^2)}}.$$

or

$$\Theta = \pi - 4s \int_0^1 \frac{d\rho}{\sqrt{\frac{r_m^2}{\rho^2 E} (V(r_m) - V(r)) + s^2(2 - \rho^2)}},$$

by changing the variable of integration to some function $\rho(r)$. Show that for a repulsive potential the integrand is never singular in the limit $r \rightarrow r_m$. Because of the definite limits of integration, these formulations have advantages for numerical calculations of $\Theta(s)$ and allow naturally for the use of Gauss–Legendre quadrature schemes.

5. Apply the formulation of the preceding exercise to compute numerically $\Theta(s)$ and the differential cross section of $\sigma(\Theta)$ for the repulsive potential

$$V = \frac{V_0}{1+r}$$

and for a total energy $E = 1.2V_0$. It is suggested that 16-point Gauss–Legendre quadrature will give adequate accuracy. Does the scattering exhibit a rainbow?

6. If a repulsive potential drops off monotonically with r , then for energies high compared to $V(r_m)$ the angle of scattering will be small. Under these conditions show that Eq. (3.97) can be manipulated so that the deflection angle is given approximately by

$$\Theta = \frac{1}{E} \int_0^1 \frac{(V(u_m) - V(u)) dy}{(1 - y^2)^{3/2}},$$

where y , obviously, is u/u_m .

Show further, that if $V(u)$ is of the form Cu^n , where n is a positive integer, then in the high-energy limit the cross section is proportional to $\Theta^{-2(1+1/n)}$.

7. (a) Show that the angle of recoil of the target particle relative to the incident direction of the scattered particle is simply $\Phi = \frac{1}{2}(\pi - \Theta)$.
 (b) It is observed that in elastic scattering the scattering cross section is isotropic in terms of Θ . What are the corresponding probability distributions for the scattered energy of the incident particle, E_1 , and for the recoil energy of the target particle, E_2 ?
 8. Show that the angle of scattering in the laboratory system, ϑ , is related to the energy before scattering, E_0 , and the energy after scattering E_1 , according to the equation

$$\cos \vartheta = \frac{m_2 + m_1}{2m_1} \sqrt{\frac{E_1}{E_0}} - \frac{m_2 - m_1}{2m_1} \sqrt{\frac{E_0}{E_1}} + \frac{m_2 Q}{2m_1 \sqrt{E_0 E_1}}.$$

9. Show that the central force problem is soluble in terms of elliptic functions when the force is a power-law function of the distance with the following fractional exponents:

$$n = -\frac{3}{2}, -\frac{5}{2}, -\frac{1}{3}, -\frac{5}{3}, -\frac{7}{3}.$$

EXERCISES

10. A planet of mass M is in an orbit of eccentricity $e = 1 - \alpha$ where $\alpha \ll 1$, about the Sun. Assume the motion of the Sun can be neglected and that only gravitational forces act. When the planet is at its greatest distance from the Sun, it is struck by a comet of mass m , where $m \ll M$ traveling in a tangential direction. Assuming the collision is completely inelastic, find the minimum kinetic energy the comet must have to change the new orbit to a parabola.
11. Two particles move about each other in circular orbits under the influence of gravitational forces, with a period τ . Their motion is suddenly stopped at a given instant of time, and they are then released and allowed to fall into each other. Prove that they collide after a time $\tau/4\sqrt{2}$.
12. Suppose that there are long-range interactions between atoms in a gas in the form of central forces derivable from a potential

$$U(r) = \frac{k}{r^m},$$

where r is the distance between any pair of atoms and m is a positive integer. Assume further that relative to any given atom the other atoms are distributed in space such that their volume density is given by the Boltzmann factor:

$$\rho(r) = \frac{N}{V} e^{-U(r)/kT},$$

where N is the total number of atoms in a volume V . Find the addition to the virial of Clausius resulting from these forces between pairs of atoms, and compute the resulting correction to Boyle's law. Take N so large that sums may be replaced by integrals. While closed results can be found for any positive m , if desired, the mathematics can be simplified by taking $m = +1$.

13. (a) Show that if a particle describes a circular orbit under the influence of an attractive central force directed toward a point on the circle, then the force varies as the inverse-fifth power of the distance.
- (b) Show that for the orbit described the total energy of the particle is zero.
- (c) Find the period of the motion.
- (d) Find \dot{x} , \dot{y} , and v as a function of angle around the circle and show that all three quantities are infinite as the particle goes through the center of force.
14. (a) For circular and parabolic orbits in an attractive $1/r$ potential having the same angular momentum, show that the perihelion distance of the parabola is one-half the radius of the circle.
- (b) Prove that in the same central force as in part (a) the speed of a particle at any point in a parabolic orbit is $\sqrt{2}$ times the speed in a circular orbit passing through the same point.
15. A meteor is observed to strike Earth with a speed v , making an angle ϕ with the zenith. Suppose that far from Earth the meteor's speed was v' and it was proceeding in a direction making a zenith angle ϕ' , the effect of Earth's gravity being to pull it into

a hyperbolic orbit intersecting Earth's surface. Show how v' and ϕ' can be determined from v and ϕ in terms of known constants.

16. Prove that in a Kepler elliptic orbit with small eccentricity e the angular motion of a particle as viewed from the *empty* focus of the ellipse is uniform (the empty focus is the focus that is *not* the center of attraction) to first order in e . It is this theorem that enables the Ptolemaic picture of planetary motion to be a reasonably accurate approximation. On this picture the Sun is assumed to move uniformly on a circle whose center is shifted from Earth by a distance called the *equant*. If the equant is taken as the distance between the two foci of the correct elliptical orbit, then the angular motion is thus described by the Ptolemaic picture accurately to first order in e .
17. One classic theme in science fiction is a twin planet ("Planet X") to Earth that is identical in mass, energy, and momentum but is located on the orbit 90° out of phase with Earth so that it is hidden from the Sun. However, because of the elliptical nature of the orbit, it is not always completely hidden. Assume this twin planet is in the same Keplerian orbit as Earth in such a manner that it is in aphelion when Earth is in perihelion. Calculate to first order in the eccentricity e the maximum angular separation of the twin and the Sun as viewed from the Earth. Could such a twin be visible from Earth? Suppose the twin planet is in an elliptical orbit having the same size and shape as that of Earth, but rotated 180° from Earth's orbit, so that Earth and the twin are in perihelion at the same time. Repeat your calculation and compare the visibility in the two situations.
18. At perigee of an elliptic gravitational orbit a particle experiences an impulse S (cf. Exercise 11, Chapter 2) in the radial direction, sending the particle into another elliptic orbit. Determine the new semimajor axis, eccentricity, and orientation in terms of the old
19. A particle moves in a force field described by

$$F(r) = -\frac{k}{r^2} \exp\left(-\frac{r}{a}\right),$$

where k and a are positive.

- (a) Write the equations of motion and reduce them to the equivalent one-dimensional problem. Use the effective potential to discuss the qualitative nature of the orbits for different values of the energy and the angular momentum.
- (b) Show that if the orbit is nearly circular, the apsides will advance approximately by $\pi\rho/a$ per revolution, where ρ is the radius of the circular orbit.
20. A uniform distribution of dust in the solar system adds to the gravitational attraction of the Sun on a planet an additional force

$$\mathbf{F} = -mC\mathbf{r},$$

where m is the mass of the planet, C is a constant proportional to the gravitational constant and the density of the dust, and \mathbf{r} is the radius vector from the Sun to the planet (both considered as points). This additional force is very small compared to the direct Sun-planet gravitational force.

- (a) Calculate the period for a circular orbit of radius r_0 of the planet in this combined field.
- (b) Calculate the period of radial oscillations for slight disturbances from this circular orbit.
- (c) Show that nearly circular orbits can be approximated by a precessing ellipse and find the precession frequency. Is the precession in the same or opposite direction to the orbital angular velocity?

21. Show that the motion of a particle in the potential field

$$V(r) = -\frac{k}{r} + \frac{h}{r^2}$$

is the same as that of the motion under the Kepler potential alone when expressed in terms of a coordinate system rotating or precessing around the center of force.

For negative total energy, show that if the additional potential term is very small compared to the Kepler potential, then the angular speed of precession of the elliptical orbit is

$$\dot{\Omega} = \frac{2\pi mh}{l^2 \tau}$$

The perihelion of Mercury is observed to precess (after correction for known planetary perturbations) at the rate of about $40''$ of arc per century. Show that this precession could be accounted for classically if the dimensionless quantity

$$\eta = \frac{h}{ka}$$

(which is a measure of the perturbing inverse-square potential relative to the gravitational potential) were as small as 7×10^{-8} . (The eccentricity of Mercury's orbit is 0.206, and its period is 0.24 year.)

- 22. The additional term in the potential behaving as r^{-2} in Exercise 21 looks very much like the centrifugal barrier term in the equivalent one-dimensional potential. Why is it then that the additional force term causes a precession of the orbit, while an addition to the barrier, through a change in l , does not?
- 23. Evaluate approximately the ratio of mass of the Sun to that of Earth, using only the lengths of the year and of the lunar month (27.3 days), and the mean radii of Earth's orbit (1.49×10^8 km) and of the Moon's orbit (3.8×10^5 km).
- 24. Show that for elliptical motion in a gravitational field the radial speed can be written as

$$\dot{r} = \frac{\omega a}{r} \sqrt{a^2 e^2 - (r - a)^2}$$

Introduce the eccentric anomaly variable ψ in place of r and show that the resulting differential equation in ψ can be integrated immediately to give Kepler's equation.

- 25. If the eccentricity e is small, Kepler's equation for the eccentric anomaly ψ as a function of ωt , Eq. (3.76), is easily solved on a computer by an iterative technique that treats the $e \sin \psi$ term as of lower order than ψ . Denoting ψ_n by the n th iterative

solution, the obvious iteration relation is

$$\psi_n = \omega t + e \sin \psi_{n-1}.$$

Using this iteration procedure, find the analytic form for an expansion of ψ in powers of e at least through terms in e^3 .

26. Earth's period between successive perihelion transits (the "anomalous year") is 365.2596 mean solar days, and the eccentricity of its orbit is 0.0167504. Assuming motion in a Keplerian elliptical orbit, how far does the Earth move in angle in the orbit, starting from perihelion, in a time equal to one-quarter of the anomalous year? Give your result in degrees to an accuracy of one second of arc or better. Any method may be used, including numerical computation with a calculator or computer.
27. In hyperbolic motion in a $1/r$ potential, the analogue of the eccentric anomaly is F defined by

$$r = a(e \cosh F - 1),$$

where $a(e - 1)$ is the distance of closest approach. Find the analogue to Kepler's equation giving t from the time of closest approach as a function of F .

28. A *magnetic monopole* is defined (if one exists) by a magnetic field singularity of the form $\mathbf{B} = b\mathbf{r}/r^3$, where b is a constant (a measure of the magnetic charge, as it were). Suppose a particle of mass m moves in the field of a magnetic monopole and a central force field derived from the potential $V(r) = -k/r$.
- (a) Find the form of Newton's equation of motion, using the Lorentz force given by Eq. (1.60). By looking at the product $\mathbf{r} \times \dot{\mathbf{p}}$ show that while the mechanical angular momentum is not conserved (the field of force is noncentral) there is a conserved vector

$$\mathbf{D} = \mathbf{L} - \frac{qb}{c} \frac{\mathbf{r}}{r}.$$

- (b) By paralleling the steps leading from Eq. (3.79) to Eq. (3.82), show that for some $f(r)$ there is a conserved vector analogous to the Laplace-Runge-Lenz vector in which \mathbf{D} plays the same role as \mathbf{L} in the pure Kepler force problem.
29. If all the momentum vectors of a particle along its trajectory are translated so as to start from the center of force, then the heads of the vectors trace out the particle's *hodograph*, a locus curve of considerable antiquity in the history of mechanics, with something of a reviva in connection with space vehicle dynamics. By taking the cross product of \mathbf{L} with the Laplace-Runge-Lenz vector \mathbf{A} , show that the hodograph for elliptical Kepler motion is a circle of radius mk/l with origin on the y axis displaced a distance A/l from the center of force.
30. What changes, if any, would there be in Rutherford scattering if the Coulomb force were attractive, instead of repulsive?
31. Examine the scattering produced by a repulsive central force $f = kr^{-3}$. Show that the differential cross section is given by

$$\sigma(\Theta) d\Theta = \frac{k}{2E} \frac{(1-x) dx}{x^2(2-x)^2 \sin \pi x},$$

where x is the ratio of Θ/π and E is the energy.

32. A central force potential frequently encountered in nuclear physics is the *rectangular well*, defined by the potential

$$\begin{aligned} V &= 0 & r > a \\ &= -V_0 & r \leq a. \end{aligned}$$

Show that the scattering produced by such a potential in classical mechanics is identical with the refraction of light rays by a sphere of radius a and relative index of refraction

$$n = \sqrt{\frac{E + V_0}{E}}.$$

(This equivalence demonstrates why it was possible to explain refraction phenomena both by Huygen's waves and by Newton's mechanical corpuscles.) Show also that the differential cross section is

$$\sigma(\Theta) = \frac{n^2 a^2}{4 \cos \frac{\Theta}{2}} \frac{(n \cos \frac{\Theta}{2} - 1)(n - \cos \frac{\Theta}{2})}{(1 + n^2 - 2n \cos \frac{\Theta}{2})^2}$$

What is the total cross section?

33. A particle of mass m is constrained to move under gravity without friction on the inside of a paraboloid of revolution whose axis is vertical. Find the one-dimensional problem equivalent to its motion. What is the condition on the particle's initial velocity to produce circular motion? Find the period of small oscillations about this circular motion.
34. Consider a truncated repulsive Coulomb potential defined as

$$\begin{aligned} V &= \frac{k}{r} & r > a \\ &= \frac{k}{a} & r \leq a. \end{aligned}$$

For a particle of total energy $E > k/a$, obtain expressions for the scattering angle Θ as a function of s/s_0 , where s_0 is the impact parameter for which the periapsis occurs at the point $r = a$. (The formulas can be given in closed form but they are not simple!) Make a numerical plot of Θ versus s/s_0 for the special case $E = 2k/a$. What can you deduce about the angular scattering cross section from the dependence of Θ on s/s_0 for this particular case?

35. Another version of the truncated Coulomb potential has the form

$$\begin{aligned} V &= \frac{k}{r} - \frac{k}{a} & r > a \\ &= 0 & r < a. \end{aligned}$$

Obtain closed-form expressions for the scattering angle and the differential scattering cross section. These are most conveniently expressed in terms of a parameter measuring the distance of closest approach in units of a . What is the total cross section?

- 36.** The restricted three-body problem consists of two masses in circular orbits about each other and a third body of much smaller mass whose effect on the two larger bodies can be neglected.
- (a) Define an effective potential $V(x, y)$ for this problem where the x axis is the line of the two larger masses. Sketch the function $V(x, 0)$ and show that there are two “valleys” (points of stable equilibrium) corresponding to the two masses. Also show that there are three “hills” (three points of unstable equilibrium).
 - (b) Using a computer program, calculate some orbits for the restricted three-body problem. Many orbits will end with ejection of the smaller mass. Start by assuming a position and a vector velocity for the small mass.

CHAPTER

4

The Kinematics of Rigid Body Motion

A rigid body was defined previously as a system of mass points subject to the holonomic constraints that the distances between all pairs of points remain constant throughout the motion. Although something of an idealization, the concept is quite useful, and the mechanics of rigid body motion deserves a full exposition. In this chapter we shall discuss principally the *kinematics* of rigid bodies, i.e., the nature and characteristics of their motions. We devote some time to developing the mathematical techniques involved, which are of considerable interest in themselves, and have many important applications to other fields of physics.

Of essential importance is the rotational motion of a rigid body. These considerations lead directly to the relation between the time rate of change of a vector in an inertial frame and the time rate of change of the same vector in a rotating frame. Since it is appropriate at that point, we leave kinematics and develop the description of the dynamics of motion in a rotating frame. In the next chapter we discuss, using the Lagrangian formulation, how the motion of extended objects is generated by applied forces and torques.

4.1 ■ THE INDEPENDENT COORDINATES OF A RIGID BODY

Before discussing the motion of a rigid body, we must first establish how many independent coordinates are necessary to specify its configuration. From experience, we expect that there should be six independent coordinates. Three external coordinates are needed to specify the position of some reference point in the body and three more to specify how the body is oriented with respect to the external coordinates. In this section we show that these intuitive expectations are correct.

A rigid body with N particles can at most have $3N$ degrees of freedom, but these are greatly reduced by the constraints, which can be expressed as equations of the form

$$r_{ij} = c_{ij}. \quad (4.1)$$

Here r_{ij} is the distance between the i th and j th particles and the c 's are constants. The actual number of degrees of freedom cannot be obtained simply by subtracting the number of constraint equations from $3N$, for there are $\frac{1}{2}N(N-1)$ possible equations of the form of Eq. (4.1), which is far greater than $3N$ for large N . In truth, the Eqs. (4.1) are not all independent.

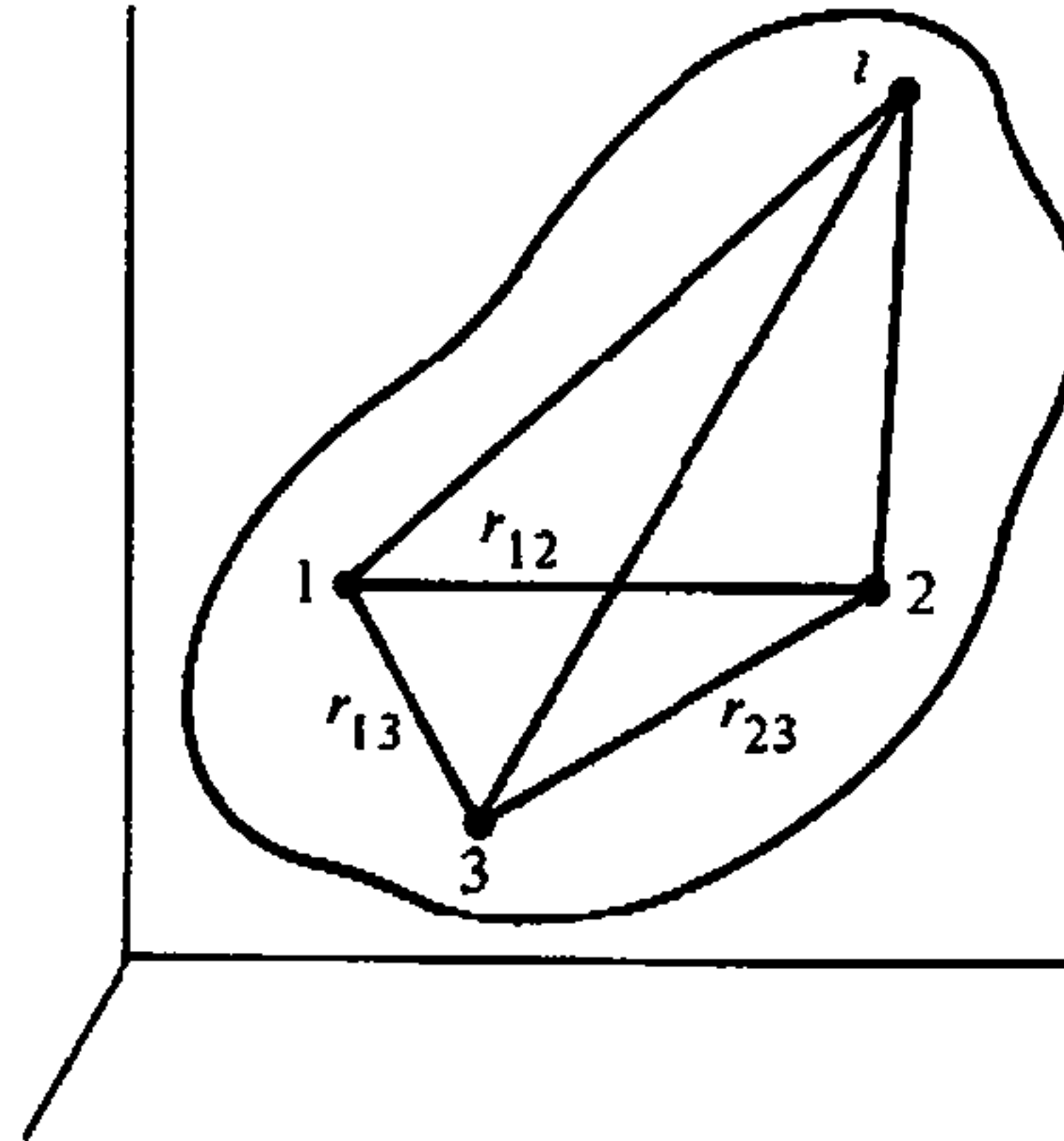

FIGURE 4.1 The location of a point in a rigid body by its distances from three reference points.

To fix a point in the rigid body, it is not necessary to specify its distances to *all* other points in the body; we need only state the distances to any three other noncollinear points (cf. Fig. 4.1). Thus, once the positions of three of the particles of the rigid body are determined, the constraints fix the positions of all remaining particles. The number of degrees of freedom therefore cannot be more than nine. But the three reference points are themselves not independent; there are in fact three equations of rigid constraint imposed on them,

$$r_{12} = c_{12}, \quad r_{23} = c_{23}, \quad r_{13} = c_{13},$$

that reduce the number of degrees of freedom to *six*. That only six coordinates are needed can also be seen from the following considerations. To establish the position of one of the reference points, three coordinates must be supplied. But once point 1 is fixed, point 2 can be specified by only two coordinates, since it is constrained to move on the surface of a sphere centered at point 1. With these two points determined, point 3 has only one degree of freedom, for it can only rotate about the axis joining the other two points. Hence, a total of six coordinates is sufficient.

A rigid body in space thus needs six independent generalized coordinates to specify its configuration, no matter how many particles it may contain—even in the limit of a continuous body. Of course, there may be additional constraints on the body besides the constraint of rigidity. For example, the body may be constrained to move on a surface, or with one point fixed. In such case, the additional constraints will further reduce the number of degrees of freedom, and hence the number of independent coordinates.

How shall these coordinates be assigned? Note that the set of configuration of a rigid body is completely specified by locating a Cartesian set of coordinates

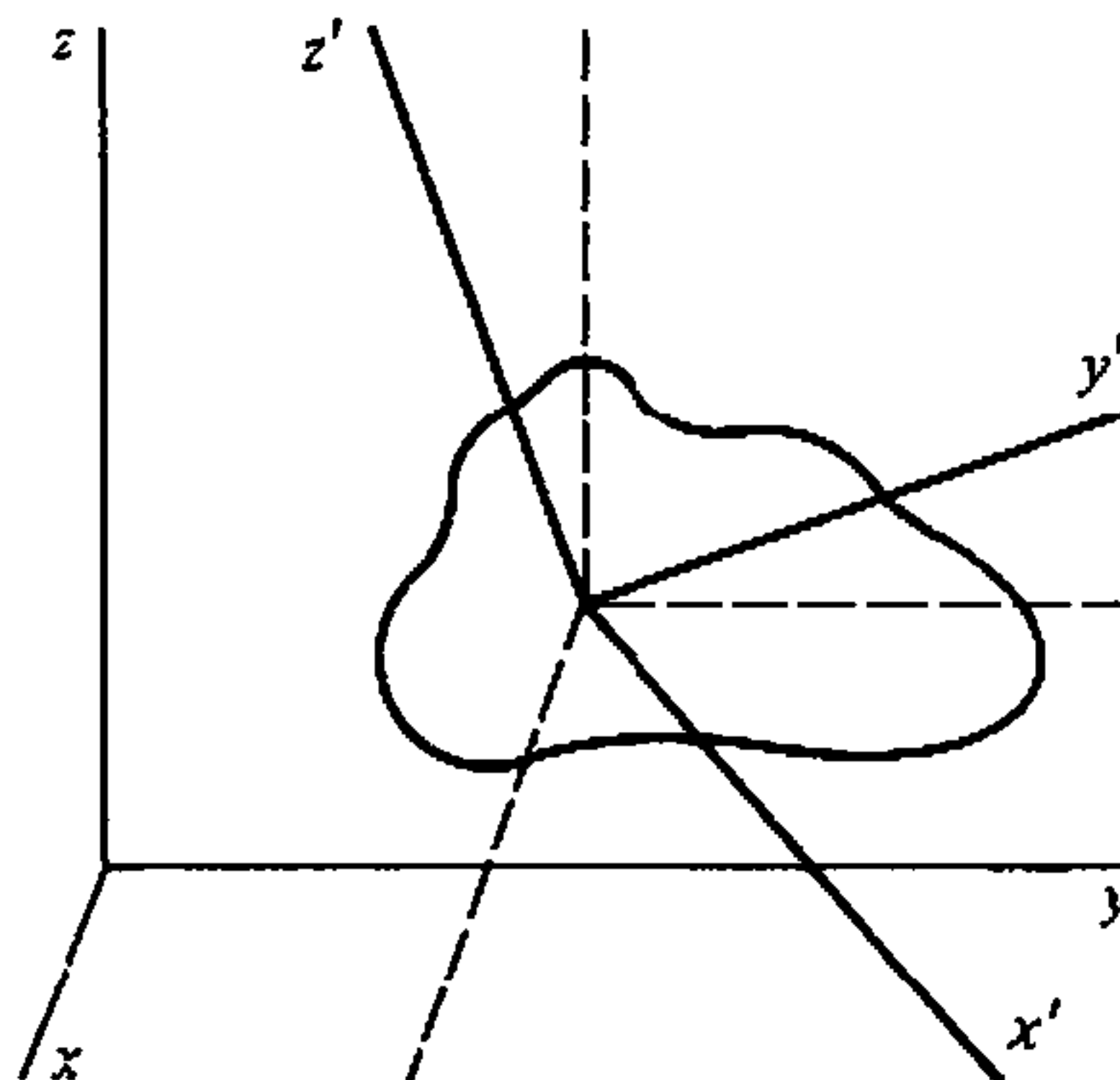

FIGURE 4.2 Unprimed axes represent an external reference set of axes; the primed axes are fixed in the rigid body.

fixed in the rigid body (the primed axes shown in Fig. 4.2) relative to the coordinate axes of the external space. Clearly three of the coordinates are needed to specify the coordinates of the origin of this “body” set of axes. The remaining three coordinates must then specify the orientation of the primed axes relative to a coordinate system parallel to the external axes, but with the same origin as the primed axes.

There are many ways of specifying the orientation of a Cartesian set of axes relative to another set with common origin. One fruitful procedure is to state the direction cosines of the primed axes relative to the unprimed. Thus, the x' axis could be specified by its three direction cosines $\alpha_1, \alpha_2, \alpha_3$, with respect to the x, y, z axes. If, as customary, $\mathbf{i}, \mathbf{j}, \mathbf{k}$ are three unit vectors along x, y, z , and $\mathbf{i}', \mathbf{j}', \mathbf{k}'$ perform the same function in the primed system (cf. Fig. 4.3), then these direction cosines are defined as

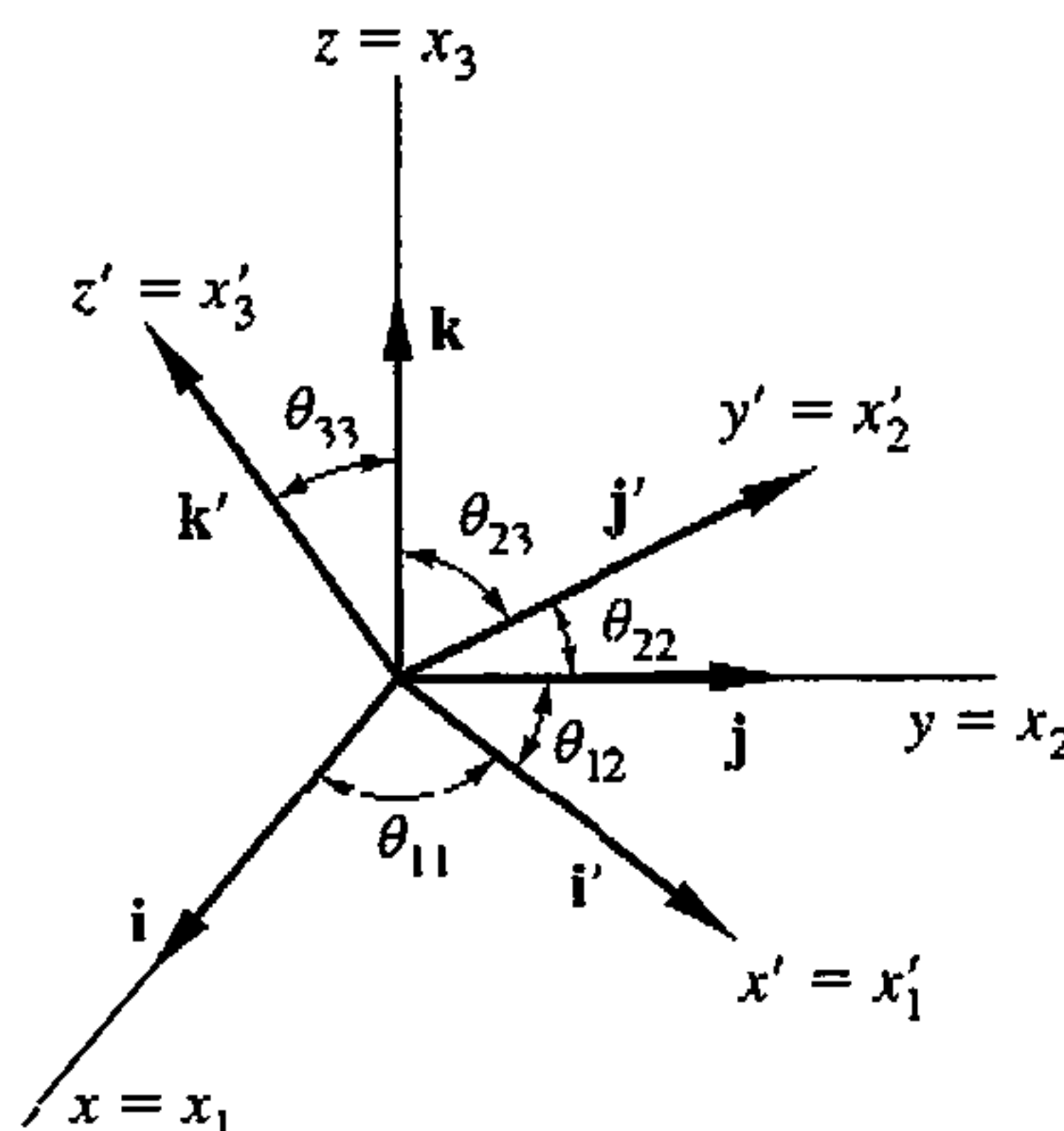

FIGURE 4.3 Direction cosines of the body set of axes relative to an external set of axes.

$$\begin{aligned}
\cos \theta_{11} &= \cos(\mathbf{i}' \cdot \mathbf{i}) = \mathbf{i}' \cdot \mathbf{i} = \mathbf{i} \cdot \mathbf{i}' \\
\cos \theta_{12} &= \cos(\mathbf{i}' \cdot \mathbf{j}) = \mathbf{i}' \cdot \mathbf{j} = \mathbf{j} \cdot \mathbf{i}' \\
\cos \theta_{21} &= \cos(\mathbf{j}' \cdot \mathbf{i}) = \mathbf{j}' \cdot \mathbf{i} = \mathbf{i} \cdot \mathbf{j}' \\
\cos \theta_{22} &= \cos(\mathbf{j}' \cdot \mathbf{j}) = \mathbf{j}' \cdot \mathbf{j} = \mathbf{j} \cdot \mathbf{j}'
\end{aligned} \tag{4.2}$$

and similarly for $\cos \theta_{13}$, $\cos \theta_{31}$, etc. Note that the angle θ_{ij} is defined so that the first index refers to the primed system and the second index to the unprimed system. These direction cosines can also be used to express the unit vector in the primed system in terms of the unit vectors of the unprimed system giving

$$\begin{aligned}
\mathbf{i}' &= \cos \theta_{11} \mathbf{i} + \cos \theta_{12} \mathbf{j} + \cos \theta_{13} \mathbf{k} \\
\mathbf{j}' &= \cos \theta_{21} \mathbf{i} + \cos \theta_{22} \mathbf{j} + \cos \theta_{23} \mathbf{k} \\
\mathbf{k}' &= \cos \theta_{31} \mathbf{i} + \cos \theta_{32} \mathbf{j} + \cos \theta_{33} \mathbf{k}.
\end{aligned} \tag{4.3}$$

These sets of nine direction cosines then completely specify the orientation of the x' , y' , z' axes relative to the x , y , z set. We can equally well invert the process, and use the direction cosines to express the \mathbf{i} , \mathbf{j} , \mathbf{k} unit vectors in terms of their components along the primed axes. Thus, we can write

$$\mathbf{r} = x\mathbf{i} + y\mathbf{j} + z\mathbf{k} = x'\mathbf{i}' + y'\mathbf{j}' + z'\mathbf{k}' \tag{4.4}$$

by

$$\begin{aligned}
x' &= (\mathbf{r} \cdot \mathbf{i}') = \cos \theta_{11}x + \cos \theta_{12}y + \cos \theta_{13}z \\
y' &= (\mathbf{r} \cdot \mathbf{j}') = \cos \theta_{21}x + \cos \theta_{22}y + \cos \theta_{23}z \\
z' &= (\mathbf{r} \cdot \mathbf{k}') = \cos \theta_{31}x + \cos \theta_{32}y + \cos \theta_{33}z
\end{aligned} \tag{4.5}$$

with analogous equations for \mathbf{i} , \mathbf{j} and \mathbf{k} .

The direction cosines also furnish directly the relations between the coordinates of a given point in one system and the coordinates in the other system. Thus, the coordinates of a point in a given reference frame are the components of the position vector, \mathbf{r} , along the primed and unprimed axes of the system, respectively. The primed coordinates are then given in terms of x , y , and z , as shown in Eq. (4.5). What has been done here for the components of the \mathbf{r} vector can obviously be done for any arbitrary vector. If \mathbf{G} is some vector, then the component of \mathbf{G} along the x' axis will be related to its x -, y -, z -components by

$$G_{x'} = \mathbf{G} \cdot \mathbf{i}' = \cos \theta_{11}G_x + \cos \theta_{12}G_y + \cos \theta_{13}G_z, \tag{4.6}$$

and so on. The set of nine direction cosines thus completely spells out the transformation between the two coordinate systems.

If the primed axes are taken as fixed in the body, then the nine direction cosines will be functions of time as the body changes its orientation in the course of the

motion. In this sense, the direction cosines can be considered as coordinates describing the instantaneous orientation of the body, relative to a coordinate system fixed in space but with origin in common with the body system. But, clearly, they are not independent coordinates, for there are nine of them and it has been shown that only three coordinates are needed to specify an orientation.

The connections between the direction cosines arise from the fact that the basis vectors in both coordinate systems are orthogonal to each other and have unit magnitude; in symbols,

$$\begin{aligned} \mathbf{i} \cdot \mathbf{j} &= \mathbf{j} \cdot \mathbf{k} = \mathbf{k} \cdot \mathbf{i} = 0, \\ \mathbf{i} \cdot \mathbf{i} &= \mathbf{j} \cdot \mathbf{j} = \mathbf{k} \cdot \mathbf{k} = 1, \end{aligned} \quad (4.7)$$

with similar relations for \mathbf{i}' , \mathbf{j}' , and \mathbf{k}' . We can obtain the conditions satisfied by the nine coefficients by forming all possible dot products among the three equations for \mathbf{i} , \mathbf{j} , and \mathbf{k} in terms of \mathbf{i}' , \mathbf{j}' , and \mathbf{k}' (as in Eq. (4.4)), making use of the Eqs. (4.7):

$$\begin{aligned} \sum_{l=1}^3 \cos \theta_{lm'} \cos \theta_{lm} &= 0 \quad m \neq m' \\ \sum_{l=1}^3 \cos^2 \theta_{lm} &= 1. \end{aligned} \quad (4.8)$$

These two sets of three equations each are exactly sufficient to reduce the number of independent quantities from nine to three. Formally, the six equations can be combined into one by using the Kronecker δ -symbol δ_{lm} , defined by

$$\begin{aligned} \delta_{lm} &= 1 \quad l = m \\ &= 0 \quad l \neq m. \end{aligned}$$

Equations (4.8) can then be written as

$$\sum_{l=1}^3 \cos \theta_{lm'} \cos \theta_{lm} = \delta_{m'm} \quad (4.9)$$

It is therefore not possible to set up a Lagrangian and subsequent equations of motion with the nine direction cosines as generalized coordinates. For this purpose, we must use some set of three independent functions of the direction cosines. A number of such sets of independent variables will be described later, the most important being the Euler angles. The use of direction cosines to describe the connections between two Cartesian coordinate systems nevertheless has a number of important advantages. With their aid, many of the theorems about the motion of rigid bodies can be expressed with great elegance and generality, and in a form naturally leading to the procedures used in special relativity and quantum mechanics. Such a mode of description therefore merits an extended discussion here.

4.2 ■ ORTHOGONAL TRANSFORMATIONS

To study the properties of the nine direction cosines with greater ease, it is convenient to change the notation and denote all coordinates by x , distinguishing the axes by subscripts:

$$\begin{aligned}x &\rightarrow x_1 \\y &\rightarrow x_2 \\z &\rightarrow x_3\end{aligned}\tag{4.10}$$

as shown in Fig. 4.3. We also change the notation for the direction cosines to

$$a_{ij} = \cos \theta_{ij}\tag{4.11}$$

Equations (4.5) and (4.6) constitute a group of transformation equations from a set of coordinates x_1, x_2, x_3 to a new set x'_1, x'_2, x'_3 . In particular, they form an example of a *linear* or *vector* transformation, defined by transformation equations of the form

$$\begin{aligned}x'_1 &= a_{11}x_1 + a_{12}x_2 + a_{13}x_3 \\x'_2 &= a_{21}x_1 + a_{22}x_2 + a_{23}x_3 \\x'_3 &= a_{31}x_1 + a_{32}x_2 + a_{33}x_3,\end{aligned}\tag{4.12}$$

where the a_{11}, a_{12}, \dots , are any set of constant (independent of x, x') coefficients.* To simplify the appearance of many of the expressions, we will also make use of the summation convention first introduced by Einstein: Whenever an index occurs two or more times in a term, it is implied, without any further symbols, that the terms are to be summed over all possible values of the index. Thus, Eqs. (4.12) can be written most compactly in accordance with this convention as

$$x'_i = a_{ij}x_j, \quad i = 1, 2, 3.\tag{4.12'}$$

The repeated appearance of the index j indicates that the left-hand side of Eq. (4.12') is a sum over the dummy index j for all possible values (here, $j = 1, 2, 3$). Some ambiguity is possible where powers of an indexed quantity occur, and for that reason, an expression such as

$$\sum_i x_i^2$$

appears under the summation convention as

$$x_i x_i.$$

*Equations (4.12) of course are not the most general set of transformation equations, cf., for example, those from the r 's to the q 's (1-38).

For the rest of the book the summation convention should be automatically assumed in reading the equations unless otherwise explicitly indicated. Where convenient, or to remove ambiguity, the summation sign may be occasionally displayed explicitly, e.g., when certain values of the index are to be excluded from the summation.

The transformation represented by Eqs. (4.11) is only a special case of the general linear transformation, Eqs. (4.12), since the direction cosines are not all independent. The connections between the coefficients, Eqs. (4.8) are rederived here in terms of the newer notation. Since both coordinate systems are Cartesian, the magnitude of a vector is given in terms of the sum of squares of the components. Further, since the actual vector remains unchanged no matter which coordinate system is used, the magnitude of the vector must be the same in both systems. In symbols, we can state the invariance of the magnitude as

$$x'_i x'_i = x_i x_i. \quad (4.13)$$

The left-hand side of Eq. (4.13) is therefore

$$a_{ij} a_{ik} x_j x_k,$$

and it will reduce to the right-hand side of Eq. (4.13), if, and only if

$$\begin{aligned} a_{ij} a_{ik} &= 1 & j &= k \\ &= 0 & j &\neq k, \end{aligned} \quad (4.14)$$

or, in a more compact form, if

$$a_{ij} a_{ik} = \delta_{jk}, \quad j, k = 1, 2, 3. \quad (4.15)$$

When the a_{ij} coefficients are expressed in terms of the direction cosines, the six equations contained in Eq. (4.15) become identical with the Eqs. (4.9).

Any linear transformation, Eq. (4.12), that has the properties required by Eq. (4.15) is called an *orthogonal* transformation, and Eq. (4.15) itself is known as the *orthogonality condition*. Thus, the transition from coordinates fixed in space to coordinates fixed in the rigid body (with common origin) is accomplished by means of an orthogonal transformation. The array of transformation quantities (the direction cosines), written as

$$\begin{bmatrix} a_{11} & a_{12} & a_{13} \\ a_{21} & a_{22} & a_{23} \\ a_{31} & a_{32} & a_{33} \end{bmatrix}, \quad (4.16)$$

is called the *matrix of transformation*, and will be denoted by a capital letter **A**. The quantities a_{ij} are correspondingly known as the *matrix elements* of the transformation.

To make these formal considerations more meaningful, consider the simple example of motion in a plane, so that we are restricted to two-dimensional rotations,

and the transformation matrix reduces to the form

$$\begin{bmatrix} a_{11} & a_{12} & 0 \\ a_{21} & a_{22} & 0 \\ 0 & 0 & 1 \end{bmatrix}.$$

The four matrix elements, a_{ij} , are connected by three orthogonality conditions:

$$a_{ij}a_{ik} = \delta_{jk}, \quad j, k = 1, 2,$$

and therefore only one independent parameter is needed to specify the transformation. But this conclusion is not surprising. A two-dimensional transformation from one Cartesian coordinate system to another corresponds to a rotation of the axes in the plane (cf. Fig. 4.4), and such a rotation can be specified completely by only one quantity, the rotation angle ϕ . Expressed in terms of this single parameter, the transformation equations become

$$\begin{aligned} x'_1 &= x_1 \cos \phi + x_2 \sin \phi \\ x'_2 &= -x_1 \sin \phi + x_2 \cos \phi \\ x'_3 &= x_3. \end{aligned}$$

The matrix elements are therefore

$$\begin{array}{lll} a_{11} = \cos \phi & a_{12} = \sin \phi & a_{13} = 0 \\ a_{21} = -\sin \phi & a_{22} = \cos \phi & a_{23} = 0 \\ a_{31} = 0 & a_{32} = 0 & a_{33} = 1, \end{array} \quad (4.17)$$

so that the matrix \mathbf{A} can be written

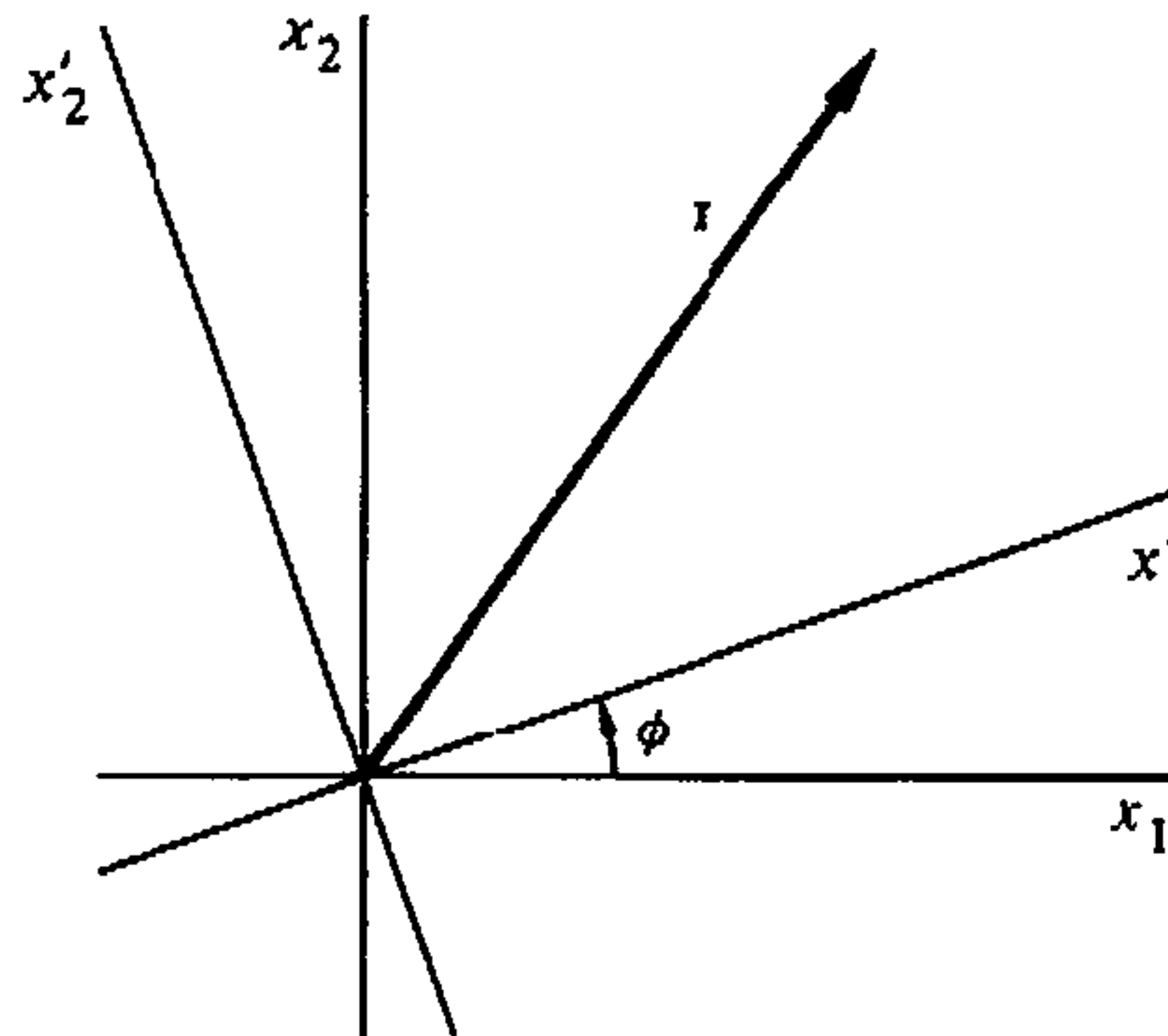

FIGURE 4.4 Rotation of the coordinate axes, as equivalent to two-dimensional orthogonal transformation.

$$\mathbf{A} = \begin{bmatrix} \cos \phi & \sin \phi & 0 \\ -\sin \phi & \cos \phi & 0 \\ 0 & 0 & 1 \end{bmatrix} \quad (4.17')$$

The three nontrivial orthogonality conditions expand into the equations

$$\begin{aligned} a_{11}a_{11} + a_{21}a_{21} &= 1 \\ a_{12}a_{12} + a_{22}a_{22} &= 1 \\ a_{11}a_{12} + a_{21}a_{22} &= 0. \end{aligned}$$

These conditions are obviously satisfied by the matrix (4-17'), for in terms of the matrix elements (4.17) they reduce to the identities

$$\begin{aligned} \cos^2 \phi + \sin^2 \phi &= 1 \\ \sin^2 \phi + \cos^2 \phi &= 1 \\ \cos \phi \sin \phi - \sin \phi \cos \phi &= 0. \end{aligned}$$

The transformation matrix \mathbf{A} can be thought of as an *operator* that, acting on the unprimed system, transforms it into the primed system. Symbolically, the process might be written

$$(\mathbf{r})' = \mathbf{A}\mathbf{r}, \quad (4.18)$$

which is to be read: The matrix \mathbf{A} operating on the components of a vector in the unprimed system yields the components of the vector in the primed system. Note that in the development of the subject so far, \mathbf{A} acts on the coordinate system only, the vector is unchanged, and we ask merely for its components in two different coordinate frames. Parentheses have therefore been placed around \mathbf{r} on the left in Eq. (4.18) to make clear that the same vector is involved on both sides of the equation. Only the components have changed. In three dimensions, the transformation of coordinates, as shown earlier, is simply a rotation, and \mathbf{A} is then identical with the *rotation* operator in a plane.

Despite this, note that without changing the formal mathematics, \mathbf{A} can also be thought of as an operator acting on the *vector* \mathbf{r} , changing it to a different vector \mathbf{r}' :

$$\mathbf{r}' = \mathbf{A}\mathbf{r}, \quad (4.19)$$

with both vectors expressed in the same coordinate system. Thus, in two dimensions, instead of rotating the coordinate system counterclockwise, we can rotate the vector \mathbf{r} *clockwise* by an angle ϕ to a new vector \mathbf{r}' , as shown in Fig. 4.5. The components of the new vector will then be related to the components of the old by the same Eqs. (4.12) that describe the transformation of coordinates. From a formal standpoint, it is therefore not necessary to use parentheses in Eq. (4.18); rather, it can be written as in Eq. (4.19) and interpreted equally as an operation on the coordinate system or on the vector. The algebra remains the same no matter

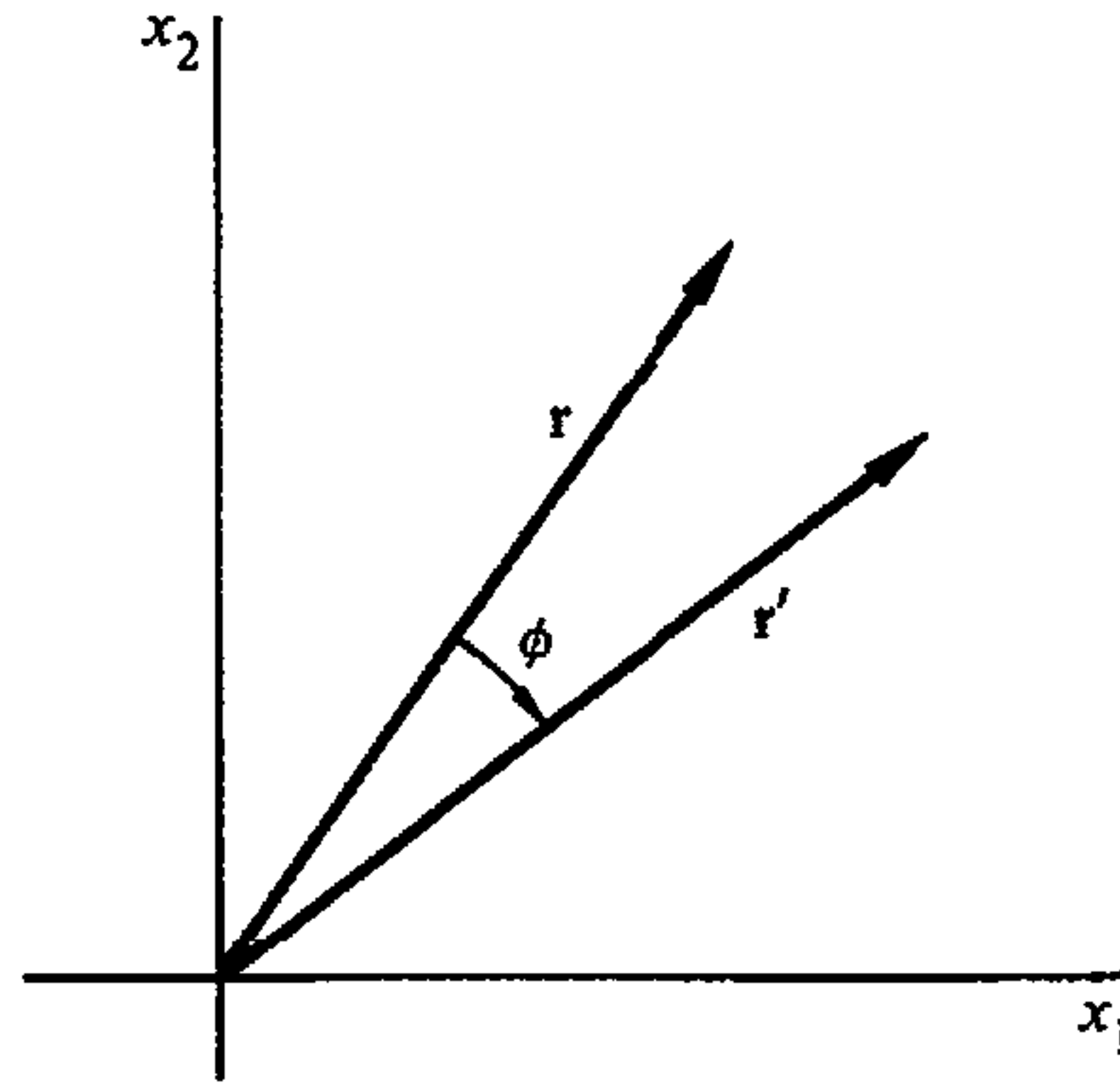

FIGURE 4.5 Interpretation of an orthogonal transformation as a rotation of the vector, leaving the coordinate system unchanged.

which of these two points of view is followed. The interpretation as an operator acting on the coordinates is the more pertinent one when using the orthogonal transformation to specify the orientation of a rigid body. On the other hand, the notion of an operator changing one vector into another has the more widespread application. In the mathematical discussion either interpretation will be freely used, as suits the convenience of the situation. Of course, note that the nature of the operation represented by \mathbf{A} will change according to which interpretation is selected. Thus, if \mathbf{A} corresponds to a *counterclockwise* rotation by an angle ϕ when applied to the coordinate system, it will correspond to a *clockwise* rotation when applied to the vector.

The same duality of roles often occurs with other types of coordinate transformations that are more general than orthogonal transformations. They may at times be looked on as affecting only the coordinate system, expressing some given quantity or function in terms of a new coordinate system. At other times, they may be considered as operating on the quantity or functions themselves, changing them to new quantities in the same coordinate system. When the transformation is taken as acting only on the coordinate system, we speak of the *passive* role of the transformation. In the *active* sense, the transformation is looked on as changing the vector or other physical quantity. These alternative interpretations of a transformation will be encountered in various formulations of classical mechanics to be considered below (cf. Chapter 9) and indeed occur in many fields of physics.

To develop further the kinematics of rigid body motion about a fixed origin, we shall make much use of the algebra governing the manipulation of the transformation matrix. The following section is therefore a brief summary of the elementary aspects of matrix algebra with specific application to orthogonal matrices. For those unacquainted with this branch of mathematics, the section should provide an introduction adequate for the immediate purpose. The material also details the particular terminology and notation we will employ. Those already thoroughly fa-

familiar with matrix algebra may however omit the section and proceed directly to Section 4.4.

4.3 ■ FORMAL PROPERTIES OF THE TRANSFORMATION MATRIX

Let us consider what happens when two successive transformations are made—corresponding to two successive displacements of the rigid body. Let the first transformation from \mathbf{r} to \mathbf{r}' be denoted by \mathbf{B} :

$$x'_k = b_{kj}x_j, \quad (4.20)$$

and the succeeding transformation from \mathbf{r}' to a third coordinate set \mathbf{r}'' by \mathbf{A} :

$$x''_i = a_{ik}x'_k. \quad (4.21)$$

The relation between x''_i and x_j can then be obtained by combining the two Eqs. (4.20) and (4.21):

$$x''_i = a_{ik}b_{kj}x_j.$$

This may also be written as

$$x''_i = c_{ij}x_j, \quad (4.22)$$

where

$$c_{ij} = a_{ik}b_{kj}. \quad (4.23)$$

The successive application of two orthogonal transformations \mathbf{A} , \mathbf{B} is thus equivalent to a third linear transformation \mathbf{C} . It can be shown that \mathbf{C} is also an orthogonal transformation in consequence of the orthogonality of \mathbf{A} and \mathbf{B} . The detailed proof will be left for the exercises. Symbolically, the resultant operator \mathbf{C} can be considered as the product of the two operators \mathbf{A} and \mathbf{B} :

$$\mathbf{C} = \mathbf{AB},$$

and the matrix elements c_{ij} are by definition the elements of the square matrix obtained by multiplying the two square matrices \mathbf{A} and \mathbf{B} .

Note that this “matrix” or operator multiplication is not commutative,

$$\mathbf{BA} \neq \mathbf{AB},$$

for, by definition, the elements of the transformation $\mathbf{D} = \mathbf{BA}$ are

$$d_{ij} = b_{ik}a_{kj}, \quad (4.24)$$

which generally do not agree with the matrix elements of \mathbf{C} , Eq. (4.23). Thus, the final coordinate system depends upon the order of application of the operators \mathbf{A} and \mathbf{B} , i.e., whether first \mathbf{A} then \mathbf{B} , or first \mathbf{B} and then \mathbf{A} . However, matrix multiplication is associative; in a product of three or more matrices the order of the *multiplications* is unimportant:

$$(\mathbf{AB})\mathbf{C} = \mathbf{A}(\mathbf{BC}). \quad (4.25)$$

In Eq. (4.19) the juxtaposition of \mathbf{A} and \mathbf{r} , to indicate the operation of \mathbf{A} on the coordinate system (or on the vector), was said to be merely symbolic. But, by extending our concept of matrices, it may also be taken as indicating an actual matrix multiplication. Thus far, the matrices used have been square, i.e., with equal number of rows and columns. However, we may also have one-column matrices, such as \mathbf{x} and \mathbf{x}' defined by

$$\mathbf{x} = \begin{bmatrix} x_1 \\ x_2 \\ x_3 \end{bmatrix}, \quad \mathbf{x}' = \begin{bmatrix} x'_1 \\ x'_2 \\ x'_3 \end{bmatrix}. \quad (4.26)$$

The product \mathbf{Ax} , by definition, shall be taken as a one-column matrix, with the elements

$$(\mathbf{Ax})_i = a_{ij}x_j = x'_i.$$

Hence, Eq. (4.19) can also be written as the matrix equation

$$\mathbf{x}' = \mathbf{Ax}.$$

The *addition* of two matrices, while not as important a concept as multiplication, is a frequently used operation. The sum $\mathbf{A} + \mathbf{B}$ is a matrix \mathbf{C} whose elements are the sum of the corresponding elements of \mathbf{A} and \mathbf{B} :

$$c_{ij} = a_{ij} + b_{ij}.$$

Of greater importance is the transformation inverse to \mathbf{A} , the operation that changes r' back to r . This transformation will be called \mathbf{A}^{-1} and its matrix elements designated by a'_{ij} . We then have the set of equations

$$x_i = a'_{ij}x'_j, \quad (4.27)$$

which must be consistent with

$$x'_k = a_{ki}x_i. \quad (4.28)$$

Substituting x_i from (4.27), Eq. (4.28) becomes

$$x'_k = a_{ki}a'_{ij}x'_j. \quad (4.29)$$

Since the components of \mathbf{r}' are independent, Eq. (4.29) is correct only if the summation reduces identically to x'_k . The coefficient of x'_j must therefore be 1 for $j = k$ and 0 for $j \neq k$; in symbols,

$$a_{ki}a'_{ij} = \delta_{kj}. \quad (4.30)$$

The left-hand side of Eq. (4.30) is easily recognized as the matrix element for the product $\mathbf{A}\mathbf{A}^{-1}$, while the right-hand side is the element of the matrix known as the unit matrix $\mathbf{1}$:

$$\mathbf{1} = \begin{bmatrix} 1 & 0 & 0 \\ 0 & 1 & 0 \\ 0 & 0 & 1 \end{bmatrix}. \quad (4.31)$$

Equation (4.30) can therefore be written as

$$\mathbf{A}\mathbf{A}^{-1} = \mathbf{1}, \quad (4.32)$$

which indicates the reason for the designation of the inverse matrix by \mathbf{A}^{-1} . The transformation corresponding to $\mathbf{1}$ is known as the *identity transformation*, producing no change in the coordinate system:

$$\mathbf{x} = \mathbf{1}\mathbf{x}.$$

Similarly multiplying any matrix \mathbf{A} by $\mathbf{1}$, in any order, leaves \mathbf{A} unaffected:

$$\mathbf{1}\mathbf{A} = \mathbf{A}\mathbf{1} = \mathbf{A}.$$

By slightly changing the order of the proof of Eq. (4.28), it can be shown that \mathbf{A} and \mathbf{A}^{-1} commute. Instead of substituting x_i in Eq. (4.29) in terms of x'_j , we could equally as well demand consistency by eliminating x'_j from the two equations, leading in analogous fashion to

$$a'_{ij}a_{jk} = \delta_{ik}.$$

In matrix notation, this reads

$$\mathbf{A}^{-1}\mathbf{A} = \mathbf{1}, \quad (4.33)$$

which proves the statement.

Now let us consider the double sum

$$a_{kl}a_{ki}a'_{ij},$$

which can be written either as

$$c_{li}a'_{ij} \quad \text{with } c_{li} = a_{kl}a_{ki}$$

or as

$$a_{kl}d_{kj} \quad \text{with } d_{kj} = a_{ki}a'_{ij}.$$

Applying the orthogonality conditions, Eq. (4.15), the sum in the first form reduces to

$$\delta_{li}a'_{ij} = a'_{lj}.$$

On the other hand, the same sum from the second point of view, and with the help of Eq. (4.30), can be written

$$a_{kl}\delta_{kj} = a_{jl}.$$

Thus, the elements of the direct matrix \mathbf{A} and the reciprocal \mathbf{A}^{-1} are related by

$$a'_{ij} = a_{jl}. \quad (4.34)$$

In general, the matrix obtained from \mathbf{A} by interchanging rows and columns is known as the *transposed matrix*, indicated by the tilde thus $\tilde{\mathbf{A}}$. Equation (4.34) therefore states that for *orthogonal matrices* the reciprocal matrix is to be identified as the transposed matrix; symbolically,

$$\mathbf{A}^{-1} = \tilde{\mathbf{A}}. \quad (4.35)$$

If this result is substituted in Eq. (4.33), we obtain

$$\tilde{\mathbf{A}}\mathbf{A} = \mathbf{1}, \quad (4.36)$$

which is identical with the set of orthogonality conditions, Eq. (4.15), written in abbreviated form, as can be verified by direct expansion. Similarly, an alternative form of the orthogonality conditions can be obtained from Eq. (4.30) by substituting (4.34):

$$a_{ki}a_{jl} = \delta_{kj}. \quad (4.37)$$

In symbolic form, (4.37) can be written

$$\mathbf{A}\tilde{\mathbf{A}} = \mathbf{1}$$

and may be derived directly from (4.36) by multiplying it from the left by \mathbf{A} and from the right by \mathbf{A}^{-1} .

A rectangular matrix is said to be of dimension $m \times n$ if it has m rows and n columns; i.e., if the matrix element is a_{ij} , then i runs from 1 to m , and j from 1 to n . Clearly the transpose of such a matrix has the dimension $n \times m$. If a vector column matrix is considered as a rectangular matrix of dimension $m \times 1$, the transpose of a vector is of dimension $1 \times m$, i.e., a one-row matrix. The product

AB of two rectangular matrices exists only if the number of columns of **A** is the same as the number of rows of **B**. This is an obvious consequence of the definition of the multiplication operation leading to a matrix element

$$c_{ij} = a_{ik}b_{kj}.$$

From this viewpoint, the product of a vector column matrix with a square matrix does not exist. The only product between these quantities that can be formed is that of a square matrix with a single column matrix. But note that a single row matrix, i.e., a vector transpose, can indeed pre-multiply a square matrix. For a vector, however, the distinction between the column matrix and its transpose is often of no consequence. The symbol **x** may therefore be used to denote either a column or a row matrix, as the situation warrants.* Thus in the expression **Ax**, where **A** is a square matrix, the symbol **x** stands for a column matrix, whereas in the expression **xA** it represents the same elements arranged in a single row. Note that the *i*th component of **Ax** can be written as

$$A_{ij}x_j = x_j(\tilde{\mathbf{A}})_{ji}.$$

Hence, we have a useful commutation property of the product of a vector and a square matrix that

$$\mathbf{Ax} = \mathbf{x}\tilde{\mathbf{A}}.$$

A square matrix that is the same as its transpose,

$$A_{ij} = A_{ji}, \quad (4.38)$$

is said (for obvious reasons) to be *symmetric*. When the transpose is the negative of the original matrix,

$$A_{ij} = -A_{ji}, \quad (4.39)$$

the matrix is *antisymmetric* or *skew symmetric*. Clearly in an antisymmetric matrix, the diagonal elements are always zero.

The two interpretations of an operator as transforming the vector, or alternatively the coordinate system, are both involved if we find the transformation of an operator under a change of coordinates. Let **A** be considered an operator acting upon a vector **F** (or a single-column matrix **F**) to produce a vector **G**:

$$\mathbf{G} = \mathbf{AF}.$$

If the coordinate system is transformed by a matrix **B**, the components of the vector **G** in the new system will be given by

$$\mathbf{BG} = \mathbf{BAF},$$

*The transpose sign on vector matrices will occasionally be retained where it is useful to emphasize the distinction between column and row matrices

which can also be written

$$\mathbf{BG} = \mathbf{BAB}^{-1}\mathbf{BF}. \quad (4.40)$$

Equation (4.40) can be stated as the operator \mathbf{BAB}^{-1} acting upon the vector \mathbf{F} , expressed in the new system, produces the vector \mathbf{G} , likewise expressed in the new coordinates. We may therefore consider \mathbf{BAB}^{-1} to be the form taken by the operator \mathbf{A} when transformed to a new set of axes:

$$\mathbf{A}' = \mathbf{BAB}^{-1}. \quad (4.41)$$

Any transformation of a matrix having the form of Eq. (4.41) is known as a *similarity transformation*.

It is appropriate at this point to consider the properties of the determinant formed from the elements of a square matrix. As is customary, we shall denote such a determinant by vertical bars, thus: $|\mathbf{A}|$. Note that the definition of matrix multiplication is identical with that for the multiplication of determinants

$$|\mathbf{AB}| = |\mathbf{A}| \cdot |\mathbf{B}|. \quad (4.41')$$

Since the determinant of the unit matrix is 1, the determinantal form of the orthogonality conditions, Eq. (4.36), can be written

$$|\tilde{\mathbf{A}}| \cdot |\mathbf{A}| = 1.$$

Further, as the value of a determinant is unaffected by interchanging rows and columns, we can write

$$|\mathbf{A}|^2 = 1, \quad (4.42)$$

which implies that the determinant of an orthogonal matrix can only be $+1$ or -1 . (The geometrical significance of these two values will be considered in the next section.)

When the matrix is not orthogonal, the determinant does not have these simple values, of course. It can be shown however that the value of the determinant is invariant under a similarity transformation. Multiplying Eq. (4.41) for the transformed matrix from the right by \mathbf{B} , we obtain the relation

$$\mathbf{A}'\mathbf{B} = \mathbf{BA},$$

or in determinantal form

$$|\mathbf{A}'| \cdot |\mathbf{B}| = |\mathbf{B}| \cdot |\mathbf{A}|.$$

Since the determinant of \mathbf{B} is merely a number, and not zero,* we can divide by

*If it were zero, there could be no inverse operator \mathbf{B}^{-1} (by Cramer's rule), which is required for Eq. (4.41) to make sense.

$|\mathbf{B}|$ on both sides to obtain the desired result:

$$|\mathbf{A}'| = |\mathbf{A}|.$$

In discussing rigid body motion later, all these properties of matrix transformations, especially of orthogonal matrices, will be employed. In addition, other properties are needed, and they will be derived as the occasion requires.

4.4 ■ THE EULER ANGLES

We have noted (cf. p. 137) that the nine elements a_{ij} are not suitable as generalized coordinates because they are not independent quantities. The six relations that express the orthogonality conditions, Eqs. (4.9) or Eqs. (4.15), of course reduce the number of independent elements to three. But in order to characterize the motion of a rigid body, there is an additional requirement the matrix elements must satisfy, beyond those implied by orthogonality. In the previous section we pointed out that the determinant of a real orthogonal matrix could have the value $+1$ or -1 . The following argument shows however that an orthogonal matrix whose determinant is -1 cannot represent a physical displacement of a rigid body.

Consider the simplest 3×3 matrix with the determinant -1 :

$$\mathbf{S} = \begin{bmatrix} -1 & 0 & 0 \\ 0 & -1 & 0 \\ 0 & 0 & -1 \end{bmatrix} = -1.$$

The transformation \mathbf{S} has the effect of changing the sign of each of the components or coordinate axes (cf. Fig. 4.6). Such an operation transforms a right-handed coordinate system into a left-handed one and is known as an *inversion* of the coordinate axes.

One method of performing an inversion is to rotate about a coordinate axis by 180° and then reflect in that coordinate axis direction. For the z -direction, this gives

$$\left(\begin{array}{l} \text{rotate} \\ \text{by } 180^\circ \\ \text{about } z \end{array} \right) \left(\begin{array}{l} \text{reflect} \\ \text{in the} \\ \text{xy plane} \end{array} \right) = \text{inversion.}$$

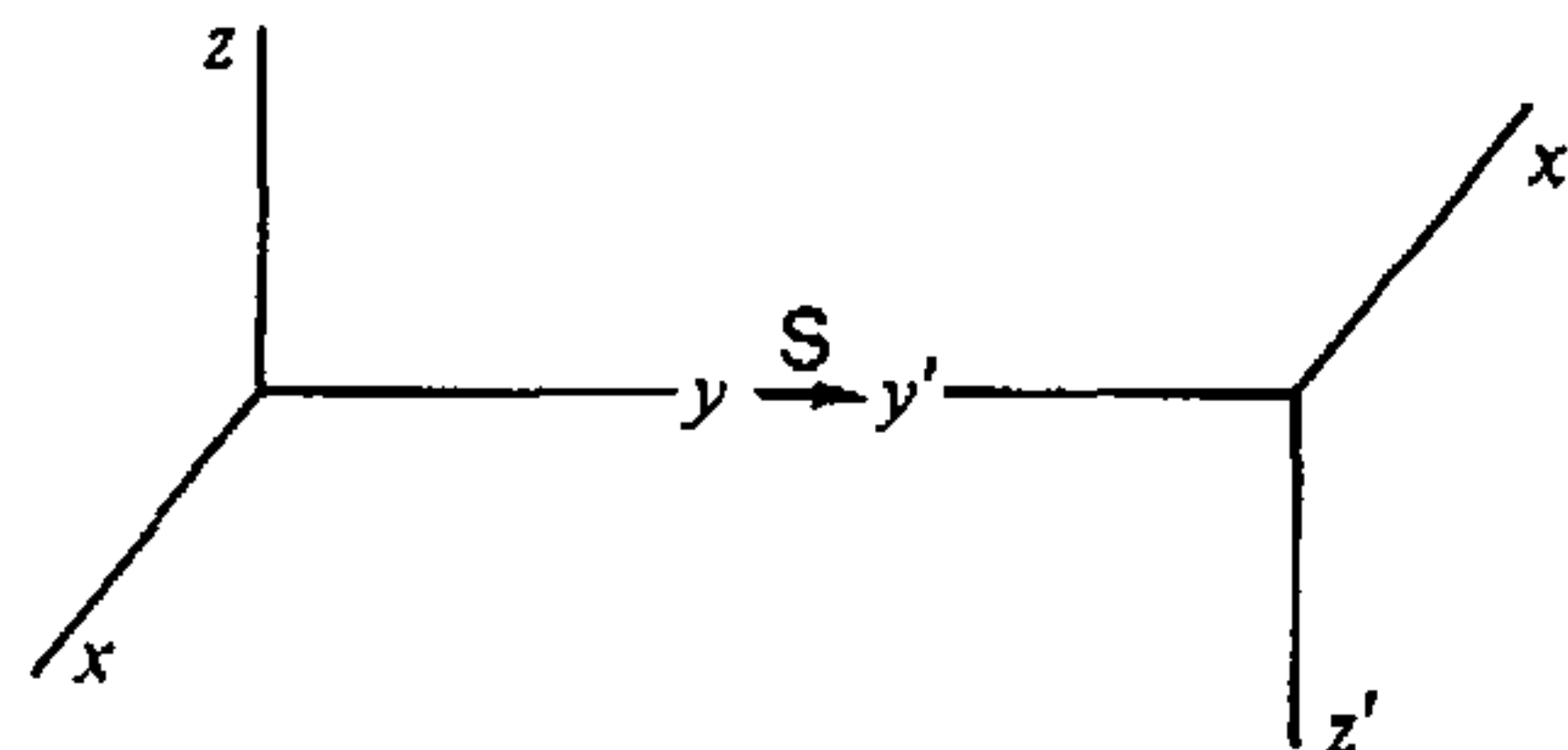

FIGURE 4.6 Inversion of the coordinate axes.

In matrix notation, this has the form

$$\begin{bmatrix} -1 & 0 & 0 \\ 0 & -1 & 0 \\ 0 & 0 & 1 \end{bmatrix} \begin{bmatrix} 1 & 0 & 0 \\ 0 & 1 & 0 \\ 0 & 0 & -1 \end{bmatrix} = \begin{bmatrix} -1 & 0 & 0 \\ 0 & -1 & 0 \\ 0 & 0 & -1 \end{bmatrix},$$

where the 180° rotation is obtained by setting $\phi = 180^\circ$ in Eq. (4.17).

From the nature of this operation, it is clear that an inversion of a right-handed system into a left-handed one cannot be accomplished by any *rigid* change in the orientation of the coordinate axes. An inversion therefore never corresponds to a physical displacement of a rigid body. What is true for the inversion \mathbf{S} is equally valid for any matrix whose determinant is -1 , for any such matrix can be written as the product of \mathbf{S} with a matrix whose determinant is $+1$, and thus includes the inversion operation. Consequently, it cannot describe a rigid change in orientation. Therefore, the transformations representing rigid body motion must be restricted to matrices having the determinant $+1$. Another method of reaching this conclusion starts from the fact that the matrix of transformation must evolve continuously from the unit matrix, which of course has the determinant $+1$. It would be incompatible with the continuity of the motion to have the matrix determinant suddenly change from its initial value $+1$ to -1 at some given time. Orthogonal transformations with determinant $+1$ are said to be *proper*, and those with the determinant -1 are called *improper*.

In order to describe the motion of rigid bodies in the Lagrangian formulation of mechanics, it will therefore be necessary to seek three independent parameters that specify the orientation of a rigid body in such a manner that the corresponding orthogonal matrix of transformation has the determinant $+1$. Only when such generalized coordinates have been found can we write a Lagrangian for the system and obtain the Lagrangian equations of motion. A number of such sets of parameters have been described in the literature, but the most common and useful are the *Euler* or *Eulerian angles*. We shall therefore define these angles at this point, and show how the elements of the orthogonal transformation matrix can be expressed in terms of them.

We can carry out the transformation from a given Cartesian coordinate system to another by means of three successive rotations performed in a specific sequence. The Euler angles are then defined as the three successive angles of rotation. Within limits, the choice of rotation angles is arbitrary. The main convention that will be followed here is used widely in celestial mechanics, applied mechanics, and frequently in molecular and solid-state physics. Other conventions will be described below and in Appendix A.

The sequence employed here is started by rotating the initial system of axes, xyz , by an angle ϕ counterclockwise about the z axis, and the resultant coordinate system is labeled the $\xi\eta\zeta$ axes. In the second stage, the intermediate axes, $\xi\eta\zeta$, are rotated about the ξ axis counterclockwise by an angle θ to produce another intermediate set, the $\xi'\eta'\zeta'$ axes. The ξ' axis is at the intersection of the xy and $\xi'\eta'$ planes and is known as the *line of nodes*. Finally, the $\xi'\eta'\zeta'$ axes are rotated coun-

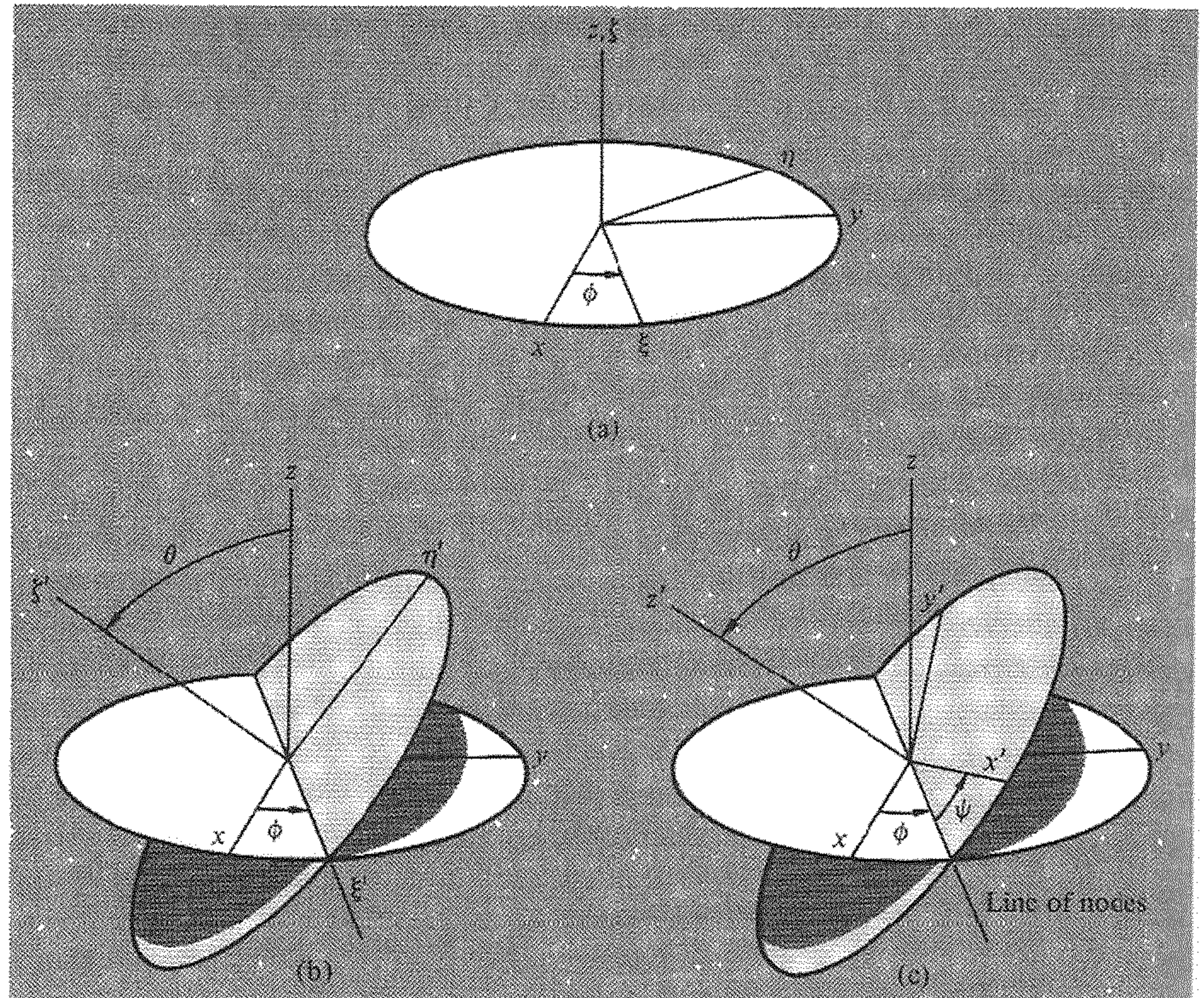

FIGURE 4.7 The rotations defining the Eulerian angles.

terclockwise by an angle ψ about the ζ' axis to produce the desired $x'y'z'$ system of axes. Figure 4.7 illustrates the various stages of the sequence. The Euler angles θ , ϕ , and ψ thus completely specify the orientation of the $x'y'z'$ system relative to the xyz and can therefore act as the three needed generalized coordinates.*

The elements of the complete transformation \mathbf{A} can be obtained by writing the matrix as the triple product of the separate rotations, each of which has a relatively simple matrix form. Thus, the initial rotation about z can be described by a matrix \mathbf{D} :

$$\xi = \mathbf{D}\mathbf{x},$$

where ξ and \mathbf{x} stand for column matrices. Similarly, the transformation from $\xi\eta\zeta$ to $\xi'\eta'\zeta'$ can be described by a matrix \mathbf{C} ,

*A number of minor variations will be found in the literature even within this convention. The differences are not very great, but they are often sufficient to frustrate easy comparison of the end formulae, such as the matrix elements. Greatest confusion, perhaps, arises from the occasional use of left-handed coordinate systems.

$$\xi' = C\xi,$$

and the last rotation to $x'y'z'$ by a matrix **B**,

$$x' = B\xi'.$$

Hence, the matrix of the complete transformation,

$$x' = Ax,$$

is the product of the successive matrices,

$$A = BCD.$$

Now the **D** transformation is a rotation about z , and hence has a matrix of the form (cf. Eq. (4.17))

$$D = \begin{bmatrix} \cos \phi & \sin \phi & 0 \\ -\sin \phi & \cos \phi & 0 \\ 0 & 0 & 1 \end{bmatrix}. \quad (4.43)$$

The **C** transformation corresponds to a rotation about ξ , with the matrix

$$C = \begin{bmatrix} 1 & 0 & 0 \\ 0 & \cos \theta & \sin \theta \\ 0 & -\sin \theta & \cos \theta \end{bmatrix}, \quad (4.44)$$

and finally **B** is a rotation about ζ' and therefore has the same form as **D**:

$$B = \begin{bmatrix} \cos \psi & \sin \psi & 0 \\ -\sin \psi & \cos \psi & 0 \\ 0 & 0 & 1 \end{bmatrix}. \quad (4.45)$$

The product matrix **A** = **BCD** then follows as

$$A = \begin{bmatrix} \cos \psi \cos \phi - \cos \theta \sin \phi \sin \psi & \cos \psi \sin \phi + \cos \theta \cos \phi \sin \psi & \sin \psi \sin \theta \\ -\sin \psi \cos \phi - \cos \theta \sin \phi \cos \psi & -\sin \psi \sin \phi + \cos \theta \cos \phi \cos \psi & \cos \psi \sin \theta \\ \sin \theta \sin \phi & -\sin \theta \cos \phi & \cos \theta \end{bmatrix}. \quad (4.46)$$

The inverse transformation from body coordinates to space axes

$$x = A^{-1}x'$$

is then given immediately by the transposed matrix \tilde{A} :

$$A^{-1} = \tilde{A} = \begin{bmatrix} \cos \psi \cos \phi - \cos \theta \sin \phi \sin \psi & -\sin \psi \cos \phi - \cos \theta \sin \phi \cos \psi & \sin \theta \sin \phi \\ \cos \psi \sin \phi + \cos \theta \cos \phi \sin \psi & -\sin \psi \sin \phi + \cos \theta \cos \phi \cos \psi & -\sin \theta \cos \phi \\ \sin \theta \sin \phi & \sin \theta \cos \phi & \cos \theta \end{bmatrix}. \quad (4.47)$$

Verification of the multiplication, and demonstration that \mathbf{A} represents a proper, orthogonal matrix will be left to the exercises.

Note that the sequence of rotations used to define the final orientation of the coordinate system is to some extent arbitrary. The initial rotation could be taken about any of the three Cartesian axes. In the subsequent two rotations, the only limitation is that no two successive rotations can be about the same axis. A total of 12 conventions is therefore possible in defining the Euler angles (in a right-handed coordinate system). The two most frequently used conventions differ only in the choice of axis for the second rotation. In the Euler's angle definitions described above, and used throughout the book, the second rotation is about the intermediate x axis. We will refer to this choice as the x -convention. In quantum mechanics, nuclear physics, and particle physics, we often take the second defining rotation about the intermediate y axis; this form will be denoted as the y -convention.

A third convention is commonly used in engineering applications relating to the orientation of moving vehicles such as aircraft and satellites. Both the x - and y -conventions have the drawback that when the primed coordinate system is only slightly different from the unprimed system, the angles ϕ and ψ become indistinguishable, as their respective axes of rotation, z and z' are then nearly coincident. To get around this problem, all three rotations are taken around different axes. The first rotation is about the vertical axis and gives the *heading* or *yaw* angle. The second is around a perpendicular axis fixed in the vehicle and normal to the figure axis; it is measured by the *pitch* or *attitude* angle. Finally, the third angle is one of rotation about the figure axis of the vehicle and is the *roll* or *bank* angle. Because all three axes are involved in the rotations, it will be designated as the xyz -convention (although the order of axes chosen may actually be different). This last convention is sometimes referred to as the *Tait–Bryan* angles.

While only the x -convention will be used in the text, for reference purposes Appendix A lists formulae involving Euler's angles, such as rotation matrices, in both the y - and xyz -conventions.

4.5 ■ THE CAYLEY–KLEIN PARAMETERS AND RELATED QUANTITIES

We have seen that only three independent quantities are needed to specify the orientation of a rigid body. Nonetheless, there are occasions when it is desirable to use sets of variables containing more than the minimum number of quantities to describe a rotation, even though they are not suitable as generalized coordinates. Thus, Felix Klein introduced the set of four parameters bearing his name to facilitate the integration of complicated gyroscopic problems. The Euler angles are difficult to use in numerical computation because of the large number of trigonometric functions involved, and the four-parameter representations are much better adapted for use on computers. Further, the four-parameter sets are of great theoretical interest in branches of physics beyond the scope of this book, wherever

rotations or rotational symmetry are involved. It therefore seems worthwhile to briefly describe these parameters, leaving the details to Appendix A.

The four *Cayley–Klein parameters* are complex numbers denoted by α , β , γ , and δ with the constraints that $\beta = \gamma^*$ and $\delta = \alpha^*$. In terms of these numbers, the transformation matrix of a rotated body is given by

$$\mathbf{A} = \begin{bmatrix} \frac{1}{2}(\alpha^2 - \gamma^2 + \delta^2 - \beta^2) & \frac{i}{2}(\gamma^2 - \alpha^2 + \delta^2 - \beta^2) & \gamma\delta - \alpha\beta \\ \frac{i}{2}(\alpha^2 + \gamma^2 - \beta^2 - \delta^2) & \frac{1}{2}(\alpha^2 + \gamma^2 + \beta^2 + \delta^2) & -i(\alpha\beta + \gamma\delta) \\ \beta\delta - \alpha\gamma & i(\alpha\gamma + \beta\delta) & \alpha\delta + \beta\gamma \end{bmatrix}.$$

The matrix \mathbf{A} is real in spite of its appearance, as we can see by writing

$$\alpha = e_0 + ie_3$$

$$\beta = e_2 + ie_1,$$

where the four real quantities e_0 , e_1 , e_2 , and e_3 are often referred to as the Cayley–Klein parameters but should be called the *Euler parameters* to be correct. They satisfy the relation

$$e_0^2 + e_1^2 + e_2^2 + e_3^2 = 1.$$

A bit of algebraic manipulation then shows that the matrix \mathbf{A} can be written in terms of the four real parameters in the form

$$\mathbf{A} = \begin{bmatrix} e_0^2 + e_1^2 - e_2^2 - e_3^2 & 2(e_1e_2 + e_0e_3) & 2(e_1e_3 - e_0e_2) \\ 2(e_1e_2 - e_0e_3) & e_0^2 - e_1^2 + e_2^2 - e_3^2 & 2(e_2e_3 + e_0e_1) \\ 2(e_1e_3 + e_0e_2) & 2(e_2e_3 - e_0e_1) & e_0^2 - e_1^2 - e_2^2 + e_3^2 \end{bmatrix}. \quad (4.47')$$

The reality of the matrix elements is now manifest. It can also be easily demonstrated that the matrix \mathbf{A} in terms of these parameters cannot be put in the form of the inversion transformation \mathbf{S} . An examination of the off-diagonal elements and their transposes shows that they all vanish only if at least three of the parameters are zero. We cannot then choose the remaining nonzero parameter such that all three of the diagonal elements (or only one of them) are -1 .

4.6 ■ EULER'S THEOREM ON THE MOTION OF A RIGID BODY

The discussions of the previous sections provide a complete mathematical technique for describing the motions of a rigid body. At any instant, the orientation of the body can be specified by an orthogonal transformation, the elements of which may be expressed in terms of some suitable set of parameters. As time progresses, the orientation will change, and hence the matrix of transformation will be a func-

tion of time and may be written $A(t)$. If the body axes are chosen coincident with the space axes at the time $t = 0$, then the transformation is initially simply the identity transformation:

$$A(0) = \mathbf{1}.$$

At any later time, $A(t)$ will in general differ from the identity transformation, but since the physical motion must be continuous, $A(t)$ must be a continuous function of time. The transformation may thus be said to evolve *continuously from the identity transformation*.

With this method of describing the motion, and using only the mathematical apparatus already introduced, we are now in a position to obtain the important characteristics of rigid body motion. Of basic importance is:

Euler's Theorem: The general displacement of a rigid body with one point fixed is a rotation about some axis.

The theorem means that for every such rotation it is always possible to find an axis through the fixed point oriented at particular polar angles θ and ϕ such that a rotation by the particular angle ψ about this axis duplicates the general rotation. Thus, three parameters (angles) characterize the general rotation. It is also possible to find three Euler angles to produce the same rotation.

If the fixed point (not necessarily at the center of mass of the object) is taken as the origin of the body set of axes, then the displacement of the rigid body involves no translation of the body axes; the only change is in orientation. The theorem then states that the body set of axes at any time t can always be obtained by a single rotation of the initial set of axes (taken as coincident with the space set). In other words, the *operation* implied in the matrix A describing the physical motion of the rigid body is a *rotation*. Now it is characteristic of a rotation that one direction, namely, the axis of rotation, is left unaffected by the operation. Thus, any vector lying along the axis of rotation must have the same components in both the initial and final axes.

The other necessary condition for a rotation, that the magnitude of the vectors be unaffected, is automatically provided by the orthogonality conditions. Hence, Euler's theorem will be proven if it can be shown that there exists a vector \mathbf{R} having the same components in both systems. Using matrix notation for the vector,

$$\mathbf{R}' = \mathbf{A}\mathbf{R} = \mathbf{R}. \quad (4.48)$$

Equation (4.48) constitutes a special case of the more general equation:

$$\mathbf{R}' = \mathbf{A}\mathbf{R} = \lambda\mathbf{R}, \quad (4.49)$$

where λ is some constant, which may be complex. The values of λ for which Eq. (4.49) is soluble are known as the characteristic values, or *eigenvalues*,* of

*This term is derived from the German *Eigenwerte* literally "proper values"

the matrix. Since equations of the form of (4.49) are of general interest and will be used in Chapter 6, we shall examine Eq. (4.49) and then specialize the discussion to Eq. (4.48).

The problem of finding vectors that satisfy Eq. (4.49) is therefore called the *eigenvalue problem* for the given matrix, and Eq. (4.49) itself is referred to as the *eigenvalue equation*. Correspondingly, the vector solutions are the *eigenvectors* of \mathbf{A} . Euler's theorem can now be restated in the following language:

The real orthogonal matrix specifying the physical motion of a rigid body with one point fixed always has the eigenvalue +1.

The eigenvalue equations (4.49) may be written

$$(\mathbf{A} - \lambda \mathbf{1})\mathbf{R} = 0, \quad (4.50)$$

or, in expanded form,

$$\begin{aligned} (a_{11} - \lambda)X + a_{12}Y - a_{13}Z &= 0 \\ a_{21}X + (a_{22} - \lambda)Y - a_{23}Z &= 0 \\ a_{31}X + a_{32}Y + (a_{33} - \lambda)Z &= 0. \end{aligned} \quad (4.51)$$

Equations (4.51) comprise a set of three homogeneous simultaneous equations for the components X , Y , Z of the eigenvector \mathbf{R} . As such, they can never furnish definite values for the three components, but only ratios of components. Physically, this corresponds to the circumstance that only the *direction* of the eigenvector can be fixed; the magnitude remains undetermined. The product of a constant with an eigenvector is also an eigenvector. In any case, being homogeneous, Eqs. (4.51) can have a nontrivial solution only when the determinant of the coefficients vanishes.

$$|\mathbf{A} - \lambda \mathbf{1}| = \begin{vmatrix} a_{11} - \lambda & a_{12} & a_{13} \\ a_{21} & a_{22} - \lambda & a_{23} \\ a_{31} & a_{32} & a_{33} - \lambda \end{vmatrix} = 0. \quad (4.52)$$

Equation (4.52) is known as the *characteristic* or *secular* equation of the matrix, and the values of λ for which the equation is satisfied are the desired eigenvalues. Euler's theorem reduces to the statement that, for the real orthogonal matrices under consideration, the secular equation must have the root $\lambda = +1$.

In general, the secular equation will have three roots with three corresponding eigenvectors. For convenience, the notation X_1 , X_2 , X_3 will often be used instead of X , Y , Z . In such a notation, the components of the eigenvectors might be labeled as X_{ik} , the first subscript indicating the particular component, the second denoting which of the three eigenvectors is involved. A typical member of the group of Eqs. (4.51) would then be written (with explicit summation) as

$$\sum_J a_{iJ} X_{Jk} = \lambda_k X_{ik}$$

or, alternatively, as

$$\sum_j a_{ij} X_{jk} = \sum_j X_{ij} \delta_{jk} \lambda_k. \quad (4.53)$$

Both sides of Eq. (4.53) then have the form of a matrix product element; the left side as the product of \mathbf{A} with a matrix \mathbf{X} having the elements X_{jk} , the right side as the product of \mathbf{X} with a matrix whose jk th element is $\delta_{jk} \lambda_k$. The last matrix is diagonal, and its diagonal elements are the eigenvalues of \mathbf{A} . We shall therefore designate the matrix by $\boldsymbol{\lambda}$:

$$\boldsymbol{\lambda} = \begin{bmatrix} \lambda_1 & 0 & 0 \\ 0 & \lambda_2 & 0 \\ 0 & 0 & \lambda_3 \end{bmatrix}. \quad (4.54)$$

Equation (4.53) thus implies the matrix equation

$$\mathbf{A}\mathbf{X} = \mathbf{X}\boldsymbol{\lambda},$$

or, multiplying from the left by \mathbf{X}^{-1} ,

$$\mathbf{X}^{-1}\mathbf{A}\mathbf{X} = \boldsymbol{\lambda}. \quad (4.55)$$

Now, the left side is in the form of a similarity transformation operating on \mathbf{A} . (We have only to denote \mathbf{X}^{-1} by the symbol \mathbf{Y} to reduce it to the form Eq. (4.41).) Thus, Eq. (4.55) provides the following alternative approach to the eigenvalue problem: We seek to diagonalize \mathbf{A} by a similarity transformation. Each column of the matrix used to carry out the similarity transformation consists of the components of an eigenvector. The elements of the diagonalized form of \mathbf{A} are the corresponding eigenvalues.

Euler's theorem can be proven directly by using the orthogonality property of $\tilde{\mathbf{A}}$. Consider the expression

$$(\mathbf{A} - \mathbf{1})\tilde{\mathbf{A}} = \mathbf{1} - \tilde{\mathbf{A}}.$$

If we take the determinant of the matrices forming both sides (cf. Eq. (4.41')), we can write the equality

$$|\mathbf{A} - \mathbf{1}||\tilde{\mathbf{A}}| = |\mathbf{1} - \tilde{\mathbf{A}}|. \quad (4.56)$$

To describe the motion of a rigid body, the matrix $\mathbf{A}(t)$ must correspond to a proper rotation; therefore the determinant of \mathbf{A} , and of its transpose, must be $+1$. Further, since in general the determinant of the transpose of a matrix is the same as that of the matrix, the transpose signs in Eq. (4.56) can be removed:

$$|\mathbf{A} - \mathbf{1}| = |\mathbf{1} - \mathbf{A}|. \quad (4.57)$$

Equation (4.57) says that the determinant of a particular matrix is the same as the determinant of the negative of the matrix. Suppose \mathbf{B} is some $n \times n$ matrix. Then it is a well-known property of determinants that

$$|-\mathbf{B}| = (-1)^n |\mathbf{B}|.$$

Since we are working in a three-dimensional space ($n = 3$), it is clear that Eq. (4.57) can hold for any arbitrary proper rotation only if

$$|\mathbf{A} - \mathbf{1}| = 0. \quad (4.58)$$

Comparing Eq. (4.58) with the secular equation (4.52), we can see that one of the eigenvalues satisfying Eq. (4.52) must always be $\lambda = +1$, which is the desired result of Euler's theorem.

Note how the proof of Euler's theorem emphasizes the importance of the number of dimensions in the space considered. In spaces with an even number of dimensions, Eq. (4.57) is an identity for all matrices and Euler's theorem doesn't hold. Thus, for two dimensions there is no vector *in the space* that is left unaltered by a rotation—the axis of rotation is perpendicular to the plane and therefore out of the space.

It is now a simple matter to determine the properties of the other eigenvalues in three dimensions. Designate the $+1$ eigenvalue as λ_3 . The determinant of any matrix is unaffected by a similarity transformation (cf. Section 4.3). Hence, by Eqs. (4.54) and (4.55) and the properties of \mathbf{A} as a proper rotation,

$$|\mathbf{A}| = \lambda_1 \lambda_2 \lambda_3 = \lambda_1 \lambda_2 = 1. \quad (4.59)$$

Further, since \mathbf{A} is a real matrix, then if λ is a solution of the secular equation (4.52), the complex conjugate λ^* must also be a solution.

If a given eigenvalue λ_i is complex, then the corresponding eigenvector, \mathbf{R}_i , that satisfies Eq. (4.59) will in general also be complex. We have not previously dealt with the properties of complex vectors under (real) orthogonal transformations, and there are some modifications to previous definitions. The square of the length or magnitude of a complex vector \mathbf{R} is $\mathbf{R} \cdot \mathbf{R}^*$, or in matrix notation $\tilde{\mathbf{R}}\mathbf{R}^*$, where the transpose sign on the left-hand vector indicates it is represented by a row matrix. Under a real orthogonal transformation, the square of the magnitude is invariant

$$\tilde{\mathbf{R}}'\mathbf{R}'^* = (\tilde{\mathbf{A}}\tilde{\mathbf{R}})\mathbf{A}\mathbf{R}^* = \tilde{\mathbf{R}}\tilde{\mathbf{A}}\mathbf{A}\mathbf{R}^* = \tilde{\mathbf{R}}\mathbf{R}^*.$$

Suppose now that \mathbf{R} is a complex eigenvector corresponding to a complex eigenvalue λ . Hence, by Eq. (4.49), we have

$$\tilde{\mathbf{R}}'\mathbf{R}'^* = \lambda\lambda^*\tilde{\mathbf{R}}\mathbf{R}^*,$$

which leads to the conclusion that *all eigenvalues have unit magnitude*:

$$\lambda\lambda^* = 1. \quad (4.60)$$

From these properties it may be concluded that there are three possible distributions of eigenvalues. If all of the eigenvalues are real, then only two situations are possible:

1. All eigenvalues are +1. The transformation matrix is then just **1**, a case we may justly call trivial.
2. One eigenvalue is +1 and the other two are both -1. Such a transformation may be characterized as an inversion in two coordinate axes with the third unchanged. Equally it is a rotation through the angle π about the direction of the unchanged axis.

If not all of the eigenvalues are real, there is only one additional possibility:

3. One eigenvalue is +1, and the other two are complex conjugates of each other of the form $e^{i\Phi}$ and $e^{-i\Phi}$.

A more complete statement of Euler's theorem thus is that any nontrivial real orthogonal matrix has one, *and only one*, eigenvalue +1.

The direction cosines of the axis of rotation can then be obtained by setting $\lambda = 1$ in the eigenvalue equations (4.51) and solving for X , Y , and Z .* The angle of rotation can likewise be obtained without difficulty. By means of some similarity transformation, it is always possible to transform the matrix **A** to a system of coordinates where the z axis lies along the axis of rotation. In such a system of coordinates, **A'** represents a rotation about the z axis through an angle Φ , and therefore has the form

$$\mathbf{A}' = \begin{bmatrix} \cos \Phi & \sin \Phi & 0 \\ -\sin \Phi & \cos \Phi & 0 \\ 0 & 0 & 1 \end{bmatrix}.$$

The trace of **A'** is simply

$$1 + 2 \cos \Phi.$$

Since the trace is always invariant under a similarity transformation, the trace of **A** with respect to any initial coordinate system must have the same form,

$$\text{Tr} \mathbf{A} = a_{11} = 1 + 2 \cos \Phi, \quad (4.61)$$

*If there are multiple roots to the secular equation, then the corresponding eigenvectors cannot be found as simply (cf. Sections 5.4 and 6.2). Indeed, it is not always possible to completely diagonalize a general matrix if the eigenvalues are not all distinct. These exceptions are of no importance for the present considerations, as Euler's theorem shows that for all nontrivial orthogonal matrices +1 is a single root.

which gives the value of Φ in terms of the matrix elements. The rotation angle Φ is to be identified also with the phase angle of the complex eigenvalues λ , as the sum of the eigenvalues is just the trace of \mathbf{A} in its diagonal form, Eq. (4.54). By Euler's theorem and the properties of the eigenvalues, this sum is

$$\text{Tr}\mathbf{A} = \sum_i \lambda_i = 1 + e^{i\Phi} + e^{-i\Phi} = 1 + 2 \cos \Phi.$$

We see that the situations in which the eigenvalues are all real are actually special cases of \mathbf{A} having complex eigenvalues. All the $\lambda_i = +1$ corresponds to a rotation angle $\Phi = 0$ (the identity transformation), while the case with a double eigenvalue -1 corresponds to $\Phi = \pi$, as previously noted.

The prescriptions for the direction of the rotation axis and for the rotation angle are not unambiguous. Clearly if \mathbf{R} is an eigenvector, so is $-\mathbf{R}$; hence the sense of the direction of the rotation axis is not specified. Further, $-\Phi$ satisfies Eq. (4.61) if Φ does. Indeed, it is clear that the eigenvalue solution does not uniquely fix the orthogonal transformation matrix \mathbf{A} . From the determinantal secular equation (4.52), it follows that the inverse matrix $\mathbf{A}^{-1} = \tilde{\mathbf{A}}$ has the same eigenvalues and eigenvectors as \mathbf{A} . However, the ambiguities can at least be ameliorated by assigning Φ to \mathbf{A} and $-\Phi$ to \mathbf{A}^{-1} , and fixing the sense of the axes of rotation by the right-hand screw rule.

Finally, note should be made of an immediate corollary of Euler's theorem, sometimes called

Chasles' Theorem: The most general displacement of a rigid body is a translation plus a rotation.

Detailed proof is hardly necessary. Simply stated, removing the constraint of motion with one point fixed introduces three translatory degrees of freedom for the origin of the body system of axes.*

4.7 ■ FINITE ROTATIONS

The relative orientation of two Cartesian coordinate systems with common origin has been described by various representations, including the three successive Euler angles of rotation that transform one coordinate system to the other. In the previous section it was shown that the coordinate transformation can be carried through by a single rotation about a suitable direction. It is therefore natural to seek a representation of the coordinate transformation in terms of the parame-

*M. Chasles (1793–1881) also proved a stronger form of the theorem, namely, that it is possible to choose the origin of the body set of coordinates so that the translation is in the same direction as the axis of rotation. Such a combination of translation and rotation is called a *screw motion*.

This formalism has some use in crystallographic studies of crystals with a screw axis of symmetry. Such symmetry produces strange optical properties. Aside from that application, there seems to be little present use for this version of Chasles' theorem, nor for the elaborate mathematics of screw motions developed in the nineteenth century.

ters of the rotation—the angle of rotation and the direction cosines of the axis of rotation.

With the help of some simple vector algebra, we can derive such a representation. For this purpose, it is convenient to treat the transformation in its active sense, i.e., as one that rotates the vector in a fixed coordinate system (cf. Section 4.2). Recall that a counterclockwise rotation of the coordinate system then appears as a *clockwise* rotation of the vector. In Fig. 4.8(a) the initial position of the vector \mathbf{r} is denoted by \overrightarrow{OP} and the final position \mathbf{r}' by \overrightarrow{OQ} , while the unit vector along the axis of rotation is denoted by \mathbf{n} . The distance between O and N has the magnitude $\mathbf{n} \cdot \mathbf{r}$, so that the vector \overrightarrow{ON} can be written as $\mathbf{n}(\mathbf{n} \cdot \mathbf{r})$. Figure 4.8(b) sketches the vectors in the plane normal to the axis of rotation. The vector \overrightarrow{NP} can be described also as $\mathbf{r} - \mathbf{n}(\mathbf{n} \cdot \mathbf{r})$, but its magnitude is the same as that of the vectors \overrightarrow{NQ} and $\mathbf{r} \times \mathbf{n}$. To obtain the desired relation between \mathbf{r}' and \mathbf{r} , we construct \mathbf{r}' as the sum of three vectors:

$$\mathbf{r}' = \overrightarrow{ON} + \overrightarrow{NV} + \overrightarrow{VQ}$$

or

$$\mathbf{r}' = \mathbf{n}(\mathbf{n} \cdot \mathbf{r}) + [\mathbf{r} - \mathbf{n}(\mathbf{n} \cdot \mathbf{r})] \cos \Phi + (\mathbf{r} \times \mathbf{n}) \sin \Phi.$$

A slight rearrangement of terms leads to the final result:

$$\mathbf{r}' = \mathbf{r} \cos \Phi + \mathbf{n}(\mathbf{n} \cdot \mathbf{r})(1 - \cos \Phi) + (\mathbf{r} \times \mathbf{n}) \sin \Phi. \quad (4.62)$$

Equation (4.62) will be referred to as the *rotation formula*. Note that Eq. (4.62) holds for any rotation, no matter what its magnitude, and thus is a finite-rotation version (in a clockwise sense) of the description given in Section 2.6, for the change of a vector under infinitesimal rotation (cf. also Section 4.8).

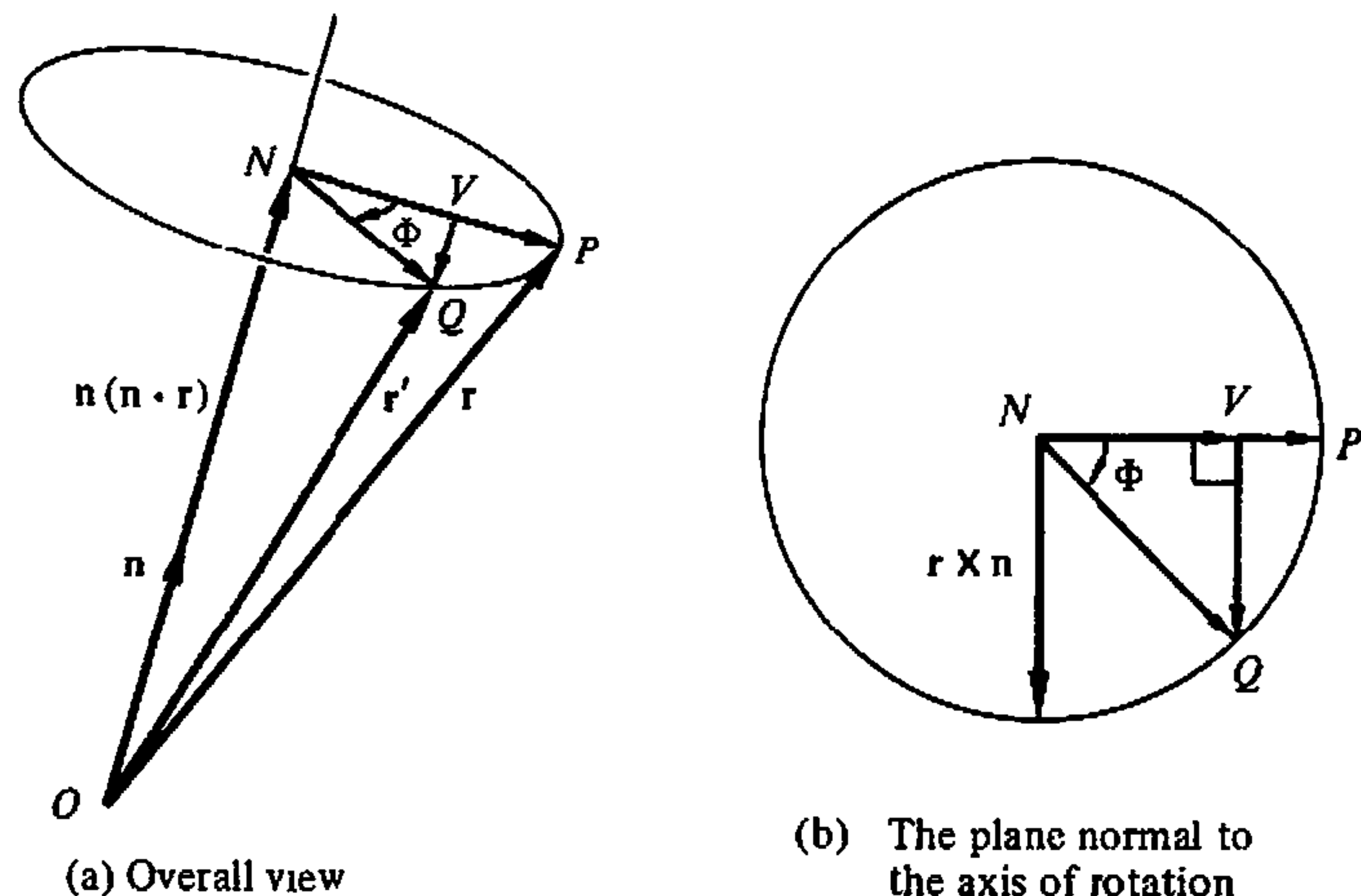

FIGURE 4.8 Vector diagrams for derivation of the rotation formula.

It is straightforward to express the rotation angle, Φ , in terms of the Euler angles. Equation (4.61) gives the trace of the rotation matrix in the plane perpendicular to the axis of rotation. Since the trace of a matrix is invariant, this expression must equal the trace of \mathbf{A} as given in Eq (4.46). If we use this equality, add one (1) to both sides, and use trigonometric identities, we get an equation whose square root is

$$\cos \frac{\Phi}{2} = \cos \frac{\phi + \psi}{2} \cos \frac{\theta}{2}, \quad (4.63)$$

where the sign of the square root is fixed by the physical requirement that $\Phi \rightarrow 0$ as ϕ , ψ , and $\theta \rightarrow 0$.

4.8 ■ INFINITESIMAL ROTATIONS

In the previous sections various matrices have been associated with the description of the rigid body orientation. However, the number of matrix elements has always been larger than the number of independent variables, and various subsidiary conditions have had to be tagged on. Now that we have established that any given orientation can be obtained by a single rotation about some axis, it is tempting to try to associate a vector, characterized by three independent quantities, with the finite displacement of a rigid body about a fixed point. Certainly a direction suggests itself obviously—that of the axis of rotation—and any function of the rotation angle would seem suitable as the magnitude. But it soon becomes evident that such a correspondence cannot be made successfully. Suppose \mathbf{A} and \mathbf{B} are two such “vectors” associated with transformations \mathbf{A} and \mathbf{B} . Then to qualify as vectors they must be commutative in addition:

$$\mathbf{A} + \mathbf{B} = \mathbf{B} + \mathbf{A}.$$

But the addition of two rotations, i.e., one rotation performed after another, it has been seen, corresponds to the product \mathbf{AB} of the two matrices. However, matrix multiplication is not commutative, $\mathbf{AB} \neq \mathbf{BA}$, and hence \mathbf{A} , \mathbf{B} are not commutative in addition and cannot be accepted as vectors. This conclusion, that the sum of finite rotations depends upon the order of the rotations, is strikingly demonstrated by a simple experiment. Thus, Fig. 4.9 illustrates the sequence of events in rotating a block first through 90° about the z' axis fixed in the block, and then 90° about the y' axis, while Fig. 4.10 presents the same rotations in reverse order. The final position is markedly different in the two sequences.

While a finite rotation thus cannot be represented by a single vector, the same objections do not hold if only *infinitesimal rotations* are considered. An infinitesimal rotation is an orthogonal transformation of coordinate axes in which the components of a vector are almost the same in both sets of axes—the change is infinitesimal. Thus, the x'_1 component of some vector \mathbf{r} (on the passive interpretation of the transformation) would be practically the same as x_1 , the difference

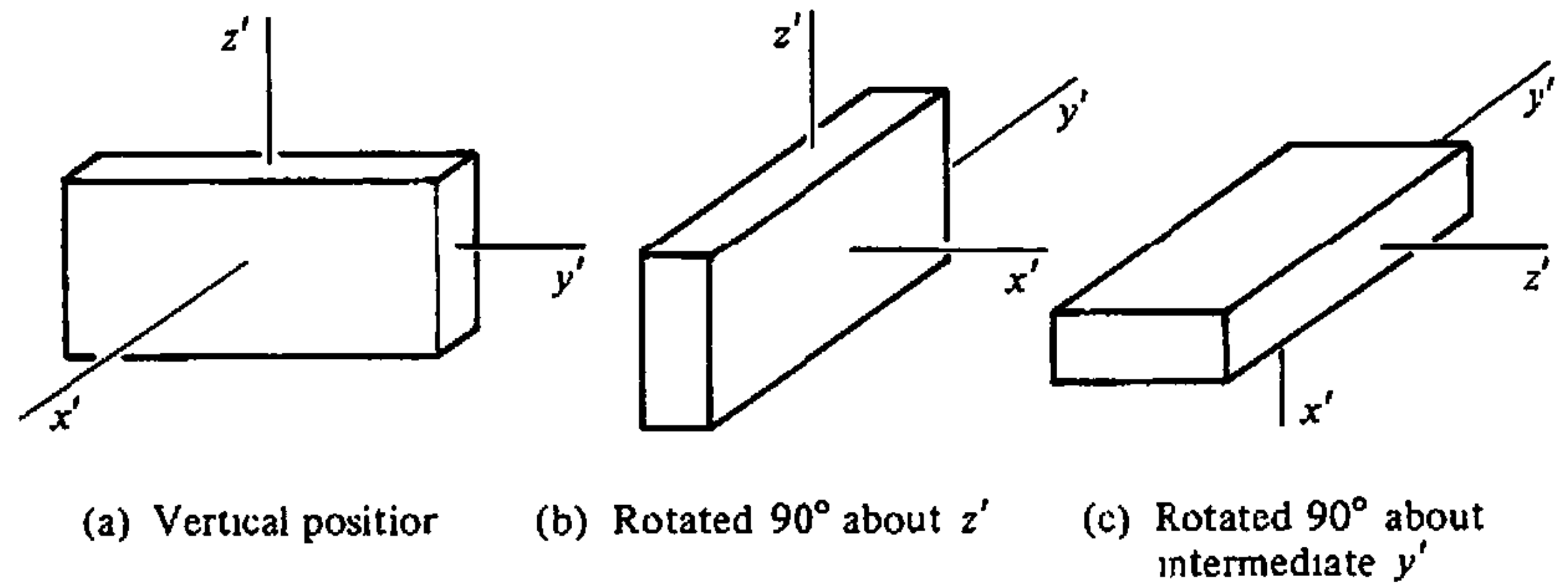

FIGURE 4.9 The effect of two rotations performed in a given order.

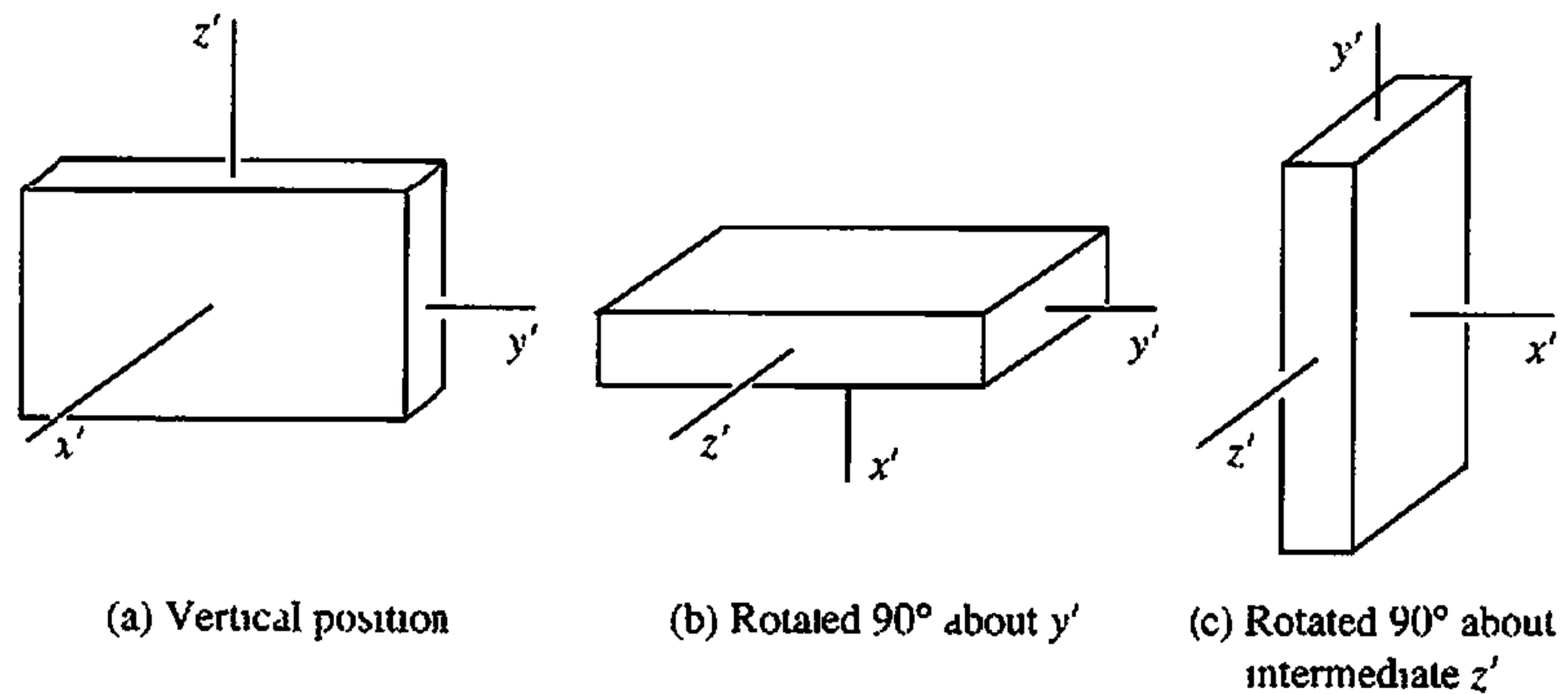

FIGURE 4.10 The two rotations shown in Fig. 4.9, but performed in reverse order.

being extremely small:

$$x'_i = x_i + \epsilon_{11}x_1 + \epsilon_{12}x_2 + \epsilon_{13}x_3. \quad (4.64)$$

The matrix elements ϵ_{11} , ϵ_{12} , etc., are to be considered as infinitesimals, so that in subsequent calculations only the first nonvanishing order in ϵ_{ij} need be retained. For any general component x'_i , the equations of infinitesimal transformation can be written as

$$x'_i = x_i + \epsilon_{ij}x_j$$

or

$$x'_i = (\delta_{ij} + \epsilon_{ij})x_j. \quad (4.65)$$

The quantity δ_{ij} will be recognized as the element of the unit matrix, and Eq. (4.65) appears in matrix notation as

$$\mathbf{x}' = (\mathbf{1} + \boldsymbol{\epsilon})\mathbf{x}. \quad (4.66)$$

Equation (4.66) states that the typical form for the matrix of an infinitesimal transformation is $\mathbf{1} + \boldsymbol{\epsilon}$; i.e., it is almost the identity transformation, differing at most by an infinitesimal operator.

It can now be seen that the sequence of operations is unimportant for infinitesimal transformations; in other words, they *commute*. If $\mathbf{1} + \boldsymbol{\epsilon}_1$ and $\mathbf{1} + \boldsymbol{\epsilon}_2$ are two infinitesimal transformations, then one of the possible products is

$$\begin{aligned} (\mathbf{1} + \boldsymbol{\epsilon}_1)(\mathbf{1} + \boldsymbol{\epsilon}_2) &= \mathbf{1}^2 + \boldsymbol{\epsilon}_1\mathbf{1} + \mathbf{1}\boldsymbol{\epsilon}_2 + \boldsymbol{\epsilon}_1\boldsymbol{\epsilon}_2 \\ &= \mathbf{1} + \boldsymbol{\epsilon}_1 + \boldsymbol{\epsilon}_2, \end{aligned} \quad (4.67)$$

neglecting higher-order infinitesimals. The product in reverse order merely interchanges $\boldsymbol{\epsilon}_1$ and $\boldsymbol{\epsilon}_2$; this has no effect on the result, as matrix addition is always commutative. The commutative property of infinitesimal transformations overcomes the objection to their representation by vectors. For example, the rotation matrix (4.46) for infinitesimal Euler rotation angles is given by

$$\mathbf{A} = \begin{bmatrix} 1 & (d\phi + d\psi) & 0 \\ -(d\phi + d\psi) & 1 & d\theta \\ 0 & -d\theta & 1 \end{bmatrix}$$

and

$$d\Omega = \mathbf{i} d\theta + \mathbf{k} (d\phi + d\psi),$$

where \mathbf{i} and \mathbf{k} are the unit vectors in the x - and z -directions, respectively.

The inverse matrix for an infinitesimal transformation is readily obtained. If $\mathbf{A} = \mathbf{1} + \boldsymbol{\epsilon}$ is the matrix of the transformation, then the inverse is

$$\mathbf{A}^{-1} = \mathbf{1} - \boldsymbol{\epsilon}. \quad (4.68)$$

As proof, note that the product $\mathbf{A}\mathbf{A}^{-1}$ reduces to the unit matrix,

$$\mathbf{A}\mathbf{A}^{-1} = (\mathbf{1} + \boldsymbol{\epsilon})(\mathbf{1} - \boldsymbol{\epsilon}) = \mathbf{1},$$

in agreement with the definition for the inverse matrix, Eq (4.32). Further, the orthogonality of \mathbf{A} implies that $\tilde{\mathbf{A}} \equiv (\mathbf{1} + \tilde{\boldsymbol{\epsilon}})$ must be equal to \mathbf{A}^{-1} as given by Eq. (4.68). Hence, the infinitesimal matrix is antisymmetric* (cf. Eq. (4.39)):

$$\tilde{\boldsymbol{\epsilon}} = -\boldsymbol{\epsilon}.$$

Since the diagonal elements of an antisymmetric matrix are necessarily zero, there can be only three distinct elements in any 3×3 antisymmetric matrix. Hence,

*In this section we have assumed implicitly that an infinitesimal orthogonal transformation corresponds to a rotation. In a sense this assumption is obvious; an "infinitesimal inversion" is a contradiction in terms. Formally, the statement follows from the antisymmetry of $\boldsymbol{\epsilon}$. All the diagonal elements of $\mathbf{1} + \boldsymbol{\epsilon}$ are then unity, and to first order in small quantities, the determinant of the transformation is always $+1$, which is the mark of a proper rotation.

there is no loss of generality in writing ϵ in the form

$$\epsilon = \begin{bmatrix} 0 & d\Omega_3 & -d\Omega_2 \\ -d\Omega_3 & 0 & d\Omega_1 \\ d\Omega_2 & -d\Omega_1 & 0 \end{bmatrix} \quad (4.69)$$

The three quantities $d\Omega_1$, $d\Omega_2$, $d\Omega_3$ are clearly to be identified with the three independent parameters specifying the rotation. We will now show that these three quantities also form the components of a particular kind of vector. By Eq. (4.66) the *change* in the components of a vector under the infinitesimal transformation of the coordinate system can be expressed by the matrix equation

$$\mathbf{r}' - \mathbf{r} \equiv d\mathbf{r}' = \epsilon \mathbf{r}, \quad (4.70)$$

which in expanded form, with ϵ given by (4.69), becomes

$$\begin{aligned} dx_1 &= x_2 d\Omega_3 - x_3 d\Omega_2 \\ dx_2 &= x_3 d\Omega_1 - x_1 d\Omega_3 \\ dx_3 &= x_1 d\Omega_2 - x_2 d\Omega_1. \end{aligned} \quad (4.71)$$

The right-hand side of each of Eqs. (4.71) is in the form of a component of the cross product of two vectors, namely, the cross product of \mathbf{r} with a vector $d\Omega$ having components* $d\Omega_1$, $d\Omega_2$, $d\Omega_3$. We can therefore write Eq. (4.71) equivalently as

$$d\mathbf{r} = \mathbf{r} \times d\Omega. \quad (4.72)$$

The vector \mathbf{r} transforms under an orthogonal matrix \mathbf{B} according to the relations (cf. Eq. (4.20))

$$x'_i = b_{ij} x_j. \quad (4.73)$$

If $d\Omega$ is to be a vector in the same sense as \mathbf{r} , it must transform under \mathbf{B} in the same way. As we shall see, $d\Omega$ passes most of this test for a vector, although in one respect it fails to make the grade. One way of examining the transformation properties of $d\Omega$ is to find how the matrix ϵ transforms under a coordinate transformation. As was shown in Section 4.3, the transformed matrix ϵ' is obtained by a similarity transformation:

$$\epsilon' = \mathbf{B}\epsilon\mathbf{B}^{-1}.$$

*It cannot be emphasized too strongly that $d\Omega$ is *not* the differential of a vector. The combination $d\Omega$ stands for a differential vector, that is, a vector of differential magnitude. Unfortunately, notational convention results in having the vector characteristic applied only to Ω , but it should be clear to the reader there is no vector of which $d\Omega$ represents a differential. As we have seen, a finite rotation *cannot* be represented by a single vector

As the antisymmetry property of a matrix is preserved under an orthogonal similarity transformation (see Derivation 3), ϵ' can also be put in the form of Eq. (4.69) with nonvanishing elements $d\Omega'_i$. A detailed study of these elements shows that ϵ transforms under the similarity transformation such that

$$d\Omega'_i = |\mathbf{B}| b_{ij} d\Omega_j. \quad (4.74)$$

The transformation of $d\Omega$ is thus almost the same as for \mathbf{r} , but differs by the factor $|\mathbf{B}|$, the determinant of the transformation matrix.

There is however a simpler way to uncover the vector characteristics of $d\Omega$, and indeed to verify its transformation properties as given by Eq. (4.74). In the previous section a vector formula was derived for the change in the components of \mathbf{r} under a finite rotation Φ of the coordinate system. By letting Φ go to the limit of an infinitesimal angle $d\Phi$, the corresponding formula for an infinitesimal rotation can be obtained. In this limit, $\cos \Phi$ in Eq. (4.62) approaches unity, and $\sin \Phi$ goes to Φ ; the resultant expression for the infinitesimal change in \mathbf{r} is then

$$\mathbf{r}' - \mathbf{r} \equiv d\mathbf{r} = \mathbf{r} \times \mathbf{n} d\Phi. \quad (4.75)$$

Comparison with Eq. (4.72) indicates that $d\Omega$ is indeed a vector and is determined by

$$d\Omega = \mathbf{n} d\Phi. \quad (4.76)$$

Equation (4.75) can of course be derived directly without recourse to the finite rotation formula. Considered in its active sense, the infinitesimal coordinate transformation corresponds to a rotation of a vector \mathbf{r} *clockwise* through an angle $d\Phi$ about the axis of rotation, a situation that is depicted in Fig. 4.11.* The magnitude of $d\mathbf{r}$, to first order in $d\Phi$ is, from the figure,

$$dr = r \sin \theta d\Phi,$$

and the direction $d\mathbf{r}$ is, in this limit, perpendicular to both \mathbf{r} and $d\Omega = \mathbf{n} d\Phi$. Finally, the sense of $d\mathbf{r}$ is in the direction a right-hand screw advances as \mathbf{r} is turned into $d\Omega$. Figure 4.11 thus shows that in magnitude, direction, and sense $d\mathbf{r}$ is the same as that predicted by Eq. (4.75).

The transformation properties of $d\Omega$, as defined by Eq. (4.76), are still to be discussed. As is well known from elementary vector algebra, there are two kinds of vectors in regard to transformation properties under an inversion. Vectors that transform according to Eq. (4.72) are known as *polar vectors*. Under a three-dimensional inversion,

$$\mathbf{S} = \begin{bmatrix} -1 & 0 & 0 \\ 0 & -1 & 0 \\ 0 & 0 & -1 \end{bmatrix}$$

*Figure 4.11 is the clockwise-rotation version of Fig. 2.8.

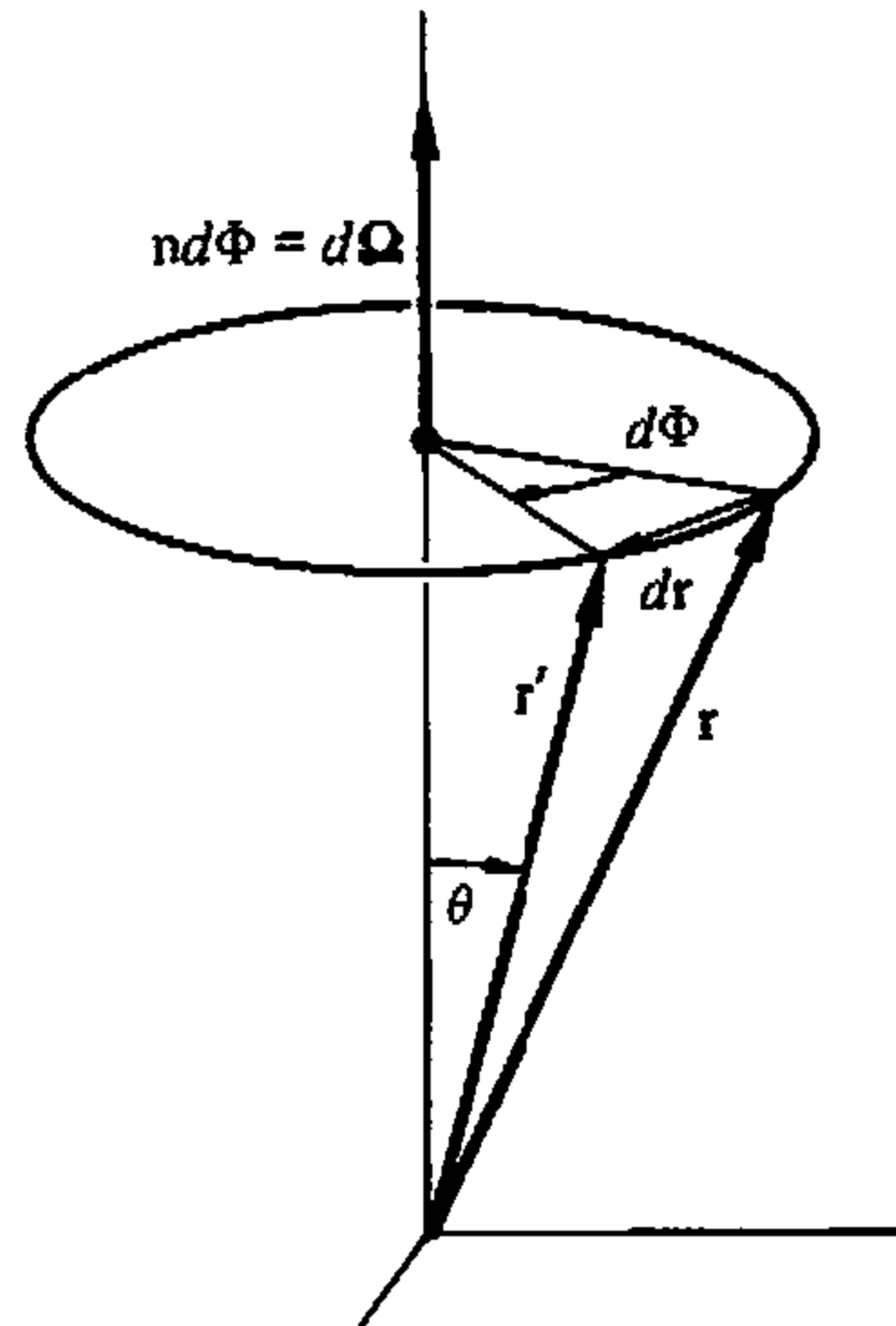

FIGURE 4.11 Change in a vector produced by an infinitesimal clockwise rotation of the vector.

whose components are

$$S_{ij} = -\delta_{ij},$$

all components of a polar vector change sign.

On the other hand, the components of *axial vectors* or *pseudovectors* do not change sign under inversion. The simplest example of an axial vector is a cross product of two polar vectors,

$$\mathbf{V}^* = \mathbf{D} \times \mathbf{F},$$

where the components of the cross product are given, as customary, by the definitions:

$$V_i^* = D_j F_k - F_j D_k, \quad i, j, k \text{ in cyclic order.} \quad (4.77)$$

The components of \mathbf{D} and \mathbf{F} change sign under inversion; hence those of \mathbf{C} do not. Many familiar physical quantities are axial vectors, such as the angular momentum $\mathbf{L} = \mathbf{r} \times \mathbf{p}$, and the magnetic field intensity. The transformation law for an axial vector is of the form of Eq. (4.74). For proper orthogonal transformations, axial and polar vectors are indistinguishable, but for improper transformations, i.e., involving inversion, the determinant $|\mathbf{V}^*|$ is -1 , and the two types of vectors behave differently.

Another way to explain this property is to define a parity operator \mathbf{P} . The operator \mathbf{P} performs the inversion $x \rightarrow -x, y \rightarrow -y, z \rightarrow -z$. Then if S is scalar, \mathbf{V} a polar vector, and \mathbf{V}^* an axial vector,

$$\mathbf{P}S = S$$

$$\mathbf{P}\mathbf{V} = -\mathbf{V}$$

$$\mathbf{P}\mathbf{V}^* = \mathbf{V}^*,$$

and, obviously,

$$\mathbf{P}(\mathbf{V} \cdot \mathbf{V}^*) = -(\mathbf{V} \cdot \mathbf{V}^*).$$

Thus, $\mathbf{V} \cdot \mathbf{V}^*$ is a pseudoscalar S^* with the property $\mathbf{P}S^* = -S^*$ and of course $\mathbf{P}(SS^*) = -SS^*$, $\mathbf{P}(S\mathbf{V}) = -S\mathbf{V}$, $\mathbf{P}(S\mathbf{V}^*) = S\mathbf{V}^*$

On the passive interpretation of the transformation, it is easy to see why polar vectors behave as they do under inversion. The vector remains unaffected by the transformation, but the coordinate axes, and therefore the components, change sign. What then is different for an axial vector? It appears that an axial vector always carries with it a “handedness” convention, as implied, e.g., by the definition, Eq. (4.77), of a cross product. Under inversion a right-handed coordinate system changes to a left-handed system, and the cyclic order requirement of Eq. (4.77) implies a similar change from the right-hand screw convention to a left-hand convention. Hence, even on the passive interpretation, there is an actual change in the direction of the cross product upon inversion.

It is clear now why $d\boldsymbol{\Omega}$ transforms as an axial vector according to Eq. (4.74). Algebraically, we see that since both \mathbf{r} and $d\mathbf{r}$ in Eq. (4.75) are polar vectors, then \mathbf{n} , and therefore $d\boldsymbol{\Omega}$, must be axial vectors. Geometrically, the inversion of the coordinates corresponds to the switch from a right-hand screw law to a left-hand screw to define the sense of \mathbf{n} .

The discussion of the cross product provides an opportunity to introduce a notation that will be most useful on future occasions. The *permutation symbol* or *Levi-Civita density** ϵ_{ijk} is defined to be zero if any two of the indices ijk are equal, and otherwise either +1 or -1 according as ijk is an even or odd permutation of 1, 2, 3. Thus, in terms of the permutation symbol, Eq. (4.77) for the components of a cross product can be written

$$C_i = \epsilon_{ijk} D_j F_k, \quad (4.77')$$

where the usual summation convention has been employed.

The descriptions of rotation presented so far in this chapter have been developed so that we can represent the orientation of a rigid body. Note that the transformations primarily involve rotation of the *coordinate system* (cf. Fig. 4.12a). The corresponding “active” interpretation of rotation of a vector in a fixed coordinate system therefore implies a rotation in the opposite direction, i.e., in a clockwise sense. But there are many areas of mechanics, or of physics in general for that matter, where we are concerned with the effects of rotating the *physical system* and associated vectors (cf. Fig. 4.12b). The connection between invariance of the system under rotation and conservation of angular momentum has already

*Also known interchangeably as the *alternating tensor* or *isotropic tensor of rank 3*.

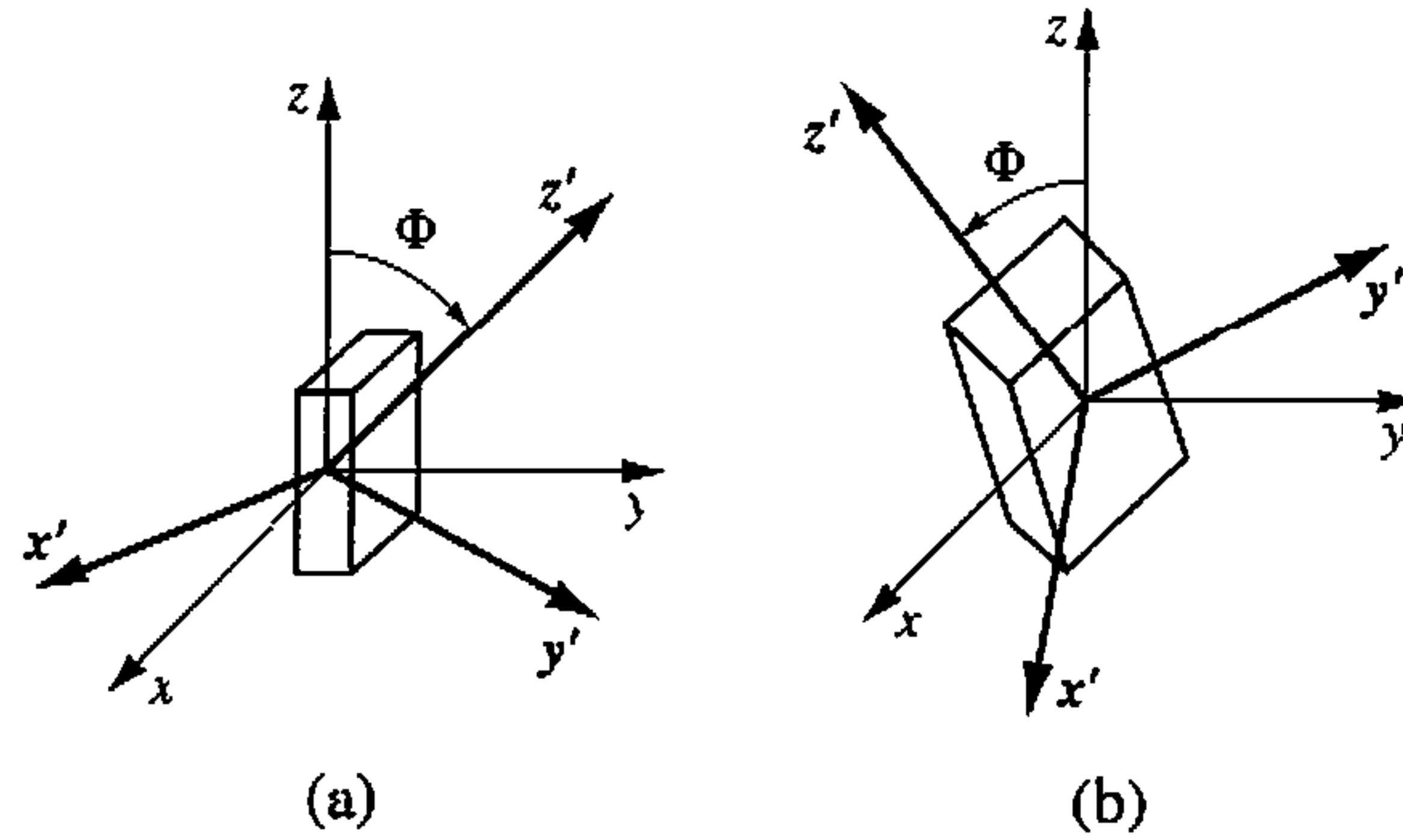

FIGURE 4.12 (a) Transformation from the coordinate system (x, y, z) to a new coordinate system (x', y', z') . By convention, this transformation is considered positive in the clockwise sense. We refer to this as a passive transformation. (b) The rotation of a body through an angle Φ' . By convention, the rotation is positive in a counterclockwise sense. Before the rotation, the coordinates of points of the body were given by (x, y, z) ; after the rotation, they are given by (x', y', z') . This is called an active transformation because the physical body moves.

been pointed out (cf. Section 2.6). In such applications it is necessary to consider the consequences of rotation of vectors in the usual counterclockwise sense. For reference purposes, a number of rotation formulae given above will be listed here, but for counterclockwise rotation of vectors. *All equations and statements from here to the end of this section apply only for such counterclockwise rotations.*

The rotation formula, Eq. (4.62), becomes

$$\mathbf{r}' = \mathbf{r} \cos \Phi + \mathbf{n}(\mathbf{n} \cdot \mathbf{r})(1 - \cos \Phi) + (\mathbf{n} \times \mathbf{r}) \sin \Phi, \quad (4.62')$$

and the corresponding infinitesimal rotation, Eq. (4.75), appears as

$$d\mathbf{r}' = d\boldsymbol{\Omega} \times \mathbf{r} = (\mathbf{n} \times \mathbf{r})d\Phi = -(\mathbf{r} \times \mathbf{n})d\Phi. \quad (4.75')$$

The antisymmetric matrix of the infinitesimal rotation, Eq. (4.69), becomes

$$\boldsymbol{\epsilon} = \begin{bmatrix} 0 & -d\Omega_3 & d\Omega_2 \\ d\Omega_3 & 0 & -d\Omega_1 \\ -d\Omega_2 & d\Omega_1 & 0 \end{bmatrix} = \begin{bmatrix} 0 & -n_3 & n_2 \\ n_3 & 0 & -n_1 \\ -n_2 & n_1 & 0 \end{bmatrix} d\Phi, \quad (4.69')$$

where n_i are the components of the unit vector $\hat{\mathbf{n}}$ along the axis of rotation. Letting $d\mathbf{r}$ stand for the infinitesimal change $\mathbf{r}' - \mathbf{r}$, Eq. (4.66) can then take the form of a matrix differential equation with respect to the rotation angle:

$$\frac{d\mathbf{r}}{d\Phi} = -\mathbf{N}\mathbf{r}. \quad (4.78)$$

where \mathbf{N} is the transpose of the matrix on right in Eq. (4.69') with elements $N_{ij} = \epsilon_{ijk}n_k$.

Another useful representation is to write ϵ in Eq. (4.69') as

$$\epsilon = n_i \mathbf{M}_i d\Phi$$

where \mathbf{M}_i are the three matrices:

$$\mathbf{M}_1 = \begin{bmatrix} 0 & 0 & 0 \\ 0 & 0 & -1 \\ 0 & 1 & 0 \end{bmatrix}, \quad \mathbf{M}_2 = \begin{bmatrix} 0 & 0 & 1 \\ 0 & 0 & 0 \\ -1 & 0 & 0 \end{bmatrix}, \quad \mathbf{M}_3 = \begin{bmatrix} 0 & -1 & 0 \\ 1 & 0 & 0 \\ 0 & 0 & 0 \end{bmatrix}. \quad (4.79)$$

The matrices \mathbf{M}_i are known as the *infinitesimal rotation generators* and have the property that their products are

$$\mathbf{M}_i \mathbf{M}_j - \mathbf{M}_j \mathbf{M}_i \equiv [\mathbf{M}_i, \mathbf{M}_j] = \epsilon_{ijk} \mathbf{M}_k. \quad (4.80)$$

The difference between the two matrix products, or *commutator*, is also called the *Lie bracket* or \mathbf{M}_i , and Eq. (4.80) defines the *Lie algebra* of the rotation group parametrized in terms of the rotation angle. To go further into the group theory of rotation would take us too far afield, but we shall have occasion to refer to these properties of the rotation operation. (cf. Section 9.5 and Appendix B)

4.9 ■ RATE OF CHANGE OF A VECTOR

The concept of an infinitesimal rotation provides a powerful tool for describing the motion of a rigid body in time. Let us consider some arbitrary vector or pseudovector \mathbf{G} involved in the mechanical problem, such as the position vector of a point in the body, or the total angular momentum. Usually such a vector will vary in time as the body moves, but the change will often depend upon the coordinate system to which the observations are referred. For example, if the vector happens to be the radius vector from the origin of the body set of axes to a point in the rigid body, then clearly such a vector appears constant when measured by the body set of axes. However, to an observer fixed in the space set of axes, the components of the vector (as measured on the space axes) will vary in time if the body is in motion.

The change in a time dt of the components of a general vector \mathbf{G} as seen by an observer in the body system of axes will differ from the corresponding change as seen by an observer in the space system. A relation between the two differential changes in \mathbf{G} can be derived on the basis of physical arguments. We can write that the only difference between the two is the effect of rotation of the body axes:

$$(d\mathbf{G})_{\text{space}} = (d\mathbf{G})_{\text{body}} + (d\mathbf{G})_{\text{rot}}.$$

Now consider a vector fixed in the rigid body. As the body rotates, there is of course no change in the components of this vector as seen by the body observer,

i.e., relative to body axes. The only contribution to $(d\mathbf{G})_{\text{space}}$ is then the effect of the rotation of the body. But since the vector is fixed in the body system, it rotates with it *counterclockwise*, and the change in the vector as observed in space is that given by Eq. (4.75'), and hence $(d\mathbf{G})_{\text{rot}}$ is given by

$$(d\mathbf{G})_{\text{rot}} = d\boldsymbol{\Omega} \times \mathbf{G}.$$

For an arbitrary vector, the change relative to the space axes is the sum of the two effects:

$$(d\mathbf{G})_{\text{space}} = (d\mathbf{G})_{\text{body}} + d\boldsymbol{\Omega} \times \mathbf{G}. \quad (4.81)$$

The time *rate of change* of the vector \mathbf{G} as seen by the two observers is then obtained by dividing the terms in Eq. (4.81) by the differential time element dt under consideration;

$$\left(\frac{d\mathbf{G}}{dt}\right)_{\text{space}} = \left(\frac{d\mathbf{G}}{dt}\right)_{\text{body}} + \boldsymbol{\omega} \times \mathbf{G}. \quad (4.82)$$

Here $\boldsymbol{\omega}$ is the instantaneous *angular velocity* of the body defined by the relation*

$$\boldsymbol{\omega} dt = d\boldsymbol{\Omega}. \quad (4.83)$$

The vector $\boldsymbol{\omega}$ lies along the axis of the infinitesimal rotation occurring between t and $t + dt$, a direction known as the *instantaneous axis of rotation*. In magnitude, $\boldsymbol{\omega}$ measures the instantaneous rate of rotation of the body.

A more formal derivation of the basic Eq. (4.82) can be given in terms of the orthogonal matrix of transformation between the space and body coordinates. The component of \mathbf{G} along the i th space axis is related to the components along the body axes:

$$G_i = \tilde{a}_{ij} G'_j = a_{ji} G'_j.$$

As the body moves in time, the components G'_j will change as will the elements a_{ij} of the transformation matrix. Hence, the change in G_i in a differential time element dt is

$$dG_i = a_{ji} dG'_j + da_{ji} G'_j. \quad (4.84)$$

It is no loss of generality to take the space and body axes as instantaneously coincident at the time t . Components in the two systems will then be the same instantaneously, but differentials will *not* be the same, since the two systems are moving relative to each other. Thus, $G'_j = G_j$ but $a_{ji} dG'_j = dG'_i$, the prime emphasizing the differential is measured in the body axis system. The change in the matrix \mathbf{A} in the time dt is thus a change from the unit matrix and therefore

*Note that $\boldsymbol{\omega}$ is *not* the derivative of any vector.

corresponds to the matrix ϵ of the infinitesimal rotation. Hence,

$$da_{ji} = (\tilde{\epsilon})_{ij} = -\epsilon_{ij},$$

using the antisymmetry property of ϵ . In terms of the permutation symbol ϵ_{ijk} , the elements of ϵ are such that (cf. Eq. (4.69))

$$-\epsilon_{ij} = -\epsilon_{ijk}d\Omega_k = \epsilon_{ikj}d\Omega_k.$$

Equation (4.84) can now be written

$$dG_i = dG'_i + \epsilon_{ikj}d\Omega_k G_j.$$

The last term on the right will be recognized as the expression for the i th component of a cross product, so that the final expression for the relation between differentials in the two systems is

$$dG_i = dG'_i + (d\boldsymbol{\Omega} \times \mathbf{G})_i, \quad (4.85)$$

which is the same as the i th component of Eq. (4.81).

Equation (4.81) is not so much an equation about a particular vector \mathbf{G} as it is a statement of the transformation of the time derivative between the two coordinate systems. The arbitrary nature of the vector \mathbf{G} made use of in the derivation can be emphasized by writing Eq. (4.82) as an operator equation acting on some given vector:

$$\left(\frac{d}{dt}\right)_s = \left(\frac{d}{dt}\right)_r + \boldsymbol{\omega} \times. \quad (4.86)$$

Here the subscripts s and r indicate the time derivatives observed in the space and body (rotating) system of axes, respectively. The resultant vector equation can then of course be resolved along any desired set of axes, fixed or moving. But again note that the time rate of change is only relative to the specified coordinate system. When a time derivative of a vector is with respect to one coordinate system, components may be taken along another set of coordinate axes only *after* the differentiation has been carried out.

It is often convenient to express the angular velocity vector in terms of the Euler angles and their time derivatives. The general infinitesimal rotation associated with $\boldsymbol{\omega}$ can be considered as consisting of three successive infinitesimal rotations with angular velocities $\omega_\phi = \dot{\phi}$, $\omega_\theta = \dot{\theta}$, $\omega_\psi = \dot{\psi}$. In consequence of the vector property of infinitesimal rotations, the vector $\boldsymbol{\omega}$ can be obtained as the sum of the three separate angular velocity vectors. Unfortunately, the directions $\boldsymbol{\omega}_\phi$, $\boldsymbol{\omega}_\theta$, and $\boldsymbol{\omega}_\psi$ are not symmetrically placed: $\boldsymbol{\omega}_\phi$ is along the space z axis, $\boldsymbol{\omega}_\theta$ is along the line of nodes, while $\boldsymbol{\omega}_\psi$ alone is along the body z' axis. However, the orthogonal transformations \mathbf{B} , \mathbf{C} , \mathbf{D} of Section 4.4 may be used to furnish the components of these vectors along any desired set of axes.

The body set of axes proves most useful for discussing the equations of motion, and we shall therefore obtain the components of $\boldsymbol{\omega}$ for such a coordinate system. Since $\boldsymbol{\omega}_\phi$ is parallel to the space z axis, its components along the body axes are given by applying the complete orthogonal transformation $\mathbf{A} = \mathbf{BCD}$, Eq. (4.46):

$$(\boldsymbol{\omega}_\phi)_{x'} = \dot{\phi} \sin \theta \sin \psi, \quad (\boldsymbol{\omega}_\phi)_{y'} = \dot{\phi} \sin \theta \cos \psi, \quad (\boldsymbol{\omega}_\phi)_{z'} = \dot{\phi} \cos \theta.$$

Note that $\dot{\phi}$ has the projection $\dot{\phi} \sin \theta$ in the x', y' plane, and it is perpendicular to the line of nodes.

The line of nodes, which is the direction of $\boldsymbol{\omega}_\theta$, coincides with the ξ' axis, so that the components of $\boldsymbol{\omega}_\theta$ with respect to the body axes are furnished by applying only the final orthogonal transformation \mathbf{B} , Eq. (4.45):

$$(\boldsymbol{\omega}_\theta)_{x'} = \dot{\theta} \cos \psi, \quad (\boldsymbol{\omega}_\theta)_{y'} = -\dot{\theta} \sin \psi, \quad (\boldsymbol{\omega}_\theta)_{z'} = 0.$$

No transformation is necessary for the components of $\boldsymbol{\omega}_\psi$, which lies along the z' axis. Adding these components of the separate angular velocities, the components of $\boldsymbol{\omega}$ with respect to the body axes are

$$\begin{aligned} \omega_{x'} &= \dot{\phi} \sin \theta \sin \psi + \dot{\theta} \cos \psi \\ \omega_{y'} &= \dot{\phi} \sin \theta \cos \psi - \dot{\theta} \sin \psi \\ \omega_{z'} &= \dot{\phi} \cos \theta + \dot{\psi}. \end{aligned} \tag{4.87}$$

Similar techniques may be used to express the components of $\boldsymbol{\omega}$ along the space set of axes in terms of the Euler angles.

4.10 ■ THE CORIOLIS EFFECT

Equation (4.86) is the basic kinematical law upon which the dynamical equations of motion for a rigid body are founded. But its validity is not restricted solely to rigid body motion. It may be used whenever we wish to discuss the motion of a particle, or system of particles, relative to a rotating coordinate system.

A particularly important problem in this latter category is the description of particle motion relative to coordinate axes rotating with Earth. Recall that in Section 1.1 an inertial system was defined as one in which Newton's laws of motion are valid. For many purposes, a system of coordinates fixed in the rotating Earth is a sufficient approximation to an inertial system. However, the system of coordinates in which the local stars are fixed comes still closer to the ideal inertial system. Detailed examination shows there are observable effects arising from Earth's rotation relative to this nearly inertial system. Equation (4.86) provides the needed modifications of the equations of motion relative to the *noninertial* system fixed in the rotating Earth.

The initial step is to apply Eq. (4.86) to the radius vector, \mathbf{r} , from the origin of the terrestrial system to the given particle:

$$\mathbf{v}_s = \mathbf{v}_r + \boldsymbol{\omega} \times \mathbf{r}, \quad (4.88)$$

where \mathbf{v}_s and \mathbf{v}_r are the velocities of the particle relative to the space and rotating set of axes, respectively, and $\boldsymbol{\omega}$ is the (constant) angular velocity of Earth relative to the inertial system. In the second step, Eq. (4.86) is used to obtain the time rate of change of \mathbf{v}_r :

$$\begin{aligned} \left(\frac{d\mathbf{v}_s}{dt}\right)_s = \mathbf{a}_s &= \left(\frac{d\mathbf{v}_s}{dt}\right)_r + \boldsymbol{\omega} \times \mathbf{v}_s \\ &= \mathbf{a}_r + 2(\boldsymbol{\omega} \times \mathbf{v}_r) + \boldsymbol{\omega} \times (\boldsymbol{\omega} \times \mathbf{r}), \end{aligned} \quad (4.89)$$

where \mathbf{v}_s has been substituted from Eq. (4.88), and where \mathbf{a}_s and \mathbf{a}_r are the accelerations of the particle in the two systems. Finally, the equation of motion, which in the inertial system is simply

$$\mathbf{F} = m\mathbf{a}_s,$$

expands, when expressed in the rotating coordinates, into the equation

$$\mathbf{F} - 2m(\boldsymbol{\omega} \times \mathbf{v}_r) - m\boldsymbol{\omega} \times (\boldsymbol{\omega} \times \mathbf{r}) = m\mathbf{a}_r. \quad (4.90)$$

To an observer in the rotating system, it therefore appears as if the particle is moving under the influence of an effective force \mathbf{F}_{eff} :

$$\mathbf{F}_{\text{eff}} = \mathbf{F} - 2m(\boldsymbol{\omega} \times \mathbf{v}_r) - m\boldsymbol{\omega} \times (\boldsymbol{\omega} \times \mathbf{r}). \quad (4.91)$$

Let us examine the nature of the terms appearing in Eq. (4.91). The last term is a vector normal to $\boldsymbol{\omega}$ and pointing outward. Further, its magnitude is $m\omega^2 r \sin\theta$. It will therefore be recognized that this term provides the familiar centrifugal force. When the particle is stationary in the moving system, the centrifugal force is the only added term in the effective force. However, when the particle is moving, the middle term known as the *Coriolis effect** comes into play. The order of magnitude of both of these quantities may easily be calculated for a particle on Earth's surface. Earth rotates counterclockwise about the north pole with an angular velocity relative to the fixed stars.

$$\omega = \left(\frac{2\pi}{24 \times 3600}\right) \left(\frac{366.5}{365.5}\right) = 7.292 \times 10^{-5} \text{ s}^{-1}.$$

Here the first set of parentheses gives the angular velocity relative to the radius vector to the Sun. The quantity in the second parentheses, the ratio of the number of sidereal days in a year to the corresponding number of solar days, is the correction factor to give the angular velocity relative to the fixed stars. With this value

*The term *Coriolis effect* is used instead of the older term, Coriolis force, to remind us that this effect exists because we are using a noninertial frame. In a proper inertial frame, the effect does not exist. You can always visualize the Coriolis effect by asking what is happening in an inertial frame.

for ω , and with r equal to Earth's equatorial radius, the maximum centripetal acceleration is

$$\omega^2 r = 3.38 \text{ cm/s}^2,$$

or about 0.3% of the acceleration of gravity. While small, this acceleration is by no means negligible. However, the measured effects of gravity represent the combination of the gravitational field of the mass distribution of Earth and the effects of centripetal acceleration. It has become customary to speak of the sum of the two as Earth's *gravity* field, as distinguished from its *gravitational* field.

The situation is further complicated by the effect of the centripetal acceleration in flattening the rotating Earth. If Earth were completely fluid, the effect of rotation would be to deform it into the shape of an ellipsoid whose surface would be an equipotential surface of the combined gravity field. The mean level of Earth's seas conforms very closely to this equilibrium ellipsoid (except for local variations of wind and tide) and defines what is called the *geoid*.

Except for effects of local perturbations, the force of gravity will be perpendicular to the equipotential surface of the geoid. Accordingly, the local vertical is defined as the direction perpendicular to the geoid at the given point on the surface. For phenomena that occur in the vicinity of a particular spot on Earth, the centripetal acceleration terms in Eq. (4.91) can be considered as swallowed up in the gravitational acceleration \mathbf{g} , which will be oriented in the local vertical direction. The magnitude of \mathbf{g} of course varies with the latitude on Earth. The effects of centripetal acceleration and the flattening of Earth combine to make \mathbf{g} about 0.53% less at the equator than at the poles.

Incidentally, the centrifugal force on a particle arising from Earth's revolution around the Sun is appreciable compared to gravity, but it is almost exactly balanced by the gravitational attraction to the Sun. If we analyze the motion of the Sun–Earth system from a frame rotating with Earth, it is of course just the balance between the centrifugal effect and the gravitational attraction that keeps the Earth (and all that are on it) and Sun separated. An analysis in a Newtonian inertial frame gives a different picture. As was described in Section 3.3, the angular momentum contributes to the effective potential energy to keep the Earth in orbit.

The Coriolis effect on a moving particle is perpendicular to both $\boldsymbol{\omega}$ and \mathbf{v} .* In the northern hemisphere, where $\boldsymbol{\omega}$ points out of the ground, the Coriolis effect $2m(\mathbf{v} \times \boldsymbol{\omega})$ tends to deflect a projective shot along Earth's surface, to the right of its direction of travel (cf. Fig. 4.13). The Coriolis deflection reverses direction in the southern hemisphere and is zero at the equator, where $\boldsymbol{\omega}$ is horizontal. The magnitude of the Coriolis acceleration is always less than

$$2\omega v \simeq 1.5 \times 10^{-4} v,$$

*From here on, the subscript r will be dropped from v as all velocities will be taken with respect to the rotating coordinate axes only

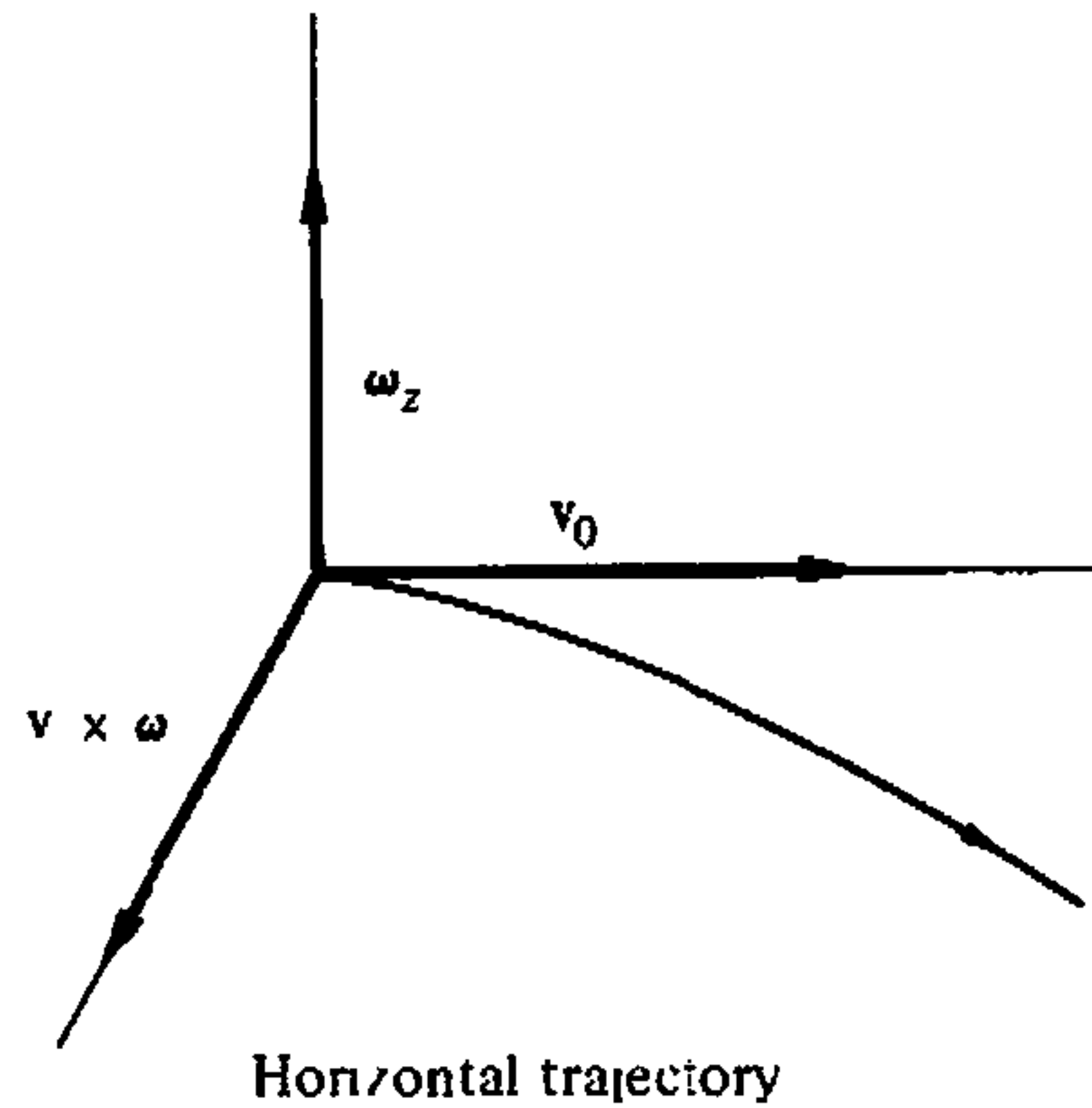

FIGURE 4.13 Direction of Coriolis deflection in the northern hemisphere.

which for a velocity of 10^5 cm/s (roughly 2000 mi/h) is 15 cm/s², or about $0.015g$. Normally, such an acceleration is extremely small, but there are instances when it becomes important. To take an artificial illustration, suppose a projectile were fired horizontally at the north pole. The Coriolis acceleration would then have the magnitude $2\omega v$, so that the linear deflection after a time t is ωvt^2 . The angular deflection would be the linear deflection divided by the distance of travel:

$$\theta = \frac{\omega vt^2}{vt} = \omega t, \quad (4.92)$$

which is the angle Earth rotates in the time t . Physically, this result means that a projectile shot off at the north pole has no initial rotational motion and hence its trajectory in the inertial space is a straight line, the apparent deflection being due to Earth rotating beneath it. Some idea of the magnitude of the effect can be obtained by substituting a time of flight of 100 s—not unusual for large projectiles—in Eq. (4.92). The angular deflection is then of the order of 7×10^{-3} radians, about 0.4° , which is not inconsiderable. Clearly the effect is even more important for long-range missiles, which have a much longer time of flight.

The Coriolis effect also plays a significant role in many oceanographic and meteorological phenomena involving displacements of masses of matter over long distances, such as the circulation pattern of the trade winds and the course of the Gulf stream. A full description of these phenomena requires the solution of complex hydrodynamic problems in which the Coriolis acceleration is only one among many terms involved. It is possible however to give some indication of the contribution of Coriolis effects by considering a highly simplified picture of one particular meteorological problem—the large-scale horizontal wind circulation. Masses of air tend to move, other things being equal, from regions of high pressure to regions of low pressure—the so-called pressure-gradient flow. In the vertical direction the pressure gradient is roughly balanced by gravitational forces so that

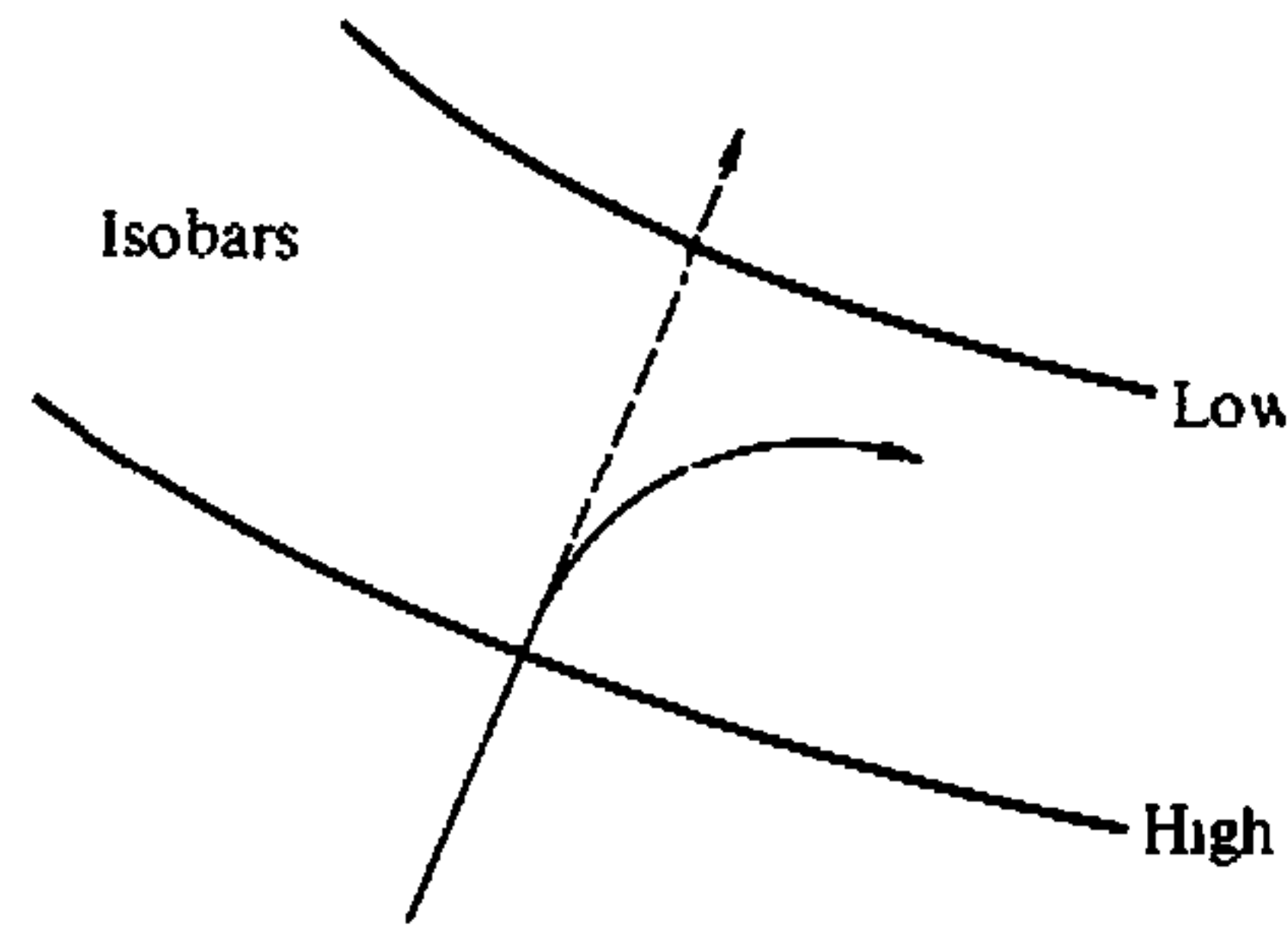

FIGURE 4.14 Deflection of wind from the direction of the pressure gradient by the Coriolis effect (shown for the northern hemisphere).

it is only in the horizontal plane that there are persistent long-range motions of air masses—which we perceive as winds. The pressure gradient forces are quite modest, and comparable in magnitude to the Coriolis effects acting on air masses moving at usual speeds. In the absence of Coriolis effects, the wind directions would ideally be perpendicular to the isobars, as shown in Fig. 4.14. However, the Coriolis effects deflect the wind to the right of this direction in the sense indicated in the figure. The deflection to the right continues until the wind vector is parallel to the isobars and the Coriolis effect is in the opposite direction to, and ideally just balances, the pressure-gradient force. The wind then continues parallel to the isobars, circulating in the northern hemisphere in a counterclockwise direction about a center of low pressure. In the southern hemisphere, the Coriolis effect acts in the opposite direction, and the cyclonic direction (i.e., the flow around a low-pressure center) is clockwise. (Such a wind flow, deflected parallel to the isobars, is known as a *geostrophic wind*.) In this simplified picture, the effect of friction has been neglected. At atmospheric altitudes below several kilometers, the friction effects of eddy viscosity become important, and the equilibrium wind direction never becomes quite parallel to the isobars, as indicated in Fig. 4.15.

Another classical instance where Coriolis effect produces a measurable effect is in the deflection from the vertical of a freely falling particle. Since the particle velocity is almost vertical and ω lies in the north–south vertical plane, the

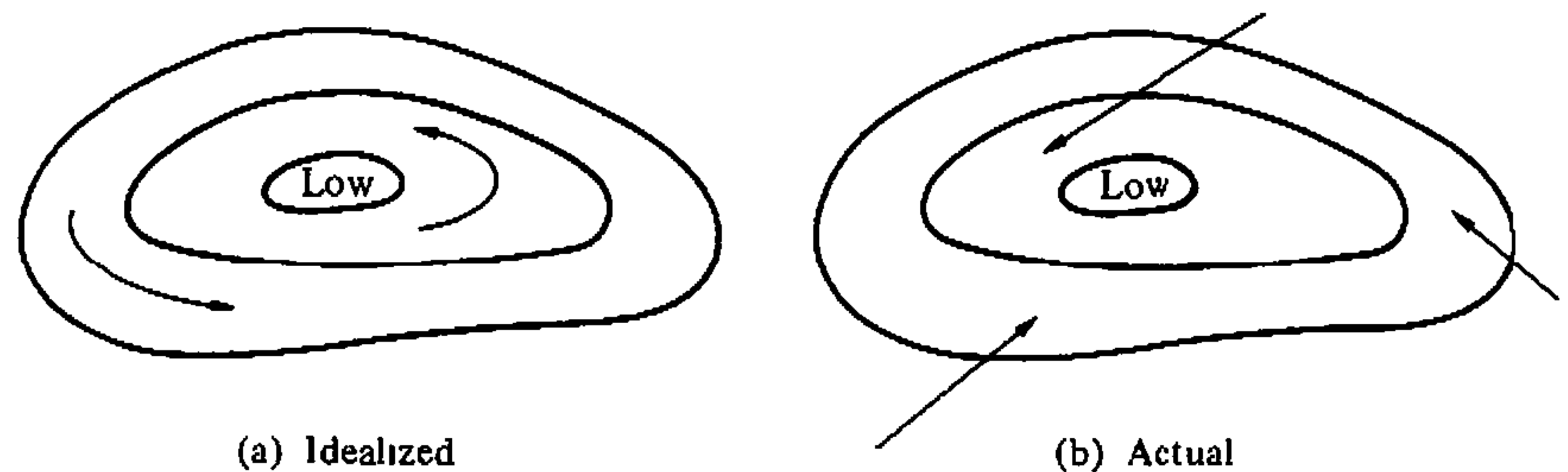

FIGURE 4.15 Cyclone pattern in the northern hemisphere.

deflecting force $2m(\mathbf{v} \times \boldsymbol{\omega})$ is in the east–west direction. Thus, in the northern hemisphere, a body falling freely will be deflected to the East. Calculation of the deflection is greatly simplified by choosing the z axis of the terrestrial coordinate system to be along the direction of the upward vertical as previously defined. If the y axis is taken as pointing North, and the frictional effect of the atmosphere is neglected, then the equation of motion in the x (East) direction is

$$\begin{aligned} m \frac{d^2 x}{dt^2} &= -2m(\boldsymbol{\omega} \times \mathbf{v})_x \\ &= -2m\omega v_z \sin \theta, \end{aligned} \quad (4.93)$$

where θ is the co-latitude. The effect of the Coriolis effect on v_z would constitute a small correction to the deflection, which itself is very small. Hence, the vertical velocity appearing in (4.93) may be computed as if Coriolis effects were absent.

$$v_z = -gt.$$

The integral of this is

$$t = \sqrt{\frac{2z}{g}}.$$

With these values, Eq. (4.93) may be easily integrated to give the deflection* as

$$x = \frac{\omega g}{3} t^3 \sin \theta$$

or

$$x = \frac{\omega}{3} \sqrt{\frac{(2z)^3}{g}} \sin \theta.$$

An order of magnitude of the deflection can be obtained by assuming $\theta = \pi/2$ (corresponding to the equator) and $z = 100$ m. The deflection is then, roughly,

$$x \simeq 2.2 \text{ cm.}$$

The actual experiment is difficult to perform, as the small deflection may often be masked by the effects of wind currents, viscosity, or other disturbing influences.†

More easily observable is the well-known experiment of the Foucault pendulum. If a pendulum is set swinging at the north pole in a given plane in space, then its linear momentum perpendicular to the plane is zero, and it will continue to swing in this invariable plane while Earth rotates beneath it. To an observer on Earth, the plane of oscillation appears to rotate once a day. At other latitudes the result is more complicated, but the phenomenon is qualitatively the same and detailed calculation will be left as an exercise.

*Again, we neglect the frictional effects of the atmosphere

†It is easy to show, using Eq. (4.93), that a particle projected upward will fall back to the ground *westward* of the original launching spot.

Effects due to the Coriolis terms also appear in atomic physics. Thus, two types of motion may occur simultaneously in polyatomic molecules: The molecule *rotates* as a rigid whole, and the atoms *vibrate* about their equilibrium positions. As a result of the vibrations, the atoms are in motion relative to the rotating coordinate system of the molecule. The Coriolis term will then be different from zero and will cause the atoms to move in a direction perpendicular to the original oscillations. Perturbations in molecular spectra due to Coriolis effects thus appear as interactions between the rotational and vibrational motions of the molecule.

DERIVATIONS

1. Prove that matrix multiplication is associative. Show that the product of two orthogonal matrices is also orthogonal.
2. Prove the following properties of the transposed and adjoint matrices:

$$\begin{aligned}\widetilde{\mathbf{AB}} &= \widetilde{\mathbf{BA}}, \\ (\mathbf{AB})^\dagger &= \mathbf{B}^\dagger \mathbf{A}^\dagger.\end{aligned}$$

3. Show that the trace of a matrix is invariant under any similarity transformation. Show also that the antisymmetry property of a matrix is preserved under an orthogonal similarity transformation.
4. (a) By examining the eigenvalues of an antisymmetric 3×3 real matrix \mathbf{A} , show that $\mathbf{1} \pm \mathbf{A}$ is nonsingular.
(b) Show then that under the same conditions the matrix

$$\mathbf{B} = (\mathbf{1} + \mathbf{A})(\mathbf{1} - \mathbf{A})^{-1}$$

is orthogonal.

5. Obtain the matrix elements of the general rotation matrix in terms of the Euler angles, Eq. (4.46), by performing the multiplications of the successive component rotation matrices. Verify directly that the matrix elements obey the orthogonality conditions.
6. The body set of axes can be related to the space set in terms of Euler's angles by the following set of rotations:
 - (a) Rotation about the x axis by an angle θ
 - (b) Rotation about the z' axis by an angle ψ .
 - (c) Rotation about the *old* z axis by an angle ϕ .

Show that this sequence leads to the same elements of the matrix of transformation as the sequence of rotations given in the book. [Hint: It is not necessary to carry out the explicit multiplication of the rotation matrices.]

7. If \mathbf{A} is the matrix of a rotation through 180° about any axis, show that if

$$\mathbf{P}_\pm = \frac{1}{2}(\mathbf{1} \pm \mathbf{A}),$$

then $\mathbf{P}_{\pm}^2 = \mathbf{P}_{\pm}$. Obtain the elements of \mathbf{P}_{\pm} in any suitable system, and find a geometric interpretation of the operation \mathbf{P}_{+} and \mathbf{P}_{-} on any vector \mathbf{F} .

8. (a) Show that the rotation matrix in the form of Eq. (4.47') cannot be put in the form of the matrix of the inversion transformation \mathbf{S} .
 (b) Verify by direct multiplication that the matrix in Eq. (4.47') is orthogonal.
9. Show that any rotation can be represented by successive reflection in two planes, both passing through the axis of rotation with the planar angle $\Phi/2$ between them.
10. If \mathbf{B} is a square matrix and \mathbf{A} is the exponential of \mathbf{B} , defined by the infinite series expansion of the exponential,

$$\mathbf{A} \equiv e^{\mathbf{B}} = \mathbf{1} + \mathbf{B} + \frac{1}{2}\mathbf{B}^2 + \cdots + \frac{\mathbf{B}^n}{n!} + \cdots,$$

then prove the following properties:

- (a) $e^{\mathbf{B}}e^{\mathbf{C}} = e^{\mathbf{B}+\mathbf{C}}$, providing \mathbf{B} and \mathbf{C} commute
 - (b) $\mathbf{A}^{-1} = e^{-\mathbf{B}}$
 - (c) $e^{\mathbf{C}\mathbf{B}\mathbf{C}^{-1}} = \mathbf{C}\mathbf{A}\mathbf{C}^{-1}$
 - (d) \mathbf{A} is orthogonal if \mathbf{B} is antisymmetric.
11. Verify the relation

$$|-\mathbf{B}| = (-1)^n |\mathbf{B}|$$

for the determinant of an $n \times n$ matrix \mathbf{B} .

12. In a set of axes where the z axis is the axis of rotation of a finite rotation, the rotation matrix is given by Eq. (4.43) with θ replaced by the angle of finite rotation Φ . Derive the rotation formula, Eq. (4.62), by transforming to an arbitrary coordinate system, expressing the orthogonal matrix of transformation in terms of the direction cosines of the axis of the finite rotation.
13. (a) Suppose two successive coordinate rotations through angles Φ_1 and Φ_2 are carried out, equivalent to a single rotation through an angle Φ . Show that Φ_1 , Φ_2 , and Φ can be considered as the sides of a spherical triangle with the angle opposite to Φ given by the angle between the two axes of rotation.
 (b) Show that a rotation about any given axis can be obtained as the product of two successive rotations, each through 180°
14. (a) Verify that the permutation symbol satisfies the following identity in terms of Kronecker delta symbols:

$$\epsilon_{ijp}\epsilon_{rmp} = \delta_{ir}\delta_{jm} - \delta_{im}\delta_{jr}.$$

- (b) Show that

$$\epsilon_{ijp}\epsilon_{ijk} = 2\delta_{pk}.$$

15. Show that the components of the angular velocity along the space set of axes are given in terms of the Euler angles by

$$\omega_x = \dot{\theta} \cos \phi + \dot{\psi} \sin \theta \sin \phi,$$

$$\omega_y = \dot{\theta} \sin \phi - \dot{\psi} \sin \theta \cos \phi,$$

$$\omega_z = \dot{\psi} \cos \theta + \dot{\phi}.$$

16. Show that the Euler parameter e_0 has the equation of motion

$$-2\dot{e}_0 = e_1\omega_{x'} + e_2\omega_{y'} + e_3\omega_{z'},$$

where the prime denotes the body set of axes. Find the corresponding equations for the other three Euler parameters and for the complex Cayley–Klein parameters α and β .

17. Verify directly that the matrix generators of infinitesimal rotation, \mathbf{M}_i , as given by Eq. (4.79) obey the commutation relations

$$[\mathbf{M}_i, \mathbf{M}_j] = \epsilon_{ijk} \mathbf{M}_k.$$

18. (a) Find the vector equation describing the reflection of \mathbf{r} in a plane whose unit normal is \mathbf{n} .
 (b) Show that if l_i , $i = 1, 2, 3$, are the direction cosines of \mathbf{n} , then the matrix of transformation has the elements

$$A_{ij} = \delta_{ij} - 2l_i l_j,$$

and verify that \mathbf{A} is an improper orthogonal matrix.

19. Figures 4.9 and 4.10 show that the order of finite rotations leads to different results. Use the notation that $\mathbf{A}(\alpha, \mathbf{l}_n)$ where \mathbf{A} is a rotation in the direction of \mathbf{l}_n through an angle α . Let n_1 and n_2 be two orthogonal directions.

- (a) If \mathbf{x} is the position vector of a point on a rigid body, which is then rotated by an angle θ around the origin, show that the new value of \mathbf{x} is

$$\mathbf{x}' = (\mathbf{l}_n \cdot \mathbf{x})\mathbf{l}_n + [\mathbf{x} - \mathbf{l}_n(\mathbf{l}_n \cdot \mathbf{x})] \cos \theta - \mathbf{n} \times \mathbf{x} \sin \theta.$$

From this, obtain the formula for $\mathbf{A}(\pi/2, \mathbf{l}_n)$ and derive the two rotations in the figures.

- (b) Discuss these two rotations. [*Hint*: The answer will involve a rotation by the angle $\frac{2}{3}\pi$ in a direction $(1/\sqrt{3})(1, 1, 1)$.]
 20. Express the “rolling” constraint of a sphere on a plane surface in terms of the Euler angles. Show that the conditions are nonintegrable and that the constraint is therefore nonholonomic.

EXERCISES

21. A particle is thrown up vertically with initial speed v_0 , reaches a maximum height and falls back to ground. Show that the Coriolis deflection when it again reaches the ground is opposite in direction, and four times greater in magnitude, than the Coriolis deflection when it is dropped at rest from the same maximum height.

22. A projectile is fired horizontally along Earth's surface. Show that to a first approximation the angular deviation from the direction of fire resulting from the Coriolis effect varies linearly with time at a rate

$$\omega \cos \theta,$$

where ω is the angular frequency of Earth's rotation and θ is the co-latitude, the direction of deviation being to the right in the northern hemisphere.

23. The Foucault pendulum experiment consists in setting a long pendulum in motion at a point on the surface of the rotating Earth with its momentum originally in the vertical plane containing the pendulum bob and the point of suspension. Show that the pendulum's subsequent motion may be described by saying that the plane of oscillation rotates uniformly $2\pi \cos \theta$ radians per day, where θ is the co-latitude. What is the direction of rotation? The approximation of small oscillations may be used, if desired.
24. A wagon wheel with spokes is mounted on a vertical axis so it is free to rotate in the horizontal plane. The wheel is rotating with an angular speed of $\omega = 3.0$ radian/s. A bug crawls out on one of the spokes of the wheel with a velocity of 0.5 cm/s holding on to the spoke with a coefficient of friction $\mu = 0.30$. How far can the bug crawl along the spoke before it starts to slip?
25. A carousel (counter-clockwise merry-go-round) starts from rest and accelerates at a constant angular acceleration of 0.02 revolutions/s². A girl sitting on a bench on the platform 7.0 m from the center is holding a 3.0 kg ball. Calculate the magnitude and direction of the force she must exert to hold the ball 6.0 s after the carousel starts to move. Give the direction with respect to the line from the center of rotation to the girl.

CHAPTER

5

The Rigid Body Equations of Motion

Chapter 4 presents all the kinematical tools needed in the discussion of rigid body motion. In the Euler angles we have a set of three coordinates, defined rather unsymmetrically it is true, yet suitable for use as the generalized coordinates describing the orientation of the rigid body. In addition, the method of orthogonal transformations, and the associated matrix algebra, furnish a powerful and elegant technique for investigating the characteristics of rigid body motion. We have already had one application of the technique in deriving Eq. (4.86), the relation between the states of change of a vector as viewed in the space system and in the body system. These tools will now be applied to obtain the Euler dynamical equations of motion of the rigid body in their most convenient form. With the help of the equations of motion, some simple but highly important problems of rigid body motion can be discussed.

5.1 ■ ANGULAR MOMENTUM AND KINETIC ENERGY OF MOTION ABOUT A POINT

Chasles' theorem states that any general displacement of a rigid body can be represented by a translation plus a rotation. The theorem suggests that it ought to be possible to split the problem of rigid body motion into two separate phases, one concerned solely with the translational motion of the body, the other, with its rotational motion. Of course, if one point of the body is fixed, the separation is obvious, for then there is only a rotational motion about the fixed point, without any translation. But even for a general type of motion such a separation is often possible. The six coordinates needed to describe the motion have already been formed into two sets in accordance with such a division: the three Cartesian coordinates of a point fixed in the rigid body to describe the translational motion and, say, the three Euler angles for the motion about the point. If, further, the origin of the body system is chosen to be the center of mass, then by Eq. (1.28) the total angular momentum divides naturally into contributions from the translation of the center of mass and from the rotation about the center of mass. The former term will involve only the Cartesian coordinates of the center of mass, the latter only the angle coordinates. By Eq. (1.31), a similar division holds for the total kinetic energy T , which can be written in the form

$$T = \frac{1}{2}Mv^2 + T'(\phi, \theta, \psi),$$

as the sum of the kinetic energy of the entire body as if concentrated at the center of mass, plus the kinetic energy of motion about the center of mass.

Often the potential energy can be similarly divided, each term involving only one of the coordinate sets, either the translational or rotational. Thus, the potential energy in a uniform gravitational field will depend only upon the Cartesian vertical coordinate of the center of gravity.* Or if the force on a body is due to a uniform magnetic field, \mathbf{B} , acting on its magnetic dipole moment, \mathbf{M} , then the potential is proportional to $\mathbf{M} \cdot \mathbf{B}$, which involves only the orientation of the body. Certainly, almost all problems soluble in practice will allow for such a separation. In such a case, the entire mechanical problem does indeed split into two. The Lagrangian, $L = T - V$, divides into two parts, one involving only the translational coordinates, the other only the angle coordinates. These two groups of coordinates will then be completely separated, and the translational and rotational problems can be solved independently of each other.

It is of obvious importance therefore to obtain expressions for the angular momentum and kinetic energy of the motion about some point fixed in the body. To do so, we will make abundant use of Eq. (4.86) linking derivatives relative to a coordinate system fixed at some point in the rigid body. It is intuitively obvious that the rotation angle of a rigid body displacement, as also the instantaneous angular velocity vector, is independent of the choice of origin of the body system of axes. The essence of the rigid body constraint is that all particles of the body move and rotate together. However, a formal proof is easily constructed.

Let \mathbf{R}_1 and \mathbf{R}_2 be the position vectors, relative to a fixed set of coordinates, of the origins of two sets of body coordinates (cf. Fig. 5.1). The difference vector is denoted by \mathbf{R} :

$$\mathbf{R}_2 = \mathbf{R}_1 + \mathbf{R}.$$

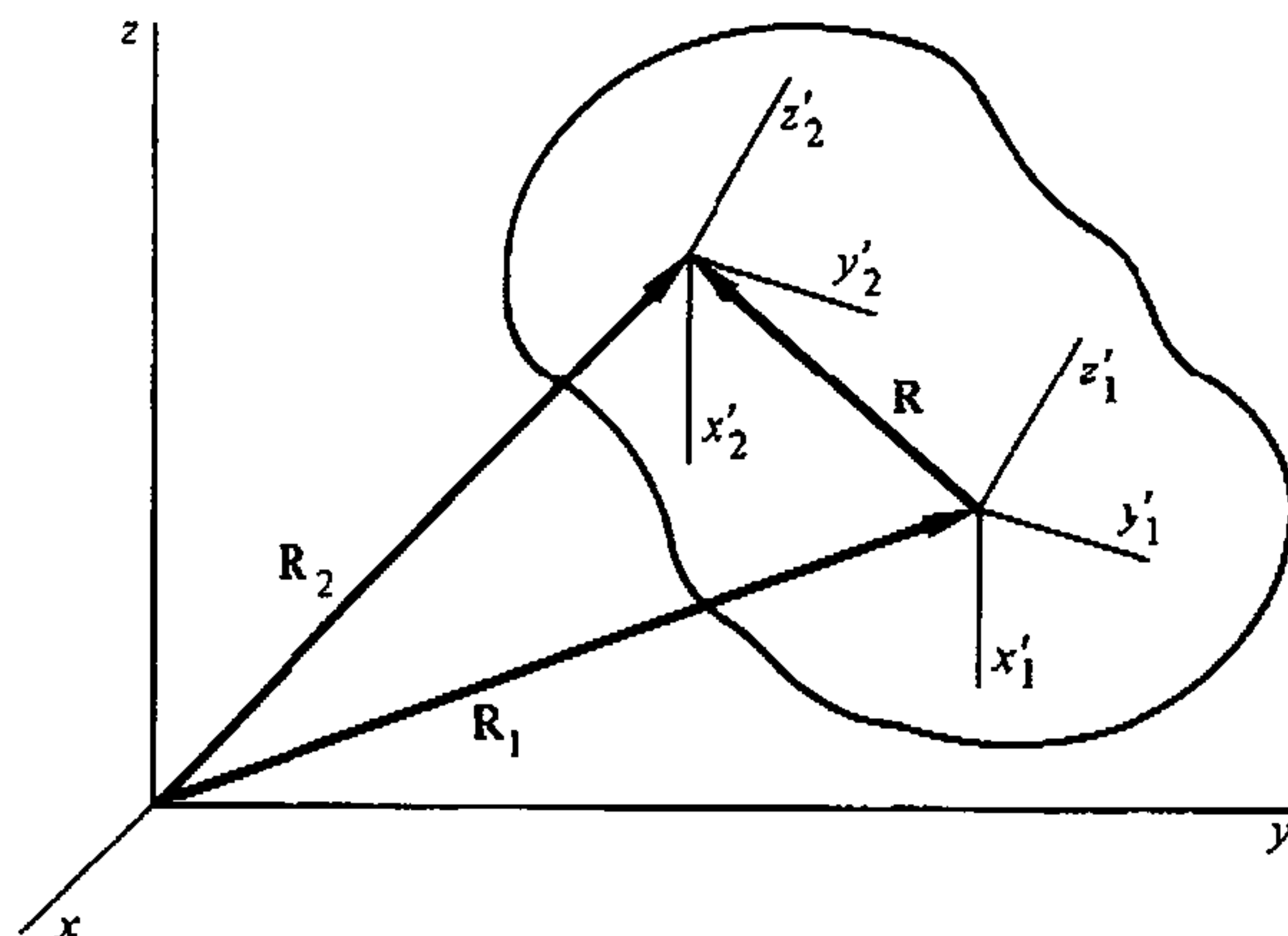

FIGURE 5.1 Vectorial relation between sets of rigid body coordinates with different origins.

*The center of gravity of course coincides with the center of mass in a uniform gravitational field.

If the origin of the second set of axes is considered as a point defined relative to the first, then the time derivative of \mathbf{R}_2 relative to the space axes is given by

$$\left(\frac{d\mathbf{R}_2}{dt}\right)_s - \left(\frac{d\mathbf{R}_1}{dt}\right)_s + \left(\frac{d\mathbf{R}}{dt}\right)_s - \left(\frac{d\mathbf{R}_1}{dt}\right)_s + \boldsymbol{\omega}_1 \times \mathbf{R}.$$

The last step follows from Eq. (4.86), recalling that the derivatives of \mathbf{R} relative to any rigid body axes must vanish, and with $\boldsymbol{\omega}_1$ as being the angular velocity vector appropriate to the first coordinate system. Alternatively, the origin of the first coordinate system can be considered as fixed in the second system with the position vector $-\mathbf{R}$. In the same manner, then, the derivative of the position vector \mathbf{R}_1 to this origin relative to the fixed-space axes can be written as

$$\left(\frac{d\mathbf{R}_1}{dt}\right)_s = \left(\frac{d\mathbf{R}_2}{dt}\right)_s - \left(\frac{d\mathbf{R}}{dt}\right)_s = \left(\frac{d\mathbf{R}_2}{dt}\right)_s - \boldsymbol{\omega}_2 \times \mathbf{R}.$$

A comparison of these two expressions shows $(\boldsymbol{\omega}_1 - \boldsymbol{\omega}_2) \times \mathbf{R} = 0$. Any difference in the angular velocity vectors at two arbitrary points must lie along the line joining the two points. Assuming the $\boldsymbol{\omega}$ vector field is continuous, the only possible solution for all pairs of points is that the two angular velocity vectors must be equal:

$$\boldsymbol{\omega}_1 = \boldsymbol{\omega}_2.*$$

The angular velocity vector is the same for all coordinate systems fixed in the rigid body.

When a rigid body moves with one point stationary, the total angular momentum about that point is

$$\mathbf{L} = m_i (\mathbf{r}_i \times \mathbf{v}_i), \quad (5.1)$$

(employing the summation convention) where \mathbf{r}_i and \mathbf{v}_i are the radius vector and velocity, respectively, of the i th particle relative to the given point. Since \mathbf{r}_i is a fixed vector relative to the body, the velocity \mathbf{v}_i with respect to the space set of axes arises solely from the rotational motion of the rigid body about the fixed point. From Eq. (4.86), \mathbf{v}_i is then

$$\mathbf{v}_i = \boldsymbol{\omega} \times \mathbf{r}_i. \quad (5.2)$$

Hence, Eq. (5.1) can be written as

$$\mathbf{L}_i = m_i [\mathbf{r}_i \times (\boldsymbol{\omega} \times \mathbf{r}_i)],$$

or, expanding the triple cross product,

$$\mathbf{L} = m_i \left[\boldsymbol{\omega} r_i^2 - \mathbf{r}_i (\mathbf{r}_i \cdot \boldsymbol{\omega}) \right]. \quad (5.3)$$

*See also N. A. Lemos, *Am. Jr. Phys.*, 68(7) 2000, pp. 668–669.

Again expanding, the x -component of the angular momentum becomes

$$L_x = \omega_x m_i (r_i^2 - x_i^2) - \omega_y m_i x_i y_i - \omega_z m_i x_i z_i, \quad (5.4)$$

with similar equations for the other components of \mathbf{L} . Thus, each component of the angular momentum is a linear function of all the components of the angular velocity. *The angular momentum vector is related to the angular velocity by a linear transformation.* To emphasize the similarity of (5.4) with the equations of a linear transformation, (4.12), we may write L_x as

$$L_x = I_{xx}\omega_x + I_{xy}\omega_y + I_{xz}\omega_z.$$

Analogously, for L_y and L_z we have

$$\begin{aligned} L_y &= I_{yx}\omega_x + I_{yy}\omega_y + I_{yz}\omega_z, \\ L_z &= I_{zx}\omega_x + I_{zy}\omega_y + I_{zz}\omega_z. \end{aligned} \quad (5.5)$$

The nine coefficients I_{xx} , I_{xy} , etc., are the nine elements of the transformation matrix. The diagonal elements are known as *moment of inertia coefficients*, and have the following form

$$I_{xx} = m_i (r_i^2 - x_i^2), \quad (5.6)$$

while the off-diagonal elements are designated as *products of inertia*, a typical one being

$$I_{xy} = -m_i x_i y_i. \quad (5.7)$$

In Eqs. (5.6) and (5.7), the matrix elements appear in the form suitable if the rigid body is composed of discrete particles. For continuous bodies the summation is replaced by a volume integration, with the particle mass becoming a mass density. Thus, the diagonal element I_{xx} appears as

$$I_{xx} = \int_V \rho(\mathbf{r})(r^2 - x^2) dV. \quad (5.6')$$

With a slight change in notation, an expression for all matrix elements can be stated for continuous bodies. If the coordinate axes are denoted by x_j , $j = 1, 2, 3$, then the matrix element I_{jk} can be written

$$I_{jk} = \int_V \rho(\mathbf{r})(r^2 \delta_{jk} - x_j x_k) dV. \quad (5.8)$$

Thus far, the coordinate system used in resolving the components of \mathbf{L} has not been specified. From now on, we will take it to be a system fixed in the body.* The various distances x_i, y_i, z_i are then constant in time, so that the matrix elements are likewise constants, peculiar to the body involved, and dependent on the origin and orientation of the particular body set of axes in which they are expressed.

Equations (5.5) relating the components of \mathbf{L} and $\boldsymbol{\omega}$ can be summarized by a single operator equation,

$$\mathbf{L} = \mathbf{I}\boldsymbol{\omega}, \quad (5.9)$$

where the symbol \mathbf{I} stands for the operator whose matrix elements are the inertia coefficients appearing in (5.5), and $\boldsymbol{\omega}$ and \mathbf{L} are column matrices. Of the two interpretations that have been given to the operator of a linear transformation (cf. Section 4.2), it is clear that here \mathbf{I} must be thought of as acting upon the vector $\boldsymbol{\omega}$, and not upon the coordinate system. The vectors \mathbf{L} and $\boldsymbol{\omega}$ are two physically different vectors, having different dimensions, and are not merely the same vector expressed in two different coordinate systems. Unlike the operator of rotation, \mathbf{I} will have dimensions—mass times length squared—and it is not restricted by any orthogonality conditions. Equation (5.9) is to be read as the operator \mathbf{I} acting upon the vector $\boldsymbol{\omega}$ results in the physically new vector \mathbf{L} .

While full use will be made of the matrix algebra techniques developed in the discussion of the rotation operator, more attention must be paid here to the nature and physical character of the operator per se. However, a certain amount of preliminary mathematical formalism needs first to be discussed. Those already familiar with tensors can proceed immediately to Section 5.3.

5.2 ■ TENSORS

The quantity \mathbf{I} may be considered as defining the quotient of \mathbf{L} and $\boldsymbol{\omega}$ for the product of \mathbf{I} and $\boldsymbol{\omega}$ gives \mathbf{L} . Now, the quotient of two quantities is often not a member of the same class as the dividing factors, but may belong to a more complicated class. Thus, the quotient of two integers is in general not an integer but rather a rational number. Similarly, the quotient of two vectors, as is well known, cannot be defined consistently within the class of vectors. It is not surprising, therefore to find that \mathbf{I} is a new type of quantity, a *tensor of the second rank*.

In a Cartesian three-dimensional space, a tensor \mathbf{T} of the N th rank may be defined for our purposes as a quantity having 3^N components $T_{i_1 i_2 \dots i_N}$ (with N indices) that transform under an orthogonal transformation of coordinates, \mathbf{A} , according to

*In Chapter 4, such a system was denoted by primes. As components along spatial axes are rarely used here, this convention will be dropped from now on to simplify the notation. Unless otherwise specified, all coordinates used for the rest of the chapter refer to systems fixed in the rigid body.

the following scheme:*

$$T'_{ijk}(\mathbf{x}') = a_{il}a_{jm}a_{kn} \dots T_{lmn}(\mathbf{x}). \quad (5.10)$$

By this definition, a tensor of the zero rank has one component, which is invariant under an orthogonal transformation. Hence, a *scalar is a tensor of zero rank*. A tensor of the first rank has three components transforming as

$$T'_i = a_{ij}T_j.$$

Comparison with the transformation equations for a vector, (4.12'), shows that a *tensor of the first rank is completely equivalent to a vector*.[†] Finally, the nine components of a tensor of the second rank transform as

$$T'_{ij} = a_{ik}a_{jl}T_{kl}. \quad (5.11)$$

Rigorously speaking, we must distinguish between a second-rank tensor \mathbf{T} and the square matrix formed from its components. A tensor is defined only in terms of its transformation properties under orthogonal coordinate transformations. On the other hand, a matrix is in no way restricted in the types of transformations it may undergo and indeed may be considered entirely independently of its properties under some particular class of transformations. Nevertheless, the distinction must not be stressed unduly. Within the restricted domain of orthogonal transformations, there is a practical identity. The tensor components and the matrix elements are manipulated in the same fashion; for every tensor equation there will be a corresponding matrix equation, and vice versa. By Eq. (4.41), the components of a square matrix \mathbf{T} transform under a linear change of coordinates defined by the matrix \mathbf{A} according to a similarity transformation:

$$\mathbf{T}' = \mathbf{A}\mathbf{T}\mathbf{A}^{-1}.$$

For an orthogonal transformation, we therefore have

$$\mathbf{T}' = \mathbf{A}\tilde{\mathbf{T}}\mathbf{A} \quad (5.12)$$

*In a Cartesian space (that is, with orthogonal straight-line axes) there is no distinction between "covariant" and "contravariant" indices, and the terminology will not be needed. Indeed, strictly speaking the tensors defined here should be denoted as "Cartesian tensors." As this is the only type of tensor that will be used in this book (except in Chapters 7 and 13), the adjective will be omitted in subsequent discussions.

[†]A *pseudotensor* in three dimensions transforms as a tensor except under inversion. In general, the transformation equation for a pseudotensor \mathbf{T}^* of the N th rank is (cf. Eq. (4.74))

$$T'^*_{ijk} = |\mathbf{A}|a_{il}a_{jm}a_{kn} \dots T^*_{lmn},$$

and the parity operation P gives

$$P\mathbf{T}^* = (-1)^{N+1}\mathbf{T}^*$$

As rigid body motion involves only proper rotations no further use will be made here of the general pseudotensor

or

$$T'_{ij} = a_{ik}T_{kl}a_{jl}. \quad (5.13)$$

Comparison with Eq. (5.11) thus shows that the matrix components transform identically, under an orthogonal transformation, with the components of a tensor of the second rank. All the terminology and operations of matrix algebra, such as “transpose” and “antisymmetrical” can be applied to tensors without change. The equivalence between the tensor and the matrix is not restricted to tensors of the second rank. For example, we already know that the components of a vector, which is a tensor of the first rank, form a column or row matrix and vector manipulation may be treated completely in terms of these associated matrices.

Two vectors can be used to construct a second-rank tensor, \mathbf{T} . Let \mathbf{A} and \mathbf{B} be vectors with components A_i and B_j and construct the tensor \mathbf{T} , by

$$T_{ij} = A_i B_j. \quad (5.14)$$

For example, if \mathbf{A} and \mathbf{B} are two-dimensional vectors,*

$$\mathbf{T} = \begin{pmatrix} T_{xx} & T_{xy} \\ T_{yx} & T_{yy} \end{pmatrix} = \begin{pmatrix} A_x B_x & A_x B_y \\ A_y B_x & A_y B_y \end{pmatrix}.$$

Since each individual vector transforms as a vector under a Cartesian transformation, each component of \mathbf{T} will transform as required by Eq. (5.10). For example,

$$T'_{xy} = \sum_{i=1}^3 \sum_{j=1}^3 a_{xi} a_{yj} T_{ij} = a_{xi} a_{yj} A_i B_j = a_{ai} A_i a_{yj} B_j = A'_x B'_y,$$

so \mathbf{T} is a tensor.

The types of operations performed with vectors can be combined with tensors in an obvious way. There is a unit tensor, $\mathbf{1}$, whose components are

$$1_{ij} = \delta_{ij} \quad (5.15)$$

where δ_{ij} is the delta function (also called the Kronecker delta), $\delta_{ij} = 1$ if $i = j$, and zero otherwise. The dot product on the right of a tensor \mathbf{T} with a vector \mathbf{C} is defined as the vector \mathbf{D} by

$$\mathbf{D} = \mathbf{T} \cdot \mathbf{C} \quad \text{where } D_i = \sum_{j=1}^3 T_{ij} C_j = T_{ij} C_j,$$

*To distinguish between matrices which are transformations and tensors which are physical quantities we use [] for matrices and () for tensors.

and the dot product on the left with a vector \mathbf{F} is defined as the vector \mathbf{E} by

$$\mathbf{E} = \mathbf{F} \cdot \mathbf{T} \quad \text{where } E_i = \sum_{j=1}^3 F_j T_{ji} = F_j T_{ji}.$$

A scalar S can be constructed by a double dot product

$$S = \mathbf{F} \cdot \mathbf{T} \cdot \mathbf{C} \quad \text{where } S = \sum_{i=1}^3 \sum_{j=1}^3 F_i T_{ij} C_j = F_i T_{ij} C_j.$$

These processes are termed contraction. If the tensor \mathbf{T} is constructed of two vectors \mathbf{A} and \mathbf{B} as in Eq. (5.14), then

$$\mathbf{T} \cdot \mathbf{C} = \mathbf{A}(\mathbf{B} \cdot \mathbf{C}) = (\mathbf{B} \cdot \mathbf{C})\mathbf{A}, \quad \text{and} \quad \mathbf{F} \cdot \mathbf{T} = (\mathbf{F} \cdot \mathbf{A})\mathbf{B} = (\mathbf{A} \cdot \mathbf{F})\mathbf{B}.$$

5.3 ■ THE INERTIA TENSOR AND THE MOMENT OF INERTIA

Considered as a linear operator that transforms $\boldsymbol{\omega}$ into L , the matrix \mathbf{I} has elements that behave as the elements of a second-rank tensor. The quantity \mathbf{I} is therefore identified as a second-rank tensor and is usually called the *moment of inertia tensor* or briefly the *inertia tensor*.

The kinetic energy of motion about a point is

$$T = \frac{1}{2} m_i v_i^2,$$

where \mathbf{v}_i is the velocity of the i th particle relative to the fixed point as measured in the space axes. By Eq. (5.2), T may also be written as

$$T = \frac{1}{2} m_i \mathbf{v}_i \cdot (\boldsymbol{\omega} \times \mathbf{r}_i),$$

which, upon permuting the vectors in the triple dot product, becomes

$$T = \frac{\boldsymbol{\omega}}{2} \cdot m_i (\mathbf{r}_i \times \mathbf{v}_i).$$

The quantity summed over i will be recognized as the angular momentum of the body about the origin, and in consequence the kinetic energy can be written in the form

$$T = \frac{\boldsymbol{\omega} \cdot \mathbf{L}}{2} = \frac{\boldsymbol{\omega} \cdot \mathbf{I} \cdot \boldsymbol{\omega}}{2}. \quad (5.16)$$

Let \mathbf{n} be a unit vector in the direction of $\boldsymbol{\omega}$ so that $\boldsymbol{\omega} = \omega \mathbf{n}$. Then an alternative form for the kinetic energy is

$$T = \frac{\omega^2}{2} \mathbf{n} \cdot \mathbf{l} \cdot \mathbf{n} = \frac{1}{2} I \omega^2, \quad (5.17)$$

where I is a scalar, defined by

$$I = \mathbf{n} \cdot \mathbf{l} \cdot \mathbf{n} = m_i \left[r_i^2 - (\mathbf{r}_i \cdot \mathbf{n})^2 \right], \quad (5.18)$$

and known as the *moment of inertia about the axis of rotation*.

In the usual elementary discussions, the moment of inertia about an axis is defined as the sum, over the particles of the body, of the product of the particle mass and the square of the perpendicular distance from the axis. It must be shown that this definition is in accord with the expression given in Eq. (5.18). The perpendicular distance is equal to the magnitude of the vector $\mathbf{r}_i \times \mathbf{n}$ (cf. Fig. 5.2). Therefore, the customary definition of I may be written as

$$I = m_i (\mathbf{r}_i \times \mathbf{n}) \cdot (\mathbf{r}_i \times \mathbf{n}). \quad (5.19)$$

Multiplying and dividing by ω^2 , this definition of I may also be written as

$$I = \frac{m_i}{\omega^2} (\boldsymbol{\omega} \times \mathbf{r}_i) \cdot (\boldsymbol{\omega} \times \mathbf{r}_i).$$

But each vector in the dot product is exactly the relative velocity \mathbf{v}_i as measured in the space system of axes. Hence, I so defined is related to the kinetic energy by

$$I = \frac{2T}{\omega^2},$$

which is the same as Eq. (5.17), and therefore I must be identical with the scalar defined by Eq. (5.19).

The value of the moment of inertia depends upon the direction of the axis of rotation. As $\boldsymbol{\omega}$ usually changes its direction with respect to the body in the course

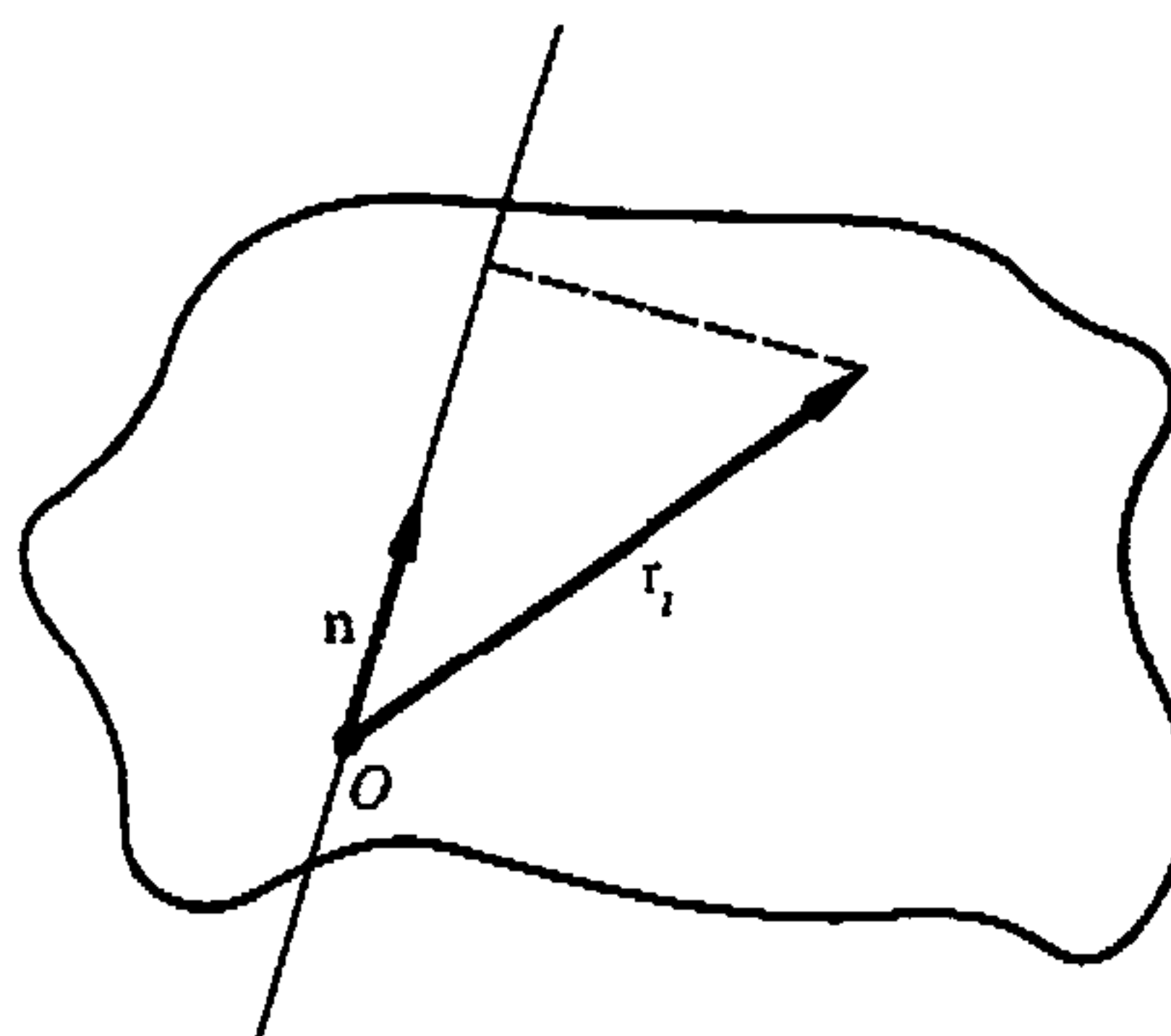

FIGURE 5.2 The definition of the moment of inertia.

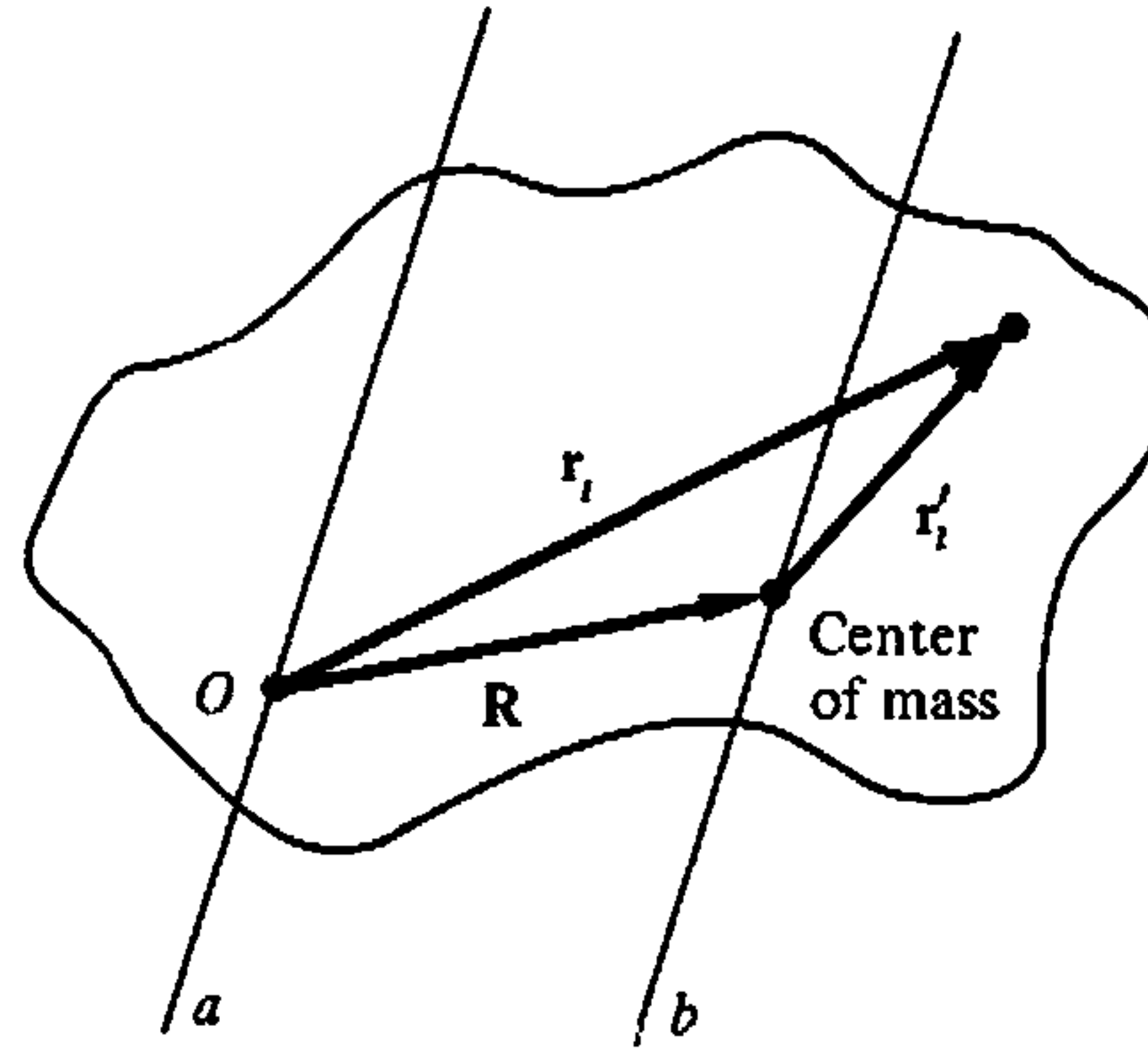

FIGURE 5.3 The vectors involved in the relation between moments of inertia about parallel axes.

of time, the moment of inertia must also be considered a function of time. When the body is constrained so as to rotate only about a fixed axis, then the moment of inertia is a constant. In such a case, the kinetic energy (5.16) is almost in the form required to fashion the Lagrangian and the equations of motion. The one further step needed is to express ω as the time derivative of some angle, which can usually be done without difficulty.

Along with the inertia tensor, the moment of inertia also depends upon the choice of origin of the body set of axes. However, the moment of inertia about some given axis is related simply to the moment about a parallel axis through the center of mass. Let the vector from the given origin O to the center of mass be \mathbf{R} , and let the radii vectors from O and the center of mass to the i th particle be \mathbf{r}_i and \mathbf{r}'_i , respectively. The three vectors so defined are connected by the relation (cf. Fig. 5.3)

$$\mathbf{r}_i = \mathbf{R} + \mathbf{r}'_i. \quad (5.20)$$

The moment of inertia about the axis a is therefore

$$I_a = m_i (\mathbf{r}_i \times \mathbf{n})^2 = m_i [(\mathbf{r}'_i + \mathbf{R}) \times \mathbf{n}]^2$$

or

$$I_a = M(\mathbf{R} \times \mathbf{n})^2 + m_i (\mathbf{r}'_i \times \mathbf{n})^2 + 2m_i (\mathbf{R} \times \mathbf{n}) \cdot (\mathbf{r}'_i \times \mathbf{n}),$$

where M is the total mass of the body. The last term in this expression can be rearranged as

$$-2(\mathbf{R} \times \mathbf{n}) \cdot (\mathbf{n} \times m_i \mathbf{r}'_i).$$

By the definition of center of mass, the summation $m_i \mathbf{r}'_i$ vanishes. Hence, I_a can be expressed in terms of the moment about the parallel axis b as

$$\begin{aligned} I_a &= I_b + M(\mathbf{R} \times \mathbf{n})^2 \\ &= I_b + MR^2 \sin^2 \theta. \end{aligned} \quad (5.21)$$

The magnitude of $\mathbf{R} \times \mathbf{n}$, which has the value $R \sin \theta$, where θ is the angle between \mathbf{R} and \mathbf{n} , is the perpendicular distance of the center of mass from the axis passing through O . Consequently, the moment of inertia about a given axis is equal to the moment of inertia about a parallel axis through the center of mass plus the moment of inertia of the body, as if concentrated at the center of mass, with respect to the original axis.

The inertia tensor is defined in general from the kinetic energy of rotation about an axis, and is written as

$$T_{\text{rotation}} = \frac{1}{2} m_i (\boldsymbol{\omega} \times \mathbf{r}_i)^2 = \frac{1}{2} \omega_\alpha \omega_\beta m_i (\delta_{\alpha\beta} r_i^2 - r_{i\alpha} r_{i\beta}),$$

where Greek letters indicate the components of $\boldsymbol{\omega}$ and \mathbf{r}_i . In an inertial frame, the sum is over the particles in the body, and $r_{i\alpha}$ is the α th component of the position of the i th particle. Because T_{rotation} is a bilinear form in the components of $\boldsymbol{\omega}$, it can be written as

$$T_{\text{rotation}} = \frac{1}{2} I_{\alpha\beta} \omega_\alpha \omega_\beta,$$

where

$$I_{\alpha\beta} = m_i (\delta_{\alpha\beta} r_i^2 - r_{i\alpha} r_{i\beta}) \quad (5.22)$$

is the moment of inertia tensor. To get the moment of inertia about an axis through the center of mass, choose the rotation about this axis. For a body with a continuous distribution of density $\rho(r)$, the sums in the components of the moment of inertia tensor in Eq. (5.22) reduce to

$$I_{\alpha\beta} = \int_V \rho(r) (\delta_{\alpha\beta} r^2 - r_\alpha r_\beta) dV. \quad (5.23)$$

As an example, let us consider a homogeneous cube of density ρ , mass M , and side a . Choose the origin to be at one corner and the three edges adjacent to that corner to lie on the $+x$, $+y$, and $+z$ axes. If we define $b = Ma^2$, then straightforward integration of Eq. (5.23) gives

$$\mathbf{I} = \begin{pmatrix} \frac{2}{3}b & -\frac{1}{4}b & -\frac{1}{4}b \\ -\frac{1}{4}b & \frac{2}{3}b & -\frac{1}{4}b \\ -\frac{1}{4}b & -\frac{1}{4}b & \frac{2}{3}b \end{pmatrix}.$$

Thus, both the moment of inertia and the inertia tensor possess a type of revolution, relative to the center of mass, very similar to that found for the linear and angular momentum and the kinetic energy in Section (1.2).

5.4 ■ THE EIGENVALUES OF THE INERTIA TENSOR AND THE PRINCIPAL AXIS TRANSFORMATION

The preceding discussion emphasizes the important role the inertia tensor plays in the discussion of the motion of rigid bodies. An examination, at this point, of the properties of this tensor and its associated matrix will therefore prove of considerable interest. From the defining equation, (5.7), it is seen that the components of the tensor are symmetrical; that is

$$I_{xy} = I_{yx}. \quad (5.24)$$

This means that, while the inertia tensor will in general have nine components, only six of them will be independent—the three along the diagonal plus three of the off-diagonal elements.

The inertia coefficients depend both upon the location of the origin of the body set of axes and upon the orientation of these axes with respect to the body. This symmetry suggests that there exists a set of coordinates in which the tensor is diagonal with the three principal values I_1 , I_2 , and I_3 . In this system, the components of \mathbf{L} would involve only the corresponding component of $\boldsymbol{\omega}$, thus*

$$L_1 = I_1\omega_1, \quad L_2 = I_2\omega_2, \quad L_3 = I_3\omega_3. \quad (5.25)$$

A similar simplification would also occur in the form of the kinetic energy:

$$T = \frac{\boldsymbol{\omega} \cdot \mathbf{I} \cdot \boldsymbol{\omega}}{2} = \frac{1}{2}I_1\omega_1^2 + \frac{1}{2}I_2\omega_2^2 + \frac{1}{2}I_3\omega_3^2. \quad (5.26)$$

We can show that it is always possible to find such axes, and the proof is based essentially on the symmetric nature of the inertia tensor.

There are several ways to understand vectors and tensors. For example, a vector is a quantity defined by its transformation properties. In any set of coordinates, a vector is specified by its three components, e.g.,

$$\mathbf{V} = V_x\mathbf{i} + V_y\mathbf{j} + V_z\mathbf{k}, \quad (5.27)$$

or by its magnitude and direction. In any frame, the magnitude is given by $\sqrt{V_x^2 + V_y^2 + V_z^2}$, and the direction is given by the polar angles θ and ϕ . An alternative is to use the first two Euler angles to specify a new z axis chosen such that the vector's direction is along that axis. Since the vector lies along that z axis, the third Euler angle is not needed.

An approach similar to this latter method can be used for the symmetric moment of inertia tensor. Consider the moment of inertia of a body about an axis passing through the center of mass of the body. A similarity transformation per-

*With an eye to future applications, components relative to these axes will be denoted by subscripts 1, 2, 3.

formed by a rotation matrix \mathbf{R} can be chosen such that

$$\mathbf{I}_D = \mathbf{R}\mathbf{I}\mathbf{R}^T. \quad (5.28)$$

This rotation can be expressed in terms of the Euler angles ϕ , θ , and ψ as shown in Eqs. (4.46) and (4.47). A proper choice of these angles will transform \mathbf{I} into its diagonal form

$$\mathbf{I}_D = \begin{pmatrix} I_1 & 0 & 0 \\ 0 & I_2 & 0 \\ 0 & 0 & I_3 \end{pmatrix} \quad (5.29)$$

where I_1 , I_2 , and I_3 , which are the eigenvalues of \mathbf{I} , are referred to as the components of the *principal moment of inertia* tensor. The directions of x' , y' , and z' defined by the rotation matrix in Eq. (5.28) are called the *principal axes*, or *eigenvectors* of the inertia tensor. These eigenvectors lie along the directions x' , y' , and z' .

Once the principal moments and their directions relative to the surface of a body are known, the inertia tensor relative to any other set of axis through the center of mass can be found by a similarity transformation defined by the Euler angles relating the two coordinate systems. If \mathbf{S} is that transformation, then

$$\mathbf{I} = \mathbf{S}\mathbf{I}_D\mathbf{S}^T, \quad (5.30)$$

gives the moment of inertia in that frame. Equation (5.21) can then be used to transform the rotation center to any desired location. The principal values of \mathbf{I} can be determined by the methods of matrix algebra.

The three principal values of the moment of inertia tensor in Eq. (5.29) can be found by solving the cubic equation for I that arises from the determinant

$$\begin{vmatrix} I_{xx} - I & I_{xy} & I_{zx} \\ I_{xy} & I_{yy} - I & I_{yz} \\ I_{zx} & I_{yz} & I_{zz} - I \end{vmatrix} = 0, \quad (5.31)$$

where the symmetry of \mathbf{I} has been displayed explicitly. Equation (5.31) is the secular equation, whose three roots are the desired principal moments. For each of these roots, Eqs. (5.28) can be solved to obtain the direction of the corresponding principal axis. In most of the easily soluble problems in rigid dynamics, the principal axes can be determined by inspection. For example, we often have to deal with rigid bodies that are solids of revolution about some axis, with the origin of the body system on the symmetry axis. All directions perpendicular to the axis of symmetry are then alike, which is the mark of a double root to the secular equation. The principal axes are then the symmetry axis and any two perpendicular axes in the plane normal to the symmetry axis.

The principal moments of inertia cannot be negative, because as the diagonal elements in the principal axes system they have the form of sums of squares. Thus.

I_{xx} is given by (cf. Eq. (5.6))

$$I_{xx} = m_i (y_i^2 + z_i^2).$$

For one of the principal moments to vanish, all points of the body must be such that two coordinates of each particle are zero. Clearly this can happen only if all points of the body are collinear with the principal axis corresponding to the zero principal moment. Any two axes perpendicular to the line of the body will then be the other principal axes. Indeed, this is clearly a limiting case of a body with an axis of symmetry passing through the origin.

We can also understand the concept of principal axes through some geometrical considerations that historically formed the first approach to the subject. The moment of inertia about a given axis has been defined as $I = \mathbf{n} \cdot \mathbf{I} \cdot \mathbf{n}$. Let the direction cosines of the axis be α , β , and γ so that

$$\mathbf{n} = \alpha \mathbf{i} + \beta \mathbf{j} + \gamma \mathbf{k};$$

I then can be written as

$$I = I_{xx}\alpha^2 + I_{yy}\beta^2 + I_{zz}\gamma^2 + 2I_{xy}\alpha\beta + 2I_{yz}\beta\gamma + 2I_{zx}\gamma\alpha, \quad (5.32)$$

using the symmetry of \mathbf{I} explicitly. It is convenient to define a vector $\boldsymbol{\rho}$ by the equation

$$\boldsymbol{\rho} = \frac{\mathbf{n}}{\sqrt{I}}. \quad (5.33)$$

The magnitude of $\boldsymbol{\rho}$ is thus related to the moment of inertia about the axis whose direction is given by \mathbf{n} . In terms of the components of this new vector, Eq. (5.32) takes on the form

$$1 = I_{xx}\rho_1^2 + I_{yy}\rho_2^2 + I_{zz}\rho_3^2 + 2I_{xy}\rho_1\rho_2 + 2I_{yz}\rho_2\rho_3 + 2I_{zx}\rho_3\rho_1. \quad (5.34)$$

Considered as a function of the three variables ρ_1 , ρ_2 , ρ_3 , Eq. (5.34) is the equation of some surface in ρ space. In particular, Eq. (5.34) is the equation of an ellipsoid designated as the *inertia ellipsoid*. We can always transform to a set of Cartesian axes in which the equation of an ellipsoid takes on its normal form:

$$1 = I_1\rho_1'^2 + I_2\rho_2'^2 + I_3\rho_3'^2, \quad (5.35)$$

with the principal axes of the ellipsoid along the new coordinate axes. But (5.35) is simply the form Eq. (5.34) has in a system of coordinates in which the inertia tensor \mathbf{I} is diagonal. Hence, the coordinate transformation that puts the equation of ellipsoid into its normal form is exactly the principal axis transformation previously discussed. The principal moments of inertia determine the lengths of the axes of the inertia ellipsoid. If two of the roots of the secular equation are equal, the inertia ellipsoid thus has two equal axes and is an ellipsoid of revolution. If all three principal moments are equal, the inertia ellipsoid is a sphere.

A quantity closely related to the moment of inertia is the *radius of gyration*, R_0 , defined by the equation

$$I = MR_0^2. \quad (5.36)$$

In terms of the radius of gyration, the vector ρ can be written as

$$\rho = \frac{\mathbf{n}}{R_0\sqrt{M}}.$$

The radius vector to a point on the inertia ellipsoid is thus inversely proportional to the radius of gyration about the direction of the vector.

It is worth reemphasizing that the inertia tensor \mathbf{I} and all the quantities associated with it—principal axes, principal moments, inertia ellipsoid, etc.—are only relative to some particular point fixed in the body. If the point is shifted elsewhere in the body, all the quantities will in general be changed. Thus, Eq. (5.21) gives the effect of moving the reference point from the center of mass to some other point. The principal axis transformation that diagonalizes \mathbf{I}' at the center of mass will not necessarily diagonalize \mathbf{I} about another axis, and hence is not in general the principal axis transformation for the shifted tensor \mathbf{I} . Only if the shift vector \mathbf{R} is along one of the principal axes relative to the center of mass will the difference tensor be diagonal in that system. The new inertia tensor \mathbf{I} will in that special case have the same principal axes as at the center of mass. However, the principal moments of inertia are changed, except for that corresponding to the shift axis, where the diagonal element of the difference tensor is clearly zero. The “parallel axis” theorem for the diagonalized form of the inertia tensor thus has a rather specialized and restricted form.

5.5 ■ SOLVING RIGID BODY PROBLEMS AND THE EULER EQUATIONS OF MOTION

Practically all the tools necessary for setting up and solving problems in rigid body dynamics have by now been assembled. If nonholonomic constraints are present, then special means must be taken to include the effects of these constraints in the equations of motion. For example, if there are “rolling constraints,” these must be introduced into the equations of motion by the method of Lagrange undetermined multipliers, as in Section 2.4. As discussed in Section 5.1, we usually seek a particular reference point in the body such that the problem can be split into two separate parts, one purely translational and the other purely rotational about the reference point. Of course, if one point of the rigid body is fixed in an inertial system, then that is the obvious reference point. All that has to be considered then is the rotational problem about the fixed point.

For bodies without a fixed point, the most useful reference point is almost always the center of mass. We have already seen that the total kinetic energy and angular momentum then split neatly into one term relating to the translational

motion of the center of mass and another involving rotation *about* the center of mass. Thus, Eq. (1.31) can now be written

$$T = \frac{1}{2}Mv^2 + \frac{1}{2}I\omega^2.$$

For many problems (certainly all those that will be considered here), a similar sort of division can be made for the potential energy. We can then solve individually for the translational motion of the center of mass and for the rotational motion about the center of mass. For example, the Newtonian equations of motion can be used directly: Eq. (1.22) for the motion of the center of mass and Eq. (1.26) for the motion about that point.

With holonomic conservative systems, the Lagrangian formulation is available, with the Lagrangian taking the form

$$L(q, \dot{q}) = L_c(q_c, \dot{q}_c) + L_b(q_b, \dot{q}_b).$$

Here L_c is that part of the Lagrangian involving the generalized coordinates q_c (and velocities \dot{q}_c) of the center of mass, and L_b the part relating to the orientation of the body about the center of mass, as described by q_b, \dot{q}_b . In effect then, there are two distinct problems, one with Lagrangian L_c and the other with Lagrangian L_b .

In both the Newtonian and Lagrangian formulations, it is convenient to work in terms of the principal axes system of the point of reference, so that the kinetic energy of rotation takes the simple form given in Eq. (5.26). So far, the only suitable generalized coordinates we have for the rotational motion of the rigid body are the Euler angles. Of course, the motion is often effectively confined to two dimensions, as in the motion of a rigid lamina in a plane. The axis of rotation is then fixed in the direction perpendicular to the plane; only one angle of rotation is necessary and we may dispense with the cumbersome machinery of the Euler angles.

For the rotational motion about a fixed point or the center of mass, the direct Newtonian approach leads to a set of equations known as Euler's equations of motion. We consider either an inertial frame whose origin is at the fixed point of the rigid body, or a system of space axes with origin at the center of mass. In these two situations, Eq. (1.26) holds, which here appears simply as

$$\left(\frac{d\mathbf{L}}{dt}\right)_s = \mathbf{N}.$$

The subscript s is used because the time derivative is with respect to axes that do not share the rotation of the body. However, Eq. (4.86) can be used to obtain the derivatives with respect to axes fixed in the body:

$$\left(\frac{d\mathbf{L}}{dt}\right)_s = \left(\frac{d\mathbf{L}}{dt}\right)_b + \boldsymbol{\omega} \times \mathbf{L}.$$

or, by dropping the “body” subscript:

$$\frac{d\mathbf{L}}{dt} + \boldsymbol{\omega} \times \mathbf{L} = \mathbf{N}. \quad (5.37)$$

Equation (5.37) is thus the appropriate form of the Newtonian equation of motion relative to body axes. The i th component of Eq. (5.37) can be written

$$\frac{dL_i}{dt} + \epsilon_{ijk}\omega_j L_k = N_i. \quad (5.38)$$

If now the body axes are taken as the principal axes relative to the reference point, then the angular momentum components are $L_i = I_i \omega_i$. By Eq. (5.25), Eq. (5.38) takes the form (no summation on i *)

$$I_i \frac{d\omega_i}{dt} + \epsilon_{ijk}\omega_j \omega_k I_k = N_i, \quad (5.39)$$

since the principal moments of inertia are of course time independent. In expanded form, the three equations making up Eq. (5.39) look like

$$\begin{aligned} I_1 \dot{\omega}_1 - \omega_2 \omega_3 (I_2 - I_3) &= N_1 \\ I_2 \dot{\omega}_2 - \omega_3 \omega_1 (I_3 - I_1) &= N_2 \\ I_3 \dot{\omega}_3 - \omega_1 \omega_2 (I_1 - I_2) &= N_3. \end{aligned} \quad (5.39')$$

Equations (5.39) or (5.39') are Euler's equations of motion for a rigid body with one point fixed. They can also be derived from Lagrange's equations in the form of Eq. (1.53) where the generalized forces Q_j are the torques, N_j , corresponding to the Euler angles of rotation. However, only one of the Euler angles has its associated torque along one of the body axes, and the remaining two Euler's equations must be obtained by cyclic permutation (cf. Derivation 4).

Consider the case where $I_1 = I_2 \neq I_3$. A torque with components N_1 or N_2 will cause both ω_1 and ω_2 to change without affecting ω_3 . We shall return to a discussion of this in Section 5.7 when we consider the heavy symmetric top with one point fixed. Let us first consider the torque-free motion of a rigid body.

5.6 ■ TORQUE-FREE MOTION OF A RIGID BODY

One problem in rigid dynamics where Euler's equations are applicable is in the motion of a rigid body not subject to any net forces or torques. The center of mass is then either at rest or moving uniformly, and it does not decrease the generality of the solution to discuss the rotational motion in a reference frame in which the center of mass is stationary. In such a case, the angular momentum arises only from rotation about the center of mass, and Euler's equations are the equations of

*It should be obvious that Eq. (5.39), as the i th component of a vector equation, does not involve a summation over i , although summation is implied over the repeated indices j and k .

motion for the complete system. In the absence of any net torques, they reduce to

$$\begin{aligned} I_1 \dot{\omega}_1 &= \omega_2 \omega_3 (I_2 - I_3) \\ I_2 \dot{\omega}_2 &= \omega_3 \omega_1 (I_3 - I_1) \\ I_3 \dot{\omega}_3 &= \omega_1 \omega_2 (I_1 - I_2). \end{aligned} \quad (5.40)$$

The same equations, of course, will also describe the motion of a rigid body when one point is fixed and there are no net applied torques. We know two immediate integrals of the motion, for both the kinetic energy and the total angular momentum vector must be constant in time. With these two integrals it is possible to integrate (5.40) completely in terms of elliptic functions, but such a treatment is not very illuminating. However, it is also possible to derive an elegant geometrical description of the motion, known as Poinsot's construction, without requiring a complete solution to the problem.

Let us consider a coordinate system oriented along the principal axes of the body but whose axes measure the components of a vector $\boldsymbol{\rho}$ along the instantaneous axis of rotation as defined by Eq. (5.33). For our purposes, it is convenient to make use of Eq. (5.17) for the kinetic energy (here constant) and write the definition of $\boldsymbol{\rho}$ in the form

$$\boldsymbol{\rho} = \frac{\boldsymbol{\omega}}{\omega \sqrt{I}} = \frac{\boldsymbol{\omega}}{\sqrt{2T}}. \quad (5.41)$$

In this $\boldsymbol{\rho}$ space, we define a function

$$F(\boldsymbol{\rho}) = \boldsymbol{\rho} \cdot \mathbf{l} \cdot \boldsymbol{\rho} = \rho_i^2 I_i, \quad (5.42)$$

where the surfaces of constant F are ellipsoids, the particular surface $F = 1$ being the inertia ellipsoid. As the direction of the axis of rotation changes in time, the parallel vector $\boldsymbol{\rho}$ moves accordingly, its tip always defining a point on the inertia ellipsoid. The gradient of F , evaluated at this point, furnishes the direction of the corresponding normal to the inertia ellipsoid. From Eq. (5.42) for $F(\boldsymbol{\rho})$, the gradient of F with respect to $\boldsymbol{\rho}$ has the form

$$\nabla_{\boldsymbol{\rho}} F = 2\mathbf{l} \cdot \boldsymbol{\rho} = \frac{2\mathbf{l} \cdot \boldsymbol{\omega}}{\sqrt{2T}},$$

or

$$\nabla_{\boldsymbol{\rho}} F = \sqrt{\frac{2}{T}} \mathbf{L}. \quad (5.43)$$

Thus, the $\boldsymbol{\omega}$ vector will always move such that the corresponding normal to the inertia ellipsoid is in the direction of the angular momentum. In the particular case under discussion, the direction of \mathbf{L} is fixed in space, and it is the inertia ellipsoid (fixed with respect to the body) that must move in space in order to preserve this connection between $\boldsymbol{\omega}$ and \mathbf{L} (cf. Fig. 5.4).

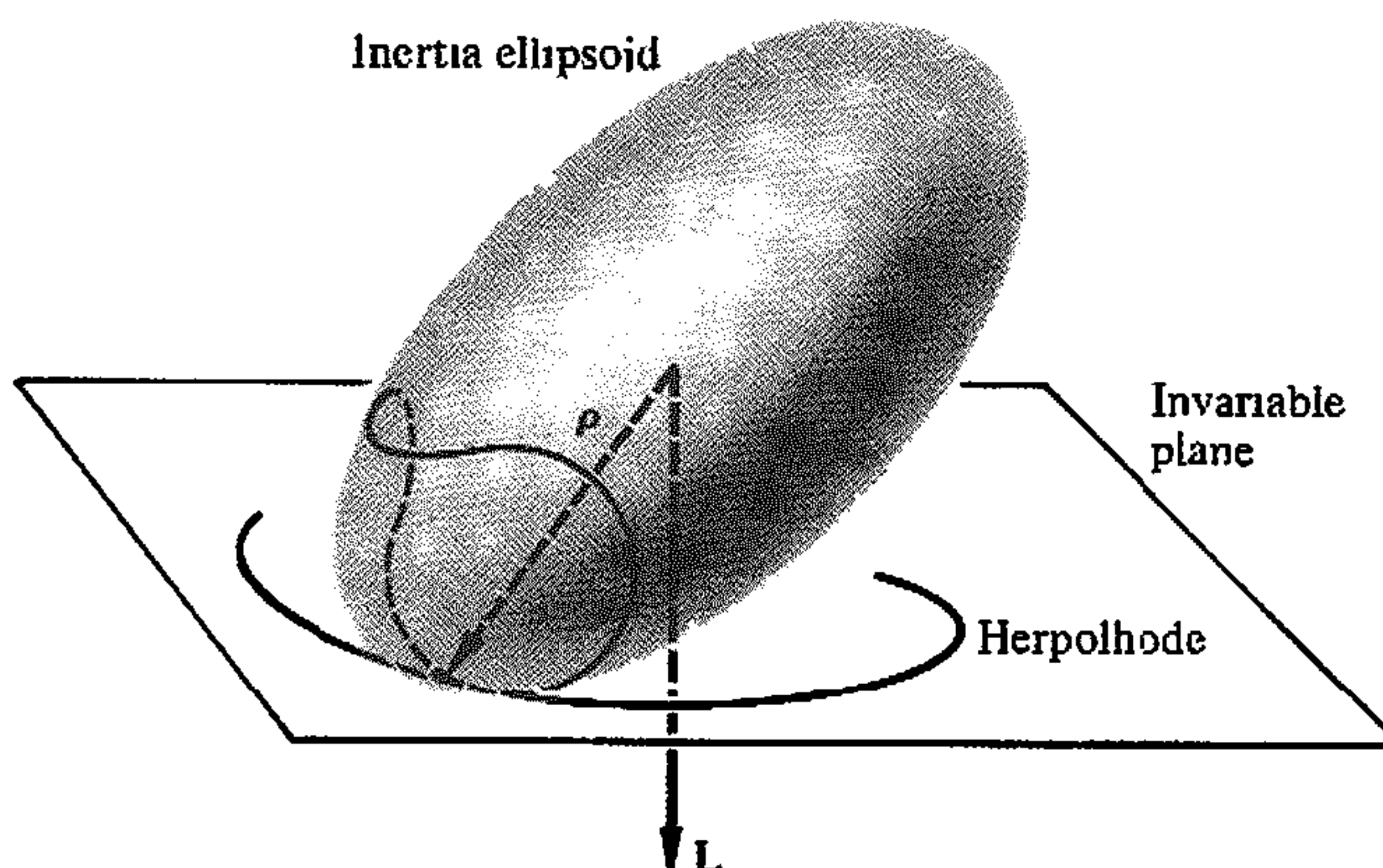

FIGURE 5.4 The motion of the inertia ellipsoid relative to the invariable plane.

It can also be shown that the distance between the origin of the ellipsoid and the plane tangent to it at the point ρ must similarly be constant in time. This distance is equal to the projection of ρ on \mathbf{L} and is given by

$$\frac{\rho \cdot \mathbf{L}}{L} = \frac{\omega \cdot \mathbf{L}}{L\sqrt{2T}}$$

or

$$\frac{\rho \cdot \mathbf{L}}{L} = \frac{\sqrt{2T}}{L}, \quad (5.44)$$

where use has been made of Eq. (5.16). Both T , the kinetic energy, and \mathbf{L} , the angular momentum, are constants of the motion, and the tangent plane is therefore always a fixed distance from the origin of the ellipsoid. Since the normal to the plane, being along \mathbf{L} , also has a fixed direction, the tangent plane is known as the *invariable plane*. We can picture the force-free motion of the rigid body as being such that the inertia ellipsoid rolls, without slipping, on the invariable plane, with the center of the ellipsoid a constant height above the plane. The rolling occurs without slipping because the point of contact is defined by the position of ρ , which, being along the instantaneous axis of rotation, is the one direction in the body momentarily at rest. The curve traced out by the point of contact on the inertia ellipsoid is known as the *polhode*, while the similar curve on the invariable plane is called the *herpolhode*.*

Poinsot's geometrical discussion is quite adequate to describe completely the force-free motion of the body. The direction of the invariable plane and the height of the inertia ellipsoid above it are determined by the values of T and \mathbf{L} , which are among the initial conditions of the problem. It is then a matter of geometry to

*Hence, the jaberwockian-sounding statement: the polhode rolls without slipping on the herpolhode lying in the invariable plane.

trace out the polhode and the herpolhode.* The direction of the angular velocity in space is given by the direction of $\boldsymbol{\rho}$, while the instantaneous orientation of the body is provided by the orientation of the inertia ellipsoid, which is fixed in the body. Many elaborate descriptions of force-free motion obtained in this fashion can be found in the literature.

In the special case of a symmetrical body, the inertia ellipsoid is an ellipsoid of revolution, so that the polhode on the ellipsoid is clearly a circle about the symmetry axis. The herpolhode on the invariable plane is likewise a circle. An observer fixed in the body sees the angular velocity vector $\boldsymbol{\omega}$ move on the surface of a cone—called the *body cone*—whose intersection with the inertia ellipsoid is the polhode. Correspondingly, an observer fixed in the space axes sees $\boldsymbol{\omega}$ move on the surface of a *space cone* whose intersection with the invariable plane is the herpolhode. Thus, the free motion of the symmetrical rigid body is sometimes described as the rolling of the body cone on the space cone. If the moment of inertia about the symmetry axis is less than that about the other two principal axes, then from Eq. (5.35) the inertia ellipsoid is prolate, i.e., football shaped—somewhat as is shown in Fig. 5.4. In that case, the body cone is outside the space cone. When the moment of inertia about the symmetry axis is the greater, the ellipsoid is oblate and the body cone rolls around the inside of the space cone. In either case, the physical description of the motion is that the direction of $\boldsymbol{\omega}$ *precesses* in time about the axis of symmetry of the body.

The Poinsot construction shows how $\boldsymbol{\omega}$ moves, but gives no information as to how the \mathbf{L} vector appears to move in the body system of axes. Another geometrical description is available however to describe the path of the \mathbf{L} vector as seen by an observer in the principal axes system. Equations (5.25) and (5.26) imply that in this system the kinetic energy is related to the components of the angular momentum by the equation

$$T = \frac{L_x^2}{2I_1} + \frac{L_y^2}{2I_2} + \frac{L_z^2}{2I_3}. \quad (5.45)$$

Since T is constant, this relation defines an ellipsoid, referred to as the *Binet* ellipsoid, also fixed in the body axes but *not* the same as the inertia ellipsoid.

If we adopt the convention

$$I_3 \leq I_2 \leq I_1,$$

and write the equations for the ellipsoid in the standard form

$$\frac{L_x^2}{2TI_1} + \frac{L_y^2}{2TI_2} + \frac{L_z^2}{2TI_3} = 1 \quad (5.45')$$

then we see that the ellipsoid sketched on Fig. 5.5a has semimajor axes, in order of decreasing size, of $\sqrt{2TI_1}$, $\sqrt{2TI_2}$, and $\sqrt{2TI_3}$. The conservation of the total

*The herpolhode is always concave to the origin, belying its name, which means “snakelike.”

angular momentum, L , gives us

$$\frac{L_x^2 + L_y^2 + L_z^2}{L^2} = 1, \quad (5.46)$$

the equation for a sphere in $L_x L_y L_z$ space. The vector \mathbf{L} moves in such a way that it describes a path on both the ellipsoid of Eq. (5.45) and the sphere of Eq. (5.46). In other words, the path of \mathbf{L} is the intersection of the ellipsoid and the sphere. The components \mathbf{L} satisfy the equation

$$\frac{L_x^2}{2T I_1} + \frac{L_y^2}{2T I_2} + \frac{L_z^2}{2T I_3} = \frac{L_x^2 + L_y^2 + L_z^2}{L^2}.$$

It is easy to show that these two surfaces will intersect for values of L larger than the ellipsoid semiminor axis and less than the semimajor axis, that is,

$$\sqrt{2T I_3} < L < \sqrt{2T I_1}.$$

The sphere is outside the ellipsoid on the L_z axis and inside the ellipsoid along L_x . Figure 5.5 depicts curves where the sphere intersects the ellipsoid for various values of L . Fig. 5.5a shows a perspective view and Fig. 5.5b shows the view as seen from the L_y axis. The curves that appear as straight lines on Fig 5.5b correspond to the case where $L = \sqrt{2T I_2}$.

With the help of this geometrical construction, something can be said about the possible motions of a free asymmetric body. It is easy to see that a steady rotation

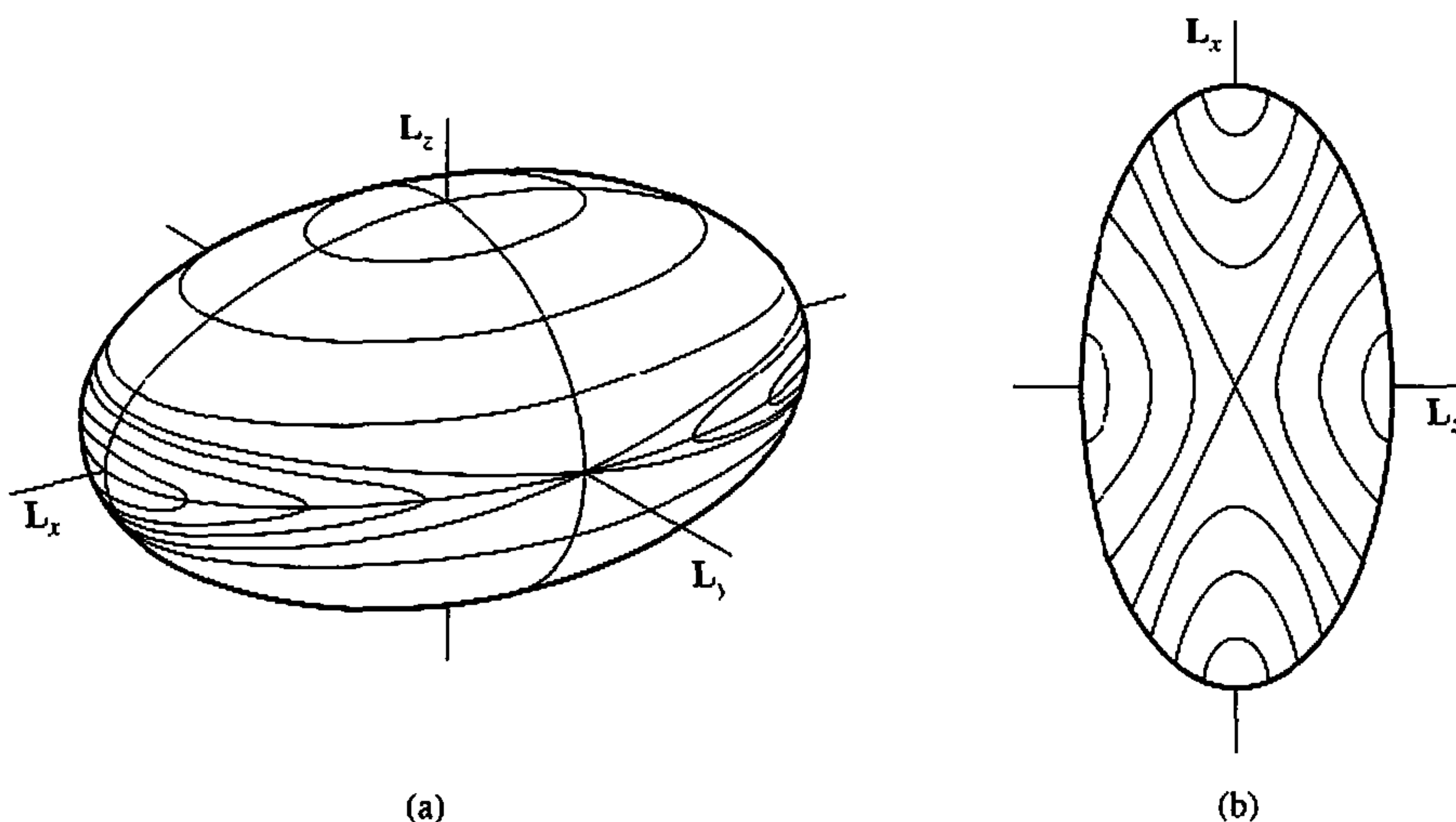

FIGURE 5.5 (a) The kinetic energy, or Binet, ellipsoid fixed in the body axes, and some possible paths of the \mathbf{L} vector in its surface. (b) Side view of Binet ellipsoid.

of such a body is possible only about one of the principal axes. From the Euler equations (5.40), all the components of ω can be constant only if

$$\omega_1\omega_2(I_1 - I_2) = \omega_2\omega_3(I_2 - I_3) = \omega_3\omega_1(I_3 - I_1) = 0,$$

which requires that at least two of the components ω_i be zero; i.e., ω is along only one of the principal axes. However, not all of these possible motions are stable—that is, not moving far from the principal axis under small perturbation. For example, steady motion about the L_z axis will occur when $L^2 = 2TI_3$. When there are slight deviations from this condition, the radius of the angular momentum sphere is just slightly smaller than this value, and the intersection with the kinetic energy ellipsoid is a small circle about the L_z axis. The motion is thus stable, the L vector never being far from the axis.

Similarly, at the other extreme, when the motion about the axis of smallest I is perturbed, the radius of the angular momentum sphere is just slightly larger than the smallest semimajor axis. The intersection is again a small closed figure around the principal axis, and the motion is stable. However, the motion about the intermediate axis is *unstable*. This is clearly shown in Fig. 5.5. For the intermediate (L_y) axis, the kinetic energy has two orbits that encircle the ellipsoid and cross each other where the $\pm L_y$ pass through the ellipsoid. Hence, there are two different orbits with values slightly less than $\sqrt{2TI_2}$ and two other distinctly different orbits with values slightly exceeding $\sqrt{2TI_2}$, all four of which have quite long paths on the surface.

This behavior can be best understood by recognizing that at the intermediate axis the radius of curvature of the ellipsoid in one direction is greater than that of the contact sphere, and less in the perpendicular direction. At the other two extremes, the radii of curvature are either greater or smaller than the sphere radius in all directions. These conclusions on the stability of free-body motion have been known for a long time, but applications, e.g., to the stability of spinning spacecraft, have brought them out of the obscurity of old monographs on rigid body dynamics.*

For a symmetrical rigid body, the analytical solution for the force-free motion is not difficult to obtain, and we can directly confirm the precessing motion predicted by the Poincot construction. Let the symmetry axis be taken as the L_z principal axis so that $I_1 = I_2$. Euler's equations (5.40) reduce then to

*If there are dissipative mechanisms present, these stability arguments have to be modified. It is easy to see that for a body with constant L , but slowly decreasing T , the only stable rotation is about the principal axis with the largest moment of inertia. The kinetic energy of rotation about the i th principal axis for given L is $T = L^2/2I_i$, which is least for the axis with the largest I_i . If a body is set spinning about any other principal axis, the effect of a slowly decreasing kinetic energy is to cause the angular velocity vector to shift until the spinning is about the axis requiring the least value of T for the given L . Such dissipative effects are present in spacecraft because of the flexing of various members in the course of the motion, especially of the long booms carried by many of them. These facts were learned the hard way by the early designers of spacecraft!

$$\begin{aligned}
 I_1 \dot{\omega}_1 &= (I_1 - I_3) \omega_3 \omega_2 \\
 I_1 \dot{\omega}_2 &= (I_1 - I_3) \omega_3 \omega_1 \\
 I_3 \dot{\omega}_3 &= 0.
 \end{aligned}
 \tag{5.47}$$

The last of these equations states that ω_3 is a constant, and it can therefore be treated as one of the known initial conditions of the problem. The remaining two equations can now be written

$$\dot{\omega}_1 = -\Omega \omega_2, \quad \dot{\omega}_2 = \Omega \omega_1, \tag{5.48}$$

where Ω is an angular frequency

$$\Omega = \frac{I_3 - I_1}{I_1} \omega_3. \tag{5.49}$$

Elimination of ω_2 between Eqs. (5.48) leads to the standard differential equation for simple harmonic motion

$$\ddot{\omega}_1 = -\Omega^2 \omega_1,$$

with the typical solution

$$\omega_1 = A \cos \Omega t.$$

The corresponding solution for ω_2 can be found by substituting this expression for ω_1 , back in the first of Eqs. (5.48):

$$\omega_2 = A \sin \Omega t.$$

The solutions for ω_1 and ω_2 show that the vector $\omega_1 \mathbf{i} + \omega_2 \mathbf{j}$ has a constant magnitude and rotates uniformly about the z axis of the body with the angular frequency Ω (cf. Fig. 5.6). Hence, the total angular velocity $\boldsymbol{\omega}$ is also constant in magnitude and *precesses* about the z axis with the same frequency, exactly as predicted by the Poinsot construction. * Recall that the precession described here is relative to the body axes, which are themselves rotating in space with the larger frequency $\boldsymbol{\omega}$. From Eq. (5.49), it is seen that the closer I_1 is to I_3 , the slower will be the precession frequency Ω compared to the rotation frequency $\boldsymbol{\omega}$. The constants A (the amplitude of the precession) and ω_3 can be evaluated in terms of the more usual constants of the motion, namely, the kinetic energy and the magnitude of the angular momentum. Both T and L^2 can be written as functions of A and ω_3 :

*The precession can be demonstrated in another fashion by defining a vector $\boldsymbol{\Omega}$ lying along the z axis with magnitude given by (5.49). Equations (5.47) are then essentially equivalent to the vector equation

$$\dot{\boldsymbol{\omega}} = \boldsymbol{\omega} \times \boldsymbol{\Omega},$$

which immediately reveals the precession of $\boldsymbol{\omega}$ with the frequency Ω .

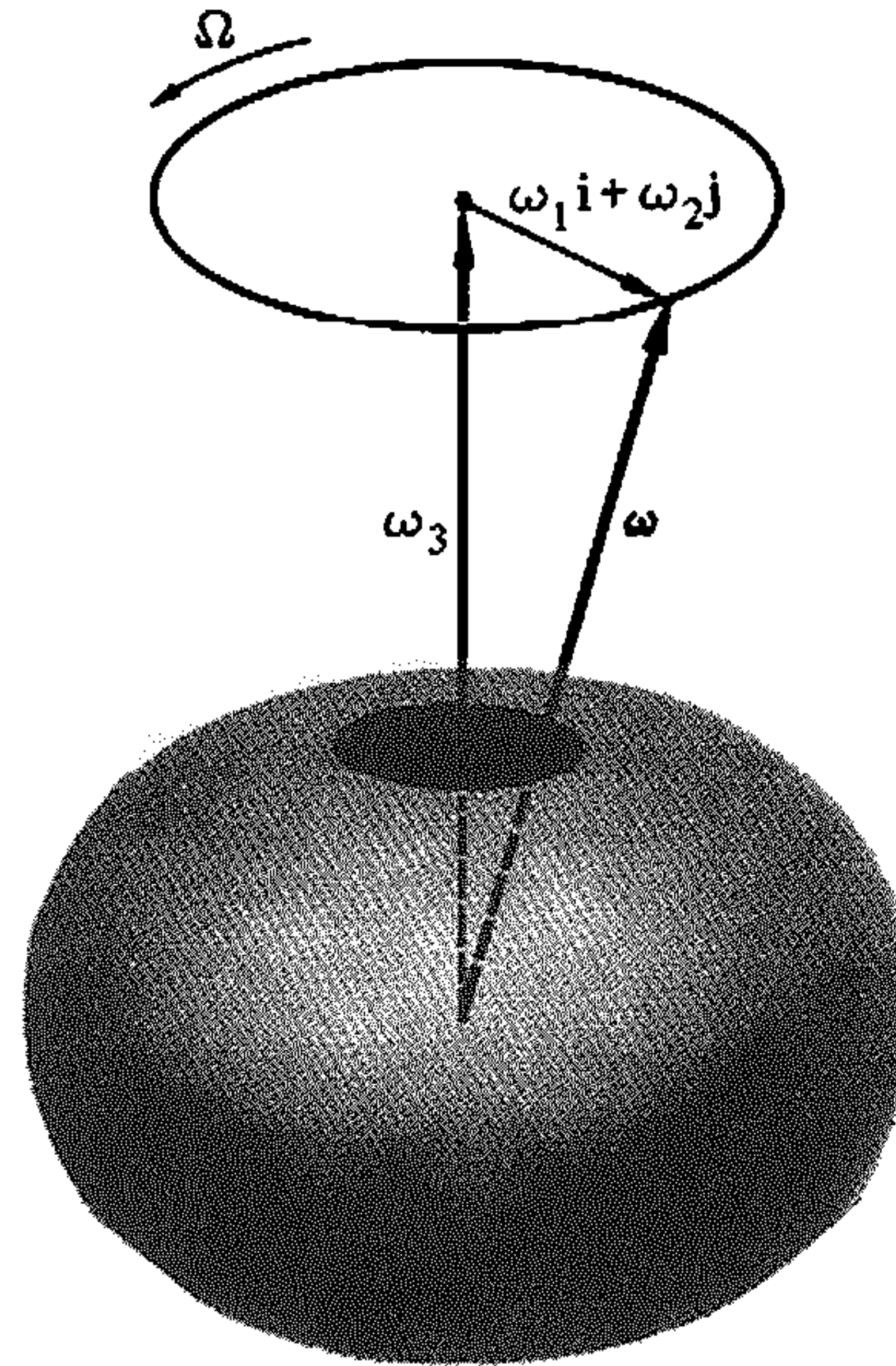

FIGURE 5.6 Precession of the angular velocity about the axis of symmetry in the force-free motion of a symmetrical rigid body.

$$T = \frac{1}{2}I_1A^2 + \frac{1}{2}I_3\omega_3^2,$$

$$L^2 = I_1^2A^2 + I_3^2\omega_3^2,$$

and these relations in turn may be solved for A and ω_3 in terms of T and L .

We would expect that Earth's axis of rotation should exhibit this precession, for the external torques acting on Earth are so weak that the *rotational* motion may be considered as that of a free body. Earth is approximately symmetrical about the polar axis and slightly flattened at the poles so that I_1 is less than I_3 . Numerically, the ratio of the moments is such that

$$\frac{I_3 - I_1}{I_1} = 0.00327,$$

and the magnitude of the precession angular frequency should therefore be

$$\Omega = \frac{\omega_3}{305.81039} \approx \frac{\omega_3}{306}.$$

Since ω_3 is practically the same as the magnitude of ω , this result predicts a period of precession of approximately 306 days or about 10 months. If some circumstance disturbed the axis of rotation from the figure axis of Earth, we would therefore expect the axis of rotation to precess around the figure axis (i.e., around the north pole) once every 10 months. Practically, such a motion should show up

as a periodic change in the apparent latitude of points on Earth's surface. Careful measurements of latitude at a network of locations around the world, carried out now for about a century, show that the rotation axis is indeed moving about the pole with an amplitude of the order of a few tenths of a second of latitude (about 10 m). But the situation is far more complicated (and interesting) than the above simple analysis would suggest.

The deviations between the figure and rotation axes are very irregular so that it's more a "wobble" than a precession. Careful frequency analysis shows the existence of an annual period in the motion, thought to arise from the annual cycle of seasons and the corresponding mean displacement of atmospheric masses about the globe. Additionally, a strong frequency component is centered about a period of 420 days, known as the *Chandler wobble*. The present belief is that this motion represents the free-body precession derived above. It is thought that the difference in period arises from the fact that Earth is not a rigid body but is to some degree elastic. In effect, some part of Earth follows along with the shift in the rotation axis, which has the effect of reducing the difference in the principal moments of inertia and therefore increasing the period. (If, for example, Earth were completely fluid, then the figure axis would instantaneously adjust to the rotation axis and there could be no precession.)

There are still other obscure features to the observed wobble. The frequency analysis indicates strong damping effects are present, believed to arise from either tidal friction or dissipative effects in the coupling between the mantle and the core. The damping period ought to be on the order of 10–20 years. But no such decay of the amplitude of the Chandler wobble has been observed; some sort of random excitation must be present to keep the wobble going. Various sources of the excitation have been suggested. Present speculation points to deep earthquakes, or the mantle phenomena underlying them, as possibly producing discontinuous changes in the inertia tensor large enough to keep exciting the free-body precession.*

5.7 ■ THE HEAVY SYMMETRICAL TOP WITH ONE POINT FIXED

As a further and more complicated example of the application of the methods of rigid dynamics, let us consider the motion of a symmetrical body in a uniform gravitational field when one point on the symmetry axis is fixed in space. A wide variety of physical systems, ranging from a child's top to complicated gyroscopic navigational instruments, are approximated by such a *heavy symmetrical top*. Both for its practical applications and as an illustration of many of the tech-

*The free precession of Earth's axis is not to be confused with its slow precession about the normal to the ecliptic. This *astronomical* precession of the equinoxes is due to the gravitational torques of the Sun and Moon, which were considered negligible in the above discussion. That the assumption is justified is shown by the long period of the precession of the equinoxes (26,000 years) compared to a period of roughly one year for the force-free precession. The astronomical precession is discussed further below.

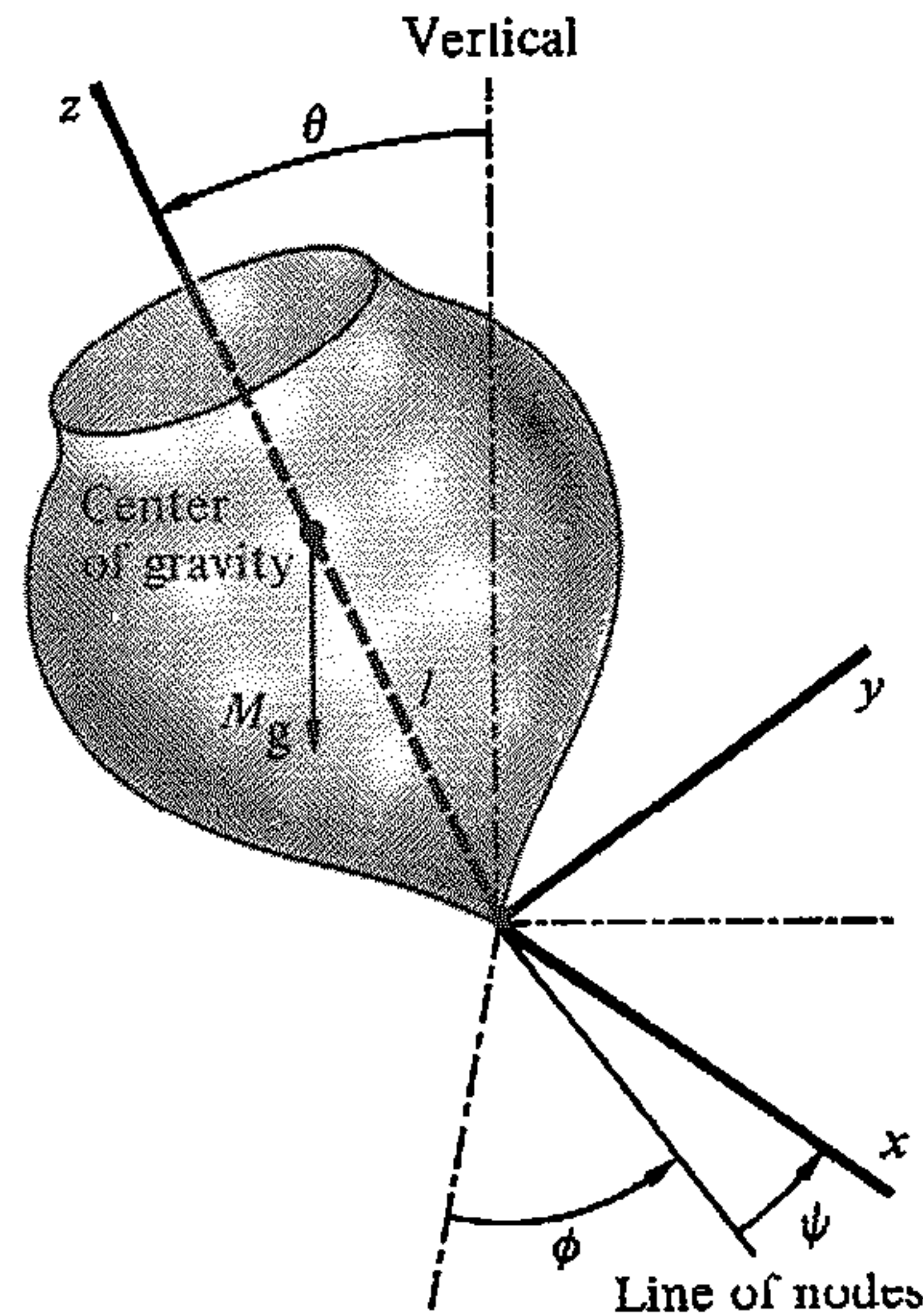

FIGURE 5.7 Euler's angles specifying the orientation of a symmetrical top.

niques previously developed, the motion of the heavy symmetrical top deserves a detailed exposition.

The symmetry axis is of course one of the principal axes and will be chosen as the z axis of the coordinate system fixed in the body.* Since one point is stationary, the configuration of the top is completely specified by the three Euler angles: θ gives the inclination of the z axis from the vertical, ϕ measures the azimuth of the top about the vertical, while ψ is the rotation angle of the top about its own z axis (cf. Fig. 5.7). The distance of the center of gravity (located on the symmetry axis) from the fixed point will be denoted by l

The rate of change of these three angles give the characteristic motions of the top as

$\dot{\psi}$ = rotation of the top about its own figure axis, z

$\dot{\phi}$ = precession or rotation of the figure axis z about the vertical axis z'

$\dot{\theta}$ = nutation or bobbing up and down of the z figure axis relative to the vertical space axis z' .

For many cases of interest such as the top and the gyroscope, we have $\dot{\psi} \gg \dot{\theta} \gg \dot{\phi}$. Since $I_1 = I_2 \neq I_3$, Euler's equations (5.39') become

*Only the body axes need specific identification here, it will therefore be convenient to designate them in this section as the xyz axes, without fear of confusing them with the space axes, which will be designated by the $x'y'z'$ axes

$$I_1 \dot{\omega}_1 + \omega_2 \omega_3 (I_3 - I_2) = N_1,$$

$$I_2 \dot{\omega}_2 + \omega_1 \omega_3 (I_1 - I_3) = N_2,$$

and

$$I_3 \dot{\omega}_3 = N_3.$$

Let us consider the case where initially $N_3 = 0 = N_2$, $N_1 \neq 0$, and $\omega_1 = \omega_2 = 0$, $\omega_3 \neq 0$, then ω_3 will be constant. The torque N_1 will cause ω_1 to change since $\omega_1 \neq 0$. Since ω_1 is no longer zero, the second equation requires that ω_2 begin to change also. What this means in terms of an observation is not obvious. We observe the changes in the Euler angles $\dot{\psi}$, $\dot{\phi}$, $\dot{\theta}$ and their associated angles in the x' , y' , z' laboratory frame rather than the $\dot{\omega}_1$, $\dot{\omega}_2$, $\dot{\omega}_3$ and their associated angles in the principal axis system. This suggests that the Euler equations may not provide the most useful description of the motion.

The Lagrangian procedure, rather than Euler's equations, will be used to obtain a solution for the motion of the top. Since the body is symmetrical, the kinetic energy can be written as

$$T = \frac{1}{2} I_1 (\omega_1^2 + \omega_2^2) + \frac{1}{2} I_3 \omega_3^2,$$

or, in terms of Euler's angles, and using Eqs. (4.87), as

$$T = \frac{I_1}{2} (\dot{\theta}^2 + \dot{\phi}^2 \sin^2 \theta) + \frac{I_3}{2} (\dot{\psi} + \dot{\phi} \cos \theta)^2, \quad (5.50)$$

where the $\dot{\phi}$, $\dot{\theta}$ cross terms in ω_1^2 and ω_2^2 cancel.

It is a well-known elementary theorem that in a constant gravitational field the potential energy is the same as if the body were concentrated at the center of mass. We will however give a brief formal proof here. The potential energy of the body is the sum over all the particles:

$$V = -m_i \mathbf{r}_i \cdot \mathbf{g},$$

where \mathbf{g} is the constant vector for the acceleration of gravity. By Eq. (1.21), defining the center of mass, this is equivalent to

$$V = -M \mathbf{R} \cdot \mathbf{g}, \quad (5.51)$$

which proves the theorem. In terms of the Euler angles,

$$V = Mgl \cos \theta, \quad (5.51')$$

so that the Lagrangian is

$$L = \frac{I_1}{2} (\dot{\theta}^2 + \dot{\phi}^2 \sin^2 \theta) + \frac{I_3}{2} (\dot{\psi} + \dot{\phi} \cos \theta)^2 - Mgl \cos \theta. \quad (5.52)$$

Note that ϕ and ψ do not appear explicitly in the Lagrangian; they are therefore cyclic coordinates, indicating that the corresponding generalized momenta are constant in time. Now, we have seen that the momentum conjugate to a rotation angle is the component of the total angular momentum along the axis of rotation, which for ϕ is the vertical axis, and for ψ , the z axis in the body. We can in fact show from elementary principles that these components of the angular momentum must be constant in time. Since the torque of gravity is along the line of nodes, there is no component of the torque along either the vertical or the body z axis, for by definition both of these axes are perpendicular to the line of nodes. Hence, the components of the angular momentum along these two axes must be constant in time.

We therefore have two immediate first integrals of the motion:

$$p_\psi = \frac{\partial L}{\partial \dot{\psi}} = I_3(\dot{\psi} + \dot{\phi} \cos \theta) = I_3 \omega_3 = I_1 a \quad (5.53)$$

and

$$p_\phi = \frac{\partial L}{\partial \dot{\phi}} = (I_1 \sin^2 \theta + I_3 \cos^2 \theta) \dot{\phi} + I_3 \dot{\psi} \cos \theta = I_1 b. \quad (5.54)$$

Here the two constants of the motion are expressed in terms of new constants a and b . There is one further first integral available; since the system is conservative, the total energy E is constant in time:

$$E = T + V = \frac{I_1}{2}(\dot{\theta}^2 + \dot{\phi}^2 \sin^2 \theta) + \frac{I_3}{2}\omega_3^2 + Mgl \cos \theta. \quad (5.55)$$

Only three additional quadratures are needed to solve the problem, and they are easily obtained from these three first integrals without directly using the Lagrange equations. From Eq. (5.53), ψ is given in terms of ϕ by

$$I_3 \dot{\psi} = I_1 a - I_3 \dot{\phi} \cos \theta, \quad (5.56)$$

and this result can be substituted in (5.54) to eliminate ψ :

$$I_1 \dot{\phi} \sin^2 \theta + I_1 a \cos \theta = I_1 b,$$

or

$$\dot{\phi} = \frac{b - a \cos \theta}{\sin^2 \theta}. \quad (5.57)$$

Thus, if θ were known as a function of time, Eq. (5.57) could be integrated to furnish the dependence of ϕ on time. Substituting Eq. (5.57) back in Eq. (5.56) results in a corresponding expression for $\dot{\psi}$:

$$\dot{\psi} = \frac{I_1 a}{I_3} - \cos \theta \frac{b - a \cos \theta}{\sin^2 \theta}. \quad (5.58)$$

which furnishes ψ if θ is known. Finally, Eqs. (5.57) and (5.58) can be used to eliminate $\dot{\phi}$ and $\dot{\psi}$ from the energy equation, resulting in a differential equation involving θ alone.

First notice that Eq. (5.53) says ω_3 is constant in time and equal to $(I_1/I_3)a$. Therefore, $E - I_3\omega_3^2/2$ is a constant of the motion, which we shall designate as E' . Making use of Eq. (5.57), the energy equation can thus be written as

$$E' = \frac{I_1 \dot{\theta}^2}{2} + \frac{I_1 (b - a \cos \theta)^2}{2 \sin^2 \theta} + Mgl \cos \theta. \quad (5.59)$$

Equation (5.59) has the form of an equivalent one-dimensional problem in the variable θ , with the effective potential $V'(\theta)$ given by

$$V'(\theta) = Mgl \cos \theta + \frac{I_1}{2} \left(\frac{b - a \cos \theta}{\sin \theta} \right)^2. \quad (5.60)$$

Thus, we have four constants associated with the motion, the two angular momenta p_ψ and p_ϕ , the energy term $E - \frac{1}{2}I_3\omega_3^2$, and the potential energy term Mgl . It is common to define four normalized constants of the motion as

$$\begin{aligned} \alpha &= \frac{2E - I_3\omega_3^2}{I_1} \\ \beta &= \frac{2Mgl}{I_1} \\ a &= \frac{p_\psi}{I_1} \\ b &= \frac{p_\phi}{I_1}. \end{aligned} \quad (5.61)$$

In terms of these constants, the energy equation (5.55) can be written as

$$\alpha = \dot{\theta}^2 + \frac{(b - a \cos \theta)^2}{\sin^2 \theta} + \beta \cos \theta. \quad (5.62)$$

We will use this one-dimensional problem to discuss the motion in θ , very similarly to what was done in Section 3.3 in describing the radial motion for the central force problem. It is more convenient to change variables as we did for the central force problem. Using the variable $u = \cos \theta$, rewrite Eq. (5.62) as

$$\dot{u}^2 = (1 - u^2)(\alpha - \beta u) - (b - au)^2, \quad (5.62')$$

which can be reduced immediately to a quadrature:

$$t = \int_{u(0)}^{u(t)} \frac{du}{\sqrt{(1-u^2)(\alpha - \beta u) - (b - au)^2}}. \quad (5.63)$$

With this result, and Eqs. (5.57) and (5.58), ϕ and ψ can also be reduced to quadratures. However, the polynomial in the radical is a cubic so that we have to deal with elliptic integrals. These solutions can be generated on current desk-top computers. In the case of the force-free motion, the physics tends to be obscured in the profusion of mathematics. Fortunately, the general nature of the motion can be discovered without actually performing the integrations.

Before proceeding with the study of the possible solutions of Eq. (5.63), a few comments on the constants defined in Eqs. (5.61) will be useful. Figure 5.7 shows the case where the fixed point is not at the center of mass. If the top is spinning on a horizontal surface, both α and β are greater than zero. If the top is supported by a stand that allows it to dip below horizontal, β is still larger than zero, but α could be positive or negative. Another common application is the gyroscope where the center of mass is the fixed point. In terms of Fig. 5.7, α is the energy in the system excluding the x_3 angular kinetic energy. For the gyroscope, $\beta = 0$ and $\alpha \geq 0$. We shall restrict our attention to situations in which the rotational kinetic energy about the x_3 axis is much larger than the kinetic energy about the other two axes.

It is convenient to designate the right-hand side of Eq. (5.62') as a function $f(u)$ and discuss the behavior of the cubic equation

$$f(u) = \beta u^3 - (\alpha + a^2)u^2 + (2ab - \beta)u + (\alpha - b^2).$$

For the gyroscope, $f(u)$ is only a quadratic equation since $\beta = 0$, while for the top the full cubic equation must be considered. Since many of the applications of the gyroscope use torque-free mountings, precession and nutations are suppressed so the gyroscope motions are trivial. To understand the general motions of a spinning body, we will consider only cases where $\beta > 0$.

The roots of the cubic polynomial furnish the angles at which $\dot{\theta}$ changes sign, that is, the "turning angles" in θ . Knowing these angles will give qualitative information about the motion. There are three roots to a cubic equation and three possible combinations of solutions. There can be one real root and a complex conjugate pair of roots; there can be three real roots, two of which are equal; and there can be three real and unequal roots. These possibilities depend upon the relative signs and magnitudes of the four constants in Eqs. (5.61). There is also the physical constraint that the solution u must satisfy $-1 < u \leq 1$. We will draw all figures as if $u > 0$, which would be the case if the top is supported by a horizontal surface. Recall that a point support could allow the smallest root to be less than zero.

For u large, the dominant term in $f(u)$ is βu^3 . Since β (cf. Eqs. (5.61)) is always a positive constant $f(u)$ is positive for large positive u and negative for large negative u . At points $u = \pm 1$, $f(u)$ becomes equal to $-(b \mp a)^2$ and is therefore always negative, except for the unusual case where $u = \pm 1$ is a root

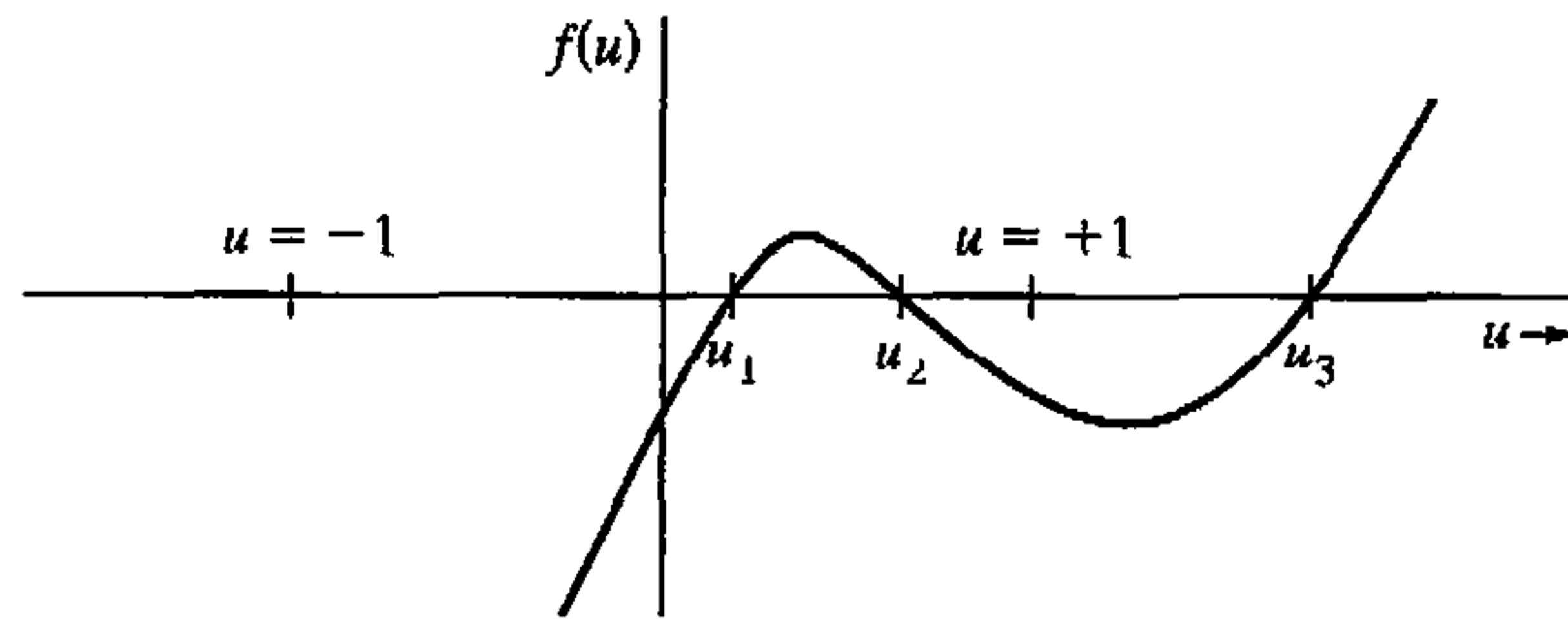

FIGURE 5.8 Illustrating the location of the turning angles of θ in the motion of a heavy symmetric top supported on a horizontal plane. A point support could allow one of the roots to be negative.

(corresponding to a vertical top). Hence, at least one root must lie in the region $u > 1$, a region that does not correspond to real angles. Indeed, physical motion of the top can occur only when u^2 is positive somewhere in the interval between $u = -1$ and $u = +1$, that is, θ between 0 and $+\pi$. We must conclude therefore that for any actual top $f(u)$ will have two roots, u_1 and u_2 , between -1 and $+1$ (cf. Fig. 5.8), and that the top moves such that $\cos \theta$ always remains between these two roots. The location of these roots, and the behavior of $\dot{\phi}$ and $\dot{\psi}$ for values of θ between them, provide much qualitative information about the motion of the top.

It is customary to depict the motion of the top by tracing the curve of the intersection of the figure axis on a sphere of unit radius about the fixed point. This curve is known as the *locus* of the figure axis. The polar coordinates of a point on the locus are identical with the Euler angles θ , ϕ for the body system. From the discussion in the preceding paragraph, we can see that the locus lies between the two bounding circles of colatitude $\theta_1 = \arccos u_1$ and $\theta_2 = \arccos u_2$, with $\dot{\theta}$ vanishing at both circles. The shape of the locus curve is in large measure determined by the value of the root of $b - au$, which we denote by u' :

$$u' = \frac{b}{a}. \quad (5.64)$$

Suppose, for example, the initial conditions are such that u' is larger than u_2 . Then, by Eq. (5.57), $\dot{\phi}$ will always have the same sign for the allowed inclination angles between θ_1 and θ_2 . Hence, the locus of the figure axis must be tangent to the bounding circles in such a manner that $\dot{\phi}$ is in the same direction at both θ_1 and θ_2 , as is shown in Fig. 5.9(a). Since ϕ therefore increases secularly in one direction or the other, the axis of the top may be said to *precess* about the vertical axis. But it is not the regular precession encountered in force-free motion, for as the figure axis goes around, it nods up and down between the bounding angles θ_1 and θ_2 —the top *nutates* during the precession.

Should b/a be such that u' lies between u_1 and u_2 , the direction of the precession will be different at the two bounding circles, and the locus of the figure axis exhibits loops, as shown in Fig. 5.9(b). The average of $\dot{\phi}$ will not vanish however so that there is always a net precession in one direction or the other. It can

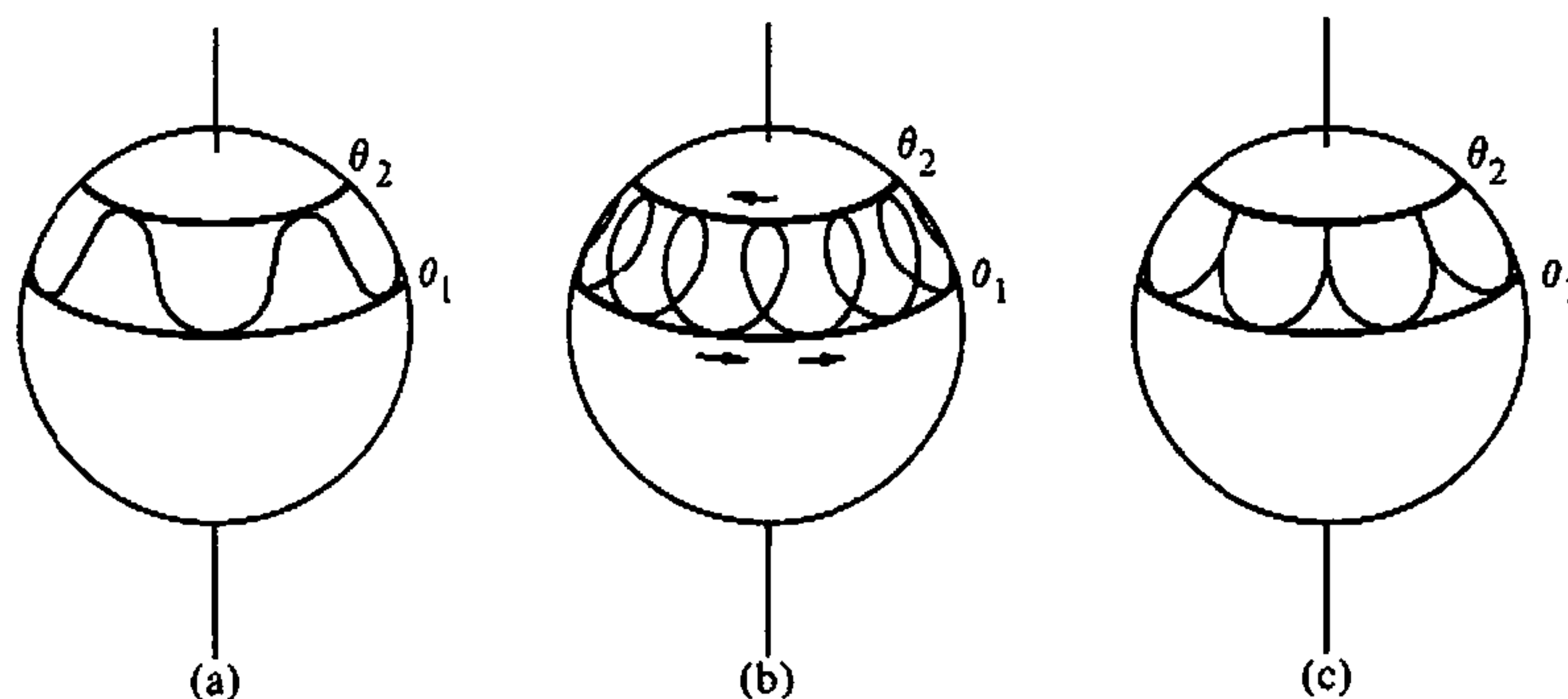

FIGURE 5.9 The possible shapes for the locus of the figure axis on the unit sphere.

also happen that u' coincides with one of the roots of $f(u)$. At the corresponding bounding circles, both $\dot{\theta}$ and $\dot{\phi}$ must then vanish, which requires that the locus have cusps touching the circle, as shown in Fig. 5.9(c).

This last case is not as exceptional as it sounds; it corresponds in fact to the initial conditions usually stipulated in elementary discussions of tops: We assume that initially the symmetrical top is spinning about its figure axis, which is fixed in some direction θ_0 . At time $t = 0$, the figure axis is released and the problem is to describe the subsequent motion. Explicitly, these initial conditions are that at $t = 0$, $\theta = \theta_0$ and $\dot{\theta} = \dot{\phi} = 0$. The quantity $u_0 = \cos \theta_0$ must therefore be one of the roots of $f(u)$; in fact, it corresponds to the upper circle:

$$u_0 = u_2 = u' = \frac{b}{a}. \quad (5.65)$$

For proof, note that with these initial conditions E' is equal to $Mgl \cos \theta_0$, and that the terms in E' derived from the top's kinetic energy can never be negative. Hence, as $\dot{\theta}$ and $\dot{\phi}$ begin to differ from their initial zero values, energy can be conserved only by a decrease in $Mgl \cos \theta$, i.e., by an increase in θ . The initial θ_0 is therefore the same as θ_2 , the minimum value θ can have. When released in this manner, *the top always starts to fall*, and continues to fall until the other bounding angle θ_1 is reached, precessing the meanwhile. The figure axis then begins to rise again to θ_2 , the complete motion being as shown in Fig. 5.9(c).

Some quantitative predictions can be made about the motion of the top under these initial conditions of vanishing $\dot{\theta}$ and $\dot{\phi}$, provided that the initial kinetic energy of rotation about the z -axis is assumed large compared to the maximum change in potential energy:

$$\frac{1}{2} I_3 \omega_3^2 \gg 2Mgl. \quad (5.66)$$

The effects of the gravitational torques, namely, the precession and accompanying nutation, will then be only small perturbations on the dominant rotation of the top about its figure axis. In this situation, we speak of the top as being a "fast top."

With this assumption we can obtain expressions for the extent of the nutation, the nutation frequency, and the average frequency of precession.

The extent of the nutation under these given initial conditions is given by $u_1 - u_0$, where u_1 is the other physical root of $f(u)$. The initial conditions $E' = Mgl \cos \theta_0$ is equivalent to the equality

$$\alpha = \beta u_0.$$

With this relation, and the conditions of Eq. (5.65), $f(u)$ can be rewritten more simply as

$$f(u) = (u_0 - u) \left[\beta(1 - u^2) - a^2(u_0 - u) \right]. \quad (5.67)$$

The roots of $f(u)$ other than u_0 are given by the roots of the quadratic expression in the brackets, and the desired root u_1 therefore satisfies the equation

$$(1 - u_1^2) - \frac{a^2}{\beta}(u_0 - u_1) = 0. \quad (5.68)$$

Denoting $u_0 - u$ by x and $u_0 - u_1$ by x_1 , Eq. (5.68) can be rewritten as

$$x_1^2 + px_1 - q = 0, \quad (5.69)$$

where

$$p = \frac{a^2}{\beta} - 2 \cos \theta_0, \quad q = \sin^2 \theta_0.$$

The condition for a “fast” top, Eq. (5.66), implies that p is much larger than q . This can be seen by writing the ratio a^2/β as

$$\frac{a^2}{\beta} = \left(\frac{I_3}{I_1} \right) \frac{I_3 \omega_3^2}{2Mgl}.$$

Except in the case that $I_3 \ll I_1$ (which would correspond to a top in the unusual shape of a cigar), the ratio is much greater than unity, and $p \gg q$. To first order in the small quantity q/p , the only physically realizable root of Eq. (5.68) is then

$$x_1 = \frac{q}{p}.$$

Neglecting $2 \cos \theta_0$ compared to a^2/β , this result can be written

$$x_1 = \frac{\beta \sin^2 \theta_0}{a^2} = \frac{I_1}{I_3} \frac{2Mgl}{I_3 \omega_3^2} \sin^2 \theta_0. \quad (5.70)$$

Thus, the extent of the nutation, as measured by $x_1 = u_0 - u_1$, goes down as $1/\omega_3^2$. The faster the top is spun, the less is the nutation.

The *frequency* of nutation likewise can easily be found for the “fast” top. Since the amount of nutation is small, the term $(1 - u^2)$ in Eq. (5.67) can be replaced by its initial value, $\sin^2 \theta_0$. Equation (5.67) then reads, with the help of Eq. (5.70),

$$f(u) = \dot{x}^2 = a^2 x(x_1 - x).$$

If we shift the origin of x to the midpoint of its range, by changing variable to

$$y = x - \frac{x_1}{2},$$

then the differential equation becomes

$$\dot{y}^2 = a^2 \left(\frac{x_1^2}{4} - y^2 \right),$$

which on differentiation again reduces to the familiar equation for simple harmonic motion

$$\ddot{y} = -a^2 y.$$

In view of the initial condition $x = 0$ at $t = 0$, the complete solution is

$$x = \frac{x_1}{2}(1 - \cos at), \quad (5.71)$$

where x_1 is given by (5.70). The angular frequency of nutation of the figure axis between θ_0 and θ_1 is therefore

$$a = \frac{I_3}{I_1} \omega_3, \quad (5.72)$$

which *increases* the faster the top is spun initially.

Finally, the angular velocity of precession, from (5.57), is given by

$$\dot{\phi} = \frac{a(u_0 - u)}{\sin^2 \theta} \approx \frac{ax}{\sin^2 \theta_0},$$

or, substituting Eqs. (5.72) and (5.70),

$$\dot{\phi} = \frac{\beta}{2a}(1 - \cos at). \quad (5.73)$$

The rate of precession is therefore not uniform but varies harmonically with time, with the same frequency as the nutation. The *average* precession frequency however is

$$\bar{\dot{\phi}} = \frac{\beta}{2a} = \frac{Mgl}{I_3 \omega_3}, \quad (5.74)$$

which indicates that the rate of precession decreases as the initial rotational velocity of the top is increased.

We are now in a position to present a complete picture of the motion of the fast top when the figure axis initially has zero velocity. Immediately after the figure axis is released, the initial motion of the top is always to fall under the influence of gravity. But as it falls, the resultant torque around the axis of fall causes the top to pick up a precession velocity, directly proportional to the extent of its fall, which starts the figure axis moving sideways about the vertical. The initial fall results in a periodic nutation of the figure axis in addition to the precession. As the top is spun faster and faster, the extent of the nutation decreases rapidly, although the frequency of nutation increases, while at the same time the precession about the vertical becomes slower. In practice, for a sufficiently fast top the nutation is damped out by the friction at the pivot and becomes unobservable. The top then *appears* to precess uniformly about the vertical axis. Because the precession is regular only in appearance, Klein and Sommerfeld have dubbed it a *pseudoregular* precession. In most of the elementary discussions of precession, the phenomenon of nutation is neglected. As a consequence, such derivations seem to lead to the paradoxical conclusion that upon release the top *immediately* begins to precess uniformly, a motion that is *normal* to the forces of gravity that are the ultimate cause of the precession. Our discussion of pseudoregular precession serves to resolve the paradox; the precession builds up continuously from rest without any infinite accelerations, and the initial tendency of the top *is* to move in the direction of the forces of gravity.

It is of interest to determine exactly what initial conditions will result in a true regular precession. In such a case, the angle θ remains constant at its initial value θ_0 , which means that $\theta_1 = \theta_2 = \theta_0$. In other words, $f(u)$ must have a double root at u_0 (cf. Fig. 5.10), or

$$f(u) = \dot{u}^2 = 0, \quad \frac{df}{du} = 0; \quad u = u_0.$$

The first of these conditions, from Eq. (5.62') with $\dot{u} = 0$, implies

$$(\alpha - \beta u_0) = \frac{(b - a u_0)^2}{1 - u_0^2}, \quad (5.75)$$

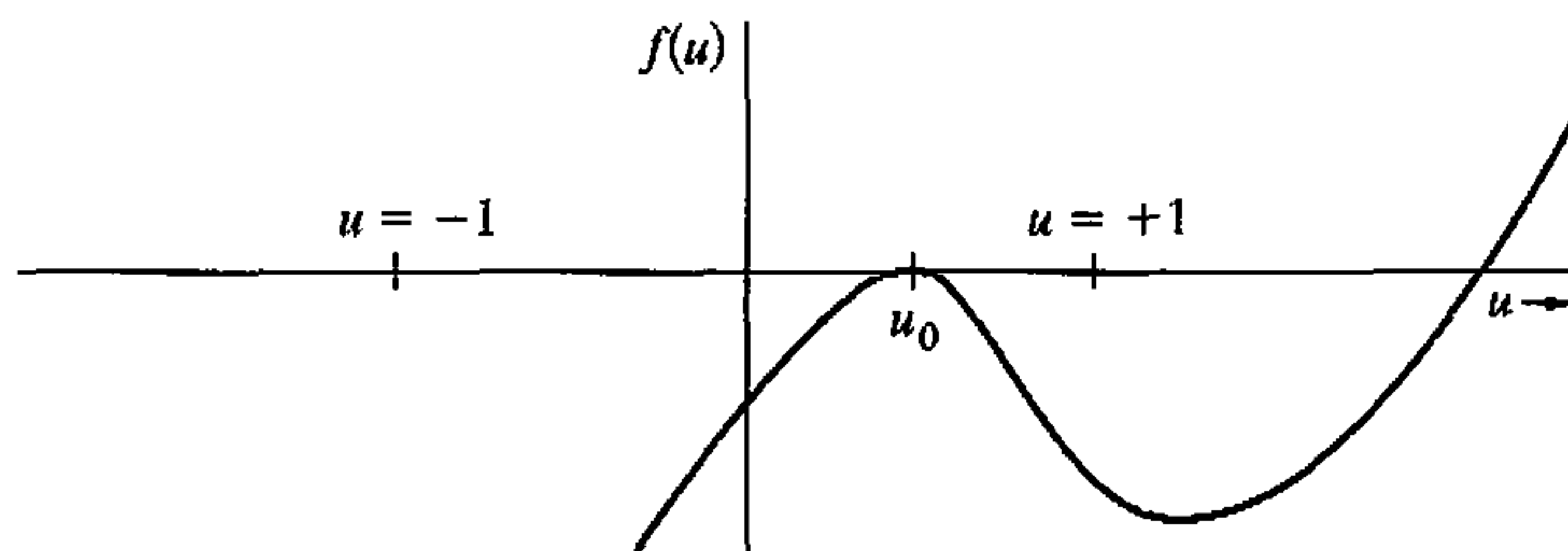

FIGURE 5.10 Appearance of $f(u)$ for a regular precession.

the second corresponds to

$$\frac{\beta}{2} = \frac{a(b - au_0)}{1 - u_0^2} - u_0 \frac{(\alpha - \beta u_0)}{1 - u_0^2}. \quad (5.76)$$

Substitution of Eq. (5.75) in Eq. (5.76) leads, in view of Eq. (5.57) for $\dot{\phi}$, to a quadratic equation for $\dot{\phi}$:

$$\frac{\beta}{2} = a\dot{\phi} - \dot{\phi}^2 \cos \theta_0. \quad (5.76')$$

With the definitions of β and a , Eq. (5.61), this can be written in two alternative forms, depending on whether a is expressed in terms of ω_3 or the (constant) $\dot{\psi}$ and $\dot{\phi}$

$$Mgl = \dot{\phi}(I_3\omega_3 - I_1\dot{\phi} \cos \theta_0), \quad (5.77)$$

or

$$Mgl = \dot{\phi}(I_3\dot{\psi} - (I_1 - I_3)\dot{\phi} \cos \theta_0). \quad (5.77')$$

The initial conditions for the problem of the heavy top require the specification of θ , ϕ , ψ , $\dot{\theta}$, $\dot{\phi}$, and, say, either $\dot{\psi}$ or ω_3 at the time $t = 0$. Because they are cyclic, the initial values of ϕ and ψ are largely irrelevant, and in general we can choose any desired value for each of the four others. But if in addition we require that the motion of the figure axis be one of uniform precession without nutation, then our choice of these four initial values is no longer completely unrestricted. Instead, they must satisfy either of Eqs. (5.77). For $\dot{\theta} = 0$, we may still choose initial values of θ and ω_3 , almost arbitrarily, but the value of $\dot{\phi}$ is then determined. The phrase "almost arbitrarily" is used because Eqs. (5.77) are quadratic, and for $\dot{\phi}$ to be real, the discriminant of Eq. (5.77) must be positive:

$$I_3^2\omega_3^2 > 4MglI_1 \cos \theta_0. \quad (5.78)$$

For $\theta_0 > \pi/2$ (a top mounted so its center of mass is below the fixed point), then any value of ω_3 can lead to uniform precession. But for $\theta_0 < \pi/2$, ω_3 must be chosen to be above a minimum value ω'_3 ,

$$\omega_3 > \omega'_3 = \frac{2}{I_3} \sqrt{MglI_1 \cos \theta_0} \quad (5.79)$$

to achieve the same situation. Similar conditions can be obtained from Eq. (5.77') for the allowable values of $\dot{\psi}$. As a result of the quadratic nature of Eq. (5.77), there will in general be two solutions for $\dot{\phi}$, known as the "fast" and "slow" precession. Also note that (5.77) can never be satisfied by $\dot{\phi} = 0$ for finite $\dot{\psi}$ or ω_3 ; to obtain uniform precession, we must always give the top a shove to start it on its

way. Without this correct initial precessional velocity, we can obtain at best only a pseudoregular precession.

If the precession is slow, so that $\dot{\phi} \cos \theta_0$ may be neglected compared to a , then an approximate solution for $\dot{\phi}$ is

$$\dot{\phi} \approx \frac{\beta}{2a} = \frac{Mgl}{I_3 \omega_3} \quad (\text{slow}),$$

which agrees with the average rate of pseudoregular precession for a fast top. This result is to be expected of course; if the rate of precession is slow, there is little difference between starting the gyroscope off with a little shove or with no shove at all. Note that with this value of $\dot{\phi}$, the neglect of $\dot{\phi} \cos \theta_0$ compared to a is equivalent to requiring that ω_3 be much greater than the minimum allowed value. For such large values of ω_3 , the “fast” precession is obtained when $\dot{\phi}$ is so large that Mgl is small compared to the other terms in Eq. (5.77):

$$\dot{\phi} = \frac{I_3 \omega_3}{I_1 \cos \theta_0} \quad (\text{fast}).$$

The fast precession is independent of the gravitational torques and can in fact be related to the precession of a free body (see Derivation 6a in the Exercises).

One further case deserves some attention, namely, when $u = 1$ corresponds to one of the roots of $f(u)$.^{*} Suppose, for instance, a top is set spinning with its figure axis initially vertical. Clearly then $b = a$, for $I_1 b$ and $I_1 a$ are the constant components of the angular momentum about the vertical axis and the figure axis respectively, and these axes are initially coincident. Since the initial angular velocity is only about the figure axis, the energy equation (5.59) evaluated at time $t = 0$ states that

$$E' = E - \frac{1}{2} I_3 \omega_3^2 = Mgl.$$

By the definitions of α and β (Eq. (5.61)), it follows that $\alpha = \beta$.

The energy equation at any angle may therefore be written as

$$\dot{u}^2 = (1 - u^2)\beta(1 - u) - a^2(1 - u)^2$$

or

$$\dot{u}^2 = (1 - u)^2 \left[\beta(1 + u) - a^2 \right].$$

The form of the equation indicates that $u = 1$ is always a double root, with the third root given by

$$u_3 = \frac{a^2}{\beta} - 1.$$

^{*}Note that this must be treated as a special case, since in the previous discussions factors of $\sin^2 \theta$ were repeatedly divided out of the expressions.

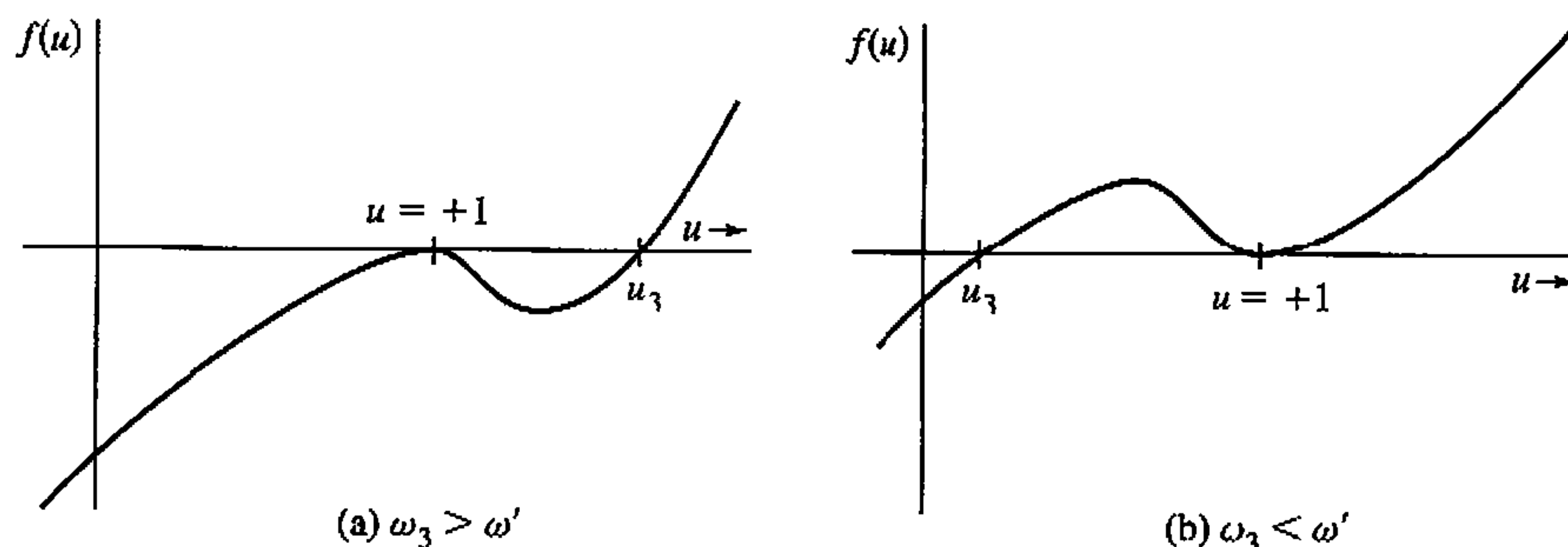

FIGURE 5.11 Plot of $f(u)$ when the figure axis is initially vertical.

If $a^2/\beta > 2$ (which corresponds to the condition for a “fast” top), u_3 is larger than 1 and the only possible motion is for $u = 1$; the top merely continues to spin about the vertical. For this state of affairs, the plot of $f(u)$ appears as shown in Fig. 5.11(a). On the other hand, if $a^2/\beta < 2$, the third root u_1 is then less than 1, $f(u)$ takes on the form shown in Fig. 5.11(b), and the top will nutate between $\theta = 0$ and $\theta = \theta_3$. There is thus a critical angular velocity, ω' , above which only vertical motion is possible, whose value is given by

$$\frac{a^2}{\beta} = \left(\frac{I_3}{I_1}\right) \frac{I_3 \omega'^2}{2Mgl} = 2$$

or

$$\omega'^2 = 4 \frac{MglI_1}{I_3^2}, \quad (5.80)$$

which is identical with Eq. (5.79) for the minimum frequency for uniform precession with $\theta_0 = 0$.

In practice, if a top is started spinning with its axis vertical and with ω_3 greater than the critical angular velocity, it will continue to spin quietly for a while about the vertical (hence the designation as a “sleeping” top). However, friction gradually reduces the frequency of rotation below the critical value, and the top then begins to wobble in ever larger amounts as it slows down.

The effects of friction (which of course cannot be directly included in the Lagrangian framework) can give rise to unexpected phenomena in the behavior of tops. A notable example is the “tippie-top,” which consists basically of somewhat more than half a sphere with a stem added on the flat surface. When set rotating with the spherical surface downwards on a hard surface, it proceeds to skid and nutate until it eventually turns upside down, pivoting on the stem, where it then behaves as a normal “sleeping” top. The complete reversal of the angular momentum vector is the result of frictional torque occurring as the top skids on its spherical surface.

A large and influential technology is based on the applications of rapidly spinning rigid bodies, particularly through the use of what are called “gyroscopes.” Basically, a three-frame gyroscope is a symmetrical top rotated very rapidly by external means about the figure axis and mounted in gimbals so that the motion of the figure axis is unrestricted about three perpendicular spatial axes while the center of gravity remains stationary. The figure axis maintains the same direction in space no matter how the mounting is reoriented, a phenomenon called gyroscopic inertia. Such an instrument can indicate the roll, pitch, and attitude directions of an airplane flying “blind” by using the xyz Euler angle convention described in Section 4.4 and Appendix A.

If external torques are suitably exerted on the gyroscope, it will undergo the precession and nutation motions described earlier for the heavy top. However, the condition for the “fast” top is abundantly satisfied, so that the extent of the nutation is always very small, and moreover is deliberately damped out by the method of mounting. The only gyroscopic phenomenon then observed is precession, and the mathematical treatment required to describe this precession can be greatly simplified. We can see how to do this by generalization from the case of the heavy symmetrical top.

If \mathbf{R} is the radius vector along the figure axis from the fixed point to the center of gravity, then the gravitational torque exerted on the top is

$$\mathbf{N} = \mathbf{R} \times M\mathbf{g}, \quad (5.81)$$

where \mathbf{g} is the *downward* vector of the acceleration of gravity. If \mathbf{L}_3 is the vector along the figure axis, describing the angular momentum of rotation about the figure axis, and $\boldsymbol{\omega}_p$, known as the precession vector, is aligned along the vertical with magnitude equal to the mean precession angular velocity $\bar{\phi}$, Eq. (5.74), then the sense and magnitude of the (pseudoregular) precession is given by

$$\boldsymbol{\omega}_p \times \mathbf{L}_3 = \mathbf{N}. \quad (5.82)$$

Since any torque about the fixed point or center of mass can be put in the form $\mathbf{R} \times \mathbf{F}$, similar to Eq. (5.81), the resulting average precession rate for a “fast” top can always be derived from Eq. (5.82), with the direction of the force \mathbf{F} defining the precession axis. Almost all engineering applications of gyroscopes involve the equilibrium behavior (i.e., neglecting transients) which can be derived from Eq. (5.82).

Free from any torques, a gyroscope spin axis will always preserve its original direction relative to an inertial system. Gyros can therefore be used to indicate or maintain specific directions, e.g., provide stabilized platforms. As indicated by Eq. (5.82), through the precession phenomena they can sense and measure angular rotation rates and applied torques. Note from Eq. (5.82) that the precession rate is proportional to the torque, whereas in a nonspinning body it is the angular acceleration that is given by the torque. Once the torque is removed, a nonspinning

body will continue to move; under similar conditions a gyro simply continues spinning without precessing.

The gyrocompass involves more complicated considerations because here we are dealing with the behavior of a gyroscope fixed in a noninertial system, while Earth rotates underneath it. In a gyrocompass, an additional precession is automatically applied by an external torque at a rate just enough to balance Earth's rotation rate. Once set in the direction of Earth's rotation, i.e., the north direction, the gyrocompass then preserves this direction, at least in slowly moving vehicles. What has been presented here is admittedly an oversimplified, highly compressed view of the fascinating technological uses of fast spinning bodies. To continue further in this direction would regrettably lead us too far afield.

There are however two examples of precession phenomena in nature for which a somewhat fuller discussion would be valuable, both for the great interest in the phenomena themselves and as examples of the techniques derived in this chapter. The first concerns the types of precession that arise from the torques induced by Earth's equatorial "bulge," and the second is the precession of moving charges in a magnetic field. The next two sections are concerned with these examples.

5.8 ■ PRECESSION OF THE EQUINOXES AND OF SATELLITE ORBITS

It has been mentioned previously that Earth is a top whose figure axis is precessing about the normal to the ecliptic, the plane of Earth's orbit, a motion known astronomically as the precession of the equinoxes. Were Earth completely spherical, none of the other members of the solar system could exert a gravitational torque on it. But, as has been pointed out, Earth deviates slightly from a sphere, being closely approximated by an oblate spheroid of revolution. It is just the net torque on the resultant equatorial "bulge" arising from gravitational attraction, chiefly of the Sun and Moon, that sets Earth's axis precessing in space.

To calculate the rate of this precession, a slight excursion into potential theory is needed to find the mutual gravitational potential of a mass point (representing the sun or the moon) and a nonspherical distribution of matter. We will find the properties of the inertia tensor as obtained above very useful in the derivation of this potential.

Consider a distribution of mass points forming one body, and a single mass point, mass M , representing the other (cf. Fig. 5.12). If r_i is the distance between the i th point in the distribution and the mass point M , then the mutual gravitational potential between the two bodies is*

$$V = -\frac{GMm_i}{r_i} = -\frac{GMm_i}{r\sqrt{1 + \left(\frac{r'_i}{r}\right)^2 - 2\frac{r'_i}{r}\cos\psi_i}}. \quad (5.83)$$

*It may be worth a reminder that summation is implied over repeated subscripts

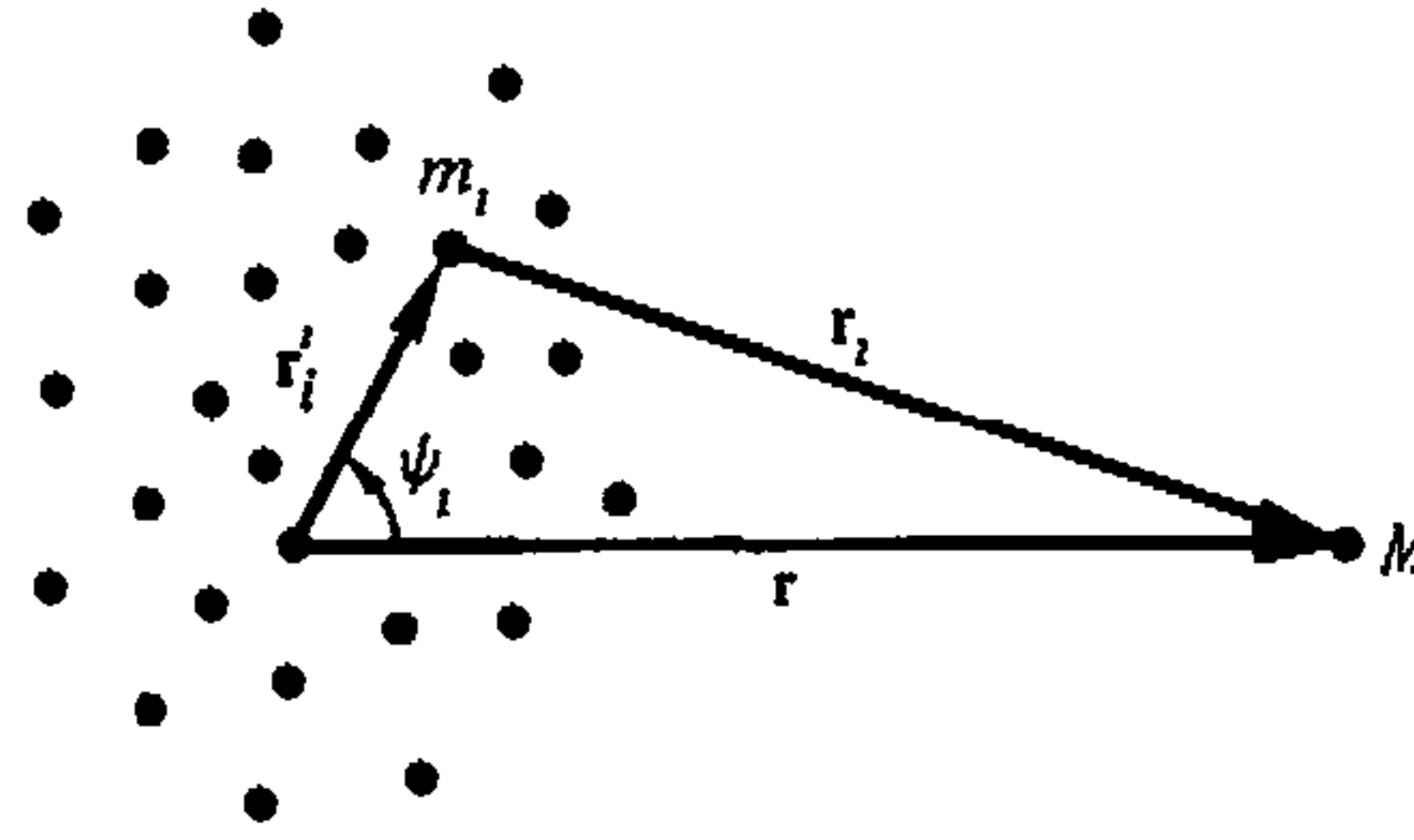

FIGURE 5.12 Geometry involved in gravitational potential between an extended body and a mass point.

In this last expression the terminology of Fig. 5.12 is used: r'_i is the radius vector to the i th particle from a particular point, which will later be taken to be the center of mass of the first body, r is the corresponding radius vector to the mass point M , and ψ_i is the angle between the two vectors. It is well known that a simple expansion in terms of Legendre polynomials can be given for Eq. (5.83); in fact, the reciprocal of the square root in Eq. (5.83) is known as the *generating function* for Legendre polynomials, so that

$$V = -\frac{GM}{r} \sum_{n=0} m_i \left(\frac{r'_i}{r}\right)^n P_n(\cos \psi_i), \quad (5.84)$$

providing r , the distance from the origin to M , is much greater than any r'_i . We shall make use of only the first three Legendre polynomials that, for reference, are

$$P_0(x) = 1, \quad P_1(x) = x, \quad P_2(x) = \frac{1}{2}(3x^2 - 1). \quad (5.85)$$

For a continuous spherical body, with only a radial variation of density, all terms except the first in Eq. (5.84) can easily be shown to vanish. Thus, the n th term inside the summation, for a body with spherical symmetry and mass density $\rho(r')$, can be written

$$\iiint dV' \rho(r') \left(\frac{r'}{r}\right)^n P_n(\cos \psi).$$

Using spherical polar coordinates, with the polar axis along r , this becomes

$$\int r'^2 dr' \rho(r') \left(\frac{r'}{r}\right)^n \int_{-1}^{+1} d(\cos \psi) P_n(\cos \psi).$$

From the orthonormal properties of P_n with respect to P_0 , the integral over $\cos \psi$ vanishes except for $n = 0$, which proves the statement.

If the body deviates only slightly from spherical symmetry, as is the case with Earth, we would expect the terms in Eq. (5.84) beyond $n = 0$ to decrease rapidly

with increasing n . It will therefore be sufficient to retain only the first nonvanishing correction term in Eq. (5.48) to the potential for a sphere. Now, the choice of the center of mass as origin causes the $n = 1$ term to vanish identically, since it can be written

$$-\frac{GM}{r^2} m_i r'_i \cos \psi_i = -\frac{GM}{r^3} \mathbf{r} \cdot m_i \mathbf{r}'_i,$$

which is zero, by definition of the center of mass. The next term, for $n = 2$, can be written

$$\frac{GM}{2r^3} m_i r_i'^2 (1 - 3 \cos^2 \psi_i).$$

Simple tensor manipulation gives the complete second-order approximation to the nonspherical potential as

$$V = -\frac{GMm}{r} + \frac{GM}{2r^3} (3I_r - \text{Tr } \mathbf{I}),$$

where m is the mass of the first body (Earth), I_r is the moment of inertia about the direction of \mathbf{r} , and \mathbf{I} is the moment of inertia tensor in the principal axis system. From the diagonal representation of the inertia tensor in the principal axis system, its trace is just the sum of the principal moments of inertia, so that V can be written as

$$V = -\frac{GMm}{r} + \frac{GM}{2r^3} [3I_r - (I_1 + I_2 + I_3)]. \quad (5.86)$$

Equation (5.86) is sometimes known as *MacCullagh's formula*. So far, no assumption of rotational symmetry has been made. Let us now take the axis of symmetry to be along the third principal axis, so that $I_1 = I_2$. If α, β, γ are the direction cosines of \mathbf{r} relative to the principal axes, then the moment of inertia I_r can be expressed as

$$I_r = I_1(\alpha^2 + \beta^2) + I_3\gamma^2 = I_1 + (I_3 - I_1)\gamma^2. \quad (5.87)$$

With this form for I_r , the potential, Eq. (5.86), becomes

$$V = -\frac{GMm}{r} + \frac{GM(I_3 - I_1)}{2r^3} (3\gamma^2 - 1),$$

or

$$V = -\frac{GMm}{r} + \frac{GM(I_3 - I_1)}{r^3} P_2(\gamma). \quad (5.88)$$

The general form of Eq. (5.88) could have been foretold from the start, for the potential from a mass distribution obeys Poisson's equation. The solution appropriate to the symmetry of the body, as is well known, is an expansion of terms

of the form $P_n(\gamma)/r^{n+1}$, of which Eq. (5.88) shows the first two nonvanishing terms. However, this approach does not give the coefficients of the terms any more simply than the derivation employed here. It should also be remarked that the expansion of V is the gravitational analog of the multipole expansion of, say, the electrostatic potential of an arbitrary charged body. The $n = 1$ term is absent here because there is only one sign of gravitational “charge” and there can be no gravitational dipole moment. Further, the inertia tensor is defined analogously to the quadrupole moment tensor. Therefore, the mechanical effects we are seeking can be said to arise from the gravitational quadrupole moment of the oblate Earth.*

Of the terms in Eq. (5.88) for the potential, the only one that depends on the orientation of the body, and thus could give rise to torques, is

$$V_2 = \frac{GM(I_3 - I_1)}{r^3} P_2(\gamma). \quad (5.89)$$

For the example of Earth’s precession, it should be remembered that γ is the direction cosine between the figure axis of Earth and the radius vector from Earth’s center to the Sun or Moon. As these bodies go around their apparent orbits, γ will change. The relation of γ to the more customary astronomical angles can be seen from Fig. 5.13 where the orbit of the Sun or Moon is taken as being in the xy plane, and the figure axis of the body in the xz plane. The angle θ between the figure axis and the z direction is the obliquity of the figure axis. The dot product of a unit vector along the figure axis with the radius vector to the celestial body involves only the products of their x -components, so that

$$\gamma = \sin \theta \cos \eta.$$

Hence, V_2 can be written

$$V_2 = \frac{GM(I_3 - I_1)}{2r^3} (3 \sin^2 \theta \cos^2 \eta - 1).$$

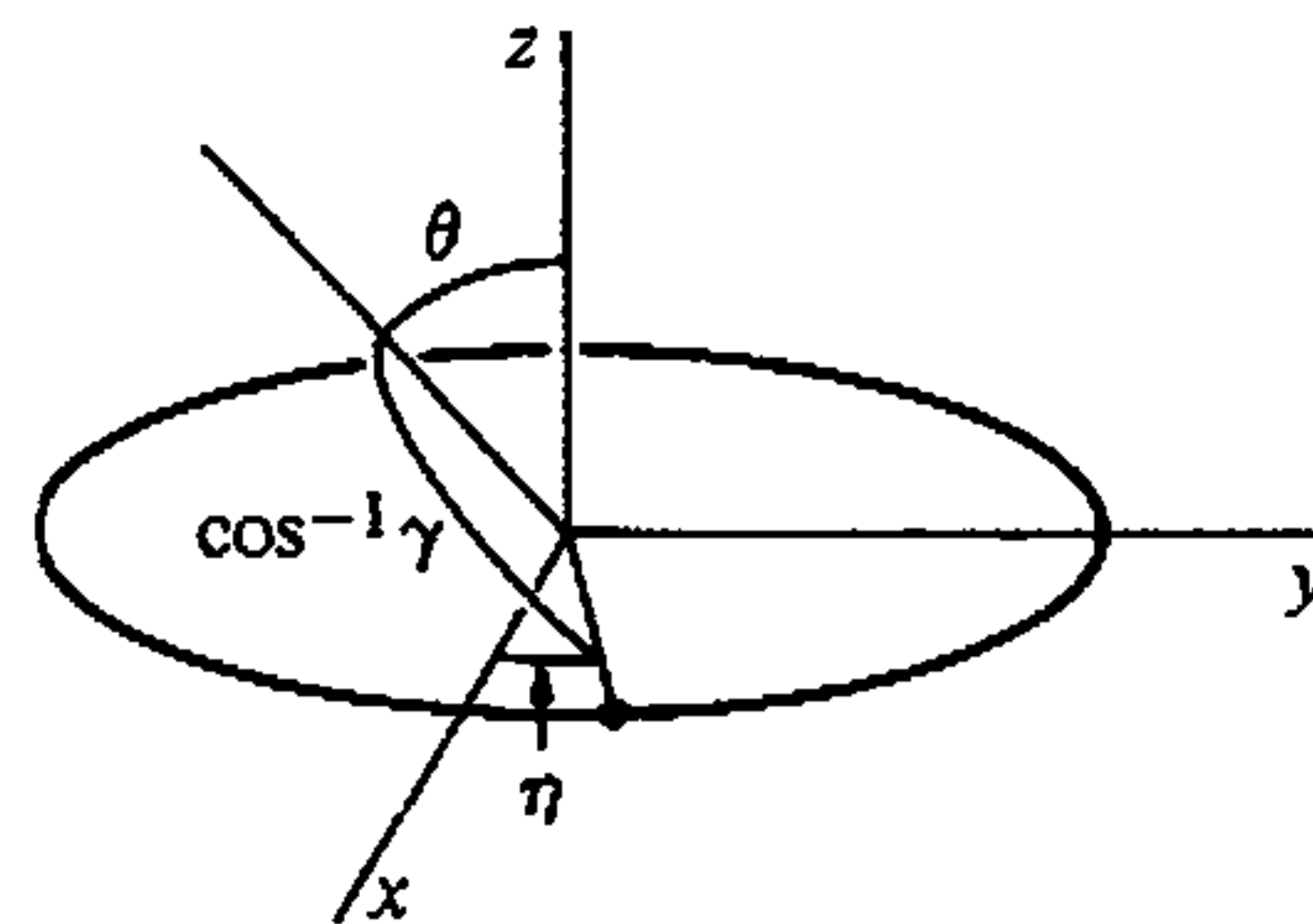

FIGURE 5.13 Figure axis of Earth relative to orbit of mass point.

*Note that so far nothing in the argument restricts the potential of Eq (5.88) to *rigid* bodies. The constraint of rigidity enters only when we require from here on that the principal axes be fixed in the body and the associated moments of inertia be constant in time.

As we shall see, the orbital motion is very rapid compared to the precessional motion, and for the purpose of obtaining the mean precession rate, it will be adequate to average V_2 over a complete orbital period of the celestial body considered. Since the apparent orbits of the Sun and Moon have low eccentricities, r can be assumed constant and the only variation is in $\cos \eta$. The average of $\cos^2 \eta$ over a complete period is $\frac{1}{2}$, and the averaged potential is then

$$\bar{V}_2 = \frac{GM(I_3 - I_1)}{2r^3} \left(\frac{3}{2} \sin^2 \theta - 1 \right) = \frac{GM(I_3 - I_1)}{2r^3} \left(\frac{1}{2} - \frac{3}{2} \cos^2 \theta \right),$$

or, finally,

$$\bar{V}_2 = -\frac{GM(I_3 - I_1)}{2r^3} P_2(\cos \theta). \quad (5.90)$$

The torque derived from Eq. (5.90) is perpendicular to both the figure axis and the normal to the orbit (which plays the same role as the vertical axis for the heavy top). Hence, the precession is about the direction of the orbit normal vector. The magnitude of the precession rate can be obtained from Eq. (5.82), but because the potential differs in form from that for the heavy top, it may be more satisfying to obtain a more formal derivation. For any symmetric body in which the potential is a function of $\cos \theta$ only, the Lagrangian can be written, following Eq. (5.52), as

$$L = \frac{I_1}{2} (\dot{\theta}^2 + \dot{\phi}^2 \sin^2 \theta) + \frac{I_3}{2} (\dot{\psi} + \dot{\phi} \cos \theta)^2 - V(\cos \theta). \quad (5.91)$$

If we are to assume only uniform precession and are not concerned about the necessary initial conditions, we can simply take $\dot{\theta}$ and $\ddot{\theta}$ to be zero in the equations of motion. The Lagrange equation corresponding to θ is then

$$\frac{\partial L}{\partial \theta} = I_1 \dot{\phi}^2 \sin \theta \cos \theta - I_3 \dot{\phi} \sin \theta (\dot{\psi} + \dot{\phi} \cos \theta) - \frac{\partial V}{\partial \theta} = 0$$

or

$$I_3 \omega_3 \dot{\phi} - I_1 \dot{\phi}^2 \cos \theta = \frac{\partial V}{\partial(\cos \theta)}, \quad (5.92)$$

which is the analog of Eq. (5.76') for a more general potential. For slow precession, which means basically that $\dot{\phi} \ll \omega_3$, the $\dot{\phi}^2$ terms in Eq. (5.92) can be neglected, and the rate of uniform precession is given by

$$\dot{\phi} = \frac{1}{I_3 \omega_3} \frac{\partial V}{\partial(\cos \theta)}. \quad (5.93)$$

From Eq. (5.51') we see that for the heavy top Eq. (5.93) agrees with the average result of Eq. (5.74). With the potential of Eq. (5.90), the precession rate is

$$\dot{\phi} = -\frac{3GM}{2\omega_3 r^3} \frac{I_3 - I_1}{I_3} \cos \theta. \quad (5.94)$$

For the case of the precession due to the Sun, this formula can be put in a simpler form, by taking r as the semimajor axis of Earth's orbit and using Kepler's law, Eq. (3.71), in the form

$$\omega_0^2 = \left(\frac{2\pi}{\tau}\right)^2 = \frac{GM}{r^3}.$$

The precession rate, relative to the orbital angular velocity, ω_0 , is then

$$\frac{\dot{\phi}}{\omega_0} = -\frac{3}{2} \frac{\omega_0}{\omega_3} \frac{I_3 - I_1}{I_3} \cos \theta. \quad (5.95)$$

With the value of $(I_3 - I_1)/I_3$ as given in Section 5.6, and $\theta = 23^\circ 27'$, Eq. (5.95) says that the solar-induced precession would be such as to cause a complete rotation of the figure axis about the normal to the ecliptic (plane of Earth's orbit) in about 81,000 years.

The Moon is far less massive than the Sun, but it is also much closer; the net result is that the lunar-induced precession rate is over twice that caused by the Sun. Since the lunar orbit is close to the ecliptic and has the same sense as the apparent solar orbit, the two precessions nearly add together arithmetically, and the combined lunisolar precession rate is $50.25''/\text{year}$, or one complete rotation in about 26,000 years. Note that this rate of precession is so slow that the approximation of neglecting $\dot{\phi}$ compared to ω_3 is abundantly satisfied. Because the Sun, Moon, and Earth are in constant relative motion, and the Moon's orbit is inclined about 5° to the ecliptic, the precession exhibits irregularities designated as *astronomical nutation*. The extent of these periodic irregularities is not large—about $9''$ of arc in θ and about $18''$ in ϕ . Even so, they are far larger than the true nutation that, as Klein and Sommerfeld have shown, is manifested by the Chandler wobble whose amplitude is never more than a few tenths of an arc second.

One further application can be made of the potential, Eq. (5.88), and associated uniform precession rate, Eq. (5.93). It has been stressed that the potential represents a *mutual* gravitational interaction; if it results in torques acting on the spinning Earth, it also gives rise to (noncentral) forces acting on the mass point M . The effect of these small forces appears as a precession of the plane of the orbit of the mass point, relative to an inertial frame. It is possible to obtain an approximate formula for this precession by an argument again based on the behavior of spinning rigid bodies.

Since the precession rates are small compared to the orbital angular velocity, we can again average over the orbit. The averaging in effect replaces the particle by a rigid ring of mass M with the same radius as the (assumed circular) orbit, spinning about the figure axis of the ring with the orbital frequency. Equation (5.90) gives the potential field in which this ring is located, with θ the angle

between the figure axes of the ring and Earth. The average precession rate is still given by Eq. (5.93), *but now I_3 and ω_3 refer to the spinning ring and not Earth.* It would therefore be better to rewrite Eq. (5.93) for this application as

$$\dot{\phi} = \frac{\tau}{2\pi Mr^2} \frac{\partial V}{\partial(\cos \theta)}, \quad (5.93')$$

and Eq. (5.94) appears as

$$\dot{\phi} = -\frac{\tau}{2\pi} \frac{3}{2} \frac{G(I_3 - I_1)}{r^5} \cos \theta. \quad (5.94')$$

Equation (5.94') could be used, for example, to find the precession of the orbit of the Moon due to Earth's oblateness. A more current application would be to the precession of nearly circular orbits of artificial satellites revolving about Earth. The fraction of a complete precession rotation in one period of the satellite is

$$\frac{\dot{\phi}\tau}{2\pi} = -\left(\frac{\tau}{2\pi}\right)^2 \frac{3}{2} \frac{G(I_3 - I_1)}{r^5} \cos \theta.$$

An application of Kepler's law, this time for the period of the satellite, reduces this result to

$$\frac{\dot{\phi}\tau}{2\pi} = -\frac{3}{2} \frac{I_3 - I_1}{mr^2} \cos \theta, \quad (5.96)$$

where m is Earth's mass. If Earth were a uniform sphere, then the principal moments of inertia would be

$$I_3 \sim I_1 = \frac{2}{5}mR^2,$$

with R Earth's radius. Because the core is much more dense than the outer layers, the moment of inertia is smaller, such that in fact*

$$I_3 = 0.331mR^2 \approx \frac{1}{3}mR^2.$$

The approximate precession is thus given by

$$\frac{\dot{\phi}\tau}{2\pi} = -\frac{1}{2} \frac{I_3 - I_1}{I_3} \left(\frac{R}{r}\right)^2 \cos \theta. \quad (5.97)$$

For a "close" satellite where r is very close to R , and the inclination of the satellite orbit to the equator is, say, 30° , Eq. (5.97) says that the plane of the orbit precesses completely around 2π in about 700 orbits of the satellite. Since the period of a close satellite is about $1\frac{1}{2}$ hours, complete rotation of the orbital plane occurs in a little over six weeks time. Clearly the effect is quite significant. We shall rederive the precession of the satellite orbit later on, when we discuss the subject of perturbation theory (cf. Section 12.3).

*The best values of I_3 are now obtained from observation of just such effects on satellite orbits.

5.9 ■ PRECESSION OF SYSTEMS OF CHARGES IN A MAGNETIC FIELD

The motion of systems of charged particles in magnetic fields does not normally involve rigid body motion. In a number of particular instances, the motion is however most elegantly discussed using the techniques developed here for rigid body motion. For this reason, and because of their importance in atomic and nuclear physics, a few examples will be given here.

The *magnetic moment* of a system of moving charges (relative to a particular origin) is defined as

$$\mathbf{M} = \frac{1}{2} q_i (\mathbf{r}_i \times \mathbf{v}_i) \rightarrow \frac{1}{2} \int dV \rho_e(\mathbf{r})(\mathbf{r} \times \mathbf{v}). \quad (5.98)$$

Here the first expression is a sum over discrete particles with charge q_i , while the second is the corresponding generalization to a continuous distribution of charge density $\rho_e(\mathbf{r})$. The angular momentum of the system under corresponding conventions is

$$\mathbf{L} = m_i (\mathbf{r}_i \times \mathbf{v}_i) \rightarrow \int dV \rho_m(\mathbf{r})(\mathbf{r} \times \mathbf{v}).$$

Both the magnetic moment and the angular momentum have a similar form. We shall restrict the discussion to situations in which \mathbf{M} is directly proportional to \mathbf{L} :

$$\mathbf{M} = \gamma \mathbf{L}, \quad (5.99)$$

most naturally by having a uniform q/m ratio for all particles or at all points in the continuous system. In such cases, the *gyromagnetic ratio* γ is given by

$$\gamma = \frac{q}{2m}, \quad (5.100)$$

but, with an eye to models of particle and atomic spin, γ will often be left unspecified. The forces and torques on a magnetic dipole may be considered as derived from a potential

$$V = -(\mathbf{M} \cdot \mathbf{B}). \quad (5.101)$$

It is implied along with Eq. (5.101) that the magnetic field is substantially constant over the system. Indeed, the picture applies best to a pointlike magnetic moment whose magnitude is not affected by the motion it undergoes—a picture appropriate to permanent magnets or systems on an atomic or small scale. With uniform \mathbf{B} , the potential depends only on the orientation of \mathbf{M} relative to \mathbf{B} ; no forces are exerted on the magnetic moment, but there is a torque

$$\mathbf{N} = \mathbf{M} \times \mathbf{B}. \quad (5.102)$$

(Compare with Eq. (5.81).) The time rate of change of the total angular momentum is equal to this torque, so that in view of Eq. (5.99) we can write

$$\frac{d\mathbf{L}}{dt} = \gamma \mathbf{L} \times \mathbf{B}. \quad (5.103)$$

But this is exactly the equation of motion for a vector of constant magnitude rotating in space about the direction of \mathbf{B} with an angular velocity $\boldsymbol{\omega} = -\gamma \mathbf{B}$. The effect of a uniform magnetic field on a permanent magnetic dipole is to cause the angular momentum vector (and the magnetic moment) to *precess* uniformly.

For the classical gyromagnetic ratio, Eq. (5.100), the precession angular velocity is

$$\boldsymbol{\omega}_l = -\frac{q\mathbf{B}}{2m}, \quad (5.104)$$

known as the *Larmor frequency*. For electrons q is negative, and the Larmor precession is counterclockwise around the direction of \mathbf{B} .

As a second example, consider a collection of moving charged particles, without restrictions on the nature of their motion, but assumed to all have the same q/m ratio, and to be in a region of uniform constant magnetic field. It will also be assumed that any interaction potential between particles depends only on the scalar distance between the particles. The Lagrangian for the system can be written (cf. Eq. (1.63))

$$L = \frac{1}{2}m_i v_i^2 + \frac{q}{m}m_i \mathbf{v}_i \cdot \mathbf{A}_i(\mathbf{r}_i) + V(|\mathbf{r}_i - \mathbf{r}_j|), \quad (5.105)$$

where the constant magnetic field \mathbf{B} is generated by a vector potential \mathbf{A} :

$$\mathbf{A} = \frac{1}{2}\mathbf{B} \times \mathbf{r}. \quad (5.106)$$

In terms of \mathbf{B} , the Lagrangian has the form (permuting dot and cross products)

$$L = \frac{1}{2}m_i v_i^2 + \frac{q\mathbf{B}}{2m} \cdot (\mathbf{r}_i \times m_i \mathbf{v}_i) + V(|\mathbf{r}_i - \mathbf{r}_j|). \quad (5.107)$$

The interaction term with the magnetic field can be variously written (cf. Eqs. (5.101) and (5.104))

$$\frac{q\mathbf{B} \cdot \mathbf{L}}{2m} = \mathbf{M} \cdot \mathbf{B} = -\boldsymbol{\omega}_l \cdot (\mathbf{r}_i \times m_i \mathbf{v}_i). \quad (5.108)$$

Suppose now we express the Lagrangian in terms of coordinates relative to “primed” axes having a common origin with the original set, but rotating uniformly about the direction of \mathbf{B} with angular velocity $\boldsymbol{\omega}_l$. Distance vectors from the origin are unchanged as of course are scalar distances such as $|\mathbf{r}_i - \mathbf{r}_j|$. However, velocities relative to the new axes differ from the original velocities by the relation

$$\mathbf{v}_i = \mathbf{v}'_i + \boldsymbol{\omega}_l \times \mathbf{r}_i.$$

The two terms in the Lagrangian affected by the transformation are

$$\begin{aligned} \frac{m_i v_i^2}{2} &= \frac{m_i v_i'^2}{2} + m_i \mathbf{v}_i' \cdot (\boldsymbol{\omega}_l \times \mathbf{r}_i) + \frac{m_i}{2} (\boldsymbol{\omega}_l \times \mathbf{r}_i) \cdot (\boldsymbol{\omega}_l \times \mathbf{r}_i), \\ -\boldsymbol{\omega}_l \cdot \mathbf{r}_i \times m_i \mathbf{v}_i &= -\boldsymbol{\omega}_l \cdot (\mathbf{r}_i \times m_i \mathbf{v}_i') - \boldsymbol{\omega}_l \cdot (\mathbf{r}_i \times m_i (\boldsymbol{\omega}_l \times \mathbf{r}_i)). \end{aligned}$$

By permuting dot and cross product, we can see that the terms linear in $\boldsymbol{\omega}_l$ and \mathbf{v}_i' are just equal and opposite and therefore cancel in the Lagrangian. A similar permutation in the terms quadratic in $\boldsymbol{\omega}_l$ show that they are of the same form and are related to the moment of inertia of the system about the axis defined by $\boldsymbol{\omega}_l$ (cf Section 5.3). The quadratic term in the Lagrangian can in fact be written as

$$-\frac{m_i}{2} (\boldsymbol{\omega}_l \times \mathbf{r}_i) \cdot (\boldsymbol{\omega}_l \times \mathbf{r}_i) = -\frac{1}{2} \boldsymbol{\omega}_l \cdot \mathbf{I} \cdot \boldsymbol{\omega}_l = -\frac{1}{2} I_l \omega_l^2, \quad (5.109)$$

where I_l denotes the moment of inertia about the axis of $\boldsymbol{\omega}_l$. In terms of coordinates in the rotating system, the Lagrangian thus has the simple form

$$L = \frac{1}{2} m_i v_i'^2 + V(|\mathbf{r}_i - \mathbf{r}_j|) - \frac{1}{2} I_l \omega_l^2. \quad (5.110)$$

from which all linear terms in the magnetic field have disappeared.

We can get an idea of the relative magnitude of the quadratic term by considering a situation in which the motion of the system consists of a rotation with some frequency ω , e.g., an electron revolving around the atomic nucleus. Then for systems not too far from spherical symmetry, the kinetic energy is approximately $\frac{1}{2} I \omega^2$ (without subscripts on the moment of inertia) and the linear term in ω_l is on the order of $\boldsymbol{\omega}_l \cdot \mathbf{L} \approx I \omega_l \omega$. Hence, the quadratic term in Eq. (5.110) is on the order of $(\omega_l/\omega)^2$ compared to the kinetic energy, and on the order of (ω_l/ω) relative to the linear term.

In most systems on the atomic or smaller scale, the natural frequencies are much larger than the Larmor frequency. Compare, for example, the frequency of a spectral line (which is a difference of natural frequencies) to the frequency shift in the simple Zeeman effect, which is proportional to the Larmor frequency. Thus, for such systems the motion in the rotating system is the same as in the laboratory system when there is no magnetic field. What we have is *Larmor's theorem*, which states that to first order in \mathbf{B} , the effect of a constant magnetic field on a classical system is to superimpose on its normal motion a uniform precession with angular frequency ω_l .

DERIVATIONS

1. If \mathbf{R}_i is an antisymmetric matrix associated with the coordinates of the i th mass point of a system, with elements $R_{mn} = \epsilon_{mnl} x_l$ show that the matrix of the inertia tensor can be written as

$$\mathbf{I} = -m_i (\mathbf{R}_i)^2.$$

2. Show directly by vector manipulation that the definition of the moment of inertia as

$$I = m_i (\mathbf{r}_i \times \mathbf{n}) \cdot (\mathbf{r}_i \times \mathbf{n})$$

reduces to Eq (5.18)

3. Prove that for a general rigid body motion about a fixed point, the time variation of the kinetic energy T is given by

$$\frac{dT}{dt} = \boldsymbol{\omega} \cdot \mathbf{N}.$$

4. Derive Euler's equations of motion, Eq (5.39'), from the Lagrange equation of motion, in the form of Eq. (1.53), for the generalized coordinate ψ .
5. Equation (5.38) holds for the motions of systems that are not rigid, relative to a chosen rotating set of coordinates. For general nonrigid motion, if the rotating axes are chosen to coincide with the (instantaneous) principal axes of the continuous system, show that Eqs. (5.39) are to be replaced by

$$\frac{d(I_i \omega_i)}{dt} + \epsilon_{ijk} \omega_j \omega_k I_k - \omega_i \frac{dI_i}{dt} = N_i, \quad i = 1, 2, 3,$$

where

$$I_i = \int dV \rho(\mathbf{r}) \epsilon_{ijk} x_j v'_k$$

with $\rho(\mathbf{r})$ the mass density at point \mathbf{r} , and \mathbf{v}' the velocity of the system point at \mathbf{r} relative to the rotating axes. These equations are sometimes known as the *Liouville equations* and have applications for discussing almost-rigid motion, such as that of Earth including the atmosphere and oceans.

6. (a) Show that the angular momentum of the torque-free symmetrical top rotates in the body coordinates about the symmetry axis with an angular frequency Ω . Show also that the symmetry axis rotates in space about the fixed direction of the angular momentum with the angular frequency

$$\dot{\phi} = \frac{I_3 \omega_3}{I_1 \cos \theta},$$

where ϕ is the Euler angle of the line of nodes with respect to the angular momentum as the space z axis.

- (b) Using the results of Exercise 15, Chapter 4, show that $\boldsymbol{\omega}$ rotates in space about the angular momentum with the same frequency $\dot{\phi}$, but that the angle θ' between $\boldsymbol{\omega}$ and \mathbf{L} is given by

$$\sin \theta' = \frac{\Omega}{\dot{\phi}} \sin \theta'',$$

where θ'' is the inclination of $\boldsymbol{\omega}$ to the symmetry axis. Using the data given in Section 5.6, show therefore that Earth's rotation axis and the axis of angular momentum are never more than 1.5 cm apart on Earth's surface.

- (c) Show from parts (a) and (b) that the motion of the force-free symmetrical top can be described in terms of the rotation of a cone fixed in the body whose axis is the symmetry axis, rolling on a fixed cone in space whose axis is along the angular momentum. The angular velocity vector is along the line of contact of the two cones. Show that the same description follows immediately from the Poinsot construction in terms of the inertia ellipsoid.
7. For the general asymmetrical rigid body, verify analytically the stability theorem shown geometrically above on p. 204 by examining the solution of Euler's equations for small deviations from rotation about each of the principal axes. The direction of $\boldsymbol{\omega}$ is assumed to differ so slightly from a principal axis that the component of $\boldsymbol{\omega}$ along the axis can be taken as constant, while the product of components perpendicular to the axis can be neglected. Discuss the boundedness of the resultant motion for each of the three principal axes.
 8. When the rigid body is not symmetrical, an analytic solution to Euler's equation for the torque-free motion cannot be given in terms of elementary functions. Show, however, that the conservation of energy and angular momentum can be used to obtain expressions for the body components of $\boldsymbol{\omega}$ in terms of elliptic integrals.
 9. Apply Euler's equations to the problem of the heavy symmetrical top, expressing ω_i in terms of the Euler angles. Show that the two integrals of motion, Eqs. (5.53) and (5.54), can be obtained directly from Euler's equations in this form.
 10. Obtain from Euler's equations of motion the condition (5.77) for the uniform precession of a symmetrical top in a gravitational field, by imposing the requirement that the motion be a uniform precession without nutation.
 11. Show that the magnitude of the angular momentum for a heavy symmetrical top can be expressed as a function of θ and the constants of the motion only. Prove that as a result the angular momentum vector precesses uniformly only when there is uniform precession of the symmetry axis.
 12. (a) Consider a primed set of axes coincident in origin with an inertial set of axes but rotating with respect to the inertial frame with fixed angular velocity $\boldsymbol{\omega}_0$. If a system of mass points is subject to forces derived from a conservative potential V depending only on the distance to the origin, show that the Lagrangian for the system in terms of coordinates relative to the primed set can be written as

$$L = T' + \boldsymbol{\omega}_0 \cdot \mathbf{L}' + \frac{1}{2} \boldsymbol{\omega}_0 \cdot \mathbf{I}' \cdot \boldsymbol{\omega}_0 - V,$$

where primes indicate the quantities evaluated relative to the primed set of axes. What is the physical significance of each of the two additional terms?

- (b) suppose that $\boldsymbol{\omega}_0$ is in the $x'_2x'_3$ plane, and that a symmetric top is constrained to move with its figure axis in the $x'_2x'_1$ plane, so that only two Euler angles are needed to describe its orientation. If the body is mounted so that the center of mass is fixed at the origin and $V = 0$, show that the figure axis of the body oscillates about the x'_3 axis according to the plane-pendulum equation of motion and find the frequency of small oscillations. This illustrates the principle of the gyro compass.

EXERCISES

13. Two thin rods each of mass m and length l are connected to an ideal (no friction) hinge and a horizontal thread. The system rests on a smooth surface as shown in the figure. At time $t = 0$, the thread is cut. Neglecting the mass of the hinge and the thread, and considering only motion in the xy plane
- (a) Find the speed at which the hinge hits the floor.
- (b) Find the time it takes for the hinge to hit the floor.

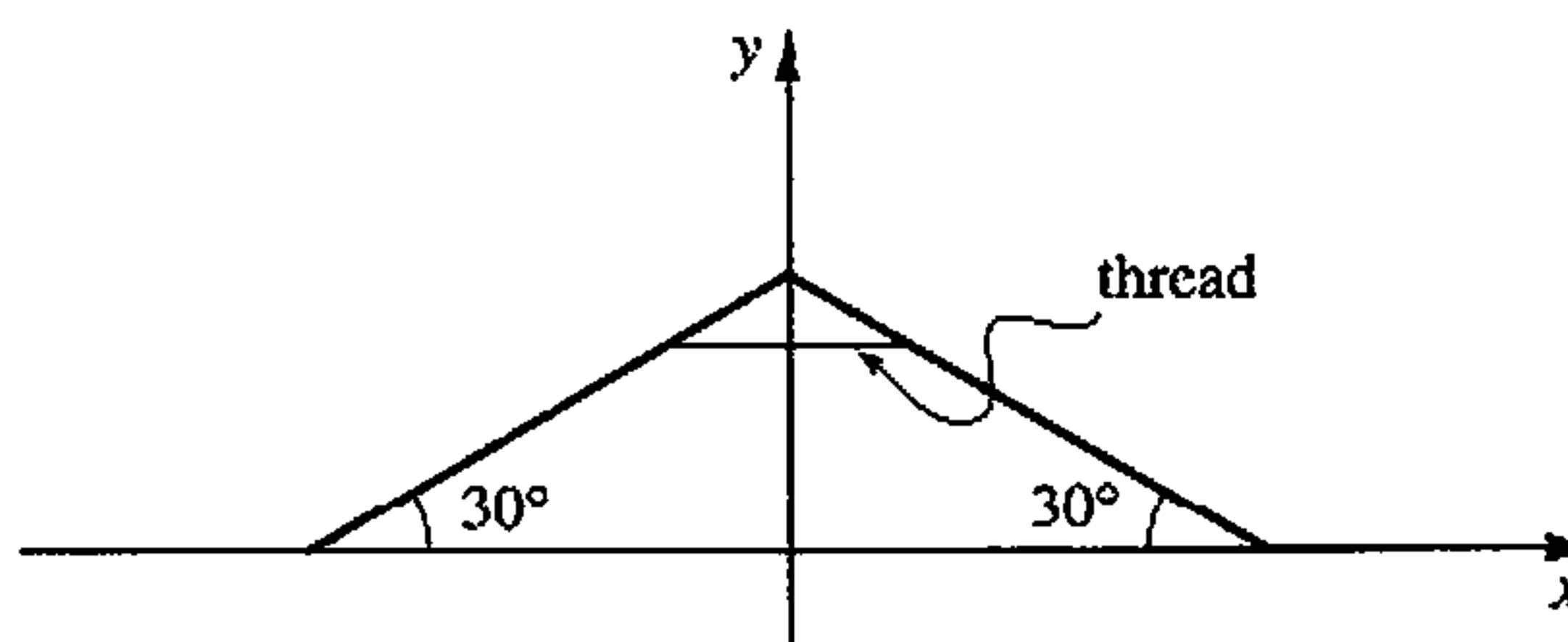

14. What is the height-to-diameter ratio of a right cylinder such that the inertia ellipsoid at the center of the cylinder is a sphere?
15. Find the principal moments of inertia about the center of mass of a flat rigid body in the shape of a 45° right triangle with uniform mass density. What are the principal axes?
16. Three equal mass points are located at $(a, 0, 0)$, $(0, a, 2a)$, $(0, 2a, a)$. Find the principal moments of inertia about the origin and a set of principal axes.
17. A uniform right circular cone of height h , half-angle α , and density ρ rolls on its side without slipping on a uniform horizontal plane in such a manner that it returns to its original position in a time τ . Find expressions for the kinetic energy and the components of the angular momentum of the cone.
18. (a) A bar of negligible weight and length l has equal mass points m at the two ends. The bar is made to rotate uniformly about an axis passing through the center of the bar and making an angle θ with the bar. From Euler's equations find the components along the principal axes of the bar of the torque driving the bar.
- (b) From the fundamental torque equation (1.26) find the components of the torque along axes fixed in space. Show that these components are consistent with those found in part (a).
19. A uniform bar of mass M and length $2l$ is suspended from one end by a spring of force constant k . The bar can swing freely only in one vertical plane, and the spring is constrained to move only in the vertical direction. Set up the equations of motion in the Lagrangian formulation.

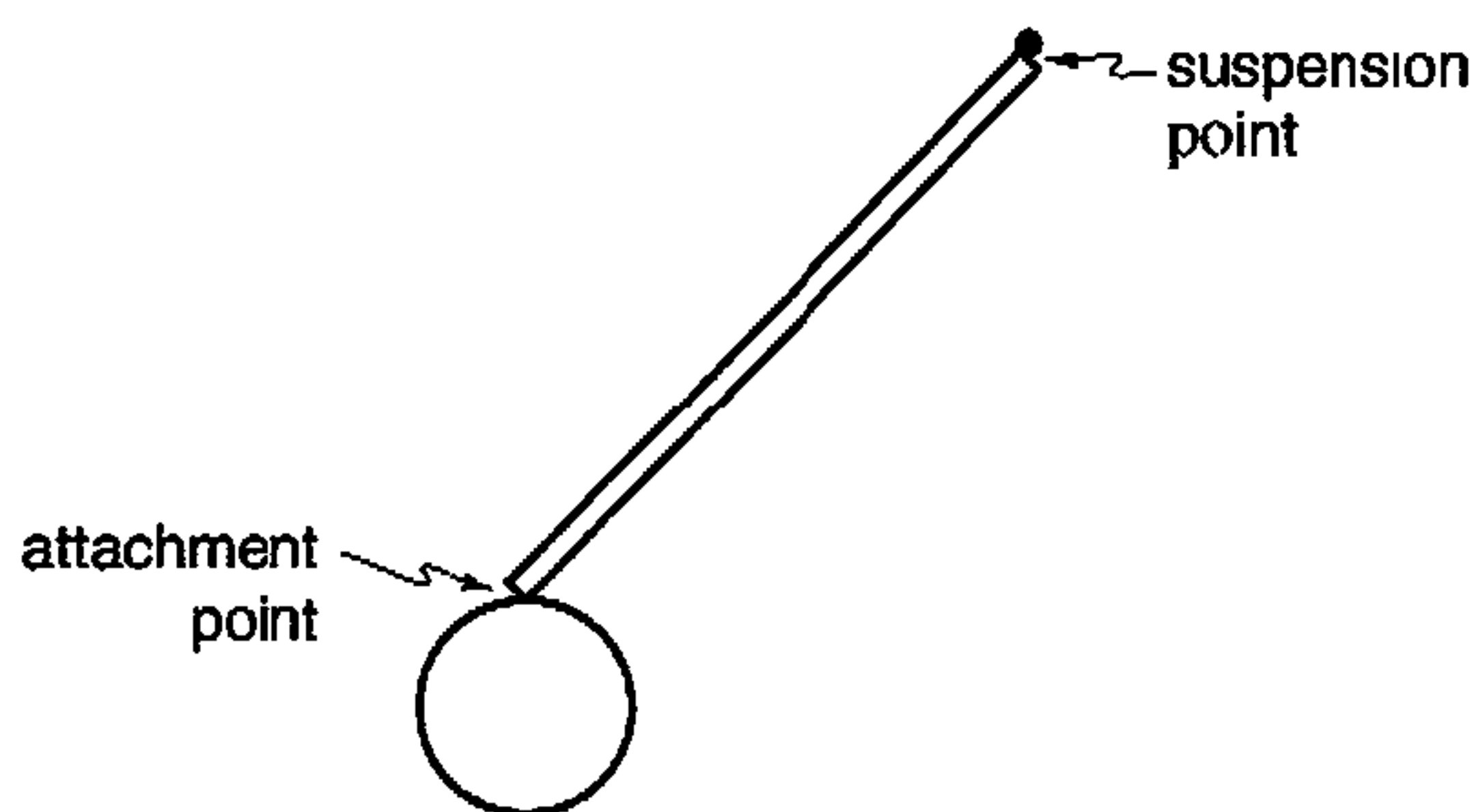

20. A plane pendulum consists of a uniform rod of length l and negligible thickness with mass m , suspended in a vertical plane by one end. At the other end a uniform disk of radius a and mass M is attached so it can rotate freely in its own plane, which is the vertical plane. Set up the equations of motion in the Lagrangian formulation.
21. A compound pendulum consists of a rigid body in the shape of a lamina suspended in the vertical plane at a point other than the center of gravity. Compute the period for small oscillations in terms of the radius of gyration about the center of gravity and the separation of the point of suspension from the center of gravity. Show that if the pendulum has the same period for two points of suspension at unequal distances from the center of gravity, then the sum of these distances is equal to the length of the equivalent simple pendulum.
22. A uniform rod slides with its ends inside a smooth vertical circle. If the rod subtends an angle of 120° at the center of the circle, show that the equivalent simple pendulum has a length equal to the radius of the circle.
23. An automobile is started from rest with one of its doors initially at right angles. If the hinges of the door are toward the front of the car, the door will slam shut as the automobile picks up speed. Obtain a formula for the time needed for the door to close if the acceleration f is constant, the radius of gyration of the door about the axis of rotation is r_0 , and the center of mass is at a distance a from the hinges. Show that if f is 0.3 m/s^2 and the door is a uniform rectangle 1.2 m wide, the time will be approximately 3.04 s.
24. A wheel rolls down a flat inclined surface that makes an angle α with the horizontal. The wheel is constrained so that its plane is always perpendicular to the inclined plane, but it may rotate about the axis normal to the surface. Obtain the solution for the two-dimensional motion of the wheel, using Lagrange's equations and the method of undetermined multipliers.
25. (a) Express in terms of Euler's angles the constraint conditions for a uniform sphere rolling without slipping on a flat horizontal surface. Show that they are nonholonomic.
 (b) Set up the Lagrangian equations for this problem by the method of Lagrange multipliers. Show that the translational and rotational parts of the kinetic energy are separately conserved. Are there any other constants of motion?
26. For the axially symmetric body precessing uniformly in the absence of torques, find analytical solutions for the Euler angles as a function of time.

27. In Section 5.6, the precession of Earth's axis of rotation about the pole was calculated on the basis that there were no torques acting on Earth. Section 5.8, on the other hand, showed that Earth is undergoing a forced precession due to the torques of the Sun and Moon. Actually both results are valid: The motion of the axis of rotation about the symmetry axis appears as the nutation of the Earth in the course of its forced precession. To prove this statement, calculate θ and $\dot{\phi}$ as a function of time for a heavy symmetrical top that is given an initial velocity $\dot{\phi}_0$, which is large compared with the net precession velocity $\beta/2a$, but which is small compared with ω_3 . Under these conditions, the bounding circles for the figure axis still lie close together, but the orbit of the figure axis appears as in Fig. 5.9(b), that is, shows large loops that move only slowly around the vertical. Show for this case that (5.71) remains valid but now

$$x_1 = \left(\frac{\beta}{a^2} - \frac{2\dot{\phi}_0}{a} \right) \sin^2 \theta_0.$$

From these values of θ and $\dot{\phi}$, obtain ω_1 and ω_2 , and show that for $\beta/2a$ small compared with $\dot{\phi}_0$, the vector $\boldsymbol{\omega}$ precesses around the figure axis with an angular velocity

$$\Omega = \frac{I_3 - I_1}{I_1} \omega_3$$

in agreement with Eq. (5.49). Verify from the numbers given in Section 5.6 that $\dot{\phi}_0$ corresponds to a period of about 1600 years, so that $\dot{\phi}_0$ is certainly small compared with the daily rotation and is sufficiently large compared with $\beta/2a$, which corresponds to the precession period of 26,000 years.

28. Suppose that in a symmetrical top each element of mass has a proportionate charge associated with it, so that the e/m ratio is constant—the so-called charged symmetric top. If such a body rotates in a uniform magnetic field the Lagrangian, from (5.108), is

$$L = T - \boldsymbol{\omega}_l \cdot \mathbf{L}.$$

Show that T is a constant (which is a manifestation of the property of the Lorentz force that a magnetic field does no work on a moving charge) and find the other constants of motion. Under the assumption that $\boldsymbol{\omega}_l$ is much smaller than the initial rotational velocity about the figure axis, obtain expressions for the frequencies and amplitudes of nutation and precession. From where do the kinetic energies of nutation and precession come?

29. A homogeneous cube of sides l is initially at rest in unstable equilibrium with one edge in contact with a horizontal plane. The cube is given a small angular displacement and allowed to fall. What is the angular velocity of the cube when one face contacts the plane if:
- the edge in contact with the plane cannot slide?
 - the plane is frictionless so the edge can slide?
30. A door is constructed of a thin homogeneous material. It has a height of 2 m and a width of 0.9 m. If the door is opened by 90° and released from rest, it is observed that the door closes itself in 3 s. Assuming that the hinges are frictionless, what angle do these hinges make with the vertical?

CHAPTER 6

Oscillations

A class of mechanical motions that can best be treated in the Lagrangian formulation is that of the oscillations of a system about positions of equilibrium. The theory of small oscillations finds widespread physical applications in acoustics, molecular spectra, vibrations of mechanisms, and coupled electrical circuits. If the deviations of the system from stable equilibrium conditions are small enough, the motion can generally be described as that of a system of coupled linear harmonic oscillators. It will be assumed the reader is familiar with the properties of a simple harmonic oscillator of one degree of freedom, both in free and forced oscillation, with and without damping. Here the emphasis will be on methods appropriate to discrete systems with more than one degree of freedom. As will be seen, the mathematical techniques required turn out to be very similar to those employed in studying rigid body motion, although the mechanical systems considered need not involve rigid bodies at all. Analogous treatments of oscillations about stable motions can also be developed, but these are most easily done in the Hamiltonian formulation presented in Chapter 8.

6.1 ■ FORMULATION OF THE PROBLEM

We consider conservative systems in which the potential energy is a function of position only. It will be assumed that the transformation equations defining the generalized coordinates of the system, q_1, \dots, q_n , do not involve the time explicitly. Thus, time-dependent constraints are to be excluded. The system is said to be in *equilibrium* when the generalized forces acting on the system vanish:

$$Q_i = - \left(\frac{\partial V}{\partial q_i} \right)_0 = 0. \quad (6.1)$$

The potential energy therefore has an extremum at the equilibrium configuration of the system, $q_{01}, q_{02}, \dots, q_{0n}$. If the configuration is initially at the equilibrium position, with zero initial velocities \dot{q}_n , then the system will continue in equilibrium indefinitely. Examples of the equilibrium of mechanical systems are legion—a pendulum at rest, a suspension galvanometer at its zero position, an egg standing on end.

An equilibrium position is classified as *stable* if a small disturbance of the system from equilibrium results only in small bounded motion about the rest po-

sition. The equilibrium is *unstable* if an infinitesimal disturbance eventually produces unbounded motion. A pendulum at rest is in stable equilibrium, but the egg standing on end is an obvious illustration of unstable equilibrium. It can be readily seen that when the extremum of V is a minimum the equilibrium must be stable. Suppose the system is disturbed from the equilibrium by an increase in energy dE above the equilibrium energy. If V is a minimum at equilibrium, any deviation from this position will produce an increase in V . By the conservation of energy, the velocities must then decrease and eventually come to zero, indicating bound motion. On the other hand, if V decreases as the result of some departure from equilibrium, the kinetic energy and the velocities increase indefinitely, corresponding to unstable motion. The same conclusion may be arrived at graphically by examining the shape of the potential energy curve, as shown symbolically in Fig. 6.1. A more rigorous mathematical proof that stable equilibrium requires a minimum in V will be given in the course of the discussion.

We shall be interested in the motion of the system within the immediate neighborhood of a configuration of stable equilibrium. Since the departures from equilibrium are too small, all functions may be expanded in a Taylor series about the equilibrium, retaining only the lowest-order terms. The deviations of the generalized coordinates from equilibrium will be denoted by η_i :

$$q_i = q_{0i} + \eta_i, \quad (6.2)$$

and these may be taken as the new generalized coordinates of the motion. Expanding the potential energy about q_{0i} , we obtain

$$V(q_1, \dots, q_n) = V(q_{01}, \dots, q_{0n}) + \left(\frac{\partial V}{\partial q_i} \right)_0 \eta_i + \frac{1}{2} \left(\frac{\partial^2 V}{\partial q_i \partial q_j} \right)_0 \eta_i \eta_j + \dots, \quad (6.3)$$

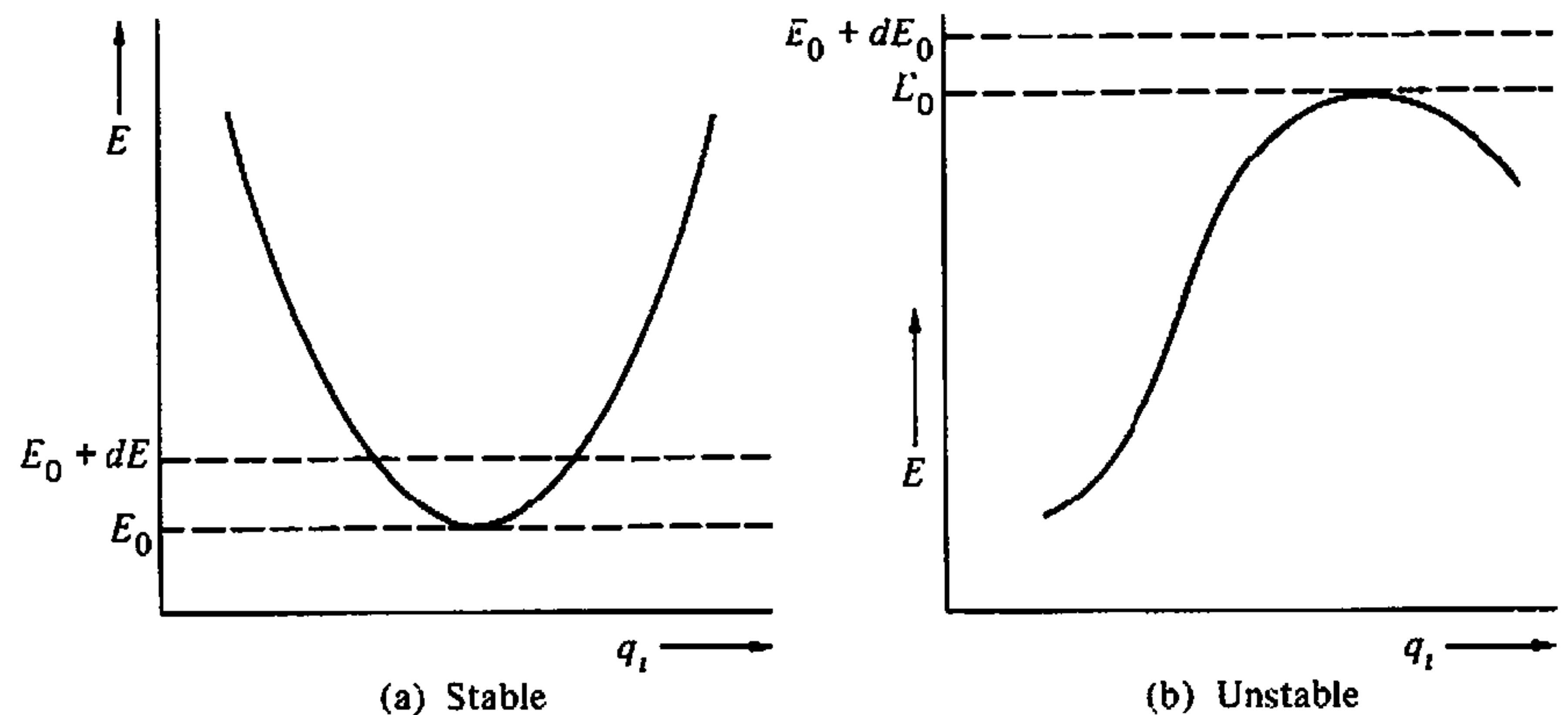

FIGURE 6.1 Shape of the potential energy curve at equilibrium.

where the summation convention has been invoked, as usual. The terms linear in η_i vanish automatically in consequence of the equilibrium conditions (6.1). The first term in the series is the potential energy of the equilibrium position, and by shifting the arbitrary zero of potential to coincide with the equilibrium potential, this term may also be made to vanish. We are therefore left with the quadratic terms as the first approximation to V :

$$V = \frac{1}{2} \left(\frac{\partial^2 V}{\partial q_i \partial q_j} \right)_0 \eta_i \eta_j = \frac{1}{2} V_{ij} \eta_i \eta_j, \quad (6.4)$$

where the second derivatives of V have been designated by the constants V_{ij} depending only upon the equilibrium values of the q_i 's. It is obvious from their definition that the V_{ij} 's are symmetrical, that is, that $V_{ij} = V_{ji}$. The V_{ij} coefficients can vanish under a variety of circumstances. Thus, the potential can simply be independent of a particular coordinate, so that equilibrium occurs at any arbitrary value of that coordinate. We speak of such cases as *neutral* or *indifferent* equilibrium. It may also happen, for example, that the potential behaves like a quadratic at that point, again causing one or more of the V_{ij} 's to vanish. Either situation calls for special treatment in the mathematical discussion that follows.

A similar series expansion can be obtained for the kinetic energy. Since the generalized coordinates do not involve the time explicitly, the kinetic energy is a homogeneous quadratic function of the velocities (cf. Eq. (1.71)):

$$T = \frac{1}{2} m_{ij} \dot{q}_i \dot{q}_j = \frac{1}{2} m_{ij} \dot{\eta}_i \dot{\eta}_j. \quad (6.5)$$

The coefficients m_{ij} are in general functions of the coordinates q_k , but they may be expanded in a Taylor series about the equilibrium configuration:

$$m_{ij}(q_1, \dots, q_n) = m_{ij}(q_{01}, \dots, q_{0n}) + \left(\frac{\partial m_{ij}}{\partial q_k} \right)_0 \eta_k + \dots$$

As Eq (6.5) is already quadratic in the $\dot{\eta}_i$'s, the lowest nonvanishing approximation to T is obtained by dropping all but the first term in the expansions of m_{ij} . Denoting the constant values of the m_{ij} functions at equilibrium by T_{ij} , we can therefore write the kinetic energy as

$$T = \frac{1}{2} T_{ij} \dot{\eta}_i \dot{\eta}_j. \quad (6.6)$$

It is again obvious that the constants T_{ij} must be symmetric, since the individual terms in Eq. (6.6) are unaffected by an interchange of indices. From Eqs. (6.4) and (6.6), the Lagrangian is given by

$$L = \frac{1}{2} (T_{ij} \dot{\eta}_i \dot{\eta}_j - V_{ij} \eta_i \eta_j). \quad (6.7)$$

Taking the η 's as the general coordinates, the Lagrangian of Eq. (6.7) leads to the following n equations of motion:

$$T_{ij} \ddot{\eta}_{ij} + V_{ij} \eta_j = 0. \quad (6.8)$$

where explicit use has been made of the symmetry property of the V_{ij} and T_{ij} coefficients. Each of Eqs. (6.8) will involve, in general, all of the coordinates η_i , and it is this set of simultaneous differential equations that must be solved to obtain the motion near the equilibrium.

In almost all cases of interest, the kinetic energy term can be easily written so as to have no cross terms.* This corresponds to the Lagrangian

$$L = \frac{1}{2}(T_i \dot{\eta}_i^2 - V_{ij} \eta_i \eta_j), \quad (6.9)$$

which generates the following equations of motion

$$T_i \ddot{\eta}_i + V_{ij} \eta_j = 0. \quad (\text{no sum over } i) \quad (6.10)$$

6.2 ■ THE EIGENVALUE EQUATION AND THE PRINCIPAL AXIS TRANSFORMATION

The equations of motion (6.8) are linear differential equations with constant coefficients, of a form familiar from electrical circuit theory. We are therefore led to try an oscillatory solution of the form

$$\eta_i = C a_i e^{i\omega t}. \quad (6.11)$$

Here $C a_i$ gives the complex amplitude of the oscillation for each coordinate η_i , the factor C being introduced for convenience as a scale factor, the same for all coordinates. It is understood of course that it is the real part of Eq. (6.9) that is to correspond to the actual motion. Substitution of the trial solution (6.9) into the equations of motion leads to the following equations for the amplitude factors:

$$(V_{ij} a_j - \omega^2 T_{ij} a_j) = 0. \quad (6.12)$$

Equations (6.12) constitute n linear homogeneous equations for the a_i 's, and consequently can have a nontrivial solution only if the determinant of the coefficients vanishes:

*Mathematically, we could go even further when the coordinates are Cartesian and making the $T_{ij} = \delta_{ij}$ by rescaling the coordinates. Such coordinates are called *mass-weighted coordinates* since they are generated by dividing the coordinates by the square root of the mass. This transforms the kinetic energy to the form

$$T = \frac{\dot{\eta}_i \dot{\eta}_i}{2}.$$

This reduces the problem to the eigenvalue problem of Chapters 4 and 5, only in n dimensions instead of three, however, the mathematical simplification can obscure the physics, since each coordinate can have a different characteristic scale

$$\begin{vmatrix} V_{11} - \omega^2 T_{11} & V_{12} - \omega^2 T_{12} & \dots \\ V_{21} - \omega^2 T_{21} & V_{22} - \omega^2 T_{22} & \\ V_{31} - \omega^2 T_{31} & & \\ \vdots & & \end{vmatrix} = 0. \quad (6.13)$$

This determinantal condition is in effect an algebraic equation of the n th degree for ω^2 , and the roots of the determinant provide the frequencies for which Eq. (6.11) represents a correct solution to the equations of motion. For each of these values of ω^2 , Eqs. (6.12) may be solved for the amplitudes of a_i , or more precisely, for $n - 1$ of the amplitudes in terms of the remaining a_i .

Equations (6.12) represent a type of eigenvalue equation, for writing T_{ij} as an element of the matrix \mathbf{T} , the equations may be written

$$\mathbf{V}\mathbf{a} = \lambda\mathbf{T}\mathbf{a}. \quad (6.14)$$

Here the effect of \mathbf{V} on the eigenvector \mathbf{a} is not merely to reproduce the vector times the factor λ , as in the ordinary eigenvalue problem. Instead, the eigenvector is such that \mathbf{V} acting on \mathbf{a} produces a multiple of the result of \mathbf{T} acting on \mathbf{a} . We shall show that the eigenvalues λ for which Eq. (6.14) can be satisfied are all real in consequence of the symmetric and reality properties of \mathbf{T} and \mathbf{V} , and, in fact, must be positive. It will also be shown that the eigenvectors \mathbf{a} are orthogonal—in a sense. In addition, the matrix of the eigenvectors, \mathbf{A} , diagonalizes *both* \mathbf{T} and \mathbf{V} , the former to the unit matrix $\mathbf{1}$ and the latter to a matrix whose diagonal elements are the eigenvalues λ . Most importantly it is necessary to show that \mathbf{a} and λ are real.

Proceeding as in Section 5.4, let \mathbf{a}_k be a column matrix representing the k th eigenvector, satisfying the eigenvalue equation*

$$\mathbf{V}\mathbf{a}_k = \lambda_k\mathbf{T}\mathbf{a}_k. \quad (6.15)$$

Assume now that the only solution to Eq. (6.15) involves complex λ and \mathbf{a}_k . The adjoint equation, i.e., the transposed complex conjugate equation, for λ_l has the form

$$\mathbf{a}_l^\dagger\mathbf{V} = \lambda_l^*\mathbf{a}_l^\dagger\mathbf{T}. \quad (6.16)$$

Here \mathbf{a}_l^\dagger stands for the adjoint vector—the complex conjugate row matrix—and explicit use has been made of the fact that the \mathbf{V} and \mathbf{T} matrices are real and symmetric. Multiply Eq. (6.16) from the right by \mathbf{a}_k and subtract the result of the similar product of Eq. (6.15) from the left with \mathbf{a}_l^\dagger . The left-hand side of the difference equation vanishes, leaving only

$$0 = (\lambda_k - \lambda_l^*)\mathbf{a}_l^\dagger\mathbf{T}\mathbf{a}_k. \quad (6.17)$$

*It hardly need be added that there is *no* summation over k in Eq. (6.15). Indeed, in this chapter the summation convention will apply only to the components of matrices or tensors (of any rank) and *not* to the matrices and tensors themselves.

When $l = k$, Eq. (6.17) becomes

$$(\lambda_k - \lambda_k^*) \mathbf{a}_k^\dagger \mathbf{T} \mathbf{a}_k = 0. \quad (6.18)$$

That the matrix product in Eq. (6.18) is real can be shown immediately by taking its complex conjugate and using the symmetry property of \mathbf{T} . However, we want to prove that the matrix product is not only real but is positive definite. For this purpose, separate \mathbf{a}_k into its real and imaginary components.

$$\mathbf{a}_k = \boldsymbol{\alpha}_k + i \boldsymbol{\beta}_k.$$

The matrix product can then be written as

$$\mathbf{a}_k^\dagger \mathbf{T} \mathbf{a}_k = \tilde{\boldsymbol{\alpha}}_k \mathbf{T} \boldsymbol{\alpha}_k + \tilde{\boldsymbol{\beta}}_k \mathbf{T} \boldsymbol{\beta}_k + i(\tilde{\boldsymbol{\alpha}}_k \mathbf{T} \boldsymbol{\beta}_k - \tilde{\boldsymbol{\beta}}_k \mathbf{T} \boldsymbol{\alpha}_k). \quad (6.19)$$

The imaginary term vanishes by virtue of the symmetry of \mathbf{T} and therefore, as noted earlier, the matrix product is real. Further, the kinetic energy in Eq. (6.6) can be rewritten in terms of a column matrix $\dot{\boldsymbol{\eta}}$ as

$$T = \frac{1}{2} \dot{\boldsymbol{\eta}}^\dagger \mathbf{T} \dot{\boldsymbol{\eta}}. \quad (6.20)$$

Hence, the first two terms in Eq. (6.18) are twice the kinetic energies when the velocity matrix $\dot{\boldsymbol{\eta}}_k$ has the values $\boldsymbol{\alpha}_k$ and $\boldsymbol{\beta}_k$, respectively. Now, a kinetic energy by its physical nature must be positive definite for real velocities, and therefore the matrix product in Eq. (6.18) cannot be zero. It follows that the eigenvalues λ_k must be real.

Since the eigenvalues are real, the ratios of the eigenvector components a_{jk} determined by Eqs. (6.15) must all be real. There is still some indeterminateness of course since the value of a particular one of the a_{jk} 's can still be chosen at will without violating Eqs. (6.15). We can require however that this component shall be real, and the reality of λ_k then ensures the reality of all the other components. (Any complex phase factor in the amplitude of the oscillation will be thrown into the factor C , Eq. (6.11).) Multiply now Eq. (6.15) by $\tilde{\mathbf{a}}_k$ from the left and solve for λ_k :

$$\lambda_k = \frac{\tilde{\mathbf{a}}_k \mathbf{V} \mathbf{a}_k}{\tilde{\mathbf{a}}_k \mathbf{T} \mathbf{a}_k}. \quad (6.21)$$

The denominator of this expression is equal to twice the kinetic energy for velocities a_{ik} and since the eigenvectors are all real, the sum must be positive definite. Similarly, the numerator is the potential energy for coordinates a_{ik} , and the condition that V be a minimum at equilibrium requires that the sum must be positive or zero. Neither numerator nor denominator can be negative, and the denominator cannot be zero, hence λ is always finite and positive. (It may however be zero.) Recall that λ stands for ω^2 , so that positive λ corresponds to real frequencies of oscillation. Were the potential not a local minimum, the numerator in Eq. (6.21)

might be negative, giving rise to imaginary frequencies that would produce an unbounded exponential increase of the η_i with time. Such motion would obviously be unstable, and we have here the promised mathematical proof that a minimum of the potential is required for stable motion.

Let us return for the moment to Eq. (6.17) which, in view of the reality of the eigenvalues and eigenvectors, can be written

$$(\lambda_k - \lambda_l)\tilde{\mathbf{a}}_l \mathbf{T} \mathbf{a}_k = 0. \quad (6.17')$$

If all the roots of the secular equation are distinct, then Eq. (6.17') can hold only if the matrix product vanishes for l not equal to k :

$$\tilde{\mathbf{a}}_l \mathbf{T} \mathbf{a}_k = 0, \quad l \neq k. \quad (6.22a)$$

It has been remarked several times that the values of the a_{jk} 's are not completely fixed by the eigenvalue equations (6.12). We can remove this indeterminacy by requiring further that

$$\tilde{\mathbf{a}}_k \mathbf{T} \mathbf{a}_k = 1. \quad (6.22b)$$

There are n such equations (6.22), and they uniquely fix the one arbitrary component of each of the n eigenvectors \mathbf{a}_k .* If we form all the eigenvectors \mathbf{a}_k into a square matrix \mathbf{A} with components a_{jk} (cf. Section 4.6), then the two equations (6.22a and b) can be combined into one matrix equation:

$$\tilde{\mathbf{A}} \mathbf{T} \mathbf{A} = \mathbf{1}. \quad (6.23)$$

When two or more of the roots are repeated, the argument leading to Eq. (6.22a) falls through for $\lambda_l = \lambda_k$. We shall reserve a discussion of this exceptional case of *degeneracy* for a later time. For the present, suffice it to state that a set of a_{jk} coefficients can always be found that satisfies both the eigenvalue conditions Eqs. (6.10), and Eq. (6.22a), so that Eq. (6.23) always holds.

In Chapter 4, the *similarity* transformation of a matrix \mathbf{C} by a matrix \mathbf{B} was defined by the equation (cf. Eq. (4.41):

$$\mathbf{C}' = \mathbf{B} \mathbf{C} \mathbf{B}^{-1}.$$

*Equation (6.22b) may be put in a form that explicitly shows that it suffices to remove the indeterminacy in the a_{jk} 's. Suppose it is the magnitude of a_{1k} that is to be evaluated; the ratio of all the other a_{jk} 's to a_{1k} is obtained from Eqs. (6.12). Then Eq. (6.22b) can be written as

$$\sum_{i,j} T_{ij} \frac{a_{ik}}{a_{1k}} \frac{a_{jk}}{a_{1k}} = \frac{1}{a_{1k}^2}.$$

The left-hand side is completely determined from the eigenvalue equations and may be evaluated directly to provide a_{1k} .

We now introduce the related concept of the *congruence* transformation of \mathbf{C} by \mathbf{A} according to the relation

$$\mathbf{C}' = \tilde{\mathbf{A}}\mathbf{C}\mathbf{A}. \quad (6.24)$$

If \mathbf{A} is orthogonal, so that $\tilde{\mathbf{A}} = \mathbf{A}^{-1}$, there is no essential difference between the two types of transformation (as may be seen by denoting \mathbf{A}^{-1} by the matrix \mathbf{B}). Equation (6.23) can therefore be read as the statement that \mathbf{A} transforms \mathbf{T} by a congruence transformation into a diagonal matrix, in particular into the unit matrix.

If a diagonal matrix $\boldsymbol{\lambda}$ with elements $\lambda_{ik} = \lambda_k \delta_{ik}$ is introduced, the eigenvalue equations (6.15) may be written

$$V_{ij}a_{jk} = T_{ij}a_{jl}\lambda_{lk},$$

which becomes in matrix notation

$$\mathbf{V}\mathbf{A} = \mathbf{T}\mathbf{A}\boldsymbol{\lambda}. \quad (6.25)$$

Multiplying by $\tilde{\mathbf{A}}$ from the left, Eq. (6.25) takes the form

$$\tilde{\mathbf{A}}\mathbf{V}\mathbf{A} = \tilde{\mathbf{A}}\mathbf{T}\mathbf{A}\boldsymbol{\lambda},$$

which by Eq. (6.23) reduces to

$$\tilde{\mathbf{A}}\mathbf{V}\mathbf{A} = \boldsymbol{\lambda}. \quad (6.26)$$

Our final equation (6.26) states that a congruence transformation of \mathbf{V} by \mathbf{A} changes it into a diagonal matrix whose elements are the eigenvalues λ_k . Eq. (6.26) has solutions

$$|\mathbf{V} - \boldsymbol{\lambda}\mathbf{1}| = 0. \quad (6.26')$$

In summary we can use normalized Cartesian coordinates so that $T_{ij} = \delta_{ij}$ which reduces the physics to solving

$$\tilde{\mathbf{A}}\mathbf{A} = \mathbf{1} \quad (4.36) \quad \text{and} \quad \tilde{\mathbf{A}}\mathbf{V}\mathbf{A} = \mathbf{V}_{\text{diagonal}} \quad (6.26),$$

or we may choose more general coordinates where $T_{ij} \neq \delta_{ij}$, even allowing $T_{ij} = T_{ji} \neq 0$ for $i \neq j$, and use

$$\tilde{\mathbf{A}}\mathbf{T}\mathbf{A} = \mathbf{1} \quad (6.23) \quad \text{and} \quad \tilde{\mathbf{A}}\mathbf{V}\mathbf{A} = \mathbf{V}_{\text{diagonal}} \quad (6.26),$$

to solve the general problem.

As an example, we consider a particle of mass m with two degrees of freedom (x_1, x_2) that obeys the Lagrangian (cf. Eq. (6.9))

$$L = \frac{1}{2}m(\dot{x}_1^2 + \dot{x}_2^2) - \frac{1}{2}V_{ij}x_ix_j$$

where the V_{ij} are constants. The congruence transformation (6.26) has solutions only when Eq. (6.26') is satisfied, so

$$\begin{vmatrix} V_{11} - \lambda & V_{12} \\ V_{21} & V_{22} - \lambda \end{vmatrix} = 0$$

This equation has two solutions:

$$\begin{aligned} \lambda_1 &= \frac{1}{2} \left(V_{11} + V_{22} + \sqrt{(V_{11} - V_{22})^2 + 4V_{12}V_{21}} \right) \\ \lambda_2 &= \frac{1}{2} \left(V_{11} + V_{22} - \sqrt{(V_{11} - V_{22})^2 + 4V_{12}V_{21}} \right). \end{aligned}$$

Associated with the eigenvalues λ_i are the eigenvectors a_i , that satisfy

$$a_{ij}(V_{ij} - \lambda_i \delta_{ij}) = 0 \quad \text{and} \quad a_{i1}^2 + a_{i2}^2 = 1 \quad (\text{no sum on } i)$$

We consider two limiting cases. The first case assumes $V_{11} > V_{22} > 0$ and $0 \neq V_{21} = V_{12} \ll (V_{11} - V_{22})$. We write the small quantity $\delta = [V_{12}/(V_{11} - V_{22})]$ then, to first order in δ , the eigenvalues are

$$\begin{aligned} \lambda_1 &= V_{11} + V_{12}\delta \\ \lambda_2 &= V_{22} - V_{12}\delta \end{aligned} \tag{6.27}$$

whose eigenvectors are, to lowest order in δ ,

$$\mathbf{a} = \begin{bmatrix} a_{11} & a_{21} \\ a_{12} & a_{22} \end{bmatrix} = \begin{bmatrix} 1 - \frac{\delta^2}{2} & -\delta + \frac{\delta^3}{2} \\ \delta - \frac{\delta^3}{2} & 1 - \frac{\delta^2}{2} \end{bmatrix}. \tag{6.28}$$

These correspond to the relations

$$a_{11} = a_{22} \quad \text{and} \quad a_{12} = -a_{21}.$$

The other limiting case assumes $V_{12} > V_{22} > 0$ and $(V_{11} - V_{22}) \ll V_{12} = V_{21}$. We now write $\varepsilon = (V_{11} - V_{22})/8V_{12}$, which is a small quantity. To first order in ε the eigenvalues are

$$\begin{aligned} \lambda_1 &= \frac{1}{2}(V_{11} + V_{22}) + V_{12} + (V_{11} - V_{22})\varepsilon \\ \lambda_2 &= \frac{1}{2}(V_{11} + V_{22}) - V_{12} - (V_{11} - V_{22})\varepsilon \end{aligned} \tag{6.29}$$

whose eigenvectors are, to lowest order in ε ,

$$\mathbf{a} = \begin{bmatrix} a_{11} & a_{21} \\ a_{12} & a_{22} \end{bmatrix} = \begin{bmatrix} \frac{1}{\sqrt{2}}(1 + 2\varepsilon) & -\frac{1}{\sqrt{2}}(1 - 2\varepsilon) \\ \frac{1}{\sqrt{2}}(1 - 2\varepsilon) & \frac{1}{\sqrt{2}}(1 + 2\varepsilon) \end{bmatrix}. \tag{6.30}$$

The relations among the components of the eigenvectors are different than in the previous example. Here $a_{12} = -a_{21}$ is slightly less than $1/\sqrt{2}$ while $a_{11} = a_{22}$ is slightly greater than $1/\sqrt{2}$.

The preceding approximations looked at the behavior of the eigenvalues and eigenvectors in limiting cases. The qualitative changes in these quantities as a function of $V_{12}/(V_{11} - V_{22})$ from zero to three are shown in Fig. 6.2. We shall return to this example after considering the general problem of multiple roots of the eigenvalue equation (6.26').

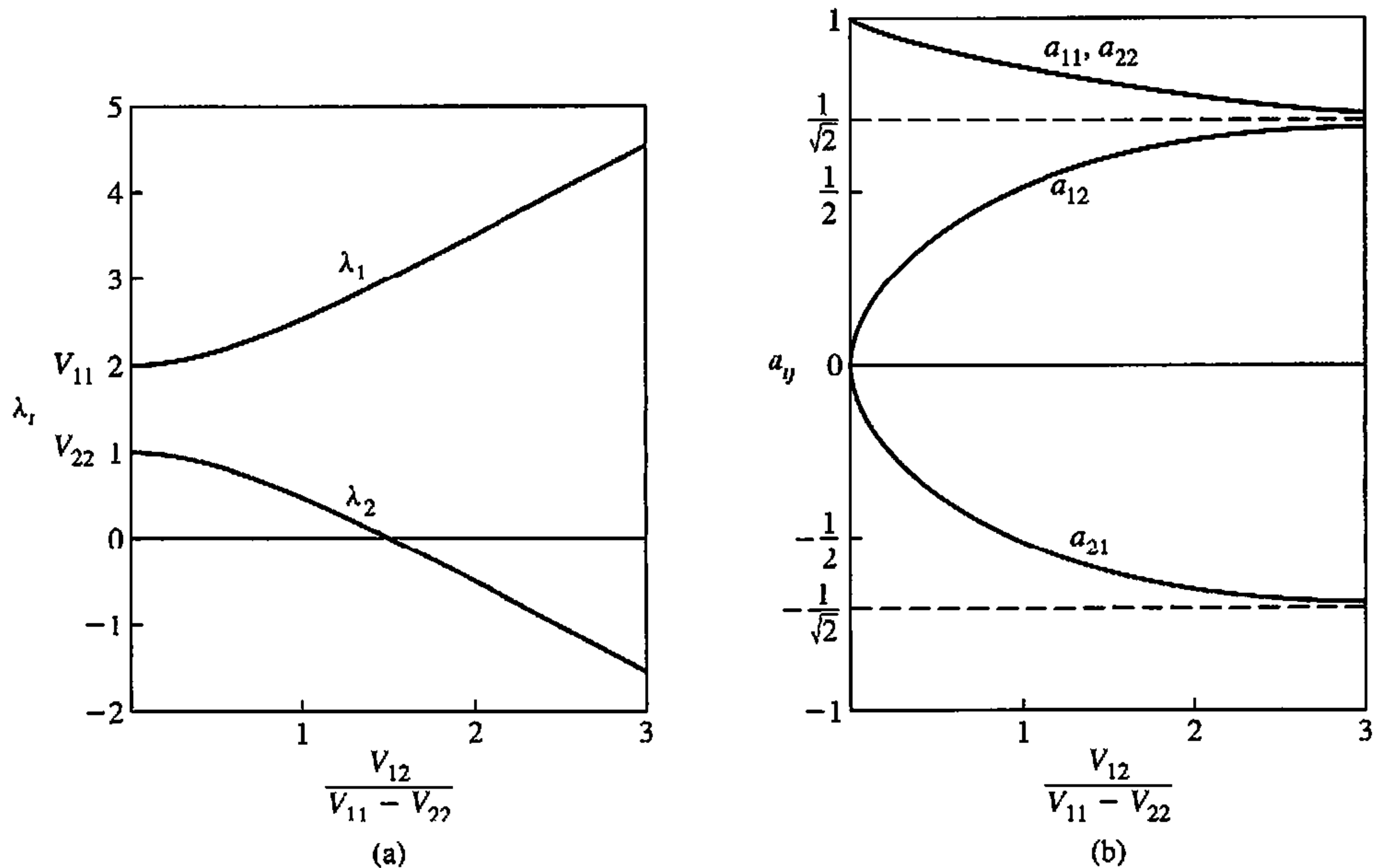

FIGURE 6.2 Behavior of the (a) eigenvalues and (b) eigenvector components as the energy ratio $\frac{V_{12}}{V_{11} - V_{22}}$ changes from 0 to 3.

It remains only to consider the case of multiple roots to the secular equation, a situation that is more annoying in the mathematical theory than it is in practice. If one or more of the roots is repeated, it is found that the number of independent equations among the eigenvalues is insufficient to determine even the ratio of the eigenvector components. Thus, if the eigenvalue λ is a double root, any two of the components a_i may be chosen arbitrarily, the rest being fixed by the eigenvalue equations.

In general, any pair of eigenvectors randomly chosen out of the infinite set of allowed vectors will not be orthogonal. Nevertheless, it is always possible to construct a pair of allowed vectors that are orthogonal, and these can be used to form the orthogonal matrix \mathbf{A} . Consider for simplicity the procedure to be followed for a double root. Let \mathbf{a}'_k and \mathbf{a}'_l be any two allowable eigenvectors for a given

double root λ , which have been normalized so as to satisfy Eq. (6.22b). Any linear combination of \mathbf{a}'_k and \mathbf{a}'_l will also be an eigenvector for the root λ . We therefore seek to construct a vector \mathbf{a}_l ,

$$\mathbf{a}_l = c_1 \mathbf{a}'_k + c_2 \mathbf{a}'_l, \quad (6.31)$$

where c_1 and c_2 are constants such that \mathbf{a}_l is orthogonal to \mathbf{a}'_k . The orthogonality condition, Eq. (6.22a), then requires that

$$\tilde{\mathbf{a}}_l \mathbf{T} \mathbf{a}'_k = c_1 + c_2 \tilde{\mathbf{a}}'_l \mathbf{T} \mathbf{a}'_k = 0,$$

where use has been made of the normalization of \mathbf{a}'_k . It therefore follows that the ratio of c_1 to c_2 must be given by

$$\frac{c_1}{c_2} = -\tilde{\mathbf{a}}'_l \mathbf{T} \mathbf{a}'_k \equiv -\tau_l. \quad (6.32)$$

We can illustrate these ideas by again considering our two-dimensional example given by Eqs (6.27) through (6.30). The two limiting cases of the off-diagonal potential term V_{12} , being much less than and much greater than the difference factor $(V_{11} - V_{22})$, provide an excellent example of the problems introduced by degeneracy. When

$$V_{11} = V_{22} = V_0, \quad V_{12} = 0,$$

the two eigenvalues become the same, $\lambda_1 = \lambda_2 = V_0$.

If the limit is taken by letting $V_{12} \rightarrow 0$ first and then taking the limit $(V_{11} \rightarrow V_{22})$, the eigenvectors in Eqs. (6.28) become

$$\mathbf{a}_1 = \begin{pmatrix} 1 \\ 0 \end{pmatrix} \quad \text{and} \quad \mathbf{a}_2 = \begin{pmatrix} 0 \\ 1 \end{pmatrix}. \quad (6.33)$$

If the limit is taken in the reverse order, Eqs. (6.30) give

$$\mathbf{b}_1 = \begin{pmatrix} \frac{1}{\sqrt{2}} \\ \frac{1}{\sqrt{2}} \end{pmatrix} \quad \text{and} \quad \mathbf{b}_2 = \begin{pmatrix} -\frac{1}{\sqrt{2}} \\ \frac{1}{\sqrt{2}} \end{pmatrix}, \quad (6.34)$$

where \mathbf{b} is used for the eigenvectors in Eqs. (6.34) to avoid confusion with the eigenvectors in Eqs. (6.33). Each of the eigenvectors in (6.33) and (6.34) are linear combinations of the other set of eigenvectors. For example,

$$\mathbf{b}_1 = \frac{1}{\sqrt{2}}(\mathbf{a}_1 + \mathbf{a}_2), \quad \text{and} \quad \mathbf{b}_2 = \frac{1}{\sqrt{2}}(\mathbf{a}_2 - \mathbf{a}_1),$$

so either set of eigenvectors is a linear combination of the other, as was discussed in this section. These results obviously generalize to the infinite set

$$\mathbf{a}_1 = \begin{pmatrix} a \\ b \end{pmatrix} \quad \text{and} \quad \mathbf{a}_2 = \begin{pmatrix} -b \\ a \end{pmatrix},$$

where a and b are any pairs of numbers that satisfy

$$a^2 + b^2 = 1.$$

This shows that there is an infinite set of possible eigenvectors in the case of degeneracy.

There is another way to consider the significance of these results. The approximate eigenvectors in Eqs. (6.28) are for the case where the main potential energy terms are V_{11} and V_{22} , which are at diagonal positions, and the V_{12} are in the off-diagonal positions. If we take the eigenvectors of Eq. (6.30) in the limit $\varepsilon \rightarrow 0$ and let the eigenvectors of Eqs. (6.30) transform V as $\mathbf{V}' = \tilde{\mathbf{A}}\mathbf{V}\mathbf{A}$, we obtain the transformed potential energy tensor

$$\mathbf{V}' = \begin{pmatrix} \frac{1}{2}(V_{11} + V_{22}) + V_{12} & \frac{1}{2}(V_{11} - V_{22}) \\ \frac{1}{2}(V_{11} - V_{22}) & \frac{1}{2}(V_{11} + V_{22}) - V_{12} \end{pmatrix}$$

in which the difference term $(V_{11} - V_{22})$ is off-diagonal. Thus, the set of eigenvectors given by Eqs. (6.30) are for the physical situation in which the small energy term $(V_{11} - V_{22})$ is off-diagonal.

Returning to the main discussion, the requirement that \mathbf{a}_l of Eq. (6.32) be normalized provides another condition on the two coefficients, which in terms of τ_l defined by Eq. (6.32) takes the form

$$\tilde{\mathbf{a}}_l \mathbf{T} \mathbf{a}_l = 1 = c_1^2 + c_2^2 + 2c_1 c_2 \tau_l.$$

Together the two equations fix the coefficients c_1 and c_2 , and therefore the vector \mathbf{a}_l . Both \mathbf{a}_l and $\mathbf{a}_k \equiv \mathbf{a}'_k$ are automatically orthogonal to the eigenvectors of the other distinct eigenvalues, for then the argument based on Eq. (6.17') remains valid. Hence, we have a set of n eigenvectors \mathbf{a}_j whose components form the matrix \mathbf{A} satisfying Eq. (6.23).

A similar procedure is followed for a root of higher multiplicity. If λ is an m -fold root, then orthogonal normalized eigenvectors are formed out of linear combinations of any of the m corresponding eigenvectors $\mathbf{a}'_1, \dots, \mathbf{a}'_m$. The first of the "orthonormal" eigenvectors \mathbf{a}_1 is then chosen as a multiple of \mathbf{a}'_1 ; \mathbf{a}_2 is taken as a linear combination of \mathbf{a}'_1 and \mathbf{a}'_2 ; and so on. In this manner, the number of constants to be determined is equal to the sum of the first m integers, or $\frac{1}{2}m(m-1)$. The normalization requirements provide m conditions, while there are $\frac{1}{2}m(m-1)$ orthogonality conditions, and together these are just enough to fix the constants uniquely.

This processes of constructing orthogonalized eigenvectors in the case of multiple roots is completely analogous to the Gram-Schmidt method of constructing a sequence of orthogonal functions out of any arbitrary set of functions. Phrased in geometrical language, it is also seen to be identical with the procedure followed in Chapter 5 for multiple eigenvalues of the inertia tensor. For example, the added indeterminacy in the eigenvector components for a double root means that all of the vectors in a *plane* are eigenvectors. We merely choose any two perpendicular

directions in the plane as being the new principal axes, with the eigenvectors in \mathbf{A} as unit vectors along these axes.

6.3 ■ FREQUENCIES OF FREE VIBRATION, AND NORMAL COORDINATES

The somewhat lengthy arguments of the preceding section demonstrate that the equations of motion will be satisfied by an oscillatory solution of the form (6.11), not merely for one frequency but in general for a set of n frequencies ω_k . A complete solution of the equations of motion therefore involves a superposition of oscillations with all the allowed frequencies. Thus, if the system is displaced slightly from equilibrium and then released, the system performs small oscillations about the equilibrium with the frequencies $\omega_1, \dots, \omega_n$. The solutions of the secular equation are therefore often designated as the frequencies of *free vibration* or as the *resonant frequencies* of the system.

The general solution of the equations of motion may now be written as a summation over an index k :

$$\eta_i = C_k a_{ik} e^{-i\omega_k t}, \quad (6.35)$$

there being a complex scale factor C_k for each resonant frequency. It might be objected that for each solution λ_k of the secular equation there are two resonant frequencies $+\omega_k$ and $-\omega_k$. The eigenvector \mathbf{a}_k would be the same for the two frequencies, but the scale factors C_k^+ and C_k^- could conceivably be different. On this basis, the general solution should appear as

$$\eta_i = a_{ik} (C_k^+ e^{+i\omega_k t} + C_k^- e^{-i\omega_k t}). \quad (6.35')$$

Recall however that the actual motion is the real part of the complex solution, and the real part of either (6.35) or (6.35') can be written in the form

$$\eta_i = f_k a_{ik} \cos(\omega_k t + \delta_k), \quad (6.36)$$

where the amplitude f_k and the phase δ_k are determined from the initial conditions. Either of the solutions ((6.35) and (6.36)) will therefore represent the actual motion, and the former of course is the more convenient.

The orthogonality properties of \mathbf{A} greatly facilitate the determination of the scale factors C_k in terms of the initial conditions. At $t = 0$, the real part of Eq. (6.35) reduces to

$$\eta_i(0) = \text{Re } C_k a_{ik}, \quad (6.37)$$

where Re stands for "real part of." Similarly, the initial value of the velocities is obtained as

$$\dot{\eta}_i(0) = \text{Im } C_k a_{ik} \omega_k, \quad (6.38)$$

where $\text{Im } C_k$ denotes the imaginary part of C_k . From these $2n$ equations, the real and imaginary parts of the n constants C_k may be evaluated. To solve Eq. (6.37), for example, let us first write it in terms of column matrices $\boldsymbol{\eta}(0)$ and \mathbf{C} :

$$\boldsymbol{\eta}(0) = \mathbf{A} \text{Re } \mathbf{C}. \quad (6.37')$$

If we multiply by $\tilde{\mathbf{A}}\mathbf{T}$ from the left and use Eq. (6.23), we immediately obtain a solution for $\text{Re } \mathbf{C}$:

$$\text{Re } \mathbf{C} = \tilde{\mathbf{A}}\mathbf{T}\boldsymbol{\eta}(0).$$

or, taking the l th component,

$$\text{Re } C_l = a_{jl} T_{jk} \eta_k(0). \quad (6.39)$$

A similar procedure leads to the imaginary part of the scale factors as*

$$\text{Im } C_l = \frac{1}{\omega_l} \sum_{j,k} a_{jl} T_{jk} \dot{\eta}_k(0). \quad (6.40)$$

Equations (6.39) and (6.40) thus permit the direct computation of the complex factors C_l (and therefore the amplitudes and phases) in terms of the initial conditions and the matrices \mathbf{T} and \mathbf{A} .

The solution for each coordinate, Eq. (6.35), is in general a sum of simple harmonic oscillations in all of the frequencies ω_k satisfying the secular equation. Unless it happens that all of the frequencies are commensurable, that is, rational fractions of each other, η_i never repeats its initial value and is therefore not itself a periodic function of time. However, it is possible to transform from the η_i to a new set of generalized coordinates that are all simple periodic functions of time—a set of variables known as the *normal coordinates*.

We define a new set of coordinates ζ_j

$$\eta_i = a_{ij} \zeta_j, \quad (6.41)$$

or, in terms of single column matrices $\boldsymbol{\eta}$ and $\boldsymbol{\zeta}$,

$$\boldsymbol{\eta} = \mathbf{A}\boldsymbol{\zeta}. \quad (6.41')$$

The potential energy, Eq. (6.4), is written in matrix notation as

$$V = \frac{1}{2} \tilde{\boldsymbol{\eta}} \mathbf{V} \boldsymbol{\eta}. \quad (6.42)$$

Now, the single-row transpose matrix $\tilde{\boldsymbol{\eta}}$ is related to $\tilde{\boldsymbol{\zeta}}$ by the equation

$$\tilde{\boldsymbol{\eta}} = \tilde{\mathbf{A}}\tilde{\boldsymbol{\zeta}} = \tilde{\boldsymbol{\zeta}}\mathbf{A},$$

*The summation over j and k is shown explicitly because there is no summation over the repeated subscript l .

so that the potential energy can be written also as

$$V = \frac{1}{2} \tilde{\zeta} \tilde{\mathbf{A}} \mathbf{V} \mathbf{A} \zeta.$$

But \mathbf{A} diagonalizes \mathbf{V} by a congruence transformation (cf. Eq. (6.26)), and the potential energy therefore reduces simply to

$$V = \frac{1}{2} \tilde{\zeta} \boldsymbol{\lambda} \zeta = \frac{1}{2} \omega_k^2 \zeta_k^2. \quad (6.43)$$

The kinetic energy has an even simpler form in the new coordinates. Since the velocities transform as the coordinates, T as given in Eq. (6.20) transforms to

$$T = \frac{1}{2} \tilde{\zeta} \tilde{\mathbf{A}} \mathbf{T} \mathbf{A} \dot{\zeta}$$

which by virtue of Eq. (6.23) reduces to

$$T = \frac{1}{2} \tilde{\zeta} \dot{\zeta} = \frac{1}{2} \dot{\zeta}_i \dot{\zeta}_i. \quad (6.44)$$

Equations (6.43) and (6.44) state that in the new coordinates both the potential and kinetic energies are sums of squares only, without any cross terms. Of course, this result is simply another way of saying that \mathbf{A} produces a principal axis transformation. Recall that the principal axis transformation of the inertia tensor was specifically designed to reduce the moment of inertia to a sum of squares; the new axes being the principal axes of the inertia ellipsoid. Here the kinetic and potential energies are also quadratic forms (as was the moment of inertia) and both are diagonalized by \mathbf{A} . For this reason, the principal axis transformation employed here is a particular example of the well-known algebraic process of the *simultaneous diagonalization of two quadratic forms*.

The equations of motion share in the simplification resulting from their use. The new Lagrangian is

$$L = \frac{1}{2} (\dot{\zeta}_k \dot{\zeta}_k - \omega_k^2 \zeta_k^2) \quad (6.45)$$

so that the Lagrange equations for ζ_k are

$$\ddot{\zeta}_k + \omega_k^2 \zeta_k = 0. \quad (6.46)$$

Equations (6.47) have the immediate solutions

$$\zeta_k = C_k e^{-i\omega_k t}, \quad (6.47)$$

which could have been seen of course directly from Eqs. (6.35) and (6.41). Each of the new coordinates is thus a simply periodic function involving only *one* of the resonant frequencies. As mentioned earlier, it is therefore customary to call the ζ 's the *normal coordinates* of the system.

Each normal coordinate corresponds to a vibration of the system with only one frequency, and these component oscillations are spoken of as the *normal modes of vibration*. All of the particles in each mode vibrate with the same frequency and with the same phase;* the relative amplitudes being determined by the matrix

*Particles may be exactly out of phase if the a 's have opposite sign

elements a_{jk} . The complete motion is then built up out of the sum of the normal modes weighted with appropriate amplitude and phase factors contained in the C_k 's.

Harmonics of the fundamental frequencies are absent in the complete motion essentially because of the stipulation that the amplitude of oscillation be small. We are then allowed to represent the potential as a quadratic form, which is characteristic of simple harmonic motion. The normal coordinate transformation emphasizes this point. For the Lagrangian in the normal coordinates (6.45) is seen to be the sum of the Lagrangians for harmonic oscillators of frequencies ω_k . We can thus consider the complete motion for small oscillations as being obtained by exciting the various harmonic oscillators with different intensities and phases.*

6.4 ■ FREE VIBRATIONS OF A LINEAR TRIATOMIC MOLECULE

To illustrate the technique for obtaining the resonant frequencies and normal modes, we shall consider in detail a model based on a linear symmetrical triatomic molecule. In the equilibrium configuration of the molecule, two atoms of mass m are symmetrically located on each side of an atom of mass M (cf. Fig. 6.3). All three atoms are on one straight line, the equilibrium distances apart being denoted by b . For simplicity, we shall first consider only vibrations along the line of the molecule, and the actual complicated interatomic potential will be approximated by two springs of force constant k joining the three atoms. There are three obvious coordinates marking the position of the three atoms on the line. In these coordinates, the potential energy is

$$V = \frac{k}{2}(x_2 - x_1 - b)^2 + \frac{k}{2}(x_3 - x_2 - b)^2. \quad (6.48)$$

We now introduce coordinates relative to the equilibrium positions:

$$\eta_i = x_i - x_{0i},$$

where

$$x_{02} - x_{01} = b = x_{03} - x_{02}.$$

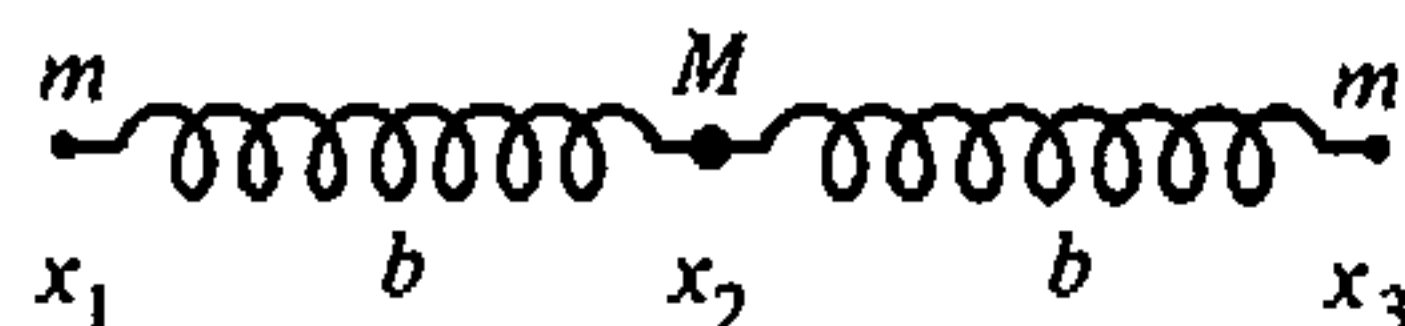

FIGURE 6.3 Model of a linear symmetrical triatomic molecule.

*Note for future reference that the same sort of picture appears in the quantization of the electromagnetic field. The frequencies of the harmonic oscillators are identified with the photon frequencies, and the amplitudes of excitation become the discrete quantized "occupation numbers"—the number of photons of each frequency.

The potential energy then reduces to

$$V = \frac{k}{2}(\eta_2 - \eta_1)^2 + \frac{k}{2}(\eta_3 - \eta_2)^2,$$

or

$$V = \frac{k}{2}(\eta_1^2 + 2\eta_2^2 + \eta_3^2 - 2\eta_1\eta_2 - 2\eta_2\eta_3). \quad (6.49)$$

Hence, the \mathbf{V} tensor has the form

$$\mathbf{V} = \begin{pmatrix} k & -k & 0 \\ -k & 2k & -k \\ 0 & -k & k \end{pmatrix}. \quad (6.50)$$

The kinetic energy has an even simpler form:

$$T = \frac{m}{2}(\dot{\eta}_1^2 + \dot{\eta}_3^2) + \frac{M}{2}\dot{\eta}_2^2, \quad (6.51)$$

so that the \mathbf{T} tensor is diagonal:

$$\mathbf{T} = \begin{pmatrix} m & 0 & 0 \\ 0 & M & 0 \\ 0 & 0 & m \end{pmatrix}. \quad (6.52)$$

Combining these two tensors, the secular equation appears as

$$|\mathbf{V} - \omega^2\mathbf{T}| = \begin{vmatrix} k - \omega^2m & -k & 0 \\ -k & 2k - \omega^2M & -k \\ 0 & -k & k - \omega^2m \end{vmatrix} = 0. \quad (6.53)$$

Direct evaluation of the determinant leads to the cubic equation in ω^2 :

$$\omega^2(k - \omega^2m)(k(M + 2m) - \omega^2Mm) = 0, \quad (6.54)$$

with the obvious solutions

$$\omega_1 = 0, \quad \omega_2 = \sqrt{\frac{k}{m}}, \quad \omega_3 = \sqrt{\frac{k}{m} \left(1 + \frac{2m}{M}\right)}. \quad (6.55)$$

The first eigenvalue, $\omega_1 = 0$, may appear somewhat surprising and even alarming at first sight. Such a solution does not correspond to an oscillatory motion at all, for the equation of motion for the corresponding normal coordinate is

$$\ddot{\xi}_1 = 0,$$

which produces a uniform translational motion. But this is precisely the key to the difficulty. The vanishing frequency arises from the fact that the molecule

may be translated rigidly along its axis without any change in the potential energy, an example of neutral equilibrium mentioned previously. Since the restoring force against such motion is zero, the effective "frequency" must also vanish. We have made the assumption that the molecule has three degrees of freedom for vibrational motion, whereas in reality one of them is a rigid body degree of freedom.

A number of interesting points can be discussed in connection with a vanishing resonant frequency. It is seen from Eq. (6.21) that a zero value of ω can occur only when the potential energy is positive but is not positive definite; that is, it can vanish even when not all the η_i 's are zero. An examination of V , Eq. (6.49), shows that it is not positive definite and that V does in fact vanish when all the η 's are equal (uniform translation).

Since the zero frequency found here is of no consequence for the vibration frequencies of interest, it is often desirable to phrase the problem so that the root is eliminated from the outset. We can do this here most simply by imposing the condition or constraint that the center of mass remain stationary at the origin:

$$m(x_1 + x_3) + Mx_2 = 0. \quad (6.56)$$

Equation (6.56) can then be used to eliminate one of the coordinates from V and T , reducing the problem to one of two degrees of freedom (cf. Derivation 1, this chapter).

The restriction of the motion to be along the molecular axis allows only one possible type of uniform rigid body motion. However, if the more general problem of vibrations in all three directions is considered, the number of rigid body degrees of freedom will be increased to six. The molecule may then translate uniformly along the three axes or perform uniform rotations about the axes. Hence, in any general system of n degrees of freedom, there will be six vanishing frequencies and only $n - 6$ true vibration frequencies. Again, the reduction in the number of degrees of freedom can be performed beforehand by imposing the conservation of linear and angular momentum upon the coordinates.

In addition to rigid body motion, it has been pointed out that zero resonant frequencies may also arise when the potential is such that both the first *and* second derivatives of V vanish at equilibrium. Small oscillations may still be possible in this case if the fourth derivatives do not also vanish (the third derivatives must vanish for a stable equilibrium), but the vibrations will not be simple harmonic. Such a situation therefore constitutes a breakdown of the customary method of small oscillations, but fortunately it is not of frequent occurrence.

Returning now to the examination of the resonant frequencies, ω_2 will be recognized as the well-known frequency of oscillation for a mass m suspended by a spring of force constant k . We are therefore led to expect that only the end atoms partake in this vibration; the center molecule remains stationary. It is only in the third mode of vibration, ω_3 , that the mass M can participate in the oscillatory motion. These predictions are verified by examining the eigenvectors for the three normal modes.

The components a_{ij} are determined for each frequency by the equations

$$\begin{aligned} (k - \omega_j^2 m)a_{1j} - ka_{2j} &= 0 \\ -ka_{1j} + (2k - \omega_j^2 M)a_{2j} - ka_{3j} &= 0 \\ -ka_{2j} + (k - \omega_j^2 m)a_{3j} &= 0, \end{aligned} \quad (6.57a)$$

along with the normalization condition:

$$m(a_{1j}^2 + a_{3j}^2) + Ma_{2j}^2 = 1. \quad (6.57b)$$

For $\omega_1 = 0$, it follows immediately from the first and third of Eqs. (6.57a) that all three coefficients are equal: $a_{11} = a_{21} = a_{31}$. This of course is exactly what was expected from the translational nature of the motion (cf. Fig. 6.4a). The normalization condition then fixes the value of a_{1j} so that

$$a_{11} = \frac{1}{\sqrt{2m + M}}, \quad a_{12} = \frac{1}{\sqrt{2m + M}}, \quad a_{13} = \frac{1}{\sqrt{2m + M}}. \quad (6.58a)$$

The factors $(k - \omega_j^2 m)$ vanish for the second mode, and Eqs. (6.57a) show immediately that $a_{22} = 0$ (as predicted) and $a_{12} = -a_{32}$. The numerical value of these quantities is then determined by Eq. (6.57b):

$$a_{12} = \frac{1}{\sqrt{2m}}, \quad a_{22} = 0, \quad a_{32} = -\frac{1}{\sqrt{2m}}. \quad (6.58b)$$

In this mode the center atom is at rest, while the two outer ones vibrate exactly out of phase (as they must in order to conserve linear momentum) (cf. Fig. 6.4b). Finally, when $\omega = \omega_3$, it can be seen from the first and third of Eqs. (6.57a) that a_{13} and a_{33} must be equal. The rest of the calculation for this mode is not quite as simple as for the others, and it will be sufficient to state the final result:

$$a_{13} = \frac{1}{\sqrt{2m \left(1 + \frac{2m}{M}\right)}}, \quad a_{23} = \frac{-2}{\sqrt{2M \left(2 + \frac{M}{m}\right)}}, \quad a_{33} = \frac{1}{\sqrt{2m \left(1 + \frac{2m}{M}\right)}}. \quad (6.58c)$$

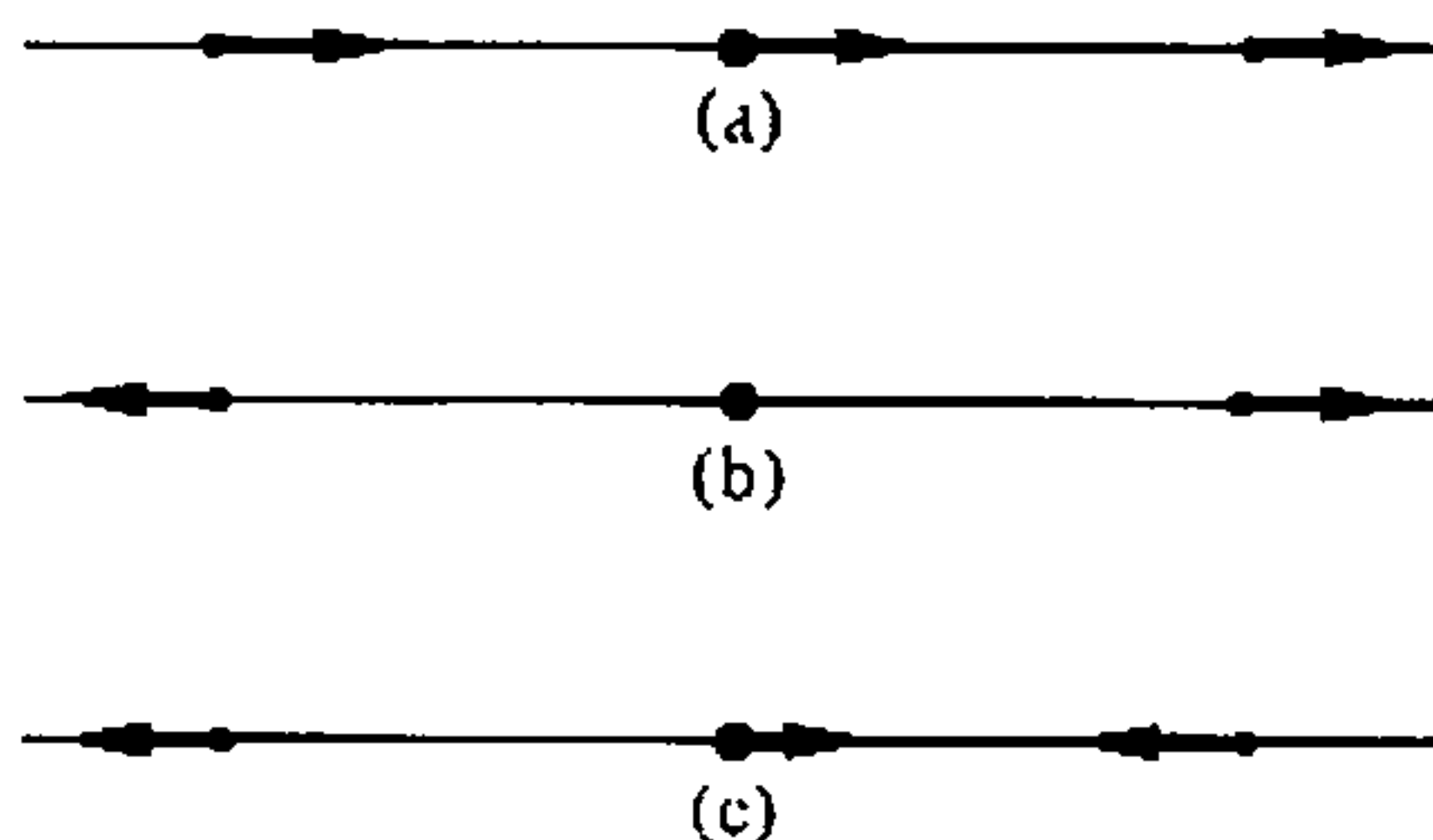

FIGURE 6.4 Longitudinal normal modes of the linear symmetric triatomic molecule

Here the two outer atoms vibrate with the same amplitude, while the inner one oscillates out of phase with them and has a different amplitude, (cf. Fig. 6.4c.)

The normal coordinates may be found by inverting Eq. (6.41) as

$$\begin{aligned}\zeta_1 &= \frac{1}{\sqrt{2m + M}} (\sqrt{m}\eta_1 + \sqrt{M}\eta_2 + \sqrt{m}\eta_3) \\ \zeta_2 &= \sqrt{\frac{1}{2}} (\eta_1 - \eta_3) \\ \zeta_3 &= \frac{1}{\sqrt{2m + M}} \left[\sqrt{\frac{M}{2}} (\eta_1 + \eta_3) - \sqrt{2m}\eta_2 \right].\end{aligned}\tag{6.59}$$

These normal modes describe each of the behaviors shown on Fig. 6.4. Any general longitudinal vibration of the molecule that does not involve a rigid translation will be some linear combination of the normal modes ω_2 and ω_3 . The amplitudes of the normal modes, and their phases relative to each other, will of course be determined by the initial conditions (cf. Exercise 5).

We have spoken so far only of vibrations along the axis; in the actual molecule there will also be normal modes of vibration perpendicular to the axis. The complete set of normal modes is naturally more difficult to determine than merely the longitudinal modes, for the general motion in all directions corresponds to nine degrees of freedom. While the procedure is straightforward, the algebra rapidly becomes quite complicated, and it is not feasible to present the detailed calculation here. However, it is possible to give a qualitative discussion on the basis of general principles, and most of the conclusions of the complete solution can be predicted beforehand.

The general problem will have a number of zero resonant frequencies corresponding to the possibility of rigid body motion. For a molecule with n atoms there are $3n$ degrees of freedom. Subtracting the three translational and three rigid rotational degrees of freedom, there will be in general $3n - 6$ vibrational modes. For the linear molecule, there will be three degrees of freedom for rigid translation, but rigid rotation can account for only *two* degrees of freedom. Rotation about the axis of the molecule is obviously meaningless and will not appear as a mode of rigid body motion. We are therefore left with four true modes of vibration. Two of these are the longitudinal modes, which have already been examined so that there can only be two modes of vibration perpendicular to the axis. However, the symmetry of the molecule about its axis shows that these two modes of perpendicular vibration must be degenerate. There is nothing to distinguish a vibration in the y direction from a vibration in the z direction, and the two frequencies must be equal.

The additional indeterminacy of the eigenvectors of a degenerate mode appears here, in that all directions perpendicular to the molecular axis are alike. Any two orthogonal axes in the plane normal to the molecule may be chosen as the directions of the degenerate modes of vibration. The complete motion of the atoms

normal to the molecular axis will depend upon the amplitudes and relative phases of the two degenerate modes. If both are excited, and they are exactly in phase, then the atoms will move on a straight line passing through the equilibrium configuration. But if they are out of phase, the composite motion is an elliptical Lissajous figure, exactly as in a two-dimensional isotropic oscillator. The two modes then represent a rotation, rather than a vibration.

It is obvious from the symmetry of the molecules that the amplitudes of the end atoms must be identical in magnitude. The complete calculation shows that the end atoms also travel in the same direction along the Lissajous figure. Hence, the center atom must revolve in the opposite direction, in order to conserve angular momentum. Figure 6.5 illustrates the motion for the two degenerate modes when they are 90° out of phase.

As the complexity of the molecule increases, the size of the secular determinant becomes very large, and finding the normal frequencies and amplitudes becomes a problem of considerable magnitude. We have seen however that even in a situation as simple as the linear triatomic molecule, a study of the symmetries to be expected in the vibrations greatly simplifies the calculations. Considerable mathematical ingenuity has been devoted to exploiting the symmetries inherent in complex molecules to reduce the labor involved in finding their vibration frequencies. The theory of symmetry groups has been applied with great success in factoring the large secular determinant into smaller blocks that may be diagonalized separately. It has been pointed out however that such elaborate mathematical manipulation was more appropriate in a time when numerical computations were difficult and tedious. Considering the speed and memory capacity of present-day computers, a straightforward approach may be easier and more accurate in the long run. Fast and accurate routines for solving the eigenvalue problems of large matrices are the stock-in-trade today of scientific computers of even moderate size. There has therefore been a trend toward a more brute-force approach in which mass-weighted Cartesian coordinates (see p. 241) are used to formulate the problem. The kinetic energy ellipsoid for the molecular vibrations is then already a sphere, and finding the normal modes reduces to diagonalizing the potential energy. These approaches are extensively applied in infrared and Raman spectroscopy.

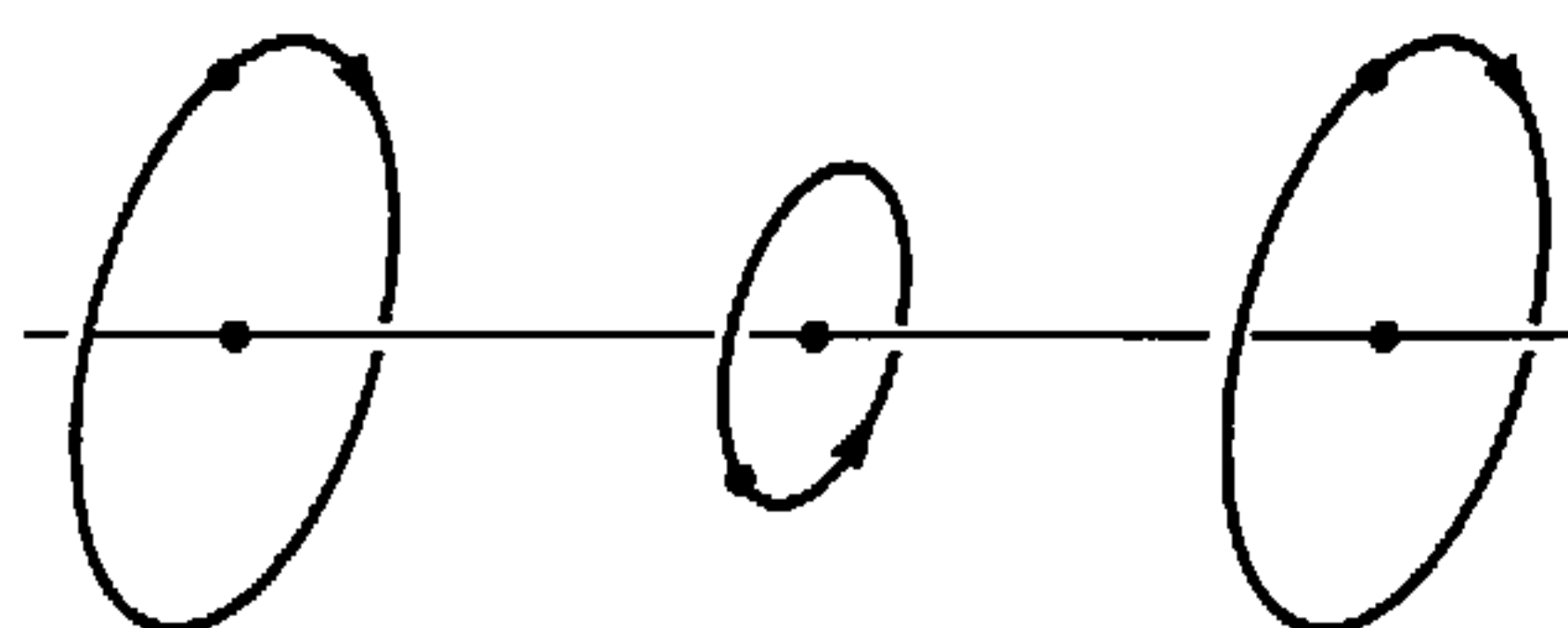

FIGURE 6.5 Degenerate modes of the symmetrical triatomic molecule.

6.5 ■ FORCED VIBRATIONS AND THE EFFECT OF DISSIPATIVE FORCES

Free vibrations occur when the system is displaced initially from its equilibrium configuration and is then allowed to oscillate by itself. Very often, however, the system is set into oscillation by an external driving force that continues to act on the system after $t = 0$. The frequency of such a *forced oscillation* is then determined by the frequency of the driving force and not by the resonant frequencies. Nevertheless, the normal modes are of great importance in obtaining the *amplitudes* of the forced vibration, and the problem is greatly simplified by use of the normal coordinates obtained from the free modes.

If F_j is the generalized force corresponding to the coordinate η_j , then by Eq. (1.49) the generalized force Q_i for the normal coordinate ζ_i is

$$Q_i = a_{ji} F_j. \quad (6.60)$$

The equations of motion when expressed in normal coordinates now become

$$\ddot{\zeta}_i + \omega_i^2 \zeta_i = Q_i. \quad (6.61)$$

Equations (6.61) are a set of n inhomogeneous differential equations that can be solved only when we know the dependence of Q_i on time. While the solution will not be as simple as in the free case, note that the normal coordinates preserve their advantage of separating the variables, and each equation involves only a single coordinate.

Frequently, the driving force varies sinusoidally with time. In an acoustic problem, for example, the driving force might arise from the pressure of a sound wave impinging on the system, and Q_i then has the same frequency as the sound wave. Or, if the system is a polyatomic molecule, a sinusoidal driving force is present if the molecule is illuminated by a monochromatic light beam. Each atom in the molecule is then subject to an electromagnetic force whose frequency is that of the incident light. Even where the driving force is not sinusoidal with a single frequency, it can often be considered as built up as a superposition of such sinusoidal terms. Thus, if the driving force is periodic, it can be represented by a Fourier series; other times, a Fourier integral representation is suitable. Since Eqs. (6.61) are linear equations, its solutions for particular frequencies can be superposed to find the complete solution for given Q_i .

It is therefore of general interest to study the nature of the oscillations when the force Q_i can be written as

$$Q_i = Q_{0i} \cos(\omega t + \delta_i), \quad (6.62)$$

where ω is the angular frequency of an external force. The equations of motion now appear as

$$\ddot{\zeta}_i + \omega_i^2 \zeta_i = Q_{0i} \cos(\omega t + \delta_i). \quad (6.63)$$

A complete solution of Eq. (6.63) consists of the general solution to the homogeneous equation (that is, the free modes of vibration) plus a particular solution to the inhomogeneous equation. By a proper choice of initial conditions, the superimposed free vibrations can be made to vanish,* centering our interest on the particular solution of Eqs. (6.63) that will obviously have the form

$$\zeta_i = B_i \cos(\omega t + \delta_i). \quad (6.64)$$

Here the amplitudes B_i are determined by substituting the solution in Eqs. (6.63):

$$B_i = \frac{Q_{0i}}{\omega_i^2 - \omega^2}. \quad (6.65)$$

The complete motion is then

$$\eta_j = a_{ji} \zeta_i = \frac{a_{ji} Q_{0i} \cos(\omega t + \delta_i)}{\omega_i^2 - \omega^2}. \quad (6.66)$$

Thus, the vibration of each particle is again composed of linear combinations of the normal modes, but now each normal oscillation occurs at the frequency of the driving force.

Two factors determine the extent to which each normal mode is excited. One is the amplitude of the generalized driving force, Q_{0i} . If the force on each particle has no component in the direction of vibration of some particular normal mode, then obviously the generalized force corresponding to the mode will vanish and Q_{0i} will be zero. *An external force can excite a normal mode only if it tends to move the particles in the same direction as in the given mode.* The second factor is the closeness of the driving frequency to the free frequency of the mode. As a consequence of the denominators in Eq. (6.66), the closer ω approaches to any ω_i , the stronger will that mode be excited relative to the other modes. Indeed, Eq. (6.66) apparently predicts infinite amplitude when the driving frequency agrees exactly with one of the ω_i 's—the familiar phenomenon of resonance. Actually, of course, the theory behind Eq. (6.66) presumes only small oscillations about equilibrium positions; when the amplitude predicted by the formula becomes large, this assumption breaks down and Eq. (6.66) is then no longer valid. Note that the oscillations are in phase with the driving force when the frequency is less than the resonant frequency, but that there is a phase change of π in going through the resonance.

Our discussion has been unrealistic in that the absence of dissipative or frictional forces has been assumed. In many physical systems, these forces, when present, are proportional to the particle velocities and can therefore be derived

*The free vibrations are essentially the transients generated by the application of the driving forces. If we consider the system to be initially in an equilibrium configuration, and then slowly build up the driving forces from zero, these transients will not appear. Alternatively, dissipative forces can be assumed present (see pages following) that will damp out the free vibrations.

from a dissipation function \mathcal{F} (cf. Section 1.5). Let us first consider the effects of frictional forces on the free modes of vibration.

From its definition, \mathcal{F} must be a homogeneous quadratic function of the velocities:

$$\mathcal{F} = \frac{1}{2} \mathcal{F}_{ij} \dot{\eta}_i \dot{\eta}_j. \quad (6.67)$$

The coefficients \mathcal{F}_{ij} are clearly symmetric, $\mathcal{F}_{ij} = \mathcal{F}_{ji}$, and in general will be functions of the coordinates. Since we are concerned with only small vibrations about equilibrium, it is sufficient to expand the coefficients about equilibrium and retain only the first, constant term, exactly as was done for the kinetic energy. In future applications of Eq. (6.67), we shall take \mathcal{F}_{ij} as denoting these constant factors. Recall that $2\mathcal{F}$ is the rate of energy dissipation due to the frictional forces (cf. Eq. (2.60)). The dissipation function \mathcal{F} therefore can never be negative. The complete set of Lagrange equations of motion now become (cf. Section 1.5)

$$T_{ij} \ddot{\eta}_j + \mathcal{F}_{ij} \dot{\eta}_j + V_{ij} \eta_j = 0. \quad (6.68)$$

Clearly in order to find normal coordinates for which the equations of motion would be decoupled, it is necessary to find a principal axis transformation that simultaneously diagonalizes the three quadratic forms T , V , and \mathcal{F} . As was shown above, this is not in general possible; normal modes cannot usually be found for any arbitrary dissipation function.

There are however some exceptional cases when simultaneous diagonalization is possible. For example, if the frictional force is proportional both to the particle's velocity *and* its mass, then \mathcal{F} will be diagonal whenever T is. When such simultaneous diagonalization is feasible, then the equations of motion are decoupled in the normal coordinates with the form

$$\ddot{\zeta}_i + \mathcal{F}_i \dot{\zeta}_i + \omega_i^2 \zeta_i = 0. \quad (\text{no summation}) \quad (6.69)$$

Here the \mathcal{F}_i 's are the nonnegative coefficients in the diagonalized form of \mathcal{F} when expressed in terms of ζ_i . Being a set of linear differential equations with constant coefficients, Eqs. (6.69) may be solved by functions of the form

$$\zeta_i = C_i e^{-i\omega'_i t},$$

where ω'_i satisfies the quadratic equation

$$\omega_i'^2 + i\omega'_i \mathcal{F}_i - \omega_i^2 = 0. \quad (\text{no summation}) \quad (6.70)$$

Equation (6.70) has the two solutions

$$\omega'_i = \pm \sqrt{\omega_i^2 - \frac{\mathcal{F}_i^2}{4}} - i \frac{\mathcal{F}_i}{2}. \quad (6.71)$$

The motion is therefore not a pure oscillation, for ω' is complex. It is seen from Eq. (6.71) that the imaginary part of ω'_i results in a factor $\exp(-\mathcal{F}_i t/2)$, and by reason of the nonnegative nature of the \mathcal{F}_i 's, this is always an exponentially decreasing function of time.* The presence of a damping factor due to the friction is hardly unexpected. As the particles vibrate, they do work against the frictional forces, and the energy of the system (and hence the vibration amplitudes) must decrease with time. The real part of Eq. (6.71) corresponds to the oscillatory factor in the motion; note that the presence of friction also affects the frequency of the vibration. However, if the dissipation is small, the squared term in \mathcal{F}_i may be neglected, and the frequency of oscillation reduces to the friction-free value. The complete motion is then simply an exponential damping of the free modes of vibration:

$$\zeta_i = C_i e^{-\mathcal{F}_i t/2} e^{-i\omega_i t}. \quad (6.72)$$

If the dissipation function cannot be diagonalized along with T and V , the solution is much more difficult to obtain. The general nature of the solution remains pretty much the same, however: an exponential damping factor times an oscillatory exponential function. Suppose we seek a solution to Eqs. (6.68) of the form

$$\eta_j = C a_j e^{-i\omega t} = C a_j e^{-\kappa t} e^{-2\pi i \nu t}. \quad (6.73)$$

With this solution, Eqs. (6.68) become a set of simultaneous linear equations

$$V_{ij} a_j - i\omega \mathcal{F}_{ij} a_j - \omega^2 T_{ij} a_j = 0. \quad (6.74)$$

It is convenient to write ω as $i\gamma$, so that

$$\gamma = -i\omega = -\kappa - 2\pi i \nu, \quad (6.75)$$

and thus $-\kappa$ is the real part of γ . In terms of the square tensors of V , T , and \mathcal{F} , the set of equations (6.74) become a column matrix equation involving γ :

$$\mathbf{V}\mathbf{a} + \gamma\mathbf{F}\mathbf{a} + \gamma^2\mathbf{T}\mathbf{a} = 0. \quad (6.76)$$

The set of homogeneous equations (6.74) or (6.76) can be solved for the a_j only for certain values of ω or γ .

Without actually evaluating the corresponding secular equation, we can show that κ must always be nonnegative. Convert the matrix equation (6.76) into a scalar equation for γ by multiplying from the left with \mathbf{a}^\dagger :

$$\mathbf{a}^\dagger \mathbf{V}\mathbf{a} + \gamma \mathbf{a}^\dagger \mathbf{F}\mathbf{a} + \gamma^2 \mathbf{a}^\dagger \mathbf{T}\mathbf{a} = 0. \quad (6.77)$$

*Some (but not all) \mathcal{F}_i 's may be zero, which simply means there are no frictional effects in the corresponding normal modes. The important point is that the \mathcal{F}_i 's cannot be negative

Equation (6.77) is a quadratic equation for γ with coefficients that are matrix products of the same general type as those encountered in Eq. (6.19). By virtue of the symmetry of \mathbf{V} , \mathbf{F} , and \mathbf{T} , the matrix products are all real, as can be seen by expanding \mathbf{a} as $\boldsymbol{\alpha} + i\boldsymbol{\beta}$ (cf. Eq. (6.19)). Hence, if γ is a solution of the quadratic equation, its complex conjugate γ^* must also be a solution. Now, the sum of the two roots of a quadratic equation is the negative of the coefficient of the linear term divided by the coefficient of the square term

$$\gamma + \gamma^* = -2\kappa = -\frac{\mathbf{a}^\dagger \mathbf{F} \mathbf{a}}{\mathbf{a}^\dagger \mathbf{T} \mathbf{a}}. \quad (6.78)$$

Hence, κ can be expressed in terms of the real and imaginary parts of a_j as

$$\kappa = \frac{1}{2} \frac{\mathcal{F}_{ij}(\alpha_i \alpha_j + \beta_i \beta_j)}{T_{kl}(\alpha_k \alpha_l + \beta_k \beta_l)}. \quad (6.79)$$

The dissipation function \mathcal{F} must always be positive, and T is positive definite; hence κ cannot be negative. The oscillations of the system may decrease exponentially with time, but they can never increase with time. Note that if \mathcal{F} is positive definite, κ *must* be different from zero (and positive), and all modes will have an exponential damping factor. The frequencies of oscillation, given by the real part of ω , will of course be affected by the dissipative forces, but the change will be small if the damping is not very large during a period of oscillation.

Finally, we may consider forced sinusoidal oscillations in the presence of dissipative forces. Representing the variation of the driving force with time by

$$F_j = F_{0j} e^{-i\omega t},$$

where F_{0j} may be complex, the equations of motion are

$$V_{ij} \eta_j + \mathcal{F}_{ij} \dot{\eta}_j + T_{ij} \ddot{\eta}_j = F_{0i} e^{-i\omega t}. \quad (6.80)$$

If we seek a particular solution to these equations of the form

$$\eta_j = A_j e^{-i\omega t},$$

we obtain the following set of inhomogeneous linear equations for the amplitudes A_j :

$$(V_{ij} - i\omega \mathcal{F}_{ij} - \omega^2 T_{ij}) A_j - F_{0i} = 0. \quad (6.81)$$

The solution to these equations* may easily be obtained from Cramer's rule:

$$A_j = \frac{D_j(\omega)}{D(\omega)}. \quad (6.82)$$

*They are of course merely the inhomogeneous version of Eqs. (6.74)

where $D(\omega)$ is the determinant of the coefficients of A_j in Eq. (6.81) and $D_j(\omega)$ is the modification in $D(\omega)$ resulting when the j th column is replaced by $F_{01} \dots F_{0n}$. It is the denominator $D(\omega)$ that is of principal interest to us here, for the resonances arise essentially out of the algebraic form of the denominator. Now, D is the determinant appearing in the secular equation corresponding to the homogeneous equations (6.74); its roots are the complex frequencies of the free modes of vibration. The requirement that both γ and γ^* are roots of Eq. (6.77) means, on the basis of Eq. (6.75), that if ω_i is a root of $D(\omega)$, then $-\omega_i^*$ is a root. For a system of n degrees of freedom, it is therefore possible to represent $D(\omega)$ as

$$D(\omega) = G(\omega - \omega_1)(\omega - \omega_2) \dots (\omega - \omega_n)(\omega + \omega_1^*)(\omega + \omega_2^*) \dots (\omega + \omega_n^*),$$

where G is some constant. Using product notation, and denoting ω by $2\pi v$, this representation can be written as

$$D(\omega) = G \prod_{i=1}^n (2\pi(v - v_i) + i\kappa_i) (2\pi(v + v_i) + i\kappa_i). \quad (6.83)$$

When we rationalize Eq. (6.83) to separate A_i into its real and imaginary parts, the denominator will be

$$D^*(\omega)D(\omega) = GG^* \prod_{i=1}^n (4\pi^2(v - v_i)^2 + \kappa_i^2)(4\pi^2(v + v_i)^2 + \kappa_i^2). \quad (6.84)$$

The amplitudes of the forced oscillation thus exhibit typical resonance behavior in the neighborhood of the frequencies of free oscillations $\pm v_i$. As a result of the presence of the damping constants κ_i , the resonance denominators no longer vanish at the free mode frequencies, and the amplitudes remain finite. The driving frequency at which the amplitude peaks is no longer exactly at the free frequencies because of frequency dependence of terms in A_j other than the particular resonance denominator. However, so long as the damping is small enough to preserve a recognizable resonant peak, the shift in the resonance frequencies is usually small.

We have discussed the properties of small oscillations solely in terms of mechanical systems. The reader however has undoubtedly noticed the similarity with the theory of the oscillations of electrical networks. The equations of motion (6.68) become the circuit equations for n coupled circuits if we read the V_{ij} coefficients as reciprocal capacitances, the \mathcal{F}_{ij} 's as resistances, and the T_{ij} 's as inductances. Driving forces are replaced by generators of frequency ω applied to one or more of the circuits, and the equations of forced vibration (6.80) reduce to the electrical circuit equations (2.42) mentioned in Chapter 2.

We have presented here only a fraction of the techniques that have been devised for handling small oscillations, and of the general theorems about the motion. For example, space does not permit a discussion of the powerful Laplace transform techniques to study the response of a linearly oscillating system to driving forces

with arbitrary time dependencies. Nor is it appropriate here to fully consider the extensive subject of nonlinear oscillations, where the potential energy contains terms beyond the quadratic, and the motion is no longer simple harmonic. (Some relevant portions of this field will be introduced later when we treat chaos and perturbation theory). As mentioned earlier, a formal development of the theory of small oscillations about steady motion will be given later in connection with the Hamiltonian version of mechanics. Another generalization that will deserve our attention relates to the oscillation of systems with continuously infinite numbers of degrees of freedom. The question is how we can construct a way of handling continuous systems that is analogous to the classical mechanics of discrete systems. We shall postpone such considerations of continuous systems to Chapter 13—after we have developed the canonical formulation of discrete mechanics, and after we have seen how the structure of Newtonian mechanics must be modified in the special theory of relativity.

6.6 ■ BEYOND SMALL OSCILLATIONS: THE DAMPED DRIVEN PENDULUM AND THE JOSEPHSON JUNCTION

As an example of forced vibrations with dissipative forces, we consider the motion of the pendulum sketched in Fig. 6.6, which is subjected to an applied torque N , and is permitted to rotate through its full range of motion $-\pi \leq \phi \leq \pi$. In addition, the pendulum is subject to damping by the *viscosity* η of the medium in which it rotates. For simplicity, we will assume that the rod is massless, and that all of the pendulum mass is concentrated at the end of the rod.

Let us begin by recalling the dynamics of a simple pendulum of length R and mass m . The angular acceleration of the pendulum is produced by the restoring

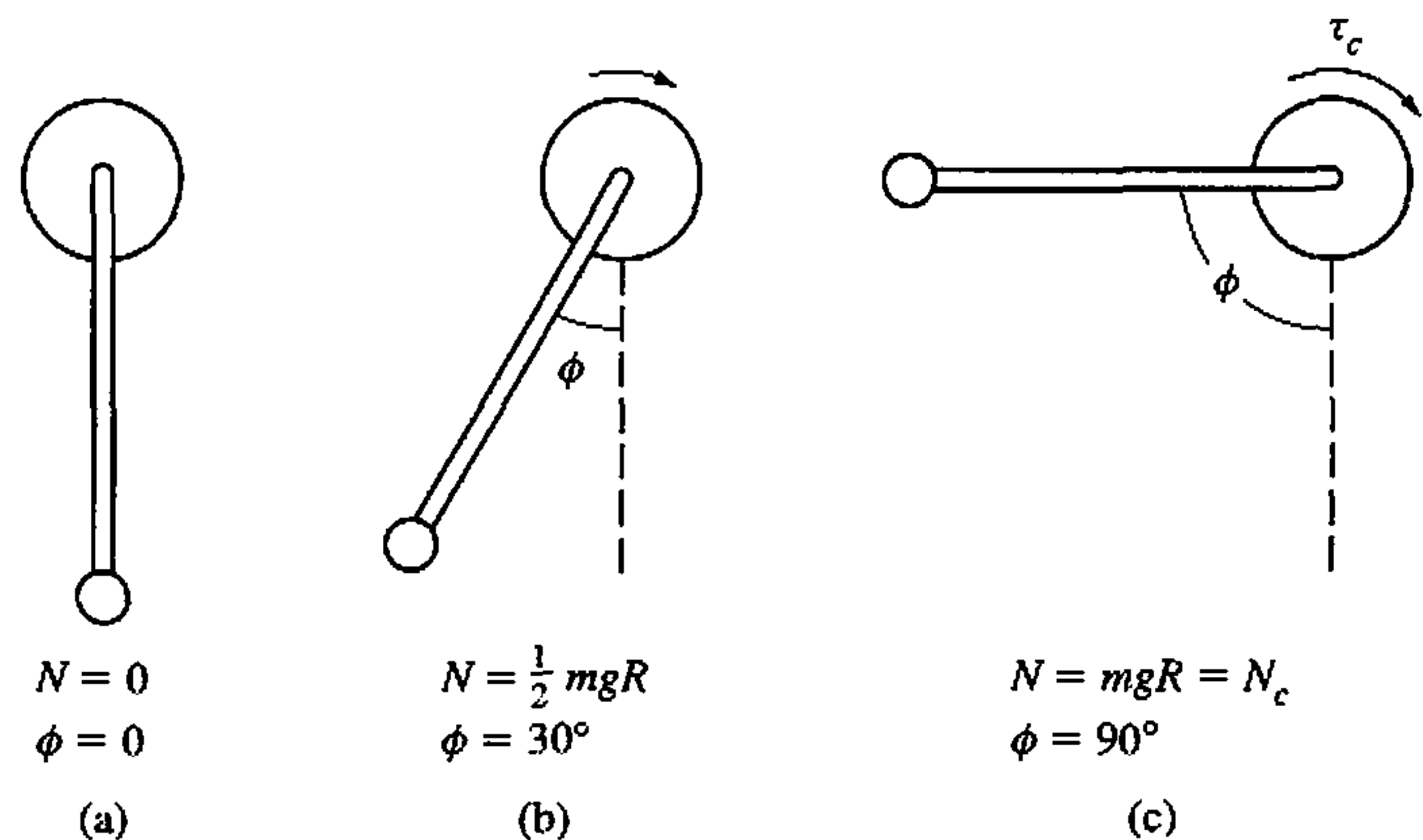

FIGURE 6.6 Pendulum (a) with no applied torque, $N = 0$, (b) with the torque $N = \frac{1}{2} mgR$, and (c) with the critical torque applied, $N_c = mgR$. Figures 6.6, 6.8, 6.10, and 6.11 are adapted from C. P. Poole, Jr., H. A. Farach and R. J. Creswick, "Superconductivity," Wiley, NY, 1995.

gravitational torque $mgR \sin \phi$ corresponding to the equation of motion

$$mR^2 \frac{d^2\phi}{dt^2} + mgR \sin \phi = 0, \quad (6.85)$$

where $I = mR^2$ is the moment of inertia. For small angular displacements, the approximation $\sin \phi \approx \phi$ linearizes the problem by making the torque proportional to the displacement, and the motion is simple harmonic, $\phi = \phi_0 \sin \omega t$ with the *characteristic frequency* ω_0

$$\omega_0 = \left(\frac{g}{R} \right)^{1/2} \quad (6.86)$$

If a torque N is applied to a stationary pendulum, it will swing out through an angle ϕ . The force of gravity acting on the mass m provides the restoring torque $mgR \sin \phi$, as we noted above, and the pendulum assumes an equilibrium position at the angle ϕ given by

$$N = mgR \sin \phi \quad \left(\frac{d\phi}{dt} = 0 \right), \quad (6.87)$$

as indicated in Fig. 6.6b. The greater the torque, the larger the angle ϕ . There is a critical torque N_c indicated on Fig. 6.6(c) for which the angle ϕ assumes the values $\pi/2$:

$$N_c = mgR. \quad (6.88)$$

If N exceeds this critical value, then the applied torque becomes larger than the restoring torque, $N > mgR \sin \phi$, for all angles ϕ . As a result, the pendulum will begin to rotate beyond $\phi = \pi/2$, and it will continue to rotate as long as the torque $N > N_c$ is applied. The motion will take place at a variable angular speed ω

$$\omega = \frac{d\phi}{dt}, \quad (6.89)$$

and it can persist if the torque is later removed.

With these facts in mind, let us proceed to examine the case of the damped pendulum assuming that the damping force $F_{\text{damp}} = \eta\omega$ is proportional to the angular velocity ω . To write the differential equation of its motion, we add the restoring and damping torques $mgR \sin \phi$ and $\eta d\phi/dt$, respectively, to Eq. (6.85):

$$N = mR^2 \frac{d^2\phi}{dt^2} + \eta \frac{d\phi}{dt} + mgR \sin \phi. \quad (6.90)$$

If we define a *critical frequency* ω_c corresponding to the angular speed at which the damping torque $\eta\omega$ equals the *critical torque* mgR ,

$$\omega_c = \frac{mgR}{\eta} = \frac{N_c}{\eta}, \quad (6.91)$$

then we can write the pendulum equation (6.90) in the normalized form

$$\frac{N}{N_c} = \frac{1}{\omega_0^2} \frac{d^2\phi}{dt^2} + \frac{1}{\omega_c} \frac{d\phi}{dt} + \sin\phi. \quad (6.92)$$

The solutions of this equation exhibit complex time variations of the angular position $\phi(t)$.

When a constant torque is applied to the pendulum at rest, there will be a initial transient behavior that eventually settles down to a *dynamic steady state* after the transients die out. We shall examine several cases of this dynamic steady state.

1. For low applied torques, $N \leq N_c$, there is a *static steady state*

$$N = N_c \sin\phi, \quad (6.93)$$

in which all time derivatives vanish after the initial oscillations have died out. This is illustrated in Fig. 6.6b with the pendulum stationary at the angle ϕ .

2. For undamped motion ($\eta = 0$) with a constant applied torque, N , Eq. (6.90) assumes the form

$$\text{torque} = N - mgR \sin\phi = mR^2 \frac{d^2\phi}{dt^2}, \quad (6.94)$$

so we see that the acting torque is angularly dependent. This torque has special values at four particular angles:

$$\text{torque} = N \quad \phi = 0 \quad (6.95a)$$

$$\text{torque} = N - N_c \quad \phi = \pi/2 \quad (6.95b)$$

$$\text{torque} = N \quad \phi = \pi \quad (6.95c)$$

$$\text{torque} = N + N_c \quad \phi = 3\pi/2 \quad (6.95d)$$

If the applied torque N exceeds the critical torque N_c , the motion will be continuously accelerated rotation, and the pendulum increases its energy as time goes on. The angular speed also increases with time, but with fluctuations that repeat every cycle, as indicated in Fig. 6.7. Note that Fig. 6.7 is drawn for the case where damping is present. The average over these oscillations provides the average angular speed

$$\langle\omega\rangle = \left\langle \frac{d\phi}{dt} \right\rangle, \quad (6.96)$$

which continually increases linearly with the time.

3. When damping is present with $\omega_c \ll \omega_0$ and $N > N_c$, the angular speed ω continues to increase until the damping term $\eta d\phi/dt$ approaches the

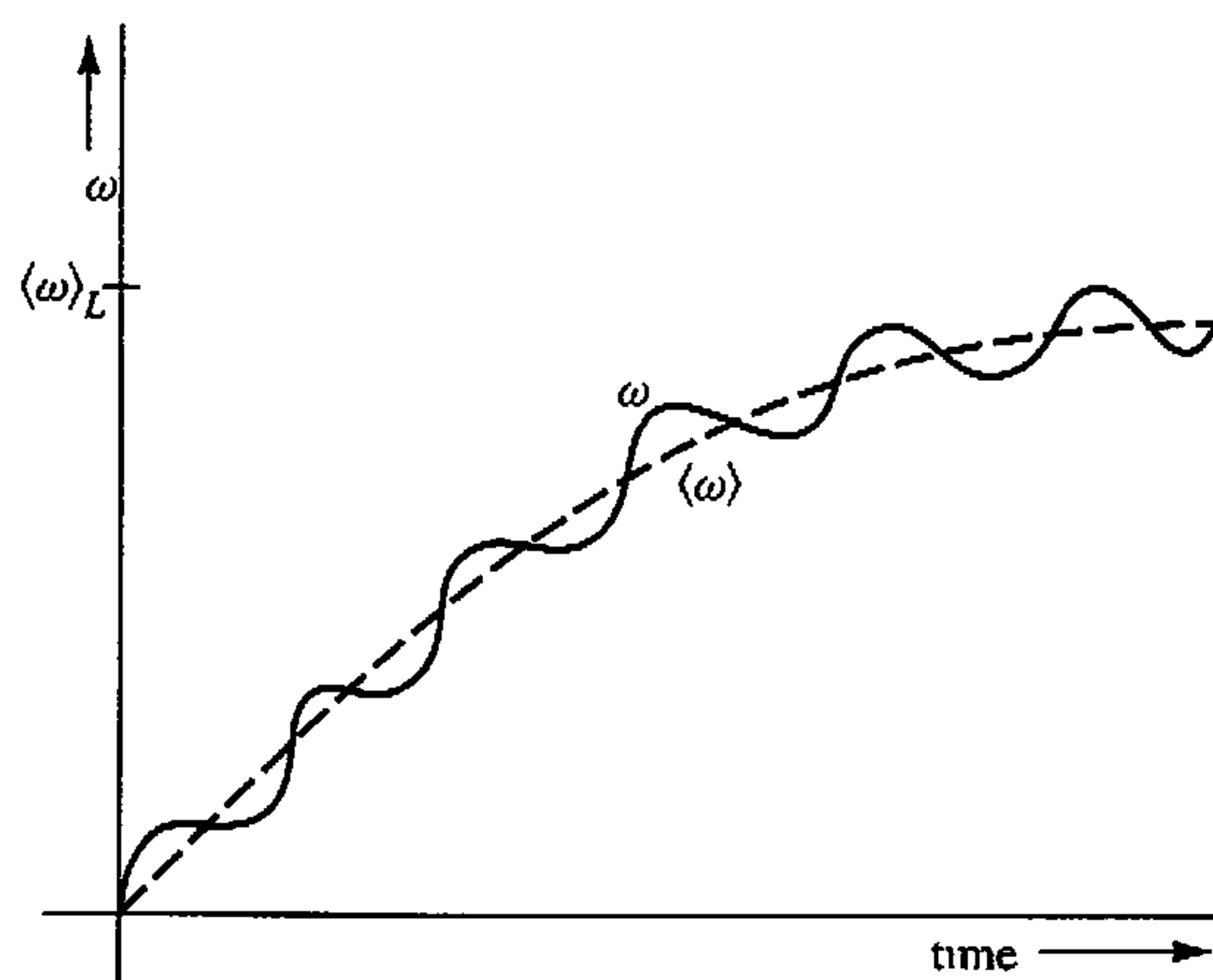

FIGURE 6.7 Dependence of the angular velocity $\omega = d\phi/dt$ on the time for an applied torque $N > N_c$. The average value $\langle\omega\rangle$ increases linearly with time in the absence of damping (linear region), and the overall curve applies to the case $\omega_e \ll \omega_0$ with damping.

value of the applied torque. When this occurs, the average angular speed $\langle\omega\rangle$ approaches a limiting value $\langle\omega\rangle_L$, as shown in Fig. 6.7, and the acceleration fluctuates around an average that is zero: $\langle d^2\phi/dt^2 \rangle = 0$. The pendulum undergoes what is called *quasi-static motion*, rotating with an angular speed ω that undergoes periodic variations but always remains close to the average $\langle\omega\rangle_L$.

To obtain more insight into this quasi-static behavior, we neglect the acceleration term in the equation of motion (6.92), and write

$$\frac{N}{N_c} = \frac{1}{\omega_c} \frac{d\phi}{dt} + \sin\phi, \quad (6.97)$$

which is an equation that can be solved analytically with the solutions

$$\langle\omega\rangle = 0 \quad \text{for } N < N_c \quad (6.98a)$$

$$\langle\omega\rangle = \omega_c [(N/N_c)^2 - 1]^{1/2} \quad \text{for } N > N_c \quad (6.98b)$$

$$\langle\omega\rangle = (N/N_c)\omega_c \quad \text{for } N \gg N_c, \quad (6.98c)$$

which are plotted in Fig. 6.8. The actual cyclic variations in ω for points A and B on this plot are presented in Fig. 6.9. At point A, the applied torque has the value $N = 1.2N_c$, so from Eqs. (6.95) the net torque varies between $0.2N_c$ and $2.2N_c$ around the cycle, and the angular speed is fast at the bottom and slow at the top, with the variations shown at the lower part of Fig. 6.9. For point B, we have $N = 2N_c$ so the net torque varies between N_c and $3N_c$, producing the more regular variations in angular speed presented

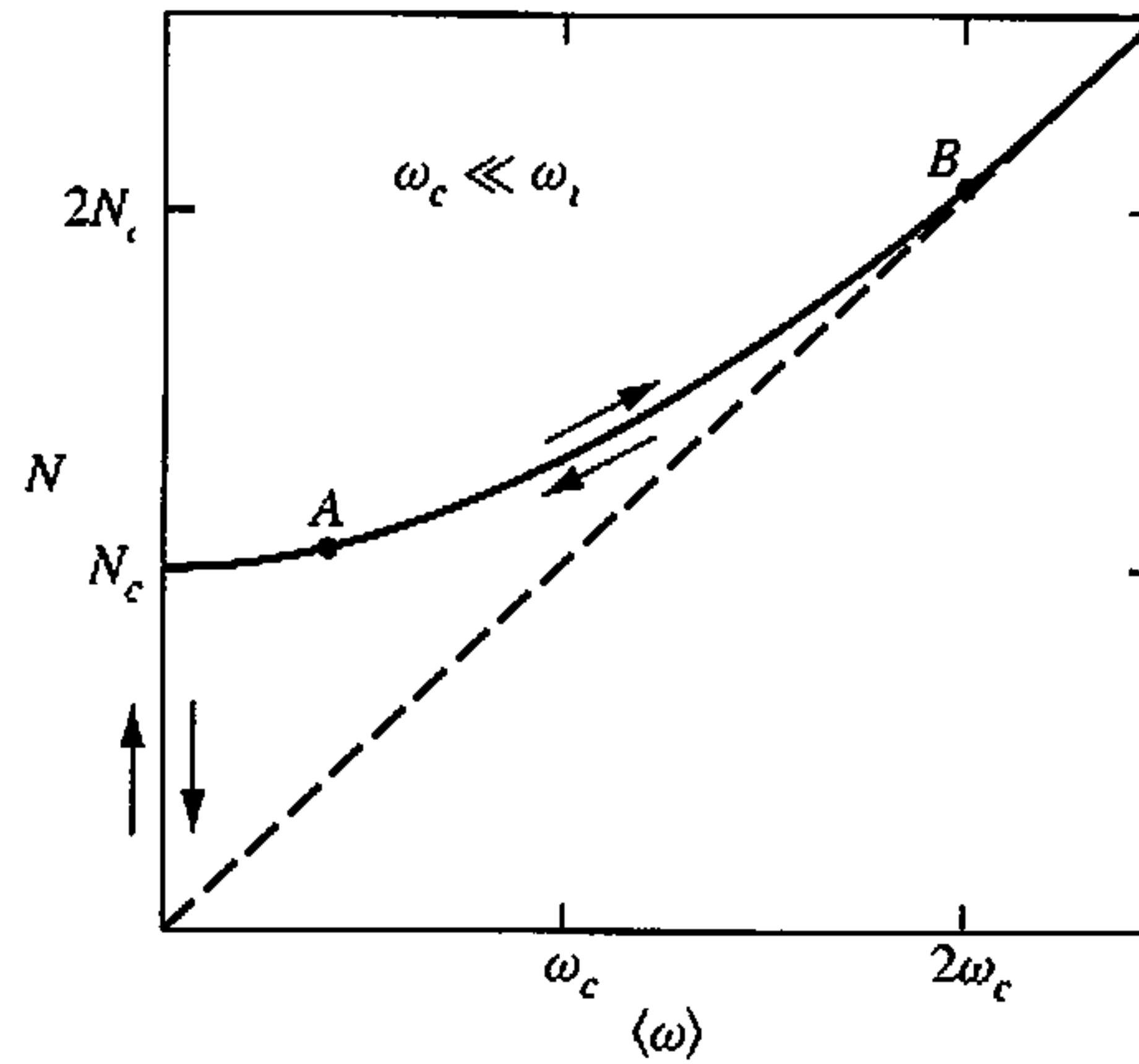

FIGURE 6.8 Relationship between the applied torque N and the average angular velocity $\langle \omega \rangle$ for $\omega_c \ll \omega_0$. We see that $\langle \omega \rangle = 0$ for $N < N_c$ and $\langle \omega \rangle$ increases with increasing $N > N_c$.

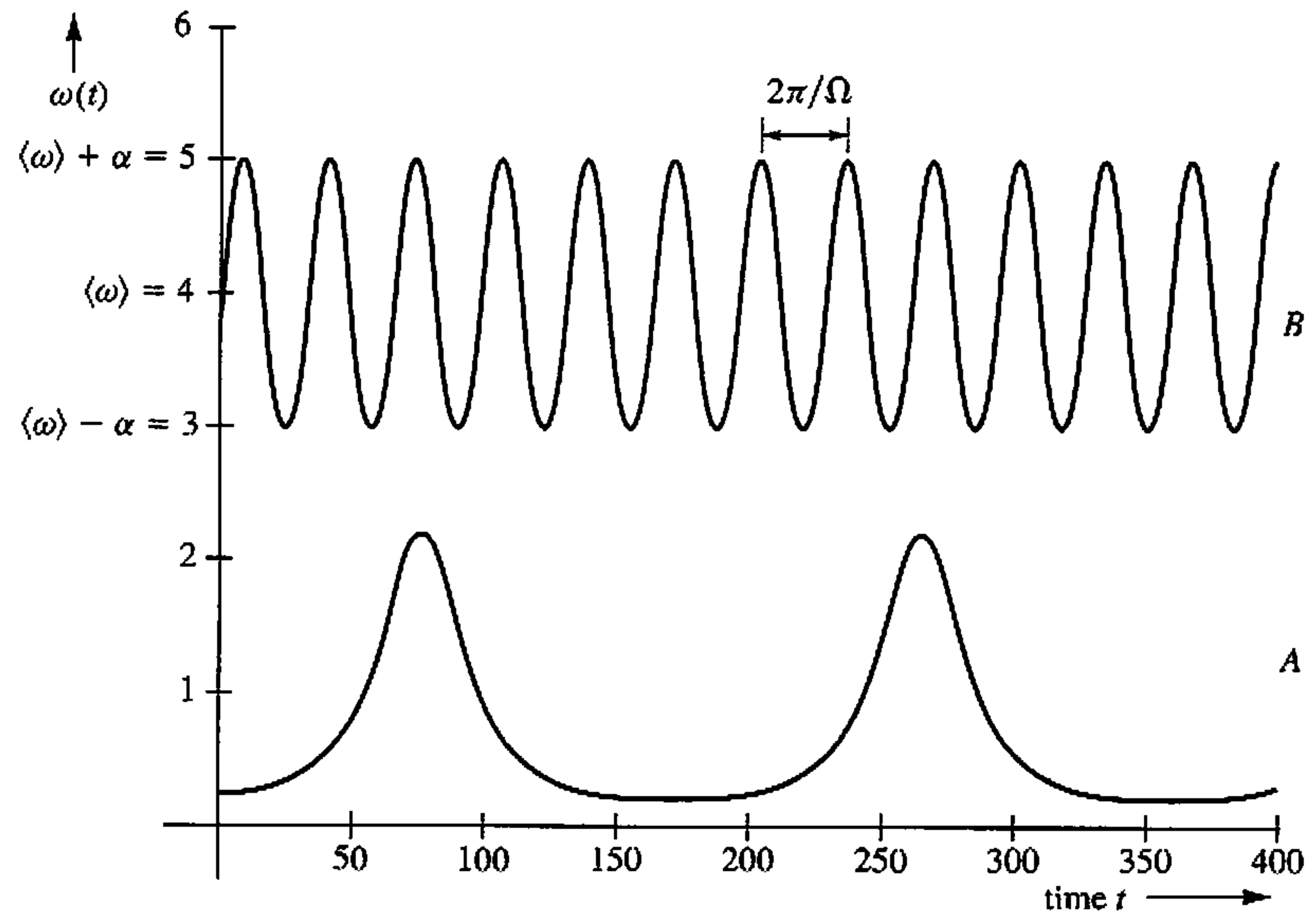

FIGURE 6.9 Oscillations at points A ($N = 1.2N_c$) and B ($2N_c$) for $\omega_c \ll \omega_0$ indicated on Fig. 6.8 for the damped harmonic oscillator. Adapted from A. Barone and G. Paterno, "Physics and Applications of the Josephson Effect," Wiley, NY, 1982.

at the top of Fig. 6.9. In the limit $N \gg N_c$, meaning $\langle \omega \rangle \gg \omega_c$, the angular speed begins to approximate a sinusoidal variation with time

$$\omega(t) \approx \langle \omega \rangle + \alpha \sin \Omega t, \quad (6.99)$$

which approximates point *B* in Fig. 6.8.

4. For the negligible damping case ($\eta \rightarrow 0$ and $\omega_c \gg \omega_0$), the steady-state solution (6.98a) can still occur for $N < N_c$ with the pendulum held fixed at the angle ϕ defined by Eq. (6.93), which means that $\omega = \langle \omega \rangle = 0$. In addition, the solution, (6.98c), in which the torque balances the time averaged damping force, now applies for all values of N , both less than and greater than N_c , and so we have

$$\omega = 0 \quad \text{for } N \leq N_c \quad (6.100a)$$

$$\langle \omega \rangle = (N/N_c)\omega_c \quad \text{for } 0 \leq N \quad (6.100b)$$

These solutions are plotted in Fig. 6.10. Note from the figure that the system exhibits hysteresis, meaning that the behavior differs for increasing and decreasing torques. When the torque is increased for $N < N_c$, the pendulum is stabilized at the angle ϕ satisfying the relation $N = N_c \sin \phi$ of Eq. (6.87), so $\omega = 0$ via Eq. (6.100a). When N reaches the critical torque N_c , the angular speed jumps to the value ω_c , and then rises linearly with further increases in N , as shown in the figure. For decreasing torques, Eq. (6.100b) applies, and $\langle \omega \rangle$ remains proportional to N all the way to the origin, as shown.

5. Figure 6.8 shows the response for $\omega_c \ll \omega_0$, Fig. 6.10 presents it for $\omega_c \gg \omega_0$, and the question arises as to what is the behavior for an intermediate condition such as $\omega_c \approx \omega_0$? This requires solving the general

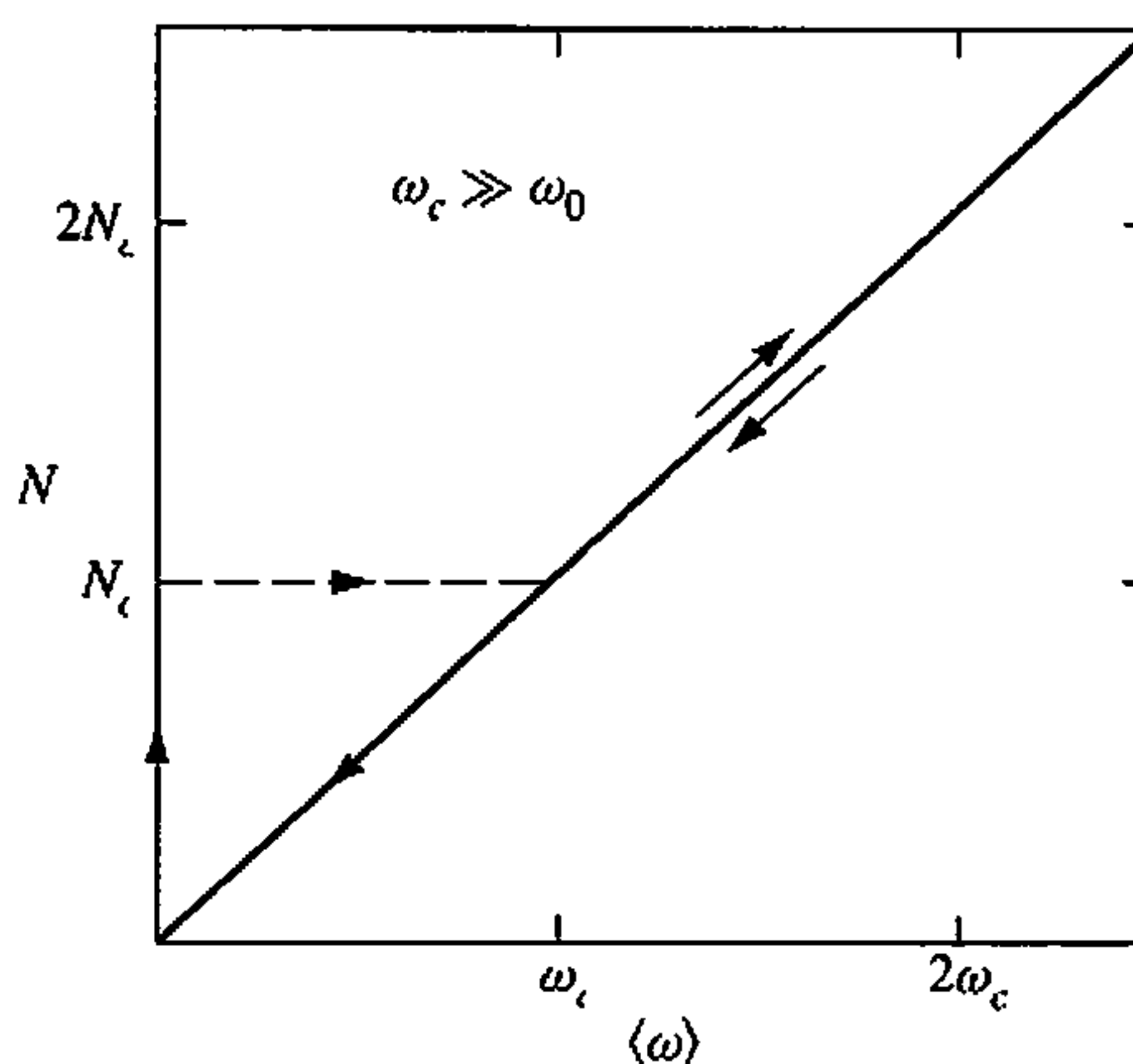

FIGURE 6.10 Relationship between the applied torque N and the average angular velocity $\langle \omega \rangle$ for $\omega_c \gg \omega_0$. There is hysteresis for the behavior when $\langle \omega \rangle < \omega_c$.

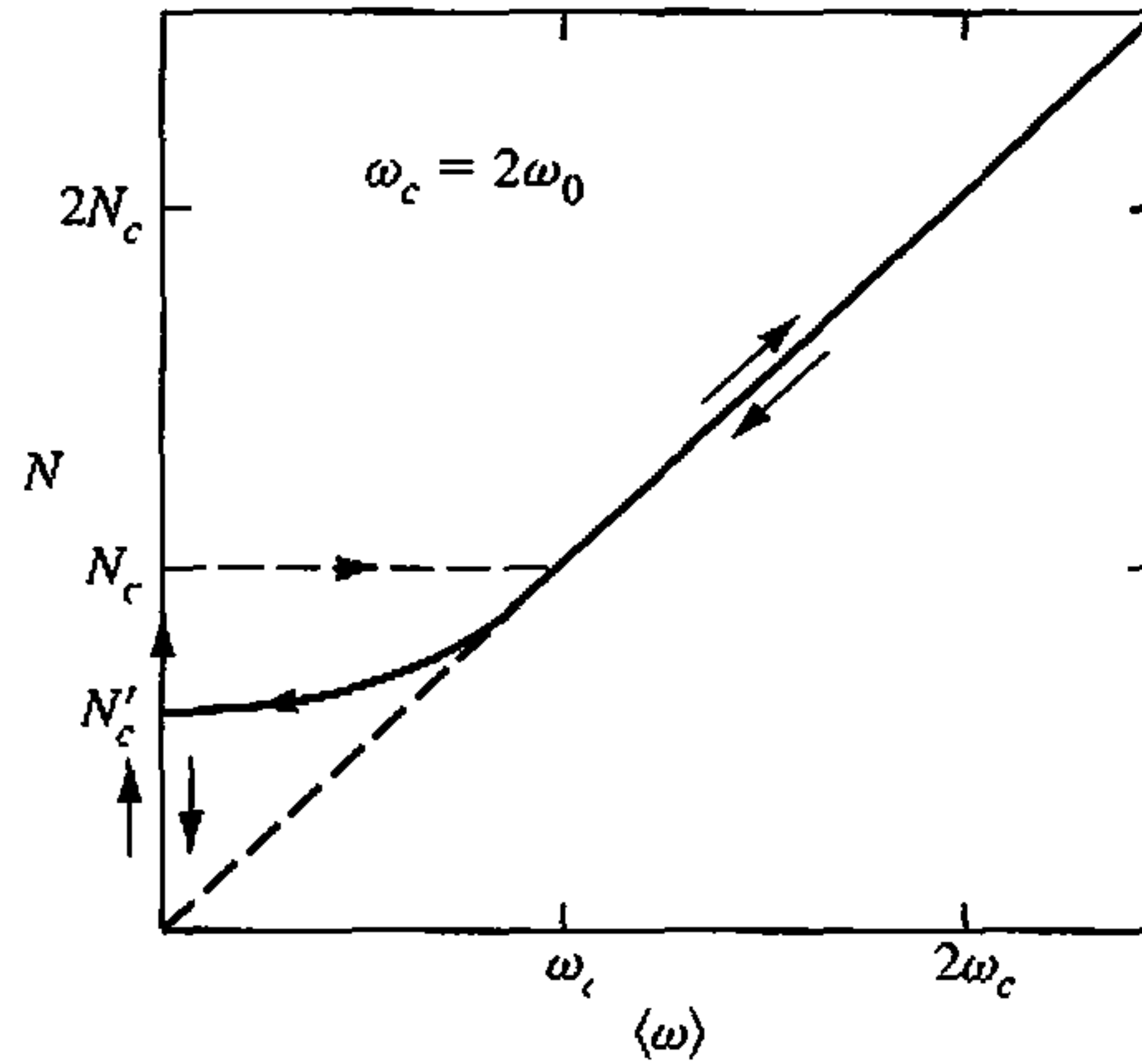

FIGURE 6.11 Relationship between the average angular velocity of the pendulum $\langle \omega \rangle$ and the applied torque N . For low applied torques, the pendulum oscillates and the average velocity is zero, whereas at high torques, $N > N_c$, motion is continuous with $\langle \omega \rangle$ proportional to N . Note the hysteresis for increasing and decreasing torques.

equation (6.92) since no approximations can be made. The N versus $\langle \omega \rangle$ characteristic for the particular case $\omega_c = 2\omega_0$ is plotted in Fig. 6.11. We see from the figure that for increasing torques there is the usual initial rise in N at zero frequency until the critical value N_c is reached, at which point the average angular speed jumps to ω_c , as in the $\omega_c \gg \omega_0$ case of Fig. 6.10. For decreasing torques, there is hysteresis with zero average frequency reached at a torque N'_c , which is less than N_c .

The damped-driven pendulum equation (6.92) has a particularly important application in solid-state physics. When two superconductors are in close proximity with a thin layer of insulating material between them, the arrangement constitutes a *Josephson junction*, which has the property that electric current I can flow across the junction with zero applied voltage, up to a certain critical value I_c . Current exceeding this value is accompanied by the presence of a voltage, and plots of current I versus voltage V for the junction exhibit *hysteresis*. The Josephson junction satisfies the same differential equation (6.93) as the damped oscillator with the current playing the role of the torque, the voltage playing the role of the average angular speed, the capacitance acting like a moment of inertia, and the electrical conductance serving as the viscosity. The variable, which is the angle ϕ for the oscillator, becomes the phase difference ψ across the Josephson junction. Many physicists find it helpful to obtain an intuitive understanding of the operation of the Josephson junction by studying properties of the damped driven pendulum that mimics its behavior.

DERIVATIONS

1. The problem of the linear triatomic molecule can be reduced to one of two degrees of freedom by introducing coordinates $y_1 = x_2 - x_1$, $y_2 = x_3 - x_2$, and eliminating x_2 by requiring that the center of mass remain at rest. Obtain the frequencies of the normal modes in these coordinates and show that they agree with the results of Section 6.4. The distances between the atoms, y_1 and y_2 , are known as *internal coordinates*.
2. Obtain the frequencies of longitudinal vibration of the molecule discussed in Section 6.4, except that now the center atom is to be considered bound to the origin by a spring of force constant k . Show that the translational mode disappears

EXERCISES

3. A bead of mass m is constrained to move on a hoop of radius R . The hoop rotates with constant angular velocity ω around a diameter of the hoop, which is a vertical axis (line along which gravity acts).
 - (a) set up the Lagrangian and obtain the equations of motion of the bead.
 - (b) Find the critical angular velocity Ω below which the bottom of the hoop provides a stable equilibrium for the bead.
 - (c) Find the stable equilibrium position for $\omega > \Omega$.
4. Obtain the normal modes of vibration for the double pendulum shown in Fig. 1.4, assuming equal lengths, but not equal masses. Show that when the lower mass is small compared to the upper one, the two resonant frequencies are almost equal. If the pendula are set in motion by pulling the upper mass slightly away from the vertical and then releasing it, show that subsequent motion is such that at regular intervals one pendulum is at rest while the other has its maximum amplitude. This is the familiar phenomenon of "beats."
5. (a) In the linear triatomic molecule, suppose the initial condition is that the center atom is at rest but displaced by an amount a_0 from equilibrium, the other two being at their equilibrium points. Find the amplitudes of the longitudinal small oscillations about the center of mass. Give the amplitudes of the normal modes
 - (b) Repeat part (a) but with the center atom initially at its equilibrium position but with an initial speed v_0 .
6. (a) A five-atom linear molecule is simulated by a configuration of masses and ideal springs that looks like the following diagram:

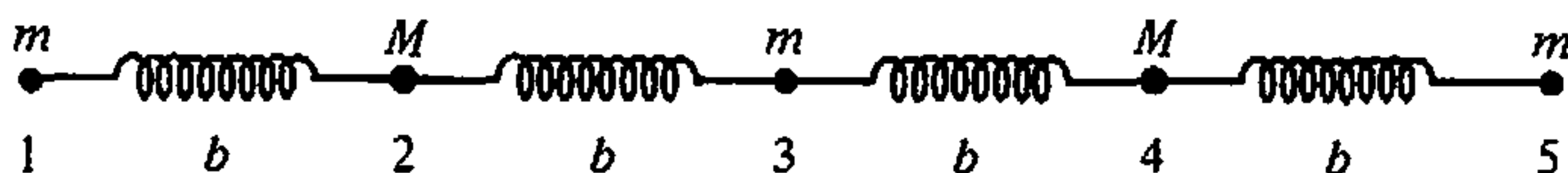

All force constants are equal. Find the eigenfrequencies and normal modes for longitudinal vibrations. [Hint: Transform the coordinates η_i to ζ_i defined by

$$\eta_3 = \zeta_3, \quad \eta_1 = \frac{\zeta_1 + \zeta_5}{\sqrt{2}}, \quad \eta_5 = \frac{\zeta_1 - \zeta_5}{\sqrt{2}}$$

with symmetrical expressions for η_2 and η_4 . The secular determinant will then factor into determinants of lower rank.]

(b) Solve this problem using computer techniques.

7. In the linear triatomic molecule, suppose that motion in the y and z directions is governed by the potentials

$$V_y = \frac{k}{2}(y_2 - y_1)^2 + \frac{k}{2}(y_3 - y_2)^2,$$

$$V_z = \frac{k}{2}(z_2 - z_1)^2 + \frac{k}{2}(z_3 - z_2)^2.$$

Find the eigenfrequencies for small vibrations in three dimensions and describe the normal modes. What symmetries do the zero frequencies represent? You may want to use the kind of intermediate coordinates suggested in Exercise 6.

8. The equilibrium configuration of a molecule is represented by three atoms of equal mass at the vertices of a 45° right triangle connected by springs of equal force constant. Obtain the secular determinant for the modes of vibration in the plane and show by rearrangement of the columns that the secular equation has a triple root $\omega = 0$. Reduce the determinant to one of third rank and obtain the nonvanishing frequencies of free vibration.
9. Show directly that the equations of motion of the preceding problem are satisfied by (a) a uniform translation of all atoms along the x axis, (b) a uniform translation along the y axis, and (c) a uniform rotation about the z axis
10. (a) Three equal mass points have equilibrium positions at the vertices of an equilateral triangle. They are connected by equal springs that lie along the arcs of the circle circumscribing the triangle. Mass points and springs are constrained to move only on the circle, so that, for example, the potential energy of a spring is determined by the arc length covered. Determine the eigenfrequencies and normal modes of small oscillations in the plane. Identify physically any zero frequencies.
- (b) Suppose one of the springs has a change in force constant δk , the others remaining unchanged. To first order in δk , what are the changes in the eigenfrequencies and normal modes?
- (c) Suppose what is changed is the mass of one of the particles by an amount δm . Now how do the normal eigenfrequencies and normal modes change?
11. A uniform bar of length l and mass m is suspended by two equal springs of equilibrium length b and force constant k , as shown in the diagram.

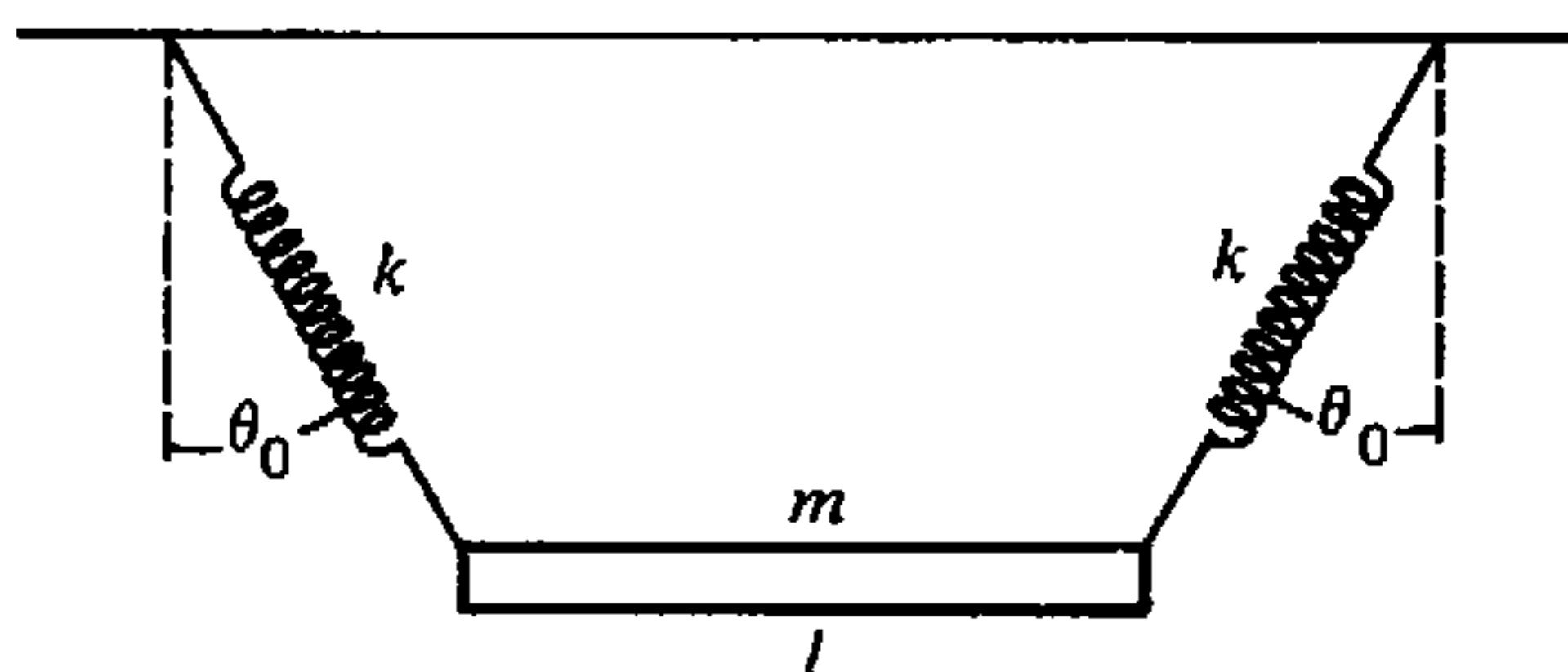

Find the normal modes of small oscillation in the plane.

12. Two particles move in one dimension at the junction of three springs, as shown in the figure. The springs all have unstretched lengths equal to a , and the force constants and masses are shown

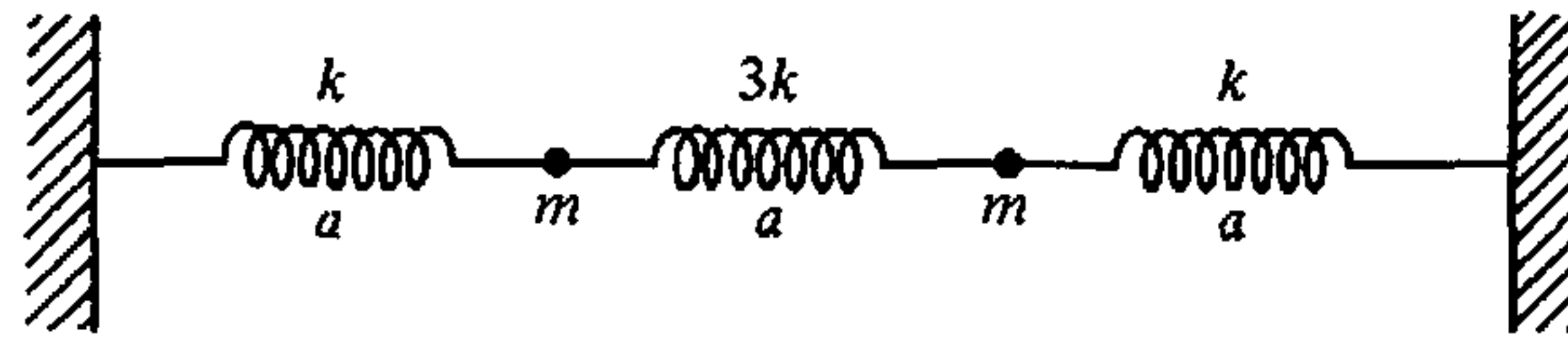

Find the eigenfrequencies and normal modes of the system.

13. Two mass points of equal mass m are connected to each other and to fixed points by three equal springs of force constant k , as shown in the diagram.

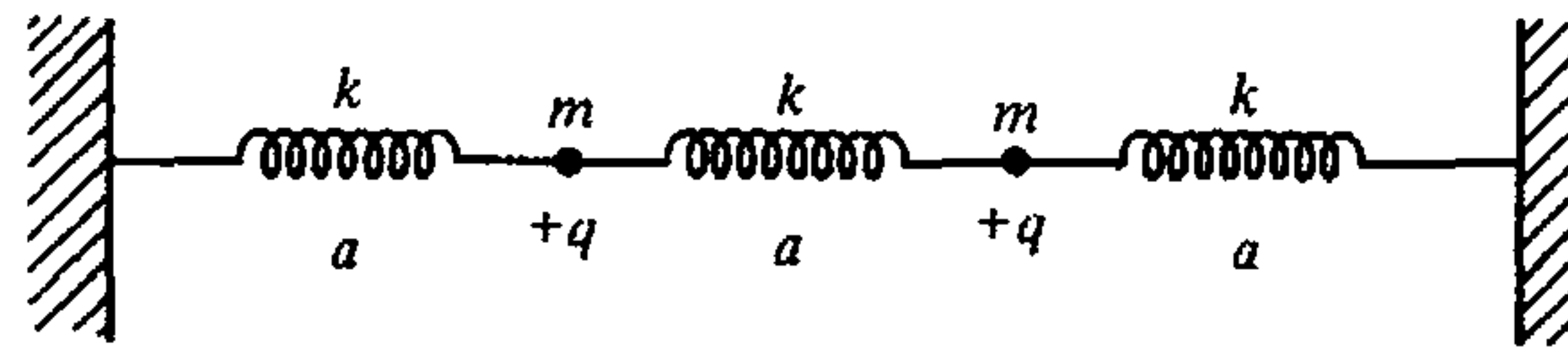

The equilibrium length of each spring is a . Each mass point has a positive charge $+q$, and they repel each other according to the Coulomb law. Set up the secular equation for the eigenfrequencies.

14. Find expressions for the eigenfrequencies of the following electrical coupled circuit.

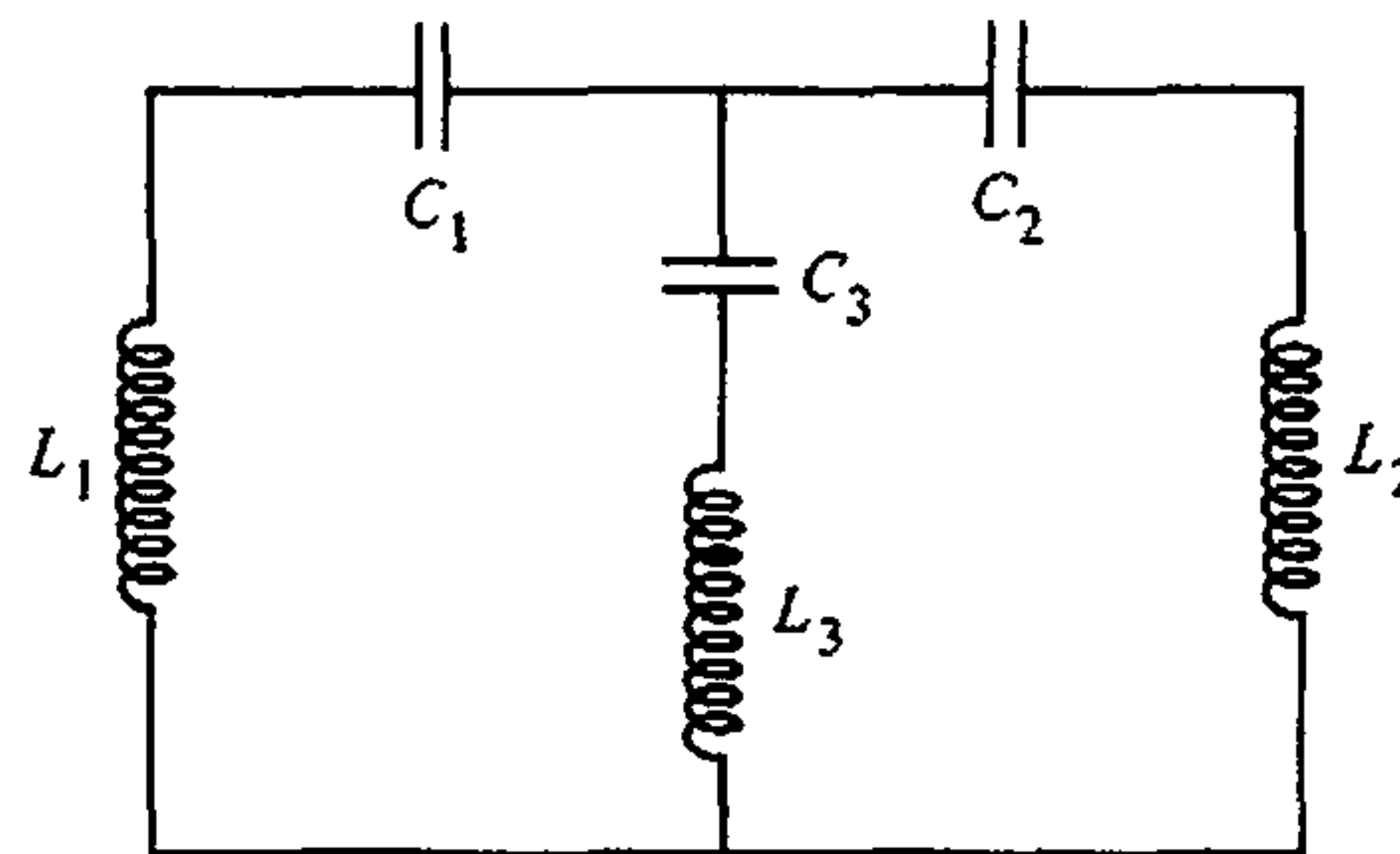

15. If the generalized driving forces Q_i are not sinusoidal, show that the forced vibrations of the normal coordinates in the absence of damping are given by

$$\zeta_i = \frac{1}{\sqrt{2\pi}} \int_{-\infty}^{+\infty} \frac{G_i(\omega)}{\omega_i^2 - \omega^2} e^{-i\omega t} d\omega,$$

where $G_i(\omega)$ is the Fourier transform of Q_i defined by

$$Q_i(t) = \frac{1}{\sqrt{2\pi}} \int_{-\infty}^{+\infty} G_i(\omega) e^{-i\omega t} d\omega.$$

If the dissipation function is simultaneously diagonalized along with T and V , show that the forced vibrations are given by

$$\zeta_i = \frac{1}{\sqrt{2\pi}} \int_{-\infty}^{+\infty} \frac{G_i(\omega)(\omega_i^2 - \omega^2 + i\omega\mathcal{F}_i)}{(\omega_i^2 - \omega^2)^2 + \omega^2\mathcal{F}_i^2} e^{-i\omega t} dt,$$

which has the typical resonance denominator form. These results are simple illustrations of the powerful technique of the *operational calculus* for handling transient vibrations.

16. A mass particle moves in a constant vertical gravitational field along the curve defined by $y = ax^4$, where y is the vertical direction. Find the equation of motion for small oscillations about the position of equilibrium.
17. A plane triatomic molecule consists of equal masses m at vertices of an equilateral triangle of sides a . Assume the molecule is held together by forces that are harmonic for small oscillations and that the force constants are identical and equal to k . Allow motion only in the plane of the molecule.
 - (a) Without writing the equations of motion, justify your reasoning on the number of normal modes of the system and how many of these modes have zero frequency.
 - (b) One of the normal modes corresponds to a symmetrical stretching of all three vertices of the molecule. Find the frequency of this mode.
18. A particle in an isotropic three-dimensional harmonic oscillator potential has a natural frequency of ω_0 . Assume the particle is charged and that crossed static electric and magnetic fields are applied. Find the vibration frequencies with these electromagnetic fields present. Discuss the results for the limits of strong and weak fields.
19. Show for the case $V_{11} > V_{22} > 0$ and $V_{12} = V_{21} = 0$ in Eq. (6.27) that there are two normal modes with frequencies $\omega_1 = (V_{11})^{1/2}$ and $\omega_2 = (V_{22})^{1/2}$. Reintroduce the mass factor m and describe a physical system that would show this behavior for small oscillations.
20. Write the Lagrangian for the case $V_{11} = V_{22} = 0$ and $V_{12} = V_{21} > 0$ for the example discussed in Eqs. (6.27) to (6.30). Show there is one normal mode of simple harmonic motion with the frequency $\omega_1 = (V_{12})^{1/2}$, and a second mode in which the particle is unbound, receding exponentially to infinity for long time $t > \tau$ in accordance with the expression $e^{-t/\tau}$, where the parameter τ is given by $\tau = (V_{12})^{-1/2}$. For this unbounded mode, how does the distance depend upon time when $t < \tau$? What is the nature of the point $x_1 = x_2 = 0$? Restate your results with the mass parameter m included explicitly.
21. Write the Lagrangian discussed in Eqs. (6.27) to (6.30) in polar coordinates for the case $V_{11} = V_{22} > 0$ and $V_{12} = V_{21} = 0$. Show that there is a radial normal mode $r = r_0 \cos(\omega t)$ with frequency $\omega = (V_{11})^{1/2}$ when the angular momentum is zero. Show that in the case of nonzero angular momentum, the angular momentum is conserved and the particle can no longer reach $r = 0$. Write the fictitious potential energy $V'(r)$ (Chapter 3) for nonzero angular momentum. When finished, reintroduce the mass parameter, m , into all equations.
22. Repeat Exercise 21 with the conditions $V_{11} > V_{22} < 0$ and $V_{12} = V_{21} = 0$ and discuss your results in terms of the effective potential energy of Chapter 3.
23. Make a full analysis of the example discussed in Eqs. (6.27) to (6.30).

CHAPTER

7

The Classical Mechanics of the Special Theory of Relativity

At the end of the nineteenth century, the physics community had two incompatible descriptions of phenomena, Newtonian mechanics and Maxwellian electromagnetic theory. Newtonian mechanics assumed that all inertial frames were equivalent, while Maxwell's wave equations gave a universal speed of light that was the same in all inertial frames. Albert Einstein developed the special theory of relativity to replace Newtonian mechanics with a theory that was consistent with electromagnetic theory. After a brief historical survey, we shall review the assumptions of the special theory and the consequences of these assumptions. We shall then examine the formalism of the geometric picture of spacetime that results. Lastly, we develop a Lagrangian formalism and study attempts to express the results in a proper relativistic form.

In Newtonian mechanics, a set of well-verified laws applies in an inertial frame of reference defined by the first law. Any frame moving at constant velocity with respect to an inertial frame is also an inertial frame. Consider two frames denoted by S and S' with (t, x, y, z) and (t', x', y', z') the coordinates in S and S' , respectively. Without loss of generality, we assume the coordinate axes are aligned, x along x' , and so on. Let S' be moving relative to S in the $+x$ -direction at a speed v , as shown in Figure 7.1.

Newtonian mechanics assumes the spacetime coordinates in S are related to those in S' by the simple expressions

$$\begin{aligned}t' &= t \\x' &= x - vt \\y' &= y \\z' &= z.\end{aligned}\tag{7.1}$$

Transformations of this type are called *Galilean transformations*. Under this assumption, it follows that Newton's second law,

$$\mathbf{F} = \frac{d}{dt}\mathbf{p},$$

relating the applied force, \mathbf{F} , and the momentum, \mathbf{p} , remains invariant, and

$$\mathbf{F} = \mathbf{F}', \quad t = t', \quad \text{and} \quad \mathbf{p} = \mathbf{p}'.\tag{7.2}$$

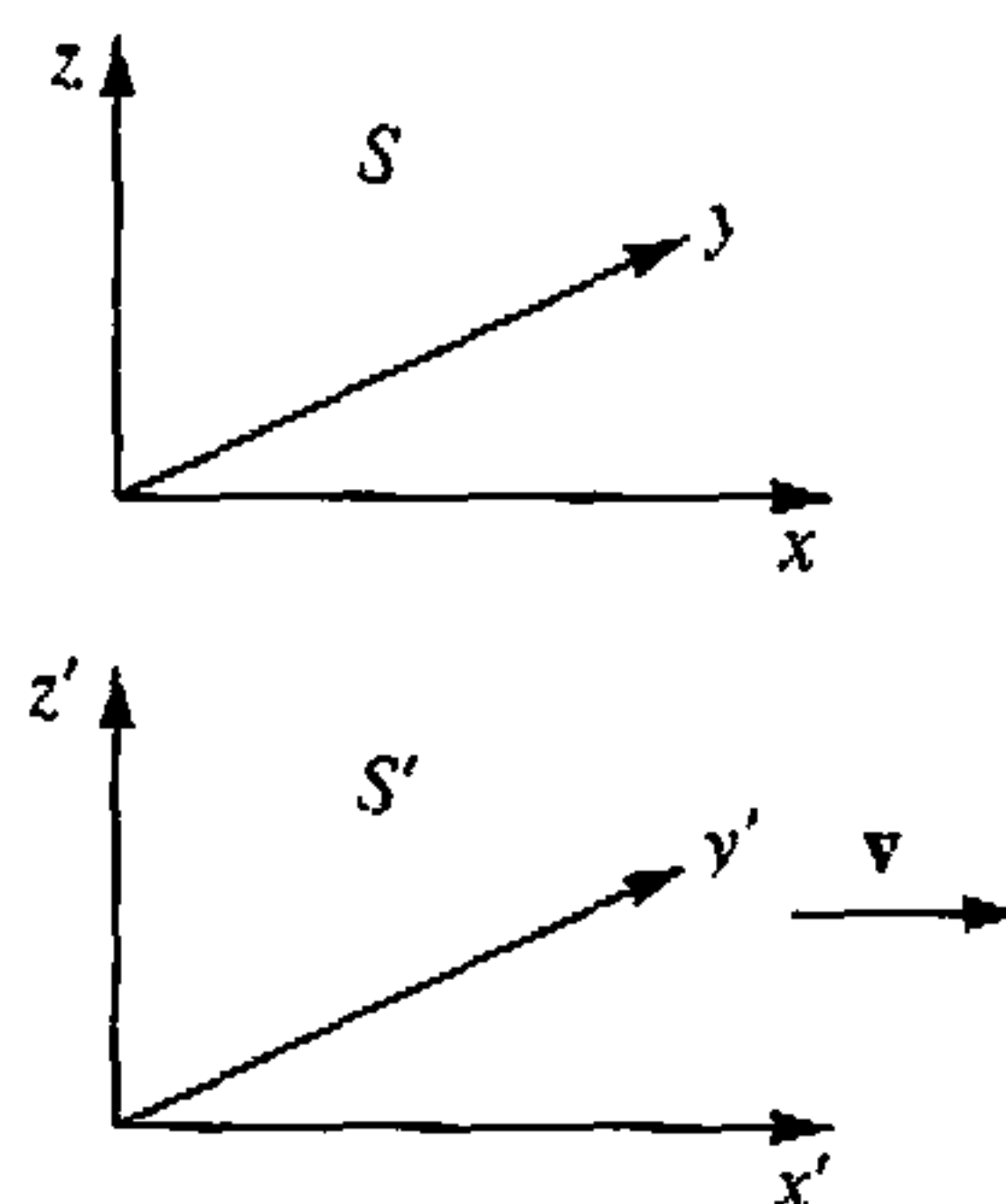

FIGURE 7.1 Galilean transformation from S to S' by a velocity v in the $+x$ -direction.

The time in both the S and S' frames is assumed to be ($t = t'$). The Newtonian world view is that the universe consists of three spatial directions and one time direction. All observers agree on the time direction up to a possible choice of units. Under these assumptions, there are no universal velocities. If \mathbf{u} and \mathbf{u}' are the velocities of a particle as measured in two frames moving with relative velocity \mathbf{v} as defined by Figure 7.1, then

$$\mathbf{u}' = \mathbf{u} - \mathbf{v}. \quad (7.3)$$

Maxwell's electromagnetic equations, on the other hand, have a universal constant (denoted by c), which is interpreted as the speed of light. Since this is inconsistent with Newtonian mechanics, either Newtonian or Maxwellian mechanics would have to be modified. After carefully thinking about how the universe would appear to an observer traveling at the speed of light, Albert Einstein decided that Maxwell's equations are correct to all inertial observers and the assumed transformations for Newtonian mechanics are incorrect. The correct transformations make the speed of light the same to all inertial observers.

7.1 ■ BASIC POSTULATES OF THE SPECIAL THEORY

Einstein used two postulates to develop what became known as the special theory:

1. The laws of physics are the same to all inertial observers.
2. The speed of light is the same to all inertial observers.

A formulation of physics that explicitly incorporates these two postulates is said to be *covariant*. Since the speed of light, c , is the same in all coordinate systems, it is reasonable to consider the numerical value of c as a conversion factor between the units used in measuring space and the units used in measuring time. So, $c dt$ is the time interval measured in the same units used to measure space units. In the SI system of units, $c dt$ has dimensions of meters. Many books

and articles on relativity set $c = 1$ and measure time and space in meters. In the material that follows, we shall show the explicit dependence upon c .

To satisfy the two postulates, the space and time of the special theory consist of a single entity that we refer to as *spacetime*. This spacetime is the geometric framework within which we perform physics. We cannot assume that all observers make the same division into time and space in the same way. The separation is unique to each inertial frame. The square of the distance in that spacetime, Δs^2 , between two points \mathcal{A} and \mathcal{B} is given by

$$(\Delta s)^2 = c^2(\text{time interval})^2 - (\text{space interval})^2, \quad (7.4)$$

where the interval is between the two points \mathcal{A} and \mathcal{B} . If the separation of the interval is assumed to be infinitesimal, the Δ is replaced by the differential symbol d . Since a point in spacetime consists of a specification of three spatial coordinate values and one time value, the usual convention is to refer to a point in spacetime as an **event**. The term *event* is used because such a point has a definite location and a definite time in any frame.

The choice of opposite signs for the time and space intervals is intrinsic to the theory; however, the choice of a positive sign for $(c dt)^2$ is arbitrary. Some authors define a $(ds)^2$, which is the negative of the choice given in Eq. (7.4). All sign choices makes $(ds)^2 = 0$ according to the definition in Eq. (7.4) for light, since the space interval is $\pm(c \times \text{time interval})$. The choice made here for the relative signs used for space and time is such that real bodies moving at a velocity less than light have $(ds)^2 > 0$. This makes ds real for bodies moving slower than light speed. If $(ds)^2 > 0$, the interval is called *timelike*. If $(ds)^2 < 0$, the interval is called *spacelike*. Intervals for which $(ds)^2 = 0$ are called *lightlike* or *null*.

Since, to all inertial observers, objects that travel on timelike paths move less than the speed of light, they are called *tardyons*. Hypothetical bodies that always move faster than light are called *tachyons*, but such bodies will not concern us here. Objects moving at the speed of light are called *null* or *lightlike*.

In the limit of small displacements (differential displacements), Eq. (7.4) becomes, in a Cartesian coordinate system,

$$(ds)^2 = (c dt)^2 - (dx^2 + dy^2 + dz^2). \quad (7.4')$$

The four-dimensional space with an interval defined by Eqs. (7.4) or (7.4'), is often called *Minkowski* space to distinguish it from a four-dimensional Euclidean space for which there would be no minus sign in Eqs. (7.4) or (7.4'). The idea of using ict for the time coordinate to make the space Euclidean is no longer useful since it obscures the non-Euclidean nature of spacetime and makes the generalization to noninertial frames more difficult.

Since the interval between two events of spacetime is a geometric quantity, all inertial observers measure coordinates that preserve the value of the interval squared, $(ds)^2$. If S and S' are two different inertial frames, then

$$ds'^2 = ds^2. \quad (7.5)$$

Thus, $(ds)^2$ is called the square of the **invariant spacetime interval**. For this to be possible, the transformations between the coordinates in S' and those in S , must involve the relative velocity between the frames in both the space and the time parts; that is, the time coordinate can no longer stand independent of the transformation. This means the relative splitting of spacetime into space and time will be different for different inertial observers. Since the time measured in a laboratory frame is different from that measured by an observer at rest with respect to the body under study, we must distinguish these times. We distinguish them by calling the time measured by clocks at rest with respect to a body the *proper time*, while the other inertial observer uses a time that is often called *laboratory time*.

As a special case of Eq. (7.4), consider the relation between the proper time, τ , measured by an observer at rest with respect to an object in frame S' with coordinates (τ, x', y', z') , which is moving at a velocity, v , with respect to a laboratory frame S with coordinates (t, x, y, z) . In the rest frame of the object, there is no motion, so Eqs. (7.4') and (7.5) give

$$c^2(d\tau)^2 = c^2(dt)^2 - v^2(dt)^2 = c^2(dt)^2 \left(\frac{1 - v^2}{c^2} \right)$$

or

$$dt = \frac{d\tau}{\sqrt{1 - \frac{v^2}{c^2}}} \quad (7.6)$$

Since Eq. (7.6) makes $d\tau < dt$, this effect on dt is called “time dilation”: moving clocks appear to run slower.

The invariance of the interval expressed in Eq. (7.5), naturally divides spacetime into four regions, sketched in Fig. 7.2 relative to any event A at time t_A (A is located at $x = y = z = 0$ in Figure 7.2). If an event B at time t_B is such that $(ds_{AB})^2 > 0$, then all inertial observers will agree on the time order of the events A and B . It is even possible to choose an inertial frame where B has the same space coordinates as A . If t_B is less than t_A in one inertial frame, then t_B is less than t_A in all inertial frames. We call this region the *past*. Likewise, there is a region called the *future* where for event C (shown in Figure 7.2), t_C is greater than t_A for all inertial observers. Both the past and the future could be causally related to the event A . For any event inside the light cone, there exists a frame in which that event and the origin have the same x, y, z coordinates.

If $(ds_{AD})^2 < 0$, then there exist a set of inertial frames in which the relative order of t_A and t_D can be reversed or even made equal. This region has sometimes been referred to as the *elsewhere*, or as the *elsewhen*. In the region in which event D is located, there exists an inertial frame S' with its origin at event the A in which D is at the same time as A (but somewhere else). There also exist frames in which the time of D occurs before A and frames in which the time of D is after event A . Separating the past-future and the elsewhere is the null or **light cone**, where $ds^2 = 0$. The null cone is the set of spacetime points from which emitted

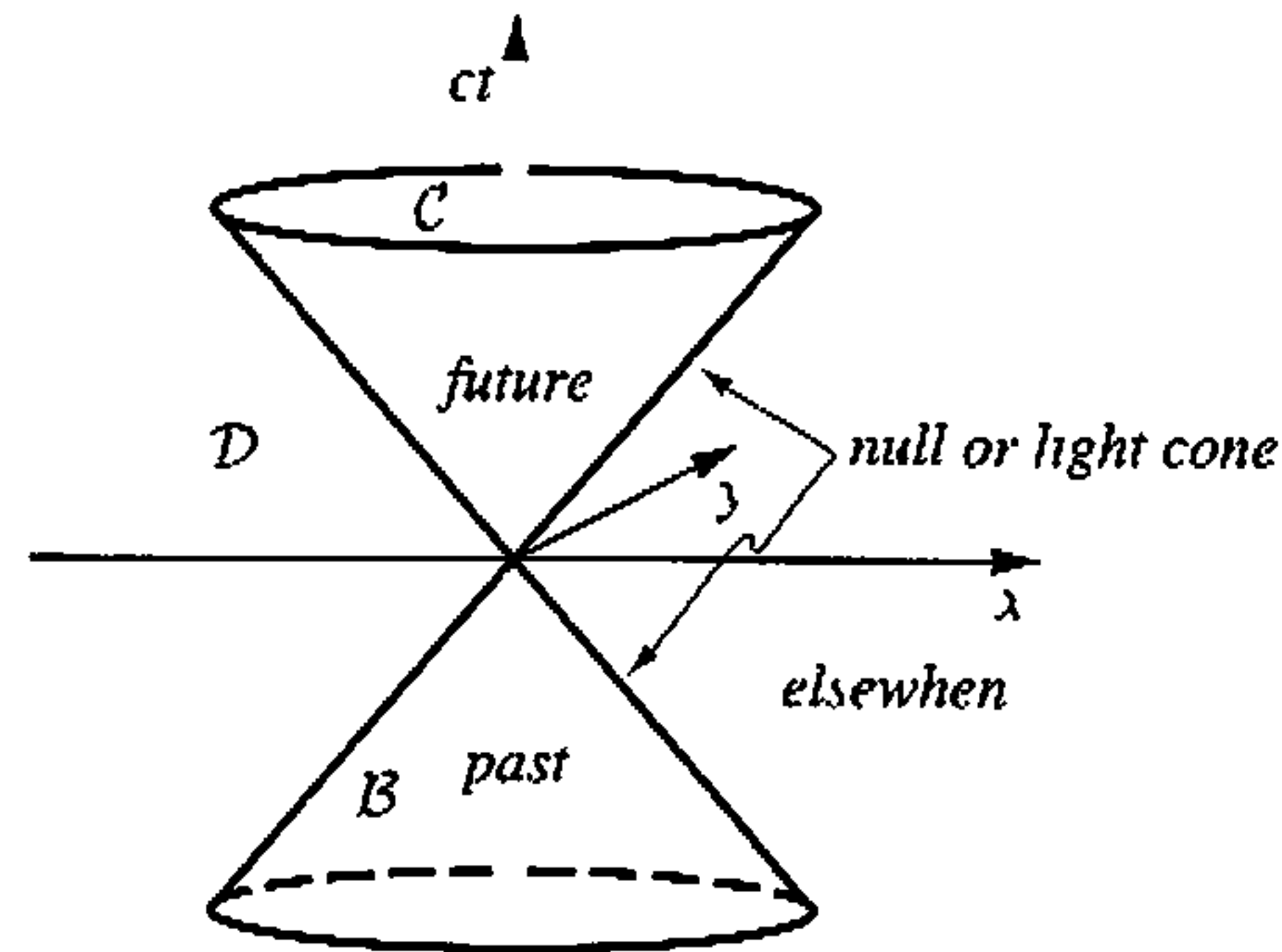

FIGURE 7.2 The three dimensions (ct , x , and y) of the light cone. The third spatial dimension has been suppressed. The event \mathcal{A} referenced in the text is located at $x = y = ct = 0$. The light cone is the set of (ct, x, y) traced out by light emitted from $ct = x = y = 0$ or by light that reaches $x = y = 0$ at time $ct = 0$. The past and future lie inside the light cone. This figure is of necessity misleading because all points on the light cone have zero separation in spacetime.

light could reach event \mathcal{A} , and those points from which light emitted from event \mathcal{A} could reach. Any interval between the origin and a point inside the light cone is timelike, and any interval between the origin to a point outside the light cone is spacelike. Understanding the implication of the division of spacetime by the light cone is usually all that is needed to resolve the apparent paradoxes of the special theory.

7.2 ■ LORENTZ TRANSFORMATIONS

The simplest set of transformations that preserve the invariance of the interval, ds^2 , are called the *Lorentz transformations*. These transformations are simplest in the sense that they are linear in the coordinates and as the relative velocity goes to zero, the transformations become identity transformations. If we consider parallel Cartesian coordinate systems, S and S' , whose origins coincide at $t = t' = 0$, and whose relative velocity is v along the x axis as measured by S , and define

$$\beta = \frac{v}{c}, \quad \text{and} \quad \gamma = \frac{1}{\sqrt{1 - \beta^2}}, \quad (7.7)$$

then the following four equations relate the two sets of coordinates

$$ct' = \frac{ct - \beta x}{\sqrt{1 - \beta^2}} = \gamma(ct - \beta x) \quad (7.8a)$$

$$x' = \frac{x - \beta ct}{\sqrt{1 - \beta^2}} = \gamma(x - \beta ct) \quad (7.8b)$$

$$y' = y \quad (7.8c)$$

$$z' = z. \quad (7.8d)$$

Here we are only interested in transformations for which $t' \rightarrow t$ and $x' \rightarrow x$ as $\beta \rightarrow 0$. As matrices, these transformations appear as

$$\begin{bmatrix} ct' \\ x' \\ y' \\ z' \end{bmatrix} = \begin{bmatrix} \gamma & -\gamma\beta & 0 & 0 \\ -\gamma\beta & \gamma & 0 & 0 \\ 0 & 0 & 1 & 0 \\ 0 & 0 & 0 & 1 \end{bmatrix} \begin{bmatrix} ct \\ x \\ y \\ z \end{bmatrix}. \quad (7.8')$$

In the limit of $\beta \ll 1$, Eqs. (7.8) reduce to the Galilean transformations as expected.

The generalization to arbitrary orientation of the velocity relative to the axes is straightforward. Since we are considering spacetime a four-dimensional entity, we would expect to deal with four-dimensional vectors. Using the notation $(ct, x, y, z) = (ct, \mathbf{r})$ allows the writing of the generalization of Eqs. (7.8') to the case where \mathbf{v} is not parallel to an axis, as

$$\begin{aligned} ct' &= \gamma(ct - \boldsymbol{\beta} \cdot \mathbf{r}) \\ \mathbf{r}' &= \mathbf{r} + \frac{(\boldsymbol{\beta} \cdot \mathbf{r})\boldsymbol{\beta}(\gamma - 1)}{\beta^2} - \boldsymbol{\beta}\gamma ct, \end{aligned} \quad (7.9)$$

provided the two sets of axes are aligned. Another way to express this arbitrary velocity is to consider the Lorentz transformation between two inertial coordinate systems with aligned axes, as a matrix transformation relating the two 4-quantities, $\mathbf{x} = (ct, \mathbf{r})$ and $\mathbf{x}' = (ct', \mathbf{r}')$, where

$$\mathbf{x}' = \mathbf{L}\mathbf{x} \quad (7.10)$$

We treat \mathbf{x}' and \mathbf{x} as column matrices and \mathbf{L} as the symmetric matrix

$$\mathbf{L} = \begin{bmatrix} \gamma & -\gamma\beta_x & -\gamma\beta_y & -\gamma\beta_z \\ -\gamma\beta_x & 1 + (\gamma - 1)\frac{\beta_x^2}{\beta^2} & (\gamma - 1)\frac{\beta_x\beta_y}{\beta^2} & (\gamma - 1)\frac{\beta_x\beta_z}{\beta^2} \\ -\gamma\beta_y & (\gamma - 1)\frac{\beta_x\beta_y}{\beta^2} & 1 + (\gamma - 1)\frac{\beta_y^2}{\beta^2} & (\gamma - 1)\frac{\beta_y\beta_z}{\beta^2} \\ -\gamma\beta_z & (\gamma - 1)\frac{\beta_x\beta_z}{\beta^2} & (\gamma - 1)\frac{\beta_y\beta_z}{\beta^2} & 1 + (\gamma - 1)\frac{\beta_z^2}{\beta^2} \end{bmatrix}. \quad (7.11)$$

This reduces to the results given in Eqs. (7.8') when $\beta_x = \beta$, $\beta_y = \beta_z = 0$.

These transformations map the origin of S and the origin of S' to $(0, 0, 0, 0)$. Hence the coordinates of both origins correspond to the same location in spacetime. If this is not desired, there is a more general transformation of the form

$$\mathbf{x}' = \mathbf{L}\mathbf{x} + \mathbf{a} \quad (7.12)$$

where \mathbf{L} is a spacetime rotation (boost) and \mathbf{a} is a spacetime translation. This is the *Poincaré transformation* or the *inhomogeneous Lorentz transformation*. We shall consider only homogeneous transformations for which \mathbf{a} of Eq. (7.12) is zero.

7.3 ■ VELOCITY ADDITION AND THOMAS PRECESSION

The most general homogeneous Lorentz transformation will involve both a velocity change and a rotation of the coordinates. The velocity transformation is termed a boost and has the form of Eq. (7.11). Any homogeneous Lorentz transformation, \mathbf{L} , can be written as

$$\mathbf{L} = \mathbf{R}\mathbf{L}_0 = \mathbf{L}'_0\mathbf{R}' \quad (7.13)$$

where \mathbf{R} is a rotation matrix as discussed in Chapter 4, and \mathbf{L}_0 , which is called a restricted or proper Lorentz transformation, corresponds to a pure boost. The restricted Lorentz transformations form a representation of the Lorentz group.* Since \mathbf{R} is not symmetric and \mathbf{L}_0 is symmetric, \mathbf{L} will, in general, have no symmetry. Also, since \mathbf{L}_0 and \mathbf{R} are matrices, $\mathbf{R}\mathbf{L}_0 \neq \mathbf{L}_0\mathbf{R}$. There will exist two other transformations \mathbf{L}'_0 and \mathbf{R}' such that $\mathbf{R}\mathbf{L}_0 = \mathbf{L}'_0\mathbf{R}'$.

For any Lorentz transformation, \mathbf{L} , there is an inverse transformation, \mathbf{L}^{-1} , such that

$$\mathbf{L}\mathbf{L}^{-1} = \mathbf{L}^{-1}\mathbf{L} = \mathbf{1}, \quad (7.14)$$

where $\mathbf{1}$ is the diagonal unit 4×4 matrix with elements $\delta_{\alpha\beta}$. The existence of an inverse places four constraints on the diagonal element and six on the off-diagonal elements for a total of ten constraints on the Lorentz transformation. There are then only six independent components. Three of these correspond to the components of the relative velocity vector and three correspond to the Euler angles of the rotation (see Section 4.4).

Consider three inertial systems, S_1 , S_2 , and S_3 , with x axes aligned. Let S_2 be moving at a velocity v along the common x -direction with respect to S_1 and let S_3 be moving at velocity v' along the common x -direction with respect to S_2 . The Lorentz transformation from S_1 to S_3 is given by

$$\begin{aligned} \mathbf{L}_{1-3} &= \begin{bmatrix} \gamma' & -\gamma'\beta' & 0 & 0 \\ -\gamma'\beta' & \gamma' & 0 & 0 \\ 0 & 0 & 1 & 0 \\ 0 & 0 & 0 & 1 \end{bmatrix} \begin{bmatrix} \gamma & -\gamma\beta & 0 & 0 \\ -\gamma\beta & \gamma & 0 & 0 \\ 0 & 0 & 1 & 0 \\ 0 & 0 & 0 & 1 \end{bmatrix} \\ &= \begin{bmatrix} \gamma\gamma'(1 + \beta\beta') & -\gamma\gamma'(\beta + \beta') & 0 & 0 \\ -\gamma\gamma'(\beta + \beta') & \gamma\gamma'(1 + \beta\beta') & 0 & 0 \\ 0 & 0 & 1 & 0 \\ 0 & 0 & 0 & 1 \end{bmatrix} \end{aligned}$$

*Group concepts are discussed in Appendix B.

where Eq. (7.7) defines β and γ for v and β' and γ' for v' . Let β'' be the speed of S_3 relative to S_1 and γ'' the associated factor, then since \mathbf{L}_{1-3} can be written as a single Lorentz transformation with a velocity β'' with its associated γ'' as

$$\mathbf{L}_{1-3} = \begin{bmatrix} \gamma'' & -\gamma''\beta'' & 0 & 0 \\ -\gamma''\beta'' & \gamma'' & 0 & 0 \\ 0 & 0 & 1 & 0 \\ 0 & 0 & 0 & 1 \end{bmatrix},$$

and, since these two forms of \mathbf{L}_{1-3} must be the same, we have

$$\beta'' = \frac{\beta + \beta'}{1 + \beta\beta'} \quad (7.15)$$

This is the relativistic addition of velocity formula for parallel velocities.

The product of any two transformations, \mathbf{L}_1 and \mathbf{L}_2 is itself a Lorentz transformation, \mathbf{L}_3 . Such a Lorentz transformation will, in general, involve not only a boost, but may also include a rotation of coordinate axes. If both \mathbf{L}_1 and \mathbf{L}_2 are pure boosts but their two velocities are not parallel, \mathbf{L}_3 will involve a rotation in addition to a boost. This rotation is called the *Thomas precession* rotation. The usual form for the Thomas precession assumes the second boost, \mathbf{L}_2 has a velocity small compared to the first boost, \mathbf{L}_1 and also that it is small compared to the speed of light. For example, the Thomas precession can be observed for a gyroscope orbiting the Earth or for electrons in atoms.

Consider three inertial frames S_1 , S_2 , and S_3 , with S_2 moving at a velocity β with respect to S_1 and S_3 moving at a velocity of β' with respect to S_2 . Without loss of generality, we can arrange the axes of S_1 so that β is along the x axis of S_1 and β' lies in the $x'y'$ plane of S_2 ; that is, β, β' define the $x'y'$ plane of S_2 . Let \mathbf{L} represent the transformation from S_1 to S_2 and \mathbf{L}' the transformation from S_2 to S_3 with γ and γ' associated with β and β' . Then from Eq. (7.11),

$$\mathbf{L} = \begin{pmatrix} \gamma & -\gamma\beta & 0 & 0 \\ -\gamma\beta & \gamma & 0 & 0 \\ 0 & 0 & 1 & 0 \\ 0 & 0 & 0 & 1 \end{pmatrix} \quad (7.16)$$

and

$$\mathbf{L}' = \begin{bmatrix} \gamma' & -\gamma'\beta'_{x'} & -\gamma'\beta'_{y'} & 0 \\ -\gamma'\beta'_{x'} & 1 + (\gamma' - 1)\frac{\beta'^2_{x'}}{\beta'^2} & (\gamma' - 1)\frac{\beta'_{x'}\beta'_{y'}}{\beta'^2} & 0 \\ -\gamma'\beta'_{y'} & (\gamma' - 1)\frac{\beta'_{x'}\beta'_{y'}}{\beta'^2} & 1 + (\gamma' - 1)\frac{\beta'^2_{y'}}{\beta'^2} & 0 \\ 0 & 0 & 0 & 1 \end{bmatrix}. \quad (7.17)$$

We assume that the components of β' are small and only need be retained to first order giving via matrix multiplications of Eq. (7.16) and Eq. (7.17)

$$\mathbf{L}'' = \mathbf{L}'\mathbf{L} = \begin{bmatrix} \gamma\gamma' & -\gamma\gamma'\beta & -\gamma'\beta'_y & 0 \\ -\gamma\beta & \gamma & 0 & 0 \\ -\gamma\gamma'\beta'_y & \gamma\beta\gamma'\beta'_y & \gamma' & 0 \\ 0 & 0 & 0 & 1 \end{bmatrix} \quad (7.18)$$

Since \mathbf{L}'' is not symmetric, it must correspond to a rotation and a boost. We shall write the velocity of S_3 as observed by S_1 as $\boldsymbol{\beta}''$.

Since the off-diagonal elements corresponding to the z axis are zero, this rotation is about an axis perpendicular to the xy plane. The boost from S_1 to S_3 is denoted by $\boldsymbol{\beta}''$, and we assume that $\boldsymbol{\beta}'$ is small compared to $\boldsymbol{\beta}$ and also small compared to the speed of light ($\gamma' \approx 1$). Then, to first order, the nonvanishing components of $\boldsymbol{\beta}''$ are (Since the velocity perpendicular to x is small we can ignore to first order the distinction among y , y' , and y'')

$$\beta''_x = \beta, \quad \beta''_y = \frac{\beta'_y}{\gamma}, \quad \beta''^2 = \beta^2, \quad \text{and} \quad \gamma'' = \gamma, \quad (7.19)$$

and Eq. (7.18) becomes

$$\mathbf{L}'' \approx \begin{bmatrix} \gamma'' & -\gamma''\beta''_x & -\gamma''\beta''_y & 0 \\ -\gamma''\beta''_x & \gamma'' & 0 & 0 \\ -\gamma''\beta''_y & \gamma''\beta''_x\beta''_y & 1 & 0 \\ 0 & 0 & 0 & 1 \end{bmatrix}. \quad (7.18')$$

In this approximation, a pure Lorentz transformation from S_3 to S_1 (the inverse transformation) would correspond to a large boost in the x'' axis of $-\beta''_x$ and a small boost in the y'' axis of $-\beta''_y$. The Lorentz boost for that transformation

$$\mathbf{L}_{3-1} = \begin{bmatrix} \gamma'' & \gamma''\beta''_x & \gamma''\beta''_y & 0 \\ \gamma''\beta''_x & \gamma'' & (\gamma'' - 1)\frac{\beta''_y}{\beta''_x} & 0 \\ \gamma''\beta''_y & (\gamma'' - 1)\frac{\beta''_y}{\beta''_x} & 1 & 0 \\ 0 & 0 & 0 & 1 \end{bmatrix}. \quad (7.20)$$

Finally, the rotation matrix induced by the rotation from S_1 to S_3 , after some algebraic simplification and the dropping of higher-order terms in $\boldsymbol{\beta}''$, is found to be

$$\mathbf{R} = \mathbf{L}''\mathbf{L}_{3-1} = \begin{bmatrix} 1 & 0 & 0 & 0 \\ 0 & 1 & (\gamma - 1)\frac{\beta''_y}{\beta} & 0 \\ 0 & -(\gamma - 1)\frac{\beta''_y}{\beta} & 1 & 0 \\ 0 & 0 & 0 & 1 \end{bmatrix}. \quad (7.21)$$

Comparison with Eq. (4.44) shows that \mathbf{R} implies S_3 is rotated with respect to S_1 about the z axis through an infinitesimal angle:

$$\Delta\Omega = (\gamma - 1) \frac{\beta_y''}{\beta} = \beta_y'' \beta \left(\frac{\gamma - 1}{\beta^2} \right). \quad (7.22)$$

The spatial rotation resulting from the successive application of two nonparallel Lorentz transformations has been declared every bit as paradoxical as the more frequently discussed apparent violations of common sense, such as the so-called “twin paradox.” But the present apparent paradox has important applications, especially in atomic physics, and therefore has been abundantly verified experimentally.

Consider a particle moving in the laboratory system with a velocity \mathbf{v} that is not constant. Since the system in which the particle is at rest is accelerated with respect to the laboratory, the two systems should not be connected by a Lorentz transformation. We can circumvent this difficulty by a frequently used stratagem (elevated by some to the status of an additional postulate of relativity). We imagine an infinite number of inertial systems moving uniformly relative to the laboratory system, one of which instantaneously matches the velocity of the particle. The particle is thus instantaneously at rest in an inertial system that can be connected to the laboratory system by a Lorentz transformation. It is assumed that this Lorentz transformation will also describe the properties of the particle and its true rest system as seen from the laboratory system.

Suppose now that S_1 is the laboratory system, while S_2 and S_3 are two of the instantaneous rest systems a time Δt apart in the particle’s motion. By Eq. (7.22), the laboratory observer will see a change in the particle’s velocity in this time, $\Delta\mathbf{v}$, which has only a y -component $\beta_y'' c = \Delta v$. Since the initial x axis has been chosen along the direction of $\mathbf{v} = \beta c$, the vector of the infinitesimal rotation in this time can be written as

$$\Delta\boldsymbol{\Omega} = -(\gamma - 1) \frac{\mathbf{v} \times \Delta\mathbf{v}}{v^2} \quad (7.23)$$

Hence, if the particle has some specific direction attached to it (such as a spin vector), it will be observed from the laboratory system that this direction precesses with an angular velocity

$$\boldsymbol{\omega} = \frac{d\boldsymbol{\Omega}}{dt} = -(\gamma - 1) \frac{\mathbf{v} \times \mathbf{a}}{v^2} \quad (7.24)$$

where \mathbf{a} is the particle’s acceleration as seen from S_1 . Equation (7.24) is frequency encountered in the form it takes when v is small enough that γ can be approximated (using $\gamma \approx 1 + \frac{1}{2}\beta^2$) as

$$\boldsymbol{\omega} = \frac{1}{2c^2} (\mathbf{a} \times \mathbf{v}). \quad (7.25)$$

In either form, $\boldsymbol{\omega}$ is known as the *Thomas precession frequency*.

7.4 ■ VECTORS AND THE METRIC TENSOR

We will use the notation that the coordinates, which need not be Cartesian, are written as x^μ where $x^0 = ct$ is the time coordinate, and x^1, x^2, x^3 are the space coordinates. This change in notation is needed to be consistent with the developments in the following sections.

Consider an arbitrary one-dimensional curve in 4-dimensional spacetime, \mathcal{P} , described by a parameter λ , where for a given λ the coordinates of a point of the curve can be written as $x^0(\lambda), x^1(\lambda), x^2(\lambda), x^3(\lambda)$. In introductory texts a 4-vector, v , is defined by this curve as an arrow whose tail is located at an event \mathcal{A} on the curve and whose head is at an event \mathcal{B} on the curve where $v_{AB} = \mathcal{P}_B - \mathcal{P}_A$. However, instead of defining the vector at two points, we can use the parameter λ , which is a measure of the length along the curve from \mathcal{A} to \mathcal{B} , by writing

$$v_{AB} = \left(\frac{d\mathcal{P}}{d\lambda} \right)_{\lambda=0}. \quad (7.26)$$

Such a 4-vector is a *tangent vector* to the curve. We adopt the notation that the components of vectors are written with superscripts such as v^0, v^1, v^2, v^3 . In spite of the way we draw tangent vectors, they do not have any extension in spacetime. The arrows we draw simply help us visualize the vector. At each point along the curve, the tangent vector has a direction and a magnitude. For curves that are timelike, the proper time, τ , is usually chosen as the parameter λ . The laboratory coordinates are then $x^0 = ct(\tau), x^1 = x(\tau), x^2 = y(\tau), x^3 = z(\tau)$, and the tangent to the curve is the *four-velocity*, u , of a particle traveling along the curve \mathcal{P} . Equation (7.26) becomes

$$u^0 = \frac{dct}{d\tau} = \gamma c, \quad u^i = \frac{dx^i}{d\tau} = \gamma v^i \quad (7.27)$$

where $v^i = dx^i/dt$ is the normal three-velocity with $\mathbf{v}^2 = (v^x)^2 + (v^y)^2 + (v^z)^2$. We shall assume that Greek letters can take on the values 0–3 and Latin letters the values 1–3. Repeated indices are summed. Since the 4-velocity of a particle is defined over a range of the parameter λ , there is an infinite set of 4-velocities for the particle, one for each value of λ . Such a set of vectors is termed a *vector field*. Some common examples of vector fields are given in Table 7.1.

We assume that the components of any 4-vector can be expressed by the values of the vector's projections along a set of basis vectors, e_0, e_1, e_2, e_3 , and that the coordinates are measured along the direction given by the basis vectors. Such a system is called a *coordinates basis*.^{*} Cartesian, spherical, and cylindrical coordinate systems, among many possible systems, can have such a basis set. The position of a point on the curve $\mathcal{P}(\tau)$ can be written as

$$\mathcal{P}(\tau) = x^\mu(\tau)e_\mu, \quad (7.28)$$

^{*}The choice of a coordinate basis is arbitrary but avoids some complications. For this introductory chapter we will assume that each basis vector lies in the direction of its increasing coordinate.

TABLE 7.1 Examples of Vector Fields

Name	Time Portion	Space Portion	(Magnitude) ²	Type
Coordinate	ct	\mathbf{r}	$c^2t^2 - r^2$	spacelike, null, or timelike
Velocity	γc	$\gamma \mathbf{v}$	c^2	timelike
Momentum	$\frac{E}{c}$	\mathbf{p}	m^2c^2	timelike
Force	$\frac{\gamma}{c} \frac{dE}{dt}$	$\gamma \frac{d\mathbf{p}}{dt} = \gamma \mathbf{F}$	$-(\mathbf{F}_{\text{Newtonian}})^2$	spacelike
Current density	$\gamma \rho c$	$\gamma \mathbf{J}$	$\rho^2 c^2$	timelike

where repeated Greek indices, one raised and one lowered, are summed from 0 to 3. In particular, the 4-velocity given in Eq. (7.27) becomes

$$u = \frac{d\mathcal{P}}{d\tau} = \frac{dx^\mu}{d\tau} \mathbf{e}_\mu = u^\mu \mathbf{e}_\mu. \quad (7.29)$$

The magnitude of the 4-velocity is a scalar whose values can vary as we change λ . This set of magnitudes is an example of a *scalar field*. To convert a 4-vector field to a scalar field, we need what is called a functional,* which can convert a pair of vectors into a scalar function at each point in spacetime. In other words, we wish to define the scalar product of two vectors or vector fields. This conversion of a 4-vector field (or two different vector fields) to a scalar field is an example of a *mapping*. If both the vectors are the same, then this scalar would be the square of the length of the vector, and when the vectors are different, it is called the scalar product of the vectors. Such a functional is called the *metric tensor*, g .† The metric tensor functional can be considered as a machine with two slots into which you can insert two vectors to produce a scalar (real-valued function). That is,

$$g(u, v) = g(v, u) = u \cdot v, \quad (7.30)$$

is the scalar product. In particular if the basis vectors are inserted into the metric,

$$g_{\alpha\beta} = \mathbf{g}(\mathbf{e}_\alpha, \mathbf{e}_\beta) = \mathbf{e}_\alpha \cdot \mathbf{e}_\beta. \quad (7.31)$$

The $g_{\alpha\beta}$ are the components of the metric tensor associated with the basis vectors \mathbf{e}_α . For example, consider a two-dimensional Minkowski space with coordinates ct and x and a vector $v = (a, b)$. Then $g(v, v) = a^2 - b^2$ and $g_{00} = 1$, $g_{11} = -1$.

The form of the $g_{\alpha\beta}$ is defined by the form for the interval. This suggests that we consider small displacements. If the relative displacement vector between two

*A functional is a function whose arguments are themselves functions.

†We use the same notation for tensors in 4-space as we do for 4-vectors.

points is small, it can be written as

$$d\zeta = \Delta x^\alpha e_\alpha. \quad (7.32)$$

Recasting Eq. (7.32) in the language of Eq. (7.4'), we see for Minkowski coordinates

$$\begin{aligned} (\Delta s)^2 &= d\zeta \cdot d\zeta = \Delta x^\alpha \Delta x^\beta e_\alpha \cdot e_\beta = g_{\alpha\beta} \Delta x^\alpha \Delta x^\beta \\ &= (c\Delta t)^2 - (\Delta x)^2 - (\Delta y)^2 - (\Delta z)^2. \end{aligned}$$

In the limit of infinitesimal displacements this can be written as

$$ds^2 = g_{\alpha\beta} dx^\alpha dx^\beta, \quad (7.32')$$

which holds for any metric tensor. The metric tensor for a Minkowski coordinate system, using the $+---$ sign convention, has the following tensor representation*

$$g = \begin{pmatrix} 1 & 0 & 0 & 0 \\ 0 & -1 & 0 & 0 \\ 0 & 0 & -1 & 0 \\ 0 & 0 & 0 & -1 \end{pmatrix}. \quad (7.33)$$

The scalar product of two vectors in this coordinate system is

$$u \cdot v = u^\alpha v^\beta g_{\alpha\beta} = u^0 v^0 - u^1 v^1 - u^2 v^2 - u^3 v^3. \quad (7.34)$$

It is straightforward to show that in any coordinate system, the square of the magnitude of the four-velocity is

$$u \cdot u = c^2. \quad (7.35)$$

The 4-momentum can be defined from Eq. (7.27)

$$p = mu, \quad (7.36)$$

where the mass, m , is a scalar. So the length squared of the four-momentum is

$$p \cdot p = m^2 c^2, \quad (7.37)$$

or from Eqs. (7.27) and (7.34),

$$p \cdot p = m^2 c^2 = m^2 c^2 \gamma^2 - m^2 v^2 \gamma^2 = \frac{E^2}{c^2} - \mathbf{p}^2 \quad (7.38)$$

*The notation used for the display of a matrix is [], while for tensors () will be used as it was in Chapter 5. Matrices are used for relating different coordinate frames while tensors are physical geometric objects.

where \mathbf{p} is the length of the 3-momentum. This last form of Eq. (7.38) is often written as

$$E^2 = m^2 c^4 + \mathbf{p}^2 c^2. \quad (7.38')$$

The relativistic kinetic energy, T , is defined as

$$T = E - mc^2 = mc^2(\gamma - 1) \quad (7.39)$$

$$= \sqrt{(mc^2)^2 + \mathbf{p}^2 c^2} - mc^2. \quad (7.39')$$

For $\beta \ll 1$, a power series expansion gives

$$T = \frac{1}{2}mv^2 + O(\beta^4). \quad (7.40)$$

Since $\mathbf{p} = m\gamma\mathbf{v}$, Eq. (7.39) shows that the kinetic energy of a body with finite rest mass tends to infinity as the speed approaches that of light (as $\beta \rightarrow 1$, $\gamma \rightarrow \infty$). In other words, it takes an infinite amount of energy to increase the speed of a mass particle (or a space ship) from any velocity less than c to c itself. This is another proof that it is impossible to attain or exceed the speed of light starting from any finite speed less than c .

7.5 ■ 1-FORMS AND TENSORS*

Suppose we insert only one 4-vector into the metric tensor in Eq. (7.30). We would produce an object that could be written as $u_\alpha = g_{\alpha\beta}u^\beta$. For example, in the two-dimensional Minkowski space, if \mathbf{u}^α has components (a, b) , then u_α has components $(a, -b)$. This geometric object, u_α , is called a *1-form* or, in an older notation, a *covariant vector*. In the older notation the vector itself was called a *contravariant vector*. If the vector is thought of as a directed line, the 1-form is a set of numbered surfaces through which the vector passes as is shown in Fig. 7.3. It is another functional (machine) similar to g , except it converts a vector to a linear real-valued scalar function. That is, if η is a 1-form (field) and v is some vector (field), the quantity denoted by $\langle \eta, \mathbf{v} \rangle$ is a number that tells us how many surfaces of η are pierced by v . For each vector field V , there is an associated 1-form, V_η such that $\langle V_\eta, V \rangle = V \cdot V$ is the scalar contraction or the square of the magnitude of V .

The gradient is an example of a 1-form since, if we consider a curve \mathcal{P} , parameterized by λ , where $\lambda = 0$ at \mathcal{P}_0 and take a scalar function, f , defined along the curve,

$$\partial_{\mathbf{v}} f = \frac{\partial}{\partial \lambda_{\lambda=0}} f(\mathcal{P}(\lambda)) = \frac{df}{d\lambda_{\mathcal{P}_0}} = v^\alpha \frac{\partial f}{\partial x^\alpha}. \quad (7.41)$$

*The material in Sections 7.5 and 7.6 is not needed for Section 7.7. The Section order has been chosen for continuity of ideas.

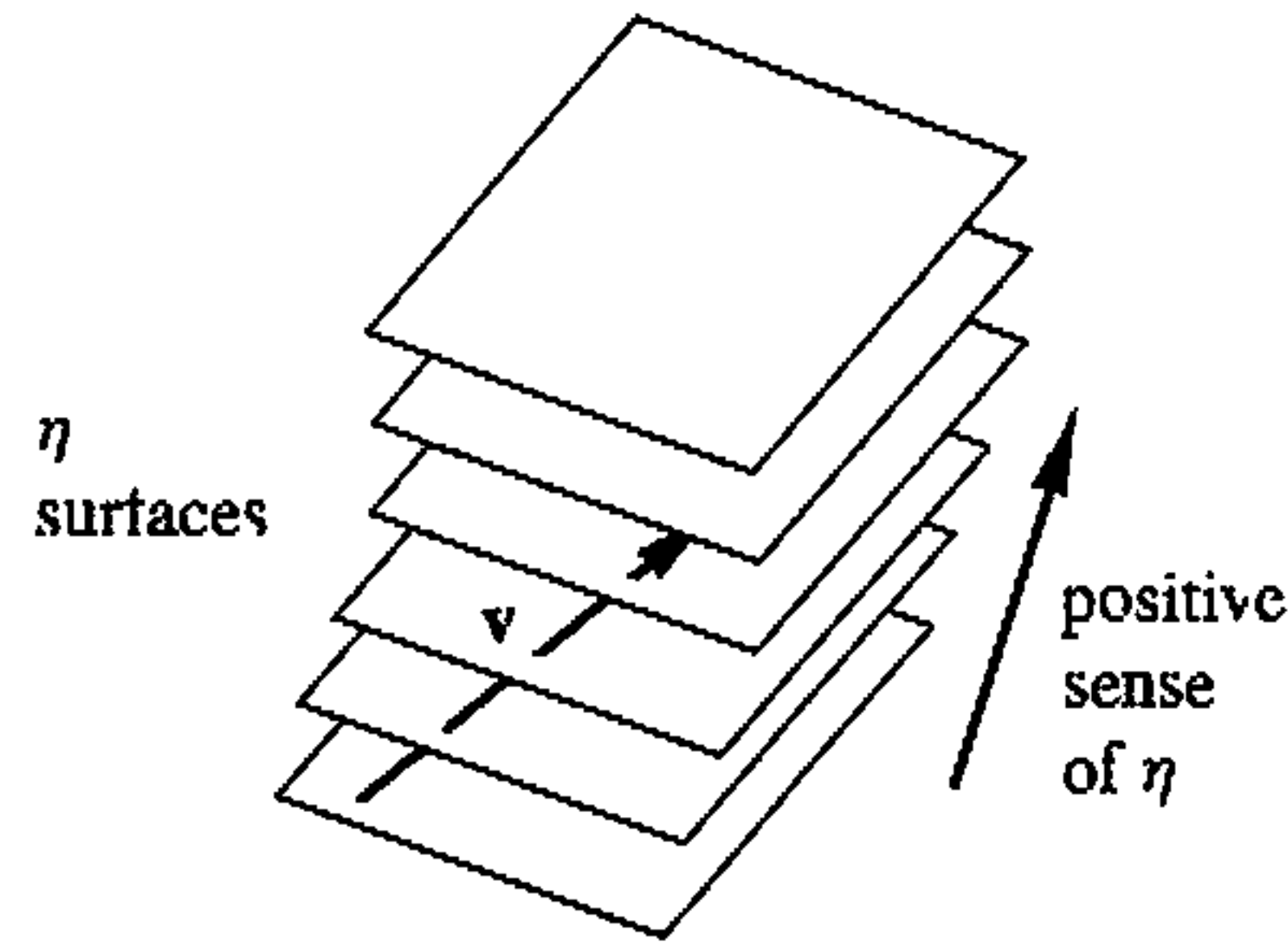

FIGURE 7.3 A vector v between two neighboring points and a 1-form η . The piercing of η by v produces a number given by $\langle \eta, v \rangle$, the number (including fractions) of surfaces pierced

So

$$\partial_\alpha = \partial_{e_\alpha} = \frac{\partial}{\partial x^\alpha}. \tag{7.42}$$

We often write either ∂_ν or d to indicate the gradient of a scalar. Several examples of vectors, 1-forms, scalar products, and metrics from relativity and other areas of physics are given in Table 7.2.

The gradient of the coordinates, ω^α , defined as

$$\omega^\alpha = dx^\alpha, \tag{7.43}$$

provides a set of **basis 1-forms** since

$$\langle \omega^\alpha, e_\beta \rangle = \delta^\alpha_\beta, \tag{7.44}$$

TABLE 7.2 Examples of Vectors and 1-forms

SYSTEM	Vectors: (Contravariant Components)	1-forms. (Covariant Components)	Scalar Contraction	Metric
Euclidean Cartesian (x, y, z)	(dx, dy, dz)	(dx, dy, dz)	$dx^2 + dy^2 + dz^2$	$\begin{matrix} 1 & 0 & 0 \\ 0 & 1 & 0 \\ 0 & 0 & 1 \end{matrix}$
Euclidean Spherical	$(dr, d\theta, d\phi)$	$(dr, r^2 d\theta, r^2 \sin^2 \theta d\phi)$	$dr^2 + r^2 d\theta^2 + r^2 \sin^2 \theta d\phi^2$	$\begin{matrix} 1 & 0 & 0 \\ 0 & r^2 & 0 \\ 0 & 0 & r^2 \sin^2 \theta \end{matrix}$
Solid-state	r (lattice vector)	k (reciprocal vector)	$r \cdot k$	varies
Quantum theory	$ i\rangle$ (ket)	$\langle j $ (bra)	$\langle j i\rangle$	$ i\rangle\langle j $
Special theory of relativity (Minkowski)	$(c dt, d\mathbf{r})$	$(c dt, -d\mathbf{r})$	$c^2 dt^2 - d\mathbf{r}^2$	$\begin{matrix} 1 & 0 & 0 & 0 \\ 0 & -1 & 0 & 0 \\ 0 & 0 & -1 & 0 \\ 0 & 0 & 0 & -1 \end{matrix}$

and any 1-form η can be written as

$$\eta = \eta_\alpha \omega^\alpha. \quad (7.45)$$

It follows that

$$\langle \eta, e_\alpha \rangle = \eta_\alpha \quad (7.46)$$

and for any vector, v

$$\langle \eta, v \rangle = \eta_\alpha v^\alpha. \quad (7.47)$$

This gives us two ways to calculate the scalar product of two vectors \mathbf{v} and \mathbf{u} . If we define the inverse metric by

$$g^{\alpha\beta} g_{\beta\gamma} = \delta^\alpha_\gamma \quad (7.48)$$

or in index-free notation by

$$g^{-1}g = gg^{-1} = 1, \quad (7.48')$$

we can convert vectors (u^α) to 1-forms (u_α) and conversely as

$$u_\alpha = g_{\alpha\beta} u^\beta \quad \text{and} \quad u^\alpha = g^{\alpha\beta} u_\beta. \quad (7.49)$$

We can therefore write for two 4-vectors u and v (or they could be two 1-forms),

$$u \cdot v = g(u, v) = g_{\alpha\beta} u^\alpha v^\beta = u^\alpha v_\alpha = u_\alpha v_\beta g^{\alpha\beta}. \quad (7.34')$$

Since each 1-form has a unique associated vector, we could use the same symbol for both. The difference is important only when considering components.

In terms of the two-dimensional example that we previously considered (Minkowski spacetime) with ct and x as the coordinates). if the vector u has components (a, b) and the vector v has components (c, d) , the last three terms of the preceding equation can be written as

$$g_{\alpha\beta} u^\alpha v^\beta = (1)(a)(c) + (-1)(b)(d) = ac - bd,$$

$$u^\alpha v_\alpha = (a)(c) + (b)(-d) = ac - bd,$$

and

$$u_\alpha v_\beta g^{\alpha\beta} = (a)(c)(1) + (b)(d)(-1) = ac - bd.$$

It may help to consider the relationship between a vector and a 1-form from a more general point of view using the Minkowski two-dimensional space as an

example. A vector V in two-dimensional space with basis vectors e_1 and e_2 can be written as

$$V = V^1 e_1 + V^2 e_2$$

In general, it is not necessary that any of the basis vectors be normalized ($e_1 \cdot e_1 \neq 1$, $e_2 \cdot e_2 \neq 1$) or that they be orthogonal ($e_1 \cdot e_2 \neq 0$). This means that the magnitude of the scalar product is not conveniently obtained from a simple sum of squares

$$\begin{aligned} V \cdot V &= \sum_{i,j=1}^2 V^i V^j = (V^1)^2 e_1 \cdot e_1 + V^1 V^2 (e_1 \cdot e_2 + e_2 \cdot e_1) + (V^2)^2 e_2 \cdot e_2 \\ &\neq \sum_{i=1}^2 V^i V^i, \end{aligned}$$

and it does not have the value $\sqrt{(V^1)^2 + (V^2)^2}$. One way to obtain the magnitude of the vector is to define the **dual space** with basis vectors ω^1 and ω^2 (cf. Eq. (7.43)), which have the properties

$$e_1 \cdot \omega^1 = \omega^1 \cdot e_1 = e_2 \cdot \omega^2 = \omega^2 \cdot e_2 = 1$$

and

$$e_1 \cdot \omega^2 = \omega^2 \cdot e_1 = e_2 \cdot \omega^1 = \omega^1 \cdot e_2 = 0.$$

We say that the vector basis, e_i , is orthonormal to the 1-form basis ω^i . The 1-form, v , corresponding to the vector V may be written as

$$v = v_1 \omega^1 + v_2 \omega^2.$$

This vector has a (magnitude)² of

$$(\text{magnitude})^2 = v \cdot V = V \cdot v = V^1 v_1 + V^2 v_2.$$

When we want to require an object to be expressed in terms of its coordinate basis vectors we will write with a Roman letter (e.g., u) and use Greek letters when it is to be expressed in terms of the basis 1-forms (e.g., η). This same approach provides the scalar product of two vectors V and U in terms of their associated 1-forms v and u as

$$\text{scalar product} = V \cdot u = v \cdot U = u \cdot V = U \cdot v = V^1 u_1 + V^2 u_2 = v_1 U^1 + v_2 U^2.$$

These results are easily generalized to more dimensions, to spaces that have an indefinite metric, and even to more general spaces, such as those discussed in Section 7.11. For example, in a four-dimensional Minkowski space, the 1-form, v , associated with the vector V , is $v_0 = V^0$, $v_1 = -V^1$, $v_2 = -V^2$, $v_3 = -V^3$, so the squared length of the vector V is

$$V^0 v_0 + V^1 v_1 + V^2 v_2 + V^3 v_3 = V^0 V^0 - V^1 V^1 - V^2 V^2 - V^3 V^3.$$

The Lorentz transformations can be expressed in terms of the basis vectors. If we let x^0, x^1, x^2, x^3 be the coordinates in a frame S and $x^{\alpha'} = x^{\alpha'}(x^0, x^1, x^2, x^3)$ be the transformed coordinates in the frame S' , then the Lorentz transformation can be written as

$$x^{\alpha'} = \mathbf{L}^{\alpha'}_{\beta} x^{\beta} \quad \text{and} \quad x^{\alpha} = \mathbf{L}^{\alpha}_{\beta'} x^{\beta'}, \quad (7.50)$$

where $\mathbf{L}^{\alpha}_{\beta'}$ is the inverse transformation of $\mathbf{L}^{\alpha'}_{\beta}$. The basis vectors transform as

$$\mathbf{e}_{\alpha'} = \mathbf{L}^{\beta}_{\alpha'} \mathbf{e}_{\beta} \quad \text{and} \quad \mathbf{e}_{\alpha} = \mathbf{L}^{\beta'}_{\alpha} \mathbf{e}_{\beta'}. \quad (7.51)$$

Any vector transforms as $v = v^{\alpha} \mathbf{e}_{\alpha} = v^{\beta'} \mathbf{e}_{\beta'}$, so $\langle \eta, v \rangle = \eta_{\alpha} v^{\alpha} = \eta_{\alpha'} v^{\alpha'}$. This means that 1-forms transform as $\eta = \eta_{\alpha} \omega^{\alpha} = \eta_{\alpha'} \omega^{\alpha'}$, and it follows that

$$\omega^{\alpha'} = \mathbf{L}^{\alpha'}_{\beta} \omega^{\beta} \quad \text{and} \quad \omega^{\alpha} = \mathbf{L}^{\alpha}_{\beta'} \omega^{\beta'}, \quad (7.52)$$

so

$$v^{\alpha'} = \mathbf{L}^{\alpha'}_{\beta} v^{\beta} \quad \text{and} \quad v^{\alpha} = \mathbf{L}^{\alpha}_{\beta'} v^{\beta'}, \quad (7.53)$$

and

$$\eta_{\alpha'} = \mathbf{L}^{\beta}_{\alpha'} \eta_{\beta} \quad \text{and} \quad \eta_{\alpha} = \mathbf{L}^{\beta'}_{\alpha} \eta_{\beta'}. \quad (7.54)$$

To convert vectors, sum on the second (lowered) index of the transformation matrix. To convert 1-forms, sum on the first (raised) index. In tensor notation, vectors are columns, while 1-forms are rows.

Scalars, vectors and 1-forms are simple examples of geometric objects called *tensors*. A tensor is a functional into which we insert p vectors and n 1-forms to produce a mapping onto a scalar. We describe a tensor by saying that it has a rank given by the numbers n and p , where n is the number of 1-form insertions possible and p is the number of possible vector insertions. A tensor, Q , with n 1-form slots and p vector slots is written as Q of rank $\binom{n}{p}$. A tensor H of rank $\binom{n}{p}$ is a functional into which we can insert n 1-forms $\sigma, \lambda, \dots, \beta$ and p vectors u, v, \dots, w to produce a scalar. For example, the energy momentum vector $(\mathbf{E}/c, \mathbf{p})$ is a tensor of rank $\binom{1}{0}$, since contracting it with a 1-form produces a scalar. An example of an ordinary second-rank tensor is the quadrupole tensor of rank $\binom{2}{0}$.

Although the components of 1-forms are written with their indices down, the number of 1-form slots is written as the upper of the two numbers used to give the rank of a tensor. This is because in component notation the object generated will have that number of indices to be contracted with 1-forms. For example, if S is a tensor of rank $\binom{2}{1}$,

$$S(\sigma_{\alpha} \omega^{\alpha}, \lambda_{\beta} \omega^{\beta}, v^{\gamma} e_{\gamma}) = \sigma_{\alpha} \lambda_{\beta} v^{\gamma} S(\omega^{\alpha}, \omega^{\beta}, e_{\gamma}) = S^{\alpha\beta\gamma} \sigma_{\alpha} \lambda_{\beta} v^{\gamma}, \quad (7.55)$$

where the $S^{\alpha\beta}_\gamma$ are called the components of the tensor S in the chosen coordinate frame. The output of S is a scalar (see Eq. (7.55)), so if we repeat this calculation in another Lorentz frame, we obtain the transformation law for the tensor components under a coordinate transformation,

$$S^{\alpha'\beta'}_{\gamma'} = S^{\alpha\beta}_\gamma L^{\alpha'}_\alpha L^{\beta'}_\beta L^\gamma_{\gamma'}. \quad (7.56)$$

The metric tensor can be used to convert indices from vector to 1-form or 1-form to vector; for example,

$$S^\alpha_{\beta\gamma} = g_{\beta\sigma} S^{\alpha\sigma}_\gamma. \quad (7.57)$$

Hence, any tensor of rank $\binom{n}{p}$ can be converted by the metric tensor, without loss of information, to any arrangement of tensor and 1-form indices desired as long as the total number of indices $(n + p)$ is conserved. All of these objects are different coordinate forms of the same geometric object (tensor).

Consider our two-dimensional example with a vector, u , whose components are (a, b) and a 1-form, σ , with components (c, d) . If we examine a tensor W of rank $\binom{1}{1}$, then, from Eq. (7.55),

$$W(\sigma, u) = W^\alpha_{\beta\sigma_\alpha} u^\beta = W^0_0 ca + W^0_1 cb + W^1_0 da + W^1_1 db.$$

Physically, by using sets of vectors, u 's, and 1-forms, σ 's, and measuring the value of the scalar field $W(\sigma, u)$, the values of the components of W^α_β can be determined in one frame. And from Eq. (7.56), specialized to the number and type of components, the values in all inertial frames are known. In a Minkowski space with pseudo-Cartesian coordinates, the components of the tensor W of rank $\binom{1}{1}$ can be converted to a corresponding tensor of rank $\binom{0}{2}$ using the metric tensor in Eq. (7.33) $\{g_{00} = 1, g_{11} = g_{22} = g_{33} = -1\}$ and the expression in Eq. (7.57) to give the following relations:

$$\begin{aligned} W_{00} &= g_{00} W^0_0 = W^0_0, & W_{01} &= g_{00} W^0_1 = W^0_1, \\ W_{10} &= g_{11} W^1_0 = -W^1_0, & \text{and} & & W_{11} &= g_{11} W^1_1 = -W^1_1. \end{aligned}$$

Given any two vectors, we can construct a second-rank tensor by the operation called *tensor product*, $T = u \otimes v$. The tensor product is a machine whose output is a number when the two vectors and the two 1-forms are inserted

$$(u \otimes v)(\sigma, \lambda) = \langle \sigma, u \rangle \langle \lambda, v \rangle. \quad (7.58)$$

The components of the tensor product are

$$T^{\alpha\beta} = u^\alpha v^\beta. \quad (7.59)$$

In our two-dimensional example of vector u with components (a, b) and vector v with components (c, d) , Eq. (7.59) becomes written in tensor form

$$(T^{\alpha\beta}) = \begin{pmatrix} ac & ad \\ bc & bd \end{pmatrix}.$$

This process can be continued and could include 1-forms as well as vectors; for example, two vectors (\mathbf{u} , \mathbf{v}) and a 1-form (σ) would be written as $\mathbf{u} \otimes \mathbf{v} \otimes \sigma$.

Other useful operations include the *gradient*, *contraction*, the *divergence*, and the *wedge product*. First, let us consider the gradient operation. We used d for the gradient operation on scalars. For a higher-rank tensor, the gradient is often denoted by ∇ . In three-dimensional Cartesian space, ∇ is the operator

$$\nabla = i \frac{\partial}{\partial x} + j \frac{\partial}{\partial y} + k \frac{\partial}{\partial z},$$

which may also be written as

$$\partial_r = e_1 \frac{\partial}{\partial x^1} + e_2 \frac{\partial}{\partial x^2} + e_3 \frac{\partial}{\partial x^3}.$$

Returning to 4-dimensions, an example of a more general case, let \mathbf{S} be a $\binom{0}{3}$ rank tensor, then by definition, $\nabla \mathbf{S}(\mathbf{u}, \mathbf{v}, \mathbf{w}, \xi) = \partial_\xi \mathbf{S}(\mathbf{u}, \mathbf{v}, \mathbf{w})$ with the vectors \mathbf{u} , \mathbf{v} , \mathbf{w} held fixed, and

$$\nabla \mathbf{S}(\mathbf{u}, \mathbf{v}, \mathbf{w}, \xi) = \partial_\xi (S_{\alpha\beta\gamma} u^\alpha v^\beta w^\gamma) = \frac{\partial S_{\alpha\beta\gamma}}{\partial x^\delta} \xi^\delta u^\alpha v^\beta w^\gamma = S_{\alpha\beta\gamma, \delta} \xi^\delta u^\alpha v^\beta w^\gamma. \quad (7.60)$$

That is, the gradient operates only on the coefficients in the definition of the tensor, not on the included vector fields. Since the vectors and 1-forms in Eq. (7.60) are arbitrary and constant, we can rewrite the preceding as

$$\partial_\xi (S_{\alpha\beta\gamma}) = \frac{\partial S_{\alpha\beta\gamma}}{\partial x^\delta} \xi^\delta = S_{\alpha\beta\gamma, \delta} \xi^\delta, \quad (7.60')$$

where the ξ^δ define the direction of the gradient, and the last equality shows clearly that the derivative does not operate on the vector given by ξ^δ .

In Minkowski spacetime, contracting the energy momentum vector ($\mathbf{E}/c, \mathbf{p}$) with the charge-current 1-form ($\rho c, -\mathbf{J}$) produces the scalar ($E\rho - \mathbf{p} \cdot \mathbf{J}$). This idea can be extended to reduce the rank of a tensor by a process called contraction. The contraction operation can be performed on any tensor whose total rank (sum of vector and 1-form indices) is equal to or greater than 2. To do this, enter a basis vector in one slot and the corresponding 1-form basis in another slot and sum over the basis, thereby producing a lower-rank tensor. For example, consider the 4-index tensor whose components are $R_{\alpha\mu}{}^\beta{}_\nu$. We can form a two-index tensor by the inserting a basis 1-form into the first slot of the tensor definition, and the related basis vector in the third slot, and summing over the basis set. Formally,

$$R(e_\alpha, u, w^\alpha, v) = M(u, v), \quad (7.61)$$

or in component form

$$M_{\mu\nu}u^\mu v^\nu = R_{\alpha\mu}{}^\alpha{}_\nu u^\mu v^\nu, \quad (7.62)$$

which can be written as

$$M_{\mu\nu} = R_{\alpha\mu}{}^\alpha{}_\nu. \quad (7.62')$$

In three-dimensional Cartesian space, the divergence of a vector \mathbf{V} is the scalar quantity $\nabla \cdot \mathbf{V} = \frac{\partial V_x}{\partial x} + \frac{\partial V_y}{\partial y} + \frac{\partial V_z}{\partial z}$, while in 4-dimensional space the 4-divergence is $\frac{\partial V^\mu}{\partial x^\mu}$. In Minkowski spacetime the 4-divergence operator is often denoted by the same symbol, ∇ , in italics, or by \square whose components are

$$\square_\mu = \nabla_\mu = \omega_\mu^\alpha \frac{1}{\partial x^\alpha},$$

with ω_μ^α the 1-form basic components. For example, the continuity equation in electromagnetic theory is

$$\frac{\partial j^\mu}{\partial x^\mu} = \square \cdot J = \nabla \cdot J = \frac{\partial(\rho c)}{\partial ct} + \nabla \cdot \mathbf{j} = \frac{\partial \rho}{\partial t} + \nabla \cdot \mathbf{j} = 0.$$

The operator ∇^2 (sometimes written as \square^2) is called the d'Alembertian and is

$$\square^2 = \nabla^2 = \nabla \cdot \nabla = g^{\mu\nu} \frac{\partial}{\partial x^\mu} \frac{\partial}{\partial x^\nu} = \frac{1}{c^2} \frac{\partial^2}{\partial t^2} - \left(\frac{\partial^2}{\partial x^2} + \frac{\partial^2}{\partial y^2} + \frac{\partial^2}{\partial z^2} \right)$$

where the last equality is the expression in Minkowski space with Cartesian coordinates. The 4-divergence operator on tensors reduces the rank of the tensor by 1. For spacetime tensors, the divergence is written as $\nabla \cdot S$ and, considering as an example a tensor S with a slot for a 1-form and three vector slots,

$$\square \cdot S(u, v) = \nabla \cdot S(u, v) = \nabla \cdot S(\omega^\alpha, u, v, e_\alpha) = S^\alpha{}_{\beta\gamma, \alpha} u^\beta v^\gamma. \quad (7.63)$$

That is, the gradient of Eq. (7.60) is taken along a basis direction, and then a contraction is formed between this direction and one of the 1-form slots in the tensor. In component form, this reduces to

$$\nabla_\alpha S^\alpha{}_{\beta\gamma} = S^\alpha{}_{\beta\gamma, \alpha}. \quad (7.63')$$

The final tensor operator we need is the *wedge product*, also called the *bivector* or *biform*, which is

$$u \wedge v = u \otimes v - v \otimes u, \quad (7.64)$$

where the tensor product, \otimes , was defined in Eq. (7.58). The wedge product is an antisymmetric vector product. In component form, Eq. (7.64) becomes

$$(u \wedge v)^{\alpha\beta} = u^\alpha v^\beta - v^\alpha u^\beta. \quad (7.64')$$

Successive \wedge operations can be strung together just like the \otimes operator. The wedge product is useful whenever we deal with antisymmetric expressions. In particular, when we look at the electromagnetic field in the next section, we will discover that the fundamental field tensor, called *Faraday*, can be expressed in terms of the wedge product.

Consider the two-dimensional example used previously, where $\mathbf{u} = u^1 \mathbf{e}_1 + u^2 \mathbf{e}_2$ and $\mathbf{v} = v^1 \mathbf{e}_1 + v^2 \mathbf{e}_2$. The wedge product in Eq. (7.64') has components $W = u \wedge v$ given by

$$W = \begin{pmatrix} u^1 v^1 - v^1 u^1 & u^1 v^2 - u^2 v^1 \\ u^2 v^1 - v^2 u^1 & u^2 v^2 - v^2 u^2 \end{pmatrix} = \begin{pmatrix} 0 & u^1 v^2 - v^1 u^2 \\ u^2 v^1 - v^2 u^1 & 0 \end{pmatrix}.$$

Although the examples given above assumed a certain combination of 1-form slots and vector slots, we must stress that the metric tensor can be used to produce a tensor with indices in any desired position.

7.6 ■ FORCES IN THE SPECIAL THEORY; ELECTROMAGNETISM

The preceding material has been concerned with the kinematics of the special theory. The dynamics of the theory follows from the assumption that Newton's laws are correct for objects at rest in the rest frame of the observer, nearly correct for objects moving slowly relative to the speed of light, and require generalizations to covariant equations. The correct generalization of the three-velocity to the four-velocity was given in Eq. (7.27). So we must generalize the force law,

$$\mathbf{F}' = \frac{d(m\mathbf{v}')}{dt}, \quad (7.65)$$

to a covariant form.

Since Maxwell's equations are assumed to be a correct description, we shall briefly consider a covariant reformulation of electromagnetic theory as a guide for the correct form of the force laws of mechanics. The vector and scalar electromagnetic potentials form a four-vector $A^\mu = (\phi/c, \mathbf{A})$. If the potentials satisfy the Lorentz condition (in SI units), which is the vanishing of the four-divergence of the electromagnetic potential 4-vector,

$$\square \cdot A = \nabla \cdot A = \frac{\partial A^\mu}{\partial x^\mu} = \nabla \cdot \mathbf{A} + \mu_0 \epsilon_0 \frac{\partial \phi}{\partial t} = 0, \quad (7.66)$$

they separately satisfy the wave equations of the form (where $\mu_0 \epsilon_0 = 1/c^2$)

$$\square^2 \mathbf{A} = \nabla^2 \mathbf{A} = \frac{1}{c^2} \frac{\partial^2 \mathbf{A}}{\partial t^2} - \nabla^2 \mathbf{A} = \mu_0 \mathbf{j} \quad (7.67a)$$

for the space components and for the time component

$$\square^2 \phi = \nabla^2 \phi = \frac{1}{c^2} \frac{\partial^2 \phi}{\partial t^2} - \nabla^2 \phi = \frac{\rho}{\epsilon_0}. \quad (7.67b)$$

In terms of ϕ and \mathbf{A} , the Lorentz force is $\mathbf{F} = e\{-\nabla\phi + \frac{1}{c^2} \frac{\partial \mathbf{A}}{\partial t} + \frac{1}{c} [\mathbf{v} \times (\nabla \times \mathbf{A})]\}$. This suggests that we should generalize the Lorentz force law to

$$\frac{dp_\mu}{d\tau} = e \left(\frac{\partial(u^\nu A_\nu)}{\partial x^\mu} - \frac{dA_\mu}{d\tau} \right). \quad (7.68)$$

For the three-momentum, \mathbf{p}_3 , and three-velocity, \mathbf{v} , Eq. (7.68) becomes

$$\frac{d\mathbf{p}_3}{dt} = e(\mathbf{E} + \mathbf{v} \times \mathbf{B}), \quad (7.68')$$

with \mathbf{E} the electric field, \mathbf{B} the magnetic field, and e the electric charge. The geometric approach is to define a tensor F , named **Faraday**, whose components will be the electromagnetic field tensor and write, with u the 4-velocity,

$$\frac{dp}{d\tau} = eF(u). \quad (7.69)$$

In component notation, this becomes

$$\frac{dp^\mu}{d\tau} = eF^\mu{}_\beta u^\beta. \quad (7.70)$$

This produces Maxwell's equations, provided (according to Eq. (7.68)) $F^\alpha{}_\beta$ is given by

$$F^\alpha{}_\beta = \begin{pmatrix} 0 & E_x & E_y & E_z \\ E_x & 0 & cB_z & -cB_y \\ E_y & -cB_z & 0 & cB_x \\ E_z & cB_y & -cB_x & 0 \end{pmatrix}. \quad (7.71)$$

In Minkowski space, the indices are raised and lowered by the metric tensor (Eq. (7.33)), so

$$F^{\alpha\beta} = \begin{pmatrix} 0 & -E_x & -E_y & -E_z \\ E_x & 0 & -cB_z & cB_y \\ E_y & cB_z & 0 & -cB_x \\ E_z & -cB_y & cB_x & 0 \end{pmatrix}. \quad (7.71')$$

and

$$F_{\alpha\beta} = \begin{pmatrix} 0 & E_x & E_y & E_z \\ -E_x & 0 & -cB_z & cB_y \\ -E_y & cB_z & 0 & -cB_x \\ -E_z & -cB_y & cB_x & 0 \end{pmatrix}. \quad (7.71'')$$

The Faraday tensor can be written in at least two different ways using either the tensor product, Eq. (7.58), or the wedge product, Eq. (7.64), as

$$\mathbf{F} = F_{\alpha\beta} dx^\alpha \otimes dx^\beta = \frac{1}{2} F_{\alpha\beta} dx^\alpha \wedge dx^\beta.$$

The latter expression explicitly shows the antisymmetry.

We can write Maxwell's equation in their normal component form using geometric notation:

$$\nabla F = 0 \quad \text{and} \quad \nabla \cdot F = J, \quad (7.72)$$

where J is the 4-current density with components $(\rho c, \mathbf{j})$, where ρ is the charge density and \mathbf{j} is the three-current density. The first of these equations produces (using three-dimensional notation) $\nabla \cdot \mathbf{B} = 0$ and $\partial \mathbf{B} / \partial t + \nabla \times \mathbf{E} = 0$, while the second gives $\nabla \cdot \mathbf{E} = \rho / \epsilon_0$ and $(1/c^2) \partial \mathbf{E} / \partial t - \nabla \times \mathbf{B} = -\mu_0 \mathbf{j}$.

Following the guide provided by the covariant formulation of electromagnetic theory, the proper generalization of Newton's second law, Eq. (7.65), is

$$\frac{dp^\mu}{d\tau} = K^\mu, \quad (7.73)$$

where K^μ is a 4-vector force, known as the *Minkowski force*. The spatial components of K^μ are not the components of the force in Eq. (7.65), but rather they are quantities that reduce to the F^i as $\beta \rightarrow 0$. The exact form clearly results from the Lorentz transformation properties of the forces present. Some aspects of the 4-force are listed in Table 7.1.

The general question (which cannot be uniquely resolved) is, How do we find the proper relativistic expression for force? Electromagnetism is used to justify the special theory, so we should expect no problem with it. As we saw in the previous paragraphs, this is trivial for electromagnetic forces because the special theory and the Lorentz transformations are constructed to make Maxwell's electromagnetic theory covariant. For example, the electromagnetic force is given by Eq. (7.68) as

$$K_\mu = -q \left(\frac{\partial u_\nu A^\nu}{\partial x^\mu} - \frac{dA_\mu}{d\tau} \right), \quad (7.74)$$

with q the charge on the particles and A_μ the components of the four-potential given by $(\phi/c, \mathbf{A})$. Note that ϕ is the scalar potential and \mathbf{A} is the three-dimensional electromagnetic vector potential. So the ordinary force, F_i , and the spatial component of the Minkowski electromagnetic force, K_i , are related by

$$F_i = K_i \sqrt{1 - \beta^2}. \quad (7.75)$$

What about other forces? Two methods are commonly used to deduce acceptable transformation properties of forces and hence the correct relativistic form of the forces.

The first method is to argue that there are only four fundamental forces in nature—gravitational, weak nuclear, electromagnetic, and strong nuclear. A cor-

rect relativistic theory must provide valid expressions for these four forces. These expressions, if stated in covariant form, will automatically provide the transformation properties of the forces. In this approach, since we understand electromagnetic forces, it remains to find expressions for the other three fundamental forces in a covariant form in some frame and assume this is correct in all inertial frames. It is assumed the transformations involve no terms that vanish in the chosen frame; for example, there is no need to arbitrarily add terms proportional to $(v/c)^3$. This program has been carried out for two of the remaining three forces (weak nuclear and strong nuclear) and for weak gravitational forces. It fails completely for strong gravitational effects. It is beyond the scope of the present text to probe more deeply in to this question.

The second approach of determining the correct relativistic force is to simply define force as being the time rate of change of the momentum. Then we write

$$\frac{dp_i}{dt} = F_i \quad (7.76)$$

where the p_i in Eq. (7.76) is some relativistic generalization of the Newtonian momentum that reduces to mv_i in the limit of small β . The simplest generalization is the one given in Eq. (7.36). This second approach has thus far failed to produce any results other than those predicted by the first approach.

7.7 ■ RELATIVISTIC KINEMATICS OF COLLISIONS AND MANY-PARTICLE SYSTEMS

The formulations of the previous sections enable us to generalize relativistically the discussion of Section 3.11 on the transformation of collision phenomena between various systems. The subject is of considerable interest in experimental high-energy physics. While the forces between elementary particles are only imperfectly known, and are certainly far from classical, so long as the particles involved in a reaction are outside the region of mutual interaction their mean motion can be described by classical mechanics. Further, the main principle involved in the transformations—conservation of the four-vector of momentum—is valid in both classical and quantum mechanics. The actual collision or reaction is taken as occurring at a point—or inside a very small black box—and we look only at the behavior of the particles before and after.

Because of the importance to high-energy physics, this aspect of relativistic kinematics has become an elaborately developed field. It is impossible to give a comprehensive discussion here. All that we can do is provide some of the important tools, and cite a few simple examples that may illustrate the flavor of the techniques employed. Although many collision experiments involve colliding beams, we shall, for simplicity, confine our attentions to problems where one of the particles is at rest in the laboratory frame. The generalization to both particles moving in the laboratory frame is straightforward.

The notion of a point designated as the center of mass obviously presents difficulties in a Lorentz-invariant theory. But the center-of-mass system can be suitably generalized as the Lorentz frame of reference in which the total spatial linear momentum of all particles is zero. That such a Lorentz frame can always be found follows from the theorem that the total momentum 4-vector is timelike for a system of mass points.

One such frame is the center-of-momentum frame. This is a frame in which the components of the spatial momentum of the initial particles add to zero. Such a frame obviously exists. Let us define E and \mathbf{p} in Eq. (7.36) to be

$$E = \sum_{i=1}^n E_i \quad \text{and} \quad \mathbf{p} = \sum_{i=1}^n \mathbf{p}_i \quad (7.77)$$

where the sum is over the particles involved. The left-hand side of Eq. (7.38) becomes

$$\sum_{r,s} m_r m_s c^2 - \sum_{r,s} m_r m_s \gamma_r \gamma_s (\mathbf{v}_r \cdot \mathbf{v}_s). \quad (7.78)$$

This clearly is positive (*hint*: separate the negative terms in which $r = s$), so it is possible to find a frame in which the three-momentum, \mathbf{p} , equals zero. The Lorentz system, in which the spatial components of the total momentum are zero, is termed the *center-of-momentum system*, or more loosely, and somewhat incorrectly, as the center-of-mass system, and will be designated by the abbreviation "C-O-M system."

As an example, let us consider a particle of mass m_1 and momentum p^1 in the x -direction, which suffers a head-on collision with a particle of mass m_2 at rest in an experimenter's frame (called the laboratory frame). The initial 4-momentum is

$$p^\mu = ([m_1 \gamma + m_2]c, m_1 \gamma v^1, 0, 0). \quad (7.79)$$

The length squared of momentum has the magnitude

$$p^\mu p_\mu = (m_1^2 + m_2^2 + 2m_1 \gamma m_2)c^2. \quad (7.79')$$

When components are given, we shall follow the practice of denoting the primed frame by primes on the indices. The two particles are denoted by subscripts 1 and 2 respectively.

In the C-O-M system, the total momentum is

$$([m_1 \gamma'_1 + m_2 \gamma'_2]c, 0, 0, 0), \quad (7.80)$$

since by definition the space part of the momentum vanishes,

$$m_1 \gamma'_1 \beta'_1 c + m_2 \gamma'_2 \beta'_2 c = 0, \quad (7.81)$$

where β'_1 and β'_2 are the velocities of m_1 and m_2 , respectively, in the C-O-M frame.

The boost, β' , needed to go from the laboratory to the C-O-M frame, has the value

$$\beta'_2 = -\beta'. \quad (7.81')$$

Since all velocities are parallel, the velocity addition formula Eq. (7.15) gives the velocity β'_1 of mass m_1 in the C-O-M system in terms of β' and its velocity $\beta = v/c$ in the laboratory frame,

$$\beta'_1 = \frac{\beta - \beta'}{1 - \beta\beta'}. \quad (7.82)$$

The total squared momentum in the C-O-M frame given in Eq. (7.80) can be rewritten using the results of Eqs. (7.81) and (7.82) as

$$p^\mu p_\mu = \frac{m_2^2 \beta^2 (1 - \beta'^2) c^2}{\beta - \beta'}. \quad (7.83)$$

Equating Eqs. (7.79') and (7.83) gives a single equation that can be solved for the boost velocity β' . There are two real roots, one of which corresponds to the physically meaningful case of $\beta' < 1$.

Since the spatial momentum in the C-O-M frame is zero, there is clearly more energy, p^0 , in this frame than in the laboratory frame.* The excess energy in the C-O-M frame, ΔE , is obtained by subtracting the time component of Eq. (7.79) from the time component of Eq. (7.80).

The total momentum four vector is conserved, which automatically implies both conservation of spatial linear momentum and conservation of total energy (including rest mass energy). Our major tools for making use of the conservation principle are Lorentz transformations to and from the C-O-M system, and the formation of Lorentz invariants (world scalars) having the same value in all Lorentz frames. Since energy and momentum are combined into one conservation law, the relativistic results are more easily obtained than the nonrelativistic results of previous chapters. The transformations between laboratory system and C-O-M system are merely special cases of the Lorentz transformation.

As an example of the use of Lorentz invariants, let us consider a reaction initiated by two particles that produces another set of particles with masses m_r , $r = 3, 4, 5, \dots$. In the C-O-M system, the transformed total momentum is

$$P^{\mu'} = (E'/c, 0, 0, 0). \quad (7.84)$$

It is often convenient to look on the C-O-M system as the proper (or rest) system of a composite mass particle of mass $M = E'/c^2$.† The square of the magnitude of

*For a single particle, the energy has a minimum value, mc^2 , in the rest frame. The C-O-M frame is not the rest frame of either particle.

†Although it is customary in high-energy physics to use units in which $c = 1$, it seems more helpful in an introductory exposition such as this to retain the powers of c throughout.

P must be invariant in all Lorentz systems and conserved in the reaction. Hence, we have

$$P_\mu P^\mu = P_{\mu'} P^{\mu'} = \frac{E'^2}{c^2} = M^2 c^2. \quad (7.85)$$

But for the initial particles, $P_\mu P^\mu$ can be evaluated as

$$P_\mu P^\mu = (m_1^2 + m_2^2)c^2 - 2p_{1\mu} p_2^\mu. \quad (7.86)$$

The energy in the C-O-M system, or equivalent mass M , is therefore given in terms of the incident particles as

$$E'^2 \equiv M^2 c^4 = (m_1^2 + m_2^2)c^4 + 2(E_1 E_2 - c^2 \mathbf{p}_1 \cdot \mathbf{p}_2). \quad (7.87)$$

Suppose now that, one particle, say 2, was initially stationary in the laboratory system. Since then $\mathbf{p}_2 = 0$ and $E_2 = m_2 c^2$, the C-O-M energy becomes

$$E'^2 \equiv M^2 c^4 = (m_1^2 + m_2^2)c^4 + 2m_2 c^2 E_1'. \quad (7.88)$$

If the excess of E_1 over the rest mass energy be denoted by T_1 , [cf. Eq. (7.39)] that is, the kinetic energy, this can be written

$$E'^2 \equiv M^2 c^4 = (m_1 + m_2)^2 c^4 + 2m_2 c^2 T_1. \quad (7.89)$$

It is clear that the available energy in the C-O-M system increases only slowly with incident kinetic energy. Even in the "ultrarelativistic" region, where the kinetic energy of motion is very large compared to the rest mass energy, E' increases only as the square root of T_1 .

The effect of the proportionally small amount of incident energy available in the C-O-M system is shown dramatically in terms of the threshold energies. It is obvious that the lowest energy at which a reaction (other than elastic scattering) is possible is when the reaction products are at rest in the C-O-M system. Any finite kinetic energy requires a higher E' or equivalently higher incident energy. The total four-momentum in the C-O-M system after the reaction, denoted by $P^{\mu''}$ has the magnitude at threshold given by

$$P_{\mu''} P^{\mu''} = c^2 \left(\sum_r m_r \right)^2, \quad (7.90)$$

which, by conservation of momentum, must be the same as Eq. (7.85). For a stationary target, the incident energy of motion as threshold is then given as a consequence of Eq. (7.89) by

$$\frac{T_1}{m_1 c^2} = \frac{\left(\sum_r m_r\right)^2 - (m_1 + m_2)^2}{2m_1 m_2}.$$

If the Q value of the reaction is defined as*

$$Q = \left[\sum_r m_r - (m_1 + m_2) \right] c^2, \quad (7.91)$$

this threshold energy becomes

$$\frac{T_1}{m_1 c^2} = \frac{Q^2 + 2Q(m_1 + m_2)c^2}{2m_1 m_2 c^4}. \quad (7.92)$$

A common illustration of the application of Eq. (7.92) is the historic production of an antiproton, \bar{p} , by the reaction, involving a proton p ,

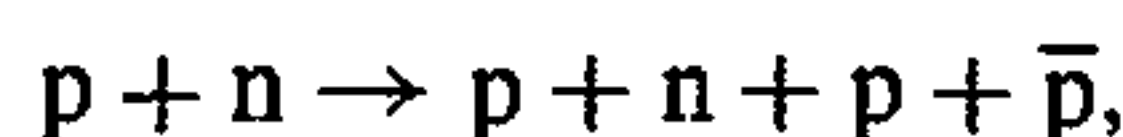

where n is a nucleon, either neutron or proton. The masses of all particles involved are nearly equal at 938 MeV equivalent rest mass energy and we select $Q = 2mc^2$. Equation (7.92) then says that the incident particle kinetic energy at threshold must be

$$T_1 = 6mc^2 = 5.63 \text{ GeV},$$

which is 3 times the energy represented by Q ! If, however, the reaction was initiated by two nucleons incident on each other with equal and opposite velocity, then the laboratory system is the same as the C-O-M system. All of the kinetic energy is available in this case to go into production of the proton-antiproton pair, and each of the incident particles at threshold need have a kinetic energy of motion equivalent to only the mass of one proton, 938 MeV. It is no wonder so much effort has been put into constructing colliding beam machines!

Another instructive example of a threshold calculation is photomeson production, say, by the reaction

$$\gamma + p = \Sigma^0 + K^+, \quad (7.93)$$

where γ stands for an incoming photon. For the purposes of classical mechanics, a photon is a zero-mass particle with spatial momentum ${}^0\mathbf{p}$ and energy ${}^0\mathbf{p}c$.[†] In calculating Q , the mass m_1 of the photon is zero:

$$Q = (m_{\Sigma^0} + m_{K^+} - m_p)c^2 = 749 \text{ MeV}.$$

* Q here has the opposite sign to the convention adopted in Eq. (3.112).

[†]The square of the magnitude of the photon momentum four-vector is zero, so the vector can be described as "lightlike." The C-O-M theorem is imperiled only if all of the particles are photons, and even then only if the photons are going in the same direction.

Equation (7.92) is rewritten for a reaction involving an incident photon as

$$T_1 = {}^0 p c = \frac{Q^2 + 2Qm_2c^2}{2m_2c^2}.$$

From the value of Q and the rest mass energy m_2 of the proton, the threshold energy for the reaction Eq. (7.93) is then

$$T_1 = 1.05 \text{ GeV},$$

which is only slightly higher than Q .

We can also easily find the energy of the reaction products in the laboratory system at threshold. The C-O-M system is the rest system for the mass M , with $P^0 = Mc$. In any other system, the zeroth component of the 4-vector is $P^0 = Mc\gamma$. But in the laboratory system

$$P^0 = \frac{1}{c}(E_1 + E_2) = \frac{1}{c}(E_1 + m_2c^2),$$

where the last form holds only for a stationary target particle. Hence, the C-O-M system moves relative to the laboratory system such that

$$\gamma = \frac{E_1 + m_2c^2}{Mc^2}. \quad (7.94)$$

But at threshold all the reaction products are at rest in the C-O-M system so that $M = \sum_r m_r$, and therefore

$$\gamma = \frac{T_1 + (m_1 + m_2)c^2}{\sum_r m_r c^2} \quad (\text{threshold}). \quad (7.95)$$

The kinetic energy of the s th reaction product in the laboratory system is then

$$T_s = m_s c^2 (\gamma - 1). \quad (7.96)$$

Thus, the antiproton at threshold has a kinetic energy $T_{\bar{p}} = mc^2 = 938 \text{ MeV}$. In contrast, the K^+ meson emerges at threshold with 494 MeV.

In Section 3.11, the kinematic transformations of a two-body nonrelativistic collision were investigated. Eq. (3.117') gives the reduction in energy of an incident particle after elastic scattering from a stationary target, as a function of the scattering angle in the C-O-M system. The derivation of the relativistic analog provides another interesting example of the methods of relativistic kinematics. Use of Lorentz invariants here is not particularly helpful; instead direct Lorentz transformations are made between the laboratory and C-O-M systems. Figure 7.4 illustrates the relations of the incident and scattered *spatial* momentum vectors in both systems. The incident and scattered momentum vectors define a plane, in-

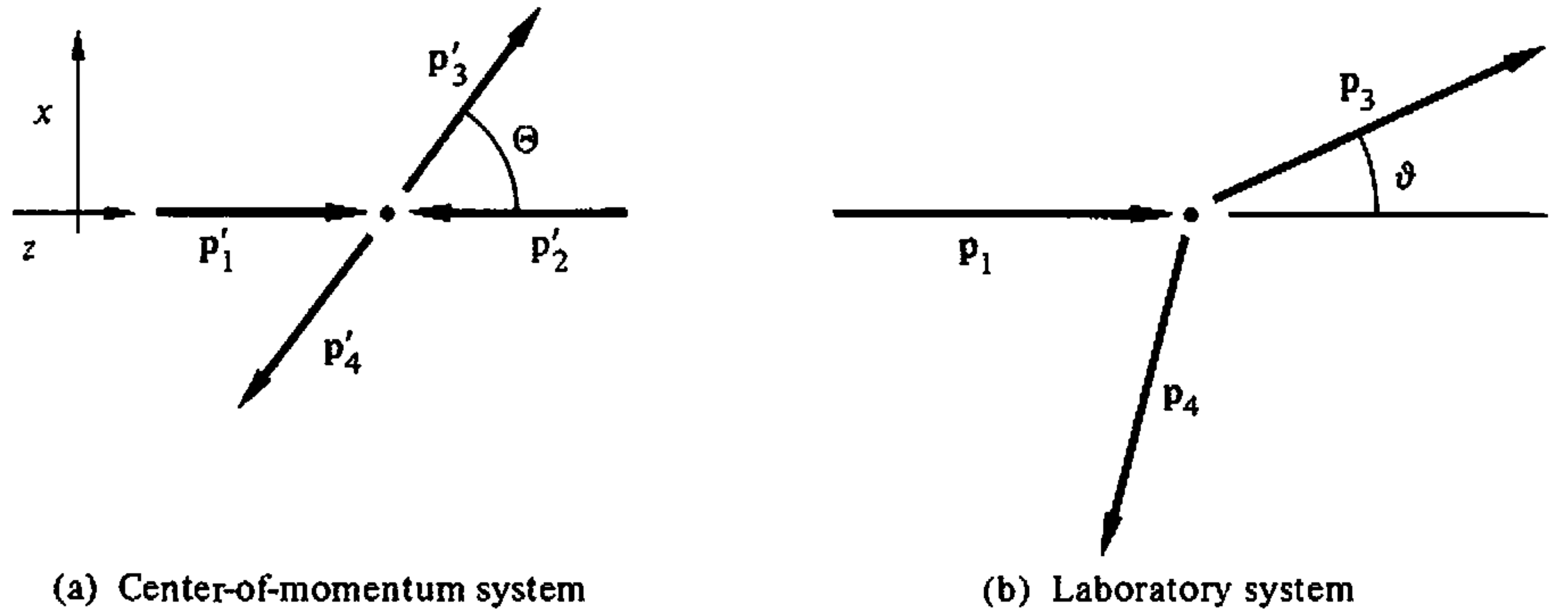

FIGURE 7.4 Momentum vectors for relativistic elastic scattering in C-O-M and laboratory Lorentz frames.

variant in orientation under Lorentz transformation, here taken to be the xz plane with the incident direction along the z axis. Because the collision is elastic, the masses of the incident particle, m_1 , and of the stationary target, m_2 , remain unchanged; that is, $m_3 = m_1, m_4 = m_2$. Primes on the vectors denote C-O-M values, unprimed vectors are in the laboratory system. To distinguish clearly between before and after the scattering, the indexes 3 and 4 will be retained for the vectors *after* scattering. We have only to remember that 3 denotes the scattered incident particle, and 4 the recoiling target particle. Components of the separate particle 4-vectors will always have two indices: the first for the particle, the second for the component.

The Lorentz transformation from the laboratory to the C-O-M system is defined by the γ of Eq. (7.94) with M given by Eq. (7.89):

$$\gamma = \frac{E_1 + m_2 c^2}{\sqrt{2m_2 c^2 E_1 + (m_1^2 + m_2^2) c^4}} = \frac{T_1 + (m_1 + m_2) c^2}{\sqrt{2m_2 c^2 T_1 + (m_1 + m_2)^2 c^4}}. \quad (7.97)$$

The quantity β can be found from γ , or more directly by arguments similar to those used to obtain γ . In the C-O-M system, the spatial part of the total momentum four-vector is zero; in any other system, the spatial part is $M c \beta \gamma$. However, in the laboratory system the spatial part is \mathbf{p}_1 . Hence, by Eq. (7.94) β must be given as

$$\beta = \frac{\mathbf{p}_1 c}{E_1 + m_2 c^2} = \frac{\mathbf{p}_1 c}{T_1 + (m_1 + m_2) c^2}. \quad (7.98)$$

Because β is along the z axis, the Lorentz transformation takes (with $\beta_x = \beta_y = 0$) the form given by Eq. (7.11), and the components of $p_1^{\mu'}$ in the C-O-M system are given by

$$\begin{aligned}
 p'_1 &= p_1^{3'} = \gamma \left(p_1 - \frac{\beta E_1}{c} \right) \\
 \frac{E'_1}{c} &= p_1^{0'} = \gamma \left(\frac{E_1}{c} - \beta p_1 \right).
 \end{aligned} \tag{7.99}$$

After the collision, \mathbf{p}'_3 is no longer along the z axis, but since the collision is elastic, its magnitude is the same as that of \mathbf{p}'_1 . If Θ is the angle between \mathbf{p}'_3 and the incident direction, as in Section 3.11, then the components of p'_3 in the C-O-M system are

$$p_3^{1'} = p'_1 \sin \Theta, \quad p_3^{3'} = p'_1 \cos \Theta, \quad p_3^{0'} = p_1^{0'} = \frac{E'_1}{c}. \tag{7.100}$$

The transformation back to the laboratory system is the same Lorentz transformation but with relative velocity $-\beta$. Hence, the components of \mathbf{p}_3 are

$$\begin{aligned}
 p_3^1 &= p_3^{1'} = p'_1 \sin \Theta \\
 p_3^3 &= \gamma(p_3^{3'} - \beta p_3^{0'}) = \gamma \left(p'_1 \cos \Theta + \frac{\beta E'_1}{c} \right) \\
 p_3^0 &= \gamma(p_3^{0'} + \beta p_3^{3'}) = \gamma \left(\frac{E'_1}{c} + \beta p'_1 \cos \Theta \right).
 \end{aligned} \tag{7.101}$$

If E'_1 and p'_1 are substituted in the last of Eqs. (7.101), from Eqs. (7.99) we obtain, after a little simplification, an expression for the energy of the scattered particle in terms of its incident properties:

$$E_3 = E_1 - \gamma^2 \beta (1 - \cos \Theta) (p_1 c - \beta E_1). \tag{7.102}$$

In Eq. (7.102), γ and β must be expressed terms of the incident quantities through Eqs. (7.97) and (7.98), resulting in the relation

$$\gamma^2 \beta (p_1 c - \beta E_1) = \frac{m_2 p_1^2 c^2}{2m_2 E_1 + (m_1^2 + m_2^2) c^2}. \tag{7.103}$$

With the help of the relation between p_1 and E_1 , Eq. (7.38'), this can be written

$$\gamma^2 \beta (p_1 c - \beta E_1) = \frac{m_2 T_1 (T_1 + 2m_1 c^2)}{2m_2 T_1 + (m_1 + m_2)^2 c^2}. \tag{7.104}$$

Some further algebraic manipulation then enables us to rewrite Eq. (7.102) as

$$\frac{T_3}{T_1} = 1 - \frac{2\rho(1 - \mathcal{E}_1/2)}{(1 + \rho)^2 + 2\rho\mathcal{E}_1} (1 - \cos \Theta), \tag{7.105}$$

where $\rho = m_1/m_2$, as in Section 3.11 for elastic scattering, and \mathcal{E}_1 is the kinetic energy of the incident particle in units of the rest mass energy,

$$\mathcal{E}_1 = \frac{T_1}{m_1 c^2}. \quad (7.106)$$

Equation (7.105) is the relativistic counterpart of Eq. (3.117'). It is easy to see that Eq. (7.105) reduces to the nonrelativistic case as $\mathcal{E}_1 \rightarrow 0$, and that if $\rho = 1$ (equal masses), the relativistic corrections cancel completely. Equation (7.105) implies that the minimum energy after scattering, in units of $m_1 c^2$, is given by

$$(\mathcal{E}_3)_{\min} = \mathcal{E}_1 \frac{(1 - \rho)^2}{(1 + \rho)^2 + 2\rho\mathcal{E}_1}. \quad (7.107)$$

In the nonrelativistic limit, the minimum fractional energy after scattering is

$$\frac{(\mathcal{E}_3)_{\min}}{\mathcal{E}_1} = \left(\frac{1 - \rho}{1 + \rho} \right)^2; \quad \mathcal{E}_1 \ll 1, \quad (7.108)$$

which is a well-known result, easily obtained from Eq. (3.117'). Equation (7.108) says that in the nonrelativistic region a particle of mass m_1 cannot lose much kinetic energy through scattering from a much heavier particle, that is, when $\rho \ll 1$, which clearly agrees with common sense. However, in the ultrarelativistic region, when $\rho\mathcal{E}_1 \gg 1$, the minimum energy after scattering is independent of \mathcal{E}_1 :

$$(T_3)_{\min} = \frac{(m_2 - m_1)^2 c^2}{2m_2}; \quad \rho\mathcal{E}_1 \gg 1. \quad (7.109)$$

Since the condition on \mathcal{E}_1 is equivalent to requiring $T_1 \gg m_2 c^2$, it follows from Eq. (7.109) that such a particle can lose a large fraction of its energy even when scattered by a much heavier particle. This behavior is unexpected, but it should be remembered that for particles at these energies, traveling very close to the speed of light, even a slight change in velocity corresponds to a large change in energy.

Finally, we may easily obtain the relation between the scattering angles in the C-O-M and laboratory system by noting that (first index particle, second component)

$$\tan \vartheta = \frac{p_{31}}{p_{33}} = \frac{\sin \Theta}{\gamma \left(\cos \Theta + \frac{\beta E'_1}{p'_1 c} \right)}. \quad (7.110)$$

By Eq. (7.36),

$$\frac{p'_1 c}{E'_1} = \frac{v'_1}{c} \equiv \beta'_1, \quad (7.111)$$

so that $\tan \vartheta$ can also be written

$$\tan \vartheta = \frac{\sin \Theta}{\gamma (\cos \Theta + \beta/\beta')} \quad (7.112)$$

In terms of initial quantities, Eqs. (7.99) show that

$$\frac{\beta E'_1}{p'_1 c} = \frac{\beta \left(\frac{E_1}{c} - \beta p_1 \right)}{p_1 - \frac{\beta E_1}{c}} \quad (7.113)$$

This can be further reduced by employing the relations (cf. Eq. (7.98))

$$\frac{\beta}{p_1 - \frac{\beta E_1}{c}} = \frac{1}{m_2 c} \quad (7.114)$$

$$E_1 - \beta p_1 = \frac{m_1(m_1 + m_2)c^4 + m_2 c^2 T_1}{(m_1 + m_2)c^2 + T_1} \quad (7.115)$$

The final expression for $\tan \vartheta$ can then be written as

$$\tan \vartheta = \frac{\sin \Theta}{\gamma [\cos \Theta + \rho g(\rho, \mathcal{E}_1)]} \quad (7.116)$$

where $g(\rho, \mathcal{E}_1)$ is the function

$$g(\rho, \mathcal{E}_1) = \frac{1 + \rho(1 + \mathcal{E}_1)}{(1 + \mathcal{E}_1) + \rho} \quad (7.117)$$

and γ , by Eq. (7.97), takes the form

$$\gamma(\rho, \mathcal{E}_1) = \frac{1 + \mathcal{E}_1 + \rho}{\sqrt{(1 + \rho)^2 + 2\rho\mathcal{E}_1}} \quad (7.118)$$

Again, in the nonrelativistic region, γ and g tend to unity, and Eq. (7.116) reduces to Eq. (3.107). The correction function $g(\rho, \mathcal{E}_1)$ never really amounts to much, approaching the constant limit ρ as \mathcal{E}_1 becomes very large. The important factor affecting the transformed angle is γ , which of course increases indefinitely as \mathcal{E}_1 increases. It does not affect the bounds of the angular distribution, when $\Theta = 0$ or π , but its presence means that at other angles ϑ is always smaller than it would be nonrelativistically. The Lorentz transformation from C-O-M to the laboratory system, which does not affect the transverse component of the momentum, thus always tends to distort the scattered angular distribution into the forward direction.

7.8 ■ RELATIVISTIC ANGULAR MOMENTUM

In Chapter 1, it was proven that the nonrelativistic angular momentum obeys an equation of motion much like that for the linear momentum, but with torques

replacing forces. It was shown that for an isolated system obeying the law of action and reaction the total angular momentum is conserved, and that in the C-O-M system it is independent of the point of reference. All of these statements have their relativistic counterparts, at times involving some additional restrictions.

For a single particle, let us define an antisymmetric tensor of rank $\binom{2}{0}$ in Minkowski space using the formalism of Eq. (7.64)

$$m = x \wedge p \quad (7.119)$$

whose elements would be

$$m^{\mu\nu} = x^\mu p^\nu - x^\nu p^\mu. \quad (7.120)$$

The 3×3 subtensor m^{ij} clearly corresponds, as was seen in Section 5.1, with the spatial angular momentum of the particle. An equation of motion for $m^{\mu\nu}$ can be found by taking its derivative with respect to the particle's proper time and making use of Eq. (7.73) giving

$$\frac{dm}{d\tau} = u \wedge p + x \wedge K = x \wedge K, \quad (7.121)$$

where the first term vanishes by the antisymmetry of the wedge product and K is the Minkowski force. In component notation, Eq. (7.121) becomes

$$\frac{dm^{\mu\nu}}{d\tau} = x^\mu K^\nu - x^\nu K^\mu. \quad (7.122)$$

This suggests we define the relativistic generalization of the torque by

$$N = x \wedge K, \quad (7.123)$$

whose components are

$$N^{\mu\nu} = x^\mu K^\nu - x^\nu K^\mu. \quad (7.124)$$

Thus, m obeys the equations of motion

$$\frac{dm}{d\tau} = N, \quad (7.125)$$

whose component form is

$$\frac{dm^{\mu\nu}}{d\tau} = N^{\mu\nu}, \quad (7.126)$$

with Eq. (1.11) as the nonrelativistic limiting form.

For a system involving a collection of particles, a total angular momentum 4-tensor can be defined (analogously to the total linear momentum 4-vector) as

$$M = \sum_s m_s \quad (7.127)$$

or in component form

$$M^{\mu\nu} = \sum_s m_s^{\mu\nu}, \quad (7.128)$$

where the index s denotes the s th particle. It is more difficult to form an equation of motion for M because each particle has its own proper time. (For the same reason, we did not attempt it even for P .) Nevertheless, plausible arguments can be given for the conservation of M under certain circumstances. If the system is completely isolated and the particles do not interact with each other or with the outside world (including fields), then m for each particle is conserved by Eq. (7.126), and therefore M is also conserved. Even if the particles interact, but the interaction takes place only through binary collisions at a point, there still could be conservation as can be seen from the following argument. Instantaneously when the two particles collide they are traveling together and have the same proper time. In other words, their world lines cross and they share the same *event*. One can therefore write an equation of motion of the form of Eq. (7.126) for the sum of their angular momenta. If the impulsive forces of contact are equal and opposite—as we would expect from conservation of linear momentum in the collision—then the sum of the impulsive torques cancel. Hence relativistic angular momentum is also conserved through such collisions. Note that unlike the nonrelativistic case covariance requires that the interactions are assumed to be instantaneous point collisions.

The relativistic angular momentum obeys the same kind of theorem regarding translation of the reference point as does its nonrelativistic counterpart. In the definition, Eq. (7.120) or Eq. (7.128), the reference point (really reference “event”) is the arbitrary origin of the Lorentz system. With respect to some other reference event \mathbf{a}_λ , the total angular momentum is

$$M(a_\lambda) = \sum_s (x_s - a_\lambda) \wedge p_s \quad (7.129)$$

$$= M(0) - a_\lambda \wedge P \quad (7.130)$$

As in the nonrelativistic case, the change in the angular momentum components is equal to the angular momentum, relative to the origin, that the whole system would have if it were located at \mathbf{a}_λ .

In Chapter 1, one particular reference point played an important role—the center of mass. We can find something similar here, at least in one Lorentz frame, by examining the nature of the mixed time and space components of $M^{\mu\nu}$, namely, $M^{0j} = -M^{j0}$. By definition, in some particular Lorentz frame, these components are given by

$$M^{0j} = \sum_s (x_s^0 p_s^j - x_s^j p_s^0) \quad (7.131)$$

$$= c \sum_s \left(t p_s^j - \frac{x_s^j E_s}{c^2} \right). \quad (7.132)$$

In the C-O-M frame, the total linear momentum $p = \sum p_s$ vanishes, and M^{0j} in this frame has the form

$$M^{0j} = -c \sum_s \frac{x_s E_s}{c^2}. \quad (7.133)$$

If the system is such that the total angular momentum is conserved, as described above, then along with other components M is conserved and hence

$$\sum_s x_s^j E_s = \text{constant}.$$

Conservation of total linear momentum means that $E = \sum E_s$ is also conserved. It is therefore possible to define a *spatial* point R_j ,

$$R_j = \frac{\sum_s x_s^j E_s}{\sum_s E_s}, \quad (7.134)$$

associated with the system, which is stationary in the C-O-M coordinate frame. In the nonrelativistic limit, where to first approximation $E_s = m_s c^2$, Eq. (7.134) reduces to the usual definition, Eq. (1.21). Thus, a meaningful center of mass (sometimes called *center of energy*) can be defined in special relativity only in terms of the angular-momentum tensor, and only for a particular frame of reference. Finally, it should be noted that by Eq. (7.130) the spatial part of the angular momentum tensor, M , is independent of reference point in the C-O-M system, exactly as in the nonrelativistic case.

Except for the special case of point collisions, we have so far carefully skirted the problem of finding the motion of a relativistic particle given the Minkowski forces. To this more general problem we address ourselves in the next section, within the nominal framework of the Lagrangian formulation.

7.9 ■ THE LAGRANGIAN FORMULATION OF RELATIVISTIC MECHANICS

Having established the appropriate generalization of Newton's equation of motion for special relativity, we can now seek to establish a Lagrangian formulation of the resulting relativistic mechanics. Generally speaking, there are two ways in which this has been attempted. One method makes no pretense at a manifestly covariant formulation and instead concentrates on reproducing, for some particular Lorentz frame, the spatial part of the equation of motion, Eq. (7.76). The forces F_i may or may not be suitably related to a covariant Minkowski force. The other method sets out to obtain a covariant Hamilton's principle and ensuing Lagrange's equations in which space and time are treated in common fashion as coordinates in a four-dimensional configuration space. The basis for the first method is at times quite shaky, especially when the forces are not relativistically well formulated. Most of

the time, however, the equations of motion so obtained, while not manifestly covariant, are relativistically correct for some particular Lorentz frame. The second method, on the other hand, seems clearly to be the proper approach, but it quickly runs into difficulties that require skillful handling if they are to be solvable, even for a single particle. For a system of more than one particle, it breaks down almost from the start. No satisfactory formulation for an interacting multiparticle system exists in classical relativistic mechanics except for some few special cases.

This section follows the first method, seeking to find a Lagrangian that leads to the relativistic equations of motion in terms of the coordinates of some particular inertial system. Within these limitations there is no great difficulty in constructing a suitable Lagrangian. It is true that the method of Section (1.4), deriving the Lagrangian from D'Alembert's principle, will not work here. While the principle itself remains valid in any given Lorentz frame, the derivation there is based on $p_i = m_i v_i$, which is no longer valid relativistically. But we may also approach the Lagrangian formulation from the alternative route of Hamilton's principle (Section 2.1) and attempt simply to find a function L for which the Euler-Lagrange equations, as obtained from the variational principle

$$\delta I = \delta \int_{t_1}^{t_2} L dt = 0. \quad (7.135)$$

agree with the known relativistic equations of motion, Eq. (7.76).

A suitable relativistic Lagrangian for a single particle acted on by conservative forces independent of velocity would be*

$$L = -mc^2 \sqrt{1 - \beta^2} - V, \quad (7.136)$$

where V is the potential, depending only upon position, and $\beta^2 = v^2/c^2$, with v the speed of the particle in the Lorentz frame under consideration. That this is the correct Lagrangian can be shown by demonstrating that the resultant Lagrange equations,

$$\frac{d}{dt} \left(\frac{\partial L}{\partial v^i} \right) - \frac{\partial L}{\partial x^i} = 0,$$

agree with Eq. (7.76). Since the potential is velocity independent v_i occurs only in the first term of (7.136) and therefore

$$\frac{\partial L}{\partial v^i} = \frac{mv^i}{\sqrt{1 - \beta^2}} = \mathcal{P}^i. \quad (7.137)$$

The equations of motion derived from the Lagrangian (7.136) are then

*We do not choose $L = mc^2 \sqrt{1 - \beta^2} - V$ because we want h in Eq. (7.139) to be the total energy

$$\frac{d}{dt} \frac{mv^i}{\sqrt{1-\beta^2}} = -\frac{\partial V}{\partial x^i} = F^i,$$

which agree with (7.76). Note that the Lagrangian is no longer $L = T - V$ but that the partial derivative of L with velocity is still the momentum. Indeed, it is this last fact that ensures the correctness of the Lagrange equations, and we could have worked backward from Eq. (7.137) to supply at least the velocity dependence of the Lagrangian.

We can readily extend the Lagrangian (7.136) to systems of many particles and change from Cartesian to any desired set of generalized coordinates q . The canonical momenta, \mathcal{P} , will still be defined by

$$\mathcal{P}_i = \frac{\partial L}{\partial \dot{q}^i}, \quad (7.138)$$

so that the connection between cyclic coordinates and conservation of the corresponding momenta remains just as in the nonrelativistic theory. Further, just as in Section (2.7), if L does not contain the time explicitly, there exists a constant of the motion

$$h = \dot{q}^i \mathcal{P}_i - L. \quad (7.139)$$

However, the identification of h with the energy for, say, a Lagrangian of the form of Eq. (7.136) cannot proceed along the same route as in Section (2.7). Note that L in Eq. (7.136) is not at all a homogeneous function of the velocity components. Nonetheless, direct evaluation of Eq. (7.139) from Eq. (7.136) shows that in this case h is indeed the total energy:

$$h = \frac{mv_i v^i}{\sqrt{1-\beta^2}} + mc^2 \sqrt{1-\beta^2} + V,$$

which, on collecting terms, reduces to

$$h = \frac{mc^2}{\sqrt{1-\beta^2}} + V = T + V + mc^2 = E. \quad (7.140)$$

The quantity h is thus again seen to be the total energy E , which is therefore a constant of the motion under these conditions.

The introduction of velocity-dependent potentials produces no particular difficulty here and can be performed in exactly the same manner as in Section 1.5 for nonrelativistic mechanics. Thus, the Lagrangian for a single particle of charge, q , in an electromagnetic field is

$$L = -mc^2 \sqrt{1-\beta^2} - q\phi + q\mathbf{A} \cdot \mathbf{v}. \quad (7.141)$$

Note that the *canonical* momentum is no longer mu ; there are now additional terms arising from the velocity dependent part of the potential:

$$\mathcal{P}^i = mu^i + qA^i. \quad (7.142)$$

This phenomenon is not a relativistic one of course; exactly the same additional term was found in the earlier treatment (cf. Eq. (2.47)). The formulation of Eq. (7.141) is not manifestly covariant. But we can confidently expect that the results will hold in all Lorentz frames as a consequence of the relativistic covariance of the Lorentz force derivable from the velocity dependent potential in Eq. (7.141).

Almost all of the procedures devised previously for the solution of specific mechanical problems thus can be carried over into relativistic mechanics. A few simple examples will be considered here by way of illustration.

1. *Motion under a constant force; hyperbolic motion.* It will be no loss of generality to take the x axis as the direction of the constant force. The Lagrangian is therefore

$$L = -mc^2\sqrt{1 - \beta^2} - max, \quad (7.143)$$

where β is \dot{x}/c and a is the constant magnitude of the force per unit mass. Either from Eq. (7.143) or directly on the basis of Eq. (7.76), the equation of motion is easily found to be

$$\frac{d}{dt} \left(\frac{\beta}{\sqrt{1 - \beta^2}} \right) = \frac{a}{c}.$$

The first integration leads to

$$\frac{\beta}{\sqrt{1 - \beta^2}} = \frac{at + \alpha}{c}$$

or

$$\beta = \frac{at + \alpha}{\sqrt{c^2 + (at + \alpha)^2}},$$

where α is a constant of integration. A second integration over t from 0 to t and x from x_0 to x ,

$$x - x_0 = c \int_0^t \frac{(at' + \alpha)dt'}{\sqrt{c^2 + (at' + \alpha)^2}},$$

leads to the complete solution

$$x - x_0 = \frac{c}{a} \left[\sqrt{c^2 + (at + \alpha)^2} - \sqrt{c^2 + \alpha^2} \right]. \quad (7.144)$$

If the particle starts at rest from the origin so that $x_0 = 0$ and $v_0 = 0 = \alpha$, then Eq. (7.144) can be written as

$$\left(x + \frac{c^2}{a} \right)^2 - c^2 t^2 = \frac{c^4}{a^2},$$

which is the equation of a hyperbola in the x, t plane. (Under the same conditions the nonrelativistic motion is of course a parabola in the x, t plane). The nonrelativistic limit is obtained from Eq. (7.144) by considering $(at + \alpha)$ small compared to c ; the usual freshman-physics formula for x as a function of t is then easily obtained, recognizing that in this limit $\alpha \rightarrow v_0$.

The motion described in this example arises in reasonably realistic situations. It corresponds, for example, to the acceleration of electrons to relativistic speeds in the laboratory system by means of a constant and uniform electric field. The illustration considered next is more academic, but is of interest as an example of the techniques employed.

2. *The relativistic one-dimensional harmonic oscillator.* The Lagrangian in this case is of the form of Eq. (7.136) with

$$V(x) = \frac{1}{2} kx^2. \quad (7.145)$$

Since L is then not explicitly a function of time and V is not velocity dependent, the total energy E is constant. Equation (7.140) may now be solved for the velocity x as

$$\frac{1}{c^2} \left(\frac{dx}{dt} \right)^2 = 1 - \frac{m^2 c^4}{(E - V)^2}. \quad (7.146)$$

For the moment, we shall postpone substituting in the particular form of $V(x)$ and generalize the problem slightly to include any potential sharing the qualitative characteristics of Eq. (7.145). Thus, let us suppose that $V(x)$ is any potential function symmetric about the origin and possessing a minimum at that point. Then providing E lies between $V(0)$ and the maximum of V , the motion will be oscillatory between limits $x = -b$ and $x = +b$, determined by

$$V(\pm b) = E.$$

The period of the oscillatory motion is, by Eq. (7.146), to be obtained from

$$\tau = \frac{4}{c} \int_0^b \frac{dx}{\sqrt{1 - \frac{m^2 c^4}{(E - V(x))^2}}}. \quad (7.147)$$

Equation (7.147), when specialized to the particular Hooke's law form (7.145) for $V(x)$, can be expressed in terms of elliptic integrals. We shall instead examine the first-order relativistic corrections when the potential energy is always small compared to the rest mass energy mc^2 . A change of notation is helpful. The energy E can be written as

$$E = mc^2(1 + \mathcal{E})$$

so that here

$$\frac{E - V(x)}{mc^2} = 1 + \mathcal{E} - \kappa x^2 = 1 + \kappa(b^2 - x^2), \quad (7.148)$$

where

$$\kappa = \frac{k}{2mc^2}. \quad (7.149)$$

To the order $(\kappa b^2)^2$, the period, Eq. (7.147) then reduces to

$$\tau \simeq \frac{4}{c} \int_0^b \frac{dx}{\sqrt{2\kappa(b^2 - x^2)}} \left[1 - \frac{3\kappa}{4}(b^2 - x^2) \right]. \quad (7.150)$$

The intergral in Eq. (7.150) can be evaluated by elementary means, most simply by changing variable through $x = b \sin \phi$; the final result is

$$\tau \simeq \frac{2\pi}{c} \frac{1}{\sqrt{2\kappa}} \left(1 - \frac{3}{8}\kappa b^2 \right) = 2\pi \sqrt{\frac{m}{k}} \left(1 - \frac{3}{16} \frac{kb^2}{mc^2} \right).$$

Note that the expression in front of the bracket is τ_0 , the nonrelativistic period of the harmonic oscillator. In special relativity, the period of the harmonic oscillator is thus not independent of the amplitude; instead, there is an amplitude dependent correction given approximately by

$$\frac{\Delta v}{v_0} = -\frac{\Delta \tau}{\tau_0} \simeq \frac{3}{16} \frac{kb^2}{mc^2} = \frac{3}{8} \mathcal{E}. \quad (7.151)$$

3. *Motion of a charged particle in a constant magnetic field.* In principle, we should start from a Lagrangian of the form of Eq. (7.141) with the scalar potential $\phi = 0$ and \mathbf{A} appropriate to a constant magnetic field (Eq. 5.106). But we know such a Lagrangian corresponds to the Lorentz force on the charged particle of charge q , given by

$$\mathbf{F} = q(\mathbf{v} \times \mathbf{B}) \quad (7.152)$$

(cf. Eq. 1.60). Hence, the equation of motion must be

$$\frac{d\mathbf{p}}{dt} = q(\mathbf{v} \times \mathbf{B}) = \frac{q}{m\gamma} (\mathbf{p} \times \mathbf{B}). \quad (7.153)$$

The nature of the force, Eq. (7.152), is clearly such that the magnetic field does no work on the particle: $\mathbf{F} \cdot \mathbf{v} = 0$. Hence, E must be a constant, as also p and γ by Eq. (7.38'). Further, by Eq. (7.152), there is no component of the force parallel to \mathbf{B} , and the momentum component along that direction must remain constant. It is therefore no loss of generality to consider the motion only in the plane perpendicular to \mathbf{B} and to let \mathbf{p} represent the projection of the total linear momentum on to that plane. Equation (7.153) then says that the vector \mathbf{p} (whose magnitude is constant) is precessing around the direction of the magnetic field with a frequency

$$\Omega = \frac{qB}{m\gamma} \quad (7.154)$$

referred to as the cyclotron frequency. In the nonrelativistic limit $\gamma \rightarrow 1$. This agrees with the cyclotron resonance expression found in solid state physics texts. Because γ is constant, the velocity vector in the plane is also of constant magnitude and rotating with the same frequency. The particle must therefore move uniformly in a circular orbit in the plane with angular speed Ω . Since the centrifugal force, F , equals mu^2/r , it follows that the magnitude of the linear momentum in the plane must be given by

$$p = m\gamma r\Omega.$$

Combining this expression with Eq. (7.154) leads to the relation between the circle radius and the momentum:

$$r = \frac{p}{qB}. \quad (7.155)$$

The radius of curvature into which the particle motion is bent depends only upon the particle properties through the ratio p/q ($= Br$), which is sometimes called the *magnetic rigidity* of the particle. Note that while Ω (Eq. (7.154)) shows relativistic corrections through the presence of γ , the relation between r and p is the same both relativistically and nonrelativistically. Recall that in both Eqs. (7.154) and (7.155) p is the magnitude of the momentum perpendicular to B , but in calculating γ we must use both the perpendicular and parallel components to find β .*

7.10 ■ COVARIANT LAGRANGIAN FORMULATIONS

The Lagrangian procedure as given above certainly predicts the correct relativistic equations of motion. Yet it is a relativistic formulation only “in a certain sense.”

*The Larmor precession frequency ω_L of Eq. (5.104) has an extra factor of 2, and corresponds to the precession of a magnetic moment in a constant magnetic field. This is a physically different case from that of the cyclotron resonance of a charged particle moving at a constant speed in a magnetic field.

No effort has been made to keep to the ideal of a covariant four-dimensional form for all the laws of mechanics. Thus, the time t has been treated as a parameter entirely distinct from the spatial coordinates, while a covariant formulation would require that space and time be considered as entirely similar coordinates in world space. Clearly some invariant parameter should be used, instead of t , to trace the progress of the system point in configuration space. Further, the examples of Lagrangian functions discussed in the previous section do not have any particular Lorentz transformation properties. Hamilton's principle must itself be manifestly covariant, which can only mean in this case that the action integral must be a world scalar. If the parameter of integration is a Lorentz invariant, then the Lagrangian function itself must be a world scalar in any covariant formulation. Finally, instead of being a function of x_i and \dot{x}_i , the Lagrangian should be a function of the coordinates in Minkowski space and of their derivatives with respect to the invariant parameter.

We shall consider primarily a system of only one particle. The natural choice of the invariant parameter in such a system would seem to be the particle's proper time τ . But the various components of the generalized velocity, u^ν , must then obey the relation

$$u \cdot u = u_\nu u^\nu = c^2, \quad (7.35)$$

which shows they are not independent. Therefore, we shall instead assume the choice of some Lorentz-invariant quantity θ with no further specification than that it be a monotonic function of the progress of the world point along the particle's world line. For the purpose of this discussion, a superscript prime will be used to denote differentiation with respect to θ :

$$x'^\nu \equiv \frac{dx^\nu}{d\theta},$$

while a dot over the letter indicates differentiation with respect to t . A suitably covariant Hamilton's principle must therefore appear as

$$\delta I = \delta \int_{\theta_1}^{\theta_2} \Lambda(x^\mu, x'^\mu) d\theta, \quad (7.156)$$

where the Lagrangian function Λ must be a world scalar and the (x^μ, x'^μ) means a function of all or any of these. Note that this formulation includes what would have ordinarily been called "time-dependent Lagrangians," because Λ is considered a function of x^0 . The Euler-Lagrange equations corresponding to Eq. (7.156) are

$$\frac{d}{d\theta} \left(\frac{\partial \Lambda}{\partial x'^\mu} \right) - \frac{\partial \Lambda}{\partial x^\mu} = 0. \quad (7.157)$$

The problem is to find the form of Λ such that Eqs. (7.157) are equivalent to the equations of motion, Eq. (7.73).

One way of seeking Λ is to transform the action integral from the usual integral over t to one over θ , and to treat the time t appearing explicitly in the Lagrangian

not as a parameter but as an additional generalized coordinate. Since θ must be a monotonic function of t as measured in some Lorentz frame, we have

$$\frac{dx^t}{dt} = \frac{dx^t}{d\theta} \frac{d\theta}{dt} = c \frac{x'^t}{x'^0}. \quad (7.158)$$

Hence, the action integral is transformed as

$$I = \int_{t_1}^{t_2} L(x^J, t, \dot{x}^J) dt = \frac{1}{c} \int_{\theta_1}^{\theta_2} L\left(x^J, c \frac{x'^J}{x'^0}\right) x'^0 d\theta.$$

It would seem therefore that a recipe for a suitable Λ is given by the relation

$$\Lambda(x^\mu, x'^\mu) = \frac{x'^0}{c} L\left(x^\mu, c \frac{x'^J}{x'^0}\right). \quad (7.159)$$

The Lagrangian obtained this way is however a strange creature, unlike any Lagrangian we have so far met. Note that no matter what the functional form of L , the new Lagrangian Λ is a homogeneous function of the generalized velocities in the first degree:

$$\Lambda(x^\mu, ax'^\mu) = a\Lambda(x^\mu, x'^\mu). \quad (7.160)$$

This is not a phenomenon of relativistic physics per se; it is a mathematical consequence of enlarging configuration space to include t as a dynamical variable and using some other parameter to mark the system-point's travel through the space. A Lagrangian obeying Eq. (7.160) is often called (somewhat misleadingly) a homogeneous Lagrangian and the corresponding "homogeneous" problem of the calculus of variations requires special treatment. The most serious of the resulting difficulties will arise in the Hamiltonian formulation, but we can glimpse some of them by noting that in consequence the energy function h , according to Eq. (2.53), is identically zero. It follows from Euler's theorem on homogeneous functions that if Λ is homogeneous to first degree in x'^μ , then

$$\Lambda = x'^\mu \frac{\partial \Lambda}{\partial x'^\mu}.$$

We can then show (cf. Derivation 10 at the end of this chapter) that as a result the function Λ *identically* satisfies the relation

$$\left[\frac{d}{d\theta} \left(\frac{\partial \Lambda}{\partial x'^\mu} \right) - \frac{\partial \Lambda}{\partial x^\mu} \right] x'^\mu = 0. \quad (7.161)$$

Thus, if any three of the Lagrangian Eqs. (7.157) are satisfied, it will follow, solely as a consequence of the homogeneous property of Λ , that the fourth is satisfied identically.

Being thus forewarned to tread carefully, so to speak, let us carry out this transformation for a free particle. From Eq. (7.136), the "relativistic" but "noncovari-

ant" Lagrangian for the free particle is

$$L = -mc\sqrt{c^2 - \dot{x}^i \dot{x}_i}.$$

By the transformation of Eq. (7.159), a possible covariant Lagrangian is then

$$\Lambda = -mc\sqrt{x'^\mu x'_\mu}. \quad (7.162)$$

With this Lagrangian, the Euler–Lagrange equations are equivalent to

$$\frac{d}{d\theta} \left(\frac{mcx'}{\sqrt{x'^\mu x'_\mu}} \right) = 0.$$

The parameter θ must be a monotonic function of the proper time τ so that derivatives with respect to θ are related to those in terms of τ according to

$$x' \equiv \frac{dx}{d\theta} = \frac{d\tau}{d\theta} u.$$

Hence, the Lagrangian equations correspond to

$$\frac{d}{d\tau} \left(\frac{mcu}{\sqrt{u_\nu u^\nu}} \right) = \frac{d(mu)}{d\tau} = 0,$$

which are Eqs. (7.73) for a free particle. As we have seen above, the fourth of these equations says that the kinetic energy T is conserved, which is indeed not new but can be derived from the other three equations.

We have thus been led to a covariant Lagrangian procedure that works, at least for a single free particle, but only in a tortuous fashion. The elaborate superstructure can be greatly simplified however by a few bold pragmatic steps. First of all, we can avoid using θ and work in terms of the proper time τ directly by a procedure introduced in a slightly different context by Dirac. The constraint on the generalized velocities in terms of τ , Eq. (7.35), is not a true dynamical constraint on the motion; rather it is a geometric consequence of the way in which τ is defined. Equation (7.35) says in effect that we cannot roam over the full four-dimensional u space; we are confined to a particular three-dimensional surface in the space. Dirac calls relations such as Eq. (7.35) *weak equations*. We can with impunity treat u^ν as unconstrained quantities, and only *after* all differentiation operations have been carried out, need the condition of Eq. (7.35) be imposed. Certainly the procedure would have worked above for the free particle Lagrangian. There would have been no difference if θ were set equal to τ from the start and Eq. (7.35) applied only in the last step. The covariant Lagrange equations can with this proviso therefore be written directly in terms of τ :

$$\frac{d}{d\tau} \left(\frac{\partial \Lambda}{\partial u^\nu} \right) - \frac{\partial \Lambda}{\partial x^\nu} = 0. \quad (7.163)$$

Secondly, it is not a sacrosanct physical law that the action integral in Hamilton's principle must have the same value whether expressed in terms of t or in terms of θ (or τ). It *needn't* be given by the prescription of Eq. (7.159). All that is required is that Λ be a world scalar (or function of a world scalar) that leads to the correct equations of motion. It doesn't *have* to be homogeneous to first degree in the generalized velocities. For example, a suitable Λ for a free particle would clearly be the quadratic expression

$$\Lambda = \frac{1}{2} m u_\nu u^\nu. \quad (7.164)$$

Many other possibilities are available.* We shall use Eq. (7.162) for the "kinetic energy" part of the Lagrangian in all subsequent discussions; many present and future headaches will thereby be avoided.

If the particle is not free, but is acted on by external forces, then interaction terms have to be added to the Lagrangian of Eq. (7.164) that would lead to the corresponding Minkowski forces. Very little can be said at this time about the additional terms, other than they must be Lorentz-invariant. For example, if G^μ were some (external) four-vector, then $G_\mu x^\mu$ would be suitable interaction term. If in some particular Lorentz frame $G_1 = ma$ and all other components vanish, then we would have an example of a constant force such as discussed in the previous section. In general, these terms will represent the interaction of the particle with some external field. The specific form will depend upon the covariant formulation of the field theory. We have only one example of a field already expressed in a covariant way—the electromagnetic field—and it is instructive therefore to examine the Lagrangian for a particle in an electromagnetic field.

A suitable Lagrangian can easily be seen to be

$$\Lambda(x^\mu, u^\mu) = \frac{1}{2} m u_\mu u^\mu + q u^\mu A_\mu(x^\lambda). \quad (7.165)$$

The corresponding Lagrange's equations are then

$$\frac{d}{d\tau}(m u^\nu) = -\frac{q dA^\nu}{d\tau} + \frac{\partial}{\partial x^\nu}(q u^\mu A_\mu),$$

which are exactly the generalized equations of motion Eq. (7.73), with the Minkowski force K_ν on a charged particle, Eq. (7.74). Note that again the "mechanical momentum" four-vector p^μ differs from the *canonical* momentum \mathcal{P}^μ :

*In general, Λ can have the form $m f(u_\nu u^\nu)$, where $f(y)$ is any function of y such that

$$\left. \frac{\partial f}{\partial y} \right|_{y=c^2} = \frac{1}{2}.$$

In Eq. (7.164), we have used $f(u_\nu u^\nu) = \frac{1}{2} u_\nu u^\nu$. The choice

$$f(u_\nu u^\nu) = -c \sqrt{u_\nu u^\nu}$$

corresponds to Eq. (7.162)

$$\mathcal{P}^\mu = \frac{\partial \Lambda}{\partial u^\mu} = mu^\mu + qA^\mu = p^\mu + qA^\mu \quad (7.166)$$

by a term linear in the electromagnetic potential. The canonical momentum, \mathcal{P} , conjugate to x^0 is now

$$\mathcal{P}^0 = \frac{E}{c} + q\frac{\phi}{c} = \frac{1}{c}\bar{E},$$

where E is the mechanical energy and \bar{E} is the total energy of the particle, $E + q\phi$. Thus, the momentum conjugate to the *time* coordinate is proportional to the total *energy*. A similar conjugate connection between these two quantities will recur later in nonrelativistic theory. The connection between the magnitude of the spatial “mechanical” momentum and the energy E is still given by Eq. (7.38'). From Eq. (7.166), it is seen that the canonical momenta conjugate to x form the components of a spatial Cartesian vector \mathcal{P} related to \mathbf{p} by

$$\mathcal{P} = \mathbf{p} + q\mathbf{A}. \quad (7.167)$$

In terms of \mathcal{P} , Eq. (7.100) can be rewritten as

$$E^2 = (\mathcal{P} - q\mathbf{A})^2 + m^2c^4, \quad (7.168)$$

which is a useful relation between the energy E and the canonical momentum vector \mathcal{P} .

The interaction term in the Lagrangian of Eq. (7.165) is an example of a vector field interaction (as is also a term of the form $G_\mu x^\mu$). We could also have a simple scalar field interaction where the term added to the Lagrangian would be some world scalar $\psi(x^\mu)$. Or more complicated invariant interaction terms can be created involving an external tensor field. The nature of such Lagrangians properly stems from the physical field theory involved and cannot concern us further here.

So far we have spoken only of systems comprising a single mass particle. Multiparticle systems introduce new complications. One obvious problem is finding an invariant parameter to describe the evolution of the system—each particle in the system has its own proper time. With a little thought, however, we could imagine ways of solving this difficulty. For example, the proper time associated with the C-O-M system involves a symmetric treatment of all the particles and might prove suitable. We could also include in the picture interactions of the particles with external fields very much as was done for a single particle. The great stumbling block however is the treatment of the type of interaction that is so natural and common in nonrelativistic mechanics—direct interaction between particles.

At first sight, it would seem indeed that such interactions are impossible in relativistic mechanics. To say that the force on a particle depends upon the positions or velocities of other particles at the same time implies propagation of effects with infinite velocity from one particle to another—“action at a distance.” In special relativity, where signals cannot travel faster than the speed of light,

action-at-a-distance seems outlawed. And in a certain sense this seems to be the correct picture. It has been proven that if we require certain properties of the system to behave in the normal way (such as conservation of total linear momentum), then there can be no covariant direct interaction between particles except through contact forces.

There have been many attempts in recent years to get around this “no-interaction” theorem. After all, we have seen that electromagnetic forces can be expressed covariantly, and a static electric field gives rise to the Coulomb law of attraction, which has the same form as the supposedly banned Newtonian gravitational attraction. Some of these attempts have led to approximately covariant Lagrangians, correct through orders of v^2/c^2 . Others involve formulations of mechanics at variance with our normal structures; most for example cannot be stated in terms of a simple Hamilton’s principle.

7.11 ■ INTRODUCTION TO THE GENERAL THEORY OF RELATIVITY

Thus far we have been careful to use the term “special theory of relativity” and not to introduce the term “special relativity,” by which we endeavored to make clear that it is the theory that is special, not the relativity. The special theory uses ideal inertial frames that are assumed to exist over all of spacetime. The general theory not only removes that requirement, but also has a spacetime whose nature is part of the solution to the question of motion. To paraphrase John A. Wheeler: “*Matter tells space how to bend, and space returns the compliment by telling matter how to move.*” The general theory is often interpreted in terms of non-Euclidean geometry, so terms like geodesic (paths of shortest distance) and curvature of spacetime are often used. In this brief section we can only outline the formalism of the general theory to show how the full tensor notation is used.

Five principles guided Einstein in the development of the general theory:

1. *Mach’s principle*—the special theory used inertial frames. E. Mach observed that Newtonian inertial frames were not rotating with respect to the fixed stars. This suggests Mach’s principle, whereby inertial properties are determined by the presence of other bodies in the universe.
2. *Principle of equivalence*—whereby the gravitational mass for each body in the universe can be consistently and universally chosen to equal its inertial mass. To the best accuracy of all experiments performed to date, the ratio of the gravitational mass (the mass that appears in Newton’s force law for gravity) to the inertial mass (the mass that appears in the second law) of any object is independent of both the total mass and of the composition of the object. This means that no local experiments can distinguish nonrotating free fall in a gravitational field from uniform motion in the absence of any gravitational fields. Likewise, local experiments cannot distinguish between being at rest in a uniform gravitational field and undergoing uniform acceleration in the absence of any gravitational field (that is, in a rocket).

3. *Principle of covariance*—in the special theory, all inertial observers are equivalent. The general theory extends this idea by postulating the principle of covariance. This principle is that all observers, inertial or not, observe the same laws of physics. That means the laws of physics can be expressed in terms of tensors, since tensors are geometric objects defined independent of any coordinate system.
4. *Correspondence principle*—in weak gravitational fields with velocities small compared to light, the general theory should make predictions that approximate the predictions of gravitational behavior in Newtonian mechanics. As gravitational fields go to zero, the correspondence principle states the predictions of the general theory should approach those of the special theory.
5. *Principle of minimal gravitational coupling*—this principle postulates that no terms explicitly containing the curvature should be added in making the transition from the special theory to the general theory.

Newton's first law tells us that in the absence of external force bodies move along straight lines without acceleration. The preceding guiding principles suggest that in the general theory, objects will move along the geodesics of spacetime. For example, let us consider a family of geodesics that start out parallel. If gravitational effects in the region under consideration are uniform, the geodesics will remain parallel. If there is a nonuniform gravitational field, the geodesics should start to approach or recede. The change in separation, or *geodesic deviation*, is the proper measure of the gravitational field. Near Earth's surface, we often assume the gravitational field is uniform over small regions. Thus, we assume two falling bodies released side by side fall parallel. An experiment for larger separations or longer fall times measures the nonuniformity of Earth's gravitational field.

To illustrate this, let us consider an example of two balls separated horizontally by a distance, d , which are dropped at the same time from the same height high above Earth. Very close to either ball, and neglecting the gravitational mass of the balls, local experiments will give results that allow us to treat the local region as an inertial frame. Locally, gravity can be made to vanish by a choice of coordinate frame. Let us choose this local free-fall frame for our observations. Locally this satisfies the conditions for an inertial frame. However, as the balls fall toward Earth, their separation, d , decreases. This change in separation, rather than the fall toward Earth, is the local measure of the gravitational effect of Earth since it can not be eliminated by a choice of frame. This is reflected by the general theory statement that only the tides (differential effects) are real gravitational effects. Any other gravitational effects can be locally eliminated by freely falling.

Now consider two geodesics as shown in Figure 7.5. We can define two vector fields at any point. One field, denoted by u , gives the 4-velocity of motion along the geodesic, while the other field, denoted by ξ , gives the separation to the next geodesic. We assume at some time, τ , there were test particles at the head and tail of the ξ vector.

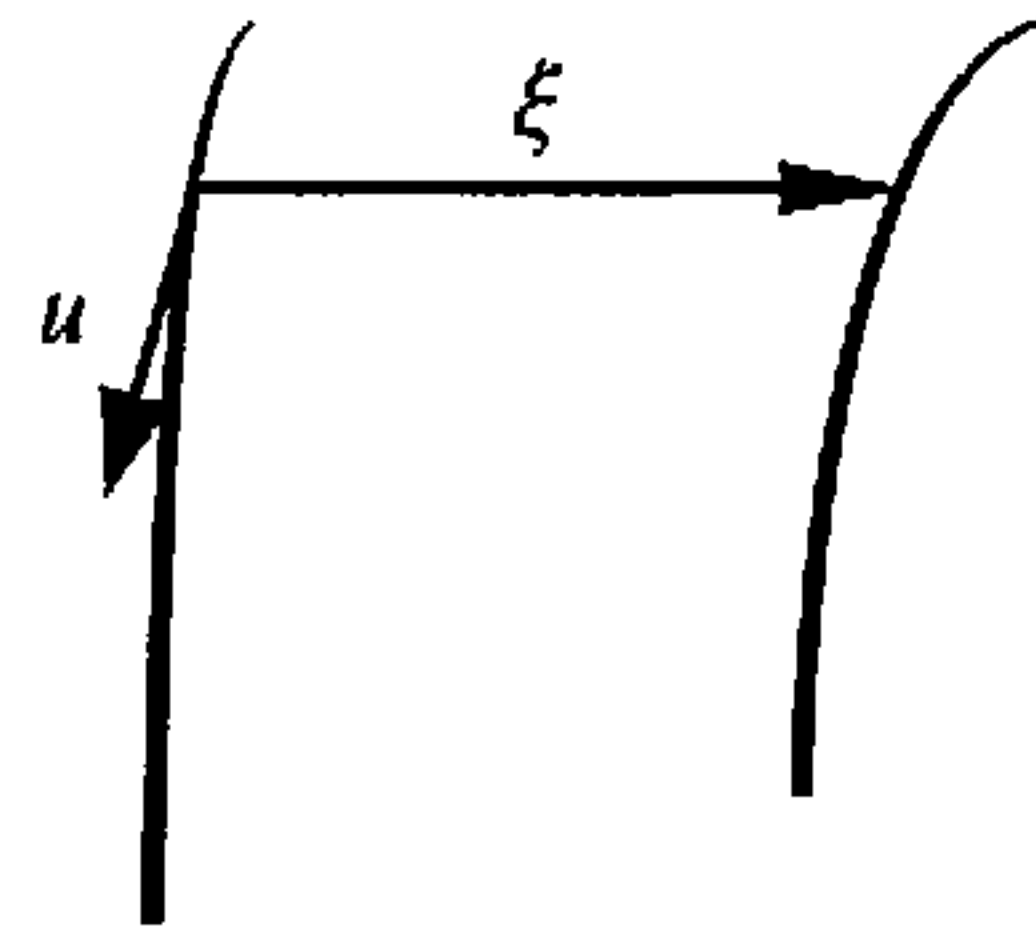

FIGURE 7.5 Tangent vector, u , and deviation vector, ξ .

We shall use the proper time at the tail of the deviation vector and have the head point to where the other test particle is at that time. In general, as the motion progresses, the proper time of the first test particle will not be the same proper time for the other test particle. A straightforward calculation, in the Newtonian limit, for the example of two falling balls, gives for the space components of ξ perpendicular to the direction toward Earth's center,

$$\frac{d^2 \xi^i}{dt^2} = R \xi^i, \quad (7.169)$$

where R depends upon the distance to Earth's center and other physical constants. Equation (7.169) says the acceleration in the separation of two geodesics is proportional to their separation. A two-dimensional example is the geodesics on the surface of a sphere. Consider two initially parallel geodesics on a sphere. These geodesics will meet after they have traveled one-quarter of the circumference of the sphere. For this case, Eq. (7.169) has $R = 1/a^2$, where a is the radius of the sphere.

If we analyze this problem in three or more dimensions, the relative acceleration is written as $D^2 \xi / ds^2$ where ds is the length of the travel along the geodesic and we use a D for the derivative since our coordinate system is completely arbitrary. The twists and turns in the coordinate system can cause changes in the components of ξ even if its magnitude is not changing. As he developed more of the theory, Einstein discovered that the mathematicians—in particular, Riemann—had already developed the mathematical tools needed. The metric serves the role of potentials and derivatives of the metric give the geometric forces. Since the derivatives of the metric are not tensors, a combination of the derivatives and the metric must be used. There are also problems introduced by the freedom of using any coordinate system. Some of the changes are due to physical forces and others are due to the choice of the coordinate system in analogy to the Coriolis effect in a rotating coordinate system. The correct expression for the deviation of geodesic motion is provided by a tensor named *Riemann*. It is constructed of linear combinations of second derivatives of the metric contracted with the metric. *Riemann* has slots for three vectors and one slot for a single one-form. If we put the tangent vector into the second and fourth slots and the deviation vector into the third slot,

Riemann produces

$$\nabla_{\mathbf{u}} \nabla_{\mathbf{u}} \xi + \text{Riemann}(\dots, \mathbf{u}, \xi, \mathbf{u}) = 0, \quad (7.170)$$

where $\nabla_{\mathbf{u}} \nabla_{\mathbf{u}} = \frac{D^2}{ds^2}$. In component notation, Eq. (7.170) is

$$\frac{d^2 \xi^\alpha}{ds^2} + R^\alpha{}_{\beta\gamma\delta} \frac{dx^\beta}{d\tau} \xi^\gamma \frac{dx^\delta}{d\tau} = 0. \quad (7.171)$$

If we contract *Riemann* on slots 1 and 3, we produce a tensor called *Ricci*, defined as

$$\text{Ricci}(\mathbf{u}, \mathbf{v}) = \text{Riemann}(\mathbf{w}^\alpha, \mathbf{u}, \mathbf{e}_\alpha, \mathbf{v}), \quad (7.172)$$

whose components are

$$R_{\mu\nu} = R^\alpha{}_{\mu\alpha\nu}. \quad (7.173)$$

Another critical contraction produces the *curvature scalar*, called *R*

$$R = \text{Ricci}(\mathbf{w}^\alpha, \mathbf{e}_\alpha) = R^\alpha{}_\alpha. \quad (7.174)$$

Of all these possible contractions of *Riemann*, only one tensor of rank $\binom{2}{0}$ retains all the differential symmetries of *Riemann*. That tensor is called *Einstein* (denoted by *G*) and is defined as

$$G = \text{Ricci} - \frac{1}{2}gR, \quad (7.175)$$

with components

$$G_{\mu\nu} = R_{\mu\nu} - \frac{1}{2}g_{\mu\nu}R. \quad (7.176)$$

Using *T* to denote the stress-energy tensor, Einstein's field equations make *Einstein* proportional to *T*.

$$G = kT. \quad (7.177)$$

These equations for weak gravitational fields and for speeds much less than light approach Newtonian gravitational theory, and for no gravitational fields produce the results of the special theory. They also correctly predict all the measured first- and second-order corrections to the special theory of relativity in experiments thus far performed. In addition, the theory predicts the existence of gravitational waves from moving masses. Although these waves have not, at this writing, been directly observed, measured changes in the periods of several binary star systems are consistent with the existence of such radiation existing.

Soon after Einstein proposed Eqs. (7.177), astronomers pointed out that the solutions of these equations were not consistent with their observation of a static universe that was neither expanding nor contracting. Einstein modified the equations by adding a term that was proportional to the metric tensor. The constant of

proportionality, called the *cosmological constant*, was denoted by Λ giving

$$G + \Lambda g = kT. \quad (7.178)$$

Soon after that, astronomers decided that the observational data showed that the universe was expanding and the cosmological constant was not needed, and most physicists dropped the term. Einstein said that the cosmological constant was his greatest mistake. However, the early 21st century observational data on distant galaxies suggests that the universe is accelerating as it expands. This would re-introduce the cosmological constant into the field equations. The current terminology, since this would be a $\Lambda < 0$, is to refer to the cosmological constant as “dark energy,” since it is a positive contribution to the right-hand side of Eq. (7.178).

DERIVATIONS

1. Consider a mechanical system of n particles, with a conservative potential consisting of terms dependent only upon the scalar distance between pairs of particles. Show explicitly that the Lagrangian for the system when expressed in coordinates derived by a Galilean transformation differs in form from the original Lagrangian only by a term that is a total time derivative of a function of the position vectors. This is a special case of invariance under a point transformation (cf. Derivation 10, Chapter 1).
2. Obtain the Lorentz transformation in which the velocity is at an infinitesimal angle $d\theta$ counterclockwise from the x axis, by means of a similarity transformation applied to Eq (7.16). Show directly that the resulting matrix is orthogonal and that the inverse matrix is obtained by substituting $-v$ for v .
3. The Einstein addition law can also be obtained by remembering that the second velocity is related directly to the space components of a four-velocity, which may then be transformed back to the initial system by a Lorentz transformation. If the second system is moving with a speed v' relative to the first in the direction of their z axes, while a third system is moving relative to the second with an arbitrarily oriented velocity \mathbf{v}'' , show by this procedure that the magnitude of the velocity \mathbf{v} between the first and third system is given by

$$\sqrt{1 - \beta^2} = \frac{\sqrt{1 - \beta'^2} \sqrt{1 - \beta''^2}}{1 + \beta' \beta''_z},$$

and that the components of \mathbf{v} are

$$\beta_x = \frac{\beta''_x \sqrt{1 - \beta'^2}}{1 + \beta' \beta''_z}, \quad \beta_y = \frac{\beta''_y \sqrt{1 - \beta'^2}}{1 + \beta' \beta''_z}, \quad \beta_z = \frac{\beta' + \beta''_z}{1 + \beta' \beta''_z}$$

Here $\beta''_x = v''_x/c$, and so forth.

4. Show that the magnitude of the velocity of the preceding exercise between the first and the third systems can be given in general by

$$\beta^2 = \frac{(\boldsymbol{\beta}' + \boldsymbol{\beta}'')^2 - (\boldsymbol{\beta}' \times \boldsymbol{\beta}'')^2}{(1 + \boldsymbol{\beta}' \cdot \boldsymbol{\beta}'')^2}.$$

5. Show that the matrix \mathbf{R} defined by Eq (7.21) has the form of a spatial rotation by doing the matrix multiplication, and by examining the properties of the 3×3 submatrix with elements R_{ij} . Prove that there cannot be two rotation matrices such that Eq. (7.21) is satisfied; that is, \mathbf{R} is unique. Finally, show that \mathbf{L} can similarly be uniquely factored into a rotation and a pure Lorentz transformation in the form

$$\mathbf{L} = \mathbf{P}'\mathbf{R}'.$$

6. Show that to each plane wave there is associated a covariant four-vector involving the frequency and the wave number. From the consequent transformation equations of the components of the four-vector, derive the Doppler-effect equations.
7. From the transformation properties of the world acceleration, show that the components of the acceleration \mathbf{a} are given in terms of the transformed acceleration \mathbf{a}' in a system momentarily at rest with respect to the particle by the formulas

$$a'_x = \frac{a_x}{(1 - \beta^2)^{3/2}}, \quad a'_y = \frac{a_y}{1 - \beta^2}, \quad a'_z = \frac{a_z}{1 - \beta^2},$$

the x axis being chosen in the direction of the relative velocity.

8. By expanding the equation of motion, Eq. (7.73), with Eq. (7.36) for the momentum show that the force is parallel to the acceleration only when the velocity is either parallel or perpendicular to the acceleration. Obtain expressions for the coefficients of the acceleration in these two cases. In the older literature, these coefficients were known as the longitudinal and transverse masses, respectively.
9. A generalized potential suitable for use in a covariant Lagrangian for a single particle

$$\mathcal{U} = -A_{\lambda\nu}(x^\mu)u^\lambda u^\nu$$

where $A_{\lambda\nu}$ stands for a symmetric world tensor of the second rank and u^ν are the components of the world velocity. If the Lagrangian is made up of Eq. (7.164) minus \mathcal{U} , obtain the Lagrange equations of motion. What is the Minkowski force? Give the components of the force as observed in some Lorentz frame.

10. Show that if Λ satisfies the Lagrange equations, it identically satisfies Eq. (7.161) on the basis of the homogeneity of Λ , by explicitly forming the total derivative with respect to θ that occurs in the equation.
11. In special relativity, it is not necessarily obvious that the velocity of system B as observed in system A is the negative of the velocity vector of system A observed in system B. From the orthogonality properties of \mathbf{L} , prove that the two vectors have the same magnitude and are in fact the negative of each other. For simplicity, a pure Lorentz transformation may be assumed, although this condition is not necessary for the proof.
12. A set of transformations are said to have the group property if they possess the following four characteristics:

- The transformation equivalent to two successive transformations (“product” of transformations) is a member of the set.
- The product operation obeys the associative law.
- The identity transformation is a member of the set.
- The inverse of each transformation in the set is also a member of the set.

Prove that the sets of full Lorentz transformations and of restricted Lorentz transformation have (separately) the group property.

EXERCISES

13. Show by direct multiplication of the vector form of the Lorentz transformation, Eqs. (7.9), that

$$r'^2 - c^2 t'^2 = r^2 - c^2 t^2.$$

14. A rocket of length l_0 in its rest system is moving with constant speed along the z axis of an inertial system. An observer at the origin of this system observes the apparent length of the rocket at any time by noting the z coordinates that can be seen for the head and tail of the rocket. How does this apparent length vary as the rocket moves from the extreme left of the observer to the extreme right? How do these results compare with measurements in the rest frame of the observer? (Note: observe, not measure).
15. A beam of particles moving with uniform velocity collides with a collection of target particles that are at rest in a particular system. Let σ_0 be the collision cross section observed in this system. In another system, the incident particles have a normalized velocity β_1 and the target particles a normalized velocity β_2 . If σ is the observed cross section in this system, show that

$$\sigma = \sigma_0 \sqrt{1 - \frac{(\beta_1 \times \beta_2)^2}{(\beta_1 - \beta_2)^2}}.$$

Remember that collision rate must be invariant under a Lorentz transformation.

16. For a “close” satellite of Earth (semimajor axis approximately the radius of Earth) calculate numerically the value of the Thomas precession rate. Compare the result with the precession rate induced in the orbit because of the oblate figure of Earth. Assume the satellite orbital plane is inclined at 30° to the equator.
17. Two particles with rest masses m_1 and m_2 are observed to move along the observer’s z axis toward each other with speeds v_1 and v_2 , respectively. Upon collision, they are observed to coalesce into one particle of rest mass m_3 moving with speed v_3 relative to the observer. Find m_3 and v_3 in terms of m_1 , m_2 , v_1 , and v_2 . Would it be possible for the resultant particle to be a photon, that is, $m_3 = 0$, if neither m_1 nor m_2 are zero?
18. In the β disintegration considered in Exercise 17, Chapter 1, the electron has a mass equivalent to a rest energy of 0.511 MeV, while the neutrino has essentially no mass

What are the total energies carried away by the electron and neutrino? What fraction of the nuclear mass is converted into kinetic energy (including the electron rest energy)?

19. A meson of mass m_π at rest disintegrates into a meson of mass m_μ and a neutrino of effectively zero mass. Show that the kinetic energy of motion of the μ meson is

$$T = \frac{(m_\pi - m_\mu)^2}{2m_\pi} c^2.$$

20. A π^+ meson of rest mass 139.6 MeV collides with a neutron (rest mass 939.6 MeV) stationary in the laboratory system to produce a K^+ meson (rest mass 494 MeV) and a Λ hyperon (rest mass 1116 MeV). What is the threshold energy for this reaction in the laboratory system?
21. A photon may be described classically as a particle of zero mass possessing nevertheless a momentum $h/\lambda = hv/c$, and therefore a kinetic energy hv . If the photon collides with an electron of mass m at rest, it will be scattered at some angle θ with a new energy hv' . Show that the change in energy is related to the scattering angle by the formula

$$\lambda' - \lambda = 2\lambda_c \sin^2 \frac{\theta}{2},$$

where $\lambda_c = h/mc$, is known as the Compton wavelength. Show also that the kinetic energy of the recoil motion of the electron is

$$T = hv \frac{2 \left(\frac{\lambda_c}{\lambda} \right) \sin^2 \frac{\theta}{2}}{1 + 2 \left(\frac{\lambda_c}{\lambda} \right) \sin^2 \frac{\theta}{2}}.$$

22. A photon of energy \mathcal{E} collides at angle θ with another photon of energy E . Prove that the minimum value of \mathcal{E} permitting formation of a pair of particles of mass m is

$$\mathcal{E}_{th} = \frac{2m^2 c^4}{E(1 - \cos \theta)}.$$

23. The theory of rocket motion developed in Exercise 13, Chapter 1, no longer applies in the relativistic region, in part because there is no longer conservation of mass. Instead, all the conservation laws are combined into the conservation of the world momentum; the change in each component of the rocket's world momentum in an infinitesimal time dt must be matched by the value of the same component of p_v for the gases ejected by the rocket in that time interval. Show that if there are no external forces acting on the rocket, the differential equation for its velocity as a function of the mass is

$$m \frac{dv}{dm} + a \left(1 - \frac{v^2}{c^2} \right) = 0,$$

where a is the constant velocity of the exhaust gases *relative to the rocket*. Verify that the solution can be put in the form

$$\beta = \frac{1 - \left(\frac{m}{m_0}\right)^{2a/c}}{1 + \left(\frac{m}{m_0}\right)^{2a/c}},$$

m_0 being the initial mass of the rocket. Since mass is not conserved, what happens to the mass that is lost?

24. A particle in hyperbolic motion starts from the origin at $t = 0$. Find the time t_0 such that if a photon is emitted from the origin after t_0 , it will never catch up with the particle.
25. A particle of rest mass m , charge q , and initial velocity \mathbf{v}_0 enters a uniform electric field \mathbf{E} perpendicular to \mathbf{v}_0 . Find the subsequent trajectory of the particle and show that it reduces to a parabola as the limit c becomes infinite.
26. Show that the relativistic motion of a particle in an attractive inverse-square law of force is a precessing ellipse. Compute the precession of the perihelion of Mercury resulting from this effect. (The answer, about $7''$ per century, is much smaller than the actual precession of $43''$ per century that can be accounted for correctly only by general relativity. The other planets produce a precession greater than $5.000''$ per century.)
27. Starting from the equation of motion (7.73), derive the relativistic analog of the virial theorem, which states that for motions bounded in space and such that the velocities involved do not approach indefinitely close to c , then

$$\overline{L_0} + \overline{T} = -\overline{\mathbf{F} \cdot \mathbf{r}},$$

where L_0 is the form the Lagrangian takes in the absence of external forces. Note that although neither L_0 nor T corresponds exactly to the kinetic energy in nonrelativistic mechanics, their sum, $L + T$, plays the same role as twice the kinetic energy in the nonrelativistic virial theorem, Eq. (3.26).

28. Let \mathbf{e}_1 and \mathbf{e}_2 be the basis vectors for a Cartesian coordinate system in a two-dimensional Euclidean space that contains a crystal whose lattice vectors are $\mathbf{a} = \mathbf{e}_1$ and $\mathbf{b} = \mathbf{e}_1 + \mathbf{e}_2$. Use the underlying Euclidean geometry to determine that the reciprocal lattice vectors are $\mathbf{A} = \mathbf{e}_1 - \mathbf{e}_2$ and $\mathbf{B} = \mathbf{e}_2$. Using the \mathbf{a} , \mathbf{b} pair as basis vectors, determine the metric tensor \mathbf{g} necessary for \mathbf{A} and \mathbf{B} to be the 1-forms as defined by Eqs. (7.34') and (7.49).
29. Using *Maple* or *Mathematica* calculate the Lorentz transformation matrix in Eq. (7.17), then without assuming that the velocities in the frame S' are small, find the exact Lorentz boost from S to S'' , (generalization of Eq. (7.20)) and the rotation (generalization of Eq. (7.21)). Show that your results reduce to Eqs. (7.20) and (7.21).
30. Using *Maple* or *Mathematica* or a similar program calculate the Einstein field equations for spherical coordinates assuming $T_{\mu\nu} = 0$ everywhere except possibly for $r = 0$, where the coordinate system is undefined. The most general spherical static metric corresponds to an interval given by

$$ds^2 = e^{\nu(r)} c^2 dt^2 - e^{\lambda(r)} dr^2 - r^2(d\theta^2 + \sin^2\theta d\phi^2),$$

where r , θ , and ϕ correspond to the usual three-dimensional spherical coordinates. Solve these equations using an integration constant m to obtain the Schwarzschild so-

lution for a point source of mass m . As you will discover, these coordinates have a singularity at $r = 2m$. Show that this is a coordinate singularity (a singularity determined by the choice of coordinates) rather than a physical singularity by examining the components of *Riemann* as r crosses $2m$.

31. To show that the word “relativity” in the special theory of relativity does not have its ordinary meaning, consider a disk rotating in an inertial frame about an axis fixed at its center and perpendicular to the disk. Mounted on the edge of the disk are mirrors arranged so that light emitted tangentially from a point on the disk is reflected tangentially around the disk back to the starting location. Compare the behavior of light emitted in the direction of rotation (assumed clockwise) to the behavior of light emitted in the opposite direction. Now consider a pulse of light emitted by a source on the axis and used to synchronize the clocks on the perimeter. Since clocks are commonly synchronized by light and distance in the special theory (elapsed time = distance/ c), what does this say about the absolute sense of rotation in the special theory?
32. Show that the space components of Eq. (7.68) are identical to the components in the equation on the preceding line.

CHAPTER

8

The Hamilton Equations of Motion

The Lagrangian formulation of mechanics was developed largely in the first two chapters, and most of the subsequent discussion has been in the nature of application, but still within the framework of the Lagrangian procedure. In this chapter we resume the formal development of mechanics, turning our attention to an alternative statement of the structure of the theory known as the Hamiltonian formulation. Nothing new is added to the physics involved; we simply gain another (and more powerful) method of working with the physical principles already established. The Hamiltonian methods are not particularly superior to Lagrangian techniques for the direct solution of mechanical problems. Rather, the usefulness of the Hamiltonian viewpoint lies in providing a framework for theoretical extensions in many areas of physics. Within classical mechanics it forms the basis for further developments, such as Hamilton–Jacobi theory, perturbation approaches and chaos. Outside classical mechanics, the Hamiltonian formulation provides much of the language with which present-day statistical mechanics and quantum mechanics is constructed. We shall assume in the following chapters that the mechanical systems are holonomic and that the forces are monogenic, that is, derived either from a potential dependent upon position only, or from velocity-dependent generalized potentials of the type discussed in Section 1.5.

8.1 ■ LEGENDRE TRANSFORMATIONS AND THE HAMILTON EQUATIONS OF MOTION

In the Lagrangian formulation (nonrelativistic), a system with n degrees of freedom possesses n equations of motion of the form

$$\frac{d}{dt} \left(\frac{\partial L}{\partial \dot{q}_i} \right) - \frac{\partial L}{\partial q_i} = 0. \quad (8.1)$$

As the equations are of second order, the motion of the system is determined for all time only when $2n$ initial values are specified, for example, the n q_i 's and n \dot{q}_i 's at a particular time t_1 , or then n q_i 's at *two* times, t_1 and t_2 . We represent the state of the system by a point in an n -dimensional *configuration space* whose coordinates are the n generalized coordinates q_i and follow the motion of the system point in time as it traverses its path in configuration space. Physically, in the Lagrangian viewpoint a system with n independent degrees of freedom is a

problem in n independent variables $q_i(t)$, and \dot{q}_i appears only as a shorthand for the time derivative of q_i . All n coordinates must be independent. In the Hamiltonian formulation there can be no constraint equations among the coordinates. If the n coordinates are not independent, a reduced set of m coordinates, with $m < n$, must be used for the formulation of the problem before proceeding with the following steps.

The Hamiltonian formulation is based on a fundamentally different picture. We seek to describe the motion in terms of *first-order* equations of motion. Since the number of initial conditions determining the motion must of course still be $2n$, there must be $2n$ independent first-order equations expressed in terms of $2n$ *independent variables*. Hence, the $2n$ equations of the motion describe the behavior of the system point in a *phase space* whose coordinates are the $2n$ independent variables. In thus doubling our set of independent quantities, it is natural (though not inevitable) to choose half of them to be the n generalized coordinates q_i . As we shall see, the formulation is nearly symmetric if we choose the other half of the set to be the generalized or *conjugate momenta* p_i already introduced by the definition (cf. Eq. (2.44)):

$$p_i = \frac{\partial L(q_j, \dot{q}_j, t)}{\partial \dot{q}_i} \quad (\text{no sum on } j) \quad (8.2)$$

where the j index shows the set of q 's and \dot{q} 's. The quantities (q, p) are known as the *canonical variables*.*

From the mathematical viewpoint, it can however be claimed that the q 's and \dot{q} 's have been treated as distinct variables. In Lagrange's equations, Eq. (8.1), the partial derivative of L with respect to q_i means a derivative taken with all other q 's and all \dot{q} 's constant. Similarly, in the partial derivatives with respect to \dot{q} , the q 's are kept constant. Treated strictly as a mathematical problem, the transition from Lagrangian to Hamiltonian formulation corresponds to changing the variables in our mechanical functions from (q, \dot{q}, t) to (q, p, t) , where p is related to q and \dot{q} by Eqs. (8.2). The procedure for switching variables in this manner is provided by the *Legendre transformation*, which is tailored for just this type of change of variable.

Consider a function of only two variables $f(x, y)$, so that a differential of f has the form

$$df = u dx + v dy, \quad (8.3)$$

where

$$u = \frac{\partial f}{\partial x}, \quad v = \frac{\partial f}{\partial y}. \quad (8.4)$$

*Unless otherwise specified, in this and subsequent chapters the symbol p will be used only for the conjugate or canonical momentum. When the forces are velocity dependent, the canonical momentum will differ from the corresponding mechanical momentum (cf. Eq. (2.47)).

We wish now to change the basis of description from x, y to a new distinct set of variables u, y , so that differential quantities are expressed in terms of the differentials du and dy . Let g be a function of u and y defined by the equation

$$g = f - ux. \quad (8.5)$$

A differential of g is then given as

$$dg = df - u dx - x du,$$

or, by (8.3), as

$$dg = v dy - x du,$$

which is exactly in the form desired. The quantities x and v are now functions of the variables u and y given by the relations

$$x = -\frac{\partial g}{\partial u}, \quad v = \frac{\partial g}{\partial y}, \quad (8.6)$$

which are the analogues of Eqs. (8.4).

The Legendre transformation so defined is used frequently in thermodynamics. The first law of thermodynamics relates the differential change in energy, dU , to the corresponding change in heat content, dQ , and the work done, dW :

$$dU = dQ - dW. \quad (8.7)$$

For a gas undergoing a reversible process, Eq. (8.7) can be written as

$$dU = T dS - P dV, \quad (8.8)$$

where $U(S, V)$ is written as a function of the entropy, S , and the volume, V , where the temperature, T , and the gas pressure, P , are given by

$$T = \frac{\partial U}{\partial S} \quad \text{and} \quad P = -\frac{\partial U}{\partial V}. \quad (8.9)$$

The enthalpy, $H(S, P)$ is generated by the Legendre transformation

$$H = U + PV, \quad (8.10)$$

which gives

$$dH = T dS + V dP. \quad (8.11)$$

where

$$T = \frac{\partial H}{\partial S} \quad \text{and} \quad V = \frac{\partial H}{\partial P}.$$

Additional Legendre transformations,

$$F = U - TS \quad (8.12)$$

$$G = H - TS,$$

generate the Helmholtz free energy, $F(T, V)$, and the Gibbs free energy, $G(T, P)$.

The transformation from (q, \dot{q}, t) to (q, p, t) differs from the type considered in Eqs. (8.3) to (8.12) only in that more than one variable is to be transformed. We begin by writing the differential of the Lagrangian, $L(q, \dot{q}, t)$, as

$$dL = \frac{\partial L}{\partial q_i} dq_i + \frac{\partial L}{\partial \dot{q}_i} d\dot{q}_i + \frac{\partial L}{\partial t} dt. \quad (8.13)$$

The canonical momentum was defined in Eq. (2.44) as $p_i = \partial L / \partial \dot{q}_i$; substituting this into the Lagrange equation (8.1), we obtain

$$\dot{p}_i = \frac{\partial L}{\partial q_i}, \quad (8.14)$$

so Eq. (8.13) can be written as

$$dL = \dot{p}_i dq_i + p_i d\dot{q}_i + \frac{\partial L}{\partial t} dt. \quad (8.13')$$

The Hamiltonian $H(q, p, t)$ is generated by the Legendre transformation

$$H(q, p, t) = \dot{q}_i p_i - L(q, \dot{q}, t), \quad (8.15)$$

which has the differential

$$dH = \dot{q}_i dp_i - \dot{p}_i dq_i - \frac{\partial L}{\partial t} dt, \quad (8.16)$$

where the term $p_i d\dot{q}_i$ is removed by the Legendre transformation. Since dH can also be written as

$$dH = \frac{\partial H}{\partial q_i} dq_i + \frac{\partial H}{\partial p_i} dp_i + \frac{\partial H}{\partial t} dt, \quad (8.17)$$

we obtain the $2n + 1$ relations

$$\left. \begin{aligned} \dot{q}_i &= \frac{\partial H}{\partial p_i} \\ -\dot{p}_i &= \frac{\partial H}{\partial q_i} \end{aligned} \right\} \quad (8.18)$$

$$-\frac{\partial L}{\partial t} = \frac{\partial H}{\partial t}. \quad (8.19)$$

Equations (8.18) are known as the *canonical equations of Hamilton*; they constitute the desired set of $2n$ first-order equations of motion replacing the n second-order Lagrange equations.*

The first half of Hamilton's equations give the \dot{q}_i 's as functions of (q, p, t) . They form therefore the inverse of the constitutive equations (8.2), which define the momenta p_i as functions of (q, \dot{q}, t) . It may therefore be said that they provide no new information. In terms of solving mechanical problems by means of the canonical equations, the statement is correct. But within the framework of the Hamiltonian picture, where $H(q, p, t)$ is some given function obtained no matter how, the two halves of the set of Hamiltonian equations are equally independent and meaningful. The first half says how \dot{q} depends on q, p , and t ; the second says the same thing for \dot{p} .

Of course, the Hamiltonian H is constructed in the same manner, and has identically the same value, as h , the energy function defined in Eq. (2.53). But they are functions of different variables: Like the Lagrangian, h is a function of q, \dot{q} (and possibly t), while H must always be expressed as a function of q, p (and possibly t). It is to emphasize this difference in functional behavior that different symbols have been given to the quantities even though they have the same numerical values.

Nominally, the Hamiltonian for each problem must be constructed via the Lagrangian formulation. The formal procedure calls for a lengthy sequence of steps:

1. With a chosen set of generalized coordinates, q_i , the Lagrangian $L(q_i, \dot{q}_i, t) = T - V$ is constructed.
2. The conjugate momenta are defined as functions of q_i, \dot{q}_i , and t by Eqs. (8.2).
3. Equation (8.15) is used to form the Hamiltonian. At this stage we have some mixed function of q_i, \dot{q}_i, p_i , and t .
4. Equations (8.2) are then inverted to obtain \dot{q}_i as functions of (q, p, t) . Possible difficulties in the inversion will be discussed below.
5. The results of the previous step are then applied to eliminate \dot{q} from H so as to express it solely as a function of (q, p, t) .

Now we are ready to use the Hamiltonian in the canonical equations of motion.

For many physical systems it is possible to shorten this drawn-out sequence quite appreciably. As has been described in Section 2.7, in many problems the Lagrangian is the sum of functions each homogeneous in the generalized veloc-

*Canonical is used here presumably in the sense of designating a simple, general set of standard equations. It appears that the term was first introduced by C. G. J. Jacobi in 1837 (*Comptes rendus de l'Académie des Sciences de Paris*, 5, p. 61) but in a slightly different context referring to an application of Hamilton's equations of motion to perturbation theory. Although the term rapidly gained common usage, the reason for its introduction apparently remained obscure even to contemporaries. By 1879, only 45 years after Hamilton explicitly introduced his equations, Thomson (Lord Kelvin) and Tait were moved by the adjective "canonical" to exclaim "Why it has been so called would be hard to say"

ities of degree 0, 1, and 2, respectively. In that case, H by the prescription of Eq. (8.15) is given by (cf. Eqs. (2.53) and (2.55))

$$H = \dot{q}_i p_i - L = \dot{q}_i p_i - [L_0(q_i, t) + L_1(q_i, t)\dot{q}_k + L_2(q_i, t)\dot{q}_k\dot{q}_m] \quad (8.20)$$

(no sum on i in the square brackets) where L_0 is the part of the Lagrangian that is independent of the generalized velocities, L_1 represents the coefficients of the part of the Lagrangian that is homogeneous in \dot{q}_i in the first degree, and L_2 is the part that is homogeneous in \dot{q}_i in the second degree. Further, if the equations defining the generalized coordinates don't depend on time explicitly, then $L_2\dot{q}_k\dot{q}_m = T$ (the kinetic energy), and if the forces are derivable from a conservative potential V (that is, work is independent of the path), then $L_0 = -V$. When both these conditions are satisfied, the Hamiltonian is *automatically* the total energy:

$$H = T + V = E. \quad (8.21)$$

If either Eq. (8.20) or (8.21) holds, then much of the algebra in steps 3 and 4 above is eliminated.

We can at times go further. In large classes of problems, it happens that L_2 is a quadratic function of the generalized velocities and L_1 is a linear function of the same variables with the following specific functional dependencies:

$$L(q_i, \dot{q}_i, t) = L_0(q, t) + \dot{q}_i a_i(q, t) + \dot{q}_i^2 T_i(q, t), \quad (8.22)$$

where the a_i 's and the T_i 's are functions of the q 's and t .

The algebraic manipulations required in steps 2–5 can then be carried out, at least formally, once and for all. To show this, let us form the \dot{q}_i 's into a single column matrix $\dot{\mathbf{q}}$. Under the given assumptions the Lagrangian can be written as

$$L(q, \dot{\mathbf{q}}, t) = L_0(q, t) + \tilde{\mathbf{q}}\mathbf{a} + \frac{1}{2}\tilde{\mathbf{q}}\mathbf{T}\dot{\mathbf{q}}, \quad (8.23)$$

where the single row matrix $\tilde{\mathbf{q}}$ has been written explicitly as the transpose of a single column matrix, $\dot{\mathbf{q}}$. Here \mathbf{a} is a column matrix, and \mathbf{T} is a square $n \times n$ matrix (much like the corresponding matrix introduced in Section 6.2). The elements of both are in general functions of q and t . To illustrate this formalism, let us consider the special case where $q_i = \{x, y, z\}$ and \mathbf{T} is diagonal. We would then write

$$\frac{1}{2}\tilde{\mathbf{q}}\mathbf{T}\dot{\mathbf{q}} = \frac{1}{2}(\dot{x}\dot{y}\dot{z}) \begin{bmatrix} m & 0 & 0 \\ 0 & m & 0 \\ 0 & 0 & m \end{bmatrix} \begin{bmatrix} \dot{x} \\ \dot{y} \\ \dot{z} \end{bmatrix} = \frac{m}{2}(\dot{x}^2 + \dot{y}^2 + \dot{z}^2) \quad (8.24a)$$

and

$$\tilde{\mathbf{q}}\mathbf{a} = (\dot{x}\dot{y}\dot{z}) \begin{bmatrix} a_x \\ a_y \\ a_z \end{bmatrix} = a_x\dot{x} + a_y\dot{y} + a_z\dot{z} = \mathbf{a} \cdot \dot{\mathbf{r}}. \quad (8.24b)$$

In this notation the Hamiltonian, $H = \tilde{\mathbf{q}}\mathbf{p} - L$, becomes

$$H = \tilde{\mathbf{q}}(\mathbf{p} - \mathbf{a}) - \frac{1}{2}\tilde{\mathbf{q}}\mathbf{T}\dot{\mathbf{q}} - L_0. \quad (8.24c)$$

The conjugate momenta, considered as a column matrix \mathbf{p} , is then, by Eq. (8.2), given as

$$\mathbf{p} = \mathbf{T}\dot{\mathbf{q}} + \mathbf{a}, \quad (8.25)$$

which can be inverted (step 4) to the column vector $\dot{\mathbf{q}}$

$$\dot{\mathbf{q}} = \mathbf{T}^{-1}(\mathbf{p} - \mathbf{a}). \quad (8.26a)$$

This step presupposes that \mathbf{T}^{-1} exists, which it normally does by virtue of the positive definite property of kinetic energy.

The corresponding equation for $\tilde{\mathbf{q}}$ is

$$\tilde{\mathbf{q}} = (\tilde{\mathbf{p}} - \tilde{\mathbf{a}})\mathbf{T}^{-1}. \quad (8.26b)$$

To obtain the correct functional form for the Hamiltonian, Eqs. (8.26) must be used to replace $\dot{\mathbf{q}}$ and $\tilde{\mathbf{q}}$, yielding the final form for the Hamiltonian:

$$H(q, p, t) = \frac{1}{2}(\tilde{\mathbf{p}} - \tilde{\mathbf{a}})\mathbf{T}^{-1}(\mathbf{p} - \mathbf{a}) - L_0(q, t). \quad (8.27)$$

If the Lagrangian can be written in the form of Eq. (8.23), then we can immediately skip the intervening steps and write the Hamiltonian as Eq. (8.27). The inverse matrix \mathbf{T}^{-1} can usually most easily be obtained straightforwardly as

$$\mathbf{T}^{-1} = \frac{\tilde{\mathbf{T}}_c}{|\mathbf{T}|}, \quad (8.28)$$

where $\tilde{\mathbf{T}}_c$ is the cofactor matrix whose elements $(\tilde{\mathbf{T}}_c)_{jk}$ are $(-1)^{j+k}$ times the determinant of the matrix obtained by striking out the j th row and the k th column of \mathbf{T} .

In the example Eq. (8.24a), these three matrices are given explicitly by

$$\mathbf{T} = \begin{bmatrix} m & 0 & 0 \\ 0 & m & 0 \\ 0 & 0 & m \end{bmatrix}, \quad \mathbf{T}^{-1} = \begin{bmatrix} \frac{1}{m} & 0 & 0 \\ 0 & \frac{1}{m} & 0 \\ 0 & 0 & \frac{1}{m} \end{bmatrix}, \quad \text{and}$$

$$\tilde{\mathbf{T}}_c = \begin{bmatrix} m^2 & 0 & 0 \\ 0 & m^2 & 0 \\ 0 & 0 & m^2 \end{bmatrix},$$

and the determinant $|\mathbf{T}| = m^3$. It is easy to see that for the usual case when \mathbf{T} is diagonal, then \mathbf{T}^{-1} is also diagonal with elements that are just the reciprocals of the corresponding elements of \mathbf{T} .

A number of exercises in applying this formalism to various mechanical systems will be found in the problems at the end of the chapter. Two very simple examples are considered here because they illustrate some important aspects of the technique. First consider the spatial motion of a particle in a central force field, using spherical polar coordinates (r, θ, ϕ) for the generalized coordinates. The potential energy is some function $V(r)$ and the kinetic energy is

$$T = \frac{mv^2}{2} = \frac{m}{2}(\dot{r}^2 + r^2 \sin^2 \theta \dot{\phi}^2 + r^2 \dot{\theta}^2). \quad (8.28')$$

Clearly the Hamiltonian has the form of Eq. (8.21) and corresponds to the total energy $T + V$. Since \mathbf{T} is diagonal the form of H is, by inspection,

$$H(r, \theta, p_r, p_\theta, p_\phi) = \frac{1}{2m} \left(p_r^2 + \frac{p_\theta^2}{r^2} + \frac{p_\phi^2}{r^2 \sin^2 \theta} \right) + V(r). \quad (8.29)$$

Note that the Hamiltonian would have a different functional form if the generalized coordinates were chosen to be the Cartesian coordinates x_i of the particle. If we make that choice, then the kinetic energy has the form

$$T = \frac{mv^2}{2} = \frac{m\dot{x}_i \dot{x}_i}{2},$$

so that the Hamiltonian is now

$$H(x_i, p_i) = \frac{p_i p_i}{2m} + V(r). \quad (8.30)$$

It is sometimes convenient to form the canonical momenta p_i conjugate to x_i into a vector \mathbf{p} such that the Hamiltonian can be written as

$$H(x_i, p_i) = \frac{\mathbf{p} \cdot \mathbf{p}}{2m} + V(\sqrt{x_i x_i}). \quad (8.31)$$

We can of course take the components of \mathbf{p} relative to any coordinate system we desire, curvilinear spherical coordinates, for example. But it is important not to confuse, say, p_θ with the θ component of \mathbf{p} , designated as $(\mathbf{p})_\theta$. The former is the canonical momentum conjugate to the coordinate θ ; the latter is the θ component of the momentum vector conjugate to the Cartesian coordinates. Dimensionally, it is clear they are quite separate quantities; p_θ is an angular momentum, $(\mathbf{p})_\theta$ is a linear momentum. *Whenever a vector is used from here on to represent canonical momenta it will refer to the momenta conjugate to Cartesian position coordinates.*

For a second example, let us consider a single (nonrelativistic) particle of mass m and charge q moving in an electromagnetic field. By Eq. (1.63), the Lagrangian for this system is

$$L = T - V = \frac{1}{2}mv^2 - q\phi + q\mathbf{A} \cdot \mathbf{v}.$$

where the scalar potential term, $-q\phi$, is the L_0 term of the Lagrangian as expressed in Eq. (8.22) and the vector potential term, $q\mathbf{A} \cdot \mathbf{v}$, is the L_1 term.

Using Cartesian position coordinates as generalized coordinates, the Lagrangian can also be written as

$$L = \frac{m\dot{x}_i\dot{x}_i}{2} + qA_i\dot{x}_i - q\phi, \quad (8.32)$$

where the potentials ϕ and \mathbf{A} are in general functions of x_i and the time.

There is now a linear term in the generalized velocities such that the matrix \mathbf{a} has the elements qA_i . Because of this linear term in V , the Hamiltonian is *not* $T + V$. However, it is still in this case the total energy since the "potential" energy in an electromagnetic field is determined by ϕ alone. The canonical momenta, either by Eq. (8.2) or Eq. (8.25), are

$$p_i = m\dot{x}_i + qA_i, \quad (8.33)$$

and the Hamiltonian (cf. Eq. (8.27)) is

$$H = \frac{(p_i - qA_i)(p_i - qA_i)}{2m} + q\phi, \quad (8.34)$$

which is the total energy of the particle. Again, the momenta p_i can be formed into a vector \mathbf{p} and H written as

$$H = \frac{1}{2m}(\mathbf{p} - q\mathbf{A})^2 + q\phi, \quad (8.35)$$

and remembering that \mathbf{p} refers only to momenta conjugate to x_i .

It is clear that Hamilton's equations of motion do not treat the coordinates and momenta in a completely symmetric fashion. The equation for \dot{p} has a minus sign that is absent in the equation for \dot{q} . Considerable ingenuity has been exercised in devising nomenclature schemes that result in entirely symmetric equations, or combine the two sets into one. Most of these schemes have only curiosity value, but one has proved to be an elegant and powerful tool for manipulating the canonical equations and allied expressions.

For a system of n degrees of freedom, we construct a column matrix $\boldsymbol{\eta}$ with $2n$ elements such that

$$\eta_i = q_i, \quad \eta_{i+n} = p_i; \quad i \leq n. \quad (8.36)$$

Similarly, the column matrix $\partial H/\partial\boldsymbol{\eta}$ has the elements

$$\left(\frac{\partial H}{\partial\boldsymbol{\eta}}\right)_i = \frac{\partial H}{\partial q_i}, \quad \left(\frac{\partial H}{\partial\boldsymbol{\eta}}\right)_{i+n} = \frac{\partial H}{\partial p_i}; \quad i \leq n. \quad (8.37)$$

Finally, let \mathbf{J} be the $2n \times 2n$ square matrix composed of four $n \times n$ zero and unit matrices according to the scheme

$$\mathbf{J} = \begin{bmatrix} \mathbf{0} & \mathbf{1} \\ -\mathbf{1} & \mathbf{0} \end{bmatrix} \quad (8.38a)$$

with the following transpose matrix, which is its inverse

$$\tilde{\mathbf{J}} = \begin{bmatrix} \mathbf{0} & -\mathbf{1} \\ \mathbf{1} & \mathbf{0} \end{bmatrix}, \quad (8.38b)$$

which means

$$\tilde{\mathbf{J}}\mathbf{J} = \mathbf{J}\tilde{\mathbf{J}} = \mathbf{1} = \begin{bmatrix} \mathbf{1} & \mathbf{0} \\ \mathbf{0} & \mathbf{1} \end{bmatrix}, \quad (8.38c)$$

so

$$\tilde{\mathbf{J}} = -\mathbf{J} = \mathbf{J}^{-1} \quad (8.38d)$$

and

$$\mathbf{J}^2 = -\mathbf{1}, \quad (8.38e)$$

and the determinant is

$$|\mathbf{J}| = +1. \quad (8.38f)$$

Here $\mathbf{0}$ is the $n \times n$ matrix all of whose elements is zero, and $\mathbf{1}$ is the standard $n \times n$ unit matrix. Hamilton's equations of motion can then be written in compact form as

$$\dot{\boldsymbol{\eta}} = \mathbf{J} \frac{\partial H}{\partial \boldsymbol{\eta}}. \quad (8.39)$$

For two coordinate variables, this has the expanded form

$$\begin{bmatrix} \dot{q}_1 \\ \dot{q}_2 \\ \dot{p}_1 \\ \dot{p}_2 \end{bmatrix} = \begin{bmatrix} 0 & 0 & 1 & 0 \\ 0 & 0 & 0 & 1 \\ -1 & 0 & 0 & 0 \\ 0 & -1 & 0 & 0 \end{bmatrix} \begin{bmatrix} -\dot{p}_1 \\ -\dot{p}_2 \\ \dot{q}_1 \\ \dot{q}_2 \end{bmatrix}, \quad (8.40)$$

where use was made of Eqs. (8.37) and (8.18). This method of displaying the canonical equations of motion will be referred to as Hamilton's equations in matrix or *symplectic** notation. In subsequent chapters we shall frequently employ this matrix form of the equations.

8.2 ■ CYCLIC COORDINATES AND CONSERVATION THEOREMS

According to the definition given in Section 2.6, a cyclic coordinate q_j is one that does not appear explicitly in the Lagrangian; by virtue of Lagrange's equations

*The term *symplectic* comes from the Greek for "intertwined," particularly appropriate for Hamilton's equations where \dot{q} is matched with a derivative with respect to p and \dot{p} similarly with the negative of a q derivative. H. Weyl first introduced the term in 1939 in his book *The Classical Groups*.

its conjugate momentum p_j is then a constant. But comparison of Eq. (8.14) with Eq. (8.16) has already told us that

$$\dot{p}_j = \frac{\partial L}{\partial q_j} = -\frac{\partial H}{\partial q_j}.$$

A coordinate that is cyclic will thus also be absent from the Hamiltonian.* Conversely if a generalized coordinate does not occur in H , the conjugate momentum is conserved. The momentum conservation theorems of Section 2.6 can thus be transferred to the Hamiltonian formulation with no more than a substitution of H for L . In particular, the connection between the invariance or symmetry properties of the physical system and the constants of the motion can also be derived in terms of the Hamiltonian. For example, if a system is completely self-contained, with only internal forces between the particles, then the system can be moved as a rigid ensemble without affecting the forces or subsequent motion. The system is said to be invariant under a rigid displacement. Hence, a generalized coordinate describing such a rigid motion will not appear explicitly in the Hamiltonian, and the corresponding conjugate momentum will be conserved. If the rigid motion is a translation along some particular direction, then the conserved momentum is the corresponding Cartesian component of the total linear (canonical) momentum of the system. Since the direction is arbitrary, the total vector linear momentum is conserved. The rigid displacement may be a rotation, from whence it follows that the total angular momentum vector is conserved. Even if the system interacts with external forces, there may be a symmetry in the situation that leads to a conserved canonical momentum. Suppose the system is symmetrical about a given axis so that H is invariant under rotation about that axis. Then H obviously cannot involve the rotation angle about the axis and the particular angle variable must be a cyclic coordinate. It follows, as in Section 2.6, that the component of the angular momentum about that axis is conserved.†

The considerations concerning h in Section 2.7 have already shown that if L (and in consequence of Eq. (8.15), also H) is not an explicit function of t , then H is a constant of motion. This can also be seen directly from the equations of motion (8.18) by writing the total time derivative of the Hamiltonian as

$$\frac{dH}{dt} = \frac{\partial H}{\partial q_i} \dot{q}_i + \frac{\partial H}{\partial p_i} \dot{p}_i + \frac{\partial H}{\partial t}.$$

In consequence of the equations of motion (8.18), the first two sums on the right cancel each other, and it therefore follows that

$$\frac{dH}{dt} = \frac{\partial H}{\partial t} = -\frac{\partial L}{\partial t}. \quad (8.41)$$

*This conclusion also follows from the definition of Eq. (8.15), for H differs from $-L$ only by $p_i \dot{q}_i$, which does not involve q_i explicitly.

†The relation between conservation laws, symmetry of the Lagrangian, (and the Hamiltonian) of the system is called Noether's theorem. The formal proof is given in Section 13.7.

Thus if t doesn't appear explicitly in L , it will also not be present in H , and H will be constant in time.

Further, it was proved in Section 2.7 that if the equations of transformation that define the generalized coordinates (1.38),

$$\mathbf{r}_m = \mathbf{r}_m(q_1, \dots, q_n; t),$$

do not depend explicitly upon the time, and if the potential is velocity independent, then H is the total energy, $T + V$. The identification of H as a constant of the motion and as the total energy are two separate matters, and the conditions sufficient for the one are not enough for the other. It can happen that the Eqs. (1.38) do involve time explicitly but that H does not. In this case, H is a constant of the motion but it is *not* the total energy. As was also emphasized in Section (2.6), the Hamiltonian is dependent both in magnitude and in functional form upon the initial choice of generalized coordinates. For the Lagrangian, we have a specific prescription, $L = T - V$, and a change of generalized coordinates within that prescription may change the functional appearance of L but cannot alter its magnitude. On the other hand, use of a different set of generalized coordinates in the definition for the Hamiltonian, Eq. (8.15), may lead to an entirely different quantity for the Hamiltonian. It may be that for one set of generalized coordinates H is conserved, but that for another it varies in time.

To illustrate some of these points in a simple example, we may consider a somewhat artificial one-dimensional system. Suppose a point mass m is attached to a spring, of force constant k , the other end of which is fixed on a massless cart that is being moved uniformly by an external device with speed v_0 (cf. Fig. 8.1). If we take as generalized coordinate the position x of the mass particle in the stationary system, then the Lagrangian of the system is obviously

$$L(x, \dot{x}, t) = T - V = \frac{m\dot{x}^2}{2} - \frac{k}{2}(x - v_0t)^2. \quad (8.42)$$

(For simplicity, the origin has been chosen so that the cart passes through it at $t = 0$.) The corresponding equation of motion is clearly

$$m\ddot{x} = -k(x - v_0t).$$

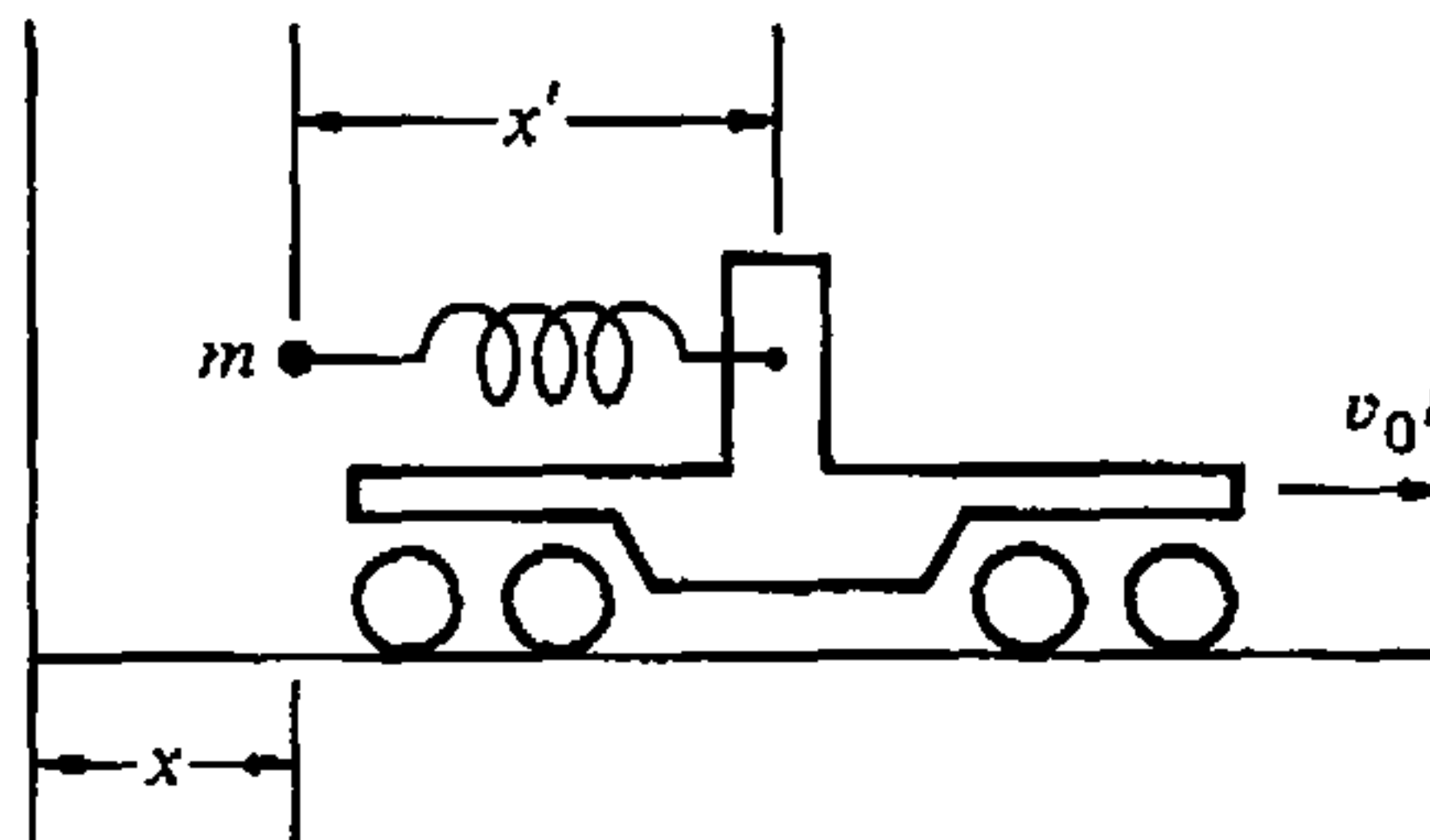

FIGURE 8.1 A harmonic oscillator fixed to a uniformly moving cart.

An obvious way of solving this equation is to change the unknown to $x'(t)$ defined as

$$x' = x - v_0 t, \quad (8.43)$$

and noting that $\ddot{x}' = \ddot{x}$, the equation of motion becomes

$$m\ddot{x}' = -kx'. \quad (8.44)$$

From Eq. (8.43), x' is the displacement of the particle relative to the cart; Eq. (8.44) says that to an observer on the cart the particle exhibits simple harmonic motion, as would be expected on the principle of equivalence in Galilean relativity.

Having looked at the nature of the motion, let us consider the Hamiltonian formulation. Since x is the Cartesian coordinate of the particle, and the potential does not involve generalized velocities, the Hamiltonian relative to x is the sum of the kinetic and potential energies, that is, the total energy. In functional form the Hamiltonian is given by

$$H(x, p, t) = T + V = \frac{p^2}{2m} + \frac{k}{2}(x - v_0 t)^2. \quad (8.45)$$

The Hamiltonian *is* the total energy of the system, but since it is explicitly a function of t , it is *not* conserved. Physically this is understandable; energy must flow into and out of the “external physical device” to keep the cart moving uniformly against the reaction of the oscillating particle.*

Suppose now we formulated the Lagrangian from the start in terms of the relative coordinate x' . The same prescription gives the Lagrangian as

$$L(x', \dot{x}') = \frac{m\dot{x}'^2}{2} + m\dot{x}'v_0 + \frac{mv_0^2}{2} - \frac{kx'^2}{2}. \quad (8.46)$$

In setting up the corresponding Hamiltonian, we note there is now a term linear in \dot{x}' , with the single component of \mathbf{a} being mv_0 . The new Hamiltonian is now

$$H'(x', p') = \frac{(p' - mv_0)^2}{2m} + \frac{kx'^2}{2} - \frac{mv_0^2}{2}. \quad (8.47)$$

Note that the last term is a constant involving neither x' nor p' ; it could, if we wished, be dropped from H' without affecting the resultant equations of motion. Now H' is *not* the total energy of the system, but it *is* conserved. Except for the last term, it can be easily identified as the total energy of motion of the particle relative to the moving cart. The two Hamiltonian's are different in magnitude.

*Put another way, the moving cart constitutes a time-dependent constraint on the particle, and the force of the constraint does do work in actual (*not* virtual) displacement of the system.

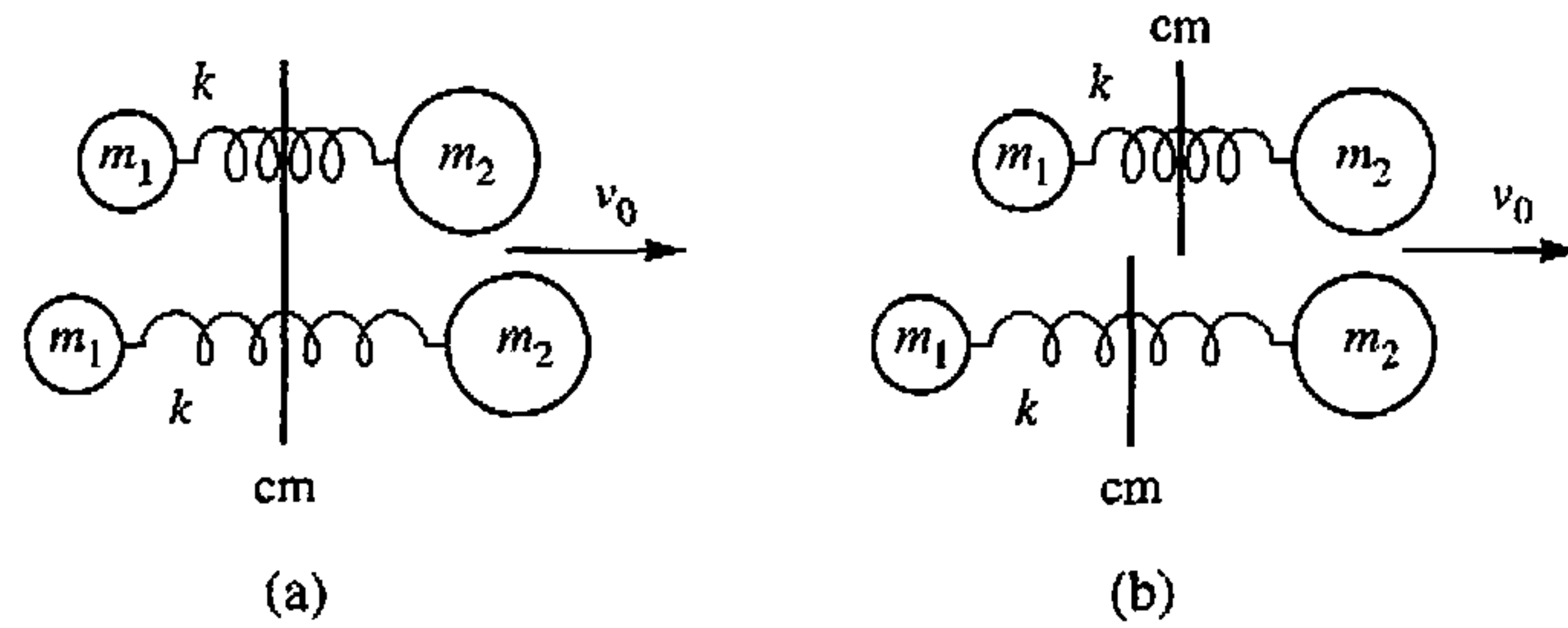

FIGURE 8.2 Vibrating dumbbell under two conditions: (a) freely oscillating, and (b) oscillating with mass m_2 kept at a constant velocity

time dependence, and functional behavior. But the reader can easily verify that both lead to the same motion for the particle.

Additional insight into the problem of the mass cart previously discussed can be gained by considering a dumbbell of two masses connected by a spring of constant k . We shall consider the case where the center of mass of the dumbbell is in constant motion at a speed v_0 along the direction determined by the spring and allow oscillations of the masses only along this direction. This is shown in Fig. 8.2, where C-O-M denotes the center of mass.

The dumbbell is made to vibrate while its center of mass has an initial velocity v_0 . It will continue with this velocity with uniform translational motion. This translational motion will have no effect on the oscillations. The motion of the center of mass and the motion relative to the center of mass separate as they do in the Kepler problem. Once the motion is started, energy is conserved and the Hamiltonian is the total conserved energy. The situation is different if the mass m_2 moves at the constant speed v_0 since a periodic force is applied. The center of mass and the mass m_1 then oscillate relative to m_2 . Since a changing external force must be applied to the system to keep m_2 at the constant velocity v_0 , the Hamiltonian is no longer conserved, nor is the Hamiltonian the total energy.

8.3 ■ ROUTH'S PROCEDURE

It has been remarked that the Hamiltonian formulation is not particularly helpful in the direct solution of mechanical problems. Often we can solve the $2n$ first-order equations only by eliminating some of the variables, for example, the p variables, which speedily leads back to the second-order Lagrangian equations of motion. But an important exception should be noted. The Hamiltonian procedure is especially adapted to the treatment of problems involving cyclic coordinates.

Let us consider the situation in Lagrangian formulation when some coordinate, say q_n , is cyclic. The Lagrangian as a function of q and \dot{q} can then be written

$$L = L(q_1, \dots, q_{n-1}; \dot{q}_1, \dots, \dot{q}_n; t).$$

All the generalized velocities still occur in the Lagrangian and in general will be functions of the time. We still have to solve a problem of n degrees of freedom, even though one degree of freedom corresponds to a cyclic coordinate. A cyclic coordinate in the Hamiltonian formulation, on the other hand, truly deserves its alternative description as “ignorable,” for in the same situation p_n is some constant α , and H has the form

$$H = H(q_1, \dots, q_{n-1}; p_1, \dots, p_{n-1}; \alpha; t).$$

In effect, the Hamiltonian now describes a problem involving only $n - 1$ coordinates, which may be solved completely ignoring the cyclic coordinate except as it is manifested in the constant of integration α , to be determined from the initial conditions. The behavior of the cyclic coordinate itself with time is then found by integrating the equation of motion

$$\dot{q}_n = \frac{\partial H}{\partial \alpha}.$$

The advantages of the Hamiltonian formulation in handling cyclic coordinates may be combined with the Lagrangian conveniences for noncyclic coordinates by a method devised by Routh. Essentially, we carry out a mathematical transformation from the q, \dot{q} basis to the q, p basis only for those coordinates that are cyclic, obtaining their equations of motion in the Hamiltonian form, while the remaining coordinates are governed by Lagrange equations. If the cyclic coordinates are labeled q_{s+1}, \dots, q_n , then a new function R (known as the Routhian) may be introduced, defined as

$$R(q_1, \dots, q_n; \dot{q}_1, \dots, \dot{q}_s; p_{s+1}, \dots, p_n; t) = \sum_{i=s+1}^n p_i \dot{q}_i - L, \quad (8.48)$$

which is equivalent to writing

$$R(q_1, \dots, q_n; \dot{q}_1, \dots, \dot{q}_s; p_{s+1}, \dots, p_n; t) = H_{cycl}(p_{s+1}, \dots, p_n) - L_{noncycl}(q_1, \dots, q_s; \dot{q}_1, \dots, \dot{q}_s). \quad (8.49)$$

It is easy to show for the s nonignorable coordinates, the Lagrange equations

$$\frac{d}{dt} \left(\frac{\partial R}{\partial \dot{q}_i} \right) - \frac{\partial R}{\partial q_i} = 0, \quad i = 1, \dots, s, \quad (8.50)$$

are satisfied, while for the $n - s$ ignorable coordinates, Hamilton's equations apply as

$$\frac{\partial R}{\partial q_i} = -\dot{p}_i = 0, \quad \text{and} \quad \frac{\partial R}{\partial p_i} = \dot{q}_i, \quad i = s + 1, \dots, n. \quad (8.51)$$

A simple, almost trivial, example may clarify Routh's procedure and the physical significance of the quantities involved. Consider the Kepler problem investi-

gated in Section 3.7, that of a single particle moving in a plane under the influence of the inverse-square central force $f(r)$ derived from the potential $V(r) = -k/r^n$. The Lagrangian is then

$$L = \frac{m}{2}(\dot{r}^2 + r^2\dot{\theta}^2) + \frac{k}{r^n}.$$

As noted before, the ignorable coordinate is θ , and if the constant conjugate momentum is denoted by p_θ , the corresponding Routhian (8.49) is

$$R(r, \dot{r}, p_\theta) = \frac{p_\theta^2}{2mr^2} - \frac{1}{2}m\dot{r}^2 - \frac{k}{r^n}.$$

Physically we see that the Routhian is the equivalent one-dimensional potential $V'(r)$ minus the kinetic energy of radial motion.

Applying the Lagrange equation (8.50) to the noncyclic radial coordinate r , we obtain the equation of motion (3.11)

$$\ddot{r} - \frac{p_\theta^2}{mr^3} + \frac{nk}{r^{n+1}} = 0. \quad (8.52)$$

Applying Hamilton's equation (8.51) to the cyclic variable θ , we obtain the pair of equations

$$\dot{p}_\theta = 0 \quad \text{and} \quad \frac{p_\theta}{mr^2} = \dot{\theta}. \quad (8.53)$$

whose solution is the same as Eq. (3.8),

$$p_\theta = mr^2\dot{\theta} = l = \text{constant}.$$

Typically, Routh's procedure does not add to the physics of the analysis presented earlier in Chapter 3, but it makes the analysis more automatic. In complicated problems with many degrees of freedom, this feature can be a considerable advantage. It is not surprising therefore that Routh's procedure finds its greatest usefulness in the direct solution of problems relating to engineering applications. But as a fundamental entity, the Routhian is a sterile hybrid, combining some of the features of both the Lagrangian and the Hamiltonian pictures. For the development of various formalisms of classical mechanics, the complete Hamiltonian formulation is more fruitful.

8.4 ■ THE HAMILTONIAN FORMULATION OF RELATIVISTIC MECHANICS

As with the Lagrangian picture in special relativity, two attitudes can be taken to the Hamiltonian formulation of relativistic mechanics. The first makes no pretense at a covariant description but instead works in some specific Lorentz or inertial frame. Time as measured in the particular Lorentz frame is then not treated on a

common basis with other coordinates but serves, as in nonrelativistic mechanics, as a parameter describing the evolution of the system. Nonetheless, if the Lagrangian that leads to the Hamiltonian is itself based on a relativistically invariant physical theory (for example, Maxwell's equations and the Lorentz force), then the resultant Hamiltonian picture will be relativistically correct. The second approach of course attempts a fully covariant description of the Hamiltonian picture, but the difficulties that plagued the corresponding Lagrangian approach (cf. Section 7.9) are even fiercer here. We shall consider the noncovariant method first.

For a single-particle Lagrangian of the form of Eq. (7.136),

$$L = -mc^2\sqrt{1 - \beta^2} - V,$$

we have already shown that the Hamiltonian (in the guise of the energy function h) is the total energy of the system:

$$H = T + V.$$

The energy T can be expressed in terms of the canonical momenta p_i (Eq. 7.139) through Eq. (7.38):*

$$T^2 = p^2c^2 + m^2c^4,$$

so that a suitable form for the Hamiltonian is

$$H = \sqrt{p^2c^2 + m^2c^4} + V. \quad (8.54)$$

When the system consists of a single particle moving in an electromagnetic field, the Lagrangian has been given as (cf. Eq. (7.141))

$$L = -mc^2\sqrt{1 - \beta^2} + q\mathbf{A} \cdot \mathbf{v} - q\phi.$$

The term in L linear in the velocities does not appear explicitly in the Hamiltonian (cf. Eq. (8.54)), as we have seen, whereas the first term leads to the appearance of T in the Hamiltonian. Thus, the Hamiltonian is again the total particle energy:

$$H = T + q\phi. \quad (8.55)$$

For this system, the canonical momenta conjugate to the Cartesian coordinates of the particle are defined by (cf. Eq. (7.142))

$$p^i = mu^i + qA^i,$$

so that the relation between T and p^i is given by Eq. (7.168), and the Hamiltonian has the final form

*In this section we use T for the motion energy (pc) plus the rest energy (mc^2) to avoid confusing it with the total energy $T + V$

$$H = \sqrt{(\mathbf{p} - q\mathbf{A})^2 c^2 + m^2 c^4} + q\phi. \quad (8.56)$$

It should be emphasized again that \mathbf{p} here is the vector of the canonical momenta conjugate to the *Cartesian* position coordinates of the particle. We may also note that $(H - q\phi)/c$ is the zeroth component of the 4-vector

$$mu^\nu + qA^\nu$$

(cf. Eqs. (7.27), (7.38'), and (7.166)). While the Hamiltonian (8.56) is not expressed in covariant fashion, it does have a definite transformation behavior under a Lorentz transformation as being, in some Lorentz form, the zeroth component of a 4-vector.

In a covariant approach to the Hamiltonian formulation, time must be treated in the same fashion as the space coordinates; that is, time must be taken as one of the canonical coordinates having an associated conjugate momentum. The foundations of such an extension of the dimensionality of phase space can in fact be constructed even in nonrelativistic mechanics. Following the pattern of Section 7.10, the progress of the system point along its trajectory in phase space can be marked by some parameter θ , and t "released," so to speak, to serve as an additional coordinate. If derivatives with respect to θ are denoted by a superscript prime, the Lagrangian in the $(q_1, \dots, q_n; t)$ configuration space is (cf. Eq. (7.159))

$$\Lambda(q, q', t, t') = t' L\left(q, \frac{q'}{t'}, t\right). \quad (8.57)$$

The momentum conjugate to t is then

$$p_t = \frac{\partial \Lambda}{\partial t'} = L + t' \frac{\partial L}{\partial t'}.$$

If we make explicit use of the connection $\dot{q} = q'/t'$, this relation becomes

$$p_t = L - \frac{q'_i}{t'} \frac{\partial L}{\partial \dot{q}_i} = L - \dot{q}_i \frac{\partial L}{\partial \dot{q}_i} = -H. \quad (8.58)$$

The momentum conjugate to the time "coordinate" is therefore the negative of the ordinary Hamiltonian.* While the framework of this derivation is completely nonrelativistic, the result is consistent with the identification of the time component of the 4-vector momentum with E/c . As can be seen from the definition, Eq. (8.2), if q is multiplied by a constant α , then the conjugate momentum is divided by α . Hence, the canonical momentum conjugate to ct is H/c .

*The remaining momenta are unchanged by the shift from t to θ , as can be seen by evaluating the corresponding derivative

$$\frac{\partial \Lambda}{\partial q'_i} = t' \frac{\partial L}{\partial q'_i} = t' \left(\frac{\partial L}{\partial \dot{q}_i} \frac{1}{t'} \right) = p_i.$$

Thus, there seems to be a natural route available for constructing a relativistically covariant Hamiltonian. But the route turns out to be mined with booby traps. It will be recalled that the covariant Lagrangian used to start the process, Eq. (7.159) or Eq. (8.57), is homogeneous in first degree in the generalized velocities q' , and for such a Lagrangian the recipe described above for constructing the Hamiltonian formulation breaks down irreparably. If L is of type L_1 , the corresponding Hamiltonian, call it $H_c(q, t, p, p_t)$, is identically zero!

Fortunately, there does not seem to be any compelling reason why the covariant Lagrangian has to be homogeneous in the first degree, at least for classical relativistic mechanics. It has already been seen that for a single free particle the covariant Lagrangian

$$\Lambda(x^\mu, u^\mu) = \frac{1}{2} m u_\mu u^\mu$$

leads to the correct equations of motion. Of course the four-velocity components, u^μ , are still not all independent, but the constraint can be treated as a "weak condition" to be imposed only *after* all the differentiations have been carried through. There is now no difficulty in obtaining a Hamiltonian from this Lagrangian, by the same route as in nonrelativistic mechanics; the result is clearly

$$H_c = \frac{p_\mu p^\mu}{2m}. \quad (8.59)$$

For a single particle in an electromagnetic field, a covariant Lagrangian has been found previously: (cf. Eq. (7.165))*

$$\Lambda(x^\mu, u^\mu) = \frac{1}{2} m u_\mu u^\mu + q u^\mu A_\mu(x_\lambda), \quad (7.147)$$

with the canonical momenta (cf. Eq. (7.167)),

$$p_\mu = m u_\mu + q A_\mu. \quad (7.149)$$

In the corresponding Hamiltonian, the term linear in u_μ does not appear explicitly in the Hamiltonian, and the remaining L_2 part in terms of the canonical momenta is

$$H'_c = \frac{(p_\mu - q A_\mu)(p^\mu - q A^\mu)}{2m}. \quad (8.60)$$

Both Hamiltonians, Eqs. (8.59) and (8.60), are constant, with the same value, $-mc^2/2$, but to obtain the equations of motion it is the *functional* dependence on the 4-vectors of position and momenta that is important. With a system of one particle, the covariant Hamiltonian leads to eight first-order equations of motion

*The Legendre transformation process is reversible: Given a Hamiltonian we can obtain the corresponding Lagrangian (cf. Derivation 1) But the difficulties also arise in either direction. If a given Hamiltonian is postulated to be homogeneous in first degree in the momenta, then it is not possible to find an equivalent Lagrangian

$$\frac{dx^\nu}{d\tau} = \frac{\partial H'_c}{\partial p^\nu}, \quad \frac{dp^\nu}{d\tau} = -\frac{\partial H_c}{\partial x^\nu}. \quad (8.61)$$

We know that these equations cannot be all independent. The space parts of Eqs. (8.61) obviously lead to the spatial equations of motion. We should expect therefore that the remaining two equations tell us nothing new, exactly as in the Lagrangian case. This can be verified by examining the $\nu = 0$ equations in some particular Lorentz frame. One of them is the constitutive equation for p^0 :

$$u^0 = \frac{\partial H'_c}{\partial p^0} = \frac{1}{m} (p^0 - qA^0)$$

or

$$p^0 = \frac{1}{c} (T + q\phi) = \frac{H'_c}{c}, \quad (8.62)$$

a general conclusion that has been noted before. The other can be written as

$$\frac{1}{\sqrt{1-\beta^2}} \frac{dp^0}{dt} = -\frac{1}{c} \frac{\partial H_c}{\partial t}$$

or

$$\frac{dH}{dt} = \sqrt{1-\beta^2} \frac{\partial H_c}{\partial t}. \quad (8.63)$$

As with the covariant Lagrangian formulation, we have the problem of finding suitable covariant potential terms in the Lagrangian to describe the forces other than electromagnetic. In multiparticle systems we are confronted in full measure with the critical difficulties of including interactions other than with fields. In Hamiltonian language, the "no-interaction" theorem already referred to in Section 7.10 says that only in the absence of direct particle interactions can Lorentz invariant systems be described in terms of the usual position coordinates and corresponding canonical momenta. The scope of the relativistic Hamiltonian framework is therefore quite limited and so for the most part we shall confine ourselves to nonrelativistic mechanics.

8.5 ■ DERIVATION OF HAMILTON'S EQUATIONS FROM A VARIATIONAL PRINCIPLE

Lagrange's equations have been shown to be the consequence of a variational principle, namely, the Hamilton's principle of Section 2.1. Indeed, the variational method is often the preferable one for deriving Lagrange's equations, for it is applicable to types of systems not usually included within the scope of mechanics. It would be similarly advantageous if a variational principle could be found that

leads directly to the Hamilton's equations of motion. Hamilton's principle,

$$\delta I \equiv \delta \int_{t_1}^{t_2} L dt = 0, \quad (8.64)$$

lends itself to this purpose, but as formulated originally it refers to paths in configuration space. The first modification therefore is that the integral must be evaluated over the trajectory of the system point in phase space, and the varied paths must be in the neighborhood of this phase space trajectory. In the spirit of the Hamiltonian formulation, both q and p must be treated as independent coordinates of phase space, to be varied independently. To this end the integrand in the action integral, Eq. (8.64), must be expressed as a function of both q and p , and their time derivatives, through Eq. (8.15). Equation (8.64) then appears as

$$\delta I = \delta \int_{t_1}^{t_2} (p_i \dot{q}_i - H(q, p, t)) dt = 0. \quad (8.65)$$

As a variational principle in phase space, Eq. (8.65) is sometimes referred to as the *modified Hamilton's principle*. Although it will be used most frequently in connection with transformation theory (see Chapter 9), the main interest in it here is to show that the principle leads to Hamilton's canonical equations of motion.

The modified Hamilton's principle is exactly of the form of the variational problem in a space of $2n$ dimensions considered in Section 2.3 (cf. Eq. (2.14)):

$$\delta I = \delta \int_{t_1}^{t_2} f(q, \dot{q}, p, \dot{p}, t) dt = 0, \quad (8.66)$$

for which the $2n$ Euler–Lagrange equations are

$$\frac{d}{dt} \left(\frac{\partial f}{\partial \dot{q}_j} \right) - \frac{\partial f}{\partial q_j} = 0 \quad j = 1, \dots, n \quad (8.67)$$

$$\frac{d}{dt} \left(\frac{\partial f}{\partial \dot{p}_j} \right) - \frac{\partial f}{\partial p_j} = 0 \quad j = 1, \dots, n. \quad (8.68)$$

The integrand f as given in Eq. (8.65) contains \dot{q}_j only through the $p_i \dot{q}_i$ term, and q_j only in H . Hence, Eqs. (8.67) lead to

$$\dot{p}_j + \frac{\partial H}{\partial q_j} = 0. \quad (8.69)$$

On the other hand, there is no explicit dependence of the integrand in Eq. (8.65) on \dot{p}_j . Equations (8.68) therefore reduce simply to

$$\dot{q}_j - \frac{\partial H}{\partial p_j} = 0. \quad (8.70)$$

Equations (8.69) and (8.70) are exactly Hamilton's equations of motion, Eqs. (8.18). The Euler–Lagrange equations of the modified Hamilton's principle are thus the desired canonical equations of motion.

This derivation of Hamilton's equations from the variational principle is so brief as to give the appearance of a sleight-of-hand trick. One wonders whether something extra has been sneaked in while we were being misdirected by the magician's patter. Is the modified Hamilton's principle equivalent to Hamilton's principle, or does it contain some additional physics? The question is largely irrelevant; the primary justification for the modified Hamilton's principle is that it leads to the canonical equations of motion in phase space. After all, no further argument was given for the validity of Hamilton's principle than that it corresponded to the Lagrangian equations of motion. So long as Hamiltonian can be constructed, the Legendre transformation procedure shows that the Lagrangian and Hamiltonian formulations, and therefore their respective variational principles, have the same physical content.

One question that can be raised however is whether the derivation puts limitations on the variation of the trajectory that are not present in Hamilton's principle. The variational principle leading to the Euler–Lagrange equations is formulated, as in Section 2.2, such that the variations of the independent variables vanish at the end points. In phase space, that would require $\delta q_i = 0$ and $\delta p_i = 0$ at the end points, whereas Hamilton's principle requires only the vanishing of δq_i under the same circumstances. A look at the derivation as spelled out in Section 2.2 will show however that the variation is required to be zero at the end points only in order to get rid of the integrated terms arising from the variations in the time derivatives of the independent variables. While the f function in Eq. (8.66) that corresponds to the modified Hamilton's principle, Eq. (8.65), is indeed a function of \dot{q}_j , there is no explicit appearance of \dot{p}_j . Equations (8.68) and therefore (8.70) follow from Eq. (8.65) without stipulating the variations of p_j at the end points. The modified Hamilton's principle, with the integrand L defined in terms of the Hamiltonian by Eq. (8.19), leads to Hamilton's equations under the same variation conditions as those in Hamilton's principle.*

Nonetheless, there are advantages to requiring that the varied paths in the modified Hamilton's principle return to the same end points in both q and p , for we then have a more generalized condition for Hamilton's equations of motion. As with Hamilton's principle, if there is no variation at the end points we can add a total time derivative of any arbitrary (twice-differentiable) function $F(q, p, t)$ to the integrand without affecting the validity of the variational principle. Suppose, for example, we subtract from the integrand of Eq. (8.65) the quantity

*It may be objected that q and p cannot be varied independently, because the defining Eqs. (8.2) link p with q and \dot{q} . We could not then have a variation of q (and \dot{q}) without a corresponding variation of p . But this entire objection is completely at variance with the intent and the spirit of the Hamiltonian picture. Once the Hamiltonian formulation has been set up, Eqs. (8.2) form no part of it. The momenta have been elevated to the status of independent variables, on an equal basis with the coordinates and connected with them and the time *only through the medium of the equations of motion themselves* and not by any a priori defining relationship.

$$\frac{d}{dt}(q_i p_i).$$

The modified Hamilton's principle would then read

$$\delta \int_{t_1}^{t_2} (-\dot{p}_i q_i - H(q, p, t)) dt = 0. \quad (8.71)$$

Here the f integrand of Eq. (8.66) is a function of \dot{p} , and it is easily verified that the Euler–Lagrange equations (8.67) and (8.68) with this f again correspond to Hamilton's equations of motion, Eqs. (8.18). Yet the integrand in Eq. (8.71) is not the Lagrangian nor can it in general be simply related to the Lagrangian by a point transformation in configuration space. By restricting the variation of both q and p to be zero at the end points, the modified Hamilton's principle provides an independent and general way of setting up Hamilton's equations of motion without a prior Lagrangian formulation. If you will, it does away with the necessity of a linkage between the Hamiltonian canonical variables and a corresponding Lagrangian set of generalized coordinates and velocities. This will be very important to us in the next chapter where we examine transformations of phase space variables that preserve the Hamiltonian form of the equations of motion.

The requirement of independent variation of q and p , so essential for the above derivation, highlights the fundamental difference between the Lagrangian and Hamiltonian formulations. Neither the coordinates q_i nor the momenta p_i are to be considered there as the more fundamental set of variables; both are equally independent. Only by broadening the field of independent variables from n to $2n$ quantities are we enabled to obtain equations of motion that are of first order. In a sense, the names "coordinates" and "momenta" are unfortunate, for they bring to mind pictures of spatial coordinates and linear, or at most, angular momenta. A wider meaning must now be given to the terms. The division into coordinates and momenta corresponds to no more than a separation of the independent variables describing the motion into two groups having an almost symmetrical relationship to each other through Hamilton's equations.

8.6 ■ THE PRINCIPLE OF LEAST ACTION

Another variational principle associated with the Hamiltonian formulation is known as *the principle of least action*. It involves a new type of variation, which we shall call the Δ -variation, requiring detailed explanation. In the δ -variation process used in the discussion of Hamilton's principle in Chapter 2, the varied path in configuration space always terminated at end points representing the system configuration at the same time t_1 and t_2 as the correct path. To obtain Lagrange's equations of motion, we also required that the varied path return to the same end points in configuration space, that is, $\delta q_i(t_1) = \delta q_i(t_2) = 0$. The Δ -variation is less constrained; in general, the varied path over which an integral is evaluated may end at different times than the correct path, and there

may be a variation in the coordinates at the end points. We can however use the same parameterization of the varied path as in the δ -variation. In the notation of Section 2.3, a family of possible varied paths is defined by functions (cf. Eq. (2.15))

$$q_i(t, \alpha) = q_i(t, 0) + \alpha \eta_i(t), \quad (8.72)$$

where α is an infinitesimal parameter that goes to zero for the correct path. Here the functions η_i do not necessarily have to vanish at the end points, either the original or the varied. All that is required is that they be continuous and differentiable. Figure 8.3 illustrates the correct and varied path for a Δ -variation in configuration space.

Let us evaluate the Δ -variation of the action integral:

$$\Delta \int_{t_1}^{t_2} L dt \equiv \int_{t_1 + \Delta t_1}^{t_2 + \Delta t_2} L(\alpha) dt - \int_{t_1}^{t_2} L(0) dt, \quad (8.73)$$

where $L(\alpha)$ means the integral is evaluated along the varied path and $L(0)$ correspondingly refers to the actual path of motion. The variation is clearly composed of two parts. One arises from the change in the limits of the integral; to first-order infinitesimals, this part is simply the integrand on the actual path times the difference in the limits in time. The second part is caused by the change in the integrand on the varied path, but now between the same time limits as the original integral. We may therefore write the Δ -variation of the action integral as

$$\Delta \int_{t_1}^{t_2} L dt = L(t_2) \Delta t_2 - L(t_1) \Delta t_1 + \int_{t_1}^{t_2} \delta L dt. \quad (8.74)$$

Here the variation in the second integral can be carried out through a parameterization of the varied path, exactly as for Hamilton's principle except that the

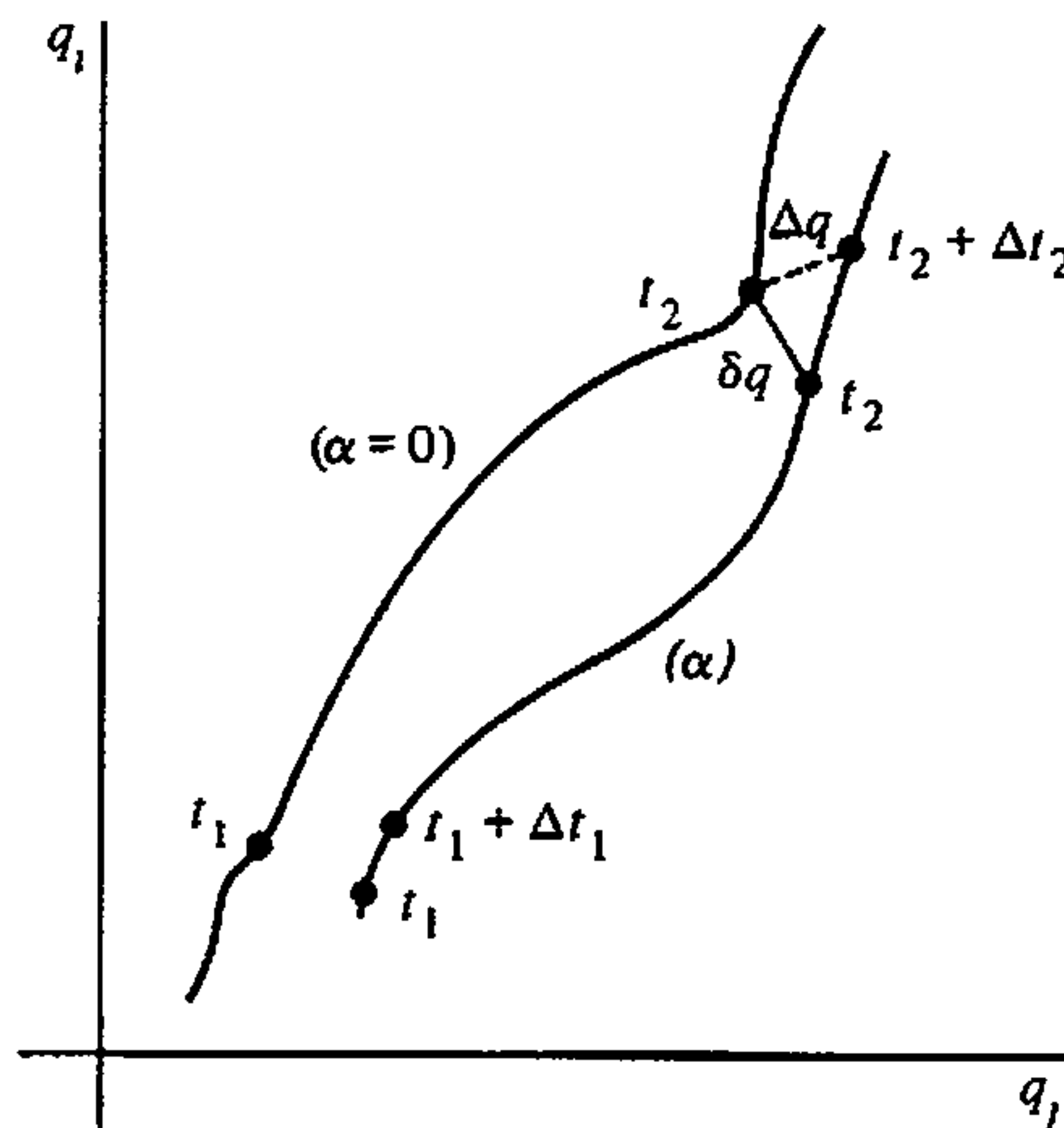

FIGURE 8.3 The Δ -variation in configuration space.

variation in q_i does not vanish at the end points. The end point terms arising in the integration by parts must be retained, and the integral term on the right appears as

$$\int_{t_1}^{t_2} \delta L dt = \int_{t_1}^{t_2} \left[\frac{\partial L}{\partial q_i} - \frac{d}{dt} \left(\frac{\partial L}{\partial \dot{q}_i} \right) \right] \delta q_i dt + \frac{\partial L}{\partial \dot{q}_i} \delta q_i \Big|_1^2.$$

By Lagrange's equations the quantities in the square brackets vanish, and the Δ -variation therefore takes the form

$$\Delta \int_{t_1}^{t_2} L dt = (L \Delta t + p_i \delta q_i) \Big|_1^2. \quad (8.75)$$

In Eq. (8.75), δq_i refers to the variation in q_i at the original end point times t_1 and t_2 . We would like to express the Δ -variation in terms of the change Δq_i between q_i at the end points of the actual path and q_i at the end points of the varied path, including the change in end point times. It is clear from Fig. 8.3 that these two variations are connected by the relation*

$$\Delta q_i = \delta q_i + \dot{q}_i \Delta t. \quad (8.76)$$

Hence, Eq. (8.75) can be rewritten as

$$\Delta \int_{t_1}^{t_2} L dt = (L \Delta t - p_i \dot{q}_i \Delta t + p_i \Delta q_i) \Big|_1^2$$

or

$$\Delta \int_{t_1}^{t_2} L dt = (p_i \Delta q_i - H \Delta t) \Big|_1^2. \quad (8.77)$$

To obtain the principle of least action, we restrict our further considerations by three important qualifications:

1. Only systems are considered for which L , and therefore H , are not explicit functions of time, and in consequence H is conserved.
2. The variation is such that H is conserved on the varied path as well as on the actual path.
3. The varied paths are further limited by requiring that Δq_i vanish at the end points (but not Δt).

*Equation (8.76) may be derived formally from the parameter form, Eq. (8.72), of the varied path. Thus, at the upper end point we have

$$\Delta q_i(2) = q_i(t_2 + \Delta t_2, \alpha) - q_i(t_2, 0) = q_i(t_2 + \Delta t_2, 0) - q_i(t_2, 0) + \alpha \eta_i(t_2 + \Delta t_2),$$

which to first order in small quantities α and Δt_2 is

$$\Delta q_i(2) = \dot{q}_i(2) \Delta t_2 + \delta q_i(2),$$

which is what Eq. (8.76) predicts

The nature of the resultant variation may be illustrated by noting that the varied path satisfying these conditions might very well describe the same curve in configuration space as the actual path. The difference will be the speed with which the system point traverses this curve; that is, the functions $q_i(t)$ will be altered in the varied path. In order then to preserve the same value of the Hamiltonian at all points on the varied path, the times of the end points must be changed. With these three qualifications satisfied, the Δ -variation of the action integral, Eq. (8.77), reduces to

$$\Delta \int_{t_1}^{t_2} L dt = -H(\Delta t_2 - \Delta t_1). \quad (8.78)$$

But under the same conditions, the action integral itself becomes

$$\int_{t_1}^{t_2} L dt = \int_{t_1}^{t_2} p_i \dot{q}_i dt - H(t_2 - t_1),$$

the Δ -variation of which is

$$\Delta \int_{t_1}^{t_2} L dt = \Delta \int_{t_1}^{t_2} p_i \dot{q}_i dt - H(\Delta t_2 - \Delta t_1). \quad (8.79)$$

Comparison of Eqs. (8.78) and (8.79) finally gives the *principle of least action*:*

$$\Delta \int_{t_1}^{t_2} p_i \dot{q}_i dt = 0. \quad (8.80)$$

By way of caution, note that the modified Hamilton's principle can be written in a form with a superficial resemblance to Eq. (8.80). If the trajectory of the system point is described by a parameter θ , as in Sections 7.10 and 8.4, the modified Hamilton's principle appears as

$$\delta \int_{\theta_1}^{\theta_2} (p_i \dot{q}_i - H)t' d\theta = 0. \quad (8.81)$$

It will be recalled (cf. footnote on p. 351) that the momenta p_i do not change under the shift from t to θ , and that $\dot{q}_i t' = q_i'$. Further, the momentum conjugate to t is $-H$. Hence, Eq. (8.81) can be rewritten as

$$\delta \int_{\theta_1}^{\theta_2} \sum_{i=1}^{n+1} p_i q_i' d\theta = 0, \quad (8.82)$$

where t has been denoted by q_{n+1} . There should however be no confusion between Eq. (8.82) and the principle of least action. Equations (8.82) involve phase

*The integral in Eq. (8.80) is usually referred to in the older literature as the action, or action integral, and the first edition of this book followed the same practice. It is now customary to refer to the integral in Hamilton's principle as the action, and we have accepted this usage here. Sometimes the integral in Eq. (8.80) is designated as the *abbreviated action*

space of $(2n + 2)$ dimensions, as is indicated by the explicit summation to $i = n + 1$, whereas Eq. (8.80) is in the usual configuration space. But most important, the principle of least action is in terms of a Δ -variation for constant H , while Eq. (8.82) employs the δ -variation, and H in principle could be a function of time. Equation (8.82) is nothing more than the modified Hamilton's principle, and the absence of a Hamiltonian merely reflects the phenomenon that the Hamiltonian vanishes identically for the "homogeneous problem."

The least action principle itself can be exhibited in a variety of forms. In non-relativistic mechanics, if the defining equations for the generalized coordinates do not involve the time explicitly, then the kinetic energy is a quadratic function of the \dot{q}_i 's (cf. Eq. (1.71)):

$$T = \frac{1}{2} M_{jk}(q) \dot{q}_j \dot{q}_k. \quad (8.83)$$

When in addition the potential is not velocity dependent, the canonical momenta are derived from T only, and in consequence

$$p_i \dot{q}_i = 2T.$$

The principle of least action for such systems can therefore be written as

$$\Delta \int_{t_1}^{t_2} T dt = 0. \quad (8.84)$$

If, further, there are no external forces on the system, as, for example, a rigid body with no net applied forces, then T is conserved along with the total energy H . The least action principle then takes the special form

$$\Delta(t_2 - t_1) = 0. \quad (8.85)$$

Equation (8.85) states that of all paths possible between two points, consistent with conservation of energy, the system moves along that particular path for which the time of transit is the least (more strictly, an extremum). In this form the principle of least action recalls Fermat's principle in geometrical optics that a light ray travels between two points along such a path that the time taken is the least. We discussed these considerations in Section 10-8 of the Second Edition when we considered the connection between the Hamiltonian formulation and geometrical optics.

In Section 7.4 we discussed the infinitesimal interval in a metric space giving the interval as

$$ds^2 = g_{\mu\nu} dx^\mu dx^\nu \quad (7.32')$$

where $g_{\mu\nu}$ was the metric of a possibly curvilinear space and ds^2 was the interval traversed for displacements given by dx^μ . We can do something entirely similar here whenever T is of the form of Eq. (8.83). A configuration space is therefore constructed for which the M_{jk} coefficients form the metric tensor. In general, the

space will be curvilinear and nonorthogonal. The element of path length in the space is then defined by (cf. Eq. (7.33'))

$$(d\rho)^2 = M_{jk} dq_j dq_k \quad (8.86)$$

so that the kinetic energy has the form

$$T = \frac{1}{2} \left(\frac{d\rho}{dt} \right)^2, \quad (8.87)$$

or equivalently

$$dt = \frac{d\rho}{\sqrt{2T}}. \quad (8.88)$$

Equation (8.88) enables us to change the variable in the abbreviated action integral from t to ρ , and the principle of least action becomes

$$\Delta \int_{t_1}^{t_2} T dt = 0 = \Delta \int_{\rho_1}^{\rho_2} \sqrt{T/2} d\rho,$$

or, finally

$$\Delta \int_{\rho_1}^{\rho_2} \sqrt{H - V(q)} d\rho = 0. \quad (8.89)$$

Equation (8.89) is often called *Jacobi's form of the least action principle*. It now refers to the path of the system point in a special curvilinear configuration space characterized by a metric tensor with elements M_{jk} . The system point traverses the path in this configuration space with a speed given by $\sqrt{2T}$. If there are no forces acting on the body, T is constant, and Jacobi's principle says the system point travels along the shortest path length in the configuration space. Equivalently stated, the motion of the system is then such that the system point travels along the geodesics of the configuration space.

Note that the Jacobi form of the principle of least action is concerned with the *path* of the system point rather than with its motion in *time*. Equation (8.89) is a statement about the element of path length $d\rho$; the time nowhere appears, since H is a constant and V depends upon q_i only. Indeed, it is possible to use the Jacobi form of the principle to furnish the differential equations for the path, by a procedure somewhat akin to that leading to Lagrange's equations. In the form of Fermat's principle, the Jacobi version of the principle of least action finds many fruitful applications in geometrical optics and in electron optics. To go into any detail here would lead us too far afield.

A host of other similar, variational principles for classical mechanics can be derived in bewildering variety. To give one example out of many, the principle of least action leads immediately to *Hertz's principle of least curvature*, which states that a particle not under the influence of external forces travels along the

path of least curvature. By Jacobi's principle such a path must be a geodesic, and the geometrical property of minimum curvature is one of the well-known characteristics of a geodesic. It has been pointed out that variational principles in themselves contain no new physical content, and they rarely simplify the practical solution of a given mechanical problem. Their value lies chiefly as starting points for new formulations of the theoretical structure of classical mechanics. For this purpose, Hamilton's principle is especially fruitful, and to a lesser extent, so also is the principle of least action.

DERIVATIONS

1. (a) Reverse the Legendre transformation to derive the properties of $L(q_i, \dot{q}_i, t)$ from $H(q_i, p_i, t)$, treating the \dot{q}_i as independent quantities, and show that it leads to the Lagrangian equations of motion.
 (b) By the same procedure find the equations of motion in terms of the function

$$L'(p, \dot{p}, t) = -\dot{p}_i q_i - H(q, p, t).$$

2. It has been previously noted that the total time derivative of a function of q_i and t can be added to the Lagrangian without changing the equations of motion. What does such an addition do to the canonical momenta and the Hamiltonian? Show that the equations of motion in terms of the new Hamiltonian reduce to the original Hamilton's equations of motion
3. A Hamiltonian-like formulation can be set up in which \dot{q}_i and \dot{p}_i are the independent variables with a "Hamiltonian" $G(\dot{q}_i, \dot{p}_i, t)$. [Here p_i is defined in terms of q_i, \dot{q}_i in the usual manner] Starting from the Lagrangian formulation, show in detail how to construct $G(\dot{p}_i, \dot{p}_i, t)$, and derive the corresponding "Hamilton's equation of motion."
4. Show that if λ_i are the eigenvalues of a square matrix, then if the reciprocal matrix exists it has the eigenvalues λ_i^{-1} .
5. Verify that the matrix J has the properties given in Eqs. (8.38c) and (8.38e) and that its determinant has the value +1.
6. Show that Hamilton's principle can be written as

$$\delta \int_1^2 [2H(\boldsymbol{\eta}, t) + \boldsymbol{\eta} \dot{\boldsymbol{\eta}}] dt = 0.$$

7. Verify that both Hamiltonians, Eq. (8.45) and Eq. (8.47), lead to the same motion as described by Eq. (8.44).
8. Show that the modified Hamilton's principle, in the form of Eq. (8.71), leads to Hamilton's equations of motion.
9. If the canonical variables are not all independent, but are connected by auxiliary conditions of the form

$$\psi_k(q_i, p_i, t) = 0,$$

show that the canonical equations of motion can be written

$$\frac{\partial H}{\partial p_i} + \sum_k \lambda_k \frac{\partial \psi_k}{\partial p_i} = \dot{q}_i, \quad \frac{\partial H}{\partial q_i} + \sum_k \lambda_k \frac{\partial \psi_k}{\partial q_i} = -\dot{p}_i,$$

where the λ_k are the undetermined Lagrange multipliers. The formulation of the Hamiltonian equations in which t is a canonical variable is a case in point, since a relation exists between p_{n+1} and the other canonical variables:

$$H(q_1, \dots, q_{n+1}; p_1, \dots, p_n) + p_{n+1} = 0.$$

Show that as a result of these circumstances the $2n + 2$ Hamilton's equations of this formulation can be reduced to the $2n$ ordinary Hamilton's equations plus Eq. (8.41) and the relation

$$\lambda = \frac{dt}{d\theta}.$$

Note that while these results are reminiscent of the relativistic covariant Hamiltonian formulation, they have been arrived at entirely within the framework of nonrelativistic mechanics.

10. Assume that the Lagrangian is a polynomial in \dot{q} of no higher order than quadratic. Convert the $2n$ equations (8.2) and (8.14)

$$p_i = \frac{\partial L}{\partial \dot{q}_i}, \quad \dot{p}_i = \frac{\partial L}{\partial q_i},$$

into $2n$ equations for \dot{q}_i and \dot{p}_i in terms of q and p , using the matrix form of the Lagrangian. Show that these are the same equations as would be obtained from Hamilton's equations of motion.

EXERCISES

11. A particle is confined to a one-dimensional box. The ends of the box move slowly towards the middle. By slowly we mean the speed of the ends is small when compared to the speed of the particle. Solve the following using Lagrangian formulation and then using the Hamiltonian.
- if the momentum of the particle is p_0 when the walls are a distance x_0 apart, find the momentum of the particle at any later time assuming the collisions with the wall are perfectly elastic. Also assume the motion is nonrelativistic at all times.
 - When the walls are a distance x apart, what average external force must be applied to each wall in order to move it at a constant speed?
12. Write the problem of central force motion of two mass points in Hamiltonian formulation, eliminating the cyclic variables, and reducing the problem to quadratures.
13. Formulate the double-pendulum problem illustrated by Fig. 1.4, in terms of the Hamiltonian and Hamilton's equations of motion. It is suggested that you find the Hamiltonian both directly from L and by Eq. (8.27).

14. The Lagrangian for a system can be written as

$$L = ax^2 + b\frac{\dot{y}}{x} + c\dot{x}\dot{y} + fy^2\dot{x}\dot{z} + g\dot{y} - k\sqrt{x^2 + y^2},$$

where $a, b, c, f, g,$ and k are constants. What is the Hamiltonian? What quantities are conserved?

15. A dynamical system has the Lagrangian

$$L = \dot{q}_1^2 + \frac{\dot{q}_2^2}{a + bq_1^2} + k_1q_1^2 + k_2\dot{q}_1\dot{q}_2,$$

where $a, b, k_1,$ and k_2 are constants. Find the equations of motion in the Hamiltonian formulation.

16. A Hamiltonian of one degree of freedom has the form

$$H = \frac{p^2}{2\alpha} - bqpe^{-\alpha t} + \frac{ba}{2}q^2e^{-\alpha t}(\alpha + be^{-\alpha t}) + \frac{kq^2}{2},$$

where $a, b, \alpha,$ and k are constants.

- (a) Find a Lagrangian corresponding to this Hamiltonian.
 (b) Find an equivalent Lagrangian that is not explicitly dependent on time.
 (c) What is the Hamiltonian corresponding to this second Lagrangian, and what is the relationship between the two Hamiltonians?
17. Find the Hamiltonian for the system described in Exercise 19 of Chapter 5 and obtain Hamilton's equations of motion for the system. Use both the direct and the matrix approach in finding the Hamiltonian.
18. Repeat the preceding exercise except this time allow the *pendulum* to move in three dimensions, that is, a spring-loaded spherical pendulum. Either the direct or the matrix approach may be used.
19. The point of suspension of a simple pendulum of length l and mass m is constrained to move on a parabola $z = ax^2$ in the vertical plane. Derive a Hamiltonian governing the motion of the pendulum and its point of suspension. Obtain the Hamilton's equations of motion.

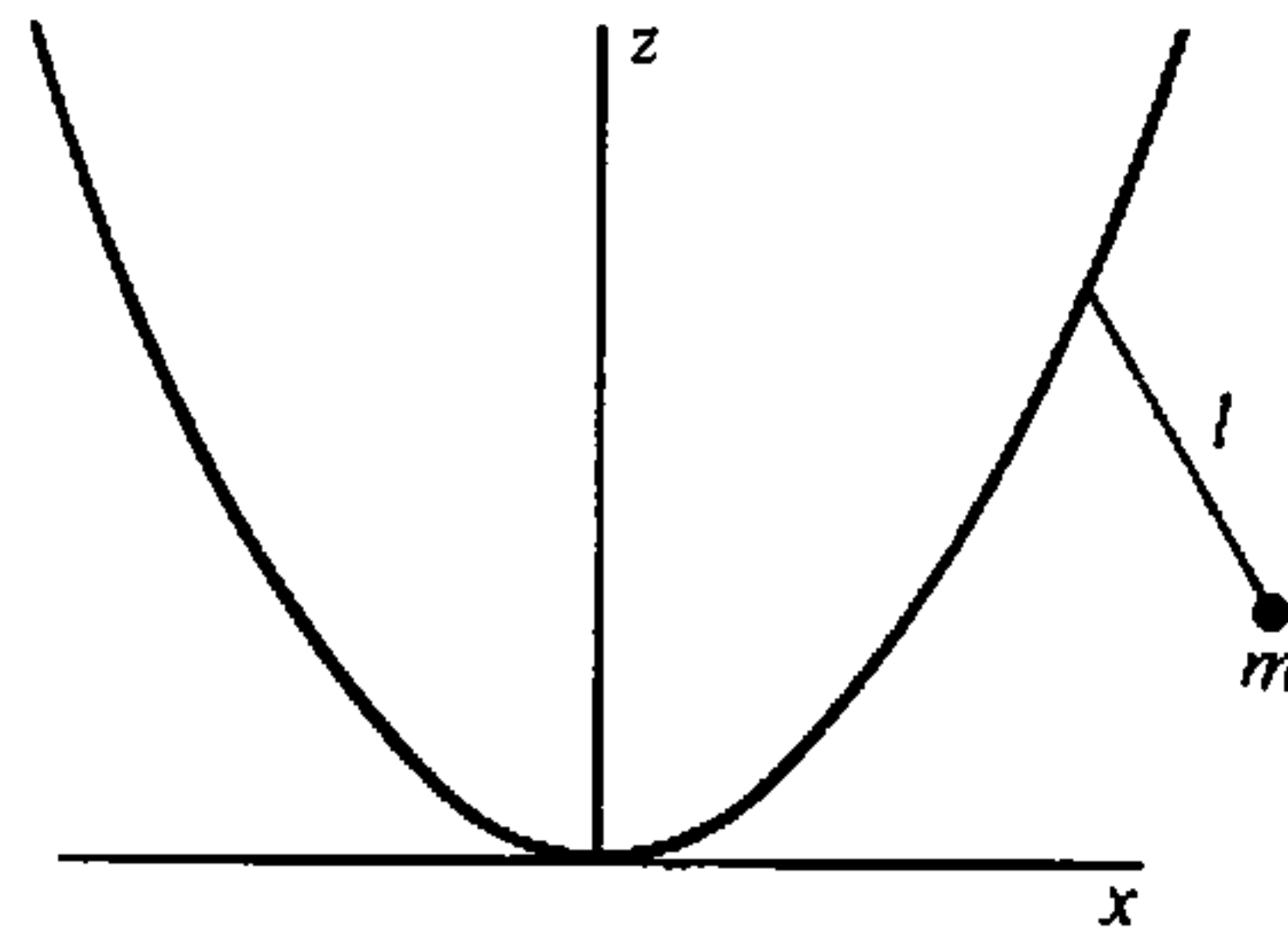

20. Obtain Hamilton's equations of motion for a plane pendulum of length l with mass point m whose radius of suspension rotates uniformly on the circumference of a vertical circle of radius a . Describe physically the nature of the canonical momentum and the Hamiltonian.

21. (a) The point of suspension of a plane simple pendulum of mass m and length l is constrained to move along a horizontal track and is connected to a point on the circumference of a uniform flywheel of mass M and radius a through a massless connecting rod also of length a , as shown in the figure. The flywheel rotates about a center fixed on the track. Find a Hamiltonian for the combined system and determine Hamilton's equations of motion.

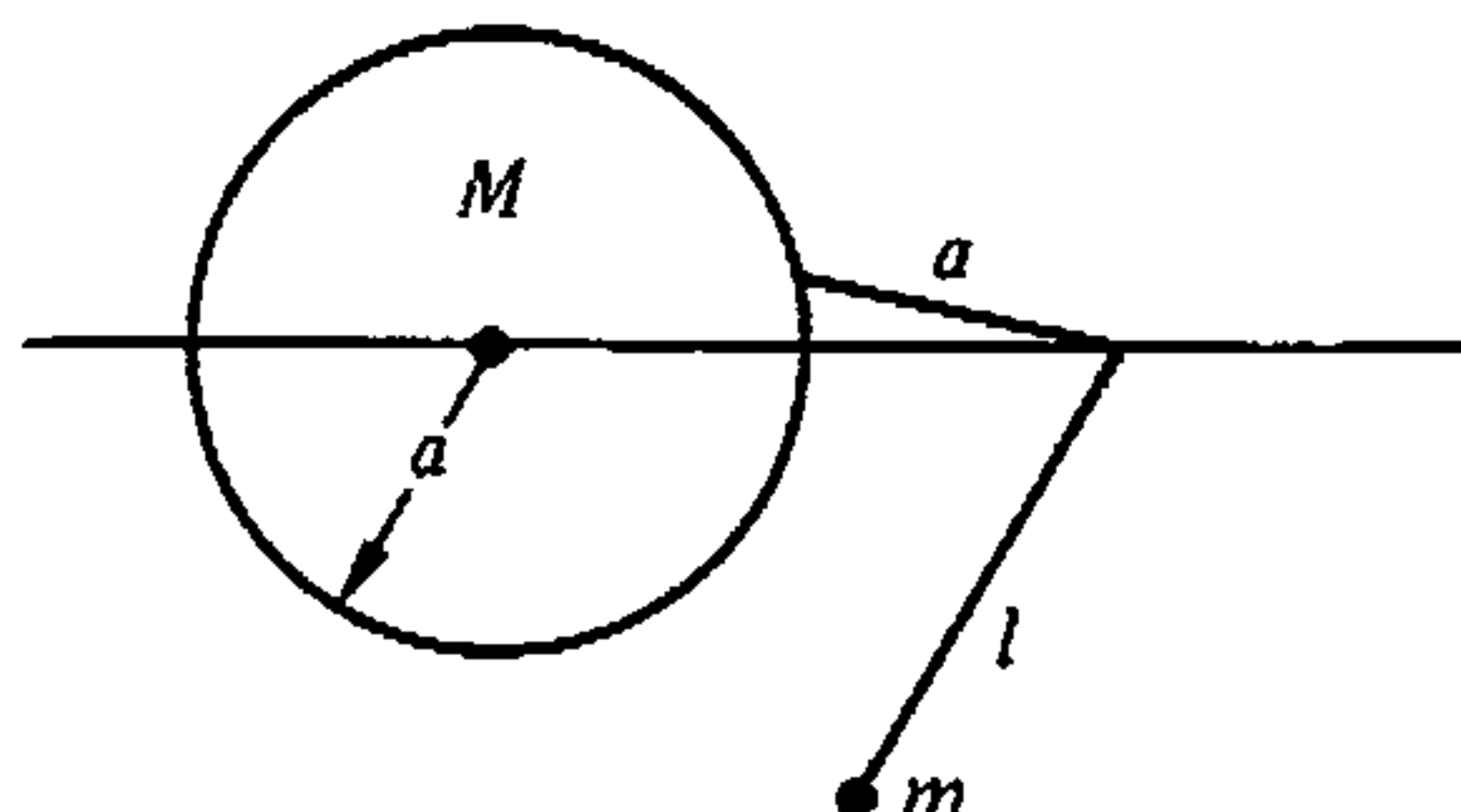

- (b) Suppose the point of suspension were moved along the track according to some function of time $x = f(t)$, where x reverses at $x = \pm 2a$ (relative to the center of the fly wheel). Again, find a Hamiltonian and Hamilton's equations of motion.
22. For the arrangement described in Exercise 21 of Chapter 2, find the Hamiltonian of the system, first in terms of coordinates in the laboratory system and then in terms of coordinates in the rotating systems. What are the conservation properties of the Hamiltonians, and how are they related to the energy of the system?
23. (a) A particle of mass m and electric charge e moves in a plane under the influence of a central force potential $V(r)$ and a constant uniform magnetic field \mathbf{B} , perpendicular to the plane, generated by a static vector potential

$$\mathbf{A} = \frac{1}{2}\mathbf{B} \times \mathbf{r}.$$

Find the Hamiltonian using coordinates in the observer's inertial system.

- (b) Repeat part (a) using coordinates rotating relative to the previous coordinate system about an axis perpendicular to the plane with an angular rate of rotation:

$$\omega = -\frac{eB}{m}$$

24. A uniform cylinder of radius a and density ρ is mounted so as to rotate freely around a vertical axis. On the outside of the cylinder is a rigidly fixed uniform spiral or helical track along which a mass point m can slide without friction. Suppose a particle starts



at rest at the top of the cylinder and slides down under the influence of gravity. Using any set of coordinates, arrive at a Hamiltonian for the combined system of particle and cylinder, and solve for the motion of the system.

25. Suppose that in the previous exercise the cylinder is constrained to rotate uniformly with angular frequency ω . Set up the Hamiltonian for the particle in an inertial system of coordinates and also in a system fixed in the rotating cylinder. Identify the physical nature of the Hamiltonian in each case and indicate whether or not the Hamiltonians are conserved.
26. A particle of mass m can move in one dimension under the influence of two springs connected to fixed points a distance a apart (see figure). The springs obey Hooke's law and have zero unstretched lengths and force constants k_1 and k_2 , respectively.

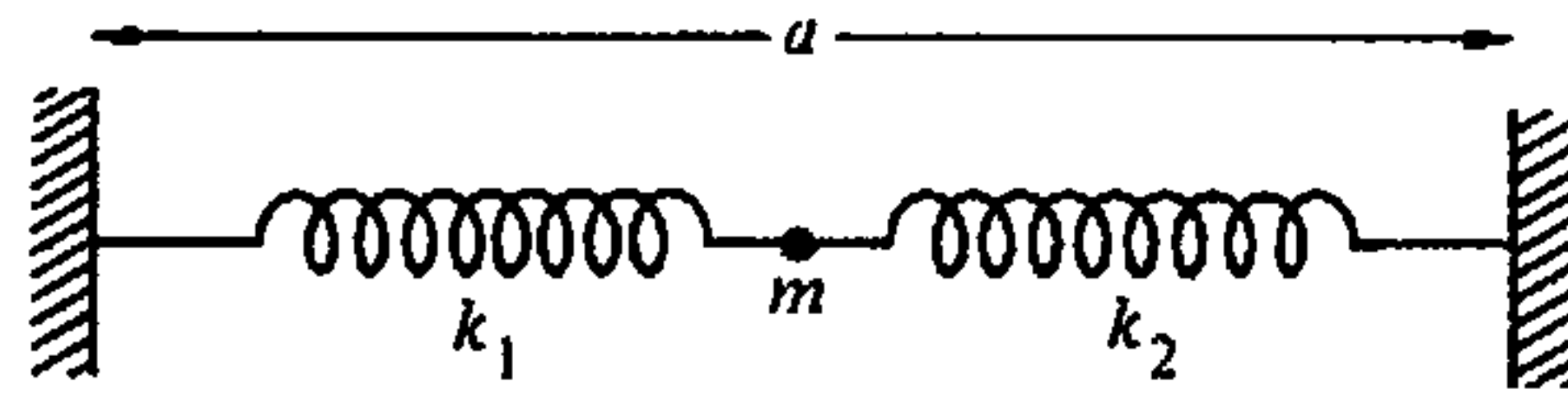

- (a) Using the position of the particle from one fixed point as the generalized coordinate, find the Lagrangian and the corresponding Hamiltonian. Is the energy conserved? Is the Hamiltonian conserved?
- (b) Introduce a new coordinate Q defined by

$$Q = q - b \sin \omega t, \quad b = \frac{k_2 a}{k_1 + k_2}.$$

What is the Lagrangian in terms of Q ? What is the corresponding Hamiltonian? Is the energy conserved? Is the Hamiltonian conserved?

27. (a) The Lagrangian for a system of one degree of freedom can be written as

$$L = \frac{m}{2} (\dot{q}^2 \sin^2 \omega t + \dot{q} q \omega \sin 2\omega t + q^2 \omega^2).$$

What is the corresponding Hamiltonian? Is it conserved?

- (b) Introduce a new coordinate defined by

$$Q = q \sin \omega t.$$

Find the Lagrangian in terms of the new coordinate and the corresponding Hamiltonian. Is H conserved?

28. Consider a system of particles interacting with each other through potentials depending only on the scalar distances between them and acted upon by conservative central forces from a fixed point. Obtain the Hamiltonian of the particle with respect to a set of axes, with origin at the center of force, which is rotating around some axis in an inertial system with angular velocity ω . What is the physical significance of the Hamiltonian in this case? Is it a constant of the motion?

29. Obtain the Hamiltonian of a heavy symmetrical top with one point fixed, and from it the Hamilton's equations of motion. Relate these to the equations of motion discussed in Section 5.7 and, in particular, show how the solution may be reduced to quadratures. Also use the Routhian procedure to eliminate the cyclic coordinates.
30. In Exercise 16 of Chapter 1, there is given the velocity-dependent potential assumed in Weber's electrodynamics. What is the Hamiltonian for a single particle moving under the influence of such a potential?
31. Treat the nutation of a "fast" top as an example of small oscillations about steady motion, here precession at constant θ . Find the frequency of nutation.
32. A symmetrical top is mounted so that it pivots about its center of mass. The pivot in turn is fixed a distance r from the center of a horizontal disk free to rotate about a vertical axis. The top is started with an initial rotation about its figure axis, which is initially at an angle θ_0 to the vertical. Analyze the possible nutation of the top as a case of small oscillations about steady motion.
33. Two mass points, m_1 and m_2 , are connected by a string that acts as a Hooke's-law spring with force constant k . One particle is free to move without friction on a smooth horizontal plane surface, the other hangs vertically down from the string through a hole in the surface. Find the condition for steady motion in which the mass point on the plane rotates uniformly at constant distance from the hole. Investigate the small oscillations in the radial distance from the hole, and in the vertical height of the second particle.
34. A possible covariant Lagrangian for a system of one particle interacting with a field is

$$\Lambda = \frac{1}{2} m u_\lambda u_\lambda + D_{\lambda\nu}(x_\mu) m_{\lambda\nu},$$

where $D_{\lambda\nu}(x_\mu)$ is an antisymmetric field tensor and $m_{\lambda\nu}$ is the antisymmetric angular momentum tensor,

$$m_{\lambda\nu} = m(x_\lambda u_\nu - x_\nu u_\lambda).$$

What are the canonical momenta? What is the corresponding covariant Hamiltonian?

35. Consider a Lagrangian of the form

$$L = \frac{1}{2} m (\dot{x}^2 - \omega^2 x^2) e^{\gamma t},$$

where the particle of mass m moves in one direction. Assume all constants are positive.

- (a) Find the equations of motion.
- (b) Interpret the equations by giving a physical interpretation of the forces acting on the particle.
- (c) Find the canonical momentum and construct the Hamiltonian. Is this Hamiltonian a constant of the motion?
- (d) If initially $x(0) = 0$ and $dx/dt = 0$, what is $x(t)$ as t approaches large values?

CHAPTER 9

Canonical Transformations

When applied in a straightforward manner, the Hamiltonian formulation usually does not materially decrease the difficulty of solving any given problem in mechanics. We wind up with practically the same differential equations to be solved as are provided by the Lagrangian procedure. The advantages of the Hamiltonian formulation lie not in its use as a calculational tool, but rather in the deeper insight it affords into the formal structure of mechanics. The equal status accorded to coordinates and momenta as independent variables encourages a greater freedom in selecting the physical quantities to be designated as “coordinates” and “momenta.” As a result we are led to newer, more abstract ways of presenting the physical content of mechanics. While often of considerable help in practical applications to mechanical problems, these more abstract formulations are primarily of interest to us today because of their essential role in constructing the more modern theories of matter. Thus, one or another of these formulations of classical mechanics serves as a point of departure for both statistical mechanics and quantum theory. It is to such formulations, arising as outgrowths of the Hamiltonian procedure, that this and the next chapter are devoted.

9.1 ■ THE EQUATIONS OF CANONICAL TRANSFORMATION

There is one type of problem for which the solution of the Hamilton’s equations is trivial. Consider a situation in which the Hamiltonian is a constant of the motion, and where *all* coordinates q_i are cyclic. Under these conditions, the conjugate momenta p_i are all constant:

$$p_i = \alpha_i,$$

and since the Hamiltonian cannot be an explicit function of either the time or the cyclic coordinates, it may be written as

$$H = H(\alpha_1, \dots, \alpha_n).$$

Consequently, the Hamilton’s equations for \dot{q}_i are simply

$$\dot{q}_i = \frac{\partial H}{\partial \alpha_i} = \omega_i, \quad (9.1)$$

where the ω_i 's are functions of the α_i 's only and therefore are also constant in time. Equations (9.1) have the immediate solutions

$$q_i = \omega_i t + \beta_i, \quad (9.2)$$

where the β_i 's are constants of integration, determined by the initial conditions.

It would seem that the solution to this type of problem, easy as it is, can only be of academic interest, for it rarely happens that all the generalized coordinates are cyclic. But a given system can be described by more than one set of generalized coordinates. Thus, to discuss motion of a particle in a plane, we may use as generalized coordinates either the Cartesian coordinates

$$q_1 = x, \quad q_2 = y,$$

or the plane polar coordinates

$$q_1 = r, \quad q_2 = \theta.$$

Both choices are equally valid, but one of the other set may be more convenient for the problem under consideration. Note that for central forces neither x nor y is cyclic, while the second set does contain a cyclic coordinate in the angle θ . The number of cyclic coordinates can thus depend upon the choice of generalized coordinates, and for each problem there may be one particular choice for which all coordinates are cyclic. If we can find this set, the remainder of the job is trivial. Since the obvious generalized coordinates suggested by the problem will not normally be cyclic, we must first derive a specific procedure for *transforming* from one set of variables to some other set that may be more suitable.

The transformations considered in the previous chapters have involved going from one set of coordinates q_i to a new set Q_i by transformation equations of the form

$$Q_i = Q_i(q, t). \quad (9.3)$$

For example, the equations of an orthogonal transformation, or of the change from Cartesian to plane polar coordinates, have the general form of Eqs. (9.3). As has been previously noted in Derivation 10 of Chapter 1, such transformations are known as *point transformations*. But in the Hamiltonian formulation the momenta are also independent variables on the same level as the generalized coordinates. The concept of transformation of coordinates must therefore be widened to include the simultaneous transformation of the independent *coordinates* and *momenta*, q_i, p_i , to a new set Q_i, P_i , with (invertible) equations of transformation:

$$\begin{aligned} Q_i &= Q_i(q, p, t), \\ P_i &= P_i(q, p, t). \end{aligned} \quad (9.4)$$

Thus, the new coordinates will be defined not only in terms of the old coordinates but also in terms of the old momenta. Equations (9.3) may be said to define

a *point transformation of configuration space*; correspondingly Eqs. (9.4) define a *point transformation of phase space*.

In developing Hamiltonian mechanics, only those transformations can be of interest for which the new Q, P are canonical coordinates. This requirement will be satisfied provided there exists some function $K(Q, P, t)$ such that the equations of motion in the new set are in the Hamiltonian form

$$\dot{Q}_i = \frac{\partial K}{\partial P_i}, \quad \dot{P}_i = -\frac{\partial K}{\partial Q_i}. \quad (9.5)$$

The function K plays the role of the Hamiltonian in the new coordinate set.* It is important for future considerations that the transformations considered be problem-independent. That is to say, (Q, P) must be canonical coordinates not only for some specific mechanical systems, but for all systems of the same number of degrees of freedom. Equations (9.5) must be the form of the equations of motion in the new coordinates and momenta no matter what the particular initial form of H . We may indeed be incited to develop a particular transformation from (q, p) to (Q, P) to handle, say, a plane harmonic oscillator. But the same transformation must then also lead to Hamilton's equations of motion when applied, for example, to the two-dimensional Kepler problem.

As was seen in Section 8.5, if Q_i and P_i are to be canonical coordinates, they must satisfy a modified Hamilton's principle that can be put in the form

$$\delta \int_{t_1}^{t_2} (P_i \dot{Q}_i - K(Q, P, t)) dt = 0, \quad (9.6)$$

(where summation over the repeated index i is implied). At the same time the old canonical coordinates of course satisfy a similar principle:

$$\delta \int_{t_1}^{t_2} (p_i \dot{q}_i - H(q, p, t)) dt = 0. \quad (9.7)$$

The simultaneous validity of Eqs. (9.6) and (9.7) does not mean of course that the integrands in both expressions are equal. Since the general form of the modified Hamilton's principle has zero variation at the end points, both statements will be satisfied if the integrands are connected by a relation of the form

$$\lambda(p_i \dot{q}_i - H) = P_i \dot{Q}_i - K + \frac{dF}{dt}. \quad (9.8)$$

Here F is any function of the phase space coordinates with continuous second derivatives, and λ is a constant independent of the canonical coordinates and the time. The multiplicative constant λ is related to a particularly simple type of transformation of canonical coordinates known as a *scale transformation*.

*It has been remarked in a jocular vein that if H stands for the Hamiltonian, K must stand for the Kamiltonian! Of course, K is every bit as much a Hamiltonian as H , but the designation is occasionally a convenient substitute for the longer term "transformed Hamiltonian"

Suppose we change the size of the units used to measure the coordinates and momenta so that in effect we transform them to a set (Q', P') defined by

$$Q'_i = \mu q_i, \quad P'_i = \nu p_i. \quad (9.9)$$

Then it is clear Hamilton's equations in the form of Eqs. (9.5) will be satisfied for a transformed Hamiltonian $K'(Q', P') = \mu\nu H(q, p)$. The integrands of the corresponding modified Hamilton's principles are, also obviously, related as

$$\mu\nu(p_i \dot{q}_i - H) = P'_i \dot{Q}'_i - K', \quad (9.10)$$

which is of the form of Eq. (9.8) with $\lambda = \mu\nu$. With the aid of suitable scale transformation, it will always be possible to confine our attention to transformations of canonical coordinates for which $\lambda = 1$. Thus, if we have a transformation of canonical coordinates $(q, p) \rightarrow (Q', P')$ for some $\lambda \neq 1$, then we can always find an intermediate set of canonical coordinates (Q, P) related to (Q', P') by a simple scale transformation of the form (9.9) such that $\mu\nu$ also has the same value λ . The transformation between the two sets of canonical coordinates (q, p) and (Q, P) will satisfy Eq. (9.8), but now with $\lambda = 1$:

$$p_i \dot{q}_i - H = P_i \dot{Q}_i - K + \frac{dF}{dt}. \quad (9.11)$$

Since the scale transformation is basically trivial, the significant transformations to be examined are those for which Eq. (9.11) holds.

A transformation of canonical coordinates for which $\lambda \neq 1$ will be called an *extended canonical transformation*. Where $\lambda = 1$, and Eq. (9.11) holds, we will speak simply of a *canonical transformation*. The conclusion of the previous paragraph may then be stated as saying that any extended canonical transformation can be made up of a canonical transformation followed by a scale transformation. Except where otherwise stated, all future considerations of transformations between canonical coordinates will involve only canonical transformations. It is also convenient to give a specific name to canonical transformations for which the equations of transformation Eqs. (9.4) do not contain the time explicitly; they will be called *restricted canonical transformations*.

The last term on the right in Eq. (9.11) contributes to the variation of the action integral only at the end points and will therefore vanish if F is a function of (q, p, t) or (Q, P, t) or any mixture of the phase space coordinates since these have zero variation at the end points. Further, through the equations of transformation, Eqs. (9.4) and their inverses F can be expressed partly in terms of the old set of variables and partly of the new. Indeed, F is useful for specifying the exact form of the canonical transformation only when half of the variables (beside the time) are from the old set and half are from the new. It then acts, as it were, as a bridge between the two sets of canonical variables and is called the *generating function* of the transformation.

To show how the generating function specifies the equations of transformation, suppose F were given as a function of the old and new generalized space

coordinates:

$$F = F_1(q, Q, t). \quad (9.12)$$

Equation (9.11) then takes the form

$$\begin{aligned} p_i \dot{q}_i - H &= P_i \dot{Q}_i - K + \frac{dF_1}{dt} \\ &= P_i \dot{Q}_i - K + \frac{\partial F_1}{\partial t} + \frac{\partial F_1}{\partial q_i} \dot{q}_i + \frac{\partial F_1}{\partial Q_i} \dot{Q}_i. \end{aligned} \quad (9.13)$$

Since the old and the new coordinates, q_i and Q_i , are separately independent, Eq. (9.13) can hold identically only if the coefficients of \dot{q}_i and \dot{Q}_i each vanish:

$$p_i = \frac{\partial F_1}{\partial q_i}, \quad (9.14a)$$

$$P_i = -\frac{\partial F_1}{\partial Q_i}, \quad (9.14b)$$

leaving finally

$$K = H + \frac{\partial F_1}{\partial t}. \quad (9.14c)$$

Equations (9.14a) are n relations defining the p_i as functions of q_j , Q_j , and t . Assuming they can be inverted, they could then be solved for the n Q_i 's in terms of q_j , p_j , and t , thus yielding the first half of the transformation equations (9.4). Once the relations between the Q_i 's and the old canonical variables (q, p) have been established, they can be substituted into Eqs. (9.14b) so that they give the n P_i 's as functions of q_j , p_j , and t , that is, the second half of the transformation equations (9.4). To complete the story, Eq. (9.14c) provides the connection between the new Hamiltonian, K , and the old one, H . We must be careful to read Eq. (9.14c) properly. First q and p in H are expressed as functions of Q and P through the inverses of Eqs. (9.4). Then the q_i in $\partial F_1/\partial t$ are expressed in terms of Q, P in a similar manner and the two functions are added to yield $K(Q, P, t)$.

The procedure described shows how, starting from a given generating function F_1 , the equations of the canonical transformation can be obtained. We can usually reverse the process: Given the equations of transformation (9.4), an appropriate generating function F_1 may be derived. Equations (9.4) are first inverted to express p_i and P_i as functions of q, Q , and t . Equations (9.14a, b) then constitute a coupled set of partial differential equations that can be integrated, in principle, to find F_1 providing the transformation is indeed canonical. Thus, F_1 is always uncertain to within an additive arbitrary function of t alone (which doesn't affect the equations of transformation), and there may at times be other ambiguities.

It sometimes happens that it is not suitable to describe the canonical transformation by a generating function of the type $F_1(q, Q, t)$. For example, the transformation may be such that p_i cannot be written as functions of q, Q , and t , but

rather will be functions of q , P , and t . We would then seek a generating function that is a function of the old coordinates q and the new momenta P . Clearly Eq. (9.13) must then be replaced by an equivalent relation involving \dot{P}_i rather than \dot{Q}_i . This can be accomplished by writing F in Eq. (9.11) as

$$F = F_2(q, P, t) - Q_i P_i. \quad (9.15)$$

Substituting this F in Eq. (9.11) leads to

$$p_i \dot{q}_i - H = -Q_i \dot{P}_i - K + \frac{d}{dt} F_2(q, P, t). \quad (9.16)$$

Again, the total derivative of F_2 is expanded and the coefficients of \dot{q}_i and P_i collected, leading to the equations

$$p_i = \frac{\partial F_2}{\partial q_i}, \quad (9.17a)$$

$$Q_i = \frac{\partial F_2}{\partial P_i}, \quad (9.17b)$$

with

$$K = H + \frac{\partial F_2}{\partial t}. \quad (9.17c)$$

As before, Eqs. (9.17a) are to be solved for P_i as functions of q_j , p_j , and t to correspond to the second half of the transformation equations (9.4). The remaining half of the transformation equations is then provided by Eqs. (9.17b).

The corresponding procedures for the remaining two basic types of generating functions are obvious, and the general results are displayed in Table 9.1.

It is tempting to look upon the four basic types of generating functions as being related to each other through Legendre transformations. For example, the

TABLE 9.1 Properties of the Four Basic Canonical Transformations

Generating Function	Generating Function Derivatives	Trivial Special Case
$F = F_1(q, Q, t)$	$p_i = \frac{\partial F_1}{\partial q_i} \quad P_i = -\frac{\partial F_1}{\partial Q_i}$	$F_1 = q_i Q_i, \quad Q_i = p_i, \quad P_i = -q_i$
$F = F_2(q, P, t) - Q_i P_i$	$p_i = \frac{\partial F_2}{\partial q_i} \quad Q_i = \frac{\partial F_2}{\partial P_i}$	$F_2 = q_i P_i, \quad Q_i = q_i, \quad P_i = p_i$
$F = F_3(p, Q, t) + q_i p_i$	$q_i = -\frac{\partial F_3}{\partial p_i} \quad P_i = -\frac{\partial F_3}{\partial Q_i}$	$F_3 = p_i Q_i, \quad Q_i = -q_i, \quad P_i = -p_i$
$F = F_4(p, P, t) + q_i p_i - Q_i P_i$	$q_i = -\frac{\partial F_4}{\partial p_i} \quad Q_i = \frac{\partial F_4}{\partial P_i}$	$F_4 = p_i P_i, \quad Q_i = p_i, \quad P_i = -q_i$

transition from F_1 to F_2 is equivalent to going from the variables q, Q to q, P with the relation

$$-P_i = \frac{\partial F_1}{\partial Q_i}. \quad (9.18)$$

This is just the form required for a Legendre transformation of the basis variables, as described in Section 8.1, and in analogy to Eq. (8.5) we would set

$$F_2(q, P, t) = F_1(q, Q, t) + P_i Q_i, \quad (9.19)$$

which is equivalent to Eq. (9.15) combined with Eq. (9.12). All the other defining equations for the generating functions can similarly be looked on, in combination with Eq. (9.12) as Legendre transformations from F_1 , with the last entry in Table 9.1 describing a double Legendre transformation. The only drawback to this picture is that it might erroneously lead us to believe that any given canonical transformation can be expressed in terms of the four basic types of Legendre transformations listed in Table 9.1. This is not always possible. Some transformations are just not suitable for description in terms of these or other elementary forms of generating functions, as has been noted above and as will be illustrated in the next section with specific examples. If we try to apply the Legendre transformation process, we are then led to generating functions that are identically zero or are indeterminate. For this reason, we have preferred to define each type of generating function relative to F , which is some unspecified function of $2n$ independent coordinates and momenta.

Finally, note that a suitable generating function doesn't have to conform to one of the four basic types for *all* the degrees of freedom of the system. It is possible, and for some canonical transformations necessary, to use a generating function that is a mixture of the four types. To take a simple example, it may be desirable for a particular canonical transformation with two degrees of freedom to be defined by a generating function of the form

$$F'(q_1, p_2, P_1, Q_2, t). \quad (9.20)$$

This generating function would be related to F in Eq. (9.11) by the equation

$$F = F'(q_1, p_2, P_1, Q_2, t) - Q_1 P_1 + q_2 p_2, \quad (9.21)$$

and the equations of transformation would be obtained from the relations

$$\begin{aligned} p_1 &= \frac{\partial F'}{\partial q_1}, & Q_1 &= \frac{\partial F'}{\partial P_1}, \\ q_2 &= -\frac{\partial F'}{\partial p_2}, & P_2 &= -\frac{\partial F'}{\partial Q_2}, \end{aligned} \quad (9.22)$$

with

$$K = H + \frac{\partial F'}{\partial t}. \quad (9.23)$$

Specific illustrations are given in the next section and in the exercises.

9.2 ■ EXAMPLES OF CANONICAL TRANSFORMATIONS

The nature of canonical transformations and the role played by the generating function can best be illustrated by some simple yet important examples. Let us consider, first, a generating function of the second type with the particular form

$$F_2 = q_i P_i \quad (9.24)$$

found in column 3 of Table 9.1. From Eqs. (9.17), the transformation equations are

$$\begin{aligned} p_i &= \frac{\partial F_2}{\partial q_i} = P_i, \\ Q_i &= \frac{\partial F_2}{\partial P_i} = q_i, \\ K &= H. \end{aligned} \quad (9.25)$$

The new and old coordinates are the same; hence F_2 merely generates the *identity transformation* (cf. Table 9.1). We also note, referring to Table 9.1, that the particular generating function $F_3 = p_i Q_i$ generates an identity transformation with negative signs; that is, $Q_i = -q_i$, $P_i = -p_i$.

A more general type of transformation is described by the generating function

$$F_2 = f_i(q_1, \dots, q_n; t) P_i, \quad (9.26)$$

where the f_i may be any desired set of independent functions. By Eqs. (9.17b), the new coordinates Q_i are given by

$$Q_i = \frac{\partial F_2}{\partial P_i} = f_i(q_1, \dots, q_n; t) \quad (9.27)$$

Thus, with this generating function the new coordinates depend only upon the old coordinates and the time and do not involve the old momenta. Such a transformation is therefore an example of the class of point transformations defined by Eqs. (9.3). In order to define a point transformation, the functions f_i must be independent and invertible, so that the q_j can be expressed in terms of the Q_i . Since the f_i are otherwise completely arbitrary, we may conclude that *all point transformations are canonical*. Equation (9.17c) furnishes the new Hamiltonian in terms of the old and of the time derivatives of the f_i functions.

Note that F_2 as given by Eq. (9.26) is not the only generating function leading to the point transformation specified by the f_i . Clearly the same point transformation is implicit in the more general form

$$F_2 = f_i(q_1, \dots, q_n; t)P_i + g(q_1, \dots, q_n; t), \quad (9.28)$$

where $g(q, t)$ is any (differentiable) function of the old coordinates and the time. Equations (9.27), the transformation equations for the coordinates, remain unaltered for this generating function. But the transformation equations of the momenta differ for the two forms. From Eqs. (9.17a), we have

$$p_j = \frac{\partial F_2}{\partial q_j} = \frac{\partial f_i}{\partial q_j} P_i + \frac{\partial g}{\partial q_j}, \quad (9.29)$$

using the form of F_2 given by Eq. (9.28). These equations may be inverted to give P as a function of (q, p) , most easily by writing them in matrix notation:

$$\mathbf{p} = \frac{\partial \mathbf{f}}{\partial \mathbf{q}} \mathbf{P} + \frac{\partial g}{\partial \mathbf{q}}. \quad (9.29')$$

Here \mathbf{p} , \mathbf{P} , and $\partial g/\partial \mathbf{q}$ are n -elements of single-column matrices, and $\partial \mathbf{f}/\partial \mathbf{q}$ is a square matrix whose ij th element is $\partial f_i/\partial q_j$. In two dimensions, Eq. (9.29') can be written as

$$\begin{bmatrix} p_1 \\ p_2 \end{bmatrix} = \begin{bmatrix} \frac{\partial f_1}{\partial q_1} & \frac{\partial f_1}{\partial q_2} \\ \frac{\partial f_2}{\partial q_1} & \frac{\partial f_2}{\partial q_2} \end{bmatrix} \begin{bmatrix} P_1 \\ P_2 \end{bmatrix} + \begin{bmatrix} \frac{\partial g}{\partial q_1} \\ \frac{\partial g}{\partial q_2} \end{bmatrix}.$$

It follows that \mathbf{P} is a linear function of \mathbf{p} given by

$$\mathbf{P} = \left[\frac{\partial \mathbf{f}}{\partial \mathbf{q}} \right]^{-1} \left[\mathbf{p} - \frac{\partial g}{\partial \mathbf{q}} \right]. \quad (9.30)$$

In two dimensions, (9.30) becomes

$$\begin{bmatrix} P_1 \\ P_2 \end{bmatrix} = \begin{bmatrix} \frac{\partial f_1}{\partial q_1} & \frac{\partial f_1}{\partial q_2} \\ \frac{\partial f_2}{\partial q_1} & \frac{\partial f_2}{\partial q_2} \end{bmatrix}^{-1} \left[\begin{bmatrix} p_1 \\ p_2 \end{bmatrix} - \begin{bmatrix} \frac{\partial g}{\partial q_1} \\ \frac{\partial g}{\partial q_2} \end{bmatrix} \right]. \quad (9.31)$$

Thus, the transformation equations (9.27) for Q are independent of g and depend only upon the $f_i(q, t)$, but the transformation equations (9.29) for P do depend upon the form of g and are in general functions of both the old coordinates and momenta. The generating function given by Eq. (9.26) is only a special case of Eq. (9.28) for which $g = 0$, with correspondingly specialized transformation equations for P .

An instructive transformation is provided by the generating function of the first kind, $F_1(q, Q, t)$, of the form

$$F_1 = q_k Q_k.$$

The corresponding transformation equations, from (9.14a, b) are

$$p_i = \frac{\partial F_1}{\partial q_i} = Q_i, \quad (9.32a)$$

$$P_i = -\frac{\partial F_1}{\partial Q_i} = -q_i. \quad (9.32b)$$

In effect, the transformation interchanges the momenta and the coordinates; the new coordinates are the old momenta and the new momenta are essentially the old coordinates. Table 9.1 shows that the particular generating function of type $F_4 = p_i P_i$ produces the same transformation. These simple examples should emphasize the independent status of generalized coordinates and momenta. They are both needed to describe the motion of the system in the Hamiltonian formulation. The distinction between them is basically one of nomenclature. We can shift the names around with at most no more than a change in sign. There is no longer present in the theory any lingering remnant of the concept of q_i as a spatial coordinate and p_i as a mass times a velocity. Incidentally, we may see directly from Hamilton's equations,

$$\dot{p}_i = -\frac{\partial H}{\partial q_i}, \quad \dot{q}_i = \frac{\partial H}{\partial p_i},$$

that this exchange transformation is canonical. If q_i is substituted for p_i , the equations remain in the canonical form only if $-p_i$ is substituted for q_i .

A transformation that leaves some of the (q, p) pairs unchanged, and interchanges the rest (with a sign change), is obviously a canonical transformation of a "mixed" form. Thus, in a system of two degrees of freedom, the transformation

$$\begin{aligned} Q_1 &= q_1, & P_1 &= p_1, \\ Q_2 &= p_2, & P_2 &= -q_2, \end{aligned}$$

is generated by the function

$$F = q_1 P_1 + q_2 Q_2, \quad (9.33)$$

which is a mixture of the F_1 and F_2 types.

9.3 ■ THE HARMONIC OSCILLATOR

As a final example, let us consider a canonical transformation that can be used to solve the problem of the simple harmonic oscillator in one dimension. If the force

constant is k , the Hamiltonian for this problem in terms of the usual coordinates is

$$H = \frac{p^2}{2m} + \frac{kq^2}{2}. \quad (9.34a)$$

Designating the ratio k/m by ω^2 , H can also be written as

$$H = \frac{1}{2m}(p^2 + m^2\omega^2q^2). \quad (9.34b)$$

This form of the Hamiltonian, as the sum of two squares, suggests a transformation in which H is cyclic in the new coordinate. If we could find a canonical transformation of the form

$$p = f(P) \cos Q, \quad (9.35a)$$

$$q = \frac{f(P)}{m\omega} \sin Q, \quad (9.35b)$$

then the Hamiltonian as a function of Q and P would be simply

$$K = H = \frac{f^2(P)}{2m}(\cos^2 Q + \sin^2 Q) = \frac{f^2(P)}{2m}, \quad (9.36)$$

so that Q is cyclic. The problem is to find the form of the yet unspecified function $f(P)$ that makes the transformation canonical. If we use a generating function of the first kind given by

$$F_1 = \frac{m\omega q^2}{2} \cot Q, \quad (9.37)$$

Eqs. (9.14) then provide the equations of transformation,

$$p = \frac{\partial F_1}{\partial q} = m\omega q \cot Q, \quad (9.38a)$$

$$P = -\frac{\partial F_1}{\partial Q} = \frac{m\omega q^2}{2 \sin^2 Q}. \quad (9.38b)$$

Solving for q and p , we have*

$$q = \sqrt{\frac{2P}{m\omega}} \sin Q, \quad (9.39a)$$

*It can be argued that F_1 does not unambiguously specify the canonical transformation, because in solving Eq (9.38b) for q we could have taken the negative square root instead of the positive root as (implied) in Eqs. (9-39). However, the two canonical transformations thus derived from F_1 differ only trivially; a shift in α by π corresponds to going from one transformation to the other. Nonetheless, it should be kept in mind that the transformations derived from a generating function may at times be double-valued or even have local singularities.

$$p = \sqrt{2pm\omega} \cos Q, \quad (9.39b)$$

and comparison with Eq. (9.35a) evaluates $f(P)$:

$$f(P) = \sqrt{2m\omega P}. \quad (9.40)$$

It follows then that the Hamiltonian in the transformed variables is

$$H = \omega P. \quad (9.41)$$

Since the Hamiltonian is cyclic in Q , the conjugate momentum P is a constant. It is seen from Eq. (9.41) that P is in fact equal to the constant energy divided by ω :

$$P = \frac{E}{\omega}.$$

The equation of motion for Q reduces to the simple form

$$\dot{Q} = \frac{\partial H}{\partial P} = \omega,$$

with the immediate solution

$$Q = \omega t + \alpha, \quad (9.42)$$

where α is a constant of integration fixed by the initial conditions. From Eqs. (9.39), the solutions for q and p are

$$q = \sqrt{\frac{2E}{m\omega^2}} \sin(\omega t + \alpha), \quad (9.43a)$$

$$p = \sqrt{2mE} \cos(\omega t + \alpha). \quad (9.43b)$$

It is instructive to plot the time dependence of the old and new variables as is shown in Fig. 9.1. We see that q and p oscillate (Fig. 9.1a, b) whereas Q and P are linear plots (Fig. 9.1d, e). The figure also shows the phase space plots for p versus q (Fig. 9.1c) and for P versus Q (Fig. 9.1f). Fig. 9.1c is an ellipse with the following semimajor axes (for the q and p directions, respectively):

$$a = \sqrt{\frac{2E}{m\omega^2}} \quad \text{and} \quad b = \sqrt{2mE},$$

where m is the mass of the oscillator, ω its frequency, and E the oscillator's energy. The area, A , of this ellipse in phase space is

$$A = \pi ab = \frac{2\pi E}{\omega}.$$

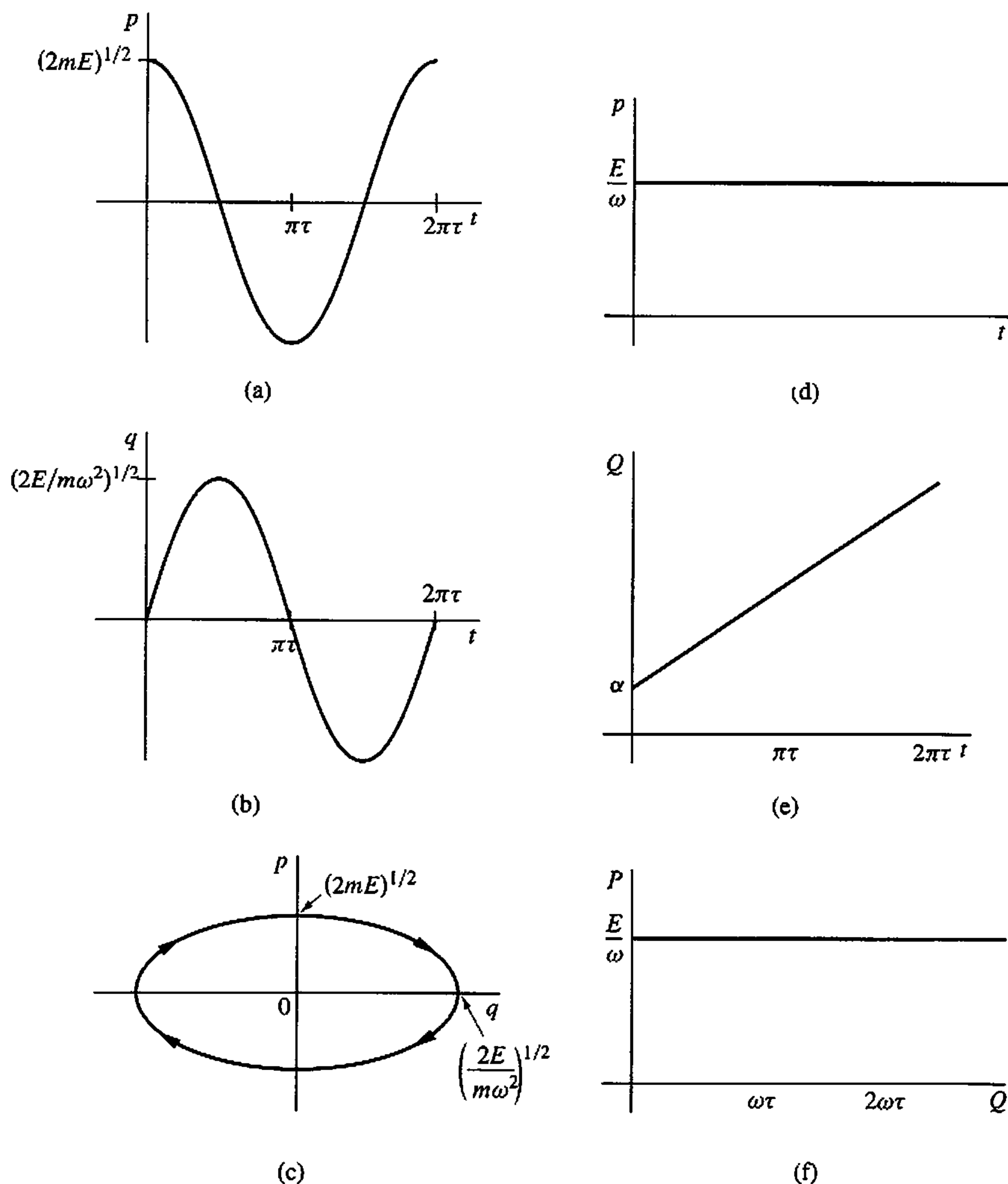

FIGURE 9.1 The harmonic oscillator in two canonical coordinate systems. Drawings (a)–(c) show the q, p system and (d)–(f) show the P, Q system.

When we invoke quantum mechanics, we write $E = \hbar\omega$, where $\hbar = h/2\pi$, and h is Planck's constant. The coordinate and momentum q and p can be normalized as

$$q' = \sqrt{\frac{m\omega^2}{2E}} q \quad \text{and} \quad p' = \frac{p}{\sqrt{2mE}},$$

to make the phase space plot of p' versus q' a circle of area π . This normalized form will be useful in Section 11.1 on chaos.

It would seem that the use of contact transformations to solve the harmonic oscillator problem is similar to “cracking a peanut with a sledge hammer.” We have here however a simple example of how the Hamiltonian can be reduced to a form cyclic in all coordinates by means of canonical transformations. Discussion of general schemes for the solution of mechanical problems by this technique will be reserved for the next chapter. For the present, we shall continue to examine the formal properties of canonical transformations.

9.4 ■ THE SYMPLECTIC APPROACH TO CANONICAL TRANSFORMATIONS

Another method of treating canonical transformations, seemingly unrelated to the generator formalism, can be expressed in terms of the matrix or symplectic formulation of Hamilton’s equations. By way of introduction to this approach, let us consider a restricted canonical transformation, that is, one in which time does not appear in the equations of transformation:

$$\begin{aligned} Q_i &= Q_i(q, p), \\ P_i &= P_i(q, p). \end{aligned} \quad (9.44)$$

We know that the Hamiltonian function does not change in such a transformation. The time derivative of Q_i , on the basis of Eqs. (9.44), is to be found as

$$\dot{Q}_i = \frac{\partial Q_i}{\partial q_j} \dot{q}_j + \frac{\partial Q_i}{\partial p_j} \dot{p}_j = \frac{\partial Q_i}{\partial q_j} \frac{\partial H}{\partial p_j} - \frac{\partial Q_i}{\partial p_j} \frac{\partial H}{\partial q_j}. \quad (9.45)$$

On the other hand, the inverses of Eqs. (9.44),

$$\begin{aligned} q_j &= q_j(Q, P), \\ p_j &= p_j(Q, P), \end{aligned} \quad (9.46)$$

enables us to consider $H(q, p, t)$ as a function of Q and P and to form the partial derivative

$$\frac{\partial H}{\partial P_i} = \frac{\partial H}{\partial p_j} \frac{\partial p_j}{\partial P_i} + \frac{\partial H}{\partial q_j} \frac{\partial q_j}{\partial P_i}. \quad (9.47)$$

Comparing Eqs. (9.45) and (9.47), it can be concluded that

$$\dot{Q}_i = \frac{\partial H}{\partial P_i};$$

that is, the transformation is canonical, only if

$$\left(\frac{\partial Q_i}{\partial q_j} \right)_{q,p} = \left(\frac{\partial p_j}{\partial P_i} \right)_{Q,P}, \quad \left(\frac{\partial Q_i}{\partial p_j} \right)_{q,p} = - \left(\frac{\partial q_j}{\partial P_i} \right)_{Q,P}. \quad (9.48a)$$

The subscripts on the derivatives are to remind us that on the left-hand side of these equations Q_i is considered as a function of (q, p) (cf. Eqs. (9.44)), while on the right-hand side the derivatives are for q_j and p_j as functions of (Q, P) (cf. Eqs. (9.46)). A similar comparison of \dot{P}_i with the partial of H with respect to Q_j leads to the conditions

$$\left(\frac{\partial P_i}{\partial q_j}\right)_{q,p} = -\left(\frac{\partial p_j}{\partial Q_i}\right)_{Q,P}, \quad \left(\frac{\partial P_i}{\partial p_j}\right)_{q,p} = \left(\frac{\partial q_j}{\partial Q_i}\right)_{Q,P}. \quad (9.48b)$$

The sets of Eqs. (9.48) together are sometimes known as the “direct conditions” for a (restricted) canonical transformation.

The algebraic manipulation that leads to Eqs. (9.48) can be performed in a compact and elegant manner if we make use of the symplectic notation for the Hamiltonian formulation introduced above at the end of Section 8.1. If $\boldsymbol{\eta}$ is a column matrix with the $2n$ elements q_i, p_i , then Hamilton’s equations can be written, it will be remembered, as Eq. (8.39)

$$\dot{\boldsymbol{\eta}} = \mathbf{J} \frac{\partial H}{\partial \boldsymbol{\eta}},$$

where \mathbf{J} is the antisymmetric matrix defined in Eq. (8.38a). Similarly the new set

~~of canonical transformation the equations of transformation (9.44) take the form~~

$$\boldsymbol{\zeta} = \boldsymbol{\zeta}(\boldsymbol{\eta}).$$

Analogously to Eq. (9.45) we can seek the equations of motion for the ~~new~~ ~~variables~~ $\boldsymbol{\zeta}$ by looking at the time derivative of a typical element of $\boldsymbol{\zeta}$

$$\dot{\zeta}_i = \frac{\partial \zeta_i}{\partial \eta_j} \dot{\eta}_j, \quad i, j = 1, \dots, 2n.$$

In matrix notation, this time derivative can be written as

$$\dot{\boldsymbol{\zeta}} = \mathbf{M} \dot{\boldsymbol{\eta}},$$

where \mathbf{M} is the Jacobian matrix of the transformation with ~~elements~~

$$M_{ij} = \frac{\partial \zeta_i}{\partial \eta_j}.$$

Making use of the equations of motion for $\boldsymbol{\eta}$, Eq. (9.50) becomes

$$\dot{\boldsymbol{\zeta}} = \mathbf{M} \mathbf{J} \frac{\partial H}{\partial \boldsymbol{\eta}}. \quad (9.52)$$

Now, by the inverse transformation H can be considered as a function of $\boldsymbol{\zeta}$, and the derivative with respect to η_i evaluated as

$$\frac{\partial H}{\partial \eta_i} = \frac{\partial H}{\partial \zeta_j} \frac{\partial \zeta_j}{\partial \eta_i},$$

or, in matrix notation*

$$\frac{\partial H}{\partial \boldsymbol{\eta}} = \tilde{\mathbf{M}} \frac{\partial H}{\partial \boldsymbol{\zeta}}. \quad (9.53)$$

The combination of Eqs. (9.52) and (9.53) leads to the form of the equations of motion for any set of variables $\boldsymbol{\zeta}$ transforming, independently of time, from the canonical set $\boldsymbol{\eta}$:

$$\dot{\boldsymbol{\zeta}} = \mathbf{M} \mathbf{J} \tilde{\mathbf{M}} \frac{\partial H}{\partial \boldsymbol{\zeta}}. \quad (9.54)$$

We have the advantage of knowing from the generator formalism that for a *restricted* canonical transformation the old Hamiltonian expressed in terms of the new variables serves as the new Hamiltonian:

$$\dot{\boldsymbol{\zeta}} = \mathbf{J} \frac{\partial H}{\partial \boldsymbol{\zeta}}. \quad (9.54')$$

The transformation, Eq. (9.49), will therefore be canonical if \mathbf{M} satisfies the condition

$$\mathbf{M} \mathbf{J} \tilde{\mathbf{M}} = \mathbf{J}. \quad (9.55)$$

That Eq. (9.55) is also a necessary condition for a restricted canonical transformation is easily shown directly by reversing the order of the steps of the proof. Note that for an extended time-independent canonical transformation, where $K = \lambda H$, the condition of Eq. (9.55) would be replaced by

$$\mathbf{M} \mathbf{J} \tilde{\mathbf{M}} = \lambda \mathbf{J}. \quad (9.56)$$

Equation (9.55) may be expressed in various forms. Multiplying from the right by the matrix inverse to $\tilde{\mathbf{M}}$ leads to

$$\mathbf{M} \mathbf{J} = \mathbf{J} \tilde{\mathbf{M}}^{-1}, \quad (9.57)$$

(since the transpose of the inverse is the inverse of the transpose). The elements of the matrix equation (9.57) will be found to be identical with Eqs. (9.48a) and (9.48b). If Eq. (9.57) is multiplied by \mathbf{J} from the left and $-\mathbf{J}$ from the right, then by virtue of Eq. (8.38e) we have

$$\mathbf{J} \mathbf{M} = \tilde{\mathbf{M}}^{-1} \mathbf{J},$$

*Readers of Section 7.5 will have recognized that Eq. (9.50) is the statement that $\boldsymbol{\eta}$ transforms contravariantly (as a vector) under the transformation, and Eq. (9.53) says that the partial derivative of H with respect to the elements of $\boldsymbol{\eta}$ transforms *covariantly* (or as a 1-form) (cf. Eqs. (7.50) and (7.54)).

or

$$\tilde{\mathbf{M}}\mathbf{M} = \mathbf{J}. \quad (9.58)$$

Equation (9.55), or its equivalent version, Eq. (9.58), is spoken of as the *symplectic condition* for a canonical transformation, and the matrix \mathbf{M} satisfying the condition is said to be a *symplectic matrix*.

These concepts may become more obvious if we display the details of the \mathbf{J} and \mathbf{M} matrices corresponding to the mixed generating function $F = F_2(q_1, P_1) + F_1(q_2, Q_2)$ of Eq. (9.33). The variables $\boldsymbol{\eta}$ and $\boldsymbol{\zeta}$ are column vectors given by

$$\boldsymbol{\eta} = \begin{bmatrix} q_1 \\ q_2 \\ p_1 \\ p_2 \end{bmatrix} \quad \text{and} \quad \boldsymbol{\zeta} = \begin{bmatrix} Q_1 \\ Q_2 \\ P_1 \\ P_2 \end{bmatrix}.$$

The transformation $\dot{\boldsymbol{\zeta}} = \mathbf{M}\dot{\boldsymbol{\eta}}$ (cf. Eq. (9.50)) is made by the following \mathbf{M} matrix:

$$\begin{bmatrix} \dot{Q}_1 \\ \dot{Q}_2 \\ \dot{P}_1 \\ \dot{P}_2 \end{bmatrix} = \begin{bmatrix} 1 & 0 & 0 & 0 \\ 0 & 0 & 0 & 1 \\ 0 & 0 & 1 & 0 \\ 0 & -1 & 0 & 0 \end{bmatrix} \begin{bmatrix} \dot{q}_1 \\ \dot{q}_2 \\ \dot{p}_1 \\ \dot{p}_2 \end{bmatrix} = \begin{bmatrix} \dot{q}_1 \\ \dot{p}_2 \\ \dot{p}_1 \\ -\dot{q}_2 \end{bmatrix},$$

in agreement with the expressions obtained by differentiating the results of the generating function with respect to time (cf. Column 3, Table 9.1). Hamilton's equations for the transformed variables $\dot{\boldsymbol{\zeta}} = \mathbf{J} \frac{\partial H}{\partial \boldsymbol{\zeta}}$ (Eq. (9.54')) are expressed as follows independent of the generating function F

$$\begin{bmatrix} \dot{Q}_1 \\ \dot{Q}_2 \\ \dot{P}_1 \\ \dot{P}_2 \end{bmatrix} = \begin{bmatrix} 0 & 0 & 1 & 0 \\ 0 & 0 & 0 & 1 \\ -1 & 0 & 0 & 0 \\ 0 & -1 & 0 & 0 \end{bmatrix} \begin{bmatrix} -\dot{P}_1 \\ -\dot{P}_2 \\ \dot{Q}_1 \\ \dot{Q}_2 \end{bmatrix}$$

where $-\dot{P}_i = \partial H / \partial \zeta_i$ for ζ_1 and ζ_2 and $\dot{Q}_i = \partial H / \partial \zeta_i$ for ζ_3 and ζ_4 . Note that \mathbf{M} depends on F whereas \mathbf{J} does not (cf. Eq. (8.38a)). This formalism is not applicable to all cases. For example, a simple \mathbf{M} matrix cannot be written for the harmonic oscillator example discussed in Section 9.3.

For a canonical transformation that contains the time as a parameter, the simple derivation given for the symplectic condition no longer holds. Nonetheless, the symplectic condition remains a necessary and sufficient condition for a canonical transformation even if it involves the time. It is possible to prove the general validity of the symplectic conditions for all canonical transformations by straightforward, albeit lengthy, procedures resembling those employed for restricted canonical transformations. Instead we shall take a different tack, one that takes

advantage of the parametric form of the canonical transformations involving time. A canonical transformation of the form

$$\zeta = \zeta(\eta, t) \quad (9.59)$$

evolves continuously as time increases from some initial value t_0 . It is a single-parameter instance of the family of continuous transformations first studied systematically by the mathematician Sophus Lie and as such plays a distinctive role in the transformation theory of classical mechanics.

If the transformation

$$\eta \rightarrow \zeta(t) \quad (9.60a)$$

is canonical, then so obviously is the transformation

$$\eta \rightarrow \zeta(t_0). \quad (9.60b)$$

It follows then from the definition of canonical transformation that the transformation characterized by

$$\zeta(t_0) \rightarrow \zeta(t) \quad (9.60c)$$

is also canonical. Since t_0 in Eq. (9.60b) is a fixed constant, this canonical transformation satisfies the symplectic condition (9.58). If now the transformation of Eq. (9.60c) obeys the symplectic condition, it is easy to show (cf. Derivation 13) that the general transformation Eq. (9.60a) will also.

To demonstrate that the symplectic condition does indeed hold for canonical transformations of the type of Eq. (9.60c), we introduce the notion of an *infinitesimal canonical transformation* (abbreviated I.C.T.), a concept that will prove to be widely useful. As in the case of infinitesimal rotations, such a transformation is one in which the new variables differ from the old only by infinitesimals. Only first-order terms in these infinitesimals are to be retained in all calculations. The transformation equations can then be written as

$$Q_i = q_i + \delta q_i, \quad (9.61a)$$

$$P_i = p_i + \delta p_i, \quad (9.61b)$$

or in matrix form

$$\zeta = \eta + \delta\eta. \quad (9.61c)$$

(Here δq_i and δp_i do *not* represent virtual displacements but are simply the infinitesimal changes in the coordinates and momenta.) An infinitesimal canonical transformation thus differs only infinitesimally from the identity transformation discussed in Section 9.1. In the generator formalism, a suitable generating function for an I.C.T. would therefore be

$$F_2 = q_i P_i + \epsilon G(q, P, t), \quad (9.62)$$

where ϵ is some infinitesimal parameter of the transformation, and G is any (differentiable) function of its $2n + 1$ arguments. By Eq. (9.17a), the transformation equations for the momenta are to be found from

$$p_j = \frac{\partial F_2}{\partial q_j} = P_j + \epsilon \frac{\partial G}{\partial q_j}$$

or

$$\delta p_j \equiv P_j - p_j = -\epsilon \frac{\partial G}{\partial q_j}. \quad (9.63a)$$

Similarly, by Eq. (9.17b), the transformation equations for Q_j are determined by the relations

$$Q_j = \frac{\partial F_2}{\partial P_j} = q_j + \epsilon \frac{\partial G}{\partial P_j}.$$

Since the second term is already linear in ϵ , and P differs from p only by an infinitesimal, it is consistent to first order to replace P_j in the derivative function by p_j . We may then consider G as a function of q , p only (and possibly t). Following the usual practice, we will refer to $G(q, p)$ as the *generating function of the infinitesimal canonical transformation*, although strictly speaking that designation belongs only to F . The transformation equation for Q_i can therefore be written as

$$\delta q_j = \epsilon \frac{\partial G}{\partial p_j}. \quad (9.63b)$$

Both transformation equations can be combined into one matrix equation

$$\delta \eta = \epsilon \mathbf{J} \frac{\partial G}{\partial \eta}. \quad (9.63c)$$

An obvious example of an infinitesimal canonical transformation would be the transformation of Eq. (9.60c) when t differs from t_0 by an infinitesimal t :

$$\zeta(t_0) \rightarrow \zeta(t_0 + dt), \quad (9.64)$$

with dt as the infinitesimal parameter ϵ . The continuous evolution of the transformation $\zeta(\eta, t)$ from $\zeta(\eta, t_0)$ means that the transformation $\zeta(t_0) \rightarrow \zeta(t)$ can be built up as a succession of such I.C.T.'s in steps of dt . It will therefore suffice to show that the infinitesimal transformation, Eq. (9.64), satisfies the symplectic condition (9.58). But it follows from the transformation equations (9.63) that the Jacobian matrix of any I.C.T. is a symplectic matrix. By definition the Jacobian matrix (9.51) for an infinitesimal transformation is

$$\mathbf{M} \equiv \frac{\partial \zeta}{\partial \eta} = \mathbf{1} + \frac{\partial \delta \eta}{\partial \eta},$$

or by Eq. (9.63c)

$$\mathbf{M} = \mathbf{1} + \epsilon \mathbf{J} \frac{\partial^2 G}{\partial \boldsymbol{\eta} \partial \boldsymbol{\eta}}. \quad (9.65)$$

The second derivative in Eq. (9.65) is a square, symmetric matrix with elements

$$\left(\frac{\partial^2 G}{\partial \boldsymbol{\eta} \partial \boldsymbol{\eta}} \right)_{ij} = \frac{\partial^2 G}{\partial \eta_i \partial \eta_j}.$$

Because of the antisymmetrical property of \mathbf{J} , the transpose of \mathbf{M} is

$$\tilde{\mathbf{M}} = \mathbf{1} - \epsilon \frac{\partial^2 G}{\partial \boldsymbol{\eta} \partial \boldsymbol{\eta}} \mathbf{J}. \quad (9.66)$$

The symplectic condition involves the value of the matrix product

$$\mathbf{M} \tilde{\mathbf{M}} = \left(\mathbf{1} + \epsilon \mathbf{J} \frac{\partial^2 G}{\partial \boldsymbol{\eta} \partial \boldsymbol{\eta}} \right) \mathbf{J} \left(\mathbf{1} - \epsilon \frac{\partial^2 G}{\partial \boldsymbol{\eta} \partial \boldsymbol{\eta}} \mathbf{J} \right).$$

Consistent to first order in this product is

$$\begin{aligned} \mathbf{M} \tilde{\mathbf{M}} &= \mathbf{J} + \epsilon \mathbf{J} \frac{\partial^2 G}{\partial \boldsymbol{\eta} \partial \boldsymbol{\eta}} \mathbf{J} - \mathbf{J} \epsilon \frac{\partial^2 G}{\partial \boldsymbol{\eta} \partial \boldsymbol{\eta}} \mathbf{J} \\ &= \mathbf{J}, \end{aligned}$$

thus demonstrating that the symplectic condition holds for any infinitesimal canonical transformation. By the chain of reasoning we have spun out, it therefore follows that *any* canonical transformation, whether or not it involves time as a parameter, obeys the symplectic conditions, Eqs. (9.55) and (9.58).

The symplectic approach, for the most part, has been developed independently of the generating function method, except in the treatment of infinitesimal canonical transformations. They are of course connected. We shall sketch later, for example, a proof that the symplectic condition implies the existence of a generating function. But the connection is largely irrelevant. Both are valid ways of looking at canonical transformations, and both encompass all of the needed properties of the transformations. For example, either the symplectic or the generator formalisms can be used to prove that canonical transformations have the four properties that characterize a group (cf. Appendix B).

1. The identity transformation is canonical.
2. If a transformation is canonical, so is its inverse.
3. Two successive canonical transformations (the group “product” operation) define a transformation that is also canonical.
4. The product operation is associative.

We shall therefore be free to use either the generator or the symplectic approach at will, depending on which leads to the simplest treatment at the moment.

9.5 ■ POISSON BRACKETS AND OTHER CANONICAL INVARIANTS

The *Poisson bracket* of two functions u, v with respect to the canonical variables (q, p) is defined as

$$[u, v]_{q,p} = \frac{\partial u}{\partial q_i} \frac{\partial v}{\partial p_i} - \frac{\partial u}{\partial p_i} \frac{\partial v}{\partial q_i}. \quad (9.67)$$

In this bilinear expression we have a typical symplectic structure, as in Hamilton's equations, where q is coupled with p , and p with $-q$. The Poisson bracket thus lends itself readily to being written in matrix form, where it appears as

$$[u, v]_{\eta} = \left(\frac{\partial u}{\partial \eta} \right)^{\sim} \frac{\partial v}{\partial \eta}. \quad (9.68)$$

The transpose sign is used on the first matrix on the right-hand side to indicate explicitly that this matrix must be treated as a single-row matrix in the multiplication. On most occasions this specific reminder will not be needed and the transpose sign may be omitted.

Suppose we choose the functions u, v out of the set of canonical variables (q, p) themselves. Then it follows trivially from the definition, either as Eq. (9.67) or (9.68), that these Poisson brackets have the values

$$[q_j, q_k]_{q,p} = 0 = [p_j, q_k]_{q,p},$$

and

$$[q_j, p_k]_{q,p} = \delta_{jk} = -[p_j, q_k]_{q,p}. \quad (9.69)$$

We can summarize the relations of Eqs. (9.69) in one equation by introducing a *square matrix Poisson bracket*, $[\eta, \eta]$, whose lm element is $[\eta_l, \eta_m]$. Equations (9.69) can then be written as

$$[\eta, \eta]_{\eta} = \mathbf{J}. \quad (9.70)$$

Now let us take for u, v the members of the transformed variables (Q, P) , or ζ , defined in terms of (q, p) by the transformation equations (9.59). The set of all the Poisson brackets that can be formed out of (Q, P) comprise the matrix Poisson bracket defined as

$$[\zeta, \zeta]_{\eta} = \left(\frac{\partial \zeta}{\partial \eta} \right)^{\sim} \frac{\partial \zeta}{\partial \eta}.$$

But we recognize the partial derivatives as defining the square Jacobian matrix of the transformation, so that the Poisson bracket relation is equivalent to

$$[\zeta, \zeta]_{\eta} = \tilde{\mathbf{M}}\mathbf{J}\mathbf{M}. \quad (9.71)$$

If the transformation $\eta \rightarrow \zeta$ is canonical, then the symplectic condition holds and Eq. (9.71) reduces to (cf. Eq. (9.58))

$$[\zeta, \zeta]_{\eta} = \mathbf{J}, \quad (9.72)$$

and conversely, if Eq. (9.72) is valid, then the transformation is canonical.

Poisson brackets of the canonical variables themselves, such as Eqs. (9.70) or (9.72), are referred to as the *fundamental Poisson brackets*. Since we have from Eq. (9.70) that

$$[\zeta, \zeta]_{\zeta} = \mathbf{J}, \quad (9.73)$$

Eq. (9.72) states that the fundamental Poisson brackets of the ζ variables have the same value when evaluated with respect to *any* canonical coordinate set. In other words, the *fundamental Poisson brackets are invariant under canonical transformation*. We have seen from Eq. (9.71) that the invariance is a necessary and sufficient condition for the transformation matrix to be symplectic. The invariance of the fundamental Poisson brackets is thus in all ways equivalent to the symplectic condition for a canonical transformation.

It does not take many more steps to show that *all* Poisson brackets are invariant under canonical transformation. Consider the Poisson bracket of two functions u, v with respect to the η set of coordinates, Eq. (9.68). In analogy to Eq. (9.53), the partial derivative of v with respect to η can be expressed in terms of partial derivatives with respect to ζ as

$$\frac{\partial v}{\partial \eta} = \tilde{\mathbf{M}} \frac{\partial v}{\partial \zeta}$$

(that is, the partial derivative transforms as a 1-form). In a similar fashion,

$$\frac{\tilde{\partial} u}{\partial \eta} = \widetilde{\tilde{\mathbf{M}}} \frac{\partial u}{\partial \zeta} = \frac{\tilde{\partial} u}{\partial \zeta} \mathbf{M}.$$

Hence the Poisson bracket Eq. (9.68) can be written

$$[u, v]_{\eta} = \frac{\tilde{\partial} u}{\partial \eta} \mathbf{J} \frac{\partial v}{\partial \eta} = \frac{\tilde{\partial} u}{\partial \zeta} \mathbf{M} \mathbf{J} \tilde{\mathbf{M}} \frac{\partial v}{\partial \zeta}.$$

If the transformation is canonical, the symplectic condition in the form of Eq. (9.55) holds, and we then have

$$[u, v]_{\eta} = \frac{\tilde{\partial} u}{\partial \zeta} \mathbf{J} \frac{\partial v}{\partial \zeta} \equiv [u, v]_{\zeta}. \quad (9.74)$$

Thus, the Poisson bracket has the same value when evaluated with respect to any canonical set of variables—all *Poisson brackets are canonical invariants*. In writing the symbol for the Poisson bracket, we have so far been careful to indicate by the subscript the set of variables in terms of which the brackets are defined. So long as we use only canonical variables that practice is now seen to be unnecessary, and we shall in general drop the subscript.*

The hallmark of the canonical transformation is that Hamilton's equations of motion are invariant in form under the transformation. Similarly, the canonical invariance of Poisson brackets implies that equations expressed in terms of Poisson brackets are invariant in form under canonical transformation. As we shall see, we can develop a structure of classical mechanics, paralleling the Hamiltonian formulation, expressed solely in terms of Poisson brackets. Historically this Poisson bracket formulation, which has the same form in all canonical coordinates, was especially useful for carrying out the original transition from classical to quantum mechanics. There is a simple "correspondence principle" that says that the classical Poisson bracket is to be replaced by a suitably defined commutator of the corresponding quantum operators.

The algebraic properties of the Poisson bracket are therefore of considerable interest. We have already used the obvious properties

$$[u, u] = 0, \quad (9.75a)$$

$$[u, v] = -[v, u]. \quad (\text{antisymmetry}) \quad (9.75b)$$

Almost equally obvious are the characteristics

$$[au + bv, w] = a[u, w] + b[v, w], \quad (\text{linearity}) \quad (9.75c)$$

where a and b are constants, and

$$[uv, w] = [u, w]v + u[v, w]. \quad (9.75d)$$

One other property is far from obvious, but is very important in defining the nature of the Poisson bracket. It is usually given in the form of *Jacobi's identity*, which states that if u , v , and w are three functions with continuous second derivatives, then

$$[u, [v, w]] + [v, [w, u]] + [w, [u, v]] = 0; \quad (9.75e)$$

that is, the sum of the cyclic permutations of the double Poisson bracket of three functions is zero. There seems to be no simple way of proving Jacobi's identity for the Poisson bracket without lengthy algebra. However, it is possible to mitigate the complexity of the manipulations by introducing a special nomenclature. We

*Note that for a scale transformation, or an extended canonical transformation, where the symplectic condition takes on the form of Eq (9.56), then Poisson brackets do *not* have the same values in all coordinate systems. That is one of the reasons scale transformations are excluded from the class of canonical transformations that are useful to consider.

shall use subscripts on u , v , w (or functions of them) to denote partial derivatives by the corresponding canonical variable. Thus,

$$u_i \equiv \frac{\partial u}{\partial \eta_i}, \quad \text{and} \quad v_{ij} \equiv \frac{\partial v}{\partial \eta_i \partial \eta_j}.$$

In this notation the Poisson bracket of u and v can be expressed as

$$[u, v] = u_i J_{ij} v_j.$$

Here J_{ij} , as usual, is simply the ij th element of \mathbf{J} . In the proof, the only property of \mathbf{J} that we shall need is its antisymmetry.

Now let us consider the first double Poisson bracket in Eq. (9.75e):

$$[u, [v, w]] = u_i J_{ij} [v, w]_j = u_i J_{ij} (v_k J_{kl} w_l)_j.$$

Because the elements J_{kl} are constants, the derivative with respect to η doesn't act on them, and we have

$$[u, [v, w]] = u_i J_{ij} (v_k J_{kl} w_{lj} + v_{kj} J_{kl} w_l). \quad (9.76)$$

The other double Poisson brackets can be obtained from Eq. (9.76) by cyclic permutation of u , v , w . There are thus six terms in all, each being a fourfold sum over dummy indices i , j , k , and l . Consider the term in Eq. (9.76) involving a second derivative of w :

$$J_{ij} J_{kl} u_i v_k w_{lj}.$$

The only other second derivative of w will appear in evaluating the second double Poisson bracket in (Eq. 9.75e):

$$[v, [w, u]] = v_k J_{kl} (w_j J_{ji} u_i)_l.$$

Here the term in the second derivative in w is

$$J_{ji} J_{kl} u_i v_k w_{jl}.$$

Since the order of differentiation is immaterial, $w_{lj} = w_{jl}$, and the sum of the two terms is given by

$$(J_{ij} + J_{ji}) J_{kl} u_i v_k w_{lj} = 0,$$

by virtue of the antisymmetry of J . The remaining four terms are cyclic permutations and can similarly be divided in two pairs, one involving second derivatives of u and the other of v . By the same reasoning, each of these pairs sums to zero, and Jacobi's identity is thus verified.

If the Poisson bracket of u , v is looked on as defining a "product" operation of the two functions, then Jacobi's identity is the replacement for the associa-

tive law of multiplication. Recall that the ordinary multiplication of arithmetic is associative; that is, the order of a sequence of multiplications is immaterial:

$$a(bc) = (ab)c.$$

Jacobi's identity says that the bracket "product" is not associative and gives the effect of changing the sequence of "multiplications." Brackets that satisfy Eqs. (9.75), together with the expression

$$[u_i, u_j] = \sum_k c_{ij}^k u_k. \quad (9.77)$$

constitute a generally noncommutative algebra called a Lie algebra. For Poisson brackets in three-dimensional space, either the structure constants c_{ij}^k are all zero or only one term in the right-hand side of Eq. (9.77) exists for any pair of indices. Examples of this will be given later, and a more detailed discussion of Lie algebras is given in Appendix B.

Poisson bracket operation is not the only type of "product" familiar to physicists that satisfies the conditions for a Lie algebra. It will be left to the exercises to show that that vector product of two vectors,

$$v[A, B] \rightarrow A \times B, \quad (9.78a)$$

and the commutator of two matrices,

$$M[A, B] \rightarrow AB - BA, \quad (9.78b)$$

satisfy the same Lie algebra conditions as the Poisson bracket. It is this last that makes it feasible to replace the classical Poisson bracket by the commutator of the quantum mechanical operators. In other words, the "correspondence principle" can work only because both the Poisson bracket and commutator are representations of a Lie algebra "product."*

There are other canonical invariants besides the Poisson bracket. One, mainly of historical interest now, is the *Lagrange bracket*, denoted by $\{u, v\}$. Suppose u and v are two functions out of a set of $2n$ independent functions of the canonical variables. By inversion, the canonical variables can then be considered as functions of the set of $2n$ functions. On this basis, the Lagrange bracket of u and v with respect to the (q, p) variables is defined as

*Of course, we must not mistake the mathematical acceptability of this version of the correspondence principle with its physical necessity. The introduction of the quantum commutation relations was a great act of physical discovery by the pioneers of quantum mechanics. All we show here is that there is a similarity in the mathematical structure of the Poisson bracket formulation of classical mechanics and the commutation relation version of quantum mechanics. The formal correspondence is that

$$[u, v] \rightarrow \frac{1}{i\hbar}(uv - vu)$$

where on the left u, v are classical functions and on the right they are quantum operators.

$$\{u, v\}_{q,p} = \frac{\partial q_i}{\partial u} \frac{\partial p_i}{\partial v} - \frac{\partial p_i}{\partial u} \frac{\partial q_i}{\partial v}, \quad (9.79)$$

or, in matrix notation,

$$\{u, v\}_{\eta} = \frac{\partial \tilde{\eta}}{\partial u} \mathbf{J} \frac{\partial \eta}{\partial v}. \quad (9.80)$$

Proof of the canonical invariance of the Lagrange bracket parallels that for the Poisson bracket.

If for u and v we take two members of the set of canonical variables, then we obtain the *fundamental Lagrange brackets*:

$$\{q_i, q_j\}_{qp} = 0 = \{p_i, p_j\}_{qp} \quad \{q_i, p_j\}_{qp} = \delta_{ij}, \quad (9.81)$$

or, in matrix notation,

$$\{\eta, \eta\} = \mathbf{J}. \quad (9.82)$$

The Lagrange and Poisson brackets clearly stand in some kind of inverse relationship to each other, but the precise form of this relation is somewhat complicated to express. Let u_i , $i = 1, \dots, 2n$, be a set of $2n$ independent functions of the canonical variables, to be represented by a column (or row) matrix \mathbf{u} . Then $\{\mathbf{u}, \mathbf{u}\}$ is the $2n \times 2n$ matrix whose ij th element is $\{u_i, u_j\}$, with a similar description for $[\mathbf{u}, \mathbf{u}]$. The reciprocal character of the two brackets manifests itself in the relation

$$\{\mathbf{u}, \mathbf{u}\}[\mathbf{u}, \mathbf{u}] = -1. \quad (9.83)$$

If for u we choose the canonical set itself, η , then Eq. (9.83) obviously follows from the fundamental bracket formulas, Eqs. (9.70) and (9.82), and the properties of \mathbf{J} . The proof for arbitrary u is not difficult if written in terms of the matrix definitions of the brackets and is reserved for the exercises. While the properties of the Lagrange and Poisson brackets parallel each other in many aspects, note that the Lagrange brackets do *not* obey Jacobi's identity. Lagrange brackets therefore do not qualify as a "product" operation in a Lie algebra.

Another important canonical invariant is the magnitude of a volume element in phase space. A canonical transformation $\eta \rightarrow \zeta$ transforms the $2n$ -dimensional phase space with coordinates η_i to another phase space with coordinates ζ_i . The volume element

$$(d\eta) = dq_1 dq_2 \dots dq_n dp_1 \dots dp_n$$

transforms to a new volume element

$$(d\zeta) = dQ_1 dQ_2 \dots dQ_n dP_1 \dots dP_n.$$

As is well known, the sizes of the two volume elements are related by the absolute value of the Jacobian determinant $\|\mathbf{M}\|$;

$$(d\xi) = \|\mathbf{M}\|(d\eta).$$

For example, in the two-dimensional transformation from $\eta_i = q, p$ to $\zeta_i = Q, P$, this expression becomes

$$dQ dP = \begin{vmatrix} \frac{\partial q}{\partial Q} & \frac{\partial q}{\partial P} \\ \frac{\partial p}{\partial Q} & \frac{\partial p}{\partial P} \end{vmatrix} dq dp = [q, p]_{\zeta} dq dp. \quad (9.84)$$

But, by taking the determinant of both sides of the symplectic condition, Eq. (9.58), we have

$$|\mathbf{M}|^2 |\mathbf{J}| = |\mathbf{J}|. \quad (9.85)$$

Thus, in a real canonical transformation the Jacobian determinant is ± 1 , and the absolute value is always unity, proving the canonical invariance of the volume element in phase space. It follows, also, that the volume of any arbitrary region in phase space,

$$J_n = \int \cdots \int (d\eta), \quad (9.86)$$

is a canonical invariant. In our two-dimensional example, the invariant is $d\eta = dq dp$ and $J_1 = \int dq dp$.

The volume integral in Eq. (9.86) is the final member of a sequence of canonical invariants known as the *integral invariants of Poincaré*, comprising integrals over subspaces of phase space of different dimensions. The other members of the sequence cannot be stated as simply as J_n , and because they are not needed for the further development of the theory, they will not be discussed here.

Finally, the invariance of the fundamental Poisson brackets now enables us to outline a proof that the symplectic condition implies the existence of a generating function, as mentioned at the conclusion of the previous section. To simplify considerations, we shall examine only a system with one degree of freedom; the general method of the proof can be directly extended to systems with many degrees of freedom.* We suppose that the first of the equations of transformation,

$$Q = Q(q, p), \quad P = P(q, p),$$

*In the literature, the connection between the symplectic approach and the generator formalism is sometimes referred to as the *Caratheodory theorem*.

is invertible so as to give p as a function q and Q , say

$$p = \phi(q, Q). \quad (9.87)$$

Substitution in the second equation of transformation gives P as some function of q and Q , say

$$P = \psi(q, Q). \quad (9.88)$$

In such a case, we would expect the transformation to be generated by a generating function of the first kind,* F_1 , with Eqs. (9.87) and (9.88) appearing as

$$p = \frac{\partial F_1(q, Q)}{\partial q}, \quad P = -\frac{\partial F_1}{\partial Q}(q, Q). \quad (9.89)$$

If Eq. (9.89) holds, then it must be true that

$$\frac{\partial \phi}{\partial Q} = -\frac{\partial \psi}{\partial q}. \quad (9.90)$$

Conversely, if we can show that Eq. (9.90) is valid, then there must exist a function F_1 such that p and P are given by Eqs. (9.89).

To demonstrate the validity of Eq. (9.90), we try to look on all quantities as functions of q and Q . Thus, we of course have the identity

$$\frac{\partial Q}{\partial Q} = 1,$$

but if Eq. (9.87) be substituted in the first transformation equation,

$$Q = Q(q, \phi(q, Q)), \quad (9.91)$$

the partial derivative can also be written

$$\frac{\partial Q}{\partial Q} = \frac{\partial Q}{\partial p} \frac{\partial \phi}{\partial Q},$$

so that we have the relation

$$\frac{\partial Q}{\partial p} \frac{\partial \phi}{\partial Q} = 1. \quad (9.92)$$

In the same spirit we evaluate the Poisson bracket

$$[Q, P] \equiv \frac{\partial Q}{\partial q} \frac{\partial P}{\partial p} - \frac{\partial P}{\partial q} \frac{\partial Q}{\partial p} = 1.$$

*Of course, if the Q transformation equation is not invertible, as in the identity transformation, then we would invert the P equation and be led to a generating function of the second kind.

The derivatives of P are derivatives of ψ from Eq. (9.88) considered as a function of q and $Q(q, p)$. Hence, the Poisson bracket can be written

$$[Q, P] = \frac{\partial Q}{\partial q} \frac{\partial \psi}{\partial Q} \frac{\partial Q}{\partial p} - \frac{\partial Q}{\partial p} \left(\frac{\partial \psi}{\partial q} + \frac{\partial \psi}{\partial Q} \frac{\partial Q}{\partial q} \right),$$

or, consolidating terms, as

$$[Q, P] = \frac{\partial \psi}{\partial Q} \left(\frac{\partial Q}{\partial q} \frac{\partial Q}{\partial p} - \frac{\partial Q}{\partial p} \frac{\partial Q}{\partial q} \right) - \frac{\partial Q}{\partial p} \frac{\partial \psi}{\partial q},$$

and therefore

$$1 = - \frac{\partial Q}{\partial p} \frac{\partial \psi}{\partial q}. \quad (9.93)$$

Combining Eqs. (9.92) and (9.93), we have

$$\frac{\partial Q}{\partial p} \frac{\partial \phi}{\partial Q} = - \frac{\partial Q}{\partial p} \frac{\partial \psi}{\partial q}.$$

Since the partial derivative of Q with respect to p is the same on both sides of the equation, that is, the other variable being held constant is q in both cases, and since the derivative doesn't vanish (else the Q equation could not be inverted), it follows that Eq. (9.90) must be true. Thus, from the value of the fundamental Poisson bracket $[Q, P]$, which we have seen is equivalent to the symplectic condition, we are led to the existence of a generating function. The two approaches to canonical transformations, though arrived at independently, are fully equivalent.

9.6 ■ EQUATIONS OF MOTION, INFINITESIMAL CANONICAL TRANSFORMATIONS, AND CONSERVATION THEOREMS IN THE POISSON BRACKET FORMULATION

Almost the entire framework of Hamiltonian mechanics can be restated in terms of Poisson brackets. As a result of the canonical invariance of the Poisson brackets, the relations so obtained will also be invariant in form under a canonical transformation. Suppose, for example, we look for the total time derivative of some function of the canonical variables and time, $u(q, p, t)$, by use of Hamilton's equations of motion:

$$\frac{du}{dt} = \frac{\partial u}{\partial q_i} \dot{q}_i + \frac{\partial u}{\partial p_i} \dot{p}_i + \frac{\partial u}{\partial t} = \frac{\partial u}{\partial q_i} \frac{\partial H}{\partial p_i} - \frac{\partial u}{\partial p_i} \frac{\partial H}{\partial q_i} + \frac{\partial u}{\partial t},$$

or

$$\frac{du}{dt} = [u, H] + \frac{\partial u}{\partial t}. \quad (9.94)$$

In terms of the symplectic notation, the derivation of Eq. (9.94) would run

$$\frac{du}{dt} = \frac{\partial u}{\partial \boldsymbol{\eta}} \dot{\boldsymbol{\eta}} + \frac{\partial u}{\partial t} = \frac{\partial u}{\partial \boldsymbol{\eta}} \left(\frac{\partial H}{\partial \boldsymbol{\eta}} \right) + \frac{\partial u}{\partial t},$$

from whence Eq. (9.94) follows, by virtue of (9.68). Equation (9.94) may be looked on as the generalized equation of motion for an arbitrary function u in the Poisson bracket formulation. It contains Hamilton's equations as a special case when for u we substitute one of the canonical variables

$$\dot{q}_i = [q_i, H], \quad \dot{p}_i = [p_i, H], \quad (9.95a)$$

or, in symplectic notation,

$$\dot{\boldsymbol{\eta}} = [\boldsymbol{\eta}, H]. \quad (9.95b)$$

That Eq. (9.95b) is identical with Hamilton's equations of motion may be seen directly from the observation that by the definition of the Poisson bracket, Eq. (8.39), we have

$$[\boldsymbol{\eta}, H] = \left(\frac{\partial H}{\partial \boldsymbol{\eta}} \right), \quad (9.96)$$

so that Eq. (9.95b) is simply another way of writing Eq. (8.31). Another familiar property may be obtained from Eq. (9.94) by taking u as H itself. Equation (9.94) then says that

$$\frac{dH}{dt} = \frac{\partial H}{\partial t},$$

as was obtained previously in Eq. (8.41).

Note that the generalized equation of motion is canonically invariant; it is valid in whatever set of canonical variables q, p is used to express the function u or to evaluate the Poisson bracket. However, the Hamiltonian used must be appropriate to the particular set of canonical variables. Upon transforming to another set of variables by a time-dependent canonical transformation, we must also change to the transformed Hamiltonian K .

If u is a constant of the motion, then Eq. (9.94) says it must have the property

$$[H, u] = \frac{\partial u}{\partial t}. \quad (9.97)$$

All functions that obey Eq. (9.97) are constants of the motion, and conversely the Poisson bracket of H with any constant of the motion must be equal to the explicit time derivative of the constant function. We thus have a general test for seeking and identifying the constants of the system. For those constants of the motion not

involving the time explicitly, the test of Eq. (9.97) reduces to requiring that their Poisson brackets with the Hamiltonian vanish, that is, $[H, u] = 0$.*

If two constants of the motion are known, the Jacobi identity provides a possible way for obtaining further constants. Suppose u and v are two constants of the motion not explicitly functions of time. Then if w in Eq. (9.75e) is taken to be H , the Jacobi identity says

$$[H, [u, v]] = 0;$$

that is, the Poisson bracket of u and v is also a constant in time. Even when the conserved quantities depend upon time explicitly, it can be shown with a bit more algebra (cf. Exercise 30) that *the Poisson bracket of any two constants of the motion is also a constant of the motion* (Poisson's theorem). Repeated application of the Jacobi identity in this manner can in principle lead to a complete sequence of constants of the motion. Quite often, however, the process is disappointing. The Poisson bracket of u and v frequently turns out to be a trivial function of u and v themselves, or even identically zero. Still, the possibility of generating new independent constants of motion by Poisson's theorem should be kept in mind.

The Poisson bracket notation can also be used to reformulate the basic equations of an infinitesimal canonical transformation. As discussed above (Section 9.4), such a transformation is a special case of a transformation that is a continuous function of a parameter, starting from the identity transformation at some initial value of the parameter (which may, for convenience, be set equal to zero). If the parameter is small enough to be treated as a first-order infinitesimal, then the transformed canonical variables differ only infinitesimally from the initial coordinates:

$$\zeta = \eta + \delta\eta \quad (9.98)$$

with the change being given in terms of the generator G through Eq. (9.63c):

$$\delta\eta = \epsilon \mathcal{J} \frac{\partial G(\eta)}{\partial \eta}.$$

Now, by the definition (9.68) of the Poisson bracket, it follows that

$$[\eta, u] = \mathcal{J} \frac{\partial u}{\partial \eta} \quad (9.99)$$

(cf. Eq. (9.96)), a relation that remains valid when the Poisson bracket is evaluated in terms of any other canonical variables. If u is taken to be G , it is seen that the equations of transformation for an infinitesimal canonical transformation can be

*In view of the "correspondence principle" between the classical Poisson bracket and the quantum commutator, it is seen that this statement corresponds to the well-known quantum theorem that conserved quantities commute with the Hamiltonian.

written as

$$\delta\eta = \epsilon[\eta, G]. \quad (9.100)$$

Consider now an infinitesimal canonical transformation in which the continuous parameter is t (as was done in proving the symplectic condition) so that $\epsilon = dt$, and let the generating function G be the Hamiltonian. Then the equations of transformation for this I.C.T. become, by Eq. (9.100),

$$\delta\eta = dt[\eta, H] = \dot{\eta} dt = d\eta. \quad (9.101)$$

These equations state that the transformation changes the coordinates and momenta at the time t to the values they have at the time $t + dt$. Thus, the motion of the system in a time interval dt can be described by an infinitesimal contact transformation generated by the Hamiltonian. Correspondingly, the system motion in a finite time interval from t_0 to t is represented by a succession of infinitesimal contact transformations, which, as we have seen, is equivalent to a single finite canonical transformation. Thus, the values of q and p at any time t can be obtained from their initial values by a canonical transformation that is a continuous function of time. According to this view, the motion of a mechanical system corresponds to the continuous evolution or unfolding of a canonical transformation. In a very literal sense, the *Hamiltonian is the generator of the system motion with time*.

Conversely, there must exist a canonical transformation from the values of the coordinates and momenta at any time t to their constant initial values. Obtaining such a transformation is obviously equivalent to solving the problem of the system motion. At the beginning of the chapter it was pointed out that a mechanical problem could be reduced to finding the canonical transformation for which all momenta are constants of the motion. The present considerations indicate the possibility of an alternative solution by means of the canonical transformation for which *both* the momenta and coordinates are constants of the motion. These two suggestions will be elaborated in the next chapter in order to show how formal solutions may be obtained for any mechanical problem.

Implicit to this discussion has been an altered way of looking at a canonical transformation and the effect it produces. The notion of a canonical transformation was introduced as a change of the coordinates used to characterize phase space. In effect, we switched from one phase space η with coordinates (q, p) to another, ζ , with coordinates (Q, P) . If the state of the system at a given time was described by a point \mathcal{A} in one system, it could also be described equally well by the transformed point \mathcal{A}' (cf. Fig. 9.2). Any function of the system variables would have the same value for a given system configuration whether it was described by the (q, p) set or by the (Q, P) set. In other words, the function would have the same value at \mathcal{A}' as at \mathcal{A} . In analogy to the corresponding description of orthogonal transformations, we may call this the *passive* view of a canonical transformation.

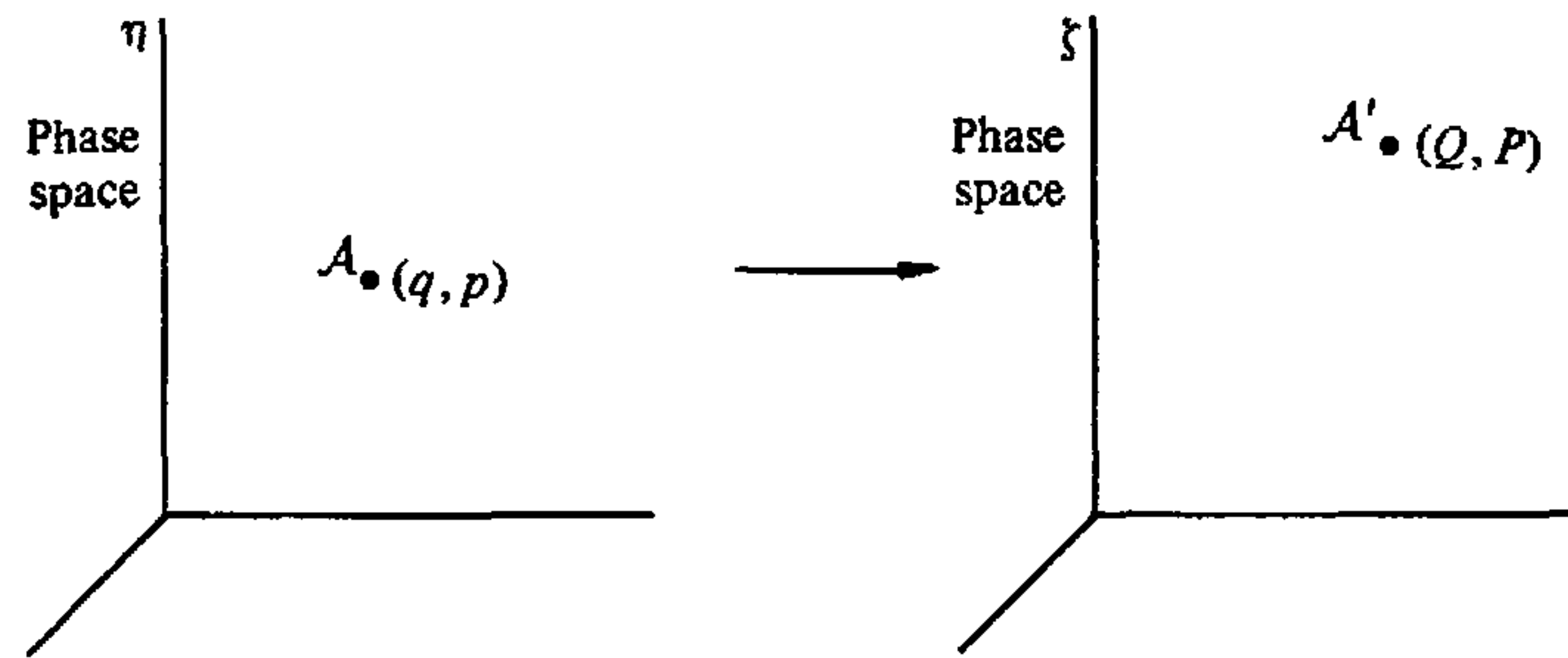

FIGURE 9.2 The passive view of a canonical transformation.

In contrast, we have spoken of the canonical transformation generated by the Hamiltonian as relating the coordinates of one point in phase space to those of another point in the *same* phase space. From this viewpoint, the canonical transformation accomplishes, in the mathematician's language, a mapping of the points of phase space onto themselves. In effect, we have an *active* interpretation of the canonical transformation as "moving" the system point from one position, with coordinates (q, p) , to another point, (Q, P) , in phase space (cf. Fig. 9.3). Of course, the canonical transformation in itself cannot move or change the system configuration. What it does is express one configuration of the system in terms of another. With some classes of canonical transformation, the active viewpoint is not helpful. For example, the point transformation from Cartesian coordinates to spherical polar coordinates is a canonical transformation of the passive type, and an "active" interpretation of it would border on the ludicrous.

The active viewpoint is particularly useful for transformations depending continuously on a single parameter. On the active interpretation, the effect of the transformation is to "move" the system point continuously on a curve in phase space as the parameter changes continuously. When the generator of the associated I.C.T. is the Hamiltonian, the curve on which the system point moves is the trajectory of the system in phase space.

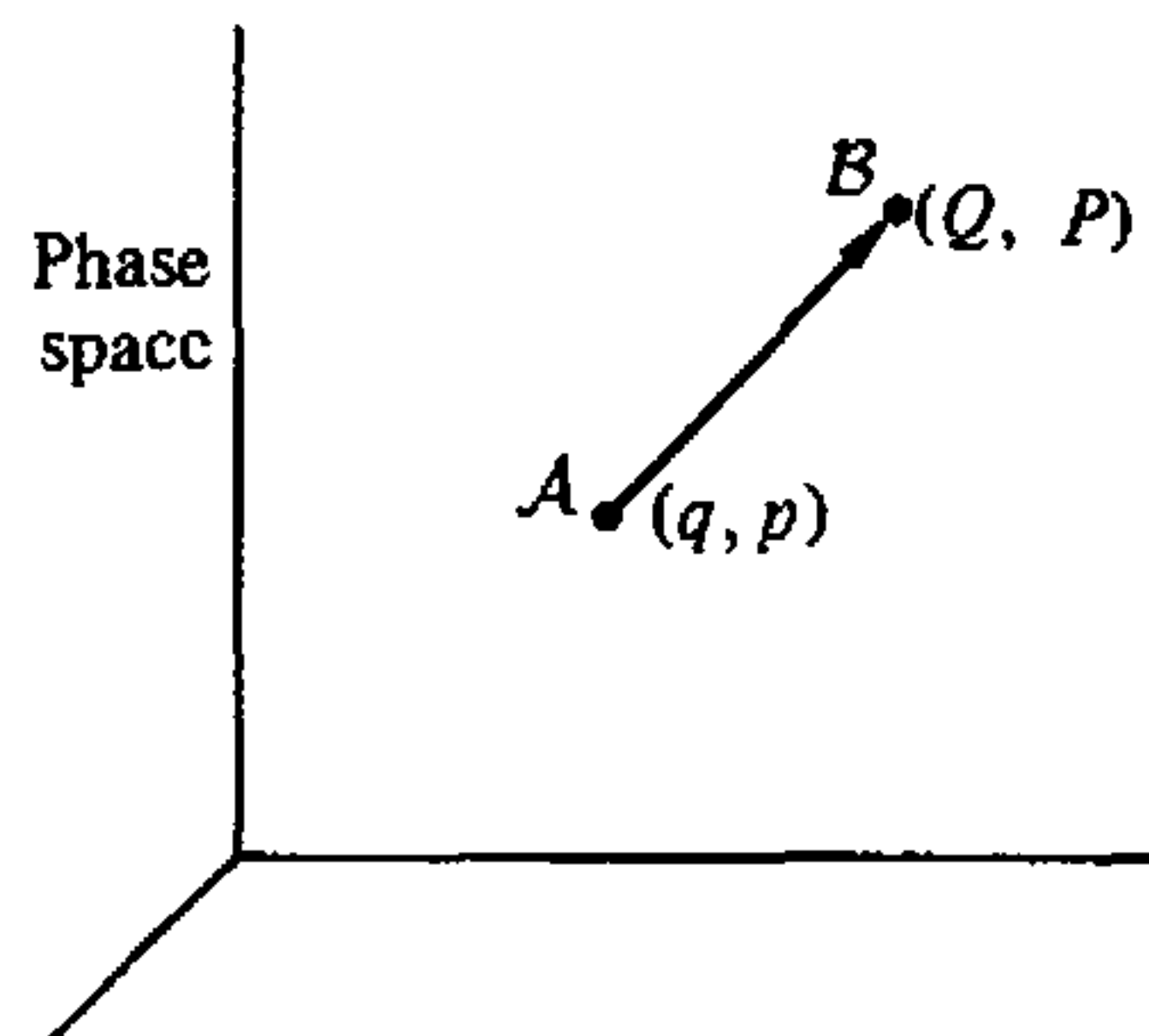

FIGURE 9.3 The active view of a canonical transformation.

If we pose the question, How does a function change under a canonical transformation? the answer depends on whether we should take an active or a passive point of view. From the passive point of view, the function changes in form, or in functional dependence, but it does not change in value. This is because in general the function, call it U , has a different functional dependence on (Q, P) than it does on (q, p) . Its value however remains the same at the corresponding points $U(q_0, p_0)$ and $U(Q_0, P_0)$ since $Q_0 = Q(q_0, p_0)$ and $P_0 = P(q_0, p_0)$, so both sets of coordinates refer to the same physical location in phase space but use different coordinates to describe the phase space.

In contrast to this, if we consider the canonical transformation from an active point of view, then we are talking about a translation of the system from point A to point B , from position (q_A, p_A) to position (q_B, p_B) . From this point of view, the function $U(q, p)$ does not change its functional dependence upon position and momentum, rather it changes its values as a result of replacing the values (q_A, p_A) by (q_B, p_B) in the function $U(q, p)$. There are then two distinct phase spaces, one using (q, p) and the other using (Q, P) . The transformation formalism uses the notation (q, p) for the variables at point A and (Q, P) for the variables at point B . This is analogous to a passive rotation in coordinate space corresponding to the rotation of the coordinate axes relative to a stationary object, and an active rotation corresponding to rotating an object relative to a fixed coordinate system.

We shall use the symbol ∂ to denote a change in the value of a function under an "active" infinitesimal canonical transformation:

$$\partial u = u(B) - u(A), \quad (9.102)$$

where of course A and B will be infinitesimally close. Using the matrix notation for the canonical variables, the change in the function value under an I.C.T. would be defined as

$$\partial u = u(\boldsymbol{\eta} + \delta\boldsymbol{\eta}) - u(\boldsymbol{\eta}).$$

Expanding in a Taylor series and retaining terms in first-order infinitesimals, we have, by virtue of Eq. (9.63c),

$$\partial u = \frac{\partial u}{\partial \boldsymbol{\eta}} \delta\boldsymbol{\eta} = \epsilon \left[\frac{\partial u}{\partial \boldsymbol{\eta}} \right] \frac{\partial G}{\partial \boldsymbol{\eta}}.$$

Recalling the definition of the Poisson bracket, Eq. (9.68), we see that the change can be written as

$$\partial u = \epsilon [u, G]. \quad (9.103)$$

An immediate application of Eq. (9.103) is to take for u one of the phase space coordinates themselves (or the matrix of the coordinates). We then have, by Eq. (9.100),

$$\partial \boldsymbol{\eta} = \epsilon [\boldsymbol{\eta}, G] = \delta \boldsymbol{\eta}.$$

Of course, this result is obvious from the definition of the point \mathcal{B} in relation to \mathcal{A} ; the “change” in the coordinates from \mathcal{A} to \mathcal{B} is just the infinitesimal difference between the old and new coordinates.

These considerations must be generalized somewhat in talking about the “change in the Hamiltonian.” Recall that the designation “Hamiltonian” does not mean a specific function, the same in all coordinate systems. Rather it refers to that function which in the given phase space defines the canonical equations of motion. Where the canonical transformation depends upon the time, the very meaning of “Hamiltonian” is also transformed. Thus, $H(\mathcal{A})$ goes over not into $H(\mathcal{A}')$ but into $K(\mathcal{A}')$, and $H(\mathcal{A})$ will not necessarily have the same value as $K(\mathcal{A}')$. In such a case, we shall mean by ∂H in effect the difference in the value of the Hamiltonian under the two interpretations:

$$\partial H = H(\mathcal{B}) - K(\mathcal{A}'). \quad (9.104)$$

Where the function itself does not change under the canonical transformation the two forms for the change, Eqs. (9.102) and (9.104), are identical since $u(\mathcal{A}') = u(\mathcal{A})$. In general, K is related to H by the equation

$$K = H + \frac{\partial F}{\partial t},$$

where for an I.C.T. the generating function is given by Eq. (9.62) in terms of G . Since only G in that equation can be an explicit function of time, the value of the new Hamiltonian is given by

$$K(\mathcal{A}') = H(\mathcal{A}') + \epsilon \frac{\partial G}{\partial t} = H(\mathcal{A}) + \epsilon \frac{\partial G}{\partial t},$$

and the change in the Hamiltonian is

$$\partial H = H(\mathcal{B}) - H(\mathcal{A}) - \epsilon \frac{\partial G}{\partial t}. \quad (9.105)$$

Following along the path that led from Eq. (9.103), we see that ∂H is given by

$$\partial H = \epsilon [H, G] - \epsilon \frac{\partial G}{\partial t}. \quad (9.106)$$

From the generalized equation of motion, Eq. (9.106), with G as u , it follows finally that the change in H is

$$\partial H = -\epsilon \frac{dG}{dt}. \quad (9.107)$$

If G is a constant of the motion, Eq. (9.107) says that it generates an infinitesimal canonical transformation that does not change the value of the Hamiltonian. Equivalently, *the constants of the motion are the generating functions of those infinitesimal canonical transformations that leave the Hamiltonian invariant.* Im-

plied in this conclusion is a connection between the symmetry properties of the system and conserved quantities, a connection that is simplest to see for constants of the motion not explicitly depending upon time. The change in the Hamiltonian under the transformation is then simply the change in the value of the Hamiltonian as the system is moved from configuration \mathcal{A} to configuration \mathcal{B} . If the system is symmetrical under the operation that produces this change of configuration, then the Hamiltonian will obviously remain unaffected under the corresponding transformation. To take a simple example, if the system is symmetrical about a given direction, then the Hamiltonian will not change in value if the system as a whole is rotated about that direction. It follows then that the quantity that generates (through an I.C.T.) such a rotation of the system must be conserved. The rotational symmetry of the system implies a particular constant of the motion. This is not the first instance of a connection between constants of the motion and symmetry characteristics. We encountered it previously (Sections 2.6, 8.2) in connection with the conservation of generalized momenta. Here, however, the theorem is more elegant, and more complete, for it embraces all independent constants of the motion and not merely the conserved generalized momenta.

The momentum conservation theorems appear now as a special case of the general statement: If a coordinate q_i is cyclic, the Hamiltonian is independent of q_i and will certainly be invariant under an infinitesimal transformation that involves a displacement of q_i alone. Consider, now, a transformation generated by the generalized momentum conjugate to q_i :

$$G(q, p) = p_i. \quad (9.108)$$

By Eqs. (9.63a and b), the resultant infinitesimal canonical transformation is

$$\begin{aligned} \delta q_j &= \epsilon \delta_{ij}, \\ \delta p_i &= 0, \end{aligned} \quad (9.109)$$

that is, exactly the required infinitesimal displacement of q_i and only q_i . We readily recognize this as the familiar momentum theorem: If a coordinate is cyclic, its conjugate momentum is a constant of the motion. The observation that a displacement of one coordinate alone is generated by the conjugate momentum may be put in a slightly expanded form. If the generating function of an I.C.T. is given by

$$G_l = (\mathbf{J}\boldsymbol{\eta})_l = J_{lr}\eta_r, \quad (9.110)$$

then the equations of transformation as obtained from Eq. (9.63c) appear as

$$\delta \eta_k = \epsilon J_{ks} \frac{\partial G_l}{\partial \eta_s} = \epsilon J_{ks} J_{lr} \delta_{rs} = \epsilon J_{ks} J_{ls}.$$

By virtue of the orthogonality of \mathbf{J} , these reduce finally to

$$\delta \eta_k = \epsilon \delta_{kl}; \quad (9.111)$$

that is, a displacement of any canonical variables η_l alone is generated in terms of the conjugate variable in the form given by Eq. (9.110). Of course, if η_l is q_i , G from Eq. (9.110) is just p_i , and if η_l is p_i , G is then $-q_i$.

As a specific illustration of these concepts, let us consider again the infinitesimal contact transformation of the dynamical variables that produces a rotation of the system as a whole by an angle $d\theta$. The physical significance of the corresponding generating function cannot depend upon the choice of initial canonical coordinates,* and it is convenient to use for this purpose the Cartesian coordinates of all particles in the system. Nor will there be any loss in generality if the axes are so oriented that the infinitesimal rotation is along the z axis. For an infinitesimal counterclockwise rotation of each particle, the change in the position vectors is to be found from the infinitesimal rotation matrix of Eq. (4.69). With a rotation only about the z axis, the changes in the particle coordinates are

$$\delta x_i = -y_i d\theta, \quad \delta y_i = x_i d\theta, \quad \delta z_i = 0. \quad (9.112a)$$

The effect of the transformation on the components of the Cartesian vectors formed by the momenta conjugate to the particle coordinates is similarly given by

$$\delta p_{ix} = -p_{iy} d\theta, \quad \delta p_{iy} = p_{ix} d\theta, \quad \delta p_{iz} = 0. \quad (9.112b)$$

Comparing these transformation equations with Eqs. (9.63a and b), it is seen that the corresponding generating function is

$$G = x_i p_{iy} - y_i p_{ix}, \quad (9.113)$$

with $d\theta$ as the infinitesimal parameter ϵ . For a direct check, note that

$$\begin{aligned} \delta x_i &= d\theta \frac{\partial G}{\partial p_{ix}} = -y_i d\theta, & \delta p_{ix} &= -d\theta \frac{\partial G}{\partial x_i} = -p_{iy} d\theta, \\ \delta y_i &= d\theta \frac{\partial G}{\partial p_{iy}} = x_i d\theta, & \delta p_{iy} &= -d\theta \frac{\partial G}{\partial y_i} = p_{ix} d\theta, \end{aligned}$$

agreeing with Eqs. (9.112). The generating function (9.113) in addition has the physical significance of being the z -component of the total canonical angular momentum:

$$G = L_z \equiv (r_i \times p_i)_z. \quad (9.114)$$

Since the z axis was arbitrarily chosen, we can state that the generating function corresponding to an infinitesimal rotation about an axis denoted by the unit vector

*This can most easily be seen from the canonically invariant Eq. (9.100). The change in the canonical variable η_i remains the same no matter in what set of canonical variables G is expressed.

\mathbf{n} is

$$G = \mathbf{L} \cdot \mathbf{n}. \quad (9.115)$$

Note that the canonical angular momentum as defined here may differ from the mechanical angular momentum. If the forces on the system are derivable from velocity-dependent potentials, then the canonical momentum vectors \mathbf{p}_i are not necessarily the same as the linear momentum vectors, and \mathbf{L} in Eqs. (9.114) and (9.115) may not be the same as the mechanical angular momentum. The result obtained here is therefore a generalization of the conclusion given in Section 2.6 that the momentum conjugate to a rotation coordinate is the corresponding component of the total angular momentum. The proof presented there was restricted to systems with velocity-independent potentials. By virtue of Eqs. (9.108) and (9.109), we can now conclude that the momentum conjugate to a generalized coordinate that measures the rotation of the system as a whole about an axis \mathbf{n} is the component of the total canonical angular momentum along the same axis. Just as the Hamiltonian is the generator of a displacement of the system in time, so the angular momentum is the generator of the spatial rotations of the system.

It has already been noted that on the “active” interpretation a canonical transformation depending upon a parameter “moves” the system point along a continuous trajectory in phase space. Since the finite transformation can be looked on as the sum of an infinite succession of infinitesimal canonical transformations, each corresponding to an infinitesimal displacement along the curve, it should therefore be possible formally to obtain the finite transformation by integrating the expression for the infinitesimal displacements. We can do this by noting that each point on the trajectory in phase space corresponds to a particular value of the parameter, which we shall call α , starting from the initial system configuration denoted by $\alpha = 0$. If u is some function of the system configuration, then u will be a continuous function of α along the trajectory, $u(\alpha)$, with initial value $u_0 = u(0)$. (For simplicity, we shall consider u as not depending explicitly upon time.) Equation (9.103) for the infinitesimal change of u on the trajectory can be written as

$$\partial u = d\alpha[u, G],$$

or as a differential equation in the variable α :

$$\frac{du}{d\alpha} = [u, G]. \quad (9.116)$$

We can get $u(\alpha)$, and therefore the effect of the finite canonical transformation, by integrating this differential equation. A formal solution may be obtained by expanding $u(\alpha)$ in a Taylor series about the initial conditions:

$$u(\alpha) = u_0 + \alpha \left. \frac{du}{d\alpha} \right|_0 + \frac{\alpha^2}{2!} \left. \frac{d^2u}{d\alpha^2} \right|_0 + \frac{\alpha^3}{3!} \left. \frac{d^3u}{d\alpha^3} \right|_0 + \cdots$$

By Eq. (9.116), we have

$$\left. \frac{du}{d\alpha} \right|_0 = [u, G]_0,$$

the zero subscript meaning that the value of the Poisson bracket is to be taken at the initial point, $\alpha = 0$. Repeated application of Eq. (9.116), taking $[u, G]$ itself as a function of the system configuration, gives

$$\frac{d^2u}{d\alpha^2} = [[u, G], G],$$

and the process can be repeated to give the third derivative of u and so on. The Taylor series for $u(\alpha)$ thus leads to the formal series solution

$$u(\alpha) = u_0 + \alpha[u, G]_0 + \frac{\alpha^2}{2!} [[u, G], G]_0 + \frac{\alpha^3}{3!} [[[u, G], G], G]_0 + \dots \quad (9.117)$$

If for u we take any of the canonical variables ζ_i , with u_0 the starting set of variables η_i , then Eq. (9.115) is a prescription for finding the transformation equations of the finite canonical transformation generated by G .

It is not difficult to find specific examples showing that this procedure actually works. Suppose for G we take L_z , so that the final canonical transformation should correspond to a finite rotation about the z axis. The natural parameter to use for α is the rotation angle. For u , let us take the x -coordinate of the i th particle in the system. Either by direct evaluation of the Poisson brackets or by inference from Eqs. (9.112a), it is easy to see that

$$[X_i, L_z] = -Y_i, \quad [Y_i, L_z] = X_i, \quad (9.118)$$

where capital letters have been used to denote the coordinates after some rotation θ , that is, the final coordinate. The initial coordinates, that is, before rotation, are as usual represented by lowercase letters. It follows then that

$$\begin{aligned} [X_i, L_z]_0 &= -y_i, \\ [[X_i, L_z], L_z]_0 &= -[Y_i, L_z]_0 = -x_i, \\ [[[X_i, L_z], L_z], L_z]_0 &= -[X_i, L_z]_0 = y_i, \end{aligned}$$

and so on. The series representation for X_i thus becomes

$$\begin{aligned} X_i &= x_i - y_i\theta - x_i \frac{\theta^2}{2} + y_i \frac{\theta^3}{3!} + x_i \frac{\theta^4}{4!} - \dots \\ &= x_i \left(1 - \frac{\theta^2}{2!} + \frac{\theta^4}{4!} - \dots \right) - y_i \left(\theta - \frac{\theta^3}{3!} + \dots \right). \end{aligned}$$

The two series will be recognized as the expansion for the cosine and sine, respectively. Hence, the equation for the finite transformation of X_i is

$$X_i = x_i \cos \theta - y_i \sin \theta,$$

which is exactly what we would expect for the finite rotation of a vector counterclockwise about the z axis.

For another example, let us consider the situation when $G = H$ and the parameter is the time. Equation (9.116) then reduces to the equation of motion for u :

$$\frac{du}{dt} = [u, H],$$

with the formal solution

$$u(t) = u_0 + t[u, H]_0 + \frac{t^2}{2!}[[u, H], H]_0 + \frac{t^3}{3!}[[[u, H], H], H]_0 + \dots \quad (9.119)$$

Here the subscript zero refers to the initial conditions at $t = 0$.

Let us apply this prescription to the simple problem of one-dimensional motion with a constant acceleration a , for which the Hamiltonian is

$$H = \frac{p^2}{2m} - max,$$

with u as the position coordinate x . The Poisson brackets needed in Eq. (9.119) are easy to evaluate directly or from the fundamental brackets:

$$[x, H] = \frac{p}{m},$$

$$[[x, H], H] = \frac{1}{m}[p, H] = a.$$

Because this last Poisson bracket is a constant, all higher-order brackets vanish identically and the series terminates, with the complete solution being given by

$$x = x_0 + \frac{p_0 t}{m} + \frac{at^2}{2}.$$

Remembering that $p_0/m = v_0$, this will be recognized as the familiar elementary solution to the problem.

It may be felt that what we have done here is a *tour de force*, a mere virtuoso performance. There is force to the objection. We would not propose the formal series solution, Eq. (9.119), as the preferred method for solving realistic problems in mechanics. It is surely one of the most recondite procedures we can conceive of for solving the easiest of freshman physics problems! Nonetheless, the technique provides insights into the structure of classical mechanics as based on canonical transformation theory. The series expansion shows directly that infinitesimal

canonical transformations can generate finite canonical transformations, depending on a parameter, and thus lead to solutions to the equations of motion. Of particular interest for the relation between classical and quantum mechanics is the observation that the series in Eqs. (9.117) or (9.119) bear a family resemblance to the series for an exponential. The nest of Poisson brackets in the n th term can be considered as the n th repeated application (from the right!) of the operator $[\ , G]$, or the n th power of the operator. Equation (9.119), for example, could symbolically be written as

$$u(t) = u e^{\hat{H}t} \Big|_0. \quad (9.120)$$

The exponential here means no more than its series representations and the symbol \hat{H} is used to indicate the operator $[\ , H]$. What we have here is very reminiscent of the Heisenberg picture in quantum mechanics where the $u(t)$ become time-varying operators, whose time dependence is given in terms of $\exp[i H t / \hbar]$ in such a manner as to lead to the same equation of motion, Eq. (9.94). (The additional factor i / \hbar arises out of the correspondence between the classical Poisson bracket and the quantum commutator.) The Poisson bracket formulation of mechanics is thus the classical analog of the Heisenberg picture of quantum mechanics.

9.7 ■ THE ANGULAR MOMENTUM POISSON BRACKET RELATIONS

The identification of the canonical angular momentum as the generator of a rigid rotation of the system leads to a number of interesting and important Poisson bracket relations. Equations (9.103) for the change of a function u under an infinitesimal canonical transformation (on the “active” view) is also valid if u is taken as the component of a vector along a *fixed* axis in ordinary space. Thus, if \mathbf{F} is a vector function of the system configuration, then (cf. Eq. (9.116))

$$\partial F_i = d\alpha [F_i, G].$$

Note that the direction along which the component is taken must be fixed, that is, not affected by the canonical transformation. If the direction itself is determined in terms of the system variables, then the transformation changes not only the value of the function but the nature of the function, just as with the Hamiltonian. With this understanding the change in a vector \mathbf{F} under a rotation of the system about a fixed axis \mathbf{n} , generated by $\mathbf{L} \cdot \mathbf{n}$, can be written in vector notation (cf. Eq. (9.115))

$$\partial \mathbf{F} = d\theta [\mathbf{F}, \mathbf{L} \cdot \mathbf{n}]. \quad (9.121)$$

To put it in other words, Eq. (9.121) implies that the unit vectors $\mathbf{i}, \mathbf{j}, \mathbf{k}$ that form the basis set for \mathbf{F} are not themselves rotated by $\mathbf{L} \cdot \mathbf{n}$.

The words describing what is meant by Eq. (9.121) must be chosen carefully for another reason. What is spoken of is the rotation of the system under the I.C.T., not necessarily the rotation of the vector \mathbf{F} . The generator $\mathbf{L} \cdot \mathbf{n}$ induces a spatial rotation of the system variables, not for example of some external vector such as a magnetic field or the vector of the acceleration of gravity. Under what conditions then does $\mathbf{L} \cdot \mathbf{n}$ generate a spatial rotation of \mathbf{F} ? The answer is clear—when \mathbf{F} is a function only of the system variables (q, p) and does not involve any external quantities or vectors not affected by the I.C.T. Only under these conditions does a spatial rotation imply a corresponding rotation of \mathbf{F} . We shall designate such vectors as *system vectors*. The change in a vector under infinitesimal rotation about an axis \mathbf{n} has been given several times before (cf. Eq. (2.50) and Eq. (4.75)):

$$d\mathbf{F} = \mathbf{n} d\theta \times \mathbf{F}.$$

For a system vector \mathbf{F} , the change induced under an I.C.T. generated by $\mathbf{L} \cdot \mathbf{n}$ can therefore be written as

$$\partial\mathbf{F} = d\theta[\mathbf{F}, \mathbf{L} \cdot \mathbf{n}] = \mathbf{n} d\theta \times \mathbf{F}. \quad (9.122)$$

Equation (9.122) implies an important Poisson bracket identity obeyed by all system vectors:

$$[\mathbf{F}, \mathbf{L} \cdot \mathbf{n}] = \mathbf{n} \times \mathbf{F}. \quad (9.123)$$

Note that in Eq. (9.123) there is no longer any reference to a canonical transformation or even to a spatial rotation. It is simply a statement about the value of certain Poisson brackets for a specific class of vectors and, as such, can be verified by direct evaluation in any given case. Suppose, for example, we had a system of an unconstrained particle and used the Cartesian coordinates as the canonical space coordinates. Then the Cartesian vector \mathbf{p} is certainly a suitable system vector. If \mathbf{n} is taken as a unit vector in the z direction, then by direct evaluation we have

$$\begin{aligned} [p_x, xp_y - yp_x] &= -p_y, \\ [p_y, xp_y - yp_x] &= p_x, \\ [p_z, xp_y - yp_x] &= 0. \end{aligned}$$

The right-hand sides of these identities is clearly the same as the components of $\mathbf{n} \times \mathbf{p}$, as predicted by Eq. (9.123).

On the other hand, suppose that in the same problem we tried to use for \mathbf{F} the vector $\mathbf{A} = \frac{1}{2}(\mathbf{r} \times \mathbf{B})$ where $\mathbf{B} = B\mathbf{i}$ is a fixed vector along the x axis. The vector \mathbf{A} will be recognized as the vector potential corresponding to a uniform magnetic field \mathbf{B} in the x -direction. As \mathbf{A} depends upon a vector external to the system, we would expect it not to fit the characteristics of a system vector and Eq. (9.123) should not hold for it. Indeed, we see that the Poisson brackets involved are here

$$\begin{aligned}
[0, xp_y - yp_x] &= 0, \\
\left[\frac{1}{2}zB, xp_y - yp_x\right] &= 0, \\
\left[-\frac{1}{2}yB, xp_y - yp_x\right] &= -\frac{1}{2}Bx,
\end{aligned}$$

whereas the vector $\mathbf{n} \times \mathbf{A}$ has instead the components $(-\frac{1}{2}Bz, 0, 0)$.

The relation (9.123) may be expressed in various notations. Perhaps the most advantageous is a form using the Levi-Civita density to express the cross product (cf. Eq. (4.77')). The i th component of Eq. (9.123) for arbitrary \mathbf{n} then can be written

$$[F_i, L_j n_j] = \epsilon_{ijk} n_j F_k, \quad (9.124)$$

which implies the simple result

$$[F_i, L_j] = \epsilon_{ijk} F_k. \quad (9.125)$$

An alternative statement of Eq. (9.125) is to note that if l, m, n are three indices in cyclic order, then

$$[F_l, L_m] = F_n, \quad l, m, n \text{ in cyclic order.} \quad (9.125')$$

Another consequence of Eq. (9.123) relates to the dot product of two system vectors: $\mathbf{F} \cdot \mathbf{G}$. Being a scalar, such a dot product should be invariant under rotation, and indeed the Poisson bracket of the dot product with $\mathbf{L} \cdot \mathbf{n}$ is easily shown to vanish:

$$\begin{aligned}
[\mathbf{F} \cdot \mathbf{G}, \mathbf{L} \cdot \mathbf{n}] &= \mathbf{F} \cdot [\mathbf{G}, \mathbf{L} \cdot \mathbf{n}] + \mathbf{G} \cdot [\mathbf{F}, \mathbf{L} \cdot \mathbf{n}] \\
&= \mathbf{F} \cdot \mathbf{n} \times \mathbf{G} + \mathbf{G} \cdot \mathbf{n} \times \mathbf{F} \\
&= \mathbf{F} \cdot \mathbf{n} \times \mathbf{G} + \mathbf{F} \cdot \mathbf{G} \times \mathbf{n} \\
&= 0.
\end{aligned} \quad (9.126)$$

The magnitude of any system vector therefore has a vanishing Poisson bracket with any component of \mathbf{L} .

Perhaps the most frequent application of these results arises from taking F to be the vector \mathbf{L} itself. We then have

$$[\mathbf{L}, \mathbf{L} \cdot \mathbf{n}] = \mathbf{n} \times \mathbf{L}, \quad (9.127)$$

$$[L_i, L_j] = \epsilon_{ijk} L_k, \quad (9.128)$$

and

$$[L^2, \mathbf{L} \cdot \mathbf{n}] = 0. \quad (9.129)$$

A number of interesting consequences follow from Eqs. (9.127)

$$[p, \mathbf{L} \cdot \mathbf{n}] = \mathbf{n} \times \mathbf{p}$$

$$[p_i, L_j] = \epsilon_{ijk} p_k.$$

If L_x and L_y are constants of the motion, Poisson's theorem then states that $[L_x, L_y] = L_z$ is also a constant of the motion. Thus, if any two components of the angular momentum are constant, the total angular momentum vector is conserved. As a further instance, let us assume that in addition to L_x and L_y being conserved there is a Cartesian vector of canonical momentum \mathbf{p} with p_z a constant of the motion. Not only is L_z conserved but we have two further constants of the motion:

$$[p_z, L_x] = p_y$$

and

$$[p_z, L_y] = -p_x,$$

that is, both \mathbf{L} and \mathbf{p} are conserved. We have here an instance in which Poisson's theorem does yield new constants of the motion. Note, however, that if p_x , p_y , and L_z were the given constants of the motion, then their Poisson brackets are

$$[p_x, p_y] = 0,$$

$$[p_x, L_z] = -p_y,$$

$$[p_y, L_z] = p_x.$$

Here no new constants can be obtained from Poisson's theorem.

Recall from the fundamental Poisson brackets, Eqs. (9.69), that the Poisson bracket of any two canonical momenta must always be zero. But, from Eq. (9.128), L_i does not have a vanishing Poisson bracket with any of the other components of \mathbf{L} . Thus, while we have described \mathbf{L} as the total canonical angular momentum by virtue of its definition as $\mathbf{r}_i \times \mathbf{p}_i$ (summed over all particles), no two components of \mathbf{L} can simultaneously be canonical variables. However, Eq. (9.129) shows that any one of the components of \mathbf{L} , and its magnitude L , can be chosen to be canonical variables at the same time.*

*It has been remarked previously that the correspondence between quantum and classical mechanics is such that the quantum mechanical commutator goes over essentially into the classical Poisson bracket as $\hbar \rightarrow 0$. Much of the formal structure of quantum mechanics appears as a close copy of the Poisson bracket formulation of classical mechanics. All the results of this section therefore have close quantum analogs. For example, the fact that two components of \mathbf{L} cannot be simultaneous canonical momenta appears as the well-known statement that L_i and L_j cannot have simultaneous eigenvalues. But L^2 and any L_i can be quantized together. Indeed, most of these relations are known far better in their quantum form than as classical theorems.

9.8 ■ SYMMETRY GROUPS OF MECHANICAL SYSTEMS

It has already been pointed out that canonical transformations form a group. Canonical transformations that are analytic functions of continuous parameters form groups that are Lie groups. A Lie group with continuous parameters, θ_i , has associated with it a flat vector space whose basis vectors, u_i , constitute a Lie algebra satisfying the previously given condition on the Poisson bracket

$$[u_i, u_j] = \sum_k c_{ij}^k u_k. \quad (9.77)$$

The elements, $Q(\theta_i)$, of the associated Lie group are related to the elements of the Lie algebra by

$$Q(\theta_i) = \exp\left(\frac{i}{2} \sum \theta_i u_i\right). \quad (9.130)$$

The definitions of Lie groups and Lie algebras are considered in more detail in Appendix B.

In Chapter 4 of the first two editions of this text, an extensive discussion was given of the Pauli matrix representation of the rotational group in three dimensions where the Pauli matrices that form the basis,

$$\sigma_x = \begin{pmatrix} 0 & 1 \\ 1 & 0 \end{pmatrix}, \quad \sigma_y = \begin{pmatrix} 0 & -i \\ i & 0 \end{pmatrix}, \quad \sigma_z = \begin{pmatrix} 1 & 0 \\ 0 & -1 \end{pmatrix}$$

are both hermitian (the matrix is equal to its own transpose complex conjugate) and unitary (the transpose complex conjugate of the matrix is the inverse). These matrices have the properties*

$$[\sigma_i, \sigma_j] = 2i\sigma_k$$

for i, j , and k a cyclic permutation of x, y , and z . The structure constants are thus $c_{ij}^k = 2i\epsilon_{ijk}$ and $\sigma_i^2 = 1$, the unit 2×2 matrix. The Euler angles can be used as the parameters that generate the group elements. For a rotation in the y - z plane we have, for example,

$$Q(\theta) = 1 \cos \frac{\theta}{2} + i\sigma_x \sin \frac{\theta}{2} = \begin{pmatrix} \cos \frac{\theta}{2} & i \sin \frac{\theta}{2} \\ i \sin \frac{\theta}{2} & \cos \frac{\theta}{2} \end{pmatrix}.$$

*Some physicists define a Lie algebra with the expression $[u_i, u_j] = i \sum_k c_{ij}^k u_k$ instead of Eq. (9.77). This makes the structure constants in the following discussion real. Many mathematicians omit the $i = \sqrt{-1}$ in the definition. The present text follows the latter convention.

In this formalism, vectors are represented by 2×2 matrices of the form

$$V_{(x,y,z)} = \begin{pmatrix} V_z & V_x - iV_y \\ V_x + iV_y & -V_z \end{pmatrix},$$

and a rotation is performed by a similarity transformation

$$V_{(x',y',z')} = Q(\theta)V_{(x,y,z)}Q^\dagger(\theta),$$

where Q^\dagger is the adjoint, or complex conjugate transpose of the matrix Q .

The 2×2 matrices Q are unitary with determinant $+1$, so they constitute a representation of the special unitary group in two dimensions, $SU(2)$. The set of unitary 2×2 matrices with determinant either $+1$ or -1 has twice as many elements (both infinite in number), which form the full unitary group $U(2)$ in two dimensions. This group of 2×2 rotation matrices has the same properties as the group of the associated infinitesimal canonical transformations (I.C.T.). It is customary to work primarily with the I.C.T.'s as they are easier to handle. The Lie groups of I.C.T.'s whose generators are the constants of the motion of the system are known as the *symmetry groups* of the system for, as we have seen, such transformations leave the Hamiltonian invariant. Finding the symmetry groups of a system goes a long way toward solving the problem of its classical motion and is even closer to a solution of the quantum-mechanical problem.

A system with spherical symmetry is invariant under rotation about any axis, so it can be represented by the group $SU(2)$ as discussed above. Of more practical use is the set of the usual 3×3 rotation matrices with determinant $+1$, which represent the special rotation group in three dimensions $R(3) \equiv SO(3)$. The vector \mathbf{L} is conserved in such a system in accord with our identification of the components of \mathbf{L} as the generators of spatial rotations. For the group of transformations generated by L_i , Eq. (9.128) shows that the structure constants are $c_{ij}^k = \epsilon_{ijk}$, and it is this relationship that stamps the group as being the rotation group in three dimensions. Thus, the matrix generators \mathbf{M}_i of infinitesimal rotations, Eqs. (4.79), have been seen to obey the commutation relations, Eq. (4.80),

$$[\mathbf{M}_i, \mathbf{M}_j] = \epsilon_{ijk}\mathbf{M}_k, \quad (4.80)$$

that is, with the same structure constants as for L_i . The quantities L_i and \mathbf{M}_i are different physically; the brackets in Eqs. (9.125) and (4.80) refer to different operations (although they share the same significant algebraic properties). But the identity of the structure constants for L_i and \mathbf{M}_i (cf. Eqs. (9.128) and (4.80)) shows that they have the same group structure, that of $SO(3)$.

For the bound Kepler problem, we have seen (Section 3.9) that there exists in addition to \mathbf{L} another conserved vector quantity, \mathbf{A} , the Laplace-Runge-Lenz vector defined by Eq. (3.82)

$$\mathbf{A} = \mathbf{p} \times \mathbf{L} - \frac{mkr}{r}. \quad (3.82)$$

The Poisson bracket relations of the components of \mathbf{A} with themselves and with the components of \mathbf{L} can be obtained in a straightforward manner. Since \mathbf{A} clearly qualifies as a system vector, we immediately have the bracket relations

$$[A_i, L_j] = \epsilon_{ijk} A_k. \quad (9.131)$$

The Poisson brackets of the components of \mathbf{A} among themselves cannot be obtained by any such simple stratagem, but after a fair amount of tedious manipulation it is found that*

$$[A_1, A_2] = - \left(p^2 - \frac{2mk}{r} \right) L_3. \quad (9.132)$$

The quantity on the right in the parentheses will be recognized as $2mH$, which has the conserved value $2mE$. If we therefore introduce a new constant vector \mathbf{D} defined as

$$\mathbf{D} = \frac{\mathbf{A}}{\sqrt{-2mE}} \equiv \frac{\mathbf{A}}{\sqrt{2m|E|}} \quad (9.133)$$

(note that E is negative for bound motion!), then the components of \mathbf{D} satisfy the Poisson bracket relation

$$[D_1, D_2] = L_3.$$

By cyclically permuting the indices, the complete set of Poisson brackets follows immediately. Thus, the components of \mathbf{L} and \mathbf{D} together form a Lie algebra for the bound Kepler problem, with structure constants to be obtained from the identities.

$$[L_i, L_j] = \epsilon_{ijk} L_k, \quad (9.128)$$

$$[D_i, L_j] = \epsilon_{ijk} D_k, \quad (9.134)$$

and

$$[D_i, D_j] = \epsilon_{ijk} L_k. \quad (9.135)$$

An examination of the fundamental matrices for rotation will show that the symmetry group for the bound Kepler problem is to be identified with the group of four-dimensional real proper rotations, called the special orthogonal group of dimension 4, which is usually designated as $SO(4)$ or $R(4)$. Such a transformation preserves the value of the scalar quadratic form $x_\mu x_\mu$, where all the x_μ are real. An orthogonal transformation in four dimensions has 10 conditions on the 16 el-

*Some reduction in the length of the derivation is obtained by identifying $\mathbf{p} \times \mathbf{L}$ as a system vector \mathbf{C} , and first evaluating the Poisson brackets $[C_1, (\mathbf{p} \times \mathbf{L})_2]$ and $[C_1, \mathbf{r}/r]$ making use of the fundamental Poisson brackets and Eqs. (9.125) to the utmost.

elements of the matrix with determinant ± 1 , so only 6 are independent. By looking on the infinitesimal transformation as being made up of a sequence of rotations in the various planes, we can easily obtain the corresponding six generators. Three of them are rotations in the three distinct x_i-x_j planes and so correspond to the \mathbf{M}_i generators of Eqs. (4.79), except that there are added zeros in the zeroth row and column. The remaining three generate infinitesimal rotations in the x_0-x_1 planes. Thus, the generator matrix for an infinitesimal rotation in the x_0-x_1 plane would be

$$\mathbf{N}_1 = \begin{bmatrix} 0 & -1 & 0 & 0 \\ 1 & 0 & 0 & 0 \\ 0 & 0 & 0 & 0 \\ 0 & 0 & 0 & 0 \end{bmatrix}, \quad (9.136)$$

with \mathbf{N}_2 and \mathbf{N}_3 given in corresponding fashion. Direct matrix multiplication shows that these six matrices satisfy the commutator (or Lie bracket) relations

$$\begin{aligned} [\mathbf{M}_i, \mathbf{M}_j] &= \epsilon_{ijk} \mathbf{M}_k, \\ [\mathbf{N}_i, \mathbf{M}_j] &= \epsilon_{ijk} \mathbf{N}_k, \\ [\mathbf{N}_i, \mathbf{N}_j] &= \epsilon_{ijk} \mathbf{M}_k, \end{aligned}$$

with structure constants $c_{ij}^k = \epsilon_{ijk}$. Since these are the same as the Poisson bracket relations, Eqs. (9.128), (9.134), and (9.135), the identification of the symmetry group of the bound Kepler problem with $R(4)$ is thus proven.

Note that for the Kepler problem with positive energy (that is, scattering) \mathbf{A} is still a constant of the motion,* but the appropriate reduced real vector, instead of \mathbf{D} , is \mathbf{C} defined as

$$\mathbf{C} = \frac{\mathbf{A}}{\sqrt{2mE}}, \quad (9.137)$$

and the Poisson bracket relations for \mathbf{L} and \mathbf{C} are now

$$\begin{aligned} [L_i, L_j] &= \epsilon_{ijk} L_k, \\ [C_i, L_j] &= \epsilon_{ijk} C_k, \\ [C_i, C_j] &= -\epsilon_{ijk} L_k. \end{aligned} \quad (9.138)$$

These structure constants are the same as for the restricted Lorentz group, which must therefore be the symmetry group for the positive energy Kepler problem—in nonrelativistic mechanics. We must not read any kinship of physical ideas into this happenstance. The Kepler problem does *not* contain in it the seed of the basic conceptions of special relativity; it is purely a problem of nonrelativistic Newtonian mechanics. That the symmetry group may involve a space of higher dimension than ordinary space is connected with the fact that the symmetry we seek here

*The arguments of Section 3.9 are independent of the sign of either E or the force constant k .

is one in the six-dimensional phase space. The symmetry group consists of the canonical transformations in this space that leave the Hamiltonian unchanged. It should not be surprising therefore that the group can be interpreted in terms of transformations of spaces of more than three dimensions.

The two-dimensional isotropic harmonic oscillator is another mechanical system for which a symmetry group is easily identified. In Cartesian coordinates, the Hamiltonian for this system may be written as

$$H = \frac{1}{2m}(p_x^2 + m^2\omega^2x^2) + \frac{1}{2m}(p_y^2 + m^2\omega^2y^2). \quad (9.139)$$

As it doesn't depend on time explicitly, the Hamiltonian is constant and is equal to the total energy of the system. The z axis is an axis of symmetry for the system, and hence the angular momentum along that axis (which is in fact the total angular momentum) is also a constant of motion:

$$L = xp_y - yp_x. \quad (9.140)$$

Further constants of the motion exist for this problem that can be written as components of a symmetrical two-dimensional tensor \mathbf{A} defined as

$$A_{ij} = \frac{1}{2m}(p_i p_j + m^2\omega^2 x_i x_j). \quad (9.141)$$

Of the three distinct elements of the tensor, the diagonal terms may be identified as the energies associated with the separate one-dimensional motions along the x and y axes, respectively. Physically, as there is no coupling between the two motions, the two energies must separately be constant. A little more formally, it is obvious from the way in which H has been written in Eq. (9.139) that A_{11} and A_{22} each have a vanishing Poisson bracket with H . The off-diagonal element of \mathbf{A} ,

$$A_{12} = A_{21} = \frac{1}{2m}(p_x p_y + m^2\omega^2 xy), \quad (9.142)$$

is a little more difficult to recognize. That it is a constant of the motion may easily be seen by evaluating the Poisson bracket with H . In relation to the separate x and y motions, A_{11} and A_{22} are related to the amplitudes of the oscillations, whereas A_{12} is determined by the phase difference between the two vibrations. Thus, the solutions for the motion can be written as

$$\begin{aligned} x &= \sqrt{\frac{2A_{11}}{m\omega^2}} \sin(\omega t + \theta_1), \\ y &= \sqrt{\frac{2A_{22}}{m\omega^2}} \sin(\omega t + \theta_2), \end{aligned}$$

and it then follows from Eq. (9.142) that

$$A_{12} = \sqrt{A_{11}A_{22}} \cos(\theta_2 - \theta_1). \quad (9.143)$$

The trace of the \mathbf{A} tensor is the total energy of the harmonic oscillator. Out of the elements of the matrix, we can form two other distinct constants of the motion, which it is convenient to write in the form

$$S_1 = \frac{A_{12} + A_{21}}{2\omega} = \frac{1}{2m\omega} (p_x p_y + m^2 \omega^2 xy), \quad (9.144)$$

$$S_2 = \frac{A_{22} - A_{11}}{2\omega} = \frac{1}{4m\omega} [p_y^2 - p_x^2 + m^2 \omega^2 (y^2 - x^2)]. \quad (9.145)$$

To these we may add a third constant of the motion from Eq. (9.140):

$$S_3 = \frac{L}{2} = \frac{1}{2} (xp_y - yp_x). \quad (9.146)$$

The quantities S_i plus the total energy H form four algebraic constants of the motion not involving time explicitly. It is clear that not all of them can be independent, because in a system of two degrees of freedom there can at most be only three such constants. We know that the orbit for the isotropic harmonic oscillator is an ellipse and three constants of the motion are needed to describe the parameters of the orbit in the plane—say, the semimajor axis, the eccentricity, and the orientation of the ellipse. The fourth constant of motion relates to the passage of the particle through a specific point at a given time and would therefore be explicitly time dependent. Hence, there must exist a single relation connecting S_i and H . By direct evaluation it is easy to show that*

$$S_1^2 + S_2^2 + S_3^2 = \frac{H^2}{4\omega^2}. \quad (9.147)$$

By straight forward manipulation of the Poisson brackets, we can verify that the three S_i quantities satisfy the relations

$$[S_i, S_j] = \epsilon_{ijk} S_k. \quad (9.148)$$

These are the same relations as for the three-dimensional angular momentum vector, or for the generators of rotation in a three-dimensional space. The group of transformations generated by S_i may therefore be identified with $R(3)$ or $SO(3)$. Actually, there is some ambiguity in the identification.

*An equivalent form of the condition Eq. (9.147) is that the determinant of \mathbf{A} is $L^2 \omega^2 / 4$. It will be recalled that similarly in the case of the Kepler problem, the components of the new vector constant of motion \mathbf{A} were not all independent of the other constants of the motion. There exist indeed two relations linking \mathbf{A} , \mathbf{L} , and H , Eqs. (3.83) and (3.87).

There is a homomorphism (in this case, a 2 to 1 mapping) between the orthogonal unimodular group $SO(3)$ also called the rotation group $R(3)$ in three dimensions and the unitary unimodular group* $SU(2)$ in two dimensions. It turns out that $SU(2)$ is here more appropriate. To glimpse at the circumstances justifying this choice, note that Eq. (9.147) suggests there is a three-dimensional space, each point of which corresponds to a particular set of orbital parameters. For a given system energy, Eq. (9.147) says the orbit “points” in this space lie on a sphere. The constants S_i generate three-dimensional rotations on this sphere; that is, they change one orbit into another orbit having the same energy. It may be shown that S_1 generates a transformation that changes the eccentricity of the orbit and that for any given final eccentricity we can find *two* transformations leading to it. It is this double-valued quality of the transformation that indicates $SU(2)$ rather than $SO(3)$ is the correct symmetry group for the two-dimensional harmonic oscillator.

For higher dimensions, the structure constants of the Lie algebras of the $SO(n)$ rotation groups and the $SU(n)$ unitary groups are no longer identical, and a clear-cut separation between the two can be made. For the three-dimensional isotropic harmonic oscillator, there is again a tensor constant of the motion defined by Eq. (9.141), except that the indices now run from 1 to 3. The distinct components of this tensor, together with the components of \mathbf{L} now satisfy Poisson bracket relations with the rather complicated structure constants that belong to $SU(3)$. Indeed, it is possible to show that for the n -dimensional isotropic harmonic oscillator the symmetry group is $SU(n)$.

It has previously been pointed out in Section 3.9 that there exists a connection between the existence of additional algebraic constants of the motion—and therefore of higher-symmetry groups—and degeneracy in the motions of the system. In the case of the Kepler and isotropic harmonic oscillator problems, the additional constants of the motion are related to parameters of the orbit. Unless the orbit is closed, that is, the motion is confined to a single curve, we can hardly talk of such orbital parameters. Only when the various components of the motion have commensurate periods will the orbit be closed. The classic example is the two-dimensional anisotropic oscillator. When the frequencies in the x and y directions are rational fractions of each other, the particle traverses a closed Lissajous figure. But if the frequencies are incommensurate, the motion of the particle is space-filling or ergodic, eventually coming as close as desired to any specific point in the rectangle defined by the energies of motion in the two directions (ergodic hypothesis). Attempts at finding complicated (and perhaps complex) symmetry groups for incommensurate systems, applicable to all problems of the same number of degrees of freedom, have not yet proved fruitful. We shall have occasion in Section 13.7 to consider further the relation between symmetry and invariance when we discuss Noether’s theorem which gives a formal proof of the relation between invariance and conserved quantities.

*A matrix is unitary if its inverse is its transpose complex conjugate, and a unimodular matrix is one whose determinant is $+1$.

9.9 ■ LIOUVILLE'S THEOREM

As a final application of the Poisson bracket formalism, we shall briefly discuss a fundamental theorem of statistical mechanics known as Liouville's theorem. While the exact motion of any system is completely determined in classical mechanics by the initial conditions, it is often impracticable to calculate an exact solution for complex systems. It would be obviously hopeless, for example, to calculate completely the motion of some 10^{23} molecules in a volume of gas. In addition, the initial conditions are often only incompletely known. We may be able to state that at time t_0 a given mass of gas has a certain energy, but we cannot determine the initial coordinates and velocities of each molecule. Statistical mechanics therefore makes no attempt to obtain a complete solution for systems containing many particles. Its aim, instead, is to make predictions about certain average properties by examining the motion of a large number of identical systems. The values of the desired quantities are then computed by forming averages over all the systems in the *ensemble*. All the members of the ensemble are as like the actual systems as our imperfect knowledge permits, but they may have any of the initial conditions that are consistent with this incomplete information. Since each system is represented by a single point in phase space, the ensemble of systems corresponds to a swarm of points in phase space. Liouville's theorem states that the density of systems in the neighborhood of some given system in phase space remains constant in time.

The density, D , as defined above can vary with time through two separate mechanisms. Since it is the density in the neighborhood of a given system point, there will be an *implicit* dependence as the coordinates of the system (q_i, p_i) vary with time, and the system point wanders through phase space. There may also be an explicit dependence upon time. The density may still vary with time even when evaluated at a fixed point in phase space. By Eq. (9.94), the total time derivative of D , due to both types of variation with time, can be written as

$$\frac{dD}{dt} = [D, H] + \frac{\partial D}{\partial t}, \quad (9.149)$$

where the Poisson bracket arises from the implicit dependence, and the last term from the explicit dependence.

The ensemble of system points moving through phase space behaves much like a fluid in a multidimensional space, and there are numerous similarities between our discussion of the ensemble and the well-known notions of fluid dynamics. In Eq. (9.149), the total derivative is a derivative of the density as we follow the motion of a particular bit of the ensemble "fluid" in time. It is sometimes referred to as the *material* or *hydrodynamic* derivative. On the other hand, the partial derivative is at fixed (q, p) ; it is as if we station ourselves at a particular spot in phase space and measure the time variation of the density as the ensemble of system points flows by us. These two derivatives correspond to two viewpoints frequently used in considering fluid flow. The partial derivative at a fixed point in phase space is in line with the Eulerian viewpoint that looks on the coordinates solely as iden-

tifying a point in space. The total derivative fits in with the Lagrangian picture in which individual particles are followed in time; the coordinates in effect rather identify a particle than a point in space. Basically, our consideration of phase space has been more like the Lagrangian viewpoint; the collection of quantities (q, p) identifies a system and its changing configuration with time.

Consider an infinitesimal volume in phase space surrounding a given system point, with the boundary of the volume formed by some surface of neighboring system points at the time $t = 0$. Note that the surface of the volume is one-dimension less than the volume. In the course of time, the system points defining the volume move about in phase space, and the volume contained by them will take on different shapes as time progresses. The dashed curve in Fig. 9.4 indicates the evolution of the infinitesimal volume with time. It is clear that the number of systems within the volume remains constant, for a system initially inside can never get out. If some system point were to cross the border, it would occupy at some time the same position in phase space as one of the system points defining the boundary surface. Since the subsequent motion of a system is uniquely determined by its location in phase space at a particular time, the two systems would travel together from there on. Hence, the system can never leave the volume. By the same token, a system initially outside can never enter the volume.

It has been shown that on the active picture of a canonical transformation, the motion of a system point in time is simply the evolution of a canonical transformation generated by the Hamiltonian. The canonical variables (q, p) at time t_2 , as shown in Fig. 9.4, are related to the variables at time t_1 by a particular canonical transformation. The change in the infinitesimal volume element about the system point over the time interval is given by the same canonical transformation. Now, Poincaré's integral invariant, Eq. (9.86), says that a volume element in phase space is invariant under a canonical transformation. Therefore, the size of the volume element about the system point cannot vary with time.

Thus, both the number of systems in the infinitesimal region, dN , and the volume, dV , are constants, and consequently the density

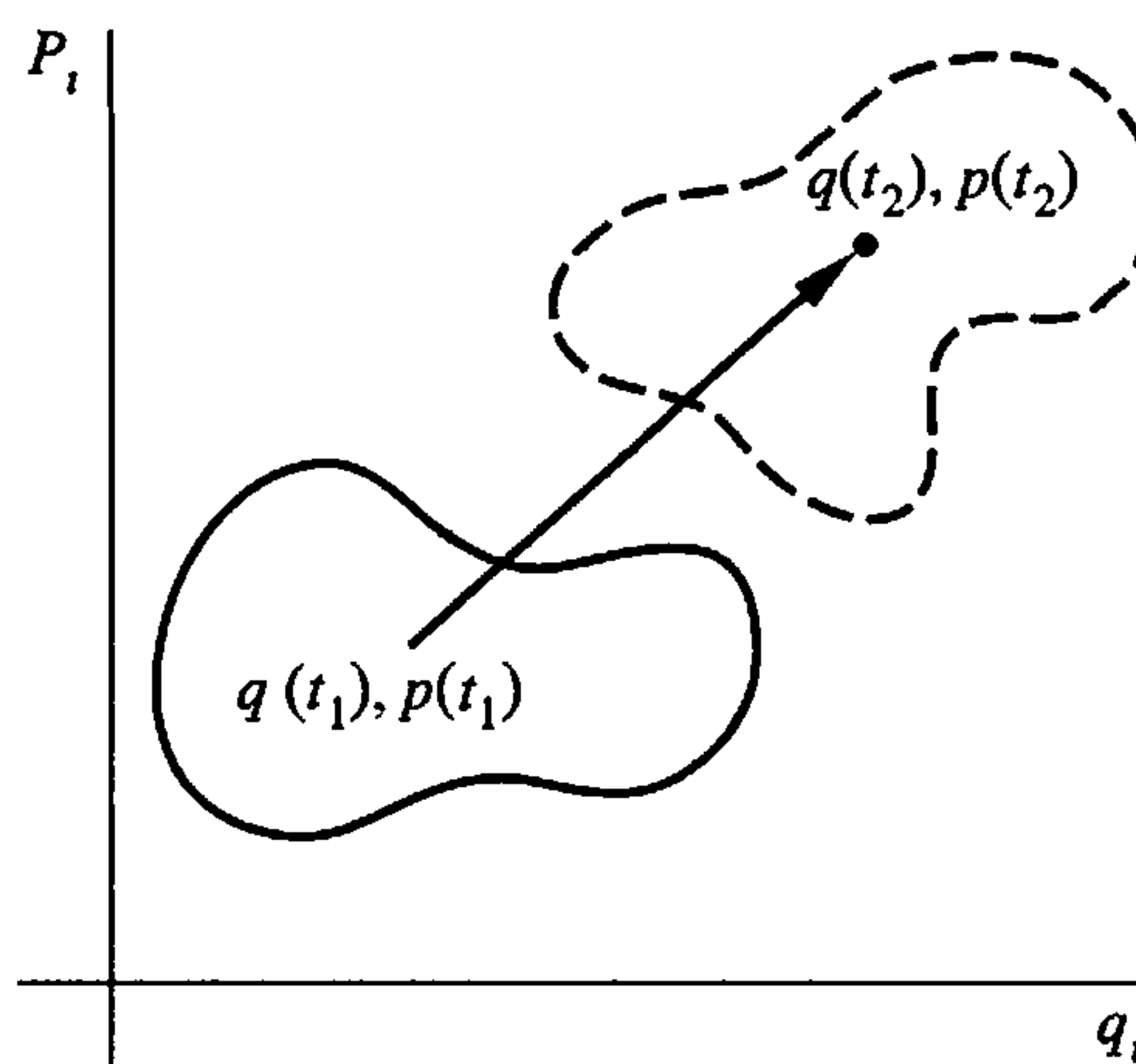

FIGURE 9.4 Motion of a volume in two-dimensional phase space.

$$D = \frac{dN}{dV}$$

must also be constant in time, that is,

$$\frac{dD}{dt} = 0,$$

which proves Liouville's theorem. An alternative statement of the theorem follows from Eq. (9.149) as

$$\frac{\partial D}{\partial t} = -[D, H]. \quad (9.150)$$

When the ensemble of systems is in statistical equilibrium, the number of systems in a given state must be constant in time, which is to say that the density of system points at a given spot in phase space does not change with time. The variation of D with time at a fixed point corresponds to the partial derivative with respect to t , which therefore must vanish in statistical equilibrium. By Eq. (9.150), it follows that the equilibrium condition can be expressed as

$$[D, H] = 0.$$

We can ensure equilibrium therefore by choosing the density D to be a function of those constants of the motion of the system not involving time explicitly, for then the Poisson bracket with H must vanish. Thus, for conservative systems D can be any function of the energy, and the equilibrium condition is automatically satisfied. The characteristics of the ensemble will be determined by the choice of function for D . As an example, one well-known ensemble, the *microcanonical* ensemble, occurs if D is constant for systems having a given narrow energy range and zero outside the range.

The considerations have been presented here to illustrate the usefulness of the Poisson bracket formulation in classical statistical mechanics. Further discussion of these points would carry us far outside our field.

DERIVATIONS

1. One of the attempts at combining the two sets of Hamilton's equations into one tries to take q and p as forming a complex quantity. Show directly from Hamilton's equations of motion that for a system of one degree of freedom the transformation

$$Q = q + ip, \quad P = Q^*$$

is not canonical if the Hamiltonian is left unaltered. Can you find another set of coordinates Q', P' that are related to Q, P by a change of scale only, and that are canonical?

2. Show that the transformation for a system of one degree of freedom,

$$Q = q \cos \alpha - p \sin \alpha,$$

$$P = q \sin \alpha + p \cos \alpha,$$

satisfies the symplectic condition for any value of the parameter α . Find a generating function for the transformation. What is the physical significance of the transformation for $\alpha = 0$? For $\alpha = \pi/2$? Does your generating function work for both of these cases.

3. In Section 8.4 some of the problems of treating time as one of the canonical variables are discussed. If we are able to sidestep these difficulties, show that the equations of transformation in which t is considered a canonical variable reduce to Eqs. (9.14) if in fact the transformation does not affect the time scale.
4. Show directly that the transformation

$$Q = \log \left(\frac{1}{q} \sin p \right), \quad P = q \cot p$$

is canonical.

5. Show directly that for a system of one degree of freedom the transformation

$$Q = \arctan \frac{\alpha q}{p}, \quad P = \frac{\alpha q^2}{2} \left(1 + \frac{p^2}{\alpha^2 q^2} \right)$$

is canonical, where α is an arbitrary constant of suitable dimensions.

6. The transformation equations between two sets of coordinates are

$$Q = \log(1 + q^{1/2} \cos p),$$

$$P = 2(1 + q^{1/2} \cos p)q^{1/2} \sin p.$$

- (a) Show directly from these transformation equations that Q, P are canonical variables if q and p are.
- (b) Show that the function that generates this transformation is

$$F_3 = -(e^Q - 1)^2 \tan p.$$

7. (a) If each of the four types of generating functions exist for a given canonical transformation, use the Legendre transformation to derive relations between them.
- (b) Find a generating function of the F_4 type for the identity transformation and of the F_3 type for the exchange transformation.
- (c) For an orthogonal point transformation of q in a system of n degrees of freedom, show that the new momenta are likewise given by the orthogonal transformation of an n -dimensional vector whose components are the old momenta plus a gradient in configuration space.
8. Prove directly that the transformation

$$\begin{aligned} Q_1 &= q_1, & P_1 &= p_1 - 2p_2, \\ Q_2 &= p_2, & P_2 &= -2q_1 - q_2 \end{aligned}$$

is canonical and find a generating function.

9. (a) For a single particle show directly (that is, by direct evaluation of the Poisson brackets), that if u is a scalar function only of r^2 , p^2 , and $\mathbf{r} \cdot \mathbf{p}$, then

$$[u, \mathbf{L}] = 0.$$

- (b) Similarly show directly that if \mathbf{F} is a vector function,

$$\mathbf{F} = u\mathbf{r} + v\mathbf{p} + w(\mathbf{r} \times \mathbf{p}),$$

where u , v , and w are scalar functions of the same type as in part (a), then

$$[F_i, L_j] = \epsilon_{ijk} F_k.$$

10. Find under what conditions

$$Q = \frac{\alpha p}{x}, \quad P = \beta x^2,$$

where α and β are constants, represents a canonical transformation for a system of one degree of freedom, and obtain a suitable generating function. Apply the transformation to the solution of the linear harmonic oscillator.

11. Determine whether the transformation

$$\begin{aligned} Q_1 &= q_1 q_2, & P_1 &= \frac{p_1 - p_2}{q_2 - q_1} + 1, \\ Q_2 &= q_1 + q_2, & P_2 &= \frac{q_2 p_2 - q_1 p_1}{q_2 - q_1} - (q_2 + q_1) \end{aligned}$$

is canonical.

12. Show that the direct conditions for a canonical condition are given immediately by the symplectic condition expressed in the form

$$\mathbf{J}\mathbf{M} = \mathbf{M}^{-1}\mathbf{J}.$$

13. The set of restricted canonical transformations has a group-property. Verify this statement once using the invariance of Hamilton's principle under canonical transformation (cf. Eq. (9.11)), and again using the symplectic condition.

14. Prove that the transformation

$$\begin{aligned} Q_1 &= q_1^2, & Q_2 &= q_2 \sec p_2, \\ P_1 &= \frac{p_1 \cos p_2 - 2q_2}{2q_1 \cos p_2}, & P_2 &= \sin p_2 - 2q_1 \end{aligned}$$

is canonical, by any method you choose. Find a suitable generating function that will lead to this transformation.

15. (a) Using the fundamental Poisson brackets find the values of α and β for which the equations

$$Q = q^\alpha \cos \beta p, \quad P = q^\alpha \sin \beta p$$

represent a canonical transformation.

- (b) For what values of α and β do these equations represent an *extended* canonical transformation? Find a generating function of the F_3 form for the transformation.
- (c) On the basis of part (b), can the transformation equations be modified so that they describe a canonical transformation for all values of β ?
16. For a symmetric rigid body, obtain formulas for evaluating the Poisson brackets

$$[\dot{\phi}, f(\theta, \phi, \psi)], \quad [\dot{\psi}, f(\theta, \phi, \psi)]$$

where θ , ϕ , and ψ are the Euler angles, and f is any arbitrary function of the Euler angles.

17. Show that the Jacobi identity is satisfied if the Poisson bracket sign stands for the commutator of two square matrices:

$$[\mathbf{A}, \mathbf{B}] = \mathbf{AB} - \mathbf{BA}.$$

Show also that for the same representation of the Poisson bracket that

$$[\mathbf{A}, \mathbf{BC}] = [\mathbf{A}, \mathbf{B}]\mathbf{C} + \mathbf{B}[\mathbf{A}, \mathbf{C}].$$

18. Prove Eq. (9.83) using the symplectic matrix notation for the Lagrange and Poisson brackets.
19. Verify the analog of the Jacobi identity for Lagrange brackets,

$$\frac{\partial\{u, v\}}{\partial w} + \frac{\partial\{v, w\}}{\partial u} + \frac{\partial\{w, u\}}{\partial v} = 0,$$

where u , v , and w are three functions in terms of which the (q, p) set can be specified.

20. (a) Verify that the components of the two-dimensional matrix \mathbf{A} , defined by Eq. (9.141), are constants of the motion for the two-dimensional isotropic harmonic oscillator problem.
- (b) Verify that the quantities S_i , $i = 1, 2, 3$, defined by Eqs. (9.144), (9.145), (9.146), have the properties stated in Eqs. (9.147) and (9.148).

EXERCISES

21. (a) For a one-dimensional system with the Hamiltonian

$$H = \frac{p^2}{2} - \frac{1}{2q^2},$$

show that there is a constant of the motion

$$D = \frac{pq}{2} - Ht.$$

(b) As a generalization of part (a), for motion in a plane with the Hamiltonian

$$H = |\mathbf{p}|^n - ar^{-n},$$

where \mathbf{p} is the vector of the momenta conjugate to the Cartesian coordinates, show that there is a constant of the motion

$$D = \frac{\mathbf{p} \cdot \mathbf{r}}{n} - Ht.$$

(c) The transformation $Q = \lambda q$, $p = \lambda P$ is obviously canonical. However, the same transformation with t time dilatation, $Q = \lambda q$, $p = \lambda P$, $t' = \lambda^2 t$, is not. Show that, however, the equations of motion for q and p for the Hamiltonian in part (a) are invariant under this transformation. The constant of the motion D is said to be associated with this invariance.

22. For the point transformation in a system of two degrees of freedom,

$$Q_1 = q_1^2, \quad Q_2 = q_1 + q_2,$$

find the most general transformation equations for P_1 and P_2 consistent with the overall transformation being canonical. Show that with a particular choice for P_1 and P_2 the Hamiltonian

$$H = \left(\frac{p_1 - p_2}{2q_1} \right)^2 + p_2 + (q_1 + q_2)^2$$

can be transformed to one in which both Q_1 and Q_2 are ignorable. By this means solve the problem and obtain expressions for q_1 , q_2 , p_1 , and p_2 as functions of time and their initial values.

23. By any method you choose, show that the following transformation is canonical:

$$\begin{aligned} x &= \frac{1}{\alpha} \left(\sqrt{2P_1} \sin Q_1 + P_2 \right), & p_x &= \frac{\alpha}{2} \left(\sqrt{2P_1} \cos Q_1 - Q_2 \right), \\ y &= \frac{1}{\alpha} \left(\sqrt{2P_1} \cos Q_1 + Q_2 \right), & p_y &= -\frac{\alpha}{2} \left(\sqrt{2P_1} \sin Q_1 - P_2 \right), \end{aligned}$$

where α is some fixed parameter.

Apply this transformation to the problem of a particle of charge q moving in a plane that is perpendicular to a constant magnetic field \mathbf{B} . Express the Hamiltonian for this problem in the (Q_i, P_i) coordinates letting the parameter α take the form

$$\alpha^2 = \frac{qB}{c}.$$

From this Hamiltonian, obtain the motion of the particle as a function of time.

24. (a) Show that the transformation

$$Q = p + iaq, \quad P = \frac{p - iaq}{2ia}$$

is canonical and find a generating function.

- (b) Use the transformation to solve the linear harmonic oscillator problem.

25. (a) The Hamiltonian for a system has the form

$$H = \frac{1}{2} \left(\frac{1}{q^2} + p^2 q^4 \right).$$

Find the equation of motion for q .

- (b) Find a canonical transformation that reduces H to the form of a harmonic oscillator. Show that the solution for the transformed variables is such that the equation of motion found in part (a) is satisfied.

26. A system of n particles moves in a plane under the influence of interaction forces derived from potential terms depending only upon the scalar distances between particles.

- (a) Using plane polar coordinates for each particle (relative to a common origin), identify the form of the Hamiltonian for the system.

- (b) Find a generating function for the canonical transformation that corresponds to a transformation to coordinates rotating in the plane counterclockwise with a uniform angular rate ω (the same for all particles). What are the transformation equations for the momenta?

- (c) What is the new Hamiltonian? What physical significance can you give to the difference between the old and the new Hamiltonians?

27. (a) In the problem of small oscillations about steady motion, show that at the point of steady motion all the Hamiltonian variables $\boldsymbol{\eta}$ are constant. If the values for steady motion are $\boldsymbol{\eta}_0$ so that $\boldsymbol{\eta} = \boldsymbol{\eta}_0 + \boldsymbol{\xi}$, show that to the lowest nonvanishing approximation the effective Hamiltonian for small oscillation can be expressed as

$$H(\boldsymbol{\eta}_0, \boldsymbol{\xi}) = \frac{1}{2} \boldsymbol{\xi} \mathbf{S} \boldsymbol{\xi},$$

where \mathbf{S} is a square matrix with components that are functions of $\boldsymbol{\eta}_0$ only.

- (b) Assuming all frequencies of small oscillation are distinct, let \mathbf{M} be a square $2n \times 2n$ matrix formed by the components of a possible set of eigenvectors (for both positive and negative frequencies). Only the directions of the eigenvectors are fixed, not their magnitudes. Show that it is possible to apply conditions to the eigenvectors (in effect fixing their magnitudes) that make \mathbf{M} the Jacobian matrix of a canonical transformation.

- (c) Show that the canonical transformation so found transforms the effective Hamiltonian to the form

$$H = i\omega_j q_j p_j,$$

where ω_j is the magnitude of the normal frequencies. What are the equations of motion in this set of canonical coordinates?

(d) Finally, show that

$$F_2 = q_j P_j + \frac{i}{2} \frac{P_j^2}{\omega_j} - \frac{i}{4} \omega_j q_j^2$$

leads to a canonical transformation that decomposes H into the Hamiltonians for a set of uncoupled linear harmonic oscillators that oscillate in the normal modes.

28. A charged particle moves in space with a constant magnetic field \mathbf{B} such that the vector potential, \mathbf{A} , is

$$\mathbf{A} = \frac{1}{2}(\mathbf{B} \times \mathbf{r})$$

(a) If v_j are the Cartesian components of the velocity of the particle, evaluate the Poisson brackets

$$[v_i, v_j], \quad i \neq j = 1, 2, 3.$$

(b) If p_i is the canonical momentum conjugate to x_i , also evaluate the Poisson brackets

$$[x_i, v_j], \quad [p_i, v_j],$$

$$[x_i, \dot{p}_j], \quad [p_i, \dot{p}_j].$$

29. The semimajor axis a of the elliptical Kepler orbit and the eccentricity e are functions of first integrals of the motion, and therefore of the canonical variables. Similarly, the mean anomaly

$$\phi \equiv \omega(t - T) = \psi - e \sin \psi$$

is a function of r , θ , and the conjugate momenta. Here T is the time of periapsis passage and is a constant of the motion. Evaluate the Poisson brackets that can be formed of a , e , ϕ , ω , and T . There are in fact only nine nonvanishing distinct Poisson brackets out of these quantities.

30. (a) Prove that the Poisson bracket of two constants of the motion is itself a constant of the motion even when the constants depend upon time explicitly.

(b) Show that if the Hamiltonian and a quantity F are constants of the motion, then the n th partial derivative of F with respect to t must also be a constant of the motion.

(c) As an illustration of this result, consider the uniform motion of a free particle of mass m . The Hamiltonian is certainly conserved, and there exists a constant of the motion

$$F = x - \frac{pt}{m}.$$

Show by direct computation that the partial derivative of F with t , which is a constant of the motion, agrees with $[H, F]$.

31. Show by the use of Poisson brackets that for a one-dimensional harmonic oscillator there is a constant of the motion u defined as

$$u(q, p, t) = \ln(p + im\omega q) - i\omega t, \quad \omega = \sqrt{\frac{k}{m}}.$$

What is the physical significance of this constant of the motion?

32. A system of two degrees of freedom is described by the Hamiltonian

$$H = q_1 p_1 - q_2 p_2 - a q_1^2 + b q_2^2.$$

Show that

$$F_1 = \frac{p_1 - a q_1}{q_2} \quad \text{and} \quad F_2 = q_1 q_2$$

are constants of the motion. Are there any other independent algebraic constants of the motion? Can any be constructed from Jacobi's identity?

33. Set up the magnetic monopole described in Exercise 28 (Chapter 3) in Hamiltonian formulation (you may want to use spherical polar coordinates). By means of the Poisson bracket formulation, show that the quantity D defined in that exercise is conserved.
34. Obtain the motion in time of a linear harmonic oscillator by means of the formal solution for the Poisson bracket version of the equation of motion as derived from Eq. (9.116). Assume that at time $t = 0$ the initial values are x_0 and p_0 .
35. A particle moves in one dimension under a potential

$$V = \frac{mk}{x^2}.$$

Find x as a function of time, by using the symbolic solution of the Poisson bracket form for the equation of motion for the quantity $y = x^2$. Initial conditions are that at $t = 0$, $x = x_0$, and $v = 0$.

36. (a) Using the theorem concerning Poisson brackets of vector functions and components of the angular momentum, show that if \mathbf{F} and \mathbf{G} are two vector functions of the coordinates and momenta only, then

$$[\mathbf{F} \cdot \mathbf{L}, \mathbf{G} \cdot \mathbf{L}] = \mathbf{L} \cdot (\mathbf{G} \times \mathbf{F}) + L_i L_j [F_i, G_j].$$

- (b) Let \mathbf{L} be the total angular momentum of a rigid body with one point fixed and let L_μ be its component along a set of Cartesian axes fixed in the rigid body. By means of part (a) find a general expansion for

$$[L_\mu, L_\nu], \quad \mu, \nu = 1, 2, 3.$$

(Hint: Choose for \mathbf{F} and \mathbf{G} unit vectors along the μ and ν axes.)

- (c) From the Poisson bracket equations of motion for L_μ derive Euler's equations of motion for a rigid body.
37. Set up the problem of the spherical pendulum in the Hamiltonian formulation, using spherical polar coordinates for the q_i . Evaluate directly in terms of these canonical variables the following Poisson brackets:

$$[L_x, L_y], \quad [L_y, L_z], \quad [L_z, L_x],$$

showing that they have the values predicted by Eq. (9.128). Why is it that p_θ and p_ψ can be used as canonical momenta, although they are perpendicular components of the angular momentum?

- 38.** In Section 9.7, it is shown that if any two components of the angular momentum are conserved, then the total angular momentum is conserved. If two of the components are identically zero, the third must be conserved. From this it would appear to follow that in any motion confined to a plane, so that the components of the angular momentum in the plane are zero, the total angular momentum is constant. There appear to be a number of obvious contradictions to this prediction; for example, the angular momentum of an oscillating spring in a watch, or the angular momentum of a plane disk rolling down an inclined plane all in the same vertical plane. Discuss the force of these objections and whether the statement of the theorem requires any restrictions.
- 39. (a)** Show from the Poisson bracket condition for conserved quantities that the Laplace–Runge–Lenz vector \mathbf{A} ,

$$\mathbf{A} = \mathbf{p} \times \mathbf{L} - \frac{mk\mathbf{r}}{r},$$

is a constant of the motion for the Kepler problem.

- (b)** Verify the Poisson bracket relations for the components of \mathbf{A} as given by Eq. (9.131).
- 40.** Consider a system that consists of a rigid body in three-space with one point fixed. Using cylindrical coordinates find the canonical transformation corresponding to new axes rotating about the z -axis with an arbitrary time-dependent angular velocity. Verify that your proposed solution is canonical.
- 41.** We start with a time independent Hamiltonian $H_o(q, p)$ and impose an external oscillating field making the Hamiltonian

$$H = H_o(q, p) - \varepsilon \sin \omega t$$

where ε and ω are given constants.

- (a)** How are the canonical equations modified?
- (b)** Find a canonical transformation that restores the canonical form of the equations of motion and determine the “new” Hamiltonian.
- (c)** Give a possible physical interpretation of the imposed field.

CHAPTER

10

Hamilton–Jacobi Theory and Action-Angle Variables

It has already been mentioned that canonical transformations may be used to provide a general procedure for solving mechanical problems. Two methods have been suggested. If the Hamiltonian is conserved, then a solution could be obtained by transforming to new canonical coordinates that are all cyclic, thereby providing new equations of motion with trivial solutions. An alternative technique is to seek a canonical transformation from the coordinates and momenta, (q, p) , at the time t , to a new set of constant quantities, which may be the $2n$ initial values, (q_0, p_0) , at $t = 0$. With such a transformation, the equations of transformation relating the old and new canonical variables are exactly the desired solution of the mechanical problem:

$$\begin{aligned}q &= q(q_0, p_0, t), \\p &= p(q_0, p_0, t).\end{aligned}$$

They give the coordinates and momenta as a function of their initial values and the time. This last procedure is the more general one, especially as it is applicable, in principle at least, even when the Hamiltonian involves the time. We shall therefore begin our discussion by considering how such a transformation may be found.

10.1 ■ THE HAMILTON–JACOBI EQUATION FOR HAMILTON’S PRINCIPAL FUNCTION

We can automatically ensure that the new variables are constant in time by requiring that the transformed Hamiltonian, K , shall be identically zero, for then the equations of motion are

$$\begin{aligned}\frac{\partial K}{\partial P_i} &= \dot{Q}_i = 0, \\-\frac{\partial K}{\partial Q_i} &= \dot{P}_i = 0.\end{aligned}\tag{10.1}$$

As we have seen, K must be related to the old Hamiltonian and to the generating function by the equation

$$K = H + \frac{\partial F}{\partial t},$$

and hence will be zero if F satisfies the equation

$$H(q, p, t) + \frac{\partial F}{\partial t} = 0. \quad (10.2)$$

It is convenient to take F as a function of the old coordinates q_i , the new constant momenta P_i , and the time; in the notation of the previous chapter we would designate the generating function as $F_2(q, P, t)$. To write the Hamiltonian in Eq. (10.2) as a function of the same variables, use may be made of the equations of transformation (cf. Eq. (9.17a)),

$$p_i = \frac{\partial F_2}{\partial q_i},$$

so that Eq. (10.2) becomes

$$H\left(q_1, \dots, q_n; \frac{\partial F_2}{\partial q_1}, \dots, \frac{\partial F_2}{\partial q_n}; t\right) + \frac{\partial F_2}{\partial t} = 0. \quad (10.3)$$

Equation (10.3), known as the *Hamilton–Jacobi equation*, constitutes a partial differential equation in $(n + 1)$ variables, $q_1, \dots, q_n; t$, for the desired generating function. It is customary to denote the solution F_2 of Eq. (10.3) by S and to call it *Hamilton’s principal function*.

Of course, the integration of Eq. (10.3) only provides the dependence on the old coordinates and time; it would not appear to tell how the new momenta are contained in S . Indeed, the new momenta have not yet been specified except that we know they must be constants. However, the nature of the solution indicates how the new P_i ’s are to be selected.

Mathematically Eq. (10.3) has the form of a first-order partial differential equation in $n + 1$ variables. Suppose there exists a solution to Eq. (10.3) of the form

$$F_2 \equiv S = S(q_1, \dots, q_n; \alpha_1, \dots, \alpha_{n+1}; t), \quad (10.4)$$

where the quantities $\alpha_1, \dots, \alpha_{n+1}$ are $n + 1$ *independent* constants of integration. Such solutions are known as *complete solutions* of the first-order partial differential equation.* One of the constants of integration, however, is in fact irrelevant to the solution, for it will be noted that S itself does not appear in Eq. (10.3); only its partial derivatives with respect to q or t are involved. Hence, if S is some solution of the differential equation, then $S + \alpha$, where α is any constant, must also be a solution. One of the $n + 1$ constants of integration in Eq. (10.4) must therefore appear only as an additive constant tacked on to S . But by the same token, an additive constant has no importance in a generating function, since only partial derivatives of the generating function occur in the transformation equations.

*Equation (10.4) is not the only type of solution possible for Eq. (10.3). The most general form of the solution involves one or more arbitrary functions rather than arbitrary constants. Nor is there necessarily a unique solution of the form (10.4). There may be several complete solutions for the given equation. But all that is important for the subsequent argument is that there exist *a* complete solution.

Hence, for our purposes a complete solution to Eq. (10.3) can be written in the form

$$S = S(q_1, \dots, q_n; \alpha_1, \dots, \alpha_n; t), \quad (10.5)$$

where none of the n independent constants is solely additive. In this mathematical garb, S tallies exactly with the desired form for an F_2 type of generating function, for Eq. (10.5) presents S as a function of N coordinates, the time t , and n independent quantities α_i . We are therefore at liberty to take the n constants of integration to be the new (constant) momenta:

$$P_i = \alpha_i. \quad (10.6)$$

Such a choice does not contradict the original assertion that the new momenta are connected with the initial values of q and p at time t_0 . The n transformation equations (9.17a) can now be written as

$$p_i = \frac{\partial S(q, \alpha, t)}{\partial q_i}, \quad (10.7)$$

where q, α stand for the complete set of quantities. At the time t_0 , these constitute n equations relating the n α 's with the initial q and p values, thus enabling us to evaluate the constants of integration in terms of the specific initial conditions of the problem. The other half of the equations of transformation, which provide the new constant coordinates, appear as

$$Q_i = \beta_i = \frac{\partial S(q, \alpha, t)}{\partial \alpha_i}. \quad (10.8)$$

The constant β 's can be similarly obtained from the initial conditions, simply by calculating the value of the right side of Eq. (10.8) at $t = t_0$ with the known initial values of q_i . Equations (10.8) can then be “turned inside out” to furnish q_j in terms of α, β , and t :

$$q_j = q_j(\alpha, \beta, t), \quad (10.9)$$

which solves the problem of giving the coordinates as functions of time and the initial conditions.* After the differentiation in Eqs. (10.7) has been performed,

*As a mathematical point, it may be questioned whether the process of “turning inside out” is feasible for Eqs. (10.7) and (10.8), that is, whether they can be solved for α_i and q_i , respectively. The question hinges on whether the equations in each set are independent, for otherwise they are obviously not sufficient to determine the n independent quantities α_i or q_i as the case may be. To simplify the notation, let S_α symbolize members of the set of partial derivatives of S with respect to α_i , so that Eq. (10.8) is represented by $\beta = S_\alpha$. That the derivatives S_α in (10.8) form independent functions of the q 's follows directly from the nature of a complete solution to the Hamilton–Jacobi equation; indeed this is what we mean by saying the n constants of integration are independent. Consequently, the Jacobian of S_α with respect to q_i cannot vanish. Since the order of differentiation is immaterial, this is equivalent to saying that the Jacobian of S_q with respect to α_i cannot vanish, which proves the independence of Eqs. (10.7).

Eqs. (10.9) may be substituted for the q ’s, thus giving the momenta p_i as functions of the α , β , and t :

$$p_i = p_i(\alpha, \beta, t). \quad (10.10)$$

Equations (10.9) and (10.10) thus constitute the desired complete solution of Hamilton’s equations of motion.

Hamilton’s principal function is thus the generator of a canonical transformation to constant coordinates and momenta; *when solving the Hamilton–Jacobi equation, we are at the same time obtaining a solution to the mechanical problem.* Mathematically speaking, we have established an equivalence between the $2n$ canonical equations of motion, which are first-order differential equations, to the first-order partial differential Hamilton–Jacobi equation. This correspondence is not restricted to equations governed by the Hamiltonian; indeed, the general theory of first-order partial differential equations is largely concerned with the properties of the equivalent set of first-order ordinary differential equations. Essentially, the connection can be traced to the fact that both the partial differential equation and its canonical equations stem from a common variational principle, in this case Hamilton’s modified principle.

To a certain extent, the choice of the α_i ’s as the new momenta is arbitrary. We could just as well choose any n quantities, γ_i , which are independent functions of the α_i constants of integration:

$$\gamma_i = \gamma_i(\alpha_i, \dots, \alpha_n). \quad (10.11)$$

By means of these defining relations, Hamilton’s principal function can be written as a function of q_i , γ_i , and t , and the rest of the derivation then goes through unchanged. It often proves convenient to take some particular set of γ_i ’s as the new momenta, rather than the constants of integration that appear naturally in integrating the Hamilton–Jacobi equation.

Further insight into the physical significance of Hamilton’s principal function S is furnished by an examination of its total time derivative, which can be computed from the formula

$$\frac{dS}{dt} = \frac{\partial S}{\partial q_i} \dot{q}_i + \frac{\partial S}{\partial t},$$

since the P_i ’s are constant in time. By Eqs. (10.7) and (10.3), this relation can also be written

$$\frac{dS}{dt} = p_i \dot{q}_i - H = L, \quad (10.12)$$

so that Hamilton’s principal function differs at most from the indefinite time integral of the Lagrangian only by a constant:

$$S = \int L dt + \text{constant}. \quad (10.13)$$

Now, Hamilton's principle is a statement about the definite integral of L , and from it we obtained the solution of the problem via the Lagrange equations. Here the same action integral, in an indefinite form, furnishes another way of solving the problem. In actual calculations, the result expressed by Eq. (10.13) is of no help, because we cannot integrate the Lagrangian with respect to time until q_i and p_i are known as functions of time, that is, until the problem is solved.

When the Hamiltonian does not depend explicitly upon the time, Hamilton's principle function can be written in the form

$$S(q, \alpha, t) = W(q, \alpha) - at, \quad (10.14)$$

where $W(q, \alpha)$ is called *Hamilton's characteristic function*. The physical significance of W can be understood by writing its total time derivative

$$\frac{dW}{dt} = \frac{\partial W}{\partial q_i} \dot{q}_i.$$

Comparing this expression to the results of substituting Eq. (10.14) into Eq. (10.7), it is clear that

$$p_i = \frac{\partial W}{\partial q_i}, \quad (10.15)$$

and hence,

$$\frac{dW}{dt} = p_i \dot{q}_i. \quad (10.16)$$

This can be integrated to give

$$W = \int p_i \dot{q}_i dt = \int p_i dq_i, \quad (10.17)$$

which is just the abbreviated action defined by Eq. (8.80).

10.2 ■ THE HARMONIC OSCILLATOR PROBLEM AS AN EXAMPLE OF THE HAMILTON–JACOBI METHOD

To illustrate the Hamilton–Jacobi technique for solving the motion of mechanical systems, we shall work out in detail the simple problem of a one-dimensional harmonic oscillator. The Hamiltonian is

$$H = \frac{1}{2m}(p^2 + m^2\omega^2q^2) \equiv E, \quad (10.18)$$

where

$$\omega = \sqrt{\frac{k}{m}}, \quad (10.19)$$

k being the force constant. We obtain the Hamilton–Jacobi equations for S by setting p equal to $\partial S/\partial q$ and substituting in the Hamiltonian; the requirement that the new Hamiltonian vanishes becomes

$$\frac{1}{2m} \left[\left(\frac{\partial S}{\partial q} \right)^2 + m^2 \omega^2 q^2 \right] + \frac{\partial S}{\partial t} = 0. \quad (10.20)$$

Since the explicit dependence of S on t is present only in the last term, Eq. (10.14) can be used to eliminate the time from the Hamilton–Jacobi equation (10.20)

$$\frac{1}{2m} \left[\left(\frac{\partial W}{\partial q} \right)^2 + m^2 \omega^2 q^2 \right] = \alpha. \quad (10.21)$$

The integration constant α is thus to be identified with the total energy E . This can also be recognized directly from Eq. (10.14) and the relation (cf. Eq. (10.3))

$$\frac{\partial S}{\partial t} + H = 0,$$

which then reduces to

$$H = \alpha.$$

Equation (10.21) can be integrated immediately to

$$W = \sqrt{2m\alpha} \int dq \sqrt{1 - \frac{m\omega^2 q^2}{2\alpha}}, \quad (10.22)$$

so that

$$S = \sqrt{2m\alpha} \int dq \sqrt{1 - \frac{m\omega^2 q^2}{2\alpha}} - \alpha t. \quad (10.23)$$

While the integration involved in Eq. (10.23) is not particularly difficult, there is no reason to carry it out at this stage, for what is desired is not S but its partial derivatives. The solution for q arises out of the transformation equation (10.8):

$$\beta' = \frac{\partial S}{\partial \alpha} = \sqrt{\frac{m}{2\alpha}} \int \frac{dq}{\sqrt{1 - \frac{m\omega^2 q^2}{2\alpha}}} - t,$$

which can be integrated without trouble to give

$$t + \beta' = \frac{1}{\omega} \arcsin q \sqrt{\frac{m\omega^2}{2\alpha}}. \quad (10.24)$$

Equation (10.24) can be immediately “turned inside out” to furnish q as a function of t and the two constants of integration α and $\beta = \beta'\omega$:

$$q = \sqrt{\frac{2\alpha}{m\omega^2}} \sin(\omega t + \beta), \quad (10.25)$$

which is the familiar solution for a harmonic oscillator. Formally, the solution for the momentum comes from the transformation equation (10.7), which, using Eq. (10.22), can be written

$$p = \frac{\partial S}{\partial q} = \frac{\partial W}{\partial q} = \sqrt{2m\alpha - m^2\omega^2 q^2}. \quad (10.26)$$

In conjunction with the solution for q , Eq. (10.25), this becomes

$$p = \sqrt{2m\alpha(1 - \sin^2(\omega t + \beta))},$$

or

$$p = \sqrt{2m\alpha} \cos(\omega t + \beta) \quad (10.27)$$

Of course, this result checks with the simple identification of p as $m\dot{q}$.

To complete the story, the constants α and β must be connected with the initial conditions q_0 and p_0 at time $t = 0$. By squaring Eqs. (10.25) and (10.27), it is clearly seen that α is given in terms of q_0 and p_0 by the equation

$$2m\alpha = p_0^2 + m^2\omega^2 q_0^2. \quad (10.28)$$

The same result follows immediately of course from the previous identification of α as the conserved total energy E . Finally, the phase constant β is related to q_0 and p_0 by

$$\tan \beta = m\omega \frac{q_0}{p_0}. \quad (10.29)$$

The choice $q_0 = 0$ and hence $\beta = 0$ corresponds to starting the motion with the oscillator at its equilibrium position $q = 0$.

Thus, Hamilton’s principle function is the generator of a canonical transformation to a new coordinate that measures the phase angle of the oscillation and to a new canonical momentum identified as the total energy.

If the solution for q is substituted into Eq. (10.23), Hamilton’s principal function can be written as

$$S = 2\alpha \int \cos^2(\omega t + \beta) dt - \alpha t = 2\alpha \int (\cos^2(\omega t + \beta) - \frac{1}{2}) dt. \quad (10.30)$$

Now, the Lagrangian is

$$\begin{aligned} L &= \frac{1}{2m}(p^2 - m^2\omega^2q^2) \\ &= \alpha(\cos^2(\omega t + \beta) - \sin^2(\omega t + \beta)) \\ &= 2\alpha(\cos^2(\omega t + \beta) - \frac{1}{2}), \end{aligned}$$

so that S is the time integral of the Lagrangian, in agreement with the general relation (10.13). Note that the identity could not be proved until *after* the solution to the problem had been obtained.

As another illustration for the Hamilton–Jacobi method, it is instructive to consider the two-dimensional anisotropic harmonic oscillator. If we let m be the mass of the oscillating body and k_x and k_y be the spring constants in the x - and y -directions, respectively, the Hamiltonian is

$$E = \frac{1}{2m}(p_x^2 + p_y^2 + m^2\omega_x^2x^2 + m^2\omega_y^2y^2),$$

where

$$\omega_x = \sqrt{\frac{k_x}{m}} \quad \text{and} \quad \omega_y = \sqrt{\frac{k_y}{m}}.$$

Since the coordinates and momenta separate into two distinct sets, the principal function can be written as a sum of the characteristic function for each pair. Assuming that we solve the y -functional dependency first, this means

$$S(x, y, \alpha, \alpha_y, t) = F_x(x, \alpha) + F_y(y, \alpha_y) - \alpha t, \quad (10.31)$$

and the Hamilton–Jacobi equation assumes the form

$$\frac{1}{2m} \left[\left(\frac{\partial W}{\partial x} \right)^2 + m^2\omega_x^2x^2 + \left(\frac{\partial W}{\partial y} \right)^2 + m^2\omega_y^2y^2 \right] = \alpha \quad (10.32)$$

in analogy with Eq. (10.18). Since the variables are separated, the y -part of the Eq. (10.32) must be equal to a constant, which we call α_y , so

$$\frac{1}{2m} \left(\frac{\partial W}{\partial y} \right)^2 + \frac{1}{2}m\omega_y^2y^2 = \alpha_y, \quad (10.33)$$

and we replace the y -term in (10.32) with α_y from (10.33), yielding

$$\frac{1}{2m} \left(\frac{\partial W}{\partial x} \right)^2 + \frac{1}{2}m\omega_x^2x^2 = \alpha_x, \quad (10.34)$$

where we write $\alpha - \alpha_y = \alpha_x$ showing the symmetry of Eqs. (10.33) and (10.34).

Each equation has a solution analogous to Eqs. (10.25) and (10.27), so

$$\begin{aligned}
 x &= \sqrt{\frac{2\alpha_x}{m\omega_x^2}} \sin(\omega_x t + \beta_x) \\
 p_x &= \sqrt{2m\alpha_x} \cos(\omega_x t + \beta_x) \\
 y &= \sqrt{\frac{2\alpha_y}{m\omega_y^2}} \sin(\omega_y t + \beta_y) \\
 p_y &= \sqrt{2m\alpha_y} \cos(\omega_y t + \beta_y),
 \end{aligned} \tag{10.35}$$

where the β_i 's are phase constants and the total energy is given by

$$E = \alpha_x + \alpha_y = \alpha.$$

As a third example of Hamilton–Jacobi theory, we again consider the two-dimensional harmonic oscillator; only we will assume the oscillator is isotropic, so

$$k_x = k_y = k \quad \text{and} \quad \omega_x = \omega_y = \omega,$$

and use polar coordinates to write

$$\begin{aligned}
 x &= r \cos \theta & r &= \sqrt{x^2 + y^2} \\
 y &= r \sin \theta & \theta &= \tan^{-1} \frac{y}{x} \\
 p_x &= m\dot{x} & p_r &= m\dot{r} \\
 p_y &= m\dot{y} & p_\theta &= mr^2\dot{\theta}.
 \end{aligned} \tag{10.36}$$

The Hamiltonian now written as

$$E = \frac{1}{2m} \left(p_r^2 + \frac{p_\theta^2}{r^2} + m^2 \omega^2 r^2 \right) \tag{10.37}$$

is cyclic in the angular coordinate θ . The principle function can then be written as

$$\begin{aligned}
 S(r, \theta, \alpha, \alpha_\theta) &= W_r(r, \alpha) + W_\theta(\theta, \alpha_\theta) - \alpha t \\
 &= W_r(r, \alpha) + \theta \alpha_\theta - \alpha t,
 \end{aligned} \tag{10.38}$$

where, as we show later, a cyclic coordinate q_i always has the characteristic function component $W_{q_i} = q_i \alpha_i$. The canonical momentum p_θ associated with the cyclic coordinate, θ , is calculated from the generating function

$$p_\theta = \frac{\partial F_\theta}{\partial \theta} = \alpha_\theta$$

has its expected constant value.

When this p_θ is substituted into Eqs. (10.37) and (10.38), $W_r(r, \alpha)$ satisfies

$$\frac{1}{2m} \left(\frac{\partial W_r}{\partial r} \right)^2 + \frac{\alpha_\theta^2}{2mr^2} + \frac{1}{2} m \omega^2 r^2 = \alpha. \quad (10.39)$$

Rather than solving this equation directly for W_r , we shall write the Cartesian coordinate solution for these conditions as

$$\begin{aligned} x &= \sqrt{\frac{2\alpha}{m\omega^2}} \sin(\omega t + \beta) & p_x &= \sqrt{2m\alpha} \cos(\omega t + \beta) \\ y &= \sqrt{\frac{2\alpha}{m\omega^2}} \sin \omega t & p_y &= \sqrt{2m\alpha} \cos \omega t, \end{aligned} \quad (10.35')$$

and use these to get the polar counterparts,

$$r = \sqrt{\frac{2\alpha}{m\omega^2}} \sqrt{\sin^2 \omega t + \sin^2(\omega t + \beta)}, \quad p_r = m\dot{r},$$

and

$$\theta = \tan^{-1} \left[\frac{\sin \omega t}{\sin(\omega t + \beta)} \right], \quad p_\theta = mr^2 \dot{\theta}. \quad (10.40)$$

There are two limiting cases. The linear case is when $\beta = 0$, for which

$$r = \sqrt{\frac{4\alpha}{m\omega^2}} \sin \omega t, \quad p_r = \sqrt{2m\alpha} \cos \omega t,$$

and

$$\theta = \frac{\pi}{4}, \quad p_\theta = 0. \quad (10.41)$$

The motion in an x - y plot will be an oscillation along a diagonal line as shown in Fig. 10.1a. The other limiting case is when $\beta = \pi/2$, for which

$$\begin{aligned} r &= r_0 = \sqrt{\frac{2\alpha}{m\omega^2}}, & p_r &= 0 \\ \theta &= \omega t, & p_\theta &= mr_0^2 \omega. \end{aligned} \quad (10.42)$$

The motion in an x - y plot for this limiting case is a circle of radius r_0 as is shown in Figure 10.1b. For other values of β ($0 < \beta < \pi/2$), the orbit in coordinate space is an ellipse. The case for $\beta = \pi/4$ is shown in Fig. 10.1c. The plots shown in Fig. 10.1 are further examples of *Lissajous figures*.

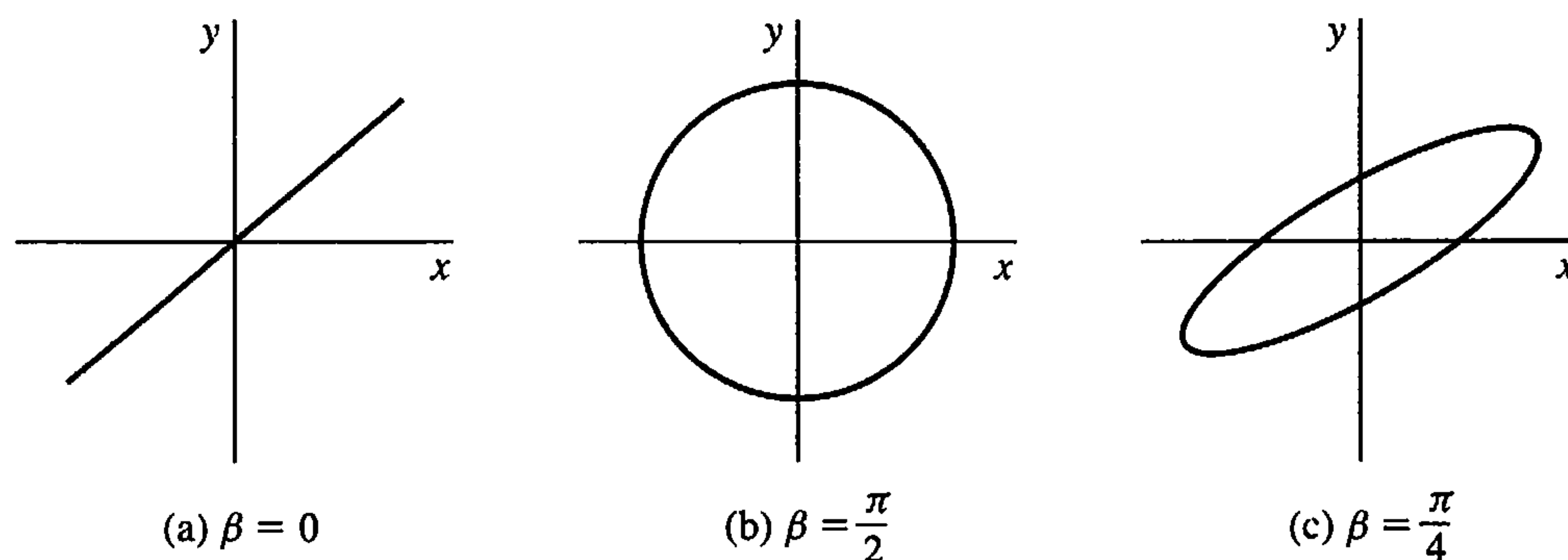

FIGURE 10.1 The two limiting cases (a) and (b) for the harmonic oscillator and an intermediate example (c).

10.3 ■ THE HAMILTON–JACOBI EQUATION FOR HAMILTON’S CHARACTERISTIC FUNCTION

It was possible to integrate the Hamilton–Jacobi equation for the simple harmonic oscillator primarily because S could be separated into two parts, one involving q only and the other only time. Such a separation of variables using Hamilton’s characteristic function $W(q, \alpha)$ (Eq. (10.14)) is always possible *whenever the old Hamiltonian does not involve time explicitly*. This provides us with the restricted Hamilton–Jacobi equation

$$H\left(q_i, \frac{\partial W}{\partial q_i}\right) = \alpha_1, \quad (10.43)$$

which no longer involves the time. One of the constants of integration, namely α_1 , is thus equal to the constant value of H . (Normally H will be the energy, but remember that this need not always be the case, cf. Section 8.2.)

The time-independent function, Hamilton’s characteristic function W , appears here merely as a part of the generating function S when H is constant. It can also be shown that W separately generates its own contact transformation with properties quite different from that generated by S . Let us consider a canonical transformation in which the new momenta are all constants of the motion α_i , and where α_1 in particular is the constant of motion H . If the generating function for this transformation be denoted by $W(q, P)$, then the equations of transformation are

$$p_i = \frac{\partial W}{\partial q_i}, \quad Q_i = \frac{\partial W}{\partial P_i} = \frac{\partial W}{\partial \alpha_i}. \quad (10.44)$$

While these equations resemble Eqs. (10.7) and (10.8) respectively for Hamilton’s principal function S , the condition now determining W is that H is the new canonical momentum α_1 :

$$H(q_i, p_i) = \alpha_1.$$

Using Eqs. (10.44), this requirement becomes the partial differential equation:

$$H\left(q_i, \frac{\partial W}{\partial q_i}\right) = \alpha_1,$$

which is seen to be identical with Eq. (10.43). Since W does not involve the time, the new and old Hamiltonians are equal, and it follows that $K = \alpha_1$.

Hamilton's characteristic function W thus generates a canonical transformation in which all the new coordinates are cyclic. It was noted in the introduction to this chapter that when H is a constant of the motion, a transformation of this nature in effect solves the mechanical problem involved, for the integration of the new equations of motion is then trivial. The canonical equations for P_i , in fact, merely repeat the statement that the momenta conjugate to the cyclic coordinates are all constant:

$$\dot{P}_i = -\frac{\partial K}{\partial Q_i} = 0, \quad P_i = \alpha_i. \quad (10.45)$$

Because the new Hamiltonian depends upon only one of the momenta α_i , the equations of motion for \dot{Q}_i are

$$\begin{aligned} \dot{Q}_i &= \frac{\partial K}{\partial \alpha_i} = 1, & i = 1, \\ &= 0, & i \neq 1, \end{aligned}$$

with the immediate solutions

$$\begin{aligned} Q_1 &= t + \beta_1 \equiv \frac{\partial W}{\partial \alpha_1}, \\ Q_i &= \beta_i \equiv \frac{\partial W}{\partial \alpha_i} \quad i \neq 1. \end{aligned} \quad (10.46)$$

The only coordinate that is not simply a constant of the motion is Q_1 , which is equal to the time plus a constant. We have here another instance of the conjugate relationship between the time as a coordinate and the Hamiltonian as its conjugate momentum.

The dependence of W on the old coordinates q_i is determined by the partial differential equation (10.43), which, like Eq. (10.3), is also referred to as the Hamilton–Jacobi equation. There will now be n constants of integration in a complete solution, but again one of them must be merely an additive constant. The $n - 1$ remaining independent constants, $\alpha_2, \dots, \alpha_n$, together with α_1 may then be taken as the new constant canonical momenta. When evaluated at t_0 the first half of Eqs. (10.44) serve to relate the n constants α_i with the initial values of q_i and p_i . Finally, Eqs. (10.45) and (10.46) can be solved for the q_i as a function of α_i , β_i , and the time t , thus completing the solution of the problem. It will be noted

that $(n - 1)$ of the Eqs. (10.46) do not involve the time at all. One of the q_i 's can be chosen as an independent variable, and the remaining coordinates can then be expressed in terms of it by solving only these time-independent equations. We are thus led directly to the *orbit equations* of the motion. In central force motion, for example, this technique would furnish r as a function of θ , without the need for separately finding r and θ as functions of time.

It is not always necessary to take α_1 and the constants of integration in W as the new constant canonical momenta. Occasionally it is desirable rather to use some particular set of n independent functions of the α_i 's as the transformed momenta. Designating these constants by γ_i the characteristic function W can then be expressed in terms of q_i and γ_i as the independent variables. The Hamiltonian will in general depend upon more than one of the γ_i 's and the equations of motion for \dot{Q}_i become

$$\dot{Q}_i = \frac{\partial K}{\partial \gamma_i} = v_i,$$

where the v_i 's are functions of γ_i . In this case, all the new coordinates are linear functions of time:

$$Q_i = v_i t + \beta_i. \quad (10.47)$$

The form of W cannot be found a priori without obtaining a complete integral of the Hamilton–Jacobi equation. The procedures involved in solving a mechanical problem by either Hamilton's principal or characteristic function may now be summarized in the following tabular form:

The two methods of solution are applicable when the Hamiltonian		
is any general function of q, p, t :		is conserved:
$H(q, p, t).$		$H(q, p) = \text{constant}.$

We seek canonical transformations to new variables such that

all the coordinates and momenta		all the momenta P_i are constants.
Q_i, P_i are constants of the motion.		

To meet these requirements it is sufficient to demand that the new Hamiltonian

shall vanish identically:		shall be cyclic in all the coordinates:
$K = 0.$		$K = H(P_i) = \alpha_1.$

Under these conditions, the new equations of motion become

$\dot{Q}_i = \frac{\partial K}{\partial P_i} = 0,$		$\dot{Q}_i = \frac{\partial K}{\partial P_i} = v_i,$
$\dot{P}_i = -\frac{\partial K}{\partial Q_i} = 0,$		$\dot{P}_i = -\frac{\partial K}{\partial Q_i} = 0,$

with the immediate solutions

$$\begin{array}{l|l} Q_i = \beta_i, & Q_i = v_i t + \beta_i \\ P_i = \gamma_i, & P_i = \gamma_i \end{array}$$

which satisfy the stipulated requirements.

The generating function producing the desired transformation is Hamilton's

$$\begin{array}{l|l} \text{Principal Function:} & \text{Characteristic Function:} \\ S(q, P, t), & W(q, P), \end{array}$$

satisfying the Hamilton–Jacobi partial differential equation:

$$H\left(q, \frac{\partial S}{\partial q}, t\right) + \frac{\partial S}{\partial t} = 0. \quad \left| \quad H\left(q, \frac{\partial W}{\partial q}\right) - \alpha_1 = 0.$$

A complete solution to the equation contains

$$\begin{array}{l|l} n \text{ nontrivial constants of integra-} & n - 1 \text{ nontrivial constants of in-} \\ \text{tion } \alpha_1, \dots, \alpha_n. & \text{tegration, which together with } \alpha_1 \\ & \text{form a set of } n \text{ independent con-} \\ & \text{stants } \alpha_1, \dots, \alpha_n. \end{array}$$

The new constant momenta, $P_i = \gamma_i$, can be chosen as any n independent functions of the n constants of integration:

$$P_i = \gamma_i(\alpha_1, \dots, \alpha_n), \quad \left| \quad P_i = \gamma_i(\alpha_1, \dots, \alpha_n),$$

so that the complete solutions to the Hamilton–Jacobi equation may be considered as functions of the new momenta:

$$S = S(q_i, \gamma_i, t). \quad \left| \quad W = W(q_i, \gamma_i).$$

In particular, the γ_i 's may be chosen to be the α_i 's themselves. One-half of the transformations equations,

$$p_i = \frac{\partial S}{\partial q_i}, \quad \left| \quad p_i = \frac{\partial W}{\partial q_i},$$

are fulfilled automatically, since they have been used in constructing the Hamilton–Jacobi equation. The other half,

$$Q_i = \frac{\partial S}{\partial \gamma_i} = \beta_i, \quad \left| \quad Q_i = \frac{\partial W}{\partial \gamma_i} = v_i(\gamma_j)t + \beta_i,$$

can be solved for q_i in terms of t and the $2n$ constants β_i, γ_i . The solution to the problem is then completed by evaluating these $2n$ constants in terms of the initial values, (q_{i0}, p_{i0}) , of the coordinates and momenta.

When the Hamiltonian does not involve time explicitly, both methods are suitable, and the generating functions are then related to each other according to the formula

$$S(q, P, t) = W(q, P) - \alpha_1 t.$$

10.4 ■ SEPARATION OF VARIABLES IN THE HAMILTON–JACOBI EQUATION

It might appear from the preceding section that little practical advantage has been gained through the introduction of the Hamilton–Jacobi procedure. Instead of solving the $2n$ ordinary differential equations that make up the canonical equations of motion, we now must solve the partial differential Hamilton–Jacobi equation, and partial differential equations can be notoriously complicated to solve. Under certain conditions, however, it is possible to separate the variables in the Hamilton–Jacobi equation, and the solution can then always be reduced to quadratures. In practice, the Hamilton–Jacobi technique becomes a useful computational tool only when such a separation can be effected.

A coordinate q_j is said to be separable in the Hamilton–Jacobi equation when (say) Hamilton’s principal function can be split into two additive parts, one of which depends only on the coordinate q_j and the other is entirely independent of q_j . Thus, if q_1 is taken as a separable coordinate, then the Hamiltonian must be such that one can write

$$S(q_1, \dots, q_n; \alpha_1, \dots, \alpha_n; t) = S_1(q_1; \alpha_1, \dots, \alpha_n; t) + S'(q_2, \dots, q_n; \alpha_1, \dots, \alpha_n; t), \quad (10.48)$$

and the Hamilton–Jacobi equation can be split into two equations—one separately for S_1 and the other for S' . Similarly the Hamilton–Jacobi equation is described as *completely separable* (or simply, *separable*) if all the coordinates in the problem are separable. A solution for Hamilton’s principal function of the form

$$S = \sum_i S_i(q_i; \alpha_1, \dots, \alpha_n; t) \quad (10.49)$$

will then split the Hamilton–Jacobi equation into n equations of the type

$$H_i \left(q_j; \frac{\partial S_j}{\partial q_j}; \alpha_1, \dots, \alpha_n; t \right) + \frac{\partial S_j}{\partial t} = 0. \quad (10.50)$$

If the Hamiltonian does not explicitly depend upon the time, then, for each S_i we have

$$S_i(q_j; \alpha_1, \dots, \alpha_n; t) = W_i(q_j; \alpha_1, \dots, \alpha_n; t) - \alpha_i t, \quad (10.51)$$

which provide n restricted Hamilton–Jacobi equations,

$$H_i \left(q_i; \frac{\partial W_i}{\partial q_i}; \alpha_1, \dots, \alpha_n \right) = \alpha_i. \quad (10.52)$$

(No summation in Eqs. (10.50) to (10.52)!)

The functions H_i in Eqs. (10.50) and (10.52) may or may not be Hamiltonians, and the α_i may be an energy, an angular momentum squared, or some other quantity depending on the nature of q_i . We shall show this by example in the Kepler problem in the next section.

The constants α_i are referred to now as the *separation constants*. Each of the Eqs. (10.52) involves only one of the coordinates q_i and the corresponding partial derivative of W_i with respect to q_i . They are therefore a set of ordinary differential equations of a particularly simple form. Since the equations are only of first order, it is always possible to reduce them to quadratures; we have only to solve for the partial derivative of W_i with respect to q_i and then integrate over q_i . In practice, each H_i will only contain one or at most a few of the α 's. There will also be cases where a subset of r variables can be separated in this fashion, leaving $n - r$ variables, which will not separate. We shall also examine this eventuality in the next section.

It is possible to find examples in which the Hamilton–Jacobi equation can be solved without separating the time variable (cf. Exercise 8). Nonetheless, almost all useful applications of the Hamilton–Jacobi method involve Hamiltonians not explicitly dependent upon time, for which t is therefore a separable variable. The subsequent discussion on separability is thus restricted to such systems where H is a constant of motion, and Hamilton's characteristic function W will be used exclusively.

10.5 ■ IGNORABLE COORDINATES AND THE KEPLER PROBLEM

We can easily show that any cyclic or ignorable coordinate is separable. Suppose that the cyclic coordinate is q_1 ; the conjugate momentum p_1 is a constant, say γ . The Hamilton–Jacobi equation for W is then

$$H \left(q_2, \dots, q_n; \gamma; \frac{\partial W}{\partial q_2}, \dots, \frac{\partial W}{\partial q_n} \right) = \alpha_1. \quad (10.53)$$

If we try a separated solution of the form

$$W = W_1(q_1, \alpha) + W'(q_2, \dots, q_n; \alpha), \quad (10.54)$$

then it is obvious that Eq. (10.53) involves only the separate function W' , while W_1 is the solution of the equation

$$p_1 = \gamma = \frac{\partial W_1}{\partial q_1}. \quad (10.55)$$

The constant γ is thus the separation constant, and the obvious solution for W_1 (to within a trivial additive constant) is

$$W_1 = \gamma q_1,$$

and W is given by

$$W = W' + \gamma q_1. \quad (10.56)$$

There is an obvious resemblance between Eq. (10.56) and the form S assumes when H is not an explicit function of time, Eq. (10.43). Indeed, both equations can be considered as arising under similar circumstances. We have seen that t may be considered in some sense as a generalized coordinate with $-H$ as its canonical momentum (cf. Eq. (8.58)). If H is conserved, then t may be treated as a cyclic coordinate.

If S of the n coordinates are noncyclic (that is, they appear explicitly in the Hamiltonian), then the Hamiltonian is of the form $H(q_1, \dots, q_s; \alpha_1, \dots, \alpha_n; t)$. The characteristic function can then be written as

$$W(q_1, \dots, q_s; \alpha_1, \dots, \alpha_n) = \sum_{i=1}^s W_i(q_i; \alpha_1, \dots, \alpha_n) + \sum_{i=s+1}^n q_i \alpha_i, \quad (10.56')$$

and there are s Hamilton–Jacobi equations to be solved:

$$H\left(q_1; \frac{\partial W_1}{\partial q_1}; \alpha_2, \dots, \alpha_n\right) = \alpha_1. \quad (10.57)$$

Since these are ordinary first-order differential equations in the independent variable q_1 , they can be immediately reduced to quadratures, and the complete solutions for W can be obtained.

In general, a coordinate q_j can be separated if q_j and the conjugate momentum p_j can be segregated in the Hamiltonian into some function $f(q_j, p_j)$ that does not contain any of the other variables. If we then seek a trial solution of the form

$$W = W_j(q_j, \alpha) + W'(q_i, \alpha),$$

where q_i represents the set of all q 's *except* q_j , then the Hamilton–Jacobi equation appears as

$$H\left(q_i, \frac{\partial W'}{\partial q_i}, f\left(q_j, \frac{\partial W_j}{\partial q_j}\right)\right) = \alpha_1. \quad (10.58)$$

In principle, at least, Eq. (10.58) can be inverted so as to solve for f :

$$f\left(q_j, \frac{\partial W_j}{\partial q_j}\right) = g\left(q_i, \frac{\partial W'}{\partial q_i}, \alpha_1\right). \quad (10.59)$$

The argument used previously in connection with Eq. (10.51) holds here in slightly varied guise; f is not a function of any of the q 's except q_j ; g on the other hand is independent of q_j . Hence, Eq. (10.59) can hold only if both sides are equal to the same constant, independent of all q 's:

$$\begin{aligned} f\left(q_j, \frac{\partial W_j}{\partial q_j}\right) &= \alpha_j, \\ g\left(q_i, \frac{\partial W'}{\partial q_i}\right) &= \alpha_j, \end{aligned} \quad (10.60)$$

and the separation of the variable has been accomplished.

Note that the separability of the Hamilton–Jacobi equation depends not only on the physical problem involved but also on the choice of the system of generalized coordinates employed. Thus, the one-body central force problem is separable in polar coordinates, but not in Cartesian coordinates. For some problems, it is not possible to completely separate the Hamilton–Jacobi equation, the famous three-body problem being one illustration. On the other hand, in many of the basic problems of mechanics and atomic physics, separation is possible in more than one set of coordinates. In general, it is feasible to solve the Hamilton–Jacobi equation in closed form only when the variables are completely separable. Considerable ingenuity has therefore been devoted to finding the separable systems of coordinates appropriate to each problem.

No simple criterion can be given to indicate what coordinate systems lead to separable Hamilton–Jacobi equations for any particular problem. In the case of orthogonal coordinate systems, the so-called Staeckel conditions have proved useful. They provide necessary and sufficient conditions for separability under certain circumstances. A proof of the sufficiency of the conditions and references will be found in Appendix D of the second edition of this text.

The Staeckel conditions for the separation of the Hamilton–Jacobi equations are:

1. The Hamiltonian is conserved.
2. The Lagrangian is no more than a quadratic function of the generalized velocities, so the Hamiltonian takes the form:

$$H = \frac{1}{2}(\tilde{\mathbf{p}} - \tilde{\mathbf{a}})\Gamma^{-1}(\mathbf{p} - \mathbf{a}) + V(q). \quad (8.27)$$

3. The vector \mathbf{a} has elements a_i that are functions only of the corresponding coordinate, that is $a_i = a_i(q_i)$.
4. the potential function can be written as a sum of the form

$$V(q) = \sum_i \frac{V_i(q_i)}{T_{ii}}. \quad (10.61)$$

5. Consider the matrix ϕ^{-1} , with an inverse ϕ whose elements are

$$\delta_{ij}\phi_{ij}^{-1} = \frac{1}{T_{ii}}. \quad (\text{no summation on } i) \quad (10.62)$$

where

$$\left(\frac{\partial W_i}{\partial q_i} - a_i \right) = 2\delta_{ik}\phi_{kj}\gamma_j$$

with γ a constant unspecified vector. If the diagonal elements of both ϕ and ϕ^{-1} depend only upon the associated coordinate, that is, ϕ_{ii}^{-1} and ϕ_{ii} are constants or a function of q_i only, then provided 1–4 are true, the Hamiltonian–Jacobi equations separate.

Since we have assumed that the generalized coordinates q_i form an orthogonal coordinate system, the matrix \mathbf{T} (introduced in Section 8.1) is diagonal. It follows that the inverse matrix \mathbf{T}^{-1} is also diagonal and, if we are dealing with a particle in an external force field, the diagonal elements are:

$$\phi_{ii}^{-1} = \frac{1}{T_{ii}} = \frac{1}{m}, \quad (\text{no summation}) \quad (10.63)$$

so the fifth Stackel condition is satisfied.

If the Staeckel conditions are satisfied, then Hamilton's characteristic function is completely separable:

$$W(q) = \sum_i W_i(q_i),$$

with the W_i satisfying equations of the form

$$\left(\frac{\partial W_i}{\partial q_i} - a_i \right)^2 = -2V_i(q_i) + 2\phi_{ij}\gamma_j, \quad (10.64)$$

where γ_j are constants of integration (and there is summation only over the index j).

While these conditions appear mysterious and complicated, their application usually is fairly straightforward. As an illustration of some of the ideas developed here about separability, the Hamilton–Jacobi equation for a particle moving in a central force will be discussed in polar coordinates. The problem will then be generalized to arbitrary potential laws, to furnish an application of the Staeckel conditions.

Let us first consider the central force problem in terms of the polar coordinates (r, ψ) in the plane of the orbit. The motion then involves only two degrees of freedom and the Hamiltonian has the form

$$H = \frac{1}{2m} \left(p_r^2 + \frac{p_\psi^2}{r^2} \right) + V(r), \quad (10.65)$$

which is cyclic in ψ . Consequently, Hamilton's characteristic function appears as

$$W = W_1(r) + \alpha_\psi \psi, \quad (10.66)$$

where α_ψ is the constant angular momentum p_ψ conjugate to ψ . The Hamilton–Jacobi equation then becomes

$$\left(\frac{\partial W_1}{\partial r}\right)^2 + \frac{\alpha_\psi^2}{r^2} + 2mV(r) = 2m\alpha_1, \quad (10.67)$$

where α_1 is the constant identified physically as the total energy of the system. Solving Eq. (10.66) for the partial derivative of W_1 we obtain

$$\frac{\partial W_1}{\partial r} = \sqrt{2m(\alpha_1 - V) - \frac{\alpha_\psi^2}{r^2}},$$

so that W is

$$W = \int dr \sqrt{2m(\alpha_1 - V) - \frac{\alpha_\psi^2}{r^2}} + \alpha_\psi \psi. \quad (10.68)$$

With this form for the characteristic function, the transformation equations (10.46) appear as

$$t + \beta_1 = \frac{\partial W}{\partial \alpha_1} = \int \frac{m dr}{\sqrt{2m(\alpha_1 - V) - \frac{\alpha_\psi^2}{r^2}}}, \quad (10.69a)$$

and

$$\beta_2 = \frac{\partial W}{\partial \alpha_\psi} = - \int \frac{\alpha_\psi dr}{r^2 \sqrt{2m(\alpha_1 - V) - \frac{\alpha_\psi^2}{r^2}}} + \psi. \quad (10.69b)$$

Equation (10.69a) furnishes r as a function of t and agrees with the corresponding solution, Eq. (3.18), found in Chapter 3, with α_1 and α_ψ written explicitly as E and l , respectively. It has been remarked previously that the remaining transformation equations for Q_i , here only Eq. (10.69b), should provide the orbit equation. If the variable of integration in Eq. (10.69b) is changed to $u = 1/r$, the equation reduces to

$$\psi = \beta_2 - \int \frac{du}{\sqrt{\frac{2m}{\alpha_\psi^2}(\alpha_1 - V) - u^2}}$$

which agrees with Eq. (3.37) previously found for the orbit, identifying ψ as θ and β_2 as θ_0 .

As a further example of separation of variables, we shall examine the same central force problem, but in spherical polar coordinates, that is, ignoring our a priori knowledge that the orbit lies in a plane. The appropriate Hamiltonian has been shown to be (cf. Eq. (8.29)):

$$H = \frac{1}{2m} \left(p_r^2 + \frac{p_\theta^2}{r^2} + \frac{p_\phi^2}{r^2 \sin^2 \theta} \right) + V(r). \quad (10.70)$$

If the variables in the corresponding Hamilton–Jacobi equation are separable, then Hamilton’s characteristic function must have the form

$$W = W_r(r) + W_\theta(\theta) + W_\phi(\phi). \quad (10.71)$$

The coordinate ϕ is cyclic in the Hamiltonian and hence

$$W_\phi = \alpha_\phi \phi \quad (10.72)$$

where α_ϕ is a constant of integration. In terms of this form for W , the Hamilton–Jacobi equation reduces to

$$\left(\frac{\partial W_r}{\partial r} \right)^2 + \frac{1}{r^2} \left[\left(\frac{\partial W_\theta}{\partial \theta} \right)^2 + \frac{\alpha_\phi^2}{\sin^2 \theta} \right] + 2mV(r) = 2mE, \quad (10.73)$$

where we have explicitly identified the constant Hamiltonian with the total energy E . Note that all dependence on θ , and on θ alone, has been segregated into the expression within the square brackets. The Hamilton–Jacobi equation then conforms to the appearance of Eq. (10.58), and following the argument given there we see that the quantity in the square brackets must be a constant:

$$\left(\frac{\partial W_\theta}{\partial \theta} \right)^2 + \frac{\alpha_\phi^2}{\sin^2 \theta} = \alpha_\theta^2. \quad (10.74)$$

Finally the dependence of W on r is given by the remainder of the Hamilton–Jacobi equation:

$$\left(\frac{\partial W_r}{\partial r} \right)^2 + \frac{\alpha_\theta^2}{r^2} = 2m(E - V(r)). \quad (10.75)$$

The variables in the Hamilton–Jacobi equation are thus completely separated. Equations (10.74) and (10.75) may be easily reduced to quadratures providing at least a formal solution for $W_\theta(\theta)$ and $W_r(r)$, respectively.

Note that the constants of integration α_ϕ , α_θ , α_1 all have directly recognizable physical meanings. The quantity α_ϕ is of course the constant value of the angular momentum about the polar axis (cf. Eq. (10.44)):

$$\alpha_\phi = p_\phi = \frac{\partial W_\phi}{\partial \phi}. \quad (10.76)$$

To identify α_θ we use Eq. (10.44) to rewrite Eq. (10.74) as

$$p_\theta^2 + \frac{P_\theta^2}{\sin^2 \theta} = \alpha_\theta^2, \quad (10.74')$$

so that the Hamiltonian, Eq. (10.70) appears as

$$H = \frac{1}{2m} \left(p_r^2 + \frac{\alpha_\theta^2}{r^2} \right) + V(r). \quad (10.70')$$

Comparison with Eq. (10.65) for the Hamiltonian as expressed in terms of polar coordinates in the plane of the orbit shows that α_θ is the same as p_ψ , the magnitude of the total angular momentum:

$$\alpha_\theta = p_\psi \equiv l. \quad (10.77)$$

Lastly, α_1 is of course the total energy E . Indeed, the three differential equations for the component parts of W can be looked on as statements of conservation theorems. Equation (10.75) says the z -component of the angular momentum vector, L , is conserved, while Eq. (10.74) states the conservation of the magnitude, l , of the angular momentum. And Eq. (10.75) is a form of the energy conservation theorem.

In this simple example, some of the power and elegance of the Hamilton–Jacobi method begins to be apparent. A few short steps suffice to obtain the dependence of r on t and the orbit equation, Eqs. (10.69a and b), results derived earlier only with considerable labor. The conserved quantities of the central force problem also appear automatically. Separation of variables for the purely central force problem can also be performed in other coordinate systems, for example, parabolic coordinates, and the conserved quantities appear there in forms appropriate to the particular coordinates.

Finally, we can employ the Staeckel conditions to find the most general form of a scalar potential V for a single particle for which the Hamilton–Jacobi equation is separable in spherical polar coordinates. The matrix ϕ of the Staeckel conditions depends only on the coordinate system and not on the potential. Since the Hamilton–Jacobi equation is separable in spherical polar coordinates for at least one potential, that is, the central force potential, it follows that the matrix ϕ does exist. The specific form of ϕ is not needed to answer our question. Further, since a by hypothesis is zero, all we need do is apply Eq. (10.62) to find the most general separable form of V . From the kinetic energy (Eq. 8.28'), the diagonal elements of T are

$$T_{rr} = m, \quad T_{\theta\theta} = mr^2, \quad T_{\phi\phi} = mr^2 \sin^2 \theta.$$

By Eq. (10.62) it follows that the desired potential must have the form

$$V(q) = V_r(r) + \frac{V_\theta(\theta)}{r^2} + \frac{V_\phi(\phi)}{r^2 \sin^2 \theta}. \quad (10.78)$$

It is easy to verify directly that with this potential the Hamilton–Jacobi equation is still completely separable in spherical polar coordinates.

10.6 ■ ACTION-ANGLE VARIABLES IN SYSTEMS OF ONE DEGREE OF FREEDOM

Of especial importance in many branches of physics are systems in which the motion is periodic. Very often we are interested not so much in the details of the orbit as in the frequencies of the motion. An elegant and powerful method of handling such systems is provided by a variation of the Hamilton–Jacobi procedure. In this technique, the integration constants α_i appearing directly in the solution of the Hamilton–Jacobi equation are not themselves chosen to be the new momenta. Instead, we use suitably defined constants J_i , which form a set of n independent functions of the α_i 's, and which are known as the *action variables*.

For simplicity, we shall first consider in this section systems of one degree of freedom. It is assumed the system is conservative so that the Hamiltonian can be written as

$$H(q, p) = \alpha_1.$$

Solving for the momentum, we have that

$$p = p(q, \alpha_1), \quad (10.79)$$

which can be looked on as the equation of the orbit traced out by the system point in the two-dimensional phase space, p, q when the Hamiltonian has the constant value α_1 . What is meant by the term “periodic motion” is determined by the characteristics of the phase space orbit. Two types of periodic motion may be distinguished:

1. In the first type, the orbit is *closed*, as shown in Fig. 10.2(a), and the system point retraces its steps periodically. Both q and p are then periodic functions of the time with the same frequency. Periodic motion of this nature will be found when the initial position lies between two zeros of the kinetic energy. It is often designated by the astronomical name *libration*, although to a physicist it is more likely to call to mind the common oscillatory systems, such as the one-dimensional harmonic oscillator.
2. In the second type of periodic motion, the orbit in phase space is such that p is some periodic function of q , with period q_0 , as illustrated in Fig. 10.2(b). Equivalently, this kind of motion implies that when a is increased by q_0 , the configuration of the system remains essentially unchanged. The most familiar example is that of a rigid body constrained to rotate about a given axis, with q as the angle of rotation. Increasing q by 2π then produces no essential change in the state of the system. Indeed, the position coordinate in this type of periodicity is invariably an angle of rotation, and the motion

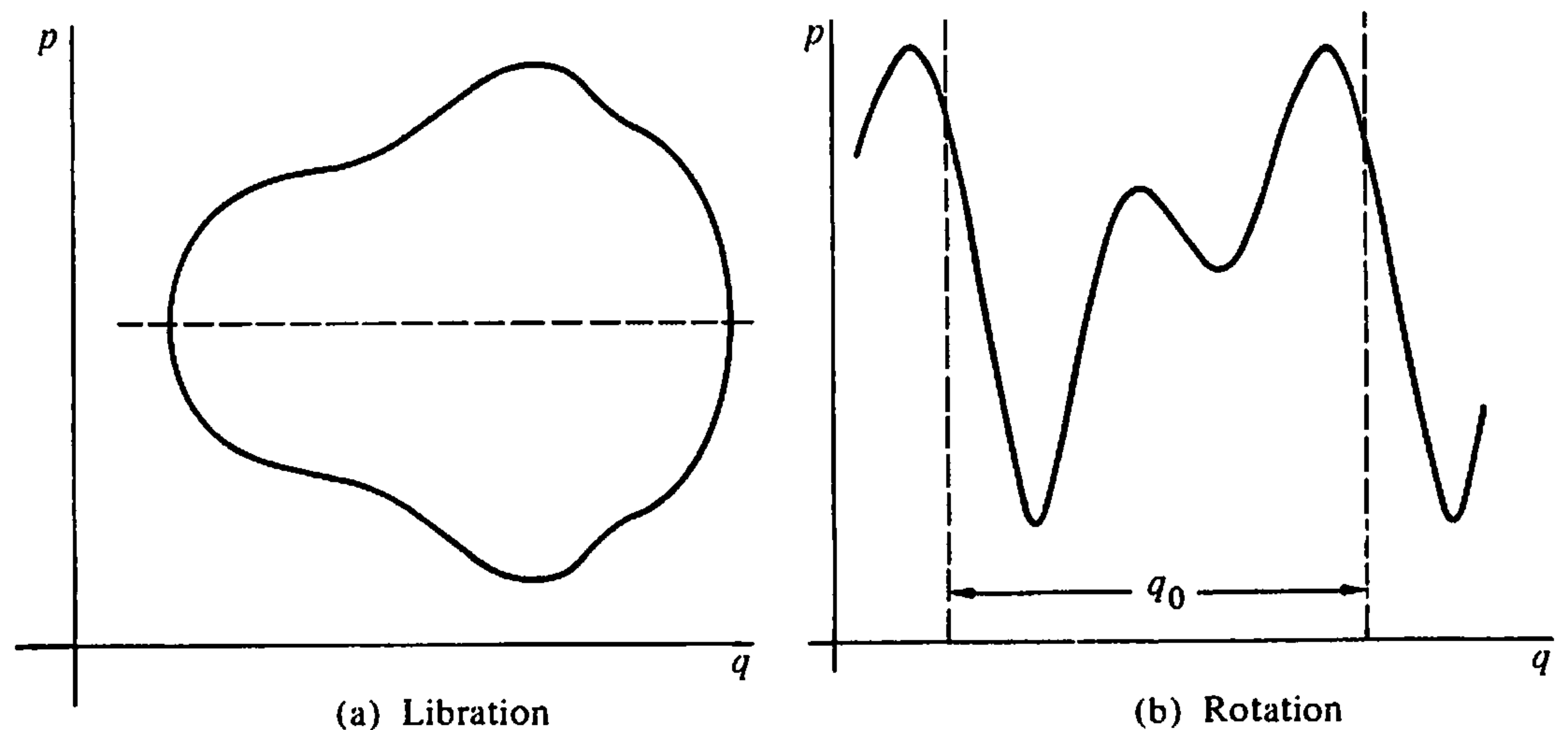

FIGURE 10.2 Orbit of the system point in phase space for periodic motion of one-dimensional systems.

will be referred to simply as *rotation*, in contrast to libration. The values of q are no longer bounded but can increase indefinitely.

It may serve to clarify these ideas to note that both types of periodicity may occur in the same physical system. The classic example is the simple pendulum where q is the angle of deflection θ . If the length of the pendulum is l and the potential energy is taken as zero at the point of suspension, then the constant energy of the system is given by

$$E = \frac{p_{\theta}^2}{2ml^2} - mgl \cos \theta. \quad (10.80)$$

Solving Eq. (10.64) for p_{θ} , the equation of the path of the system point in phase space is

$$p_{\theta} = \pm \sqrt{2ml^2(E + mgl \cos \theta)}. \quad (10.81)$$

If E is less than mgl , then physical motion of the system can only occur for $|\theta|$ less than a bound, θ' , defined by the equation

$$\cos \theta' = -\frac{E}{mgl}.$$

Under these conditions, the pendulum oscillates between $-\theta'$ and $+\theta'$, which is a periodic motion of the libration type. The system point then traverses some such path in phase space as the curve 1 of Fig. 10.3. However, if $E > mgl$, all values of θ correspond to physical motion and θ can increase without limit to produce a periodic motion of the rotation type. What happens physically in this case is that the pendulum has so much energy that it can swing through the vertical position

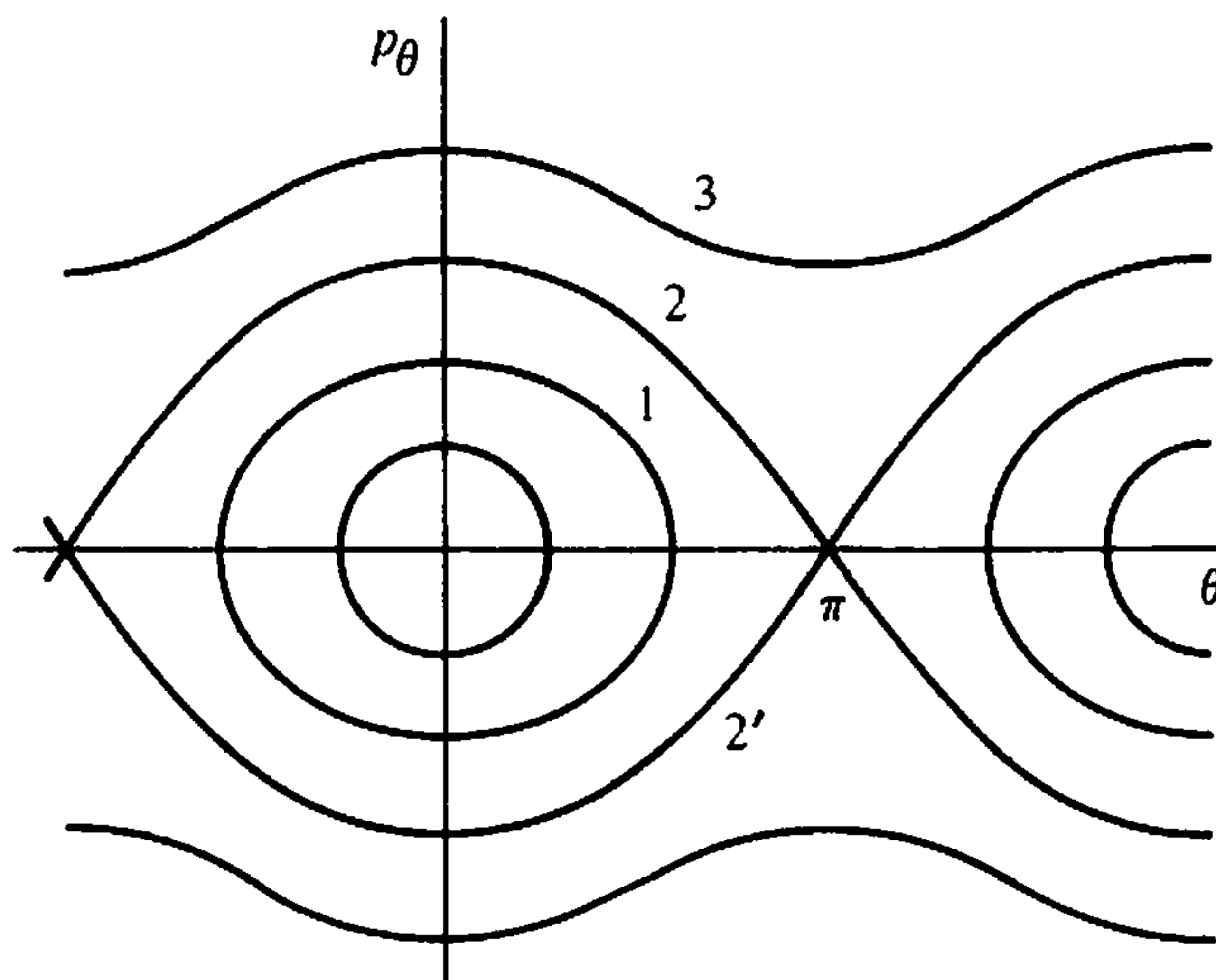

FIGURE 10.3 Phase space orbits for the simple pendulum.

$\theta = \pi$ and therefore continues rotating. Curve 3 in Fig. 10.3 corresponds to the rotation motion of the pendulum. The limiting case when $E = mgl$ is illustrated by curves 2 and 2' in Fig. 10.3. At this energy, the pendulum arrives at $\theta = \pi$, the vertical position, with zero kinetic energy, that is, $p_\theta = 0$. It is then in unstable equilibrium and could in principle remain there indefinitely. However, if there is the slightest perturbation, it could continue its motion either along curve 2 or switch to curve 2'—it could fall down either way. The point $\theta = \pi$, $p_\theta = 0$ is a saddle point of the Hamiltonian function $H = E(p_\theta, \theta)$ and there are two paths of constant E in phase space that intersect at the saddle point. We have here an instance of what is called a *bifurcation*, a phenomenon that will be discussed extensively in the next chapter. (See also Section 6.6.)

For either type of periodic motion, we can introduce a new variable J designed to replace α_1 as the transformed (constant) momentum. The so-called action variable J is defined as (cf. Eq. (8.80))

$$J = \oint p dq, \quad (10.82)$$

where the integration is to be carried over a complete period of libration or of rotation, as the case may be. (The designation as action variable stems from the resemblance of Eq. (10.82) to the abbreviated action of Section 8.6. Note that J always has the dimensions of an angular momentum.) From Eq. (10.79), it follows that J is always some function of α_1 alone:

$$\alpha_1 \equiv H = H(J). \quad (10.83)$$

Hence, Hamilton's characteristic function can be written as

$$W = W(q, J). \quad (10.84)$$

The generalized coordinate conjugate to J , known as the *angle variable* w , is defined by the transformation equation:

$$w = \frac{\partial W}{\partial J}. \quad (10.85)$$

Correspondingly, the equation of motion for w is

$$\dot{w} = \frac{\partial H(J)}{\partial J} = v(J), \quad (10.86)$$

where v is a constant function of J only. Equation (10.86) has the immediate solution

$$w = vt + \beta, \quad (10.87)$$

so that w is a linear function of time, exactly as in Eq. (10.47).

So far the action-angle variables appear as no more than a particular set of the general class of transformed coordinates to which the Hamilton–Jacobi equation leads. Equation (10.85) could be solved for q as a function of w and J , which, in combination with Eq. (10.87), would give the desired solution for q as a function of time. But when employed in this fashion the variables have no significant advantage over any other set of coordinates generated by W . Their particular merit rises rather from the physical interpretation that can be given to v . Consider the change in w as q goes through a complete cycle of libration or rotation, as given by

$$\Delta w = \oint \frac{\partial w}{\partial q} dq. \quad (10.88)$$

By Eq. (10.85), this can also be written

$$\Delta w = \oint \frac{\partial^2 W}{\partial q \partial J} dq. \quad (10.89)$$

Because J is a constant, the derivative with respect to J can be taken outside the integral sign:

$$\Delta w = \frac{d}{dJ} \oint \frac{\partial W}{\partial q} dq = \frac{d}{dJ} \oint p dq = 1, \quad (10.90)$$

where the last step follows from the definition for J , Eq. (10.82).

Equation (10.90) states that w changes by unity as q goes through a complete period. But from Eq. (10.87), it follows that if τ is the period for a complete cycle of q , then

$$\Delta w = 1 = v\tau.$$

Hence, the constant ν can be identified as the reciprocal of the period,

$$\nu = \frac{1}{\tau}, \quad (10.91)$$

and is therefore *the frequency associated with the periodic motion of q* . The use of action-angle variables thus provides a powerful technique for obtaining the frequency of periodic motion *without finding a complete solution to the motion of the system*. If it is known a priori that a system of one degree of freedom is periodic according to the definitions given above, then the frequency can be found once H is determined as a function of J . The derivative of H with respect to J , by Eq. (10.86), then directly gives the frequency ν of the motion. The designation of w as an angle variable becomes obvious from the identification of ν in Eq. (10.87) as a frequency. Since J has the dimensions of an angular momentum, the coordinate w conjugate to it is an angle.*

As an illustration of the application of action-angle variables to find frequencies, let us again consider the familiar linear harmonic oscillator problem. From Eqs. (10.26) and the defining equation (10.82), the constant action variable J is given by

$$J = \oint p dq = \oint \sqrt{2m\alpha - m^2\omega^2q^2} dq, \quad (10.92)$$

where α is the constant total energy and $\omega^2 = k/m$. The substitution (10.25)

$$q = \sqrt{\frac{2\alpha}{m\omega^2}} \sin \theta$$

reduces the integral to

$$J = \frac{2\alpha}{\omega} \int_0^{2\pi} \cos^2 \theta d\theta, \quad (10.93)$$

where the limits are such as to correspond to a complete cycle in q . This integrates to

$$J = \frac{2\pi\alpha}{\omega}$$

or, solving for α ,

$$\alpha \equiv H = \frac{J\omega}{2\pi}. \quad (10.94)$$

The frequency of oscillation is therefore

*For some applications the action variable is defined in the literature of celestial mechanics as $(2\pi)^{-1}$ times the value given in Eq. (10.82). By Eq. (10.90), the corresponding angle variable is 2π times our definition and in place of ν we have ω , the angular frequency. However, we shall stick throughout to the familiar definitions used in physics, as given above.

$$\frac{\partial H}{\partial J} = v = \frac{\omega}{2\pi} = \frac{1}{2\pi} \sqrt{\frac{k}{m}}, \quad (10.95)$$

which is the customary formula for the frequency of a linear harmonic oscillator. Although it is entirely unnecessary for obtaining the frequencies, it is nevertheless instructive (and useful for future applications) to write the solutions, Eqs. (10.25) and (10.27), in terms of J and w . It will be recognized first that the combination $(\omega t + \beta)$ is by Eqs. (10.95) and (10.87) the same as $2\pi w$, with the constant of integration suitably redefined. Hence, the solutions for q , Eq. (10.25), and p , Eq. (10.27), take on the form

$$q = \sqrt{\frac{J}{\pi m \omega}} \sin 2\pi w, \quad (10.96)$$

$$p = \sqrt{\frac{m J \omega}{\pi}} \cos 2\pi w. \quad (10.97)$$

Note that Eqs. (10.96) and (10.97) can also be looked on as the transformation equations from the (w, J) set of canonical variables to the (q, p) canonical set.

10.7 ■ ACTION-ANGLE VARIABLES FOR COMPLETELY SEPARABLE SYSTEMS*

Action-angle variables can also be introduced for certain types of motion of systems with many degrees of freedom, providing there exists one or more sets of coordinates in which the Hamilton–Jacobi equation is completely separable. As before, only conservative systems will be considered, so that Hamilton’s characteristic function will be used. Complete separability means that the equations of canonical transformation have the form

$$p_i = \frac{\partial W_i(q_i; \alpha_1, \dots, \alpha_n)}{\partial q_i}, \quad (10.98)$$

which provides each p_i as a function of the q_i and the n integration constants α_j :

$$p_i = p_i(q_i; \alpha_1, \dots, \alpha_n). \quad (10.99)$$

Equation (10.99) is the counterpart of Eq. (10.79), which applied to systems of one degree of freedom. It will be recognized that Eq. (10.99) here represents the orbit equation of the projection of the system point on the (p_i, q_i) plane in phase space. We can define action-angle variables for the system when the orbit equations for *all* of the (q_i, p_i) pairs describe either closed orbits (libration, as in Fig. 10.2(a)) or periodic functions of q_i (rotation, as in Fig. 10.2(b)).

Note that this characterization of the motion does not mean that each q_i and p_i will necessarily be periodic functions of the time, that is, that they repeat their

*Unless otherwise stated, the summation convention will *not* be used in this section.

values at fixed time intervals. Even when each of the separated (q_i, p_i) sets are indeed periodic in this sense, the overall system motion need not be periodic. Thus, in a three-dimensional harmonic oscillator the frequencies of motion along the three Cartesian axes may all be different. In such an example, it is clear the complete motion of the particle may not be periodic. If the separate frequencies are not rational fractions of each other, the particle will not traverse a closed curve in space but will describe an open “Lissajous figure.” Such motion will be described as *multiply periodic*. It is the advantage of the action-angle variables that they lead to an evaluation of all the frequencies involved in multiply periodic motion without requiring a complete solution of the motion.

In analogy to Eq. (10.82), the action variables J_i are defined in terms of line integrals over complete periods of the orbit in the (q_i, p_i) plane:

$$J_i = \oint p_i dq_i. \quad (10.100)$$

If one of the separation coordinates is cyclic, its conjugate momentum is constant. The corresponding orbit in the q_i, p_i plane of phase space is then a horizontal straight line, which would not appear to be in the nature of a periodic motion. Actually the motion can be considered as a limiting case of the rotation type of periodicity, in which q_i may be assigned any arbitrary period. Since the coordinate in a rotation periodicity is invariably an angle, such a cyclic q_i always has a natural period of 2π . Accordingly, the integral in the definition of the action variable corresponding to a cyclic angle coordinate is to be evaluated from 0 to 2π , and hence

$$J_i = 2\pi p_i \quad (10.101)$$

for all cyclic variables.

By Eq. (10.98), J_i can also be written as

$$J_i = \oint \frac{\partial W_i(q_i; \alpha_1, \dots, \alpha_n)}{\partial q_i} dq_i. \quad (10.102)$$

Since q_i is here merely a variable of integration, each action variable J_i is a function only of the n constants of integration appearing in the solution of the Hamilton–Jacobi equation. Further, it follows from the independence of the separate variable pairs (q_i, p_i) that the J_i 's form n independent functions of the α_i 's and hence are suitable for use as a set of new constant momenta. Expressing the α_i 's as functions of the action variables, the characteristic function W can be written in the form

$$W = W(q_1, \dots, q_n; J_1, \dots, J_n) = \sum_j W_j(q_j; J_1, \dots, J_n),$$

while the Hamiltonian appears as a function of the J_i 's only:

$$H = \alpha_1 = H(J_1, \dots, J_n). \quad (10.103)$$

As in the system of one degree of freedom, we can define conjugate angle variables w_i by the equations of transformation that here appear as

$$w_i = \frac{\partial W}{\partial J_i} = \sum_{j=1}^n \frac{\partial W_j(q_j; J_1, \dots, J_n)}{\partial J_i}. \quad (10.104)$$

Note in general w_i could be a function of several or all of the q_i ; that is, $w_i = w_i(q_i, \dots, q_n; J_i, \dots, J_n)$. The w_i 's satisfy equations of motion given by

$$\dot{w}_i = \frac{\partial H(J_1, \dots, J_n)}{\partial J_i} = v_i(J_1, \dots, J_n). \quad (10.105)$$

Because the v_i 's are constants, functions of the action variables only, the angle variables are all linear functions of time

$$w_i = v_i t + \beta_i. \quad (10.106)$$

Note that in general the separate w_i 's increase in time at different rates.

The constants v_i can be identified with the frequencies of the multiply periodic motion, but the argument to demonstrate the relation is more subtle than for periodic systems of one degree of freedom. The transformation equations to the (w, J) set of variables implies that each q_j (and p_j) is a function of the constants J_i and the variables w_i . What we want to find is what sort of mathematical function the q 's are of the w 's. To do this, we examine the change in a particular w_i when each of the variables q_j is taken through an integral number, m_j , of cycles of libration or rotation. In carrying out this purely mathematical procedure, we are clearly *not* following the motion of the system in time. It is as if the flow of time were suspended and each of the q 's were moved, manually as it were, independently through a number of cycles of their motion. In effect, we are dealing with analogues of the virtual displacements of Chapter 1, and accordingly the infinitesimal change in w_i as the q_j 's are changed infinitesimally will be denoted by δw_i and is given by

$$\delta w_i = \sum_j \frac{\partial w_i}{\partial q_j} dq_j = \sum_j \frac{\partial^2 W}{\partial J_i \partial q_j} dq_j,$$

where use has been made of Eq. (10.104). The derivative with respect to q_i vanishes except for the W_j constituent of W , so that by Eq. (10.98) δw_i reduces to

$$\delta w_i = \frac{\partial}{\partial J_i} \sum_j p_j(q_j, J) dq_j. \quad (10.107)$$

Equation (10.107) represents δw_i as the sum of independent contributions each involving the q_j motion. The total change in w_i as a result of the specified ma-

never is therefore

$$\Delta w_i = \sum_j \frac{\partial}{\partial J_i} \oint_{m_j} p_j(q_j, J) dq_j. \quad (10.108)$$

the differential operator with respect to J_i can be kept outside the integral signs because throughout the cyclic motion of q_i all the J 's are of course constant. Below each integral sign, the symbol m_j indicates the integration is over m_j cycles of q_j . But each of the integrals is, by the definition of the action variables, exactly $m_j J_j$. Since the J 's are independent, it follows that

$$\Delta w_i = m_i. \quad (10.109)$$

Further, note that if any q_j does not go through a complete number of cycles, then in the integration over q_j there will be a remainder of an integral over a fraction of a cycle and Δw_i will not have an integral value. If the sets of w 's and m 's are treated as vectors \mathbf{w} and \mathbf{m} , respectively, Eq. (10.109) can be written as

$$\Delta \mathbf{w} = \mathbf{m}. \quad (10.109')$$

Suppose, first, that the separable motions are all of the libration type so that each q_j , as well as p_j , returns to its initial value on completion of a complete cycle. The result described by Eq. (10.109') could now be expressed somewhat as follows: $\boldsymbol{\eta}$ (the vector of q 's and p 's) is such a function of \mathbf{w} that a change $\Delta \boldsymbol{\eta} = 0$ corresponds to a change $\Delta \mathbf{w} = \mathbf{m}$, a vector of integer values. Since the number of cycles in the chosen motions of q_j are arbitrary, \mathbf{m} can be taken as zero except for $m_i = 1$, and all the components of $\boldsymbol{\eta}$ remain unchanged or return to their original values. Hence, in the most general case the components of $\boldsymbol{\eta}$ must be periodic functions of *each* w_i with period unity; that is, the q 's and p 's are multiply periodic functions of the w 's with unit periods. Such a multiply periodic function can always be represented by a multiple Fourier expansion, which for q_k , say, would appear as

$$q_k = \sum_{j_1=-\infty}^{\infty} \sum_{j_2=-\infty}^{\infty} \cdots \sum_{j_n=-\infty}^{\infty} a_{j_1, \dots, j_n}^{(k)} \cdot e^{2\pi i(j_1 w_1 + j_2 w_2 + j_3 w_3 + \cdots + j_n w_n)}, \quad (\text{libration}) \quad (10.110)$$

where the j 's are n integer indices running from $-\infty$ to ∞ . By treating the set of j 's also as a vector in the same n -dimensional space with \mathbf{w} , the expansion can be written more compactly as

$$q_k = \sum_{\mathbf{j}} a_{\mathbf{j}}^{(k)} a^{2\pi i \mathbf{j} \cdot \mathbf{w}}, \quad (\text{libration}). \quad (10.110')$$

If we similarly write Eq. (10.109') as a vector equation,

$$\mathbf{w} = \mathbf{v}t + \boldsymbol{\beta}, \quad (10.106')$$

then the time dependence of q_k appears in the form

$$q_k(t) = \sum_{\mathbf{j}} a_{\mathbf{j}}^{(k)} e^{2\pi i \mathbf{j} \cdot (\mathbf{v}t + \boldsymbol{\beta})}, \quad (\text{libration}). \quad (10.111)$$

Note that in general $q_k(t)$ is *not* a periodic function of t . Unless the various v_i 's are commensurate (that is, rational multiples of each other), q_k will not repeat its values at regular intervals of time. Considered as a function of t , q_k is designated as a *quasi-periodic* function. Finally it should be remembered that the coefficients $a_{\mathbf{j}}^{(k)}$ can be found by the standard procedure for Fourier coefficients; that is, they are given by the multiple integral over the unit cell in \mathbf{w} space:

$$a_{\mathbf{j}}^{(k)} = \int_0^1 \cdots \int_0^1 q_k(\mathbf{w}) e^{-2\pi i \mathbf{j} \cdot \mathbf{w}} (d\mathbf{w}). \quad (10.112)$$

Here $(d\mathbf{w})$ stands for the volume element in the n -dimensional space of the w_i 's.

When the motion is in the nature of a rotation, then in a complete cycle of the separated variable pair (q_k, p_k) the coordinate q_k does not return to its original value, but instead increases by the value of its period q_{0k} . Such a rotation coordinate is therefore not itself even multiply periodic. However, during the cycle we have seen that w_k increases by unity. Hence, the function $q_k - w_k q_{0k}$ does return to its initial value and, like the librational coordinates, is a multiply periodic function of all the w 's with unit periods. We can therefore expand the function in a multiple Fourier series analogous to Eq. (10.110)

$$q_k - w_k q_{0k} = \sum_{\mathbf{j}} a_{\mathbf{j}}^{(k)} e^{2\pi i \mathbf{j} \cdot \mathbf{w}}, \quad (\text{rotation}) \quad (10.113)$$

or

$$q_k = q_{0k}(v_k t + \beta_k) + \sum_{\mathbf{j}} a_{\mathbf{j}}^{(k)} e^{2\pi i \mathbf{j} \cdot (\mathbf{v}t + \boldsymbol{\beta})}, \quad (\text{rotation}). \quad (10.114)$$

Thus, it is always possible to derive a multiply periodic function from a rotation coordinate, which can then be handled exactly like a libration coordinate. To simplify the further discussion, we shall therefore confine ourselves primarily to the libration type of motion.

The separable momentum coordinates, p_k , are by the nature of the assumed motion also multiply periodic functions of the w 's and can be expanded in a multiple Fourier series similar to Eq. (10.110). It follows then that any function of the several variable pairs (q_k, p_k) will also be multiply periodic functions of the w 's and can be written in the form

$$f(q, p) = \sum_{\mathbf{j}} b_{\mathbf{j}} e^{2\pi i \mathbf{j} \cdot \mathbf{w}} = \sum_{\mathbf{j}} b_{\mathbf{j}} e^{2\pi i \mathbf{j} \cdot (\mathbf{v}t + \boldsymbol{\beta})}. \quad (10.115)$$

For example, where the Cartesian coordinate of particles in the system are not themselves the separation coordinates, they can still be written as functions of time in the fashion of Eq. (10.115).

While Eqs. (10.110) and (10.111) represent the most general type of motion consistent with the assumed nature of the problem, not all systems will exhibit this full generality. In particular, for most problems simple enough to be used as illustrations of the application of action-angle variables, Eq. (10.104) simplifies to

$$w_i = \frac{\partial w_i}{\partial J_i}(q_i; J_1, \dots, J_n) \quad (10.116)$$

and each separation coordinate q_i is a function only of its corresponding w_k . When this happens, q_k is then a periodic function of w_k (and therefore of time), and the multiple Fourier series reduces to a single Fourier series:

$$q_k = \sum_j a_j^{(k)} e^{2\pi i j w_k} = \sum_j a_j^{(k)} e^{2\pi i j (v_k t + \beta_k)}. \quad (10.117)$$

In the language of Chapter 6, in such problems the q_k 's are in effect the normal coordinates of the system. However, even when the motion in the q 's can be so simplified, it frequently happens that functions of all the q 's, such as Cartesian coordinates, remain multiply periodic functions of the w 's and must be represented as in Eq. (10.115). If the various frequencies v_k are incommensurate, then such functions are not periodic functions of time. The motion of a two-dimensional anisotropic harmonic oscillator provides a convenient and familiar example of these considerations.

Suppose that in a particular set of Cartesian coordinates the Hamiltonian is given by

$$H = \frac{1}{2m} [(p_x^2 + 4\pi^2 m^2 v_x^2 x^2) + (p_y^2 + 4\pi^2 m^2 v_y^2 y^2)].$$

These Cartesian coordinates are therefore suitable separation variables, and each will exhibit simple harmonic motion with frequencies v_x and v_y , respectively. Thus, the solutions for x and y are particularly simple forms of the single Fourier expansions of Eq. (10.117). Suppose now that the coordinates are rotated 45° about the z axis; the components of the motion along the new x' , y' axes will be

$$\begin{aligned} x' &= \frac{1}{\sqrt{2}} [x_0 \cos 2\pi(v_x t + \beta_x) + y_0 \cos 2\pi(v_y t + \beta_y)], \\ y' &= \frac{1}{\sqrt{2}} [y_0 \cos 2\pi(v_y t + \beta_y) - x_0 \cos 2\pi(v_x t + \beta_x)]. \end{aligned} \quad (10.118)$$

If v_x/v_y is a rational number, these two expressions will be commensurate, corresponding to closed Lissajous figures of the type shown in Fig. 10.4. But if v_x and v_y are incommensurable, the Lissajous figure never exactly retraces its steps and Eqs. (10.118) provide simple examples of multiply periodic series expansions of the form (10.117).

Even when q_k is a multiply periodic function of all the w 's, we intuitively feel there must be a special relationship between q_k and its corresponding w_k (and

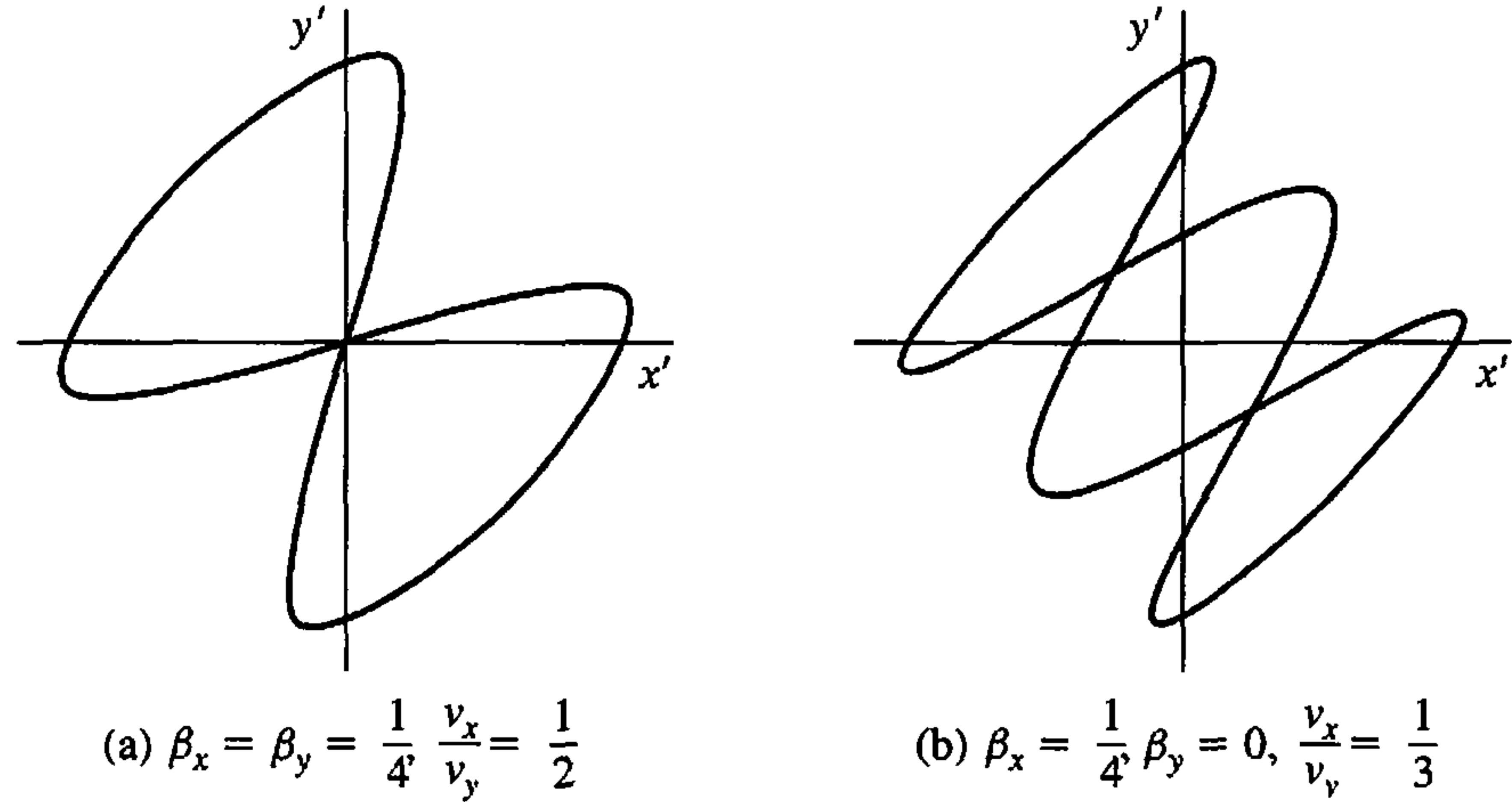

FIGURE 10.4 Lissajous figures for Eq. (10.118). (a) $\beta_x = \beta_y = \frac{1}{4}, \frac{v_x}{v_y} = \frac{1}{2}$ (b) $\beta_x = \frac{1}{4}, \beta_y = 0, \frac{v_x}{v_y} = \frac{1}{3}$.

therefore v_k). After all, the argument culminating in Eq. (10.109) says that when q_k alone goes through its complete cycle, w_k increases by unity, while the other w 's return to their initial values. It was only in 1961 that J. Vinti succeeded in expressing this intuitive feeling in a precise and rigorous statement.*

Suppose that the time interval T contains m complete cycles of q_k plus a fraction of a cycle. In general, the times required for each successive cycle will be different, since q_k will not be a periodic function of t . Then Vinti showed, on the basis of a theorem in number theory, that as T increases indefinitely,

$$\lim_{T \rightarrow \infty} \frac{m}{T} = v_k. \quad (10.119)$$

The *mean* frequency of the motion of q_k is therefore always given by v_k , even when the entire motion is more complicated than a periodic function with frequency v_k .

Barring commensurability of all the frequencies, a multiply periodic function can always be formed from the generating function W . The defining equation for J_i , Eq. (10.102), in effect states that when q_i goes through a complete cycle; that is, when w_i changes by unity, the characteristic function increases by J_i . It follows that the function

$$W' = W - \sum_k w_k J_k \quad (10.120)$$

remains unchanged when *each* w_k is increased by unity, all the other angle variables remaining constant. Equation (10.120) therefore represents a multiply periodic function that can be expanded in terms of the w_i (or of the frequencies v_i) by a series of the form of Eq. (10.115). Since the transformation equations for the

*J. Vinti, *J. Res. Nat. Bur. Standards*, **65B**, 131 (1961).

angle variables are

$$w_k = \frac{\partial W}{\partial J_k},$$

it will be recognized that Eq. (10.120) defines a Legendre transformation from the q, J basis to the q, w basis. Indeed, comparison with Eq. (9.15) in combination with Eq. (9.12) shows that if $W(q, J)$ is a generating function of the form $F_2(q, P)$, then $W'(q, w)$ is the corresponding generating function of the type $F_1(q, Q)$, transforming in both cases from the (q, p) variables to the (w, J) variables. While W' thus generates the same transformation as W , it is of course *not* a solution of the Hamilton–Jacobi equation.

It has been emphasized that the system configuration is multiply periodic only if the frequencies ν_i are not rational fractions of each other. Otherwise, the configuration repeats after a sufficiently long time and would therefore be simply periodic. The formal condition for the commensurability of two frequencies ν_i and ν_j is that they satisfy the relation $j_i \nu_i = j_j \nu_j$ (no sum) where j_i and j_j are nonzero positive integers. For complete commensurability, all pairs of frequencies must satisfy relations of the form

$$j_i \nu_i = j_k \nu_k, \quad (\text{no sum}) \quad (10.121)$$

where the j_i and j_k are nonzero positive integers.

When we can express any ν_i as a rational fraction of any of the other frequencies, the system is said to be *completely commensurate*. If only $m + 1$ of the n frequencies satisfy Eq. (10.121), the system is said to be m -fold commensurate. For example, consider the set of seven frequencies $\nu_1 = 3$ MHz, $\nu_2 = 5$ MHz, $\nu_3 = 7$ MHz, $\nu_4 = 2\sqrt{2}$ MHz, $\nu_5 = 3\sqrt{2}$ MHz, $\nu_6 = \sqrt{3}$ MHz, $\nu_7 = \sqrt{7}$ MHz. The first three $\nu_1, \nu_2,$ and ν_3 are triply commensurate, the next two ν_4 and ν_5 are doubly commensurate.

There is an interesting connection between commensurability and the coordinates in which the Hamilton–Jacobi equation is separable. It can be shown that the path of the system point for a noncommensurate system completely fills a limited region of both configuration and phase space. This can be seen in the Lissajous figures of incommensurate frequencies.

Suppose the problem is such that the motion in any one of the separation coordinates is simply periodic and has therefore been shown to be independent of the motion of the other coordinates. Hence, the path of the system point as a whole must be limited by the surfaces of constant q_i and p_i that mark the bounds of the oscillatory motion of the separation variables. (The argument is easily extended to rotation by limiting all angles to the region 0 to 2π .) These surfaces therefore define the volume in space that is densely filled by the system point orbit. It follows that the separation of variables in noncommensurate systems must be unique; the Hamilton–Jacobi equation cannot be separated in two different coordinate systems (aside from trivial variations such as change of scale). The possibility of separating the motion in more than one set of coordinates thus normally provides evidence that the system is commensurate.

The simplest example of being commensurate is degeneracy which occurs when two or more of the frequencies are equal. If two of the force constants in a three-dimensional harmonic oscillator are equal, then the corresponding frequencies are identical and the system is singly degenerate. In an isotropic linear oscillator, the force constants are the same along all directions, all frequencies are equal, and the system is completely degenerate.

Whenever this simple degeneracy is present, the fundamental frequencies are no longer independent, and the periodic motion of the system can be described by less than the full complement of n frequencies. Indeed, the m conditions of degeneracy can be used to reduce the number of frequencies to $n - m + 1$. The reduction of the frequencies may be most elegantly performed by means of a point transformation of the action-angle variables. The m degeneracy conditions may be written where j_{ki} are positive or negative integers

$$\sum_{i=1}^n j_{ki} v_i = 0, \quad k = 1, \dots, m. \quad (10.122)$$

Consider now a point transformation from (w, J) to (w', J') defined by the generating function (cf. Eq. (9.26) where the summation convention is used):

$$F_2 = \sum_{k=1}^m \sum_{i=1}^n J'_k j_{ki} w_i + \sum_{k=m+1}^n J'_k w_k. \quad (10.123)$$

The transformed coordinates are

$$\begin{aligned} w'_k &= \sum_{i=1}^n j_{ki}, & k &= 1, \dots, m, \\ &= w_k, & k &= m+1, \dots, n. \end{aligned} \quad (10.124)$$

Correspondingly, the new frequencies are

$$\begin{aligned} v'_k &= \dot{w}'_k = \sum_{i=1}^n j_{ki} v_i = 0 & k &= 1, \dots, m, \\ &= v_k & k &= m+1, \dots, n. \end{aligned} \quad (10.125)$$

Thus in the transformed coordinates, m of the frequencies are zero, and we are left with a set of $n - m$ independent frequencies plus the zero frequency. It is obvious that the new w'_k may also be termed as angle variables in the sense that the system configuration is multiply periodic in the w'_k coordinates with the fundamental period unity. The corresponding constant action variables are given as the solution of the n equations of transformation

$$J_i = \sum_{k=1}^m J'_k j_{ki} + \sum_{k=m+1}^n J'_k \delta_{ki}. \quad (10.126)$$

The zero frequencies correspond to constant factors in the Fourier expansion. These are of course also present in the original Fourier series in terms of the v 's, Eq. (10.110), occurring whenever the indices j_i are such that degeneracy conditions are satisfied. Since

$$v'_i = \frac{\partial H}{\partial J'_i},$$

the Hamiltonian must be independent of the action variables J'_i whose corresponding frequencies vanish. In a completely degenerate system, the Hamiltonian can therefore be made to depend upon only one of the action variables.

Note that Hamilton's characteristic function W also serves as the generating function for the transformation from the (q, p) set to the (w', J') set. Since the J' quantities are n independent constants, the original constants of integration may be expressed in terms of the J' set, and W given as $W(q, J')$. In this form, it is a generating function to a new set of canonical variables for which the J' quantities are the canonical momenta. But by virtue of the point transformation generated by the F_2 of Eq. (10.123), we know that w' is conjugate to J' . Hence, it follows that the new coordinates generated by $W(q, J')$ must be the angle variable w' set, with equations of transformation given by

$$w'_i = \frac{\partial W}{\partial J'_i}. \quad (10.127)$$

(For a more formal proof of Eq. (10.127) based on the algebraic structure of Eq. (10.123), see Derivation 3.)

The problem of the bound motion of a particle in an inverse-square law central force illustrates many of the phenomena involved in degeneracy. A discussion of this problem also affords an opportunity to show how the action-angle technique is applied to specific systems, and to indicate the connections with Bohr's quantum mechanics and with celestial mechanics. Accordingly, the next section is devoted to a detailed treatment of the Kepler problem in terms of action-angle variables.

10.8 ■ THE KEPLER PROBLEM IN ACTION-ANGLE VARIABLES*

To exhibit all of the properties of the solution, we shall examine the motion in three dimensional space, rather than make use of our a priori knowledge that the orbit lies in a plane. In terms of spherical polar coordinates, the Kepler problem becomes a special case of the general treatment given above in Section 10.5 for central force motion in space. Equations (10.70) through (10.77) can be taken over here immediately, replacing $V(r)$ wherever it occurs by its specific form

$$V(r) = -\frac{k}{r}. \quad (10.128)$$

*The summation convention will be resumed from here on.

Since the potential $V(r)$ depends only upon one of the three coordinates, it follows that the Hamilton–Jacobi equation is completely separable in spherical polar coordinates. We shall confine our discussion to the bound case, that is, $E < 0$. Hence, the motion in each of the coordinates will be periodic—libration in r and θ , and rotation in ϕ . The conditions for the application of action-angle variables are thus satisfied, and we can proceed to construct the action variables on the basis of the defining equation (10.102). From Eq. (10.72), it follows that

$$J_\phi = \oint \frac{\partial W}{\partial \phi} d\phi = \oint \alpha_\phi d\phi. \quad (10.129a)$$

Similarly, on the basis of Eq. (10.74), J_θ is given by

$$J_\theta = \oint \frac{\partial W}{\partial \theta} d\theta = \oint \sqrt{\alpha_\theta^2 - \frac{\alpha_\phi^2}{\sin^2 \theta}} d\theta. \quad (10.129b)$$

Finally the integral for J_r from Eq. (10.75), is

$$J_r = \oint \frac{\partial W}{\partial r} dr = \oint \sqrt{2mE + \frac{2mk}{r} - \frac{\alpha_\theta^2}{r^2}} dr. \quad (10.129c)$$

The first integral is trivial; ϕ goes through 2π radians in a complete revolution and therefore

$$J_\phi = 2\pi\alpha_\phi = 2\pi p_\phi. \quad (10.130)$$

This result could have been predicted beforehand, for ϕ is a cyclic coordinate in H , and Eq. (10.130) is merely a special case of Eq. (10.101) for the action variables corresponding to cyclic coordinates. Integration of Eq. (10.129b) can be performed in various ways; a procedure involving only elementary rules of integration will be sketched here. If the polar angle of the total angular momentum vector is denoted by i , so that

$$\cos i = \frac{\alpha_\phi}{\alpha_\theta}, \quad (10.131)$$

then Eq. (10.129b) can also be written as

$$J_\theta = \alpha_\theta \oint \sqrt{1 - \cos^2 i \csc^2 \theta} d\theta. \quad (10.132)$$

The complete circuitual path of integration is for θ going from a limit $-\theta_0$ to $+\theta_0$ and back again, where $\sin \theta_0 = \cos i$, or $\theta_0 = (\pi/2) - i$. Hence, the circuitual integral can be written as 4 times the integral over from 0 to θ_0 , or after some manipulation,

$$J_\theta = 4\alpha_\theta \int_0^{\theta_0} \csc \theta \sqrt{\sin^2 i - \cos^2 \theta} d\theta.$$

The substitution

$$\cos \theta = \sin i \sin \psi$$

transforms the integral to

$$J_\theta = 4\alpha_\theta \sin^2 i \int_0^{\pi/2} \frac{\cos^2 \psi \, d\psi}{1 - \sin^2 i \sin^2 \psi}. \quad (10.133)$$

Finally, with the substitution

$$u = \tan \psi,$$

the integral becomes

$$\begin{aligned} J_\theta &= 4\alpha_\theta \sin^2 i \int_0^\infty \frac{du}{(1+u^2)(1+u^2 \cos^2 i)} \\ &= 4\alpha_\theta \int_0^\infty du \left(\frac{1}{1+u^2} - \frac{\cos^2 i}{1+u^2 \cos^2 i} \right). \end{aligned} \quad (10.134)$$

This last form involves only well-known integrals, and the final result* is

$$J_\theta = 2\pi \alpha_\theta (1 - \cos i) = 2\pi (\alpha_\theta - \alpha_\phi). \quad (10.135)$$

The last integral (Eq. (10.129c)), for J_r , can now be written as

$$J_r = \oint \sqrt{2mE + \frac{2mk}{r} - \frac{(J_\theta + J_\phi)^2}{4\pi^2 r^2}} \, dr. \quad (10.136)$$

After performing the integration, this equation can be solved for the energy $E \equiv H$ in terms of the three action variables J_ϕ , J_θ , J_r . Note that J_ϕ and J_θ can occur in E only in the combination $J_\theta + J_\phi$, and hence the corresponding frequencies ν_ϕ and ν_θ must be equal, indicating a degeneracy. This result has not involved the inverse-square law nature of the central force; *any motion produced by a central force is at least singly degenerate*. The degeneracy is of course a consequence of the fact that the motion is confined to a plane normal to the constant angular momentum vector \mathbf{L} . Motion in this plane implies that θ and ϕ are related to each other such that as ϕ goes through a complete 2π period, θ varies through a complete cycle between the limits $(\pi/2) \pm i$. Hence, the frequencies in θ and ϕ are necessarily equal.

The integral involved in Eq. (10.136) can be evaluated by elementary means, but the integration is most elegantly and quickly performed using the complex

*In evaluating the integral of the second term in the final integrand of Eq. (10.134), it has been assumed that $\cos i$ is positive. This is always possible, since there is no preferred direction for the z axis in the problem and it may be chosen at will. If $\cos i$ were negative, the sign of α_ϕ in Eq. (10.135) would be positive. For changes in the subsequent formulas, see Exercise 23.

contour integration method of residues. For the benefit of those familiar with this technique, we shall outline the steps involved in integrating Eq. (10.136). Bound motion can occur only when E is negative (cf. Section 3.3), and since the integrand is equal to $p_r = m\dot{r}$, the limits of the motion are defined by the roots r_1 and r_2 of the expression in the square root sign. If r_1 is the inner bound, as in Fig. 3.6, a complete cycle of r involves going from r_1 to r_2 and then back again to r_1 . On the outward half of the journey, from r_1 to r_2 , p_r is positive and we must take the positive square root. However, on the return trip to r_1 , p_r is negative and the square root must likewise be negative. The integration thus involves both branches of a double-valued function, with r_1 and r_2 as the branch points. Consequently, the complex plane can be represented as one of the sheets of a Riemann surface, slit along the real axis from r_1 to r_2 (as indicated in Fig. 10.5).

Since the path of integration encloses the line between the branch points r_1 and r_2 , the method of residues cannot be applied directly. However, we may also consider the path as enclosing all the rest of the complex plane, the direction of integration now being in the reverse (clockwise) direction. The integrand is single-valued in this region, and there is now no bar to the application of the method of residues. Only two singular points are present, namely, the origin and infinity, and the integration path can be distorted into two clockwise circles enclosing these two points. Now, the sign in front of the square root in the integrand must be negative for the region along the real axis below r_1 , as can be seen by examining the behavior of the function in the neighborhood of r_1 . If the integrand is represented as

$$-\sqrt{A + \frac{2B}{r} - \frac{C}{r^2}},$$

the residue at the origin is

$$R_0 = -\sqrt{-C}.$$

Above r_2 , the sign of the square root on the real axis is found to be positive, and the residue is obtained by the standard technique of changing the variable of integration to $z = r^{-1}$:

$$-\oint \frac{1}{z^2} \sqrt{A + 2Bz - Cz^2} dz. \quad (10.137)$$

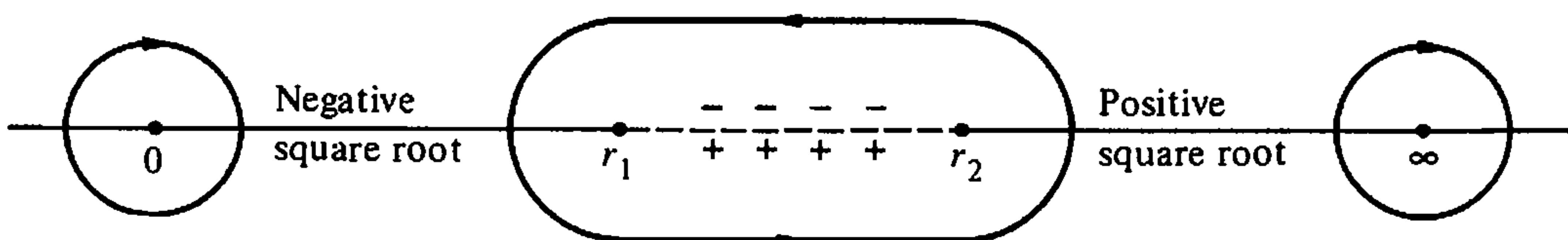

FIGURE 10.5 The complex r plane in the neighborhood of the real axis; showing the paths of integration occurring in the evaluation of J .

Expansion about $z = 0$ now furnishes the residue

$$R_\infty = -\frac{B}{\sqrt{A}}.$$

The total integral is $-2\pi i$ times the sum of the residues:

$$J_r = 2\pi i \left(\sqrt{-C} + \frac{B}{\sqrt{A}} \right), \quad (10.138)$$

or, upon substituting the coefficients A , B , and C :

$$J_r = -(J_\theta + J_\phi) + \pi k \sqrt{\frac{2m}{-E}}. \quad (10.139)$$

Equation (10.139) supplies the functional dependence of H upon the action variables; for solving for E , we have

$$H \equiv E = -\frac{2\pi^2 m k^2}{(J_r + J_\theta + J_\phi)^2}. \quad (10.140)$$

Note that, as predicted, J_θ and J_ϕ occur only in the combination $J_\theta + J_\phi$. More than that, all three of the action variables appear only in the form $J_r + J_\theta + J_\phi$. Hence, all of the frequencies are equal; *the motion is completely degenerate*. This result could also have been predicted beforehand, for we know that with an inverse-square law of force the orbit is closed for negative energies. With a closed orbit, the motion is simply periodic and therefore, in this case, completely degenerate. If the central force contained an r^{-3} term, such as is provided by first-order relativistic corrections, then the orbit is no longer closed but is in the form of a precessing ellipse. One of the degeneracies will be removed in this case, but the motion is still singly degenerate, since $\nu_\theta = \nu_\phi$ for all central forces. The one frequency for the motion here is given by

$$\nu = \frac{\partial H}{\partial J_r} = \frac{\partial H}{\partial J_\theta} = \frac{\partial H}{\partial J_\phi} = \frac{4\pi^2 m k^2}{(J_r + J_\theta + J_\phi)^3}. \quad (10.141)$$

If we evaluate the sum of the J 's in terms of the energy from Eq. (10.140) the period of the orbit is

$$\tau = \pi k \sqrt{\frac{m}{-2E^3}}. \quad (10.142)$$

This formula for the period agrees with Kepler's third law, Eq. (3.71), if it is remembered that the semimajor axis a is equal to $-k/2E$.

The degenerate frequencies may be eliminated by canonical transformation to a new set of action-angle variables, following the procedure outlined in the previous section. Expressing the degeneracy conditions as

$$\nu_\phi - \nu_\theta = 0, \quad \nu_\theta - \nu_r = 0,$$

the appropriate generating function is

$$F = (w_\phi - w_\theta)J_1 + (w_\theta - w_r)J_2 + w_r J_3. \quad (10.143)$$

The new angle variables are

$$\begin{aligned} w_1 &= w_\phi - w_\theta \\ w_2 &= w_\theta - w_r, \\ w_3 &= w_r, \end{aligned} \quad (10.144)$$

and, as planned, two of the new frequencies, ν_1 and ν_2 , are zero. We can obtain the new action variables from the transformation equations

$$\begin{aligned} J_\phi &= J_1, \\ J_\theta &= J_2 - J_1, \\ J_r &= J_3 - J_2, \end{aligned}$$

which yields the relations

$$\begin{aligned} J_1 &= J_\phi, \\ J_2 &= J_\phi + J_\theta, \\ J_3 &= J_\phi + J_\theta + J_r. \end{aligned} \quad (10.145)$$

In terms of these transformed variables the Hamiltonian appears as

$$H = -\frac{2\pi^2 mk^2}{J_3^2}, \quad (10.146)$$

a form involving only that action variable for which the corresponding frequency is different from zero.

If we are willing to use, from the start, our a priori knowledge that the motion for the bound Kepler problem is a particular closed orbit in a plane, then the integrals for J_θ and J_r can be evaluated very quickly and simply. For the J_θ integral, we can apply the following procedure. It will be recalled that when the defining equations for the generalized coordinates do not involve time explicitly, then (cf. Eq. (8.20) and the material following (8.20))

$$p_i \dot{q}_i = 2L_2 \dot{q}_i \dot{q}_i = 2T.$$

Knowing that the motion is confined to a plane, we can express the kinetic energy T either in spherical polar coordinates or in the plane polar coordinates (r, ψ) . It follows, then, that

$$2T = p_r \dot{r} + p_\theta \dot{\theta} + p_\phi \dot{\phi} = p_r \dot{r} + p\dot{\psi}, \quad (10.147)$$

where p ($\equiv l$) is the magnitude of the total angular momentum. Hence, the definition for J_θ can also be written as

$$J_\theta \equiv \oint p_\theta d\theta = \oint p d\psi - \oint p_\phi d\phi. \quad (10.148)$$

Because the frequencies for θ and ϕ are equal, both ϕ and ψ vary by 2π as θ goes through a complete cycle of libration, and the integrals defining J_θ reduce to

$$J_\theta = 2\pi(p - p_\phi) = 2\pi(\alpha_\theta - \alpha_\phi),$$

in agreement with Eq. (10.135).

The integral for J_r , Eq. (10.136), was evaluated in order to obtain $H \equiv E$ in terms of the three action variables. If we use the fact that the closed elliptical orbit in the bound Kepler problem is such that the frequency for r is the same as that for θ and ϕ , then the functional dependence of H on J can also be obtained from Eq. (10.147). In effect then we are evaluating J_r in a different way. The virial theorem for the bound orbits in the Kepler problem says that (cf. Eq. (3.30))

$$\bar{V} = -2\bar{T},$$

where the bar denotes an average over a single complete period of the motion. It follows that

$$H \equiv E = \bar{T} + \bar{V} = -\bar{T}. \quad (10.149)$$

Integrating Eq. (10.147) with respect to time over a complete period of motion we have

$$\frac{2\bar{T}}{v_3} = J_r + J_\theta + J_\phi = J_3, \quad (10.150)$$

where v_3 is the frequency of the motion, that is, the reciprocal of the period. Combining Eqs. (10.149) and (10.150) leads to the relation

$$-\frac{2}{J_3} = \frac{v_3}{H} = \frac{1}{H} \frac{dH}{dJ_3}, \quad (10.151)$$

where use has been made of Eq. (10.105). Equation (10.151) is in effect a differential equation for the functional behavior of H on J_3 . Integration of the equation immediately leads to the solution

$$H = \frac{D}{J_3^2}, \quad (10.152)$$

where D is a constant that cannot involve any of the J 's, and must therefore depend only upon m and k . Hence, we can evaluate D by considering the elementary case of a circular orbit, of radius r_0 , for which $J_r = 0$ and $J_3 = 2\pi p$. The total energy is here

$$H = -\frac{k}{2r_0} \quad (10.153)$$

(as can most immediately be seen from the virial theorem). Further, the condition for circularity, Eq. (3.40), can be written for the inverse-square force law as

$$\frac{k}{r_0^2} = \frac{p^2}{mr_0^3} = \frac{J_3}{4\pi^2mr_0^3}. \quad (10.154)$$

Eliminating r_0 between Eqs. (10.153) and (10.154) leads to

$$H = -\frac{2\pi^2mk^2}{J_3^2}. \quad (10.155)$$

This result has been derived only for circular orbits. But Eq. (10.152) says it must also be correct for *all* bound orbits of the Kepler problem, and indeed it is identical with Eq. (10.146). Thus, if the existence of a single period for all coordinates is taken as known beforehand, it is possible to obtain $H(J)$ without direct evaluation of the circuital integrals.

In any problem with three degrees of freedom, there must of course be six constants of motion. It has previously been pointed out that in the Kepler problem five of these are algebraic functions of the coordinates and momenta and describe the nature of the orbit in space, and only the last refers to the position of the particle in the orbit at a given time (cf. Sections 3.7 to 3.9). It is easy to see that five parameters are needed to completely specify, say, the elliptical orbit of the bound Kepler problem in space. Since the motion is in a plane, two constants are needed to describe the orientation of that plane in space. One constant is required to give the *scale* of the ellipse, for example, the semimajor axis a , and the other the *shape* of the ellipse, say, through the eccentricity e . Finally, the fifth parameter must specify the *orientation* of the ellipse relative to some arbitrary direction in the orbital plane.

The classical astronomical *elements* of the orbit provide the orbital parameters almost directly in the form given above. Two of the angles appearing in these elements have unfamiliar but time-honored names. Their definitions, and functions as orbital parameters, can best be seen from a diagram, such as is given in Fig. 10.6. Here xyz defines the chosen set of axes fixed in space, and the unit vector \mathbf{n} characterizes the normal to the orbital plane. The intersection between the xy plane and the orbital plane is called the *line of nodes*. There are two points on the line of nodes at which the elliptical orbit intersects the xy plane; the point at which the particle enters from below into the upper hemisphere (or goes from the “southern” to the “northern” hemispheres) is known as the *ascending node*. In Fig. 10.6, the portion of the orbit in the southern hemisphere is shown, for clarity, as a dashed line. The dot-dashed line ON is a portion of the line of nodes containing the ascending node. We can measure the direction of ON in the xy plane by the angle xON , which is customarily denoted by Ω , and is known as the *longitude*

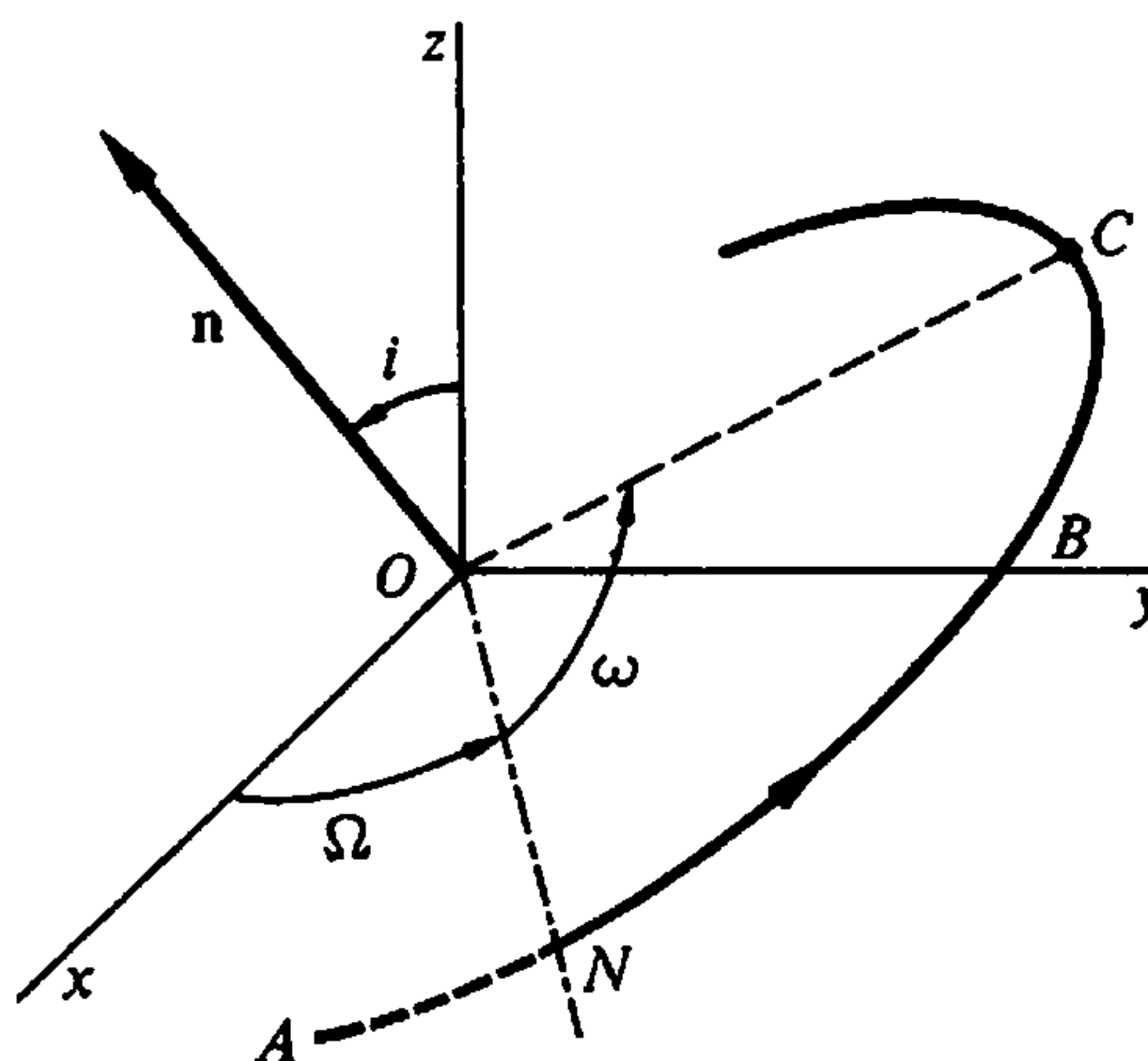

FIGURE 10.6 Angular elements of the orbit in the bound Kepler problem.

of the ascending node. Finally, if C denotes the point of periaapsis in the orbit, then the angle NOC in the orbital plane is denoted by ω and is called the *argument of the perihelion*.^{*} The more familiar angle i , introduced in Eq. (10.131), is in its astronomical usage known as the *inclination of the orbit*. One usual set of astronomical elements therefore consists of the six constants

$$i, \Omega, a, e, \omega, T,$$

where the last one, T , is the time of passage through the periaapsis point. Of the remaining five, the first two define the orientation of the orbital plane in space, while a , e , and ω directly specify the scale, shape, and orientation of the elliptic orbit, respectively.

The action-angle variable treatment of the Kepler problem also leads to five algebraic constants of the motion. Three of them are obvious as the three constant action variables, J_1 , J_2 , and J_3 . The remaining two are the angle variables w_1 and w_2 , which are constants, because their corresponding frequencies are zero. It must therefore be possible to express the five constants J_1 , J_2 , J_3 , w_1 , and w_2 in terms of the classical orbital elements i , Ω , a , e , and ω , and vice versa. Some of these interrelations are immediately obvious. From Eqs. (10.145) and (10.135) it follows that

$$J_2 = 2\pi\alpha_\theta \equiv 2\pi l, \quad (10.156)$$

and hence, by Eq. (10.131),

$$\frac{J_1}{J_2} = \cos i. \quad (10.157)$$

As is well known, the semimajor axis a is a function only of the total energy E (cf. Eq. (3.61)) and therefore, by Eq. (10.146), a is given directly in terms of J_3 :

^{*}This terminology appears to be commonly used even for orbits that are not around the sun. The proper term for orbits about stars is periastra; for Earth-orbiting satellites, this term is perigee.

$$a = -\frac{k}{2E} = \frac{J_3^2}{4\pi^2mk}. \quad (10.158)$$

In terms of J_2 , Eq. (3.62) for the eccentricities can be written as

$$e = \sqrt{1 - \frac{J_2^2}{4\pi^2mka}},$$

or

$$e = \sqrt{1 - \left(\frac{J_2}{J_3}\right)^2}. \quad (10.159)$$

It remains only to relate the angle variables w_1 and w_2 to the classic orbital elements. Obviously, they must involve Ω and ω . In fact, it can be shown that for suitable choice of additive constants of integration they are indeed proportional to Ω and ω , respectively. This will be demonstrated for w_1 ; the identification of w_2 will be left as an exercise.

The equation of transformation defining w_1 is, by Eq. (10.127),

$$w_1 = \frac{\partial W}{\partial J_1}.$$

It can be seen from the separated form of W , Eq. (10.71), that W can be written as the sum of indefinite integrals:

$$W = \int p_\phi d\phi + \int p_\theta d\theta + \int p_r dr. \quad (10.160)$$

As we have seen from the discussion on J_r , the radial momentum p_r does not involve J_1 , but only J_3 (through E) and the combination $J_\theta + J_\phi = J_2$. Only the first two integrals are therefore involved in the derivative with respect to J_1 . By Eq. (10.130),

$$p_\phi = \alpha_\phi = \frac{J_1}{2\pi}, \quad (10.161)$$

and by Eq. (10.74), with the help of Eqs. (10.156) and (10.161),

$$p_\theta = \pm \sqrt{\alpha_\theta^2 - \frac{\alpha_\phi^2}{\sin^2 \theta}} = \pm \frac{1}{2\pi} \sqrt{J_2^2 - \frac{J_1^2}{\sin^2 \theta}}. \quad (10.162)$$

It turns out that in order to relate w_1 to the ascending node, it is necessary to choose the negative sign of the square root.* The angular variable w_1 is therefore determined by

*Note that when the particle passes through the ascending node (cf. Fig. 10.6) θ is *decreasing* and the corresponding momentum is negative. In calculating J_θ , it was not necessary to worry about the choice of sign because in going through a complete cycle both signs are encountered.

$$w_1 = \frac{\phi}{2\pi} + \frac{J_1}{2\pi} \int \frac{d\theta}{\sin^2 \theta \sqrt{J_2^2 - J_1^2 \csc^2 \theta}},$$

or

$$\begin{aligned} 2\pi w_1 &= \phi + \cos i \int \frac{d\theta}{\sin^2 \theta \sqrt{1 - \cos^2 i \csc^2 \theta}} \\ &= \phi + \int \frac{\cot i \csc^2 \theta d\theta}{\sqrt{1 - \cot^2 i \cot^2 \theta}}. \end{aligned}$$

By a change of variable to u , defined through

$$\sin u = \cot i \cot \theta, \quad (10.163)$$

the integration can be performed trivially, and the expression for w_1 reduces to

$$2\pi w_1 = \phi - u. \quad (10.164)$$

The angle coordinate ϕ is the azimuthal angle of the projection on the xy plane measured relative to the x axis. Clearly, from Eq. (10.163) u is a function of the polar angle θ of the particle. But what is its geometrical significance? We can see what u is by reference to Napier's rules* as applied to the spherical triangle defined by the line of nodes, the radius vector, and the projection of the radius vector on the xy plane. However, it may be more satisfying to indulge in a little trigonometric manipulation and derive the relation *ab initio*. In Fig. 10.7, the line ON is the line of nodes, OR is the line of the radius vector at some time, and the dotted line OP is the projection of the radius vector on the xy plane. The angle that OP makes with the x axis is the azimuth angle ϕ . We contend that u is the angle OP makes with the line of nodes. To prove this, imagine a plane normal both to the xy plane and to the line of nodes, which intersects the radius vector at unit distance OB from the origin O . The points of intersection A , B , and C of this plane, with the three lines from the origin, define with the origin four right triangles. Since OB has unit length, it follows that $BC = \cos \theta$ and therefore $AC = \cos \theta \cot i$. On the other hand, $OC = \sin \theta$ and therefore it is also true that $AC = \sin \theta \sin u$. Hence, $\sin u = \cot i \cot \theta$, which is identical with Eq. (10.163) and proves the stipulated identification of the angle u . Figure 10.7 shows clearly that the difference between ϕ and u must be Ω , so that

$$2\pi w_1 = \Omega. \quad (10.165)$$

In a similar fashion, we can identify the physical nature of the constant w_2 . Of the integrals making up W , Eq. (10.160), the two over θ and r contain J_2 and

*For an explanation of Napier's rules for spherical triangles, see handbooks such as the *Handbook of Mathematical Tables* (Chemical Rubber Publishing Co.) or *Handbook of Applied Mathematics* (Van Nostrand-Reinhold).

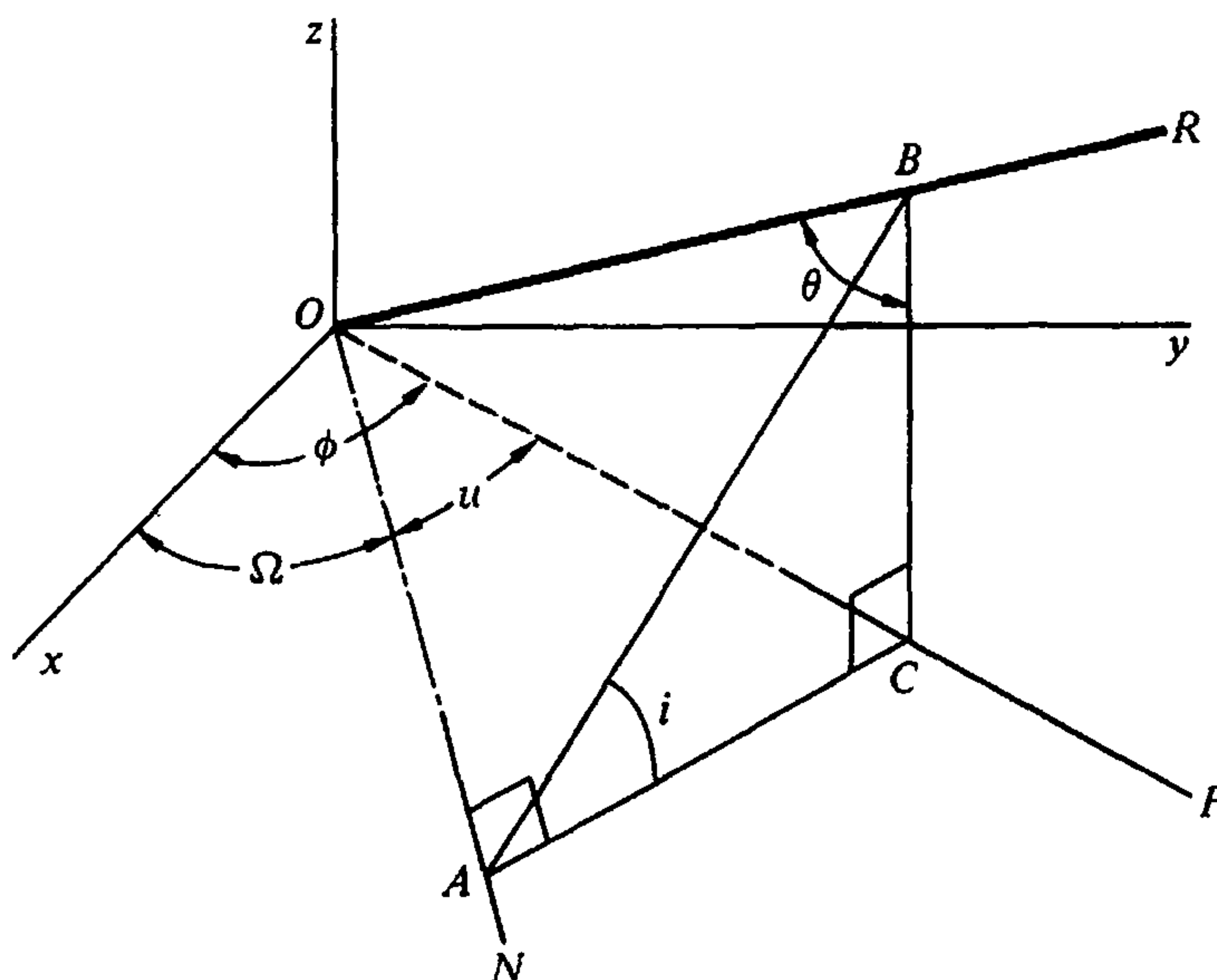

FIGURE 10.7 Diagram illustrating angles appearing in action-angle treatment of the Kepler problem.

are therefore involved in finding w_2 . After differentiation with respect to J_2 , the integral over θ can be performed by the same type of trigonometric substitution as employed for w_1 . The corresponding integral over r can be carried out in a number of ways, most directly by using the orbit equation for r in terms of the polar coordinate angle in the orbital plane. By suitable choice of the arbitrary lower limit of integration, it can thus be found that $2\pi w_2$ is the difference between two angles in the orbital plane, one of which is the angle of the radius vector relative to the line of nodes and the other is the same angle but relative to the line of the periastron. In other words, $2\pi w_2$ is the argument of the perihelion:

$$2\pi w_2 = \omega. \quad (10.166)$$

Detailed derivation is left to one of the exercises.

The method of action-angle variables is certainly not the quickest way to solve the Kepler problem, and the practical usefulness of the set of variables is not obvious. However, their value has long been demonstrated in celestial mechanics, where they appear under the guise of the *Delaunay variables*.* As will be seen in Section 12.2, they provide the natural orbital elements that can be used in perturbation theory, to describe the modifications of the nominal Kepler orbits produced by small deviations of the force from the inverse-square law. Many of the basic studies on possible perturbations of satellite orbits were carried out in terms of the action-angle variables.

*As customarily defined, the Delaunay variables differ from the (J_i, w_i) set by multiplicative constants.

DERIVATIONS

1. For a conservative system show that by solving an appropriate partial differential equation we can construct a canonical transformation such that the new Hamiltonian is a function of the new *coordinates* only. (Do not use the exchange transformation, F_1 .) Show how a formal solution to the motion of the system is given in terms of the new coordinates and momenta.
2. In the text, the Hamilton–Jacobi equation for S was obtained by seeking a contact transformation from the canonical coordinates (q, p) to the constants (α, β) . Conversely, if $S(q_i, \alpha_i, t)$ is any complete solution of the Hamilton–Jacobi equation (10.3), show that the set of variables (Q_i, p_i) defined by Eqs. (10.7) and (10.8) are canonical variables, that is, that they satisfy Hamilton’s equations.
3. In the action-angle formalism, the arguments of Hamilton’s characteristic function are the original coordinates q_k and the action variables J_k . In the case of degeneracy, a subsequent canonical transformation is made to new variables (w'_i, J'_i) from (w_k, J_k) , in order to replace the degeneracies by zero frequencies. By considering each J_k a function of the J'_i quantities as defined by Eq. (10.126), show that it remains true that

$$\frac{\partial W}{\partial J'_i} = w'_i.$$

4. The so-called Poincaré elements of the Kepler orbits can be written as

$$\begin{array}{ll} w_1 + w_2 + w_3, & J_\phi, \\ \frac{J_r}{\pi} \cos 2\pi(w_2 + w_1), & \frac{J_r}{\pi} \sin 2\pi(w_2 + w_1), \\ \frac{J_\theta}{\pi} \cos 2\pi w_1, & \frac{J_\theta}{\pi} \sin 2\pi w_1. \end{array}$$

Show that they form a canonical set of coordinates, with the new coordinates forming the left-hand column, their conjugate momenta being given on the right-hand side.

EXERCISES

5. Show that the function

$$S = \frac{m\omega}{2}(q^2 + \alpha^2) \cot \omega t - m\omega q \alpha \csc \omega t$$

is a solution of the Hamilton–Jacobi for Hamilton’s principal function for the linear harmonic oscillator with

$$H = \frac{1}{2m}(p^2 + m^2\omega^2 q^2).$$

Show that this function generates a correct solution to the motion of the harmonic oscillator.

6. A charged particle is constrained to move in a plane under the influence of a central force potential (nonelectromagnetic) $V = \frac{1}{2}kr^2$, and a constant magnetic field \mathbf{B}

perpendicular to the plane, so that

$$\mathbf{A} = \frac{1}{2} \mathbf{B} \times \mathbf{r}$$

Set up the Hamilton–Jacobi equation for Hamilton’s characteristic function in plane polar coordinates. Separate the equation and reduce it to quadratures. Discuss the motion if the canonical momentum p_θ is zero at time $t = 0$.

7. (a) A single particle moves in space under a conservative potential. Set up the Hamilton–Jacobi equation in ellipsoidal coordinates u, v, ϕ defined in terms of the usual cylindrical coordinates r, z, ϕ by the equations

$$r = a \sinh v \sin u, \quad z = a \cosh v \cos u.$$

For what forms of $V(u, v, \phi)$ is the equation separable?

- (b) Use the results of part (a) to reduce to quadratures the problem of a point particle of mass m moving in the gravitational field of two unequal mass points fixed on the z axis a distance $2a$ apart.
8. Suppose the potential in a problem of one degree of freedom is linearly dependent upon time, such that the Hamiltonian has the form

$$H = \frac{p^2}{2m} - mAtx,$$

where A is a constant. Solve the dynamical problem by means of Hamilton’s principal function, under the initial conditions $t = 0, x = 0, p = mv_0$.

9. Set up the plane Kepler problem in terms of the generalized coordinates

$$u = r + x,$$

$$v = r - x.$$

Obtain the Hamilton–Jacobi equation in terms of these coordinates, and reduce it to quadratures (at least).

10. One end of a uniform rod of length $2l$ and mass m rests against a smooth horizontal floor and the other against a smooth vertical surface. Assuming that the rod is constrained to move under gravity with its ends always in contact with the surfaces, use the Hamilton–Jacobi equations to reduce the solution of the problem to quadratures.
11. A particle is constrained to move on a roller coaster, the equation of whose curve is

$$z = A \cos^2 \frac{2\pi x}{\lambda}.$$

There is the usual constant downward force of gravity. Discuss the system trajectories in phase space under all possible initial conditions, describing the phase space orbits in as much detail as you can, paying special attention to turning points and transitions between different types of motion.

12. A particle of mass m moves in a plane in a square well potential:

$$\begin{aligned} V(r) &= -V_0 & 0 < r < r_0, \\ &= 0 & r > r_0. \end{aligned}$$

- (a) Under what initial conditions can the method of action-angle variables be applied?
 (b) Assuming these conditions hold, use the method of action-angle variables to find the frequencies of the motion.
13. A particle moves in periodic motion in one dimension under the influence of a potential $V(x) = F|x|$, where F is a constant. Using action-angle variables, find the period of the motion as a function of the particle's energy.
14. A particle of mass m moves in one dimension under a potential $V = -k/|x|$. For energies that are negative, the motion is bounded and oscillatory. By the method of action-angle variables, find an expression for the period of motion as a function of the particle's energy.
15. A particle of mass m moves in one dimension subject to the potential

$$V = \frac{a}{\sin^2\left(\frac{x}{x_0}\right)}.$$

Obtain an integral expression for Hamilton's characteristic function. Under what conditions can action-angle variables be used? Assuming these are met, find the frequency of oscillation by the action-angle method. (The integral for J can be evaluated by manipulating the integrand so that the square root appears in the denominator.) Check your result in the limit of oscillations of small amplitude.

16. A particle of mass m is constrained to move on a curve in the vertical plane defined by the parametric equations

$$\begin{aligned} y &= l(1 - \cos 2\phi), \\ x &= l(2\phi + \sin 2\phi). \end{aligned}$$

There is the usual constant gravitational force acting in the vertical y direction. By the method of action-angle variables, find the frequency of oscillation for all initial conditions such that the maximum of ϕ is less than or equal to $\pi/4$.

17. Solve the problem of the motion of a point projectile in a vertical plane, using the Hamilton–Jacobi method. Find both the equation of the trajectory and the dependence of the coordinates on time, assuming the projectile is fired off at time $t = 0$ from the origin with the velocity v_0 , making an angle α with the horizontal.
18. For the system described in Exercise 12 of Chapter 6, find a linear point transformation to variables in which the Hamilton–Jacobi equation is separable. By use of the action-angle variables, find the eigenfrequencies of the system.
19. A three-dimensional harmonic oscillator has the force constant k_1 in the x - and y -directions and k_3 in the z -direction. Using cylindrical coordinates (with the axis of the cylinder in the z direction), describe the motion in terms of the corresponding action-angle variables, showing how the frequencies can be obtained. Transform to the “proper” action-angle variables to eliminate degenerate frequencies.
20. Find the frequencies of a three-dimensional harmonic oscillator with *unequal* force constants using the method of action-angle variables. Obtain the solution for each Cartesian coordinate and conjugate momentum as functions of the action-angle variables.

21. (a) In the harmonic oscillator of Exercise 20, allow all the frequencies to become equal (isotropic oscillator) so that the motion is completely degenerate. Transform to the “proper” action-angle variables, expressing the energy in terms of only one of the action variables.
- (b) Solve the problem of the isotropic oscillator in action-angle variables using spherical polar coordinates. Transform again to proper action-angle variables and compare with the result of part (a). Are the two sets of proper variables the same? What are their physical significances? This problem illustrates the feasibility of separating a degenerate motion in more than one set of coordinates. The nondegenerate oscillator can be separated only in Cartesian coordinates, not in polar coordinates.
22. The motion of a degenerate plane harmonic oscillator can be separated in any Cartesian coordinate system. Obtain the relations between the two sets of action-angle variables corresponding to two Cartesian systems of axes making an angle θ with each other. Note that the transformation between the two sets is *not* the orthogonal transformation of the rotation.
23. (a) Evaluate the J_θ integral in the Kepler problem by the method of complex contour integration. To get the integral into a useful form, it is suggested that the substitution $\cos \theta = x \sin i$ might be made.
- (b) Verify the integration procedure used for J_θ in the text, carrying out the final integrations in Eq. (10.134).
- (c) Follow the consequences of the inclination being greater than 90° , that is, $\cos i$ negative. In particular, what are the changes in Eq. (10.135), in the canonical transformations to zero frequencies and therefore in Eqs. (10.145)? Can you write these equations in such a form that they are valid whether $\cos i$ is positive or negative? Justify your answer.
24. Evaluate the integral for J_r in the Kepler problem by elementary means. This includes using tables of integrals, but if so, explicit and detailed references should be given to the tables used.
25. Show, but the method outlined in the text (or any other), that $2\pi w_2$ is ω , the argument of the periapsis, in the three-dimensional Kepler problem.
26. Set up the problem of the heavy symmetrical top, with one point fixed, in the Hamilton–Jacobi method, and obtain the formal solution to the motion as given by Eq. (5.63).
27. Describe the phenomenon of small radial oscillations about steady circular motion in a central force potential as a one-dimensional problem in the action-angle formalism. With a suitable Taylor series expansion of the potential, find the period of the small oscillations. Express the motion in terms of J and its conjugate angle variable.
28. Set up the problem of the relativistic Kepler motion in action-angle variables, using the Hamiltonian in the form given by Eq. (8.54). Show in particular that the total energy (including rest mass) is given by

$$\frac{E}{mc^2} = \frac{1}{\sqrt{1 + \frac{4\pi^2 k^2}{[(J'_3 - J'_2)c + \sqrt{J'^2_2 c^2 - 4\pi^2 k^2}]^2}}}$$

Note that the degeneracy has been partly lifted, because the orbit is no longer closed, but is still confined to a plane. In the limit as c approaches infinity, show that this reduces to Eq. (10.146).

CHAPTER

11

Classical Chaos

We have in the previous chapters devoted most of our attention to integrable problems, that is, problems in which the equations of motion can be integrated to provide solutions in closed form. For example, in Sections 3.7 and 3.8 we found exact solutions for the two-body, inverse-square force law problem by integrations of the equations of motion. For many physical situations exact solutions cannot be found. In the next chapter we shall examine problems with potentials that can be broken into a main integrable part and a weaker additional part that renders the problem nonintegrable, but that can be taken into account by applying classical perturbation theory. A weak interaction term might, for example, couple together two equations of motion so the variables are no longer separable. The present chapter deals with some situations involving perturbations and lack of integrability that cannot be conveniently handled by classical perturbation theory.

If the interaction term is no longer “small” in the sense of classical perturbation theory (cf. Section 12.1), the solutions may become complex and differ considerably from those of the uncoupled equations. In some cases new solutions appear that cannot be generated from the uncoupled equations. These solutions are often well behaved in the sense that a small change in the initial conditions brings about only a small change in the motion. When this is the case, the solutions are referred to as regular or normal. There also exist cases in which the motion evolves in entirely different ways even for nearly identical starting circumstances. Solutions of this type are referred to as *chaotic*. It is important to point out that this chaos still involves deterministic solutions to deterministic equations. They are called chaotic because, although deterministic, they are not predictable because they are highly sensitive to initial conditions. If we consider two bounded solutions in the nonchaotic regime that start nearby within a small region of phase space, the phase space region covered by the solutions at a later time will still be relatively small and compact as expected from Liouville’s theorem (cf. Section 9.9). In the chaotic regime, the sector of phase space covered by these solutions will continually disperse in one or more directions with the passage of time.

Chaos is a type of motion that lies between the regular deterministic trajectories arising from solutions of integrable equations and a state of noise or unpredictable stochastic behavior characterized by complete randomness. Chaos exhibits extensive randomness tempered by some regularity. Chaotic trajectories arise from the motion of nonlinear systems, which is nonperiodic, but still somewhat predictable. Specific solutions change exponentially in response to small

changes in the initial conditions. In this chapter we shall examine some of the properties of this chaotic motion, and give examples of it.

This chapter is only an introduction to the subject of chaos; it presents the general principles that underlie chaotic motion. We begin with a discussion of periodic motion in general, and we discuss ways to transform it to circular motions in phase space. Then we add perturbations that disturb the regular motion, and examine the Kolmogorov–Arnold–Moser (KAM) theorem, which provides conditions for the breakdown of regularity. We introduce the Liapunov exponent as a quantitative measure of chaos through dispersion in phase space and use it to summarize some predictions concerning the stability of the solar system. The role played by attractors in nonchaotic motion is explained, as well as the characteristics of the strange attractor involved in chaos. Our next task is to show how to conveniently display the regularities and irregularities of motion with the aid of Poincaré sections. We then examine the motions of independent oscillators and, using the Hénon–Heiles Hamiltonian as an example, we introduce the effect of a perturbation interaction and demonstrate that orbits that are initially regular will, when subject to a continual increase in the magnitude of the perturbing coupling potential, gradually transform to a state of chaos. The logistic equation is treated in detail and used to explain *bifurcations* and *invariants*, including a universal constant associated with chaos. Some brief comments are made on nonintegral dimensionality and fractals before closing.

11.1 ■ PERIODIC MOTION

In Chapter 3, we discussed bounded motion with an emphasis on motion in which the orbits are closed; that is, the trajectory repeats itself every period. The simple harmonic oscillator and the Kepler problem are examples of closed periodic motion. In the latter case there are two periodicities, the radial coordinate r varies from its minimum value r_1 at perihelion to its maximum r_2 at aphelion and then back to perihelion during the time that the angular motion goes from $\theta = 0$ to $\theta = 2\pi$. Hence, the periods for the radial and the angular motions are the same. These periods exemplify two types of motion that are degenerate. We know from Section 3.2 that the rate of change, $\dot{\theta}$, depends upon the radial distance r

$$\dot{\theta}(t) = \frac{\ell}{mr^2}, \quad (3.8)$$

and the rate of change of r is a complicated analytical closed-form expression. The angular speed $v_\theta = r\dot{\theta}$ depends upon the angle θ in the manner sketched in Fig. 3.17. In Chapter 3, we showed how to integrate the equations of motion to obtain the polar coordinate equation for the orbit

$$r = \frac{a(1 - e^2)}{1 + e \cos \theta}, \quad (3.64)$$

where the origin of the angular coordinate, $\theta = 0$, is chosen at perihelion. Figures 3.16 and 3.17 present phase space plots in the v_r versus r and v_θ versus θ planes, respectively, for Kepler orbits with the same energy and different eccentricities.

In Section 10.6, we found that a convenient way to represent periodic motion is to carry out a variant of the Hamilton–Jacobi procedure and transform the Hamiltonian to action-angle variables. The new momentum, called the action variable $J = \oint p dq$ is a constant of the motion, and the new conjugate coordinate w depends linearly upon the time: $w = \omega t + \beta$. We are interested in a Hamiltonian $\mathcal{H}(q_1, q_2, \dots, q_n; p_1, p_2, \dots, p_n; t)$ of a conservative system containing several variables p_i, q_i , which exhibits bounded motion. If this Hamiltonian \mathcal{H} is transformed to a new set of canonical variables P_i, Q_i in which all of the Q_i 's are cyclic, that is, $\mathcal{H} = \mathcal{H}(P_1, P_2, \dots, P_n; t)$, then Hamilton's equations (8.18) can be readily integrated to provide the solution

$$Q_i(t) = w(t) = \omega_i t + \beta_i \quad P_i(t) = P_i(0) - \alpha_i, \quad (11.1)$$

where the $2n$ constants of integration β_i and α_i are invariants of the motion. When canonical transformations exist that provide this type of solution, then the Hamiltonian is said to be integrable. This solution is similar to the action-angle variables discussed in Chapter 10. For the motion to remain bounded, that is, confined to a finite region of phase space, the coordinates $w(t)$, which are growing linearly with the time, must be arguments of bounded functions, and in many cases, they will be arguments of periodic functions, as is the case with the radial variable r of Eq. (3.64) quoted above.

In Sections 10.2 and 10.7, we showed that the Hamiltonian of a harmonic oscillator can undergo a canonical transformation to conjugate coordinates and momenta with the time dependencies of Eqs. (11.1). It follows that a Hamiltonian with the coordinates $Q_i(t)$ and $P_i(t)$ can be transformed to that of a harmonic oscillator in standard form, with the coordinates q'_i, p'_i . For the case $n = 2$, this gives

$$\mathcal{H} = \frac{p_1'^2}{2m_1} + \frac{1}{2}m_1\omega_1^2 q_1'^2 + \frac{p_2'^2}{2m_2} + \frac{1}{2}m_2\omega_2^2 q_2'^2, \quad (11.2)$$

which corresponds to a system of two uncoupled harmonic oscillators with a Hamiltonian that equals the total energy

$$\mathcal{H} = \mathcal{H}_1 + \mathcal{H}_2 = E_T, \quad (11.3)$$

where we have, in action variable notation (cf. (10.94))

$$\mathcal{H}_1 = \frac{J_1\omega_1}{2\pi} = E_1 \quad \text{and} \quad \mathcal{H}_2 = \frac{J_2\omega_2}{2\pi} = E_2. \quad (11.4)$$

To visualize the motion, we can express each individual oscillator in normalized coordinates

$$p_i \Rightarrow \frac{p'_i}{(2m_i)^{1/2}} \quad \text{and} \quad q_i \Rightarrow q'_i \left(\frac{1}{2}m\omega_i^2\right)^{1/2}. \quad (11.5)$$

Each part \mathcal{H}_i of Hamiltonian (11.3) corresponds to the equation of a circle in its p_i, q_i plane of phase space

$$p_i^2 + q_i^2 = E_i. \quad (11.6)$$

Figure 11.1 illustrates these circles by presenting constant total energy $E_T = E_1 + E_2$ plots in the p_1, q_1 plane for $E_1 < E_2$ (small circle), $E_1 \sim E_2$ (medium-size circle) and $E_1 > E_2$ (large circle).

This representation of an oscillator by uniform circular motion provides us with an easy way to picture the motion associated with the double oscillator (11.2), where for convenience we select $\omega_2 \gg \omega_1$. Consider the movement of the low-frequency oscillator ω_1 proceeding along a circle of large radius in the p_1, q_1 plane and then plot the trajectory of the high-frequency oscillator ω_2 along a small circle in a p_2, q_2 plane drawn perpendicular to the circle of ω_1 and centered on its circumference, as shown in Fig. 11.2 for the case $\omega_2 \gg \omega_1$. The joint motion in the total phase space is a spiraling of the system point along the surface of a torus, as illustrated in the figure. If the frequency ω_2 is a multiple of ω_1 , meaning that their ratio is an integer

$$\frac{\omega_2}{\omega_1} = n, \quad (11.7)$$

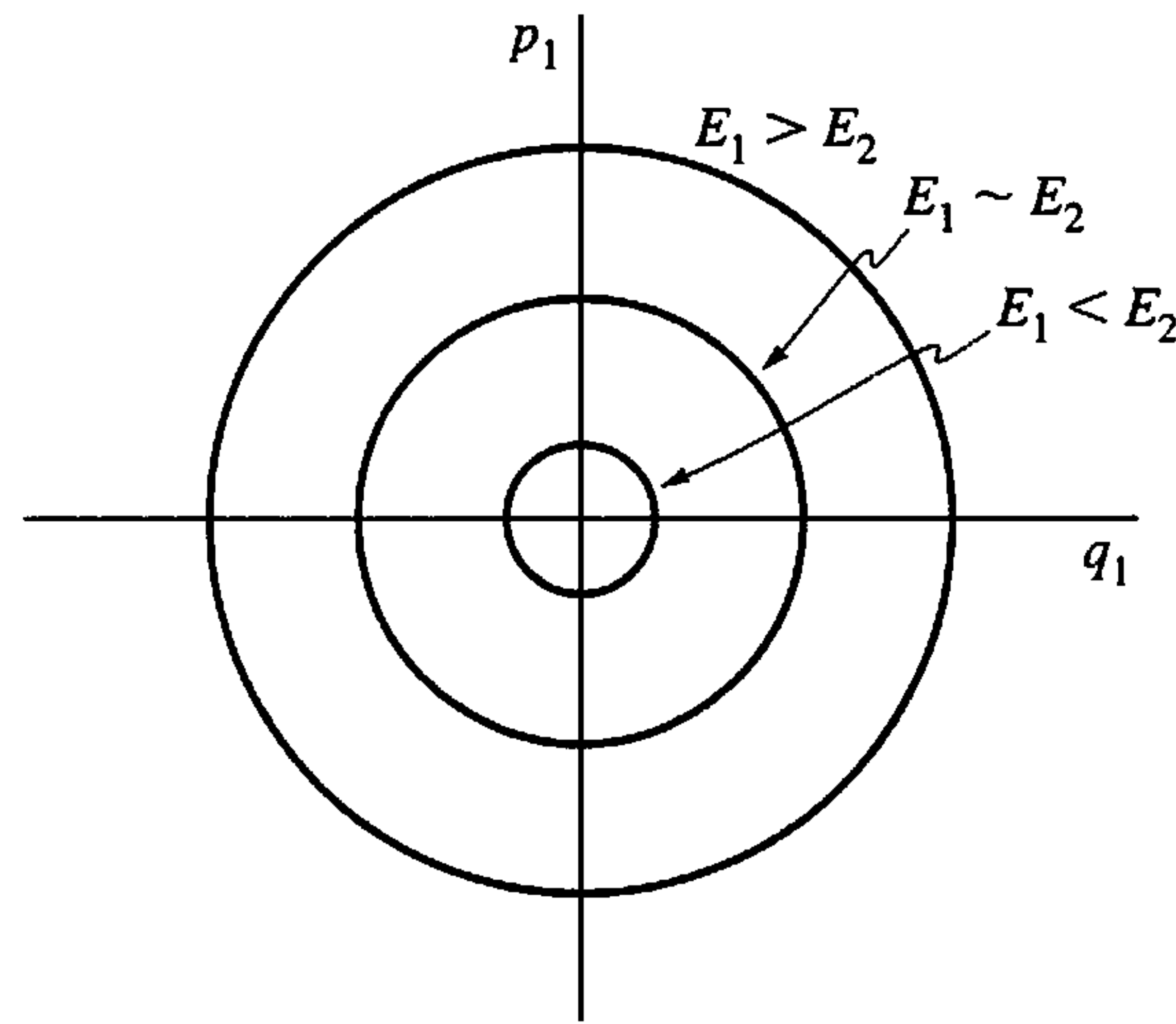

FIGURE 11.1 Circular orbits in the p_1, q_1 phase space for three values of the energy ratio E_1/E_2 of two uncoupled harmonic oscillators plotted for the same total energy $E_T = E_1 + E_2$.

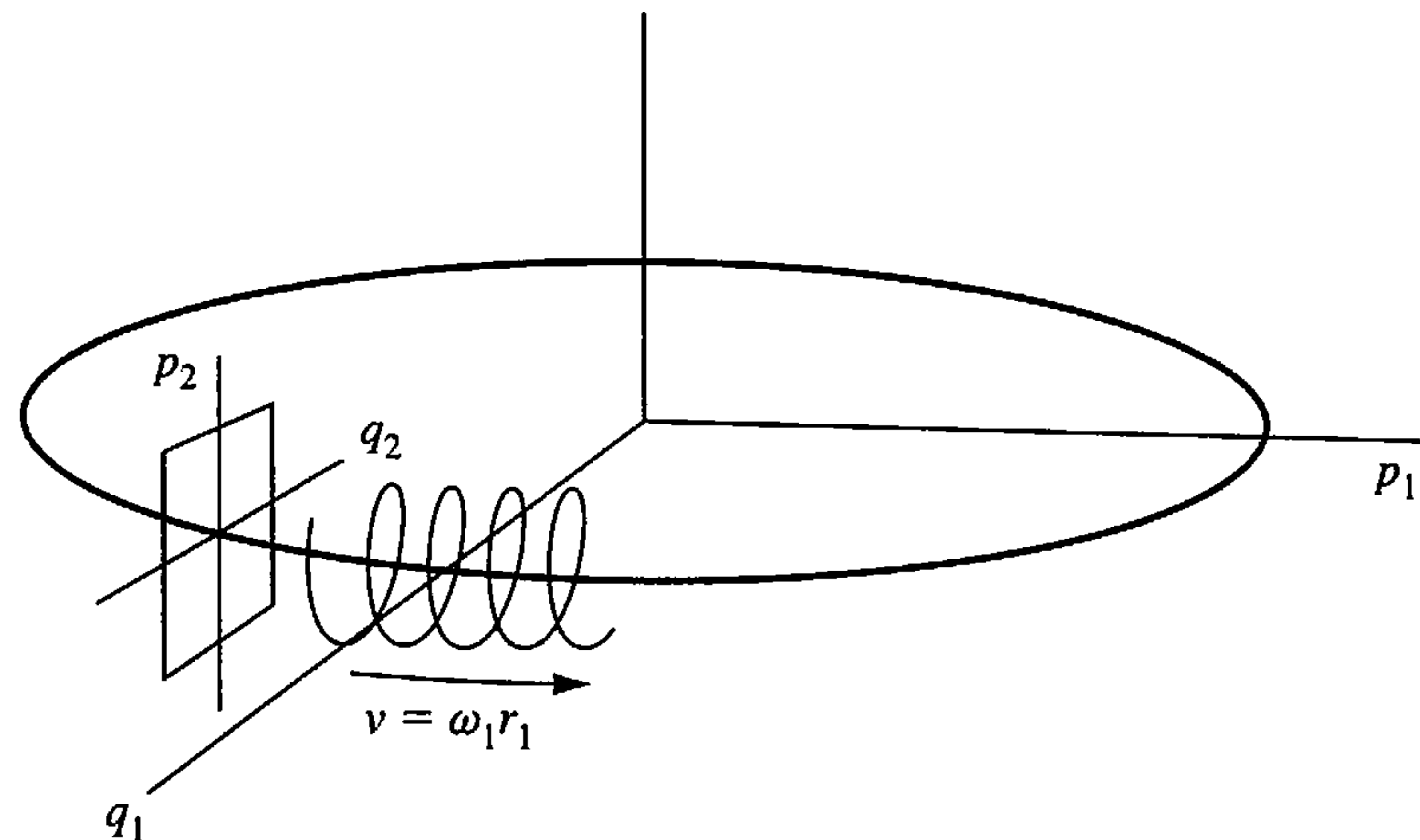

FIGURE 11.2 Circular motions of a low-frequency (ω_1) harmonic oscillator in the horizontal p_1, q_1 plane and of a high-frequency ($\omega_2 > \omega_1$) harmonic oscillator in the uniformly moving p_2, q_2 vertical plane. The oscillators are uncoupled, and the resultant spiraling motion of the second oscillator generates a torus, as shown.

then the trajectory will close on itself and repeat the same pattern every period $\tau_1 = 2\pi/\omega_1$. More generally, if the frequencies are commensurate, meaning that n in this Eq. (11.7) is a rational number like $\frac{2}{3}$, then the orbit will still be closed, but it will trace out more than one path around the p_1, q_1 circle before closing on itself. If, however, the frequencies are incommensurate, meaning that n in Eq. (11.7) is an irrational number, then the trajectory will never close, but will gradually cover the surface of the torus, without ever passing through exactly the same point twice. Eventually, however, it will pass arbitrarily close to every point on the surface. This is called a dense periodic orbit. Such an orbit is bounded and confined to a surface, but it is not closed.

This approach can be generalized to more than two oscillators. If there are three such oscillators with the frequencies ω_1, ω_2 , and ω_3 , then the motion will be confined to a three-dimensional surface called a 3-torus in the six-dimensional $p_1, p_2, p_3, q_1, q_2, q_3$ phase space. For N oscillators, there will be an N -torus in a $2N$ -dimensional phase space. It is not easy to visualize the N -tori for $N > 2$.

11.2 ■ PERTURBATIONS AND THE KOLMOGOROV–ARNOLD–MOSER THEOREM

In the real world we can often express the dynamics of a system in terms of an integrable Hamiltonian perturbed by a small interaction that makes it nonintegrable. An example is the motion of Earth in a Keplerian orbit around the Sun primarily perturbed by the presence of the planets Mars and Jupiter. This interaction is so weak that there is very little disturbance of Earth's orbit. Weak interactions of this type are most conveniently treated with the aid of canonical perturbation theory, which is explained in detail in Chapter 12. The following outline of the method

discussed in Section 12.2 is sufficient for the consideration of chaos. References are given to the equations in Chapter 12 but reading the chapter is not necessary to follow the arguments, so we have placed this chapter first.

We assume a Hamiltonian \mathcal{H} involving a dominant interaction arising from an integrable Hamiltonian \mathcal{H}_0 for which the solution is known, plus an additional interaction arising from a small perturbation term $\Delta\mathcal{H}$

$$\mathcal{H} = \mathcal{H}_0 + \Delta\mathcal{H}. \quad (11.8)$$

It is convenient to use the generating function $S(q, P, t) = F_2(q, P, t)$ introduced in Section 9.1 to transform the dominant Hamiltonian term \mathcal{H}_0 from the phase space coordinates p, q to new coordinates P, Q of a transformed Hamiltonian $K_0(Q, P)$, that is identically zero, as was illustrated in the Hamilton–Jacobi approach of Chapter 10. Hamilton’s equations (10.1) for $K_0 = 0$ provide new coordinates and momenta, Q_0 and P_0 , which are constants of the motion. The same transformation carried out for the total Hamiltonian, $\mathcal{H} = \mathcal{H}_0 + \Delta\mathcal{H}_0$, provides a transformed Hamiltonian ΔK_0 , which can be used to obtain first-order corrections P_1, Q_1 to the time derivatives of the coordinates and momenta via Hamilton’s equations (cf. Equation (12.4))

$$\frac{\partial}{\partial P} \Delta K_0(P, Q) = \dot{Q}_1 \quad \frac{\partial}{\partial Q} \Delta K_0(P, Q) = -\dot{P}_1. \quad (11.9)$$

After differentiation, Q and P are replaced in ΔK_0 by their unperturbed forms, that is, by $q = Q_0$ and $p = P_0$. These expressions (11.9) can be integrated over time to give the first-order determination of $Q = Q_1$ and $P = P_1$. The procedure provides us with a new generating function $S(Q_1, P_1, t)$, and hence a new perturbed Hamiltonian ΔK_1 , which can be iterated to give the next higher-order terms Q_2 and P_2 , and so on. Further cycles of perturbation are obtained by iteration with the aid of the following relations (cf. Eq. (12.6)) with no summation intended:

$$\frac{\partial}{\partial P_i} \Delta K_i(P_i, Q_i) = \dot{Q}_{i+1}, \quad \frac{\partial}{\partial Q_i} \Delta K_i(P_i, Q_i) = -\dot{P}_{i+1}. \quad (11.10)$$

Thus, we have a systematic canonical iteration technique for obtaining better and better approximations to the solution when the perturbation $\Delta\mathcal{H}$ is present. This method can be continued to higher order, as discussed in Chapter 12.

We have seen that perturbation theory provides us with a solution when $\Delta\mathcal{H}$ is small relative to \mathcal{H}_0 , but the question arises as to whether the perturbed solution is stable, and whether or not the orbits will remain close to the unperturbed ones over long periods of time. Large perturbations can clearly disturb the regular motion. A theorem known as the *Kolmogorov–Arnold–Moser (KAM) theorem* provides the conditions for the breakdown of regularity. This theorem tells us that

If the bounded motion of an integrable Hamiltonian \mathcal{H}_0 is disturbed by a small perturbation, $\Delta\mathcal{H}$, that makes the total Hamiltonian, $\mathcal{H} = \mathcal{H}_0 + \Delta\mathcal{H}$, nonintegrable and if two conditions are satisfied:

- (a) the perturbation $\Delta\mathcal{H}$ is small, and
 (b) the frequencies ω_i of \mathcal{H}_0 are incommensurate,

then the motion remains confined to an N -torus, except for a negligible set of initial conditions that result in a meandering trajectory on the energy surface.

Thus, the perturbed orbits will be stable, only slightly altered in shape, and localized in the same region as the unperturbed ones. Another way to say this is to observe that for a perturbation of the Hamiltonian that is sufficiently small, most quasi-periodic orbits will only experience minimal changes. The method of proof for this theorem was originally suggested by Kolmogorov in 1954, and the proofs themselves, approached from different viewpoints, were worked out independently by Arnold and by Moser a decade later. A great deal of mathematical sophistication is needed for the proof, and references can be consulted for details.* For example, the second condition (b) of the theorem is mathematically more complex than simple incommensurability.

The caveat “except for a negligible set of initial conditions” introduces the possibility of initial conditions for which the theorem does not hold. This is analogous to the case of a differential equation with well-behaved solutions over an entire domain except for one or more singular points where the solutions blow up to infinity. The exceptions are so few that they have very little effect on applications. Chaos can occur when KAM does not hold.

11.3 ■ ATTRACTORS

The previous section was concerned with an integrable Hamiltonian \mathcal{H}_0 being disturbed by a small perturbation $\Delta\mathcal{H}$. We found that stable orbits of \mathcal{H}_0 persist as slightly modified but still stable orbits of the total Hamiltonian, $\mathcal{H} = \mathcal{H}_0 + \Delta\mathcal{H}$. Another case to consider is that of a system in which the initial conditions start the motion on a trajectory that does not lie on a stable path but that evolves toward a particular *fixed point* in phase space or toward a stable orbit in phase space called a *limit cycle*. A fixed point of this type as well as a limit cycle are examples of *attractors*.

In general, an *attractor* is a set of points in phase space to which the solution of an equation evolves long after transients have died out. It might be a point with dimension $d_A = 0$, a trajectory or limit cycle orbit (cf. Fig. 11.1) with dimension $d_A = 1$, or perhaps a toroidal surface or torus with dimension $d_A = 2$. For a regular attractor, the attractor dimension, d_A , is an integer that is less than the overall dimensions of the phase space. In higher dimensions, the attractors can be N -dimensional tori, where $d_A = 2$ for the torus generated by the orbit in Fig. 11.2. There also exist somewhat bizarre types of attractors called *strange attractors*,

*See, for example, H. Bai-Lin, *Chaos*, Singapore: World Science, 1984; E. A. Jackson, *Perspectives of Nonlinear Dynamics*, Cambridge, England: Cambridge University Press, 1989; L. E. Reichl, *The Transition to Chaos*, Berlin: Springer-Verlag, 1992.

associated with chaos, which tend to be widely dispersed rather than localized in phase space. In addition, they have fractal dimensions—in other words, dimensions that are fractions or irrational numbers rather than whole numbers. These properties, as well as the term *fractal dimension*, are counterintuitive. We shall clarify the meanings of strange attractors and fractal dimensions later in the chapter.

An example of a fixed-point attractor is the equilibrium position of a pendulum at rest. If the pendulum is oscillating while subject to the action of a weak frictional drag force, then successive oscillations will decrease in amplitude until the pendulum finally comes to a stop at its equilibrium position. We say that the motion is drawn to the attractor. If the drag force is a perturbation on the main Hamiltonian, then the motion is underdamped and the pendulum undergoes many oscillations before stopping at the attractor point. If the damping term exceeds the main Hamiltonian term, then the motion is overdamped and the pendulum falls to rest without undergoing any oscillations. Either way, the motion of the pendulum finds its way to the attractor. Being a point, it is clear that the dimensionality of this attractor is zero; $d_A = 0$.

An example of a limit cycle type of attractor is provided by the van der Pol equation,

$$m \frac{d^2x}{dt^2} - \epsilon(1 - x^2) \frac{dx}{dt} + m\omega_0^2 x = F \cos \omega_D t, \quad (11.11)$$

which has been employed to describe oscillations in mechanical and electrical systems, as well as cardiac rhythms. If we set $\epsilon = 0$, then we have a driven simple harmonic oscillator with a resonant frequency ω_0 and a driving frequency ω_D . If ω_D is close to ω_0 , then the motion repeats itself at the frequency ω_D of the applied force. If $F = 0$, then the motion will be simple harmonic at the resonant frequency ω_0 . If the small damping term $\epsilon(1 - x^2) dx/dt$ is included in the equation, then the motion will be drawn toward the limit cycle, which in this case is a circle of unit radius. If $x^2 > 1$, the damping is positive and the motion spirals inward toward the limit cycle, while for $x^2 < 1$, the damping is negative and the motion spirals outward toward the limit cycle. Both cases are shown in Fig. 11.3a. The final state of motion has long-term stability since the damping vanishes for $x = 1$, and the system point moves along the circular path, which by its nature has dimension $d_A = 1$. If ϵ is large enough, the damping term becomes comparable in magnitude to the other terms in the equation of motion, and the damping still draws the trajectories toward the limit cycle, but the cycle itself becomes distorted from a circular shape, as shown in Fig. 11.3b. The distortion in shape does not change the dimension of the path, which remains $d_A = 1$. In addition, the strong damping causes the previously simple harmonic oscillations $x = \sin \omega_0 t$ to decrease in frequency and become distorted, as shown in Fig. 11.3c. For very large damping, the shape approximates a square wave.

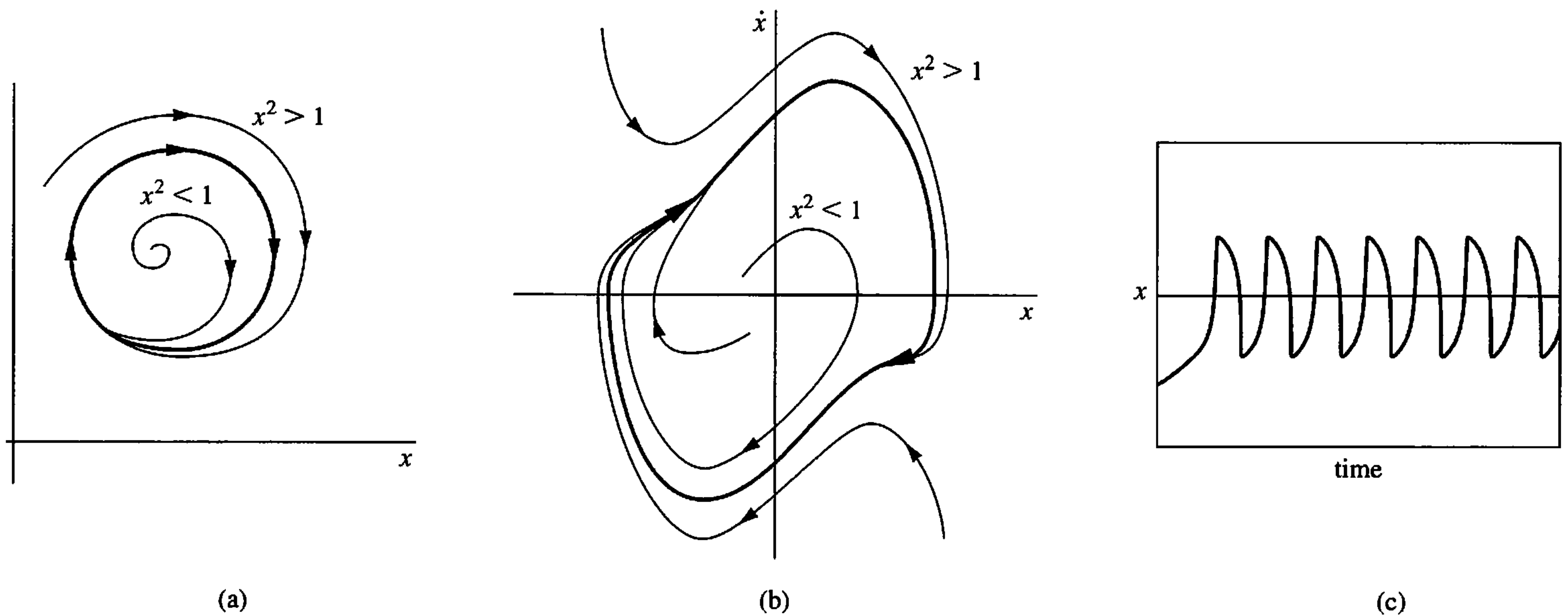

FIGURE 11.3 Limit cycles (darkened curves) of the van der Pol equation in the \dot{x} , x phase space showing (a) circular motion for a small damping coefficient ϵ , and (b) distorted curve for large damping. Approaches to the limit cycles via orbits outside and inside them are shown. Part (c) sketches the distorted sine wave obtained for the case of appreciable damping (large ϵ).

11.4 ■ CHAOTIC TRAJECTORIES AND LIAPUNOV EXPONENTS

The orbits that we have discussed thus far have been well behaved, and confined to a relatively small region of phase space. Examples are the ellipses of the Kepler problem, the circles of the simple harmonic oscillator, and the limit cycle of the van der Pol equation (11.11). Under certain conditions, trajectories, called chaotic trajectories, will be encountered in which the motion wanders around an extensive and perhaps irregularly shaped region of phase space in a manner that appears to be random, but that in fact is tempered by constraints. This path or region where the meandering takes place is an example of a strange attractor. It is called strange because of its (fractal) geometry and chaotic because of its dynamics.* The chaotic trajectory roams here and there, back and forth through this strange attractor region seeming to fill the space, but without ever actually passing through the same point twice. In short, *chaotic motion* has affinities with ergodic motion (cf. Section 9.8), with characteristics between regular deterministic trajectories and totally random roaming.

The motion involved in chaos has the properties of mixing, dense quasi-periodic orbits, and sensitivity to initial conditions. The properties are as follows. Mixing means that if we choose two arbitrarily small but nonzero regions, I_1 and I_2 , of the domain of the motion and we follow an orbit that passes through region I_1 , then it will eventually pass through region I_2 . The orbits are quasi-periodic

*See A. B. Çambel, *Applied Chaos Theory*, New York: Academic Press, 1993, p. 70.

in the sense that they repeatedly and irregularly pass through the whole range of the domain without ever closing on themselves, and without any particular time period associated with successive transits. They are dense because they pass through or arbitrarily close to every point of the domain, a property that conforms with the ergodic hypothesis (cf. Section 9.8). A chaotic orbit that visits and revisits (that is, mixes with) all regions of the available phase space is identified with what is called a *strange attractor*. Its association is not with a localized attractor such as a fixed point or a limit cycle, but rather with a very extended region of phase space, hence the designation strange. The property of ergodicity, which involves covering all accessible regions of a domain, is shared by incommensurate non-chaotic orbits with respect to an ordinary attractor (for example, a torus), and by chaotic orbits with respect to a strange attractor.

Sensitivity to initial conditions means that a small change in the initial conditions can result in a large change in position and velocity many transits or iterations later. For example, a small change can convert a parabolic orbit of the Kepler problem to either a weakly bound elliptic orbit or to a hyperbolic orbit that extends to infinity. In the Hénon–Heiles Hamiltonian, (cf. Section 11.6), a small increase in the energy can induce the onset of chaos with the Liapunov exponent (defined below) giving the time scale for this breakdown of order.

The KAM theorem of the previous section is valid for small perturbations. As the perturbation increases, the effect on the motion of the system becomes more and more pronounced. If the perturbation becomes sufficiently large, the behavior may become chaotic. Then successively calculated orbits move farther and farther away from each other. Even if the first few orbits of a chaotic sequence lie relatively close to the original one, each iteration involves a greater recession than the previous one, so the extent to which they move apart can increase exponentially with the number of iterations. An example is a spaceship in an Earth orbit. A small rocket boost will move it to a nearby orbit whereas a strong boost could throw it out of orbit, heading for outer space. Another common example of how linear and chaotic motions differ when periodicity is not present is turbulence in water. While there is streamline flow, two nearby points in the water stay close together as they move along; after the onset of turbulence the same two points, on average, keep moving farther and farther apart.

A quantitative measure of this exponential divergence is a coefficient, λ , called a *Liapunov exponent*, (sometimes spelled Lyapunov or Ljapunov). In the chaotic region of many systems, if two orbits are separated by the small distance s_0 at the time $t = 0$, then at a later time t their separation is given by

$$s(t) \sim s_0 e^{\lambda t}. \quad (11.12)$$

If $\lambda > 0$ the motion is chaotic, and the Liapunov exponent λ quantifies the average growth of an infinitesimally small deviation of a regular orbit arising from a perturbation. It sets a time scale $\tau \sim 1/\lambda$ for the growth of divergences brought about by sufficiently large perturbations. The chaos becomes appreciable for $t \gg \tau$ when the trajectory winds its way around the extensive, but bounded, phase space

of the strange attractor. Eventually the separation $s(t)$ becomes comparable to the dimensions of the accessible coordinate space so it can no longer increase further, and from that point on the separations $s(t)$ vary randomly in time.

If the system evolves by an iterative process rather than by a temporal process then Eq. (11.12) assumes the form

$$s(n) \sim s_0 e^{n\lambda}, \quad (11.13)$$

where n is the number of iterations, and the exponent λ is now dimensionless. Moreover, this divergence of orbits is not reversible. In a chaotic region it is impossible to reconstruct the distant past history of a system from its present state. This means that current trajectories can no longer be projected back to determine the initial configuration.

If the Liapunov exponent is negative it measures the rate at which a system point approaches a regular attractor. In other words, in the nonchaotic region $\lambda < 0$ and the distance $s(t)$ from an attractor at time t is given by the expression

$$s(t) \sim s_0 e^{-|\lambda|t} \quad (11.14)$$

where s_0 is the initial distance at time $t = 0$. For an iterative process we have the analogous expression

$$s(n) \sim s_0 e^{-n|\lambda|} \quad (11.15)$$

for the distance $s(n)$ after n iterations. A negative exponent characterizes the rate at which the orbit spirals into the circle on Fig. 11.3a. In the previously considered damped pendulum case the time constant τ of the damping process is the reciprocal of the associated negative Liapunov exponent, $\tau \sim 1/|\lambda|$.

As an example, consider the elliptic orbit of a planet in the solar system that is perturbed by the gravitational interaction with another planet. The perturbation is nonlinear, and it is also small since the gravitational interactions of the two planets with the much larger Sun are dominant. We might expect that the KAM theorem would predict that any perturbed orbit is stable, but this is not correct for two reasons. First, many natural frequencies in the solar system correspond to resonances involving individual planets and asteroids. Second, many of the objects in the solar system are asteroids, and perturbations resulting from their presence no longer remain small. Both of these effects lead to chaotic results. Some of this chaos simply means that we cannot make exact predictions about the future. Other effects may lead to the eventual ejection of one or more bodies from bound orbits, a possibility that was mentioned in Section 3.12 on the three-body problem.

When we consider natural frequencies, it is not only the orbital periods that are important. The rotation, obliquity (axial tilt), rotational plane, orbital plane, and eccentricity provide some of the other frequencies that may interact in surprising ways. The massive planets of the outer solar system have apparently settled into quasi-periodic orbits of marginal stability. Marginal stability means that their or-

bital motion is stable on a time scale comparable with the age of the solar system. Other orbital parameters occasionally change. The obliquity of Earth's axis is apparently stabilized by the presence of the Moon. Both Venus and Earth interact in a bounded chaotic fashion with little change in their periods. Mercury, Mars, Pluto, and many asteroids may undergo much more chaotic motion.

Calculations, projecting motions for the next 100 Gyr, show that there is a finite probability that Mercury will be ejected or collide with Venus some time during the next 3.5 Gyr. Using the approximation $\tau \sim 1/|\lambda|$ with $\tau = 3.5$ Gyr provides a Liapunov exponent $\lambda \sim 3 \times 10^{-10}$ per year as the time scale for planetary chaos. The eccentricity of the orbit of Mars could increase to 0.2, while its axial tilt can vary by 60° , perhaps sufficient to release water on the surface through the possible melting of its ice caps. Pluto also has chaotic motions, but they seem to be bounded. Thus, chaos has been a mechanism for the reorganization of the planetary bodies since the formation of the solar system.

Motions in both the outer (> 2.8 AU) and inner (< 2.5 AU) asteroid belts are chaotic. The outer belt chaos is dominated by Jupiter and the Jupiter–Saturn–asteroid interactions, while the inner belt chaos involves Mars and Mars–Jupiter–asteroid resonances. These interactions provide a steady impetus for Mars crossing asteroids. Once established along such a path, the Liapunov exponent is much larger, leading to changes in orbit.

We must note that these conclusions are based upon the results of numerical calculations. Every effort has been made to ensure that current limits of numerical accuracy, as well as the inclusion or exclusion of members of the solar family, do not affect the conclusions. Although there is evidence of past chaos in the solar system, we must remember that our future predictions are based upon our model of the solar system, not the system itself. Stability could be better or worse than the model predicts, but the chaos itself is definitely present.

11.5 ■ POINCARÉ MAPS

In Section 11.1, we discussed the periodic motion of uncoupled oscillators. When two one-dimensional oscillators become coupled by adding a term such as x^2y to the Hamiltonian, then the motion becomes rather complex in the four-dimensional $p_x x p_y y$ phase space, and it is no longer feasible to follow the trajectories. It is more convenient to sample the motion at regular intervals and use the resulting information to deduce some of its general characteristics. A convenient way to sample the motion is to map it on a cross section of phase space.

When the total energy, E_T , of a double oscillator is fixed, the dimensionality of the space is lowered by one, and the motion is confined to a three-dimensional region in this phase space called an *energy hypersurface*. Some authors refer to it as a “three-dimensional energy surface.” To avoid the complications of tracing out orbits wandering around this three-dimensional region, it is more advantageous to study a two-dimensional slice or section through the hypersurface. The slice is called a *Poincaré section*. We calculate the positions of points where or-

bits pass through the section. A convenient choice for this section is either the $p_x x$ or the $p_y y$ plane. Since the equations of motion are known via Hamilton's equations (8.18), the positions where successive orbits pass through this two-dimensional section can be calculated. For bounded motion, such sequences of points map out closed curves. The paths on the section defined by these points constitute what is called a *Poincaré map*.

As an example of the determination of a Poincaré map, consider the Kepler problem that was solved in Section 3.7 for the case of negative energies. We now reexamine this problem using Cartesian coordinates x , $p_x = m\dot{x}$, y and $p_y = m\dot{y}$, taking into account a perturbation that causes the elliptical orbit to precess in the xy (that is, in the r, θ) coordinate space plane, as shown in Fig. 11.4. The energy E is conserved with the value

$$E = \frac{1}{2}m\dot{x}^2 + \frac{1}{2}m\dot{y}^2 - k(x^2 + y^2)^{-1/2}. \quad (11.16)$$

On this figure we imagine a vertical plane located at the position $y = 0$, with the vertical ordinate p_x axis and the horizontal abscissa x axis shown in Fig. 11.5. To calculate a Poincaré map on this $p_x x$ cross section, we start the motion ($t = 0$) at the perihelion point A of Fig. 11.4 with the initial values $x = r_1$, $y = 0$, $\dot{x} = 0$, and the velocity component \dot{y} a maximum value determined by Eq. (11.16). The polar coordinates for this starting point are $r = r_1$ and $\theta = 0$. The equations of

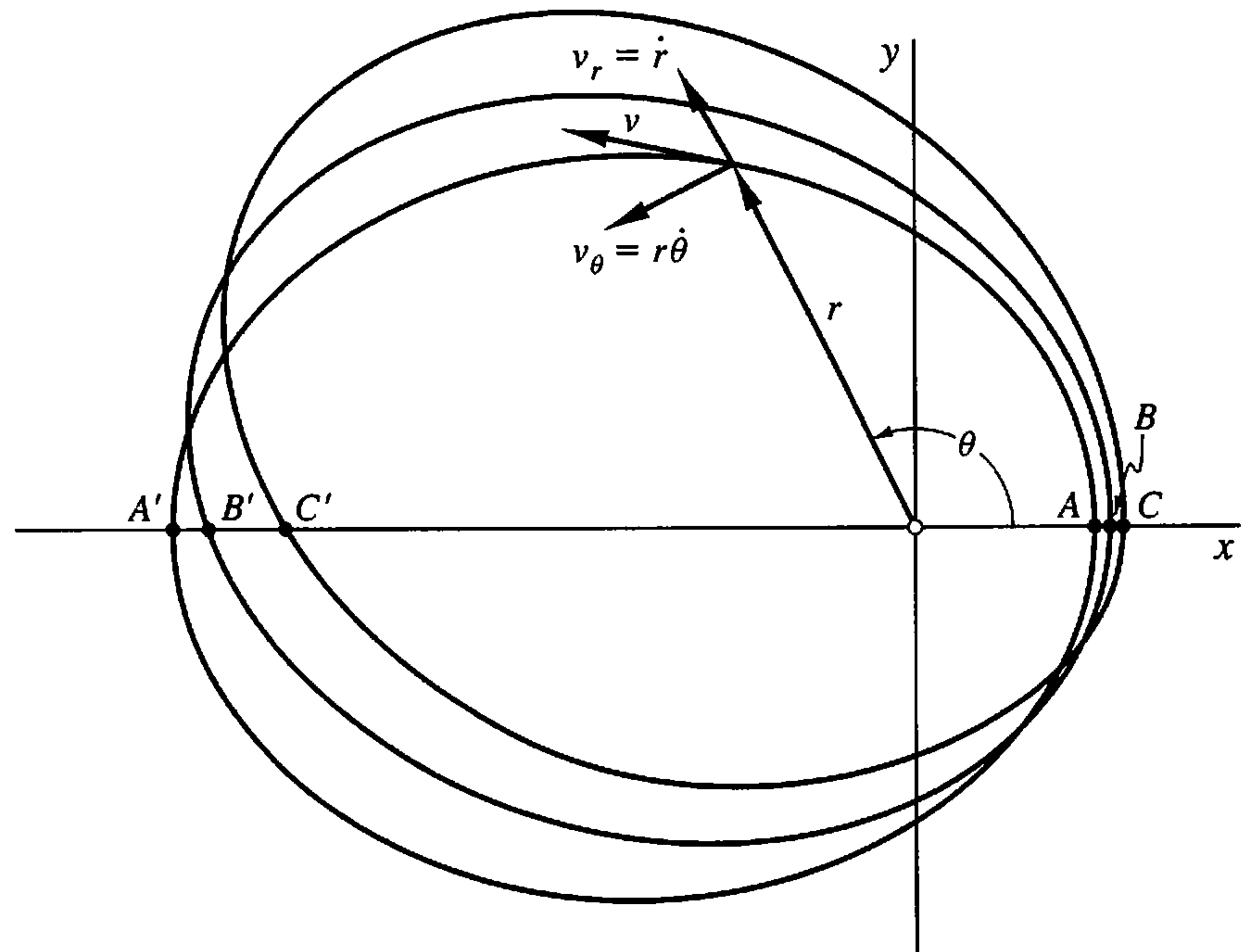

FIGURE 11.4 Precessing elliptic orbits of the Keplerian problem sketched in Cartesian coordinate space. The figure shows the vector velocity v tangent to the orbit at a point (r, θ) , together with its radial (\dot{r}) and angular ($r\dot{\theta}$) components. Points A , B , and C along the x axis near perihelion denote successive penetrations of orbits through the \dot{x}, x Poincaré section of Fig. 11.5 located along the x axis where $y = 0$.

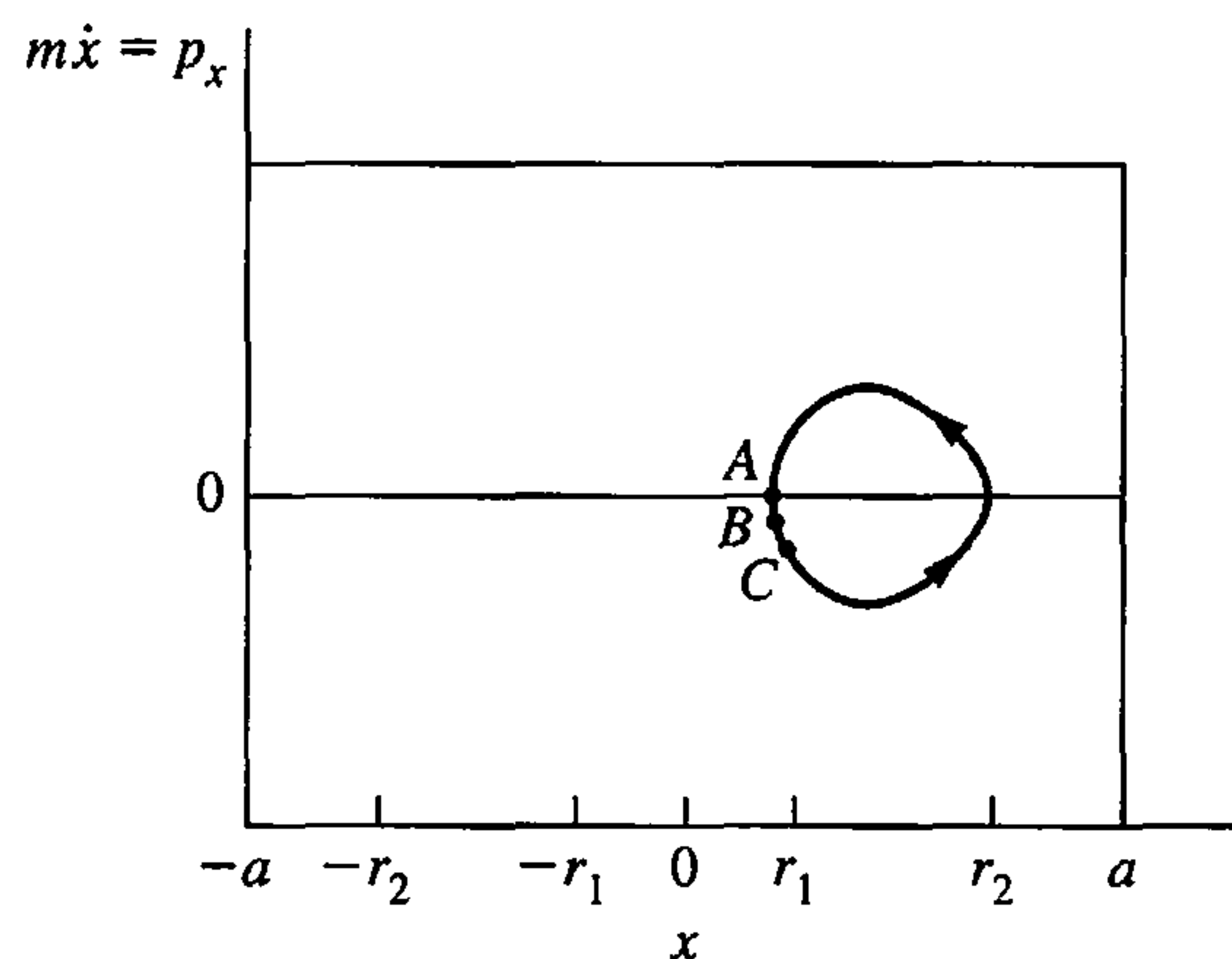

FIGURE 11.5 A $p_x x$ Poincaré section for the Kepler problem with the solid curve on the right tracing out the orbit generated by points A, B, C, \dots of the precessing ellipse of Fig. 11.4. Points A', B', C' are not shown but are located at negative values of x .

motion are used to calculate successive points that trace out the orbit. Every time the orbit passes through the $p_x x$ section, a point is marked on it indicating the value of p_x . Since the orbit is fixed for the unperturbed Kepler problem, the orbit will always pass through the same two points on the section, point A going from back to front and A' going from front to back, with $p_x = 0$ for both points, as indicated in Fig. 11.5. Poincaré maps generally only show points going through the section in one direction, which does not include point A' , so this Poincaré map consists of only one point A . When the perturbation is taken into account, perhaps arising from the attractive forces of other planets on Earth as it travels around the Sun, then the orbit can precess in time, in the fashion of Fig. 11.4. Successive orbits pass through the x axis at different orbital distances indicated by points A, B, C, \dots on Fig. 11.4. These points map onto the $p_x x$ section at the positions indicated in Fig. 11.5, and trace out the solid curve called the Poincaré map on the right side of the figure. The amount of precession that takes place for each cycle has been greatly exaggerated on these figures.

We have seen that in a four-dimensional phase space a Poincaré section is a two-dimensional slice through a three-dimensional constant-energy hypersurface. More generally, a Poincaré section is a $2N-2$ dimensional slice through a $2N-1$ dimensional constant energy hypersurface in a $2N$ dimensional phase space. Although the concept of a Poincaré section is defined for these higher dimensions, its main usefulness is for the $N = 2$ case where it provides a two-dimensional representation of the orbits, which is easy to visualize. For $N > 2$, it is not nearly as easy to visualize the orbits.

11.6 ■ HÉNON–HEILES HAMILTONIAN

Over three decades ago, M. Hénon and C. Heiles were investigating the motion of stars about the galactic center. Two constants of the motion are the vector angular

momentum ℓ and the scalar energy E . The observed motions of stars near the Sun suggested that one additional constraint might, under certain conditions, restrict the possible motions. Under other energy conditions, however, the motion is not restricted, so only the two standard constants the angular momentum ℓ and the energy E are available. Rather than solve this problem with the the actual potential of the galaxy, which is relatively unmanageable, Hénon and Heiles restricted the motion to the xy plane, as in the Kepler problem, and studied a relatively simple analytic potential $V(x, y)$ that illustrates the general features of the problem.* This potential, called the *Hénon–Heiles potential*, provides two cubic perturbation terms, which couple together two standard harmonic oscillators, corresponding to the Hamiltonian,

$$\mathcal{H} = \frac{p_x^2}{2m} + \frac{p_y^2}{2m} + \frac{1}{2}k(x^2 + y^2) + \lambda \left(x^2y - \frac{1}{3}y^3 \right), \quad (11.17)$$

where the coefficient λ is small so the last term serves as a perturbation. These cubic terms prevent the equations of motion from being integrated in closed form. When this Hamiltonian is expressed in polar coordinates $x = r \cos \theta$, $y = r \sin \theta$ the perturbation potential exhibits threefold symmetry,

$$\mathcal{H} = \frac{p_r^2}{2m} + \frac{p_\theta^2}{2mr^2} + \frac{1}{2}kr^2 + \frac{1}{3}\lambda r^3 \sin 3\theta. \quad (11.18)$$

To simplify their computer calculations, Hénon and Heiles set $p_x = m\dot{x}$ and $p_y = m\dot{y}$, expressed the Hamiltonian in normalized form using dimensionless units, and set it equal to a dimensionless energy E , with $\lambda = 1$,

$$E = \frac{1}{2}\dot{x}^2 + \frac{1}{2}\dot{y}^2 + \frac{1}{2}x^2 + \frac{1}{2}y^2 + x^2y - \frac{1}{3}y^3. \quad (11.19)$$

The equations of motion, which may be obtained from either Lagrange's equations or Hamilton's equations,

$$\begin{aligned} \ddot{x} &= -x - 2xy \\ \ddot{y} &= -y - x^2 + y^2, \end{aligned} \quad (11.20)$$

are coupled together and nonlinear, so there is no solution in closed form. We can see from the form of the dimensionless potential energy expressed in polar coordinates,

$$V(r, \theta) = \frac{1}{2}r^2 + \frac{1}{3}r^3 \sin 3\theta, \quad (11.21)$$

that for a particular value of V , the radial coordinate r attains its maximum value for $\sin 3\theta = -1$ (that is, for $\theta = 90^\circ, 210^\circ, 330^\circ$), and it attains its minimum

*M. Hénon, *Numerical Exploration of Hamiltonian Systems*, Course 2 in Chaotic Behavior of Deterministic Systems, at the 1981 *Les Houches École D'Été de Physique Théorique*, Session 36, G. Iooss, R. H. G. Helleman, and R. Stora (eds.), New York: North Holland, 1983.

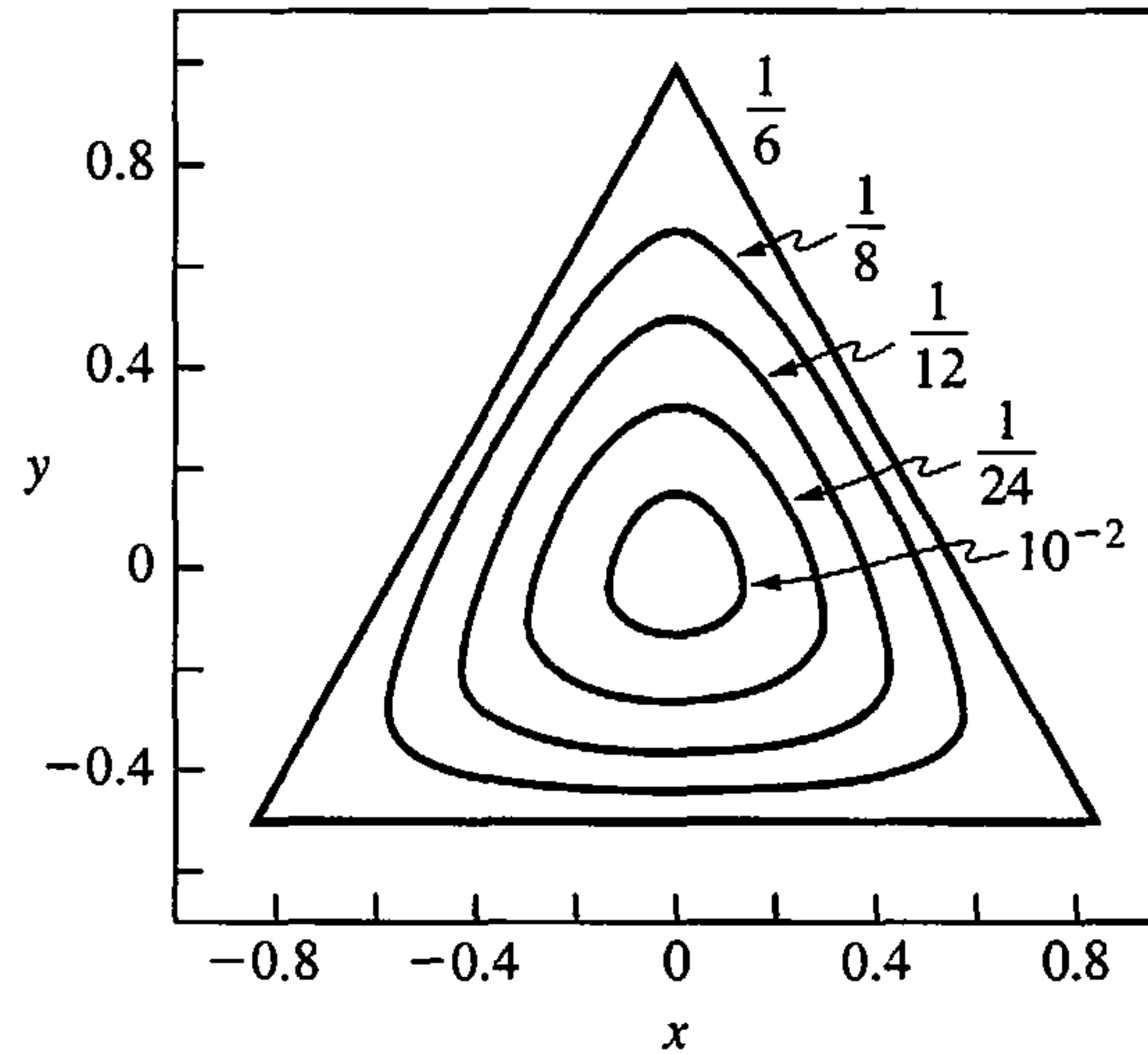

FIGURE 11.6 Hénon-Heiles equipotentials labeled with their dimensionless energies E plotted on the y, x plane. Closed curves for energies $E \leq \frac{1}{6}$ reduce to an equilateral triangle for the limit $E = \frac{1}{6}$. Open curves outside the triangle (not shown) exist for higher energies. Adapted from M. Hénon (1983), Fig. 19.

value for $\sin 3\theta = +1$ (that is, for $\theta = 30^\circ, 150^\circ, 270^\circ$). Figure 11.6 presents equipotential curves (that is, curves of constant V) drawn for several values of the energy E . For the limit $E \ll \frac{1}{6}$, not represented in the figure, the cubic perturbation terms $x^2y - \frac{1}{3}y^3$ are negligible relative to the quadratic harmonic oscillator potential terms, $\frac{1}{2}(x^2 + y^2)$, and the curves closely approximate circles centered at $x = y = 0$. When the cubic terms are appreciable for $E < \frac{1}{6}$, the equipotentials form closed curves as shown, and for $E = \frac{1}{6}$, the curve becomes an equilateral triangle with $r_{\max}/r_{\min} = 2$. For energies exceeding $\frac{1}{6}$, the equipotentials (not shown) lie beyond the equilateral triangle, are open, and diverge to infinity. Thus, the magnitude of the energy determines whether or not the cubic terms constitute a perturbation or serve as main potential terms.

When the energy is fixed at a value $E < \frac{1}{6}$, the sum of the terms in the Hamiltonian must be equal to E , which means that the kinetic and potential terms both satisfy the inequalities

$$\begin{aligned} V(x, y) &\leq E \\ \frac{1}{2}\dot{x}^2 + \frac{1}{2}\dot{y}^2 &\leq E, \end{aligned} \quad (11.22)$$

because the potential is positive definite. The first inequality tells us that any trajectory started inside the closed equipotential curve $V(x, y) = E$ must remain entirely within that line, the second inequality sets limits to the allowed kinetic energy, and the overall effect is to restrict the motion to a finite region in four-dimensional phase space. To help us visualize what is happening, we examine Poincaré sections in the \dot{y}, y plane located at $x = 0$. The accessible region in such

a section lies within the limits set by letting $x = 0$ and $\dot{x} = 0$ in Eq. (11.19),

$$\frac{1}{2}\dot{y}^2 + \frac{1}{2}y^2 - \frac{1}{3}y^3 = E. \quad (11.23)$$

The maximum velocity \dot{y} occurs at $y = 0$, and the extrema of the coordinate y are found by solving the cubic equation (11.23) with \dot{y} set equal to zero.

To give an example of the calculation of a Poincaré map on a \dot{y}, y section located at the position $x = 0$ in phase space, we follow Hénon and Heiles and select the energy $E = \frac{1}{12}$ and the values $\dot{y}_1 = -0.08$, $y = 0.02$ as starting points for the calculation. The initial velocity, \dot{x}_1 , is fixed by Eq. (11.19) with $x = 0$

$$\dot{x}_1 = \left(2E - \dot{y}_1^2 - y_1^2 + \frac{2}{3}y_1^3\right)^{1/2}, \quad (11.24)$$

where we set $x_1 = 0$ since the starting point is on the section. A numerical calculation provides the sequence of points (\dot{y}_2, y_2) , (\dot{y}_3, y_3) , (\dot{y}_4, y_4) , \dots , which are labeled 2, 3, 4, \dots on the Poincaré map of Fig. 11.7. The first eight points lie on a closed curve, as shown, the next nine points retrace this same curve, as do the subsequent points 18, 19, 20, \dots . A number of trajectories that were calculated by Hénon–Heiles for the same energy and different starting points are displayed in Fig. 11.8(a).

Note that Fig. 11.7 provides an enlargement of the large oval curve on the right side of Fig. 11.8(a). The outermost curve of the latter figure marks the boundary of the accessible region defined by solutions to Eq. (11.23). For $E = \frac{1}{12}$, the velocity \dot{y} reaches its maximum value $\dot{y} = \pm(2E)^{1/2} = 0.408$ at the position $y = 0$, and the coordinate y attains its extremal values at the velocity $\dot{y} = 0$ given by the two roots to the cubic equation (11.23),

$$y = \frac{1}{2}, \quad -\frac{1}{2}(\sqrt{3} - 1) \quad (11.25)$$

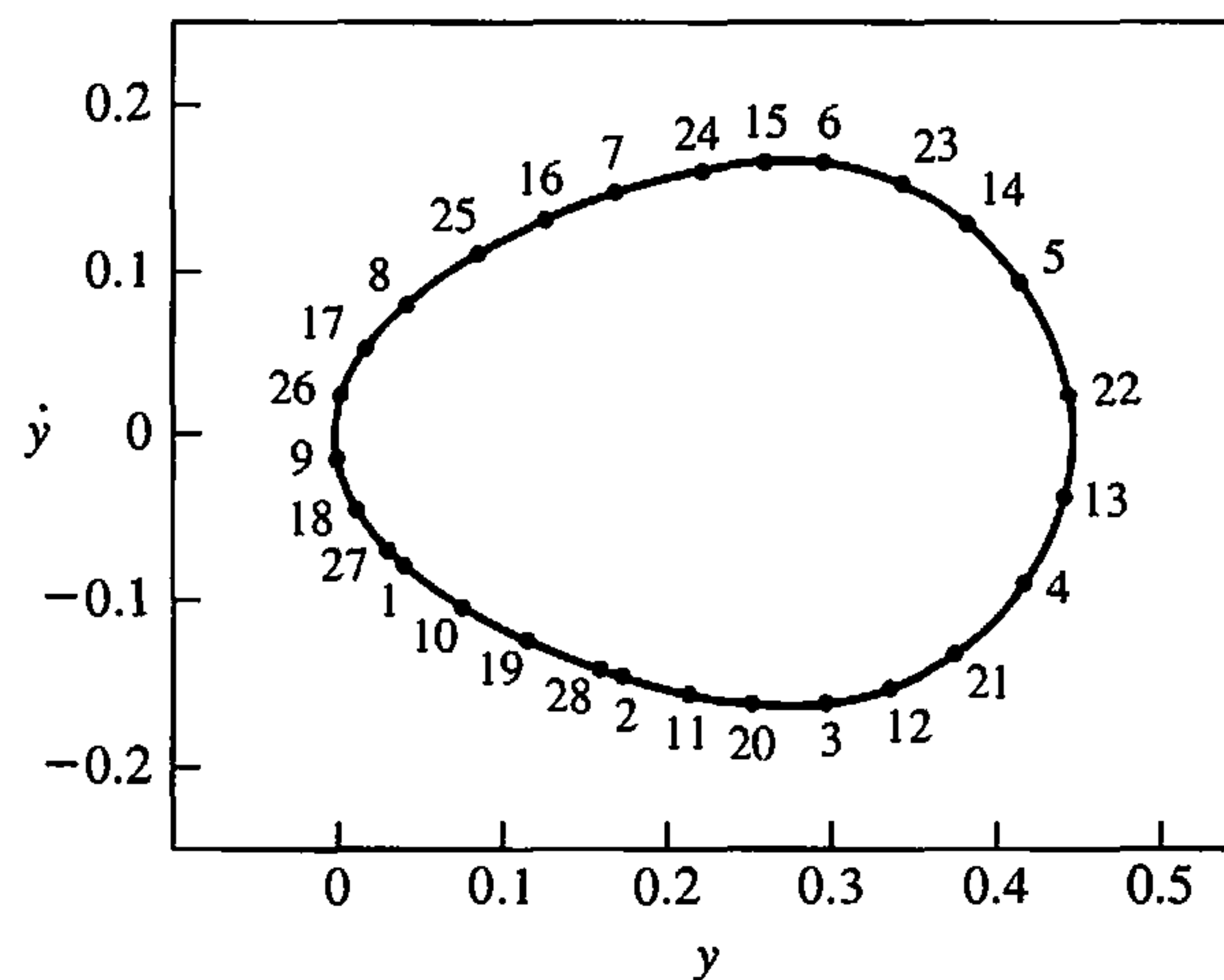

FIGURE 11.7 Poincaré section in the $\dot{y}y$ plane showing the successive points 1, 2, 3, \dots of a Hénon–Heiles orbit for the energy $E = \frac{1}{12}$. This particular curve also appears on the right side of Fig. 11.8a. From M. Hénon (1983), Fig. 20.

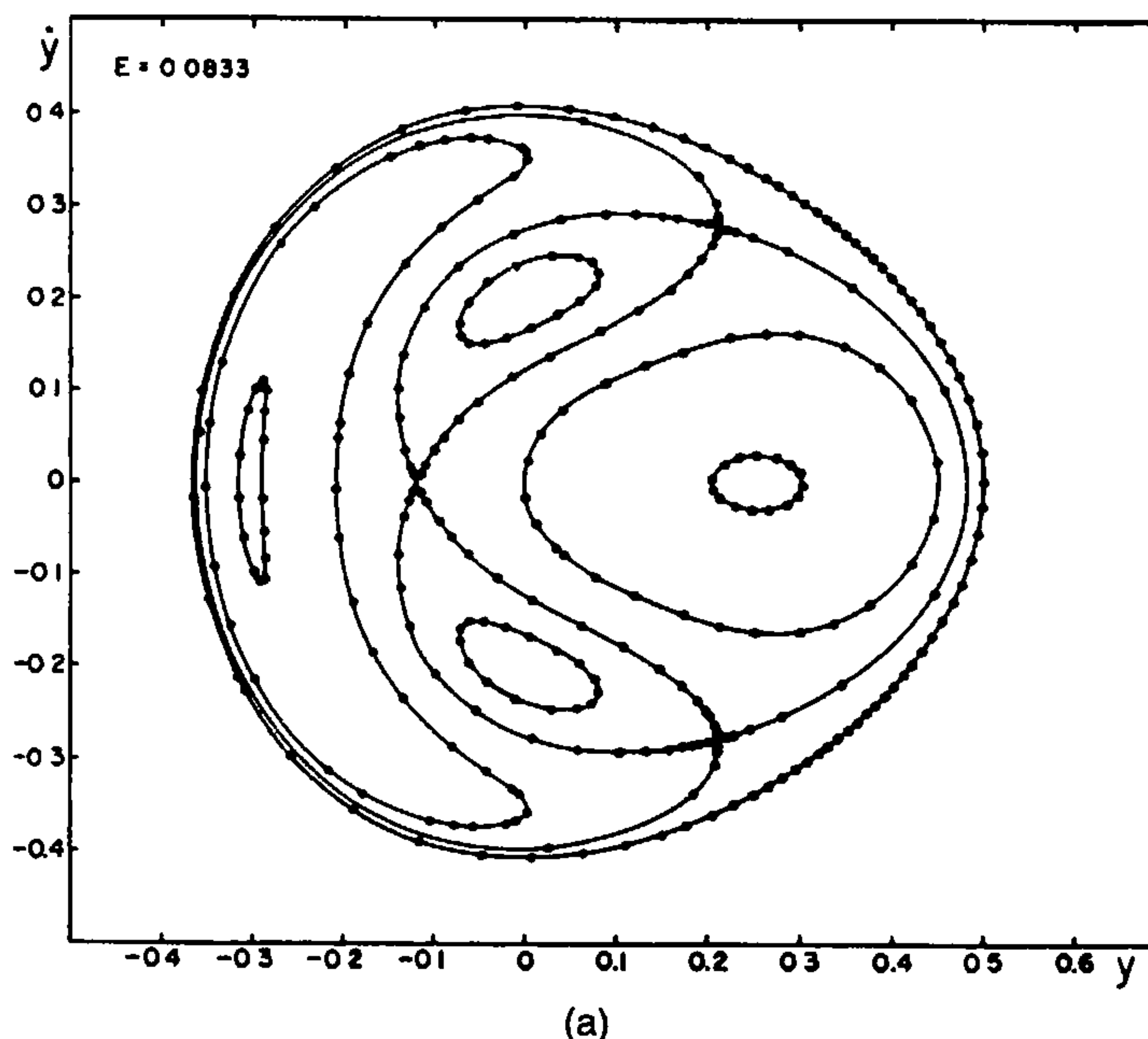
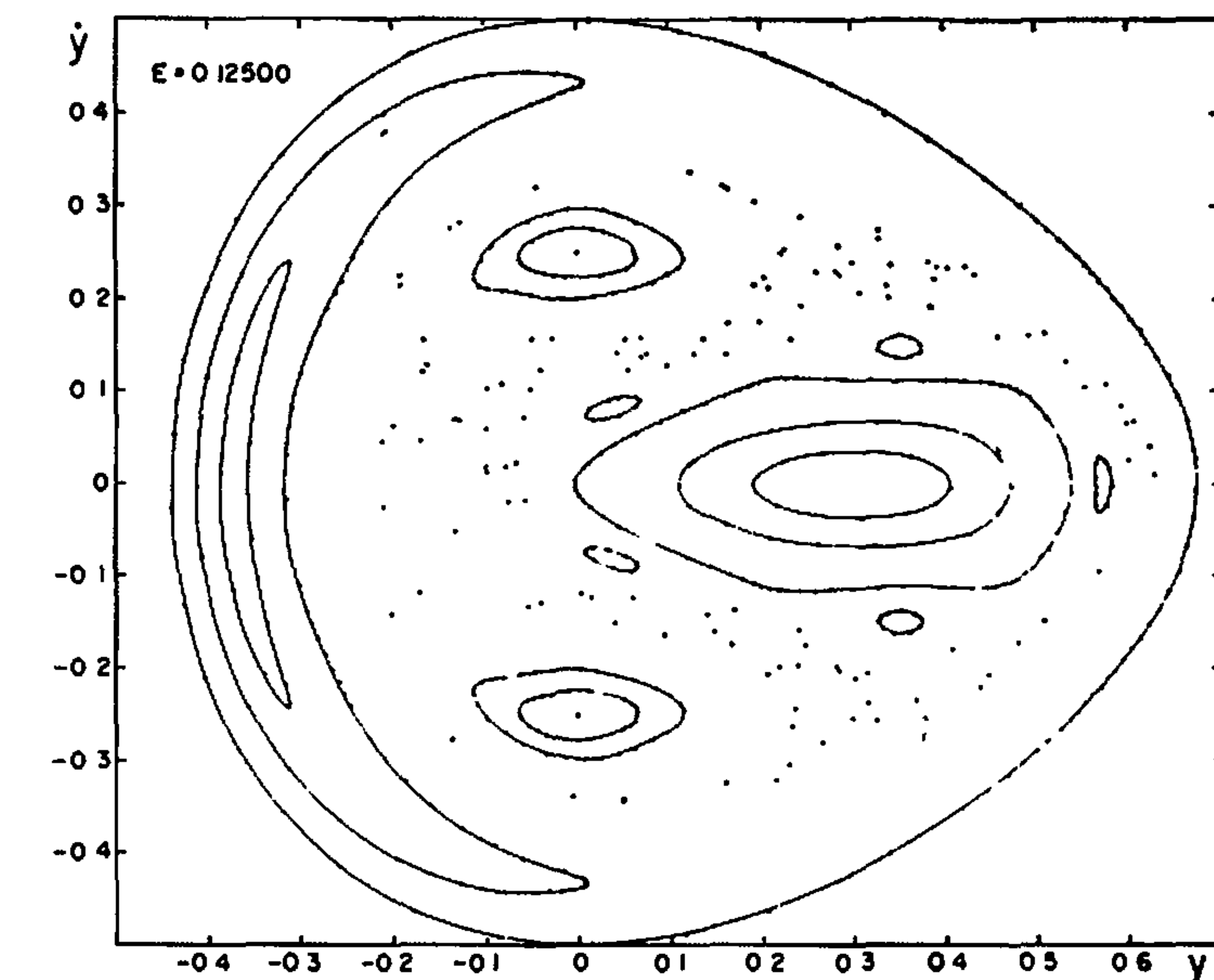

FIGURE 11.8(a) Poincaré maps in the \dot{y} , y plane showing several Hénon–Heiles orbits: (a) $E = \frac{1}{12}$ with regular orbits.

as indicated in Fig. 11.8(a). The third root of the cubic equation $+\frac{1}{2}(\sqrt{3} + 1)$ violates condition (11.22), so it is not acceptable. The figure shows that there are four regions with oval-shaped orbits, which (if calculated for smaller and smaller circumferences) would shrink to four fixed points called elliptic fixed points. Separating and bounding these regions of elliptic type closed orbits is a single continuous curve that crosses itself three times at what are called hyperbolic points. A horizontal line drawn for $\dot{y} = 0$ is a line of mirror symmetry with the curves above this line being mirror images of those below it. This symmetry results from the Hamiltonian being invariant under the transformation $\dot{y} \rightarrow -\dot{y}$, but not invariant under the transformation $y \rightarrow -y$ because odd powers of y in Eq. (11.19) produce asymmetry in the y -direction.

If the energy is increased to $E = \frac{1}{8}$ and the calculations are repeated, an unexpected result is obtained. The regions where the oval orbits were found for the lower energy $E = \frac{1}{12}$ still produce closed trajectories with fixed points at their centers; however, in the regions between these closed trajectories, there is no continuous curve and the points there appear to have no regularity, as shown in Fig. 11.8(b). If we follow the order in which these scattered points appear, we find that, instead of following a regular curve, they jump around in a more or less random fashion from one part of the Poincaré section to another. All of the scattered points on Fig. 11.8(b) arose from the same single chaotic trajectory, and the chaotic region where they appear on the figures constitutes a cross section of a strange attractor. In other words, they all originate from a single orbit meandering through the strange attractor region of phase space and repeatedly penetrating the Poincaré section randomly throughout the chaotic region of this section. Raising the energy still further to the critical value $E = \frac{1}{6}$ causes the strange attractor



(b)

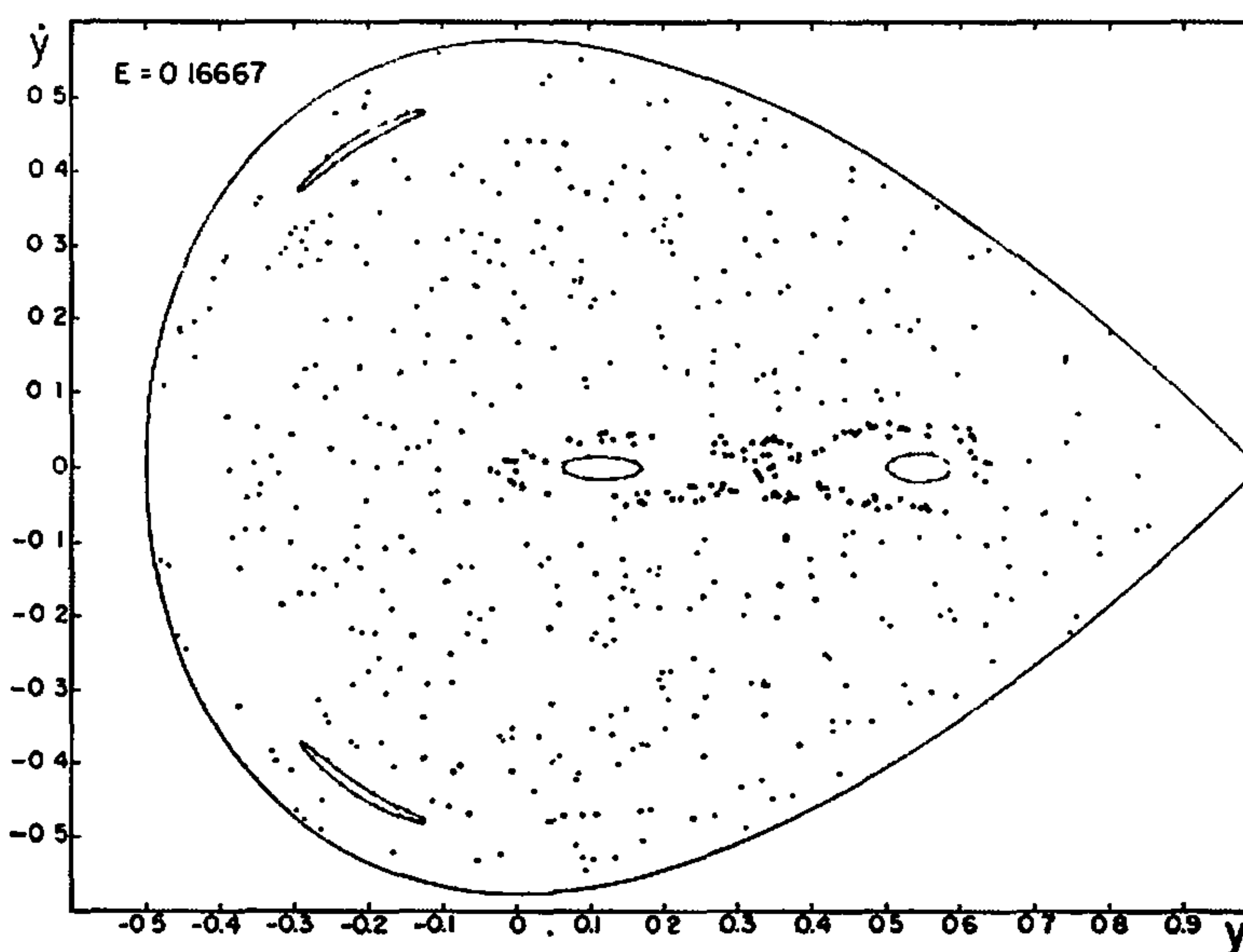

(c)

FIGURE 11.8(b&c) (b) $E = \frac{1}{8}$ with regions of regular motion and regions of chaos, and (c) $E = \frac{1}{6}$ with chaos dominant. The orbit on the right side of (a) is plotted in Fig. 11.7 on an enlarged scale. From M. Hénon (1983), Figs. 21, 22, and 23.

to fill most of the available phase space, and this has the effect of extending the chaotic region to include almost the entire accessible area of Fig. 11.8(c). An index of the extent of the chaos is the fraction of the accessible region where the calculated points lie on regular trajectories. Figure 11.9 shows how the relative area of the regular region declines as the energy increases. The onset of chaos occurs near $E = \frac{1}{9}$, beyond which the region of regularity decreases linearly with the energy until complete chaos sets in at about $E = \frac{1}{6}$. Calculations for this

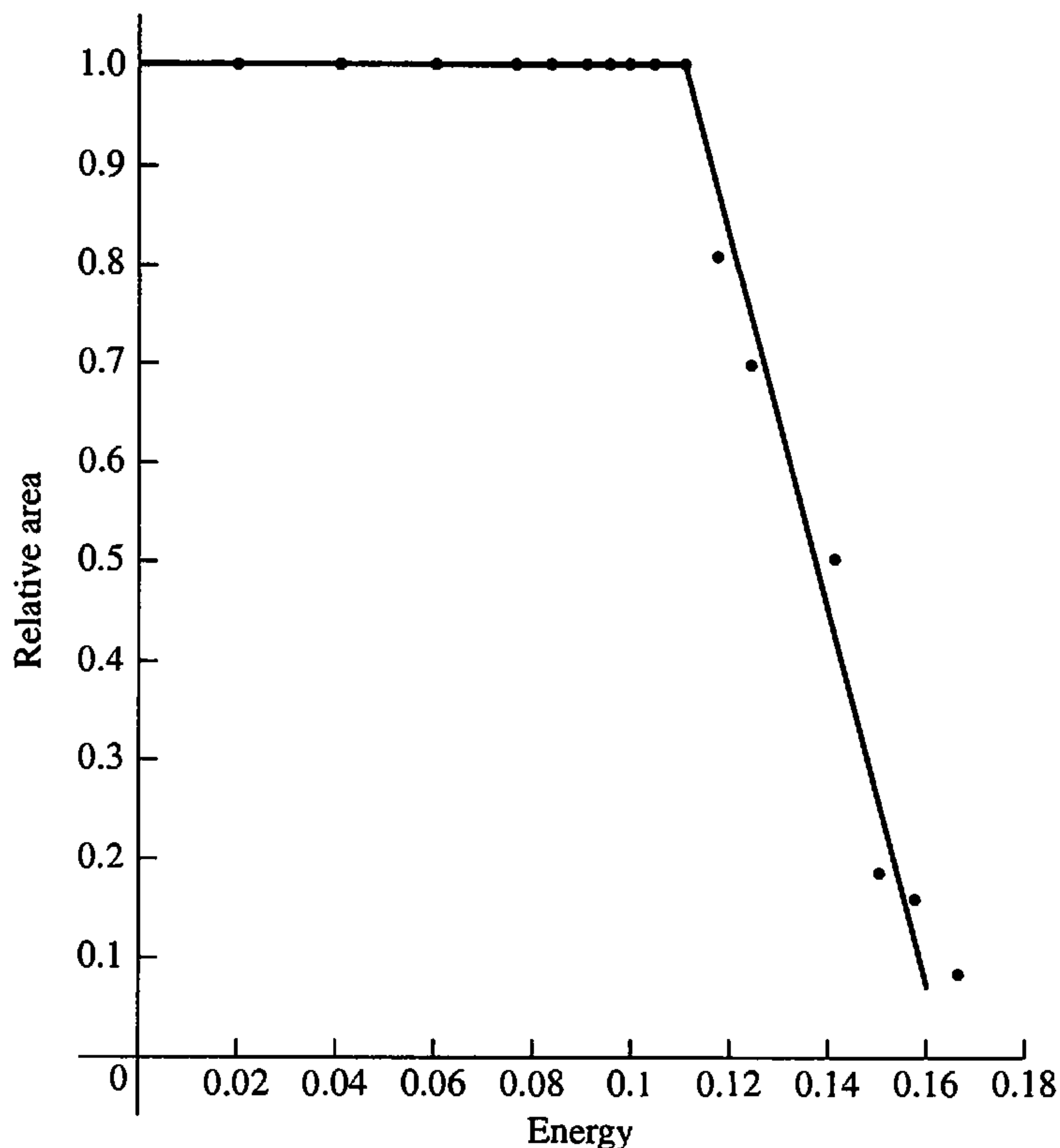

FIGURE 11.9 Fraction of the available Hénon–Heiles Hamiltonian phase space occupied by regular (nonchaotic) orbits plotted as a function of the energy E . From M. Hénon (1983), Fig. 24.

figure at higher energies are not meaningful because the equipotential lines no longer close on themselves, and the accessible area becomes infinite.

Chaos can also be viewed as a breakdown of integrability. The trajectories of Figs. 11.7 and 11.8(a) for $E = \frac{1}{12}$ can be obtained by integrating the equations of motion for particular initial conditions; the results obtained by carrying out the integrations are unique and reproducible, and the path followed by the position point is predictable. At the higher energy $E = \frac{1}{8}$, the equations are integrable for some initial conditions, but produce points randomly located in the chaotic region for other initial conditions, in accordance with Fig. 11.8(b). For $E = \frac{1}{6}$, integrability breaks down over virtually the entire accessible region of phase space depicted in Fig. 11.8(c).

Another interesting feature of chaos is the appearance of what are called *islands*. For very small coupling, such as for energies in the range $E \sim 10^{-3}$, the \dot{y} versus y section consists of closed orbits slightly perturbed from being circular. The much larger perturbation for the energy $E = \frac{1}{12}$ produces four sets of elliptic type orbits, and the increase in the energy to $E = \frac{1}{8}$ results in the appearance of five islands of integrability along the border of the chaotic region on the right side of Fig. 11.8(b). Figure 11.8(c) shows that such islands persist even when almost complete chaos reigns.

In addition to the above features, the chaotic region can exhibit an hierarchy of islands, and these are most easily visualized by plotting constant energy orbits in xy coordinate space. This can be done for the Hénon–Heiles system, but it will be more instructive for us to plot these coordinate space orbits and display some features of the hierarchy of islands with the aid of another chaotic system called quadratic mapping, which arises from the set of coupled equations

$$\begin{aligned}x_{n+1} &= x_n \cos \alpha - y_n \sin \alpha + x_n^2 \sin \alpha \\y_{n+1} &= x_n \sin \alpha + y_n \cos \alpha - x_n^2 \cos \alpha,\end{aligned}\quad (11.26)$$

where the variables lie in the ranges $-1 < x < +1$, $-1 < y < +1$, and α , which might be called a *control parameter*, determines the extent to which the solutions are regular or chaotic. These equations are solved by an iteration technique similar

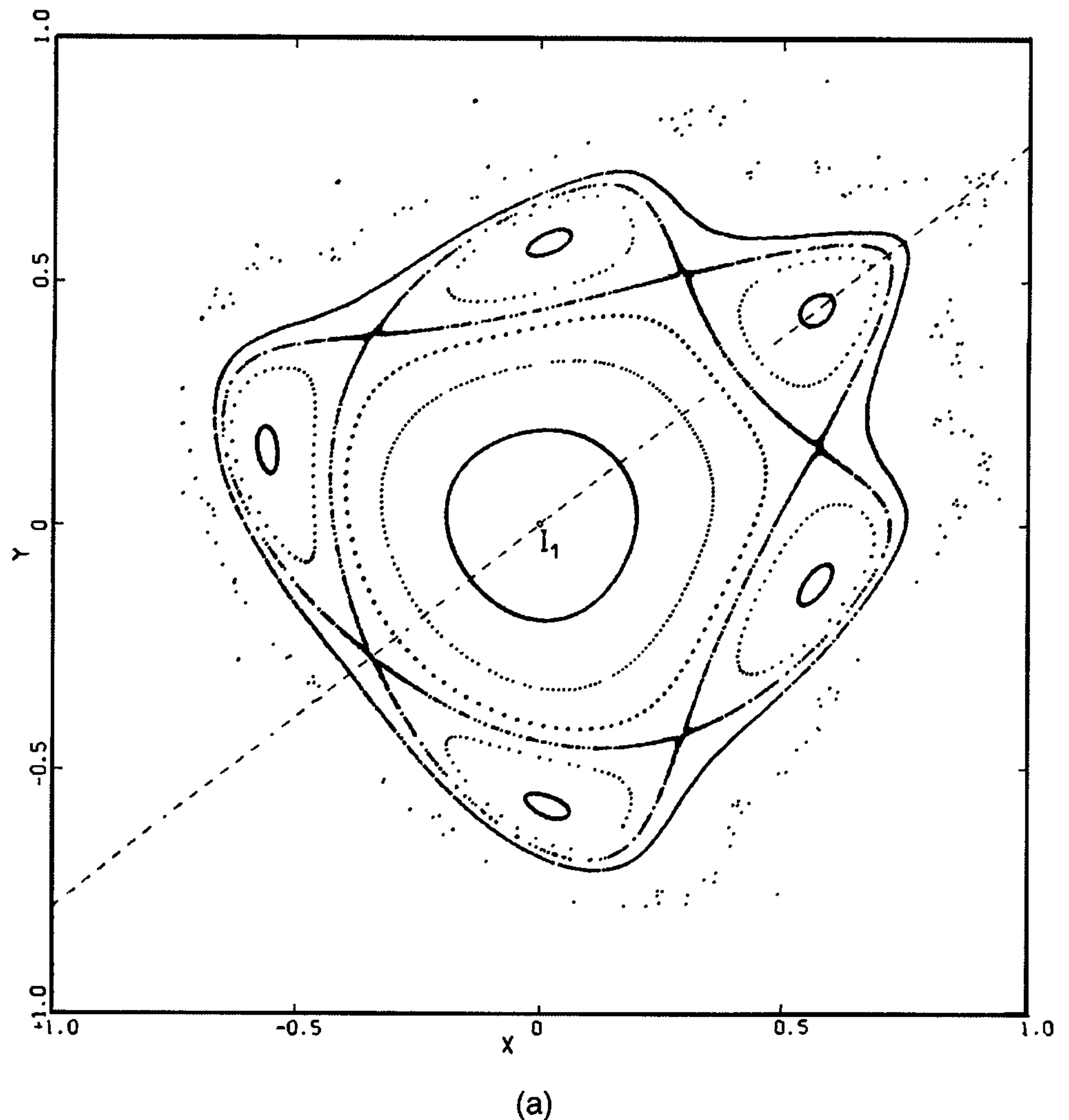

FIGURE 11.10(a) (a) Trajectories in coordinate space for the quadratic mapping system (11.26) at an energy near the onset of chaos. From M. Hénon (1983), Figs. 33 and 34.

to that described for the logistic equation at the beginning of Section 11.8. Trajectories calculated numerically for the case $\cos \alpha = 0.4$ are plotted in Fig. 11.10(a). We see from the figure that this system exhibits one main centrally located elliptic-type region, five hyperbolic points where trajectories appear to cross, five outlying elliptic-type regions, and what appears to be a somewhat irregular distribution of dots called islands. The main trajectories can also be referred to as zero-order islands. When the area near one of the hyperbolic points (for example, $x = 0.57$, $y = 0.15$) is enlarged by a factor of 20, we see from Fig. 11.10(b) that the trajectories do not actually cross at a hyperbolic point, but rather there are several series of islands in this region, and some hint of incipient chaos. The well-formed curves on the left are associated with the main central elliptic-type zero-order island region, and the structure at the upper right involves a continuous curve that

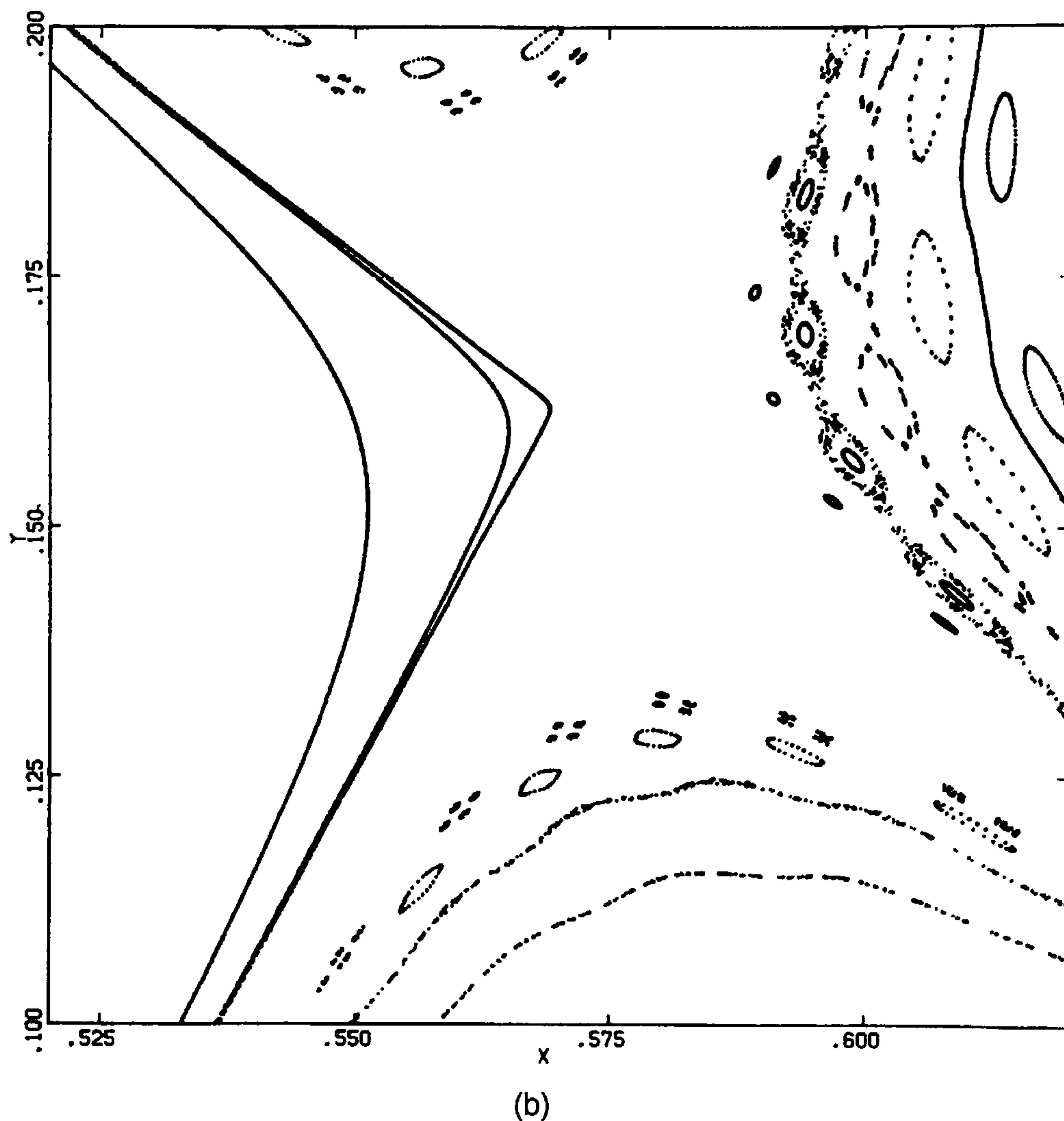

FIGURE 11.10(b) (b) Enlargement of the rightmost hyperbolic point of (a) showing several orders of “islands.”

encircles the ordered region of Fig. 11.10(a). The long dashed curves at the bottom of Fig. 11.10(b) are part of an outlying elliptic-type region of zero-order islands, and directly above them are first-order islands, each of which has four second-order islands nearby. At the upper border of the figure are first- and second-order islands associated with the zero-order island out of view above the figure. In general, islands tend to be organized in an infinite hierarchy, they are self-similar, and the relatively few islands at one level of enlargement are associated with many islands at the next lower level. Indeed, Fig. 11.10(b) shows islands with a large range of diameters: $\sim 1.0, 0.3, 0.01, 0.003,$ and 0.0005 .

The property of “islands” being replicated at higher and higher levels of magnification is a property characteristic of entities called *fractals*. This *self-similarity* is much more regular in the case of fractals because highly magnified regions can look almost identical to views at much lower magnification. The nonintegral dimensionality associated with a strange attractor that was mentioned earlier in the chapter is also characteristic of fractals. We will have more to say about fractals later in the chapter.

11.7 ■ BIFURCATIONS, DRIVEN-DAMPED HARMONIC OSCILLATOR, AND PARAMETRIC RESONANCE

The minimal requirements for a system of first-order equations to exhibit chaos is that they be nonlinear and have at least three variables. While many nonlinear equations in physics are second order, it is possible to reduce a set of second-order nonlinear differential equations to a larger system of first-order nonlinear differential equations. Recall from Section 8.1 that a set of N second-order Lagrange equations reduces to a set of $2N$ first-order Hamilton equations. Our present topic deals with the nonlinear analogue of this behavior.

The Hénon–Heiles Hamiltonian satisfies these minimum criteria for chaotic motion. This can be seen by rewriting its two nonlinear second-order equations of motion (11.20) as four first-order equations, two of which are nonlinear

$$\begin{aligned} \frac{dx}{dt} &= v_x & \frac{dv_x}{dt} &= -x - 2xy \\ \frac{dy}{dt} &= v_y & \frac{dv_y}{dt} &= -y + -x^2 + y^2, \end{aligned} \quad (11.27)$$

where there are now four generalized coordinates $x, y, v_x,$ and v_y .

Let us consider, as another example, the driven, damped, harmonic oscillator that has the following equation of motion (cf. Eq. (6.90)):

$$\frac{d^2\theta}{dt^2} + \left(\frac{1}{q}\right) \frac{d\theta}{dt} + \sin\theta = g \cos(\omega_D t), \quad (11.28)$$

where ω_D is the driving frequency which is independent of time, and the angle and time coordinates have been renormalized to absorb the excess constants. This

nonlinear second-order differential equation can be converted to a system of three first-order differential equations by writing

$$\begin{aligned}\frac{d\phi}{dt} &= \omega_D \\ \frac{d\theta}{dt} &= \omega \\ \frac{d\omega}{dt} &= -\frac{1}{q}\omega - \sin\theta + g \cos\phi\end{aligned}\tag{11.29}$$

where ϕ is the phase of the driving term. There are now three dependent variables, $\phi(t)$, $\theta(t)$, $\omega(t)$, and one independent variable t . Since the third of these equations is nonlinear, we expect that particular values of the parameters q , g , and ω_D might produce chaotic motion. One physical way to justify this expectation is to note that the motion of the pendulum should depend upon the interplay between the “natural” frequency ω and the driving frequency ω_D .

To obtain quantitative results, we choose $q = 2$ and let the amplitude g of the forcing function play the role of what is called a *control parameter*. Such a parameter is an index that delineates regions of normal and chaotic behavior. In Fig. 11.11(a), we show the $\omega = \dot{\theta}$ versus θ Poincaré section for the control parameter $g = 0.9$. We see from this figure that the motion is regular, while Fig. 11.11(b) constructed for $g = 1.15$ displays chaotic motion, that is, randomness in the distribution of points. The periodic nature of the differential equations (11.29) produces regions of stability, and then regions of chaos as the control parameter g is increased.

If we examine how the frequency of oscillation, ω , depends upon this forcing function amplitude g for a fixed choice of phase, ϕ , we find that the system undergoes a number of *bifurcations* in the measured frequency of the oscillator. At each bifurcation, the number of allowed frequencies doubles. A plot of this is shown in Fig. 11.12. The bifurcations are associated with normal or non-chaotic behavior. The figure also shows shaded regions where the oscillator exhibits chaos. Fig. 11.12(b), which is a factor of ten enlargement of a region of (a), shows that bifurcations and chaos have a complex dependence upon the control parameter. Figures of this type are called *bifurcation diagrams* or *Feigenbaum plots*. A comparison of the two Feigenbaum plots of Fig. 11.12 makes it clear that this system exhibits the property of self-similarity whereby the behavior of $\omega(t)$ in the neighborhood of one bifurcation resembles that in the neighborhood of other bifurcations, even though the scale or linear dimensions are so much different. It is also evident that the quantity g seems to “control” the extent to which the system bifurcates and displays chaos. In the Hénon–Heiles system discussed in the previous section, the control parameter is the magnitude of the perturbation $\Delta\mathcal{H} = x^2y - \frac{1}{3}y^3$. In the dimensionless units being used there, the effective magnitude of $\Delta\mathcal{H}$ was set by the choice of energy.

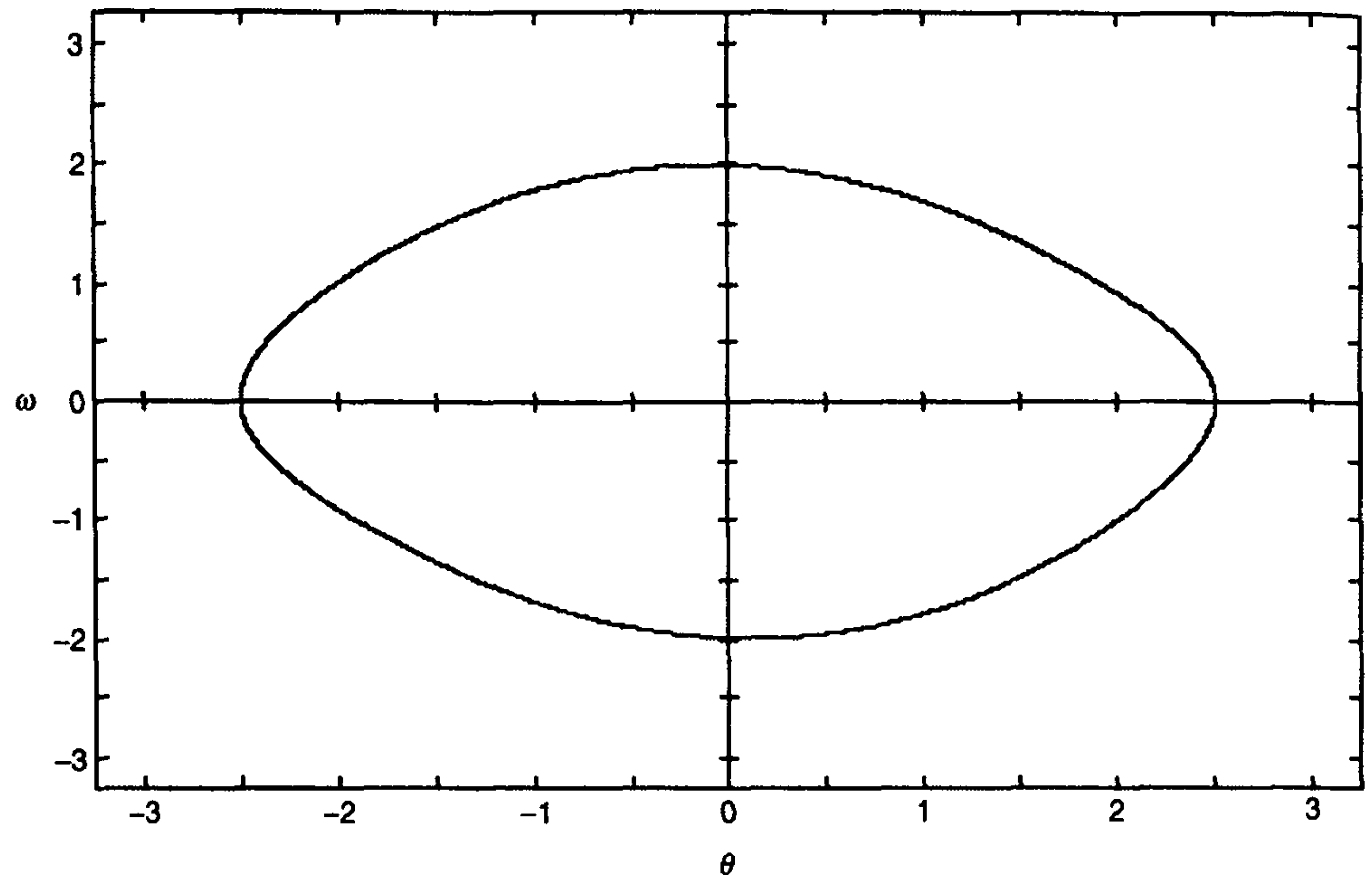

(a)

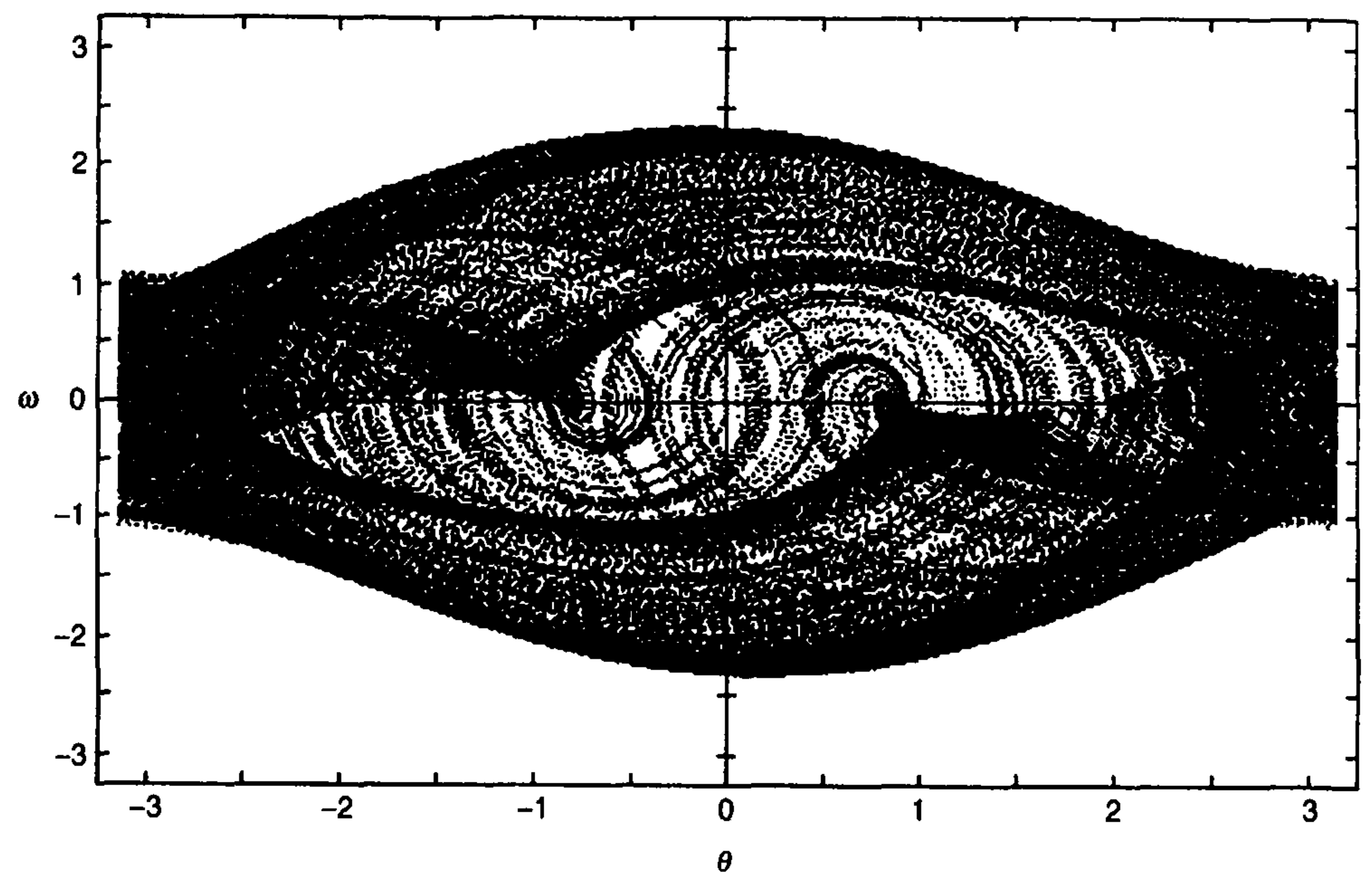

(b)

FIGURE 11.11 Phase space diagram of an orbit of the driven, damped harmonic oscillator (a) in the normal behavior region for $q = 2$ and control parameter $g = 0.9$, and (b) in the chaotic region for $q = 2$ and $g = 1.15$. Reprinted with the permission of Cambridge University Press. From G. L. Baker and J. P. Gollub, *Chaotic Dynamics, An Introduction*, Cambridge, England: Cambridge University Press, 1990, Figs. 3-4a and 3-4c.

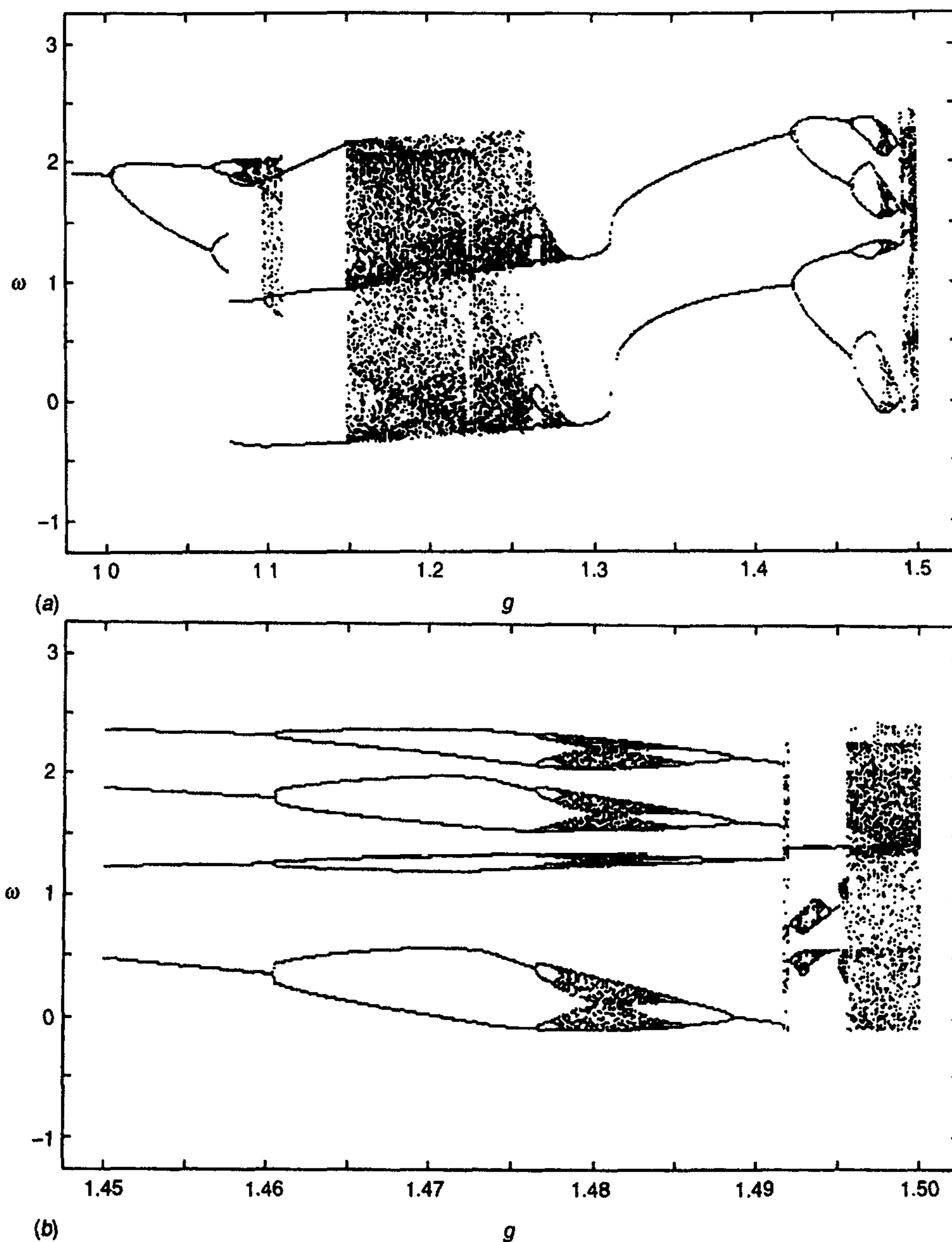

FIGURE 11.12 Feigenbaum plot of the driven, damped harmonic oscillator showing regions of regular and of chaotic behavior. Part (b) is an enlargement of the region on the right side of (a). Reprinted with the permission of Cambridge University Press. From G. L. Baker and J. P. Gollub, *Chaotic Dynamics, An Introduction*, Cambridge, England: Cambridge University Press, 1990, Fig. 4-22.

An example of a parametric harmonic oscillator type system that can become chaotic is the *parametric oscillator*, which satisfies the equation

$$m \frac{d^2x}{dt^2} + G(t, \tau)x = m \frac{d^2x}{dt^2} + (m\omega_0^2 + k(t))x = 0 \quad (11.30)$$

where $G(t, \tau)$ is the parameter of the oscillator, and the term $k(t) = k(t + \tau)$ is a perturbation periodic in the time τ . Many functions $k(t)$ produce what is called *parametric resonance*, and we give an example of one. Recall that for a simple rigid rod pendulum of length L , corresponding to $k = 0$ in Eq. (11.30), the resonant frequency $\omega_0 = (g/L)^{1/2}$ and the oscillations can be perturbed by changing the length of the bob. Parametric resonance can be induced in a simple pendulum by shortening the length L by a small amount ΔL when the mass is at its lowest point with the maximum kinetic energy, and increasing the length by the same amount ΔL at the top of the motion where the mass is instantaneously at rest, with the kinetic energy zero and the potential energy a maximum. More energy is added at the bottom than is subtracted at the top, so there is a continual increase in energy every cycle.

In general, the evolution in time of the solution of Eq. (11.30) can be highly sensitive to small changes in the initial conditions and the nature of $k(t)$. This is a condition for chaos.

11.8 ■ THE LOGISTIC EQUATION

Since the driven-damped harmonic oscillator and the parametric resonance oscillator solutions can only be calculated with the aid of sophisticated numerical techniques, we shall consider the detailed analysis of a much simpler mathematical equation called the *logistic equation* or *quadratic iterator*, which lends itself to elementary calculations and exemplifies most of the characteristics of chaos. Its solutions exhibit regularities as well as chaotic behavior. The properties of this equation, using successive iterations, are easy to carry out on a small calculator, and the description of chaos that the calculations provide has much in common with many realistic physical situations. This ubiquitous equation describes behavior in various disciplines such as physics, engineering and economics. For example, in biology it describes population dynamics, or the rise and decline of populations interacting with each other through predator–prey relationships. Other simple functions with a quadratic term also give qualitative and quantitative results similar to those of the quadratic iterator.

The logistic equation is defined by the expression

$$x_{n+1} = ax_n(1 - x_n), \quad (11.31)$$

where a is the control parameter, with the variable x is restricted to the domain

$$0 \leq x \leq 1. \quad (11.32)$$

Successive iterations of this equation are expected to bring x_{n+1} closer and closer to a limiting value, x_∞ , so that further iterations produce no additional change in x_n . This limiting value x_∞ is called a fixed point, and it is obtained by setting $x_{n+1} = x_n$ in the logistic equation (11.31), which gives

$$x_\infty = \frac{a - 1}{a}. \quad (11.33)$$

Since x_n is limited to the range given by Eq. (11.32), the control parameter must be positive with the limit $1 \leq a$. Equation (11.33) does not set any upper limit on the control parameter, and ordinarily the range $1 \leq a \leq 4$ is studied.

It is of interest to know the conditions for the fixed point to be stable. For stability, a value of x_n near the fixed point will iterate to a value x_{n+1} , which is closer to x_∞ than x_n was. To check this, we can select a value of x_n that is close to the fixed-point value by writing

$$x_n = \frac{a-1}{a} \pm \delta, \quad (11.34a)$$

where $\delta \ll 1$. We shall show in Derivation 4 that this gives, to first order in δ

$$x_{n+1} = \frac{a-1}{a} \pm \delta(2-a). \quad (11.34b)$$

For convergence to x_∞ , we require the coefficient $(2-a)$ of δ to have an absolute value less than 1, which means that this stable fixed point has the condition

$$1 < a < 3. \quad (11.35)$$

Such a fixed point constitutes an attractor since values of x_n are attracted to it; that is, they iterate toward it. We see from a left-hand column of Table 11.1 that for the choice $a = 2$ and the initial value $x_0 = 0.3$, less than half a dozen iterations are needed to reach the fixed point $x_\infty = \frac{1}{2}$ obtained from Eq. (11.33).

It is of interest to find out what happens when we iterate the logistic equation for control parameters beyond the value $a = 3$. For $a = 3.2$ then, we find that after two dozen iterations the value of x_n alternates between two final values or attractors as follows:

$$\begin{aligned} x_n &= 0.51304 \\ x_{n+1} &= 0.79946, \end{aligned} \quad (11.36)$$

as shown in the center columns of Table 11.1, and for the control parameter $a = 3.5$, a double bifurcation corresponds to a fourfold cycle involving the four attractors

$$\begin{aligned} x_n &= 0.501 \\ x_{n+1} &= 0.875 \\ x_{n+2} &= 0.383 \\ x_{n+3} &= 0.827. \end{aligned} \quad (11.37)$$

There is an eightfold cycle for $a = 3.55$, a sixteenfold cycle for $a = 3.566, \dots$ Figures 11.13(a) and Fig. 11.14 illustrate the bifurcations. These Feigenbaum diagrams, which plot x_∞ against a , show how the number of values of x_∞ succes-

TABLE 11.1 Examples of iterations of the logistic equation (11.31) before bifurcation with control parameter $a = 2.0$ (left side), after one bifurcation with control parameter $a = 3.2$ (center), and in the chaotic region ($a > a_\infty$) with control parameter $a = 4.0$ (right side). In the normal regions, values of $|x_n - x_\infty|$ are given, and in the chaotic region, values of $\Delta x_n = |x_n - x'_n|$ are given for two iterations x_n and x'_n , which start close together.

n	Normal, $a = 2.0$		Normal, $a = 3.2$		Chaotic, $a = 4.0$		
	x_n	$ x_n - x_\infty \times 10^4$	x_n	$ x_n - x_\infty \times 10^4$	x_n	x'_n	$\Delta x_n \times 10^4$
0	0.3000	2000	0.3000	2130	0.3000	0.3001	1
1	0.4200	800	0.6720	1590	0.8400	0.8402	2
2	0.4872	128	0.7053	942	0.5376	0.5372	4
3	0.4997	3	0.6651	1521	0.9943	0.9948	5
4	0.5000	0	0.7128	867	0.0225	0.0220	5
5	0.5000	0	0.6551	1421	0.0879	0.0859	20
6	0.5000	0	0.7230	765	0.3208	0.3143	65
7	0.5000	0	0.6408	1278	0.8716	0.8621	95
8	0.5000	0	0.7365	630	0.4476	0.4755	279
9	0.5000	0	0.6210	1080	0.9890	0.9976	86
10	0.5000	0	0.7531	264	0.0434	0.0096	338
11			0.5950	820	0.1661	0.0381	1280
12			0.7711	284	0.5542	0.1465	4077
13			0.5647	517	0.0734	0.4714	4268
14			0.7866	129	0.2720	0.9967	7247
15			0.5372	242	0.7922	0.0199	7723
16			0.7960	35	0.6586	0.2877	3709
17			0.5204	74	0.8999	0.8197	802
18			0.7987	8	0.3619	0.5911	2292
19			0.5146	16	0.9237	0.9668	431
20			0.7993	2	0.2819	0.1282	1537
21			0.5133	3	0.8097	0.4472	3625

sively doubles: 1, 2, 4, 8, . . . , for increasing control parameter a until the value

$$a_\infty = 3.5699456 \dots \quad (11.38)$$

called the Feigenbaum point is reached, beyond which the behavior becomes chaotic. For the choice of control parameter $a = 4.0$ in the chaotic region beyond a_∞ , successive x_n -terms generate a sequence of what seems like random numbers. If we start with two very close initial values, such as $x_0 = 0.3000$ and $x'_0 = 0.3001$, we see from the right-hand column of Table 11.1 that after 10 or 11 iterations x_n and x'_n become widely separated from each other, and their difference $\Delta x_n = |x_n - x'_n|$ becomes comparable to their values. Additional iterations produce seemingly random values of x_n and x'_n .

A Feigenbaum diagram has some other interesting properties. When the region near each bifurcation is enlarged, we find successive bifurcations that are

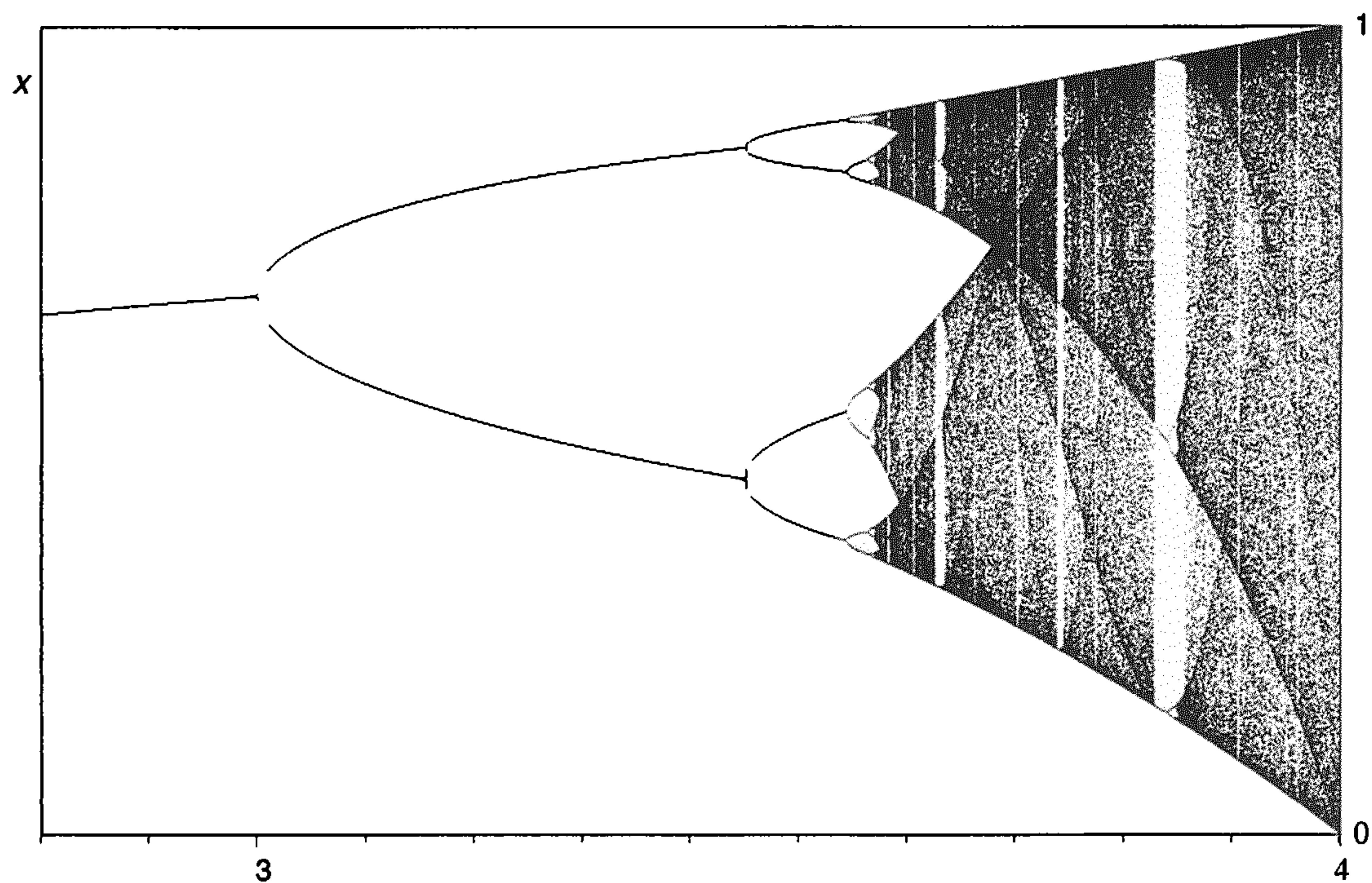

(a)

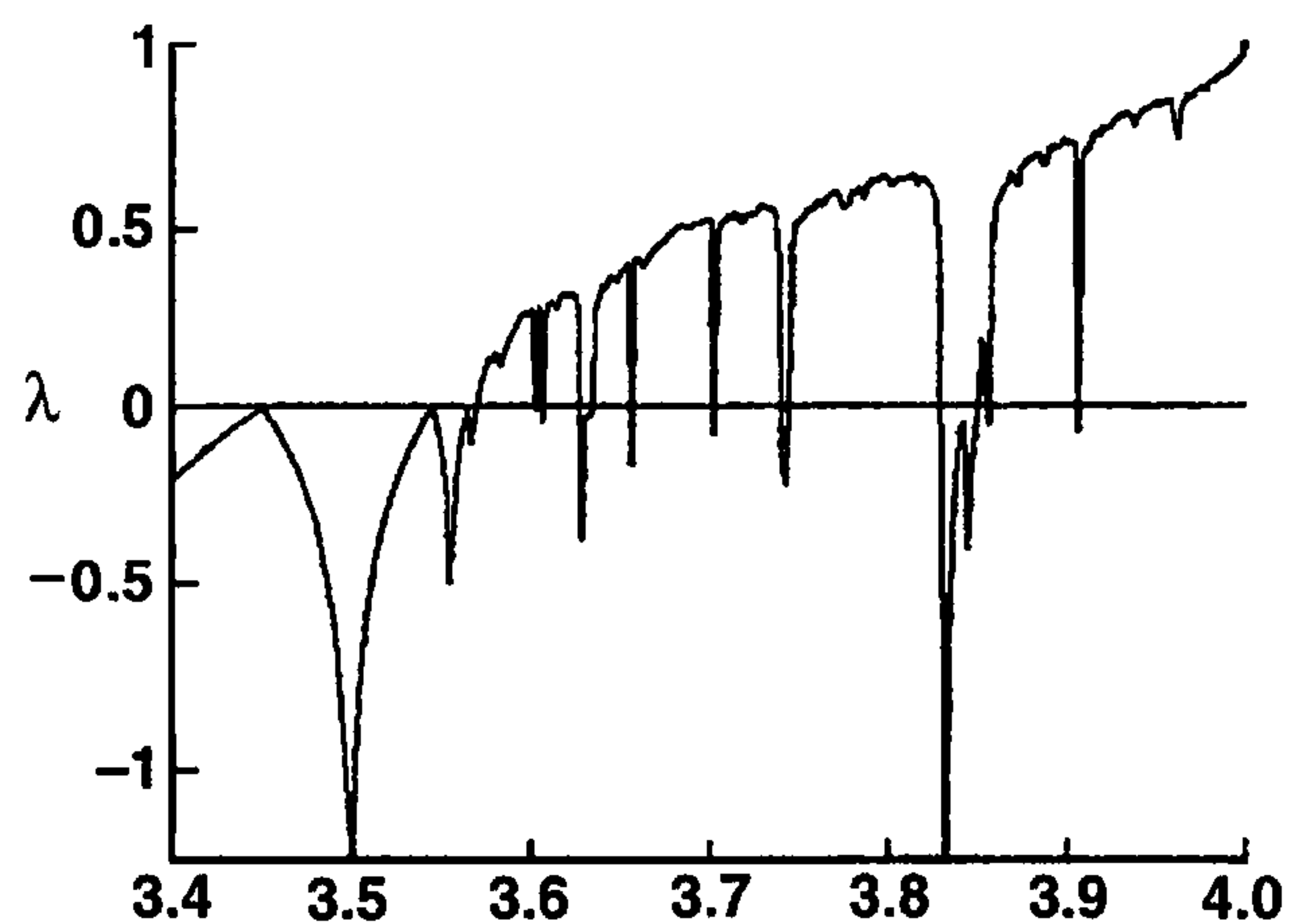

(b)

FIGURE 11.13 Correlation between Feigenbaum plot (a) and the Liapunov exponent λ (b) of the logistic equation in the control parameter range from $a = 3.4$ to $a = 4.0$. The figures are aligned with corresponding values of a to show how sharp minima in λ correlate with bands of normal behavior embedded in the chaos. The Liapunov exponent is negative in the range $a < a_\infty$ of normal behavior, and positive in the chaotic region $a > a_\infty$, except where regions of normal behavior appear in the chaos beyond $a = a_\infty$. From Peitgen et al. (1992), Fig. 11-1 (upper figure) and R. Shaw, *Z. Naturforsch.*, 36a, 80 (1981) (lower figure).

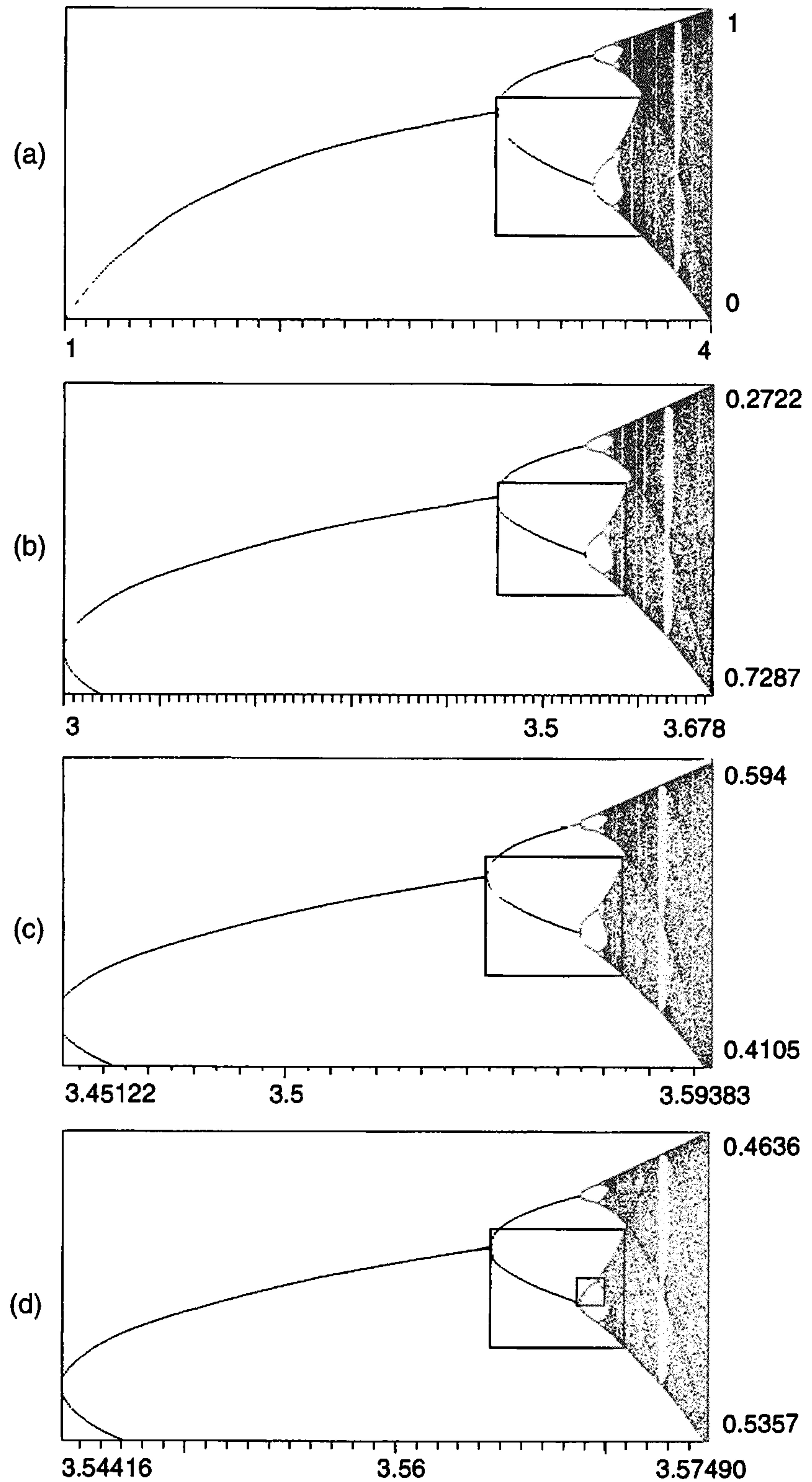

FIGURE 11.14 Feigenbaum diagram of the logistic equation over a wide range (1–4) of control parameter a (a). Diagrams (b), (c), and (d) show successively greater enlargements of regions near bifurcations. Note the reversals in order of the ordinate scales on the right side of successive figures. From Peitgen et al. (1992), Fig. 11.3.

self-similar to each other, but on successively smaller scales. This is illustrated graphically in the sequence of enlargements, Figs. 11.14(a–d). The ratio of the horizontal spacing between successive bifurcations converges to a limit called the Feigenbaum number δ

$$\delta = \lim_{n \rightarrow \infty} \frac{a_n - a_{n-1}}{a_{n+1} - a_n} = 4.6692016 \dots, \quad (11.39)$$

and the ratio of successive vertical spacings also converges to a limit α :

$$\alpha = \lim_{n \rightarrow \infty} \frac{x_n - x_{n-1}}{x_{n+1} - x_n} = 2.50290787 \dots \quad (11.40)$$

The Feigenbaum number δ is a universal constant found with many chaotic systems, but the numbers α and a_∞ depend upon the specific model, which in the present case is the logistic equation. Another interesting property of a Feigenbaum diagram is the presence of regions of normality embedded in the chaos. This is evident in Fig. 11.13(a), and is more prominent in the expanded diagrams of Fig. 11.15, which display bifurcations for three levels of enlargements. Each enlargement displays more bifurcations and new regions of normality within the chaos. The fractal property of self-similarity is evident.

In Section 11.4, we discussed how the rate of approach to a normal-state fixed point or to randomization in the chaotic region is determined by the value of the associated Liapunov exponent λ . This exponent λ from Eq. (11.13) is dimensionless, and we write for the normal and chaotic regions, respectively, as

$$|x_n - x_\infty| = e^{n\lambda} = e^{-n|\lambda|} \quad (\text{normal region}) \quad (11.41a)$$

$$|x_n - x'_n| = e^{n\lambda} = e^{n|\lambda|} \quad (\text{chaotic region}). \quad (11.41b)$$

Note that the exponent $n\lambda$ is written as $-n|\lambda|$ for the normal region because λ is negative there. In the normal region $x_n \Rightarrow x_\infty$ for large n , so the difference $|x_n - x_\infty|$ goes to zero. In the chaotic region, the difference $|x_n - x'_n|$ grows exponentially until it becomes comparable to the overall range of values, namely $0 < x < 1$, which means exponential growth in separation until perhaps $|x_n - x'_n| > 0.2$. Further iterations keep this separation $x_n - x'_n$ in the approximate range $0.2 < x < 1$. These behaviors are clear from the data in the right-hand columns of Table 11.1. Figure 11.13 shows how the Liapunov exponent depends upon the control parameter. We see from the figure that λ is negative in the normal range $a < a_\infty$, and rises to zero at bifurcation points, as can be seen by comparing Figs. 11.13(a) and (b). It is positive in the chaotic region where $a > a_\infty$, except where regions of normal behavior that appear white in Fig. 11.13(a) are embedded in the chaos. Near control parameter $a = 3.83$, we see three successive minima of λ in the region of negative values that correspond to the period doublings visible in Fig. 11.13(a), and that appear considerably enlarged in Fig. 11.15.

We must remember when studying systems such as the logistic equation that values of x_n obtained from the iterative process of Eq. (11.31) do not correspond

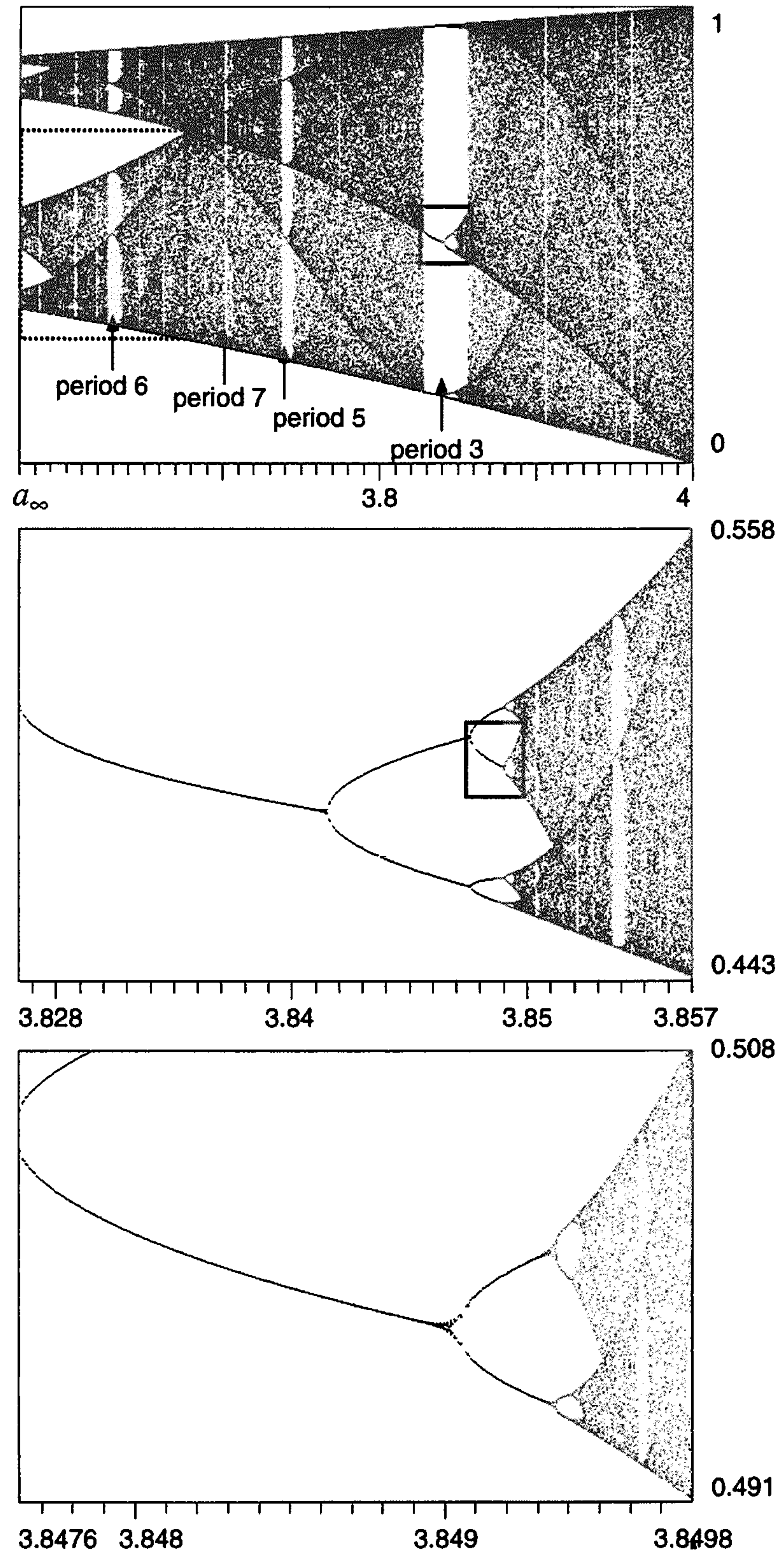

FIGURE 11.15 Feigenbaum diagram of the logistic equation showing regions of normal behavior embedded in regions of chaos. Three successive enlargement figures are shown, as indicated by their abscissa and ordinate scales. From Peitgen et al. (1992), Fig. 11.41.

to a particle moving in space. Successive iterations merely illustrate some of the properties of chaos. We must maintain a clear distinction between the chaos that results from simplified models such as that of Hénon–Heiles, and the actual motion of real stars in the galaxy. These simplified models display many of the features that are found in numerical solutions that more closely approximate the real world, but they cannot make reasonable quantitative predictions about the onset of chaos in real physical situations.

By way of summary, we have seen that where the logistic equation behaves in a normal manner, the solutions occur at values of x called attractors, stable fixed points that constitute one-dimensional analogues of limit cycles. Beyond this, successive bifurcations are found. In the chaotic region the equation generates numbers in a random manner so that if we start with a value of x in one small interval, the iteration will eventually produce a number in another previously designated small interval, corresponding to the property of mixing. We also saw that in the chaotic region two points that are initially very close generate successive sequences that do not remain near each other, corresponding to the property of sensitivity to initial conditions. There are also regions of order with attractors, period doublings, and negative Liapunov exponents imbedded in the chaos.

11.9 ■ FRACTALS AND DIMENSIONALITY

The phenomenon of “islands” being replicated at higher and higher levels of magnification, as described in Section 11.6, is characteristic of many chaotic systems, and also of entities called fractals. A fractal is an object or set with nonintegral dimensions that exhibits the property of self-similarity. For example, consider a line segment, remove its middle third to produce two line segments, remove the middle third of these latter line segments to produce a total of four, and so on, as indicated in Fig. 11.16(a). If this process of removing the middle third of successively smaller line segments is continued indefinitely, we end up with a series of dots with characteristic spacings called a *Cantor set*. The Cantor set at various stages in its generation is self-similar in the sense that magnifications of the set at later stages of generation have the same appearance as the set itself at earlier stages of formation. The dimensionality of the Cantor set is a little more subtle to deduce because the recursion process of its generation continually increases the number and reduces the size of the residual “dots.”

Before discussing the dimensionality of the Cantor set it will be helpful to say a few words about dimensionality d in ordinary Cartesian or Euclidian space. In one dimension consider a line segment of length a_0 divided into a large number of equal subdivisions each of length $a \ll a_0$. In two dimensions we have a square of side a_0 subdivided into many equal subdivisions each of side $a \ll a_0$. In three dimensions the same type tiny squares are made of a cube of side a_0 . In each case the total number of subdivisions, which we denote by $N(a)$, is given by

$$N(a) = (a_0/a)^d$$

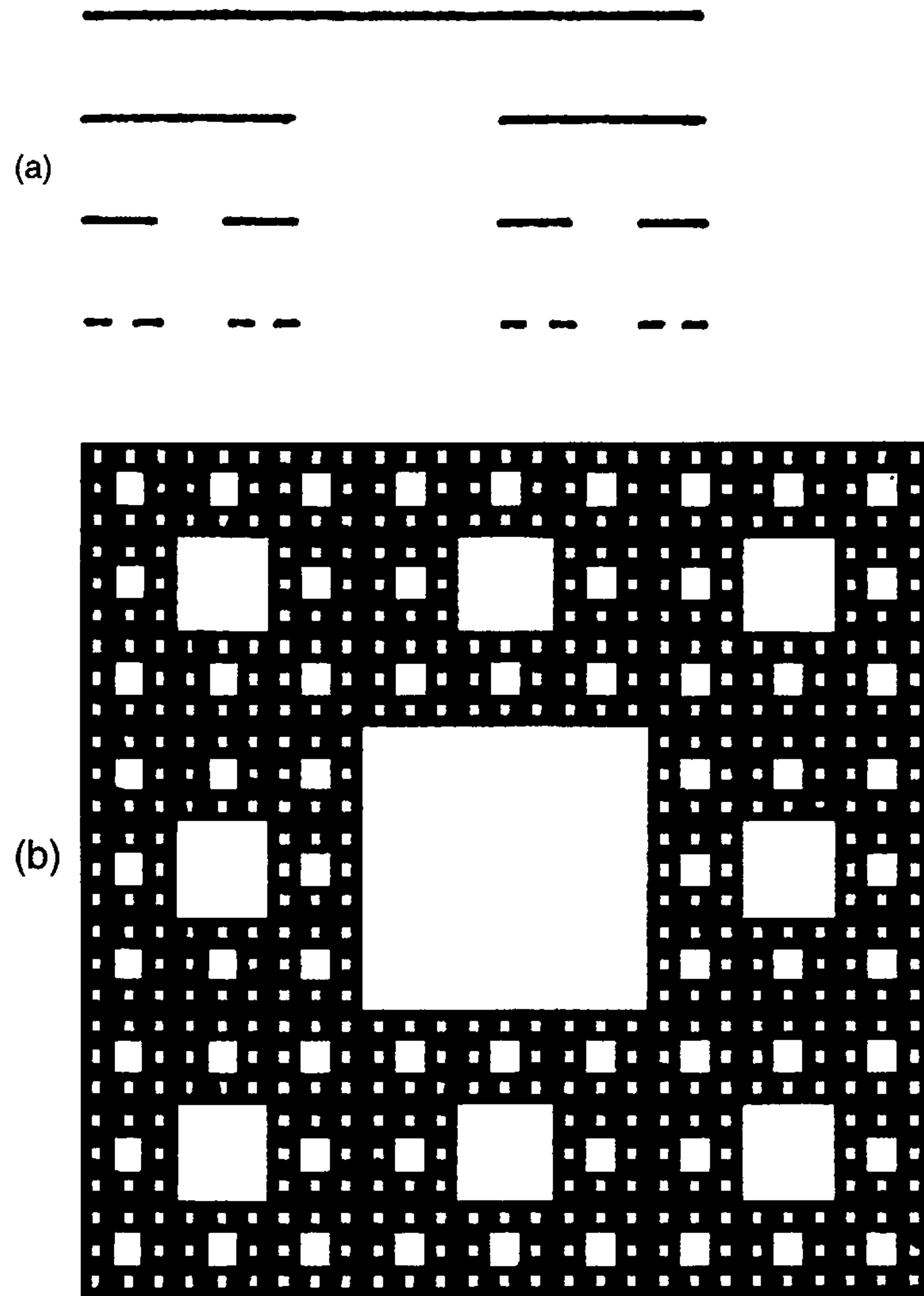

FIGURE 11.16 Recursive procedure that generates (a) the Cantor set, and (b) the Sierpinski carpet shown after four steps of iteration. From R. J. Creswick, H. A. Farach, and C. P. Poole, Jr., *Introduction to Renormalization Groups in Physics*, New York: Wiley (1992), Figs. 1.1.1 and 1.2.3.

where the dimensionality $d = 1, 2, 3$ for these three cases. Solving this expression for the dimensionality of the space we obtain

$$d = \frac{\log N(a)}{\log(a_0/a)} \quad (11.42)$$

This formula for the dimension d is intuitively obvious for systematic subdivisions of ordinary Euclidian space in any number of dimensions. We will also find it applicable for what we might call the pathological subdivisions of space that are characteristic of fractals. In this application the dimensionality d determined by the application of Eq. (11.42) is called the Hausdorff or fractal dimension d_F .

Returning to the Cantor set, it involves subdividing a line originally of length a_0 , which is one-dimensional; that is, its Euclidean dimensionality $d_E = 1$. Eventually we feel by intuition that after an infinity of splittings the lines diminish to points that have a dimensionality of zero, and we say that the topological dimensionality of the Cantor set $d_T = 0$. Further consideration, however, leads us to think that the limit is never really reached, and that any large but finite number of splittings still leaves an enormous number of infinitesimal one-dimensional line segments present. This suggests that we need another way to assign dimensionality. This can be done by noting that at the n th level of subdivision the line segments are of length $a = a_0/3^n$, and the number of them $N(a)$ is 2^n . Thus, we have

$$\begin{aligned} a &= 3^{-n} a_0 \\ N(a) &= 2^n. \end{aligned} \tag{11.43}$$

The *fractal dimension* or *Hausdorff dimension* d_F is defined by the expression

$$d_F = \frac{\log N(a)}{\log(a_0/a)}. \tag{11.44}$$

This definition is chosen to be consistent with the results of Eq. (11.42). Inserting Eqs. (11.43) into Eq. (11.44) to get for the Cantor set

$$d_F = \frac{\log 2}{\log 3} = 0.6309. \tag{11.45}$$

In the following discussion, we shall use d_E for the initial Euclidean dimension, d_T for the final limiting Euclidean (called topological) dimension, and d_F for the counterintuitive non-integer dimension characteristic of fractals and strange attractors. The fractal dimension d_F is always between the two limiting values d_T and d_E ,

$$d_T < d_F < d_E, \tag{11.46}$$

and we see that this relation is satisfied for the Cantor set

$$0 < 0.6309 < 1. \tag{11.47}$$

It will be instructive to determine the fractal dimensions of an initially two-dimensional ($d_E = 2$) self-similar figure called the Sierpinski carpet of linear dimension a_0 and area $A_0 = a_0^2$ illustrated in Fig. 11.16(b). To start, a square is divided into nine squares of length $a = a_0/3$ and area $A = a^2 = (a_0/3)^2$, and the middle square removed. Then each of the remaining eight squares is divided into nine smaller squares, and the middle one of each is removed. The figure shows the fourth step in this iteration process. At the n th level of subdivision, the squares are of length $a = a_0/3^n$ and the number of them $N(a)$ is 8^n . Thus, we have

$$a = a_0 3^{-n}$$

$$N(a) = 8^n. \quad (11.48)$$

The appropriate limit is a set of edges of squares delineating intersecting jagged filamentary lines, which become progressively thinner and thinner with successive iterations, appearing to approach $d_T = 1$. The fractal dimension d_F is again given by Eq. (11.44),

$$d_F = \frac{\ln 8}{\ln 3} = 1.8928, \quad (11.49)$$

and Eq. (11.46) is satisfied by the Sierpinski carpet, as expected,

$$1 < 1.8928 < 2. \quad (11.50)$$

In the general case of a fractal object in a d_E -dimensional Euclidean space, we define the fractal dimensionality d_F , also referred to as the capacity dimension, by a covering of the region occupied by the object by d_E -dimensional spheres in accordance with the expression

$$d_F = \lim_{r \rightarrow 0} \frac{\log N(r)}{\log (r_0/r)}, \quad (11.51)$$

where r is the radius of the d_E -dimensional spheres. This definition is clearly independent of the value of r_0 . If $d_E = 2$, the sphere is a 2-sphere or circle of radius r , and if $d_E = 1$, the "sphere" is a 1-sphere or line segment of length $2r$. In the case of the Cantor set the object being covered by line segments or one dimensional spheres of radius $r = a/2$ is the multitude of residual line segments after many subdivisions. In the Sierpinski carpet case the covering is by circles of radius $r = a/\sqrt{2}$, where a circle of radius $r = a_0/\sqrt{2}$ covers the initial square before any subdivisions. Fractal dimensions have been evaluated for many chaotic systems.* For example, the logistic equation was quoted as having a strange attractor dimension of 0.538, which is between the topological dimension $d_T = 0$ corresponding to the individual points x_n and the Euclidean dimension $d_E = 1$ corresponding to the range of x given by Eq. (11.32). The driven-damped pendulum with the equation of motion (11.25) exists in two-dimensional (x, y) Euclidean space, and has one-dimensional orbits of the type shown in Fig. 11.11(a). Its fractal dimensionality determined from Liapunov exponents ranges from 1.2 to 1.4 for various damping factors, which is between the values of $d_T = 1$ and $d_E = 2$ that we just mentioned.

We saw in the previous section that chaotic systems exhibit a type of self-similarity, but less regular than in the case of systematically constructed fractals such as those in Fig. 11.16. This does, however, suggest that chaotic systems could have a fractal-type nature, and that nonintegral dimensionality might be a

*See A. B. Çambel, *Applied Chaos Theory*, New York: Academic Press, 1993, p. 70; G. L. Baker and J. P. Gollub, *Chaotic Dynamics, An Introduction*, Cambridge, England: Cambridge University Press, 1990.

characteristic of chaos. This suggestion is correct. The fractal dimensionality d_F of a *strange attractor* can be calculated from the Liapunov exponents associated with its expansion in phase space. To illustrate this, we consider the particular case of a strange attractor in two-dimensional configuration space, which evolves in time by continuously expanding in one direction and continuously contracting in its orthogonal direction in such a manner that its area $A(t)$ continuously decreases in magnitude with the passage of time. This permits it to continuously elongate and meander throughout the available regions of phase space. We start with a square zone in the x, y plane of a chaotic region with the initial dimension a_0 in the x - and y -directions and the corresponding initial area, $A_0 = a_0^2$, as shown in Fig. 11.17a. This means that $d_E = 2$. If the area evolves in time by contracting in the x -direction with the negative Liapunov exponent λ_1 and expanding in the y -direction with the positive Liapunov exponent λ_2 it gets continuously thinner and evolves toward a line of topological dimension $d_T = 1$. In terms of these Liapunov exponents, the x - and y -dimensions of the area have the respective time

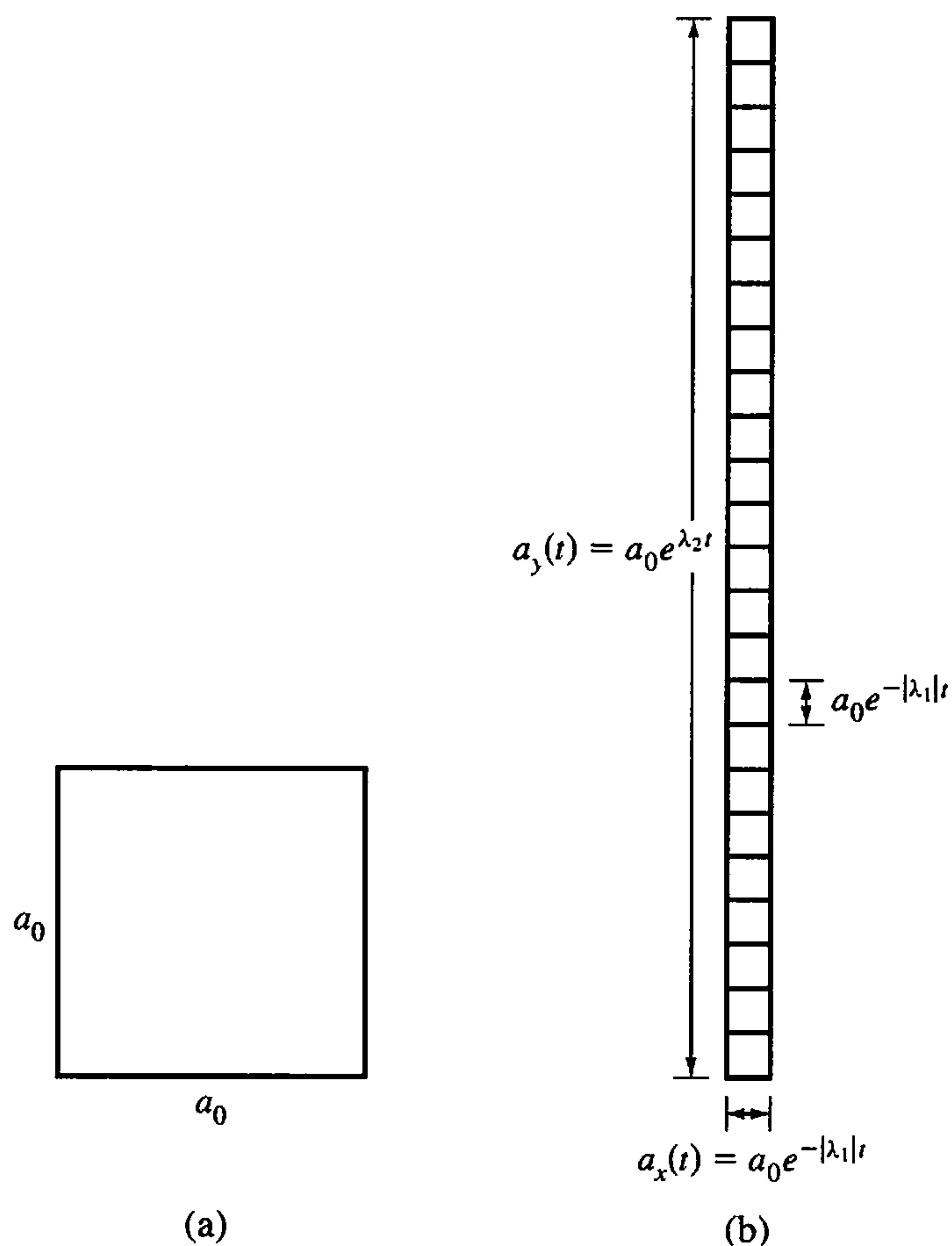

FIGURE 11.17 Role of the Liapunov exponents $\lambda_1 < 0$ and $\lambda_2 > 0$, subject to the condition $|\lambda_1| > \lambda_2$, in the evolution of an initially square area (a) in phase space that expands along one coordinate direction and contracts along the other with the passage of time (b).

dependencies from Eq. (11.12),

$$a_x(t) = a_0 e^{-|\lambda_1|t} \quad a_y(t) = a_0 e^{\lambda_2 t}, \quad (11.52)$$

and the area $A(t)$ evolves in time as

$$A(t) = A_0 e^{(\lambda_2 - |\lambda_1|)t}, \quad (11.53)$$

where $A_0 = a_0^2$. Since λ_1 is negative and λ_2 is positive, it is necessary to have $|\lambda_1| > \lambda_2$ so that the area (11.50) will continually decrease with time. The feature of a continuous decrease in the fractal area $A(t)$ of Eq. (11.50) is analogous to the continuous decrease in overall length of the line segments in the Cantor set, and of the continuous decrease in the net remaining area in the Sierpinski carpet case, as the iterations progress to the limit $n \Rightarrow \infty$.

If we consider the evolved elongated area $A(t)$ as containing a number $N(t)$ of small squares of individual area $\Delta A(t) = a_x^2$, as indicated in Fig. 11.17b then we have

$$\Delta A(t) = a_0^2 e^{-2|\lambda_1|t}, \quad (11.54)$$

where λ_1 is negative, and

$$N(t) = \frac{A(t)}{\Delta A(t)} = \frac{a_0^2 e^{(\lambda_2 - |\lambda_1|)t}}{a_0^2 e^{-2|\lambda_1|t}} = e^{(\lambda_2 + |\lambda_1|)t}. \quad (11.55)$$

By analogy with Eq. (11.44), the strange attractor dimension d_F , is given by

$$d_F = \frac{\log N(t)}{\log(a_0/a_x(t))} = 1 + \frac{\lambda_2}{|\lambda_1|}, \quad (11.56)$$

which has a nonintegral or fractal value. For the present case, $\lambda_2 < |\lambda_1|$, so Eq. (11.46) is satisfied with $1 < d_F < 2$. Thus, a strange attractor is related to a fractal in the sense that its dimension is “strange”; that is, it is not an integer.

There is a fundamental difference between the time evolution and the space-filling effect of regular trajectories and chaotic trajectories. We saw in Section 11.1 how the orbits of incommensurate oscillators can “fill” the space of a torus by ranging over the entire domain. However, technically speaking, these regular orbits do not occupy any of the area of the toroidal surface because they are one-dimensional curves without any width, meaning that the actual area taken up by them is zero. Chaotic orbits also range over their entire domain of phase space, but they do so by occupying area in this space. What is strange is that the more the chaotic orbits “fill” phase space, the smaller the area that they actually occupy (cf Eq. (11.53)). This makes it appropriate to refer to the domain over which the chaotic orbits roam as a strange attractor. The onset of chaos may be looked upon as the increase in the dimension of a regular orbit from its topological value $d_T = 1$ to its fractal value $1 < d_F < 2$ as it begins to occupy space in an area of Euclidean dimension $d_E = 2$. The fractal dimension may be looked

upon as an index of how much space is occupied by the fractal orbit. We should of course continue to bear in mind the fact that the main difference between the space-“filling” aspects of regular and chaotic orbits is that in the regular incommensurate case the space is “filled” in a systematic manner by the predetermined spiraling motion around the torus, while in the chaotic case the orbit “fills” space in a random, meandering, manner.

This nonintuitive manner in which chaotic orbits in a sense spread out more and more, and in another sense become more attenuated, as they develop in time is very analogous to the behavior of fractals. We saw above how the Cantor set and the Sierpinski carpet illustrated in Fig. 11.16 both become more disperse and more attenuated as they go through successive iterations, always remaining finite throughout the process. There is an analogue of the Sierpinski carpet in three-dimensional Euclidian space called a Sierpinski sponge, which evolves in an analogous manner through an iterative process, dispersing through space while losing volume in accordance with a fractal dimension. Chaotic trajectories are indeed closely related to fractals.

In our treatment of the quantitative aspects of chaos, we have placed more emphasis on the fractal property of nonintegral dimensionality than we have on its property of self-similarity. In the applications of fractals outside the domain of classical mechanics, the emphasis is often more on the self-similarity aspect. Many books display beautiful pictures of precisely drawn figures that illustrate self-similarity down to infinite levels of subdivision, such as the Sierpinski carpet sketched in Fig. 11.16. There are also examples from nature, such as the dendritic growth of the branches of a tree, in which the self-similarity is more approximate and irregular.

DERIVATIONS

1. Show that the system $y_{n+1} = 1 - \gamma y_n^2$ with $-1 < y < 1$ and $0 < \gamma \leq 2$ can be transformed to the logistic equation (11.31) by the substitution $y = cx + d$. Find γ , c , and d in terms of the control parameter a of the logistic equation.
2. Show that the Hénon–Heiles Hamiltonian (11.17) can be written in polar coordinates as

$$H = \frac{p_r^2}{2m} + \frac{p_\theta^2}{2mr^2} + \frac{1}{2}kr^2 + \frac{1}{3}\lambda r^3 \sin 3\theta.$$

This form explicitly exhibits the threefold symmetry.

3. Show that for the energy $E = \frac{1}{6}$, the bounding equipotential ($V(r, \theta) = \frac{1}{6}$) for the dimensionless Hénon–Heiles potential

$$V(r, \theta) = \frac{1}{2}r^2 + \frac{1}{3}r^3 \sin 3\theta,$$

forms an equilateral triangle in the x, y plane (cf. Fig. 11.6).

4. Show that Eq. (11.34b) follows from inserting Eq. (11.34a) into Eq. (11.31). In addition, show that the stability range given in the text (cf. Eq. (11.35)) also follows.

EXERCISES

Most of the following exercises are best completed using a personal computer able to run programs such as *Maple*TM, *Mathematica*TM, or *Maxima*TM. In these exercises the notation $dz/dt = \dot{z}$ is used.

5. Find the first three bifurcations for the system $y_{n+1} = 1 - by_n^2$, where $-1 < y < 1$ and $0 < b \leq 2$.
6. In an attempt to predict weather patterns, Edward N. Lorenz developed a model in 1969 with the following three coupled equations (Lorenz model) in $x(t)$, $y(t)$, and $z(t)$:

$$\frac{dx}{dt} = \sigma(y - x), \quad \frac{dy}{dt} = rx - y - xz, \quad \frac{dz}{dt} = xy - bz,$$

where σ , r , and b are positive constants and x , y , and z are real. Lorenz chose, for physical reasons, $\sigma = 10$ and $b = \frac{8}{3}$, and the parameter r is increased from 0. Let $x(0) = 2$, $y(0) = 5$, and $z(0) = 5$. Investigate the behavior for

- (a) $r = 0, 10$, and 20 , $0 \leq t < 20$
 (b) $r = 28$, $0 \leq t < 20$, where chaotic behavior sets in for $t \approx 7$

In both cases, investigate the trajectories by using either three-dimensional plots of the coordinates $x(t)$, $y(t)$, $z(t)$ for different time steps or, if your numeric programs do not generate such plots, plot $x(t)$ versus t .

7. A system of equations simpler than the Lorenz equations of Exercise 6 were proposed by O. E. Rössler in 1976, with only one nonlinear system coupling term. This system had no physical intent except to show chaos.

$$\frac{dx}{dt} = -(y + z), \quad \frac{dy}{dt} = x + ay, \quad \frac{dz}{dt} = b + z(x - c),$$

with a , b , and c positive constants and $x(t)$, $y(t)$, and $z(t)$ real.

- (a) Take $a = b = 0.2$, and initial conditions $x(0) = -1$, $y(0) = z(0) = 0$. Investigate the effects of changing c around $c = 5.7$, holding a and b fixed.
 (b) Take $a = b = 0.2$, $c = 5.7$ and investigate the effects of changing the initial conditions starting with $x(0) = -1$, $y(0) = z(0) = 0$.
8. The general forced damped oscillator equation studied by F. Duffing in 1918 (*Duffing oscillator*) can be written as

$$\frac{d^2x}{dt^2} + 2\gamma \frac{dx}{dt} + \alpha x + \beta x^3 = F \cos \omega t$$

- (a) Take $\alpha = 1$, $\beta = 0.2$, $\gamma = 0$, $F = 4.0$, $[dx/dt]_{t=0} = 0$ and choose a set of values of $x_{t=0}$ and ω to show that the amplitude (absolute magnitude of the maximum x) of the steady-state oscillation shows hysteresis. This is best done by plotting the behavior for increasing ω until there is a jump in the amplitude and then continuing the plot for slowly decreasing ω from a value slightly larger than where the jump occurred.
 (b) Having solved part (a), pick a value of ω in the range of the jump and slightly vary F to determine how the amplitude varies for a fixed ω as F is changed.

9. Study the van der Pol equation (11.11),

$$m \frac{d^2x}{dt^2} - \varepsilon(1 - x^2) \frac{dx}{dt} + m\omega_0^2 x = F \cos \omega_D t$$

- (a) For the initial conditions near $x = 0.5$ and $dx/dt = 0$ for the values of $\varepsilon = 0, 0.1, 0.2,$ and 0.3 . Plot $x(t)$ as a function of time to determine empirically the rate at which the orbit approaches the attractor at $x = 1$.
- (b) Repeat for the initial conditions $x = 1.5, dx/dt = 0$.
10. Construct the Poincaré section xp for the particular Duffing oscillator

$$\frac{d^2x}{dt^2} + 0.7 \frac{dx}{dt} + x^3 = 0.75 \cos t,$$

where $p = \dot{x} = \frac{dx}{dt}$, with initial conditions $x(0) = \frac{dx}{dt}(0) = 0$.

11. Construct the Poincaré section, as in Exercise 10, for the *inverted Duffing oscillator*,

$$\frac{d^2x}{dt^2} + 0.5 \frac{dx}{dt} - x + x^3 = F \cos t,$$

for values of F in the range 0.24 to 0.35. This oscillator is said to be inverted because the coefficient of the linear term is negative.

12. The diffusion equation is $\partial u / \partial t = \eta \nabla^2 u$ where $u(x, t)$ is the density and η is the diffusion constant. The model of diffusion by Witten and Sadler can be approximated for numerical integration in two dimensions by considering a two-dimensional square lattice and defining the size of a cluster as the minimum radius that includes all of its particles. Mathematically perform the following:

- (a) Place a particle at the center of a 25×25 lattice of spacing a .
- (b) Place a particle at a random position away from the center but not adjacent to the center and allow this particle to randomly move one location at a time until it either leaves the lattice or becomes adjacent to the original particle. For the latter eventuality, draw a circle centered on the center of the cluster that just includes these two particles. Call this radius R_{\min} . After completing this step $R_{\min} = a/2$.
- (c) Repeat this process by adding additional particles at random, increasing R_{\min} if necessary to include all adjacent particles.
- (d) After a reasonable number of particles, N , are aggregated, calculate the fractal dimension, D , by the rule

$$D = \frac{\ln N}{\ln R_{\min}}.$$

13. Construct a Poincaré section for the Hénon–Heiles potential. It is suggested that you make the plot in the $\dot{y}y$ plane so that you can compare your results with Figs. 11.7 and 11.8. Choose an energy, E , and initial conditions, $x = 0$ and $\dot{x} = 0$, and initial conditions on y and \dot{y} to satisfy the energy condition and find the boundary curve. Relax the condition on \dot{x} and choose conditions on \dot{x} , y , and \dot{y} that satisfy the energy condition for $x = 0$. Integrate the equations of motion to find the crossings.

- (a) Choose $E = \frac{1}{12}$, $y_0 = 0.01$, $\dot{y}_0 = 0.02$, and $x_0 = 0$. Use the energy equation to determine \dot{x}_0 . Integrate the equations to find the values of t where $x(t) \approx 0$ saving

the values t , $x(t) \approx 0$, $\dot{x}(t)$, $y(t)$, $\dot{y}(t)$. Find the first 27 crossings and compare with Fig. 11.7.

(b) Repeat this process for $E = \frac{1}{8}$ and plot the chaotic behavior.

14. Construct the entries in Table 11.1 for $a = 3.55$ and $a = 3.60$.
15. Refer to Figs. 11.13 and 11.15 for the logistic equation. Find the values of the three cycle attractors embedded in the region of chaos. Use the control parameter $a = 3.83$. Also find the values of the next higher cycle obtained for a larger control parameter in this same embedded region of normality.
16. Show that in the control parameter range between the first and second bifurcations of the logistic equation the two final values of the attractors, x_n and x_{n+1} such as those given by Eq. (11.36) satisfy the cubic equation

$$a^3 x^2(2 - x) - a^2(a + 1)x + (a^2 - 1) = 0.$$

CHAPTER

12

Canonical Perturbation Theory

12.1 ■ INTRODUCTION

Almost all of the problems in classical mechanics discussed in Chapters 1–10, whether in the text or in the exercises, have had exact solutions. Nevertheless, it should be clear from Chapter 11 on chaos that the great majority of problems in classical mechanics cannot be solved exactly. We have found solutions for the two-body Kepler problem, but with the exception of a few special cases the classical motion of three-point bodies acted upon only by their mutual gravitational forces has proved intractable (see Section 3.12). Even for two bodies the solutions are implicit; no closed explicit formula can be found for the coordinates as a function of time (cf. Section 3.8). There is thus considerable incentive for developing approximate methods of solution.

It often happens, fortunately, that in a physical problem that cannot be solved directly the Hamiltonian differs only slightly from the Hamiltonian for a problem that can be solved rigorously. The more complicated problem is then said to be a *perturbation* of the soluble problem, and the difference between the two Hamiltonians is called the *perturbation Hamiltonian*. Perturbation theory consists of techniques for obtaining approximate solutions based on the smallness of the perturbation Hamiltonian and on the assumed smallness of the changes in the solutions. We know from the discussion in Chapter 11 that even when the change in the Hamiltonian is small, the eventual effect of the perturbation on the motion can be large. This suggests that any perturbation solution must be carefully analyzed to be sure that it is physically correct.

The development of perturbation theory goes back to the earliest days of celestial mechanics. Newton realized, for example, that most of the oscillations in the Moon's motion were the result of small changes in the attraction to the Sun as the Moon revolves about Earth. His initial attempts at a lunar theory including these effects corresponded roughly to a form of perturbation theory. Many of the subsequent developments in the formal structure of classical mechanics, such as Hamilton's canonical theory, stemmed in large measure from the desire to perfect perturbation techniques in celestial mechanics. The need for predicting highly accurate orbits for space vehicles and the enormously increased capacity for numerical computations have spurred further improvements in perturbation theory.

Classical perturbation theory can be divided into two approaches: time-dependent and time-independent perturbations. The terminology is chosen with an eye to perturbation theory as developed for quantum mechanics, and indeed there are many points of analogy between the classical perturbation techniques and their quantum counterparts. Generally speaking, classical perturbation theory is considerably more complicated than the corresponding quantum mechanical version. We shall treat time-dependent perturbation first as being the easier form to understand. While perturbation theory can be developed for all versions of classical mechanics, it is simplest to use the Hamilton–Jacobi formulation.

12.2 ■ TIME-DEPENDENT PERTURBATION THEORY

Let $H_0(q, p, t)$ represent the Hamiltonian for the soluble, unperturbed problem. We imagine the solution has been obtained through Hamilton's principal function $S(q, \alpha, t)$, which generates a canonical transformation in which the new Hamiltonian, K_0 , for the unperturbed problem is identically zero. The transformed canonical variables, (α, β) , are then all constant in the unperturbed situation. Now let us consider the perturbed problem for which we write the Hamiltonian as (cf. Eq. (11.8))

$$H(q, p, t) = H_0(q, p, t) + \Delta H(q, p, t). \quad (12.1)$$

As has been emphasized before, the canonical property of a given coordinate transformation is independent of the particular form of the Hamiltonian. Therefore, the transformation

$$(p, q) \rightarrow (\alpha, \beta)$$

generated by $S(q, \alpha, t)$ remains a canonical transformation for the perturbed problem. Only now the new Hamiltonian will not vanish and the transformed variables may not be constant. For the perturbed problem, the transformed Hamiltonian will be

$$K(\alpha, \beta, t) = H_0 + \Delta H + \frac{\partial S}{\partial t} = \Delta H(\alpha, \beta, t). \quad (12.2)$$

Hence, the equations of motion satisfied by the transformed variables are now

$$\dot{\alpha}_i = -\frac{\partial \Delta H(\alpha, \beta, t)}{\partial \beta_i}, \quad \dot{\beta}_i = \frac{\partial \Delta H(\alpha, \beta, t)}{\partial \alpha_i}. \quad (12.3)$$

Equations (12.3) are rigorous; no approximation has yet been made. If the set of $2n$ equations can be solved for α_i and β_i as functions of time, then the equations of transformation between (p, q) and (α, β) give q_j and p_j as functions of time, that is, solve the problem. However, the exact solution of Eqs. (12.3) is usually no less difficult to obtain than for the original equations of motion. The use of

Eqs. (12.3) as an alternative approach to the rigorous solution is therefore not particularly fruitful.

In the perturbation technique, however, advantage is taken of the fact that ΔH is small. The quantities (α, β) , while no longer constant, therefore do not change rapidly, at least compared to the explicit dependence of ΔH on time. A first-order approximation to the time variation of (α, β) is obtained by replacing α and β on the *right-hand side* of Eqs. (12.3) by their *constant* unperturbed values:

$$\dot{\alpha}_{1i} = - \left. \frac{\partial \Delta H(\alpha, \beta, t)}{\partial \beta_i} \right|_0, \quad \dot{\beta}_{1i} = \left. \frac{\partial \Delta H(\alpha, \beta, t)}{\partial \alpha_i} \right|_0. \quad (12.4)$$

Here α_{1i} and β_{1i} stand for the first-order perturbation solutions for α_i and β_i , respectively, and the vertical lines with subscript 0 indicate that after differentiation α and β are to be replaced by their unperturbed forms; that is, the constants (α_0, β_0) . Equations (12.4) can be placed in matrix form by designating γ as the column matrix of the β and α canonical variables, so that

$$\dot{\gamma}_i = \mathbf{J} \left. \frac{\partial \Delta H(\gamma, t)}{\partial \gamma} \right|_0, \quad (12.5)$$

where \mathbf{J} is the matrix given by Eq. (8.38a). Equations (12.4) can now be integrated directly to yield the α_1 and β_1 as functions of time. Through the transformation equations, we then obtain (q, p) as functions of time to first order in the perturbation. Clearly, the second-order perturbation is obtained by using the first-order dependence of α and β on time in the right-hand sides of Eqs. (12.4), and so on. In general, the n th-order perturbation solution is obtained by integrating the equations (in matrix form) for γ_n given by

$$\dot{\gamma}_n = \mathbf{J} \left. \frac{\partial \Delta H(\gamma, t)}{\partial \gamma} \right|_{n-1}. \quad (12.6)$$

As a trivial example of these procedures, let us consider as the unperturbed system the force-free motion in one dimension of a particle of mass m . The unperturbed Hamiltonian is

$$H_0 = \frac{p^2}{2m}.$$

The momentum p is clearly conserved; call its constant value α . For this system the Hamilton–Jacobi equation is

$$\frac{1}{2m} \left(\frac{\partial S}{\partial x} \right)^2 + \frac{\partial S}{\partial t} = 0. \quad (12.7)$$

Because the system is conservative and x is cyclic, we know immediately that the solution for Hamilton's principal function is

$$S = \alpha x - \frac{\alpha^2 t}{2m}. \quad (12.8)$$

The transformed momentum is α ; the transformed constant coordinate is

$$Q \equiv \beta = \frac{\partial S}{\partial \alpha} = x - \frac{\alpha t}{m}$$

or

$$x = \frac{\alpha t}{m} + \beta, \quad (12.9)$$

the expected solution for the force-free motion. While Eq. (12.9) is obvious a priori, this formal derivation via the Hamilton–Jacobi equation at least shows that α and β , so defined, form a canonical set.

Now suppose the perturbation Hamiltonian is

$$\Delta H = \frac{m\omega^2 x^2}{2}, \quad (12.10)$$

where ω is some constant. The total Hamiltonian is

$$H = H_0 + \Delta H = \frac{1}{2m}(p^2 + m^2\omega^2 x^2). \quad (12.11)$$

We are thus considering the harmonic oscillator potential as a perturbation on force-free motion! In terms of the α , β variables, the perturbation Hamiltonian, by Eq. (12.9), is

$$\Delta H = \frac{m\omega^2}{2} \left(\frac{\alpha t}{m} + \beta \right)^2. \quad (12.12)$$

In the perturbed system, the equations of motion for α , β are (cf. Eqs. (12.3))

$$\dot{\alpha} = -m\omega^2 \left(\frac{\alpha t}{m} + \beta \right), \quad (12.13a)$$

$$\dot{\beta} = \omega^2 t \left(\frac{\alpha t}{m} + \beta \right). \quad (12.13b)$$

Note that

$$\dot{\beta} + \frac{t}{m}\dot{\alpha} = 0. \quad (12.14)$$

A rigorous solution of Eqs. (12.13) can be obtained by taking the time derivative of Eq. (12.13a):

$$\ddot{\alpha} = -\omega^2 \alpha - m\omega^2 \left(\beta - \frac{\dot{\alpha} t}{m} \right) = -\omega^2 \alpha. \quad (12.15)$$

Thus, α in the perturbed system rigorously has a simple harmonic variation with time. From Eqs. (12.13a) and (12.9), it follows $x = -\dot{\alpha}/(m\omega^2)$, and hence the solution for x is also simple harmonic motion. Considered as rigorous equations of motion, Eqs. (12.13) therefore lead properly to the correct and well-known solution.

But now let us treat $m\omega^2$ ($\equiv k$, the force constant) as a small parameter and seek perturbation solutions. The first-order perturbation is obtained by replacing α and β on the right by their unperturbed values α_0 and β_0 . For simplicity, we shall take $x = 0$ initially, so that $\beta_0 = 0$; the initial value of p is then α_0 . The first-order equations of motion are then

$$\dot{\alpha}_1 = -\omega^2\alpha_0 t, \quad \dot{\beta}_1 = \alpha_0 \frac{\omega^2 t^2}{m}, \quad (12.16)$$

with immediate solutions

$$\alpha_1 = \alpha_0 - \frac{\omega^2\alpha_0 t^2}{2}, \quad \beta_1 = \frac{\alpha_0\omega^2 t^3}{3m}. \quad (12.17)$$

Solutions for x and p to first order are then

$$x = \frac{\alpha_1 t}{m} + \beta_1 = \frac{\alpha_0}{m\omega} \left(\omega t - \frac{\omega^3 t^3}{6} \right), \quad (12.18a)$$

and

$$p = \alpha_1 = \alpha_0 \left(1 - \frac{\omega^2 t^2}{2} \right). \quad (12.18b)$$

Substituting Eqs. (12.17) for α and β on the right-hand side of Eqs. (12.13), the second-order equations of motion become

$$\begin{aligned} \dot{\alpha}_2 &= -\alpha_0\omega^2 \left(t - \frac{\omega^2 t^3}{6} \right), \\ \dot{\beta}_2 &= \frac{\alpha_0\omega^2}{m} \left(t^2 - \frac{\omega^2 t^4}{6} \right), \end{aligned} \quad (12.19)$$

with solutions

$$\begin{aligned} \alpha_2 &= \alpha_0 - \frac{\omega^2\alpha_0 t^2}{2} + \frac{\omega^2\alpha_0 t^4}{24}, \\ \beta_2 &= \frac{\alpha_0\omega^2}{m} \left(\frac{t^3}{3} - \frac{\omega^2 t^5}{30} \right). \end{aligned} \quad (12.20)$$

The corresponding second-order solutions for x and p are

$$\begin{aligned}
 x &= \frac{\alpha_0}{m\omega} \left(\omega t - \frac{\omega^3 t^3}{3!} + \frac{\omega^5 t^5}{5!} \right), \\
 p &= \alpha_0 \left(1 - \frac{\omega^2 t^2}{2!} + \frac{\omega^4 t^4}{4!} \right).
 \end{aligned}
 \tag{12.21}$$

By now we have enough to see where the n th-order solution is going. The quantities in the parentheses in Eqs. (12.21) are the first three terms in the expansion of the sine and cosine, respectively. In the limit of infinite order of perturbation, clearly

$$x \rightarrow \frac{\alpha_0}{m\omega} \sin \omega t, \quad p \rightarrow \alpha_0 \cos \omega t,$$

which are the standard solutions consistent with the initial conditions.

The constant transformed variables (α, β) incorporate information on the parameters of the unperturbed orbit. Thus, if the Kepler problem in three dimensions describes the unperturbed system, then a suitable set of (α, β) are the Delaunay variables, that is, the constant action variables J_1 and the constant terms in the corresponding angle variables w_i . We have seen in Section 10.8 that the Delaunay variables are simply related to the orbital parameters—semimajor axis, eccentricity, inclination, and so on. The effect of the perturbation is to cause these parameters to vary with time. If the perturbation is small, the variation of the parameters within one period of the unperturbed motion will also be small. Time-dependent perturbation theory thus implies a picture in which the perturbed system moves during small intervals of time in an orbit of the same functional form as the unperturbed system, an orbit whose parameters however will be changing in time. The unperturbed orbit along which the system is momentarily traveling is sometimes described as the “osculating orbit.” In position and tangent direction, it matches instantaneously the true trajectory.

As determined by a perturbation treatment, the parameters of the osculating orbit may vary with time in two ways. There may be a periodic variation, in which a parameter comes back to an initial value in a time interval that to first order is usually the period of the unperturbed motion. Or there may remain a net increment in the value of the parameter at the end of each successive orbital period—and the perturbed parameters are said to exhibit *secular* change. Periodic effects of perturbation do not change the average parameters of the orbit; on the whole, the trajectory remains looking much like the unperturbed orbit. A secular change, no matter how small per orbital period, means that eventually, after many periods, the instantaneous perturbed parameters may be quite different from their unperturbed values. Therefore, the major interest in a perturbation calculation will often be in the secular terms only, and the periodic effects may be eliminated early in the game by averaging the perturbation over the unperturbed period. Effectively, this is what was done in Section 5.8 when the perturbing

gravitational potential of the oblate Earth was averaged over the satellite period (cf. Eq. (5.90)).*

Often we would like to determine the time dependence of the orbital “constants”—for example, eccentricity, or inclination—directly, rather than through the intermediary of the canonical set (α, β) . This can be done easily through the Poisson bracket formalism. Let c_i be any set of $2n$ independent functions of the (α, β) constants of the unperturbed system:

$$c_i = c_i(\alpha, \beta). \quad (12.22)$$

One or more of the c_i may be the desired orbital parameters. Then in the perturbed system the time dependence of the c_i quantities is determined by the equations of motion

$$\dot{c}_i = [c_i, K] = [c_i, \Delta H]. \quad (12.23)$$

But $\Delta H(\alpha, \beta, t)$ may equally well, by the inverse of Eqs. (12.22), be considered a function of the c 's and t , so that (cf. Eq (9.68))

$$\begin{aligned} [c_i, \Delta H] &\equiv \frac{\partial c_i}{\partial \eta} \Big| \frac{\partial \Delta H}{\partial \eta} = \frac{\partial c_i}{\partial \eta} \Big| \frac{\partial \Delta H}{\partial c_j} \frac{\partial c_j}{\partial \eta} \\ &= [c_i, c_j] \frac{\partial \Delta H}{\partial c_j}. \end{aligned}$$

Hence,

$$\dot{c}_i = [c_i, c_j] \frac{\partial \Delta H}{\partial c_j}. \quad (12.24)$$

As with Eqs. (12.3), Eqs. (12.24) are rigorous equations of motion for the c_i 's. They become first-order perturbation equations when the right-hand sides, including the Poisson brackets, are evaluated for the unperturbed motion. In general the n th-order perturbation is obtained when the right-hand sides are evaluated in terms of the $(n - 1)$ st order of perturbation. Equations (12.24) thus correspond, in generalized form, to Eqs. (12.6).

*The circumstances are often be more complicated than as described in this paragraph. For example, the periodic variation of orbital parameters can exhibit more than one period. This would obviously occur when the perturbing potential has its own intrinsic periodicity, for example, the varying perturbation of the Sun's gravity on Earth–Moon orbit as Earth revolves around the Sun. Multiply periodic behavior can also appear through interactions between perturbations. Thus, the periodic perturbation of satellite parameters can show both short and long periods, and it is necessary to average over both kinds of periods to find the secular perturbation effects. Sometimes the dividing line between periodic and secular perturbations becomes a bit vague. What may appear as a secular perturbation in first order will at times on closer examination turn out to be a periodic perturbation with a very long period, as we discovered in Section 11.1 with the harmonic oscillator perturbation calculation. Depending on the purpose of the calculation, it may still be advisable to treat it as a secular perturbation term. Nonetheless, the distinction between periodic and secular terms remains useful and normally straightforward, especially in first-order perturbation theory.

A version of Eqs. (12.24) expressed in Lagrange brackets (cf. Eq. (9.79)) is often found in the literature of celestial mechanics. Multiply the equation for c_i , by the Lagrange bracket $\{c_k, c_i\}$ and sum over i :

$$\{c_k, c_i\}\dot{c}_i = \{c_k, c_i\}\{c_i, c_j\} \frac{\partial \Delta H}{\partial c_j}.$$

By the theorem expressed in Eq. (9.83), this reduces to

$$-\frac{\partial \Delta H}{\partial c_j} = \{c_j, c_i\}\dot{c}_i. \quad (12.25)$$

Historically, the perturbation equations of celestial mechanics are expressed in terms of the *disturbing function* R , defined as $-\Delta H$, so that Eqs. (12.25) appear as

$$\frac{\partial R}{\partial c_j} = \{c_j, c_i\}\dot{c}_i. \quad (12.25')$$

Equations (12.24) or (12.25) are frequently denoted as the *Lagrange perturbation equations*.

12.3 ■ ILLUSTRATIONS OF TIME-DEPENDENT PERTURBATION THEORY

A. Period of the plane pendulum with finite amplitude. In the limit of small oscillations a plane pendulum behaves like a harmonic oscillator and is isochronous; that is, the frequency is independent of the amplitude. As the amplitude increases, however, the correct potential energy deviates from the harmonic oscillator form, and the frequency shows a small dependence on the amplitude. The small difference between the potential energy and the harmonic oscillator limit can be considered as the perturbation Hamiltonian, and the shift in frequency derived from the time variation of the perturbed phase angle.

The Hamiltonian for a plane pendulum, consisting of a mass point m at the end of a weightless rod of length l , is

$$H = \frac{p^2}{2ml^2} + mgl(1 - \cos \theta), \quad (12.26)$$

where, for simplicity, the momentum conjugate to θ is denoted by p . Expanding the $\cos \theta$ term in a Taylor series, the Hamiltonian can be written as

$$H = \frac{p^2}{2ml^2} + \frac{mgl\theta^2}{2} \left(1 - \frac{\theta^2}{12} + \frac{\theta^4}{360} - \dots \right). \quad (12.27)$$

The small amplitude limit consists of dropping all but the first term in the parentheses. We can get an idea of the magnitude of the correction terms by introducing

artificially a parameter

$$\theta_1^2 = \frac{2E}{mgl} \quad (12.28)$$

and the related parameter

$$\lambda = \frac{\theta_1^2}{6} = \frac{E}{3mgl}$$

The series in the parentheses (cf. (12.27)) then looks like

$$1 - \frac{\lambda}{2} \left(\frac{\theta}{\theta_1} \right)^2 + \frac{\lambda^2}{10} \left(\frac{\theta}{\theta_1} \right)^4 - \dots$$

Now, the ratio θ/θ_1 rises to the order of unity at the maximum amplitude. Indeed, θ_1 is the maximum amplitude of oscillation when E , and therefore the amplitude, is small. Hence, the rate of convergence of the expansion is determined by the magnitude of λ .

If only one correction term is retained, first-order perturbation introduces terms of the order λ in the motion. Second-order perturbation with the same perturbation Hamiltonian introduces λ^2 terms. Thus, to obtain modifications of the motion consistently correct to λ^2 , we would have to compute second-order perturbation on the λ term in the Hamiltonian, and first-order perturbation on the λ^2 term in the Hamiltonian. We shall here content ourselves with a consistent treatment to order λ ; that is, retain only the first correction term in the Hamiltonian and carry out a first-order perturbation solution.

The unperturbed Hamiltonian derived from Eq. (12.27) can be put in the form of a harmonic oscillator by writing it as (cf. Eq. (10.18))

$$H = \frac{1}{2I}(p^2 + I^2\omega^2\theta^2), \quad (12.29)$$

where $I = ml^2$, the moment of inertia of the pendulum, and

$$\omega^2 = \frac{mgl}{I} = \frac{g}{l}. \quad (12.30)$$

A suitable set of canonical variables corresponding to a vanishing K for the unperturbed system are the action variable J and the phase angle β in the angle variable:

$$w = \nu t + \beta, \quad \nu = \frac{\omega}{2\pi}. \quad (12.31)$$

The effect of the perturbation is to cause both J and β to vary with time. The equations of transformation relating p and θ to J and β , respectively, have already been given in Eqs. (10.96) and (10.97), which here take the form

$$\begin{aligned}\theta &= \sqrt{\frac{J}{\pi I \omega}} \sin 2\pi(\nu t + \beta), \\ p &= \sqrt{\frac{I J \omega}{\pi}} \cos 2\pi(\nu t + \beta).\end{aligned}\tag{12.32}$$

In the unperturbed system J and β are constant and Eqs. (12.32) constitute the complete solutions for the motion. But the equations remain valid for the perturbed case, only J and β have time dependencies to be determined.

The unperturbed Hamiltonian is $H_0 = J\nu$, but the perturbation Hamiltonian takes the form

$$\Delta H = -\frac{mgl}{24}\theta^4 = -\frac{J^2}{24\pi^2 ml^2} \sin^4 2\pi(\nu t + \beta).\tag{12.33}$$

The first-order time dependence of β and J are to be obtained from

$$\dot{\beta} = \frac{\partial \Delta H}{\partial J}, \quad \dot{J} = -\frac{\partial \Delta H}{\partial \beta},\tag{12.34}$$

where on the right-hand side of each equation the unperturbed solutions for J and β are to be used; that is, J and β are considered constant. Thus,

$$\dot{\beta} = -\frac{J}{12\pi^2 ml^2} \sin^4 2\pi(\nu t + \beta).\tag{12.35}$$

Equation (12.35) says that to first order, $\dot{\beta}$ varies over the cycle of the unperturbed oscillation. But there is a net value for $\dot{\beta}$ when averaged over a complete cycle, for the average of \sin^4 is $\frac{3}{8}$. Hence, $\dot{\beta}$ exhibits a secular perturbation at a constant rate given by

$$\overline{\dot{\beta}} = -\frac{J}{32\pi^2 ml^2}.\tag{12.36}$$

Viewed over times long compared to the unperturbed period, β has a time dependence

$$\beta = \overline{\dot{\beta}}t + \beta_0.\tag{12.37}$$

Such a variation, when inserted in Eq. (12.32), says that, on average, the first-order solution is still simple-harmonic with a frequency

$$\nu' = \nu + \overline{\dot{\beta}}.$$

Now, in the unperturbed motion

$$J = \frac{2\pi E}{\omega} = 2\pi\omega \frac{El}{g},$$

so that $\bar{\beta}$, Eq. (12.36), becomes

$$\bar{\beta} = -\frac{\omega E}{16\pi mgl} = -\frac{\nu\theta_1^2}{16}. \quad (12.38)$$

The first-order fractional change in the frequency at a finite amplitude θ_1 is therefore

$$\frac{\Delta\nu}{\nu} = \frac{\bar{\beta}}{\nu} = -\frac{\theta_1^2}{16}, \quad (12.39)$$

a well-known result that can also be obtained by approximating the elliptic-function representation of the motion.

From Eqs. (12.33) and (12.34), it is seen that to first order the time variation of J is

$$\dot{J} = -\frac{J^2}{3\pi ml^2} \sin^3 2\pi(\nu t + \beta) \cos 2\pi(\nu t + \beta).$$

The average of $\sin^3 \phi \cos \phi$ over even a half period of ϕ is zero; hence, J shows no secular perturbation. We would expect this result physically, as J is a measure of the amplitude of the oscillations (cf. Eqs. (12.32)), and the perturbation would not be such as to cause the amplitude to grow or decay with time.

B. A central force perturbation of the bound Kepler problem. In Exercise 21, Chapter 3, it was shown rigorously that if a potential with a $1/r^2$ form is added to the Coulomb potential, the orbit in the bound problem is an ellipse in a *rotating* coordinate system. In effect, the ellipse rotates, and the periapsis appears to precess. Here we will find the precession rate by first-order perturbation theory, considering a somewhat more general form for the perturbing potential.

Suppose the total potential is

$$V = -\frac{k}{r} - \frac{h}{r^n}, \quad (12.40)$$

where n is an integer greater than or equal to $+2$. The constant h will be assumed to be such that the second term is a small perturbation on the first for the range of r considered. The perturbation Hamiltonian is thus

$$\Delta H = -\frac{h}{r^n}, \quad n \geq 2. \quad (12.41)$$

In the unperturbed problem the angular position of the periapsis in the plane of the orbit is given by the constant $\omega = 2\pi\omega_2$ (cf. Eq. (10.166)). With the perturbation, ω has a time dependence determined by

$$\dot{\omega} = 2\pi \frac{\partial \Delta H}{\partial J_2} = \frac{\partial \Delta H}{\partial l}, \quad (12.42)$$

using the relation $J_2 = 2\pi l$ (Eq. (10.156)). First-order perturbation results are obtained by evaluating ΔH , and the derivative, in terms of the unperturbed motion. Further, the instantaneous change in ω is rarely of interest. In most situations where the perturbation formalism is of value, $\dot{\omega}$ is so small the change in ω is difficult or impossible to perceive within a single orbital period, and it is sufficient to measure only the secular change in ω after many orbits. Therefore, what is wanted is $\dot{\omega}$ averaged over a time interval τ , the period of the unperturbed orbit:

$$\bar{\dot{\omega}} \equiv \frac{1}{\tau} \int_0^\tau \frac{\partial \Delta H}{\partial l} dt.$$

The derivative can be taken outside the integral sign, since τ is a function of J_3 only (Eq. (10.142) combined with Eq. (10.146)), whereas the derivative is with respect to $l = J_2/2\pi$. Hence,

$$\bar{\dot{\omega}} = \frac{\partial}{\partial l} \left(\frac{1}{\tau} \int_0^\tau \Delta H dt \right) = \frac{\partial \overline{\Delta H}}{\partial l}. \quad (12.43)$$

But the time average of the perturbation Hamiltonian is here

$$\overline{\Delta H} = -h \overline{\left(\frac{1}{r^n} \right)} = -\frac{h}{\tau} \int_0^\tau \frac{dt}{r^n}. \quad (12.44)$$

By using the conservation of angular momentum in the form $l dt = mr^2 d\psi$, the integral can be converted into one over ψ :

$$\overline{\Delta H} = -\frac{mh}{l\tau} \int_0^{2\pi} \frac{d\psi}{r^{n-2}} \quad (12.45)$$

$$= -\frac{mh}{l\tau} \left(\frac{mk}{l^2} \right)^{n-2} \int_0^{2\pi} [1 + e \cos(\psi - \psi')]^{n-2} d\psi, \quad (12.45')$$

where r has been expressed in terms of ψ through the orbit equation, Eq. (3.56) (with ψ used in place of θ). In general, only terms involving even powers of the eccentricity e will give nonvanishing contributions to the integral. The derivative with respect to l also involves e and its powers, since, by Eq. (10.159), e is a function only of J_2 and J_3 .

Two special cases are of particular interest. One occurs when $n = 2$, mentioned briefly at the start of this illustration. The average perturbation Hamiltonian is then simply

$$\overline{\Delta H} = -\frac{2\pi mh}{l\tau},$$

and the secular precession rate is

$$\overline{\dot{\omega}} = \frac{2\pi mh}{l^2 \tau}, \quad (12.46)$$

which agrees with Exercise 21 of Chapter 3.

The other case of interest is for $n = 3$ (a $1/r^3$ perturbation potential), for which Eq. (12.45') reduces to

$$\overline{\Delta H} = -\frac{2\pi m^2 hk}{l^3 \tau}$$

and

$$\overline{\dot{\omega}} = \frac{6\pi m^2 hk}{l^4 \tau}. \quad (12.47)$$

What makes this choice of n of particular significance is that general relativity theory predicts a correction to Newtonian motion that can be construed as an r^{-3} potential. The so-called Schwarzschild spherically symmetric solution of the Einstein field equations corresponds for weak fields to an additional Hamiltonian term in the Kepler problem of the form of Eq. (12.41), with $n = 3$ and

$$h = \frac{kl^2}{m^2 c^2}, \quad (12.48)$$

so that Eq. (12.47) becomes

$$\overline{\dot{\omega}} = \frac{6\pi k^2}{\tau l^2 c^2}. \quad (12.49)$$

To apply Eq. (12.49) to the secular precession rate for the precession of a body revolving around the Sun, k is set equal to GMm and Eq. (3.63), valid for the unperturbed ellipse, is used

$$l^2 = mka(1 - e^2). \quad (12.50)$$

Equation (12.49) can then be put in the form

$$\overline{\dot{\omega}} = \frac{6\pi}{\tau(1 - e^2)} \left(\frac{R}{a} \right), \quad (12.51)$$

where R is the so-called gravitational radius of the Sun is

$$R = \frac{GM}{c^2} = 1.4766 \text{ km}. \quad (12.52)$$

For the planet Mercury, $\tau = 0.2409$ sidereal years, $e = 0.2056$, and $a = 5.790 \times 10^7$ km; Eq. (12.51) then predicts a precession of the perihelion of Mercury arising from general relativity at an average rate of

$$\overline{\dot{\omega}} = 42.98''/\text{century}.$$

The observed secular precession of the perihelion of Mercury is over 100 times larger than this value, namely $5599.74 \pm 0.41''/\text{century}$. Most of this is due to the precession of the equinoxes, of the remainder, about $531.54''/\text{century}$ arises from perturbations of the orbit of Mercury by other planets. Only after these two sets of effects are subtracted from the observed precession does the small general relativity effect of approximately $43''/\text{century}$ become visible. The currently accepted observational value is stated to be $43.1'' \pm 0.5''/\text{century}$; the deviation from the theoretical prediction is not considered significant.

One point remains to be made. In the application to relativistic effects, the constant h , Eq. (12.48), is a function of the value of l . It might be asked therefore that in finding $\dot{\omega}$, why doesn't the derivative with respect to l act also on h ? The key here is that h is not functionally dependent on l as a canonical momentum, Equation (12.48) says only how the value of the constant h is determined in terms of the value of the orbit parameter l . In other words, the perturbation potential is a function of the dynamical variables only through r ; it is not to be construed as velocity dependent.

C. Precession of the equinoxes and of satellite orbits. The family of problems to be considered here was discussed previously in Section 5.8, which bears the same title. We wish to describe the relative motion of two bodies interacting through their gravitational attraction, one a spherically symmetric or point body, the other being slightly oblate with a resultant gravitational quadrupole moment. The effect of the slight oblate shape of Earth is physically that the torques exerted by the Sun and Moon on the equatorial bulge cause Earth's rotation axis to precess very slowly. Reciprocally, the effect on an object orbiting around Earth, such as the Moon or an artificial satellite, is to cause the plane of the orbit to precess about the figure axis of Earth. The small magnitude of the gravitational quadrupole term, manifested by the very slow rate of precession, suggests that a perturbation treatment should be an extremely good approximation. We shall actually examine here only the case of the perturbation of a satellite's orbit; the reciprocal phenomenon of the precession of the equinoxes proceeds very similarly (though with different notation) from the same perturbation Hamiltonian, and will be left for the exercises.

Since the emphasis here will be on a point satellite moving about a much more massive Earth, the notation of Section (5.8) will be reversed here and m used to denote the mass of the satellite while M stands for Earth's mass. The total potential acting on the satellite, by Eq. (5.88), is then

$$V = -\frac{k}{r} + \frac{k}{M} \frac{(I_3 - I_1)}{r^3} P_2(\gamma), \quad (12.53)$$

where $k = GMm$, $P_2(\gamma)$ is the second-order Legendre polynomial, and γ is the cosine of the angle θ between the radius vector to the satellite and Earth's figure axis. For the perturbation Hamiltonian, we therefore have

$$\Delta H = k \frac{I_3 - I_1}{2Mr^3} (3 \cos^2 \theta - 1). \quad (12.54)$$

The polar angle θ can be expressed in terms of the inclination angle of the orbit, i , and the angle of the radius vector in the orbital plane relative to the periapsis, ψ , (the so-called true anomaly) by the relation*

$$\cos \theta = \sin i \sin(\psi + \omega), \quad (12.55)$$

where ω is the argument of the periapsis. A small amount of manipulation enables us to rewrite the angular dependence of ΔH as

$$3 \cos^2 \theta - 1 = \left(\frac{1}{2} - \frac{3}{2} \cos^2 i\right) - \frac{3}{2} \sin^2 i \cos 2(\psi + \omega). \quad (12.56)$$

Now, because of the small size of the perturbation, the chief interest is in the cumulative effects of the secular portion. Thus, the precession of the orbital plane shows up as a secular change in Ω , the angle of the line of nodes (or longitude of the ascending node). By the same argument used in the previous illustration we can obtain the secular effects by averaging ΔH prior to taking derivatives:

$$\begin{aligned} \overline{\Delta H} &\equiv \frac{1}{\tau} \int_0^\tau \Delta H dt = \frac{m}{l\tau} \int_0^{2\pi} r^2 \Delta H d\psi \\ &= \frac{m^2 k^2 (I_3 - I_1)}{2Ml^3 \tau} \int_0^{2\pi} (1 + e \cos \psi)(3 \cos^2 \theta - 1) d\psi. \end{aligned} \quad (12.57)$$

The term in $\cos 2(\psi + \omega)$ in Eq. (12.56) gives zero contribution to the integral because it is orthogonal, in the interval of integration, to both l and $\cos \psi$. Hence the averaged perturbation Hamiltonian is

$$\overline{\Delta H} = \frac{\pi m^2 k^2 (I_3 - I_1)}{2Ml^3 \tau} (1 - 3 \cos^2 i). \quad (12.58)$$

In view of Eqs. (10.157) and (10.165) linking Ω and i with the action-angle variables, the first-order perturbation value for $\dot{\overline{\Omega}}$ is to be found from

$$\dot{\overline{\Omega}} = 2\pi \overline{\dot{w}_1} = 2\pi \frac{\partial \overline{\Delta H}}{\partial J_1} = \frac{1}{l} \frac{\partial \overline{\Delta H}}{\partial \cos i}$$

or

$$\dot{\overline{\Omega}} = -\frac{3\pi m^2 k^2 (I_3 - I_1) \cos i}{Ml^4 \tau}.$$

Finally, using Eq. (12.50), the average fractional change in Ω per unperturbed revolution is

*Equation (12.55) can be obtained in many ways, for example, by matrix rotation of the plane of the orbit into the xy plane. It is given, most simply perhaps, by some old-fashioned trigonometric reasoning based on Fig. 10.7. As $OB = 1$, $BC = \cos \theta$, but $AB = \sin(\psi + \omega)$ and therefore BC is also $\sin i \sin(\psi + \omega)$.

$$\frac{\overline{\dot{\Omega}}\tau}{2\pi} = -\frac{3}{2} \frac{I_3 - I_1}{Ma^2} \frac{\cos i}{(1 - e^2)^2}, \quad (12.59)$$

which is the appropriate generalization of Eq. (5.96) to an elliptic satellite orbit.

Once the average perturbation Hamiltonian is known, the effect of the perturbation on other average parameters of the orbit can be found. Thus, the secular precession of the periapsis in the plane of the orbit is immediately given by

$$\overline{\dot{\omega}} = 2\pi \overline{\dot{w}_2} = 2\pi \frac{\partial \overline{\Delta H}}{\partial J_2} = \frac{\partial \overline{\Delta H}}{\partial l}.$$

The canonical variable J_2 occurs in ΔH as given by Eq. (12.58) in two forms: in the l^3 term in the denominator and in the term containing $\cos i = J_1/J_2$. Upon carrying out the derivative, it is found that

$$\frac{\overline{\dot{\omega}}\tau}{2\pi} = \frac{3}{4} \frac{I_3 - I_1}{Ma^2(1 - e^2)} (5 \cos^2 i - 1). \quad (12.60)$$

The maximum value of $\overline{\dot{\omega}}$ is thus about the same as that of $\overline{\dot{\Omega}}$, but the dependence upon i is quite different. At critical inclinations of $63^\circ 26'$ and $116^\circ 34'$, the precession of the periapsis vanishes (at least to first order) and changes sign above and below these points. It is clear that, to first order, there is no secular change in either a or e , since $\overline{\Delta H}$ does not contain the constant parts of any of the angle variables. The shape and size of the osculating ellipse, when averaged over the orbital period, thus does not change with time.

It may be noted from the last two illustrations that the general relativity correction and the gravitational quadrupole field both give rise to a precession of the periapsis of an orbiting body. The former is believed to be the more dominant factor contributing to the observed precession of the perihelion of Mercury, since the measured quadrupole component of the Sun's mass is too small.

12.4 ■ TIME-INDEPENDENT PERTURBATION THEORY

Consider conservative periodic separable systems of arbitrary number of degrees of freedom with a perturbation parameter ϵ . For the unperturbed problem, we assume a set of action-angle variables (J_{0i}, w_{0i}) such that the unperturbed Hamiltonian, H_0 , is a function only of the action variables J_{0i} , and correspondingly, the w_{0i} are then linear functions of time. In the notation of Eq. (10.110'), the relation between, say, q_k and the w_{0i} can be written compactly as

$$q_k = \sum_{\mathbf{j}} A_{\mathbf{j}}^{(k)}(\mathbf{J}_0) e^{2\pi i \mathbf{j} \cdot \mathbf{w}_0}, \quad (12.61)$$

where \mathbf{j} , \mathbf{w}_0 , and \mathbf{J}_0 are n -dimensional vectors of the integer indices, angle variables, and action variables, respectively.

In the perturbed system, $(\mathbf{w}_0, \mathbf{J}_0)$ remain a valid canonical set of variables. When expressed in terms of the set $(\mathbf{w}_0, \mathbf{J}_0)$, the perturbed Hamiltonian can be expanded in powers of a small perturbation parameter ϵ :

$$H(\mathbf{w}_0, \mathbf{J}_0, \epsilon) = H_0(\mathbf{J}_0) + \epsilon H_1(\mathbf{w}_0, \mathbf{J}_0) + \epsilon^2 H_2(\mathbf{w}_0, \mathbf{J}_0) + \dots \quad (12.62)$$

We seek a canonical transformation from $(\mathbf{w}_0, \mathbf{J}_0)$ to a new set (\mathbf{w}, \mathbf{J}) , such that the \mathbf{J} are all constants and the \mathbf{w} therefore linear functions of time. In this set, H is a function only of \mathbf{J} (and ϵ) and, in its functional form with respect to \mathbf{J} , will be written as

$$\alpha(\mathbf{J}, \epsilon) = \alpha_0(\mathbf{J}) + \epsilon \alpha_1(\mathbf{J}) + \epsilon^2 \alpha_2(\mathbf{J}) + \dots \quad (12.63)$$

To obtain the perturbed frequencies through a given order in ϵ , it suffices to find the appropriate functions $\alpha_0, \alpha_1, \dots$, for then the vector representing the frequencies is

$$\boldsymbol{\nu} = \boldsymbol{\nu}_0 + \epsilon \frac{\partial \alpha_1}{\partial \mathbf{J}} + \epsilon^2 \frac{\partial \alpha_2}{\partial \mathbf{J}} + \dots \quad (12.64)$$

The generator of the canonical transformation from $(\mathbf{w}_0, \mathbf{J}_0)$ to (\mathbf{w}, \mathbf{J}) is $Y(\mathbf{w}_0, \mathbf{J}, \epsilon)$, with a corresponding expansion in ϵ :

$$Y(\mathbf{w}_0, \mathbf{J}, \epsilon) = \mathbf{w}_0 \cdot \mathbf{J} + \epsilon Y_1(\mathbf{w}_0, \mathbf{J}) + \epsilon^2 Y_2(\mathbf{w}_0, \mathbf{J}) + \dots \quad (12.65)$$

We seek to find Y as the solution of the appropriate Hamilton–Jacobi equation:

$$H\left(\mathbf{w}_0, \frac{\partial Y}{\partial \mathbf{w}_0}, \epsilon\right) = \alpha(\mathbf{J}, \epsilon). \quad (12.66)$$

As before, the terms in α to a given order in ϵ are found by expanding both sides in powers of ϵ and collecting coefficients of the same order on both sides. We shall illustrate the process for a second-order calculation, where the Hamilton–Jacobi equation reduces to

$$H_0\left(\frac{\partial Y}{\partial \mathbf{w}_0}\right) + \epsilon H_1\left(\mathbf{w}_0, \frac{\partial Y}{\partial \mathbf{w}_0}\right) + \epsilon^2 H_2\left(\mathbf{w}_0, \frac{\partial Y}{\partial \mathbf{w}_0}\right) = \alpha_0(\mathbf{J}) + \epsilon \alpha_1(\mathbf{J}) + \epsilon^2 \alpha_2(\mathbf{J}). \quad (12.67)$$

Each of the terms on the left are functions of ϵ through the derivative of Y :

$$\mathbf{J}_0 = \frac{\partial Y}{\partial \mathbf{w}_0} = \mathbf{J} + \epsilon \frac{\partial Y_1}{\partial \mathbf{w}_0} + \epsilon^2 \frac{\partial Y_2}{\partial \mathbf{w}_0}. \quad (12.68)$$

We again expand the terms H_i in a Taylor series around $\mathbf{J}_0 = \mathbf{J}$, retaining terms of order ϵ^2 in H_0 and of order ϵ in H_i , with \mathbf{J}_0 replaced directly by \mathbf{J} in H_2 . The expansions for H_0 and H_1 , in matrix notation, are then

$$H_0 \left(\frac{\partial Y}{\partial \mathbf{w}_0} \right) = H_0(\mathbf{J}) + \left(\epsilon \frac{\partial Y_1}{\partial \mathbf{w}_0} + \epsilon^2 \frac{\partial Y_2}{\partial \mathbf{w}_0} \right) \frac{\partial H_0}{\partial \mathbf{J}} + \frac{1}{2} \left(\epsilon \frac{\partial Y_1}{\partial \mathbf{w}_0} \right) \frac{\partial^2 H_0}{\partial \mathbf{J} \partial \mathbf{J}} \left(\epsilon \frac{\partial Y_1}{\partial \mathbf{w}_0} \right) \quad (12.69)$$

$$H_1 \left(\mathbf{w}_0, \frac{\partial Y}{\partial \mathbf{w}_0} \right) = H_1(\mathbf{w}_0, \mathbf{J}) + \epsilon \frac{\partial Y_1}{\partial \mathbf{w}_0} \frac{\partial H_1}{\partial \mathbf{J}}. \quad (12.70)$$

Collecting powers of ϵ in Eq. (12.67) then leads to the following expressions for the first three terms in α :

$$\alpha_0 = H_0(\mathbf{J}), \quad (12.71a)$$

$$\alpha_1 = \mathbf{v}_0 \frac{\partial Y_1}{\partial \mathbf{w}_0} + H_1(\mathbf{w}_0, \mathbf{J}), \quad (12.71b)$$

$$\alpha_2 = \mathbf{v}_0 \frac{\partial Y_2}{\partial \mathbf{w}_0} + \Phi_2(\mathbf{w}_0, \mathbf{J}), \quad (12.71c)$$

where

$$\Phi_2(\mathbf{w}_0, \mathbf{J}) = H_2(\mathbf{w}_0, \mathbf{J}) + \frac{\partial Y_1}{\partial \mathbf{w}_0} \frac{\partial H_1}{\partial \mathbf{J}} + \frac{1}{2} \frac{\partial Y_1}{\partial \mathbf{w}_0} \frac{\partial^2 H_0}{\partial \mathbf{J} \partial \mathbf{J}} \frac{\partial Y_1}{\partial \mathbf{w}_0}. \quad (12.72)$$

Again, the equation of transformation linking \mathbf{w} and \mathbf{w}_0 is given by

$$\mathbf{w} = \frac{\partial Y}{\partial \mathbf{J}} = \mathbf{w}_0 + \epsilon \frac{\partial Y_1}{\partial \mathbf{J}} + \epsilon^2 \frac{\partial Y_2}{\partial \mathbf{J}} + \dots \quad (12.73)$$

In order for the (q, p) set to be periodic in both \mathbf{w}_0 and \mathbf{w} with period 1, all of the Y_k terms must be periodic functions of \mathbf{w}_0 , that is, of the form

$$Y_k(\mathbf{w}_0, \mathbf{J}) = \sum_{\mathbf{j}} B_{\mathbf{j}}^{(k)}(\mathbf{J}) e^{2\pi i \mathbf{j} \cdot \mathbf{w}_0}. \quad (12.74)$$

Hence, all derivatives of Y_k with respect to \mathbf{w}_0 have no constant term, and the first terms on the right of Eqs. (12.71b,c) do not contribute to the J dependence. Equations (12.71) can therefore also be written as

$$\alpha_0(\mathbf{J}) = H_0(\mathbf{J}) \quad (12.75a)$$

$$\alpha_1(\mathbf{J}) = \overline{H_1(\mathbf{w}_0, \mathbf{J})}, \quad (12.75b)$$

$$\alpha_2(\mathbf{J}) = \overline{\Phi_2(\mathbf{w}_0, \mathbf{J})}, \quad (12.75c)$$

where the bar denotes an average over the periods of all \mathbf{w}_0 . We can conveniently express all of Eqs. (12.75) in a common format by

$$\alpha_i(\mathbf{J}) = \overline{\Phi_i(\mathbf{w}_0, \mathbf{J})}, \quad (12.75')$$

where $\Phi_0 = H_0$ and $\Phi_1 = H_1$. In addition, Eqs. (12.71) have counterparts periodic in \mathbf{w}_0 with zero mean:

$$\nu_0 \frac{\partial Y_i}{\partial \mathbf{w}_0} = \overline{\Phi_i} - \Phi_i. \quad (12.76)$$

Note that in second-order perturbation the terms in Y_1 do not necessarily vanish in the mean. It is true that the derivatives of Y_1 themselves have zero mean, but they are multiplied by other functions that will be periodic in \mathbf{w}_0 , and there is no guarantee that the average of the product vanishes. Hence, to find the second-order correction to the frequencies, we need to know the first-order canonical transformation. (Analogously in quantum mechanics, a second-order eigenvalue involves first-order corrections of the wave function.) In principle, the coefficients $B_j^{(1)}$ defining Y_1 through Eq. (12.74) can be found directly from Eq. (12.76) for $i = 1$. Subtraction of the average means that $H_1 - \overline{H_1}$ can be expanded in a Fourier series analogous to Eqs. (12.61) or (12.74) but without any constant term:

$$H_1 - \overline{H_1} = \sum_{\mathbf{j} \neq 0} C_{\mathbf{j}}(\mathbf{J}) e^{2\pi i \mathbf{j} \cdot \mathbf{w}_0}. \quad (12.77)$$

Using the derivative of Y_1 in Eq. (12.76) with respect to one of the \mathbf{w}_0 , say w_{0k} , will bring down a factor $2\pi i j_k$. Hence, the matrix product on the left-hand side of Eq. (12.76) can be written

$$\nu_0 \frac{\partial Y_1}{\partial \mathbf{w}_0} = \sum_{\mathbf{j} \neq 0} B_{\mathbf{j}}^{(1)}(\mathbf{J}) 2\pi i (\mathbf{j} \cdot \boldsymbol{\nu}_0) e^{2\pi i \mathbf{j} \cdot \mathbf{w}_0}. \quad (12.78)$$

From Eqs. (12.76) and (12.77), the coefficients in the series for Y_1 can be obtained as

$$B_{\mathbf{j}}^{(1)}(\mathbf{J}) = \frac{C_{\mathbf{j}}(\mathbf{J})}{2\pi i (\mathbf{j} \cdot \boldsymbol{\nu}_0)}, \quad \mathbf{j} \neq 0. \quad (12.79)$$

It is true the constant terms in Y_1 are not determined in this way, but it is only the derivatives of Y_1 that enter into the expressions for α_i and these do not involve the constant terms (cf. Eqs (12.71)).

While we have carried out the procedure in detail only for second-order perturbation, it is easy to see that the general form of the higher-order calculations must be similar; only the details of the algebra will be more complex. For the i th order perturbation, we will again be able to write α_i in the form

$$\alpha_i(\mathbf{J}) = \nu_0 \frac{\partial Y_i}{\partial \mathbf{w}_0} + \Phi_i(\mathbf{w}_0, \mathbf{J}). \quad (12.71d)$$

The first term on the right will come from the first-derivative term in the Taylor expansion of $H(\mathbf{J}_0)$ about $\mathbf{J}_0 = \mathbf{J}$, where all terms in the difference $\mathbf{J}_0 - \mathbf{J}$ are kept through order ϵ^i . Only in this term will Y_i appear; hence, Φ_i can contain only

the generators Y_k for order less than i . By virtue of the arguments already used for first- and second-order perturbations, the first term on the right in the previous equation (12.71d) has zero mean when averaged over complete cycles in w_0 , and hence, Eqs. (12.75) and (12.76) are valid in all orders. Of course, for $i > 2$, Φ_i becomes increasingly more complicated than Eq. (12.72), but it always contains only such functions as have already been found in lower order calculations. Thus, step by step, we could in principle work up to any order perturbation.

There are practical problems in such a series of calculations of course, but the most serious and obvious conceptual difficulty occurs if the unperturbed system is degenerate. As we see from Eq. (10.122), the existence of a degeneracy means there will be at least one vector of indices \mathbf{j} such that $\mathbf{j} \cdot \nu_0 = 0$. The corresponding coefficient $B_{\mathbf{j}}^{(1)}$ in the Fourier series for Y_1 will therefore, by Eq. (12.79), blow up. Indeed, something similar takes place even when the unperturbed system is *not* degenerate. Even if the frequencies are not exactly equal, as we go to higher and higher values of the integer indices in \mathbf{j} , eventually there will be found a vector \mathbf{j} for which $\mathbf{j} \cdot \nu_0$ is very small even if not zero, and the corresponding coefficients B become very large (the so-called problem of “small divisors”).* This crudely qualitative observation is the basis of the elegant proof by Poincaré at the end of the last century that the Fourier series for Y_1 , and therefore for the motion, are only semiconvergent. Nonetheless, the series can be truncated at some reasonable values of the indices and still give extremely precise results, at least for times that are not too long.

We shall discuss later what can be done in the presence of degeneracy, but at this point it may be well to illustrate a second-order calculation with a specific example of a system with one degree of freedom.

Consider a one-dimensional *anharmonic oscillator*, that is, one with a q^3 term in the potential energy. The Hamiltonian can be written as

$$H = \frac{1}{2m} \left[p^2 + m^2 \omega_0^2 q^2 \left(1 + \epsilon \frac{q}{q_0} \right) \right], \quad (12.80)$$

where ω_0 is the unperturbed angular frequency:

$$\omega_0 = 2\pi \nu_0 = 2\pi \sqrt{\frac{k}{m}},$$

q_0 is a reference amplitude that can be left unspecified for the moment, and ϵ is a small dimensionless parameter. Taken as an expansion in powers of ϵ , H consists of the terms

$$H_0 = \frac{1}{2m} (p^2 + m^2 \omega_0^2 q^2), \quad (12.81a)$$

*Similar phenomena, it will be recalled, are found in quantum mechanics, where degeneracy means that there are several states with the same energy E . Denominators of the form $E_i - E_j$ will then vanish, or become small even if there is no exact degeneracy.

$$H_1 = \frac{m\omega_0^2 q^3}{2q_0}, \quad (12.81b)$$

and

$$(12.81c)$$

$$H_i = 0, \quad i \geq 2. \quad (12.81d)$$

Using the unperturbed action-angle variables (J_0, w_0) as canonical variables the nonvanishing parts of H can, by Eqs. (10.96) and (10.97), be written as

$$H_0 = J_0 \nu_0 \quad (12.82a)$$

and

$$H_1 = \frac{m\omega_0^2}{2q_0} \left(\frac{J_0}{\pi m \omega_0} \right)^{3/2} \sin^3 2\pi w_0. \quad (12.82b)$$

The recipes of Eqs. (12.75a,b) then give as the lowest two terms in $\alpha(J)$

$$\alpha_0(J) = H \nu_0; \quad \alpha_1(J) = 0.$$

To obtain the second-order term $\alpha_2(J)$, we note that since H_0 is linear in J , and H_2 vanishes, then Φ_2 (cf. Eq. (12.72)) reduces to

$$\Phi_2 = \frac{\partial Y_1}{\partial w_0} \frac{\partial H_1}{\partial J}.$$

But the vanishing of $\overline{H_1}$ means that Eq. (12.76) for $i = 1$ has the simple form

$$\frac{\partial Y_1}{\partial w_0} = -\frac{H_1}{\nu_0}.$$

Combining these two results leads to

$$\Phi_2 = -\frac{1}{2\nu_0} \frac{\partial H_1^2}{\partial J}. \quad (12.83)$$

Now from Eq. (12.82b),

$$H_1^2(w_0, J) = \frac{\nu_0 J^3}{2\pi^2 m q_0^2} \sin^6 2\pi w_0,$$

leading to

$$\Phi_2(w_0, J) = -\frac{3J^2}{4\pi^2 m q_0^2} \sin^6 2\pi w_0. \quad (12.84)$$

Since the average of \sin^6 over one period is $\frac{15}{48}$, $\alpha_2(J)$ is simply

$$\alpha_2(J) = -\frac{15J^2}{64\pi^2mq_0^2}, \quad (12.85)$$

and to second order in ϵ the perturbed frequency is

$$\nu = \frac{\partial\alpha}{\partial J} = \nu_0 - \epsilon^2 \frac{15J}{32\pi^2mq_0^2}. \quad (12.86)$$

It is convenient to use for q_0 the maximum amplitude the oscillator would have for the given energy in its unperturbed form, so that to lowest order

$$\frac{m\omega_0^2q_0^2}{2} = E,$$

or, since $E = J\omega_0/(2\pi)$,

$$mq_0^2 = \frac{J}{\pi\omega_0}. \quad (12.87)$$

In terms of this reference amplitude, Eq. (12.86) is equivalent to saying that the second-order fractional shift in the frequency is simply

$$\frac{\Delta\nu}{\nu_0} = -\frac{15}{16}\epsilon^2. \quad (12.88)$$

Mention has already been made of the difficulties that appear in perturbation theory arising out of the existence of degeneracy, for example, the vanishing (or near vanishing) of $\mathbf{j} \cdot \boldsymbol{\nu}_0$ in the denominators of Eq. (12.79). Treatment of degeneracies in classical perturbation theory is much more complicated than in quantum mechanics. The mathematics that has been brought to bear on the problem is both subtle and complicated, and a full exposition would be out of place here. Only some brief and introductory remarks can be made at this point.

We speak of exact (or “proper”) degeneracy, as in Section 10.7, when the unperturbed frequencies $\boldsymbol{\nu}_0$ are such that there are one or more sets of integers \mathbf{j} for which $\mathbf{j} \cdot \boldsymbol{\nu}_0 = 0$. As has been pointed out in Section 10.7, we can then transform to a new set of variables (J_0, ω_0) for which the degeneracies appear as zero frequencies and the remaining nonzero unperturbed frequencies are not degenerate. The effect of the perturbation is to lift the degeneracy so that the corresponding frequencies are not exactly zero but have small values. In consequence, there appear in the solution terms that have small frequencies, that is, long periods. The corresponding angle variables are known as “slow” variables, in contrast to the angle variables with nondegenerate frequencies, which are therefore called the “fast” variables. Long-period terms may appear as secular terms over restricted time intervals; for example, $\sin 2\pi\nu t$ can be taken as a linear function of t so long as $\nu t \ll 1$.

When there is exact degeneracy, a transformation is first made to the (ω_0, \mathbf{J}_0) set. The unperturbed Hamiltonian will be a function only of the nondegenerate

J_0 variables; in all other respects Eq. (12.82) still represents the complete Hamiltonian. We now carry through the canonical transformation of the perturbation calculation, but only for the nonperturbed variables, leaving the degenerate variables unchanged. The new Hamiltonian, Eq. (12.62), now has the form

$$\alpha(\mathbf{J}, \mathbf{J}'_0, \mathbf{w}'_0, \epsilon) = \alpha_0(\mathbf{J}) + \epsilon\alpha_1(\mathbf{J}, \mathbf{J}'_0, \mathbf{w}'_0) + \epsilon^2\alpha_2(\mathbf{J}, \mathbf{J}'_0, \mathbf{w}'_0) + \dots$$

Here \mathbf{w}'_0 stands for the m (degenerate) variables that in the unperturbed problem have zero values and \mathbf{J}'_0 for their conjugate momenta. The transformed nondegenerate momenta are represented by \mathbf{J} . The result of the canonical transformation is thus to eliminate the “fast” variables, but to leave in terms with the “slow” variables. Note that since α is cyclic in w , the transformed \mathbf{J} momenta are true constants of the motion, and $\alpha(\mathbf{J}, \mathbf{J}'_0, \mathbf{w}'_0, \epsilon)$ can be considered as a Hamiltonian of a system with m degrees of freedom. Further, since $\alpha_0(\mathbf{J})$ is a constant, independent of the remaining variables, it doesn't matter for the equations of motion of $(\mathbf{J}'_0, \mathbf{w}'_0)$ and can be dropped from α . Thus, the new effective Hamiltonian is now of order ϵ ; in effect, the “unperturbed Hamiltonian” is $\epsilon\alpha_1(\mathbf{J}, \mathbf{J}'_0, \mathbf{w}'_0)$, and in *this* unperturbed problem \mathbf{w}'_0 no longer consists of zero values. If there is only one degeneracy condition, the effective problem is of only one degree of freedom and is in principle immediately integrable. With more degeneracy conditions, we can seek a second canonical transformation to eliminate the “slow” variable terms just as was done for the “fast” variables. In practice, the procedure obviously becomes quite complicated.

It has already been pointed out, in connection with Eq. (12.79), that even with nondegenerate frequencies, small values of the divisor $\mathbf{j} \cdot \nu_0$ will inevitably occur as the indices \mathbf{j} become larger and larger. This phenomenon is referred to as *resonance*, implying that the amplitude of some particular term in the Fourier expansions becomes very large. It would seem therefore that the problems of degeneracy will always be with us, no matter what the unperturbed frequencies are! The situation is not all as bad as that, in part because of the nature of the perturbation Hamiltonians encountered in practice. From Eq. (12.79), it will be noted that what counts is not so much the value of $\mathbf{j} \cdot \nu_0$ as the ratio

$$\frac{C_{\mathbf{j}}}{\mathbf{j} \cdot \nu_0},$$

where $C_{\mathbf{j}}$ is the Fourier series expansion of the perturbation Hamiltonian H_1 , cf. Eq. (12.77). It turns out that in celestial mechanics, at least, most perturbation Hamiltonians have what is called the *D'Alembert characteristic*. While the formal mathematical definition of the property is complicated, what it says, roughly, is that when the values of the integers in the \mathbf{j} indices are larger than the exponent of ϵ in the Hamiltonian, the magnitudes of $C_{\mathbf{j}}$ fall rapidly (generally exponentially) with increasing values of the indices. The ratios in Eq. (12.79) then do not become too large, and the expansion process actually can be proved to converge when the frequencies ν_0 are incommensurate.

Resonant behavior in the presence of the D'Alembert characteristic, or generally when $C_j/(\mathbf{j} \cdot \boldsymbol{\nu}_0) < O(\epsilon^{1/2})$, is described as a *shallow resonance*. In principle, at least, shallow resonances may not upset the perturbation expansion process and can be tolerated without introducing new methods. There are situations where the ratio $C_j/(\mathbf{j} \cdot \boldsymbol{\nu}_0)$ becomes large, at least larger than order $\epsilon^{1/2}$, and these are referred to as *deep resonances*. Special methods have to be devised to handle deep resonances, such as the so-called Bohlin expansion in powers of $\epsilon^{1/2}$ rather than in powers of ϵ .

12.5 ■ ADIABATIC INVARIANTS

At the first Solvay Conference in 1911, which grappled with the problems of introducing quantum notions into physics, a deceptively simple problem in classical mechanics was raised. Consider a bob on a string oscillating as a plane pendulum, with the string passing through a small hole in the ceiling. Now imagine that the string is either pulled up or let down slowly, so slowly that there is little change in the length of the pendulum during one period of oscillation. What happens to the frequency of oscillation during this process? Note that the energy of the pendulum is not conserved, for work is done on the system (or extracted from it) as the length of the string is altered. By elementary means it was demonstrated that for very slow change of the ratio E/ν would be constant. It will be recognized that this ratio is precisely the action variable J . The *adiabatic invariance* of the action variables under slow change of parameters was a very satisfying property to physicists developing quantum mechanics. For simplicity, we shall examine only periodic systems with one degree of freedom, although the extension to many degrees of freedom normally is not difficult in the absence of degeneracy. We consider a system that initially has no dependence on the time, and that involves a parameter a . Implicit in the method is a picture of the system as initially conservative with a constant. Time dependence of a is then "switched on," and a varies slowly over a long time, eventually reaching a constant value. When a is constant, the motion is periodic, and the slow change in the parameter does not alter the periodic nature of the motion. Although the changes in the motion are small in any one period, over a long interval of time the properties of the motion can accumulate large quantitative changes. The switching on of the time dependence is thus in the nature of a small perturbation, and we are looking for secular changes in the motion.

When the parameter a is constant, the system will be described by action-angle variables (J_0, w_0) such that the Hamiltonian is $H = H(J_0, a)$. It will be useful to consider these variables as derived from an original canonical set (q, p) via an F_1 generating function $W^*(q, w_0, a)$. The usual Hamilton–Jacobi equation of course leads to an F_2 generating function of the form $W(q, J_0, a)$, but these two generating functions are normally connected by a Legendre transformation (cf. Eq. (9.19)):

$$W^*(q, w_0, a) = W(q, J_0, a) - J_0 w_0. \quad (12.89)$$

When a is allowed to vary with time, (w_0, J_0) of course remain as valid canonical variables, but the generating function is now an explicit function of time through the time dependence of a . Hence, the appropriate Hamiltonian for the (w_0, J) set is now

$$\begin{aligned} K(\omega_0, J_0, a) &= H(J_0, a) + \frac{\partial W^*}{\partial t} \\ &= H(J_0, a) + \dot{a} \frac{\partial W^*}{\partial a}. \end{aligned} \quad (12.90)$$

Since J_0 is no longer a constant and w_0 does not vary linearly with time, the second term in the Hamiltonian is a perturbation. The time dependence of J_0 is governed by the equation of motion

$$\dot{J}_0 = -\frac{\partial K}{\partial w_0} = -\dot{a} \frac{\partial}{\partial w_0} \left(\frac{\partial W^*}{\partial a} \right), \quad (12.91)$$

where of course the derivative in parenthesis is expressed, as is K , in terms of J_0 , w_0 , and a . In the spirit of a first-order perturbation theory, we look for a secular term, the average of \dot{J}_0 over the period of the unperturbed motion *for the appropriate a* . Since a varies slowly, a can be taken as constant during this time interval, and the average can be written as

$$\begin{aligned} \bar{\dot{J}}_0 &= -\frac{1}{\tau} \int_{\tau} \dot{a} \frac{\partial}{\partial w_0} \left(\frac{\partial W^*}{\partial a} \right) dt \\ &= -\frac{\dot{a}}{\tau} \int_{\tau} \frac{\partial}{\partial w_0} \left(\frac{\partial W^*}{\partial a} \right) dt + O(\dot{a}^2, \bar{a}). \end{aligned} \quad (12.92)$$

It will be remembered from Eq. (10.17) that W is given by the indefinite integral

$$W = \int p dq.$$

In one period of w_0 , the generating function, W , therefore increases by J_0 . At the same time, $J_0 w_0$ also increases by J_0 , since w_0 increases by unity. Hence, by Eq. (12.89), W^* is a periodic function of w_0 , and both it and the derivative with respect to a can be expressed as a Fourier series:

$$\frac{\partial W^*}{\partial a} = \sum_k A_k(J_0, a) e^{2\pi i k w_0}. \quad (12.93)$$

The average, $\bar{\dot{J}}_0$, therefore has the form

$$\bar{\dot{J}}_0 = -\frac{\dot{a}}{\tau} \int_{\tau} \sum_{k \neq 0} 2\pi i k A_k(J_0, a) e^{2\pi i k w_0} dt + O(\dot{a}^2, \bar{a}).$$

Since the integrand has no constant term, the integral vanishes,

$$\overline{\dot{J}_0} = 0 + O(\dot{a}^2, \ddot{a}), \quad (12.94)$$

and $\overline{J_0}$ has no secular variation to first order in \dot{a} , proving the desired property of adiabatic invariance.

Let us see how this derivation would work in detail for the problem of the harmonic oscillator:

$$H = \frac{1}{2m}(p^2 + m^2\omega^2q^2),$$

where ω may be an explicit function of time. The equations of the canonical transformation from the (q, p) set to the (J_0, w_0) set are given by Eqs. (10.21) and (10.97), which can be written so as to facilitate the evaluation of W^* :

$$\begin{aligned} J_0 &= \pi m \omega q^2 \csc^2 2\pi w_0 = -\frac{\partial W^*}{\partial w_0}, \\ p &= m \omega q \cot 2\pi w_0 = \frac{\partial W^*}{\partial q}. \end{aligned} \quad (12.95)$$

To within constant (and therefore irrelevant) terms, W^* is found by integration of Eqs. (12.95) to be

$$W^*(q, w_0, \omega) = \frac{m\omega q^2}{2} \cot 2\pi w_0. \quad (12.96)$$

The derivative with respect to ω is

$$\frac{\partial W^*}{\partial \omega} = \frac{mq^2}{2} \cot 2\pi w_0,$$

or, using Eq. (10.96) as a function of w_0 , J_0 , and ω ,

$$\frac{\partial W^*}{\partial \omega} = \frac{J_0}{4\pi\omega} \sin 4\pi w_0. \quad (12.97)$$

Thus, \dot{J}_0 is given by the one-term Fourier expansion

$$\dot{J}_0 = -\frac{\dot{\omega}}{\omega} J_0 \cos 4\pi w_0, \quad (12.98)$$

which, as predicted, has no constant term. So far, Eq. (12.98) is rigorous. Similarly the rigorous connection between w_0 and time is determined by the w_0 equation of motion

$$\dot{w}_0 = \frac{\partial K}{\partial J_0} = \frac{\partial H}{\partial J_0} + \dot{\omega} \frac{\partial}{\partial J_0} \left(\frac{\partial W^*}{\partial \omega} \right) = \frac{\omega}{2\pi} + \frac{\dot{\omega}}{4\pi\omega} \sin 4\pi w_0. \quad (12.99)$$

In order to calculate an average of \dot{J}_0 over a period, including at least the first correction term, we begin to make approximations. First we shall assume that over a particular period of the perturbed motion the ratio

$$\frac{\dot{\omega}}{\omega} \equiv \epsilon \quad (12.100)$$

is a constant, and one such that $\epsilon t \leq 1$. Equation (12.100) corresponds to a variation

$$\omega = \omega_0 e^{\epsilon t} \approx \omega_0(1 + \epsilon t), \quad (12.101)$$

where t is measured from the start of the period interval, at which time $\omega(0) = \omega_0$. Equation (12.99) now looks like

$$\dot{w}_0 = \frac{\omega}{2\pi} + \frac{\epsilon}{4\pi} \sin 4\pi w_0. \quad (12.99')$$

The zeroth-order solution is

$$2\pi w_0^{(0)} = \omega_0 t,$$

where the constant term has been set zero by suitable choice of the initial phase. To first order in ϵ , Eq. (12.99') becomes

$$\dot{w}_0^{(1)} = \frac{\omega_0(1 + \epsilon t)}{2\pi} + \frac{\epsilon}{4\pi} \sin 2\omega_0 t, \quad (12.102)$$

with the solution

$$2\pi w_0^{(1)} = \omega_0 t + \frac{\epsilon}{2} \left(\omega_0 t^2 + \frac{1 - \cos 2\omega_0 t}{2\omega_0} \right). \quad (12.103)$$

Correspondingly the equation for \dot{J}_0 correct to second order in ϵ can be written as

$$\frac{d \ln J_0}{dt} = -\epsilon \cos \left[2\omega_0 t + \epsilon \left(\omega_0 t^2 + \frac{1 - \cos 2\omega_0 t}{2\omega_0} \right) \right].$$

Expanding the cosine, treating the term in ϵ as a small quantity to first order, the derivative reduces to

$$\frac{d \ln J_0}{dt} = -\epsilon \cos 2\omega_0 t + \epsilon^2 \left(\omega_0 t^2 + \frac{1 - \cos 2\omega_0 t}{2\omega_0} \right) \sin 2\omega_0 t.$$

To find the secular behavior, this equation can be averaged over the period of the motion as it is at $t = 0$, that is, over an interval $\tau = 2\pi/\omega_0$. In the averaging, almost all terms on the right drop out, except the first inside the parentheses, involving t^2 . The final result is

$$\overline{\frac{d \ln J}{dt}} = \frac{\pi \epsilon^2}{\omega_0} = \frac{\omega_0 \delta^2}{4\pi}, \quad (12.104)$$

where $\delta = \epsilon \tau$, that is, fractional change in ω over the period τ . Correspondingly, the fractional secular change in J over the period is

$$\frac{\Delta J}{J} = \frac{\delta^2}{2}. \quad (12.105)$$

As expected from the more general considerations, the secular change in the action variable has no term in first order in ϵ . Only by retaining quantities of the order $\epsilon^2 = (\dot{\omega}/\omega)^2$ do we find any nonvanishing long-term change in J .

The adiabatic invariance of the action variables has proven to be especially useful in applications involving the motion of charged particles in electromagnetic fields. One of the simplest instances, and one with important practical consequences, concerns the motion of electrons in a uniform (or nearly uniform) constant magnetic field. As is well known, the charged particle in such a situation circles around the magnetic field lines. At the most basic level, this can be shown from Newton's equations of motion. The Lorentz force in a constant magnetic field \mathbf{B} is $(\mathbf{v} \times q\mathbf{B})$; hence, the equation of motion, Eq. (1.4), is

$$\frac{d\mathbf{v}}{dt} = \mathbf{v} \times \frac{q\mathbf{B}}{m}. \quad (12.106)$$

Equation (12.106) says the velocity vector \mathbf{v} rotates, without change of magnitude, about the direction of the magnetic field, with an angular frequency

$$\omega_c = -\frac{qB}{m}. \quad (12.107)$$

The frequency, called the cyclotron frequency, has a value twice the Larmor frequency of Eq. (5.104) (cf. Eq. (7.154)).

An equivalent derivation can be formulated in terms of Lagrangian mechanics. It was shown, in Section 5.9, that the Lagrangian in this case can be written as

$$L = \frac{mv^2}{2} + \mathbf{M} \cdot \mathbf{B}, \quad (12.108)$$

where \mathbf{M} is magnetic moment of the moving particle defined in terms of its angular momentum \mathbf{L} by

$$\mathbf{M} = \frac{q\mathbf{L}}{2m}. \quad (12.109)$$

(Cf. Eq. (5.108).) In cylindrical coordinates with the z axis along the direction of B , the component of M parallel to B is

$$M_z = \frac{qr^2\dot{\theta}}{2}, \quad (12.110)$$

and the Lagrangian is

$$L = \frac{m}{2}(\dot{r}^2 + r^2\dot{\theta}^2 + \dot{z}^2) + \frac{q}{2}Br^2\dot{\theta}. \quad (12.111)$$

Since θ is cyclic in the Lagrangian, the corresponding canonical momentum p_θ ,

$$p_\theta = mr^2\dot{\theta} + \frac{qBr^2}{2}, \quad (12.112)$$

is a constant of the motion. Further, the radial equation of motion is

$$m\ddot{r} - r\dot{\theta}(m\dot{\theta} + qB) = 0. \quad (12.113)$$

A steady-motion solution to Eqs. (12.112) and (12.113) corresponds to r and $\dot{\theta}$ constant, with $\dot{\theta}$ having the cyclotron value

$$\dot{\theta} = \omega_c \equiv -\frac{qB}{m}, \quad (12.114)$$

in agreement with Eq. (12.107). In this case, $p_\theta = -(qBr^2/2)$ and the action variable corresponding to θ is

$$J_\theta = \oint p_\theta d\theta = -\pi qBr^2. \quad (12.115)$$

By (12.110), we can write

$$qr^2 = \frac{2M}{\omega_c}$$

(as M_z is equal to M for this motion), and therefore J_θ can also be written as

$$J_\theta = -\frac{2\pi MB}{\omega_c} = \frac{2\pi m}{q}M. \quad (12.116)$$

The adiabatic invariance theorem implies that under sufficiently slow variation of the magnetic field J_θ remains constant. Equation (12.116) says that the magnetic moment is similarly invariant adiabatically. An alternative statement, on the basis of Eq. (12.115), is that B times the area πr^2 of the orbit (that is, the number of lines of force threading through the orbit) remains constant.

An adiabatic variation of B might arise if the magnetic field configuration remained static but was slightly nonuniform. If then the particle had a small z component of velocity, the resultant drift would move the particle slowly into regions of different B values. From Eqs. (12.114), (12.115), and (12.116), it follows simply that the kinetic energy of motion around the lines of B is

$$T_{(\theta)} = \frac{mr^2\dot{\theta}^2}{2} = MB. \quad (12.117)$$

Suppose a charged particle drifts in the direction of increasing B ; by Eq. (12.117), the kinetic energy of rotation increases. As the total kinetic energy is conserved, the kinetic energy of longitudinal drift $m\dot{z}^2/2$ along the lines of force must decrease. Eventually, the drift velocity \dot{z} goes to zero and the motion reverses in direction. If it can be arranged that B eventually increases in the other direction, the charged particle will remain confined, drifting back and forth between the two ends—the principle of the so-called mirror confinement. The mirror principle is used to contain hot plasmas for thermonuclear energy generation. The complete story is of course more complicated, but the significance of the adiabatic invariance of M is clearly demonstrated.

We have seen that almost all phenomena of small oscillations about steady-state or steady motion can be described in terms of harmonic oscillators. In consequence, there is a good deal of practical interest in questions of the invariance of J for a harmonic oscillator under slow, and not so slow, variations of a parameter. The study of oscillations in charged particle accelerators, for example, has led to a number of new insights.

It has been possible to sketch here only the highlights of the subject of adiabatic invariants. The ramifications of the field go into many areas of classical and quantum physics and of mathematics.

EXERCISES

1. By the method of time-dependent perturbation theory, carry the solution for the linear harmonic oscillator (in which the potential is considered a perturbation on the free particle motion) out through *third*-order terms, assuming the initial condition $\beta_0 = 0$. Find expressions for both x and p as functions of time and show that they agree with the corresponding terms in the expansion of the usual harmonic solutions.
2. A mass point m hangs at one end of a vertically hung Hook's-law spring of force constant k . The other end of the spring is oscillated up and down according to $z_1 = a \cos \omega_1 t$. By treating a as a small quantity, obtain a first-order solution to the motion of m in time, using time dependent perturbation theory. What happens as ω_1 approaches the unperturbed frequency ω_0 ?
3. (a) A linear harmonic oscillator of force constant k has its mass suddenly increased by a fractional amount ϵ . Use first-order time-independent perturbation theory, to find the resultant shift in the frequency of the oscillator to first order in ϵ . Compare your results with the exact solution and discuss.
(b) Repeat part (a), for the effect of increasing k by a fractional amount ϵ .
4. Carry out a consistent second-order perturbation calculation (using whichever method you choose) of the correction to the frequency of a plane pendulum as the result of a finite amplitude of oscillation. All terms of order λ^2 should be retained in the Hamiltonian and in the perturbation treatment.
5. A mass particle is constrained to move in a horizontal straight line and is attached to the ends of two ideal springs of equal force constants, as shown in the diagram. The

unstretched length of each spring is $b \leq a$. Use perturbation theory to first-order to find the lowest order correction to the frequency of oscillation for finite amplitude of oscillation. What happens as a approaches b in magnitude?

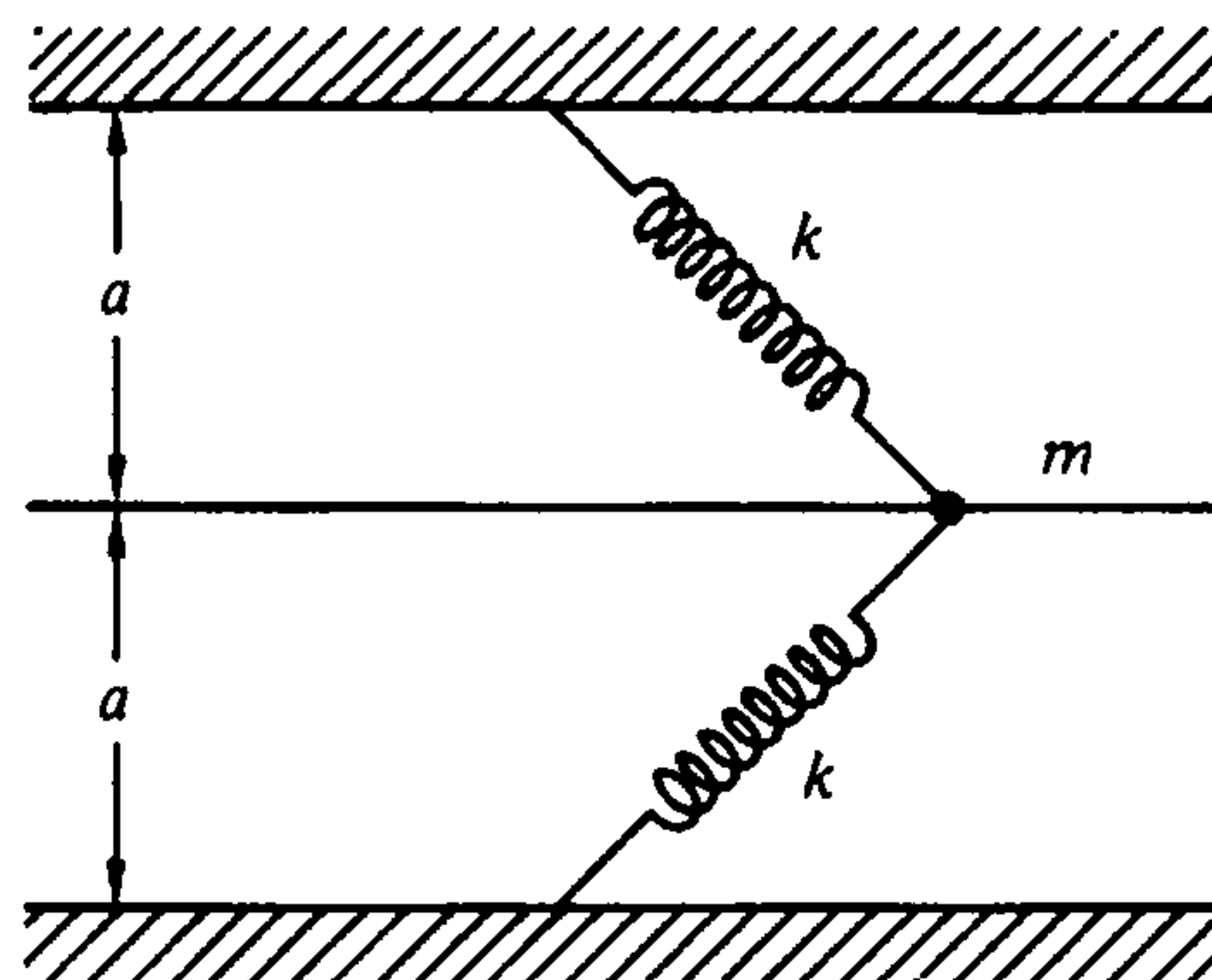

6. (a) Show that to lowest order in correction terms the relativistic (but noncovariant) Hamiltonian for the one-dimensional harmonic oscillator has the form

$$H = \frac{1}{2m} (p^2 + m^2 \omega^2 q^2) - \frac{1}{8} \frac{p^4}{m^3 c^2}.$$

- (b) Use first order perturbation theory to calculate the lowest-order relativistic correction to the frequency of the harmonic oscillator. Express your result as a fractional change in the frequency.
7. A plane isotropic harmonic oscillator is perturbed by a change in the Hamiltonian of the form

$$\epsilon H_1 = b p_x^2 p_y^2$$

where b is a constant. Use time-independent perturbation theory to first order find the shift in the frequencies.

8. A model of the atomic Stark effect can be made by taking the Kepler elliptic orbit in a plane and perturbing it by a potential $\Delta V = -Kx$. Use perturbation theory to first order to determine what happens to the frequencies of motion. This model can also be used as a first approximation to the effect of the light pressure of solar radiation on the orbit of an Earth satellite.
9. By considering the work done to alter adiabatically the length l of a plane pendulum, prove by elementary means the adiabatic invariance of J for the plane pendulum in the limit of vanishing amplitude.
10. Consider the system described in Exercise 13 of Chapter 10. Suppose the parameter F is slowly varied from an initial value. What happens to the energy of the particle? The amplitude of oscillation? The period?

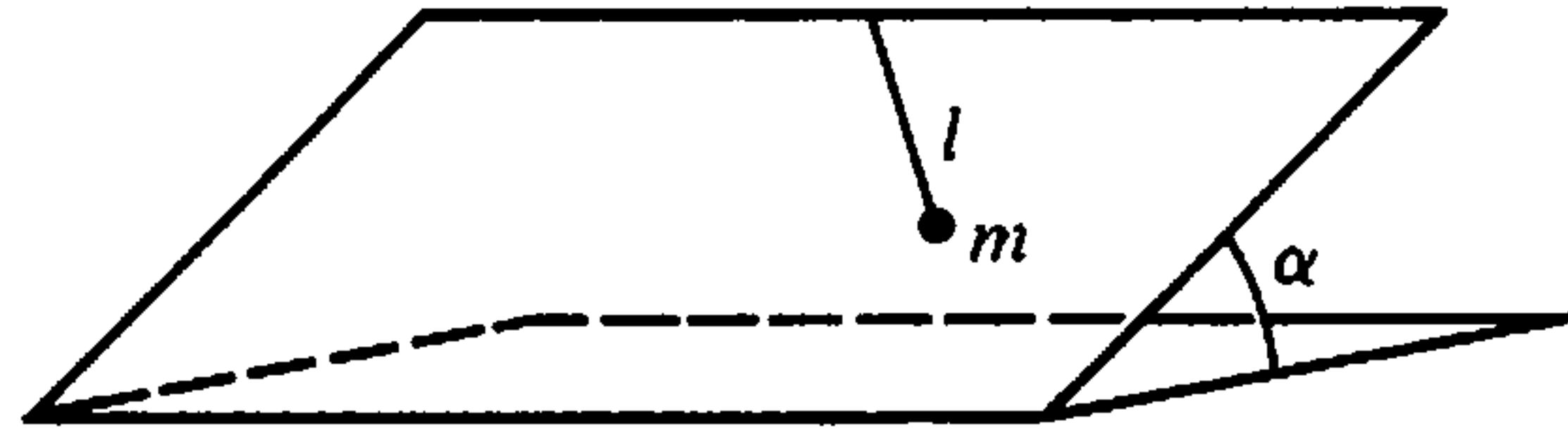

- 11.** A plane pendulum of small amplitude is constrained to move on an inclined plane, as shown in the accompanying figure. How does its amplitude change when the inclination angle α of the plane is changed slowly?

CHAPTER 13

Introduction to the Lagrangian and Hamiltonian Formulations for Continuous Systems and Fields

All the formulations of mechanics discussed thus far have been devised for treating systems with a finite or at most a denumerably infinite number of degrees of freedom. There are some mechanical problems, however, that involve continuous systems, as, for example, the problem of a vibrating elastic solid. Here each point of the continuous solid partakes in the oscillations, and the complete motion can only be described by specifying the position coordinates of *all* points. It is not difficult to modify the previous formulations of mechanics so as to handle such problems. The concepts of field theory can be developed by approximating the continuous system with a discrete system, solving that problem, and taking the continuous limit.

13.1 ■ THE TRANSITION FROM A DISCRETE TO A CONTINUOUS SYSTEM

We shall apply this procedure to an infinitely long elastic rod that can undergo small longitudinal vibrations, that is, oscillatory displacements of the particles of the rod parallel to the axis of the rod. A system composed of discrete particles that approximates the continuous rod is an infinite chain of equal mass points spaced a distance a apart and connected by uniform massless springs having force constants k (cf. Fig. 13.1). It will be assumed that the mass points can move only along the length of the chain. The discrete system will be recognized as an extension of the linear polyatomic molecule discussed in Section 6.4. We can therefore

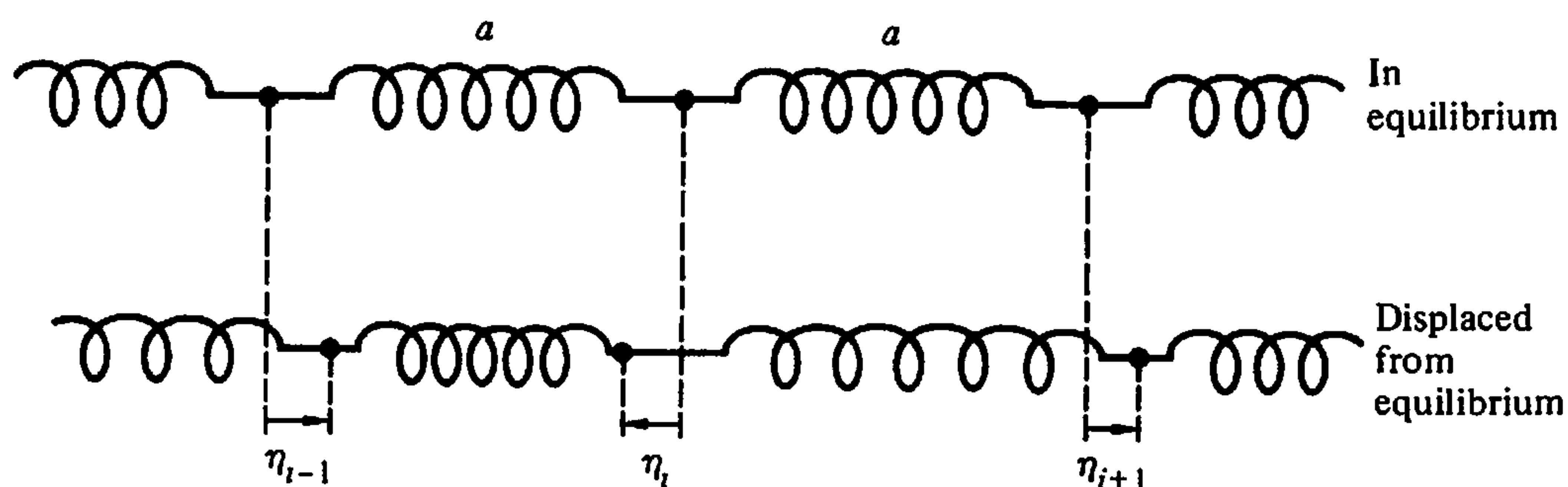

FIGURE 13.1 A discrete system of equal mass points connected by springs, as an approximation to a continuous elastic rod.

obtain the equations describing the motion by the customary techniques for small oscillations. Denoting the displacement of the i th particle from its equilibrium position by η_i , the kinetic energy is

$$T = \frac{1}{2} \sum_i m \dot{\eta}_i^2, \quad (13.1)$$

where m is the mass of each particle. The corresponding potential energy is the sum of the potential energies of each spring as the result of being stretched or compressed from its equilibrium length (cf. Section 6.4):

$$V = \frac{1}{2} \sum_i k(\eta_{i+1} - \eta_i)^2. \quad (13.2)$$

Combining Eqs. (13.1) and (13.2), the Lagrangian for the system is

$$L = T - V = \frac{1}{2} \sum_i [m \dot{\eta}_i^2 - k(\eta_{i+1} - \eta_i)^2], \quad (13.3)$$

which can also be written as

$$L = \frac{1}{2} \sum_i a \left[\frac{m}{a} \dot{\eta}_i^2 - ka \left(\frac{\eta_{i+1} - \eta_i}{a} \right)^2 \right] = \sum_i a L_i, \quad (13.4)$$

where a is the equilibrium separation between the points (cf. Fig. 13.1). The resulting Lagrange equations of motion for the coordinates η_i are

$$\frac{m}{a} \ddot{\eta}_i - ka \left(\frac{\eta_{i+1} - \eta_i}{a^2} \right) + ka \left(\frac{\eta_i - \eta_{i-1}}{a^2} \right) = 0. \quad (13.5)$$

The particular form of L in Eq. (13.4), and of the corresponding equations of motion, has been chosen for convenience in going to the limit of a continuous rod as a approaches zero. It is clear that m/a reduces to μ , the mass per unit length of the continuous system, but the limiting value of ka may not be so obvious. For an elastic rod obeying Hooke's law, it will be remembered that the extension of the rod *per unit length* is directly proportional to the force or tension exerted on the rod, a relation that can be written as

$$F = Y\xi,$$

where ξ is the elongation per unit length and Y is Young's modulus. Now the extension of a length a of a discrete system, per unit length, will be $\xi = (\eta_{i+1} - \eta_i)/a$. The force necessary to stretch the spring by this amount is

$$F = k(\eta_{i+1} - \eta_i) = ka \left(\frac{\eta_{i+1} - \eta_i}{a} \right),$$

so that ka must correspond to the Young's modulus of the continuous rod. In going from the discrete to the continuous case, the integer index i identifying the particular mass point becomes the continuous position coordinate x ; instead of the variable η_i we have $\eta(x)$. Further, the quantity

$$\frac{\eta_{i+1} - \eta_i}{a} = \frac{\eta(x+a) - \eta(x)}{a}$$

occurring in L_i obviously approaches the limit

$$\frac{d\eta}{dx},$$

as a , playing the role of dx , approaches zero. Finally, the summation over a discrete number of particles becomes an integral over x , the length of the rod, and the Lagrangian (13.4) appears as

$$L = \frac{1}{2} \int \left[\mu \dot{\eta}^2 - Y \left(\frac{d\eta}{dx} \right)^2 \right] dx. \quad (13.6)$$

In the limit as a goes to zero, the last two terms in the equation of motion (13.5) become

$$\lim_{a \rightarrow 0} -\frac{Y}{a} \left[\left(\frac{d\eta}{dx} \right)_x - \left(\frac{d\eta}{dx} \right)_{x-a} \right],$$

which clearly defines a second derivative of η . Hence, the equation of motion for the continuous elastic rod is

$$\mu \frac{d^2\eta}{dt^2} - Y \frac{d^2\eta}{dx^2} = 0, \quad (13.7)$$

the familiar wave equation in one dimension with the propagation velocity

$$v = \sqrt{\frac{Y}{\mu}}. \quad (13.8)$$

Equation (13.8) is the well-known formula for the velocity of longitudinal elastic waves.

This simple example is sufficient to illustrate the salient features of the transition from a discrete to a continuous system. The most important fact to grasp is the role played by the position coordinate x . It is *not* a generalized coordinate; it serves merely as a continuous index replacing the discrete i . Just as each value of i corresponds to a different one of the generalized coordinates, η_i , of the system, so here for each value of x there is a generalized coordinate $\eta(x)$. Since η depends also upon the continuous variable t , we should perhaps write more accurately $\eta(x, t)$, indicating that x , like t , can be considered as a parameter entering into the Lagrangian. If the continuous system were three-dimensional,

rather than one-dimensional as here, the generalized coordinates would be distinguished by three continuous indices x, y, z , and would be written as $\eta(x, y, z, t)$. Note that the quantities x, y, z , and t are completely independent of each other, and appear only as explicit variables in η . Derivatives of η with respect to any of them can therefore always be written as total derivatives without any ambiguity. Equation (13.6) also shows that the Lagrangian appears as an integral over the continuous index x ; in the corresponding three-dimensional case the Lagrangian would have the form

$$L = \int \int \int \mathcal{L} dx dy dz, \quad (13.9)$$

where \mathcal{L} is known as the *Lagrangian density*. For the longitudinal vibrations of the continuous rod the Lagrangian density is

$$\mathcal{L} = \frac{1}{2} \left[\mu \left(\frac{d\eta}{dt} \right)^2 - Y \left(\frac{d\eta}{dx} \right)^2 \right], \quad (13.10)$$

corresponding to the continuous limit of the quantity L_i , appearing in Eq. (13.4). It is the Lagrangian density, rather than the Lagrangian itself, that will be used to describe the motion of the system.

13.2 ■ THE LAGRANGIAN FORMULATION FOR CONTINUOUS SYSTEMS

It will be noted from Eq. (13.9) that \mathcal{L} for the elastic rod, besides being a function of $\dot{\eta} \equiv \partial\eta/\partial t$, also involves a spatial derivative of η , namely, $\partial\eta/\partial x$; x and t thus play a similar role as parameters of the Lagrangian density. If there were local forces present in addition to the nearest neighbor interactions, then \mathcal{L} would be a function of η itself as well as of the spatial gradient of η . Of course, in the general case \mathcal{L} might well be an explicit function of x and t also. So the Lagrangian density for any one-dimensional continuous system would appear as a function of the form

$$\mathcal{L} = \mathcal{L} \left(\eta, \frac{d\eta}{dx}, \frac{d\eta}{dt}, x, t \right). \quad (13.11)$$

The total Lagrangian, following Eq. (13.10), is then the integral of \mathcal{L} over the range of x defining the system, and Hamilton's principle, Eq. (2.2), in the limit of the continuous system appears as

$$\delta I = \delta \int_1^2 \int \mathcal{L} dx dt = 0. \quad (13.12)$$

If Hamilton's principle for the continuous system is to have any usefulness, it must be possible to derive the continuous limit of the equation of motion, for ex-

ample, Eq. (13.7), directly by variation of the double integral of \mathcal{L} in Eq. (13.12). We can carry out this variation by methods that differ only slightly from those used in Chapter 2 for a discrete system. The variation is only on η and its derivatives; the parameters x and t are not affected by the variation either directly or in the ranges of integration. Just as the variation of η is taken to be zero at the end points t_1 and t_2 , so the variation of η at the limits x_1 and x_2 of the integration in x is also to be zero. As in Section 2.2, a suitable varied path of integration in the η space can be obtained, for example, by choosing η from a one-parameter family of possible η functions:

$$\eta(x, t; \alpha) = \eta(x, t; 0) + \alpha\zeta(x, t). \quad (13.13)$$

Here $\eta(x, t; 0)$ stands for the correct function that will satisfy Hamilton's principle, and ζ is any well-behaved function that vanishes at the end points in t and x . If I is considered as a function of α , to be an extremum for $\eta(x, t; 0)$ the derivative of I with respect to α vanishes at $\alpha = 0$. By straightforward differentiation,

$$\frac{dI}{d\alpha} = \int_{t_1}^{t_2} \int_{x_1}^{x_2} dx dt \left[\frac{\partial \mathcal{L}}{\partial \eta} \frac{\partial \eta}{\partial \alpha} + \frac{\partial \mathcal{L}}{\partial \frac{d\eta}{dt}} \frac{\partial}{\partial \alpha} \left(\frac{d\eta}{dt} \right) + \frac{\partial \mathcal{L}}{\partial \frac{d\eta}{dx}} \frac{\partial}{\partial \alpha} \left(\frac{d\eta}{dx} \right) \right]. \quad (13.14)$$

Because the variation of η , that is, $\alpha\zeta$, vanishes at the end points, integration by parts in x and t yields the relations

$$\int_{t_1}^{t_2} \frac{\partial \mathcal{L}}{\partial \frac{d\eta}{dt}} \frac{\partial}{\partial \alpha} \left(\frac{d\eta}{dt} \right) dt = - \int_{t_1}^{t_2} \frac{d}{dt} \left(\frac{\partial \mathcal{L}}{\partial \frac{d\eta}{dt}} \right) \frac{\partial \eta}{\partial \alpha} dt,$$

and

$$\int_{x_1}^{x_2} \frac{\partial \mathcal{L}}{\partial \frac{d\eta}{dx}} \frac{\partial}{\partial \alpha} \left(\frac{d\eta}{dx} \right) dx = - \int_{x_1}^{x_2} \frac{d}{dx} \left(\frac{\partial \mathcal{L}}{\partial \frac{d\eta}{dx}} \right) \frac{\partial \eta}{\partial \alpha} dx.$$

Hamilton's principle can therefore be written as

$$\int_{t_1}^{t_2} \int_{x_1}^{x_2} dx dt \left[\frac{\partial \mathcal{L}}{\partial \eta} - \frac{d}{dt} \left(\frac{\partial \mathcal{L}}{\partial \frac{d\eta}{dt}} \right) - \frac{d}{dx} \left(\frac{\partial \mathcal{L}}{\partial \frac{d\eta}{dx}} \right) \right] \left(\frac{\partial \eta}{\partial \alpha} \right)_0 = 0, \quad (13.15)$$

and by the same arguments as in Section 2.2 the arbitrary nature of the varied path implies the vanishing of the expression in the brackets:

$$\frac{d}{dt} \left(\frac{\partial \mathcal{L}}{\partial \frac{d\eta}{dt}} \right) + \frac{d}{dx} \left(\frac{\partial \mathcal{L}}{\partial \frac{d\eta}{dx}} \right) - \frac{\partial \mathcal{L}}{\partial \eta} = 0. \quad (13.16)$$

The Euler-Lagrange equations (13.16) (cf. Eq. (2.18)) is the appropriate form of the equation of motion as derived from Hamilton's principle, Eq. (13.12).

A system of n discrete degrees of freedom will have n Lagrange equations of motion; for the continuous system with an infinite number of degrees of freedom we seem to obtain only one Lagrange equation! It must be remembered, however, that the equation of motion for η is a differential equation involving the time only, and in that sense Eq. (13.15) furnishes a separate equation of motion for each value of x . The continuous nature of the indices x appears in that Eq. (13.15) is a partial differential equation in the two variables x and t , yielding η as $\eta(x, t)$.

For the specific instance of longitudinal vibrations in an elastic rod, it is seen from the form of the Lagrangian density, Eq. (13.10), that

$$\frac{\partial \mathcal{L}}{\partial \frac{d\eta}{dt}} = \mu \frac{d\eta}{dt}, \quad \frac{\partial \mathcal{L}}{\partial \frac{d\eta}{dx}} = -Y \frac{d\eta}{dx}, \quad \frac{\partial \mathcal{L}}{\partial \eta} = 0.$$

Thus, as desired, Eq. (13.16), reduces properly to the equation of motion, Eq. (13.7).

The Lagrangian formulation developed here for one-dimensional continuous systems needs obviously to be extended to two- and three-dimensional situations, for example, a general elastic solid. Further, instead of one field quantity η there may be several; for example, displacement from an equilibrium position would be described by a spatial vector $\boldsymbol{\eta}$ with three components. There is no difficulty in carrying out the mathematical steps for the more general situation in close parallelism to the one-component one-dimensional case. However, the formulas become lengthy and cumbersome if written in the same manner, especially in view of the two tiers of derivatives. Considerable gain in notational simplicity can be achieved by noticing that time t and the spatial coordinates x, y, z play the same type of mathematical role in Hamilton's principle. The field quantities are functions of the coordinates of both time and space that are to be treated as independent variables. No variation of the field quantities occurs at the limits of integration in Hamilton's principle over both time and space.

It is mathematically convenient to think in terms of a four-dimensional space with coordinates $x^0 = ct, x^1 = x, x^2 = y, x^3 = z$. No physical significance is implied for this space. The c in x^0 is the speed of light used only to convert the units of x^0 to the same as those used for x^i . The entire tensor formalism developed in Chapter 7 applies. The metric tensor g will have a Euclidean metric with the Galilean transformation group as the allowed coordinate transformations on the space components of the metric tensor restricted by $g_{i0} = g_{0i} = 0$. A Roman letter superscript refers only to the three coordinates of the physical space, a Greek letter superscript or subscript refers to all four coordinates. Use of the summation convention with respect to repeated indices will be resumed for the rest of the chapter. The various components of the field quantities will be symbolized by a subscript ρ , which may cover a multitude of forms. At times, it will stand for a single index having two, three, four, or more values. Or it may stand for multiple indices. Thus, if the field quantity is a spatial tensor of second rank, then ρ really refers to two subscript indices. Finally, a derivative of the field quantities with respect to any one of the four coordinates x^μ will be denoted by the subscript ν

separated from ρ by a comma. Where there is only one field quantity the index does not appear. Examples are

$$\eta_{\rho,\nu} \equiv \frac{d\eta_\rho}{dx^\nu}; \quad \eta_{,j} \equiv \frac{d\eta}{dx^j}; \quad \eta_{i,\mu\nu} = \frac{d^2\eta_i}{dx^\mu dx^\nu}. \quad (13.17)$$

Only the derivatives of the field quantities will be symbolized in this manner.

In this notation, the most general form of the Lagrangian density to be considered here is written as

$$\mathcal{L} = \mathcal{L}(\eta_\rho, \eta_{\rho,\nu} x^\nu). \quad (13.18)$$

The total Lagrangian is then an integral over three-space:

$$L = \int \mathcal{L}(dx^i), \quad (13.19)$$

but it rarely occurs explicitly. Hamilton's principle appears as an integral over a region in 4-space:

$$\delta I = \delta \int \mathcal{L}(dx^\mu) = 0, \quad (13.20)$$

where the variation of the η_ρ vanishes at the bounding surface S of the region of integration. The derivation of the corresponding Euler–Lagrange equations of motion proceeds symbolically as before. We consider a one-parameter set of varied functions that reduce to $\eta_\rho(x^\nu)$ as the parameter α goes to zero. As previously, a possible suitable set can be constructed, for example, by adding to η_ρ the product $\alpha\zeta_\rho$, where $\zeta_\rho(x^\nu)$ are convenient arbitrary functions vanishing on the bounding surface. The vanishing of the variation of I is equivalent to setting the derivative of I with respect to α equal to zero:*

$$\frac{dI}{d\alpha} = \int \left(\frac{\partial \mathcal{L}}{\partial \eta_\rho} \frac{\partial \eta_\rho}{\partial \alpha} + \frac{\partial \mathcal{L}}{\partial \eta_{\rho,\nu}} \frac{\partial \eta_{\rho,\nu}}{\partial \alpha} \right) (dx^\mu).$$

Integration by parts yields

$$\begin{aligned} \frac{dI}{d\alpha} = \int \left[\frac{\partial \mathcal{L}}{\partial \eta_\rho} - \frac{d}{dx^\nu} \left(\frac{\partial \mathcal{L}}{\partial \eta_{\rho,\nu}} \right) \right] \frac{\partial \eta_\rho}{\partial \alpha} (dx^\mu) \\ + \int (dx^\mu) \frac{d}{dx^\nu} \left(\frac{\partial \mathcal{L}}{\partial \eta_{\rho,\nu}} \frac{\partial \eta_\rho}{\partial \alpha} \right). \end{aligned} \quad (13.21)$$

The second integral vanishes in the limit as α goes to zero, as can be seen in various ways. We can examine it term by term: carrying out the integration for the particular x^ν of each derivative term, which then vanishes because the derivative with respect to α is zero at the end points. Or the integral can be transformed by

*Unless otherwise noted, the summation convention will be used in the remainder of this chapter, for all types of subscript-superscript pairs.

a four-dimensional divergence theorem into an integral over the surface bounding the region of integration in 4-space. The surface integral again vanishes because the variation of η_ρ in the vicinity of the correct field functions is zero on the surface. Equation (13.21) in the limit as α goes to zero therefore reduces to

$$\left(\frac{dI}{d\alpha}\right)_0 = \int (dx^\mu) \left[\frac{\partial \mathcal{L}}{\partial \eta_\rho} - \frac{d}{dx^\nu} \left(\frac{\partial \mathcal{L}}{\partial \eta_{\rho,\nu}} \right) \right] \left(\frac{\partial \eta_\rho}{\partial \alpha} \right)_0. \quad (13.22)$$

Again, the arbitrary nature of the variation of each η_ρ means that Eq. (13.22) is satisfied only when each of the square brackets vanishes:

$$\frac{d}{dx^\nu} \left(\frac{\partial \mathcal{L}}{\partial \eta_{\rho,\nu}} \right) - \frac{\partial \mathcal{L}}{\partial \eta_\rho} = 0. \quad (13.23)$$

Equations (13.23) represent a set of partial differential equations for the field quantities, with as many equations as there are different values of ρ . It may be worth repeating that since the space coordinates x^i are indices for the field quantities, each of Eqs. (13.23) in effect corresponds to an entire set of Lagrange differential equations of motion in the discrete case.

For a one-dimensional continuous system, where ν takes on only the values 0 and 1, Eq. (13.23) expands to the same form as Eq. (13.16). The compactness of the notation is evident even in so simple an example. Although we have used covariant notation, the use of a four-dimensional space for symbolic convenience in no way requires covariant behavior (in the physicist's sense of the word) of any of the quantities in that space.

For discrete systems, the Lagrangian is uncertain to a total time derivative of an arbitrary function of the generalized coordinates and time. With continuous systems, the corresponding statement is that \mathcal{L} is uncertain to any "4-divergence," that is, to a term of the form

$$\frac{dF_\nu(\eta_\rho, x^\mu)}{dx^\nu} \quad (13.24)$$

where the F_ν are any four (differentiable) functions of the field quantities η_ρ and the coordinates x^μ . That such a term makes no contribution to the variation of the action integral is obvious. Application of the divergence theorem in 4-space converts the volume integral into an integral over the bounding surface where the variation of F_ν is zero. In symbols, the relevant variation can be written

$$\delta \int (dx^\mu) \frac{dF_\nu(\eta_\rho, x^\mu)}{dx^\nu} = \delta \int F_\nu(\eta_\rho, x^\mu) d\sigma^\nu = 0, \quad (13.25)$$

where $d\sigma^\nu$ represents the components of an element of surface (in Euclidean 4-space) oriented along the direction of the outward normal.

The Lagrangian formulation for a continuous set of generalized coordinates has been developed in order to treat continuous mechanical systems such as an

elastic solid in longitudinal oscillation, or a gas vibrating in such a manner as to set up acoustic waves. As has been implied, the formulation may also be used, even in the absence of a mechanical system, to describe the equations governing a *field*. Mathematically, a field is no more than a set of one or more independent functions of space and time, and the generalized coordinates fit this definition. There is no requirement that the field be related to some underlying mechanical system. In thus breaking the connection between the Lagrangian field description and purely mechanical motion, we are merely recapitulating the history of physics. For example, the electromagnetic field was long thought of in terms of the elastic vibrations of a mysterious ether. Only in recent times was it generally realized that the ether had no other role than being the subject of the verb “to undulate.” We recognize equally well that the variational procedures developed here also stand independent of the notion of a continuous mechanical system, and that they serve to furnish the equations describing any spacetime field. Hamilton’s principle then becomes in effect a convenient and compact description of the field, one that upon expansion leads to the field equations.

In addition to implying the field equations, the Lagrangian density has more to tell us about the physical nature of the field. As with systems of a discrete number of degrees of freedom, the structure of the Lagrangian also contains information on conserved properties of the system. One such set of conservation theorems is discussed in the next section.*

13.3 ■ THE STRESS-ENERGY TENSOR AND CONSERVATION THEOREMS

An analog to the conservation of Jacobi’s integral in point mechanics found in Section 2.6, can be derived here, and in much the same manner. All we have to remember is that the treatment of time must be extended in parallel fashion to the x^i since they are all independent parameters in \mathcal{L} . Thus, instead of the time derivative of L , we seek to evaluate the total derivative of \mathcal{L} with respect to x^μ :

$$\frac{d\mathcal{L}}{dx^\mu} = \frac{\partial\mathcal{L}}{\partial\eta_\rho} \eta_{\rho,\mu} + \frac{\partial\mathcal{L}}{\partial\eta_{\rho,\nu}} \eta_{\rho,\mu\nu} + \frac{\partial\mathcal{L}}{\partial x^\mu}. \quad (13.26)$$

By the equations of motion, Eq. (13.23), this becomes (with a slight change in notation),

$$\begin{aligned} \frac{d\mathcal{L}}{dx^\mu} &= \frac{d}{dx^\nu} \left(\frac{\partial\mathcal{L}}{\partial\eta_{\rho,\nu}} \right) \eta_{\rho,\mu} + \frac{\partial\mathcal{L}}{\partial\eta_{\rho,\nu}} \frac{d\eta_{\rho,\mu}}{dx^\nu} + \frac{\partial\mathcal{L}}{\partial x^\mu} \\ &= \frac{d}{dx^\nu} \left(\frac{\partial\mathcal{L}}{\partial\eta_{\rho,\nu}} \eta_{\rho,\mu} \right) + \frac{\partial\mathcal{L}}{\partial x^\mu}. \end{aligned} \quad (13.27)$$

*A more general attack on the conservation properties inherent in the Lagrangian will be found in Section 13.7 on Noether’s theorem.

Combining total derivatives, this can be written

$$\frac{d}{dx^\nu} \left[\frac{\partial \mathcal{L}}{\partial \eta_{\rho,\nu}} \eta_{\rho,\mu} - \mathcal{L} \delta_{\mu\nu} \right] = -\frac{\partial \mathcal{L}}{\partial x^\mu}. \quad (13.28)$$

Let us suppose, now, that \mathcal{L} does not depend explicitly upon x^μ . This usually means that \mathcal{L} represents a free field, that is, contains no external driving sources or sinks that interact with the field at explicit space points and with given time dependence. In effect, this means no interaction between the field and point particles moving in space and time through the field. Under this condition, Eq. (13.28) takes on the form of a set of divergence conditions,

$$\frac{dT_\mu^\nu}{dx^\nu} = T_{\mu,\nu}^\nu = 0 \quad (13.29)$$

on a quantity with the form of a 4-tensor of the second rank:

$$T_\mu^\nu = \frac{\partial \mathcal{L}}{\partial \eta_{\rho,\nu}} \eta_{\rho,\mu} - \mathcal{L} \delta_\mu^\nu. \quad (13.30)$$

That these equations have only the *form* of tensor equations in 4-space is emphasized because as yet the 4-space has no transformation properties—space and time are still distinct—and there is no transformation requirement on T_μ^ν . However, the space portions of these quantities do behave like vectors and tensors in ordinary space; that is, T_{ij} are the components of a three-dimensional tensor of the second rank. Before considering the possible transformations, we will determine the physical meaning of T_μ^ν .

The similarity between T_μ^ν and Jacobi's integral, Eq. (2.54), is obvious. It becomes especially clear for the component T_0^0 :

$$T_0^0 = \frac{\partial \mathcal{L}}{\partial \dot{\eta}_\rho} \dot{\eta}_\rho - \mathcal{L}. \quad (13.31)$$

In mechanical systems, the Lagrangian density often has the form $\mathcal{L} = \mathcal{T} - \mathcal{V}$, the difference between a kinetic energy density and a potential energy density. This is the case, for example, with the Lagrangian densities for the elastic rod, with the kinetic energy density having the form of one-half the mass density times a square of the displacement velocity:

$$\mathcal{T} = \frac{1}{2} \mu \dot{\eta}_\rho \dot{\eta}_\rho.$$

By the same arguments as used in discrete mechanics, T_0^0 can then be identified as a total energy density.

The corresponding identification tags to be placed on the other elements of T_μ^ν can be suggested by writing the set of Eqs. (13.29) as

$$\frac{dT_\mu^0}{dt} + \frac{dT_\mu^j}{dx} = 0, \quad (13.32)$$

or

$$T_{\mu,\nu}^{\nu} = \frac{dT_{\mu}^0}{cdt} + \frac{dT_{\mu}^i}{dx^i} = \frac{dT_{\mu}^0}{cdt} + \nabla \cdot T_{\mu} = 0 \quad (13.33)$$

where T_{μ} , whose components are T_{μ}^{ν} , are a set of 4-space vectors. In either form, Eqs. (13.32) or (13.33) appear as equations of continuity, which is to say that the time rate of change of some density plus the divergence of some corresponding flux or current density vanishes. In turn, the equations of continuity imply the conservation of some integral quantities providing the field volume is finite; that is, the field can be contained within a volume beyond which the field quantities are zero, defined, in such a case, integral quantities R_{μ} by

$$R_{\mu} = \int T_{\mu}^0 dV, \quad (13.34)$$

where the volume integral extends beyond the region containing the field. Then, by Eqs. (13.33),

$$\frac{dR_{\mu}}{dt} = \int \nabla \cdot T_{\mu} dV = \int T_{\mu} \cdot d\mathbf{A} = 0. \quad (13.35)$$

It is because of these conservation theorems, derived from Eq. (13.29), that the four arrays T_{μ}^{ν} , $\mu = 0, 1, 2, 3$ are known as conserved currents, in analogy with the conservation equations for electromagnetic current.

We should therefore expect T_0 to play the role of the components of an energy current density. That this is reasonable can be seen again from considerations of the longitudinal vibration field in an elastic rod. Imagine the rod divided by an imaginary cut at point x (cf. Fig. 13.2). From the considerations that led to the Lagrangian, Eq. (13.6), the force exerted by the part of the rod on the right to extend the part that is to the left of the cut is

$$Y \frac{d\eta}{dx}. \quad (13.36)$$

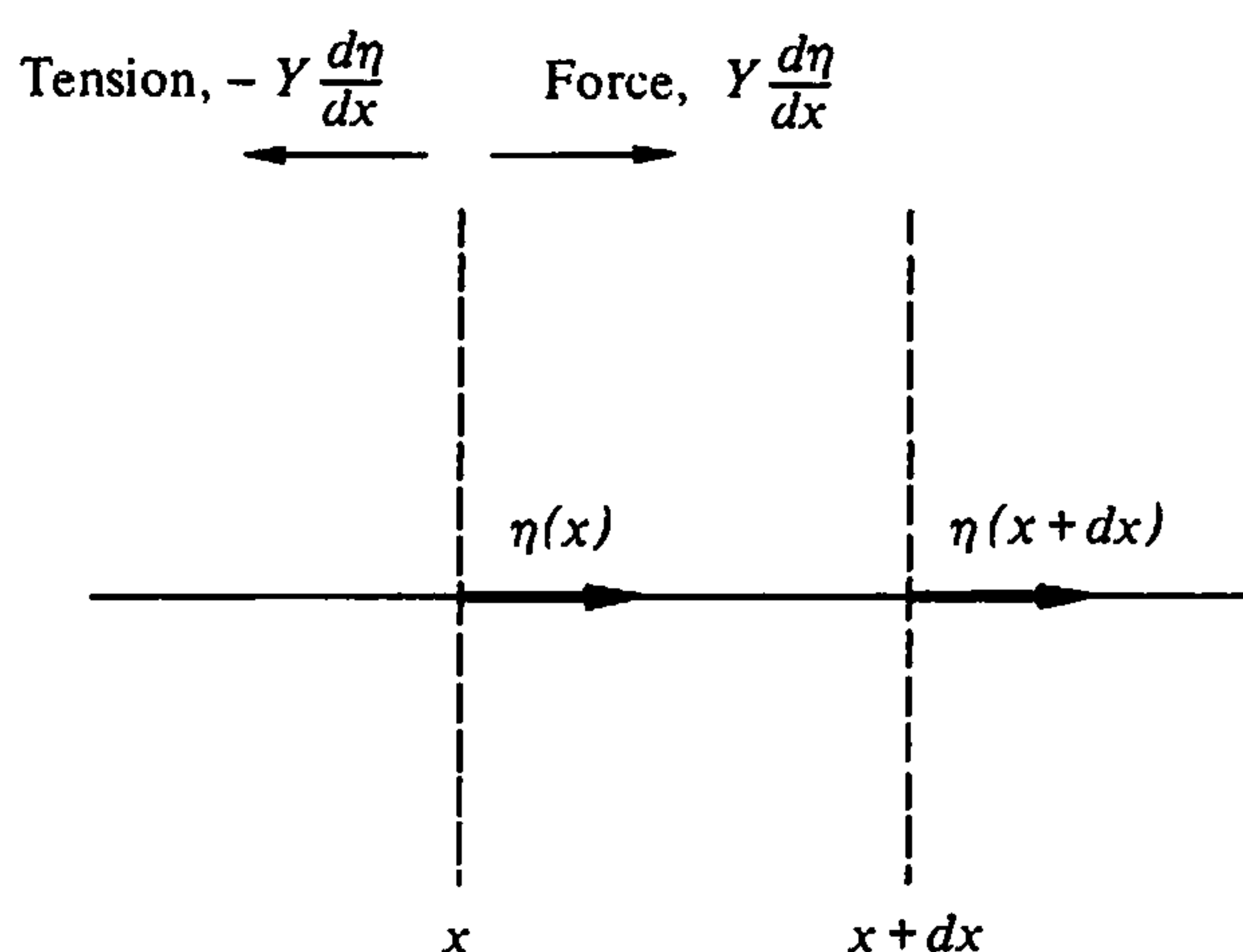

FIGURE 13.2 Diagram illustrating calculation of energy current density in elastic rod.

Hence, there is a tension at x in the left-hand portion of equal magnitude but of opposite direction. Further, the left-hand portion is being stretched by an amount that at x is η , and the rate at which this extension changes in time is $\dot{\eta}$. Hence, the rate of work being done by the tension at the cut is

$$-\dot{\eta}Y \frac{d\eta}{dx}, \quad (13.37)$$

which is thus the rate at which energy is being transferred to the right per unit time. Comparison shows that this is exactly T_0^1 for the appropriate Lagrangian density of Eq. (13.10). If T_0^0 is an energy density then the quantity, R_0 , of Eq. (13.34) can be identified as the total energy in the field. The fourth component of the conservation equation (13.35) therefore says that the total field energy is conserved if T_0^i vanishes on the bounding surface, that is, if the system does not radiate energy to the outside.

Physical meaning for the T_i^0 components can be suggested similarly by turning once more to the vibrations of the elastic rod. If the particles in the rod move by the same amount all along the rod, the motion will be that of a rigid body, that is, no oscillatory disturbances. The net change of mass in a length dx of the rod as a result of the motion would clearly be zero, since as much mass moves past $x + dx$ as past x . There would still be a net momentum density $\mu\dot{\eta}$ for this case of rigid-body motion. When wave motion takes place, a net mass change in the length dx exists, amounting at any given time to (cf. Fig. 13.2)

$$\mu[\eta(x) - \eta(x + dx)] = -\mu \frac{d\eta}{dx} dx. \quad (13.38)$$

The additional momentum in the interval resulting from the wave motion is therefore

$$-\mu\dot{\eta} \frac{d\eta}{dx} dx.$$

Thus, an additional momentum density, above and beyond that of the steady-state motion, can be identified as the wave or field momentum density:

$$-\mu\dot{\eta} \frac{d\eta}{dx}. \quad (13.39)$$

This quantity is just $-T_1^0$ for the Lagrangian density given by Eq. (13.10). Thus, we are led to identify $-T_i^0$ as the components of field momentum density and $-R_i$, as the total (linear) momentum of the field, at least in this four-dimensional convention.

The equations of continuity, Eqs. (13.33), then suggest that $-T_i$ must represent the vector flux density for the i th component of the field momentum density. We ascribe a vector property to T_i because there can be, for example, a flow in the y -direction of the x -component of the momentum density, as measured by $-T_x^y$. An alternative interpretation of T_i^j comes from considering the displacement field

of an elastic solid. It is well known that in such a solid there are also shear forces (besides the compression forces normal to a surface) along a surface element. The entire assemblage of forces can be described by saying that the force $d\mathbf{F}$ acting on an element of area $d\mathbf{A}$ is expressed in terms of a *stress tensor* T such that

$$d\mathbf{F} = T \cdot d\mathbf{A}. \quad (13.40)$$

Hence, the net force, say in the x -direction, on a rectangular volume element $dx dy dz$ has a contribution from the forces on the surfaces in yz planes given by (cf. Fig. 13.3) (where 1 indicates the x component, 2 the y , etc.)

$$[T_1^1(x + dx) - T_1^1(x)] dy dz = \frac{dT_1^1}{dx} dx dy dz, \quad (13.41)$$

but there is also a contribution from the surfaces in the xz plane;

$$[T_1^2(y + dy) - T_1^2(y)] dx dz = \frac{dT_1^2}{dy} dx dy dz, \quad (13.42)$$

and similarly from the xy planes. Newton's equations of motion here correspond to saying that the time rate of change of the momentum density in the x direction, $-T_1^0$, is equal to the x -component of the force on a unit volume element:

$$-\frac{dT_1^0}{cdt} = \frac{dT_1^1}{dx} + \frac{dT_1^2}{dy} + \frac{dT_1^3}{dz}, \quad (13.43)$$

which is precisely the x -component of Eq. (13.33). For this particular field T_i^j can be identified as the elements of the three-dimensional stress tensor, hence the origin of the name "stress-energy tensor" for T_μ^ν .

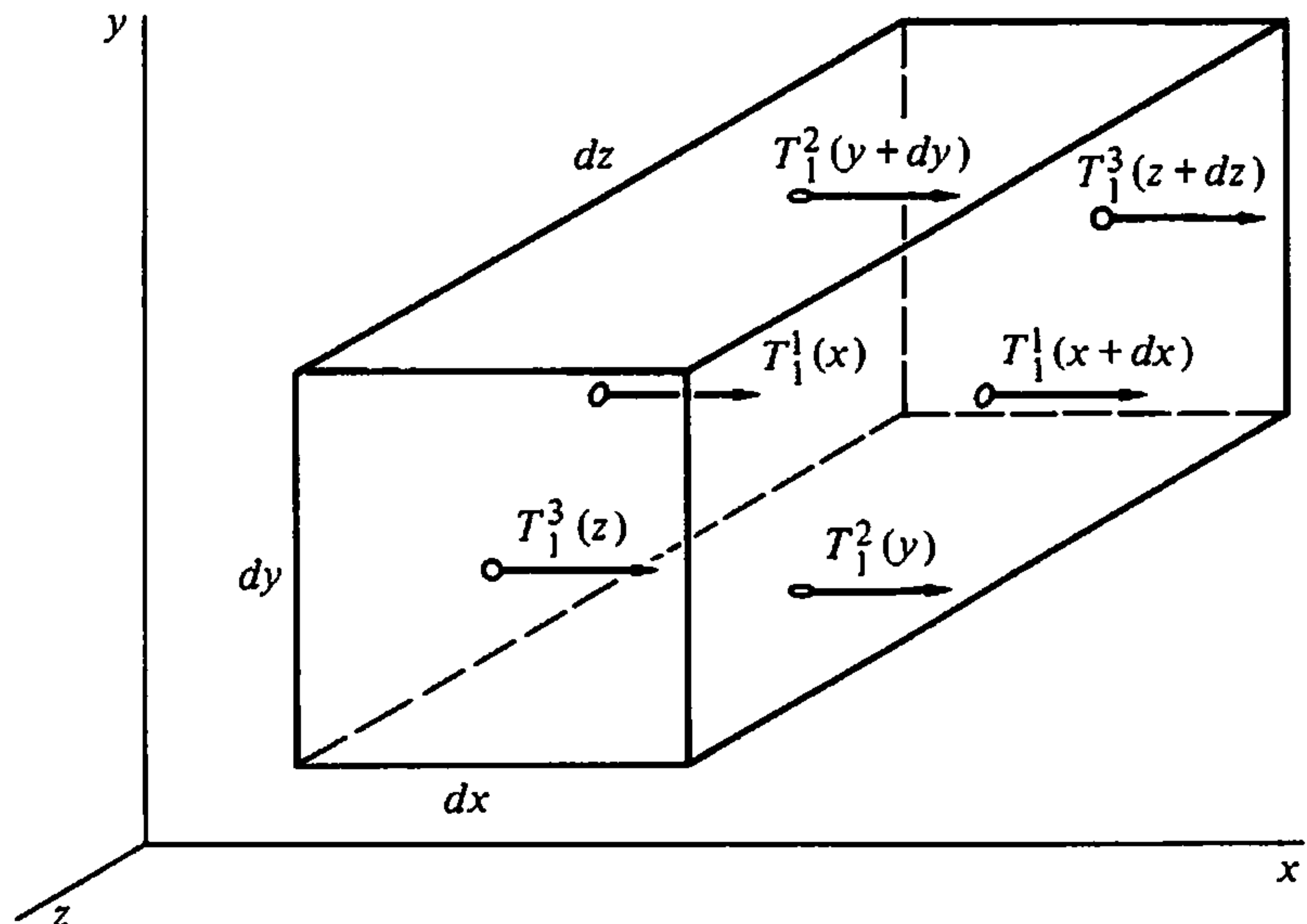

FIGURE 13.3 Force in x direction on a volume element $dx dy dz$ of an elastic solid.

By considerations of a continuous mechanical system, we have thus been able to attach physical identifications, or associations, to each of the components of the stress-energy tensor. Thus, the components are

T_0^0	field energy density divided by c ,
T_0 , with components T_0^j	field energy current density,
$-T_i^0$	field momentum density, i th component,
$-T_i$, with components T_i^0	current density for the i th component of the field momentum density,
T_i^j	three-dimensional stress tensor

where, as we saw discussed following Eqs. (13.33) and (13.35), T_0 and T_i form 4-space vectors each of which is conserved and thus identified, in analogy with the charge-current vector of electromagnetic theory as a “4-current”. All such conserved objects are called currents in field theory.

In almost all cases the three-dimensional tensor T is symmetric. This is not only physically desirable, but almost necessarily a characteristic for the spatial portion of the stress-energy tensor.

It must be remembered that although the example of mechanical systems gave birth to the procedures and nomenclature, the formalism can be applied to any field irrespective of its nature or origin. A classical theory of fields can be constructed not only for vibrations of an elastic solid, but also for the electromagnetic field, for the “field” of the Schrödinger wave function, or for the relativistic field describing a “scalar” meson, among others. We shall examine some of these examples in more detail later on.

Recalling the identification of R_i , the conservation equations, Eq. (13.35), say that for a closed noninteracting system the total linear momentum of the field is conserved. We would expect no less. But there should be a corresponding conservation theorem for the total angular momentum of the field. It is simple to construct a quantity that should act as an angular momentum density. Since angular momentum is an axial vector. We expect that the components of the angular momentum density are the elements of an antisymmetric tensor of the second rank. A suitable form for this tensor is

$$\mathcal{M}^{ij} = -(x^i T^{j0} - x^j T^{i0}), \quad (13.44)$$

with the total angular momentum of the field given by

$$M^{ij} = \int \mathcal{M}^{ij} dV. \quad (13.45)$$

In as much as t and x^i are completely independent variables, the time rate of change of M^{ij} is

$$\frac{dM^{ij}}{dt} = - \int \left(x^i \frac{dT^{j0}}{dt} - x^j \frac{dT^{i0}}{dt} \right) dV, \quad (13.46)$$

or, from the continuity conditions, Eqs. (13.32),

$$\frac{dM^{ij}}{dt} = - \int \left(x^i \frac{dT^{jk}}{dx^k} - x^j \frac{dT^{ik}}{dx^k} \right) dV. \quad (13.47)$$

Integration by parts converts this expression to

$$\frac{dM^{ij}}{dt} = - \int \frac{d}{dx^k} (x^i T^{jk} - x^j T^{ik}) dV + \int (T^{ij} - T^{ji}) dV. \quad (13.48)$$

The first integral on the right is in the form of a volume integral of a divergence. It is therefore equal to an integral over the bounding surface, which vanishes for a closed nonradiating system. Finally, if $T^{ij} = T^{ji}$, the second integral is also zero. Thus, the total angular momentum of the field is conserved if T is symmetric.

If the stress tensor is not symmetric, we can often make use of the ambiguity in defining the stress tensor to restore this symmetry. Just as for the Lagrangian, the form of the stress-energy tensor, Eq. (13.30), was chosen to satisfy divergence conditions (cf. Eq. (13.29)). Therefore T_{μ}^{ν} is indeterminate by any function whose 4-divergence vanishes. Usually it is possible to find such a quantity to “symmetrize” the stress-energy tensor.

13.4 ■ HAMILTONIAN FORMULATION

It is possible to obtain a Hamiltonian formulation for systems with a continuous set of coordinates much as was done in Chapter 8 for discrete systems. To indicate the method of approach, we return briefly to the linear chain of mass points discussed in Section 13.1. Conjugate to each field component, η_i , there is a canonical momentum

$$p_i = \frac{\partial L}{\partial \dot{\eta}_i} = a \frac{\partial L_i}{\partial \dot{\eta}_i}. \quad (13.49)$$

The Hamiltonian for the system is therefore

$$H \equiv p_i \dot{\eta}_i - L = a \frac{\partial L_i}{\partial \dot{\eta}_i} \dot{\eta}_i - L,$$

or

$$H = a \left(\frac{\partial L_i}{\partial \dot{\eta}_i} \dot{\eta}_i - L_i \right). \quad (13.50)$$

It will be remembered that in the limit of the continuous rod, when a goes to zero, $L_i \rightarrow \mathcal{L}$ and the summation in Eq. (13.50) becomes an integral:

$$H = \int dx \left(\frac{\partial \mathcal{L}}{\partial \dot{\eta}} \dot{\eta} - \mathcal{L} \right). \quad (13.51)$$

The individual canonical momenta p_i , as given by Eq. (13.49), vanish in the continuous limit, but we can define a *momentum density*, π , that remains finite:

$$\lim_{a \rightarrow 0} \frac{p_i}{a} \equiv \pi = \frac{\partial \mathcal{L}}{\partial \dot{\eta}}. \quad (13.52)$$

Equation (13.51) is in the form of a space integral over a *Hamiltonian density*, \mathcal{H} , defined by

$$\mathcal{H} = \pi \dot{\eta} - \mathcal{L}. \quad (13.53)$$

While a Hamiltonian formulation can thus be introduced in a straightforward manner for classical fields, note that the procedure singles out the time variable for special treatment. It is therefore in contrast to the development we have given for the Lagrangian formulation where the independent variables of time and space were handled symmetrically. For this reason the Hamiltonian approach, at least as introduced here, lends itself less easily to incorporation in a relativistically covariant description of fields. The Hamiltonian way of looking at fields has therefore not proved as useful as the Lagrangian method, and a rather brief description should suffice here.

The obvious route for generalizing to a three-dimensional field described by field quantities η_ρ is to define, analogously to Eq. (13.52), the canonical momentum densities

$$\pi^\rho(x^\mu) = \frac{\partial \mathcal{L}}{\partial \dot{\eta}_\rho}. \quad (13.54)$$

The quantities $\eta_\rho(x^i, t)$, $\pi^\rho(x^i, t)$ together define the infinite-dimensional *phase space* describing the classical field and its time development. A conservation theorem can be found for π_ρ that is roughly similar to that for the canonical momentum in discrete systems. If a given field quantity η_ρ is cyclic in the sense that \mathcal{L} does not contain η_ρ explicitly (as in the case of Eq. (13.10)), then the Lagrange field equation looks like an existence statement for a conserved current:

$$\frac{d}{dx^\mu} \frac{\partial \mathcal{L}}{\partial \eta_{\rho,\mu}} = 0, \quad (13.55)$$

or

$$\frac{d\pi^\rho}{dt} + \frac{d}{dx^i} \frac{\partial \mathcal{L}}{\partial \eta_{\rho,i}} = 0. \quad (13.56)$$

It follows that if η^ρ is cyclic, there is an integral conserved quantity

$$\Pi^\rho = \int dV \pi^\rho(x^i, t).$$

The obvious generalization of Eq. (13.53) for a Hamiltonian density is

$$\mathcal{H}(\eta^\rho, \eta_{\rho,i}, \pi_\rho, x^i) = \pi^\rho \dot{\eta}_\rho - \mathcal{L}, \quad (13.57)$$

where it is assumed that functional dependence upon $\dot{\eta}_\rho$ can be eliminated by inversion of the defining equations (13.49). From this definition it follows that

$$\frac{\partial \mathcal{H}}{\partial \pi^\rho} = \dot{\eta}_\rho + \pi^\lambda \frac{\partial \dot{\eta}_\lambda}{\partial \pi^\rho} - \frac{\partial \mathcal{L}}{\partial \dot{\eta}_\lambda} \frac{\partial \dot{\eta}_\lambda}{\partial \pi^\rho} = \dot{\eta}_\rho, \quad (13.58)$$

by Eq. (13.51). The other half of the canonical field equation is more cumbersome. When expressed in terms of the canonical variables, \mathcal{H} is a function of η_ρ through the explicit dependence of \mathcal{L} , and through $\dot{\eta}_\rho$. Hence,

$$\frac{\partial \mathcal{H}}{\partial \eta_\rho} = \pi^\lambda \frac{\partial \dot{\eta}_\lambda}{\partial \eta_\rho} - \frac{\partial \mathcal{L}}{\partial \dot{\eta}_\lambda} \frac{\partial \dot{\eta}_\lambda}{\partial \eta_\rho} - \frac{\partial \mathcal{L}}{\partial \eta_\rho} = -\frac{\partial \mathcal{L}}{\partial \eta_\rho}. \quad (13.59)$$

Using the Lagrange equations, this can be written

$$\frac{\partial \mathcal{H}}{\partial \eta_\rho} = -\frac{d}{dx^\mu} \left(\frac{\partial \mathcal{L}}{\partial \eta_{\rho,\mu}} \right) = -\dot{\pi}^\rho - \frac{d}{dx^i} \left(\frac{\partial \mathcal{L}}{\partial \eta_{\rho,i}} \right). \quad (13.60)$$

Because of the appearance of \mathcal{L} , we still do not have a useful form. By an exactly parallel derivation, however, we find that

$$\frac{\partial \mathcal{H}}{\partial \eta_{\rho,i}} = \pi^\lambda \frac{\partial \dot{\eta}_\lambda}{\partial \eta_{\rho,i}} - \frac{\partial \mathcal{L}}{\partial \dot{\eta}_\lambda} \frac{\partial \dot{\eta}_\lambda}{\partial \eta_{\rho,i}} - \frac{\partial \mathcal{L}}{\partial \eta_{\rho,i}} = -\frac{\partial \mathcal{L}}{\partial \eta_{\rho,i}}. \quad (13.61)$$

Hence, we can write as the second half of the canonical equations

$$\frac{\partial \mathcal{H}}{\partial \eta_\rho} - \frac{d}{dx^i} \left(\frac{\partial \mathcal{H}}{\partial \eta_{\rho,i}} \right) = -\dot{\pi}^\rho. \quad (13.62)$$

Equations (13.58) and (13.62) can be put in a notation more closely approaching Hamilton's equations for a discrete system by introducing the notion of a *functional derivative* defined as

$$\frac{\delta}{\delta \psi} = \frac{\partial}{\partial \psi} - \frac{d}{dx^i} \frac{\partial}{\partial \psi_{,i}}. \quad (13.63)$$

Since \mathcal{H} is not a function of $\pi_{,i}^\rho$, Eqs. (13.58) and (13.62) can be written as

$$\dot{\eta}_\rho = \frac{\delta \mathcal{H}}{\delta \pi^\rho}, \quad \dot{\pi}^\rho = -\frac{\delta \mathcal{H}}{\delta \eta_\rho}. \quad (13.64)$$

Note that in the same symbolism the Lagrange equations, Eqs. (13.23), take the form

$$\frac{d}{dt} \left(\frac{\partial \mathcal{L}}{\partial \dot{\eta}_\rho} \right) - \frac{\delta \mathcal{L}}{\delta \eta_\rho} = 0. \quad (13.65)$$

About the only advantage of the functional derivative, however, is that of the resultant similarity with discrete system. It suppresses, on the other hand, the parallel treatment of time and space variables.

There is a way to treat classical fields that provides almost all of the Hamiltonian formulation of discrete mechanics. The main idea behind this treatment is to replace the continuous space variable or index by a denumerable discrete index. We can see how to do this by referring again to the longitudinal oscillations of the elastic rod. Let us suppose the rod is of finite length $L = x^2 - x^1$. The requirement that η vanish at the extremities is a boundary condition that could be achieved physically by placing the rod between two perfectly rigid walls. Then the amplitude of oscillation can be represented by a Fourier series:

$$\eta(x) = \sum_{n=0}^{\infty} q_n \sin \frac{2\pi n(x - x_1)}{2L}. \quad (13.66)$$

Instead of the continuous index x , we have the discrete index n . We are allowed to use this representation for all x only when $\eta(x)$ is a well-behaved function, which most physical field quantities are.

For simplicity in illustrating how the scheme may be carried out, it will be assumed that only one real field quantity, η , can be expanded in a three-dimensional Fourier series of the form

$$\eta(\mathbf{r}, t) = \frac{1}{V^{1/2}} \sum_k q_k(t) e^{i\mathbf{k}\cdot\mathbf{r}}. \quad (13.67)$$

Here \mathbf{k} is a wave vector that can take on only discrete magnitudes and directions, such that only an integral (or sometimes, half-integral) number of wavelengths fit into a given linear dimension. We say that \mathbf{k} has a discrete spectrum. The scalar index k stands for some ordering of the set of integer indices used to denumerate the discrete values of \mathbf{k} , and V is the volume of the system, appearing in a normalization factor. Because η is real, we must have $q_k^* = q_{-k}$.

The orthogonality of the exponentials over the volume can be stated as the relation

$$\frac{1}{V} \int e^{i(\mathbf{k}-\mathbf{k}')\cdot\mathbf{r}} dV = \delta_{kk'}. \quad (13.68)$$

In effect, the allowed values of \mathbf{k} are those for which the condition (13.68) is satisfied (as can be seen by looking at the one-dimensional Fourier series). It follows that the coefficients of expansion, $q_k(t)$, are given by

$$q_k(t) = \frac{1}{V^{1/2}} \int e^{-i\mathbf{k}\cdot\mathbf{r}} \eta(\mathbf{r}, t) dV. \quad (13.69)$$

In similar fashion, the canonical momentum density can be expanded as

$$\pi(\mathbf{r}, t) = \frac{1}{V^{1/2}} \sum_k p_k(t) e^{-i\mathbf{k}\cdot\mathbf{r}}, \quad (13.70)$$

again with $p_k^* = p_{-k}$. Correspondingly, the expansion coefficients, $p_k(t)$, are to be found from

$$p_k(t) = \frac{1}{V^{1/2}} \int e^{i\mathbf{k}\cdot\mathbf{r}} \pi(\mathbf{r}, t) dV. \quad (13.71)$$

In a sense we have almost come full circle. We began this chapter with a discrete system employing a denumerable number of generalized coordinates. By then going to the limit of a continuous set of variables, we were able to treat continuous systems. Finally, we have introduced a description of the continuous system in terms of a denumerable, discrete set of coordinates that obey the same type of mechanics as the discrete system we started with. Because of the formal correspondence with the variables of discrete systems, the q_k and p_k quantities are the obvious candidates for quantization when we go from classical to quantum field theory. Indeed, the q_k correspond to what are spoken of as the “occupation numbers” for the field.

We could describe the field in terms of discrete coordinates because the finite size of the system, and the boundary conditions, permitted a discrete Fourier expansion. Equivalently, we can say that the expansion is made over a discrete spectrum of plane waves. Since the wave vector \mathbf{k} is in quantum mechanics directly proportional to the momentum of the particle associated with the plane wave, the expansions used here are often spoken of as the *momentum representation*. We

TABLE 13.1 Comparison of Minkowski 4-dimensional spacetime and symplectic structure (after Misner, Thorne & Wheeler, *Gravitation*, San Francisco: Freeman, 1973)

Comparison item	Hamiltonian symplectic structure	Minkowski spacetime metric structure
Canonical coordinates	q^1, q^2, p_1, p_2	ct, x, y, z
Canonical structure	$\Theta = \mathbf{d}p_1 \wedge \mathbf{d}q^1 + \mathbf{d}p_2 \wedge \mathbf{d}q^2$	$\mathbf{d}s^2 = c^2 \mathbf{d}t \otimes \mathbf{d}t - \mathbf{d}x \otimes \mathbf{d}x - \mathbf{d}y \otimes \mathbf{d}y - \mathbf{d}z \otimes \mathbf{d}z$
Nature of “metric”	antisymmetric	symmetric
Name for “metric” structure	canonically (or dynamically) conjugate coordinates	Lorentz coordinates
Field equations	$\nabla\Theta = 0$ satisfied automatically	$R_{\alpha\beta\gamma\delta} = 0$: flat spacetime
4-dimensional manifold	phase space	spacetime
Coordinate free description	$\nabla\Theta = 0$	<i>Riemann</i> = 0

need not be restricted to plane wave expansions. A denumerable set of coordinates can be found whenever the field functions can be expanded in terms of a discrete set of orthonormal eigenfunctions.

One final comment. The Hamiltonian or symplectic structure can be expressed in tensor notation. Table 13.1 compares the metric structure of 4-dimensional Minkowski spacetime with the symplectic structure of a Hamiltonian with coordinates $q^1, q^2, p_1,$ and p_2 .

13.5 ■ RELATIVISTIC FIELD THEORY

We saw in Chapter 7 that there is considerable difficulty in constructing relativistically covariant Lagrangian and Hamiltonian descriptions of particle mechanics. Part of the problem can be traced to the separate roles played by space and time coordinates. For point particles, the space coordinates are mechanical variables while time is a monotonic parameter. But in classical field theory there is a natural similarity in handling space and time coordinates. They are all parameters, together defining a point in the spacetime continuum at which the field variables are to be determined. While the four-dimensional spacetime system has been used so far only for reasons of notational simplicity, the easy and natural way it fits into the formulation suggests that a relativistically covariant description is quite feasible for classical fields. Indeed, only relatively minor tinkering has to be done to the formulation already presented so that it can handle relativistic fields in a manner that is manifestly Lorentz covariant.

Three points require specific attention: (1) the nature (and metric) of the four-dimensional space used; (2) the Lorentz transformation properties of the field quantities, Lagrangian densities, and related functions; and (3) the covariant description of the limits of integration. The simple Cartesian, 4-space with coordinates t, x, y, z that we have implicitly used so far in this chapter is not convenient for exhibiting Lorentz invariance. We will use the notation and conventions adopted in Chapter 7 as well as the results of that chapter. Accordingly, the Greek letter indices will still run from 0 to 3, with $x^0 = ct$. Note that the Lagrange equations (13.23) are unaffected by this change. Indeed, the term

$$\frac{d}{dx^\nu} \left(\frac{\partial \mathcal{L}}{\partial \eta_{\rho,\nu}} \right)$$

remains unaltered by a scale change of any of the x^ν , and the other term in the Lagrange equation does not involve the coordinates at all. Further, the change in space does not affect the formulation of Hamilton's principle in Eq. (13.20), since it only introduces a multiplicative constant.

All of the quantities related to the field and associated equations must now have some definite Lorentz covariant properties. The field quantities must therefore consist of 4-tensors of some given rank—scalar, 4-vector, and so on. In principle, η_ρ need not be restricted to any one of these categories but may stand for a set of such, for example, two scalars. The Lagrangian and Hamiltonian densities must

also be covariant. In Hamilton's principle, the volume element (dx^ν) of 4-space is invariant under Lorentz transformation. Since we usually think of the action I as a scalar, this means that the Lagrangian density (and therefore \mathcal{H}) should be scalars. That is to say, they must be functions of the field quantities (possibly along with external covariant quantities) in such manner as to form scalars under Lorentz transformations. It then follows that the stress-energy tensor $T_{\mu\nu}$, as defined by Eq. (13.30) is automatically a 4-tensor of the second rank. The change in the 4-space however means that the components of $T_{\mu\nu}$ may be altered in value.

In tensor notation, the stress-energy tensor, \mathbf{T} , is a linear, symmetric "functional" with slots for two vectors. It has the following properties:

1. If we insert the 4-velocity u of the observer into one of the slots and leave the other slot empty, the output is

$$\mathbf{T}(u, \dots) = \mathbf{T}(\dots, u) = - \left(\text{density of 4-momentum, } \frac{d\mathbf{p}}{dV} \right) \quad (13.72)$$

The right-hand side is the negative of the 4-momentum per unit three-dimensional volume as measured in the observer's frame at the event where \mathbf{T} is measured. In component notation,

$$T^\alpha{}_\beta u^\alpha = T_\beta{}^\alpha u^\beta = - \left(\frac{dp^\alpha}{dV} \right) \quad (13.73)$$

2. If we insert the 4-velocity u of the observer into one of the slots and an arbitrary unit vector n into the other slot, the output is

$$T(u, n) = T(n, u) = - \left(n \cdot \frac{d\mathbf{p}}{dV} \right) \quad (13.74)$$

The right-hand side is the negative of the component of the 4-momentum density along the n direction. In component notation

$$T_{\alpha\beta} u^\alpha n^\beta = T_{\beta\alpha} u^\beta n^\alpha = -n_\mu \frac{dp^\mu}{dV}. \quad (13.75)$$

3. If we insert the 4-velocity of the observer into both slots, the output is

$$T(u, u) = (\text{mass energy per unit volume}) \quad (13.76)$$

as measured in the frame with 4-velocity u .

In component notation,

$$T_{\alpha\beta} u^\alpha u^\beta = T_{\beta\alpha} u^\beta u^\alpha = u_\mu \frac{dp^\mu}{dV}. \quad (13.75')$$

4. If we pick a frame and insert two spacelike basis vectors e_i and e_k in that frame, the output is

$$\begin{aligned}
T_{ik} &= T_{ki} = T(e_i, e_k) = T(e_k, e_i) \\
&= i\text{-component of force acting from side } x^k - \delta \text{ to side } x^k + \delta \text{ across} \\
&\quad \text{a unit surface area perpendicular to direction } e_k \\
&= k\text{-component of force acting from side } x^i - \delta \text{ to side } x^i + \delta \text{ across} \\
&\quad \text{a unit surface area perpendicular to direction } e_i \qquad (13.77)
\end{aligned}$$

For example, if we assume the Lorentz transformations apply and consider a perfect fluid moving with a 4-velocity u , which may vary in spacetime, we can describe the fluid in terms of its mass density, ρ , and an isotropic pressure, p , both in the rest frame of the fluid element. The stress-energy tensor is given by

$$T = (\rho + p)u \otimes u + pg \qquad (13.78)$$

or in component form

$$T_{\alpha\beta} = (\rho + p)u_\alpha u_\beta + pg_{\alpha\beta}. \qquad (13.79)$$

Insert the 4-velocity into one slot giving

$$T^\alpha{}_\beta u^\beta = [(\rho + p)u^\alpha u_\beta + p\delta^\alpha{}_\beta]u^\beta = \rho u^\alpha. \qquad (13.80)$$

In the rest frame of the fluid, this becomes

$$T^0{}_\beta u^\beta = \rho c \qquad (13.81)$$

and

$$T^i{}_\beta u^\beta = \frac{dp^i}{dV} = \text{momentum density} = 0, \qquad (13.82)$$

where the last equality follows from the choice of the rest frame. Finally

$$T_{ik} = T(e_i, e_k) = p\delta_{ik}. \qquad (13.83)$$

The Lagrangian density is of course uncertain to a multiplicative constant factor. It is customary to choose the factor such that T_{00} (or its symmetrized form) directly represents the energy density in the field. In the chosen 4-space the quantities R_μ , Eq. (13.34), are now defined as

$$R_\mu = \int T_\mu{}^0 dV. \qquad (13.84)$$

Let us consider a related set P^μ defined as

$$P^\mu = \frac{1}{c} R^\mu. \qquad (13.85)$$

It follows then, from Eqs. (13.72) to (13.76) and the interpretation given above for T_{i0} , that P^i represents the components of the total linear momentum of the field,

and P^0 is E/c , where E is the total energy in the field. This suggests that we can interpret P^μ as the 4-momentum of the field. However, we still have to show that R^μ and P^μ transform like 4-vectors under a Lorentz transformation. To prove this property, we shall examine what is meant by an integration over three-space in a covariant formulation and indeed how the integration limits are to be treated in general.

The first instance where the covariance of the limits of integration may be questioned is in Hamilton's principle. In Eq. (13.20), the integral appears manifestly covariant, but the limits of integration derived from Eq. (13.12) are not. The spatial integration is over some fixed volume in three-space followed by an integration over time between t_1 and t_2 . But an integration over V for fixed t is not a covariant concept, for simultaneity ("constant time") is not preserved under Lorentz transformation. A suitable covariant description is to say the integration is conducted over a hypersurface of three dimensions that is *spacelike*. By a spacelike surface, we mean one in which all 4-vectors lying in it are spacelike. The vectors normal to such a surface are timelike. Now, any vector connecting two points on a surface of constant time is certainly spacelike, for its x^0 -component vanishes. Hence, a surface at constant time is a particular example of a spacelike surface. But such a surface retains its character in all Lorentz frames, because the spacelike or timelike quality of a vector is not affected by the Lorentz transformation. In a similar fashion, what is in one frame an integration over t at a fixed point can be described covariantly as an integration over a timelike surface. With a system of one dimension (in physical space), the integration in Hamilton's principle as given in Eq. (13.12) is over the rectangle shown in Fig. 13.4. A Lorentz transformation is a rotation in Minkowski space, and the sides of the rectangle will not be parallel to the axes in the transformed space. But we can describe the integration in all Lorentz frames as being over a region in 4-space contained between two spacelike hypersurfaces and bounded by intersecting timelike surfaces.

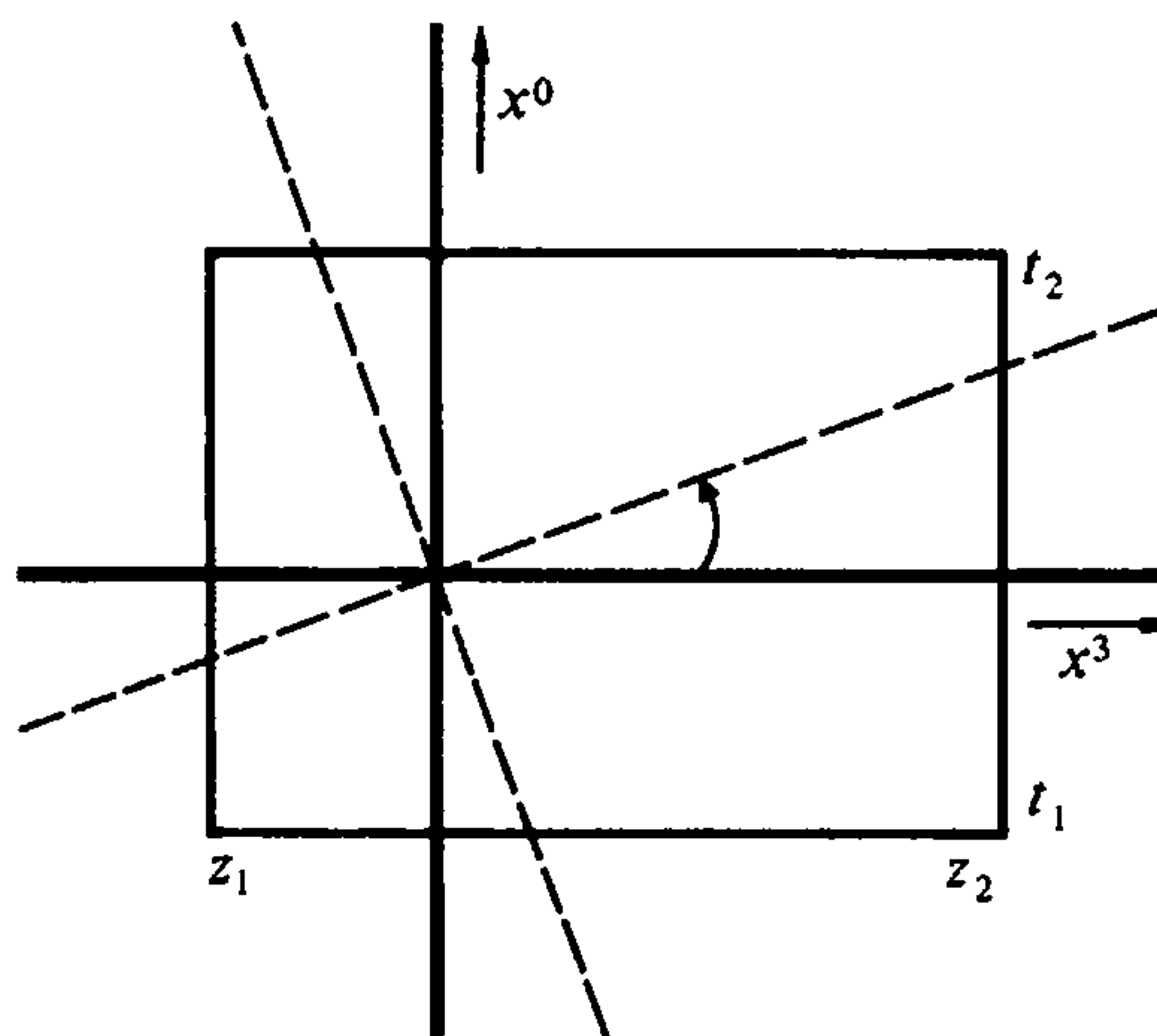

FIGURE 13.4 Regions of integration in Hamilton's principle for a system extending in only one space dimension.

The appropriate covariant description of integral quantities such as P^μ is then given as

$$P^\mu = \frac{1}{c} \int_S T^\mu{}_\nu dS^\nu, \quad (13.86)$$

where the integration is over a region on a spacelike hypersurface for which the 1-form elements of surface, in the direction of the surface normal, are dS^ν (a gradient). As $T^{\mu\nu}$ is a 4-tensor of the second rank, it is obvious that P^μ so defined is a 4-vector. But now we can show that the components of P^μ given by (13.86) reduce to a volume integral in ordinary three-space, *providing* it is divergenceless, that is, satisfies Eq. (13.29). Imagine a region in 4-space defined by three surfaces: S_1 and S_2 that are spacelike, and S_3 that is timelike (cf. Fig. 13.5). By a four-dimensional divergence theorem, a volume integral of a divergence can be replaced by a surface integral:

$$\int_{V_4} \frac{dT^{\mu\nu}}{dx^\nu} (dx^4) = \int_{S_1+S_2+S_3} T^{\mu\nu} dS_\nu, \quad (13.87)$$

where dx^4 is the invariant 4-volume, $\sqrt{|g|}cdtdx dy dz$. The integration over S_3 corresponds to an integration over t at constant \mathbf{r} . By allowing the volume to expand sufficiently, the integral over this surface will involve \mathbf{r} outside the system, where all field quantities vanish. Because of the assumed divergenceless property of $T^{\mu\nu}$, the integral on the left-hand side also vanishes. Therefore, if the normals to the spacelike surfaces are taken in the same sense,

$$\int_{S_1} T^{\mu\nu} dS_\nu = \int_{S_2} T^{\mu\nu} dS_\nu. \quad (13.88)$$

If S_1 is any arbitrary spacelike surface, and S_2 is a particular surface for which x^0 , or t , is constant, then by Eq. (13.88),

$$\int_{S_1} T^{\mu\nu} dS_\nu = \int T^{\mu 0} dV. \quad (13.89)$$

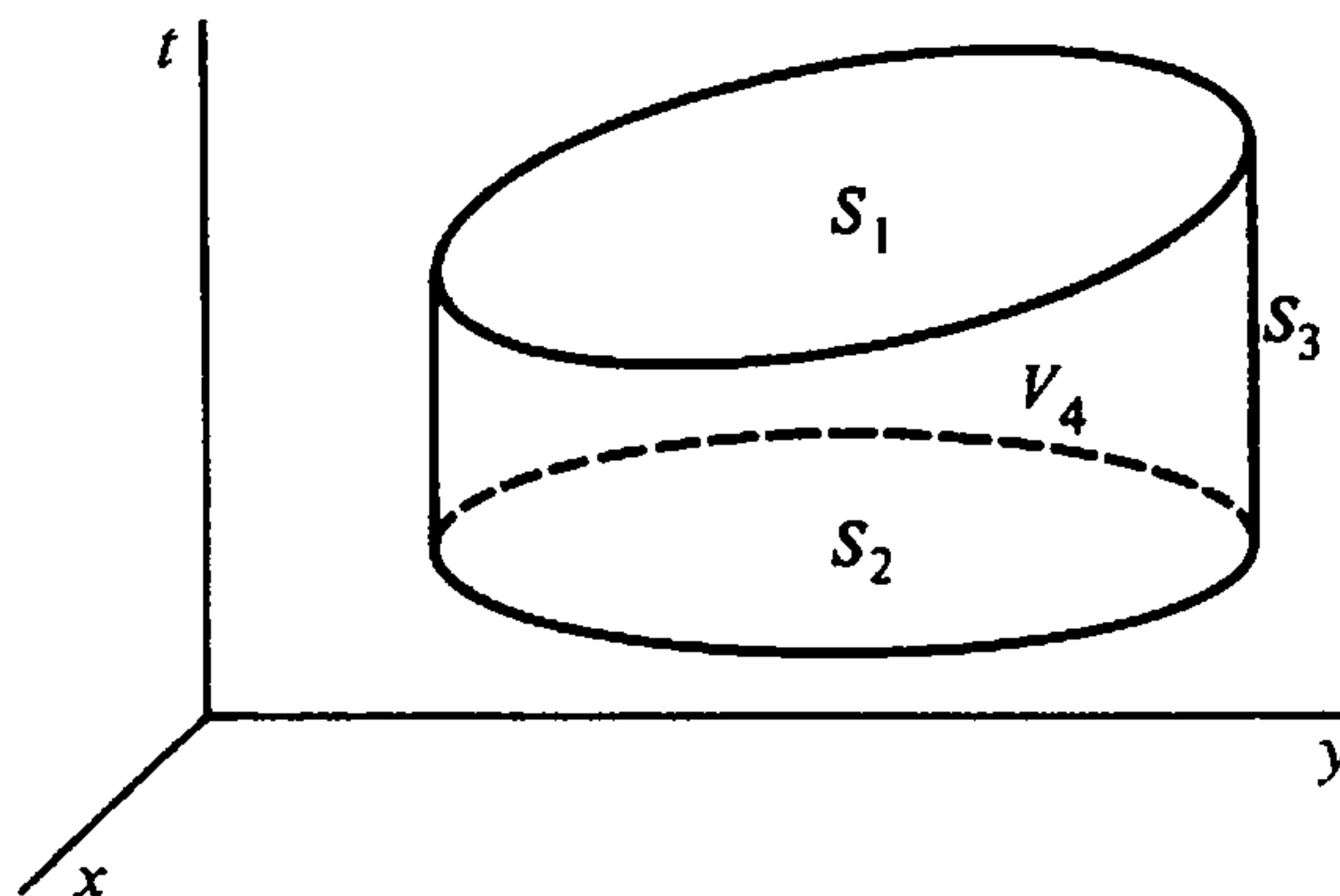

FIGURE 13.5 Schematic integration volume in 4-space

The 4-vector transformation property of the left-hand side is obvious; hence, the right-hand side, i.e., R^μ according to Eq. (13.84), also transforms as a 4-vector. Further, if *both* S_1 and S_2 are surfaces at constant t , say t_1 and t_2 , respectively, then Eq. (13.88) is equivalent to

$$R^\mu(t_1) = R^\mu(t_2), \quad (13.90)$$

which is thus the covariant way proving that R^μ is conserved in time.

With some care, therefore, the conserved integral quantities can still be used within the framework of a relativistic theory of classical fields. We shall not always carry through the detailed correspondence but will let it suffice in most instances that the volume integration refers to a particular Lorentz frame in which the spacelike hypersurface is a region in three-space at constant t . For the angular momentum density, note that the covariant analog of \mathcal{M}^{ij} , Eq. (13.44), is a 4-tensor of third rank:

$$\mathcal{M}^{\mu\nu\lambda} = \frac{1}{c}(x^\mu T^{\nu\lambda} - x^\nu T^{\mu\lambda}), \quad (13.91)$$

which is antisymmetric in μ and ν . The corresponding global or integral quantity is

$$M^{\mu\nu} = \int \mathcal{M}^{\mu\nu\lambda} dS_\lambda, \quad (13.92)$$

where the integration is over a spacelike hypersurface. If the Lorentz frame is chosen such that the surface is one at constant t , then

$$M^{\mu\nu} \rightarrow \int \mathcal{M}^{\mu\nu 0} dV, \quad (13.93)$$

which corresponds to the previous definition. The rest of the argument on the conservation of M^{ij} for symmetrical stress-energy tensors then can be carried out as before by considering this particular Lorentz frame. All of this follows from Chapter 7.

As constructed in the previous section, the Hamiltonian formulation sharply distinguishes between the time coordinate and the space coordinates. This is not to say that it is necessarily nonrelativistic, merely that the formulation is not manifestly covariant. We must imagine the Hamiltonian framework as constructed in terms of the time as seen by each particular observer. Providing the field quantities and derived functions have suitable transformation properties, this construction for each Lorentz frame is not in violation of special relativity.

One further point needs to be made here. By allowing η_ρ to stand for a set of covariant field quantities, we allow for the possibility that the system consists of two or more fields that interact with each other. The complete Lagrangian density may consist of a sum of Lagrangian densities representing the free fields plus terms that describe the interactions between the fields. It will be remembered that

one of the difficulties of relativistic point mechanics was the problem of considering interactions between particles that necessarily implied action-at-a-distance. However, interactions between fields can be at a point and, therefore, consistent with special relativity. We can often go further and treat the interaction between a field and a particle at a given point in spacetime. There is thus the possibility of considering relativistically a system consisting of a continuous field, a discrete particle, and the interaction between them. How this can be done in a specific case will be shown in the next section, which provides illustrations of relativistic field theories.

13.6 ■ EXAMPLES OF RELATIVISTIC FIELD THEORIES

We shall consider three examples, of increasing complexity.

A. Complex scalar field. Any complex field will be described by two independent parts, which can be expressed either as the real and imaginary part of the field or as the complex field itself and its complex conjugate. We shall follow the latter alternative. Accordingly, the Lagrangian density and associated functions will here be given in terms of two independent field variables, ϕ and ϕ^* , each of which are 4-scalars.* For this particular example, we choose the Lagrangian density

$$\mathcal{L} = c^2 \phi_{,\lambda} \phi^{*,\lambda} - \mu_0^2 c^2 \phi \phi^* \quad (13.94)$$

where μ_0 is a constant and $\phi_{,\lambda} = \frac{\partial \phi}{\partial x^\lambda}$, $\phi^{,\lambda} = g^{\lambda\nu} \frac{\partial \phi}{\partial x^\nu}$ as given in Eq. (13.17). Notice, that as required, \mathcal{L} is a world scalar. Expressed in terms of space and time variables, \mathcal{L} is written as (where $\dot{\phi} = \partial \phi / \partial t$)

$$\mathcal{L} = \dot{\phi} \dot{\phi}^* - c^2 \nabla \phi \cdot \nabla \phi^* - \mu_0^2 c^2 \phi \phi^*. \quad (13.95)$$

To obtain the field equation for which $\eta_\rho = \phi^*$, note that

$$\frac{\partial \mathcal{L}}{\partial \phi^{*,\nu}} = c^2 \phi_{,\nu}, \quad \frac{\partial \mathcal{L}}{\partial \phi^*} = -\mu_0^2 c^2 \phi. \quad (13.96)$$

Hence, the Lagrange-Euler field equation is

$$\phi_{,\nu}{}^\nu + \mu_0^2 \phi = 0, \quad (13.97)$$

or, in equivalent form,

$$\sum_\nu \frac{d^2 \phi}{(dx^\nu)^2} + \mu_0^2 \phi = 0 \quad (13.98)$$

*As shall be seen in the next section, complex fields lead naturally to an associated charge and current density, and this is the main reason for their introduction in physical theories.

and

$$-\nabla^2\phi + \frac{1}{c^2}\frac{d^2\phi}{dt^2} + \mu_0^2\phi = 0. \quad (13.97')$$

In terms of the D'Alembertian (cf. Section 7.5), the field equation can also be written covariantly as

$$(\square^2 + \mu_0^2)\phi = (\nabla^2 + \mu_0^2)\phi = 0. \quad (13.99)$$

Similarly, from the symmetry of \mathcal{L} , the field equation obtained when $\eta_\rho = \phi^*$ is

$$(\square^2 + \mu_0^2)\phi^* = (\nabla^2 + \mu_0^2)\phi^* = 0. \quad (13.100)$$

This basic field equation satisfied by both ϕ and ϕ^* is known as the Klein–Gordon equation and, as given here, represents the relativistic analog of the Schrödinger equation for a charged zero-spin particle of rest mass energy μ_0 .

The stress-energy tensor defined by Eq. (13.30) has components

$$T_{\mu\nu} = c^2\phi_{,\mu}\phi^*_{,\nu} + c^2\phi^*_{,\mu}\phi_{,\nu} + c^2(\phi_{,\lambda}\phi^*_{,\lambda} + \mu_0^2\phi\phi^*)g_{\mu\nu} \quad (13.101)$$

and is clearly symmetrical. As the Lagrangian density describes a free field, without interactions with the outside world, \mathcal{L} does not contain x explicitly and the conservation theorem (13.29) holds for $T_{\mu\nu}$, as can be verified directly. To introduce the Hamiltonian formulation, we must distinguish between the time and space coordinates in some particular Lorentz frame. The conjugate momenta, according to Eq. (13.54), are then (cf. Eq. (13.95))

$$\pi = \frac{\partial\mathcal{L}}{\partial\dot{\phi}} = \dot{\phi}^*, \quad \pi^* = \frac{\partial\mathcal{L}}{\partial\dot{\phi}^*} = \dot{\phi}. \quad (13.102)$$

It follows that the Hamiltonian density (which has the same magnitude as T_{00}) takes the form

$$\begin{aligned} \mathcal{H} &\equiv \pi\dot{\phi} + \pi^*\dot{\phi}^* - \mathcal{L}, \\ &= \pi\pi^* + c^2\nabla\phi \cdot \nabla\phi^* + \mu_0^2c^2\phi\phi^*. \end{aligned} \quad (13.103)$$

For the moment, all that we shall do here is illustrate the transformation to the momentum representation. The expansions (13.67) and (13.70) can be introduced into the Hamiltonian density. Since the field is not real, we do *not* have that $q_k^* = q_{-k}$. In effect, q_k and q_k^* now stand for two independent sets of discrete coordinates, one representing ϕ and the other ϕ^* . The total Hamiltonian is a sum of volume integrals over the three terms in Eq. (13.103). As a typical example, let us consider

$$\mu_0^2 \int \phi\phi^* dV = \frac{\mu_0^2}{V} \sum_{k,k'} \int q_k q_{k'}^* e^{i(\mathbf{k}-\mathbf{k}')\cdot\mathbf{r}} dV, \quad (13.104)$$

which by Eq. (13.68) reduces to

$$\mu_0^2 q_k q_k^*.$$

The only other term requiring any special note at all is that involving the divergences, which introduce a factor $(i\mathbf{k}) \cdot (-i\mathbf{k}')$ in the integrand. The final form for H can be written as

$$H = p_k p_k^* + \omega_k^2 q_k q_k^*, \quad (13.105)$$

where ω_k is related to k through the dispersion relation

$$\omega_k^2 = c^2(k^2 + \mu_0^2). \quad (13.106)$$

Each term of the summation in Eq. (13.105) is in the form of a harmonic oscillator of unit mass with frequency ω_k . This can be seen explicitly by evaluating Hamilton's equations of motion. In the momentum or plane wave representations, the fields ϕ and ϕ^* are thus replaced by discrete systems of harmonic oscillators, much in the same manner that the sound field in a solid is looked on as a collection of "phonons." The discrete spectrum of "vibrations" of our scalar charged field is given by Eq. (13.106). Quantization of the field (that is, the so-called second quantization) is done most simply via the momentum representation. In effect, the motion of each harmonic oscillator is quantized as would be done for an actual harmonic oscillator. But this subject certainly lies outside our province.

B. The Sine–Gordon equation and associated field. If the scalar field in the previous example were taken as real (that is, $\phi^* = \phi$) and to exist in only one spatial dimension, then the obvious corresponding Lagrangian density along the model of Eq. (13.95) would be

$$\mathcal{L} = \frac{c^2}{2} \left[\frac{\dot{\phi}^2}{c^2} - \left(\frac{\partial \phi}{\partial x} \right)^2 - \mu_0^2 \phi^2 \right]. \quad (13.107)$$

(The factor of $\frac{1}{2}$ is introduced for convenience; it clearly does not affect the form of the equations of motion.) The associated field equation (cf. Eq. (13.16))

$$\frac{\partial^2 \phi}{\partial x^2} - \frac{1}{c^2} \frac{\partial^2 \phi}{\partial t^2} = \mu_0^2 \phi, \quad (13.108)$$

is the one-dimensional Klein–Gordon equation. Note that it is linear in the field $\phi(x, t)$.

We can look upon the Lagrangian density of Eq. (13.107) as a small-field approximation to a Lagrangian density of the form

$$\mathcal{L} = \frac{c^2}{2} \left[\frac{\dot{\phi}^2}{c^2} - \left(\frac{\partial \phi}{\partial x} \right)^2 \right] - \mu_0^2 c^2 (1 - \cos \phi), \quad (13.109)$$

which has the corresponding field equation

$$\frac{\partial^2 \phi}{\partial x^2} - \frac{1}{c^2} \frac{\partial^2 \phi}{\partial t^2} = \mu_0^2 \sin \phi. \quad (13.110)$$

Inevitably, if perhaps frivolously, Eq. (13.110) has come to be known as the sine-Gordon equation. If the Klein-Gordon equation, Eq. (13.99), is reminiscent of the harmonic oscillator, then the “potential” term in the Lagrangian equation (13.109) recalls the potential term of the linear pendulum. Indeed, Eq. (13.110) has also been called, perhaps more appropriately, the pendulum equation.

In this one-dimensional world, the stress-energy tensor has only four components. As x and t again do not appear explicitly in \mathcal{L} , the elements of the tensor satisfy conservation equations, which are here two in number. Details will be left to the exercises, but of particular interest is the energy density T_{00} :

$$T_{00} = \frac{1}{2} \left[\dot{\phi}^2 + c^2 \left(\frac{\partial \phi}{\partial x} \right)^2 \right] + \mu_0^2 c^2 (1 - \cos \phi), \quad (13.111)$$

which is of course the same in magnitude as the Hamiltonian density

$$\mathcal{H} = \frac{1}{2} \left[\pi^2 + c^2 \left(\frac{\partial \phi}{\partial x} \right)^2 \right] + \mu_0^2 c^2 (1 - \cos \phi), \quad (13.112)$$

where the conjugate momentum is

$$\pi(x, t) = \dot{\phi}. \quad (13.113)$$

The momentum representation for the Klein-Gordon field as the sum over harmonic oscillators means that in the one-dimensional case the field can be built up as a superposition of plane waves of the form

$$q_k(t) e^{ikr} = A_0(k) e^{i(kr - \omega_k t)}, \quad (13.114)$$

where k and ω_k are related by the *dispersion relation*, Eq. (13.106). For the field obeying the sine-Gordon equation, it is much more difficult to apply a momentum representation, because of the presence of the $\cos \phi$ term in \mathcal{H} . But we can still solve the sine-Gordon equation by something resembling a traveling wave. A solution for ϕ in Eq. (13.110) that has the form of a disturbance traveling with a speed v , but otherwise keeping its shape, must be a function only of $\tau = t - x/v$. In that case, Eq. (13.110) reduces to

$$\frac{d^2 \phi}{d\tau^2} - A \sin \phi = 0, \quad (13.115)$$

where

$$A = \frac{\mu_0^2 c^2 v^2}{c^2 - v^2}. \quad (13.116)$$

In terms of the variable τ , the equation of motion is indeed that for a simple pendulum of finite amplitude. For very small amplitude, we know that ϕ is a simple harmonic motion in τ with ω given by Eq. (13.106) for a wave number $k = \omega/v$, independent of the amplitude. With finite amplitude, we also know from our study of the pendulum, that while ϕ will still be periodic, the frequency ω will also depend upon the amplitude. That is to say, the dispersion relation will be amplitude dependent. This is a characteristic of course of nonlinear equations, of which the sine-Gordon equation is one example. The Klein-Gordon equation is linear, but the dispersion equation, Eq. (13.106), is said to be nonlinear; that is, ω_k is not a linear function of k . It becomes linear only when $\mu_0 \rightarrow 0$, reducing the Klein-Gordon equation the usual linear wave equation.

We can thus describe the sine-Gordon equation as being nonlinear, with a nonlinear amplitude-dependent dispersion relation. Further examination reveals that it can have solutions with properties shared by only a few other nonlinear equations. These solutions are traveling wave disturbances that can interact with each other—pass through each other—and emerge with unchanged shape except perhaps for a phase shift. Such solutions are also found, for example, for the nonlinear Korteweg-deVries equation,

$$\frac{\partial \phi}{\partial t} + \alpha \phi \frac{\partial \phi}{\partial x} + \nu \frac{\partial^3 \phi}{\partial x^3} = 0, \quad (13.117)$$

where α and ν are constants. These solitary waves that preserve their shape even through interactions have been termed “solitons” and have found many applications throughout physics, from elementary particles through solid-state physics. The pendulum sine-Gordon equation, for example, has been used to describe families of elementary particles, and it also shows up in connection with the theory of the Josephson junction.

*C. The Electromagnetic Field.** The formalism and field equations for the electromagnetic field were developed in Section 7.5. It remains to express these ideas in terms of the Lagrangian formalism. If the components A^μ of the electromagnetic potential are treated as the field quantities, then a suitable Lagrangian density for the electromagnetic field is

$$\mathcal{L} = -\frac{F_{\lambda\rho}F^{\lambda\rho}}{4} + j_\lambda A^\lambda. \quad (13.118)$$

To obtain the Euler-Lagrange equations, we note that

$$\frac{\partial \mathcal{L}}{\partial A^\mu} = j_\mu; \quad \frac{\partial \mathcal{L}}{\partial A_{\mu,\nu}} = -\frac{F_{\lambda\rho}}{2} \frac{\partial F^{\lambda\rho}}{\partial A_{\mu,\nu}}$$

*Part of the difficulty in handling the electromagnetic field arises from the fact that the components A^μ are not entirely independent; to be unique, they must be connected through some gauge condition, such as Eq. (7.66). However, it will be sufficient for our present purposes if we treat the gauge condition as a “weak” constraint.

Now, from the defining equations (7.71), the derivative of $F_{\lambda\rho}$ vanishes except when $\lambda = \mu, \rho = \nu$ and $\lambda = \nu, \rho = \mu$. Hence,

$$\frac{\partial \mathcal{L}}{\partial A_{\mu,\nu}} = \frac{F_{\mu\nu}}{2} - \frac{F_{\nu\mu}}{2} = F_{\mu\nu}, \quad (13.119)$$

and the Euler–Lagrange equations are

$$\frac{dF^{\mu\nu}}{dx^\nu} - \sqrt{\frac{\mu_0}{\epsilon_0}} j^\mu = 0. \quad (13.120)$$

Finally, it has already been noted that \mathcal{L} for an electromagnetic field consists of a free-field Lagrangian density plus a term describing the interaction of a continuous charge and current density with the field. It is tempting to see how far we can go toward introducing field–particle interactions, by localizing the charge to a point. This is most easily done by considering the physical situation in some particular Lorentz frame, that is, as seen by a particular observer. Manifest covariance is thereby abandoned, but the result still conforms to special relativity, as it derives from a clearly relativistic theory. The current density is a measure of the motion of the charges, and in any given system \mathbf{j} is defined in terms of the charge density ρ by the relation

$$\mathbf{j}(\mathbf{r}, t) = \rho(\mathbf{r}, t)\mathbf{v}(\mathbf{r}, t).$$

Here \mathbf{v} is the velocity “field” of the continuous charge distribution. The localization can be carried out through the use of the well-known Dirac δ -function. In three-dimensional form, the δ -function has the property that if $f(\mathbf{r})$ is any function of space, then

$$\int dV f(\mathbf{r})\delta(\mathbf{r} - \mathbf{s}(t)) = f(\mathbf{s}), \quad (13.121)$$

where $\mathbf{s}(t)$ is the spatial position, say, of a particle at time t (so long as \mathbf{s} is inside the volume of integration). Thus, the spatial charge and current density corresponding to a particle of charge q at point \mathbf{s} is

$$\rho = q\delta(\mathbf{r} - \mathbf{s}) \quad (13.122)$$

and

$$\mathbf{j} = q\delta(\mathbf{r} - \mathbf{s})\mathbf{v}(\mathbf{r}). \quad (13.123)$$

If we write \mathcal{L} of Eq. (13.118) as the sum of a free-field term \mathcal{L}_0 and an interaction term, the Lagrangian as seen in the given Lorentz frame is

$$L = \int dV \mathcal{L}_0 - \int dV \rho \phi + \int dV \mathbf{A} \cdot \mathbf{j} = \int dV \mathcal{L}_0 - q\phi + q\mathbf{A} \cdot \mathbf{v}. \quad (13.124)$$

The interaction terms in Eq. (13.124) are exactly the same as those in Eq. (7.141) for the Lagrangian of a single particle in an electromagnetic field. This suggests that a single Lagrangian can be formed for the complete system of particle and field that, analogous to Eq. (7.141), would look like

$$L = -mc^2\sqrt{1 - \beta^2} - q\phi + q\mathbf{v} \cdot \mathbf{A} + \int dV \mathcal{L}_0. \quad (13.125)$$

Considered as a function of the field tensor or potentials, this Lagrangian implies the field equations; considered as a function of the particle coordinates, L leads to the particle equations of motion. The mechanical descriptions of the continuous field and the discrete particle have in effect been put under one wing, expressed in a common formalism!

An important branch of modern physics is concerned with the construction of fields to represent various types of elementary particles. Of course, all such theories are quantum-mechanical, but many features of quantum field theories will have concomitant or nearly corresponding classical analogs. There is little a priori physical guidance in the construction of possible Lagrangian densities and interaction terms for the various particles. Some constraint on the form of these functions comes from covariance limitations. For example, the terms in \mathcal{L} must be combinations of field and other quantities in such a manner as to produce a 4-scalar. Usually, \mathcal{L} is also restricted to the field quantities or their first derivatives, although Lagrangian densities with higher derivatives have also been explored. Additional requirements on the form of the terms are also provided, or suggested, by conservation and invariance properties, implicit in the Lagrangians. These properties go beyond the conservation conditions contained in the stress-energy tensor and are usually to be found by the application of a powerful procedure known as Noether's theorem, which forms the subject of the next and last section.

13.7 ■ NOETHER'S THEOREM

A recurring theme throughout this text has been that symmetry properties of the Lagrangian (or Hamiltonian) imply the existence of conserved quantities. Thus, if the Lagrangian does not contain explicitly a particular coordinate of displacement, then the corresponding canonical momentum is conserved. The absence of explicit dependence on the coordinate means the Lagrangian is unaffected by a transformation that alters the value of that coordinate; it is said to be invariant, or symmetric, under the given transformation. Similarly, invariance of the Lagrangian under time displacement implies conservation of energy. The formal description of the connection between invariance or symmetry properties and conserved quantities is contained in Noether's theorem. It is in the 4-space of classical field theory that the theorem attains its most sophisticated and fertile form. For that reason, explicit discussion of the theorem has been reserved for the treatment of fields, although a discrete-system version can also be derived.

Symmetry under coordinate transformation refers to the effects of an infinitesimal transformation of the form

$$x^\mu \rightarrow x'^\mu = x^\mu + \delta x^\mu, \quad (13.126)$$

where the infinitesimal change δx^μ may be a function of all the other x^ν . Noether's theorem also considers the effect of a transformation in the field quantities themselves, which may be described by

$$\eta_\rho(x^\mu) \rightarrow \eta'_\rho(x'^\mu) = \eta_\rho(x^\mu) + \delta\eta_\rho(x^\mu). \quad (13.127)$$

Here $\delta\eta_\rho(x^\mu)$ measures the effect of both the changes in x^μ and in η_ρ and may be a function of all the other field quantities η_λ . Note that the change in one of the field variables at a particular point in x^μ space is a different quantity $\bar{\delta}\eta_\rho$:

$$\eta'_\rho(x^\mu) = \eta_\rho(x^\mu) + \bar{\delta}\eta_\rho(x^\mu). \quad (13.128)$$

The description of the transformations in terms of infinitesimal changes from the untransformed quantities indicates we are dealing only with *continuous* transformations. Thus, symmetry under inversion in three dimensions (parity symmetry) is not one of the symmetries for which Noether's theorem can be applied. As a consequence of the transformations of both the coordinates and the field quantities the Lagrangian appears, in general, as a different function of both the field variables and the spacetime coordinates:

$$\mathcal{L}(\eta_\rho(x^\mu), \eta_{\rho,\nu}(x^\mu), x^\mu) \rightarrow \mathcal{L}'(\eta'_\mu(x'^\mu), \eta'_{\rho,\nu}(x'^\mu), x'^\mu). \quad (13.129)$$

The version of Noether's theorem that we shall present here is not the most general form possible, but is such as to facilitate the derivation without significantly restricting the scope of the theorem or the usefulness of the conclusions. Three conditions will be assumed to hold. The first two are

1. The 4-space is flat; that is, either it is Euclidean, or in the form of Eq. (7.171), $R^\alpha{}_{\beta\gamma\sigma} = 0$.
2. The Lagrangian density displays the same functional form in terms of the transformed quantities as it does of the original quantities, that is,

$$\mathcal{L}'(\eta'_\rho(x'^\mu), \eta'_{\rho,\nu}(x'^\mu), x'^\mu) = \mathcal{L}(\eta'_\rho(x'^\mu), \eta'_{\rho,\nu}(x'^\mu), x'^\mu). \quad (13.130)$$

This type of condition has not previously entered our discussions of conserved quantities, mainly because it has been automatically satisfied under the transformations considered. When cyclic coordinates are transformed by displacement, the functional dependence of the Lagrangian on the variables is unaltered by the implied shift in origin. But in our present extended types of transformation, it becomes a symmetry property that needs study. Thus, the *free-field* version of the Lagrangian density for the electromagnetic field,

Eq. (13.118), retains its functional form when A^μ is subject to a gauge transformation, while other forms may not. Note also that Eq. (13.130) ensures that the equations of motion have the same form whether expressed in terms of the old or the new variables (form invariance). The condition of form-invariance is not the most general circumstance under which this is true; the original and transformed Lagrangian densities may also differ by a 4-divergence without modifying the equations of motion. Indeed, it is possible to carry out the derivation of Noether's theorem with such an extended version of form-invariance because the volume integral of the 4-divergence term vanishes. But for simplicity we shall restrict ourselves to Eq. (13.130). The third condition is

3. The magnitude of the action integral is invariant under the transformation, that is to say, (cf. Hamilton's principle Eq. (2.1))

$$\begin{aligned} I' &= \int_{\Omega'} (dx'^4) \mathcal{L}'(\eta'_\rho(x'^\mu), \eta'_{\rho,\nu}(x'^\mu), x'^\mu) \\ &= \int_{\Omega} (dx^4) \mathcal{L}(\eta_\rho(x^\mu), \eta_{\rho,\nu}(x^\mu), x^\mu), \end{aligned} \quad (13.131)$$

where dx^4 is the invariant volume element is equal to $\sqrt{|g|} dx^0 dx^1 dx^2 dx^3$ and $\sqrt{|g|} = \sqrt{|\det(g)|}$ is the square root absolute value of the determinant of g .

Again, Eq. (13.131) represents an extension of, and includes, our previous symmetry properties such as cyclic coordinates. The Lagrangian does not change numerically under translation of a cyclic coordinate, nor does the value of the action integral. Equation (13.131) will be called the condition of *scale-invariance*. Our second and third conditions thus represent generalizations of the symmetry or invariance conditions that led to the existence of conserved quantities for discrete systems.

Combining Eqs. (13.130) and (13.131) gives the requirement

$$\int_{\Omega'} \mathcal{L}(\eta'_\rho(x'^\mu), \eta'_{\rho,\nu}(x'^\mu), x'^\mu) dx'^4 - \int_{\Omega} \mathcal{L}(\eta_\rho(x^\mu), \eta_{\rho,\nu}(x^\mu), x^\mu) dx^4 = 0. \quad (13.132)$$

In the first integral, x'^μ now represents merely a dummy variable of integration and can therefore be relabeled x^μ . But of course there remains a change in the domain of integration, so the condition becomes

$$\int_{\Omega'} \mathcal{L}(\eta'_\rho(x^\mu), \eta'_{\rho,\nu}(x^\mu), x^\mu) dx^4 - \int_{\Omega} \mathcal{L}(\eta_\rho(x^\mu), \eta_{\rho,\nu}(x^\mu), x^\mu) dx^4 = 0. \quad (13.133)$$

The sequence of transformations of space and of integration region is illustrated in Fig. 13.6 for a space of two dimensions. Equation (13.133) says that if in the action integral over (x^μ) space we replace the original field variables by the

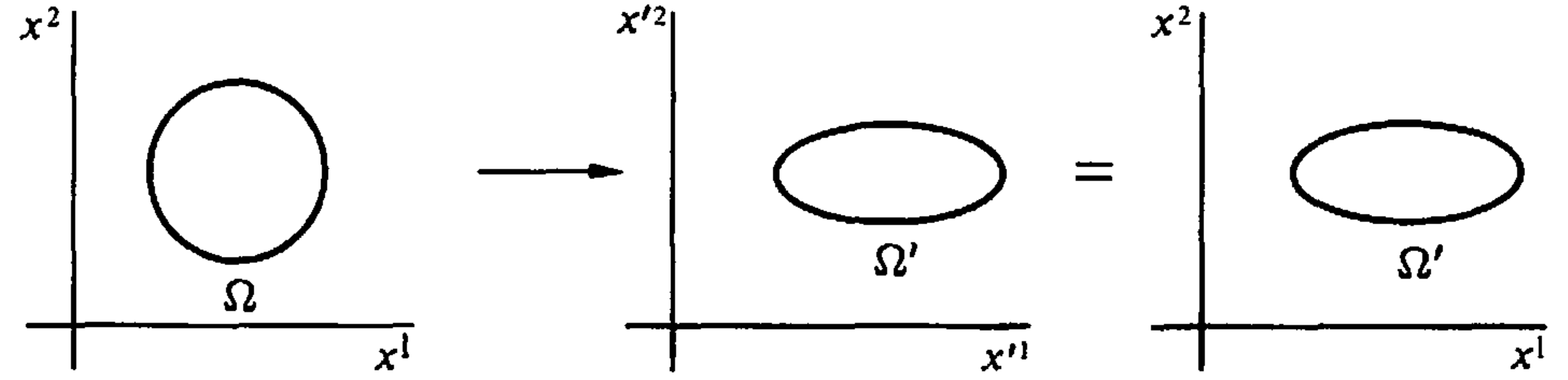

FIGURE 13.6 Schematic illustration of the transformation of the invariant action integral.

transformed quantities, and transform the region of integration, then the action integral remains unaltered.

Under the infinitesimal transformations of Eqs. (13.126) and (13.127), the first-order difference between the integrals in Eq. (13.133) thus consists of two parts, one being an integral over Ω and the other an integral over the difference volume $\Omega' - \Omega$. An example in one-dimension will show how the terms are to be formed. Consider the difference of two integrals:

$$\begin{aligned} \int_{a+\delta a}^{b+\delta b} (f(x) + \delta f(x)) dx - \int_a^b f(x) dx &= \int_a^b \delta f(x) dx \\ &+ \int_b^{b+\delta b} (f(x) + \delta f(x)) dx \\ &- \int_a^{a+\delta a} (f(x) + \delta f(x)) dx. \end{aligned} \quad (13.134)$$

To first order in small quantities, the last two terms on the right can be written as

$$\int_b^{b+\delta b} f(x) dx - \int_a^{a+\delta a} f(x) dx = \delta b f(b) - \delta a f(a).$$

To this approximation, Eq. (13.134) becomes

$$\int_{a+\delta a}^{b+\delta b} (f(x) + \delta f(x)) dx - \int_a^b f(x) dx = \int_a^b \delta f(x) dx + f(x) \delta x \Big|_a^b, \quad (13.135)$$

or

$$= \int_a^b \left[\delta f(x) + \frac{d}{dx} (\delta x f(x)) \right] dx. \quad (13.136)$$

The multidimensional analog of Eq. (13.135) then says that the invariance condition of Eq. (13.133) takes the form

$$\int_{\Omega'} \mathcal{L}(\eta', x'^{\mu}) dx'^4 - \int_{\Omega} \mathcal{L}(\eta, x^{\mu}) dx^4 = \int_{\Omega} [\mathcal{L}(\eta', x^{\mu}) - \mathcal{L}(\eta, x^{\mu})] dx^4 + \int_S \mathcal{L}(\eta) \delta x^{\mu} dS_{\mu} = 0. \quad (13.137)$$

Here, $\mathcal{L}(\eta, x^{\mu})$ is shorthand for the full functional dependence, S is the three-dimensional surface of the region Ω (corresponding to the end points a and b in the one-dimensional case), and δx^{μ} is in effect the difference vector between points on S and corresponding points on the transformed surface S' (cf. Fig. 13.7). Corresponding to Eq. (13.136), the last integral can be transformed by the four-dimensional divergence theorem, so for the invariance condition we have

$$0 = \int_{\Omega} dx^4 \left\{ [\mathcal{L}(\eta', x^{\mu}) - \mathcal{L}(\eta, x^{\mu})] + \frac{d}{dx} (\mathcal{L}(\eta, x) \delta x^{\nu}) \right\}. \quad (13.138)$$

Now, by Eq. (13.128), the difference term in the square brackets can be written to first order as

$$\mathcal{L}(\eta'_{\rho}(x^{\mu}), \eta'_{\rho, \nu}(x^{\mu}), x^{\mu}) - \mathcal{L}(\eta(x^{\mu}), \eta_{\rho, \nu}(x^{\mu}), x^{\mu}) = \frac{\partial \mathcal{L}}{\partial \eta_{\rho}} \Big|_{\bar{\delta} \eta_{\rho}} + \frac{\partial \mathcal{L}}{\partial \eta_{\rho, \nu}} \Big|_{\bar{\delta} \eta_{\rho, \nu}}. \quad (13.139)$$

The important property of the $\bar{\delta}$ change is that it is a change of η at a fixed point in x^{μ} space (unlike the δ variation, Eq. (13.127)). Hence, it commutes with the spatial differentiation operator; that is, the order of the quantities

$$\bar{\delta} \quad \text{and} \quad \frac{d}{dx^{\nu}}$$

can be interchanged. Symbolically,

$$\mathcal{L}(\eta', x^{\mu}) - \mathcal{L}(\eta, x^{\mu}) = \frac{\partial \mathcal{L}}{\partial \eta_{\rho}} \bar{\delta} \eta_{\rho} + \frac{\partial \mathcal{L}}{\partial \eta_{\rho, \nu}} \frac{d \bar{\delta} \eta_{\rho}}{dx^{\mu}}, \quad (13.140)$$

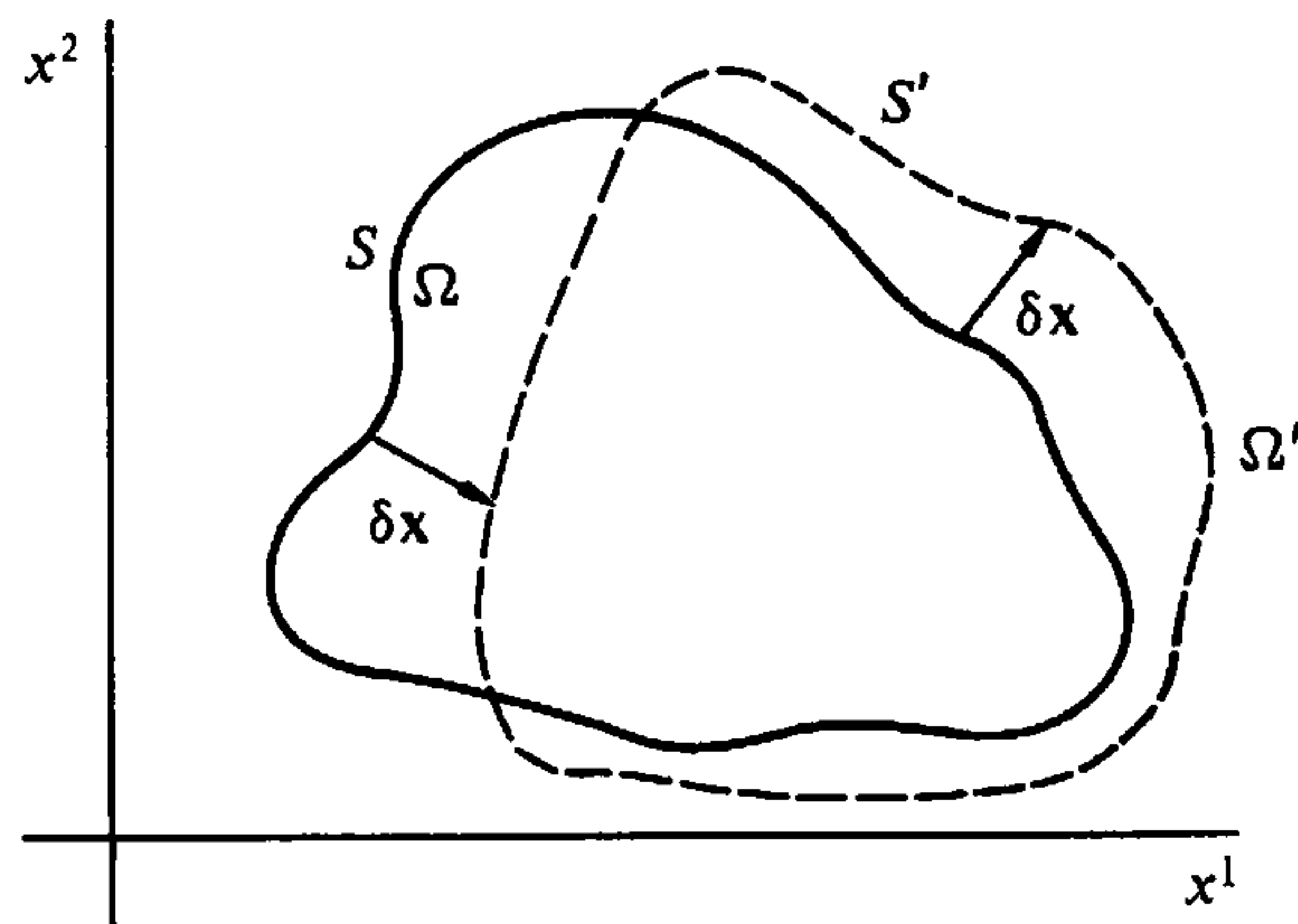

FIGURE 13.7 The integration regions in two dimensions involved in the transformation of the action integral.

or, using the Lagrange field equations,

$$\mathcal{L}(\eta', x^\mu) - \mathcal{L}(\eta, x^\mu) = \frac{d}{dx^\nu} \left(\frac{\partial \mathcal{L}}{\partial \eta_{\rho, \nu}} \bar{\delta} \eta_\rho \right). \quad (13.141)$$

Hence, the invariance condition, Eq. (13.138), appears as

$$\int (dx^\mu) \frac{d}{dx^\nu} \left\{ \frac{\partial \mathcal{L}}{\partial \eta_{\rho, \nu}} \bar{\delta} \eta_\rho + \mathcal{L} \delta x^\nu \right\} = 0, \quad (13.142)$$

which is a conserved current equation (cf. arguments on pg. 571).

It is helpful however to develop the condition further by specifying the form of the infinitesimal transformation in terms of R infinitesimal parameters ϵ_r , $r = 1, 2, \dots, R$, such that the change in x^ν and η_ρ is linear in the ϵ_r :

$$\delta x^\nu = \epsilon_r X_r^\nu, \quad \delta \eta_\rho = \epsilon_r \Psi_{r\rho}. \quad (13.143)$$

The functions X_r^ν and $\Psi_{r\rho}$ may depend upon the other coordinates and field variables, respectively. If the transformation symmetry relates to the coordinates only, and corresponds to a displacement of a single coordinate x^ν , then these functions are simply

$$X_r^\nu = \delta_r^\nu, \quad \Psi_{r\rho} = 0. \quad (13.144)$$

Thus, the transformations contained in the form of Eq. (13.143) constitute a far more extensive test for symmetries than we have used thus far. From Eqs. (13.127) and (13.128), it follows that to first order $\delta \eta$ and $\bar{\delta} \eta$ are related by

$$\delta \eta_\rho = \bar{\delta} \eta_\rho + \frac{\partial \eta_\rho}{\partial x^\sigma} \delta x^\sigma. \quad (13.145)$$

Hence,

$$\bar{\delta} \eta_\rho = \epsilon_r (\Psi_{r\rho} - \eta_{\rho, \sigma} X_r^\sigma). \quad (13.146)$$

Substituting Eqs. (13.143) and (13.146) in the invariance condition, Eq. (13.128), we have

$$\int \epsilon_r \frac{d}{dx^\nu} \left[\left(\frac{\partial \mathcal{L}}{\partial \eta_{\rho, \nu}} \eta_{\rho, \sigma} - \mathcal{L} \delta_\sigma^\nu \right) X_r^\sigma - \frac{\partial \mathcal{L}}{\partial \eta_{\rho, \nu}} \Psi_{r\rho} \right] dx^4 = 0. \quad (13.147)$$

Since the ϵ_r parameters are arbitrary, there exist in analogy with Eq. (13.142), r conserved currents with differential conservation theorems: (integral of divergence = 0)

$$\frac{d}{dx^\nu} \left\{ \left(\frac{\partial \mathcal{L}}{\partial \eta_{\rho, \nu}} \eta_{\rho, \sigma} - \mathcal{L} \delta_\sigma^\nu \right) X_r^\sigma - \frac{\partial \mathcal{L}}{\partial \eta_{\rho, \nu}} \Psi_{r\rho} \right\} = 0. \quad (13.148)$$

Equations (13.148) form the main conclusion of Noether's theorem, which thus says that if the system (or the Lagrangian density) has symmetry properties such that conditions (2) and (3) above hold for transformations of the type of Eqs. (13.143), then there exist r conserved quantities.

The conservation of the stress-energy tensor is easily recovered as a special case of Eq. (13.142). If \mathcal{L} does not contain any of the x^μ , then it, and therefore the action integral, will be invariant under transformations such as Eq. (13.144), where λ takes on all the values μ . Equation (13.148) then reduces to

$$\frac{d}{dx^\nu} \left[\left(\frac{\partial \mathcal{L}}{\partial \eta_{\rho,\sigma}} \eta_{\rho,\sigma} - \mathcal{L} \delta_\sigma^\nu \right) \delta_\mu^\sigma \right] = \frac{d}{dx^\nu} \left(\frac{\partial \mathcal{L}}{\partial \eta_{\rho,\nu}} \eta_{\rho,\mu} - \mathcal{L} \delta_\mu^\nu \right), \quad (13.149)$$

which is identical with Eqs. (13.29) with $T_{\mu\nu}$ given by Eq. (13.30).

A large number of other symmetries are covered by transformations of the form of Eq. (13.142). One of the most interesting is a family of transformations of the field variables only, called *gauge transformations of the first kind*,* such that

$$\delta x = 0, \quad \delta \eta_\rho = \epsilon c_\rho \eta_\rho \quad (\text{no summation on } \rho), \quad (13.150)$$

where the c_ρ are constants. If the Lagrangian density, and therefore the action integral, is invariant under this transformation, then there is a conservation equation of the form

$$\frac{d\Theta^\nu}{dx^\nu} = 0, \quad (13.151)$$

where

$$\Theta^\nu = c_\rho \frac{\partial \mathcal{L}}{\partial \eta_{\rho,\nu}} \eta_\rho. \quad (13.152)$$

Equation (13.151) is in the form of an equation of continuity with Θ^ν in the role of a current density j^ν . Hence, invariance under a gauge transformation of the first kind leads to the identification of a conserved current that would be appropriate for an electric charge and current density to be associated with the field.

As an illustration, let us consider the first example of Section 13.6, the complex scalar field. A transformation of the type

$$\phi' = \phi e^{i\epsilon}, \quad \phi^{*'} = \phi^* e^{-i\epsilon} \quad (13.153)$$

corresponds in infinitesimal form to a gauge transformation of the first type, Eq. (13.150), with

$$c = i, \quad c^* = -i.$$

*The familiar gauge transformation of the electromagnetic field, which adds a 4-gradient $\Lambda_{,\mu}$ to A_μ , is part of a gauge transformation of the second kind and is not considered here.

It is obvious that the Lagrangian density of Eq. (13.94) is invariant under the transformation (13.153). Hence, there is an associated current density for the Klein–Gordon field that can be given as

$$j_\mu = iq \left(\frac{d\phi}{dx^\mu} \phi^* - \phi \frac{d\phi^*}{dx^\mu} \right), \quad (13.154)$$

which is in agreement with the conventional quantum-mechanical current density. Note that the entire derivation of the conserved charge current density depends upon the fact that the field is complex. Thus, as mentioned above, a real field does not lead to a charge or current density associated with the field. To describe fields associated with charged particles, we must use a pair of complex fields such as ϕ and ϕ^* for the (spin-less) Klein–Gordon particle.

Note that while Noether's theorem proves that a continuous symmetry property of the Lagrangian density leads to a conservation condition, the converse is not true. There appear to be conservation conditions that cannot correspond to any symmetry property. The most prominent examples at the moment are the fields that have soliton solutions, for example, are described by the sine–Gordon equation or the Korteweg–deVries equation.

Consider, for example, the Lagrangian density for the sine–Gordon equation, Eq. (13.107). As x and t do not appear explicitly, the Lagrangian density is invariant under translations of space and time in the manner fulfilling the conditions of Noether's theorem. In addition, there is a symmetry under a Lorentz transformation (in x, t space). No other symmetry is apparent. We would therefore expect no more than three conserved quantities from the application of Noether's theorem. Yet it has been demonstrated, by methods lying outside the Lagrangian description of fields, that there exists an infinite number of conserved quantities. That is to say, an infinite number of distinct functions F_i and G_i that are polynomials of ϕ , and derivatives can be found for which

$$\frac{dF_i}{dt} + \frac{dG_i}{dx} = 0, \quad (13.155)$$

so that the volume integrals of the F_i are constant in time. It appears that the presence of such an infinite set of conserved quantities is a necessary condition in order for the field to describe solitons.

Finally, we can easily deduce the version of Noether's theorem that should apply to discrete systems. Here the four coordinates of spacetime are no longer parametric variables on equal footing—the space coordinates revert to their status as mechanical variables (or functions thereof), and only time remains to fill the role of a parameter. The action integral, instead of being a four-dimensional volume integral,

$$I = \int \mathcal{L} dx^4,$$

is a one-dimensional integral in t as in Eq. (2.1) which is Hamilton's principle:

$$I = \int L dt.$$

Instead of the continuously indexed field variables $\eta_\rho(x^\nu)$, we have the discrete generalized coordinates $q_k(t)$. It is straightforward enough to recapitulate with these translations the steps that led to Noether's theorem. We could repeat in this manner the arguments contained in Eqs. (13.126) through (13.148) as applied to discrete systems. But the effect of the conversion is sufficiently obvious and clear, that we can readily see the translation need be done directly only on the final result, Eq. (13.148).

The rules for the translation can be summarized as

$$\begin{aligned} \mathcal{L} &\rightarrow L, \\ x^\mu \text{ or } x^\nu &\rightarrow t, \\ \eta_\rho &\rightarrow q_k, \\ \eta_{\rho,\nu} &\rightarrow \dot{q}_k. \end{aligned} \quad (13.156)$$

Further, all sums over 4-valued Greek indices reduce to one term, in t . As a result, the transformations, Eq. (13.143), under which the Lagrangian is to exhibit form and scale invariance become

$$\delta t = \epsilon_r X_r, \quad \delta q_k = \epsilon_r \Psi_{rk}. \quad (13.157)$$

Equation (13.148), the statement of the conservation theorems resulting from the invariance, now becomes

$$\frac{d}{dt} \left[\left(\frac{\partial L}{\partial \dot{q}_k} \dot{q}_k - L \right) X_r - \frac{\partial L}{\partial \dot{q}_k} \Psi_{rk} \right] = 0. \quad (13.158)$$

Equation (13.158) is the statement of the conclusions of Noether's theorem for a discrete mechanical system.

The expression in the parentheses in Eq. (13.158) is our old friend the Jacobi integral h of Eq. (2.53), or equivalently in terms of (q, p) , the Hamiltonian. Indeed, we can recover the conservation of h by considering a transformation that involves a displacement of time only:

$$X_r = \delta_{r1}, \quad \Psi_{rk} = 0. \quad (13.159)$$

If the Lagrangian is not an explicit function of time, then clearly the form of the Lagrangian and the value of the action integral are unaffected by this transformation. But Noether's theorem, Eq. (13.148), then says that as a result there is a conservation theorem

$$\frac{d}{dt} \left(\frac{\partial L}{\partial \dot{q}_k} \dot{q}_k - L \right) = 0,$$

which is identical with the familiar conclusion of Section 2.6.

Let us suppose further that a particular coordinate q_l is cyclic. Then the Lagrangian and the action are invariant under a transformation for which

$$X_r = 0, \quad \Psi_{rk} = \delta_{kl} \delta_{rl} \quad (13.160)$$

and Eq. (13.158) immediately implies the single conservation statement

$$\frac{d}{dt} \left(\frac{\partial L}{\partial \dot{q}_l} \right) = 0,$$

or

$$\dot{p}_l = 0.$$

so the canonical momentum is conserved. Thus, the theorems on the conservation both of Jacobi's integral and of the generalized momentum conjugate to a cyclic coordinate are subsumed under Noether's theorem as stated in Eq. (13.158).

The connection between symmetry properties of a mechanical system and conserved quantities has run as a thread throughout formulations of mechanics as presented here. Having come full circle, as it were, and rederived by sophisticated techniques symmetry theorems found in the first chapters, it seems an appropriate point at which to end our discussions.

EXERCISES

1. (a) The transverse vibrations of a stretched string can be approximated by a discrete system consisting of equally spaced mass points located on a weightless string. Show that if the spacing is allowed to go to zero, the Lagrangian approaches the limit

$$L = \frac{1}{2} \int \left[\mu \dot{\eta}^2 - T \left(\frac{\partial \eta}{\partial x} \right)^2 \right] dx$$

for the continuous string, where T is the fixed tension. What is the equation of motion if the density μ is a function of position?

- (b) Obtain the Lagrangian for the continuous string by finding the kinetic and potential energies corresponding to transverse motion. The potential energy can be obtained from the work done by the tension force in stretching the string in the course of the transverse vibration.
2. (a) Describe the field of sound vibrations in a gas in the Hamiltonian formalism and obtain the corresponding Hamilton equations of motion.
- (b) Generalizing the momentum expansion to a vector field, express the Hamiltonian for the acoustic modes of a gas in the momentum representation.

3. Obtain Hamilton's equations of motion for a continuous system from the modified Hamilton's principle, following the procedure of Section 8.5.
4. Show that if ψ and ψ^* are taken as two independent field variables, the Lagrangian density

$$\mathcal{L} = \frac{\hbar^2}{8\pi^2 m} \nabla\psi \cdot \nabla\psi^* + V\psi^*\psi + \frac{\hbar}{4\pi i} (\psi^*\dot{\psi} - \psi\dot{\psi}^*)$$

leads to the Schrödinger equation

$$-\frac{\hbar^2}{8\pi^2 m} \nabla^2\psi + V\psi = \frac{i\hbar}{2\pi} \frac{\partial\psi}{\partial t},$$

and its complex conjugate. What are the canonical momenta? Obtain the Hamiltonian density corresponding to \mathcal{L} .

5. Show that

$$G_i = - \int \pi^k \frac{\partial\eta_k}{\partial x^i} dV$$

is a constant of the motion if the Hamiltonian density is not an explicit function of position. The quantity G_i can be identified as the total linear momentum of the field along the x^i direction. The similarity of this theorem with the usual conservation theorem for linear momentum of discrete systems should be obvious.

6. (a) In a 4-space that is not Euclidean, the D'Alembertian is defined as

$$\square^2 = \nabla^2 = g^{\mu\nu} \frac{\partial^2}{\partial x^\mu \partial x^\nu}.$$

Here $g^{\mu\nu}$ is the contravariant metric tensor, which in the flat space of special relativity is indeed the same as $g_{\mu\nu}$. For the metric tensor of trace +2 instead of -2 used in Eq. (7.33), find the explicit form of the D'Alembertian so defined.

- (b) A suitable Lagrangian for the charged scalar meson field in this metric is

$$\mathcal{L} = \frac{1}{2} \left(g^{\mu\nu} \frac{\partial\phi}{\partial x^\mu} \frac{\partial\phi^*}{\partial x^\nu} - \mu_0^2 \phi\phi^* \right).$$

Show that one of the corresponding field equations is

$$(\square^2 - \mu_0^2)\phi = (\nabla^2 - \mu_0^2)\phi = 0.$$

Show also that in light of part (a) this equation is actually identical with Eq. (13.99).

7. To the Lagrangian density for the scalar charged meson, Eq. (13.94), add the following term to represent the interaction with an electromagnetic field:

$$j^\lambda A_\lambda$$

where

$$j_\lambda = i(\phi\phi^*_{,\lambda} - \phi_{,\lambda}\phi^*).$$

What are the field equations for ϕ and ϕ^* ? What happens to the conserved currents and associated conservation theorems?

8. Suppose the Lagrangian density in Hamilton's principle is a function of higher derivatives of the field quantities η_ρ :

$$\mathcal{L} = \mathcal{L}(\eta_\rho; \eta_{\rho,\mu}; \eta_{\rho,\mu\nu}; x^\lambda).$$

Assuming the vanishing of the variation at the end points, what is the form of the field equations corresponding to such a Lagrangian density?

9. Consider a scalar field quantity η that, for simplicity, is a function only of x and t . Suppose now that the Hamiltonian density is a function of higher spatial derivatives of η and π , that is,

$$\mathcal{H} = \mathcal{H}(\eta, \eta_{,x}, \pi, \pi_{,x}, \pi_{,xx}).$$

What are the corresponding Hamilton equations of motion?

10. Show that the Korteweg-deVries equation corresponds to the field equation for a scalar field ψ with Lagrangian density

$$\mathcal{L} = \frac{1}{2} \psi_x \psi_t + \frac{\alpha}{6} \psi^3 - \frac{\nu}{2} \psi_{xx}^2,$$

where the subscripts indicate derivatives with respect to the variables indicated, provided ψ is a potential function for the quantity ϕ of Eq. (13.117):

$$\phi = \frac{\partial \psi}{\partial x}.$$

11. Consider a Hamiltonian density in (x, t) space:

$$\mathcal{H} = \eta^3 + \frac{1}{2} \eta^2_{,x} + \pi^3_{,x} + \frac{1}{2} \pi^2_{,xx}.$$

Show that the Hamilton equations of motion correspond to a form of the Korteweg-deVries equation, Eq. (13.117), if

$$\begin{aligned} \eta &= \phi(x, t) \\ \pi &= \int_{-\infty}^{\infty} \phi(x', t) dx'. \end{aligned}$$

12. Evaluate explicitly T_j^0/c and T_{ij} for the symmetrized stress-energy tensor of the free electromagnetic field as given by

$$T_{\mu\nu sym} = T_{\mu\nu} - \frac{A_{\mu,\lambda} F^\lambda{}_\nu}{4\pi} = -\frac{F_{\lambda\mu} F^\lambda{}_\nu}{4\pi} + \mathcal{L} g_{\mu\nu}$$

What can be said about the physical meaning of these components?

13. In a 4-space with metric $g_{\mu\nu}$ of trace +2, evaluate explicitly the elements of the covariant (mathematically speaking) tensor $F_{\mu\nu}$ of the electromagnetic field. Also give the elements of the matrix with one index lifted and with two indices lifted:

$$F^\lambda{}_\rho = g^{\lambda\mu} F_{\mu\nu}; \quad F^{\lambda\rho} = g^{\lambda\mu} F_{\mu\nu} g^{\rho\nu}.$$

Euler Angles in Alternate Conventions and Cayley–Klein Parameters

The Euler angles as defined in Section 4.4 are specified by an initial rotation about the original z axis through an angle ϕ , a second rotation about the intermediate x axis through an angle θ , and a third rotation about the final z axis through an angle ψ . This sequence is here denoted as the “ x convention,” referring to the choice of the second rotation. For the x convention the Cayley–Klein parameters in terms of the Euler angles are

$$\begin{aligned}\alpha &= e^{i(\psi+\phi)/2} \cos \frac{\theta}{2}, & \beta &= i e^{i(\psi-\phi)/2} \sin \frac{\theta}{2}, \\ \gamma &= i e^{-i(\psi-\phi)/2} \sin \frac{\theta}{2}, & \delta &= e^{-i(\psi-\phi)/2} \cos \frac{\theta}{2},\end{aligned}$$

Other conventions are possible, and two in particular have found frequent applications in particular fields. Formulas will be given here for properties of a general rotation in terms of the Euler angles of these two alternate conventions.

y CONVENTION

The y convention differs from the x convention only in that the second rotation is about the intermediate y axis. Transcription from the x to the y convention is particularly simple because θ retains its meaning in both conventions and the changes for the other angles are easily obtained. In the x convention, ϕ is the angle between the line of nodes and the x axis; in the y convention, it is the same angle measure to the y axis. Similarly in the x convention, ψ is the angle between the line of nodes and the x' axis; while in the y convention, it is the same angle relative to the y' axis. Temporarily using subscripts to indicate the convention used, these relations imply the connection (cf. Fig. 4.7)

$$\begin{aligned}\phi_x &= \phi_y + \frac{\pi}{2} \\ \psi_x &= \psi_y - \frac{\pi}{2},\end{aligned}\tag{A.1y}$$

or

$$\begin{aligned}\sin \phi_x &= \cos \phi_y & \sin \psi_x &= -\cos \psi_y \\ \cos \phi_x &= -\sin \phi_y & \cos \psi_x &= \sin \psi_y.\end{aligned}\tag{A.2y}$$

With this recipe we obtain the following formulas in terms of the Euler angles in the y convention:

Rotation matrix.

$$\mathbf{A} = \begin{pmatrix} -\sin \psi \sin \phi + \cos \theta \cos \phi \cos \psi & \sin \psi \cos \phi + \cos \theta \sin \phi \cos \psi & -\cos \psi \sin \theta \\ -\cos \psi \sin \phi - \cos \theta \cos \phi \sin \psi & \cos \psi \cos \phi - \cos \theta \sin \phi \sin \psi & \sin \psi \sin \theta \\ \sin \theta \cos \phi & \sin \theta \sin \phi & \cos \theta \end{pmatrix} \quad (\text{A.3y})$$

The same result can be obtained by noting that the exchange of y for x corresponds to a rotation of the reference frames about the z axis through an angle of $-\pi/2$ or $3\pi/2$. We can therefore translate the \mathbf{A} matrix from x convention to y convention by a similarity transformation by the orthogonal matrix \mathbf{G} :

$$\mathbf{G} = \begin{pmatrix} 0 & -1 & 0 \\ 1 & 0 & 0 \\ 0 & 0 & 1 \end{pmatrix} \quad (\text{A.4y})$$

again leading to Eq. (A.3y).

Cayley–Klein parameters. For this convention the Cayley–Klein parameters are

$$\begin{aligned} \alpha &= e^{i\left(\frac{\psi+\phi}{2}\right)} \cos \frac{\theta}{2} & \beta &= e^{i\left(\frac{\psi-\phi}{2}\right)} \sin \frac{\theta}{2} \\ \gamma &= -e^{-i\left(\frac{\psi-\phi}{2}\right)} \sin \frac{\theta}{2} & \delta &= e^{-i\left(\frac{\psi+\phi}{2}\right)} \cos \frac{\theta}{2}. \end{aligned} \quad (\text{A.5y})$$

Euler parameters. It immediately follows from the definitions of $e_0 - e_x$ in Section 4.5 and Eq. (A.4y) that in the y convention the Euler parameters are given by

$$\begin{aligned} e_0 &= \cos \frac{\psi + \phi}{2} \cos \frac{\theta}{2} & e_2 &= \cos \frac{\psi - \phi}{2} \sin \frac{\theta}{2} \\ e_1 &= \sin \frac{\psi - \phi}{2} \sin \frac{\theta}{2} & e_3 &= \sin \frac{\psi + \phi}{2} \cos \frac{\theta}{2}. \end{aligned} \quad (\text{A.6y})$$

Components of angular velocity. Either by direct use of the translation equations, (A.2y), or by following through the physical meanings of the component parts of $\boldsymbol{\omega}$, we can obtain the following components of $\boldsymbol{\omega}$ along the body axes in the y convention:

$$\begin{aligned} \omega_{x'} &= -\dot{\phi} \sin \theta \cos \psi + \dot{\theta} \sin \psi \\ \omega_{y'} &= \dot{\phi} \sin \theta \sin \psi + \dot{\theta} \cos \psi \\ \omega_{z'} &= \dot{\psi} \cos \theta + \dot{\psi}. \end{aligned} \quad (\text{A.7y})$$

Similarly, the components of $\boldsymbol{\omega}$ along the space axes are

$$\begin{aligned}\omega_x &= -\dot{\theta} \sin \phi + \dot{\psi} \sin \theta \cos \phi \\ \omega_y &= \dot{\theta} \cos \phi + \dot{\psi} \sin \theta \sin \phi \\ \omega_z &= \dot{\psi} \cos \theta + \dot{\phi}.\end{aligned}\tag{A.8y}$$

Finally, note that

$$\cos\left(\frac{\Phi}{2}\right) = e_0 = \cos\frac{\psi + \phi}{2} \cos\frac{\theta}{2}\tag{A.9y}$$

which is the same as Eq. (4.63) for the x convention.

xyz CONVENTION

In this convention each rotation is about a differently labeled axis. Obviously, various sequences of rotations are still possible. It appears that most U.S. and British aerodynamicists and pilots prefer the sequence in which the first rotation is the *yaw* angle ϕ about a z axis, the second is the *pitch* angle θ about an intermediary y axis, and the third is a *bank* or *roll* angle ψ about the final x axis (or figure axis of the vehicle). Of the three elementary rotation matrices \mathbf{D} remains the same as Eq. (4.43), \mathbf{C} appears as

$$\mathbf{C} = \begin{pmatrix} \cos \theta & 0 & -\sin \theta \\ 0 & 1 & 0 \\ \sin \theta & 0 & \cos \theta \end{pmatrix},\tag{A.10xyz}$$

and \mathbf{B} is the same as Eq. (4.44) (with ψ in place of θ , of course). The product \mathbf{BCD} gives the following formulas:

Rotation matrix.

$$\mathbf{A} = \begin{pmatrix} \cos \theta \cos \phi & \cos \theta \sin \phi & -\sin \theta \\ \sin \psi \sin \theta \cos \phi - \cos \psi \sin \phi & \sin \psi \sin \theta \sin \phi + \cos \psi \cos \phi & \cos \theta \sin \psi \\ \cos \psi \sin \theta \cos \phi + \sin \psi \sin \theta & \cos \psi \sin \theta \sin \phi - \sin \psi \cos \phi & \cos \theta \cos \psi \end{pmatrix}\tag{A.11xyz}$$

Cayley–Klein parameters. These parameters have the form

$$\begin{aligned}\alpha = \delta^* &= \left(\cos \frac{\psi}{2} \cos \frac{\theta}{2} - i \sin \frac{\psi}{2} \sin \frac{\theta}{2} \right) e^{i\phi/2} \\ \beta = -\gamma^* &= \left(\cos \frac{\psi}{2} \sin \frac{\theta}{2} + i \sin \frac{\psi}{2} \cos \frac{\theta}{2} \right) e^{-i\phi/2}.\end{aligned}\tag{A.12xyz}$$

Euler parameters. From Section 4.5 and Eqs. (A.12xyz), it follows that the Euler parameters are

$$\begin{aligned}
 \cos \frac{\Phi}{2} = e_0 &= \cos \frac{\psi}{2} \cos \frac{\theta}{2} \cos \frac{\phi}{2} + \sin \frac{\psi}{2} \sin \frac{\theta}{2} \sin \frac{\phi}{2} \\
 e_1 &= \sin \frac{\psi}{2} \cos \frac{\theta}{2} \cos \frac{\phi}{2} - \cos \frac{\psi}{2} \sin \frac{\theta}{2} \sin \frac{\phi}{2} \\
 e_2 &= \cos \frac{\psi}{2} \sin \frac{\theta}{2} \cos \frac{\phi}{2} + \sin \frac{\psi}{2} \cos \frac{\theta}{2} \sin \frac{\phi}{2} \\
 e_3 &= -\sin \frac{\psi}{2} \sin \frac{\theta}{2} \cos \frac{\phi}{2} + \cos \frac{\psi}{2} \cos \frac{\theta}{2} \sin \frac{\phi}{2}.
 \end{aligned}
 \tag{A.13xyz}$$

Note that the cosine of the total angle of rotation now has a different form from either the x or the y convention.

Components of angular velocity. Clearly ω_ψ lies along the body x axis, ω_ϕ along the space z axis, and ω_θ along the intermediate axis, and therefore in the final yz plane. The resulting components along body axes are

$$\begin{aligned}
 \omega_{x'} &= \dot{\psi} - \dot{\phi} \sin \theta \\
 \omega_{y'} &= \dot{\theta} \cos \psi + \dot{\phi} \cos \theta \sin \psi \\
 \omega_{z'} &= -\dot{\theta} \sin \psi + \dot{\phi} \cos \theta \cos \psi.
 \end{aligned}
 \tag{A.14xyz}$$

Similarly, the components of ω along the space axes are

$$\begin{aligned}
 \omega_x &= \dot{\psi} \cos \theta \cos \phi - \dot{\theta} \sin \phi \\
 \omega_y &= \dot{\psi} \cos \theta \sin \phi + \dot{\theta} \cos \phi \\
 \omega_z &= \dot{\phi} - \dot{\psi} \sin \theta.
 \end{aligned}
 \tag{A.15xyz}$$

The previous editions of this work dealt with the Cayley–Klein parameters in more depth.

APPENDIX

B

Groups and Algebras

As we have seen in almost every chapter of this text, invariances in the formulation of classical mechanics display themselves as symmetries in the equations of motion. This property is formally discussed in Section 13.7 as Noether's theorem. Newtonian mechanics was formulated with the explicit assumption that the laws are invariant under any Galilean transformation to another inertial frame. In the special theory of relativity, the laws are formulated to be invariant under Lorentz transformations between inertial frames. The general theory of relativity is formulated to remove the restriction of using inertial frames. These and other invariances and transformation properties that we have discussed can be understood in terms of groups of transformations. In many cases, physicists deal extensively with representations of groups, rather than the groups themselves, so we will put some stress on representations. For example, the set of 3×3 rotation matrices with determinant $+1$, which appear so extensively in the text, is a representation of the special orthogonal group in three dimensions (denoted by $SO(3)$). Since the reader's knowledge of groups may not be extensive, we will begin with basics by defining a group and give some examples of finite groups. We shall then discuss infinite groups* and representations.

PROPERTIES OF GROUPS

A group is a set of objects called elements with a product operation and the following defining properties:

1. Closure—the product of two elements equals a third element in the group. If a and b are elements in the group, the product $ab = c$ where c is also a member of the group.
2. Multiplication is associative—if a , b , and c are group members, $a(bc) = (ab)c$.
3. The group contains a unit element, I , called the identity with the property that for all elements of the group, $a = aI = Ia$.
4. Each element a of the group has an inverse element, a^{-1} with the property $aa^{-1} = a^{-1}a = I$.

*Mathematicians at this point will use a different terminology for infinite groups. We shall follow the physicist's convention of referring to both finite and infinite collections of elements as groups.

TABLE B.1 Multiplication Table for the Four-Element Cyclic Abelian Group, C_4

	1	-1	i	$-i$
1	1	-1	i	$-i$
-1	-1	1	$-i$	i
i	i	$-i$	-1	1
$-i$	$-i$	i	1	-1

A group is *abelian* if the multiplication operation commutes; that is, for all elements a and b of the group, $ab = ba$. If any of the group elements fail to commute, then the group is *nonabelian*. An example of a finite abelian group is the set of elements $\{1, -1, i, -i\}$ where 1 is the identity, and $i = \sqrt{-1}$. This group has four elements, so it is said to be of order $h = 4$. We shall use h for the group order. This group multiplication table is shown in Table B.1.

Each group element appears once and only once in each row and in each column of the multiplication table. This group can be generated from one element, i , called the generator, with the property

$$i^2 = -1, \quad i^3 = -i, \quad i^4 = 1, \quad (\text{B.1})$$

so it is called C_4 , the cyclic group of four elements. Any cyclic group, C_n , of order $h = n$ elements has a generator element A with the property that the m th element of the group, A_m , is of the form

$$A_m = A^m, \quad (\text{B.2})$$

where

$$A^n = I. \quad (\text{B.3})$$

A *dihedral* group, D_n , is a group with $h = 2n$ members and two generators A and F with the properties

$$A^n = I \quad \text{and} \quad F^2 = I. \quad (\text{B.4})$$

A *subgroup* is a collection of some of the elements of a larger group that by themselves form a smaller group. For example, in C_4 as we can see from the multiplication table, the elements 1 and -1 form a subgroup. Two elements b and c are *conjugate* with respect to each other if for some element of the group, a ,

$$aba^{-1} = c. \quad (\text{B.5})$$

The collection of all elements “ c ” conjugate to b as a runs through all the elements of the group is called a *class*. All classes are disjoint subsets of the group with each element belonging to one and only one class. For abelian groups, such as the one shown in Table B.1, all elements are their own class. The identity element, I , always belongs to a class by itself. The class structure is important for nonabelian groups.

There are two groups with six elements, the cyclic group C_6 and the dihedral group D_3 . The elements of D_3 are usually denoted by $I, A, B, C, D,$ and F . The generator A has the property $A^3 = I$. It generates the element B

$$AA = A^2 = B, \tag{B.6}$$

and $A^{-1} = B$ and $B^{-1} = A$, since

$$AB = BA = I. \tag{B.7}$$

The element F , has the property $F^2 = I$ and generates the remaining two elements C and D through multiplications of A and B . The elements C, D and F are their own reciprocals since $F^2 = C^2 = D^2 = I$; that is,

$$C^{-1} = C, \quad D^{-1} = D, \quad \text{and} \quad F^{-1} = F. \tag{B.8}$$

This is a *nonabelian* group since, for example, the elements A and C do not commute

$$AC = F \quad CA = D. \tag{B.9}$$

The group multiplication table is shown in Table B.2.

The subgroups are

- subgroup 1 $\rightarrow I, C$
- subgroup 2 $\rightarrow I, D$
- subgroup 3 $\rightarrow I, F$
- subgroup 4 $\rightarrow I, A, B$.

The six elements divide into three classes,

- class 1 I
- class 2 A, B
- class 3 C, D, F .

TABLE B.2 The Multiplication Table for the Dihedral Group, D_3

	I	A	B	C	D	F
I	I	A	B	C	D	F
A	A	B	I	F	C	D
B	B	I	A	D	F	C
C	C	D	F	I	A	B
D	D	F	C	B	I	A
F	F	C	D	A	B	I

Note that in Table B.2 class 3 appears only in the upper-right and the lower-left quadrant of the multiplication table, while classes 1 and 2 appear only in the upper-left and lower-right. This shows the representations that are possible for D_3 .

REPRESENTATIONS OF GROUPS

A *representation* of a group is a set of matrices that satisfies the multiplication table of the group.* By a representation we mean what is more precisely called an inequivalent *irreducible* representation, Γ_i , or a set of $m \times m$ matrices that cannot be simultaneously decomposed into lower-order matrices. A theorem in group theory states that the number of irreducible representations, k , is equal to the number of classes and the sum of the squares of the dimensions, l_i , of the irreducible representations, Γ_i equals the group order, h . That is,

$$\sum_{i=1}^k l_i^2 = h, \quad (\text{B.10})$$

where h is the number of elements in the group, k is the number of irreducible representations, and l_i is the dimension of the i th representation. For the group D_3 , $k = 3$ and $h = 6$, so Eq. (B.10) becomes

$$l_1^2 + l_2^2 + l_3^2 = 6, \quad (\text{B.11})$$

whose only solution is $l_1 = l_2 = 1, l_3 = 2$. There is, as for all groups, a one-dimensional identity representation, Γ_1 in which we map each element onto +1. Another one-dimensional representation of D_3 is the set $\Gamma_2 = \{1, -1\}$, where the mapping is $\{I, A, B\} \rightarrow 1$ and $\{C, D, F\} \rightarrow -1$ as can be seen from Table B.2. The two-dimensional matrix representation, Γ_3 , can be given in terms of the unit matrix and the Pauli matrices:

$$I = \begin{bmatrix} 1 & 0 \\ 0 & 1 \end{bmatrix}, \quad \sigma_1 = \begin{bmatrix} 0 & 1 \\ 1 & 0 \end{bmatrix}, \quad \sigma_2 = \begin{bmatrix} 0 & -i \\ i & 0 \end{bmatrix}, \quad \sigma_3 = \begin{bmatrix} 1 & 0 \\ 0 & -1 \end{bmatrix}, \quad (\text{B.12})$$

with

$$\begin{aligned} I &= 1, & A &= -\frac{1}{2} (I - i\sigma_2\sqrt{3}), & B &= -\frac{1}{2} (I + i\sigma_2\sqrt{3}), \\ C &= \frac{1}{2} (\sqrt{3}\sigma_1 + \sigma_3), & D &= -\frac{1}{2} (\sqrt{3}\sigma_1 - \sigma_3), & F &= \sigma_3. \end{aligned} \quad (\text{B.13})$$

Notice how the group elements in class 3 involve only σ_1 and σ_3 . Thus, they are independent of the matrices I and σ_2 , as is expected from the structure of the

*Mathematicians always mean matrices when they refer to representations. Some field theorists take a more general meaning.

multiplication table. However, since each representation has an identity element, there is no simple association between classes and representations.

The representation of a group can be *faithful* or *unfaithful*. For a faithful matrix representation, each element in the group is represented by a unique matrix. In an unfaithful matrix representation, more than one element in the group is represented by the same matrix. The representations Γ_1 and Γ_2 of D_3 are unfaithful, while Γ_3 is a faithful representation. A faithful representation is an *isomorphism* or a one-to-one mapping of the group elements onto the matrices of the representation. An unfaithful representation is a *homomorphism* or a many-to-one mapping.

We have discussed the dihedral group D_3 as an abstract entity, that is, as a set of elements that satisfy a group multiplication table, and which has a two-dimensional representation that is a set of matrices also satisfying the same multiplication table. Groups also have mathematical and physical realizations in nature. For example, the permutation group of three numbers (123) is a D_3 group. It has the identity (123), three twofold cycles (213), (132), and (321), which correspond with the elements C , D , and F , and two threefold cycles, (231) and (312), which correspond to the elements A and B . A physical realization of this group is the symmetry operations of an equilateral triangle. The elements A and B are 120° and 240° rotations about a centered axis perpendicular to the plane of the triangle, and the reflection planes m_1 , m_2 , and m_3 , correspond to the elements C , D , and F of the group. This is sketched in Fig. B.1. We say that the abstract group D_3 , the threefold permutation group and the invariance group of operations on the equilateral triangle are isomorphisms because there is a one-to-one mapping between their elements.

As a further example, let us consider the quaternion group, Q , which is one of the five groups of order 8 (8 elements). The multiplication table is normally written as shown in Table B.3. This group has 5 classes

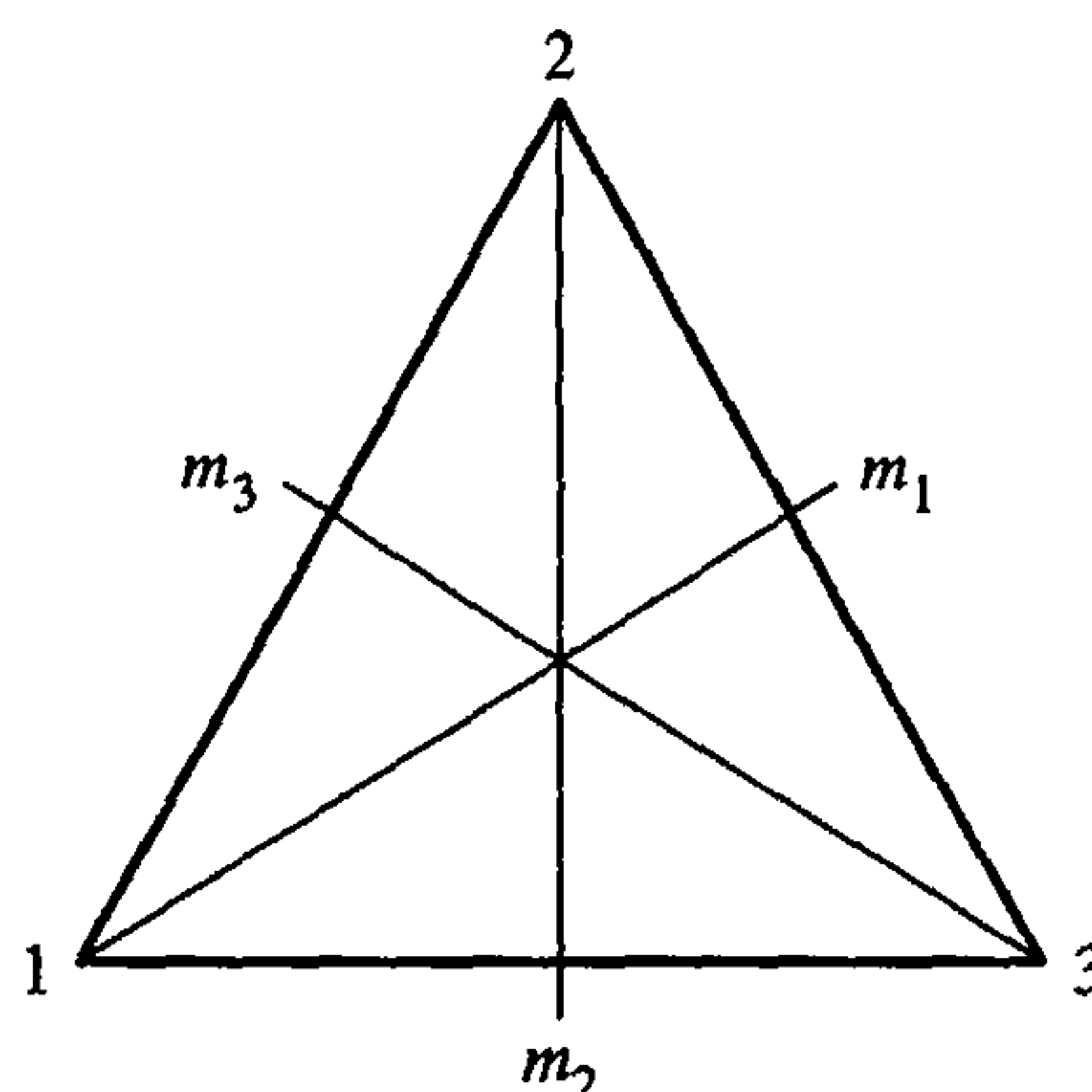

FIGURE B.1 Equilateral triangle showing the three mirror planes m_i .

TABLE B.3 The Multiplication Table for the Quaternion Group

	I	$-I$	e_1	$-e_1$	e_2	$-e_2$	e_3	$-e_3$
I	I	$-I$	e_1	$-e_1$	e_2	$-e_2$	e_3	$-e_3$
$-I$	$-I$	I	$-e_1$	e_1	$-e_2$	e_2	$-e_3$	e_3
e_1	e_1	$-e_1$	$-I$	I	e_3	$-e_3$	$-e_2$	e_2
$-e_1$	$-e_1$	e_1	I	$-I$	$-e_3$	e_3	e_2	$-e_2$
e_2	e_2	$-e_2$	$-e_3$	e_3	$-I$	I	e_1	$-e_1$
$-e_2$	$-e_2$	e_2	e_3	$-e_3$	I	$-I$	$-e_1$	e_1
e_3	e_3	$-e_3$	e_2	$-e_2$	$-e_1$	e_1	$-I$	I
$-e_3$	$-e_3$	e_3	$-e_2$	e_2	e_1	$-e_1$	I	$-I$

Class 1 $\rightarrow I$

Class 2 $\rightarrow -I$

Class 3 $\rightarrow \pm e_1$

Class 4 $\rightarrow \pm e_2$

Class 5 $\rightarrow \pm e_3$

From Eq. (B.10), we have

$$l_1^2 + l_2^2 + l_3^2 + l_4^2 + l_5^2 = 8,$$

which has the solution

$$l_1 = l_2 = l_3 = l_4 = 1, \quad \text{and} \quad l_5 = 2. \quad (\text{B.14})$$

For the one-dimensional representations, all elements can be mapped into $+1$, or they can be mapped into the one-dimensional representation $\Gamma = \{1, -1\}$ by $\{I, -I, e_1, -e_1\} \rightarrow +1$ and $\{e_2, -e_2, e_3, -e_3\} \rightarrow -1$. The two-dimensional faithful matrix representation has elements (cf. Eq. (B.12))

$$I = I, \quad -I = -I, \quad \pm e_1 = \mp i\sigma_1, \quad \pm e_2 = \mp i\sigma_2, \quad \text{and} \quad \pm e_3 = \mp i\sigma_3. \quad (\text{B.15})$$

Thus far we have confined our attention to finite groups. However, the rotations in three-space and the Lorentz transformations are infinite dimensional groups since the rotation angles and the boost velocities can take on values from the continuum. The set of all proper (determinant = $+1$) 3×3 rotation matrices are a faithful representation of the special orthogonal group in three dimensions, $\text{SO}(3)$. If we add the inversion operation, we include the improper rotations with determinant = -1 and obtain the larger orthogonal group $\text{O}(3)$. The group $\text{SO}(3)$ is a subgroup of the group $\text{O}(3)$. The set of Lorentz transformation matrices in one direction constitutes a group with the $\text{O}(3)$ a subgroup. If we allow boosts in two directions, we have a much larger group of inhomogeneous Lorentz transformations.

TABLE B.4 The Character Table for D_3

D_3	C_1	$2C_2$	$3C_3$
Γ_1	1	1	1
Γ_2	1	1	-1
Γ_3	2	-1	0

The sum of the diagonal elements of a matrix is called the *trace* of the matrix. The trace of the matrix in an irreducible representation, Γ_i , is called the *character*, χ_i , of that matrix. The character of a matrix in a representation is determined by the class; that is, all the matrices of a representation that correspond to the same class have the same character. For the dihedral group D_3 , the relation between the classes C_i of the two-dimensional representation, Γ_3 , is given as follows:

Class C_i	Elements	Character χ_i
Class 1	I	+2
Class 2	A, B	-1
Class 3	C, D, F	0

For the one-dimensional representations Γ_1 and Γ_2 of D_3 , the characters are the same as the one-dimensional matrices. This information can be most conveniently expressed in a *character table*. For D_3 , this is shown in Table B.4.

In Table B.4, the headings nC_m on the columns give the number of elements n in the class C_m of that row. The characters in the first row for class C_1 also give the dimensionality of the representation. The rows of the character table are orthogonal to each other, provided we take into account the number of elements in each column. For example, considering Γ_2 and Γ_3 , we have $1 \times 2 + 2 \times (1 \times -1) + 3 \times (-1 \times 0) = 0$. As an application, in quantum mechanics the Γ_i 's can represent energy levels split from a parent atomic state by an electric field environment of D_3 symmetry.

LIE GROUPS AND ALGEBRAS

The terms Lie group and the associated idea of Lie algebra are used in several chapters. A Lie group is a manifold, which is also a group. A manifold is a continuous geometric object; for example, Euclidean space, the spacetime of the special theory, and a circle of radius 1 in the complex plane are all manifolds. Most of the manifolds considered in physics are continuous manifolds.* For a manifold to be a Lie group, there must exist a group operation (termed multiplication) for

*A continuous manifold is a manifold with the concept of nearness. That is, for every point, P , in the manifold, there exist other points in the manifold that are as close to P as desired. As the mathematicians would say, for every point, P , in the manifold and given any $\epsilon > 0$, there exists another point in the manifold that is closer to P than ϵ , no matter how small ϵ .

all pairs of points in the manifold, which is consistent with the continuous nature of the manifold. Consider four points in the manifold a , b , c , and d and denote the group operation of a and c by ac . Consistent means, if a and b are close to each other and c and d are also close to each other, then ac , ad , bc , and bd are all close to each other. If we restrict our attention to the Lie groups that physicists are likely to encounter, there are only a few. One set of Lie group elements corresponds to rotations in odd dimensions, for example, the three-dimensional rotation group $O(3)$. A second set is the rotations in even dimensions, for example, the Lorentz group in 4 dimensions. Another set involves the unitary groups, for example, $SU(2)$, which is the set of 2×2 unitary matrices with determinant $+1$. The final set contains the symplectic groups (See Section 9.4). There are also five special finite groups.

Corresponding to the Lie groups are Lie algebras, which are flat vector spaces with a Lie bracket or commutator defined for a set of vector fields, $\{\tau_i\}$, which can serve as the basis vectors of the space. These vectors satisfy

$$[\tau_i, \tau_j] = \tau_i \tau_j - \tau_j \tau_i = c_{ij}^k \tau_k \quad (\text{summation convention}) \quad (\text{B.16})$$

where the c_{ij}^k (which clearly satisfy $c_{ij}^k = -c_{ji}^k$) are called the *structure constants* of the algebra. All Lie algebras must, by symmetry, satisfy the Jacobi identity

$$J(\tau_i, \tau_j, \tau_k) = [\tau_i, [\tau_j, \tau_k]] + [\tau_j, [\tau_k, \tau_i]] + [\tau_k, [\tau_i, \tau_j]] = 0. \quad (\text{B.17})$$

For example, the Pauli matrices satisfy Eqs. (B.16) and (B.17) with the structure constants $c_{ij}^k = 2i\epsilon_{ijk}$, where ϵ_{ijk} is the Levi-Civita density symbol. They form a Lie algebra.

There is a distinction between the elements of the Lie group and the elements of the Lie algebra. The manifold of the Lie group is not conceptually identical with the flat vector space of the Lie algebra. The relation between the Lie group and the associated Lie algebra is exponential. The Lie algebra is the logarithm of the Lie group, and conversely the Lie group is the exponential of the Lie algebra in the following sense. Let a_m be a member of the Lie group, then

$$a_m = e^{(i \sum_k \theta_m^k \tau_k)}, \quad (\text{B.18})$$

where τ_k is a basis vector of the Lie algebra. The equal sign is interpreted as a one-to-one uniqueness. For infinite dimensional Lie groups and algebras, the sum in Eq. (B.18) is replaced by an integral and m is replaced by a continuous index. Each quantity θ_m^k is the k th component (along the basis vector τ_k) of a vector θ_m of the algebra associated with the m th element of the Lie group. The vector θ is said to parameterize the Lie group and the Lie algebra.

An example of the group–algebra relationship is provided by the $SU(2)$ representation of the rotation group. The algebra basis vectors are the unitary Pauli matrices Eq. (B.12) which satisfy Eq. (B.16) (cf. page 412) with the structure constants given above. For a rotation through the angle θ about the direction of the

unit vector \mathbf{n} , we have the rotation matrix $Q(\theta, \mathbf{n})$ where \mathbf{n} is a unit vector

$$Q = I \cos \frac{\theta}{2} + i \mathbf{n} \cdot \boldsymbol{\sigma} \sin \frac{\theta}{2}. \quad (\text{B.19})$$

This can be written in the form of Eq. (B.18)

$$Q = e^{[i(\theta/2)\mathbf{n} \cdot \boldsymbol{\sigma}]}. \quad (\text{B.20})$$

This follows from the expansion of the exponential in a power series. An expansion of the scalar product

$$\mathbf{n} \cdot \boldsymbol{\sigma} = n_x \sigma_x + n_y \sigma_y + n_z \sigma_z \quad (\text{B.21})$$

enables us to identify $\frac{1}{2}n_k\theta$ with the parameter θ_m^k of Eq. (B.18) and to identify τ_k as σ_k . The matrices Q are a faithful representation of SU(2). The use of SU(2) was introduced into classical dynamics long before quantum mechanics was devised. It was used because SU(2) notation allows a finite rotation to be described in terms of a single angle and a single direction vector (cf. Eq. (B.21)). For a more extended discussion, see Section 4.5 of the 2nd edition of this text.

Another example of the Lie group–Lie algebra relationship is the Heisenberg algebra which, in one dimension, has the three elements x , p and I , and the three commutators

$$\begin{aligned} [x, p] &= I = ih/2\pi, \\ [x, I] &= 0 \\ [p, I] &= 0. \end{aligned} \quad (\text{B.22})$$

An associated Lie subgroup comprises the infinite set of elements $e^{i\alpha p}$ which transform a wavefunction $|x\rangle$ in the quantum-mechanical coordinate representation as follows:

$$e^{i\alpha p}|x\rangle = |\alpha + x\rangle, \quad (\text{B.23})$$

where α is a real constant. Another Lie subgroup comprises the $e^{i\beta x}$ operators which transform a wavefunction $|p\rangle$ in the quantum-mechanical momentum representation in the following manner:

$$e^{i\beta x}|p\rangle = |\beta + p\rangle, \quad (\text{B.24})$$

where β is real. The overall Heisenberg Lie group is formed by group multiplication of the corresponding subgroup elements $e^{i\alpha p}$ with $e^{i\beta x}$.

For most physical theories, there exists an action that remains unchanged in value for certain continuous changes in the dynamical variables. This is used in Chapters 1, 7, 8, 10, and 13 to derive dynamical equations of the Lagrange and Hamiltonian approaches. We can now see that the set of transformations of the dynamical variables that leave the action integral unchanged form a representation of the invariance group (often a Lie group) of that physical theory.

CLIFFORD ALGEBRAS

The three Pauli matrices σ_k , their three counterparts $i\sigma_k$, the 2×2 unit matrix I and the matrix iI together form another type of algebra called a Clifford algebra. The lowest order Clifford algebra contains the two elements i and 1 . A higher order Clifford algebra is formed from the 4×4 Dirac matrices γ_i and their products. The γ_i can be expressed as direct products of Pauli matrices and the unit matrix I as follows:

$$\begin{aligned} \gamma_1 &= \begin{bmatrix} 0 & \sigma_1 \\ \sigma_1 & 0 \end{bmatrix} & \gamma_2 &= \begin{bmatrix} 0 & \sigma_2 \\ \sigma_2 & 0 \end{bmatrix} & \gamma_3 &= \begin{bmatrix} 0 & \sigma_3 \\ \sigma_3 & 0 \end{bmatrix} \\ \gamma_4 &= \begin{bmatrix} I & 0 \\ 0 & -I \end{bmatrix} \end{aligned} \quad (\text{B.25})$$

In a Pauli matrix Clifford algebra formalism the scalar ($\mathbf{A} \cdot \mathbf{B}$) and cross ($\mathbf{A} \times \mathbf{B}$) products combine into a single operation \mathbf{AB} called a geometric product: $\mathbf{AB} = \mathbf{A} \cdot \mathbf{B} + \mathbf{A} \times \mathbf{B}$. The coordinate vector is written in the form $\mathbf{r} = x\sigma_1 + y\sigma_2 + z\sigma_3$, so the Pauli matrices act as basis vectors. A quantity $(S, \mathbf{V}|\mathbf{V}_p, S_p)$ defined in this algebra, called a multivector, has one scalar component S , three vector components V_x, V_y, V_z , three pseudovector components from \mathbf{V}_p , and one pseudoscalar component S_p . Several examples of multivectors and multivector transformations are:

$$\text{energy-momentum 4-vector} \quad (0, 0|\mathbf{p}, E/c) \quad (\text{B.26a})$$

$$\text{electromagnetic field tensor} \quad (0, \mathbf{E}|c\mathbf{B}, 0) \quad (\text{B.26b})$$

$$\text{space rotation} \quad (\cos \theta/2, 0|\mathbf{n} \sin \theta/2, 0) \quad (\text{B.26c})$$

$$\text{special Lorentz transformation} \quad ([\{\gamma - 1\}/2]^{1/2}, -\boldsymbol{\beta}[\{\gamma + 1\}/2]^{1/2}|0, 0) \quad (\text{B.26d})$$

$$\text{identity transformation} \quad (1, 0|0, 0) \quad (\text{B.26e})$$

The first four expressions constitute various ways of combining the nonzero parts of the four terms S, V, V_p , and S_p in pairs. For example, the electromagnetic fields \mathbf{B} and \mathbf{E} combine together in a multivector in which \mathbf{E} is the vector part, $c\mathbf{B}$ is the pseudovector part, and the scalar and pseudoscalar components are zero. Note that Eq. (B.26c) reduces to (B.26e) in the limit $\theta \Rightarrow 0$. In this formalism the product of two successive individual rotations about different axes automatically provides the axis direction \mathbf{n} and angle θ of the equivalent single rotation, information which cannot be readily obtained from the usual rotation matrix product operation. This convenient successive rotation technique involving the use of half angles was described in Section 4.5 of the second edition of the present text, and is omitted in the present third edition to make room for new material. The Clifford algebra approach was developed by Hestenes in his *New Foundations for Classical Mechanics* where he called it *geometric algebra* (see selected bibliography).

GROUP THEORY CLASSIFICATION OF ELEMENTARY PARTICLES

The power of group theory is demonstrated by the simple unitary group $SU(n)$ classification schemes of elementary particles. We briefly discuss this for baryons. A small submultiplet containing N baryons is classified in terms of an $SU(2)$ representation by its isospin number I where

$$N = 2I + 1. \quad (\text{B.27})$$

For example $I = 1/2$ for the neutron, proton pair n and p , and $I = 1$ for the sigma triplet Σ^- , Σ^0 , and Σ^+ . Each particle is labeled by its m_I value, where for a given I the m_I values have integer spacings in the range $-I \leq m_I \leq I$. When the next higher unitary group $SU(3)$ is invoked a new quantum number called strangeness, s , is added, and various $SU(2)$ submultiplets with different s values group together in the larger irreducible representations Γ_i of $SU(3)$. Each baryon has three quarks called up (u), down (d) and strange (s) for a total of $3^3 = 27$ combinations (e.g., a proton has the uud grouping), and the $SU(3)$ group theory classification divides these 27 into three irreducible representations Γ_1 , Γ_8 and Γ_{10} , with Γ_8 appearing twice, and the respective dimensionalities of Γ_i add as follows

$$\Gamma_1 + \Gamma_8 + \Gamma_8 + \Gamma_{10} = 1 + 8 + 8 + 10 = 27 \quad (\text{B.28})$$

Figure B.2 presents a plot of s versus m_I for the particles of the ground state $SU(3)$ octet Γ_8 which combines four $SU(2)$ submultiplets: (n , p , $I = 1/2$), (Λ^0 , $I = 0$), (Σ^- , Σ^0 , Σ^+ , $I = 1$), and (Ξ^- , Ξ^0 , $I = 1/2$). A higher order classification of the baryons in terms of the special unitary group $SU(4)$ takes into account a fourth quark c called charm, and groups together $SU(3)$ multiplets in terms of their total charm values. Now there are four types of quarks, u , d , s , and c , corresponding

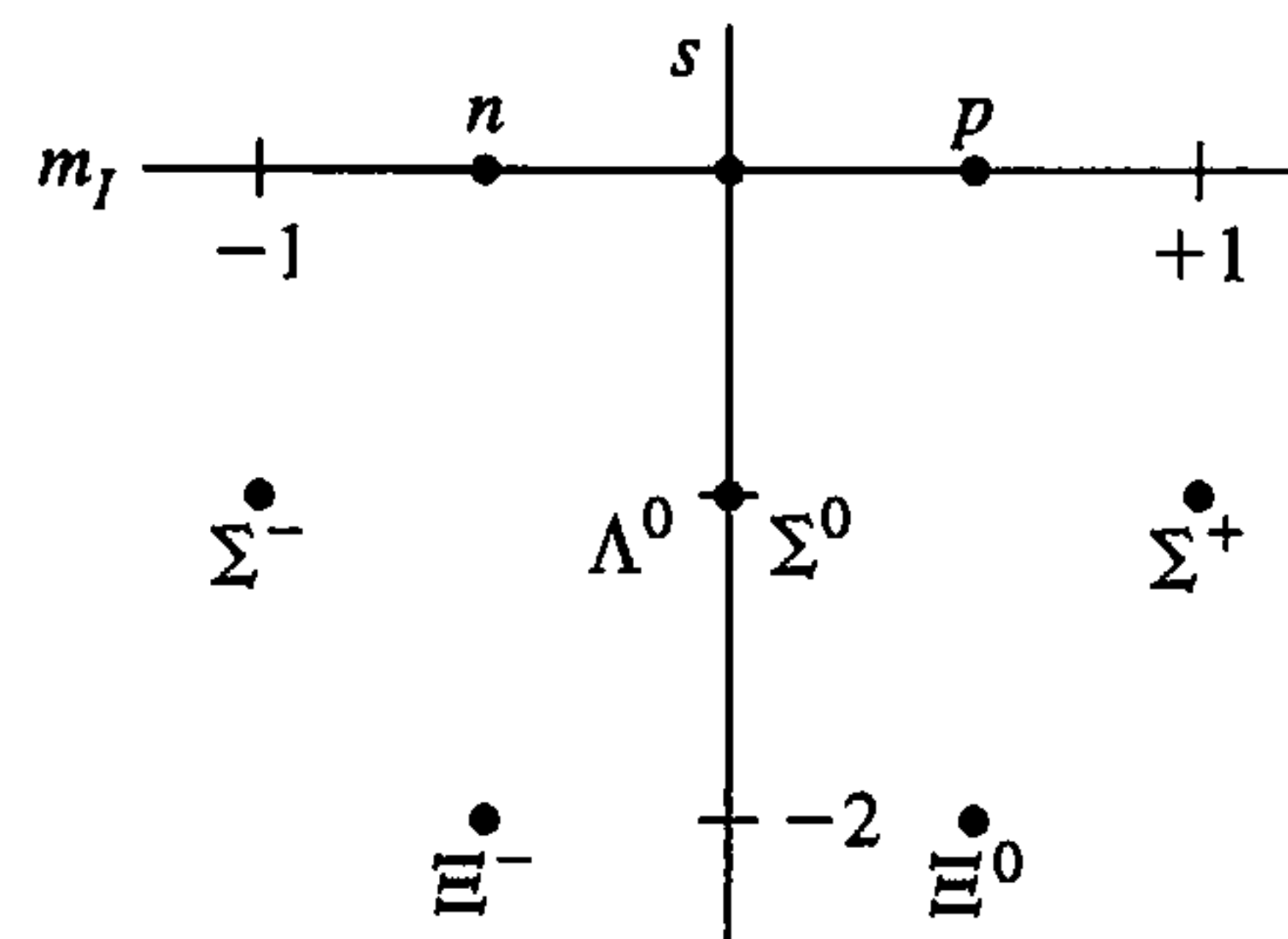

FIGURE B.2 Plot of strangeness (s) on the ordinate versus isotopic spin (m_I) on the abscissa. The strangeness ranges from -2 to 0 while the isotopic spin ranges from -1 to $+1$. Horizontal lines of constant strangeness contain $SU(2)$ submultiplets.

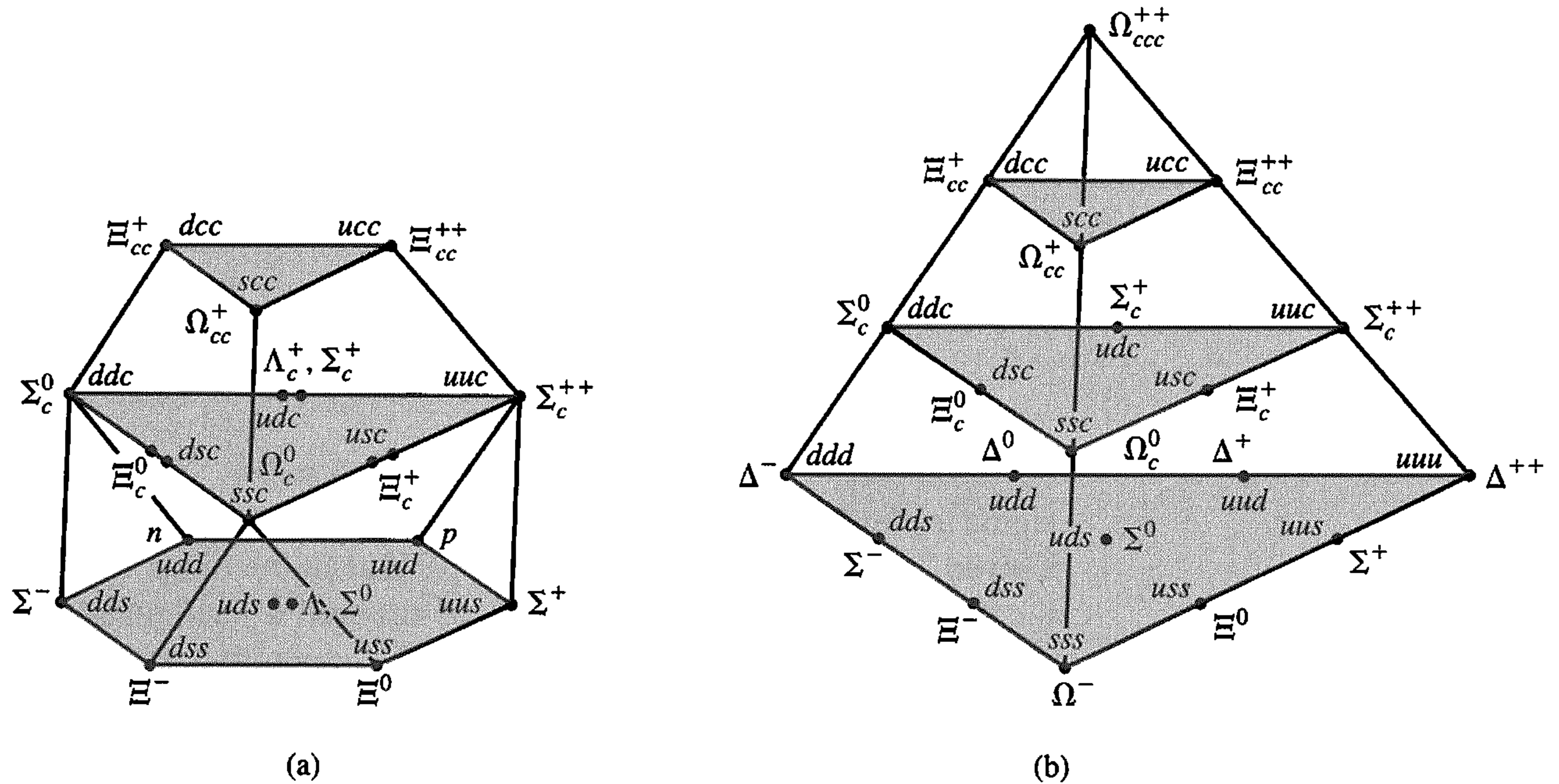

FIGURE B.3 Two of the 20-fold supermultiplets of the SU(4) classification of baryons. Charm (c) is plotted vertically and strangeness (s) and isotopic spin (m_I) are plotted on the horizontal plane. (a) has the uncharged ground-state octet, Γ_8 of Fig. B.2 at the bottom. (b) is the plot of another supermultiplet of SU(4). (See *Phys. Rev.*, **D54**, Part 1, 1996, p. 100.)

to $4^3 = 64$ baryon quark combinations. Figure B.3a shows a plot of the 20-fold SU(4) supermultiplet formed by horizontal groupings of SU(3) multiplets, with each particle labeled by its quark composition. In the lowest level we find the ground state uncharged baryons of Fig. B.2, that is baryons which contain only combinations of the quarks u , d , and s . The middle level contains singly charmed particles, that is baryons with one c and two ordinary quarks, and the upper layer contains doubly charmed particles such as Ω_{cc}^+ with the quark content scc . Figure B.3b shows another of the SU(4) supermultiplets.

These classification schemes are of more than academic interest because they provide selection rules for predicting elementary particle interactions, such as the conservation of strangeness for strong and electromagnetic interactions, but not for weak interactions. Mesons, each of which contains a quark plus an antiquark, also conform to classification schemes by the simple unitary groups SU(n).

Selected Bibliography

TEXTBOOKS ON CLASSICAL MECHANICS

- V. I. Arnold, *Mathematical Methods of Classical Mechanics*, (Berlin: Springer-Verlag, 1989). A very advanced treatment of the subject.
- A. Arya, *Introduction to Classical Mechanics*, (Upper Saddle River, NJ: Prentice Hall, 1998). Undergraduate text.
- V. Barger and M. Olsson, *Classical Mechanics: A Modern Perspective*, (New York: McGraw Hill, 1995). Undergraduate text that contains some discussion of chaotic dynamics and a unique section on Newtonian Cosmology.
- H. C. Corben and P. Stehle, *Classical Mechanics*, (New York: Dover, 1994). Reprinted as a classic.
- A. L. Fetter and J. D. Walecka, *Theoretical Mechanics of Particles and Continua*, (New York: McGraw Hill, 1980). Has extensive discussion of continuous systems.
- G. Fowles and G. Cassiday, *Analytical Dynamics*, (Ft. Worth, TX: Saunders, 1999). Undergraduate text with many computer problems.
- L. Hand and J. Finch, *Analytical Mechanics*, (Cambridge, England: Cambridge University Press, 1998). Covers standard topics, including Chaos, at a level similar to that of the present text.
- D. Hestenes, *New Foundations for Classical Mechanics*, (Dordrecht, The Netherlands: Kluwer, 1999). An unconventional approach to classical mechanics written in the mathematical language of geometric algebra. It has many keen insights on the subject.
- J. V. Jose and E. J. Saletan, *Classical Dynamics, A Contemporary Approach*, (Cambridge, England: Cambridge University Press, 1998). A good overall coverage of the subject. Much of the theory is expressed in terms of configuration manifolds and tangent bundles.
- L. D. Landau and E. M. Lifshitz, *Mechanics*, Volume I of *Course in Theoretical Physics*, (Oxford, England: Pergamon, 1976). A very economical and pedagogic approach to Mechanics. Contains many popular partially worked out examples.
- J. B. Marion and S. T. Thornton, *Classical Dynamics of Particles and Systems*, (Ft. Worth, TX: Saunders, 1995). A standard undergraduate text recently updated with some chaotic dynamics in the context of nonlinear oscillations.

- F. Scheck, *Mechanics: From Newton's Laws to Deterministic Chaos*, (Berlin: Springer-Verlag, 1990). This recent textbook on classical mechanics includes a chapter on the geometric aspects of mechanics which develops the theory in the language of manifolds. There is also a chapter on chaos.

LAGRANGIAN FORMULATION

Chapters 1 to 3

- D. Hestenes, *New Foundations for Classical Mechanics*, op cit. It has many good examples from astronomy. The three-body problem, together with the Euler and Lagrange solutions, are explained very well.
- L. D. Landau and E. M. Lifshitz, *Mechanics*, Volume I of *Course in Theoretical Physics*, op cit. A very pedagogic approach to mechanics.
- K. R. Symon, *Mechanics*, (Reading, MA: Addison Wesley, 1971). Discusses the restricted three-body problem.

RIGID BODIES

Chapters 4 and 5

- T. L. Chow, *Classical Mechanics*, (New York: Wiley, 1995). Provides an excellent treatment of the spinning top.
- D. Hestenes, *New Foundations for Classical Mechanics*, op cit. Provides new insights into rigid body motion, including the symmetric top.
- L. D. Landau and E. M. Lifshitz, *Mechanics*, op cit. A good, pedagogic discussion of rigid bodies.

SMALL OSCILLATIONS

Chapter 6

- L. D. Landau and E. M. Lifshitz, *Mechanics*, op cit. Treatment includes damped, unharmonic, and nonlinear oscillations.
- C. P. Poole, Jr., H. A. Farach and R. J. Creswick, *Superconductivity* (Boston, Academic Press, 1995). Chapter 13 discusses Josephson junctions and their mechanical analogues.

RELATIVITY**Chapter 7**

- C. W. Misner, K. S. Thorne, and J. A. Wheeler, *Gravitation*, (San Francisco; Freeman, 1973). A complete introduction to the geometric notation as applied to both the special theory and the general theory of relativity.
- B. F. Schutz, *A First Course in General Relativity*, (Cambridge, England: Cambridge University Press, 1985). The first four chapters introduce the reader to the formalism of the special theory of relativity in a form that can carry over to the general theory.
- E. F. Taylor and J. A. Wheeler, *Spacetime Physics*, (San Francisco: Freeman, 1992). An excellent discussion emphasizing the physical thoughts behind and the physical processes of relativity.

HAMILTONIAN FORMULATION**Chapters 8 to 10**

- I. Percival and D. Richards, *Introduction to Dynamics*, (Cambridge, England: Cambridge University Press, NY, 1982). Good treatment of canonical transformations, Hamilton–Jacobi equation, and action-angle variables.

CHAOS**Chapter 11**

- H. Bai-Lin, *Chaos*, (Singapore: World Scientific, 1984). The first part of the book consists of ten good introductory chapters that explain chaos. Chapter 2 develops the theory of chaos from Hamilton's equations and Chapter 3 discusses the logistic equation. The second and main part of the book is a collection of 41 reprinted papers, many of them landmark articles in the development of the subject.
- R. H. Enns and G. McGuire, *Nonlinear Physics with Maple for Scientists and Engineers*, (Boston: Birkhäuser, 2000). A good selection of problems with a disk of Maple programs.
- M. Hénon, *Numerical Exploration of Hamiltonian Systems*, Course 2 in *Chaotic Behavior of Deterministic Systems*, *Les Houches École D'Été de Physique Théorique*, 1981, ed. G. Iooss, R. H. G. Helleman and R. Stora, (New York: North Holland, 1983). This 114-page lecture is very readable. It provides one of the best explanations of the Hénon–Heiles Hamiltonian, and covers several other topics included in the present chapter.
- E. A. Jackson, *Perspectives of Nonlinear Dynamics*, (Cambridge, England: Cambridge University Press, 1990). This two-volume set provides a readable pre-

sentation of a variety of complementary approaches to topics in nonlinear dynamics. There are useful discussions of several topics covered in this chapter such as the Hénon–Heiles Hamiltonian, the logistic equation, Liapunov exponents and Poincaré maps. An explanation is given of the KAM theorem.

- S. A. Kauffman, *The Origins of Order*, (New York: Oxford University Press, 1993). An introduction to the concepts of complexity.
- W. Kinzel and G. Reents, *Physics by Computer*, (New York: Springer, 1998). Numerical solutions of linear and nonlinear problems using *Mathematica* and C.
- H. O. Peitgen, H. Jürgens and D. Saupe, *Chaos and Fractals, New Frontiers of Science*, (Berlin: Springer-Verlag, 1992). This volume constitutes one of the best available sources for information on fractals, and it does a good job of explaining the chaotic behavior of the logistic equation. The text is very long and wordy, but it contains many beautiful figures of fractals and trajectories of attractors.
- L. E. Reichl, *The Transition to Chaos*, (Berlin: Springer-Verlag, 1992). The theory is developed from the viewpoint of classical mechanics, using, for example, action-angle variables. There are good discussions of Poincaré sections, Liapunov exponents, the Hénon–Heiles Hamiltonian, and Kolmogorov’s approach for proving the KAM theorem.

PERTURBATION THEORY

Chapter 12

- I. Percival and D. Richards, *Introduction to Dynamics*, op cit. Good treatment of perturbation theory.

CONTINUOUS SYSTEMS AND FIELDS

Chapter 13

- B. S. Dewitt, Dynamical theory of groups and fields, in B. S. Dewitt and C. Dewitt (eds.) *Relativity, Groups and Topology*, (New York: Gordon and Breach, 1964). An excellent formalistic approach to the use of groups in modern field theory.
- A. L. Fetter and J. D. Walecka, *Theoretical Mechanics of Particles and Continua*, op cit. Has an extensive discussion of continuous systems.
- C. W. Misner, K. S. Thorne, and J. A. Wheeler, *Gravitation*, op cit. This contains an excellent discussion of the concepts of field theory in a Riemannian spacetime. The material is presented in multiple level tracks.

APPENDIX B

- H. Goldstein, *Classical Mechanics* (Reading, MA: Addison Wesley, 1st ed., 1950, 2nd Ed., 1980). The first and second editions of the present work have thorough explanations of the correspondence between the 2×2 complex unitary matrices of $SU(2)$ and the 3×3 real orthogonal matrices of $O(3)$, including the Cayley-Klein parameters. These discussions involve applications of Clifford algebras to classical mechanics.
- M. Hamermesh, *Group Theory*, (Reading, MA: Addison Wesley, 1962). A good coverage of group theory and its applications to physical problems. Lie groups and algebras are discussed in Chapter 8.
- D. Hestenes, *New Foundations for Classical Mechanics*, op. cit, A classical mechanics textbook with extensive sections written in the formalism of Clifford algebra, illustrating the insights to be gained by this approach.
- C. P. Poole, Jr. and H. A. Farach, Pauli-Dirac Matrix Generators of Clifford Algebras, *Found. Phys*, **12**, 719–738 (1982). This article provides background on the role that Clifford algebras can play in classical mechanics.
- M. Tinkham, *Group Theory and Quantum Mechanics*, (New York, McGraw Hill, 1964). A well written introduction to groups. Chapter 5 covers the rotation group and angular momentum.

Author Index

- Abel, N. H., 608. *See also* Abelian
in subject index
Arnold, V. I., 484, 487, 489, 617
Arya, A., 617
Atwood, G., 27, 28
- Bai-Lin, H., 489, 619
Baker, G. L., 507, 508, 519
Barger, V., 617
Barone, A., 269
Bernoulli, J., 43
Bertrand, J., 89
Bessel, F. W., 127
Binet, A., 203
Bohlin, 549
Bohr, N. H. D., 95, 466
Boltzmann, L. E., 85, 128
Boyle, R., 128
Bryan, 154
- Çambel, A. B., 519
Cantor, G. F. L. P., 516, 517, 519,
522
Cassiday, G., 617
Carathéodory, C., 394
Cayley, A., 154, 182, 603, 621
Chandler, S. C., 208, 228
Chasles, M., 161, 184, 228
Chow, T. L., 618
Clausius, R. J. E., 84, 128
Clifford, W. K., 614, 621
Corben, H. C., 617
Coriolis, G. G., 174, 326
Coulomb, C. A. de, 111
Cramer, G., 149, 263
Creswick, R. J., 265, 517, 618
- D'Alembert, J., 16, 18, 296, 313,
548. *See also*
D'Alembertian in subject
index
Delaunay, C. E., 477
Descartes, R., 26. *See also*
Cartesian in subject index
deVries, C., 587, 596
Dewitt, B. S., 620
Dirac, P. A. M., 588, 621
Duffing, G., 523, 524
- Einstein, A., 139, 276, 326, 327,
332, 538
Enns, R. H., 619
Euclid, 278, 517. *See also*
Euclidean in subject index
Euler, L., 45, 122, 150, 155, 165,
196, 197, 200, 209, 234,
319, 564, 617
- Farach, H. A., 265, 517, 618, 621
Faraday, M., 297, 298
Feigenbaum, M. J., 506–515
Fermat, P. de, 360
Fetter, A. L., 617, 620
Finch, J., 617
Foucault, J. B. L., 179
Fourier, Baron J. B. J., 14, 126,
259, 274, 460, 545, 551,
575
Fowles, G., 617
- Galilei, G., 2. *See also* Galilean in
subject index
Gibbs, J. W., 337
- Goldschmidt, 64
Goldstein, H., 621
Gollub, J. P., 507, 508, 519
Gordon, W., 584, 585, 596
Gram, 249
- Hamermesh, M., 621
Hamilton, Sir W. R., 34, 44, 45,
313, 324, 334, 430, 479,
488, 562. *See also*
Hamiltonian in subject
index
Hand, L., 617
Hausdorff, F., 517
Helmholtz, H. L. F. von, 337
Hénon, M., 484, 492, 496, 497,
619, 621
Heiles, C., 484, 492, 496, 497,
619, 621
Helleman, R. H. G., 497, 619
Hertz, H. R., 361
Hestenes, D., 121, 617,
618, 621
Hooke, R., 52, 91, 317
Huygens, C., 132
- Iooss, G., 497, 619
- Jackson, E. A., 489, 619
Jacobi, K. G. J., 61, 334, 338, 361,
390, 398, 426, 430, 479,
488, 566, 597
Jose, J. V., 617
Josephson, B. D., 265, 271,
618
Jürgens, H., 620

- Kauffman, S. A., 620
 Kelvin, Baron W. T., 85, 338
 Kinzel, I. W., 620
 Klein, F., 154, 182, 218, 228, 584, 585, 596, 603, 621
 Kepler, J., 73, 92, 101, 347, 370, 414, 445, 466, 470, 484, 495, 537
 Kirchhoff, G. R., 66
 Kolmogorov, A. N., 484, 487, 489, 621
 Korteweg, D. J., 587, 596, 600
 Kronecker, L., 138, 190

 Lagrange, J. L., 14, 123, 198, 200, 319, 392, 533, 561, 564, 618. *See also* Lagrangian in subject index
 Landau, L. D., 617, 618
 Laplace, P. S., marquis de 102, 264, 413
 Larmor, Sir J., 231, 318
 Legendre, A. M., 224, 334, 539
 Lenz, H. F. E., 102–104, 413
 Levi-Civita, T., 169, 410
 Liapunov, M. A., 484, 492, 512, 519, 621
 Lie, M. S., 171, 385, 392, 411, 613, 621
 Lifshitz, E. M., 617, 618
 Liouville, J., 418, 483
 Lissajous J. A., 83, 258, 439, 358, 462, 464
 Lorentz, H. A., 22, 131, 280, 319, 328, 415, 580, 612
 Lorenz, E. N., 523, 576

 MacCullagh, 225
 Mach, E., 324
 Marion, J. B., 617
 Maxwell, J. C., 54

 McGuire, G., 619
 Minkowski, H., 278, 287, 290, 319, 576, 580, 601
 Misner, C. W., 619, 620
 Moser, J., 484, 487, 489

 Napier, J. N., 476
 Newton, Sir I., 1, 5, 101, 132, 199, 299, 526. *See also* Newtonian in subject index
 Nielsen, A. C., 30
 Noether, A. E., 344, 566, 589, 597

 Olsson, M., 617

 Paterno, G., 269
 Pauli, W., 610, 614, 621
 Peitgen, H. O., 512, 513, 515, 620
 Percival, I., 619, 620
 Planck, M. K. E. L., 380
 Poincaré, J. H., 282, 394, 494, 524, 545, 621
 Poinsoot, L., 201, 202, 206, 234
 Poisson, S. D., 225, 388, 398, 411, 532. *See also* subject index
 Poole, C. P., Jr., 265, 517, 618, 621
 Ptolemy, C., 129

 Raman, Sir C. V., 258
 Ray, J., 47
 Rayleigh, Baron R. J. S., 23
 Reents, G., 620
 Reichl, L. E., 489, 620
 Ricci-Curbastro, G., 327
 Richards, D., 619, 620
 Riemann, G. F. B., 326, 327, 566, 620
 Rössler, O. E., 523
 Routh, E. J., 56, 347
 Runge, C., 102–104, 413
 Rutherford, Baron E., 110, 113

 Saletan, E. J., 617
 Sander, L. N., 524
 Saupe, D., 620
 Scheck, F., 618
 Schrödinger, E., 54, 571, 584, 599
 Schutz, B. F., 619
 Schmidt, 249
 Schwarzschild, K., 538
 Shaw, R., 512
 Sierpinski, W., 517, 519, 522
 Sommerfeld, A. J. W., 218, 228
 Staeckel, 447
 Stehle, P., 617
 Stokes, Sir G. G., 20, 24, 52
 Stora, R., 497
 Symon, K. R., 618

 Tait, P. G., 154
 Taylor, B., 239
 Taylor, E. F., 619
 Thomas, L. H., 282, 330
 Thomson, Sir W., *see* Baron (Lord) Kelvin
 Thorne, K. S., 619, 620
 Thornton, S. T., 617
 Tinkham, M., 621

 van der Pol, B., 490, 491
 Vinti, J., 463

 Walecka, J. D., 617, 620
 Weber, W. E., 367
 Wheatstone, Sir C., 66
 Wheeler, J. A., 324, 619, 620
 Witten, I. H., 524

 Young, T., 559

 Zeeman, P., 232

Subject Index

- 1-form, 289
 - charge, current, 295
 - covariant vector, 290
 - definition, 290
 - energy, momentum, 295
 - figure, 290
 - table, 290
- 4-vector
 - energy, momentum, 295, 300, 301
 - photon momentum, 304
 - table, 287
 - velocity, 286–288
- 4-velocity, 286–288

- Abbreviated action, 354, 434
- Abelian group, 606
- Acceleration, centripetal, 29, 80
- Acoustics, 53, 237, 239
- Action, 356
 - abbreviated, 359, 434
 - and reaction, 7
 - strong law, 7, 10
 - weak law, 5
 - at a distance, 323, 583
 - integral, 359, 596
 - variable, 452
 - integral over orbit, 458
- Action-angle variable, 430, 452–478, 619
 - celestial mechanics, 456
 - chaos, 485
 - completely separable, 457–466
 - degeneracy, 73, 464, 468
 - harmonic oscillator, 456
 - Kepler problem, 466–478
 - one degree of freedom, 452–457
 - periodic motion, 452
 - perturbation, 541
 - proper variables, 481
- Adiabatic invariance, 549–555
- Algebra, 611
 - Clifford, 614, 621
 - geometric, 617
 - Heisenberg, 613
 - Lie, 611, 612. *See also* Lie algebra
- Analogy, structural, 54
- Analytical mechanics, 1
- Angle variable, 455
 - Fourier expansion, 460
 - libration, 460
 - multiply periodic, 460
 - quasi-periodic, 461
 - rotation, 461
 - time dependence, 454, 458, 460
- Angular momentum
 - 4-vector, 310
 - areal velocity, 73
 - canonical, 405
 - central force problem, 72
 - conservation, 3, 72, 73, 571
 - total, 7
 - definition, 2
 - density, total, 571
 - eigenvalue, 411
 - electromagnetic, 8
 - ellipsoid, 203
 - mechanical. 8, 405
 - Poisson bracket, 408, 411
 - relativistic, 309
 - rigid body, 188
 - spherical symmetry, 72
 - spin, 10
 - total, 8
- Angular velocity in Euler angles, 602, 615
- Anharmonic oscillator, 545
- Anomalistic year, 131
- Anomaly
 - eccentric, 100
 - mean, 102
 - true, 540
- Antiproton, 304
- Antiquark, 616
- Aphelion, 484
- Approximation, semiclassical, 115
- Apsidal
 - distance, 78, 95, 96
 - vector, 86
- Areal velocity, 73
- Ascending node, 472
- Astronomy, medieval, 100
- Attitude angle, 154
- Attractor, 489, 516, 620
 - regular, 493
 - strange, 489, 492, 500
 - strange, Hénon-Heiles 500
- Atwood's machine, 27, 28
- Axis
 - rigid body, 135
 - screw, 161
 - semimajor, 95, 475
 - semiminor, 101
 - symmetry, 161
- Azimuth, 209

- Backward glory, 114
- Bank angle, 154, 603
- Barrier, centrifugal, 112
- Baryon. 615, 616
- Basis vector, 286
- Bertrand's theorem, 89, 92

- Bessel function, 126
 Biform, 296
 Bifurcation, 454, 484, 505, 513, 514
 diagram, 506, 508, 513, 515
 Bilinear, 219, 388
 form, 194
 Binet ellipsoid, 203, 204
 Biot-Savart law, 7
 Bivector, 296
 Black box, 121
 Bohr
 quantum mechanics, 466
 theory, 95
 Boltzmann
 constant, 185
 factor, 128
 Boost, 280. *See also* Lorentz transformation
 Bounded motion, 80, 484
 Boyle law, 128
 and virial, 84
 Brachistochrone, 42, 63
 Calculus
 operational, 275
 of variations, 36, 43
 fundamental lemma, 38
 Canonical, 338
 equations of Hamiltonian, 338
 extended transformation, 371
 invariant, 388
 momentum, 55, 314
 relativistic, 322, 323
 perturbation theory, *see* Perturbation theory
 restricted transformation, 371
 variables, 335, 377
 Canonical transformation, 348, 368–421, 619
 active and passive, 400, 405
 cyclic Hamiltonian, 369, 377, 399, 430, 441
 degeneracy, 464, 470
 equations, 368–375
 examples, 375–377
 explicit time dependence, 385, 397, 402
 generated by Hamiltonian, 420
 generating function, 373
 group, 387
 harmonic oscillator, 377–381
 infinitesimal, 385, 402
 invariant,
 phase space volume, 393, 420
 Poisson bracket, 389
 Jacobi matrix, 382, 394
 parametric, 385, 405, 408
 restricted, 371, 381, 382, 387
 symplectic, 381–388
 table of, 373
 Cantor set, 516, 519, 522
 Capacitance, 271
 Carathéodory theorem, 394
 Carousel, 183
 Cartesian coordinates, 25, 141
 Catenary, 41, 42, 64
 Cayley-Klein parameters, 154, 182, 601, 602
 Celestial mechanics, 533
 Center of
 energy, 312
 force, 106
 gravity, 185
 mass, 5, 6, 185, 312
 momentum, 301, 312
 system, 301
 Central force problem, 70–126.
 See also Kepler problem
 Centrifugal
 barrier, 112
 effect, 126
 Centripetal acceleration, 29, 175
 Chain rule, 18
 Chandler wobble, 208, 228
 Chaos, 483–522, 617, 619
 attractor, 489–491
 bifurcation, 505–509
 damped harmonic oscillator, 505–509
 dimensionality, 616–522
 fractals, 516–522
 Hénon-Heiles, 496–503, 506
 Islands, 503–505
 KAM theorem, 487–489
 logistic equation, 509–516
 motion, 491
 onset, 492, 501, 503
 parametric
 oscillator, 508
 resonance, 509
 perturbation theory, 487–489
 properties of, 491
 trajectory, 491, 494, 521, 522
 Character table, 611
 Characteristic
 equation, 157
 value, 156
 Charge density, 588
 Charged particle in
 electromagnetic field, 23, 317, 553
 Charm, 615, 616
 Chasles' theorem, 161, 184
 Class of group, 607
 Classical mechanics, 1–600
 Clifford algebra, 614, 621
 Closed orbit, 89, 452
 Colliding beam, 304
 Collision
 elastic, 118, 120, 306
 inelastic, 118
 C-O-M, center of momentum, 301
 Commensurability, 463
 condition, 464
 Commensurate, 105, 463
 completely, 464
 condition, 464
 frequency, 462
 m-fold, 464
 Commutator, 171, 411
 quantum mechanics, 392, 398
 relations, 170
 Configuration space, 34, 357
 point transformation, 370
 variation, 36
 Congruence transformation, 245, 246, 252
 Conic section, 94, 99
 Conjugate momentum, 55, 335, 351
 Conservation
 differential theorem, 594
 energy function, 62
 momentum, 403
 Conservation theorems, 7, 55, 72, 343, 597

- angular momentum, 3, 344
 - total, 7
- canonical momentum, 315, 340
- energy, 4, 11, 345, 450
- linear momentum, 2, 6, 344
 - system of particles, 6
- Noether's theorem, 589
- Poisson bracket, 396, 402
- relation to symmetry properties, 54–59
- Conservative system, 4
- Conserved current, 594, 595
- Constant of motion, 105, 397, 402, 403, 415
 - algebraic, 418
 - central force, 105
 - Jacobi identity, 397, 411
 - Poisson bracket, 398
- Constraint, 12–16, 24
 - differential, 16
 - equation, 15
 - holonomic, 12
 - nonholonomic, 12
 - nonintegral, 16
 - rheonomous, 13
 - rigid body, 12
 - rolling, 182
 - schleronomous, 13, 25
 - semiholonomic, 46, 49
 - virtual work, 16, 17, 48
 - weak, 321
- Continuity
 - conditions, 572
 - equation, 595
- Continuous system, 265, 558, 568
 - Hamiltonian formulation, 572–577
 - Lagrangian density, 561–566
 - stress energy tensor, 566–572
 - transition from discrete to continuous, 558–561
- Contour integration, 469
- Contraction, 290, 295
 - of tensor, 191
- Contravariant, 289
- Control parameter, 503, 506
 - logistic equation, 510
- Coordinate
 - basis, 286
- Cartesian, 184
- contraction, 295
- cyclic, 55, 343, 369, 445
- generalized, 13, 19, 239
- internal, 272
- mass weighted, 241, 258
- normal, 251, 257, 259
- polar, 72
- pseudo-Cartesian, 294
- rotating, 175
- Coriolis, 174–179
 - acceleration, 176
 - circulation of fluid dynamics, 177
 - deflection, 176–178, 182
 - effect, 126, 174–179, 326
 - on meteorological phenomena, 177
 - force, 175
 - Foucault pendulum, 179
 - hemisphere, 178
 - pressure gradient, 176
- Correspondence principle, 325, 390, 392, 398
 - Poisson bracket, 388, 391, 392, 398
- Cosmological constant, 328
- Cosmology, 617
- Coulomb
 - field, 109, 111
 - law, 274
 - scattering, 110
- Coupled electrical circuits, 53
- Covariant
 - definition, 277
 - equation, 297
 - Hamiltonian, 349, 352
 - Lagrangian, 318, 321, 322, 350, 352
 - principle, 325
 - relativistic, 577
 - vector, 289
- Cramer's rule, 149, 263
- Cross section
 - high energy limit, 127
 - Rutherford, 110
 - total, 110
- Crossing the T, 8
- Current
 - conserved, 594, 595
 - density, 588
 - elastic rod, 567
 - field flow, 568, 571, 594
 - flow, RL circuit, 51
- Curvature scalar, 327
- Cyclic
 - coordinate, 55, 343, 369
 - Kepler problem, 445
 - group, 606
- Cyclotron
 - frequency, 318, 553
 - resonance, 318
- δ -function, 588
- δ -variation, 38
- δ_{ij} Kronecker delta, 138, 181, 190
- Δ -variation, 357–359
- D'Alembert
 - characteristic, 548
 - principle, 16–20, 46, 313
- D'Alembertian, 296
- Damping, 519
 - exponential, 262
 - van der Pol equation, 490
- Deflection angle, scattering, 113
- Degeneracy, 244, 465
 - conditions, 465
 - exact, 547
 - Kepler problem, 470, 484
 - proper, 547
 - vibrational modes and frequencies, 257
- Degrees of freedom, 13, 245, 255, 342, 427, 541, 549, 563
 - Hamiltonian, 342
 - many, 457
 - molecular vibrations, 256
 - n particles, 13
 - oscillator, 264
 - rigid body, 135
 - vibration, 257
- Delaunay variables, 477
- Delta
 - δ -function, 588
 - δ -variation, 38
 - Kronecker (δ_{ij}), 138, 181, 190
- Dense quasi-periodic orbits, 491

- Derivative, functional, 574
- Deterministic, 483
- Differential equation,
 - inhomogeneous, 259
- Diffusion, 524
- Dihedral group, 606, 607
- Dilation of time, 279
- Dimension
 - Cantor set, 516
 - fractal, 516, 517
 - Hausdorff, 517
- Dipole moment
 - gravitational, 226
 - magnetic, 185, 230
- Dirac δ -function, 588
- Direction cosines, 136
 - orthogonality, 138
 - transformation, 139
- Dissipation
 - exponential damping, 263
 - forces, 259
 - function, 22–24, 53, 63, 261
 - Rayleigh, 23
- Disturbing function, 533
- Divergence, 295
 - 4-divergence, 296
 - relativistic, 565
 - theorem, four dimensional, 581, 593
- Divergenceless, 581
- Doppler effect, 329
- Drag force, 24, 52
- Dual space, 292
- Duffing oscillator, 523
 - inverted, 524
- Dumbbell molecule, 347
- Dynamic steady state, 267
- ϵ_{ijk} Levi-Civita density,
 - permutation symbol, 169, 410
- Earth
 - equatorial bulge, 223
 - figure axis, 226
 - Lagrangian for precession, 227
 - potential, 226, 227
 - precession, 226
 - spinning ring, 229
 - torques, 237
- Earth-Moon system, 124
- Eccentric anomaly, 99
- Eccentricity, 94, 95, 532
 - Sun and Moon, 227
- Ecliptic, 208, 228
- Eigenvalue, 156–158
 - angular momentum, 411
 - equation, 157
 - oscillations, 241
 - Euler's theorem, 157
 - inertia tensor, 195, 196
 - linear triatomic molecule, 254
 - problem, 157
 - transformation matrix, 160
- Eigenvector, 247
 - indeterminacy, 258
 - inertia tensor, 196
 - linear combination, 248
 - orthonormal, 249
 - oscillations, 244
- Eigenwerte (German for eigenvalue), 156
- Einstein
 - field equations, 327, 538
 - summation convention, 139
 - tensor, 327
 - velocity addition law, 283, 328
- Elastic
 - collision, 118, 120, 306
 - scattering, 120
 - solid, 563
 - wave, 560
- Electric circuit
 - equation, 264
 - Lagrangian, 53
- Electromagnetic
 - field, 31, 51, 55, 275, 571, 587
 - Lagrangian, 350
 - Lagrangian, covariant, 352
 - potential, 342
 - radiation, 54
 - theory, 276
- Elementary particle, 51, 54, 300, 615
- Ellipse, 81
 - figure, 96
 - harmonic oscillator, 377
 - orbit equation, 484
 - phase space plot, 98
- properties, 97
- semimajor axis, 95, 475
- shape, scale, orientation, 105, 473
- table, 97
- Ellipsoid
 - Binet, 203, 204
 - inertia, 196, 201
 - kinetic energy, 204, 258
 - rigid body, 185–188
 - moment of inertia, 197
- Ellipsoidal coordinates for
 - Hamilton-Jacobi equation, 479
- Elliptic
 - function, 89
 - integral, 234
 - region for chaos, 504
- Elsewhen, 279
- Elsewhere, 279
- Energy
 - center of, 312
 - conservation, 60
 - central force, 74, 77
 - free, Gibbs, 337
 - free, Helmholtz, 337
 - function, 60–63, 314
 - conserved, 61–63
 - hypersurface, 494
 - potential, 4
- Ensemble, 419
 - microcanonical, 421
- Enthalpy, 336
- Equant, 129
- Equation
 - of motion, 74
 - of state, gas, 85
- Equilateral triangle group, 609
- Equilibrium
 - generalized forces, 238
 - indifferent, 240
 - neutral, 240
 - stable, 238
 - statistical, 421
 - unstable, 239
- Equinox, 539
 - precession, 223–230
- Equipotential curve
 - gravitation, 125

- Hénon-Heiles, 498
- Equivalence principle, 324, 346
- Ergodic hypothesis, 418
- Escape velocity, 31
- Ether, 566
- Euclidean
 - dimension, 518, 519
 - space, 517
- Euler
 - equations, 198, 199, 234
 - derived from Lagrange's equations, 200
 - heavy symmetrical top, 210
 - symmetric body, 205
 - inhomogeneous function, 86
 - parameters, 155, 182, 602, 603
 - solution of three body problem, 122
 - theorem, 155–161
 - homogeneous functions, 320
- Euler angles, 150–154, 196, 601
 - angular velocity, 602, 615
 - conventions, 154
 - figure, 152
 - infinitesimal, 165
 - left handed, 152
 - SU(2) rotation, 412
 - time changes, 210
 - x -convention, 154, 601
 - xyz -convention, 154, 603
 - y -convention, 154, 601
- Euler-Lagrange, 564
 - complex scalar field, 583
 - electromagnetic field, 587
 - equation, 45, 64, 65, 319, 354
 - relativistic equation, 564, 588
- Event, 279, 311
- Extremum
 - path, 40
 - problem, 39
 - surface area, 40
- Faraday tensor, 297, 298
- Feigenbaum
 - diagram, logistic equation, 510, 513–515
 - number, 514
 - plot, 506
 - point, 511
- Fermat's principle, 360
- Field
 - canonical equations, 574
 - classical theory, 571
 - complex, 596
 - scalar, 583
 - definition, 566
 - elastic, 51
 - electromagnetic, 31, 51, 55, 275, 571, 587
 - elementary particle, 51
 - equation, Lagrange-Euler, 583
 - gravitational, 176, 185, 210, 275
 - relativistic, 571
 - scalar 287, 583
 - meson, 571, 599
 - theory, 558–589
 - Hamiltonian formulation, 571–577
 - Noether's theorem, 589–598
 - relativistic, 583–598
- Schrödinger
 - quantum theory, 576
 - spacetime, 566
 - vector, 286
 - velocity, 588
 - wave function, 571
- Figure axis, 539
- Fission, 120
- Fluid
 - dynamics, 419
 - perfect, 579
- Flux density, 107
- Force
 - central, 7, 70
 - centrifugal, 176
 - cut off, 111
 - driving, 259
 - effective, 80, 94, 175
 - electromagnetic, 259
 - external, 5
 - generalized, 19, 21, 58, 238
 - gradient of potential, 10
 - gravitational, 93
 - inertial, 5
 - internal, 5, 11
 - inverse square, 77, 92
 - linear restoring, 83
 - long range, 110
- Lorentz, 22, 131, 237, 317, 350
- Minkowski, 299, 322
 - relativistic, 297
 - reversed effective, 18, 80
 - strong, 299
 - weak, 299
- Foucault pendulum, 179, 183, 184
- Four-vector, *see* 4-vector
- Four-velocity, *see* 4-velocity
- Fourier
 - series, 14, 126, 574
 - convergence, 545
 - multiple, 460
 - transform, 274
- Fractal, 516, 620
 - area, 521
 - dimension, 490
 - Sierpinski carpet, 519
 - geometry, 491
 - self-similarity, 505, 514
- Free energy
 - Gibbs, 337
 - Helmholtz, 337
- Frequency
 - characteristic, 266
 - commensurate, 106
 - critical, 266
 - cyclotron, 318, 553
 - driving, 490
 - imaginary, 244
 - Larmor, 231
 - resonant, 490
- Friction, 24
 - atmosphere, 32
 - drag, 24
 - electrical, 52
 - oscillating system, 262
 - rolling, 17
- Functional, 287, 293
 - derivative, 574, 575
- Future, 279
- Galactic center, 496
- Galaxy model, Hénon-Heiles, 496, 497, 516
- Galilean
 - system, 2
 - transformation, 276–280
- Gas, equation of state, 85

- Gauge transformation, 595
 general, 619
- General relativity, 324
- Generalized
 force 19, 21, 57, 58
 mechanics, 65
- Generating function, 371, 372
 canonical transformations, table
 of, 373
 chaos, 488
 infinitesimal
 canonical transformation
 (I.C.T.), 403
 rotation, 404
 Poisson bracket, 404, 406
 symplectic, 394
 table, 373
- Geodesic 40, 324–326, 362
 deviation, 325
- Geoid, 176
- Geostrophic wind, 178
- Gibbs free energy, 337
- Glory scattering, 114
- Goldschmidt solution, 64, 65
- Gradient, 295
- Gram-Schmidt method, 249
- Gravitational
 charge, 226
 field, 176, 185, 210, 275
 quadrupole moment, 226
- Greek subscript convention, 286
- Group
 abelian, 606
 canonical transformation,
 387
 class, 607
 conjugation, 606
 cyclic, 606
 definition, 605
 dihedral, 606, 607
 generator, 606
 Lorentz, 282, 610
 multiplication table, 606
 properties, 387, 605–611
 quaternion, 610
 representation, 608
 rotation, 171
 symmetry, 412
 for system, 413
 symplectic, 387, 612
 theory, 605
- Gyration, radius of, 198
- Gyrocompass, 223
- Gyromagnetic ratio, 230
- Gyroscope
 inertia, 222
 torque free mounting, 213
- Hamilton's principle, 34–36,
 44–50, 313, 324, 355, 562,
 564
- Lagrange's equations
 derivation, 44, 45
 modified, 354, 355, 599
 nonholonomic systems, 45–50
- Hamiltonian, 334–353
 as total energy, 339
 covariant, 349, 352
 degrees of freedom, 342
 density, 573, 586
 formulation
 continuous systems, 572
 relativistic mechanics, 349
 generates canonical
 transformation, 420
 generator of system motion, 399
- Hénon-Heiles, 492, 497, 522
- perturbation, 526
- quantum mechanics, 613
- symplectic, 576
- Hamiltonian formulation, 334–363
 advantages, 51–54
 characteristic function, 434,
 440–444
 comparison of characteristic and
 principal functions,
 442–443
 conservation theorems,
 347–349
 cyclic coordinates, 343–349
- Hamilton equations of motion,
 334–363, 368, 397, 402
 derived from variational
 principle, 353
 least action principle,
 356–363
- Legendre transformation
 derivation, 334–342
- principal function, 430–434,
 433, 528
 compared with characteristic
 function, 442
 relativistic formulation,
 349–353
- Routh procedure, 347–349
- symplectic approach, 339–343
- variational principle derivation,
 353–356
- Hamilton-Jacobi theory and
 equation, 334, 430–451,
 488, 528, 549, 619
- central force, 448
- chaos, 485
- completely separable, 444
- cyclic coordinates, 445–451
- ellipsoidal coordinates, 479
- harmonic oscillator, 434–439
- method, 434–439
- new constant coordinates, 432
- Kepler problem, 445–451
 spherical coordinates, 451
- separation of variables,
 444–445
- two methods of solution, 442
- Handedness convention, 169
- Harmonic oscillator, 434–440,
 485
 action-angle variables, 455, 456,
 485
 adiabatic invariant, 550
 canonical transformation, 377
 constants of motion, 417
 coordinate space plot, 440
 damped, 269
 driven, 505, 507
 ellipse, 377
 Feigenbaum plot, 508
 Hamilton-Jacobi, 434–440
 isotropic, 82
 three dimensional, 275
 perturbation, 529, 542
 phase diagram, 380
 Poisson brackets, 417
 relativistic, 316
 two dimensional, 415, 416
 anisotropic, 437
- Heading angle, 154

- Heisenberg
 algebra, 613
 picture, 408
 Helmholtz free energy, 337
 Hénon-Heiles
 chaos, 484
 equipotentials, 498
 galaxy model, 516
 Hamilton equations, 497
 Hamiltonian, 492, 496, 497, 522
 islands in chaos, 502
 Poincaré map, 499–501
 potential, 497
 Hermitean matrix, 412
 Herpolhode, 202, 203
 Hertz principle of least curvature, 361
 Hierarchy of islands, 504, 505
 High energy physics, 300
 Hodograph, 131
 Holonomic, 12
 constraint, 12
 system, 199
 Homogeneous
 function, 320
 problem, 320, 359
 Homomorphism, 418, 609
 Hooke's law, 52, 92, 317, 559
 Hoop
 rolling, 50
 vertical, 66
 Huygens' waves, 132
 Hydrodynamic derivative, 419
 Hyperbola, 81, 316
 Hyperbolic
 motion, 315
 point, 504
 region, 504
 Hypersurface, 580
 energy, 494
 spacelike, 580
 Hypocycloid, 64
 Hysteresis, 270, 271, 523

 I.C.T. (infinitesimal canonical transformation), 385, 386, 402, 403, 408, 410, 413
 Identity transformation, 146, 156
 Ignorable, *see* cyclic

 Imbedding in chaos, 514–516
 Impact parameter, 107
 Inclination, 532
 Incommensurate, 548
 frequency, period, 462, 489, 548
 oscillator, 521
 Inelastic collision, 118
 Inertia
 ellipsoid, 197, 201
 tensor, 191
 components, 195
 diagonal, 196
 eigenvalue, 195, 196
 eigenvector, 196
 integral, 194
 principal axes, 196
 principal moments, 197
 properties, 195
 similarity transformation, 196
 Inertial
 force, 5
 system, definition, 2
 Infinitesimal
 canonical transformation, 385, 386, 396, 398, 399, 401
 rotation, 163, 166
 Infrared spectroscopy, 258
 Instability, 205
 Integrability breakdown, 502
 Integral
 invariants of Poincaré, 394
 Jacobi, 61
 line, 35
 variation, 44
 Integrating factor, 15
 Invariable plane, 202
 Invariance
 adiabatic, 549
 condition, 594
 group, 613
 logistic equation, 484
 Lorentz, 302
 Poisson bracket, 388
 rotation, 60
 scale, 591
 translation, 60
 Inversion, 150, 181
 Islands
 in chaos, 502, 503

 hierarchy, 504, 505
 various orders, 504
 Isomorphism, 609

J-matrix, 342, 382–389, 393
 Poisson bracket, 388
 Jabberwocky, 202
 Jacobi
 determinant, 394
 form of least action principle, 361
 identity, 393, 398, 424, 428
 integral 61, 566, 597
 Lagrange brackets, 424
 Poisson bracket, 390
 matrix of canonical transformation, 426
 Josephson junction, 265, 271, 618

 KAM (Kolmogorov-Arnold-Moser) theorem, 484, 487–492
 Kamiltonian, 370
 Kepler
 equation, 102, 126, 131
 second law, 73
 third law, 101, 470
 Kepler problem, inverse square law potential, 70–126, 347, 415
 action variables, 471
 action-angle variables, 466
 closed orbits, conditions, 89–92
 cyclic coordinate, 445
 equations of motion, 72–76
 equivalent one body problem, 70–71
 equivalent one dimensional problem, 76–83
 inverse square law, 92–96
 Lie algebra, 414
 motion in time, 96
 orbit equation, 86–89, 96–103
 perturbation, 536
 Poincaré map, 495, 496
 scattering, 106–121
 spherical polar coordinates, 467
 symmetry group, 414
 virial theorem, 472

- Kinematics
 rigid body, 134, 184
 tools, 184
- Kinetic energy
 ellipsoid, 203
 rigid body, 184
 rotational, 191
 total, 9
- Kinetic theory, 85, 112
- Kirchhoff junction conditions, 66
- Klein-Gordon
 equation, 585
 field, 585
 particle, 596
- Kolmogorov-Arnold-Moser
 (KAM) theorem, 484,
 487–492
- Korteweg-deVries equation, 596,
 600
- Kronecker delta (δ_{ij}), 138, 181,
 190
- Laboratory
 frame, 302
 system, transformation, 306
 time, 279
- Lagrange
 bracket, 392–394
 fundamental, 393
 calculus of variations, 36
 equations, 16, 21–23
 derivation from Hamilton's
 principle, 44, 45
 Euler equation derivation,
 200
 Nielsen form, 30
 perturbation, 533
 multipliers, 16, 67
 point, 124
 solution of three body problem,
 123
 undetermined multiplier, 198
- Lagrangian
 applications, 24–29
 central force, 71
 conserved quantities, 566
 covariant, 318, 321, 322,
 352
 definition, 21
 density, 564, 567, 583
 continuous system, 561–566
 discrete system, 558–560
 electromagnetic field, 350
 formulation versus Newtonian,
 199
 from Hamilton's principle, 44
 heavy symmetrical top, 208
 precession of Earth, 227
 relativistic, 312
 rigid body, 185, 199
 separable, 185
- Laplace transform, 264
- Laplace-Runge-Lenz vector,
 102–106, 131, 429
- Larmor
 frequency, 231
 precession, 318
 theorem, 232
- LC* circuit, 51
- Least action principle, 356, 362
 Δ -variation, 359
 Jacobi form, 361
 restrictions, 358
- Legendre
 polynomial, 539
 polynomial generating function,
 224
 transformation, 334, 335, 375,
 549
- Levi-Civita density, (ϵ_{ijk}) 169,
 410
- Liapunov exponent, 491, 519
 damped pendulum, 519
 diagram, 520
 dimension, 521
 logistic equation, 514, 519
 negative, 492
 Sierpinski carpet, 519
 solar system, 494
- Libration, 452, 455, 460
- Lie
 algebra, 171, 412–415, 611–613
 definition, 412
 Kepler problem, 414
 Poisson bracket, 392
 structure constant, 413, 612
 bracket, 171
 relations, 415
 group, 411, 412, 611–613
 subgroup, 613
- Light cone, 279, 280
- Lightlike, 278, 304
- Limit cycle, 489
 figure, 491
 van der Pol equation, 491
- Line of nodes, 150, 473
- Linear momentum, 1
 particle, 1
 system of particles, 6
 total, 6
- Liouville theorem, 418–421, 428,
 483
- Lissajous figure, 83, 258, 439,
 458, 462
 noncommensurate, 464
 sketch, 440, 463
- Ljapunov, *see* Liapunov
- Logistic equation, 509, 620
 control parameter, 510
 Feigenbaum diagram, 510,
 513–515
 fourfold cycle, 510
 iterations, 510
 Liapunov exponent, 512, 514
 self-similarity, 514
 twofold cycle, 510
- Longitude of ascending node, 474
- Lorentz, 282
 boost, 284
 condition, 297
 force, 22, 131, 237, 350
 frame, 580
 group, 282, 610
 invariance, 302, 577
 ten constraints, 282
 transformation, 280–265
 boost, 282
 equations for ct' and r' ,
 281
 general matrix, 281
 homogeneous, 282
 inhomogeneous, 282, 610
 invariance, 302
 pure, 284
 scattering, 306
- Lorenz equations, 523
- Lyapunov, *see* Liapunov

- M*-matrix, 382–389, 394
 MacCullagh formula, 225
 Mach's principle, 324
 Magnetic field
 charge particle motion, 23, 317
 uniform, 409
 moment, 230
 rigidity, 318
 Manifold, 576, 611, 618
 Mapping, 287
 quadratic, 503
 Mass
 center of, 312
 reduced, 71
 weighted coordinates, 241
 Matrix
 addition, 145
 antisymmetric, 148, 165
 cofactor, 340
 determinant, 159
 hermitean, 412
 infinitesimal element, 164
 inverse, 147
 J-, 342, 383–389
 M-, 382–389, 394
 multiplication, 144
 orthogonal, 147
 reciprocal, 147
 rectangular, 147
 skew symmetric, 148
 transpose, 147
 unitary, 412
 Maxwell's equations, 54, 276, 297, 350
 covariant form, 298
 Mean anomaly, 102
 Mechanics, *see* Classical mechanics
 Merry-go-round, 183
 Meson, 331, 616
 scalar, 571, 599
 Metric
 Minkowski space, 287, 580
 matrix, 287
 tensor, 327
 MeV, definition, 32
 Microcanonical ensemble, 421
 Million electron volt, definition, 32
 Minimum
 gravitational coupling principle, 325
 surface of revolution, 40
 Minkowski
 coordinate, 288
 force, 299, 322
 space, 278, 580
 two dimensional, 287
 Mixing, 516
 property of chaos, 491
 Mode, normal, 252
 Moderator, 120
 Molecule
 internal coordinates, 272
 linear triatomic, 272
 pentatomic, 272
 polyatomic, 258, 259
 rotation and vibration, 180
 triatomic, 275
 vibrating, 253, 258
 linear polyatomic, 558
 Moment
 of force, definition, 2
 of inertia, 191
 about axis of rotation, 192
 choice of origin, 193
 coefficients, 187
 ellipsoid, 197
 integral, 194
 operator, 188
 parallel axes, 193, 194
 Momentum
 angular, 187, 344
 canonical, 55, 314
 center of, 312
 conjugate, 55, 335, 351
 conservation, 403
 density, 569, 573, 579
 electromagnetic, 55
 generalized, 55
 linear, 1, 6, 24, 344
 representation, 576, 598
 Monochromatic light, 259
 Monogenic, 34
 Monopole. magnetic, 131, 427
 Motion
 bounded, 80, 484
 chaotic, 491–493
 equation, 74
 hyperbolic, 315
 periodic, 484
 Multiplet, 615, 616
 Multiply periodic, 458, 461
 Multivector, 614
 Napier's rules, 476
 Network, electrical, 264
 Neutron scattering, 120
 Newtonian
 equations of motion, 199
 formulation versus Lagrangian, 199
 mechanical corpuscles, 132
 second law, 1, 299
 third law, 5
 Nielsen form of Lagrange's equations, 30
 No-interaction theorem, 324, 353
 Node
 ascending, 472
 line of, 150, 473
 Noether's theorem, 344, 566, 589, 594
 conditions, 590
 conserved current, 594
 conserved quantities, 418
 discrete, 596, 597
 statement of, 594, 595, 597
 symmetry properties, 598
 Non-Euclidean, 278
 Nonabelian group, 606
 Noncommensurate, 464
 Nonholonomic system, 45
 Noninertial system, 175
 Normal
 behavior in chaos, 515
 coordinates, 250, 251
 modes, 252, 256
 Number theory theorem, 463
 Nutation, 215
 heavy symmetrical top, 209, 214

- O(3) group, 610
 Oblateness
 Earth, 229
 Moon, 229
 Occupation number, 253
 One dimensional problem,
 equivalent, 76
 One-form, *see* 1-form
 Operational calculus, 275
 Optics
 geometric, 112
 meteorological, 114
 Orbit
 bounded, 80
 chaotic, 522
 circular, 80, 81, 94
 closed, 452
 conditions for, 89
 commensurate, 106
 degenerate, 106
 elliptic, 94, 95, 484
 equation, 99
 of state, 86
 integration, 93
 hyperbolic, 94, 110
 inclination, 474
 open, 452
 osculating, 531
 parabolic, 94
 phase space, 452
 quasi-periodic, 490
 reflection symmetry, 87
 regular, 522
 satellite, 229
 shape, scale, orientation, 105,
 473
 stable, 90
 unbounded, 79
 unstable, 90
 Orbiting, 113
 Orthogonal
 matrix, 147
 transformation, 139
 Orthogonality condition, 140
 Oscillation, 238–265
 eigenvalue equation, 241–249
 forced, 259–265
 free vibration frequencies,
 249–253
 Josephson junction, 271
 normal coordinates, 249–253
 pendulum, damped and driven,
 265–271
 potential expansion, 238–241
 principal axis transformation,
 241–249
 triatomic molecule, 253–259
 Oscillator
 anharmonic, 545
 double, 486
 parametric, 508
 Parabola, 81, 94, 128
 Parametric resonance, 505, 508,
 509
 Parity, 590
 Past, 279
 Pauli matrices, 412, 612, 614
 Pendulum
 damped driven, 265
 double, 14
 equation, 267
 hysteresis, 270
 periodicity, 453
 perturbation, 533
 phase angle, 533
 plane, 234
 spherical, 83, 428
 Pentatomic molecule, 272
 Periapsis, 99, 108, 540, 541
 Periastra, 474
 Pericyynthion, 99
 Perigee, 474
 Perihelion, 99, 100, 474, 477,
 484
 Mercury, 332, 538, 539
 Period doubling, 516
 Periodic
 frequency, 455
 motion, 452, 484
 libration, 452
 rotation, 452
 multiply, 458
 orbits of pendulum, 454
 quasi, 461
 Permutation
 group, 609
 symbol (ϵ_{ijk}), 169, 173, 181
 Perturbation, 487
 action-angle variables, 541
 adiabatic invariance, 549–555
 degeneracy, 547, 548
 fast variable, 547
 first order, 530, 534, 537
 Hamilton-Jacobi equation, 543
 Hamiltonian, 526
 harmonic oscillator, 529
 Kepler problem, 536
 n-th order, 530
 pendulum, 533
 precession
 equinoxes, 539
 Mercury, 538, 539
 satellite orbits, 539
 second order, 534, 544
 secular, 532, 535
 slow variable, 547
 solar system, 532
 theory, 229, 338, 483,
 526–555
 quantum, 527
 time dependent, 527–533
 examples, 533–541
 time independent, 541–549
 Phase space, 335, 370, 453, 573
 ellipse, 98
 harmonic oscillator, 380
 damped driven, plot of, 507
 uncoupled, 486, 487
 Kepler problem, 98
 orbits, 454
 point transformation, 370
 regular orbits, Hénon-Heiles,
 502
 trajectory, 354
 Photomeson production, 304
 Photon, 253
 Pitch angle, 154, 603
 Planck's constant, 380
 Poincaré
 integral invariants, 394
 map, (or section), 494, 495
 Hénon-Heiles, 499–501
 Kepler problem, 495
 transformation, 282
 Poinso't's construction, 201, 202,
 206, 234

- Point
 inflection, 42
 Lagrange, 124
 saddle, 124
 transformation, 31, 370, 422
 configuration space, 370
 phase space, 370
 turning, 78
- Poisson
 equation, 225
 theorem, 398
- Poisson bracket, 388–411
 angular momentum, 408–411
 applications, 396
 canonically invariant, 390
 conservation theorem,
 402–404
 correspondence principle, 390,
 398
 double, 390
 equation of motion, 396–398,
 407
 fundamental, 389, 411
 generating function, 402–406
 infinitesimal canonical
 transformation (I.C.T.),
 398–405
 integral invariants of Poincaré,
 394
 invariance, 388
 Jacobi identity, 390
 Jacobian determinant, 394
 Lagrange bracket, 392
 Lie algebra, 392
 linear and angular momentum,
 411
 nested, 408
 perturbation theory, 532
 symmetry groups, 411–418
 symplectic, 388, 389
 theorem, 411
- Polar coordinate, 72
 central force Lagrangian, 73
 plane, 25
 spherical, 32
- Polhode, 202
- Polyatomic molecule, 258, 259
 linear, 558
 rotation and vibration, 180
- Potential, 4
 energy, 4
 equilibrium, 239
 total, 11
 equivalent one dimensional,
 central force, 78
 generalized, 22
 gradient, 10
 Hénon-Heiles, 497, 498
 hole, 82
 integrable, 86
 linear restoring force, 83
 power law, 86, 87
 scalar, 20
 velocity dependent, 22–24
- Power series, 43
- Precession, 206
 astronomical, 208, 228
 average frequency, 217
 Earth, 207, 226
 equinoxes, 209, 223–229
 fast and slow, 219
 force free motion, 207
 free body, 205
 heavy symmetrical top, 209
 Larmor, 231
 magnetic field, 230
 Mercury, 332, 538, 539
 orbital plane, 540
 pseudoregular, 218
 regular, 218
 satellite, 228
 system of charges, 230
 Thomas, 282, 330
- Principal axis transformation,
 241
- Proper time, 279, 310, 321
- Proton-neutron reaction, 304
- Pseudoscalar, 614
- Pseudotensor, 189
- Pseudovector, 168, 614
- Ptolemaic system, 129
- Q value, 304
- Quadratic
 forms, diagonalization, 252
 iterator, 509
 mapping, 503
- Quadrature, 75, 211
- Quadrupole moment
 gravitational, 226
 Sun, 541
- Quantization, 54
- Quantum
 commutator, 392
 corrections, 115
 electrodynamics, 54
 field theory, 576
 Hamiltonian, 613
 Heisenberg picture, 408
 mechanics, 111
 Bohr, 466
 perturbation theory, 526
 scattering, 120
 theory, 290
 transition from classical
 mechanics, 76
- Quark, 615
- Quasi-
 periodic, 461, 490
 static motion, 268
- Quaternion group, 610
- Radius
 gyration, 198
 vector, 73
- Rainbow scattering, 114
- Raman spectroscopy, 258
- Randomness, 483
- Rayleigh's dissipation function,
 23
- Reactance, 53
- Regularity, 488
 breakdown, 488
- Relativity, 276–328, 619
 4-vector, 287
 angular momentum,
 309–312
 collisions, 300–309
 electromagnetism, 297–300
 force, 297–300
 general, 324–328, 538
 Lagrangian, 312–324
 metric tensor, 287, 288, 291
 reduced mass, 71
 spacetime, 278–280
 special, 265, 276–324
 postulates, 277

- Representation**
 faithful, 609, 613
 group, 608
 irreducible, 608
 momentum, 576
Repulsive centrifugal barrier, 78
Residue, 469
Resonance, 260, 548
 deep, 549
 parametric, 509
 shallow, 549
 transients, 260
 vibrating system, 260
Resonant frequency of linear triatomic molecule, 255
Reversed effective force, 80
Reversible process, 336
Rheonomous, 13
Ricci tensor, 327
Riemann
 surface, 469
 tensor, 326, 327
Rigid body, 11
 angular momentum, 185–188
 definition, 134–138
 degrees of freedom, 134
 equations of motion, 184, 198–200
 Euler
 equations, 198–200
 theorem, 155, 156
 heavy symmetrical top motion, 208–223
 kinematics, 134, 184
 Lagrangian, 199
 motion, 134, 155–174
 nutating, 209, 214
 orientation, 169
 rotation, 155–174
 finite, 161–163
 infinite, 163–171
 solving problems, 198
 torque free motion, 200–223
Rigidity, 318
Roll angle, 154, 603
Rolling
 constraint, 14
 disk, 15
 hoop, 50
Rössler equations, 523
Rotation, 141, 452, 455
 active sense, 143
 clockwise, 162
 counterclockwise, 170
 finite, 161
 formula, 162, 170
 generator, 171
 group, 171
 infinitesimal, 162, 163
 instantaneous axis, 172
 kinetic energy, 191
 matrix, 142
 passive, 169
 sense, 143
 proper, 158
 trace, 160
 vector, 59
Routh
 Kepler problem, 348
 procedure, 56, 347
 Routhian, 348
Rutherford
 cross section, 110
 scattering, 131
Satellite
 artificial, 229
 close, 229
 orbiting Earth, 474
 orbits, 223, 229
Scalar, 189, 293
 curvature, 327
 field, 287
 meson, 571
 field, 599
 potential, 20
 product. Minkowski space, 288, 290, 291
 scale invariance, 591
 transformation, 370
Scattering, 106, 306
 angle, 112, 308, 309
 center of mass, 116
 cross section 107
 deflection angle, 114
 differential cross section, 107, 119
 elastic, 118, 120, 306
 glory, 114
 inelastic, 118
 laboratory coordinates, 115–121
 neutron, 120
 rainbow, 112
 Rutherford, 111, 131
Schrödinger equation, 54, 584, 599
Schwarzschild solution of Einstein field equations, 538
Scleronomous, 13, 25
Screening, nucleus, 111
Screw
 motion, 161
 symmetry axis, 161
Secular
 change, 531
 equation, 157, 244
 linear triatomic molecule, 254
 perturbation, 532, 535
Self-similarity, 505, 514
 fractal, 516–519
 logistic equation, 513–515
Semiclassical approximation, 115
Semiholonomic, 46, 48, 49
Semimajor axis, 95, 475
Semiminor axis, 101
Sensitivity to initial conditions, 491
Separation constant, 445
Siderial
 day, 175
 year, 538
Sierpinski
 carpet, 517–519, 522
 fractal dimension, 518
 sponge, 522
Sigma elementary particle, 615
Similarity transformation, 149, 158, 189
 trace, 160
Simultaneity, 580
Sine-Gordon
 equation, 585
 field, 585
SO(3) group, 413, 418, 610
SO(4) group, 414
SO(n) group, 418
SOHO, 126
Solar day, 175

- Soliton, 587, 596
- Sound vibrations in gas, 598
- Space
 configuration, 34, 357
 dual, 292
 filling, 521
 Minkowski, 278, 290
- Spacelike, 278, 580
- Spacetime, 278
 interval, 278
- Special relativity, 276
 postulates, 277
- Spherical triangle, 181, 476
- Spin angular momentum, 10
- Spiraling, 113
- Stability, 205
 marginal, 493
- Staeckel conditions, 446, 447
- Stationary
 path, 37
 value, 35
- Steady state, dynamic, 267
- Stochastic, 483
- Stokes' law, 24, 52
- Strange attractor, 489, 492, 500
 dimension, 521
 fractal dimension, 520
 Hénon-Heiles, 500, 501
- Strangeness, 615
- Stress
 energy tensor, 566, 570, 589
 conservation, 595
 properties, 578
 symmetrize, 572, 600
 tensor, 570
- Strong
 law of action and reaction, 7
 nuclear force, 299
- Structure
 analogy, 54
 constant, 412, 413, 612
- SU(2) group, 413, 418, 612, 615, 616, 621
- SU(3) group, 418, 615
- SU(4) group, 616
- SU(n) group, 418, 615, 616
- Subgroup, 606
- Submultiplet, 615
- Summation convention, 138, 169, 186
- Superconductivity, 618
- Supermultiplet, 615, 616
- Susceptance, 53
- Symmetry
 groups, 411–418
 mechanical systems, 411–418
 properties, 60
 spherical, 60, 72
- Symplectic, 343, 381
 approach, 339, 343
 canonical transformation, 381, 382
 condition, 384, 387, 422
 generating function, 394
 group, 387, 612
 Hamilton's equations, 343
 matrix, 384
 Poisson bracket, 388, 397
- System
 continuous, 568
 discrete, 558
 vector, 409, 410, 413
- Tachyon, 278
- Tait-Bryan angles, 154
- Tardyion, 278
- Taylor series, 239
 potential expansion, 482
- Temperature, definition, 85
- Tensor, 188–191
 alternating, 169
 Cartesian, 189
 definition, 293
 first rank, 189
 inertia, 191–198
 isotropic of rank 3, 169
 metric, 286
 moment of inertia, 191–198
 product, 294
 properties, 188
 rank, 293
 second rank, 188
 slots, 293
 unit, 190
 wedge product, 295
 zero rank, 189
- Thermodynamics, 336
- Thomas
 frequency, 285
 precession, 282, 330
- Three body problem, 121–126, 617
 Euler solution, 122
 Lagrange solution, 123
 restricted, 124, 133
- Threshold energy, 302–305
- Time dilation, 279
- Timelike, 278
- Top
 Euler equations, 210
 fast, 215, 221
 heavy symmetrical, 200, 208, 482
 with one point fixed, 208
 motion, 208, 212
 sleeping, 221
 symmetric, 618
 tippie, 221
 uniform, 221
- Topological dimension, 518
- Torque, 2
 critical, 266
 damping, 266
 gravitational, 223
 pendulum, 266
- Torus, 487, 492
- Tour de force, 407
- Trace of similarity transformation, 160
- Transformation
 active sense, 143
 canonical, 368–421
 infinitesimal, 396
 restricted, 371, 382
 congruence, 245, 246, 252
 equation, 13
 extended canonical, 371
 formal properties, 144
 Galilean, 281
 gauge, 595
 generating function, 371
 identity, 146, 156, 395
 improper, 151, 168
 infinitesimal, 165
 canonical (I.T.C.), 396

- Transformation (*cont.*)
 Legendre, 375, 549
 examples, 375
 linear, 187
 Lorentz, 280
 matrix, 144
 elements, 140
 operator, 142
 orthogonal, 139–150, 184
 passive sense, 143
 point, 31, 370, 422
 principal axis, 241
 proper, 151
 restricted canonical, 371, 382
 rigid body rotation, 139–155
 scale, 370
 similarity, 149, 158, 180, 189, 244
- Transient, 260
- Translational mode, 272
- Triatomic molecule, 275
- Triple cross product, 186
- Turning angles, 213
- Twin paradox, 285
- Ultrarelativistic, 303
 region, 308
- Undetermined multipliers of
 Lagrange, 46, 363
- Unitary matrix, 412
- Unstable moment of inertia axis,
 205
- van der Pol
 equation, 490
 limit cycle, 491
- Variable
 canonical, 335
- fast, 547
 slow, 547
- Variation, 354
 δ -type, 38, 44
 Δ -type, 357, 359
 integral, 44
 line integral, 35
- Variational
 Hamiltonian, 353
 principle, 5, 34–43, 51
- Vector
 4-vector
 energy, momentum, 295, 300, 301
 photon momentum, 304
 table, 287
 velocity, 286–288
 addition, 163
 axial, 168
 conserved, 104
 covariant, 289
 field, table, 287
 first rank tensor, 189
 flux density, 569
 Minkowski space, 286
 polar, 167
 radius, 73
 rate of change, 171–174
 system, 409, 410, 413
 tangent, 286, 326
- Velocity
 addition law, 282
 angular, 172, 187
 critical, 221
 rigid body, 172
 areal, 73
 critical angular, 221
 escape, 31
- field, 588
 four-, 286
 generalized, 25, 319
- Vibration
 anharmonic, 255
 forced, 259, 264
 free, 250, 253
 modes, 261
 linear triatomic molecule,
 253
 longitudinal mode, 257
 number of normal modes,
 255
 transverse mode, 257
- Virial
 Clausius, 84, 128
 theorem, 83–86, 94, 472
- Virtual
 displacement, 16, 20
 work principle, 17
- Viscosity, 51, 265
- Wavefunction, 613
- Weak nuclear force, 299
- Weber's electrodynamics,
 367
- Wedge product, 295, 296
- Wheatstone bridge, 66
- Witten and Sander diffusion
 model, 524
- Wobble, Chandler, 208, 228
- Work, 9
- Yaw angle, 154, 603
- Year, anomalistic, 131
- Young's modulus, 559, 560
- Zeeman effect, 232

