

This is a reproduction of a library book that was digitized by Google as part of an ongoing effort to preserve the information in books and make it universally accessible.

Google™ books

<https://books.google.com>

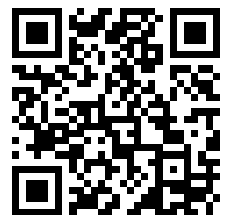

THE UNIVERSITY
OF ILLINOIS

LIBRARY
Q.535.05
JO
v.6



NOTICE: Return or renew all Library Materials! The *Minimum Fee* for each Lost Book is \$50.00.

The person charging this material is responsible for its return to the library from which it was withdrawn on or before the **Latest Date** stamped below.

Theft, mutilation, and underlining of books are reasons for disciplinary action and may result in dismissal from the University.
To renew call Telephone Center, 333-8400

UNIVERSITY OF ILLINOIS LIBRARY AT URBANA-CHAMPAIGN

OCT 24 1968

IRR

OCT 13 1967

~~INTERLIBRARY LOAN~~

~~INTERLIBRARY LOAN~~

L161—O-1096

Journal of the Optical Society of America and Review of Scientific Instruments

EDITOR-IN-CHIEF: PAUL D. FOOTE
BUREAU OF STANDARDS, WASHINGTON, D.C.

ASSISTANT EDITOR-IN-CHIEF AND BUSINESS MANAGER: F. K. RICHTMYER
CORNELL UNIVERSITY, ITHACA, N. Y.

CONSULTING BUSINESS MANAGER, M. E. LEEDS, Philadelphia, Pa.

Associate Editors:

Term Ending
Dec. 31, 1923
H. D. CURTIS
E. P. HYDE
PAUL E. KLOPSTEG
L. SILBERSTEIN
L. T. TROLAND
F. E. WRIGHT

Term Ending
Dec. 31, 1925
G. K. BURGESS
K. T. COMPTON
L. R. INGERSOLL
C. E. K. MEES
C. E. MENDENHALL
D. C. MILLER

Term Ending
Dec. 31, 1927
W. T. BOWIE
H. G. GALE
HERBERT E. IVES
W. B. LANCASTER
P. G. NUTTING
J. P. C. SOUTHALL

Volume VI, Numbers 1 to 10, 1922

OFFICE OF PUBLICATION:
GEORGE BANTA PUBLISHING COMPANY
MENASHA, WISCONSIN

THE
MEMOIRS
OF



Q.535.05

JO
v. 6

1111

TABLE OF CONTENTS

Volume VI

JANUARY, 1922

Announcement	1
Brilliance and Chroma in Relation to Zone Theories of Vision	3
LEONARD THOMPSON TROLAND	
Measurement of the Color Temperature of the More Efficient Artificial Light Sources by the Method of Rotatory Dispersion	27
IRWIN G. PRIEST	
The Blue Glow	42
E. L. NICHOLS AND H. L. HOWES	
The Significance of the $\frac{1}{2}$ Terms in Spectral Series Formulae	54
PAUL D. FOOTE AND F. L. MOHLER	
The Dispersion of Glass	57
T. SMITH	

INSTRUMENT SECTION

The Crystalliptometer, an Instrument for the Polariscopic Analysis of Very Slender Beams of Light	67
LE ROY D. WELD	
Reviews and Notices	92

MARCH, 1922

Report on Atmospheric Scattering, Sky Polarization and Allied Phenomena	99
F. E. FOWLE	
Note on Mr. F. E. Wright's Article for Determining Prism Angle Errors . . .	108
WALTER F. C. FERGUSON	
Invariant Ratios and Functions in Glass Dispersion	109
P. G. NUTTING	
The Propagation of Light in Rotating Systems	112
A. C. LUNN	
Observations on the Rare Earths, XI: The Arc Spectrum of Yttrium	121
L. F. YNTEMA WITH B. S. HOPKINS	
1921 Report of Committee on Standard Wave-Lengths	135
W. F. MEGGERS	
The Gloss Characteristics of Photographic Papers	140
L. A. JONES	

INSTRUMENT SECTION

Standard Radio Wavemeter, Bureau of Standards Type R 70B	162
R. T. COX	
Mercury Lubricated Resistance Box Plugs	169
J. R. ROEBUCK	

III

526579

TABLE OF CONTENTS—Continued

A High-Voltage Storage Battery for Use with Electron Tube Generators of Radio-Frequency Currents	17
E. L. HALL AND J. L. PRESTON	
A Method of Testing Plates from Piezo-Electric Crystals	18
W. G. CADY	
An Electron Tube Amplifier for Amplifying Direct Current	18
H. A. SNOW	
A Simple Form of Laboratory Potentiometer	19
H. W. FARWELL	
Photography of Moving Interference Fringes	19
AUGUSTUS TROWBRIDGE	
A High Speed Precision Relay	19
CARL KINSLEY	
Notices	20

MAY, 1922

Review of the Present Status of the Two Forms of Quantum Theory	21
RICHARD C. TOLMAN	
Mathematical Aspects of Quantum Theory	22
H. B. PHILLIPS	
Some Recent Applications of the Quantum Theory to Spectral Series	23
SAUL DUSHMAN	
The Evaluation of Quantum Integrals	25
A. SOMMERFELD	
Critical Frequency Relations in Scotopic Vision	25
HERBERT E. IVES	

INSTRUMENT SECTION

A Pocket Size Range Estimator	26
H. W. FARWELL	
A New Form of Electrostatic Voltmeter	27
J. E. SHRADER	
The Phonelescope	27
HERBERT GROVE DORSEY	
A Differential Electrodynamometer	28
E. D. DOYLE	
A Precision X-Ray Spectrometer	28
H. M. TERRILL	
Notices	25

JUNE, 1922

The Beginnings of Optical Science	29
JAMES P. C. SOUTHALL	

TABLE OF CONTENTS—Continued

Helmholtz on the Doctrine of Energy	312
HENRY CREW	
Helmholtz's Contributions to Physiological Optics	327
LEONARD THOMPSON TROLAND	
Reminiscences of Hermann von Helmholtz	336
M. I. PUPIN	
A Theory of Intermittent Vision	343
HERBERT E. IVES	
The Visibility Function and Visibility Thresholds for Color-Defectives	362
MARGARET C. SHIELDS	
Recalescence in Antimony	369
ENOCH KARRER	

INSTRUMENT SECTION

Three-plane Orientation Clamp	374
W. R. MILES	
Note on a Method of Increasing the Carrying Capacity of a Rheostat	376
W. E. FORSYTHE	
Constructional Data for a Cemented Objective of Barium Crown and Flint ..	379
I. C. GARDNER	
An Apparatus for Studying the Motion of Relays	391
HERBERT E. IVES AND T. L. DOWEY	
Infra Red Telegraphy and Telephony	398
T. W. CASE	
Notices	407

JULY, 1922

False Spectra from Diffraction Gratings	
I. Secondary Spectra	417
W. F. MEGGERS AND C. C. KIESS	
II. Theory of Lyman Ghosts	429
CARL RUNGE	
III. Periodic Errors in Ruling Machines	434
J. A. ANDERSON	
On the Propagation of Light in Rotating Systems, A Rejoinder to Dr. A. C. Lunn	443
LUDWIK SILBERSTEIN	
On the Optical Constants of Selenium in the form of Isolated Crystals	448
L. P. SIEG	
Huygens' Contributions to Dioptrics, with Notes	461
JAMES P. C. SOUTHALL	
Accuracy in Color Matching of Incandescent Light Sources	476
W. E. FORSYTHE	

TABLE OF CONTENTS—Continued

INSTRUMENT SECTION

Cooperation Between the Makers and the Users of Apparatus in America . . .	4
F. K. RICHTMYER	
A Field Telemeter for Approximate Surveying	4
I. C. GARDNER	
On the Characteristics of Optical Systems for Reading Small Mirror Deflections	4
G. W. MOFFITT	
Contact Resistance	5
IRVING B. SMITH	
An Apparatus for Demonstrating the Electrical Properties of Conducting Gases	5
JOHN ZELENY	
Reviews and Notices	5

AUGUST, 1922

Report of Committee on Colorimetry for 1920-21	5
L. T. TROLAND	
Heteromorphies Due to Variation of Effective Aperture and Visual Acuity . .	5
K. HOROVITZ	
The Absorption of the Eye for Ultra-Violet Radiation	6
WINIFRED P. GRAHAM	

INSTRUMENT SECTION

A New Principle and Its Application to the Lummer-Brodhun Photometer . .	6
E. P. HYDE AND F. E. CADY	
An Electromagnetic Method of Detecting Minute Irregularities in Curvature of Spheres and Cylinders and of Controlling the Oscillations of a Mass of Metal Suspended by Means of a Torsion Fibre	6
ALEXANDER MARCUS	
An Improved Form of Nichols Radiometer	6
B. J. SPENCE	
A Portable Seismometer	6
P. G. NUTTING	
An Instrument for the Gamma Ray Measurement of the Radium Content of Weakly Active Materials	6
N. ERNEST DORSEY	
The Effect of a Photo-electric Material on the Thermo-electric Current in High Vacuum Audion Bulbs	6
THEODORE W. CASE	
Direct Capacity Measurement	6
GEORGE A. CAMPBELL	
Notices	6

TABLE OF CONTENTS—Continued

SEPTEMBER, 1922

Magnetic Rotation in Various Liquids in the Short Infra-red Spectrum	663
L. R. INGERSOLL	

INSTRUMENT SECTION

The Classification of Optical Instruments	682
T. SMITH	
Summary of the Literature Relative to the Formation of Film on Polished Glass Surfaces	688
GEORGE W. MOREY	
A Suspension to Eliminate Mechanical Disturbances	694
ALBERT P. CARMAN	
A Form of Iron Clad Thomson Astatic Galvanometer	696
B. J. SPENCE	
A Low Voltage Cathode Ray Oscillograph	701
J. B. JOHNSON	
Specifications for Recording Vapor-Pressure Thermometers and for Pressure Gages	713
FREDERICK J. SCHLINK	
Sieve Testing Apparatus	719
L. V. JUDSON AND R. E. GOULD	
The Film Method of Measuring Surface and Interfacial Tension	722
A. W. FAHRENWALD	
The Passage of Hydrogen Through Quartz Glass	734
J. B. JOHNSON AND R. C. BURT	
A Simple Apparatus for Comparing Thermal Conductivity of Metals and Very Thin Specimens of Poor Conductors	739
M. S. VAN DUSEN	
Aeronautic Instruments	744
FRANKLIN L. HUNT	
Reviews	812

OCTOBER, 1922

A Photo-Electric Theory of Color Vision	813
JANET H. CLARK	
Pioneers in Physiological Optics	827
JAMES P. C. SOUTHALL	

INSTRUMENT SECTION

The Mechanics of Optical Polishing	843
ELIHU THOMSON	
A Variable Resistor of Low Value	848
C. N. HICKMAN	

TABLE OF CONTENTS—Continued

A Rotary Slide-Wire for Producing Uniform Variation in Potential Difference	S. J. MAUCHLY
A Simple Direct-Reading Potentiometer for Standard Cell Comparisons . . .	MARION EPPLEY AND WILLIAM R. GRAY
On Construction of Platinum Thermometers and of Resistance Coils	J. R. ROEBUCK
The Drainage Error in the Bingham Viscometer	WINSLOW H. HERSCHEL
Specifications for Bourdon Tube Pressure Gages for Air, Steam, and Water Pressures, and for Use as Reference Standards	FREDERICK J. SCHLINK
A Method of Maintaining Small Objects at any Temperature Between -180° and $+20^{\circ}$ C	P. P. CIOFFI AND L. S. TAYLOR
A Tungsten Furnace for Experiments on Dissociation and Ionization	K. T. COMPTON

NOVEMBER, 1922

Note on the Energy Exchanges in the Formation of the Latent Image of a Photographic Emulsion	S. E. SHEPPARD AND E. P. WIGHTMAN
The Optical Constants of Isolated Tellurium Crystals	GEORGE DEWEY VAN DYKE
The Study of Visual Processes by Means of Momentary Retinal Shadows . .	FREDERICK W. ELLIS
A Comparison of the Fechner and Munsell Scales of Luminous Sensation Value	ELLIOT Q. ADAMS

INSTRUMENT SECTION

The Measurement and Specification of Optical Characteristics in Projector Performance	G. W. MOFFITT
An Electron Tube Tuning Fork Drive	E. A. ECKHARDT, J. C. KARCHER AND M. KEISER
A Laboratory Hypsometer	E. F. MUELLER AND T. S. SLIGH, JR.
A High Temperature Regulator for Use with Alternating Current	HOWARD S. ROBERTS
An Integraph Based on Parallel Double Tongs	VLADIMIR KARAPETOFF
Reviews and Notices	

TABLE OF CONTENTS—Continued

DECEMBER, 1922

Extraordinary Diffraction of X-Rays	989
L. W. MCKEEHAN	
On the Quantity of Light Energy Required to Render Developable a Grain of Silver Bromide	998
P. S. HELMICK	
Recent Measurements of Stellar and Planetary Radiation	1016
W. W. COBLENTZ	

INSTRUMENT SECTION

The Lensometer, An Instrument for the Measurement of the Effective or Vertex Power of Ophthalmic Lenses	1030
CHARLES SHEARD AND E. D. TILLYER	
A Hemispherical Photometric Integrator	1040
FRANK BENFORD	
Telephone Receiver and Transmitter	1059
C. W. HEWLETT	
A Small High Intensity Mercury Arc in Quartz-glass	1066
L. J. BUTTOLPH	
Correlation of Elementary Proofs of the Fundamental Properties of Oblique Deviation by Prisms	1072
H. S. UHLER	
Index to Volume VI	1077

OFFICERS
OF THE
OPTICAL SOCIETY OF AMERICA
FOR THE YEAR 1922

President: L. T. TROLAND	Harvard University, Cambridge, Mass.
Vice-Pres: HERBERT E. IVES	Western Electric Co. New York, N. Y.
Secretary: IRWIN G. PRIEST	Bureau of Standards Washington, D. C.
Treasurer: ADOLPH LOMB	Rochester, N. Y.

The Council consists of the above officers, the Editor-in-Chief and the Assistant Editor-in-Chief and Business Manager of the JOURNAL, the past President, James P. C. Southall, Columbia University, and the following elected members: Adelbert Ames, Dartmouth College, H. G. Gale, University of Chicago, Ernest Merritt, Cornell University and W. E. Forsythe, Nela Research Laboratories.

The object of the Optical Society of America is to serve the interests of all who are engaged in any branch of optics from fundamental research to the manufacture of optical goods.

The Constitution provides that anyone who has contributed materially to the advancement of optics shall be eligible to regular membership in the Society, with the privilege of voting and holding office. Anyone interested in optics is eligible to associate membership.

23451
351

Journal
of the
Optical Society of America
and
Review of Scientific Instruments

Vol. VI JANUARY, 1922 Number 1

ANNOUNCEMENT

The Optical Society of America announces the addition to its JOURNAL of a section on "Scientific Instruments" beginning with the March, 1922 number. The Journal will henceforth be known as the JOURNAL OF THE OPTICAL SOCIETY OF AMERICA AND REVIEW OF SCIENTIFIC INSTRUMENTS.

For several years the question of establishing an Instrument Journal in this country has been agitated. Practically no source of publicity has existed for the presentation of articles describing new laboratory and scientific instruments. There has been no question as to the need for and desirability of such a journal; the problem has been as to the means whereby it might be established.

Some time past the National Research Council suggested that the JOURNAL OF THE OPTICAL SOCIETY might enlarge its field to include papers on instrument design of all kinds, as well as optical. After careful consideration on the part of the Council of the Society it was decided that such an arrangement was in the best interest of the readers of the JOURNAL.

By cooperation with the Association of Scientific Apparatus Makers of the United States of America, especially through the efforts of its president, Mr. M. E. Leeds, by cooperation with the National Research Council, and through the agency of certain generous patrons, the Optical Society has been able to launch the

combined "JOURNAL OF THE OPTICAL SOCIETY OF AMERICA AND REVIEW OF SCIENTIFIC INSTRUMENTS" on a strong financial basis.

The March and succeeding issues of the new JOURNAL will devote approximately $\frac{3}{8}$ of the reading matter to material on instruments other than optical. Beginning May 1922 the JOURNAL will be issued monthly instead of bi-monthly, so that the total for each year will contain as much material in pure optics as formerly and in addition some 400 or 500 pages on design of instruments of every description. The rate of subscription probably will be increased sometime during the current year, but for the immediate present the same rate will be maintained as formerly.

The success of any journal is largely determined by the length of the subscription list. While the JOURNAL OF THE OPTICAL SOCIETY has been very fortunate in this respect, its circulation having doubled twice in the past two years, it nevertheless, from the specialized nature of the material presented, must have a direct appeal to a comparatively limited number of readers.

The new JOURNAL should interest a very large group of readers. It is believed that this enterprise will meet with the approval and cooperation of all engaged in scientific work from the manufacture of apparatus to fundamental research. The permanent success of the venture rests with the readers and contributors. Let each reader and member of the Society cooperate to make this JOURNAL one of high scientific merit and large circulation. Let us place 2500 subscriptions as a conservative goal for 1923.

BRILLIANCE AND CHROMA IN RELATION TO ZONE THEORIES OF VISION*

BY
LEONARD THOMPSON TROLAND

I. INTRODUCTION

Ophthalmologists draw a clear line of demarcation between three functions of vision which they call the light sense, the form sense, and the color sense respectively. They find that in visual derangements these three functions may be disturbed more or less independently. However, theorists in the field of physiological optics have not been able to agree that these three functions rest upon separate mechanisms. From some points of view and by certain tests they appear to be distinct, but from other angles they appear to be simply different aspects of an integral process. It is my purpose in the present paper to discuss certain problems relating to the separateness of the mechanisms underlying two of these functions, *viz.*, those of the light sense and the color sense. I shall review and attempt to synthesize certain data previously established by others, but in addition shall present new data of my own bearing upon the problem.

It will be necessary in the beginning to define clearly certain of the terms to be used in the ensuing discussion. A great deal of confusion exists in arguments over visual problems as a result of the absence of a definitely established nomenclature. In the majority of discussions in this field there is a failure to distinguish clearly between psychological, or subjective conceptions, and physical conceptions which relate only to the stimulus. The Colorimetry Committee of the Optical Society in its forthcoming report¹ has worked out what it deems to be a consistent terminology, and I shall make an endeavor to employ this in the present paper. You have been accustomed to hear the two aspects of visual experience, which I am to consider, described by the terms

* Paper presented to the Rochester Section of the Optical Society of America, October 10, 1921.

¹ To appear in a later number of this JOURNAL.

“brightness” and “color.” However, the word “brightness” has a distinct meaning in photometry which should not be confused with that dimension of visual sensation which is defined by the terminal qualities black and white. The preferred term for this dimension, or attribute, of visual sensation is the word “brilliance.” A careful consideration of all of the circumstances bearing upon the problem, moreover, seems to make it advisable to employ the word “color” to designate any visual sensation whatsoever, including the neutral, or achromatic, qualities as well as the chromatic ones. In order to distinguish the latter from the former, therefore, we must employ a different word, for which the term “chroma” appears to be appropriate. I may therefore define my problem succinctly as that of the interrelation between the physiological mechanisms underlying brilliance and chroma vision.

II. FACTS INDICATING THE INDEPENDENCE OF BRILLIANCE AND CHROMA

There is a considerable array of facts which strongly suggest that these mechanisms are distinct from one another. The first consideration which comes to mind is naturally that of the evolution of color vision. Experiments in the field of comparative physiology, such as those carried out by the indefatigable Carl von Hess,² indicate clearly that the invertebrates are totally lacking in chroma vision. Their reactions to radiation are wholly in terms of different degrees in a single dimension which we may suppose to be that of brilliance or apparent brightness. Their vision is achromatic. The consensus of evidence also is that the lower vertebrates, such as fish, are incapable of chromatic discrimination, their differentiated responses to various colors being based wholly upon differences in the brightness effects of the latter.³ Many birds and mammals, however, seem to possess the power of true chromatic differentiation between stimuli. The visual capacities of the higher primates are apparently practically

² See, for example, Hess C. v. Beiträge zur Kenntnis des Lichtsinnes bei Wirbellosen. *Arch. f. d. ges. Physiol.*, 177, 57-109; 1920.

³ See, for example, Schnurmann, F. Untersuchungen an Elritzen über Farbenwechsel und Lichtsinn der Fische. *Zeitsch. f. Biol.*, 71, 69-98; 1920.

the same as those of man. It appears probable, therefore, that brilliance vision appeared in the course of evolution long before chromatic vision, the latter being superposed upon the former by a process of accretion or of differentiation.

Facts of visual pathology and anomaly also suggest strongly that brilliance vision is more fundamental than chromatic vision. Disease or injury of the nervous mechanisms connected with vision more readily disturbs chromatic discrimination than it does discrimination in terms of brilliance. Congenital partial or total "color blindness" involves a loss or impairment of the capacity for differentiation of chromas without necessarily bringing with it a similar disorder of brilliance judgment. The different types of chromatic blindness can, in fact, be arranged in an evolutionary series ranging from anomalous trichromatism through deuteranopia, or green blindness, and protanopia, or red blindness, to the complete absence of chromatic response which is commonly known as "total color blindness."⁴ In these various forms of chromatic blindness it would appear that successively laid down strata of visual mechanism have been destroyed by accidents to the germ plasm, these accidents representing various degrees of atavism. The resulting visual types may be taken to represent actual stages in the evolution of human vision.

However, we do not have to look to pathological or rare cases for evidence that chromatic vision is something superposed upon a more fundamental brilliance vision. In the distribution of the capacity for chromatic discrimination between the center and the periphery of the visual field we seem to discover a replica of the evolutionary process. In the extreme periphery of the visual field chromatic vision appears to be practically in abeyance, all objects, except under conditions of very high illumination, being perceived as neutral in color.⁵ As the stimulus is moved from the periphery towards the center, chromatic discrimination in terms of blueness

⁴ See Hess, C. v. Die Rotgrünblindheiten. *Arch. f. d. ges. Physiol.*, 185, 147-164, 1920.

⁵ Ferree and Rand find that red, yellow and blue, but not green, can be perceived as chromatic at the extreme periphery with a sufficient intensity of light. See Ferree, C. E. and Rand, G. The Absolute Limit of Color Sensitivity and the Effect of Intensity of Light on the Apparent Limit. *Psychol. Rev.*, 27, 1-23, 1920.

or yellowness first becomes possible, this being succeeded at a more central position by an added power of discrimination in terms of redness and greenness. In the center of the field for the normal individual we find complete color vision. It is a very significant fact that in spite of these wide differences which exist between the chromatic perception of various portions of the retina, under conditions of daylight adaptation, the visibility curves representing the brilliance responses of these various portions are practically identical.⁶

Another very impressive group of facts which indicate the separability of the mechanisms underlying brilliance and chroma is to be found in a considerable number of laws of visual response in which the effects produced by lights of different color are substantially independent of the chromatic aspect and rest almost wholly upon the brilliance factor. One of the most familiar of these laws is to be found in the logarithmic function which connects visual acuity with luminosity. This function, which represents the threshold of the form sense, is seemingly determined, to the first order at least, by the brilliance value of any stimulus independently of its hue or saturation effects.⁷ There are, of course, second order dependencies upon wave-length, as has been demonstrated by Luckiesh,⁸ but these latter dependencies are

⁶ See Parsons, J. H. *An Introduction to the Study of Color Vision*, p. 71, 1915.

⁷ The proposition that the acuity index depends upon the brightness value of a stimulus, independently of its color, was clearly enunciated by Helmholtz in several places, and had been assumed by previous workers such as Macé de Lapinay and Nicati who employed equality of acuity as a criterion of equality of brightness. Repeated attempts have been made to employ an acuity test as a basis for heterochromatic photometry. König regarded his very systematic work on this subject as clearly substantiating Helmholtz's original conjecture. See König, A. *Die Abhängigkeit der Sehscharfe von der Beleuchtungsintensität, Gesammelte Abhandlungen zur Physiologischen Optik*. 1903, p. 391. However, the problem is much complicated by uncertainty in the conditions or method of observation; the proportions of rod and cone vision involved, the exact visibility curves of the observers, and the exact importance of the purely physical chromatic aberration effects within the eye. Dr. Ferree finds a very considerable dependence of acuity upon chroma even when rod vision is excluded. Whether his results, in common with those of Luckiesh, can be explained in terms of the refractive properties of the eye or whether they will require a retinal basis is at present uncertain.

⁸ Luckiesh, M. *Color and Its Applications*, pp. 130-137, 1915.

directly traceable to the chromatic aberration of the eye which forms a sharper image upon the retina for the mid wave-lengths of the spectrum than for the extreme wave-lengths. Given equally sharp retinal pictures, it would seem that the resolving power of the optical mechanism is determined wholly by the brilliance response without reference to chroma.

Another well known law of this character is that which links critical flicker frequency with the brightness of the stimulus. T. C. Porter found that this frequency, the rate of alternation of a color with black which is required just to eliminate flicker, is strictly proportional to the logarithm of the brightness throughout a range of from 1 to 12800 units of intensity and that the proportionality factor is strictly independent of wave-length.⁹ Here again, as shown later by Ives,¹⁰ there are secondary dependencies upon chroma, but these seem to rest upon the fact that there are two kinds of flicker, one a brilliance flicker and the other a chromatic flicker, which are not quite separable at low intensities and rates of alternation. Moreover, the situation is complicated by the different degrees of participation of rod and cone vision in the process as aroused by stimuli of different wave-lengths at low brightnesses, the brilliance response of the rods being much more sluggish than that of the cones. The substantial independence of critical flicker frequency upon chroma is, of course, the basis of the critical frequency method of heterochromatic photometry.

Another function of brilliance which shows very little concomitant dependence upon chroma is the time required for the brilliance sensation to reach its maximum after the first application of the stimulus. McDougall's investigation¹¹ indicated that this so-called action time was quite independent of chroma. The much discussed experiments of Broca and Sulzer,¹² however,

⁹ Parsons, J. H., *op. cit.*, p. 96.

¹⁰ Ives, H. E. Studies in the Photometry of Lights of Different Colors. II. Spectral Luminosity Curves by the Method of Critical Flicker Frequency. *Phil. Mag.*, 24, p. 357-362, 1912.

¹¹ McDougall, W. The Variation of the Intensity of Visual Sensation with the Duration of the Stimulus. *British Jour. of Psychol.*, 1, p. 189, 1904

¹² See Nutting, P. G. The Luminous Equivalent of Radiation. *Bull. of the Bur. of Stands.*, 5, p. 293; 1908.

showed a considerable difference in the rates of rise of sensation due to stimuli of different wave-length compositions. The recent very elaborate measurements of Bills¹³ also show an appreciable difference between colors of the same brilliance but differing hue. However, neither of these investigations, apparently, were made under conditions which insure equal degrees of participation of rod and cone vision for all of the stimuli employed, and the close affiliation which exists between rates of rise and fall, for various stimuli, and flicker frequency, suggests that causes of error in the investigations in question may exist.

A further very important visual function which rests exclusively upon the luminosity of the stimulus is the brightness discrimination threshold. The elaborate measurements made by König¹⁴ with a wide range of spectral stimuli demonstrate that for cone vision Weber's constant, and Fechner's law, which is derived from it, are practically independent of chroma. It is probable also that the brilliance contrast effects between color fields of differing brilliance are independent of concomitant chroma or chroma differences. I gather this from qualitative observations of my own, although I have not been able to find any published accurate data on the subject. The investigations of Ives¹⁵ and others have made it clear that the separate brightnesses of different colors which are mixed additively summate arithmetically without reference to their differences in chroma.

All of the above discussed facts, which indicate that brilliance can act as an independent variable determining other visual functions almost without reference to the accompanying chroma, may perhaps be regarded as somewhat lacking in significance because, to a certain extent at least, they may be considered as definitory of the nature of brilliance. It has been suggested, for example, that brilliance be defined in terms of equal flicker frequencies or in terms of equal acuity results. I do not regard

¹³ Bills, M. A. The Lag of Visual Sensation and Its Relation to Wave-Length and Intensity of Light. *Psychological Review Monographs*, 28, No. 5.

¹⁴ See Nutting, P. G. *loc. cit.*, p. 286.

¹⁵ Ives, H. E. Studies in the Photometry of Lights of Different Colors. IV. The Addition of Luminosity to Different Colors. *Phil. Mag.* 24, pp. 845-853, 1912.

this objection as actually capable of substantiation, but, on the other hand, it is significant that most of the laws which we have above considered involve processes of discrimination as essential factors. These discrimination processes undoubtedly depend upon cortical mechanisms which are especially adapted to deal exclusively with brilliance or its underlying physiological correlate, and hence the lack of dependence which the resulting reactions show with respect to chroma might be considered as indicative merely of a highly efficient selective response of these discriminative activities. However, there are other facts to which we can yet appeal which are not subject even to this last objection.

It is a common conviction among students of physiological optics that negative after-image phenomena depend upon retinal rather than upon central changes. These phenomena are usually explained in terms of general or differential retinal fatigue, that is, as results of reduction in the sensitivity of the retinal mechanism to stimuli, this sensitivity being supposedly represented by the concentration of some chemical substance. Negative after-image effects may be divided into brilliance and chromatic aspects. I have personally made a very large number of observations and measurements upon the brilliance aspects of negative after-images produced by spectral or other highly chromatic stimuli. Except under special conditions which I shall discuss in more detail later on I have found these effects to be practically independent of chroma. For example, the duration of negative after images produced by spectral colors and projected upon a reacting field or background of the same spectral color as produced the image are practically the same for all wave-lengths of the stimulus.¹⁶ It is true that there is a slightly less duration for stimuli lying at the ends of the spectrum than for those lying in the middle, and also that the red after-image has a somewhat longer life than the violet one. However, it seems probable that these secondary differences are due to differences in the sharpness of the primary stimulus images which produce the after-effects, such sharpness

¹⁶ Troland, L. T. Apparent Brightness; Its Conditions and Properties. *Trans. of the Illum. Eng. Soc.* 5, p. 954; 1916.

discrepancies being referable to the chromatic aberration of the eye, which influences the distinctness of the retinal picture in the several cases. I have made careful measurements of the time required for brilliance fatigue, or minuthesis, as I have proposed to call it, to reach an equilibrium condition for different spectral stimuli, and find that for colors of equal brilliance this time is practically independent of chroma. Similar statements apply to the degree of reduction of the sensitivity of the visual system which is brought about by this minuthetic process in any specified time or at equilibrium with stimuli of equal brightness. The general laws of brilliance minuthesis, in other words, are substantially independent of chroma. I shall return to a consideration of such further special laws later on.

III. THE PROBLEM IN THE LIGHT OF CLASSICAL THEORIES

Having reviewed the above facts bearing upon our problem, let us now turn to a discussion of the most important theoretical treatments dealing with the interrelation of brilliance and chroma vision. The two salient theories of vision, those of Hering and of Young and Helmholtz,¹⁷ involve radically distinct conceptions of the relation holding between brilliance and chroma. Hering, in the original formulation of his theory, regarded brilliance as identical with whiteness and, therefore, as proportional to the degree of excitation of the white process, in his theory, or of lack of excitation of the black process. Later on, however, he introduced the conception of the specific brightness of colors according to which the red and yellow processes of his theory possess a brilliance-producing power while the green and blue processes have a negative capacity in this respect, or are "specifically dark." The total brilliance effect according to Hering's view, therefore, represents the algebraic sum of contributions made by all six processes, the white, red, and yellow adding to, while the black, blue, and green subtract from the total. Even in accordance with this specific brightness theory, however, the preponderant contribution appears to be made by the black-white process,

¹⁷ For expositions of these two theories see Parsons, J. H., *op. cit.*, Part III.

so that Hering's hypothesis seems consistent with the existence of a very considerable independence of brilliance function with respect to chroma. A residual dependence, however, should be expected, and this should be of the order of magnitude of the difference between cone and rod vision luminosity distribution over the spectrum, or between the photopic and scotopic visibility curves. It was in order to explain these differences that Hering originally introduced the specific brightness theory.

The Young-Helmholtz theory, being characterized in general by a less subtle psychological analysis, than that which governed Hering's conjectures, makes assumptions concerning the interrelations of the brightness and chroma mechanisms which are far simpler and more naïve. Helmholtz himself and also his followers, König and Dieterici, paid relatively little attention to the relations of photometric measures to color-mixture data. The latter two investigators, for example, although their determinations of the three color sensation curves are probably the most thorough on record, provide us with no measures whatsoever of the relative photometric values of the unit in which their sensation curves are expressed. This criticism, however, does not apply to Abney,¹⁸ whose recent death robs us of one of the most painstaking investigators of visual phenomena in the light of the Helmholtz Theory. This theory, as is well known, makes the chromatic aspects of color vision depend upon the proportions of excitation of three elementary mechanisms. It is very natural to hold that the brilliance accompanying any complex or simple excitation is simply the sum of the excitation values of the components which are involved.

The treatment of brilliance or luminosity value as the sum of the color excitation values is not only a theoretically obvious hypothesis, but is a straightforward development of the data involved in the case; although in spite of this fact these data cannot be regarded as proving the physiological identity of the brilliance and chroma mechanisms. When a spectrum having a characteristic luminosity distribution,—for example one possessing

¹⁸ See Abney, W. de W. *Researches in Color Vision and the Trichromatic Theory*, 1913.

equal energy values, for all wave-lengths, in which case the luminosity distribution would be proportional to the visibility curve,—is matched by varying mixtures of three elementary stimuli it is of course a necessary consequence of the additive property of luminosities that the sum of the luminosity distributions of the three elementaries should yield the original luminosity distribution of the spectrum which was matched. However, this same result should be expected if the luminosity values of the elementaries do not represent integral aspects of the color excitation processes, but simply more or less accidental associates of these excitation values the magnitudes of which are determined by the exact point in the spectrum from which the three elementary stimuli are picked. The brilliance process necessarily has a characteristic distribution over the spectrum, represented approximately at least by the visibility curve. Similarly, the three chromatic processes also have their own characteristic distributions, and a stimulus taken at any point in the spectrum will naturally pick up the chromatic and the brilliance activities in a fixed ratio, and this ratio will enter as a constant in all subsequent color-mixture operations. These experimental facts, therefore, provide us with no basis for distinguishing between the inherent brilliance assumption and the idea that brilliance depends upon a mechanism distinct from that governing chroma.

It does seem to me, however, that the relative magnitudes of the three coefficients which are empirically found to represent the above mentioned proportionality between the brilliance and chromatic powers of any stimulus, do have some bearing upon the probability of the inherent brilliance assumption. When the elementaries to be mixed are red, green and blue, practically all of the luminosity of the spectrum appears to depend upon the red and green, the blue contributing only about one per cent. of the total. Depending upon the exact elementaries which are selected, either the red or the green may greatly preponderate over the other. Such large discrepancies between the chromatic and the brilliance powers of the elementaries would suggest that the underlying mechanisms of the two functions are actually distinct, these coefficients representing an arbitrary association of the two.

Another consideration which points in the direction of an independence between the brilliance and chromatic mechanisms is to be found in the very perfect symmetry of the retinal visibility curve.¹⁹ This latter curve is obtained by correcting the ordinary normal visibility curve for the selective absorption of the ocular media, and should be regarded as representing the spectral sensitivity of the brilliance process by itself. It is improbable that independent spectral distributions having maxima in different portions of the spectrum, such as those of the three fundamental chromatic excitations, should be capable of summing to yield the very perfect, symmetrical curve which represents the retinal visibility function. It is true that the empirically obtained chromatic excitation curves do actually summate in this manner, but it seems probable that their exact form is dictated by the relations between a symmetrical brilliance function and chromatic response curves which in their true physiological forms do not actually summate to yield a symmetrical curve.

IV. STUDIES ON THE "ABNEY EFFECT"

Although a direct analysis of the color-mixture system does not permit us to differentiate between the two hypotheses which we have under consideration, it is far from being impossible to find a means of testing between them. It would seem likely, *a priori*, that there must be some way by which the casual association of a chromatic and a brilliance process, such as that which a theory of the Hering type supposes to exist for a stimulus of any given wave-length, could be broken down. A method of actually dissolving this association presents itself in experiments of brilliance fatigue with lights of different color. Exposure of the retina to continued stimulation by radiation of any wave-length composition brings about a radical reduction in both the chromatic and the brilliance responses of the eye. In the course of the exposure the apparent brightness of the color is reduced by an asymptotic process to a level which is lower the higher the

¹⁹ See Troland, L. T. *loc. cit.*, p. 955-957.

intensity of the stimulus and which at moderately low intensities may amount to the elimination of ninety per cent. of the original value. At the same time the color, if it be chromatic, changes in saturation and usually also in hue. A careful study of the laws governing these simultaneous brilliance and chromatic fatigue processes, or as I have proposed to call them, *minutheses*, ought to throw a clear light upon the question as to the fundamental dependence or independence of the two.

I am not acquainted with any exact data bearing on the question as to the identity of the *laws* of minuthesis for brilliance and chroma. Qualitative observations of my own indicate that the two processes do not occur at the same rate or exhibit the same constants. I hope in the near future to make some careful quantitative measurements on the simultaneous courses of these two processes. It ought to be particularly instructive to carry the minuthesis to its asymptotic limit both for the brilliance and chromatic aspects of the sensation, and then to observe the course of recovery of these two attributes. Qualitative observations indicate that they do not recover at the same rate.

One very obvious method, resting upon the facts of minuthesis, of attacking our problem is as follows. Suppose that we fatigue the retina by a spectral red of given intensity and that we measure the diminution in apparent brightness brought about by this minuthetic process. Let us then throw upon this fatigued area a spectral green stimulus and again measure the reduction in apparent brightness which has been produced for this second stimulus. Since the spectral red should be expected to fatigue the elementary red sensation mechanism much more than the elementary green mechanism we should anticipate on the Abney-Helmholtz assumption that the luminosity reduction for the green stimulus would be much less than for the red one. On the other hand, if brilliance and chroma depend upon distinct mechanisms the factors involved, so far as brilliance is concerned, should be the same in the case of the green as in that of the red, and consequently the percentage reduction of the two should be identical. Another way of stating the proposition in a very general form is to say that fatigue with colored stimuli should be

expected on the Abney-Helmholtz hypothesis to modify the form of the visibility curve, whereas on the alternative theory this should not occur.

Abney himself carried out experiments of this general character, and his results indicate clearly that a modification in the form of the visibility curve actually does occur.²⁰ Moreover, according to Abney's analysis, the change in question is exactly such as would be expected in accordance with his own hypothesis. His results, so far as they go, are clearly in the direction of substantiating the idea that brilliance and chroma depend upon the same mechanism. However, Abney's conditions of experimentation were such as still to leave some doubt in our minds as to the exact significance of his results. In the first place, the size of field which he employed was evidently such as to permit a considerable amount of rod vision to be involved. Different degrees of participation of rod and cone vision accompanying the application of various spectral stimuli yield results very similar to those obtained in Abney's experiments. The effects obtained by Abney were apparently small, although the smoothness of his curves indicates a precision which is astonishing for heterochromatic comparisons of the type involved in such investigations. Moreover, the contrasts in color saturation which appear in such experiments may readily be confused with brilliance contrasts, provided the latter are small. However, the most serious objection to Abney's work lies in the fact that he neglected, in his experiments, to determine the absolute degree of fatigue, his data giving simply the proportionality between the two compared colors. Although his results may indicate some degree of interdependence of brilliance and chroma, we cannot from his data determine whether the relation is of the exact magnitude which is required by his own theory or not.

I have particularly been led to doubt the significance of Abney's results because of the outcome of certain experiments of my own. Several years ago at Nela Park I carried through a series of minuthesis measurements²¹ with spectral colors the conclusions

²⁰ Abney, W. de W. *op. cit.*, pp. 371-380.

²¹ As yet unpublished.

of which were that the brilliance minuthesis brought about by one spectral color carried over without change to any other such color, or in other words, that the minuthetic effects of different spectral colors of the same brightness are identical as tested by all colors. Large saturation contrasts existing in my experiment, however, would have made impossible the reliable detection of apparent brightness contrasts much less than twenty per cent in magnitude, although I employed the constant error technique and was able to compute statistical differences less than the threshold. The upshot of my measurements was that if any Abney effect,—as we may call it,—existed, it was smaller than the photometric threshold in my comparisons. More recently Mr. C. H. Langford and I have taken up this problem anew in the Harvard Psychological Laboratory. Mr. Langford has made preliminary observations of a qualitative nature employing a considerable number of subjects to determine whether or not the Abney effect is observed. He finds that the majority of persons experience such an effect, although it is so small that the observer often has difficulty in determining whether the contrast is one of brilliance or of saturation. At the same time there are some persons who report a reversed Abney effect. I have observed the latter myself quite strongly with certain combinations of stimuli. This reversed effect, so far as it goes, would point in the direction of the Hering theory of specific brightnesses combined with the doctrine of antagonistic colors. It is quite probable, however, that the reverse phenomenon is attributable to a failure exactly to balance photometrically the two stimuli of different color which are utilized in the fatigue phase of the experiment.

Since one of the principal difficulties which is encountered in experiments of the type just described consists in the existence of a very large saturation contrast superposed upon the brightness contrast which it is desired to study, it occurred to me that a flicker method might be applied to the problem, the saturation contrast being eliminated by fusion in accordance with the well known principle of the flicker photometer. Mr. Langford and I have carried through a systematic series of observations employing this method, the two color stimuli which were used being an

extreme spectral red or its equivalent, and a minus red obtained by use of the Wratten No. 44 filter. The procedure was as follows. The retina of one eye was first fatigued for three minutes to a two degree field of the red, fixation being kept constant on the center of the field. The red stimulus was now alternated with the minus red, or green, in the same field, and the intensity of one or the other of the two stimuli was varied until the minimum or zero flicker point was found. The intensity of the variable stimulus required for this flicker match was recorded. At another time a similar flicker match was established in the absence of minuthesis by the red stimulus. Two photometric values were thus obtained, the one standing for the brilliance of the red relative to the green with minuthesis, and the other for the same relationship substantially without minuthesis. In parallel with these two measurements, determinations were made of the degree of minuthesis which resulted from the three minute fatigue exposure, this being accomplished by fatiguing a semicircular field and matching this in brilliance by variations in the intensity of a stimulus projected upon the adjacent semicircle at the termination of the fatigue exposure.

From the data thus obtained, using Abney's color sensation curves and the known spectral distributions of the stimuli which were employed, it was possible to compute not only the intensity of the Abney effect which actually appeared to two observers, but also that which should be expected theoretically in accordance with the Young-Helmholtz assumptions. This latter value is approximately 75 per cent., representing the depression of the apparent brightness of the red relative to that of the green. The values actually found, however, were for one observer only 3 per cent. and for the other 5 per cent. The empirical results, therefore, are in radical disagreement with the Young-Helmholtz assumptions as interpreted by Abney. They indicate that the linkage between brilliance and chroma is far less thorough-going than is supposed by these latter theoretical interpretations. Indeed the Abney effect is so small as to suggest that there is actually no affiliation whatsoever between the two functions, on the supposition that the values for the effect actually found are simply due to errors of

observation. However, considerable care was taken in the experiments to eliminate all asymmetries in the technique, and computation of the probable error of the average results indicates that the magnitudes actually found probably have some significance. The results would seem more consistent with an hypothesis of Hering's type in which the main body of brilliance sensations is attributed to a single process independent of the chromatic excitations although there is a slight residual contribution of brilliance due to the latter. It is possible, however, to reconcile the results with the Young-Helmholtz Theory if we suppose that the three chromatic spectral distribution curves overlap in the spectrum much more extensively than has been assumed by Abney and other interpreters of the Young-Helmholtz Theory. This overlap, however, in order to explain our results, would necessarily be so great that all three of the chromatic curves would differ only slightly from the visibility curve. There are other data which indicate that the actual overlap is greater than assumed by Abney, and on this hypothesis our data could be employed to compute the magnitude of this overlap.

V. THE DIMMING EFFECT AND THE ASSOCIATION OF BRILLIANCE WITH CHROMA

In the foregoing discussion I have supported the thesis that the mechanisms underlying brilliance and chromatic vision are distinct, and have attempted to refute the doctrine of the Young-Helmholtz Theory which identifies these mechanisms. I wish to turn now to certain phenomena which, I believe, are quite new and which point in the opposite direction, indicating a very strong affiliation between the brilliance and chromatic functions. These phenomena appear under the influence of sudden changes in the brightness of the stimulus field. The fundamental processes which are involved are probably identical with those of effects which I have previously described elsewhere in conjunction with such brightness changes.²²

²²Troland, L. T. Preliminary Note; The Influence of Changes of Illumination upon After-Images. *Amer. Jour. of Psychol.*, 28, pp. 497-503; 1917.

The conditions for the observation of the phenomena in question, in relation to our present problem, may be described as follows. The retina is first fatigued by exposure to a bipartite field consisting of two semicircular areas of different color, for example a red and a green, of equal brilliance. Fixation is constantly directed to the center of the dividing line of this field. At the end of the fatigue phase of the experiment the entire circular field is converted into a single color, ordinarily that of one of the fatigue phase stimuli. This is an ordinary procedure for the study of the Abney effect, and this effect, if it manifests itself at all, should be visible on the homogeneous field at the moment of the removal of the additional color which was present in the first phase. In my own experience, as previously stated, however, practically no brilliance difference exists between the two halves of the field. The Abney effect, if it appears, will be of the order of magnitude of five per cent. If now the stimulus field be suddenly darkened or dimmed in intensity, say to about one quarter of its initial value, a very strong brilliance contrast will often appear. The degree of this contrast depends upon that of the dimming as well as upon the absolute brightnesses of the stimuli, and it is furthermore dependent in a very important way upon the exact color pairs which were employed in producing the original minuthesis. For some color pairs the contrast is practically absent, but for others it is very high, amounting often, I should estimate, to a difference of ninety per cent. In other words this dimming technique, or test, brings out an Abney effect, or analogous phenomenon, which is of the magnitude which should actually be expected from theory for the case of stimuli not varied in intensity. These results seem to indicate inevitably that there is a fundamental linkage between the brilliance and chromatic mechanisms, which linkage manifests itself, however, only under these special conditions.

I have made some preliminary experiments on the influence of various combinations of spectral colors upon the effect in question. Four spectral colors, representing red, yellow, green and blue, were selected and each of these were made up into a pair with each other and in successive series of observations the minuthetic effects of all of these pairs were projected upon each of the

four spectral stimuli as reacting excitations. The results form a rather complex system but in practically every case in which a red was involved a strong brightness contrast appeared during the dim phase of the experiment. The indications, therefore, are that the red chromatic excitation is affiliated with the brilliance process in a unique manner.²³ The brilliance contrasts in the case of the red in comparison with other stimuli were in the direction coinciding with an expected Abney effect. However, the brilliance contrasts appearing in the case of the blue stimulus in comparison with certain others were in an opposite direction.

It is not my purpose in the present paper to attempt a thorough explanation of these complicated relationships. It will be necessary to accumulate a considerable mass of quantitative data before this can be accomplished with any degree of satisfaction. However, it is necessary as a portion of the argument here to consider briefly a certain general hypothesis concerning the mechanism underlying these dimming effects. I have previously studied experimentally in great detail similar phenomena which appear upon dimming a homogeneous circular stimulus field upon one half of which is projected a negative after-image produced by the same stimulus but of lesser area. Under such conditions a very strong initial brilliance contrast exists between the two halves of the field, since one half has been fatigued to brilliance and the other has suffered no minuthesis whatsoever. In the course of a minute or so, depending upon the length of the fatigue exposure, this brilliance contrast disappears, owing to the reduction of the fresh area to a level of sensitivity substantially similar to that of the other half of the field. If now, however, the field be dimmed, the brilliance contrast returns with great vividness. On maintaining the field at the dimmed intensity, this brilliance contrast rapidly disappears. If, next, the intensity be restored to its original value a brilliance contrast reappears, but this time in the opposite direction from that which characterized the original effect and also that obtained by dimming. In other

²³ In the Young-Helmholtz Theory, as interpreted by the majority of its exponents, this uniqueness of the red would probably consist in its being the only chromatic process which is capable of being excited in isolation from others.

words there is a *reversal* of the brilliance contrast during brightening of the field. If the bright state is maintained, the brilliance contrast again fades out. This process of dimming and brightening with rejuvenation of the brilliance contrast can be carried out over and over again.

On account of the fact that these brilliance contrasts which result from changes in the brightness of the stimuli are ephemeral in character the most reasonable conception of their nature would regard them as dependent upon differences between the *rates of fall and rise* of the excitations in the two halves of the field. Upon or during dimming the brilliance in the more minuthesized half of the field drops more rapidly than in the less minuthesized half, while upon or during brightening the rise is more rapid in the former than in the latter. This principle can be stated in terms of resistance of the excitations in the two halves of the field to change in their magnitudes. The resistance to change, whether in decrease or increase, is apparently less in the more minuthesized field than in the less minuthesized one. Given sufficient time, both sides of the field reach the same asymptotic limit either in the process of increase or of decrease, but during the course of their change a difference appears between them due to the greater speed of change of one as compared with the other.

If we turn now from an abstract consideration of the experimental results to the neural mechanism which is responsible for them we find that the most plausible portion of this mechanism in which to look for the resistance changes above considered consist in the so-called synapses, or nerve junctions, which enter into the conductional processes of the optic nerve and tract. Physiologists are accustomed to regard these synapses as seats of a variable resistance or conductance. In general, exercise, or the passage of a nerve current, through the synapses, reduces their resistance. This principle is obviously in harmony with the relationship of our dimming and brightening phenomena, since it is always the more fatigued, or more exercised, portion of the retinal field which exhibits the greater facility of change; which, in other words, darkens or brightens the faster with the corresponding changes in the stimulus intensity. We are therefore led to suppose that the

mechanisms underlying these dimming and brightening phenomena are localized in the nerve synapses rather than in the retinal receptors.

VI. EXPLANATION IN TERMS OF A ZONE THEORY OF VISION

In the considerations of the last paragraph we find an indication of the manner in which we may hope to resolve the paradox established in the present paper. This paradox is the outcome of two sets of data, one of which seems to indicate the complete, or at least the very approximate, independence of brilliance function with respect to chromatic function. The other system of data, centering around effects resulting from intensity changes in the stimulus, point in exactly the opposite direction, necessitating the supposition that the brilliance and chromatic mechanisms are very closely affiliated. Even a cursory examination of the mechanism underlying visual sensation and perception reveals its extreme intricacy. The prevailing theories of visual processes err in many respects, but fundamentally in their tacit assumption that the visual mechanism is simple, or can be so regarded. The first step in the analytic description of the complex mechanism which we find in the eye and its nervous appendages would appear to be to divide up the propagational or conductional system in which it consists into successive stages or zones. The first of these may be considered to be the object in space before the eye, the second the radiation which is sent off from the object to impinge upon the cornea, the third stage would consist in the refractive adventures of the radiation in the ocular media, the fourth the photochemical changes occurring in the retinal receptors, and the fifth the reaction of the photochemical end products with the optic nerve fibers to initiate the visual impulses. Following thereafter comes a series of nerve conduction stages or zones involving successive synaptic and nerve fibre activities leading finally through the subordinate ocular motor nuclei of the corpora quadrigemina and other lower visual centers, to the visual projection areas of the cerebral cortex. Finally there are the complicated connections of the visual projection areas with various association areas of the cortex. It is probably only in conjunction with processes

occurring in these latter association areas that chroma and brilliance as aspects of visual consciousness are aroused.

It is clear that visual effects observed in consciousness may depend upon any one or any combination of the mechanisms lying in these successive zones of the visual conduction apparatus. One criterion, or test, such as flicker, may bring out the peculiarities of the mechanism in a certain zone such as, for example, the cortex, whereas another test, such as our dimming procedure, may emphasize the characteristics of some other zonal mechanism, say for example the mechanism of certain synaptic regions which lie afferent to the cortex. Other phenomena, such as the three color sensation curves, may rest principally upon the characteristics of retinal mechanisms. By a proper selection of tests or procedures we might hope to be able to isolate the characteristics and internal relationships of any one of these visual zones. The resolution of our paradox concerning the interrelations of brilliance and chroma would therefore seem to lie in the suggestion that the retinal mechanisms underlying brilliance and chroma respectively are nearly or quite independent of one another, but that the synaptic or certain nerve conduction mechanisms which are subsequent to the retinal processes involve a very definite linkage of the factors which transmit the values of these distinct retinal excitations to the cerebrum.

This doctrine of the existence of *zones* in the visual mechanism is by no means a new one. It has been recognized by practically all visual theorists, although very few of them have made any use of it since they have tended to suppose that, although the mechanisms involved in the separate zones were separate, they were nevertheless quite similar in character to one another and connected by a point to point correspondence. The theory of Donders,²⁴ however, is a definite exception to this rule. Von Kries has also advocated a zone theory which makes the retinal apparatus different in character from that of the cerebrum. The most serious of all theories of this type which has yet appeared, however, is that of

²⁴ Cf. Parsons, J. H., *op. cit.*, p. 270.

Schjelderup,²⁵ a very recent, and apparently a very important, addition to our vast collection of visual speculations. Schjelderup's theory is worthy of careful study by all students of the visual mechanism.

Schjelderup divides the visual apparatus into three successive zones; those of the retina, the cerebral cortex, and an intermediate stage (*Zwischenprozesse*). He recognizes the correctness of Hering's analysis of the visual qualities into the six psychological primaries, white, black, red, yellow, green, and blue. In the cerebral zones there are, according to his view, six distinct activities which are in one to one correspondence with these six psychological primaries. There is no element of linkage or identity between these six cerebral mechanisms in and for themselves. In the intermediate zone, however, the activities which correspond with the six psychological primaries, although still in a one-to-one relation with the latter *via* the cortical elements, are arranged in antagonistic pairs. The black- and white-representing activities are linked together and one of them cannot be affected without influencing the other. The same consideration holds true for the pairs red and green, as well as for blue and yellow. In cases of color blindness due to the dropping out of any one of these intermediate zone processes the antagonistic activities must disappear together. However, in the case of color blindness due to cortical derangement an independent dropping out of elementaries corresponding to antagonists in the intermediate zones is possible. In the third or retinal zone three separate mechanisms are supposed to exist, each having a characteristic response curve to different wave-lengths in the spectrum. One of the retinal mechanisms responds by a process of oxidation to all of the wave-lengths of the spectrum but to a varying degree which is represented approximately by the visibility curve. The activities of this mechanism are transmitted exclusively to the white-representing process of the intermediate zone. A second retinal mechanism responds by an oxidative process to the long waves of the spectrum but by an opposed or reductive process to shorter

²⁵ Schjelderup, H. K. Zur Theorie der Farbenempfindungen. *Zeits. für Sinnesphysiol.* 51, 19-45; 1920.

waves, ending approximately at the blue of the spectrum. The oxidative phase of this mechanism transmits its energy not merely to the red-representing process of the intermediate zone but also to a certain extent to the white- and yellow-representing factors of the latter zone. The reductive phase of the same retinal activity also transmits its response not merely to the green-representing element of the intermediate zone but also to a certain extent to the black and blue components of the latter. A third retinal mechanism also shows opposed oxidative and reductive reactions to different wave-lengths with maxima for these respective phases of its activity localized approximately at the yellow and blue, the energies of the oxidative response being transmitted to the green and yellow factors in the intermediate zone activity while the reductive response influences the blue and red components of the intermediate stage. The relation between the retinal zone and the intermediate zone is obviously not a plain one-to-one correspondence but a far more complicated arrangement.

By means of the mechanism thus sketched, which in my opinion is by no means too complicated to represent the actual system of visual response, Schjelderup is able to explain all known forms of color blindness, including not only the common types which are considered by the Hering and Young-Helmholtz Theories but also the rarer forms for which these latter theories are powerless to account. The general nature of the interrelation which Schjelderup's hypothesis postulates as existing between the chromatic and brilliance producing mechanisms promises to be of assistance in the attempt to explain many of the facts which we have considered in the present paper. The retinal mechanism which is associated most closely with the red chromatic process is also linked with the brilliance producing activity, a fact which suggests a possible rationale of the brilliance contrasts which are brought out by the dimming procedure whenever a red enters into a comparison with other colors. The association of the retinal mechanism which is most intimately connected with the green chromatic process with the black producing excitation also suggests a possible explanation of the reversed brilliance contrast which appears in the dimming experiment when blue is contrasted with green or

yellow. However, it is not my purpose in the present paper to attempt a detailed development of these possibilities.

The moral of the foregoing discussion is that to arrive at a thorough understanding of the mechanism or theory of visual response, it is absolutely necessary to take into consideration the zonal structure of the mechanism which is involved. The three zones of Schjelderup's hypothesis are not too many to account for the actual maze of facts which we encounter. Anatomical analysis shows that many more than three are inevitably concerned in the total process. All of the many visual theories which have been propounded probably have some truth in reference to some zone of the visual process, and it is possible that a sufficient number of zones actually exist to permit each of these multitudinous theories to be substantially true for at least one of the zones, leaving other zones open for its opponents.

HARVARD UNIVERSITY
CAMBRIDGE, MASS.

MEASUREMENT OF THE COLOR TEMPERATURE OF THE MORE EFFICIENT ARTIFICIAL LIGHT SOURCES BY THE METHOD OF ROTATORY DISPERSION*

BY
IRWIN G. PRIEST

I. INTRODUCTION

The color temperatures of a number of sources of comparatively low or medium efficiency have been published¹ some years ago. Forsythe has recently communicated results on various lamps including gas-filled tungsten lamps at several efficiencies up to 27.3 lumens per watt.² So far as the author knows there are no data extant for higher temperatures than those given by Forsythe and no data duplicating the higher temperatures given by him. Also so far as we know, no attempt has heretofore been made to determine the color temperature of the carbon arc by direct observation.

The author has previously described an apparatus which may be readily adapted to the measurement of very high color temperatures³ by the rotatory dispersion method.

The purposes of the present paper are:

(1) To illustrate the practical applicability of the rotatory dispersion method to the measurement of color temperatures between 3000° and 4000° K.

(2) To present some data on the precision and accuracy of measurements of color temperature at about 2850°K.

* Published by permission of the Director, Bureau of Standards. This paper was first presented at the Rochester Meeting of the Optical Society of America, Oct. 25, 1921.

The author is indebted to Dr. K. S. Gibson, Mr. E. P. T. Tyndall and Mr. H. J. McNicholas for their assistance in obtaining the data on precision and accuracy shown in Tables I and II, and to Dr. M. Katherine Frehafer and Dr. Gibson for much assistance in computing.

¹ Hyde and Forsythe: *J. Frank. Inst.*, 183, pp. 353-354; 1917. E. F. Kingsbury: *J. Frank. Inst.*, 183, pp. 781-782; 1917.

² Meeting of American Physical Society, Washington, April, 1921; *Phy. Rev.* (2) 18, p. 147; Aug., 1921.

³ *J. Op. Soc. Am.*, 5, pp. 178-183; March, 1921. Cf. also *Phy. Rev.* (2), 10, pp. 208-212; 1917, particularly the closing paragraph.

(3) To present an independent confirmation of Forsythe's data on the color temperature of gas-filled lamps.

(4) To present new data on the color temperature of the gas-filled lamp (Mazda C) up to efficiencies of about 39 lumens per watt, which corresponds very nearly to the melting point of tungsten and the consequent failure of the filament.

(5) To present some data on the color temperature of the crater of the carbon arc.

II. DEFINITION OF COLOR TEMPERATURE

In this paper, color temperature is understood to mean the temperature at which a hypothetical Planckian radiator ("black body") would emit light competent to evoke a color of the same quality (hue and saturation) as the light from the lamp under test.

The value 14350 micron-degrees is assumed for the Planckian constant c_2 throughout this paper.⁴

III. THE PRECISION AND ACCURACY OF MEASUREMENTS OF COLOR TEMPERATURE

Before proceeding further it is pertinent to introduce some data on the precision and accuracy of temperature measurements of lamps by the method of color matching in general, and quite aside from the particular features of the method to be described in this paper.

These data were obtained under the following conditions:—

(1) Type of photometric field: Circular and divided along a diameter, (Martens photometer).

(2) Angular size of whole field: 6°.

(3) Absolute temperature, 2850° K.

(4) Method: The observer adjusts lamp voltage to color match while an assistant records the voltages thus set. The differences between single settings and averages are computed and these residuals translated into temperature by means of the known relation between voltage and temperature.

Data on precision are shown in Table I.

⁴ Coblenz, B. S. Sci. Pap. No. 248; p. 470; 1916. Forsythe, J. Op. Soc. Am., 4, p. 332; 1920.

TABLE 1

Set No. ↓Obs.	AVERAGE DEVIATIONS FROM MEANS OF TEN OBSERVATIONS (Degrees, Centigrade)								Average of Average Deviations	PROBABLE ERROR OF ONE OBSERVATION	PROBABLE ERROR OF MEAN OF TEN
	1	2	3	4	5	6	7	8			
IGP	3.6	9.8	10.8	5.9	6.7	7.5	5.3	6.9	7.1°C	± 6.3°C	± 2.0°C
KSG	6.7	6.9	5.5	4.5	8.6	4.8	5.8	6.9	6.2	± 5.5	± 1.7
EPTT	11.0	5.3	6.5	4.3	4.2	7.1	8.8	6.0	6.6	± 5.9	± 1.8
HJM	4.2	5.0	5.7	7.9	3.4	5.1	4.2	6.1	5.2	± 4.6	± 1.3
Average→									6.3	5.6	1.7

Precision of color matching lamps at about 2850° K. Circular photometric field divided on a diameter. Angular diameter of whole field about 6° (Martens Photometer). Observer sets voltage on test lamp to color match comparison standard. Assistant records voltages. Observed deviations in volts have been reduced to corresponding deviations in temperature.

Data from four gas-filled 500-watt lamps, June 29-30, 1921.

Data on the agreement among the final results of determinations by different observers on the same lamps are shown in Table II. The systematic differences between observers shown in this table is probably due to the fact that for each observer a constant setting of the comparison lamp was used.

TABLE 2

Lamp No. Obs.	DEVIATIONS, degrees C				Average
	3254	3255	3256	3257	
IGP	- 3.2	- 4.9	- 1.7	- 7.0	- 4.2
KSG	+ 9.4	+ 7.4	+ 6.7	+ 10.2	+ 8.4
EPTT	- 9.2	- 4.1	- 6.9	- 5.6	- 6.4
HJM	+ 3.0	+ 1.8	+ 1.9	+ 2.5	+ 2.3
Average without regard to sign					5.3

Departure of individual observer's means (20 observations) from mean of four observers. Substitution method.

Circular photometric field divided on a diameter. Angular diameter of whole field about 6° (Martens Photometer).

Data from four gas-filled 500-watt lamps, June 29-30, 1921.

IV. STANDARD SOURCE

1. Description of Lamp

The fundamental reference standard on which the temperature scale in this paper is based is embodied in a particular 500-watt gas-filled concentrated-filament tungsten stereopticon lamp,

Fig. 1

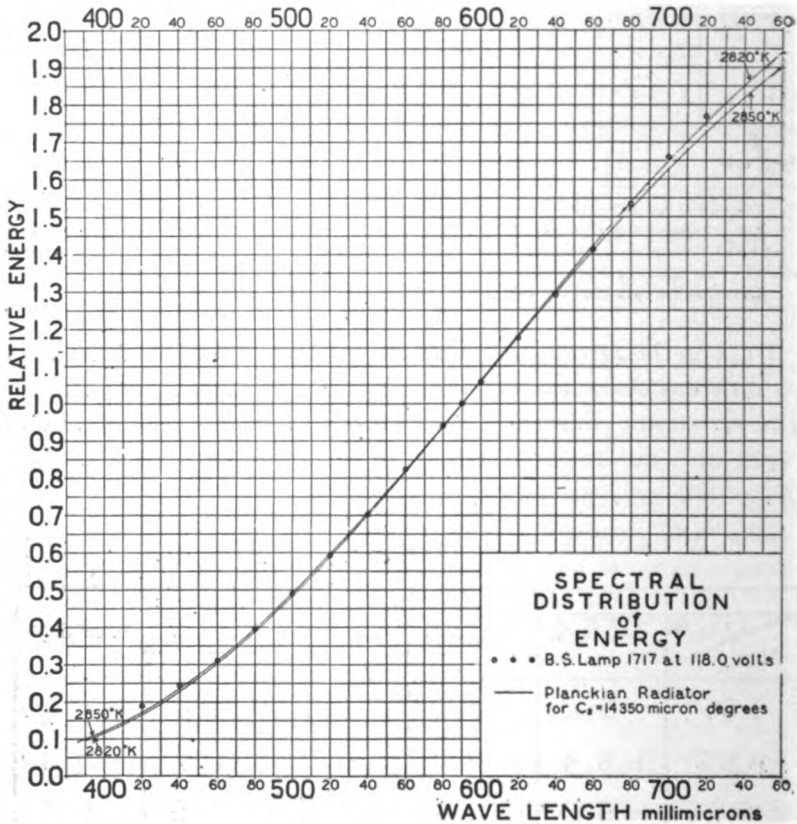

Spectral distribution of energy, B. S. Lamp No. 1717 and Planckian radiator at 2820° and 2850°

designated as B. S. Lamp No. 1717, operated at 118.0 volts. [The efficiency of this lamp as found by the photometric section, Bureau of Standards, was:—

On April 3, 1917 at 118.0 v, 4.06 a, 15.6 l.p.w.

On June 17-18, 1921 at 118.0 v, 4.05 a, 15.75 l.p.w.

2. Standardization by Spectral Distribution

The spectral distribution of energy from this standard lamp as determined radiometrically by Dr. W. W. Coblentz of the Bureau of Standards in April 1917 is shown by the circles in Fig. 1. The continuous curves in the same figure show the theoretical spectral distribution of energy from a Planckian radiator at 2820° and 2850°K. It may be inferred from this figure that the color temperature of this lamp is approximately 2840 to 2850°K but from mere inspection of the figure this conclusion is subject to considerable uncertainty.⁵ A more precise value has been derived from the same data by the following procedure:

(1) The wave-length of the center of gravity of a spectral distribution of light is defined as

$$\lambda_c = \frac{\int V \cdot E \cdot \lambda d\lambda}{\int V \cdot E d\lambda}$$

where λ = wave-length;
 E = energy per unit wave-length for wave-length, λ ;
 V = visibility of radiant energy for wave-length, λ .

(The graphic significance of this definition may be explained by reference to Fig. 2. λ is plotted as abscissa. VE is plotted as ordinate. The different curves represent spectral distributions of light from a Planckian radiator at different temperatures. For any temperature, λ_c is the λ -coordinate of the center of gravity of a thin template of uniform density bounded by the λ -axis and the distribution curve for that temperature.)⁶

(2) λ_c has been computed for a Planckian radiator at various temperatures and plotted as a function of temperature as shown

⁵ In previous papers (J. Op. Soc. Am., 5, pp. 178-183; March 1921 and B. S. Sci. Pap. No. 417, Vol. 17, pp. 231-265; 1921), the color temperature 2830°K was inferred from these same data. This value was merely a rough approximation as inferred from plotting the data on a small scale and is not accurate enough for the present purpose. The revised value given in the present paper results from a more careful examination of the data, and a more precise and reliable method of reducing it.

⁶ Compare also:—Jour. Op. Soc. Am., 4, pp. 389-401; 1920. B. S. Sci. Pap. No. 417, Vol. 17, p. 234; 1921.

in Fig. 3. These computations have been made by arithmetic throughout by the formula

$$\lambda_c = \frac{\sum V \cdot E \cdot \lambda}{\sum V \cdot E}$$

taking values of V , E and λ at intervals of 10 millimicrons, and are more accurate than the *graphic* integrations used in previous papers.⁷

Fig. 2

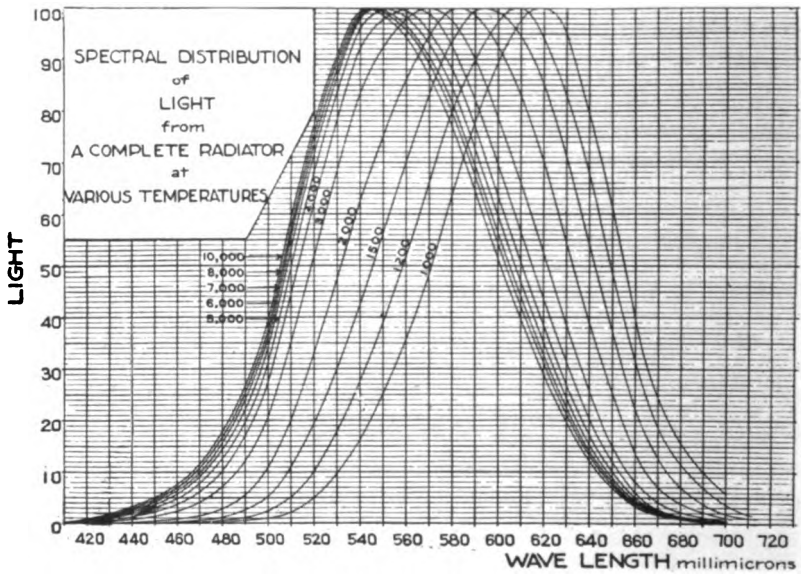

Spectral distribution of light, Planckian radiator at various temperatures. Energy by Planck's Formula ($C_1=14350$).

Visibility:—

λ , 560–650

H. E. Ives, Phil. Mag. Dec. 1912, p. 859.

λ , 410–550 and 660–710

Hyde, Forsythe & Cady, Jour. Frank. Inst. 48, p. 87.

Numbers attached to curves indicate temperatures in degrees K.

(3) λ_c has likewise been computed in the same way for the original experimental data on the spectral distribution of energy from the lamp, and this value of λ_c used to derive the color tem-

⁷ J. Op. Soc. Am., 4, pp. 389–401; 1920. B. S. Sci. Pap. 417, Vol. 17, pp. 234–235; 1921.

perature from the relation between λ_c and color temperature shown in Fig. 3. The color temperature so derived is⁸

2848°K

Fig. 3

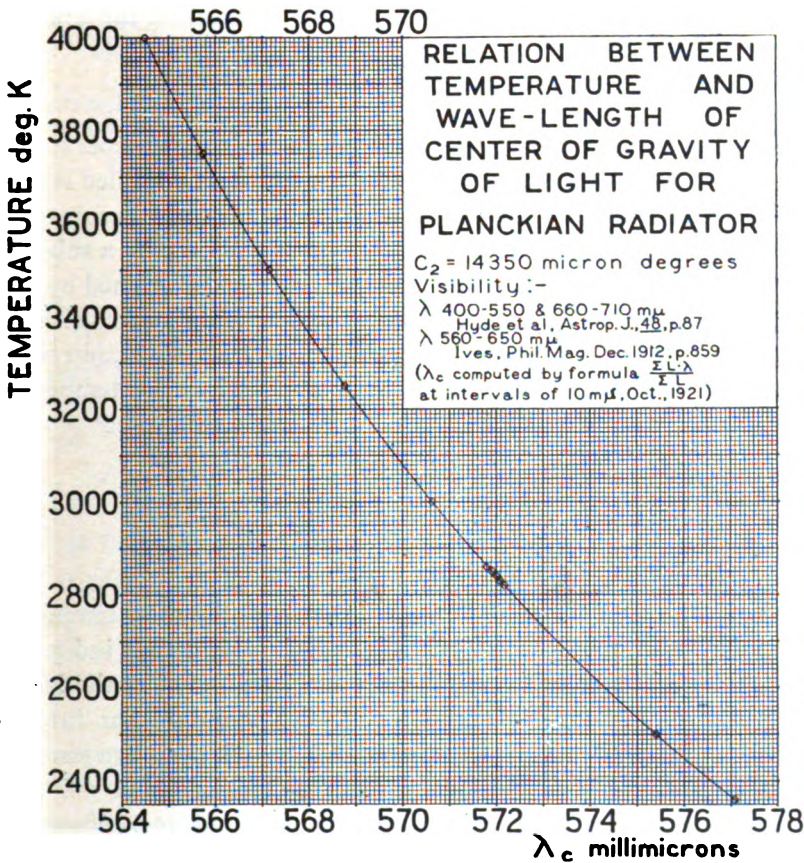

Relation between temperature and wave-length of center of gravity, Planckian radiator

This value is the weighted mean of three separate computations, and from their agreement, it is estimated that the uncer-

⁸ It is to be observed that while the visibility of energy enters into the formulas used, it does *not* enter in such a way as to affect the temperature found so long as the same values of visibility known to be approximately correct, are used in determining all values of λ_c considered and the spectral distribution approximates Planck's formula. The values of visibility actually used throughout the present paper are shown by the solid curve in Fig. 8, *J. Op. Soc. Am.*, 4, p. 471.

tainty of this result due to approximations in computation is less than 3° .

The sensibility and accuracy of this method are clearly demonstrated by the consistency of the several points determining the curve at about 2850°K , Fig. 3. Judging from this, the uncertainty is less than 5° .

3. Standardization by Color Match with Planckian Radiator (Nela Laboratory)

In order to compare this standard with the color temperature scale of the Nela Research Laboratory, a 500-watt gas-filled lamp of the type now used as photometric standards was accurately color matched with B. S. Lamp 1717, at 118.0 volts by a substitution method. The voltage for color match was determined by 20 settings by *each* of four observers. The resulting mean voltage was 101.0 v, for which the current was 4.097 a. The lamp was then sent to the Nela Research Laboratory and its color temperature by color match with a "black body" was found to be⁹

2848°K

at 101.0 v, 4.099 a.

4. Conclusion as to Standard

On the basis of the good agreement between the color temperature derived from Coblenz's isothermal data and that independently found by color matching with a "black body" at the Nela Research Laboratory, we may define our standard for future reference in a more fundamental way than by referring to a particular lamp, as we have at the beginning of this discussion.

Our standard source is accordingly a source closely approximating the Planckian spectral distribution in the visible spectrum and having a color temperature of 2848°K .

V. EXPERIMENTAL METHOD

The essential feature of the rotatory dispersion method is this: A quartz plate between nicol prisms, serving as a light filter of adjustable spectral transmission,¹⁰ is used to modify the color of

⁹ Letter, W. E. Forsythe, Nela Lab., to I. G. Priest, Aug. 11, 1921.

a comparison source so as to match the unknown, the constants of the apparatus being chosen so that the spectral distribution of the light emerging from the quartz-nicol train is always represented by the Planckian formula. Colorimetrically, the experiment is equivalent to varying the temperature of a "black body" until it is color matched with the lamp in question and then noting the temperature. The essential parts and arrangement of the apparatus are shown in Fig. 4. The experimental procedure is

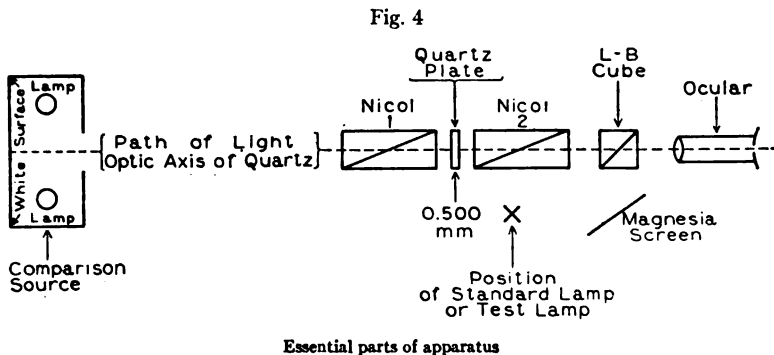

then as follows: The standard lamp of known spectral distribution is placed at X so as to illuminate part of the photometric field. The quartz plate being removed, the current in the comparison lamps in the box is adjusted to give a color match in the photometric field. This current is thenceforth maintained constant. The source whose color temperature is to be measured is then substituted for the standard lamp; the quartz plate is inserted between the nicols and nicol No. 2 is rotated (angle, ϕ) to produce a match of color quality. (A brilliance match is of course simultaneously made by other nicols, not shown in Fig. 4.)

The actual apparatus used was the Arons Chromoscope.¹⁰ The Lummer-Brodhun cube is set so that the field has the form shown in Fig. 5. The visual angle of the circle (comparison light) is about 3.5° . This form of field appeared to be somewhat more sensitive than the *concentric* field for matching of color quality, although its particular odd shape is not to be recommended.

¹⁰ J. Op. Soc. Am. 4, pp. 485-486.

¹¹ Ann. der Phys. (4) 39, pp. 545-568; 1912.

Fig. 5

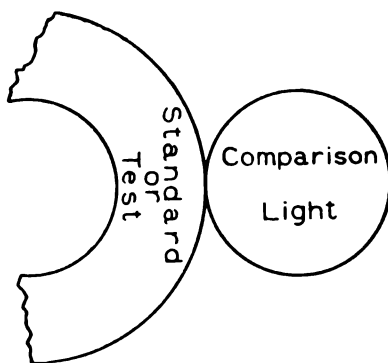

Form of photometric field

Fig. 6

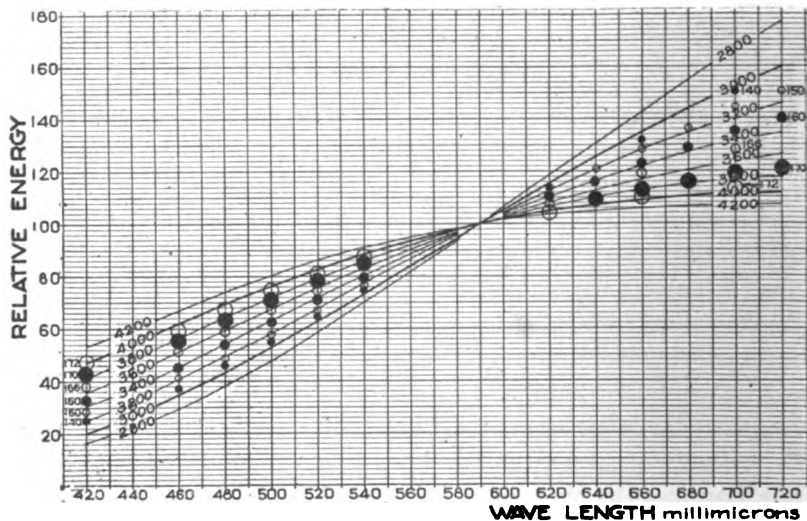

Spectral distributions of energy, Planckian radiator at various temperatures compared with distributions obtained by rotatory dispersion.

The solid black curves represent Planck's formula with $C_1=14350$. The numbers attached to these curves indicate temperatures in degrees K.

The various circles represent distributions obtained by the arrangement shown in Fig. 4. Each different style and size of circle refers to a particular value of ϕ ; and the numbers attached to the circles indicate values of ϕ in circular degrees.

In all cases, energy=100.0 at wave-length 590 (arbitrary convention).

VI. METHOD OF CONSTRUCTING THE TEMPERATURE SCALE

Let ϕ (measured from extinction position with quartz removed, and in same direction as the rotation by the quartz) be the angle through which nicol No. 2 is rotated to obtain a color match.

The method of constructing the temperature scale corresponding to the instrument reading (ϕ) is a refinement and extension of that previously published.¹²

The spectral distributions of energy corresponding to different values of ϕ are shown in Fig. 6, together with the spectral distributions of a Planckian radiator at various temperatures.

Inspection of this figure shows:—

(1) The distributions obtained by rotatory dispersion approximate very closely to the theoretical distributions by the Planckian formula.

(2) The temperature corresponding to any value of ϕ can be inferred *approximately* from simple inspection of this figure, although this method of establishing the relation between ϕ and temperature is not sufficiently precise for our present purpose.¹³

The precise relation between ϕ and temperature has been obtained as follows:

(1) λ_c has been computed for the spectral distributions corresponding to different values of ϕ (Fig. 6) in the same way as for the standard lamp and the Planckian radiator as described above.

(2) Temperatures corresponding to these values of λ_c have been read from Fig. 3 and plotted as a function of ϕ in Fig. 7.

Figure 7 thus obtained now serves as a calibration curve for deriving color temperature from experimentally observed values¹⁴ of ϕ .

VII. CHECK MEASUREMENTS

1. Check of the Method with Radiometric Determinations

The color temperature of B. S. Lamp 1716 (a 500-watt gas-filled stereopticon lamp, like 1717) at 22.0 l.p.w., has been found by this method to be

3082°K

(mean of 30 observations)

¹² J. Op. Soc. Am., 5, pp. 178-183; March, 1921.

¹³ The curve shown in Fig. 6, J. Op. Soc. Am., 5, p. 182, was obtained by this simple process of inspection.

¹⁴ Cf. "Experimental Method" above.

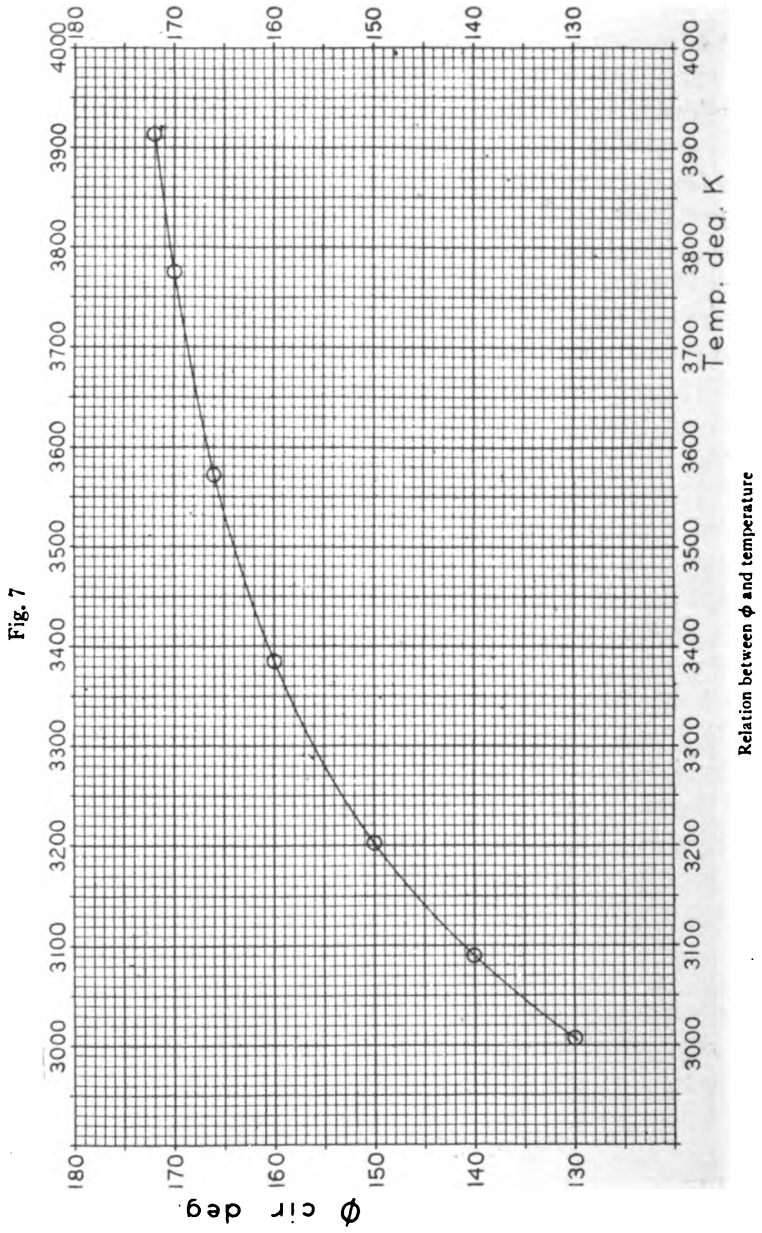

The temperature derived by means¹⁵ of λ_c from the spectral energy distribution determined by Coblentz¹⁶ is

3086°K

2. Check of the Method with Color Temperature Determinations
by the Nela Research Laboratory

The color temperature of a 900-watt gas-filled "Movie" Lamp at 22.7 l.p.w., has been independently determined by Forsythe at the Nela Research Laboratory, using their methods, and by the author at the Bureau of Standards, using the present method. The results follow.¹⁷

Nela	{	before B. S. Measurement.....	3091°K
		after B. S. Measurement.....	3083
		Mean.....	3087
Bureau of Standards (Each value is mean of 10 observations).....		3090°K	
		3095	
		3067	
		3087	
		3093	
		3079	
Mean.....		3085	

VIII. THE COLOR TEMPERATURE OF THE GAS-FILLED
TUNGSTEN LAMP AS A FUNCTION OF EFFICIENCY

The data shown by the small open circles in Fig. 8 refer to a 500-watt gas-filled lamp (Mazda C National Lamp Works) of the type now used as a photometric standard at the Bureau of Standards.

These data were obtained in the following way:

- (1) Two lamps of nearly identical characteristics (equal efficiencies at equal voltages) were selected.
- (2) One of these (B. S. 3261) was used to determine efficiency as a function of voltage for increasing voltage until the filament

¹⁵ By the same method as described above for deriving the color temperature of the standard lamp No. 1717 from the radiometric data.

¹⁶ Coblentz's determinations of Lamp 1717 were made in April 1917. His determinations on Lamp 1716 were made in December 1918, after readjusting his apparatus.

¹⁷ Letter, Forsythe to Priest, July 29, 1921.

failed.¹⁸ This filament failed at 200 volts, the efficiency at 195 v being 38.2 l.p.w.

(3) The other (B.S. 3260) was used to determine color temperature as a function of voltage at increasing voltages until the filament failed, at 206 volts.

(4) Correlating the data on the two lamps, color temperature is shown as a function of efficiency, in Fig. 8.

Fig. 8

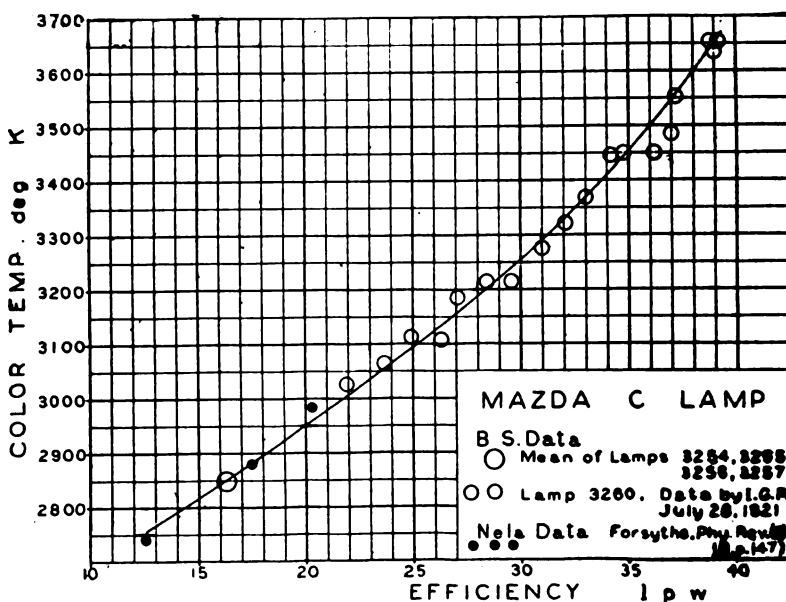

Color temperature of 500-watt gas-filled photometric standard lamp as a function of efficiency

Some of Forsythe's previously published data¹⁹ are also plotted in this figure. The agreement is as good as could be expected considering the different lamps involved.

In order to avoid burning the lamp longer than absolutely necessary at any one voltage (which would have shortened its life and forestalled observations at the highest temperatures), accuracy was sacrificed for speed in these observations. The observations of temperature were made as rapidly as possible and only five at

¹⁸ These determinations were made by Ben S. Willis, Photometric Section, Bureau of Standards.

¹⁹ *Phy. Rev.* (2) 18, p. 147; Aug. 1921.

each voltage. On this account the points (Fig. 8) depart from a smooth curve. It is believed nevertheless that the curve which has been drawn through them is not in error, on this account, by more than 10° at any point. These data are, however, presented as a preliminary roughing out of the color temperature—efficiency relation rather than a precision determination.

At the highest efficiency attained (39.2 l.p.w.) the color temperature observed was 3644°K . The accepted value²⁰ for the true temperature of the melting point of tungsten is 3673°K . No precise relation between the true temperature and the color temperature of gas-filled lamps can be stated; it appears, however, that the present determination is in as close accord with the accepted melting point as could be expected.²¹

IX. THE COLOR TEMPERATURE OF THE CRATER OF THE CARBON ARC

Previous work has shown²² that the temperature of the crater of the arc varies by nearly 200°C , dependent upon the carbons particularly, and upon the current and other conditions to a less extent.

The most reliable of our data by the rotatory dispersion method indicate color temperatures as follows for the crater of a 65-volt, 10-ampere arc:

Solid carbons 3780°K (mean of 50 observations)

Cored carbons 3420°K (mean of 50 observations)

These means are considered uncertain by about 50° .

So far as we know there are no previous determinations of "color temperature" of the arc with which to compare these results. Waidner and Burgess²³ give 3680° to 3720° as "black body brightness temperature."

The method described would be convenient and suitable to use in an extensive determination of the temperature of the arc under various conditions.

NATIONAL BUREAU OF STANDARDS

NOVEMBER 4, 1921.

²⁰ Worthing, *Phys. Rev.* (2) 10, p. 392; 1917.

²¹ Cf. Forsythe, *Phy. Rev.* (2), 18, p. 147; 1921.

²² Waidner and Burgess, *B. S. Bulletin*, 1, pp. 109–124; 1904.

²³ *B. S. Bulletin*, 1, p. 123.

THE BLUE GLOW

BY

E. L. NICHOLS AND H. L. HOWES

Certain oxides when heated to incandescence emit light of a distinctly bluish cast at temperatures corresponding to the dull red heat of non-selective radiators.

To this effect, which is particularly well marked when the heating is done with a hydrogen flame sufficiently reinforced with oxygen to secure the desired temperature, we have given the name of the *blue glow*. It is a special case of the luminescence of incandescent solids, a topic upon which we are now engaged and which, in its broader aspects, will form the subject of a forthcoming paper. In our study of the blue glow it was desired to determine (1) the temperature of the glowing oxide; (2) the brightness of its temperature-radiation proper; and (3) the brightness of the *blue glow* itself which may be regarded as superimposed upon the temperature-radiation.

For this purpose we used an optical pyrometer of the type based upon the well known Morse gauge, in which the filament of an incandescent lamp in the eyepiece of the instrument is superimposed upon the image of the glowing surface the temperature of which is to be measured. To mount the oxide for observation an annular groove about 1 cm in outer diameter, 1 mm deep and 2 mm wide was ground in a bed of alundum. Fragments of thick walled alundum tubing of large diameter, of which an abundance chanced to be available, answered admirably for this purpose. The annular groove was pressed full of the black oxide of uranium, a substance which affords an excellent approximation to the ideal black body and which withstands the direct contact of the H-O flame better than any black powder which we have thus far found. The disk of alundum within this ring of uranium oxide was then covered with the oxide to be studied, the two surfaces of powder being carefully pressed down to the same level. Especial care was taken to have a sharp boundary line between the white oxide within and the ring of black powder surrounding it. Upon the surface thus prepared a flame of hydrogen from a blast lamp, with just

sufficient oxygen to give it direction and stability, played vertically and concentrically from above. It was found that when the two surfaces were at the same level, neither being sensibly elevated or depressed with reference to the other, and when the flame was large enough to cover them fully and was properly centered, they attained the same temperature.

TABLE I
The Blue Glow of Magnesium and Beryllium Oxides

Temp. C.	<i>I_{bb}</i>	<i>Mg O</i>				<i>Be O</i>			
		<i>I_o</i>		<i>I_o/I_{bb}</i>		<i>I_o</i>		<i>I_o/I_{bb}</i>	
		.65μ	.45μ	.65μ	.45μ	.65μ	.45μ	.65μ	.45μ
665°	.00013	.00000018	.0202	.00140	156.7	.000000025	.0563	.000195	437.
735°	.00123	.0000026	.0320	.00214	45.0	.0000016	.0795	.000867	65.8
837°	.0246	.00033	.423	.0135	17.2	.00067	.295	.0271	12.0
960°	.419	.0202	3.63	.0482	8.77	.038	1.44	.0832	3.14
1037°	1.95	.165	8.91	.0847	4.57	.213	1.95	.109	1.00
1097°	5.93	1.077	16.1	.182	2.72	1.00	3.31	.169	.561
1145°	13.2	2.46	6.37	.186	.511
1190°	26.6	9.77	26.4	.367	1.04	6.75	13.0	.252	.423
1228°	45.7	72.5	110.2	1.58	2.44
1263°	76.7	26.6	36.7	.347	.479	146.	179.9	1.91	2.35
1294°	156.	229.	230.	1.98	1.99
1328°	178.	55.6	72.0	.312	.404	295.	254.	1.66	1.43
1394°	389.	62.0	139.	.357	.356	513.	316.	1.32	.813
1429°	582.	182.	194.	.313	.333
1462°	828.	285.	277.	.344	.334	767.	513.	.927	.621
1488°	1097.	910.	600.	.830	.535
1527°	1602.	745.	525.	.460	.324	1181.	773.	.728	.477
1580°	2690.	1614.	1012.	.600	.375	1641.	1052.	.610	.391
1606°	3420.	2309.	1387.	.675	.406	1928.	1282.	.564	.375

Seen through the pyrometer, with the usual red screen in the eye-piece the field of view at about 700°C appeared as a red ring with dark center. Through a blue screen it consisted of a blue central patch, the blue and violet rays from the red hot uranium oxide not being of sufficient brightness to render the surrounding ring visible.

To express these conditions and their changes with rising temperature in quantitative form the following cycle of readings

was made at intervals of about fifty degrees between 600°C and 1600° C, or up to the point of fusion of the oxide under observation:—

(a) A setting on the outer ring through the red screen (equivalent wave-length $.65\mu$). This gave the *actual black body temperature* of the black surface which was the same as that of the oxide of the central disk.

(b) A setting on the central disk through the red screen. This gave the black body temperature corresponding to the red radiation from the oxide of the central disk.

TABLE 2
The Blue Glow of Calcium and Aluminum Oxides

Temp. C.	I_{bb}	CaO				Al_2O_3			
		I_o		I_o/I_{bb}		I_o		I_o/I_{bb}	
		$.65\mu$	$.45\mu$	$.65\mu$	$.45\mu$	$.65\mu$	$.45\mu$	$.65\mu$	$.45\mu$
665°	.00013	.00000055	.0276	.00432	216	.00000051	.0794	.00039	.617
735°	.00123	.0000159	.0632	.0128	52.2	.0000036	.144	.00287	117
837°	.0246	.00292	.336	.114	13.7	.000209	.422	.00851	17.2
960°	.419	.100	1.46	.240	3.49	.0121	.733	.0287	1.74
1037°	1.95	.802	7.31	.411	3.75	.159	1.66	.0813	.852
1097°	5.93	2.62	25.0	.453	4.19	.912	3.76	.154	.634
1145°	13.2	6.92	41.7	.522	3.11	2.72	7.41	.206	.573
1190°	26.6	17.5	58.2	.656	2.18	7.76	24.5	.292	.923
1228°	45.7	33.1	87.5	.725	1.91
1263°	76.7	40.7	151.	.531	1.97	32.2	103.5	.420	1.35
1294°	156.	61.7	254.	.535	2.20	64.6	155.	.595	1.34
1328°	178.	120.	351.	.671	1.97	133.4	195.	.748	1.09
1362°	266.	264.	310.	.994	1.17	251.0	298.	.944	1.12
1394°	389.	345.	226.	.887	.582	408.	582.	1.048	1.49
1429°	528.	422.	190.	.725	.326
1462°	828.	507.	226.	.613	.274	1000.	1084.	1.21	1.31
1488°	1097.	624.	126.	.570	.115
1527°	1602.	871.	327.	.536	.202	2370.	1863.	1.46	1.15
1580°	2690.	1225.	578.	.455	.215
1606°	3420.	1429.	794.	.381	.232

Since, as has already been mentioned, the oxides in question are exceedingly feeble temperature radiators and since the blue glow is of too short wave-lengths to pass the red screen, these measurements, for the lower portion of our range

of temperature, i.e., below 1000°C, gave black body temperatures far below the actual temperature of the surface.

(c) A setting upon the central disk seen through a solution of ammonio-sulphate of copper which cut out all red and yellow rays and practically all of the green of the spectrum. The equivalent wave-length for this screen was about .45 μ . It transmitted the greater part of the radiation constituting the "blue glow" and since for the lower range, from 800° downwards, the temperature-radiation of these wave-lengths was almost too small to measure, this setting, with a very close approximation, gave the *blue glow alone*. At higher temperatures where the ordinary temperature-radiation became appreciable, this setting gave the sum of temperature-radiation and blue glow.

TABLE 3
The Blue Glow of Silicon and Zirconium Oxides

Temp. C.	I_{bb}	SiO_2				Zr_2O_2			
		I_o		I_o/I_{bb}		I_o		I_o/I_{bb}	
		.65 μ	.45 μ	.65 μ	.45 μ	.65 μ	.45 μ	.65 μ	.45 μ
665°	.00013	.00000076	.0382	.00059	195	.0000026	.0068	.0204	53.1
735°	.00123	.0000026	.0708	.00210	57.3	.000077	.0382	.0621	30.9
837°	.0246	.00059	.341	.0239	13.9	.0039	.403	1.61	16.4
960°	.419	.0275	1.65	.0600	3.59	.121	3.41	.288	8.15
1037°	1.95	.191	4.42	.0977	2.26	1.20	69.1	.617	3.50
1097°	5.93	1.10	11.0	.186	1.86	6.34	19.2	1.07	3.25
1190°	26.6	8.51	35.3	.316	1.33	24.5	87.5	.923	3.29
1263°	76.7	41.2	89.1	.537	1.16	59.0	146.	.770	1.91
1294°	156.	100.0	167.	.865	1.44
1328°	178.	233.	316.	1.31	1.77	155.	233.	.870	1.31
1362°	266.	254.	317.	.979	1.19
1394°	389.	614.	631.	1.58	3.09	419.	397.	1.07	1.00
1429°	528.	769.	610.	1.32	1.04
1462°	828.	1390.	1902.	1.68	2.30	1150.	798.	1.38	.990
1527°	1602.	2500.	2566.	1.54	1.55	1950.	1102.	1.20	.679
1580°	2690.	2620.	1500.	.973	.427

By measurements of this sort on the oxides of calcium, magnesium, zirconium, beryllium, silicon, aluminum, etc., some of the results of which are given in the following tables and figures, we are able to describe the *blue glow* in fairly definite terms.

The blue glow is essentially a phenomenon of the lower stages of incandescence. Its upper limit cannot be given definitely in degrees since it depends upon the state of activity of the oxide, but it lies between 1000° and 1200° in the cases thus far studied. If, as in Fig. 1, we plot the brightness of the blue of the spectrum ($.45\mu$) of one of these oxides (MgO) between 900° and 1200° and for comparison the brightness curve (B.B.) for the corresponding region of the spectrum of a black body we see that the oxide remains *brighter than the black body* until a temperature of about 1200° is reached. It is this excess of radiation above what even a perfect radiator such as the ideal black body is capable of producing by virtue of its temperature alone which constitutes the effect in question.

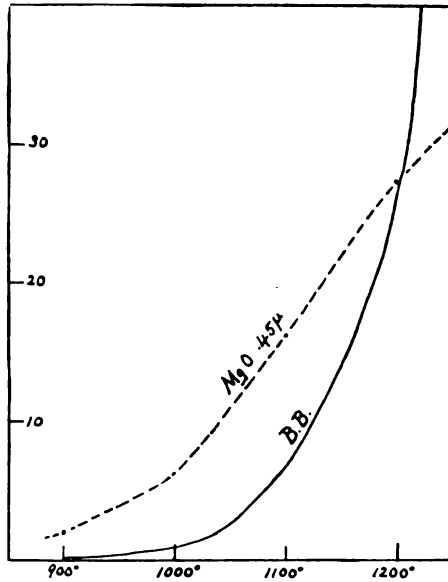

Fig. 1. Blue glow of magnesium oxide, 900° to 1200° C

The lower limit of the blue glow is the temperature threshold of visibility. For the lowest temperature at which we can observe we get the *maximum value* of the ratio between the brightness of the glow and that of a black body of the same temperature. This ratio may be denoted as I_o/I_{bb} .

In Fig. 2 are plotted curves for this ratio for several oxides. Such a diagram, to this scale, indicates nothing of the phenomena occurring above 1000° where the values approach and often fall

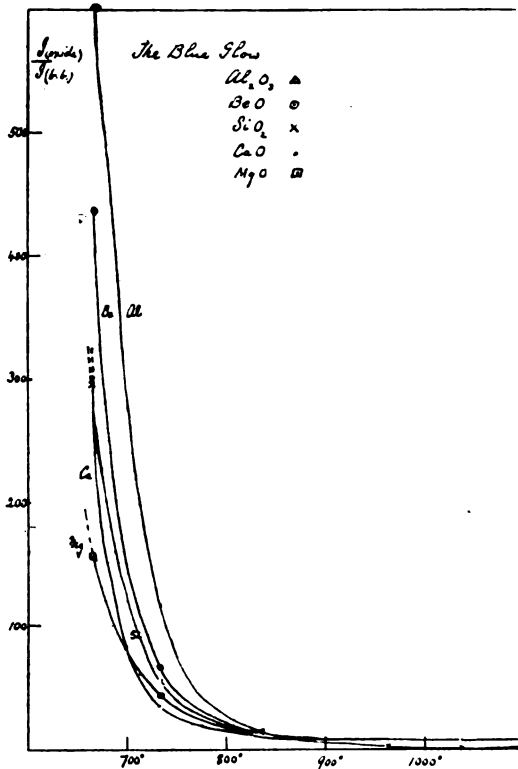

Fig. 2. Ratios of luminescence to black body radiation for several oxides below 1000° C

below unity. Still less can the ratio for the red of the spectrum be thus depicted. The figure shows, however, that:—

- (1) The curves for the various oxides are similar as to type.
- (2) In no case is there an indication of an approaching maximum in the direction of lower temperatures.
- (3) The temperature range within which the brightness of the blue end of the spectrum, to which these curves apply, falls to values of the same order as the corresponding intensity of black body radiation is nearly the same for all these oxides.

With logarithms of the intensity ratios as ordinates, we can bring the entire range of temperatures over which measurements were made into one plot and compare the changes occurring in the intensity of the red end of the spectrum with those in the blue.

Figure 3 contains such curves for magnesium oxide and these are quite typical of all the substances thus far investigated.

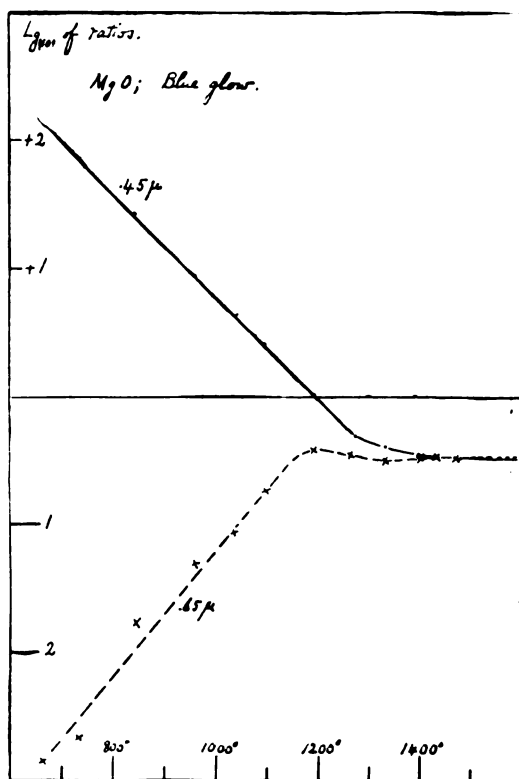

Fig. 3. Logarithmic curves for blue glow (.45 μ) and temperature-radiation (.65 μ) of Mg O

The characteristics common to all are as follows:—

(1) The luminescent outburst, with certain exceptions to be considered later, does not involve the longer wave lengths.

(2) The radiation in the red which, at the lower temperatures, is probably all temperature-radiation, rises from very small intensities and approaches the falling values for the radiation in the

blue. Thus the oxide in passing from 600° to 1200° goes over from a body exhibiting blue luminescence and almost no temperature-radiation (for MgO less than a thousandth of that of a black body) to a body radiating almost nonselectively by temperature alone with a radiating power of the same order as that of the black body.

(3) The logarithmic curve is approximately linear up to the point where temperature-radiation supplants luminescence (1000° to 1200°). The curves for the ratio $\frac{I_o}{I_{bb}}$ in Fig. 2 are, then, exponential curves, warped sometimes by changes due to fatigue during the run and rendered more or less irregular by failures to completely control the conditions.

(4) When temperature radiation has supplanted luminescence (at from 1000° to 1200°) the logarithmic curve tends to become horizontal; indicating that the effect of temperature is now that expressed by the usual equation for black-body radiation.

(5) The knee of the logarithmic curve affords a criterion for the change to temperature-radiation and thus serves to locate the upper limit of the blue glow. Comparing Figs. 1 and 3 we should conclude that luminescence did not altogether cease at the crossing of the curves at 1200° but continued slightly beyond to a point at which the normal radiating power by temperature had been reached. (Say at 1260° for MgO in the experiment which these curves illustrate.)

The foregoing paragraphs describe the blue glow as though it were the only form of luminescence occurring above the red heat. More frequently than not there are, however, other manifestations of luminescence within the range covered by our experiments. These either modify or supplant the blue glow at temperatures below 1200° or succeed it when the oxide is still further heated.

Outbursts of luminescence at higher temperatures characterize several of the oxides already described notably, CaO, BeO and SiO₂. In silica, as may be seen from Fig. 4, in which the ratio curves for $.45\mu$ and $.65\mu$ between 1000° and 1600° are plotted, we have such an outburst. In this cut ordinates are magnified one hundred times as compared with those in Fig. 2. The hori-

zontal line, of intensity equal to unity, represents the brightness of the black body at the wave length and temperatures in question.

This luminescence, expressed in terms of ratios, appears quite insignificant when compared with the blue glow of silica which at 600° is represented by a value for I_o/I_{bb} of over 400 as against

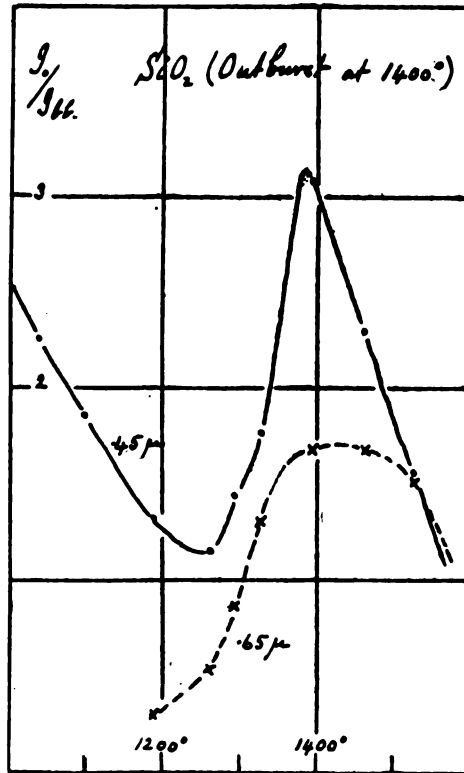

Fig. 4. Luminescence of SiO_2 at 1400° C

3.1 for the outburst at 1400° . Since, however, the intensity of the black body radiation which forms the denominator of this ratio increases according to the usual radiation law, we find the luminescence at 1400 degrees to be about 300,000 times as bright as the blue glow at 600 degrees and nearly 40,000 as great as the latter at 700 degrees. This high temperature outburst differs

from the blue glow also in that a greater portion of the spectrum is involved. That the red end at $.65\mu$ is considerably affected is evident from the curve for that wave length.

Modifications of the blue glow itself occur in several of the substances which we have examined. When cerium oxide for example is heated and its spectrum studied, we find excess radiation at

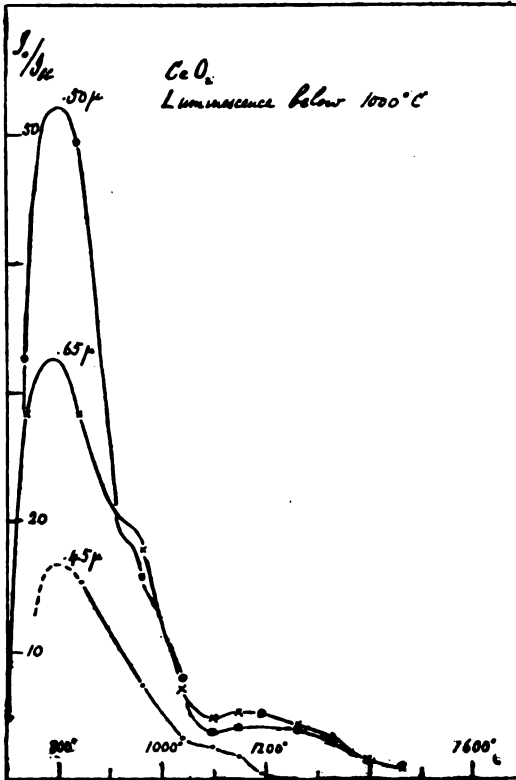

Fig. 5. Luminescence of cerium oxide below 1000°C

the lowest stages of incandescence. The phenomenon differs from the blue glow in that the red and green become visible before the blue and in that the ratio I_r/I_{bb} rises in value to a maximum, at about 800 degrees. (See Table 4 and Fig. 5.) The blue is less strongly involved than either red or green and the brightness of the red instead of starting with almost infinitesimal values is

nearly nine times great at 700 degrees as the corresponding region in the spectrum of the black body.

TABLE 4
Modified Blue Glow in Cerium Oxide

Temp. C	I_{bb}	Brightness at Various Temperatures					
		I_o			I_o/I_{bb}		
		.65 μ	.50 μ	.45 μ	.65 μ	.50 μ	.45 μ
702°	.00045	.0040	.0017	8.95	4.72
735°	.00123	.0349	.0403	28.3	32.6
837°	.0246	.692	1.21	.370	28.2	49.5	15.2
960°	.419	4.92	6.53	3.02	17.7	15.6	7.21
1037°	1.95	13.9	15.3	13.7	7.12	7.85	3.09
1097°	5.93	28.3	21.4	15.2	4.78	3.63	2.55
1145°	13.2	69.5	53.2	25.4	5.25	4.02	1.91
1190°	26.6	133.	133.	11.7	5.02	5.02	0.44
1263°	76.7	334.	304.	11.1	4.34	3.95	.144
1328°	178.	596.	519.	25.4	3.34	2.91	.142
1394°	389.	653.	695.	87.9	1.58	1.69	.227
1462°	828.	783.	887.	113.	0.95	1.07	.136
1527°	1602.	1319.	1109.	423.	.813	0.684	.260
1580°	2690.	3304.	1514.	656.	1.23	0.562	.244

Here then is a luminescent glow which at 800 degrees is composed approximately of one part blue, two parts red and three parts green, not in energy units but relatively to a nonselective radiator of the like temperature.

Without going further into details in the present paper it may be stated that the blue glow and other similar instances of luminescence at high temperatures occur in bodies which have the following characteristics.

- (1) They are inactive under excitation by light or by the X-rays.
- (2) They are, however, in general, excited to luminescence in the cathode tube.
- (3) In many cases they are sensitive to flame excitation.
- (4) Like other luminescent substances they are white, or nearly so, i.e. transparent to most portions of the visible spectrum.
- (5) They are of necessity highly refractory.

The luminescence of incandescent bodies is subject to fatigue. It is in the highest degree affected by previous heat treatment of the material; it is in some cases destroyed by fusion of the oxide; it is dependent on the mode of heating, being much more intense where an excess of oxygen is present than where there is a deficiency.

Finally it appears to be a phenomenon of instability associated with and perhaps dependent upon changes of the conditions of equilibrium. Thus all the oxides which exhibit the blue glow are in transition, within the temperature range in question from a condition of almost infinite electric resistance to one of semi-metallic conductivity and this change is accompanied by the well known profound modifications in optical properties, radiating power etc. Again the outburst of luminescence in silica at 1400 degrees occurs at the transformation point of quartz and is presumably intimately related to that change.

The most promising view at the present moment would seem to be that this form of luminescence like many well known forms at lower temperatures is the result of oxidation.

During these transitional conditions it would appear that a partial reduction takes place through the agency of the hydrogen of the flame and that this is immediately followed by oxidation, the two opposing processes going on in rapid alternation.

PHYSICAL LABORATORY OF CORNELL UNIVERSITY,
OCTOBER, 1921.

THE SIGNIFICANCE OF THE $\frac{1}{2}$ TERMS IN SPECTRAL SERIES FORMULÆ

BY
PAUL D. FOOTE and F. L. MOHLER*

Sommerfeld¹ from his mathematical derivation of the empirical Ritz equation concluded that the ratio of the constant a^* for the enhanced spectrum of an alkali earth to the constant a for the arc spectrum of the alkali of next lower atomic number should be $a^*/a = 2$.

Fues² showed that this relation was approximately true only when to m were assigned the values 1.5, 2.5 etc. in the ms and $m \text{ } \textcircled{S}$ terms. The ratios thereby obtained for the elements Mg/Na , Ca/K , Sr/Rb , Ba/Cs , are 2.9, 2.2, 2.6, 2.1 respectively. The mean value is $2.45 \pm 12\%$ average deviation, or a positive average deviation from 2 of 22% .

In spite of these large variations Sommerfeld³ later affirms that the "atomic field constant s gives the deviation from half numbers rather than from whole numbers."

The constant a by Sommerfeld's derivation takes the following form, to terms of the first order.

$$a = \frac{(2\pi)^4 m^2 e^2 k c_1}{n^3 h^4} \dots \dots \dots (1)$$

$$c_1 = \frac{1}{4} (Z - k) e^2 a_1^2 \dots \dots \dots (2)$$

where $k = 1$ for arc spectra, $k = 2$ for spark spectra, a_1 is the diameter of the ring of electrons surrounding the nucleus, and n the azimuthal quantum number. Sommerfeld assumed that c_1 remained constant for any pair of elements. However, with the same number of electrons in a ring, the diameter of the ring decreases when the charge on the nucleus is increased. If this

* Published by permission of the Director, Bureau of Standards.

¹ Sommerfeld *Atombau*, 2nd Ed. p. 506. $(m, a) = \frac{Nk^2}{[m+a+a(m, a)]^2}$

² *Ann. d. Phys.* 63, p. 1, 1920.

³ *Ann. d. Phys.* 63, p. 238, 1920.

factor is considered we no longer obtain $a^* = 2a$, although the approximation is closer when a large number of electrons are assumed in the same ring. For 50 electrons in a ring $a^* = 1.8a$.

As a little better representation, however, of actual atomic conditions we shall consider two coplanar rings, the inner ring containing p electrons, the outer ring q electrons and around the whole the quantized coplanar orbit of the single remaining valence electron. The azimuthal quantum number for the inner ring is 1 and for the outer ring 2. On carrying through the derivation for the case of two rings, exactly as Sommerfeld's except that we consider the effect of the nuclear charge on the radii a_1 and a_2 of the rings, as follows:⁴

$$a_1 = \frac{1^2 a_h}{Z - s_p} \qquad a_2 = \frac{2^2 a_h}{(Z - p - s_q)}$$

we obtain eq (3) for the general relation between a^* and a .

$$\frac{a^*}{a} = 2 \frac{\frac{p}{(Z^* - s_p)^2} + \frac{16q}{(q + 2 - s_q)^2}}{\frac{p}{(Z - s_p)^2} + \frac{16q}{(q + 1 - s_q)^2}} \dots \dots \dots (3)$$

Here Z^* and Z are the atomic numbers of the alkali earth and alkali respectively and s_p and s_q are the nuclear defects of the rings.

The following table gives the values $a^* = \textcircled{m}$ and $a = s$, as far as known, for the alkali earths and the alkalis, empirically deter-

\textcircled{m} and s terms for integral m

q	Element	$a^* = \textcircled{m}$	Element	$a = s$	a^*/a	
					obs.	comp.
8	Mg	.93	Na	.65	1.43	1.48
8	Ca	1.20	K	.82	1.46	1.49
18	Sr	1.32	Rb	.81	1.63	1.66
18	Ba	1.43	Cs	.95	1.50	1.66
					Av. dev. = 4%	

⁴ Sommerfeld Atombau, p. 258. a_h = radius of hydrogen atom.

mined for integral values of m . They accordingly contain the quantity $\frac{1}{2}$ ordinarily considered as belonging to m . Column 6 gives the ratio a^*/a obtained from these data and column 7 the ratio computed by eq (3).

The average deviation of the computed values of this ratio from the observed is only 4% in contrast with 22% found by Fues. This fact would seem to indicate that to m should be assigned integers for the ms and $m\mathfrak{S}$ terms, as is the case with the mp , md and mb terms. To an approximation (3) may be written

$$\frac{a^*}{a} = 2 \frac{(q+1-s_q)^2}{(q+2-s_q)^2} \dots \dots \dots (4)$$

It may be noted that by assigning various integers to q and in some cases by using more rings, these equations may be manipulated to give fairly close values of a and a^* as well as of their ratio. In the above, however, we have employed the generally accepted numbers for q , and the distribution of inner rings does not materially affect the ratio a^*/a .

Conclusion: The frequently expressed opinion that the half integral values of m in the ms terms have some mysterious significance is not founded upon sufficient reason. The simple physical conceptions of the quantum theory suggest that m should be an integer and in the present note as good evidence is offered confirming this viewpoint as has been advocated to the contrary.

BUREAU OF STANDARDS,
DEC. 6, 1921.

THE DISPERSION OF GLASS

BY
T. SMITH

The circumstances during the war which forced America to manufacture the optical glass needed for her own use have led to the appearance of a number of interesting papers in which the properties of glass are discussed. Among these are some concerned with dispersive relations, for the representation of which various formulas have been proposed. In these discussions a very satisfactory expression due to Conrady has been overlooked, though less good suggestions have been considered. According to Conrady¹ the dispersion may be regarded as a linear function of λ^{-1} and λ^{-2} . A graphical demonstration shows that there is little room for improvement on this formula. In an investigation² based on the figures of the Jena catalogues the indices -0.91 and -3.4 have been found by the present writer. The final formula is

$$\begin{aligned} \mu - \mu_D = & \left\{ .226(\mu_F - \mu_C) + \beta(\mu_D - 1) \right\} \frac{\lambda^{-0.91} - \lambda_D^{-0.91}}{\lambda_F^{-0.91} - \lambda_C^{-0.91}} \\ & + \left\{ .774(\mu_F - \mu_C) - \beta(\mu_D - 1) \right\} \frac{\lambda^{-3.4} - \lambda_D^{-3.4}}{\lambda_F^{-3.4} - \lambda_C^{-3.4}} \dots\dots\dots (1) \end{aligned}$$

where β is .0062 for normal glasses, and assumes a slightly lower value for telescope crowns, and a slightly higher value for telescope flints. Neglecting variations in β the formula may be regarded as a special case of the type

$$\mu = a(\mu_F - \mu_C) + b\mu_D + c, \dots\dots\dots (2)$$

the particular assumption being $b + c = 1$. Another member of the same class has been investigated by Wright³ whose assumption is $b = 1$. As these two cases lead to divergent conclusions on the possible properties of achromatic lenses it is hardly superfluous to investigate the matter closely and particularly to determine which assumption fits the facts most closely as far as these are known.

¹ Monthly Notices R.A.S. 64, p. 458.
² Trans. Opt. Soc., 27, p. 99.
³ JOUR. OPT. SOC. AMER., 5, p. 389.

If a number of glasses satisfy (2) with the same values of a , b , c for given lines of the spectrum, a thin lens built up of such glasses will satisfy the relation

$$\kappa - \kappa_D = a(\kappa_F - \kappa_C) + (b-1)\kappa_D + (b+c-1)R$$

where κ is the power of the complete lens and R the sum of the total curvatures of its components. If the lens is achromatic for C and F complete achromatism (absence of secondary spectrum) may be attained in one of three ways

$$(I) \quad b = 1, \quad c = 0$$

$$(II) \quad b = 1, \quad R = 0$$

$$(III) \quad \frac{R}{\kappa_D} = -\frac{b-1}{b+c-1}$$

Of these (I) may be ruled out at once since if these conditions fitted the actual facts the removal of the ordinary chromatic aberration would necessarily eliminate the secondary spectrum also. According to (II) if Wright's assumption is correct the secondary spectrum can be removed by a suitable choice of glasses, the criterion being that if these are arranged to form a thin cemented system the curvatures of the first and last surface should be equal. This condition can be readily attained with three normal glasses provided they do not in addition to (2) satisfy a common relation of the type

$$\Delta\mu = \mu_r - \mu_c = d\mu_D + e$$

a relation which will certainly not be satisfied if the choice falls upon a crown and a flint of the ordinary silicate series together with a dense barium crown. For if an achromatic combination of three such glasses of given focal length is constituted of elements of powers κ_1 , κ_2 , κ_3 , another combination having these same properties may be built from

$$\kappa_1 + j\left(\frac{1}{\nu_2} - \frac{1}{\nu_3}\right), \quad \kappa_2 + j\left(\frac{1}{\nu_3} - \frac{1}{\nu_1}\right), \quad \kappa_3 + j\left(\frac{1}{\nu_1} - \frac{1}{\nu_2}\right)$$

and the change in the total curvature due to the alteration is

$$j \frac{(\mu_2 - \mu_3)\Delta\mu_1 + (\mu_3 - \mu_1)\Delta\mu_2 + (\mu_1 - \mu_2)\Delta\mu_3}{(\mu_1 - 1)(\mu_2 - 1)(\mu_3 - 1)}$$

which must be finite under the condition just given. A value may be given to j which will enable the known total curvature of the original system to be removed, and the system should then be free from secondary spectrum. That reasonable powers may thus be secured for the components may be seen from a rough example. If the crown has an index 1.5, and the other two lenses the common value 1.625, the dispersions will be approximately in the ratios 7: 11: 17. The three conditions are obviously satisfied if the powers are given by

$$\frac{\kappa_1}{(\mu_1 - 1) (\Delta \mu_2 - \Delta \mu_3)} = \frac{\kappa_2}{(\mu_2 - 1) (\Delta \mu_3 - \Delta \mu_1)} = \frac{\kappa_3}{(\mu_3 - 1) (\Delta \mu_1 - \Delta \mu_2)}$$

$$= \frac{\kappa}{\mu_1(\Delta \mu_2 - \Delta \mu_3) + \mu_2(\Delta \mu_3 - \Delta \mu_1) + \mu_3(\Delta \mu_1 - \Delta \mu_2)}$$

or in this case

$$\frac{\kappa_1}{-12} = \frac{\kappa_2}{25} = \frac{\kappa_3}{-10} = \frac{\kappa}{3}$$

values by no means unattractive for an achromatic objective constructed from normal glasses.

As an actual example using typical glasses from the Jena list of the three types mentioned let numbers 0.2188, 0.5799 and 0.93 be chosen. For $\kappa=1$ the total curvatures of the elements are

$$-8.3734 \qquad 14.3648 \qquad -5.9914$$

giving for the various spectrum lines the following powers for the complete lens

A'	0.9990
C	0.9997
D	1.0000
F	0.9997
G'	0.9975

The differences here are of the same order of magnitude as those of an ordinary doublet, and the conclusions to which Wright's formula would lead are not realized.

Condition (III) gives a solution only if c is a constant multiple, as the colour changes, of $1 - b$. The value of a solution depends

upon the sign and upon the magnitude of the constant multiplier. In the special case, $b+c=1$, the removal of the secondary spectrum becomes impossible. A decisive contradiction is therefore involved in the apparently small difference between the two cases $b=1$ and $b+c=1$, and an appeal to known reliable measurements must be invoked to decide which is more closely in accordance with the facts. It seems preferable under the circumstances to quote figures compiled by independent observers, and the comparison below is based on the figures of Jena catalogues. The general experience of manufacturers who have relied on these values for the construction of apochromatic as well as of ordinary achromatic systems affords an indication of their accuracy. The corrections which must be applied in the fifth decimal place to the indices calculated by each formula to give the catalogued figures are given in Table 1.

A glance at these figures indicates that on the whole the residuals in the columns headed $b+c=1$ are distinctly the smaller. The distribution of these residuals is given in Table 2. In compiling the latter table the last four glasses, which have indices exceeding 1.7, are left out of account as they are of no interest for the construction of optical instruments such as are now considered. The most notable differences in the two sets of corrections are in those applicable to the G' line. While the corrections for the case in which $b+c=1$ form a reasonably compact group, those for $b=1$ are widely spread, and the figures relating to the extreme barium crowns form a detached group at one end. From the figures summarising the whole position at the end of the table it appears that each formula is a good fit of its kind, and that while in the central region of the spectrum and at the red end the assumption $b+c=1$ leads only to slightly greater accuracy, the superiority of this formula over the alternative $b=1$ becomes very pronounced at the blue end. In particular Wright's formula fails for the dense barium crowns.

When glasses too unstable to be listed as general types are considered, it is found that one formula is better in some cases, the other for other types. Phosphate crowns and dense borate flints are better represented by $b+c=1$, while barium phosphate

TABLE I
Fifth Place Corrections Required to the Calculated Indices for Schott Glasses, List Dated 1913

Spectrum Line		A'		C and F		G'	
Formula		b=1	b+c=1	b=1	b+c=1	b=1	b+c=1
Glass Type No.	Description						
6781	F c	+4	-1	+2	0	+11	+3
6500	"	+6	-2	+2	-1	+13	-1
2188	B Si c	+3	-1	+2	0	+10	+2
7185	F c	+7	-2	+3	0	+15	0
802	B Si c	0	-5	-1	-3	+2	-6
3199	UV c	-2	-5	-1	-2	-1	-6
3832	B Si c	-1	-3	+1	0	-1	-2
144	"	+3	0	+1	-1	+7	-2
3848	"	-4	-5	-1	-2	+3	-1
599	"	+2	-2	-1	-2	+5	-2
3512	"	-5	-5	+1	+1	+1	-2
57	c	+7	+3	+1	-1	+7	0
3390	B Si c	+5	+1	+3	+1	+10	+3
6367	"	-1	-6	+1	-1	+3	-5
2122	Ba c	-2	+5	-1	0	-9	-1
337	c	+2	0	+1	0	+8	+2
4817	"	+7	+1	+2	0	+9	0
6223	"	+3	0	+1	0	+6	-1
3453	"	+7	+4	+1	0	+5	-1
546	Z Si c	+2	-1	+2	0	+6	-1
60	c	+4	+1	+1	0	+6	0
138	"	+4	+2	+1	0	+5	+1
4125	"	+3	+1	+1	0	+5	+1
6634	"	+3	-1	+1	0	+6	0
567	"	+3	-1	+2	0	+9	+1
227	Ba Si c	+3	+3	0	-1	0	-3
2118	c	-1	-5	+1	0	+11	+4
3712	Ba c	-7	+1	-2	0	-11	0
203	c	+3	0	-1	-2	+5	-1
2071	Ba c	-8	+1	-3	-1	-11	0
2164	c	+6	+1	+3	+1	+12	+4
15	Z Si c	+1	-1	0	-1	+2	-2

TABLE 1—Continued

Spectrum Line		A'		C and F		G'	
Formula		b=1	b+c=1	b=1	b+c=1	b=1	b+c=1
Glass Type No.	Description						
211	Ba Si c	+2	+7	-1	0	-4	+1
3376	c	+4	0	+2	+1	+7	0
3551	Z Si c	+1	-3	+1	-1	+8	0
1209	Ba c	-6	+3	-3	0	-12	0
5970	"	-6	+4	-3	0	-14	-2
114	c	+9	+4	+2	0	+8	0
2994	Ba c	+2	+11	-1	+1	-12	-1
1615	"	-5	+3	-2	0	-11	0
7550	Ba f	0	+1	0	0	-3	-1
3961	Ba c	+2	+10	-2	+1	-12	-1
7336	Ba f	+1	+3	0	0	-4	-2
3248	UV f	+4	+2	0	-1	+3	-2
463	Ba f	0	+1	0	0	-1	0
5878	Ba c	-5	+3	-1	+1	-11	0
608	c	+10	+4	+2	0	+8	0
4679	Ba c	-5	+4	-1	+1	-11	0
722	Ba f	-1	+2	-2	-1	-7	-2
5799	Ba c	-5	+4	-2	+1	-13	-1
602	Ba f	+1	+2	+1	-1	-2	-2
846	"	+2	+3	0	+1	+1	-2
3439	T f	-3	-8	-1	-2	0	-7
381	c	+7	+2	+2	+1	+7	0
583	Ba f	+2	+3	0	0	-3	-2
152	Si g	+4	+1	+2	0	+6	0
543	Ba f	+2	+2	0	0	0	0
527	"	+4	+6	+1	0	-1	0
3338	T f	-2	-5	-1	-2	-3	-7
2015	Ba c	-3	+3	0	+1	-8	-2
575	Ba f	+2	+3	+1	+1	-1	0
522	"	+4	+2	+2	+1	+4	+1
7821	B Si f	-4	-4	0	-1	-3	-4
726	f	+4	0	+1	0	+3	-4
6241	"	0	-2	+1	0	+2	-2

TABLE 1—Continued

Spectrum Line		A'		G and F		G'	
Formula		$b+1$	$b+c=1$	$b=1$	$b+c=1$	$b=1$	$b+c=1$
Glass Type No.	Description						
578	Ba f	+2	+3	0	0	-3	-2
378	f	+5	+1	+1	0	+5	-1
6296	"	+2	-1	+1	0	+1	-2
1266	Ba f	-1	+1	-2	0	-6	-1
154	f	0	-2	-1	-1	+1	0
376	"	0	-2	+1	0	+4	0
276	"	0	-2	0	-1	+7	+6
569	"	-1	-4	0	0	+4	+1
340	"	+1	-1	0	0	+2	0
184	"	0	-1	-3	-3	-5	-4
748	Ba f	+6	+9	0	+1	-3	+1
318	f	-1	-2	0	0	-1	-1
118	"	+1	-1	-2	-2	-3	-2
167	"	-2	-3	-3	-2	-3	-2
3269	Ba f	-3	+1	+1	+2	+1	+8
103	f	-1	-1	-2	-1	-2	0
93	"	0	0	-4	-3	-4	-2
6131	"	+3	+2	+1	+1	+2	+3
919	"	+5	+5	0	+1	+4	+7
355	"	+4	+3	-3	-2	-1	+3
102	"	-1	0	-3	-2	-2	+3
192	"	0	+2	-3	-1	-2	+5
41	"	+1	+5	-1	+2	+2	+13
113	"	+8	+11	0	+3	+4	+16
165	"	+8	+11	0	+3	+8	+21
198	"	+5	+11	+1	+5	+16	+32

crowns and light borate crowns leave smaller residuals with $b = 1$. In the case of very dense flints neither formula is satisfactory; which is better depends upon the presence or absence of boric acid as a constituent of the glass.

TABLE 2
Analysis of Residual Corrections

Spectrum line	A'		C and F		G'	
	b=1	b+c=1	b=1	b+c=1	b=1	b+c=1
Formula						
Value of correction						
15	0	0	0	0	1	0
14	0	0	0	0	0	0
13	0	0	0	0	1	0
12	0	0	0	0	1	0
11	0	1	0	0	2	0
10	1	1	0	0	2	0
9	1	1	0	0	2	0
8	0	0	0	0	4	1
7	5	1	0	0	5	1
6	3	1	0	0	5	1
5	3	2	0	0	6	1
4	10	6	0	0	4	2
3	9	12	3	0	4	5
2	11	9	12	1	5	2
1	6	13	24	17	5	7
0	10	8	18	40	3	25
- 1	9	11	13	16	7	14
- 2	5	8	8	10	4	19
- 3	3	3	8	3	8	1
- 4	2	2	1	0	3	3
- 5	5	6	0	0	1	1
- 6	2	1	0	0	1	2
- 7	1	0	0	0	1	2
- 8	1	1	0	0	1	0
- 9	0	0	0	0	1	0
-10	0	0	0	0	0	0
-11	0	0	0	0	5	0
-12	0	0	0	0	3	0
-13	0	0	0	0	1	0
-14	0	0	0	0	1	0
Mean	1.08	.64	0	-.30	.41	-.44
Mean of absolute values	3.10	2.67	1.31	.74	5.10	1.82
Root mean square error	4.40	3.95	1.86	1.25	7.72	3.01

A formula suggested by Nutting⁴ requires less detailed consideration. He proposes a particular case of the type

$$\frac{1}{\mu - 1} = A + B\lambda^c$$

It is easy to show that no such formula can be applicable to glasses in general. For it involves among other relations the particular relations

$$\frac{\mu_{A'} - \mu_C}{\mu_C - \mu_F} \cdot \frac{\mu_F - 1}{\mu_{A'} - 1} = f, \text{ a constant}$$

and

$$\frac{\mu_F - \mu_{C'}}{\mu_C - \mu_F} \cdot \frac{\mu_C - 1}{\mu_{C'} - 1} = g, \text{ a constant}$$

If the three partial ratios

$$\frac{\mu_{A'} - \mu_D}{\mu_C - \mu_F}, \frac{\mu_D - \mu_f}{\mu_C - \mu_F}, \frac{\mu_f - \mu_{C'}}{\mu_C - \mu_F}$$

which are quoted in manufacturers' lists are denoted by p_1 , p_2 and p_3 respectively the above relations may be expressed as

$$p_1 + p_2 - 1 = f \cdot \frac{\nu - p_1}{\nu + p_2}$$

and

$$p_3 = g \cdot \frac{\nu + p_2 + p_3}{\nu + p_2 - 1}$$

Now normal clear glasses vary regularly in their partial dispersions from the fluor crowns with values such as

$$\nu = 69.9, \quad p_1 = .662, \quad p_2 = .700, \quad p_3 = .552$$

to the dense flints with such values as

$$\nu = 32.0, \quad p_1 = .597, \quad p_2 = .717, \quad p_3 = .615.$$

Over this range

$$p_1 + p_2 - 1 \text{ decreases by } 13\%$$

and

$$p_3 \text{ increases by } 11\%$$

⁴ JOUR. OPT. SOC. AMER., 2 and 3, p. 61.

On the other hand $\frac{\nu - p_1}{\nu + p_2}$ falls from .981 to .960, just over 2%,

and $\frac{\nu + p_2 + p_3}{\nu + p_2 - 1}$ rises from 1.022 to 1.065, rather more than 3%.

It is clear from these figures that no formula of this class is of general interest in connection with optical glass.

OPTICS DEPARTMENT,
NATIONAL PHYSICAL LABORATORY.

INSTRUMENT SECTION

THE CRYSTELLIPTOMETER

AN INSTRUMENT FOR THE POLARISCOPIC ANALYSIS OF VERY
SLENDER BEAMS OF LIGHT

BY
LE ROY D. WELD

I. INTRODUCTORY

The determination of the elements of elliptic vibration of light, which has been transformed from a condition of plane to one of elliptical polarization, is found to reveal so much concerning the optical nature of the agencies effecting the transformation that it becomes a matter of considerable importance to be able to make such measurements with reasonable accuracy. It so happens that the ordinary methods, which are employed for the elliptical analysis, and most of which are too well known to need setting forth here, require a fair breadth of field, and would therefore not easily apply, for example, to a ray passing through a pin-hole.

The research presented in this paper had its origin in a problem suggested to the writer some years ago by Dr. L. P. Sieg, and was begun in 1915. It has been carried out at Coe College by means of apparatus, much of which was kindly loaned for the purpose by the University of Iowa.

Various investigators have attempted to obtain the optical constants of metals and other opaque substances by reflection methods, with indifferent success. It appears certain from the research of Tate¹ that the difficulty has been due, not to lack of precision in the analysis of the elliptically polarized light reflected from the opaque surfaces, but to the variation in surface conditions, brought about by the polishing process, which modified the nature of that light. Thus it was found impossible to prepare two mirrors of the same kind of metal, even by the same process, which would give consistent results, while different measurements, and even different kinds of reflection measurements, on

¹ Tate, Phys. Rev., 34, p. 321, 1912.

the same fresh surface, gave good agreement. Dr. Sieg's suggestion was that opaque crystals, with their natural, unpolished facets, might be prepared of such surface purity as to obviate this difficulty, and at the same time furnish material for an interesting experimental research in crystal optics.

Comparatively few large opaque crystals can be obtained in perfect form. Drude² made some experiments long since with lead sulphide, and Müller³ subsequently, with antimony sulphide, freshly exposed by cleavage, employing ordinary polariscopic methods. In 1916 the writer made a preliminary report⁴ on the present research, which had already given unmistakable evidence of strong double refraction in minute hexagonal selenium crystals, and at the same meeting,⁵ Dr. Sieg reported having found by direct photometric measurements that the selenium crystal has two different reflecting powers in the two principal directions. Mr. C. H. Skinner has given an account⁶ of his interesting observations on selenium, using the ordinary Babinet compensator method, from which he concluded that the crystals, like artificially prepared surfaces, have in some respects their individual peculiarities, especially in the longitudinal direction.

The method adopted by the writer was presented to the Physical Society in 1917 but was published only in abstract⁷ at that time, the research being then still in progress. It is applicable not only to the polariscopic analysis of light reflected from polished plane surfaces of any sort, however small (such as minute spikelets or flakes of selenium, tellurium, cadmium, etc.), but to light in slender beams from any source. Its application has recently been suggested, for example, to the comparison, from point to point, of the optical properties of metal film-deposits of non-uniform thickness. Furthermore, being a photographic method, it is adaptable to the ultra-violet, and the apparatus was designed with this in view. Its original application to crystal-reflected,

² Drude, Ann. d. Physik, 36, p. 532, 1889.

³ Müller, Neues Jahrbuch für Mineralogie, 17, p. 187, 1903.

⁴ Weld, Proc. Iowa Acad. Sci., 1916, p. 233.

⁵ Sieg, Proc. Iowa Acad. Sci., 1916, p. 179.

⁶ Skinner, Phys. Rev., N.S. 9, p. 148, 1917.

⁷ Weld, Phys. Rev., N.S. 11, p. 249, 1918.

elliptically polarized light is what suggested to the writer the name "crystelliptometer" for the distinctive apparatus employed.

II. PRINCIPLE OF THE POLARISCOPIIC METHOD

As regards the polariscopic analysis itself, the method employed is a modification of that used by Voigt for the study of polarized ultra-violet. The principle is stated in Voigt's original article⁸ and a more detailed account given by Mr. R. S. Minor⁹ who applied it to artificially polished mirrors of steel, copper, silver, etc. A non-mathematical statement of the original method will first be given.

Let us have a uniform parallel beam of elliptically polarized monochromatic light; to determine the two elements of the elliptic vibration, which may be taken as the ratio $r = \frac{a}{b}$ of the X to the Y amplitude, and the phase advance ∇ of the X ahead of the Y harmonic component (either positive or negative).¹⁰

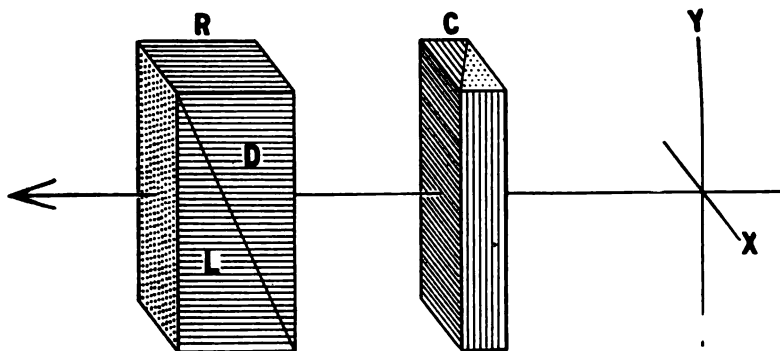

Fig. 1

Cross hairs and quartz wedge systems. XY , reticule. C , compensator. R , rotator

This beam first passes through a pair of quartz wedges similar to a Babinet compensator, except that they are fixed with reference to each other (C , Fig. 1). The edges are, let us say, vertical, that is, parallel to the Y direction. As we now face the oncoming

⁸ Voigt, Physik. Zeitschr., 2, p. 203, 1901.

⁹ Minor, Ann. d. Physik, 10, p. 581, 1903.

¹⁰ The reason for here using the inverted ∇ instead of the customary Δ will appear later (Sec. VII).

light and move across the emergent beam from left to right, we encounter a steady increase in the phase advance, so that, whereas the light through the center of the compensator has phase difference ∇ (the same as the original light), that at distance x from the center has phase difference $\nabla + sx$, where s is the compensator constant in degrees of phase per millimeter. Periodically, therefore, we shall come to regions of light *plane polarized* at some angle, viz., where $\nabla + sx = 0, \pi, 2\pi, \dots$

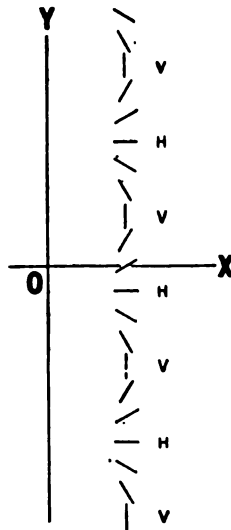

Fig. 2

Showing action of rotator on a strip of plane-polarized light

The next optical member is another pair of wedges, which will be called a *rotator* (R, Fig. 1). This consists of a wedge D of right-handed, and one L of left-handed, quartz, the optic axis of each being along the path of the light. It is easily seen that if the light entering the rotator be plane-polarized, it will suffer a net rotation of plane which will be the greater, the higher the point at which it traverses the two wedges. This rotation may be designated by qy , q being the rotator constant in degrees of azimuth per millimeter.

To an observer facing the light as it comes from the rotator, any one of the periodic vertical ribbons of plane-polarized light from the compensator will have been acted upon by the rotator as

shown in Fig. 2. Therefore as we traverse this emergent beam vertically along any one of these plane-polarized regions, we shall encounter, at intervals, light vibrating vertically, and half way between these, light vibrating horizontally (V and H, Fig. 2).

Finally, let the beam be passed through a Nicol set so as to extinguish, say, the vertical component. Obviously, wherever we had in one of these plane-polarized strips a point of vertical vibration, we shall now have a black spot. The field will then be covered with black spots arranged in a regular pattern of vertical columns and horizontal rows, the exact design of which will depend upon the elements of the original elliptic vibration. Conversely, these elements may be easily deduced from the observed arrangement of the spot-pattern. There is introduced into the

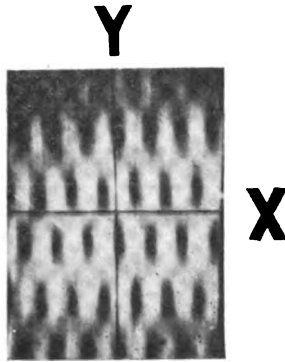

Fig. 3

Spot-pattern for elliptically polarized light reflected from nickel. (Enlarged.)

field a pair of cross hairs corresponding to X and Y axes and coinciding with the neutral lines of rotator and compensator, respectively. This reticule is photographed along with the spot-pattern and the coordinates of the spots determined by subsequent measurements on the plate. Such a spot-pattern, with the cross hairs, is shown, enlarged, in Fig. 3, in which the elliptic polarization was produced by reflection from nickel.

The equations relating to the processes just described, and the practical deduction of the elliptic elements therefrom, will be worked out in subsequent sections of the paper.

III. ADAPTATION OF THE METHOD TO SLENDER BEAMS

The above procedure, as followed by Voigt and others, obviously requires a beam of light whose cross section is large enough to cover the entire spot-pattern, and hence would not be adapted at all, for example, to light reflected from one facet of a small crystal. The writer's modification of it consists simply in keeping the very slender parallel beam, so reflected, stationary, and moving the whole analyzing system of quartz wedges, cross hairs, Nicol and camera back and forth perpendicularly across it, with

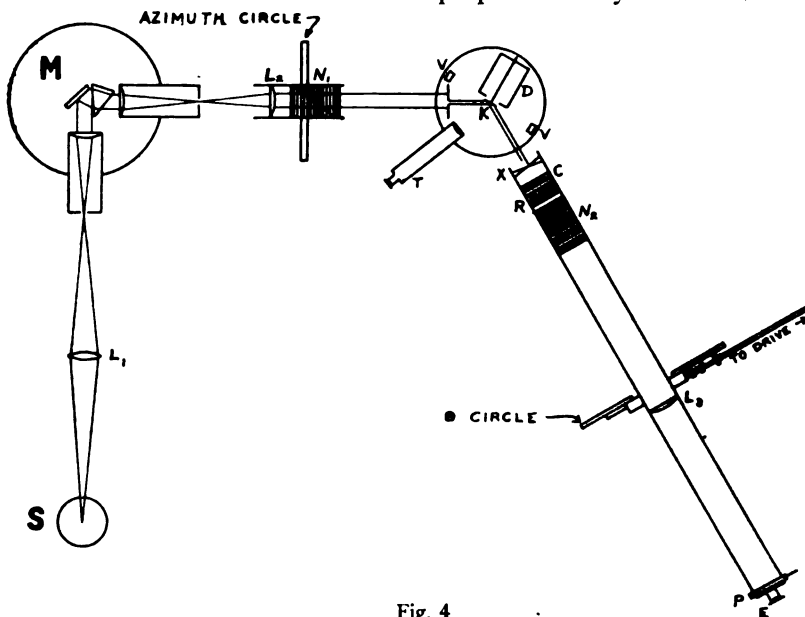

Fig. 4

Diagrammatic layout of apparatus. *S*, source. *M*, monochromator. *L*₁, *N*₁, collimator and polarizer. *K*, reflecting surface mounted in front of drum *D*. *X* to *E*, crystalliptometer

a sort of weaving motion, until the whole spot-pattern has been covered. The effect is the same as if the beam had a cross section as large as the field thus traced out. Whenever any point of the analyzing system corresponding to one of the dark spots arrives at the beam, the latter is extinguished thereby, and the spot is left on the plate. In practice it is not necessary to cover the whole pattern, but only the regions of it in which the rows of spots are known approximately to lie; and this fact saves much time.

The assemblage of optical parts, which is given the lateral motion just described, together with its mountings, considered as a single instrument, is what has been referred to as the "crystelliptometer."

The arrangement of the writer's apparatus for the study of crystals is shown in Fig. 4. Light from the source S is focused by the quartz lens L_1 on the inlet slit of the monochromator M , from whose outlet slit the monochromatic light diverges and is collimated by the quartz lens L_2 . (In the earlier work, color filters were used instead of the monochromator, and the filtered light focused by L_1 directly upon the slit of the collimator.) The parallel beam from L_2 is plane-polarized in any desired azimuth by N_1 , a large polarizing prism with square ends and a glycerine film.

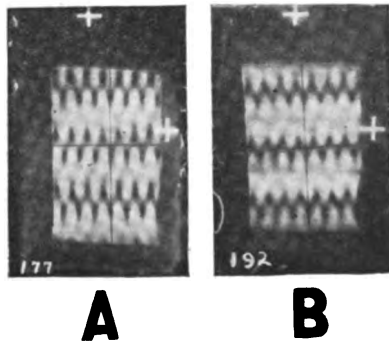

Fig. 5

A, spot-pattern for light reflected for selenium in parallel position. *B*, in perpendicular position

The crystal or other small reflector K is mounted on a spectrometer, by means of whose telescope T and verniers V any desired angle of incidence may be secured. The mounting can be rotated so that it is very easy to exhibit the double refraction of selenium, tellurium, etc., the spot-patterns obtained with axis horizontal and with axis vertical being quite visibly different, as seen in Fig. 5.

The slender reflected beam, in general elliptically polarized, now enters the analyzing system X, C, R, N_2 of the crystelliptometer. X represents the cross hairs, which the writer has found it necessary to place in front of the compensator C . (See Sec. VI.)

The compensator wedges have an angle of $52'$, which gives a relative phase change of about 144° per horizontal millimeter with sodium light. R is the rotator, with wedge angle 24° , which gives a rotation in azimuth of about 16° per vertical millimeter with sodium light. The dimensions of the field are about 15×30 mm. The wedge system and cross hairs are mounted adjustably in a brass tube which screws upon the tube containing the analyzing prism N_2 .

N_2 is a duplicate of N_1 , the two being interchangeable. They are rectangular prisms $15 \times 30 \times 30$ mm consisting of Iceland spar wedges separated by glycerine, the angle of incidence on the interface being 65° . The emergent (extraordinary) light vibrates parallel to the 15 mm dimension.

The spot-pattern and cross hairs are photographed together, by means of the quartz lens L_3 , upon the plate P . Behind the plate is an eyepiece E , used in adjusting the focus and alignment before the plate is inserted. The plates are $1 \times 1\frac{1}{2}$ inch, with emulsion adapted to the wave-length, and are held in a diminutive plate holder.

The whole crystalliptometer, from cross hairs X to eyepiece E , is contained in a tube about 85 cm long, so mounted on two pairs of guides at right angles that it can be given the weaving motion referred to in order to trace out the spot-pattern. This is accomplished by means of two micrometer screws perpendicular to each other. One of these screws is driven by a worm-gear electric motor mechanism so as to move the instrument slowly across, along a line determined by the other screw, the speed varying with the exposure required. Furthermore, the whole tube, with its micrometer mountings, can be rotated about its longitudinal axis through any desired angle, thus varying the relative inclination of the elliptic vibration to be analyzed, with respect to the coordinate axes of the analyzing system. The extinction plane of the analyzer N_2 , which coincides with the Y axis, being first vertical, one spot-pattern is produced. On rotating the instrument through an angle θ another is obtained, and so on; without, however, modifying in any way the actual nature of the elliptic light under analysis. The equations used in the subsequent

theory make provision for this arbitrary angle θ , the advantage of which will then appear.

The source of light at first employed was an open Nernst filament, which has later been replaced by a special low-voltage tungsten ribbon lamp. In some preliminary work with ultraviolet, an iron arc was employed.

A general view of the apparatus is shown in Fig. 6.

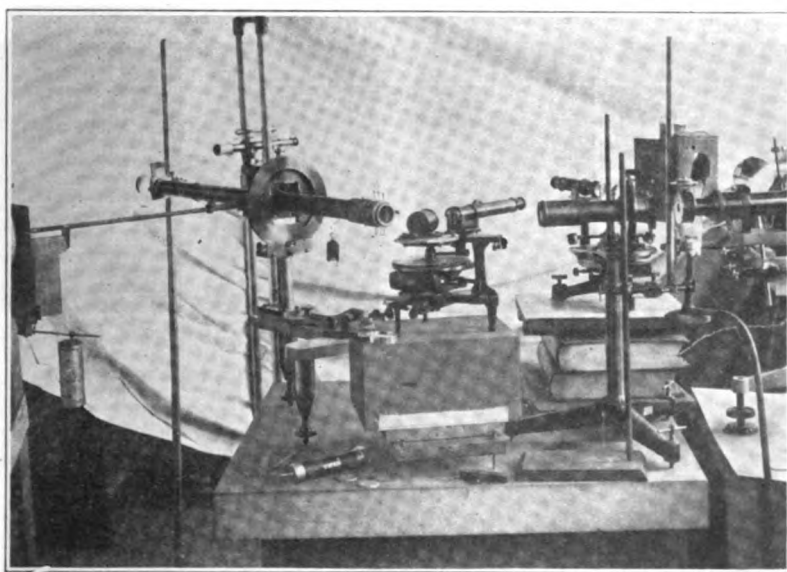

Fig. 6

General view of crystalliptometer and accessory apparatus

The spot-patterns are measured upon a micrometer comparator to one-hundredth of a millimeter. The lenses were removed from the microscope, and a pin-hole and hair-line substituted, a device suggested to the writer by Dr. Elmer Dershem. Not a little of the routine work consists of the plate measurements and their reduction. It has been found possible, with good, clear plates, to locate a spot by a single measurement with a probable error of less than one-hundredth of a millimeter. A selenium spot-pattern and the corresponding "comparison plate" (see Sec. VI) are shown

together as *A*, *B* in Fig. 7, and another similar pair, with greater wave-length, as *C*, *D*.

The quartz lenses and wedges and the Iceland spar wedges for the Nicols, designed by the writer, were made by Hilger of London, as was also the monochromator; the comparator by Gaertner of Chicago. The remainder of the special apparatus, including the driving mechanism, was built at the University of Iowa by Messrs. M. H. Teeuwen and J. B. Dempster, assisted by the writer.

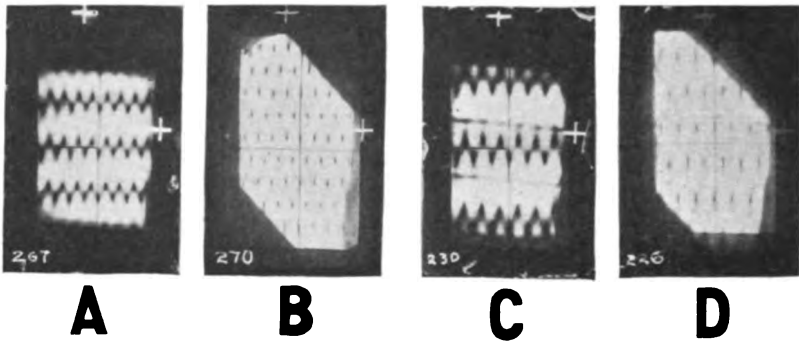

Fig. 7

A, selenium spot-pattern. *B*, corresponding comparison plate. *C*, *D*, same, with greater wave-length. Note the greater spot-intervals

IV. OUTLINE OF THE MATHEMATICAL THEORY OF THE ANALYZING SYSTEM

The mathematical theory of the action of the analyzing system, as used in the writer's method, and of the determination of the elliptic elements, will now be briefly given.¹¹ In the notation here used, X and Y are components of the vibration displacement of the light, while x and y are coordinates of points of the field with reference to the axes.

¹¹ This is necessary for the reason that the present method departs in certain essential particulars from the original and gives rise to a different set of equations. Minor did not, for example, rotate the quartz wedge system through the arbitrary angle θ which makes possible the least square adjustment of the observations, and which, as will be easily seen, also provides automatically for any difficulty due to the azimuth of the light under examination happening to be very small, without altering that light in any way.

Let the harmonic components of the elliptic vibration to be analyzed, as viewed by one facing the oncoming waves, be given by the equations

$$X = a \cos (\omega t + \nabla) \dots \dots \dots (1)$$

$$Y = b \cos \omega t \dots \dots \dots (2)$$

If the analyzing system by now rotated through an angle θ , these equations are transformed, with reference to the new axes, into

$$X' = a \cos \theta \cos (\omega t + \nabla) + b \sin \theta \cos \omega t \dots \dots \dots (3)$$

$$Y' = b \cos \theta \cos \omega t - a \sin \theta \cos (\omega t + \nabla) \dots \dots \dots (4)$$

Upon passage through the compensator, the Y -component receives an advance of phase, varying with the abscissa x of the point where it passes through, and equal to sx . (3) and (4) then become

$$X'' = a \cos \theta \cos (\omega t + \nabla) + b \sin \theta \cos \omega t, \dots \dots \dots (5)$$

$$Y'' = b \cos \theta \cos (\omega t + sx) - a \sin \theta \cos (\omega t + \nabla + sx) (6)$$

Upon passage through the rotator, there is a simple rotation of the axes of the ellipse, without further change, through an angle qy , which corresponds to a rotation $-qy$ of the coordinate axes, so that the components of the finally emergent light are

$$X''' = a \cos \theta \cos qy \cos (\omega t + \nabla) + b \sin \theta \cos qy \cos \omega t - b \cos \theta \sin qy \cos (\omega t + sx) + a \sin \theta \sin qy \cos (\omega t + \nabla + sx) \dots \dots \dots (7)$$

$$Y''' = (\text{a corresponding long expression which we shall not need}) \dots \dots \dots (8)$$

The light now passes through the Nicol N_2 , which shuts off the Y -component all over the field; hence (8) is not needed. Only X''' gets through, and this will vanish, leaving the dark spots, at every point where x and y have such values as to render the expression (7) equal to zero *all the time*, that is, independently of the value of t . To fulfill this condition, dividing (7) by $b \cos \theta$,

letting $\frac{a}{b} = r$, expanding the parentheses containing ωt and group-

ing the terms in $\sin \omega t$ and $\cos \omega t$ separately, we have

$$[-r \tan \theta \sin qy \sin (\nabla + sx) + \sin qy \sin sx - r \cos qy \sin \nabla] \sin \omega t$$

$$+[\tan \theta \cos qy + r \cos qy \cos \nabla - \sin qy \cos sx + r \tan \theta \sin qy \cos (\nabla + sx)] \cos \omega t = 0.$$

That this may be true independently of t , the coefficients must separately vanish, giving

$$-r \tan \theta \sin qy \sin (\nabla + sx) + \sin qy \sin sx - r \cos qy \sin \nabla = 0 \dots (9)$$

$$\tan \theta [\cos qy + r \sin qy \cos (\nabla + sx)] + r \cos qy \cos \nabla - \sin qy \cos sx = 0 \dots (10)$$

Letting $\tan \theta = m$, expanding the functions of $\nabla + sx$, and collecting, these become

$$[m \sin qy \cos sx + \cos qy]r \sin \nabla + m \sin qy \sin sx \cdot r \cos \nabla = \sin qy \sin sx \dots (11)$$

$$m \sin qy \sin sx \cdot r \sin \nabla + [m \sin qy \cos sx + \cos qy]r \cos \nabla = \sin qy \cos sx - m \cos qy \dots (12)$$

In these equations, x and y are the measured coordinates of any dark spot, s and q are the compensator and rotator constants, determined from the spot intervals, and m is the tangent of the known angle θ . Hence everything is known except r and ∇ .

Letting

$$\left. \begin{aligned} m \sin qy \cos sx + \cos qy &= H, \\ m \sin qy \sin sx &= K, \\ \sin qy \sin sx &= L, \\ \sin qy \cos sx - m \cos qy &= P, \end{aligned} \right\} \dots (13)$$

(11) and (12) become

$$H \cdot r \sin \nabla + K \cdot r \cos \nabla = L \dots (14)$$

$$K \cdot r \sin \nabla + H \cdot r \cos \nabla = P \dots (15)$$

the solution of which, as simultaneous equations, gives the required elliptic elements

$$r = \frac{\sqrt{(L^2 + P^2)(H^2 + K^2) - 4LHPK}}{H^2 - K^2} \dots (16)$$

$$\tan \nabla = \frac{LH - PK}{PH - LK} \dots (17)$$

It is thus theoretically possible to deduce the elements from the measured coordinates of any single spot.

V. APPLICATION TO SPOT-PATTERNS

If we place under examination light which is plane-polarized at azimuth 45° , so that $r=1$ and $\nabla=0$, it will be seen from the manner of their formation, as described in Sec. II, that the spots will be *symmetrically* arranged with respect to the *Y*-axis in *equally spaced* horizontal rows. This is the condition of things on the comparison plate, Fig. 7 B (see Sec. VI). Let the distance apart of the spots in the rows be d , and in the vertical columns, δ (Fig. 8). These are easily measured (see Sec. VI). The compensator constant s is equal to $\frac{360}{d}$, and the rotator constant q equals $\frac{180}{\delta}$, in degrees per millimeter (see Sec. II).

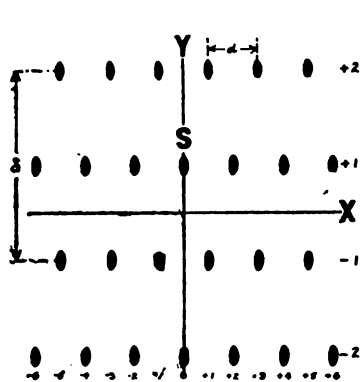

Fig. 8

Diagram of spots on a comparison plate, taken with plane-polarized light at 45° azimuth

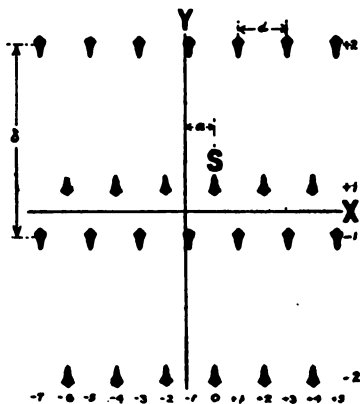

Fig. 9

Diagram of spots on a pattern taken with light elliptically polarized at phase difference 202° and azimuth 29°

If now we introduce by any means a phase difference ∇ between the *X*- and *Y*-components, there will be a uniform lateral displacement a of the whole spot system, so that the coordinates of the spot *S*, which in Fig. 8 are $0, \frac{\delta}{4}$, now become $a, \frac{\delta}{4}$. Then, again, if a change is produced in the azimuth of the incident light, the alternate rows $+1, -2$, etc. will be displaced vertically one way,

and rows +2, -1, etc., the other way, through a certain amount a , so that now the coordinates of S are $x = a$, $y = \frac{\delta}{4} + a$ (a being negative). These changes are shown in Fig. 9.¹²

Introducing the above values of s , q , x , and y into (13), and resuming $m = \tan \theta$, we get

$$\left. \begin{aligned} H &= \tan \theta \sin \left[45^\circ + \frac{a}{\delta} 180^\circ \right] \cos \left[\frac{a}{d} 360^\circ \right] + \cos \left[45^\circ + \frac{a}{\delta} 180^\circ \right], \\ K &= \tan \theta \sin \left[45^\circ + \frac{a}{\delta} 180^\circ \right] \sin \left[\frac{a}{d} 360^\circ \right], \\ L &= \sin \left[45^\circ + \frac{a}{\delta} 180^\circ \right] \sin \left[\frac{a}{d} 360^\circ \right], \\ P &= \sin \left[45^\circ + \frac{a}{\delta} 180^\circ \right] \cos \left[\frac{a}{d} 360^\circ \right] - \tan \theta \cos \left[45^\circ + \frac{a}{\delta} 180^\circ \right]. \end{aligned} \right\} (18)$$

While the attention is, indeed, fixed on one particular spot S , Fig. 9, whose coordinates are a and $\frac{\delta}{4} + a$, yet in actual practice it is expedient to make measurements on a number of spots, usually twenty or more, and deduce the position of S from them. Referring to Fig. 9, it is clear that the abscissa of any spot in the n th vertical column (numbered along the bottom of the figure) is

$$x \doteq a + n \frac{d}{2},$$

which gives

$$a = x - \frac{n}{2} d \dots \dots \dots (19)$$

By measuring the abscissas of several spots in different rows, thus varying x and n , we obtain as many independent observations upon a .

¹² If the azimuth is made 90° , rows +1, +2, rows -1, -2, etc., will merge or dove-tail together in pairs forming continuous horizontal dark stripes. If it is made 0, the pairs of rows +1, -1, etc., will similarly coincide. This affords a good means of adjusting the quartz wedge system with respect to the previously adjusted analyzing Nicol (see Sec. VI).

Again, the ordinate of any spot in the ν th horizontal row (counted upward or downward from the X -axis) may be seen to be

$$y = \pm (-1)^{\nu+1} a - \frac{\pm 1 - 2\nu}{4} \delta,$$

$$\text{or } a = \pm (-1)^{\nu+1} \left[y + \frac{\pm 1 - 2\nu}{4} \delta \right] \dots \dots \dots (20)$$

(\pm according as the row is above or below the X -axis), and we shall have, therefore, as many observations upon a as there are spots measured.

The averages from these observations on a and a are easily obtained by means of formulas depending upon the particular selection of spots made. If the selection consists of an equal number of vertical columns on each side of the Y -axis and of horizontal rows above and below the X -axis (as should be the case for other reasons), these averaging formulas become quite simple. a , a , d and δ being thus determined from the measurements on the plate, substitution of their values in (18) gives the necessary constants H , K , L , P , appearing in the expressions for r and $\tan \nabla$; Eqs. (16), (17), and the problem is solved so far as is possible from a single experiment.

We may, however, expose other plates with different values of θ , obtained by rotating the crystelliptometer tube about its own axis. This does not alter the elliptic elements, but it gives new values of H , K , L , P . In such case, (14) and (15) may be used as *observation equations* of the first degree with $r \sin \nabla$ and $r \cos \nabla$ as unknowns, and we may obtain as many different pairs of them as there are measured plates, finally adjusting them by the method of least squares. It has been the writer's practice to assign a weight to each measured plate by means of the grading method,¹³ each plate characteristic, such as clearness, symmetry of spots, etc., being graded separately.

It should be stated that, *except in cases where the number of spots on a plate available for measurement is too limited for precision*, a

¹³ Weld, *A Method of Assigning Weights to Original Observations*, Science, 50, p. 461, 1919.

single plate, with $\theta = 0$, is sufficient, and a vast amount of laborious calculation is thus avoided. For with $\theta = 0$ in (18), the elliptic elements, given by (16) and (17), reduce at once to

$$r = \tan \left[45^\circ + \frac{a}{\delta} 180^\circ \right] \dots \dots \dots (21)$$

$$\nabla = \frac{a}{d} 360^\circ \dots \dots \dots (22)$$

It is only with light of very large wave-length that the number of spots in the field is likely to be so few as to require the repeated exposures.

VI. MISCELLANEOUS DETAILS AND SOURCES OF ERROR

The general arrangement of the apparatus as employed for the study of opaque crystals was explained in Sec. III. In order to adjust all the parts in proper relation to each other, use is made of a sensitive cathetometer set with reference to the pier on which the apparatus stands. By this means is secured the horizontality of the monochromator, the collimator, the polarized incident beam, the reflected beam from the crystal, and the crystelliptometer tube, taken in the order named. The plane of incidence and reflection is thus strictly horizontal, and the azimuth of polarization, the arbitrary angle θ , and the vibration components X and Y are reckoned with reference to it. The crystal is mounted on the end of a small rod in front of the dark opening into a hollow drum,—a black body, so to speak, which makes a perfectly dead back-ground. The mounting may be turned in a vertical plane, and is provided with a graduated circle, so as to give the crystal any desired angle from 0° to 180° with the plane of reflection. The drum (D , Fig. 4) is placed on a spectrometer prism table for adjusting the angle of incidence, as previously explained.

Considerable trouble has been experienced with the monochromator, inasmuch as no reliance can apparently be placed upon the wave-lengths indicated by it; and furthermore, the wave-length corresponding to any given setting is found to vary from day to day. In all final work it has therefore been customary to

divert the light emerging from the monochromator into a separate grating spectrometer (not shown in Fig. 4) and compare it with the sodium standard just before making each exposure. Another and more serious difficulty with the monochromator is the impurity of the light furnished, especially in the shorter wave-lengths.

The accurate adjustment of the focus of the collimating and camera lenses is a matter of some importance, especially the latter. These quartz lenses are, of course, not achromatic, and the focus must be calibrated for wave-length. In the case of the collimator, it has sufficed to measure the focal length for one wave-length on an optical bench and calibrate the tube from the known dispersion of quartz. But any inaccuracy in the focus of the camera lens will result in displacements of the spot images and resultant errors in the elliptic elements, so that this requires greater precision. The method here employed is one devised by the writer and referred to as the "offset" or "broken prism" method.¹⁴ The proper focus for a given wave-length may be thus obtained with a probable error of only one or two tenths of a millimeter, and it is easy to calibrate the focus tube accordingly.

The need for a special precaution arises from the fact that the spot-pattern in the crystelliptometer appears to be a sort of virtual image lying in a definite plane. It is necessary to get the cross hairs accurately into that plane, otherwise there will be an apparent parallax between cross hairs and spots, and the results will be seriously affected if the light happens to be not strictly parallel to the crystelliptometer axis. Furthermore, the position of this virtual plane is found to vary systematically with the wave-length, so that the adjustment has to be made for each wave-length used. This is accomplished by mounting the cross hairs in a ring having a longitudinal micrometer movement in the tube. The crystelliptometer is turned a little to right and left with respect to the beam of light and the reticule moved forward or backward until the parallax disappears. It has always been found necessary, in the visible spectrum, to place the reticule in front of the compensator, as in Fig. 4.

¹⁴ Weld, *Some Precise Methods of Focusing Lenses*, School Science and Mathematics, 18, p. 547, 1918.

The cross hairs in the writer's instrument are of very fine spun glass, their images representing on the plate the X - and Y -axes of the spot-pattern. The ring in which they are mounted is provided with the usual lateral adjusting screws. It is inevitable that the reticule will get out of adjustment laterally, and for the purpose of determining this error (which would be serious if neglected), what are called *comparison plates* are taken at frequent intervals, using a full-sized beam of parallel, strictly plane-polarized light direct from the polarizing Nicol. The cross hairs are first given approximate adjustment visually, using this light. The comparison plate is then taken and the small errors of cross hair adjustment remaining, amounting to a few thousandths of a millimeter, are determined by measurements upon it and proper allowance made for them in the reduction of other plates. If a symmetrical pattern is selected, the adjustment of the *horizontal* cross hair is really immaterial, as the true X -axis can readily be found as the mean position of the horizontal rows of spots employed in measuring any plate.

Owing, no doubt, to slight inequality of the quartz wedge angles, the cross hair adjustment error is found, like the parallax, to vary systematically with the wave-length, and a new comparison plate must therefore be taken for each wave-length used. It is very difficult, even with the spectrometer test, to keep the wave-length strictly constant through a series of experiments. Curiously enough, the most sensitive, and the final, check on wave-length has been found to be the spot-interval d (Figs. 8, 9), which can be measured with great precision (see below). The greater the wave-length, the farther apart are the spots, both horizontally and vertically, on account of the dependence of both the phase-relation change, and the rotation, in quartz, upon the wave-length. (See Fig. 7.) In practice, it is found advisable to determine, by means of auxiliary comparison plates, the relation of the cross hair error to d for light in each region of the spectrum used, and to deduce the required correction from the measured d on each elliptic plate.

The accurate determination of the spot intervals d and δ for each plate is an essentially vital part of the work. The most

probable value of d can be deduced from the plate measurements by forming observation equations from the abscissas of the spots taken by groups in each row, and applying the simple least square adjustment requisite to the case. This is all done very quickly by means of a formula which is the same for all spot-patterns similarly selected. With a symmetrical spot-pattern δ is simply twice the mean absolute ordinate of the spots (without sign). Thus no extra measurements are necessary for d and δ . But it will not do to rely on the comparison plate, or any other one plate, for the spot-intervals corresponding to a supposedly fixed wave-length, as variations of wave-length too slight to have noticeable effect on the ordinary properties of the light, will cause serious errors through this means.

When, as usual, the arbitrary orientation θ (Sec. IV) is zero, it is seen by Eq. (21) that the ratio r of the two vibration components of the unknown light, which is the tangent of the azimuth, is given in terms of α and δ . These are determined from the y measurements alone. For some reason not certainly explained, it has been found that there is a persistent error in r as deduced from the measurements on the spot-pattern, whose value appears to be a linear function of r itself. The error is eliminated by first finding the uncorrected value of r from the plate measurements, and then taking a correction pattern with plane-polarized light having azimuth set for that value of r (which is thus accurately known). The measurement of this plate, and the comparison of the erroneous value of r deduced therefrom with the true value given by the polarizer azimuth circle, afford the necessary correction, which sometimes amounts to as much as two or three degrees. This must be done for each wave-length used. These azimuth-correction plates, like the comparison plates, are taken with full-sized beam from the polarizer and require only a short exposure.

One more detail of technique is worthy of note. It will be noticed from Fig. 7C, for example, that on some patterns the spots are not symmetrical vertically, but are decidedly triangular or cuneiform, and tend to run together in double rows. This makes it difficult to estimate the Y position of the spot nucleus with certainty in measuring these plates. It will not do to bisect the

spot with the micrometer in this direction. In order to ascertain the location of the nucleus within the spot, the means adopted has been to calculate, theoretically, the geometrical form of the concentric lines of equal intensity surrounding it, taking the constants from actual measurements on typical plates. The form of these lines, derived from an application of the mean value theorem, is

$$\cos(\nabla - sx) = \frac{1 - M - (1 - r^2)\cos^2 qy}{r \sin 2qy} \dots \dots \dots (23)$$

in which M is a parameter depending on the intensity along the curve in question; for the nucleus, $M = 0$. x and y are the coordinate

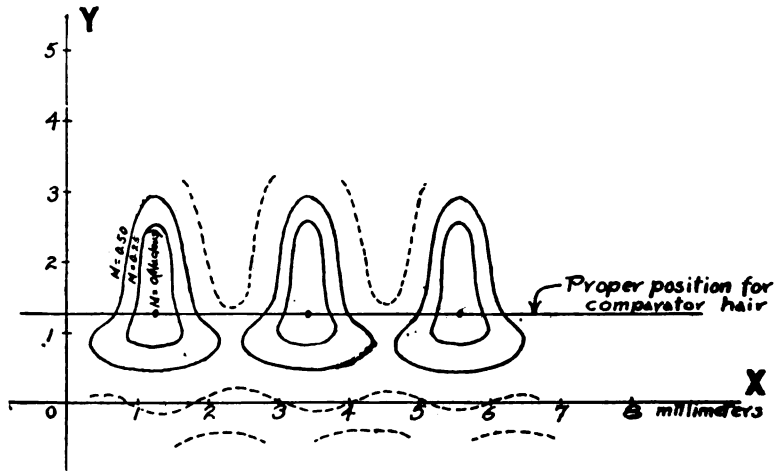

Fig. 10
Lines of equal intensity about the spots of Fig. 5B, greatly enlarged

variables, and the other quantities have the same meanings as in Sec. IV. Fig. 10 shows the nuclei and curves corresponding to $M = 0, 0.25$ and 0.50 on the plate shown in Fig. 5B. With the knowledge afforded by such a figure, it is easy to estimate with some accuracy what point within the spot is to be aimed at in making the measurement. The nucleus appears to represent approximately the center of gravity of the spot area, rather than to bisect its vertical dimension.

VII. TYPICAL APPLICATIONS. REFLECTION FROM SELENIUM CRYSTALS

Among the preliminary tests of the crystelliptometer and the methods of using it set forth in the foregoing sections were the analysis of polarized light rendered elliptical by reflection from nickel and copper mirrors or from crystals of lead sulphide and tellurium, or by passage through sheets of mica; and a tryout of Fresnel's equations for the rotation of plane-polarized light reflected from glass. The only problem, however, upon which serious attack has yet been made by the crystelliptometer method is the experimental part of an extensive research now in progress at the University of Iowa, viz., the optical laws of absorbing crystals. The general theory of this subject was handled with great thoroughness by Drude in his inaugural dissertation¹⁵ many years ago, but until recently the only experimental data upon which tests of the theory might be based have been with reference to certain large crystals of the rhombic system. The unique electro-optical properties of the hexagonal selenium crystal have suggested a revival of the subject, the outgrowth of which is the research in question. The few data given below are the first final results obtained by this method, and will serve to illustrate it. They are summarized from a long series of measurements on many selenium crystals, and involved the taking of nearly three hundred plates. The instrument is now in the hands of other observers whose aim is to accumulate information regarding the optical properties of small crystals of various metallic substances.

Some of the finest crystals of hexagonal selenium ever prepared were kindly put at the writer's disposal by Dr. E. O. Dieterich, who produced them by sublimation at the University of Iowa. They are 2 or 3 cm long and with facets often 0.5 mm in width. From some hundreds of these, about a dozen superb specimens were selected and mounted for use with the crystelliptometer. Selenium has a tendency to twist and warp, and great care had to be exercised to select crystals with plane facets. Even with these it

¹⁵ Drude, *Ann. d. Physik*, 32, p. 584, 1887.

was usually found expedient to limit the illumination to only one or two millimeters of length, so that an area of one square millimeter or less of reflecting surface was quite typical.

Much of the work was carried on at wave-lengths near the middle of the visible spectrum. The incident light was, in every case, plane-polarized at azimuth 45° . Several crystals were tested in both horizontal and vertical positions at wave-length 0.5μ , and at incidence angles 45° and 60° . At the other wave-lengths the incidence angle was maintained at 60° . The wave-lengths principally used were 0.45μ , 0.50μ , 0.55μ , 0.65μ , and 0.70μ , a range sufficient to give typical results. The wave-length 0.60μ was deferred to a separate research, for the reason that the data obtained by C. H. Skinner¹⁶ and others with selenium contain certain anomalies near this point, while the writer's results are strongly suggestive of what, with a transparent substance, would correspond to an absorption band, in the neighborhood of this wave-length. The matter deserves, therefore, more minute investigation.

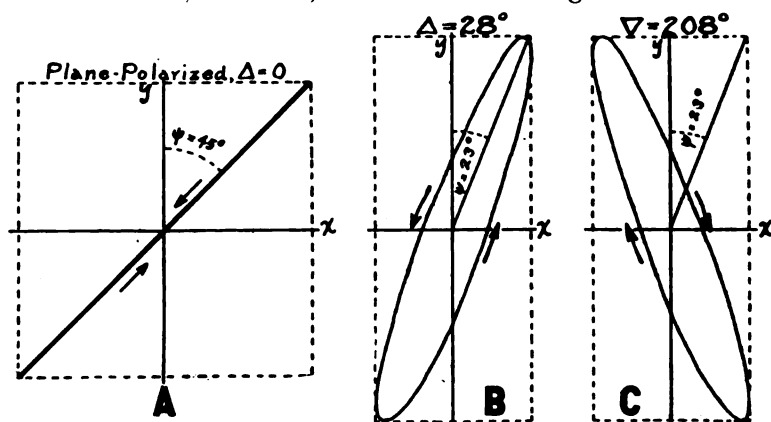

Fig. 11

A, incident vibrations, plane-polarized. B, C, elliptic vibrations viewed looking *with* and *against* the beam, respectively

Upon experimenting with a number of crystals prepared at different times, it was found that, with one or two exceptions, they gave fairly consistent results, *though all the crystals were several months old when the experiments were begun.* Great care, however,

¹⁶ *Loc. cit.*

had been taken to keep them clean and away from contact with fumes or corrosive gases. It is quite possible that these exceptions were due to surfaces that had in some way become tarnished or contaminated, in spite of the precautions. After the first trials, three crystals were selected which gave the clearest spot-patterns, and subsequent work was confined to these. The data in the accompanying tables are the weighted means of the results obtained at the respective wave-lengths. It should be stated that those corresponding to 0.70μ have small relative weight.

Elliptic Elements for Selenium Crystal at 60° Incidence

Wave-length (Microns)	Crystal Axis Parallel to Incidence Plane		Crystal Axis Perpendicular to Incidence Plane	
	Δ	Ψ	Δ	Ψ
0.45	23° 11'	35° 22'	29° 31'	24° 25'
.50	11 52	34 14	27 54	23 15
.55	4 26	32 27	20 41	24 26
.65	13 54	34 12	21 49	27 7
.70	11 24	31 13	14 38	26 7

The data refer to the light vibrations as they would appear to an observer stationed just behind, or within, the reflecting surface of the crystal. The plane-polarized incident light vibrating as represented in Fig. 11A, the reflected light vibrates elliptically as in B. But as the latter is viewed through the crystelliptometer, the observer, *facing the oncoming reflected beam*, it would of course appear reversed, as in C. The phase difference ∇ of Sec. IV, which is what the crystelliptometer analysis gives, applies to Fig. 11C; while the Δ given in the tables below, corresponding to Fig. 11B, is simply ∇ minus 180° . Ψ is the azimuth angle, whose tangent is the amplitude ratio $\frac{a}{b}$ or r of Sec. IV.

Two Incidences at Wave-length 0.5 Micron

Incidence	Axis Parallel		Axis Perpendicular	
	Δ	Ψ	Δ	Ψ
45°	2° 11'	44° 52'	14° 1'	37° 46'
60°	11 52	34 14	27 54	23 15

The values given in the second table are capable, according to Dr. R. P. Baker, who has recently investigated the application of Drude's theory to hexagonal crystals, of yielding the two sets of optical constants of selenium corresponding to this wave-length. It is expected that this calculation will appear in a subsequent paper along with data from the further experimental work now in progress.

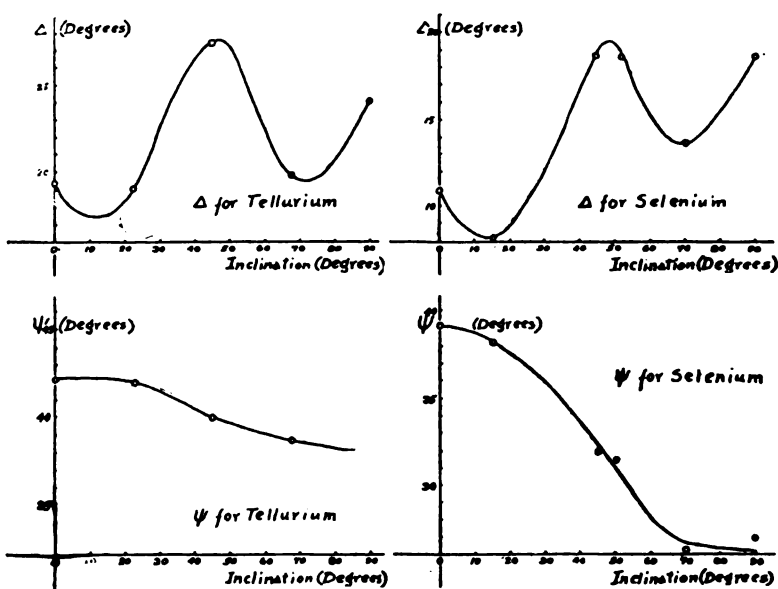

Fig. 12

Variations of Δ and Ψ with inclination of crystal, to plane of incidence, for selenium and tellurium

The above results refer only to the two principal positions of the crystal, namely, with the axis parallel to and perpendicular to the

incidence plane. Incidentally it was thought worth while to study the variations of the elliptic elements with the angle of inclination as the crystal is turned from one position to the other. Typical results are depicted in Fig. 12 with selenium and tellurium. No explanation is immediately apparent for the maxima and minima occurring in both cases in the value of Δ , but it is hoped that the mathematical theory may ultimately yield one. Further experiments of this kind would be desirable.

In conclusion, the writer wishes to pay tribute to the "team work" among the various workers at the University of Iowa who have contributed toward the progress of the research, to one phase of which this paper is devoted. The generous cooperation of the staff of the Physics Department, and especially of Dr. Sieg, who suggested the problem, is very greatly appreciated.

COE COLLEGE, CEDAR RAPIDS, IOWA,
OCTOBER, 1921.

REVIEWS AND NOTICES

The Manufacture of Optical Glass and of Optical Systems. By Lieut. Col. F. E. Wright, Ordnance Reserve Corps, Ordnance Department Document No. 2037. pp. 309 Government Printing Office, 1921.

Col. Wright was in charge of production and inspection of optical glass at the plant of the Bausch and Lomb Optical Co. from April 1917 to May 1918; the Army representative on the military optical glass and instrument section of the War Industries Board from March 15, 1918 until after the armistice; chairman of the Army commodity committee on optical glass and instruments under the Director of Purchase, Storage and Traffic from April 1918 until after the armistice; and in charge of Optical Systems in the fire-control section of the engineering division of the office of the Chief of Ordnance from August 4, 1918 to June 18, 1919. This war experience added to that gained by many years of special optical research work fitted Col. Wright most admirably for preparing, at the request of the artillery division of the Ordnance Department, this most excellent summary of the best practice in making, inspecting and using optical glass in America.

With the exception of a brief introductory outline of the general manufacturing problem and of the progress made during the war and the concluding chapter dealing with the lessons learned, the book is a mass of concise information relating to optical glass; its properties, constitution, defects and utilization. Desirable and undesirable characteristics are briefly discussed at the end of the second chapter. Chapter III on glass manufacturing processes is the heart of the book. Raw materials, pots, furnaces, batch composition, mixing, filling, skimming, stirring, cooling, annealing, breaking up, molding and final annealing are dealt with briefly but adequately in rapid succession in about a hundred pages. The three following chapters deal with the inspection of optical glass, the manufacture of lenses and prisms and with the inspection of finished optical parts and systems.

The big thing about this book is that it opens wide the doors of publicity upon the vital processes of glass making heretofore held closely secret. Dr. Wright further turns a scientific searchlight (the phase diagram of a three component system) upon those "secrets," shows them up, brushes away the cobwebs, selects the best and discourses upon them for our edification.

One cannot but be impressed with the volume and high quality of the technical results achieved by this selected corps of able workers in a very short time. They found the field ripe for their efforts. Optical glass of a variety of essential classes had previously been produced at at least four or five different plants and at least two of these were attempting quantity production. As every one familiar with manufacture knows, the next step toward success is the establishment of rigid factory control and inspection. This was quickly worked out and put in effect by the corps of experts under the leadership of Dr. Day and Dr. Wright. Innumerable details of processes had to be investigated under high pressure and the results immediately applied in practice. Production was "over the top" in but a few months. At the time of the armistice it was 40 tons per month (ample for our needs), of a quality equal to any imported and fully as far within the limits of tolerance in variation of index.

The reviewer offers criticisms of this admirable work only with the greatest reluctance and in the hope that they may be of service in the preparation of a future edition. Misprints and repetition of statements are noticeably frequent as might be expected in a book hurriedly written from fresh notes. The historical matter might well be omitted or better still perhaps, expanded to include an outline of previous work in this field by Keuffel, Feil, Kerr, Duval and others in various plants, noting that many million dollars worth of optical war instruments had been made for the Allies in this country prior to 1917 in which American made optical glass was used in part. The brief introductory discussion of lenses and optical instruments, pp. 16-29, appears quite unrelated to the remainder of the book. A comparison of the effects produced by defective glass with the various lens aberrations would have been in order. Had a hundred page discussion of war instruments been added it would have been well worth while.

In connection with the discussion of the coloration of glass by iron, it would be well to add cuts of the characteristic absorption curves of ferrous and ferric silicates which have been carefully studied. But two dispersion formulas are noted; the valuable Hartmann (for interpolation) and Cuthbertson formulas among a dozen others not being mentioned. On the other hand a simple well known invariant ratio is enlarged upon at considerable length with no mention of its simple mathematical basis. The sections on the testing of optical parts and systems could be considerably improved. Several of the best methods of testing are not even mentioned and limits of tolerance in performance are neither set nor discussed as fully as might be desired.

All optical engineers will be glad to have this work in their reference libraries. Even to the laymen it will prove very interesting. The printing is exceptionally fine, the paper and binding good.

P. G. Nutting.

OPTICAL SOCIETY OF AMERICA

MINUTES OF THE EXECUTIVE COUNCIL

Woods Hole, July 20, 1921

A meeting of the Executive Council was held at Woods Hole, Mass., July 20, 1921, with the following members present:—Southall, Forsythe, Nutting, Jones, Richtmyer and Priest.

The following new members were elected:—

Frederick J. Bates (Regular), 1649 Harvard St., Washington, D. C.
 Charles Bittinger (Associate), Duxbury, Mass.
 Paul S. Helmick (Regular), Physics Department, Iowa City, Ia.
 Lawrence Radford, (Associate, Transferred to Regular, Oct. 24, 1921), Bureau of Ordnance, Navy Dept., Washington, D. C.
 Fred E. Altman, (Regular) 27 Lake View Terrace, Rochester, N. Y.
 John S. Paraskevopoulos (Regular), National Observatory, Athens, Greece.
 Frederick C. Clark (Associate), American Writing Paper Co., Holyoke, Mass.
 Herman A. Holz (Associate), 17 Madison Ave., New York City.
 John C. Hubbard (Regular), New York University, University Heights, New York City.
 (Karl) Wilhelm Stenstrom (Regular), University Club, Buffalo, N. Y.
 E. Leon Chaffee (Regular), Cruft Lab., Harvard College, Cambridge, Mass.
 Paul E. Klopsteg (Regular), 460 E. Ohio St., Chicago, Ill.

Gordon Ferrie Hull (Regular), Dartmouth College, Hanover, N. H.
 Saul Dushman (Regular), General Electric Co., Res. Lab., Schenectady, N. Y.
 Hugo Fricke (Regular), Cleveland Clinic, Euclid Ave. & 93rd St., Cleveland, O.
 Arthur W. Gray (Regular), 312 S. Walnut St., Milford, Delaware.
 William Gaertner & Co. (Associate Corp.), 5345 Lake Park Ave., Chicago, Ill.
 Charles C. Bidwell (Regular), Cornell University, Ithaca, N. Y.
 Erich A. Bandoly (Associate), 460 E. Ohio St., Chicago, Ill.
 George R. Harrison (Associate), Box 863, Stanford University, Cal.
 Frank Milton Gilley (Associate), 21 John St., Chelsea, Mass.
 E. P. T. Tyndall (Regular), Rockefeller Hall, Ithaca, N. Y.
 Archie Garfield Worthing (Regular), Nela Research Laboratories, Nela Park,
 Cleveland, Ohio.

"Draft of a proposed agreement between the Optical Society of America and the Association of Scientific Apparatus Makers of the United States, with respect to the publication of a journal (Written July 4, 1921)" was approved *via voce* after discussion, Nutting and Priest having advanced arguments against the agreement. No record vote was taken. (Copy of the draft is on file with the Secretary.)

Pres. Southall's plans for the Helmholtz Centennial Memorial in connection with the Rochester Meeting, Oct. 1921 were approved.

Irwin G. Priest,
 Secretary

OPTICAL SOCIETY
 OF AMERICA

REPORT ON AMENDMENT OF BY-LAWS

Washington, Oct. 20, 1921.

Irwin G. Priest, Secy.

Optical Society of America.

We, the undersigned regular members of the Optical Society of America, have counted the votes on Amendments to the By-laws as proposed on the attached ballot form, and have found the vote to be as entered in the blanks after "Yes" and "No" on the form herewith.

H. J. McNicholas
 (Signed) *M. K. Frehafer*
 Tellers.

OPTICAL SOCIETY OF AMERICA
 BALLOT

AMENDMENTS TO BY-LAWS

The following amendments have been duly proposed and considered favorably by the Council. They are now submitted to the Honorary and Regular Members. Vote "Yes" or "No" in the spaces provided. To be counted, votes must be received by the Secretary not later than 4:30 P.M., October 20, 1921.

By-law IV, Election of Officers, Section 1, Eligibility, now reads "Officers shall be elected from among the regular and honorary members of the society. The president of the society shall not be eligible for election to a second consecutive term. No officer of the society shall be eligible to hold the same office for more than two years in succession"

to be amended to read; (Yes 106, No 8)

“Officers shall be elected from among the regular and honorary members of the society. The president and vice-president shall be elected for a two-year term, the secretary and treasurer for a five-year term of office and shall not be eligible to re-election. Members at large of the council shall be elected for a two-year term and shall be eligible to but one re-election.”

By-law, Section 3, Mode of Election, now reads

“Election shall be by ballot and shall be by the primary system. The two persons receiving the highest number of votes cast for any office in the primary shall be placed in nomination for regular election. In any primary, if no nominee receives twenty per cent of the votes cast, nomination shall be made by the Council”

to be amended to read; (Yes 95, No 17)

“Election shall be by ballot. Nominations shall be made by a nominating committee appointed by the president and approved by the Council. This committee shall consist of five regular members of the society, at least three of whom shall be past presidents of the society.”

On the basis of the count certified above and in accord with By-Law VIII providing for amendment, the proposed amendments are certified as adopted.

(Signed) *Irwin G. Priest*
Secretary.

Approved by Council, Oct. 25, 1921.

I. G. P.

OPTICAL SOCIETY OF AMERICA

MINUTES OF THE EXECUTIVE COUNCIL

Rochester, N. Y., Oct. 24, 1921

A meeting of the Council was held at the Hotel Rochester, Rochester, N. Y., Oct. 24, with the following members present:—Southall, Priest, Lomb, Foote, Richtmyer, Jones, and Forsythe.

The following new members were elected:

REGULAR

Wheeler P. Davey, Research Laboratory, General Electric Co., Schenectady, N. Y.
Wm. Francis Gray Swann, Dept. of Physics, Univ. of Minnesota, Minneapolis, Minn.
Arthur H. Compton, Washington University, St. Louis, Mo.
Yosikatu Sugiura, 3 Yurai-machi, Ushigome, Tokyo, Japan.
LeRoy D. Weld, 1531 B. Ave., Cedar Rapids, Ia.
Jukichi Imai, c/o Nippon Kogaku Kogyo K. K., Morimae Oimachi, Tokyo, Japan.
Frederic Eugene Ives, 1327 Spruce St., Philadelphia, Pa.
Ralph E. DeLury, Dominion Observatory, Ottawa, Canada.
Charles Greeley Abbot, Smithsonian Institution, Washington, D. C.
Glenn A. Shook, Norton, Mass.
Henry Franklin Dawes, McMaster University, Toronto, Canada.
E. P. Lewis, University of California, Berkeley, Cal.
Carl Danforth Miller, University of Manitoba, Winnipeg, Manitoba.
Ernest Merritt, Rockefeller Hall, Ithaca, N. Y.
Charles D. Hodgman, Case School of Applied Science, Cleveland, O.
Gordon S. Fulcher, Corning Glass Works, Corning, N. Y.
George F. Kunz, 409 Fifth Ave., New York City.
Kakuya Sunayama, 3405 Oimachi, Tokyo, Japan.

Elihu Thomson, 22 Monument Ave., General Electric Co., Lynn, Mass.
 Elizabeth Rebecca Laird, Mount Holyoke College, South Hadley, Mass.
 T. R. Merton, Clarendon Lab., Oxford University, Oxford, England.
 Elmer George Quin, 18 Ave. A. West, Rochester, N. Y.
 E. Leavenworth Elliott, 95 River St., Hoboken, N. J.
 William G. Exton, 98 Central Park West, New York City.
 Axel Oskar Thure Waldner, Sturevagen 45, Stocksund, Sweden.

ASSOCIATE INDIVIDUAL

Conrad G. Goddard, 33 East 50th St., New York City.
 William H. Williams, University of California, Berkeley, Cal.
 Thomas S. Stewart, S. E. Cor. 18th & Spruce Sts., Philadelphia, Pa.
 Edwin L. Hettinger, 1325 Mineral Spring Rd., Reading, Pa.
 David Rines, 99 State St., Boston, Mass.
 Olof A. Axelsson Tenow, Metallograpiska Institutet, Stockholm, Sweden.

ASSOCIATE CORPORATION

Munsell Color Company, 120 Tremont St., Boston 9, Mass.

The following members were transferred from Associate to Regular Membership:

Carl Bahn
 Raymond Davis
 Lawrence Radford

Complying with a request of the National Research Council, the Council recommended the appointment of a Standing Committee on Physiologic Optics and the devotion of one or more sessions of the Society's annual meeting to papers on vision and physiologic optics.

(Cf. *Minutes of the Society, 6th Meeting to be published later.*)

On Nov. 17, the president appointed: Richtmyer (Chairman), Troland, and Lancaster on this committee.

Irwin G. Priest,
 Secretary.

OPTICAL SOCIETY OF AMERICA

MINUTES OF THE EXECUTIVE COUNCIL

Rochester, N. Y., Oct. 25, 1921

A meeting of the Council was held at the Hotel Rochester, Rochester, N. Y. Oct. 25, with the following members present:—Southall, Priest, Lomb, Foote, Richtmyer, Jones, and Forsythe.

The following actions were taken:

(1) A nominating committee directed to make nominations for the election of officers were appointed by the President and confirmed by the Council as follows:—

F. K. Richtmyer (Chairman)

P. G. Nutting, Fred Wright, Adolph Lomb, I. G. Priest.

(2) A motion directing the president to appoint a committee on revision of the by-laws was carried. The president announced that he would appoint such a committee later.

The president later appointed:—F. K. Richtmyer (Chairman), P. G. Nutting, and Irwin G. Priest on this committee.

(3) The following committee on combination of the Journal with Instrument Maker's Journal was appointed and confirmed: Southall, Richtmyer, Lomb.

This committee was given power to act in carrying into effect the action of the Council at the Woods Hole Meeting. The committee was authorized to make such minor changes and adjustments in the contract as might be required to carry out the intention of the Council as indicated at the Woods Hole Meeting.

(4) The Council unanimously recommended the following amendment to the by-laws: Substitute for Art. VIII:

"By-laws may be enacted, amended or suspended by concurrence of two-thirds of the whole Executive Council."

(5) It was ordered that the next meeting be held in Washington, during the latter part of October, 1922.

(6) Prof. F. K. Richtmyer was appointed the Society's representative to the A.A.A.S.

(7) The Council expressed unanimous approval of the plan of publishing in the program brief advance abstracts of papers to be presented at the meetings.

(8) The application of the ——— Library for free copies of the JOURNAL was referred to the Editor with power to act.

(9) The question of payment for foreign subscriptions was referred to the treasurer and the editor with power to act.

(10) The president was directed to appoint a committee to report back to the Council on ways and means of preparing and publishing an English Translation of Helmholtz's "Physiologischen Optik" (2nd Ed.). The president appointed on this committee:

Southall, Lomb and Priest (resigned Nov. 15). Troland was later (Nov. 17) appointed to succeed Priest.

(11) The Council approved holding in connection with the Washington meeting, October, 1922, an exhibit of optical apparatus, provided such an exhibit can be arranged without expense to the Society. The Secretary was authorized to appoint a committee to assist him in planning such an exhibit.

(12) The following Finance Committee was appointed and confirmed:

Lomb (Chairman), Richtmyer, Foote, and Priest.

(13) The editor was directed to publish in a suitable memorial number of the JOURNAL the minutes of the Helmholtz Memorial Meeting and the addresses delivered by Prof. Southall, Prof. Crew, Prof. Pupin, and Dr. Troland.

The following subjects were discussed without definitive action being taken:

(1) The provision in the amended by-laws requiring three past presidents on the nominating committee. It was represented to the Council that this provision should be stricken out. Those present were of the opinion that it should either be stricken out entirely or modified to require only one or two.

(2) An Assistant Treasurer.

(3) Payment of salary to Editor.

(4) Qualifications for membership.

Irwin G. Priest,
Secretary.

OPTICAL SOCIETY OF AMERICA

MINUTES OF THE EXECUTIVE COUNCIL

Rochester, N. Y., Oct. 26, 1921

A meeting of the Executive Council was held at Rochester, N. Y., Oct. 26, 1921, with the following members present:—Southall, Priest, Lomb, Foote, Richtmyer, Mees, Jones and Forsythe.

The following new members were elected:

REGULAR

Robert Scott Lamb, Stoneleigh Court, Washington, D. C.
Conrad Berens, Jr., 9 E. 46th St., New York City.
Dr. Herman Haessler, Penna. Hospital, 8th & Spence St., Philadelphia, Pa.
J. McKeen Cattell, Garrison on Hudson, N. Y.
Lucien Howe, 520 Delaware Ave., Buffalo, N. Y.
Floyd C. Fairbanks, 700 Post Ave., Rochester, N. Y.
M. I. Pupin, Columbia University, New York City.

ASSOCIATE

M. Rea Paul, 129 York St., Brooklyn, N. Y.

The Treasurer made an informal report.

Irwin G. Priest,
Secretary.

Journal of the Optical Society of America and Review of Scientific Instruments

Vol. VI

MARCH, 1922

Number 2

REPORT ON ATMOSPHERIC SCATTERING, SKY POLARIZATION, AND ALLIED PHENOMENA¹

BY
F. E. FOWLE

ATMOSPHERIC SCATTERING

Atmospheric scattering of light, with the allied phenomenon of sky polarization, is of considerable importance to meteorologists and astronomers. The former is interested in it as an indication of the amount and condition of the atmospheric water vapor, the latter as it affects the measures of the brightness or intensity of radiation from celestial bodies.

The scattering of energy out of the direct beam from a celestial object follows the formula $e_m = e_0 a^m$ where e_0 is the intensity of the incident radiation or light, e_m that after passing through the mass of air m , a , the transmission coefficient for passage through the atmosphere vertically, m the air mass taken equal to unity for a vertical path through the atmosphere to the ground and practically proportional to the secant of the zenith distance of the

TABLE 1

wave-length, μ360	.371	.384	.397	.431	.475	.503	.574	.720
dry air595	.630	.669	.706	.779	.845	.876	.926
air with 1.6 cm									
H_2O629	.706	.735	.769	.865
air with 0.3 cm									
H_2O735	.834	.837	.850	.910

¹ Section of 1921 Report of Standards Committee on Spectroradiometry, W. W. Coblentz, Chairman.

TABLE 2.—Transmission Percentages of Radiation Through Moist Air

The values of this table will be of use for finding the transmission of energy through air containing a known amount of water vapor. An approximate value for the transmission may be had if the amount of energy from the source between the wave-lengths of the first column is multiplied by the corresponding transmission coefficients of the subsequent columns. The values for the wave-lengths greater than 18μ are tentative and doubtful. Fowle, Water-vapor Transparency, Smithsonian Misc. Collections, 68, No. 8, 1917; Fowle, The Transparency of Aqueous Vapor, Astrophysical J. 42, p. 394, 1915.

Range of wave-lengths		Precipitable water in centimeters												
μ	μ	.001	.003	.006	.01	.03	.06	.10	.25	.50	1.0	2.0	6.0	10.0
0.75	to 1.0	100	99	99	98	97	95	93	90	83	78
1.0	1.25	99	99	98	97	95	92	89	85	74	69
1.25	1.5	96	92	84	80	66	57	51	44	31	28
1.5	2.0	98	97	94	88	79	73	70	66	60	57
* 2	3	96	92	87	84	77	70	64
3	4	95	88	84	78	72	66	63
* 4	5	92	83	76	71	65	60	53
5	6	95	82	75	68	56	51	47	35
6	7	83	54	50	31	24	8	4	3	2	0	0	0	0
7	8	94	84	76	68	57	46	35	16	10	2	0	0	0
8	9	100	100	100	99	98	96	94	65
†9	10	100	100	100	100	100	100	100	100	100	100	100
†10	11	100	100	100	100	100	100	100	100	100	100	100
11	12	100	100	100	100	100	99	98	96	95	93
12	13	100	100	100	100	99	99	97	86	82
*13	14	100	100	100	99	97	94	90	80	60
*14	15	96	93	80	75	50	15	0	0	0	0	0
*15	16	70	55	40	0	0	0	0	0	0
16	17	50	20	0	0	0	0	0	0
17	18	25	10	0	0	0	0	0	0
18	∞	98	94	89	82	45	0	0	0	0	0	0	0	0

*These places require multiplication by the following factors to allow for losses in CO_2 gas. Under average sea-level outdoor conditions the CO_2 (partial pressure = 0.0003 atmos.) amounts to about 0.6 gram per cu.m. Paschen gives 3 times as much for indoor conditions.

2μ to 3μ , for 2 grams in m^2 path (95); for 140 grams in m^3 path (93);

4μ to 5μ , for 2 grams in m^2 path (93); for 140 grams in m^3 path (70); more CO_2 no further effect;

13μ to 14, slight allowance to be made;

14μ to 15, 80 grams in m^2 path reduces energy to zero;

15μ to 16, 80 grams in m^2 path reduces energy to zero;

† These places require multiplication by 0.90 and 0.70 respectively for one air mass and 0.85 and 0.65 for two air masses to allow for ozone absorption when the radiation comes from a celestial body.

body for other directions. The air mass in its variation with the elevation is proportional to the barometric reading. Table 1 gives in the first line the wave-length, and in the succeeding lines, the value of a at sea-level for dry, dust-free air, for air with 1.57 precipitable water vapor and dust scattering 9 per cent of the incoming radiation and for air on a cold winter day with 0.33 cm precipitable water and dust scattering about 3.6 per cent.

More complete details will be found in references 1 to 11.

The light scattered by 1 cm of presipitable water vapor in the atmosphere decreases from about 8 per cent at $.342\mu$ through 5 per cent at $.413\mu$, 2 at $.764\mu$ to practically none at 1.5μ . For wave-lengths less than $.6\mu$ there is very little light absorbed except for a small amount in the neighborhood of the D lines. For longer wave-lengths, however it begins to exercise an increasingly powerful absorption as indicated by Table 2, taken from the Smithsonian Physical Tables.¹²

TABLE 3.—Relative Illumination Intensities¹⁴

Source of Illumination	Intensity Foot-Candles	Ratio to Zenithal Full Moon
Zenithal sun.....	9600.	465000.
Twilight at sunset or sunrise.....	33.0	1598.
Twilight center of sun 1° below horizon.	30.0	1453.
“ “ “ “ 2° “ “	15.0	727.
“ “ “ “ 3° “ “	7.4	358.
“ “ “ “ 4° “ “	3.1	150.
“ “ “ “ 5° “ “	1.1	53.
“ “ “ “ 6° “ “	0.40	19.0
(End of civil twilight)		
Twilight center of sun 7° below horizon	0.10	5.0
“ “ “ “ 8° “ “	.04	2.0
Zenithal full moon.....	.02	1.00
Twilight center of sun 9° below horizon	.015	0.75
“ “ “ “ 10° “ “	.008	.40
Starlight.....	.00008	.004

For the “Variations in the total and luminous solar radiation with geographical position in the United States” the paper with that title by Professor Kimball should be consulted.¹³ The above table quoted from Humphreys’ “Physics of the Air” and due to photometric measures by Kimball and Thiessen gives the

approximate value of a number of clear-sky, twilight and other natural illumination intensities on a fully exposed horizontal surface.

Table 4 is taken from Volume 4 of the Annals of the Astrophysical Observatory of the Smithsonian Institution.¹⁵

TABLE 4.—*Radiation from Sun and Sky*

Altitude of Sun.....	5°	15°	25°	35°	47½°	65°	82½°
Sun's radiation cal. per cm ² per min.....	0.533	0.900	1.233	1.358	1.413	1.496	1.521
Sun's radiation on horizontal surface cal. per cm ² per min.....	0.046	0.233	0.524	0.780	1.041	1.355	1.507
Mean radiation							
$\frac{\text{Sky}}{\text{Sun}} \times 10^3$. Normal.....	423	403	385	365	346	326	310
Mean radiation of sky on horizontal surfaces							
$\frac{\text{Sky}}{\text{Sun}} \times 10^3$. Sun Normal.....	115	132	142	150	156	163	170
Mean sky on normal. Calories per sq. degree $\times 10^7$, per cm ² per min.....	101	163	213	222	219	219	211
Total sky on horizontal. Cal. per cm ² per min.....	0.056	0.110	0.162	0.189	0.205	0.226	0.240
Total Sun and sky on horizontal. Cal. per cm ² per min.....	0.102	0.343	0.686	0.969	1.246	1.581	1.747

Relative to the night sky illumination the following is adapted from a review in the Monthly Weather Review by Woolard.²¹

The light received from a given area of the night sky is made up of (1) star-light, (2) scattered star-light, and (3) earth-light the last including all light not due to the stars. Above 40° galactic latitude the star-light is a relatively small percentage of the whole and can be computed from star counts; the *total* light received from any area may be photometrically measured. Van Rhijn²² shows that there is a kind of zodiacal light extending over the whole sky, the intensity depending upon the celestial latitude and longitude. By finding the excess of this zodiacal brightness over its mean value for each part of the sky and applying a corresponding correction to all the measurements the latter become independent of the azimuth; the difference between total observed illumination and corrected earth-light gives the star-light, even

for galactic regions. The earth-light corrected for the zodiacal illumination consists of direct earth-light and scattered earth-light; applying a correction for the latter the earth-light is found to increase towards the horizon, indicating illumination due to a permanent aurora.²³ The total light received from all the stars in both hemispheres is equal to 1,440 stars of magnitude 1.0,²⁴ Chapman has obtained by a very different process 900 to 1,000 for this figure. Rayleigh finds the night sky yellower than the day sky. Burns gives the following summary of the determinations of the brightness of the night sky;²⁵

TABLE 5

Author	Reference	Brightness*
Newcomb ¹	Astrophysical Journal, 14, p. 279, 1901.....	0.029
Burns ²	<i>Ibid.</i> , 16, p. 166, 1902.....	.050
Townley ³	Pub. Ast. Soc. of Pacific, 15, p. 13,	.050
Fabry ⁴	Comptes rendus, 150, p. 272, 1910.	.036
Yntema ⁵	Gron. Publ., 22.....	.140
Abbot ⁶	Astronomical Journal, 27, p. 20, 1911.....	.075
Van Rhijn ⁷	Astrophysical Journal, 50, p. 347, 1919.....	.130
Burns ⁸	J. Brit. Ast. Assoc., 24, p. 463, 1914	.030
Mean value.....		.068

* Amount of light per square degree of non-galactic sky expressed in terms of light of star of first magnitude.

¹ Net claimed to be precise.

² Unfavorable locality.

^{3, 4} photographic and therefore would differ from visual values.

^{5, 6, 7} Yntema's method.

⁸ Special photometer.

POLARIZATION OF SKY-LIGHT

The work done with the polarization of sky light consists mostly of more or less systematic observations of its amount and characteristics. The two principal observers have been Dr. Dorno at Davos²⁶ and Professor Kimball at the Mount Weather Observatory.²⁶ Dorno has mapped the polarization characteristic

for the whole sky systematically for various seasons and conditions.

THEORETICAL

King¹⁰ and subsequently the author by somewhat refined methods (^{8, 11}) showed that atmospheric transmission coefficients for radiation, when corrected for the scattering caused by dust and aqueous vapor, yielded through Rayleigh's formula a value for the number of molecules per cm³ of air at standard temperature and pressure, namely, 2.72×10^{19} which corresponds very closely with Millikan's selected value, 2.705×10^{19} . The close agreement of the two values may be taken as proof either of Rayleigh's formula or of the accuracy of the estimation of the losses of the sun's energy in passing through the atmosphere.

In yet another direction the polarization of scattered light has led to estimates of molecular quantities. For perfect polarization of the scattered light a symmetrical spherical molecule is postulated. It has been found, however, that there is a measurable defect from perfect polarization which varies with different gases as shown in Table 6: ^{34, 35, 36}

TABLE 6

Gas	Defect from Perfect Polarization	Gas	Defect from Perfect Polarization
	Per Cent		Per Cent
Argon.....	6.	Helium.....	0.5
Hydrogen.....	3.83	Oxygen.....	9.4
Nitrogen.....	4.06	Carbon dioxide....	11.7
Air.....	5.00	Nitrous oxide.....	15.4

Helium therefore polarizes the most completely of all the gases studied and so far as this evidence goes, is the most perfectly spherical of molecules known.

Rayleigh finds that liquid ether scatters seven times less than the equal weight of vapor³⁷ which is in line with what the author found for water vapor compared with liquid water.^{8, 11}

Gans has carried the investigation one step further and determined the assymetry of gas molecules through this defect of polarization. His formula is double-valued and leads to two values of the ratio of the polar to the equatorial axes, a/b as given in Table 7. σ is the mean diameter of the molecule. The first five values are from measures by Gans, the rest by Strutt.³⁹

TABLE 7

	a/b		I		II		σ $\times 10^8$ cm
	I	II	a $\times 10^8$ cm	b $\times 10^8$ cm	a $\times 10^8$ cm	b $\times 10^8$ cm	
CO ₂	1.78	0.44	1.95	1.10	0.74	1.70	2.76
N ₂	1.45	.63	1.52	1.05	.86	1.37	2.41
O ₂	1.73	.46	1.62	.94	.65	1.42	2.33
NH ₃	1.25	.77	1.50	1.20	1.08	1.41	2.61
N ₂ O.....	2.10	.28	2.21	1.05	.54	1.89	2.88
He.....	9.18	1.62	1.76	1.31
CS ₂	2.10	.28	3.15	1.50	.76	2.69	4.10
CN.....	2.10	.28	2.62	1.25	.64	2.25	3.42
O ₃	1.68	.48	1.60	.95	.68	1.41	2.33
C ₆ H ₆	1.68	.48	2.97	1.77	1.27	2.62	4.34
CO.....	1.47	.62	1.59	1.08	.89	1.43	2.50
Ar.....	1.47	.62	1.50	1.02	.84	1.35	2.36
CHCl ₃	1.45	.63	2.57	1.77	1.46	2.32	4.07
H ₂	1.33	.71	1.12	.84	.73	1.03	1.86
C ₂ H ₄	1.43	.63	2.05	1.41	1.17	1.85	3.25
C ₂ H ₁₀ O.....	1.33	.71	2.47	1.86	1.62	2.29	4.13

It should be noted, however, that Rayleigh³⁴ calls attention to later measures on He which leads him to conclude that it polarizes more completely than the majority of gases so that it is the most completely spherical of all the observed gases as already stated, and not as elongated as this last table indicates.

BIBLIOGRAPHY

¹ Annals of the Astrophysical Observatory of the Smithsonian Institution, C. G. Abbot, F. E. Fowle and L. B. Aldrich, vol. 2, 1908.
² *Ibid.*, vol. 3, 1913.
³ *Ibid.*, vol. 4, 1922.
⁴ The spectroscopic determination of aqueous vapor, F. E. Fowle, *Astrophys. J.* 35, p. 149, 1912.

- ⁵ The non-selective transmissibility of radiation through dry and moist air, F. E. Fowle, *Astrophys. J.* 38, p. 392, 1913.
- ⁶ Atmospheric transparency for radiation, F. E. Fowle, *Monthly Weather Review*, Jan., 1914.
- ⁷ Die Durchlässigkeit der Atmosphäre für Strahlung, F. E. Fowle, *Met. Zeit.* p. 271, 1914.
- ⁸ Avogadro's constant and atmospheric transparency, F. E. Fowle, *Astrophys. J.* 40, p. 435, 1914.
- ⁹ The transparency of aqueous vapor, F. E. Fowle, *Astrophys. J.* 42, p. 394, 1915.
- ¹⁰ Water-vapor transparency to low-temperature radiation, F. E. Fowle, *Smithsonian Misc. Collections*, 68, no. 8, 1917.
- ¹¹ The atmospheric scattering of light, F. E. Fowle, *Smithsonian Misc. Coll.* 69, no. 3, 1918.
- ¹² *Smithsonian Physical Tables*, reprint 7th revised edition, F. E. Fowle, 1921.
- ¹³ Variations in the total and luminous solar radiation with geographical position in the U. S., H. H. Kimball, *Monthly Weather Rev.* 47, p. 769, 1919.
- ¹⁴ Physics of the air, W. J. Humphreys, 1920.
- ¹⁵ The blue sky and the optical properties of air, Rayleigh, *Nature*, 105, p. 584, 1920.
- ¹⁶ On the scattering and absorption of light in gaseous media, L. V. King, *Phil. Trans.* 212 A, p. 375, 1913.
- ¹⁷ Sur la diffusion de la lumière par l'air, J. Cabannes, *C. R.* 160, p. 62, 1915. Also *Sur la diffusion de la lumière par les molécules des gaz transparents*, J. Cabannes, Thesis, Paris, 1921. Also *Annales de Phys.* 15, 5, 1921.
- ¹⁸ Light scattering by air and the blue color of the sky, R. W. Wood, *Phil. Mag.* 39, p. 423, 1920.
- ¹⁹ Brightness of the sky, A. F. Moore and L. H. Abbot, *Smithsonian Misc. Coll.* 71, no. 4, 1920.
- ²⁰ Aerial photometry, M. Luckiesh, *Astrophys. J.* 49, p. 108, 1919.
- ²¹ The light from the sky, E. W. Woolard, *Monthly Weather Rev.* 48, p. 600, 1920.
- ²² On the brightness of the sky at night and the total amount of star light, Van Rhijn, *Astrophys. Jour.* 50, p. 356, 1919.
- ²³ The direct and scattered radiation of the sun and stars, C. G. Abbot, *Astron. J.* 28, p. 129, 1914.
- ²⁴ Chapman, *Monthly Notices*, 74, p. 450, 1914.
- ²⁵ Himmelshelligkeit, Himmelpolarization, und Sonnenintensität in Davos, 1911-1918, C. Dorno, *Abhl. Preuss. Meteor. Inst.* vol. 6, no. 303, also *Met. Zeit.* 36, 1919.
- ²⁶ H. H. Kimball, *Bull. Mt. Weather Obsy.*, vols 1 to 6, 1908 to 1913.
- ²⁷ Brightness of the unclouded sky, altitude 3000 m, Teneriffe, M. Uibe, *Abh. Sachs, Akad. Wiss.*, 35, p. 219, 1918.
- ²⁸ Spectrophotometry of sky-light, altitude 1090 m, D. Pacini, *Mem. Soc. Spettros. Ital.* 8, p. 62, 1920.
- ²⁹ Color and polarization of sky-light, Gockel, *Ann. der Phys.* 62, p. 283, 1920.
- ³⁰ Relation between the absorption of solar radiation by the atmosphere and the polarization of diffuse sky-light, A. Bouteric, *J. de Phys.*, 9, p. 239, 1920.
- ³¹ Diffusion of light by rain, cloud, or fog, R. Mallock, *Pr. Roy. Soc. A* 96, p. 267, 1920.

²² Scattering of light by gases, C. Fabry, *J. de Phys.*, 7, p. 89, 1917. (Application of Rayleigh's theory to the explanation of various atmospheric phenomena.)

²³ The scattering and diffraction of light by mist and clouds, R. Mecke, *Ann. d. Phys.* 65, p. 257, 1921.

²⁴ Polarization of light scattered by helium atoms, Rayleigh, *Nature*, 104, p. 412, 1919. (Corrects earlier statement; helium polarizes more rather than less completely than the generality of gases.)

²⁵ Scattering of light by gases, Rayleigh, *Proc. Roy. Soc.*, 97A, p. 435, 1920.

²⁶ Scattering of light by gases II. Rayleigh, *Proc. Roy. Soc.*, 98A, p. 57, 1920.

²⁷ Light scattered by gases, R. J. Strutt, *Pr. Roy. Soc.* 95A, p. 155, 1918.

²⁸ Asymmetrie von Gasmolekeln, *Gans. Ann. d. Phys.*, 65, p. 97, 1921.

²⁹ Strutt, *Pr. Roy. Soc.* 94A, p. 453, 1918; 95A, p. 155, 1918.

³⁰ The blue sky and the optical properties of air, Rayleigh, *Nature*, 105, p. 584, 1920.

³¹ Molecular scattering of radiation, J. Larmor, *Phil. Mag.* 37, p. 161, 1919.

³² Scattering of light by air molecules, J. Cabannes, *C. R.* 163, p. 340, 1919.

³³ Relative spectral transmission of the atmosphere and an apparatus for the determination of the same, E. Karrer and E. P. T. Tyndall, *Bull. Bureau of Standards*, 16, p. 377, 1920. (Determines relative values for transparency of air near the surface of the ground for various conditions.)

³⁴ Scattering of light by Argon and the determination of Avogadro's constant, J. Cabannes, *C. R.*, 171, p. 852, 1920.

³⁵ Scattering of light by carbon particles in luminous flames, H. Senftleben and Miss E. Benedict, *Verh. Deutsch. Phys. Ges.* 21, p. 144, 1919.

³⁶ Scattering of light by solid substances, R. J. Strutt, *Pr. Roy. Soc.* 95 A, p. 476, 1919. (Glass scatters freely, scattered light in many cases completely polarized but probably not molecular but due to minute inclusions. The defect, 3 to 8 per cent, from complete polarization with some glasses is probably due to the large size of light compared with some of these inclusions.)

³⁷ Investigation of turbid media, T. Isnardi, *Ann. d. Phys.* 62, p. 573, 1920. (Shape of colloidal particles.)

³⁸ Scattering of light by resonating molecules, Rayleigh, *Nature*, 104, p. 276, 1919. (Mercury vapor scatters incident Mercury vapor violet light ($\lambda = 2536$) with exact resonance and the scattered light is unpolarized; but as the exact resonating light is absorbed in the front layer of the mercury vapor, the less exact resonance in the succeeding layers with the remaining light of slightly greater or smaller wave-length results in the appearance of polarization.)

³⁹ Elementary theory of light scattering by small dielectric spheres, J. Kunz, *Phil. Mag.* 39, p. 416, 1920.

⁴⁰ Absorption and scattering of light, A. Schuster, *Pr. Roy. Soc.* 98A, p. 248, 1920. (Points out that anomalous refraction is not due to true absorption, i.e., conversion of energy into heat. It is a perfectly normal result of the refractive index introduced by the excited vibration of the oscillator and of the scattering of light which accompanies them.)

NOTE ON MR. F. E. WRIGHT'S ARTICLE FOR DETERMINING PRISM ANGLE ERRORS

BY
WALTER F. C. FERGUSON

In Mr. Wright's article, published in this *Journal*,¹ the writer finds in the curves for determining deviations caused by a Dove erecting prism with incorrect axial angles, a difference from similar curves which he had previously constructed for the same purpose.

It is well known that an erecting prism can be made with base angles other than 45° ; and if the base angles are equal, the prism will function correctly, the only difference being in the aperture ratio of the prism: length / height.² Translated into Mr. Wright's notation this means that equal changes in s and t will produce zero deviation of the emergent from the path of the incident ray.

Therefore the writer would reconstruct the diagonals; so that values of s will fall on *equal* values of t , corresponding to zero deviation, d .

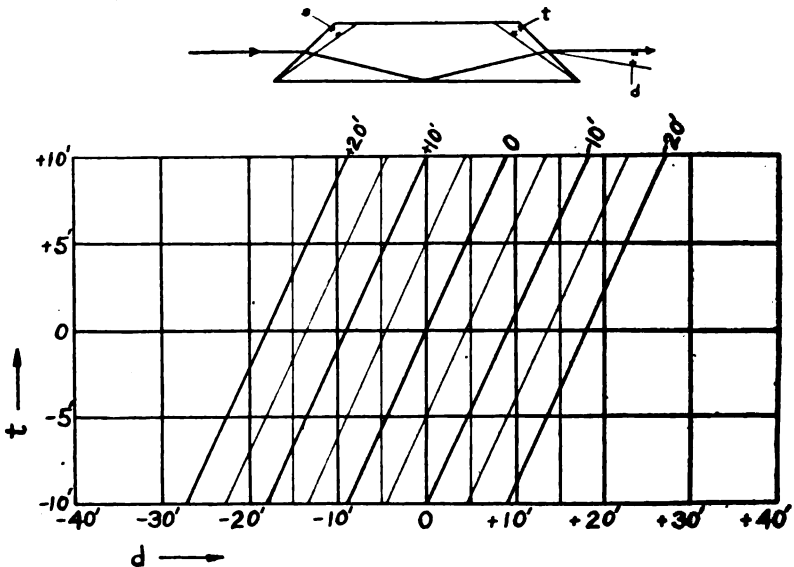

OPTICAL SHOP, NAVY YARD,
WASHINGTON, D. C.

¹ March, 1921, p. 200.

² Trans. Opt. Soc., 21, 5, p. 217, 1920.

INVARIANT RATIOS AND FUNCTIONS IN GLASS DISPERSION

BY
P. G. NUTTING

Designers of optical systems have for years been familiar with the fact that the ratios of any two partial dispersions is approximately the same constant for all optical glasses and have made use of the fact in selecting and ordering glasses.

Dr. F. E. Wright¹ has recently made a careful study of these dispersion relations, plotting various partial dispersions against each other for practically all glasses (nearly 300 in all) for which data are available. His plotted curves are all straight lines upon which the data for all known glasses fall very closely. These straight lines do not however, quite pass through the origin nor through any other point in common. In other words, any partial dispersion such as $n_{\tau} - n_c$ is sensibly a linear function of any other partial dispersion such as $n_b - n_{\lambda'}$, but the ratio of the two is not quite invariant for all glasses.

Considerable interest has been aroused in this apparently significant and, at first sight, rather remarkable relation between refractive index and wave-length. The opinion appears to prevail that it indicates some unique dispersion function to which the many heretofore advanced are mere approximations. A critical mathematical examination shows, however, that this deduction is not justified.

By way of introduction, consider first a simple linear function of x and y say

$$(1) \quad y = ax + b$$

in which a and b are variable parameters. This represents a double infinity of straight lines. Ordinates erected at any four fixed points on the x axis, say x_1 , x_2 , x_3 and x_4 , intersect all lines of both systems in the points $y_1 = ax_1 + b$, $y_2 =$ etc. Now by eliminat-

¹ JOUR. OPT. SOC. AM. 4, pp. 148-159, and 5, pp. 389-397, 1921.

ing the variable parameters, an expression is obtained which is invariant for *all* lines of both systems, namely;

$$(2) \quad \frac{y_1 - y_2}{y_3 - y_4} = \frac{x_1 - x_2}{x_3 - x_4} = \text{constant}$$

Of the four points chosen, of course any two may be coincident. The second member of (2) would still be invariant and the elimination of a and b be unaffected if x in (1) were given any exponent. However it is evident that the dependent variable y must be of the first degree and must not occur with x as a product. The most general form of function which will satisfy (2) appears to be that in which y is *any explicit linear function of any function of x not involving parameters, or*

$$(3) \quad y = a f(x) + b$$

in which $f(x)$ involves only numerical constants. This is certainly a sufficient and I believe a necessary condition for giving the invariant ratio of ordinate differences (2). It obviously covers a wide variety of functions and even classes of functions.

The application of these results to dispersion theory is simply a matter of translation. If refractive index n is a function of wave-length λ such that

$$(4) \quad \frac{n_1 - n_2}{n_3 - n_4} = \text{constant} = c,$$

it is necessary and sufficient that the form of the dispersion function fall within the limitations

$$(5) \quad n = a f(\lambda) + b$$

in which, as in (3), $f(\lambda)$ involves only numerical constants while a and b vary from glass to glass. The limitations imposed by (4) and (5) of course fail to exclude many forms of dispersion functions which do not fit data at all.

Now Dr. Wright finds (l.c.) that (4) is not sufficiently general to fit known glass data but that

$$(6) \quad n_1 - n_2 = c(n_3 - n_4) + k$$

holds very exactly for any fixed set of four wave-lengths. The added constant k , although small (.0002 to .0008 and either positive or negative), is a very definite quantity and by no means to be regarded as merely a second order term giving a closer

approximation. The reason for this finite value of k is not apparent for the Cauchy and other dispersion formulas known to fit glass dispersion data quite well fall within class (5) and satisfy (4) and therefore imply $k = 0$.

The limitations set by (6) are broader even than those set by (4) unless perchance a direct functional relation exists between c and k . The most general relation between index and wavelength found by the writer to satisfy (6) is

$$(7) \quad n = a f(\lambda) + b + F(\lambda)$$

and this is believed to be both sufficient and necessary for the existence of (6). In (7) both $f(\lambda)$ and $F(\lambda)$ are unlimited except each must involve only numerical constants. Any function which will satisfy (6) will of course satisfy (4), but the converse is not true.

Hence while such a simple relation as (4) or the more exact relation (6) may be useful in such practical work as mixing glass batches and selecting glasses for lens systems, they cannot be regarded as indicating any specific dispersion formula or even as setting any but very wide limitations on such functions in general.

DEC. 11, 1921.

THE PROPAGATION OF LIGHT IN ROTATING SYSTEMS

BY
A. C. LUNN

Some parts of the recent paper on this subject by Silberstein¹ seem to call for comment, partly because of certain features of obscurity or incompleteness, partly because of certain statements whose justice is at least not made clear. In particular may be questioned what seems to be the main conclusion, according to which ether theory is better prepared than relativity theory to adjust itself to a conceivable outcome of Michelson's pending experiment different from the expected. A few minor items may be noticed first, but the following notes refer chiefly to what appears to be the main topic of the paper referred to, a comparison of ether and relativity theories as to their inferences concerning the influence of rotation on optical phenomena.

The suggestion, page 291, that a specification of rotation with respect to some such frame of reference as the fixed stars is necessary also in the relativity theory, "in spite of appearances to the contrary," may be granted readily, but one is left to wonder what those appearances are. Avoidance of reference to a hypothetical set of absolute directions, one natural aim of a theory of relative motion, does not imply rejection of the notion of an angular velocity uniquely determinable with reference to an observable system of bodies. The difficulties connected with the interpretation of the earth's rotation under the generalized theory of Einstein are well known, but there seems to be no known reason why they cannot be ascribed entirely to the insufficiency of data regarding the distribution and motion of cosmic matter. A fair analogy may be found in the case of the general translatory motion of the solar system with respect to the proper motion stars, or the radial velocity stars, this motion being not determinable from Newtonian theory nor yet in conflict with it.

Similarly, the later remark, pages 301-302, that the relativity theory proved unable to "deduce the terrestrial ds as a gravita-

¹ Silberstein, J. OPT. SOC. AM., 5, p. 291-307, 1921.

tional effect of the stars . . . ,” does not really point out what can be called a flaw in that theory. When a theory is embodied primarily in differential equations an incomplete knowledge of the suitable values to be assigned to the constants of integration is a deficiency in experimental material rather than in the theory.

In this same connection, the reference, page 304, to Thirring's solution for the gravitational field of a rotating body as a “complete failure” seems rather extreme. Thirring's solution is avowedly only an approximation, the exact solution being presumably a difficult matter even if the proper boundary conditions were not uncertain. The apparent strangeness of some of Thirring's results might be reduced by knowledge of a more precise solution. One may be reminded here of some of the early results in celestial mechanics for the values of certain apparently secular variations, which other theories were able to interpret as first approximations to oscillatory variations. At least it seems wiser not to prejudge a theory too firmly in connection with problems where its inferences are not yet definitive.

The remarks at the foot of page 302 concerning the limitations of special relativity are substantially untrue, and seem to be a recrudescence of a mere misconception that formerly had some currency. That theory can use other than inertial frames of reference just as freely as Newtonian mechanics can use rotating axes, by a suitable transformation of variables, and is certainly not “wholly incompetent” to deal with optical problems in rotating systems.

The rule, page 295, regarding convexity of light rays to the left of a person walking in the direction of propagation is to be understood as for the northern hemisphere only, and opposite in the southern. If the intent of the text is equivalent to this the footnote should have “counter-clockwise.” As Silberstein in effect points out the curvature is so tiny as to be a mere curiosity of theory. But an indication may be added that the negligibility of this curvature has an important bearing on the feasibility of sufficient accuracy in the construction of Michelson's optical circuit, with reference in this connection to the illustrative diagram on page 300.

The telescope supplies a single beam for incidence on the parting plate; if the transmitted and reflected portions start along the sides of the straight-line triangle and swerve as understood, the other corners of the concave triangle will touch the mirrors below the points B and C, those of the convex triangle above those points, so that the figure will be more like Fig. 1, corresponding to the case where the finally emergent pencils are parallel.

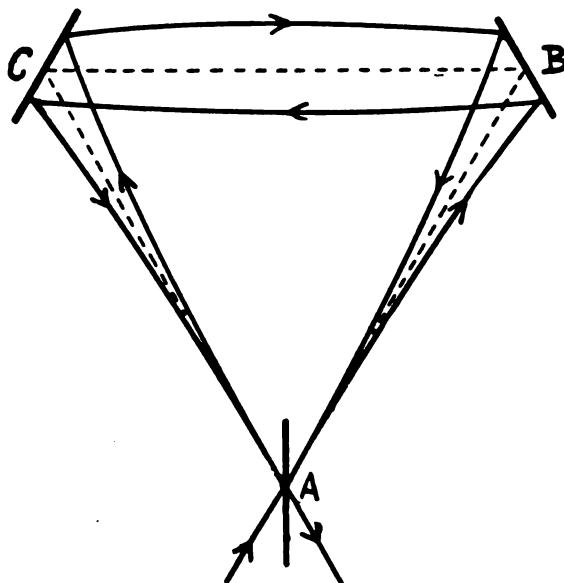

FIG. 1

This is of course merely one ideal arrangement for reference, but departures from it must be understood to be at least partly under instrumental control in order to provide for observable fringes of suitable width. In general, therefore, it appears that the oppositely travelling beams would be reflected at somewhat different portions of the mirrors. While the differences of path thereby introduced are of the first order individually for the successive sides of the circuit, the first order sum is zero because the angles of incidence and reflection are equal to a corresponding approximation. For a circuit of any polygon form in fact this modification does not imply any change in the first order formula for the shift

of fringes, but if the swerving were large enough to involve a perceptible portion of the aperture of the beam, so that the two pencils would be reflected at somewhat different portions of the mirror faces, the location of the fringes might be affected by the errors of the optical surfaces and non-homogeneity of intervening medium in a way more difficult to allow for than would be the case where a test by reversal were possible. Actually, however, even with distances of several kilometers the shift along the mirror face is a small part of a wave-length. There appears thus to be no practical error involved in the use of the rectilinear diagram.

In the formula for the line-element, page 303, there is an unnoticed change of notation, in that the letter r , previously denoting a radius in spherical coordinates becomes here the symbol for a radius in cylindrical coordinates. Since the meaning and relation of these two types of coordinates stands in need of definition when the gravitational curvatures are introduced, the foot-note on page 306 wants explanation, to show in what sense it can be considered true that the only modification needed is the additive term mentioned. This is not important for the main discussion since it is agreed that the gravitational terms, including doubtless those due to the rotation of the central mass, are here of insensible magnitude. But it should be noticed that neglecting these terms is equivalent to reducing the general to the special relativity, in spite of the adverse remarks on the latter previously referred to. In other words, the characteristic differences in relevant physical content between Einstein's restricted and extended theories are practically evanescent to the degree of approximation needed for this problem; so that the treatment of optical problems by the method of null geodesics reduces to the elementary case of isotropic rectilinear propagation with respect to a suitable frame of reference, this feature being common to special relativity and to the better developed ether theories.

Moreover, the omission of terms of higher degree in the velocity, again quite sufficient for the purpose, masks the chief features of contrast between the special relativity and such ether theories as are developed without such features as the contraction-factor.

In fact, it is well understood that the Lorentz-Larmor theory, by postulation of the contraction as an effect of motion through the ether, becomes in effect exactly equivalent physically to Einstein's theory over a wide range of phenomena.

For reasons such as these it is apparent that the theories in question are nearly equivalent for the treatment of the problem in hand. It seems to the writer that if the ether theories have any advantage over Einstein's it is likely to lie primarily in two remaining features that still need examination. First, it may be imagined that a theory like Fresnel's or Lorentz', while retaining the notion of a stagnant or rigid ether at least for certain limited regions, might have the greater freedom of choice of the frame of reference with respect to which it is so defined; this seems to be Silberstein's idea, when he uses the fractional factor k for the ether case but allows it to be only unity for Einstein's. Second, the notion of a non-rigid streaming or quasi-fluid ether, possibly even with vortex motion, may seem to offer greater adaptability than relativity allows.

In connection with the first point it is convenient to amplify Silberstein's notation because of ambiguity in the meaning of his S^* , which is said to represent the stellar or other inertial frame; although the partly dragged ether, with fractional coefficient undetermined, is taken to be isotropic in it. This usage seems to blur a distinction intended to be made, since it is probably not meant that a rotating ether should necessarily be an inertial frame in the sense of mechanics.

To indicate distinctions corresponding to rotation only, suppose, then, that S^* is the stellar frame, S^i an inertial frame for either Newtonian or Einstein mechanics since a distinction between these is not needed here, S^e the frame of isotropism of an ether supposed rigid in the neighborhood of the terrestrial experiment, and S the frame of the rotating earth. It will doubtless be agreed that in purely terrestrial experiments, for most mechanical and probably all optical tests hitherto, the distinction between these is obscured and indifferent; because the differential accelerations due to rotation are masked by the effects of inevitable disturbances, and because the rotational velocity is so small com-

pared with the velocity of light. But the deviation of falling bodies speaks for some such distinction and the Foucault pendulum and gyroscope are commonly taken to indicate that S^i is much nearer to S^* than to S , though probably not yet with precision enough to distinguish surely even between sidereal and mean solar day. The Michelson experiment seems to be the first real test of the corresponding optical comparison concerning S^c .

Since all these experiments could be performed even if the sky were always clouded everywhere, it seems in a way more suitable to say that these special dynamical tests point to the difference between S^i and S , while the optical test is needed to relate the S^c to the others, with precision enough to make a distinction between them. There are some advantages in this more limited formulation, independent of reference to cosmic phenomena, but the astronomical relations of the problem are clearly vital for a comprehensive theory.

Although diurnal aberration is not directly known, there are in the mode of reduction employed on astronomical observations certain inherent assumptions corresponding to the notion, that if extrapolated as a rigid system to cosmic distances the S^c would fit S^* . Then the planetary motions are to high precision consistent with the coincidence of S^i and S^* . But with the supposition of a cosmic S^c in rotation with respect to S^* there would even be need of inquiry as to the precise meaning of the latter, especially if its determination were understood to include dynamical relations. The notion of a rotational drag extending far out from the surface of the earth would evidently carry with it the need for elaborate re-examination of astronomical observations.

A hypothesis more likely to be entertained is that there could be an ether practically rigid locally and partaking to some extent in the rotation of the earth but connected with a cosmic ether stagnant in S^* by a transitional portion where a sort of fluidity would need to be assumed, and where not even a locally rigid S^c would exist. The varied suppositions that are naturally suggested are, however, special cases of a theory where for no portion of the medium is rigidity initially assumed. Some use of the idea of fluidity seems to be difficult to escape if any rotational drag is observed.

Now it may be asked whether the possibility of a full-fledged theory of a non-rigid ether is at present more than an article of faith. Perhaps an adaptation of the Heaviside-Hertz or Lorentz equations for moving bodies could be made to serve as embodiment of it. But the perplexities that greeted the Stokes theory of aberration in a medium with pure streaming motion are familiar, and there are worse when vortical motion is included. The pending optical experiment, because of the circuital optical path, may in fact be said to be adapted to yield primarily a measure of the difference in curl between the earth's rotation and the ether motion, as measured in the frame of reference used in describing the rotation. Moreover, the determination of optical paths by Huyghens' principle is at best but kinematic, and does not imply the attainment of an ether theory competent to follow the waves with detailed reference also to amplitude and polarization. But granting that such a theory can be made, and for illustration understanding it to be a modified form of Fresnel's or Lorentz', one may still ask whether the theory of relativity could not make a corresponding adaptation within itself. Confidence in such a possibility is certainly encouraged by the previous success of Einstein's theory in absorbing the salient content of earlier theories with only such changes as are permitted by the experimental data. It is quite conceivable that this theory could expect to find such adapting changes possible in the field-equations, of any ether theory at least whose success is connected with terms of orders zero and one in the velocities. But for the present discussion it may suffice to point out the basic feature involved.

The theory of Einstein is like all physical theories using the concepts of space and time, in that it includes a kind of geometry, supplemented by a system of physical notions and postulates which can be developed in harmony with the geometry but which are by no means uniquely determined by any logical considerations alone. It is largely these postulates which are in question in connection with any experimental tests, and they can be changed in detail without destroying the main structure, just as an ether theory could introduce the notion of a locally non-rigid medium.

In the present instance it may be noticed that the postulate primarily concerned is at least as old as modern science, and is very deeply involved in Newtonian astronomy. Its perpetuation in suitable form by Einstein is natural, not because it is inevitable but because there has hitherto been no reason at hand for preferring something different and presumably more complicated. In primitive form this postulate may be roughly said to assert that the straight lines of metric geometry are dynamically and optically straight. Two centuries of celestial mechanics exhibit the remarkable success of this hypothetical identification, in connection with astronomical triangulations and the relation of Newton's first law to planetary motions. In Einstein's theory, using a combination geometry of space and time measurements, and extended in the generalized theory by introduction of the curvatures of the manifold, it is taken as a characteristic of void spaces that the optical geodesics are the null-lines of the dynamical geodesic system and that these are defined by the vanishing variation of the integral space-time separation. This postulate could certainly be changed in various ways if need be, without departing from the natural criteria of a genuine theory of relativity. If the dynamical and optical world-lines of reference do not coincide, their relation has a physical meaning and is a matter of at least partial experimental test, the results of which could be described "covariantly" or impartially, as demanded by such a theory.

This assumed coincidence of reference-lines of two-fold aspect is reflected in the absence of any new arbitrary constant in the computed values of ray-curvature and motion of Mercury's perihelion. The verification of these values suggests that no change in the theory is likely to be required for void spaces. But possibly in the immediate neighborhood of rotating masses, whose theory is still incomplete, and certainly for spaces not void of matter, as the writer expects to show in detail at another opportunity, the Einstein geometry furnishes material for some freedom of choice in modifying the analogous form of the postulate referred to, in such fashion as to fit with the original form of the theory in regions where the tensor of matter is assumed to vanish.

To make the corresponding adaptation of the wave-equations is much the same problem as in the theory of a fluid ether.

The theory of Michelson's apparatus, where source, mirrors and observing instrument alike rotate, may need further study before the interpretation becomes convincing. But it is clearly premature to conclude that any one of the theories is incapable of adapting itself to the result.

A related suggestion may be hazarded. The absence of dynamical symptoms of uniform translation was found to be paralleled by absence of optical and electrical symptoms. The presence of dynamical symptoms of rotation is natural reason for expecting positive optical analogues. But a value for the rotation, less than the expected but not zero, seems quite plausible, in view of the possibility of a region where the portion of ether in rotation merges outwardly into quiescent regions, and this transition part may extend into the body of the earth. The Einstein theory of rotating masses when suitably developed may furnish an analogue, where the internal dynamical-optical geometry merges into that of the external void. The corresponding suggestion is that the angular velocity revealed by Foucault pendulum and gyroscope may not be the sidereal value, and might possibly be found to vary with the depth if the experiments could be performed in cavities deep down within the mass. These dynamical experiments also seem to offer renewed interest.

THE UNIVERSITY OF CHICAGO,
NOVEMBER 17, 1921.

OBSERVATIONS ON THE RARE EARTHS, XI: THE ARC SPECTRUM OF YTTRIUM¹

BY
L. F. YNTEMA WITH B. S. HOPKINS

During the progress of the work on the rare earth group of elements at the University of Illinois, several members of the group have been separated in a high state of purity and their atomic weights determined. This present investigation is a part of a plan that comprises the spectroscopic examination of a number of those elements in order to establish standards of purity that can be employed in future work on the separation of the members of the group.

The emission spectrum of yttrium has been studied by a number of workers. Values have been published by Kayser,² Eberhard,³ and Exner and Haschek.⁴ The latest, and probably the best determinations are those of Eder,⁵ which were made on yttrium material prepared by Auer v. Welsbach. They are included in the following table.

The yttrium examined was a portion of that prepared by the one of us and co-workers for the determination of the atomic weight value that has lately been accepted by the International Committee on Atomic Weights.⁶ The only known impurity was 0.005 per cent or less of holmium,—an estimate made by comparing the intensity of the absorption spectrum with standard solutions.

The spectrograph used is an autocollimating quartz prism machine constructed by Adam Hilger of London. Its dispersion increases from 17.5 angstroms per millimeter at 4500A° to 1.5 angstroms per millimeter at 2200 A°.

¹ Submitted by L. F. Yntema to the Graduate School of the University of Illinois in partial fulfillment of the requirements for the degree of Doctor of Philosophy. Contribution from the Chemical Laboratory of the University of Illinois.

² Königl. preuss. Akad. d. Wiss., Berlin, 1903.

³ Zeitschr. f. wiss. Photogr., 7, p. 245, 1909.

⁴ "Die Spektren der Elemente bei normalem Druck, II," Leipzig und Wien, 1911.

⁵ Sitzber, K. Akad. wiss., Wien, IIa, 125, p. 471.

⁶ J. Amer. Chem. Soc., 42, p. 327, 1920; *ibid.*, 41, p. 718, 1919. *Ibid.*, 38, p. 2332, 1916.

The iron spectrum was employed as reference.⁷ A bar of pure iron for this purpose was kindly furnished by the Westinghouse Electric and Manufacturing Company of East Pittsburg, Pennsylvania. Copper electrodes, as carriers for the yttrium oxide, were found to be preferable to the graphite generally employed, because the copper arc is steadier and the electrodes do not burn away as rapidly. Furthermore, a regulus of yttrium oxide in the molten copper is formed and mechanical loss is avoided.⁸

A direct current of four or five amperes at an E.M.F. of 220 volts was used.⁹

Seed plates, No. 23, size 4'' by 10'', were used and hydrochinone was used as a developer. The negative plates were measured on a dividing engine, made by Adam Hilger of London, which is graduated to read to 0.001 millimeter.

The wave-lengths in International Angstrom units, were calculated by Hartmann's dispersion formula.¹⁰

$$\lambda = \lambda^{\circ} \frac{C}{R - R_0}$$

The mean of the determinations from at least four plates was taken.

The results are given in the following table. The first column gives the wave-lengths as measured in International Angstroms. The second column indicates the intensity and character of each line, the most prominent lines being assigned an intensity "10" and the faintest lines an intensity "1." The character or appearance of a line is indicated by letters that have the following significance:

d = diffuse

v = shaded to violet

[R = reversed

BR = head of a band toward red

] The column headed "Notes" contains other elements having lines that coincide closely with yttrium lines of lower order of

⁷ Handbuch der Spectroscopie, VI. Band, H. Kayser.

⁸ Pfund, *Astrophy. Jour.* 27, p. 296, 1908.

⁹ *Astrophy. Jour.* 39, p. 93, 1914.

¹⁰ *Astrophy. Jour.* 8, p. 218, 1898.

intensity. These elements were probably present as impurities in the material examined.

Intensity and Character of Spectral Lines of Yttrium

Yntema and Hopkins	I	Eder	I	Notes
.....		2231.55	1
2243.02	4	2243.03	2
.....		2328.95	1
2331.67	2	2331.63	1
2332.59	3	2332.58	2
2340.80	1	2340.79	1
2343.55	3d
2349.71	2	2349.69	1
2354.21	4	2354.20	3
2355.42	2	2355.40	1
2358.75	2	2358.70	2
2361.82	2	2361.81	2
2373.86	4
2385.24	5	2385.24	2
2398.10	2	2398.06	2
2404.09	1	2404.11	1
2413.94	3	2413.94	1
2417.29	2	2417.29	1
2422.19	7	2422.20	4
.....		2457.93	1/2
2460.13	2	2460.11	1
2460.60	3	2460.60	2
2465.80	2
.....		2479.09	1
.....		2479.80	1
2490.44	3
2492.68	1d
2516.13	2	Silicon
.....		2529.14	1
2540.31	3d	2540.28	1
2545.61	2d
2547.57	4	2547.56	2
2550.17	2d	2550.35	1
.....		2554.87	1
.....		2570.72	1
.....		2579.36	1
.....		2593.76	1
2594.89	2d	2594.88	1
2612.42	1d	2612.38	1
.....		2619.46	1
2634.36	1	2634.32	1

Yntema and Hopkins	I	Eder	I	Notes
2647.76	1(?)	2647.74	½
.....	2671.20	½
2672.09	3	2672.08	1
2681.67	3	2681.65	1
2684.20	1	2684.20	½
2694.18	4	2694.21	1
2695.37	3	2695.40	1
2699.01	2
2705.87	2	2705.85	1
2710.15	1(?)	2710.15	1
2720.04	2d	2719.99	1
2723.01	4	2723.00	3
2730.09	3	2730.06	1
.....	2733.93	1
2734.82	2	2734.85	2
2742.48	5	2742.55	3
.....	2749.23	1
2750.17	2	2750.20	2
.....	2755.79	1
.....	2756.33	1
2760.08	5	2760.10	3
2772.28	1
(2779.85)	1	Magnesium
2785.18	2	2785.19	2
2785.59	2	2785.58	2
2790.13	1
2791.23	2	2791.20	1
(2795.56)	2	(2795.53)	2	Magnesium
2800.10	3	2800.12	2
2801.14	1(?)
.....	(2802.73)	2	Magnesium
2807.77	1	2807.66	1
2813.65	3	2813.66	1
2818.87	2	2818.87	1
2822.57	2	2822.56	1
.....	2823.55	1
.....	2824.48	1
2826.33	2
2834.42	1	2834.39	1
2835.78	1d
2840.83	2	2840.84	1
2842.44	1
2842.63	1d
2850.63	1
.....	(2852.11)	2	Magnesium
2854.42	3	2854.42	2

Yntema and Hopkins	I	Eder	I	Notes
2856.30	2	2856.30	2
2857.91	1	2857.87	1
2871.23	1	2871.20	1
2873.29	1		
2881.60	1	(2881.60)	3	Silicon
2886.48	4	2886.49	2
2890.38	2	2890.40	1
		2891.32	1
2897.68	2	2897.68	1
2898.81	1	2898.82	1
2901.46	2d	2901.48	1
2919.06	6	2919.06	3
		2929.00	1
2930.00	2	2930.03	2
2930.75	1	2930.77	1
		2935.91	1
		2943.58	1
2948.41	8	2948.40	4
		2948.78	1
2953.13	1	2953.14	1
2955.86	1	2955.86	1
2964.97	7	2964.95	3
2973.89	1(?)	2973.91	1
2974.60	10	2974.60	4
		2977.99	1
2980.56	2	2980.55	2
2984.26	10	2984.25	4
2995.27	3	2995.25	2
		2996.94	3
3005.26	3	3005.25	2
		3009.51	1
3018.96	3d	3018.95	2
3021.73	3	3021.73	3
3022.28	3	3022.27	3
3023.73	1d	3023.70	1
3023.95	1d(?)	3023.99	1
		3027.68	1
		3030.08	1
		3036.59	3
		3037.82	1
3038.44	1	3038.46	1
		3039.98	1
3044.84	2	3044.84	2
3045.37	4		
3047.13	1	3047.11	1
3047.36	2	3047.41	1

Yntema and Hopkins	I	Eder	I	Notes
3049.88	1	3049.86	1
.....	3051.52	1
3053.25	1(?)	3053.26	2
3054.49	3(?)	3054.41	1
3055.22	3	3055.21	3
(3056.33)	1	(3056.33)	1	Sodium
(3059.52)	2	(3059.50)	2	Dysprosium?
.....	3065.83	1
.....	3067.27	1
3069.10	1(?)	3069.04	1
3072.37	2	3072.32	2
3076.49	2	3076.49	2
3077.00	1(?)	3076.95	1
3078.57	1d(?)	3078.57	1
3080.29	1
.....	(3082.16)	1	Aluminium
3086.88	3	3086.84	4
3091.74	3d	3091.70	3
.....	(3092.71)	3	Aluminium
.....	3093.75	3
.....	3095.49	1
3095.89	3	3095.88	4
3096.61	1d	3096.57	1
3103.29	1(?)	3103.25	1	Dysprosium?
3103.72	1	3103.69	2
3104.69	1	3104.69	2
.....	3108.86	2
.....	3109.77	1	Dysprosium?
.....	3110.50	1
3111.79	3	3111.80	3
3112.03	3	3112.03	3
3114.29	2	3114.27	3
.....	3118.50	1	Holmium?
.....	3122.60	1
.....	3126.00	1
.....	3128.74	3
3129.96	3	3129.93	4
.....	3133.15	1
3135.19	4	3135.16	4
.....	3140.63	1	Dysprosium?
.....
.....	3141.16	1	Aldebaranium?
.....
.....	3144.20	1
3152.68	2d	3152.67	2
3155.66	1

Yntema and Hopkins	I	Eder	I	Notes
.....		3157.50	1
.....		3158.36	1
.....		(3158.88)	1	Calcium
.....		3159.47	1
.....		3160.54	1	Dyspro- sium?
.....		3162.83	1	Dyspro- sium?
.....		3164.76	1
.....		3170.00	1	Dyspro- sium?
3171.72	3	3171.69	2
3173.05	3	3173.05	4
.....		3173.72	1
.....		3174.36	1
3179.45	4	3179.40	4
3182.27	1	3182.23	2
3185.99	1	3185.93	1
.....		3188.75	1
3191.38	3	3191.29	3
.....		3193.29	2
.....		3194.37	2
3195.66	8	3195.61	6
.....		3197.69	1
3198.45	1(?)	3198.41	2
3200.29	10	3200.25	6
3203.37	10	3203.32	6
.....		3203.82	1
.....		3206.22	1
.....		3209.35	2
.....		3211.26	1
3212.24	1d	3212.28	2
.....		3214.04	1
.....		3215.20	1	Dyspro- sium?
3216.68	10	3216.67	10
.....		3217.80	1
.....		3220.72	1
.....		3221.50	1	Dyspro- sium?
.....		3222.02	1
.....		3223.28	1	Dyspro- sium?
.....		3225.03	3
.....		3227.08	1
.....		3227.69	1

Yntema and Hopkins	I	Eder	I	Notes
.....	3230.57	2	Holmium
.....	3231.32	1
.....	3231.80	2
.....	3235.88	1	Dysprosium
.....	3237.93	1
.....	3239.29	1
3242.28	8	3242.28	15
.....	3245.07	1	Dysprosium
.....	3247.02	1
.....	3247.54	4	Copper
.....	3251.29	2	Dyspro- sium?
3252.34	2(?)	3252.27	3
.....	3255.82	1
.....	3256.20	1
.....	3257.52	1
.....	3261.23	1
3262.39	2
.....	3263.22	1
.....	3264.77	3	Holmium?
.....	3267.24	1
.....	3267.81	1
.....	3269.11	1
.....	3269.40	1
.....	3270.94	1
.....	3271.13	1
.....	3273.04	1
.....	3273.96	3	Copper?
.....	3275.56	2
.....	3278.43	2
.....	3279.35	1	Erbium?
.....	3280.13	2	Dyspro- sium?
.....	3280.91	4
.....	3281.98	1	Holmium?
.....	3282.45	3
.....	3282.77	1
.....	3283.21	2
.....	3283.85	1
.....	3286.68	3
3287.25	1	3287.21	3
.....	3287.93	1	Dyspro- sium?
.....	3289.37	3	Aldebaran- ium
.....	3290.11	1

Yntema and Hopkins	I	Eder	I	Notes
.....	3290.56	3
.....	3290.96	1	Holmium?
.....	3291.44	1	Dysprosium?
.....	3293.44	2
.....	3293.68	2
.....	3294.55	1
.....	3298.26	1
.....	3302.17	2
.....	3302.56	1/2
.....	3303.86	1
.....	3304.32	1/2
.....	3305.49	1/2
.....	3305.90	1/2
.....	3306.27	1/2
.....	3307.61	1/2
.....	3308.47	3
.....	3308.84	1
.....	3310.13	1/2
.....	3312.40	1
.....	3312.67	1/2
.....	3315.40	1/2
.....	3316.32	1/2
.....	3317.03	1/2
.....	3318.52	2
.....	3319.76	3
.....	3320.60	1
.....	3323.13	1
3327.97	10	3327.89	15
3330.90	2	3330.88	2
.....	3333.42	1
.....	3335.20	2
.....	3336.18	1
.....	3337.82	2
.....	3338.76	1
3340.36	2	3340.37	3
.....	3340.98	1/2
.....	3341.85	1
3344.51	1d	3344.53	2
.....	3349.26	1
.....	3352.64	1/2
.....	3353.56	1/2
.....	3354.57	2
3358.98	2	3358.94	2
3362.05	5	3361.99	5
.....	3364.79	2

Yntema and Hopkins		Eder	I	Notes
(3372.77)	2			Holmium
3377.76	2	3377.72	2	
3379.85	1			
3382.85	6	3382.83	$\frac{1}{2}$	
		3383.06	1	
3388.60	3	3388.58	2	
3389.90	2d			
3393.50	1(?)			
3394.98	1			
3397.05	3	3397.03	3	
3399.02	2			
3406.11	1			
(3407.76)	1			Dysprosium
3409.72	1d			
3412.49	2d	3412.47	2	
3424.14	2d			
(3429.15)	1d			Holmium
3431.00	2			
3431.67	2d			
		3433.02	1	
3437.98	2d			
(3445.52)	1d			Dysprosium
3448.85	5	3448.81	4	
3450.88	2	3450.94	2	
3453.03	1d			Holmium
3456.01	2d			Holmium
3461.01	2			
3467.86	4	3467.88	4	
3469.36	1			
3470.14	1			
3473.12	2			
3474.28	1			
		3484.06	2	
3485.75	4	3485.73	4	
3496.06	9	3496.09	8	
3497.23	1			
3498.93	2dv			
3500.63	1d			
3501.96	1			
3503.47	1d			
3506.51	2			
3507.95	1			
3510.54	1d			
3511.19	1d	3511.20	3	
3521.52	2d			
		3512.90	2	

Yntema and Hopkins	I	Eder	I	Notes
		3531.65	2	
(3538.49)	1d			Dysprosium
		3544.03	4	
		3544.93	3 } *	
3545.94	1			Holmium?
3548.98	10	3548.99	6	
3551.76	1			
3552.71	5	3552.69	4	
3558.72	4			
3562.74	1d			
3564.00	1			
3571.42	3	3571.44	1	
3576.05	4	3576.04	2	
3584.43	7	3584.51	4	
3587.76	3	3587.75	1	
3589.61	2			
3592.85	7	3592.91	4	
3600.69	6	3600.72	6	
3601.92	6BR	3601.91	5	
		3608.84	1	
3611.05	8BR	3611.05	10	
3612.32	2			
3616.62	1			
		3618.77	1	
3620.93	6BR	3620.94	6	
3628.69	7BR	3628.70	5	
3633.01	10BR	3633.11	8	
		3635.32	1	
		3639.27	3	
3664.62	10BR	3664.59	10	
3668.51	2	3668.48	3	
3692.54	3	3692.54	6	
		3694.20	3	Aldebaran- ium
3696.62	1			
3710.14	10	3710.30	15	
		3716.94	1	
3718.10	2	3718.14	3	
		3724.76	2	
3732.19	1			
3738.60	2	3738.62	2	
3747.59	6BR	3747.55	3	
3749.90	2			
3755.50	1			
(3757.27)	1			Holmium
3760.02	1d			

Yntema and Hopkins	I	Eder	I	Notes
3761.45	1	Erbium
3762.18	1
3769.51	1
3770.38	2d
3774.28	10BR	3774.33	5
3776.53	6BR
3782.26	1
3788.62	10BR	3788.69	5
(3796.65)	1	Holmium
(3810.72)	1	Holmium
3818.32	6BR	3818.37	3
.....	3825.91	1
3832.84	10BR	3832.87	2
3836.79	1d
.....	3840.43	1 }*
3843.43	1d
3847.87	3v
(3872.12)	1	Dysprosium
3876.82	2
3878.31	4	3878.27	1
3884.81	1
3887.81	2	3887.93	2
.....	3890.13	1
3890.95	1d
3892.39	1	3892.41	2
.....	3900.27	1
3904.56	2	3904.59	2
3913.66	1
3918.30	2
3930.66	4	3930.65	3
3942.53	1d	Dyspro- sium?
3944.74	1	Dyspro- sium?
3946.20	1	3946.20	2
3946.95	1(?)
3950.36	10BR	3950.35	5
.....	3951.60	3
3955.05	2	3955.09	3
3967.72	1
3973.53	1d(?)	3973.45	2
3982.61	10	3982.60	8
3987.48	1	3987.50	1
(4000.54)	1(?)	(4000.44)	3	Holmium
(4008.00)	1	Erbium
4029.85	1	4029.86	1

Yntema and Hopkins	I	Eder	I	Notes
4039.80	5	4030.83	5}*	
4047.69	7	4047.65	6	
4049.45	1(?)			
(4053.93)	1dv			Holmium
		4065.02	1	
		4076.39	8}+	
4077.38	10			
4079.14	1(?)			
		4080.93	1	
4081.19	2d	4081.23	1	
4083.74	7	4083.71	5	
4085.50	1			
4090.45	1			
4095.45	1d			
4099.30	1			
4099.85	1			
4102.35	10BR	4102.38	10	
4106.41	2	4106.39	1	
4110.82	2	4110.81	2	
4124.96	4			
		4125.93	5}*	
4128.25	10BR	4128.32	10	
4142.89	9BR	4142.87	10	
4157.63	3	4157.63	2	
(4163.10)	1d			Holmium
4167.56	8	4167.52	8	
4169.42	1(?)			
4174.16	7	4174.14	4	
4177.54	10BR	4177.51	5	
(4186.83)	1d			Dysprosium
4191.26	1d(?)			
4199.26	3	4199.28	3	

* The values given by Kayser and others agree with those found by the authors. It is suggested that the discrepancies may be due to clerical errors.

The impurities found to be present in the yttrium material were the rare earth elements, holmium, erbium, and dysprosium, besides magnesium, and silicon. The presence of the rare earths is to be expected in small amounts. The order of increasing solubility of the bromates, which were used for the first step in the purification of the yttrium, is as follows:—

Dy, Ho, Y, Er

The final purification was accomplished by methods depending on differences in basicity. The order of decreasing basicity is as follows:—

Y, Dy, Ho, Er

Complete separation of yttrium from its less basic neighbors is hardly possible, but the separation was so nearly complete that their most prominent lines were found to be of the faintest order in the spectrograms obtained.

The solution, from which the yttrium was precipitated as oxalate, had stood in Jena glass for some time; the silicon and possibly the magnesium were introduced by solution of the glass.

Attention may be called to the fact that the yttrium material examined has a few lines in common with the eurosamarium of Eder.¹¹ Lines 4309.65 \AA , 4174.16 \AA , and 3950.35 \AA are prominent yttrium lines and they are reported as faint lines of eurosamarium. Other prominent yttrium lines, however, were not found by Eder in eurosamarium. There are several instances of coincidence of rather faint lines, such as those at 4090.45 \AA and 3129.96 \AA , but these are probably accidental. It must be concluded that Eder's material contained no more than a very small per cent of yttrium.

It may, also, be noted that Kayser,¹² reports two lines, 5205.72 \AA , and 5200.41 \AA , as yttrium lines of intensity 6, while they are reported by Eder as eurosamarium lines of intensity 10.

URBANA, ILL.

JUNE 1, 1921.

¹¹Sitz. K. Akad. Wiss., Wien. 126, IIa (1917), 473.

¹²Loc. cit.

1921 REPORT OF COMMITTEE ON STANDARD WAVE-LENGTHS

BY
W. F. MEGGERS (Chairman)

I. PRIMARY STANDARD

In the 1920 report of this committee the subject of Standard Wave-Lengths¹ was reviewed from its beginning and brought up to date. Notice was taken of some dissatisfaction with the primary standard, the red radiation of cadmium (6438.4696 Å). The limitations of a cadmium vapor lamp for routine measurements are appreciated by all who have made determinations of secondary standards and a more convenient working standard is no doubt desirable. To this end the following suggestions are made. The high homogeneity and exact reproducibility of the red radiation of cadmium together with the fact that it is evaluated in terms of the meter to an accuracy of probably one part in 10 million recommend its permanent retention as the Primary Standard. Since most sources of secondary standards give lines of lesser homogeneity the accuracy of their wave-length determinations cannot exceed a part in two or three millions. For practical purposes, therefore, a more convenient working standard may be defined as equivalent to the Primary Standard and the mean value of 8 lines of about equal intensity in the neon spectrum between 5881 and 6382 Å is suggested as a suitable auxiliary Primary Standard which may be substituted for the cadmium line in most cases. The following values are recommended:

5881.895	6143.062
5944.834	6266.495
6074.338	6334.428
6096.163	6382.991

These neon lines² have been compared directly with the fundamental standard and their wave-lengths are probably correct to one part in about six million. They are satisfactorily distributed

¹ JOUR. OPT. SOC. AM., 5, p. 308; 1921.

² B. S. Bulletin 14, p. 765; 1918.

in the spectrum, being separable with a single prism spectrograph but at the same time included in a small enough interval so that the dispersion of phase in interferometer reflections is negligible. The probable error in a measured length based upon the mean of 8 values is no doubt less than when depending on a single line and furthermore the use of a group of neon lines permits the determination of the exact order of interference, or the optical measurement of length to be made easily and rapidly.³ The neon lines are readily obtained with great intensity from Plücker tubes, can easily be observed either visually or photographically, and are capable of showing interference with a retardation of more than 300 000 waves. They have been used successfully in the calibration of end standards⁴ and in ruling line standards with a tested accuracy of one part in two or more million.

II. SECONDARY STANDARDS

The following wave-lengths from the spectrum of low pressure cadmium vapor have been measured⁵ in terms of the wave-length of the Primary Standard (6438.4696 Å) and are recommended as additional secondary standards which qualify in respect to sharpness and accuracy in relative value.

TABLE 1.—*Wave-Lengths in the Spectrum of Cadmium*

2980.622	3610.5098
3080.827	3612.8748
3133.167	4662.3525
3252.5248	4678.1504
3403.6529	4799.9139
3466.2010	5085.8230
3467.656	

Frequency differences among the lines which belong to corresponding members of subordinate series are constant to one part in several millions when derived from the above measurements. The entire range of these differences is the same order of magnitude as the probable error in the wave-length comparisons.

More determinations of secondary standards, especially in the spectra of the inert gases, are desirable, but none have been published since those appearing in the 1920 report of this committee.

³ B. S. Bulletin 12, p. 203; 1915.

⁴ B. S. Bulletin, Forthcoming Scientific Paper by C. G. Peters.

⁵ B. S. Bulletin, Forthcoming B. S. Sci. Paper, by Meggers and Burns.

The greatest need of International Secondary Standards of wave-length lies in extending the system to longer and to shorter waves. A fairly homogeneous and satisfactory system of secondary standards now exists for the visible spectrum and for a portion of the adjacent ultra-violet. Accurate values are scarce for the infra-red and there are none at all for wave-lengths in the extreme ultra-violet and Schumann regions. The theoretical importance of these shorter waves is ever increasing and in recent years a large number of investigators have added much to spectroscopy of the Schumann region, which has apparently been extended so that no gap remains between the so-called optical and X-ray spectra. The wave-length measurements of different observers are often in disagreement by one or 2 Angstrom units compared with the accuracy of 0.001 A striven for in the region of longer waves where International Secondary Standards now exist. With an interferometer of fluorite plates operated in a vacuum spectrograph the system of secondary standards may perhaps be extended to wave-lengths of 1400 A or less.

III. TERTIARY STANDARDS

Since the 1920 report was prepared an important contribution to the subject of tertiary standards of wave-lengths has been made by the Mt. Wilson Observatory.⁶

Observations were made on a 12 mm, 5 amp "Pfund arc" and light was used from a central zone at right angles to the axis of the arc not exceeding $1\frac{1}{4}$ mm in width. Under these conditions the iron arc is said to yield wave lengths which appear to be free from the so-called pole-effect. Mean results for 1026 lines were given including 78 International Secondary standards of which 62 stable lines came out as follows: 53 within ± 0.001 , 8 within ± 0.002 , 2 within ± 0.003 and 1 within 0.004 A of the adopted values; while in the case of 16 lines belonging to group *c*₆ and *d* (also showing pressure shift), the International values are systematically greater, the mean difference being 0.007 A, due to pole effect in the arcs used in the original determinations.

⁶ St. John and Babcock, Wave-Lengths of lines in the Iron Arc from Grating and Interferometer Measures 3370 to 6750, *Astroph. J.*, 53, pp. 260-299; 1921.

Another excellent set of measurements of tertiary standards was made by Friedrich Müller,⁷ who used an iron-carbon arc which according to St. John and Babcock⁸ is entirely free from pole effect. Overlapping spectral orders were photographed by means of a large concave grating spectrograph and the wave lengths of 388 selected lines were determined relative to the stable Secondary Standards. Except for a gap between 3903 and 4525 Å, these tertiary standards are fairly well distributed between 2332 and 5658 Å. Compared in the range 2413 to 3030 Å with the standards determined by Fabry and Buisson,⁹ the values found by Müller average 0.002 Å larger from 3030 to 2739 Å and 0.002 Å smaller from 2714 to 2413 Å. In the green-yellow (4707 to 5658 Å) 14 lines belonging to groups c and d show values which in the mean are 0.0065 Å smaller in this source than in the international iron arc. This confirms the findings of St. John and Babcock. Approximately 160 lines were measured with gratings both by St. John and Babcock and by Müller. For these, the mean difference is ± 0.0018 Å and the values by Müller are systematically 0.0005 Å larger than those by St. John and Babcock.

There is not sufficient assurance that any of the wave lengths derived from the modified iron arcs are identical with those obtained from the arc defined in 1913 as the source of International Secondary Standards, and it is regrettable that neither St. John and Babcock nor Müller tested this by comparing their wave lengths with the Primary Standard. If the iron lines are not perfectly symmetrical the increase of sharpness in the modified arcs may be expected to change the effective value of their wave lengths. Careful investigation of this point is desirable.

The measurements of tertiary standards discussed above were made in terms of the so-called stable International Secondary Standards and the investigations may be regarded as confirming the correctness in relative value of these wave lengths. If the

⁷ Müller, *Beitrag zur Aufstellung des Systems internationaler Wellenlängen-Normalen*. Dissertation, Rheinischen Friedrich-Wilhelms-Universität zu Bonn, 1921.

⁸ St. John and Babcock, *Astroph. J.*, 46, p. 138; 1917.

⁹ Fabry and Buisson, *Comptes Rendus* 144, p. 1155; 1907.

values for c_b and d lines in the modified arcs are confirmed by another investigator the mean of three independent and concordant observations may ultimately be adopted as corrections to the standards in the cases of iron arc lines which appear to be unstable. Secondary Standards of this type should be replaced as far as possible by new measurements of stable lines.

BUREAU OF STANDARDS,
WASHINGTON, D. C.

THE GLOSS CHARACTERISTICS OF PHOTOGRAPHIC PAPERS*

BY
L. A. JONES

In a systematic study of the characteristics of photographic papers a consideration of the surface quality is of great importance. The factors most frequently required in the specification of surface quality are color, texture, and gloss. The color can be measured by the employment of suitable colorimetric methods, the results being most conveniently specified by stating the diffuse reflecting power, wave-length of the dominant hue, and the saturation. These three factors which are necessary for the specification of color completely define from the subjective standpoint the quality and intensity of the light reflected from the surface. The word "texture" is used in referring to the topography of the surface. Thus far no simple numerical method of expressing quantitatively the texture of the paper has been developed. At the present time the texture is best studied by examining the surface under a microscope. A magnification of from 10 to 20 diameters has been found to be most suitable for this work. Photomicrograms made with a fixed magnification and under certain specified and constant conditions of illumination are found useful in case a permanent record of the texture characteristics is required. The third factor mentioned, that is, gloss, is dependent upon the geometrical distribution of the light reflected from the surface under consideration.

In general it may be said that of the light reflected from the surface of such materials a part is diffusely reflected while the remainder is reflected specularly, that is, in accordance with the law that the angle of reflection is equal to the angle of incidence. Considering surfaces in general, it is found that an infinite number of variations in the ratio of specular to diffusely reflected light

* Communication No. 134 from the Research Laboratory of the Eastman Kodak Company.

exists, the scale being theoretically limited at one end by a surface which reflects all of the incident light according to the law that the angle of incidence is equal to the angle of reflection, and at the other by a surface which reflects light equally in all directions regardless of the angle of incident illumination. The characteristic of the surface referred to by the words "glossy" or "glossiness" is dependent upon the relation existing between the light which is diffusely and regularly reflected from the surface, and it is with the measurement and numerical specification of this factor that this paper deals. It is customary, at the present time, to designate the gloss factor of a photographic paper by the use of such descriptive words or terms as "matte," "semi-matte," "velvet," "glossy," etc. It is evident that the use of the words can only approximately specify the gloss quality and it is very desirable for the sake of more precise designation to develop a method for the numerical specification of this quality.

The problem of mixed specular and diffuse reflection has been treated at considerable length in the reports of the Committee or Glare¹ of the Illuminating Engineering Society. In these reports, Dr. P. G. Nutting, who was chairman of the committee at that time, presented a very complete mathematical treatment of the problem and proposed as a logical specification of gloss the ratio of the specular reflecting power to that of diffuse reflecting power, the illumination being incident normally and the illuminating source of such dimensions as to subtend .01 steradian at the surface. In one of the reports considerable data relating to the gloss of various papers and to some photographic papers are given.

Taking advantage of the fact that in the case of mixed specular, and diffuse reflection the regularly reflected component is almost completely polarized under certain conditions, Professor L. R. Ingersoll² has developed a polarization method of measuring the gloss factor. In his instrument the conditions of illumination both as regards angle and size of source are chosen arbitrarily. Under these conditions, the ratio between the intensity of the regularly and diffusely reflected components is measured by some

¹ *Trans. I. E. S.*, 10, p. 353, 379 and 388, 1915.

² *J. OPT. SOC. AMER.* May, p. 213, 1921.

type of polarization photometer such as the Martins photometer or the Pickering polarimeter. This instrument provides, therefore, an arbitrary scale upon which the gloss values may be expressed.

The term "gloss" is used as descriptive of the subjective impression received when observing a surface from which light is reflected and there is little doubt that the degree of glossiness is dependent upon the contrast between the brightness of those portions of the surface which are seen by diffusely reflected light and those which are seen by regularly reflected light. In other words, gloss must be a function of the brightness contrast existing between the more or less clearly defined specular images of light sources having relatively small angular dimensions and the contiguous portions of the surface which owe their brightness to diffusely reflected light. It seems logical, therefore, that the absolute scale of gloss can be established only by measuring this brightness under certain specified conditions of illumination and observation.

THE GONIO-PHOTOMETER

Before deciding upon the conditions under which such measurements were to be made, it seemed desirable to measure the distribution of light reflected from the surface under consideration for various conditions of illumination. This involved the determination of the reflection characteristics of the surfaces for all angles of observations and under certain specified conditions of illumination.

For this purpose a special instrument termed, for convenience, a "gonio-photometer" was designed and constructed. A diagram showing the essential parts of this instrument is shown in Fig. 1.

A heavy cast-iron base, *A*, supports the arm *B*, at the end of which is carried the photometric apparatus. In order that the observer and the photometric equipment might not interfere with the illumination of the sample at angles approaching closely to the normal, the axis of observation was bent at right angles by use of the total reflecting prism *C*. A portable photometer of the illuminometer type was mounted at *D*, and the small lens *E* placed immediately in front of this photometer permitted the

formation of an image of the surface under examination in the plane of the photometer cube. In case the texture of the surface was such as to interfere with precise photometric settings, this lens could be displaced by amounts sufficient to eliminate the troublesome surface texture. A rigid bearing *F* supported by the base casting carries a movable arm *G* on one end of which is mounted the lamp house *H*, while at the other end a counterpoise weight *I* is placed. A holder is provided for the sample at *J*, this is so mounted that it holds the surface of the samples being examined in the plane passing through the axis of rotation of the

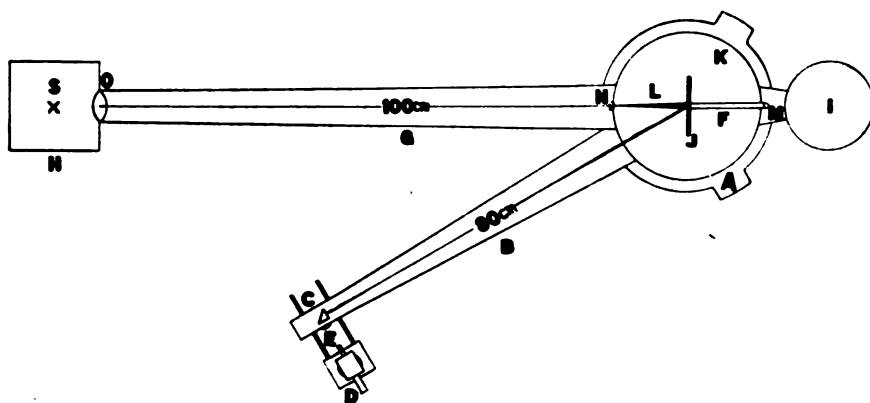

FIG. 1—Diagram showing essential parts of instrument

arm *G*. The circular scale plate *K* is mounted in a fixed position relative to base *A*. A pointer attached to the sample holder indicates the angle on the divided circle. By means of a pin *M*, the sample holder can be connected rigidly with the moving arm *G*, so that the plane of the sample will remain perpendicular to the incident illumination for all positions, and as the arm *G* is rotated the angle of observation alone varies. This provides for the measurement of the surface brightness at various angles of observation and fixed direction of illumination. By removing the pin *M* and clamping the sample holder to the base, *A*, the arm *G* moves independently of the sample, and observations of brightness at a fixed angle of observation, but with a variable angle of incidence, can be made. In the front of the lamp house is

mounted a lens O of such focal length that the source S falls at its focus. Under such conditions the light incident on the sample is approximately parallel. The dimensions of importance are as indicated in the figure. It is also so arranged that the lens O can be removed and in its place substituted a disk of diffusing material such as ground pot opal glass.

The dimensions are so adjusted that the effective area of this diffusing material is just sufficient to subtend an angle of .01 steradians at the surface of the sample under examination. A 500-watt Mazda C lamp of the concentrated filament type was used as a source of illuminating the samples. A photograph of the

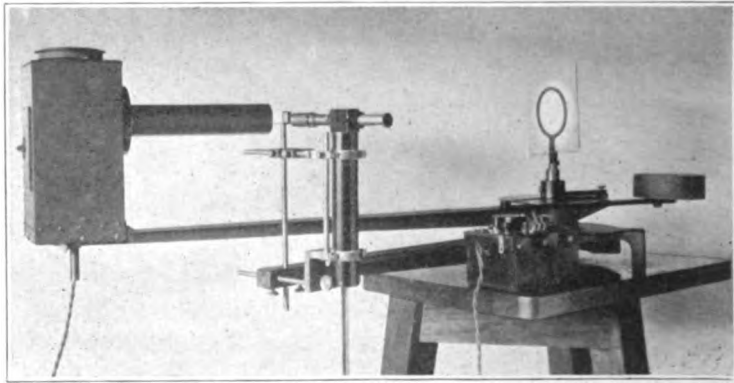

FIG. 2—Photograph of Apparatus

apparatus is shown in Fig. 2. The voltage was precisely controlled in order to eliminate variations in brightness due to fluctuations in the line voltage. Complete distribution curves of the light reflected were obtained from a series of samples with the illumination incident on the sample at various angles.

From a consideration of the way in which the average observer adjusts a photograph which he is examining with respect to the line of sight and the direction of its illumination, it appears that the most favorable and comfortable conditions are obtained when the line of sight is normal to the surface of the print and the illumination incident at an angle of approximately 45° from the normal. Such an adjustment of conditions prevents the observer from

being annoyed by specular reflection from the surface in case such exists. In a previous paper³ this same condition of illumination and observation was adopted as being the most suitable under which to measure the photographic densities of prints and of sensitometric test strips used in the determination of sensitometric constants of such materials. These conditions were chosen as representing most closely the average conditions of illumination under which photographic prints are observed.

From a consideration of the distribution curves and also from a consideration of the way in which a photographic print is usually observed, it was decided that a comparison of the brightness of the surface when viewed normally and at the angle of specular reflection with the illumination incident at an angle of 45° from the normal would give a determination of gloss most nearly in accord with the commonly observed value of that factor.

The diagram in Fig. 3 illustrates the conditions of illumination and observation which were adopted for the measurement of gloss. The line MN represents the plane of the sample under consideration. This is illuminated by a beam of parallel light incident in the direction AO . A brightness measurement of the surface is then made in the direction represented by the line BO and this brightness will be designated by the symbol B_d . A second brightness determination is made in the direction CO and this value is designated by the symbol B_o . Let the curve $KLPR$ represent the complete brightness distribution curve of the sample under consideration. It is evident from the shape of this curve that the reflection from this sample is of a mixed specular and diffuse type. It is evident that the value of B_d is a measure of the diffuse reflecting power of the sample while the value of B_o is a measure of the specular plus the diffuse reflecting power of the sample. The brightness (B_s) due to specular reflection may therefore be obtained by subtracting B_d from B_o . That is, $B_s = B_o - B_d$. As previously stated, gloss is a function of the brightness contrast between the more or less clearly defined images of light sources having fairly small angular dimensions

³ B. J. P., 9, p. 22, 38, 1914; and Phot. J. 54, p. 342, 1914.

and the contiguous portions of the surfaces which are visible by virtue of light diffusely reflected from them. It is very evident from a consideration of the values obtained in practice that the subjective impression of gloss, or perhaps more properly speaking of "glossiness," is not directly proportional to the contrast value. This contrast may, however, be taken as an adequate measure of

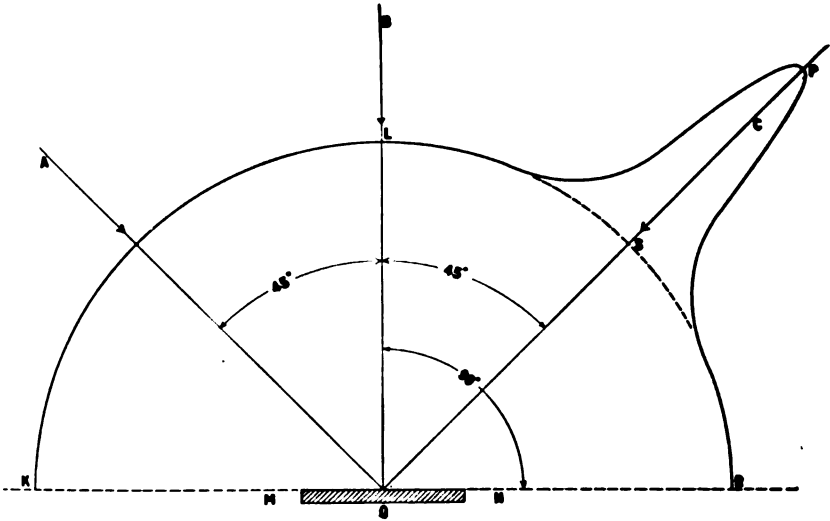

FIG. 3—Illumination and observation adopted for measurement of gloss

the physical stimulus producing the sensation of glossiness. It may be convenient to use different terms as representative of the physical aspect or stimulus and the subjective aspect or sensation. Such a procedure will be analogous to the use of "brightness" and "brilliance" in referring to the intensity factor of radiation and the subjective sensation resulting from its action on the retina. In this case the term brightness is used as descriptive of the physical or objective aspect of the stimulus while the term brilliance is used in reference to the resulting sensation.

It is proposed, therefore, to adopt the term "gloss" as descriptive of the stimulus, while the term "glossiness" will be used in referring to the subjective sensation produced. The experimental

results given in this paper relate almost entirely to the measurement of gloss, and while some indication has been obtained as to the relation existing between the stimulus, that is, gloss, and the resulting sensation, glossiness, the data available are entirely inadequate for the formulation of a definite physical relation between the stimulus and the sensation. The distribution curve of a surface having zero gloss is represented by the curve *KLSR* and for such a case $B_d = B_a$ and $B_s = 0$. Gloss (G) may therefore be defined by the equation

$$G = \frac{B_s}{B_d} = \frac{B_a - B_d}{B_d} = \frac{B_a}{B_d} - 1$$

On the basis of this definition, the scale of gloss extends from zero, for a surface which reflects light equally in other directions, that is, one obeying Lambert's cosine law, to infinity for the surface from which the reflection is entirely specular.

It will be recalled that in the reports of the Committee on Glare, (*loc. cit.*) it was recommended that a source of such dimensions as to subtend .01 steradians at the sample be used in the measurement of gloss. The practical objection to this procedure is that under such conditions it is difficult to obtain illumination on the sample sufficiently high to give a field brightness in the photometer which will result in high precision and absence of fatigue in reading the instrument. In order to determine the magnitude of the difference in the measured gloss values when using this type of illumination and that obtained by using a beam of parallel light, a series of measurements were made. A group of samples varying from very high to very low gloss were chosen and the gloss values of the group determined with both types of illumination. The results which will be given in detail later show that when illuminated with a collimated beam the gloss values ranged from .43 to 24.0, while with a source subtending .01 steradian the values varied from .36 to 12.4. This indicates that the use of collimated illumination provides a more extended gloss scale, thus permitting the measurement of smaller differences in

gloss than could be measured when the source subtends a larger angle. For these reasons, it was considered advisable to specify that gloss measurements be made with the sample illuminated by parallel light. While it is quite possible to make gloss determinations by using the gonio-photometer, this requires two individual photometric readings one made with the direction of observation normal to the surface and one at 45° from the normal. Although this method is satisfactory, it is not suitable where a very large number of samples are to be examined, nor does it afford the precision required for the comparison of samples differing but little in gloss.

THE GLOSS METER

The best conditions of illumination and observation having been determined from an analysis of the results obtained with the gonio-photometer, an instrument for the direct measurement of gloss was designed and constructed. A schematic diagram of this instrument is shown in Fig. 4.

The light source is placed at the focal point of lens *A* which is a well corrected telescopic objective. The light source used is a tungsten lamp having a highly concentrated filament thus approaching as closely as possible to a point source. The collimating beam is incident upon the sample *B* at an angle of 45° from the normal. The lenses *E* and *F* placed respectively on the normal to the surface of the sample and on the line at 45° from the normal form images of the sample *B* in the photometer cube *K*. The focal length of these lenses and the distances are such that the images are of unit magnification. The mirrors *G* and *H* properly placed serve to reflect the beams of light as indicated so that they intersect each other at an angle of 90° in the photometer cube. The photometer field is viewed through the lens *L* with an eyepiece of the type commonly used for such work. The brightness of the two images formed by the light leaving the surface normally and that formed by the light leaving at an angle of 45° can be varied by means of the neutral tint wedges *C* and *D*. The zero of the instrument is set by placing the sample by a piece of pot opal

glass so placed that the line OP which bisects the angle NOM is normal to its surface. This is illuminated by swinging the light source with its collimating lens into the position indicated by the points S_1A_1 . The opal glass is therefore illuminated normally with a beam of parallel light and images of this surface are formed

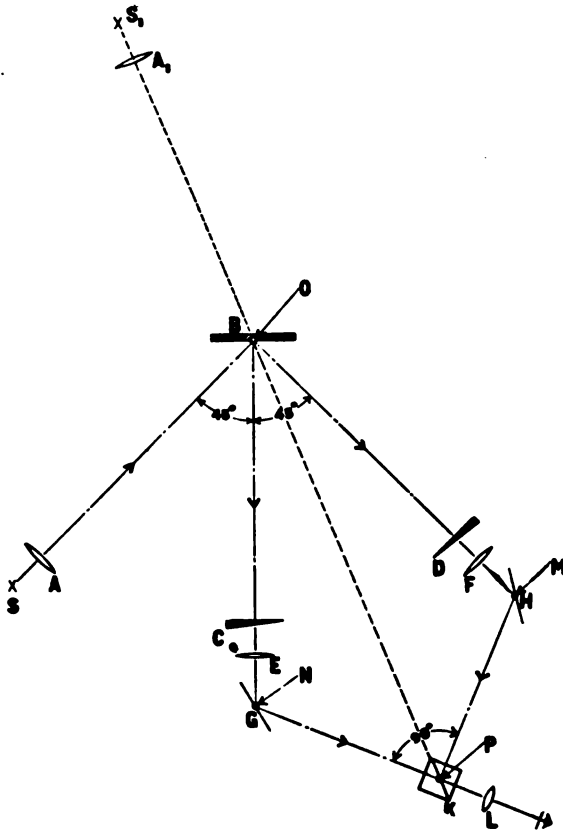

FIG. 4.—Schematic diagram of instrument

in the photometer cube by light which leaves the surface at equal angles on the opposite sides of the normal to the surface. With the scale which is attached to the neutral wedge D set at zero, a photometric balance is made by adjusting the position of the neutral tint wedge C , this adjustment having been made, the

light source is returned to the position for the illumination of the sample as designated by the letters *S* and *A*. The sample to be examined is then placed in position, *B*, and a photometric balance made by moving the neutral tint wedge *D*. This gives a direct measurement of the relative brightness of the surface as viewed normally and at the angle of specular reflection. The scale carried by the wedge *D* may be calibrated either to read the ratio of these two brightnesses or, if desired, to read directly in gloss values. In the case of some surfaces having a marked texture, it may be found difficult to make precise photometric settings when the image is focused in the photometric cube. By displacing slightly the lenses *E* and *F* the sharp focus can be destroyed and this difficulty overcome.

RESULTS

EFFECT UPON GLOSS OF VARIATIONS IN ILLUMINATION

In order to determine the influence of the type of illumination used in illuminating the sample upon the resulting gloss values, the following series of measurements were made. Eleven samples of paper varying widely in glossiness were chosen. The gloss values for each of these were then measured using a collimated beam incident at 45° in illuminating the sample. The results of these measurements are given in Table 1 in the column marked "parallel." By removing the lens, *O*, (see Fig. 1) and replacing it with a disk of opal glass of proper dimensions, the sample was illuminated by a source subtending .01 of the steradian at the sample. A second series of gloss measurements were made and the results are given in Table 1 in the column marked "semi-diffuse." It will be noted that in all cases the values obtained with parallel illumination are higher. For instance, for the most glossy surface, the reading of the semi-diffuse illumination is 12.4 while with a collimated illumination a value of 24.0 was obtained. It is evident in both cases that for a glossless surface the reading must be zero. The use of collimated illumination therefore gives a more extended scale and increases the ability to detect differences between samples varying but slightly in

TABLE 1

Sample	Parallel	Semi-Diffuse
1	.43	.36
2	.43	.39
3	.78	.78
4	1.20	1.03
5	1.89	1.65
6	2.28	1.91
7	3.96	3.12
8	13.6	9.0
9	21.2	10.9
10	22.9	12.6
11	24.0	12.4

gloss value. For this reason, therefore, and also because a satisfactory brightness can be obtained more readily for this type of illumination, it was decided to adopt the parallel illumination as a standard condition for the measurement of gloss values.

EFFECT UPON GLOSS OF VARIOUS SURFACE TREATMENTS

In order to determine the effect of certain surface treatments upon the gloss characteristics of various stocks, eleven samples of raw stock used in the manufacture of photographic papers were chosen as representing the entire range of gloss variations which occur with these materials as they come from the mill. The values of gloss will be found in Table 2, column 1. It will be noted that there is a relatively small variation in the gloss of these samples. Other samples from the same stocks were examined after having been coated with baryta. The gloss values obtained are shown in the second column of the table. A typical photographic emulsion was chosen and by coating this on each of the eleven stocks selected a finished developing-out paper was obtained. Samples of each were fixed out, washed and dried in the usual way and the gloss values determined. These values will be found in column 3. A second lot of emulsion containing a suitable material for the production of a matte surface in a photographic paper was used in making up an additional set of samples from

the same paper stocks. Samples from these were treated as previously, that is, fixed-out without exposure, washed, dried and the gloss values obtained. The values determined are shown in column 4.

It is impossible to analyse completely the results shown in Table 2. The effect of the baryta coating is not the same in all cases and this undoubtedly is due to peculiarities of treatment that occur in the process. However, it will be noted that in all cases the gloss values are increased appreciably by coating the various samples with plain emulsion while the use of the matte emulsion reduces the gloss value in all cases. In fact, the gloss values given in column 4 are so nearly equal that but little variation in gloss is apparent in this group of samples.

TABLE 2

Sample No.	1 Raw Stock	2 Baryta Coated	3 Plain Emulsion	4 Matte Emulsion
1	.33	.10	.43	.24
2	.36	.14	.43	.19
3	.62	.06	1.89	.18
4	.45	.05	.78	.29
5	.69	4.21	24.0	.44
6	.40	.31	3.96	.29
7	.70	4.94	21.2	.29
8	.50	5.08	13.6	.35
9	.49	.55	1.20	.34
10	.83	8.45	22.9	.35
11	.51	1.65	2.28	.55

VARIATION OF GLOSS WITH DIFFUSE REFLECTING POWER

When a photographic paper is exposed and developed, small particles of metallic silver are produced which, since they have a very low reflecting power, reduce the reflecting power of the surface. This blackening of the surface reduces the amount of light diffusely reflected without appreciably changing the amount of light which is reflected specularly. This follows from the fact that practically all of the specularly reflected light is that which is reflected from the surface layer of the material that is at the boundary of the air-gelatine surfaces. It will be seen, therefore,

that when glass measurements are made on photographic papers that have been subjected to varying degrees of exposure, a rapid increase in the gloss value must occur, since B_1 remains practically unaltered while B_2 decreases to a very marked extent.

In order experimentally to determine the relation between photographic density and gloss, a series of measurements were

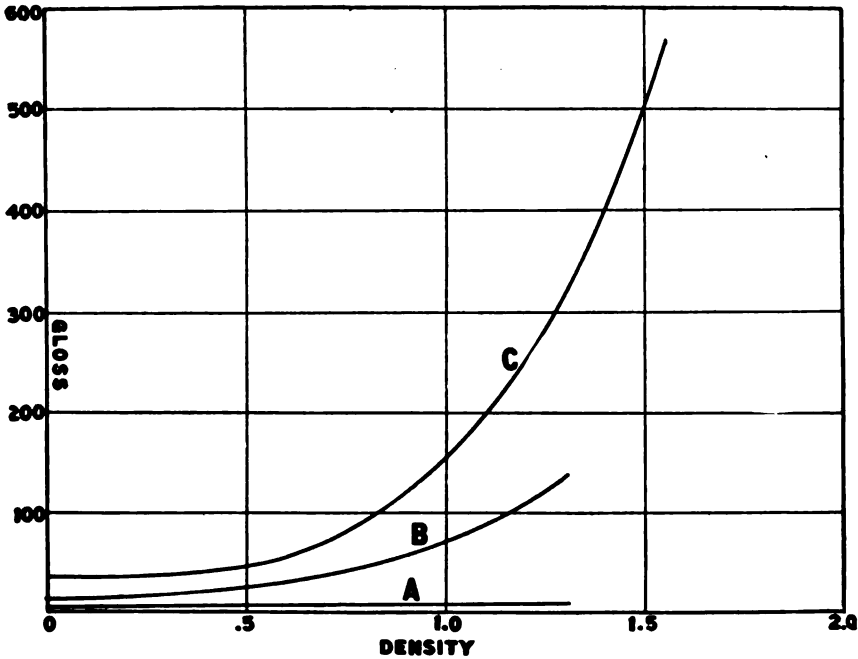

FIG. 5.—Numerical results plotted in graphic form

made on the samples that had been subjected to various degrees of exposure, developed, washed, and dried in the usual manner. It might be well to point out at this place that the word "density" as used in this connection is defined by the equation D (density) = the logarithm of $\frac{1}{R}$ where R is the value of diffuse reflecting power as measured under certain definitely specified conditions of illumination and observation.³

Three standard photographic papers representing a low, medium, and high gloss were used for the determination of the relation existing between density and gloss. Numerical results are given in Table 3 and these are plotted in graphic form in Fig. 5, curve *A* representing the variation in gloss value with density for Iris *D*, curve *B* for Azo *K*, and curve *C* for carbon black glossy.

TABLE 3

Sample	Density	Gloss
Iris <i>D</i>00	.22
	.36	.39
	.70	.85
	1.02	2.00
	1.30	3.25
Azo <i>K</i>	0	4.30
	.59	22.8
	.92	51.0
	1.30	135.
	1.70	307.
Carbon Black Glossy.	.0	31.2
	.40	29.5
	.70	72.3
	1.07	157.
	1.55	569.

These results make it very evident in the case of photographic papers at least that some specification of the condition of the material under which the gloss measurement is made must be given. For photographic papers, it seems most logical to specify that gloss measurements be made on a sample which has been fixed out without exposure, washed, and dried in the usual manner. In the case of a photographic print which is made up of areas differing widely in density, usually from the minimum to a maximum density obtainable with the material, it is evident that no single gloss value applies to the entire surface, that is, gloss varies from point to point depending upon the density. While this makes it impossible to establish a fixed value of gloss to a photographic

paper without specifying the value of its diffuse reflecting power, such a procedure seems to be in harmony with our fundamental concept of the term glossiness.

At first thought it may seem more logical to assume that a given surface should have a specific value in gloss regardless of other factors such as density, but a careful consideration of the problem leads us to the conclusion that our judgment of glossiness is very vitally dependent upon the diffuse reflecting power of the surface. Of two surfaces having equal values of specular reflecting power, the one having the lower value of diffuse reflecting power will undoubtedly appear the more glossy. It has been suggested that in order to avoid the dependence of gloss upon the density, an absolute value of specular reflecting power be taken as measurement of gloss. Such a procedure would seem to be in direct opposition to the fundamental concept of the word glossiness. As an illustration of this, let us consider the case of two equally well groomed horses, one black and the other white, seen under a brilliant illumination such as a clear, sunny day. It is probable that the value of specular reflection in the two cases is approximately equal and the high lights produced by the specular reflection of the sun would be of about the same brightness while it is undoubtedly true that a great majority of judges would say that of the two the black horse had the more glossy coat. Careful examination of samples prepared by exposing pieces of the same photographic paper to various extents and developing so that a series varying in reflecting power was obtained, indicates that glossiness increases as reflecting power decreases. The magnitude of the increase in glossiness, however, is not proportional to the increase in the value of gloss as previously specified. The correlation of the subjective sensation with the stimulus remains to be accomplished. It is probable that a method similar to that used in other fields of visual sensitometry involving the determination of the magnitude of change in the stimulus required to produce a just noticeable difference in the sensation will yield the desired results. The conclusion that our judgment of glossiness is a function of contrast seems inescapable and therefore in the case of photographic papers gloss must undoubtedly be dependent upon density.

GLOSS MEASUREMENTS ON DEVELOPING-OUT PAPERS

A satisfactory method for measuring and specifying gloss having been developed and the effect of various factors upon gloss having been determined, a large number of samples of commercial developing out papers were measured. As stated previously, certain words and phrases are at the present time used to designate in a qualitative way the gloss of such materials. There are a large number of such terms in use but the four most commonly used are "matte," "semi-matte," "semi-gloss," and "glossy." In Table 4 are given the results of the measurements. In column 1 is given the trade name of the material and in column 2 is the term used by the manufacturer in designating the gloss characteristic of the surface, while in column 3 are the gloss values obtained by measuring under the standard conditions previously outlined.

The samples were prepared by taking an unexposed sheet of the material, fixing it out in a clean, fresh, acid fixing bath, washing, and drying in the usual way. These samples were then mounted by the dry mounting process on sheets of aluminium about 1/16 of an inch thick. This method of mounting was found to be necessary in order to obtain precisely repeatable results. It is absolutely essential in doing precise work of this kind that the sample be mounted in such a way that it is held perfectly flat and smooth. If precautions are not taken to obtain perfect flatness very slight variations in the planeness of the sample introduces variations in the readings which are serious, especially in the samples having relatively high gloss. By using care in preparing the samples, it was found that values can be repeated from time to time to within approximately $\pm 4\%$. The first value given in Table 4 is that for magnesium carbonate. This sample was prepared by taking a block of the material, and carefully scraping the surface with a steel straight edge. It will be noted by comparing the value of gloss with the terms used in the description of this factor that surfaces having values up to .67 are described as matte or carbon, while values ranging from 1.57 to 2.78 apply to surfaces described as "semi-matte" or "smooth." Only two surfaces designated as "semi gloss" were measured and for these the gloss value was 4.3. The range from

TABLE NO. 4

No.	1 Name	2 Surface	3 Gloss
1	Magnesium Carbonate.....	Matte.....	.10
2	Azo A.....	Carbon.....	.20
3	Artura Iris D.....	Matte.....	.22
4	Bromide Matte Enamel.....	Smooth Matte.....	.23
5	Artura Iris C.....	Smooth Matte.....	.30
6	Artura Aegis No. 2.....	Smooth Matte.....	.30
7	Velox Carbon.....	Matte.....	.32
8	Azo B.....	Rough.....	.38
9	Axo AA.....	Carbon.....	.40
10	Velox Portrait.....	Smooth Matte.....	.43
11	Carbon Black.....	Rough Matte.....	.44
12	Carbon Black.....	Matte.....	.67
13	Artura Iris B.....	Semi Matte.....	1.57
14	Bromide Standard B.....	Smooth.....	1.87
15	Artura Iris A.....	Smooth Semi-Matte....	2.00
16	Velox Velvet.....	Semi-Matte.....	2.47
17	Azo E.....	Semi-Matte.....	2.78
18	Azo K.....	Semi-Gloss.....	4.30
19	Bromide Velvet.....	Semi-Gloss.....	4.34
20	Azo C.....	Glossy.....	14.5
21	Bromide PMC No. 1.....	Glossy.....	22.9
22	Azo F.....	Glossy.....	23.8
23	Velox Glossy.....	Glossy.....	24.8
24	Carbon Black.....	Glossy.....	31.2
25	Bromide Enameled.....	Glossy.....	32.2
26	Solio Ferrotyped.....	Glossy.....	66.3

NOTE: The values in this table were determined on samples taken at random from stock and do not represent the standards for the materials indicated.

14.5 up to 66.3 applies to those surfaces designated as "glossy." Before reaching a final correlation between the numerical gloss values and verbal descriptions of the surface, it would be well to examine a much larger number of surfaces. However, on the basis of those already examined, the following classification is proposed.

In the following table are given the numerical ranges of gloss value which apply to the various descriptive terms. It is obvious that there is no distinct line of demarkation between the various classes, but it is convenient from the practical standpoint to make a more or less definite division of the scale. The point separating the classes designated as "semi-gloss" and "gloss" is indicated as 7.0. This is a rather rough estimate since but few surfaces designated as semi-gloss have thus far been examined. It is possible that more complete data on the subject will make it necessary to alter the division point between these two classes, but at the present time it is thought that the value chosen is approximately correct.

TABLE NO. 5

Descriptive Term	Range of Numerical Values	
Matte.....	0 to 1.0	
Semi-Matte.....	1.0	3.0
Semi-Gloss.....	3.0	7.0
Glossy.....	10.0	∞

In order to show the relation between gloss values and the distribution curve of the light reflected from the surface, it may be well to show graphically some of these distribution curves. In Fig. 6 are shown the distribution curves for samples Nos. 2 and 12, these representing the high and low gloss values for the matte class of surfaces. These distribution curves were determined by illuminating the sample normally with parallel light and measuring brightness at various angles as indicated by the abscissae values. The ordinate values are in terms of relative reflecting power, the reflecting power of the magnesium carbonate surface under normal illumination and observation being taken as 100%. In Fig. 7 are shown the distribution curves for samples Nos. 13 and 17, these representing the high and low limits of gloss in the "semi-matte" class. In Fig. 8 is given the distribution curve for the "semi-gloss" class. Only two examples of the classification were examined, each having a gloss value of 4.3. In Figure 9 are

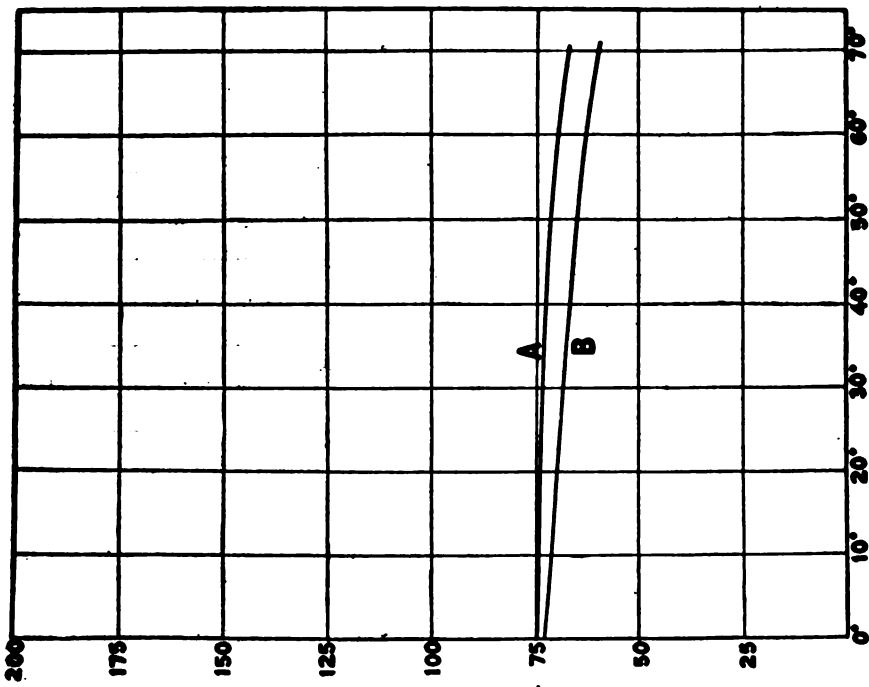

FIG. 6—Distribution curves for samples Nos. 2 and 12

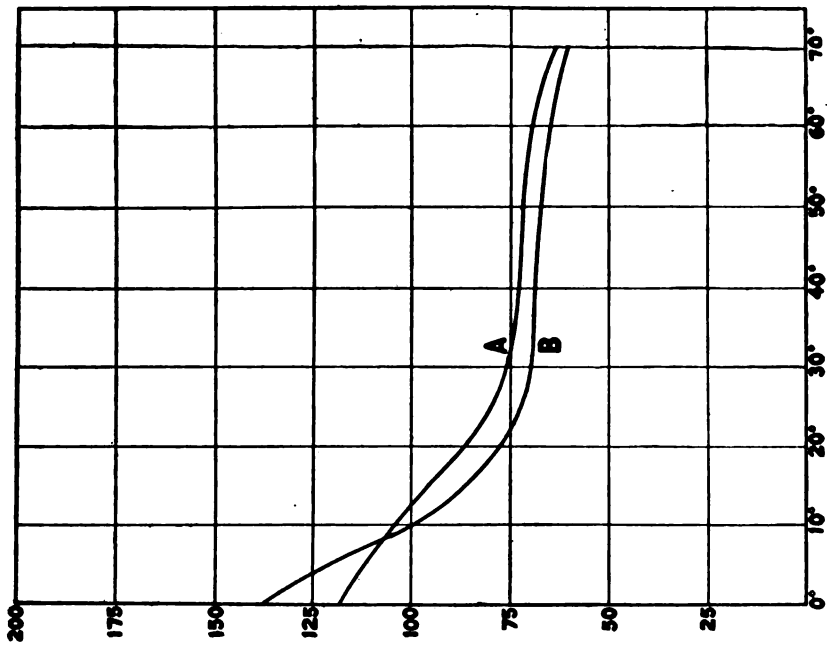

FIG. 7—Distribution curves for samples Nos. 13 and 17

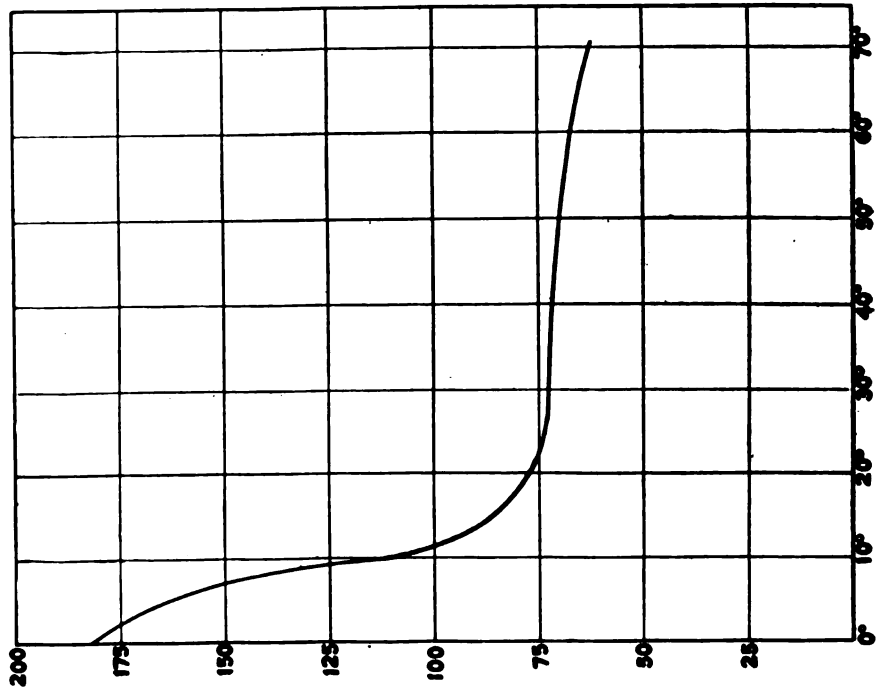

FIG. 8—Distribution curves for semi-gloss class

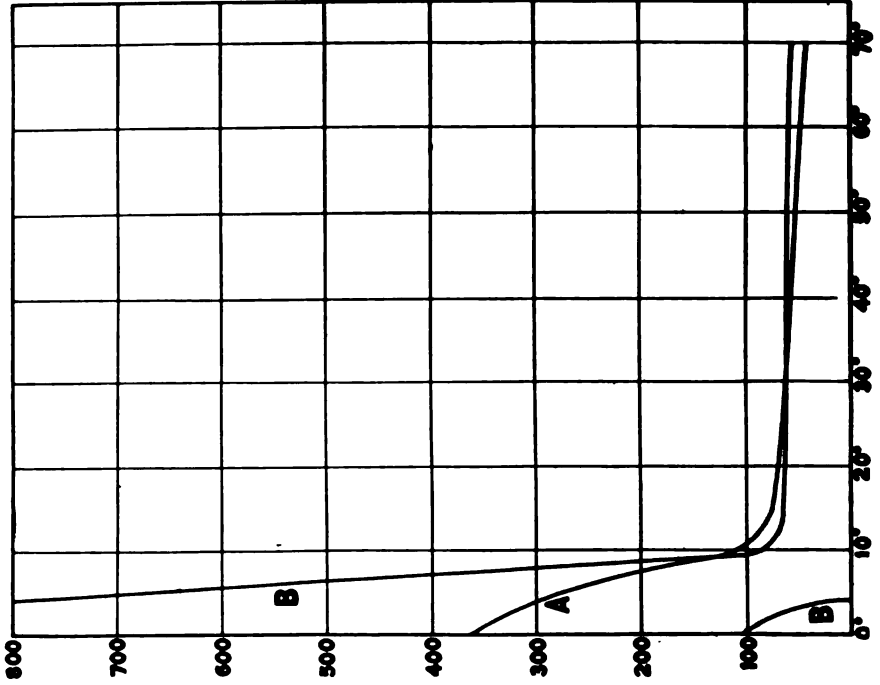

FIG. 9—Curves for samples 20 and 25

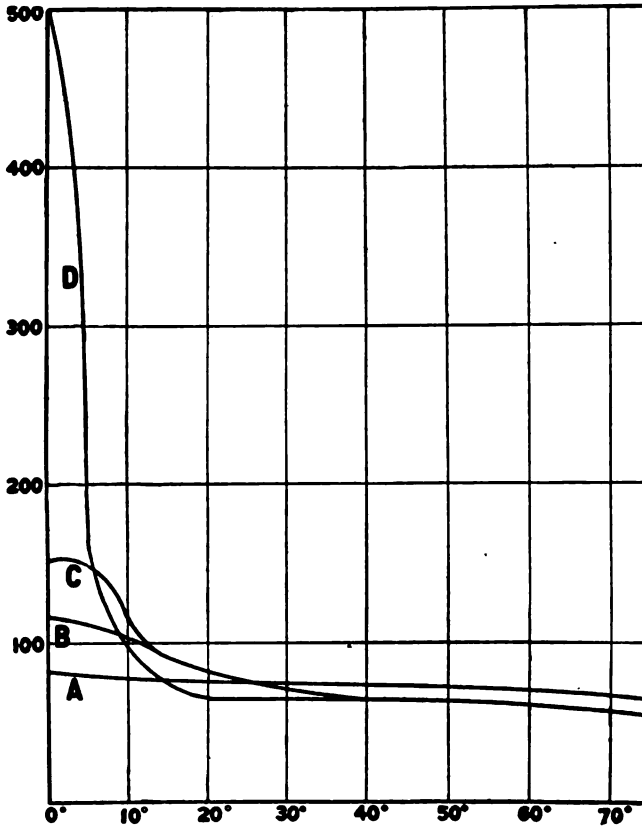

FIG. 10—Distribution curves of various classes of surface

given curves for samples 20 and 25, these representing the limits of the "glossy" group.

In order to show more clearly the relation existing between the distribution curves of these various classes of surface, the four curves shown in Fig. 10 are given. These curves represent a typical surface of each of the four groups, curve A being that for sample 8 having a gloss value of .38. This value is the approximate average for the matte group. Curve B is that for sample No. 15 having a gloss of 2.00, this again representing the average gloss for the semi-matte group. Curve C is that for sample No. 19, being the semi-gloss material, while Curve D is for sample No. 21, a typical representative of the glossy group.

INSTRUMENT SECTION

STANDARD RADIO WAVEMETER BUREAU OF STANDARDS TYPE R 70B

BY
R. T. Cox

Radio communication is carried on by electromagnetic waves whose frequencies vary from 15 000 cycles or less per second to 3 000 000 cycles or more per second. With the constantly increasing number and power of transmitting stations it is important that apparatus be available to accurately measure the frequency of the waves emitted by a transmitting station. Certain frequencies are assigned by law to certain kinds of communication, and the inspector whose duty it is to enforce the law must know that his measurements are accurate.

In the widely varied fields of scientific research in which use is made of radio-frequency current, the requirements are even more exacting, both as to range and accuracy of measurement, than in actual radio communication.

A circuit composed of a capacity and inductance is resonant to electric vibrations of a frequency $f = \frac{1}{2\pi\sqrt{LC}}$ where f is the frequency in cycles per second, L the inductance in henries, and C the capacity in farads. Thrown into a more suitable working form, the equation is:

$$f = \frac{159\,150}{\sqrt{Lp(C+C_0)}}$$

in which f is the frequency in kilocycles per second, Lp the pure inductance of the coil in microhenries, C the capacity of the condenser in micromicrofarads, and C_0 the effective capacity of the coil in micromicrofarads.

Such a circuit, with the condenser variable, is, when calibrated, a wavemeter and may subsequently be used to measure the frequency of any electric vibration within the range of variation of the instrument.

The Bureau of Standards has for a number of years been evolving for its own use standard radio wavemeters for use in testing commercial instruments and in radio research. The latest model, type R70B, is described in this paper and is shown in Fig. 1.

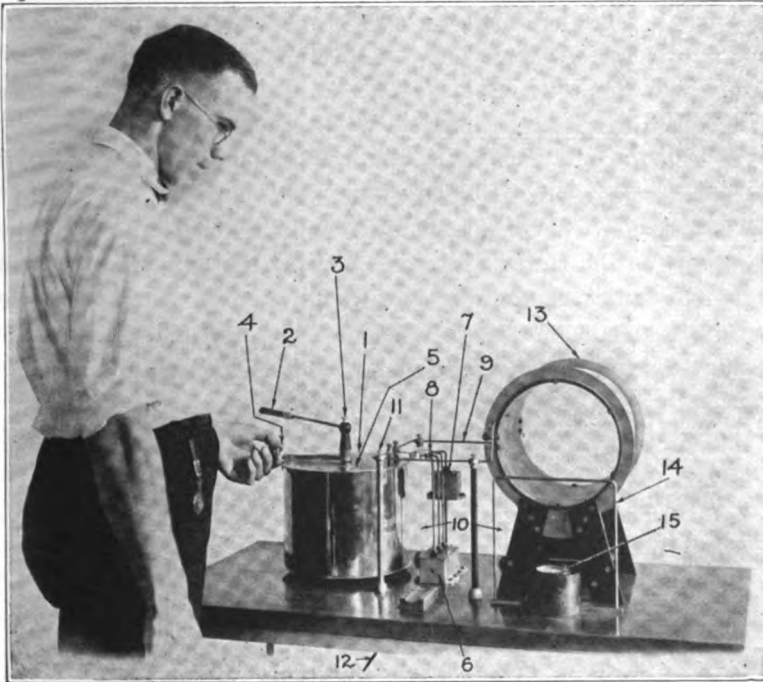

FIG. 1—Standard Wavemeter, Type R-70-B

- | | |
|--|---------------------------------------|
| 1. Variable condenser | 8. Mercury wells and links |
| 2. Handle of variable condenser | 9. Leads from condensers to coil |
| 3. Screw, clamping condenser handle | 10. Glass uprights supporting leads |
| 4. Slow motion device | 11. Metal upright |
| 5. Window for reading scale | 12. Ground wire |
| 6. Fixed mica condensers | 13. Standard inductor (glass core) |
| 7. Fixed mica condenser, capacity 0.001 microfarad | 14. Single turn to indicate resonance |
| | 15. Thermo-galvanometer |

The variable condenser is of the Bureau of Standards type¹ with the following modifications. The top of insulating material

¹ Bureau of Standards Circular No. 74, "Radio Instruments and Measurements," p. 120.

and metal has been replaced by a top entirely of metal. This top is nickel plated with dull finish. The dull finish protects the eyes of the operator against glare and offers an appearance more sightly than would a bright surface which could not be polished properly without disrespect to the condenser. The insulating part of the handle has been made shorter and the handle itself made longer. The handle axis is pierced by a vertical screw by which it can be clamped to the condenser shaft or released from it and rotated freely. With this device the handle need never obstruct the view of the scale or enter the field of the wavemeter leads. The vertical screw requires more force to clamp and release than would a horizontal screw bearing against the condenser shaft, but it escapes the tendency the latter device has to cant the handle. The scale of the condenser has graduations much narrower than the scales used on Bureau of Standards condensers previously made. The graduations are continued to 190° . This is to enable the vernier

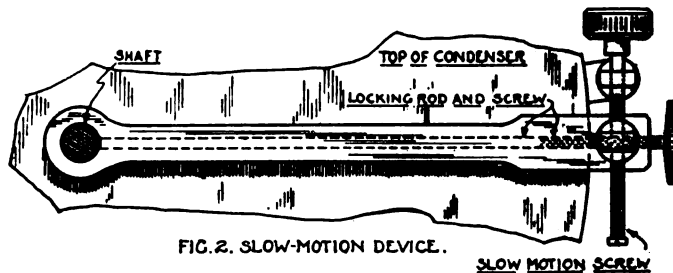

to function over the range between 171° and 180° . The vernier is engraved on a block beveled down to avoid parallax. The block extends to the rear in a flat spring by which it is securely pinned to the condenser top. The beveled edge rests lightly on the condenser scale. The 0, 5, and 10 marks on the vernier are extended and numbered and an extra division is laid off on either side of the 0 and 10 marks to aid in reading fractions of $0^\circ.1$ and $0^\circ.9$. This is a very doubtful advantage inasmuch as it is a little bewildering to read and sometimes causes errors of one degree. A reading glass is used in reading the scale. A slow-motion mechanism, shown in Fig. 2, has been attached to the condenser. An arm, extending from the rim to the center of the condenser top, is pierced to encircle the condenser shaft, to which it can be clamped

by a screw. The arm and the condenser shaft so clamped can then be rotated through a limited traverse by a screw at the rim of the condenser top. The condenser bearings, through which contact is made between the movable plates and the shield, are steel on phosphor-bronze, lubricated with powdered graphite. The slow-motion device makes it feasible to have the bearings tighter than would permit precise settings without the device and thus to eliminate all detectible vertical play of the condenser shaft. The condenser shares the following features with other Bureau of Standards condensers. It is assured a constant calibration, with proper care, by its rigid construction, its shield, its unimpeded traverse through 360° without stops which jar the plates out of alignment, and its all but total lack of any dielectric except air. It has large semi-circular plates, not sheared at one edge or rounded at the corners, which give it a capacity calibration curve very nearly linear from 5° to 170° . The resistance is kept at a negligible value by the elimination of all insulating material except three short Pyrex glass rods which insulate the fixed plates from the movable plates and the shield. The condenser has a maximum capacity of 0.0012 microfarad.

Fixed mica condensers are used to supply additional capacity. Four shielded condensers are used having capacities of 0.001, 0.002, 0.004, and 0.008 microfarad respectively. None of them has a phase difference greater than 5 minutes at 500 000 cycles a second. The high-potential terminals are rods extending up to the level of the top of the variable condenser and ending there in mercury wells. Four more mercury wells are in a projection from the high-potential terminal of the variable condenser, and by means of interchangeable links between the wells any combination of fixed condensers may be put in parallel with the variable condenser. The fixed condenser of 0.001 microfarad is raised on a metal column in order to shorten its high-potential lead and thus diminish any undesirable capacity effects that might result from a long lead. Such effects will be less important with condensers of greater capacity and these are not raised but left at the lower level where they are not in the immediate field of the leads joining the condenser to the inductor.

These leads are of 1.6 mm (1/16 inch) brass rod, enclosing a square about 25 centimeters on a side. Four uprights support the leads. The two of these on the ungrounded side are made of Pyrex glass in order to keep the resistance low. The upright nearest to that terminal of the variable condenser which is con-



FIG. 3—Standard Inductor

nected to the shield is of metal and extends through the top of the truck on which the wavemeter is mounted, terminating in a binding post for grounding. The shields of the fixed condensers are joined to this binding post. The fourth upright is a rod of ordinary insulating material. The leads end in two binding posts, into which the coil terminals can be thrust and clamped, all the coils having terminals at the same height and distance apart.

Of the seven coils to be used with this wavemeter, five are single-layer coils of polygonal cross-section like the coil shown in Fig. 3. They are wound on skeleton frames of laminated phenolic

material, which furnish by their open construction as near to an air core as the requirements of rigidity and strength permit. They are wound with silk-covered "high-frequency cable" (litzendraht wire) each strand of which was tested for continuity. The turns of wire are laid in notches in the coil frame. The binding posts are securely pinned to the frame to prevent their working loose and twisting the wire. The shape of the coils is the result of compromise between considerations of low resistance, low effective capacity, and mechanical convenience. It may be shown that of all single-layer cylindrical coils with a given inductance and a given spacing between adjacent turns that one will have the least conductor resistance whose diameter is approximately 2.46 times its length of winding.² On the other hand the effective capacity of a single-layer coil is roughly proportional to its diameter and can hence for a given inductance be reduced by decreasing the diameter and increasing the length of winding to compensate. Since the resistance of the coil does not begin to increase at any very startling rate until the coil is made longer than it is wide, the shape may be varied until the length is as nearly equal to the diameter as is convenient mechanically. Among the five coils under discussion the average ratio of coil diameter to length of winding is about 2.1. These five coils range in inductance from 10 to 5000 microhenries. The lower limit is imposed by electrical considerations, the upper by mechanical considerations.

A coil wound on a skeleton frame similar to those of the single-layer coils but having three spaced layers and designed to have an inductance of 23 000 microhenries is now being made. For a higher inductance a coil bank-wound with high-frequency cable (litzendraht wire) on a Pyrex glass cylinder is used. The inductance of this coil is 128 000 microhenries.

The combination of condensers and coils described furnishes a range of wave-lengths from 65 meters to 85 000 meters, or, expressed in frequencies, from 4 600 000 cycles a second to 3500 cycles a second.

² Bureau of Standards Circular No. 74, "Radio Instruments and Measurements," p. 290.

To indicate resonance, a single turn of 1/8 inch brass rod is coupled to the wavemeter coil. The terminals of this loop end in mercury wells fastened at the bottom of an insulating cup. Ordinarily a sensitive thermo-galvanometer rests in this cup with its terminals dipping in the mercury wells. When greater sensitiveness is desired, this instrument is exchanged for a thermo-element with leads to a wall galvanometer. This turn is fixed so that its coupling with any one coil of the wavemeter is always the same. It is grounded on the side nearest the condenser.

The carriage on which the wavemeter is mounted is a modified form of the ordinary hotel dish truck or carriage. It has a strong iron frame, which is grounded. The wheels are six inches in diameter and rubber tired. All of them are of the swivel type and have ball bearings at the swivel. The top of the truck is a heavy slab of maplewood. To it are screwed the fixed and variable condensers, the uprights supporting the leads, and the single turn used to indicate resonance. Rubber cushions are under the variable condenser to absorb shocks.

Although the wavemeter described represents the experience of the Radio Communication Section of the Bureau of Standards as a whole, its design is more especially the work of Mr. J. L. Preston.

BUREAU OF STANDARDS,
WASHINGTON, D. C.

MERCURY LUBRICATED RESISTANCE BOX PLUGS

BY
J. R. ROEBUCK

SYNOPSIS

Electrical Resistance Box Contacts

(1) *Taper plug contacts* are unreliable for careful work as their resistance varies with the chance position, firmness of seating, condition of contact surfaces, and use of neighboring contacts.

(2) *Mercury cup contacts* have the mechanical disadvantage of the spread of mercury over the surfaces and through the metal, and the electrical disadvantage of variable resistance due to the difficulty of keeping the mercury path constant.

(3) Taper plug contacts when *lubricated with oil* have much more steady but materially higher resistance.

(4) But when made of copper and *lubricated with mercury*, the contact resistance is greatly decreased, to $\frac{1}{7}$ of that of clean metal surfaces, and also becomes much more constant. The resistance of the contact is only slightly dependent on tightness of seating and on age; the contact surfaces do not cut, or squeeze out; they cement themselves together but may be separated without damage. Resistance may be trusted to 10^4 ohms.

(5) The design of *sets of contacts* should be such as to give great strength and independence between contacts. Several designs are illustrated.

It is an ordinary experience to find that the limiting errors in measuring a resistance is the variable resistance of the taper plug contacts. These are usually made of brass and fit into seats between brass blocks which are held in position by screws through a plate of hard rubber. Two distinct difficulties appear; (1) the plug when removed and replaced has a different resistance, and (2) the shift of one plug alters the resistance of its neighbors on account of the shift of the brass blocks on the hard rubber support, altering the contact pressure. These effects become greater in magnitude as the contact surfaces become scored, oxidized or dirty.

Work of high precision such as called for in platinum resistance thermometry is impossible with such contacts. The required constancy is obtained by using copper links dipping into mercury held in copper cups, or in some special cases, by using sliding contacts. In the course of a long experience with such mercury cups, a number of difficulties have been encountered. The mercury

spreads gradually over the whole surface of the copper, and ultimately reaches the necessary soft soldered connections. The mercury often forms a siphon over the walls of the cups and they empty themselves in a few hours. Or it may work through the copper and the cup leak; so that it has been found advisable to set these cups in some mercury resistant material, like hard rubber. If two cups are on a different level, the link acts as a siphon, emptying one cup into the other. The exposed surface of the mercury becomes covered with a black layer, presumably of copper oxide, so that it is necessary to keep the links submerged in the mercury except when actually in use. An apparently crystalline material forms around the rim of the cup and requires cleaning out occasionally, altho it has no great effect on the resistance. The resistance of mercury being some sixty times that of copper, the resistance of the contact varies with the position of the link in the cup, so that it is usually recommended to use a flat surface on link and cup and hold them together.

The spread of the mercury over the copper surface is retarded less by varnish than by using an oxidized surface, such as formed by heating the clean copper surface in the air. The spread may be still more effectively stopped by plating with iron.¹ Annealing in a vacuum, even at 100 degrees C, drives off considerable of the hydrogen and leaves the iron softer. The iron coat may be protected from oxidation by varnish or lacquer.

It has been found that lubricating² the brass plugs with oil or vaseline, while it increases the actual resistance, reduces its variability greatly. The explanation is apparently that when unlubricated the two similar metals soon cut each other, forming burrs and grooves, so reducing the area of contact. The forces involved when the plug is turned in hard are very considerable. If the plug be well fitted and kept lubricated, the cutting is eliminated; the surfaces in contact remain unchanged over much longer periods and the resistance consequently is not subject to as great variations.

¹ Watts, *Trans. Am. Elec. Chem. Soc.* 25, p. 529, 1914.

² Manley, *Phil. Mag.* (6), 33, 211, 1917.

If mercury could be used for lubricating the plug, the advantage gained by lubrication might be retained; the mercury being a conducting liquid should decrease the contact resistance and the absence of a mass of mercury should avoid some of the cup difficulties. It is very probable that this has been tried, but the writer has not found any record of it. This account may be of value to some workers.

The choice of metal for plug and seat falls immediately upon copper, since in the first place, it does not introduce a new metal into the circuit, and in the second place, while mercury wets copper readily, it does not sink into it and disintegrate it, as it does—for example—with zinc or brass. To try out the possibilities, several sets of plugs and seats were made up and as no serious difficulty arose in their use, the set shown in Fig. 1 was built for

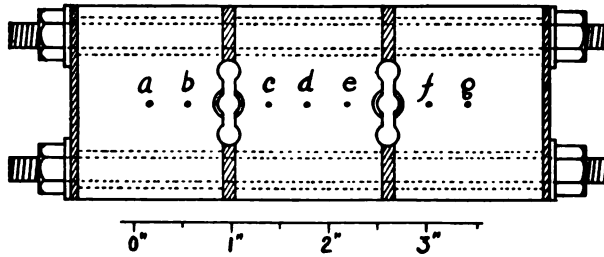

FIG. 1

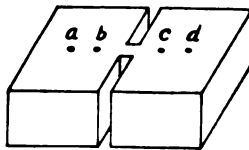

FIG. 2

measurement. The plan drawing is to the scale shown below it, and the blocks were $17/32''$ thick. The insulator shown cross hatched was bakelite fiber which soon proved quite unsuitable as it changes size with change in hygroscopic conditions. Mica fills the requirements perfectly when used to separate the blocks. The steel bolts are insulated by a sheath of hard rubber $1/16''$ thick. The insulation was tested by applying 110 volts to adjacent blocks, without the galvanometer showing any deflection.

The bolts were screwed as tight, it was judged, as they would stand without stripping. The plugs tapered from $9/32''$ to $13/16''$ giving a conducting section of $0.2 \times 17/32''$ while the length of the conductor is $1/8''$.

For comparison a very similar conductor, Fig. 2, was formed by cutting two $1/8''$ wide slots into a block of copper leaving a neck with close to the same dimensions as the plug in Fig. 1.

Holes of less than one millimeter diameter were bored as represented at a, b, c, d, e, and f, and filled with mercury. A measured current was led in and out by inserting wires into the end holes. The potential drop between holes on each side of a neck or plug was measured by connecting the holes to a galvanometer of 1.1×10^{-9} volts per mm sensibility and 55 ohms resistance. The current was adjusted to give convenient readings and varied from 0.05 to 4 amperes. Deflections were read by reversing the current.

The resistance figured from the dimensions of the neck in Fig. 2 was 0.7×10^{-6} ohms. The resistance measured as described above was 1.09×10^{-6} ohms. The difference outside of the rather large error is the resistance of the approaches to the neck.

The plugs of Fig. 1 were ground in to make a good fit and were freshly cut, clean and bright. The plug was seated firmly and the resistance read as 32.0×10^{-6} ohms. Reseated it read 9.5×10^{-6} , while the smallest resistance obtained was 6.26×10^{-6} ohms. The voltage drop was much more sensitive to the firmness of setting than later when amalgamated.

The plugs were then amalgamated thoroughly by dipping in hot mercury, having melted resin on its surface. After cooling and cleaning, they were placed in their seats and without waiting for the seats to amalgamate, the resistance was read as 5.0×10^{-6} ohms. The plugs were left in place except for dipping in fresh mercury and reseating occasionally, for several days, by which time the seats were thoroughly amalgamated also and the resistance had fallen to 2.0×10^{-6} ohms. Assuming that the plug and the neck are alike in dimensions, the contact resistance unamalgamated is 6.17×10^{-6} and amalgamated 0.91×10^{-6} so that amalgamating dropped the contact resistance by a factor

of 6.8. This is a very great advantage over lubricating with oil which increases the contact resistance.

The thickness of the mercury film depends on how firmly the plug is set in its seat. The specific resistance of mercury being about sixty times that of copper, the contact resistance should be lowered by forcing in the plug. When the plug was wet with fresh mercury, the variation between loosely and firmly set was 15–20%, amounting to 0.3×10^{-6} ohms. With a little attention to setting the plugs firmly, this variation need not exceed 0.1×10^{-6} ohms. The mercury on the copper gradually becomes pasty. Its removal by fresh mercury will produce variations of about the same magnitude (15%–20%), so that such a contact could be trusted to a millionth of an ohm with certainty. This is better than is needed for almost any resistance thermometry work, and is much better than other factors e.g., steadiness of coils with time, temperature effect on coils or perfect compensation of leads.

Since this test performance was so good, a set of 12 plugs (Fig. 6) was made up and has now been in use about 18 months. The performance has been equal to the promise and justifies a more complete discussion.

The mercury evidently lubricates the surfaces and prevents the cutting. The surfaces on the plugs are as good as when first amalgamated. If they had not been amalgamated, the amount of service they have received would have left them all scored. The cutting is practically eliminated.

The mercury does not soften the surface of the copper as might be feared. No plug has been found to work into its seat by an observable amount and with the slight taper a small amount of squeezing out would show immediately.

Since the mercury fills the whole volume between the copper surfaces, the effective conducting contact is very constant. Foreign material is pressed out when the plug is inserted which ejection is aided greatly by the surface tension of the mercury. When the plugs are used over a kerosene bath, they become spotted with small areas of a black oily like substance. It is too adherent to be wiped off with absorbent cotton, but is readily removed with a rough paper leaving the amalgamation unimpaired.

When the plug only is amalgamated, it sets itself firmly in the seat in the course of a few hours so as to require loosening with pliers. The effect decreases steadily with time but never entirely disappears. Even after a year or more, if the plugs be seated firmly and left a month or two, they become too firmly held to be loosened by the fingers, but yield readily to the pliers. No plug has been injured by the force required to unseat it, nor are the surfaces apparently injured in any way. Beyond some slight inconvenience it does not seem to be material. The plug when seated firmly has only a slightly different resistance when loosened and resealed firmly.

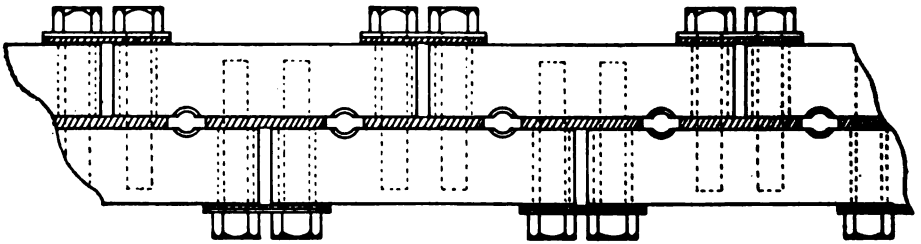

FIG. 3

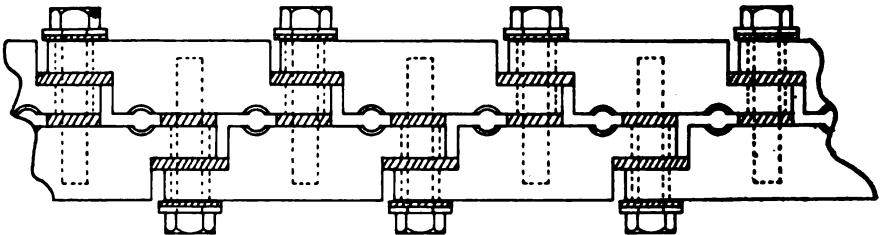

FIG. 4

The standard design of resistance boxes where the metal blocks are mounted on a plate of hard rubber, is not the most satisfactory. The blocks are not held firmly enough, and mercury or metallic scum might readily form short circuits. Much stronger and more satisfactory designs are those represented in Figs. 3, 4, 5, and 6. In case one wishes a design where the removal of one plug cannot possibly affect any others, Fig. 3 satisfies such a requirement. It is, however, much bulkier and requires more parts than the other designs. In designs Fig. 4 and 5, it is conceivable that

the shift of one plug might affect the one on either side. The experiments described above showed, however, that the mercury covered plug was much less affected by tightness of seating than when dry. Also if the $\frac{1}{4}$ " steel bolts are drawn up as tight as their strength will justify, the forces involved in seating the plugs are very much smaller, so that design Fig. 6 should be satisfactory, and experiment has shown it to be so. The resistance of a seated plug as actually measured is independent within the limits given above of the condition of the neighboring plugs. A set of 12 plugs like Fig. 6 has been in use now for a year and a half and has proved very satisfactory.

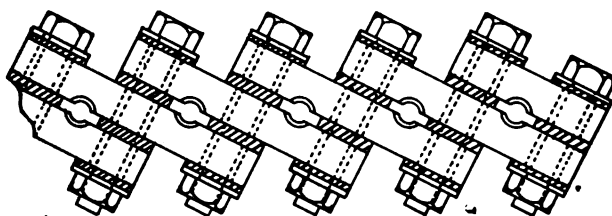

FIG. 5

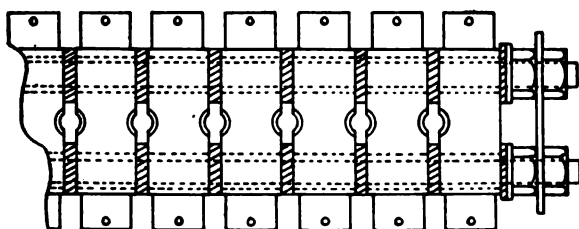

FIG. 6

In the first designs as in Fig. 1, space was left on each side of the plug and the slot was enlarged to allow keeping the insulator clean and the slot free from metallic deposit. It was found, however, that no deposit formed, so that it is quite safe to bring the end of the mica insulation nearer the plug as is done in Fig. 3-6, and it would also probably be safe to cut the slot to $\frac{3}{32}$ " or even $\frac{1}{16}$ ".

The spread of the mercury over the copper may be practically stopped by using oxidized surfaces, since there is no large supply of mercury at hand to spread. This may also be aided by bevelling

out the top of the taper hole slightly and by making the plugs long enough to project at least $1/16''$ below the copper blocks. Under these circumstances the drop of mercury hanging on the tip of the plug has little tendency to spread to the copper blocks, nor is there much likelihood of the mercury forming a bridge between the blocks.

Designs Fig. 3 and 4 have to be supported through insulators but those of Fig. 5 and 6 may be supported from the bolts as indicated in Fig. 6. The strip of steel is continued across below the plugs and the coils hang from threaded soldered connections, indicated at the rounded ends of the bars. As an additional fence for the mercury these rounded ends were wound with silk floss and then saturated with thick shellac varnish.

This means of connection for the coils could also be used in Fig. 5, but in Fig. 3 and 4 such connectors would be put preferably into the sides of the blocks, one connection for each coil terminal, so that the connection is through the body of the copper block whether the coils are in use or not.

PHYSICS LABORATORY,
UNIVERSITY OF WISCONSIN
MARCH, 1921.

A HIGH-VOLTAGE STORAGE BATTERY FOR USE WITH ELECTRON TUBE GENERATORS OF RADIO- FREQUENCY CURRENTS

BY
E. L. HALL AND J. L. PRESTON

The purpose of this paper is to give some information in regard to a high-voltage storage battery which has been used by the Radio Laboratory of the Bureau of Standards for over four years and has given excellent service. There have been many calls for information upon this subject and it is hoped that this paper may answer some of these inquiries. The present apparatus is subject to further improvements. At the close of the paper are given recommendations for several changes which seem desirable. The particular batteries to be described are used to furnish plate current for a generator of undamped radio-frequency currents. The electron tube used is either a Western Electric VT-2 or a General Electric Type P pliotron, or their equivalents. The current for the first tube may range from 5 to 30 milliamperes while for the latter tube it may be 150 milliamperes depending on the plate voltage used. It is necessary that a constant current of small value be available.

The individual elements composing this battery are made by The Electric Storage Battery Company, being their type LT Chloride Accumulator. The following data are taken from the catalogue of the above company:

Type	Size of Plate	Number of Plates	Discharge in Amperes		
			For: 8 Hrs.	5 Hrs.	3 Hrs.
LT.....	3½"×1"	2	½	¼	⅓

Normal Charge Rate Amperes	Dimensions of Glass Jar			Weight in Pounds	
	Length	Width	Height	Electrolyte	Cell Complete
½	1½"	1⅜"	4⅝"	½	¾

The batteries were made up using twelve cells per row and four rows to the tray, giving about 100 volts when charged. Fig. 1 shows the arrangement as employed at present with one exception which will be mentioned later. Wooden trays were made up of $\frac{3}{4}$ -inch lumber measuring $11\frac{1}{4}$ by 19 by 4 inches deep. Legs $1\frac{3}{4}$ inches long were placed at each corner. Vertical supports 12 inches high were fastened at each corner of the tray so that the trays might be built up in stacks if desired thus occupying a minimum of floor or table space. The trays were given two coats of black insulating varnish, allowing plenty of time for drying between coats.

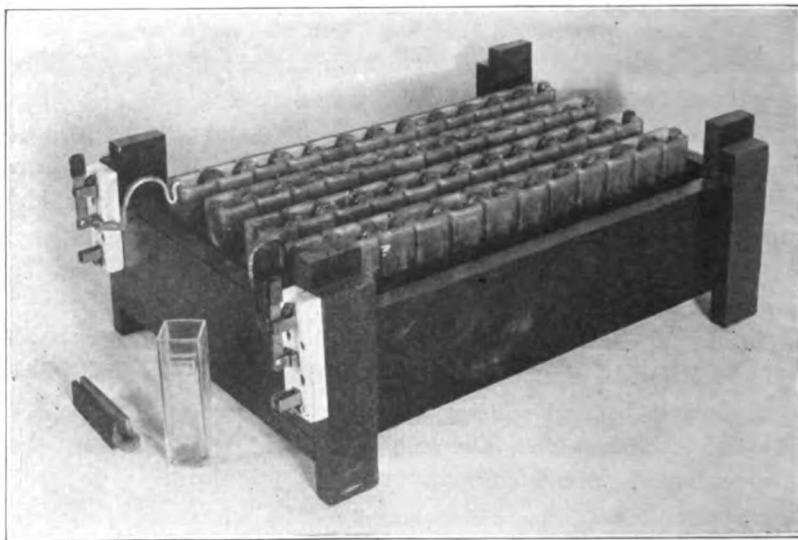

FIG. 1—View of 100-volt storage battery tray arranged to permit stacking of other trays

Melted paraffin was poured into the tray and allowed to harden. The glass jars, the tops of which had been dipped in paraffin for about an inch down the side, were then put in place and one end of the tray blocked up about 2 inches. More paraffin was poured in until it came within about 1 inch of the top at one end and about three inches from the top at the other end. After the paraffin hardened and the tilting blocks were removed a sloping

surface resulted which is convenient for washing out any acid or dirt. A flared glass tube was put through the bottom of the tray at the lower end to drain off any water or acid.

As shown in the photograph the plates for the battery come in pairs consisting of one positive and one negative plate joined by a lead link, the plates going in adjacent cells and being supported by the lead link. The battery was made up in such a way that its terminals were at the opposite end from which the tray is drained. This is the chief point of variation of the battery as now employed from that shown in the photograph.

Chemically pure sulphuric acid is diluted to bring the specific gravity to 1.210. Directions for mixing the electrolyte may be found in any handbook on storage batteries. The electrolyte in the jars should come about one-fourth inch above the top of the plates.

Paraffin covers were made for the cells. The majority of covers in use consist of one long cover for each row of cells. The paraffin was poured into a wooden mold or trough about $1\frac{1}{2} \times 18\frac{1}{4}$ inches forming a piece about $\frac{1}{4}$ inch thick. While the cover was still warm, it was removed from the mold and placed on top of the row of cells where it was pressed down and conformed to the tops of the jars and lead links. In the center above each jar a considerable depression was made and a small hole made for gases to escape. This method gives a convex surface to the under side of the cover so that the spray forming when the cell is charging collects on the cover and forms droplets which are returned to the electrolyte. As would be expected the covers have reduced the evaporation greatly in addition to keeping dust out of the cells. When the batteries are on charge no spray or fumes are noticeable in the room. The paraffin cover is not shown in the photograph.

Each terminal of each battery comes out to the blade of a single-pole double-throw switch mounted on the vertical supports of the tray. The lower terminals of all positive terminal switches are connected together, the same being true of the negative terminal switches. By throwing all of the switches downward, the batteries are placed in parallel either for obtaining 100 volts or

for charging from the 110-volt direct current mains. The batteries are connected directly to the 110-volt mains through small fuses when charging. The upper terminals of the switches are connected in series, positive to negative, and have suitable binding posts attached to each pair of switch terminals for the wires from the radio-frequency generator. By a suitable throwing of switches any voltage from 100 to 600 may be obtained with these batteries. The voltage obtained of course depends on the number of trays. When operating the larger electron tube, three of the batteries may be in use while the other three are being charged.

Quite a number of these batteries have been used by the Radio Laboratory of the Bureau of Standards and they have been entirely satisfactory for supplying a small constant current such as is necessary for electron tube generators. To obtain best results the batteries must be given some attention to see that the jars are kept filled with distilled water to a height somewhat above the top of the plates and are charged from time to time. How often the batteries are charged depends on how much they are used. It is preferable to charge them oftener and keep them well charged than to use them to the limit, charging them only at wide intervals or when nearly run down. The trays should be washed out once in two or three weeks with clean water to remove any collected acid or dirt.

As has been previously stated, storage batteries of this general type (using same type of element) have been in use in the Radio Laboratory for over four years. While no definite data have been collected to show the useful life of such high-voltage batteries some very conservative estimates may be given. The life of such batteries is greatly influenced by the care afforded them. Good care includes keeping the jars and wax free of acid spray and dust; keep jars properly filled; keep within the proper ampere-hour charge and discharge rate; and if batteries are not normally used at the specified discharge rate, they should be exercised about every two weeks by discharging, through a resistance, at the proper discharge rate and then recharged. Batteries of this type which have been given proper attention have been in use for over four years and are yet quite serviceable. Others have gone to ruin in six months for want of care.

RECOMMENDED CHANGES IN CONSTRUCTION

The wooden tray should be provided with a lining of sheet lead of 1/16 inch or less in thickness. This could be made up and dropped into the wooden box, all seams being sweated together. The inside of the lead box should be painted with insulating varnish. The lead box will protect the wood from the action of the acid, which seems to creep through the paraffin to some extent. If the lead box is used in the construction of the trays, precautions should be taken to prevent current leakage down the side of one cell, across the lead sheet and up the side of another cell. Careful painting of the inside of the lead box with asphaltum varnish and the precautions mentioned in the following paragraph should eliminate any such trouble.

In the present battery the individual jars in a row are set without any space between them. In very warm weather this is apt to cause the row to buckle as has been noticed. The worst feature of this construction, however, is the creeping of acid and moisture down between the glass jars. When the paraffin is first poured in, it is difficult to get it in between the jars thoroughly. This may permit acid and water, when the trays are washed out, to collect between the jars and work its way between the first and second layers of paraffin and out to the wood box. Some leakage of current also may take place. Hence the following method of construction is suggested. In setting up the battery allow a separation of $\frac{3}{8}$ inch between the jars in each row with the present spacing of one inch between rows. This will allow the paraffin to flow readily in between and around all jars. While the paraffin is still in the liquid state if it is splashed up around each jar a tight seal should be produced.

Individual covers for each cell could easily be made of paraffin which would cover the cells more tightly than the covers used at present, and still further reduce the evaporation and probable current leakage from cell to cell. An advantage of having one cover for each row of cells is that each row may be readily inspected as to the condition of the individual cells in the minimum of time. A possible disadvantage is the current leakage from cell to cell along the cover but this condition if present does not seem to seriously affect the performance of the battery.

Fig. 2 shows the general features of construction.

DIMENSIONS OF TRAY

Approximate Voltage	Rows	Cells per Row	Distance between rows	Distance between cells	Tray inside Dimensions	Remarks
100	4	12	1	0	$11\frac{1}{4} \times 19$	Present tray
100	4	12	1	$\frac{3}{8}$	$11\frac{1}{4} \times 24\frac{1}{4}$	Suggested size rather un-wieldy.
50	3	8	1	$\frac{3}{8}$	$8\frac{1}{2} \times 16\frac{3}{4}$	Suggested size too low voltage.
100	5	10	1	$\frac{3}{8}$	$13\frac{1}{4} \times 20\frac{1}{2}$	Suggested size. b--

FIVE ROWS OF 10 CELLS EACH; CELLS $1\frac{1}{2} \times 1\frac{7}{8} \times 4\frac{5}{8}$ HIGH.
SPACE ROWS 1" APART AND CELLS IN ROW $\frac{3}{8}$ "
INSIDE OF TRAY, $13\frac{1}{4} \times 20\frac{1}{2}$ (APPROXIMATELY)

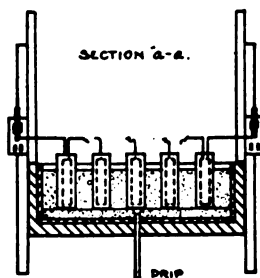
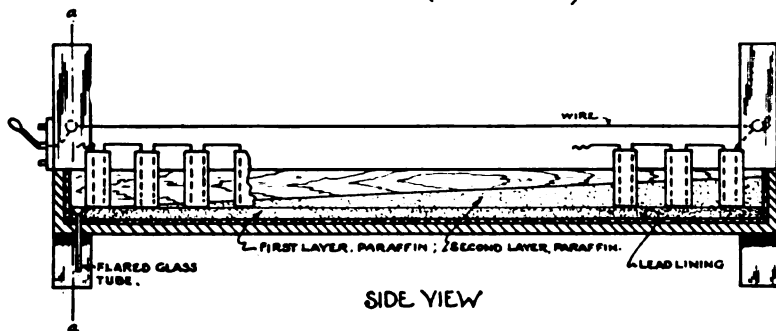

ENDVIEW

FIG. 2—Schematic drawing of 100-volt 0.2 ampere-hour storage battery

BUREAU OF STANDARDS,
WASHINGTON, D. C.

A METHOD OF TESTING PLATES FROM PIEZO-ELECTRIC CRYSTALS

BY
W. G. CADY

The increasing interest that is being shown in the properties and applications of piezo-electric crystals make it seem worth while to call attention to a convenient and sensitive method for the testing and comparison of plates cut from such crystals. Instead of the customary electrometer or ballistic galvanometer, a detector tube of the kind used in wireless receiving circuits is employed. The plate to be tested is subjected to light periodic stresses of audible frequency by means of a buzzer, and the quality of the plate is judged by the response in a telephone receiver. Plates may be tested for either the "longitudinal" or "transverse" effect.¹ The writer has used the device for several years in the testing of plates of quartz, Rochelle salt, and other crystals.

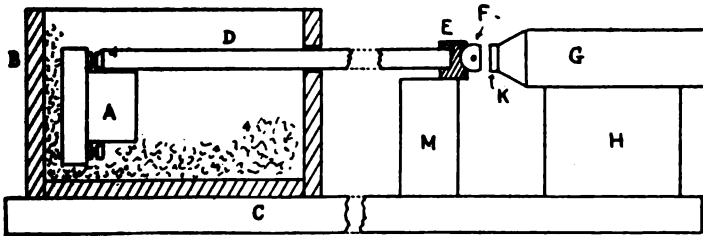

FIG. 1.—Apparatus for testing piezo-electric plates, using longitudinal effect

Fig. 1 shows the arrangement used for the longitudinal effect. *A* represents the buzzer, which should give a fairly high note, mounted, with packing to absorb sound, in the wooden box *B*, which is fastened to the base-board or table *C*. *D* is a glass tube or rod, about a foot long and $\frac{3}{8}$ inch in diameter, passing through a hole in the end of *B*, and pressing against a binding post of

¹ For a summary of piezo-electric principles, and an account of sundry applications see, for example, Nicolson, *Trans. Am. Inst. Elec. Eng.*, 38, p. 1467, 1919; or Wood, *Bull. Seismol. Soc. of Am.*, 11, p. 15, 1921; or a forthcoming paper by the writer on the "piezo-electric resonator," in *Proc. Inst. Radio Engineers*.

the buzzer, or some other rigid part that vibrates energetically when the buzzer is working. Cemented to the other end of *D* is a small brass block *E*, the end of which is cupped out as shown in section. In this cavity fits the metal ball *F*, $\frac{3}{8}$ inch in diameter, ground flat on one side, and kept from falling out by a fine wire run through a hole in its center and bent back around *E*. The flat face of this ball presses against one face of the quartz or other plate under test. On the other side of the plate is a block of metal, *G*, weighing a few ounces. This is fastened to the wooden block *H*, which can be moved to left or right between guides (not shown in the figure). The left-hand end of *G* is tapered down, and has cemented to it a round disc of the material to be tested, cut in such a way as to exhibit the longitudinal effect when compressed, of the same diameter as *F* and of approximately the same thickness as the plates to be tested. *E* is allowed to rest on the wooden block *M*. *E* and *G* are connected respectively to the filament and grid of the detector tube, the anode circuit of which contains the usual battery and telephone. A second amplifying tube may of course be used, but is usually unnecessary.

When the buzzer is connected to a battery and a quartz plate is inserted between *F* and *K*, the vibrations transmitted through the glass rod will cause a periodic compression of the quartz, and a sound will be heard in the telephone if the electric fields in both *K* and the plate are in the same direction. Reversing the plate then causes the sound to vanish, unless the plate differs appreciably from *K* in quality. The block *G*, which serves merely as a rigid backing, may be pressed against the quartz plate by hand, or an elastic band may be slipped around *M* and *H*. The amount of pressure is of small consequence. The object of the metal ball *F* is to insure as uniform a pressure as possible on opposite sides of the quartz plate. Without this precaution, results are likely to be deceptive.

A quartz plate of any size may by this method be quickly explored, and changes in polarity or marked variations in the piezo-electric constant will be readily detected. Roughly quantitative results may be obtained with an audibility meter. Plates do not have to be ground with special care before being tested.

For the transverse effect the same apparatus is used, slightly modified as shown in Fig. 2. *D* is here the same glass rod, set into longitudinal vibration as before by the buzzer. *E* is a rectangular brass block on the end of *D*, resting on the wooden block *H*. In most cases the same block *E* may be used as in Fig. 1, with the ball *F* removed. If two plates *a*, *b*, are to be compared, they are laid end to end upon a small piece of tinfoil which is cemented to *H* and connected to the grid of the detector tube. A block *G* of any fairly dense, hard material as brass or porcelain is laid upon *H* and pressed against the crystal plates. A mass of 20 to 30 grams is usually sufficient. When the buzzer is in action, the plates are periodically compressed, and alternating electric fields are set up in a direction normal to the tinfoil on *H*. These

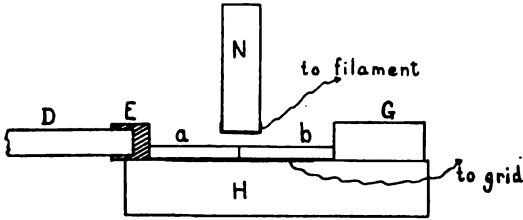

FIG. 2.—Modification of apparatus for transverse effect

fields are in the same or opposite directions according to whether the two plates happen to agree in polarity or not. Thus when the tinfoil-coated end of a small wooden exploring-rod *N* is moved back and forth in contact with the top surfaces of the plates, the sound heard in the telephone will be continuous if the upper faces of both plates possess always like electric polarity. Reversing one plate (*i.e.*, turning it upside down, not end for end) will then cause the sound to die out when the exploring-rod is midway over the edge of contact of the two plates. The relative polarities and qualities of a number of plates may thus be quickly determined. The quality of a single plate may obviously be tested with the same apparatus. Under some conditions the tip of the finger will be found to serve as well as the exploring-rod and tinfoil *N*, to make contact with the upper surface of the plates.

WESLEYAN UNIVERSITY,
MIDDLETOWN, CONN.

AN ELECTRON TUBE AMPLIFIER FOR AMPLIFYING DIRECT CURRENT

BY
H. A. SNOW

In various fields in electrical work, particularly in radio work, it is important to have a relay possessing negligible time lag, capable of operating on small impressed currents, of the order of 10 milliamperes. Such a device may be found useful, for example, in recorders for registering telegraphic or radio signals, in apparatus for remote electrical control, in railway signaling work, and for operating an oscillograph from a source of very small current.

The following paper describes a resistance coupled electron tube amplifier designed to amplify a direct or alternating current of 10 to 20 milliamperes to 110 to 200 milliamperes to take the place of a special type of polarized relay at present used for this purpose. The conditions under which the relay operates and which are imposed on the amplifier follow:

CONDITIONS

The current operating the relay is either an alternating current of 10 to 20 milliamperes at a frequency of about 40 cycles or a direct current of the same magnitude in either direction, both of which are applied intermittently from a high impedance source. The input impedance of the relay is about 750 ohms with an allowable increase to 1000 ohms. The impedance of the output circuit is 50 to 100 ohms. When a direct current in a given direction is supplied to the input of the amplifier, an amplified direct current will be produced in the output circuit. When a direct current in the opposite direction is supplied to the input, an amplified direct current in the opposite direction will be produced in the output circuit. The amplifier will amplify alternating currents of either low commercial frequencies or high radio frequencies with very little distortion.

TUBES

The electron tubes selected for the amplifier tests were UV-202 Radiotron 5 watt power tubes, because of their high filament emission and steadiness of operation with a high plate current.

CIRCUITS

Since the electron tube amplifier is essentially a voltage operated device of high impedance, it is not readily adapted for efficient current amplification. For highest efficiency the highest possible voltage should be produced from the input current it is desired to amplify. The type of amplifier circuit that may be used is limited by the fact that the input consists partially of direct current, to a resistance coupled circuit employing the voltage drop across a resistance for the input to each stage, so the maximum voltage available with 10 milliamperes flowing in the input circuit is the drop across a resistance in the input circuit. The resistance being limited to 1000 ohms, the maximum voltage available is 10 volts. This requires more than one stage of amplification for efficient use of the tubes.

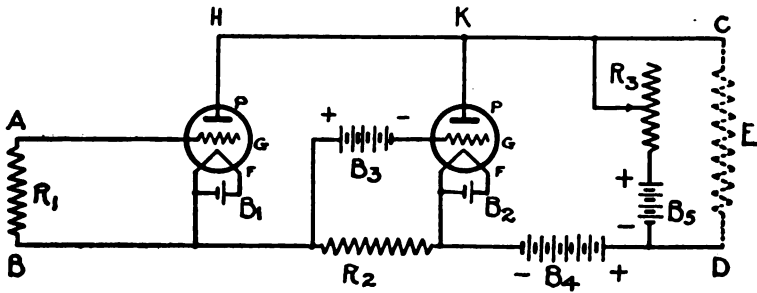

CIRCUIT 1,

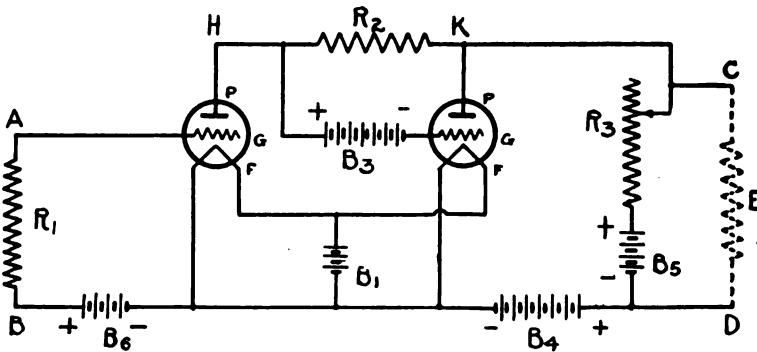

CIRCUIT 2,

FIG. 1—Amplifier circuits

CIRCUIT DESCRIPTION

Two circuits each having two resistance-coupled stages were set up and adjusted for maximum current amplification. These circuits are shown diagrammatically in Fig. 1.

In both circuits 1 and 2 of Fig. 1:

A and *B* are the input terminals.

C and *D* are the output terminals.

E (in dotted lines) represents the impedance of the output circuit. In these tests *E* was a resistance of 50 ohms.

F, *G*, and *P* are respectively the filaments, grids and plates of the tubes.

H = First stage.

K = Second stage. For simplicity only one tube is shown in each stage, although several connected in parallel were used.

*B*₁ and *B*₂ = 8 volt batteries of sufficient capacity to supply the filaments connected to each battery. Each tube requires 2.3 amperes.

*B*₃ = Source of grid voltage of 22 to 110 volts, according to tubes used, capable of carrying about 40 milliamperes in a direction opposite to the voltage of this source.

*B*₄ = Source of plate voltage, 220 volts, capable of delivering 0.5 amperes.

*B*₅ = 40 volt battery to supply 200 milliamperes.

*B*₆ = (circuit 2 only) 12 volt battery to supply 20 milliamperes.

*R*₁ = Input resistance of 1000 ohms. The sensitivity of the amplifier can be controlled completely by varying this resistance. Increasing the resistance increases the current amplification and reducing the resistance decreases the amplification.

*R*₂ = Coupling resistance of 10 000 ohms to 55 000 ohms, according to number of tubes used. Both *R*₁ and *R*₂ should have a current capacity of 30 milliamperes.

*R*₃ = Resistance which must be variable by small steps from 150 to 300 ohms, such as a slide wire rheostat. Current carrying capacity 200 milliamperes.

TESTS

With the two circuits shown in Fig. 1 adjusted to give the highest amplification, measurements were made of the output current

for an input voltage of 10 volts positive and negative which corresponds to an input current of 10 milliamperes through the input resistance of 1000 ohms. The current amplification, that is, the ratio of the output to the input current, is obtained by dividing the measured output current by the 10 milliampere input current.

RESULTS

The following table shows the amplification obtained with both circuits, using the tubes as indicated in the first three columns and also gives the values of coupling resistance and grid voltage (R_2 and B_3 respectively of Fig. 1) required for best operation in each case:

TABLE 1
Circuit 1

Total No.	Number of Tubes		R_2 Ohms	B_3 Volts	Output Current with 10 ma input	Current Amplification
	First Stage	Second Stage				
2 ¹	1	1	46 000	100	60	6
3 ¹	1	2	46 000	100	100	10
4	1	3	56 000	88	120	12
5	2	3	14 000	110	130	13
6	2	4	14 000	110	160	16

TABLE 1
Circuit 2

Total No.	Number of Tubes		R_2 ohms	B_3 volts	Output Current with 10 ma input	Current Amplification
	First Stage	Second Stage				
3 ¹	1	2	12 000	45	70	7
4 ¹	2	2	8 000	35	90	9
5	2	3	5 000	48	110	11
6	2	4	5 000	66	140	14

¹ Does not fulfil requirements.

Two curves with input voltage as abscissas and output current as ordinates with circuit 1 and one curve with circuit 2 are shown in Fig. 2. The irregularity of the sloping part indicates that the input current is distorted slightly by the amplifier due to the grid current taken by the tubes.

DISCUSSION

Table 1 shows that in order to fulfil the conditions that the input current of 10 to 20 milliamperes will be amplified to 110 to 200 milliamperes, the minimum number of tubes that can be used is four tubes in circuit 1 and 5 tubes in circuit 2. Circuit 1 should therefore be the more economical to use even though two separate filament batteries are required, because less tubes are required and the total current capacity of both batteries

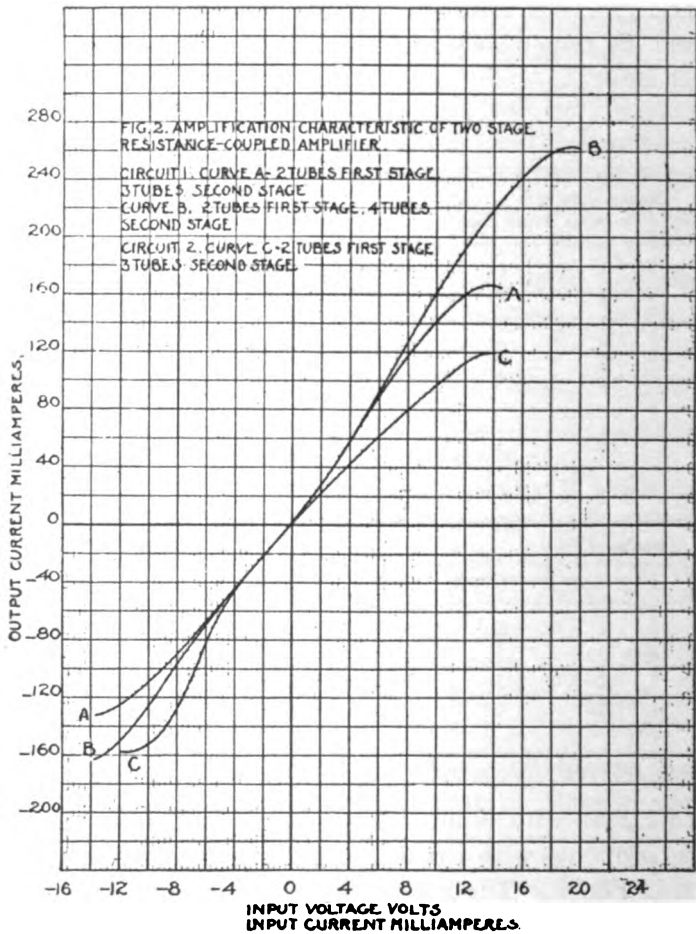

FIG. 2—Amplifier characteristics

required to supply the filaments in circuit 1 is less than the capacity of the single battery required in circuit 2. Circuit 2 also requires an additional grid battery (B_6 , Fig. 1) of 12 volts.

The difference in amplification of the two circuits is due to the manner of connecting the coupling resistance (R_3 , Fig. 1). In circuit 1, the grid current of the second stage tubes acts as a regenerator, to increase the amplification for a given input current, while in circuit 2 the amplification is decreased by the grid current.

ADJUSTMENTS

The necessary adjustments to put the amplifier in proper operating condition are:

(1) Filament Current: The filament current is adjusted by means of a series rheostat to 2.3 amperes per tube, or the filament voltage to 7.4 volts. With an 8 volt storage battery and low resistance leads no external resistance is necessary.

(2) Output Current: With no input current flowing, the resistance R_3 of Fig. 1, is adjusted until the output current is reduced to zero. The amplifier is now ready for operation.

If changes occur in the plate voltage supply or a tube is replaced, it may be necessary to readjust R_3 to reduce the output current to zero with zero input current.

GENERAL

The plate supply (B_4 , of Fig. 1) may be of any voltage between 200 and 250 volts. A 220 volt D. C. light or power line may be used provided that the voltage does not vary more than about 10 volts.

With a plate supply of less than 200 volts the amplification decreases rapidly, while voltages in excess of 250 overheat the tubes and make their operation unsteady.

The above tests were all made using *UV-202* Radiotron 5-watt power tubes. Other tubes suitable for current amplification are Western Electric type *E* tubes. With these tubes somewhat less amplification was obtained, and not as steady operation because of heating.

SUMMARY

Two resistance-coupled amplifier circuits were constructed to amplify both a direct and alternating current of 10 milliamperes to 110 to 200 milliamperes magnitude, and tests made to determine the amplification for best adjustments of the circuit constants.

**BUREAU OF STANDARDS,
WASHINGTON, D. C.**

A SIMPLE FORM OF LABORATORY POTENTIOMETER

BY
H. W. FARWELL

The increasing use of potentiometer measurements makes it very desirable to give students in general physics some laboratory instruction which shall make clear the principles involved. In many instances the available instruments are either the standard box potentiometers or two similar resistance boxes. Occasionally the ten meter potentiometer wire is found.

For the elementary student the box form is not altogether the most satisfactory, since he can not see clearly just what the connections are. Again he hardly needs at this stage instruments as accurate and as expensive as are those sent out by the standard makers, although he will need and appreciate them somewhat later.

In trying to find some satisfactory and simple arrangement to serve the purpose we decided that the most acceptable was very easily obtained. We use a high resistance tube rheostat of the Biddle or Beck type, say of 3000 ohms, connecting a 4 volt storage battery across the whole resistance, and the standard cell or unknown emf between one end and the sliding contact. Assuming that the wire is uniform and uniformly wound, the ratio of the emfs is the same as the ratio of the lengths measured from the proper end of the cylinder to the sliding contact.

Every connection is in plain sight, the apparatus is compact and the whole operation is as direct as can be desired. The width of the sliding contact may easily be made smaller, but we have not changed it as the results obtained were quite good enough for our purpose. A comparison of results obtained by a student with this arrangement and with a Leeds and Northrup "Student" potentiometer will show better than anything else what can be expected by way of accuracy.

	Emf by L. & N. potentiometer	Emf by tube potentiometer
Cell A	1.4781 volts	1.480 volts
Cell B	1.3193	1.322
Cell C	1.0757	1.061
Cell D	1.5064	1.511

COLUMBIA UNIVERSITY,
JANUARY, 1922.

PHOTOGRAPHY OF MOVING INTERFERENCE FRINGES

BY
AUGUSTUS TROWBRIDGE

A rather hasty survey which I have made of the physical periodicals has not disclosed any previous description of the fairly obvious method of photographing interference fringes which forms the subject of this note. A very brief description may therefore be worth while, if only to save some one else the trouble which I have taken in finding the proper dimensions to enable one to obtain photographs showing satisfactory contrast when the fringes are moving rapidly.

There is a very decided advantage in substituting a photographic film for the eye whenever slow temperature changes in the material of the interferometer are to be feared, for, by the aid of photography, we can record the passage of at least a thousand fringes per minute and so reduce by a factor of at least ten, the time during which the disturbing effects of changing temperature are present. Another advantage lies in the ability to repeat a fringe count since one has the photograph as a permanent record. A disadvantage is, of course, the fact that photography of rapidly moving fringes is not a practical method throughout the whole of the visible spectrum. The practical long wave-length limit with the apparatus described below was that of the bright green mercury line.

The vertical straight line fringes formed by a Michelson interferometer were used in taking the photographs illustrating this article. A real image of these fringes was formed by a small achromatic camera lens ($f=4.5$). About one inch in front of the real image formed by this lens was placed a cylindrical lens of about one inch focus with its axis horizontal. The converging beam formed by the spherical lens just completely filled the vertical aperture of the cylindrical lens.

The action of the cylindrical lens was practically to leave unchanged the horizontal spacing of the fringes, but to reduce

the vertical line images to a series of point images of enhanced brilliancy.

At the focus of the cylindrical lens, a narrow strip of sensitized paper could be made to pass in a vertical plane by a simple roller mechanism which fed the paper from a roll into a bath of developer enclosed in a light tight box. In fact, the supply of paper, the developer, and the rollers were all in the same light tight enclosure which carried the cylindrical lens. As the developed record came out of the bath it could be drawn out into the not too brightly lighted room and fixed without fogging.

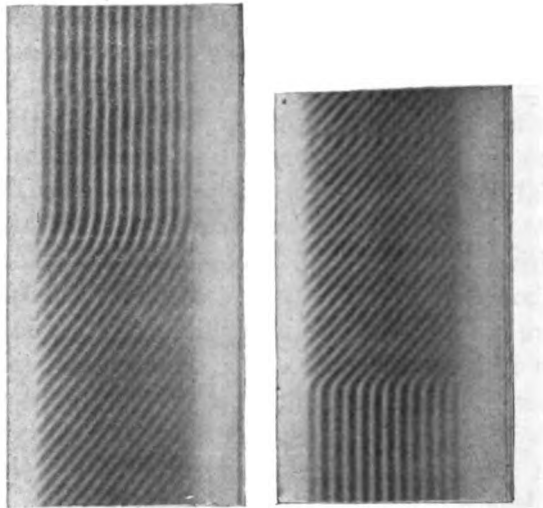

FIG. 1a

FIG. 1b

Automatic development saves a considerable amount of time and is quite possible in the case of fringes, formed by blue and violet lines. In case of faint lines, or strong lines of wave-lengths in the green or yellowish green, it is necessary to do the developing with regard to the best contrast and, in this case, it is simpler to collect the record in the light tight box and develop by hand in a dark room in the usual way.

If the fringes are stationary and the photographic paper is moved at right angles to the axis of the cylindrical lens, a record is obtained similar to the upper portion of Fig. 1 (a) or the lower

portion of Fig. 1 (b). If the fringes are in approximately uniform motion the record is similar to the lower portion of Fig. 1 (a) or the upper portion of Fig. 1(b). The inclination of the trace that looks like an inclined fringe system, is, of course, determined by the relative velocities of the paper and the moving fringe system. The number of fringes which pass a given point may be counted rapidly by counting the number which move out of the field of view at one edge of the record.

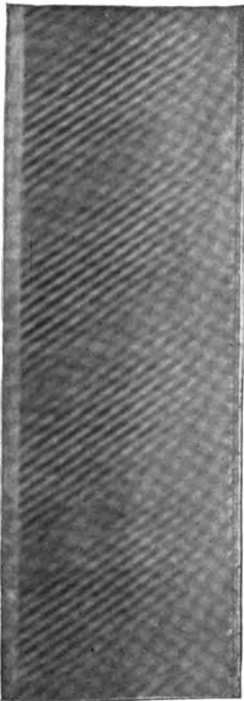

FIG. 2

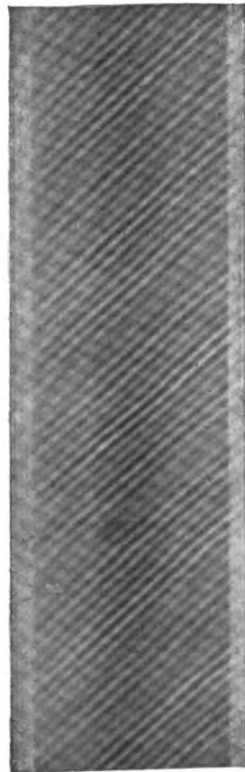

FIG. 3

It is impossible to reproduce a record several feet long, but in Fig. 1 (a) and 1 (b) are given the beginning and ending of a continuous record. The light used was the mercury violet line (λ 4047, 4078) as obtained by filtering the total radiation from a water cooled glass mercury lamp through one of the screens

prepared by the Eastman Kodak Company. Fig. 1 (a) shows the fringe system in the neighborhood of the white light fringes while Fig. 1 (b) shows those for which the path difference is about two hundred waves. Fig. 2 shows a portion of a record taken near the white light fringes in which the source of light was the mercury arc filtered with a dense solution of permanganate of potash. The periodically returning visibility caused by at least two components in the violet is evident even though the record is not a particularly good one owing to its having been developed automatically with no especial care for bringing out contrast. When this record was taken, both the fringes and the photographic paper were moving much more rapidly than was the case when records 1 (a) and 1 (b) were taken.

Fig. 3 shows a portion of a record taken with a path retardation of about a thousand waves. The light from the mercury arc was filtered through a strong solution of quinine. The cause of the more prominent visibility change is due to interference of the green and violet Hg lines. A change of visibility due to the presence of the violet line of the shorter wave-length is also noticeable on the long original record from which that reproduced in Fig. 3 is cut as a sample.

PALMER PHYSICAL LABORATORY,
PRINCETON, NEW JERSEY.

A HIGH SPEED PRECISION RELAY

BY
CARL KINSLEY

A relay has been developed in which no errors are introduced by the friction of pivots and one in which the inertia of the moving parts is usefully employed in the exact timing of the recording operations.

A careful study had been made, with an oscillograph, of several existing forms and very considerable errors had been found in every relay.¹ The different types varied somewhat but all were imperfect. The measurements given include;

Time to set relay tongue in motion, t_1 , 0.002–0.005 sec.

Time taken for the tongue to reach
the anvil, after starting, t_2 , 0.004–0.006 sec.

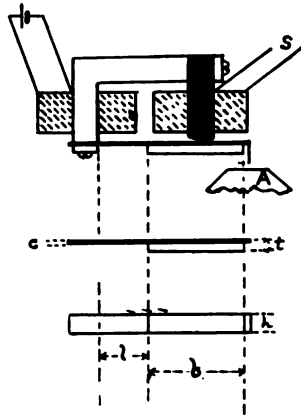

FIG. 1—Relay details

Although these time intervals are considerable they might not be of much importance except for the fact that they are not constant.

The following drawing shows the principal relations between the parts of the relay designed to meet the requirements. The method of operation is as follows.

¹ A. C. Booth, Jour. Inst. Elect. Eng. 1909, p. 43. J. Zelisco, Elektrotechnik u. Maschinenbau, April 28, 1912, p. 349.

The weighted tongue or armature is lifted by the permanent field and held against the core of the magnet, which has a thin copper facing to prevent sticking. It is also by the same means kept permanently magnetized. The core, upon which the spool connected to the signalling circuit is placed, is made of very small soft iron wires which have been soaked in shellac and baked until they make a rigid whole of finely divided iron.

The signalling impulse gives a temporary magnetomotive force opposing that due to the local battery. When the field is sufficiently weakened, the tongue is released and starts its excursion as a vibrating rod weighted at the end. There is no delay in getting the armature into motion. It starts as soon as the signalling current has reached the release value. In any permanent circuit this occurs at exactly the same time interval after each signalling impulse has started, depending on the circuit constants. The equations for the arrival curves for many types of circuits, including submarine cables, have been given by Malcolm.²

After starting, the tongue moves in accordance with its equation of motion transforming its potential energy, due to the bent spring, into the kinetic energy of its moving mass. The contact point strikes the anvil and completes the operation by thereby closing a local circuit. The equation for its motion is obtained by adapting the equations given by Lord Rayleigh for a more simple tongue with concentrated mass.³

Potential energy of distorted spring, V ,

$$V = 6qk^2 al^3 \cos^2 pt \quad (1)$$

Kinetic energy of moving spring and the weight it carries, T ,

$$T = (2Ml^6 + \frac{33}{10} \rho al^7) p^2 \sin^2 pt \quad (2)$$

Equate the maximum values of V and T and solve for p^2 .

q = modulus of elasticity of spring, assumed S. I. tables

= 19.5×10^{11} , dynes per sq cm

k = radius of gyration of a section of the spring about a line through the axis and perpendicular to the plane of bending.

² "The Theory of Submarine Telegraph and Telephone Cable," 1917.

³ Theory of Sound, vol. I, chap. 8.

$$= 0.0153 \text{ cm}$$

a = area of a section of the spring,

$$= 0.02662 \text{ sq cm}$$

l = length of the spring.

M = mass attached to the spring,

$$= 2.16 \text{ grams.}$$

k_0 = radius of gyration of M about its support.

ρ = density of the steel of the spring,

$$= 7.8.$$

f = natural frequency of the tongue.

$$p = 2\pi f.$$

It might be thought that since the armature is attached rigidly to the spring that only the portion of the spring between the support and the armature, M , takes part in producing the potential energy due to the bending. Tests, however, have shown that the spring assumes a curved form substantially the same as though it were of a length equal to the radius of gyration of the attached mass. This curvature is very different from the shape it assumes when the force is applied at the end of the free portion of the spring. In Eq. (1) replace l with k_0 .

Likewise the l of Eq. (2) should be replaced by the radius of gyration of M , when the center of mass differs appreciably from the center of gyration. In Eq. (2) replace l with k_0 .

The second term of Eq. (2) can be neglected without appreciable error; $\frac{1}{2}$ of 1% for this armature.

Make the substitutions and solve the equations for p^2

$$p^2 = 3qk^2a/Mk_0^3 \tag{3}$$

There is a correction factor which should be considered, due to the rotational inertia of the armature. The tests made indicate that it is negligible, although the approximate term given by Lord Rayleigh, if correct, could not be neglected.

Solve Eq. (4) for the frequency of vibration and arrange for experimental verification.

$$f = B \div k_0^n = \sqrt{3qk^2a / 4\pi^2M} \div k_0^{1.5} \tag{4}$$

The spring length, l , was varied and the frequency, f , was obtained by comparison with tuning forks. The $\log f$ and $\log k_0$ were plotted and all of the points fell on a straight line, within

the limits of experimental error. The constants, n and B , of the straight line were obtained and compared with the constants obtained by computation from Eq. (4).

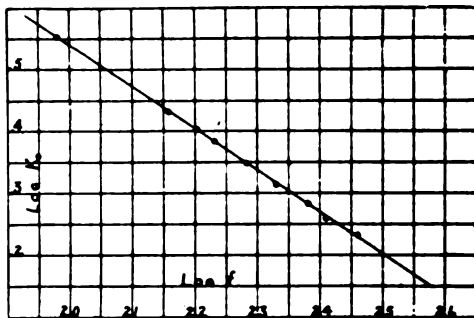

FIG. 2—Tongue vibration tests

From experiment, $n = 1.49$, from computation, $n = 1.50$

From experiment, $B = 642.7$, from computation, $B = 654.3$

The agreement is within the experimental error, but a correction of 1.8% for rotational inertia would make the two values for B identical. A large correction for rotational inertia would make the line a curve instead of a straight line, so that it is legitimate to disregard this possible correction for all purposes of design. An earlier examination of vibrating rods with small variable loads also showed that no correction was needed.⁴

The time required for the operation of the relay can be computed as follows. If the anvil is so placed that the tongue touches it when the spring is not bent, then the time required to leave the position of rest against the core and make its record at the anvil is $\frac{1}{4}$ of a period. If a tongue having a frequency of vibration of 192 pps is used, the time required to make a record is 0.0013 sec. The time the tongue is in contact with the anvil depends much on the character of the surface and the location of the point of contact. At the instant of touching there is no distortion of the spring and if the point is placed at the center of gyration the time of contact may be only a few millionths of a second.⁵

⁴ Kinsley, *Physical Review*, 8, p. 244.

⁵ A. E. Kennelly and E. F. Northrup, *Jour., Franklin Inst.*, 1911, p. 23.

In all cases this can be arranged to be negligible, even when the recording surface is a chemically prepared paper, as in the practical application described later. Assuming, therefore, the time of contact to be negligible, the tongue will return to the core and be again held by the magnetic field in 0.0013 sec. The total time for an excursion being 0.0026 sec.

It is necessary that by this time the signaling impulse shall have passed and the local current again established its normal magnetic field. If the signaling impulse has a greater duration than 0.0026 sec. it would be necessary to use a tongue with a greater natural period.

The surface against which the tongue strikes can be a moving paper strip, slightly moistened with the proper chemical⁶ so that the contact of the tongue will be recorded and at the same time close a local circuit. A standard tuning fork, electrically driven, can also be made to simultaneously make a record on the paper and the interval between two contacts of the relay obtained with great precision.

Many applications of this relay could be made to scientific and commercial problems. An obvious one would be for the purpose of obtaining chronographic records, when the exact determination of small time differences is of importance, our present methods being inadequate. A commercial use will be chosen as an illustration, the problem being one of increasing importance.

The above described relay was used in the production of a high speed printing telegraph.⁷ It had been found that a signaling impulse on an overhead telegraph line of moderate length—four hundred miles—would be substantially clear of the line in about 0.0028 sec. Any existing type of printing telegraph operating at its maximum speed of one hundred words a minute would use the line for approximately 0.016 sec. for each short impulse. There was a considerable time during which the telegraph line was relatively idle. Certain telegraph systems—notably that of Rowland and of the Western Electric—distributed the line time between several telegraph instruments. This

⁶ Prescott, *The Electric Telegraph*, 3rd edition, p. 957.

⁷ Kinsley, *Am. Inst. Elect. Eng.* June, 1914.

requires synchronism between the transmitting and receiving instruments and also greatly increases the amount of apparatus needed.

The problem of the efficient use of the telegraph line was solved also by employing the high speed relay so that six hundred words a minute could be sent and received in Roman characters, ready for use. There was at the same time no necessity for synchronism and the telegraph instruments needed were much more simple than even one of the sets of the relatively slow speed types.

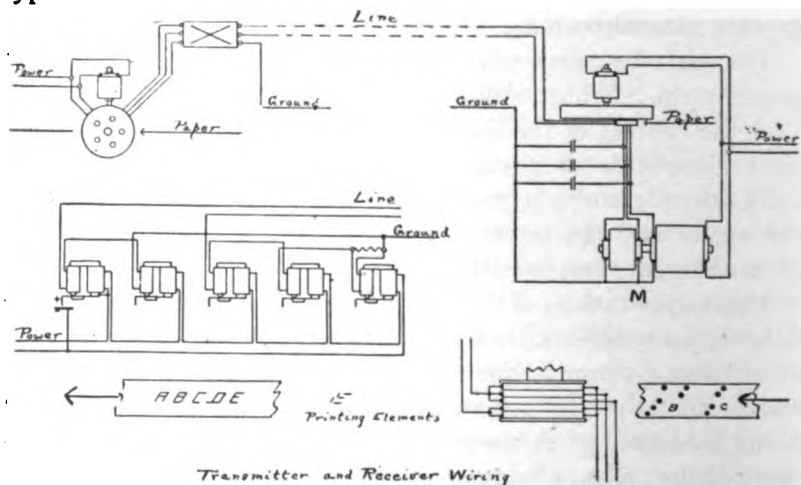

FIG. 3—Schematic drawing showing connections

Five of the high speed relays described above are nested together and each tongue carries a portion of a letter. The relays are then operated by short current impulses, sent out in a predetermined manner by an automatic transmitter, which is controlled by a punched tape in much the same way that the slow printers are operated. The transmitting tape is prepared, by an addition to a standard typewriter, at the same time that a stenographer is transcribing a dictated telegraph message.

The accompanying diagram of connections, Fig. 3, illustrates also the method by which the nested relays build up the alphabet. A schematic drawing of the transmitter, receiver, circuits, transmitting and receiving tape and certain other details are shown.

It is not believed that any further description of the method of operation is needed. A reproduction of a few words of a message is given to show the character of the lettering. All of the letters and figures are equally legible.

*WOODROW WILSON THE CASE HAS
BEEN FILED IN THE CIRCUIT COURT
WHEN CAN WE MEET IN WASHINGTON*

FIG. 4—Style of lettering employed

Two views of the receiver are given. Figure 5 shows the operating position and Figure 6 has the printing head turned back so as to show the way the tongues of the relays are nested together.

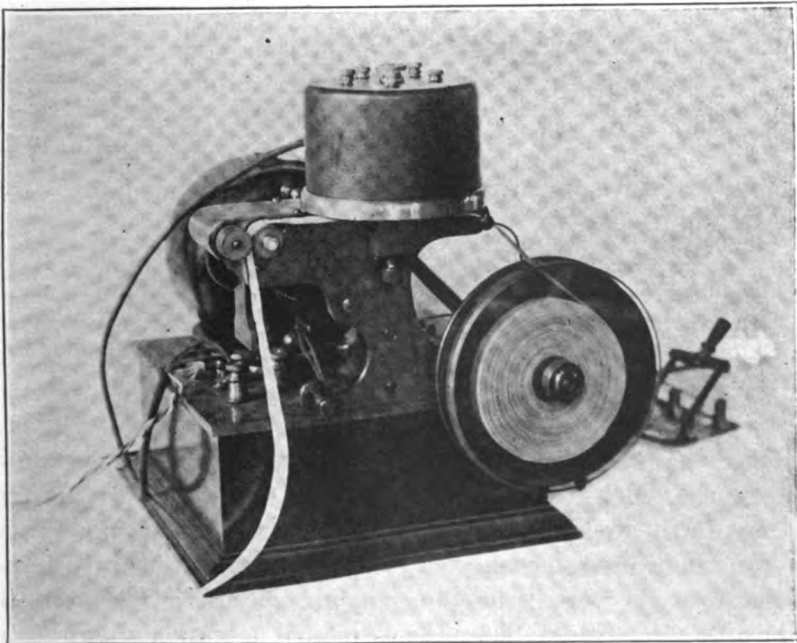

FIG. 5—Receiver

It should be specially noted that, aside from the movement of the paper continuously at a uniform speed, there are no moving parts except the five relay tongues, all of which are rigidly attached to the common, circular, external pole of the electro-magnets. These springs, therefore, never get out of alignment and the instrument can be left without attention for any length of time and then operated at once without adjustment.

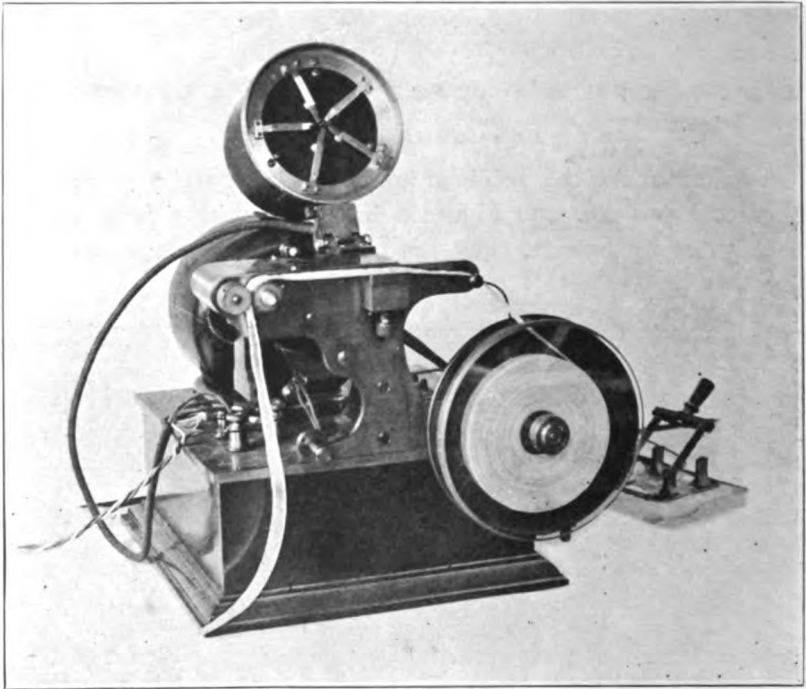

FIG. 6—Receiver with head lifted

This application of the relay illustrates the method of recording signals which are closer together than 0.0026 sec. the necessary interval with a relay having a normal frequency of 192 pps. Two relays can be used so connected as to operate independently upon reversal of the polarity of the signaling impulse. The vertical line of the letters is made by the correlated operation of two such relays. The time interval between the signals is only 0.0013 sec.

apart. The second relay starts its stroke at the time the first relay is recording. The space displacement of the two relays results in their records on the moving paper being accurately aligned. The short time of contact on the paper is shown by the entire absence of blurring of the record in spite of the high speed of the paper upon which the impact is made.

In conclusion, it can be pointed out that the equation of motion of a weighted vibrating reed has been verified and the method of design for any type of circuit or signalling impulse has been pointed out. The relay using the high speed vibrating reed tongue is not subject to the large errors found in other forms now in use.

CORNELL UNIVERSITY
ITHACA, N. Y.

NOTICES

TELLERS' REPORT ON ELECTION OF OFFICERS FOR TERMS BEGINNING JAN. 1, 1922

To Irwin G. Priest, Secretary:

We, the undersigned regular members of the Optical Society of America, have counted the ballots in the election of officers for terms indicated below, all terms beginning January 1, 1922. We have verified the count and hereby certify the following to be the true results:—

<p><i>For President (2 year term)</i></p> <p style="padding-left: 20px;">Walter B. Lancaster 60</p> <p style="padding-left: 20px;">Leonard T. Troland 94</p> <p><i>For Vice-President (2 year term)</i></p> <p style="padding-left: 20px;">Herbert E. Ives 89</p> <p style="padding-left: 20px;">Lloyd A. Jones 68</p> <p><i>For Secretary (5 year term)</i></p> <p style="padding-left: 20px;">Paul D. Foote 30</p> <p>Irwin G. Priest 126</p>	<p><i>For Treasurer (5 year term)</i></p> <p style="padding-left: 20px;">Adolph Lomb 139</p> <p><i>For Members of Executive Council (2 year term)</i></p> <p style="padding-left: 20px;">Adelbert Ames, Jr. 105</p> <p style="padding-left: 20px;">Wheeler P. Davey 79</p> <p style="padding-left: 20px;">W. E. Forsythe 121</p> <p style="padding-left: 20px;">Henry G. Gale 109</p> <p style="padding-left: 20px;">Carl W. Keuffel 98</p> <p style="padding-left: 20px;">Ernest Merritt 113</p>
---	--

Respectfully submitted,

(Signed) { M. K. FREHAFFER
FRANCIS P. PHELPS
H. J. MCNICHOLAS
Tellers.

WASHINGTON,

DECEMBER 12, 1921.

In accord with the vote certified above, the following officers are declared elected for terms beginning January 1, 1922:—

President (2 years), Leonard T. Troland; Vice-President. (2 years), Herbert E. Ives; Secretary (5 years), Irwin G. Priest; Treasurer (5 years), Adolph Lomb; Members of Council (2 years), W. E. Forsythe, Ernest Merritt, Henry G. Gale, Adelbert Ames, Jr.

(Signed) IRWIN G. PRIEST,
Secretary.

DECEMBER 13, 1921.

Tellers' Report on Vote on Amendment to By-Laws

To Irwin G. Priest, Secretary:

We, the undersigned regular members of the Optical Society of America, have counted the ballots cast for and against the amendment proposed viz:—

Art. VIII of the By-Laws now reads:—

“After recommendation by the Council, By-Laws may be enacted, amended or suspended by a two-thirds vote, by ballot, of the regular members of the society.”

The Executive Council has recommended that this be amended to read:

“By-Laws may be enacted, amended or suspended by concurrence of two-thirds of the whole Executive Council.”

We have verified our count and certify that the true results are:—

“Yes” (i.e. in favor of amendment) 120
“No” (i.e. against amendment) 17

Respectfully submitted

(Signed) { M. K. FREHAFFER
FRANCIS P. PHELPS
H. J. MCNICHOLAS
Tellers.

WASHINGTON
DECEMBER 12, 1921.

In accord with the vote certified above, the proposed amendment is declared to be adopted.

(Signed) IRWIN G. PRIEST,
Secretary.

DECEMBER 13, 1921.

ROCHESTER SECTION OF THE OPTICAL SOCIETY OF AMERICA
PROGRAM OF MEETINGS FOR 1921-1922

OCTOBER 10, 1921.

DR. L. T. TROLAND, Professor of Psychology, Harvard University, and Consulting Psycho-Physicist, Kalmus, Comstock and Wescott.
“*Brightness and Color in Relation to Zone Theories of Vision*”

OCTOBER 24

Meeting of the National Society

NOVEMBER 14

DR. C. E. K. MEES, Director, Research Laboratory, Eastman Kodak Company.
“*The Manufacture of Light Filters*”

NOVEMBER 28

DR. HERMAN KELLNER, Director, Scientific Bureau, Bausch & Lomb Optical Company.
“*The Principles of Microscopic Vision*”

DECEMBER 21

MR. R. B. WILSEY, Physicist, Research Laboratory, Eastman Kodak Company.
“*Recent Improvements in X-Ray Photography*”

JANUARY 9

DR. L. SILBERSTEIN, Mathematical Physicist, Research Laboratory, Eastman Kodak Company.
“*Optical Consequences of the Rotation of the Earth*”

JANUARY 23

DR. HENRY G. GALE, Dean, University of Chicago.
“*The Spectroscopic System of Fundamental Units*”

FEBRUARY 13

DR. F. E. ROSS, Astronomer, Research Laboratory, Eastman Kodak Company.
“*Recent Progress in Astronomy*”

FEBRUARY 27

MR. W. B. RAYTON, Scientific Bureau, Bausch & Lomb Optical Co.
“*The Optics of the Telescope*”

MARCH 13

DR. L. V. KING, Professor, McGill University.
“*Molecules and Light*”

MARCH 20

DR. R. A. MILLIKAN, Director, Physical Laboratories, California Poly-

technic Institute. (With American
Chemical Society)
"Radium"

sics Department, University of
Toronto.

"On Some Recent Advances in
Spectroscopy"

APRIL 10

PROF. F. K. RICHTMYER, Cornell
University.

"X-Ray Measurements and
Optical Properties of Thin
Metal Film"

MAY 8

MR. A. L. SCHOEN, Physicist, Research
Laboratory Eastman Kodak Com-
pany.

"Instruments and Methods Used in
Spectroscopy"

APRIL 24

PROF. J. C. MCLENNAN, Head of Phy-

MAY 22

Business Meeting and Annual Dinner.

The following are the present officers of this local section:

President: F. C. FAIRBANKS
Vice-President: HENRY KURTZ
Secretary: L. L. MELLOR
TREASURER: E. G. QUIN
Program Committee: L. A. JONES

AN ENGLISH TRANSLATION OF HELMHOLTZ'S "OPTIK"

TO THE EDITOR: Many of our readers will be glad to know that the council of the Optical Society has appointed a committee to make arrangements for bringing out an English translation of Helmholtz's great work on physiological optics.

The first edition of the "Handbuch der Physiologischen Optik" was published in 1866, more than half a century ago; and the fact that this epoch-making work, which remains to-day the most original treatise on physiological optics, has never been translated into English, is a reproach to both Great Britain and America. To make its valuable contents accessible to those who do not find it easy or convenient to read a foreign language will be conferring a boon on many scientific investigators in the vast and expanding territory which this book was originally intended to cover.

Incidentally, the proposed English edition will be a memorial of the hundredth anniversary of the birth of Hermann von Helmholtz, whose influence on modern scientific thought in nearly every direction has perhaps been as widespread and permanent as that of any of his great contemporaries in the nineteenth century.

It is estimated that the cost of translating, editing, and publishing this memorial volume (or volumes) will be \$5,000 or more. It is particularly desired that every individual who is interested in the success of this project and in the advancement of the science of light and vision in this country will have an opportunity of contributing towards it.

Contributions, no matter how small, may be sent to Adolph Lomb, Esq., treasurer of the Optical Society of America, care of Bausch & Lomb Optical Company, Rochester, New York. Make cheques payable to "Adolph Lomb, Treasurer."

Any one subscribing as much as \$15 will receive a copy of the complete work when it is issued.

JAMES P. C. SOUTHALL,
President, Optical Society of America.

DEPARTMENT OF PHYSICS,
COLUMBIA UNIVERSITY,
NOVEMBER 28, 1921.

Journal of the Optical Society of America and Review of Scientific Instruments

Vol. VI

MAY, 1922

Number 3

REVIEW OF THE PRESENT STATUS OF THE TWO FORMS OF QUANTUM THEORY*

BY
RICHARD C. TOLMAN

Members of the American Association for the Advancement of Science:—In accepting Dr. Harkin's invitation to represent the chemists at this symposium on quantum theory, I have been beset with doubts and perplexities. In the language of psychoanalysis, I have suffered from a malevolent and inhibitory, inferiority complex.

Here am I a typical, hard-worked government employee, who spends his time writing reports and signing vouchers; before me is a great company of distinguished and critical-minded scientists ready to pounce upon my every word; and somewhere, up there, swimming around in the blue empyrean is the so-called quantum theory.

This theory is based on a mass of experimental material, whose details are beyond the comprehension of any one individual mind. The theory, moreover, is not even a single, logical whole, but rather a combination of conflicting speculations which have only two characteristics in common. In the first place, these speculations all vie with one another in discarding as much as possible of the great achievements of the classical dynamics, and in the

* Presented at Toronto Dec. 29, 1921 before a Joint Session of the American Physical Society with sections B and C of the American Association for the Advancement of Science.

second place, they all contain the mysterious letter "h," introduced in any old way that fitted the enthusiasm of the moment.

Furthermore, ladies and gentlemen, I am expected to represent the point of view of chemists with respect to this uncertain field of endeavor, when that point of view is largely the negative one, of extreme hostility to the physicists, with their absurd atom, like a pan-cake of rotating electrons, an attitude which is only slightly modified by a pious wish that somehow the vitamine "h" ought to find its way into the vital organs of their own, entirely satisfactory, cubical atom.

You can easily see the reasons for my inferiority complex. Under the circumstances, I shall limit my remarks to a brief description of the two main forms of the quantum theory, point out some of their successes and limitations, and make a few suggestions as to things that we, as chemists and sensible men, would like if possible to see incorporated in the final form of theory.

The Classical Dynamics

Both of the two main forms of quantum theory are as you know attempts to modify the classical dynamics, and in order that we may be certain that we are talking the same language, I am going to ask your indulgence while I briefly review the nature of these modifications.

The older dynamics was completely deducible from a single axiom known as Hamilton's principle,—

$$\delta \int_{q_1 \dots q_n}^{q'_1 \dots q'_n} L dt = 0 \quad (1)$$

where L is the Lagrangian function of the generalized coordinates $q_1 \dots q_n$ and the velocities $\dot{q}_1 \dots \dot{q}_n$, and the limits of integration are not subject to variation.

This principle leads by simple transformations to the equations of motion in the Hamiltonian form,—

$$\begin{aligned} \frac{\partial \epsilon}{\partial q_1} &= -\frac{d p_1}{dt} & \frac{\partial \epsilon}{\partial q_2} &= -\frac{d p_2}{dt} & \dots & \\ \frac{\partial \epsilon}{\partial p_1} &= \frac{d q_1}{dt} & \frac{\partial \epsilon}{\partial p_2} &= \frac{d q_2}{dt} & \dots & \end{aligned} \quad (2)$$

where ϵ is the energy of the system in question, expressed as a function of the generalized coordinates $q_1 q_2 \dots q_n$ and the corresponding generalized momenta $p_1 p_2 \dots p_n$.

Applied to a system of molecules or elements, these equations of motion have led to a statistical mechanics which has as its cornerstone the Maxwell-Boltzmann distribution law,—

$$dN = c e^{-\frac{\epsilon}{kT}} dq_1 \dots dp_n \tag{3}$$

where dN is the number of molecules of a given kind which will be found, under equilibrium conditions, to have values of their coordinates and momenta falling in the region $dq_1 \dots dp_n$, ϵ is the increase in energy of the system per molecule introduced into the region $dq_1 \dots dp_n$, c a constant for each kind of molecule and k and T , have their customary significance.

Rise of the Quantum Theory

The quantum theory first appeared in the year 1900, because of a conflict between the *apparent* requirements of equation (3) and the facts as to the distribution of energy in the hohlraum.

Let us regard the hohlraum as consisting of modes of electromagnetic vibration whose energy ϵ and frequency ν are given by the well-known expressions for a harmonic oscillator

$$\epsilon = \frac{1}{2} a q^2 + \frac{1}{2} b p^2 \tag{4}$$

and

$$\nu = \frac{\sqrt{ab}}{2\pi} \tag{5}$$

Substituting the above expression for ϵ into the Maxwell-Boltzmann distribution law, we can evidently obtain for the average energy of a mode of vibration of frequency $\nu = \frac{\sqrt{ab}}{2\pi}$, the

expression

$$\epsilon_{av.} = \frac{\int_{-\infty}^{+\infty} \int_{-\infty}^{+\infty} e^{-\frac{1}{2} a q^2 + \frac{1}{2} b p^2} / kT \quad (\frac{1}{2} a q^2 + \frac{1}{2} b p^2) dq dp}{\int_{-\infty}^{+\infty} \int_{-\infty}^{+\infty} e^{-\frac{1}{2} a q^2 + \frac{1}{2} b p^2} / kT \quad dq dp} \tag{6}$$

which on performing the indicated integrations gives us

$$\epsilon_{av.} = kT \quad (7)$$

Since the constants a and b which determine the frequency have disappeared from equation (7), we are led to the conclusion that all modes of vibration of any frequency have the same average energy content. This is merely one example of the well-known principle of the *equipartition of energy*, which is usually regarded as a necessary result of a statistical mechanics founded on Hamilton's equations (see however, later).

In the case of the hohlraum, the principle of the equipartition of energy cannot possibly be true. Since the number of modes of vibration in the hohlraum with frequency greater than any assigned value is infinite, the principle would put all the energy of the hohlraum into the region of short wave-lengths, and would make the amount of energy associated with any single frequency equal to zero, when as a matter of fact, experiment has shown that a mode of vibration of frequency ν actually obtains instead of kT the average energy content,

$$\epsilon_{av.} = \frac{h\nu}{e^{kT} - 1} \quad (8)$$

where h is Planck's new constant.

This conflict between the principle of equipartition and the actual distribution of energy in the hohlraum is, as you know, the difficulty which led to quantum theory.

Structure of Generalized Space ($q_1 \dots p_n$) Proposed by Quantum Theory

To meet this difficulty, both of the two main forms of quantum theory propose a modification of the classical dynamics by ascribing a sort of cell-like structure to the generalized $2n$ dimensional space ($q_1 \dots q_n p_1 \dots p_n$) which can be used for representing the values of the coordinates and momenta of an individual element or molecule of the system.

We cannot discuss here the general theory of determining the equations for the boundary surfaces between the cells in the generalized space. The nature of the net-work of boundaries may easily be illustrated, however, by considering elementary systems

with a single degree of freedom, whose motion is determined by a single coordinate q and a single momentum p .

The instantaneous state of such an element can be represented by the position of a point in the qp plane. In accordance with the classical dynamics this qp plane would be a *continuum*, and, with a system at equilibrium, the chance that an element would have its representative point located in a given infinitesimal region $dqdp$ would vary continuously from point to point in the plane, always being proportional to $e^{-\epsilon/kT}$, as required by the Maxwell-Boltzmann distribution law.

In accordance with quantum theory, however, we must think of the qp plane as traversed by a net-work of curves, such that each curve represents a steady motion of the element without dissipation of energy as determined by the Hamiltonian equations of motion, and such that the area included by each curve is an integral multiple of the universal constant h . Thus the net-work of boundaries is determined by the equations,—

$$\epsilon = \text{constant} \quad (9)$$

$$\int pdq = nh \quad (10)$$

where n is an integer and the integration is to be taken over the “complete” trajectory of the element. (In the case of systems of more than one degree of freedom, equation (10) may be replaced by a similar equation for each pair of coordinates and momenta).

For the case of a simple harmonic oscillator, whose motion is determined by equation (4), it is evident that the boundaries prescribed by equations (9) and (10) are a series of ellipses in the qp plane, (see Fig. 1) such that the area enclosed by each ellipse is an integral multiple of h .

The equation for these ellipses will evidently be

$$\frac{1}{2} aq^2 + \frac{1}{2} bp^2 = \frac{nh\sqrt{ab}}{2\pi} \quad (11)$$

where n is an integer. Substituting the values for ϵ and ν given by equations (4) and (5), we obtain the very significant relation

$$\epsilon = nh\nu \quad (12)$$

which is fundamental to the quantum theory.

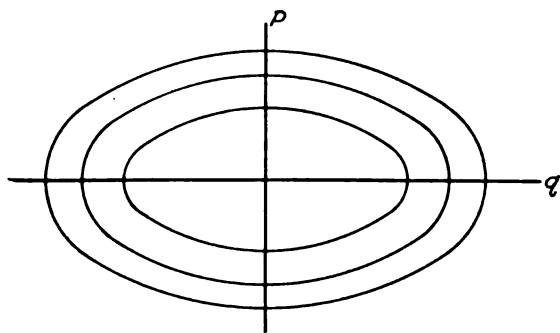

FIG. 1

For the case of a simple system rotating about an axis, with angular velocity $d\phi/dt$, and constant moment of inertia J , the state of the system at any instant can be represented by a single coordinate, the angle $\phi = q$, and a single momentum $p = J\dot{\phi}$. The lines of constant energy content will be parallel to the q axis, and our generalized qp space will have the appearance shown in Fig. 2 where the area of each of the rectangular cells is equal to h , and the kinetic energy corresponding to the boundary lines is given by the equation,—

$$\epsilon = \frac{1}{2J} p^2 = \frac{1}{2J} \frac{n^2 h^2}{4\pi^2} \quad (13)$$

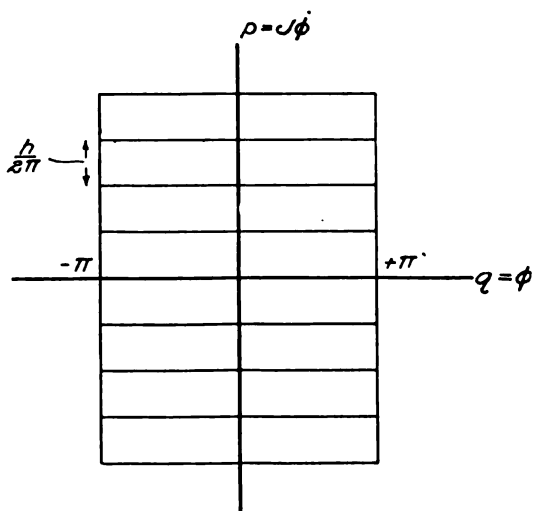

FIG. 2

Difference between the Two Main Forms of Quantum Theory

Both of the two main forms of quantum theory make use of this same net-work of boundary surfaces in the generalized ($q_1 \dots p_n$) space. They differ as to the location of representative points in the generalized space.

In accordance with the *first* and most extreme form of quantum theory, points representing elements, such as molecules or oscillators, are located in general only on the boundary surfaces between the cells. With a system of N elements which has come to equilibrium, the number of elements on the n 'th surface is considered to be determined by the energy ϵ_n , corresponding to that surface, in accordance with the following equation, which has been constructed in analogy to Maxwell's distribution law,—

$$N_n = \frac{N e^{\frac{-\epsilon_n}{kT}}}{\sum e^{\frac{-\epsilon_n}{kT}}} \quad (14)$$

$n=1 \ 2 \ 3 \ \dots$

In this first form of quantum theory, the elements with representative points located on the boundary surfaces perform steady motions without dissipation of energy, in accordance with the Hamiltonian equations of motion, and this steady motion continues, until suddenly for some mysterious reason, perhaps the occurrence of a new "epoch" in a discontinuous time, the representative point jumps to another stationary trajectory where the system again takes up its steady motion. Nothing is known of the mechanism of these "jumps" beyond the fact that there is a conservation of energy and probably also of momentum,—the energy and momentum lost by one element being handed over to other elements which themselves jump simultaneously to new paths.

In accordance with the *second form of quantum theory*, representative points may be located, as in the classical dynamics, any where in the generalized space. The distribution of these points at equilibrium is, however, not determined by the Maxwell-Boltzmann distribution law. Inside of any cell the points are uni-

formly distributed at random while on passage across a boundary from cell to cell there is an abrupt change in the density of distribution. With a system of N elements, the number of elements in the i 'th cell is determined by the *mean* energy $(\epsilon_i)_{av.}$ corresponding to that cell, in accordance with the equation,—

$$N_i = \frac{N e^{-\frac{(\epsilon_i)_{av.}}{kT}}}{\sum_{i=1}^{\infty} e^{-\frac{(\epsilon_i)_{av.}}{kT}}} \quad (15)$$

In the second form of quantum theory, elements, in particular electronic oscillators, with representative points located within the cells can absorb radiant energy in accordance with the classical electromagnetics, but can only emit energy when they cross a boundary, and then emit all the energy which they have assembled. The ratio of the chance of no emission on crossing a boundary to the chance of emission is taken as proportional to the intensity of radiant energy of the frequency in question surrounding the oscillator.

Achievements of the First Form of Quantum Theory

I need not describe to you in detail the numerous and significant achievements of the first form of quantum theory.

Equation (12)

$$\epsilon = nh\nu \quad (12)$$

may be taken in general, as a relation between the frequency ν and amount ϵ of any radiant energy which is absorbed or emitted, and may thus be considered as accounting at least formally for the photoelectric effect, the inverse photoelectric effect, and the frequency relations between absorbed and phosphorescent light.

Furthermore, equation (12) when used to determine the possible energy content of a mode of vibration of frequency ν , combined with equation (14)

$$N_n = \frac{N e^{-\frac{\epsilon_n}{kT}}}{\sum_{n=1}^{\infty} e^{-\frac{\epsilon_n}{kT}}} \quad (14)$$

for the number of modes of vibration with each possible energy value, leads at once to the experimental value for the energy distribution in the hohlraum, and applied to the possible modes of vibration of an elastic solid leads to Debye's theory of the specific heat of solids.

Equation (13)

$$\epsilon = \frac{1}{2J} \frac{n^2 h^2}{4\pi^2} \quad (13)$$

for the possible energy of a rotator, combined with equation (14) for the number of rotators with each possible energy value, leads to reasonably successful theories for the specific heat of diatomic gases, and combined with equation (12) for the relation between the amount and frequency of radiant energy, leads to a theory of the absorption (rotation) spectrum of such gases.

And most important of all, equation (13) for the possible values of the kinetic energy of a rotator leads to a determination of the possible orbits in atoms composed of an electron rotating about a positive nucleus. By calculating the energy dissipated when the electron falls from one of these orbits to another, and applying equation (12) for the relation between the amount and frequency of radiant energy, we obtain Bohr's simple and beautiful theory of the spectral frequencies emitted by the hydrogen atom, and the singly ionized helium atom. Allowing for the slight motion of the nucleus, we account for the difference between the Rydberg constant for hydrogen and helium. Introducing the possibility of elliptical paths and making the relativity corrections for the mass of the electron, we obtain a theory of the fine structure of lines, and allowing for the distortion of these orbits by electric and magnetic fields we obtain a theory of the Stark effect and the Zeeman effect. And finally considering that the more complicated atoms consist of a nucleus surrounded by rings of electrons we can make much progress towards a theory of the spectral frequencies for more complicated atoms than hydrogen and singly ionized helium.

Achievements of the Second Form of Quantum Theory

The second form of quantum theory has proved to be a much more complicated tool than the first form of quantum theory.

The principle that energy can be emitted from an electronic oscillator only in amounts $n h \nu$ may be used to account for the *inverse* photoelectric effect, and combined with the idea that a definite number of the quanta which have been assembled can be lost in the form of the kinetic energy of an electron which is shot off at the time of emission, it accounts for the photoelectric effect.

Equation (15)

$$N_n = \frac{N e^{-\frac{(\epsilon_i)_{av.}}{kT}}}{\sum_{i=1} e^{-\frac{(\epsilon_i)_{av.}}{kT}}}$$

applied to the distribution of electronic oscillators with the mean energy content $(i - \frac{1}{2}) h \nu$, combined with the laws for the absorption and emission of radiant energy, lead to the experimental expression for the energy distribution in the hohlraum.

Progress has also been made with the help of the second form of quantum theory in accounting for the rotational specific heat of gases, for their rotational spectrum, and for the para-magnetism of substances.

The great field of emission spectra has, however, been treated only with the help of the first form of quantum theory.

Ladies and Gentlemen, these achievements of quantum theory, especially in its first and simplest form, are very comprehensive and compelling. Yet even those who are most attracted by quantum theory, are compelled by the whole spirit of science to subject the theory to a rigid though disinterested examination.

Arbitrariness of Quantum Theory

I believe that, as the first fruit of such an examination, one is impressed by a feeling that the procedure adopted by quantum theory is unnecessarily arbitrary. In order to account for a limited range of phenomena, the physicist, and even more culpably the chemist, has introduced the new constant h , whenever, wherever, and in whatever way seemed necessary to account for the particular phenomena under examination. This feeling of arbitrariness has been greatly decreased as the number of achievements, parti-

cularly of the first form of quantum theory, have increased, and as the rules for introducing boundaries into the generalized space of dynamics have been elaborated. Nevertheless, even though the first form of quantum theory is becoming internally a more logical whole, it still creaks badly when we try to fit it into the much greater logical whole of the rest of physics, and thus fails in general to give that feeling of logical necessity which accompanied the introduction of the theory of relativity.

Contradictions between Quantum Theory and the Undulatory Theory of Light

As a second criticism of quantum theory, we must point out once more the well-known contradictions between the undulatory theory of light and quantum theory, in its simpler and otherwise most satisfactory forms.

The first form of quantum theory, which is by far the simpler and more completely elaborated, requires that radiant energy be of such nature that it can be practically instantaneously absorbed in definite quanta of magnitude $h\nu$. This seems to mean that radiant energy exists only in indivisible quanta, which travel around through space with the velocity of light.

The reconciliation of such an idea with all the facts of the undulatory theory of light is very difficult. Since interference can be obtained with a difference in path of about a million wave-lengths, the dimensions of these quanta must be of the order of at least a foot, which seems difficult to believe if the quanta are indivisible. Furthermore, if quanta were indivisible, the advantages of a large telescope over a small telescope could only be to permit the entrance of more quanta. This would increase the intensity of the star image, but would presumably not increase the resolving power of the telescope as is actually found to be the case. Other difficulties will readily suggest themselves.¹

It was, of course, these difficulties which led to Planck to propose his second form of quantum theory in which the absorption of radiant energy by an atom would follow in accordance with the classical electromagnetics. This form of the theory is in

¹ Compare Jeans' *Dynamical Theory of Gases*, 3rd ed., p. 378.

other ways, however, not nearly as satisfactory as the more extreme form. Thus, for example, it can be shown that electrons are emitted in the photoelectric effect, immediately after the light is turned on, and before any individual atom has had time enough to assemble a quantum of energy on the basis of the classical electromagnetics.²

Conflict between Quantum Theory and Classical Dynamics

As a third criticism of quantum theory, I cannot help but feel that up to date it has been too cavalier in its treatment of the classical dynamics.

The classical dynamics flows like an unpolluted river from a single source. This source is, of course, the axiom or postulate known as Hamilton's principle (Equation 1). Not only is this principle a remarkably simple one, with a significance which can be intuitively grasped, but owing to the infinite variety of ways in which the Lagrangian function L can be made to depend on the coordinates and velocities, the results which can be obtained from the principle would seem to contain variety enough to fit any new field of physics that might arise. Hitherto, no branch of physics has escaped its control. Even the theory of relativity has in no way disturbed its sway. I feel that the present forms of quantum theory have attempted to abandon this principle, long before they have exhausted its possibilities.

To be more specific, I believe that when confronted by the conflict between the known facts as to the distribution of energy in the hohlraum and the principle of the equipartition of energy, the attempt should first have been made, not to invent a new form of dynamics, but to examine whether the older dynamics actually leads to the principle of the equipartition of energy for all kinds of coordinates and momenta. Such an examination shows as a matter of fact, that only those coordinates and momenta which enter into the expression for energy in the quadratic form will contribute the term $\frac{1}{2}kT$ to the average energy.

Systems of elements or molecules, for which the principle of the equipartition of energy cannot be expected to hold, are

² See Norman Campbell, *Modern Electrical Theory*, 2nd ed., p. 249.

already well known, quite apart from the development of quantum theory. Thus the average potential energy of the molecules in a vertical tube subjected to the action gravity is not $\frac{1}{2} kT$, but another value which depends on the height of the tube, and actually becomes kT instead of $\frac{1}{2} kT$ for a tube of infinite height. And as another example, the average kinetic energy of a system of particles of stationary mass m_0 , which obey the relativity laws of motion is not $\frac{3}{2} kT$, but is given by a series which has as its first two terms³

$$\epsilon_{av.} = \frac{3}{2} kT + \frac{9}{8} \frac{k^2 T^2}{m_0 c^2} + \dots \quad (16)$$

These results are obtained, moreover, not by giving up the classical statistical mechanics, but are derived directly from the Maxwell-Boltzmann distribution law by substituting for ϵ the correct expression for the energy of an element in terms of its coordinates and momenta $q_1 \dots p_n$.

As to the modes of vibration of the hohlraum, I pointed out some years ago⁴ that if the energy of a mode of vibration were given by the equation,

$$\epsilon = h\nu \left\{ \epsilon - \left(\frac{h\nu}{\frac{1}{2} a q^2 + \frac{1}{2} b p^2} \right)^m + e - \left(\frac{2h\nu}{\frac{1}{2} a q^2 + \frac{1}{2} b p^2} \right)^m + \dots \right\} \quad (17)$$

where m is a large number, the average energy for such modes of vibration as determined by substituting this expression for ϵ into the Maxwell-Boltzmann distribution law would actually have the value

$$\epsilon_{av.} = \frac{h\nu}{e^{\frac{h\nu}{kT}} - 1}$$

entirely on the basis of the classical statistical mechanics.

I do not wish to give the impression that the energy of a mode of vibration is actually represented by equation (17), but merely to show that expressions are entirely possible which would give the Planck equation for the distribution of energy in the

³ See for example, Tolman, *Phil. Mag.* 28, p. 583, 1914, or *Theory of the Relativity of Motion*, Univ. of Calif. Press, 1917.

⁴ *Phys. Rev.*, 11, p. 261; 1918.

hohlraum. As originally pointed out, equation (17) might be entirely satisfactory for determining the distribution of radiant energy by performing the necessary integrations, and yet not satisfactory for determining, by differentiation, the equations of motion of the mode of vibration. As a matter of fact, this seems to be the case and for purposes of differentiation relations differing from equation (17) are preferable.

This may be illustrated by plotting the value for the energy of a mode of vibration ϵ , against the usual expression for this quantity $\frac{1}{2} a q^2 + \frac{1}{2} b p^2$, as shown in Fig. 3.

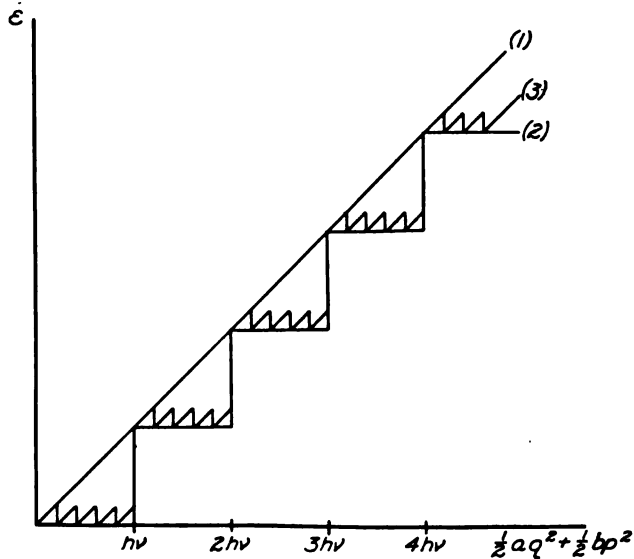

FIG. 3

Line (1) in this plot represents the usual relation between energy and the coordinates and momenta

$$\epsilon = \frac{1}{2} a q^2 + \frac{1}{2} b p^2$$

and systems having this equation will have the average energy kT instead of the Planck value

$$\frac{h\nu}{e^{\frac{h\nu}{kT}} - 1}$$

Line (2) which consists of a series of horizontal and vertical steps, represents the relation given by equation (17), which leads to the desired distribution of energy. It can easily be shown by differentiation, however, that systems whose motion is determined by equation (17) would *not* oscillate with the frequency

$$\nu = \frac{\sqrt{ab}}{2\pi}$$

As a matter of fact, systems with their representative points located on a horizontal part of the line would be stationary, and systems with a representative point located on a vertical part of the line would oscillate with zero amplitude and infinite frequency.

In order to obviate this difficulty it is possible to replace the horizontal lines by a number of steps as shown by line (3), each consisting of a diagonal and a vertical part. If the number of such steps is made large we shall obtain the Planck distribution of energy. Furthermore, systems with points located on the diagonal lines will oscillate with the desired frequency ν , and the number of representative points located on the other parts of the line become zero when these parts become absolutely vertical. Line (3) would thus have many, if not all, of the characteristics necessary for a satisfactory relation between the energy of a mode of vibration and the values of its coordinate and momentum. It would suggest, moreover, modes of vibration which "break" at a given energy content, an idea which is not out of harmony with some of the ideas of chemistry.

Nevertheless, I still do not wish to claim that line (3) does represent the true equation for the energy of a mode of vibration in the hohlraum. What I do wish to emphasize, is the enormous possibilities still resident in the classical mechanics to account for distributions of energy other than equipartition. Until these possibilities have been investigated, the abandonment of the classical mechanics, proposed by quantum theory, must be regarded, I believe, as in the nature of tentative experimentation.

As to the possibilities which must be considered, I should put first a consideration of the various expressions for ϵ in terms of a single coordinate and momentum which would give a distribution

of energy the same or similar to that of Planck's. Corresponding to the fact that the Lagrangian function L can depend on the coordinates and velocities in an infinite variety of ways, it is evident that the energy ϵ can depend on the coordinates and momenta in an infinite variety of ways, and hence there is a very great possibility that an expression for ϵ will be found which will have the desired characteristics. Nevertheless, if such considerations do not lead to a satisfactory solution of the problem, we might next consider expressions in which the energy of a mode of vibration is made dependent on the energy of neighboring modes of vibration. This will open up a new realm of possibilities. If these are not sufficient, I think we might then venture to investigate the validity of those initial stages in the development of statistical mechanics, where the authority of Liouville's theorem is invoked to prove that all the "microscopic" states of a system are equally probable. Only upon the failure of all the above three methods of attack, would I venture to assume that Hamilton's principle can be lightly discarded as seems to be the pleasure of the extreme advocates of quantum theory.

Unsatisfactoriness of the Atom Model of Quantum Theory

As a final criticism of quantum theory, I think we must regard the atomic model furnished by this theory as only partially satisfactory. This atom was constructed by the physicists, like a solar system, with electrons rotating around a central nucleus, partly because the physicists were familiar with the mechanics and mathematics of the solar system, and partly because they were entirely unfamiliar with the actual facts concerning the behavior of atoms in chemical combination. No chemist would be willing to think of a carbon atom as a positive nucleus with rings of electrons rotating around it in a single plane. The carbon atom must have tetrahedral properties, and in general I feel that the cubical atom of Lewis and Langmuir must be regarded as representing chemical facts better than anything proposed by the physicists.

A possible escape from these difficulties would be for the quantum theory to abandon the simple ring-like structure for

most of the atoms, leaving, however, the ring structure for hydrogen and singly ionized helium where the success of quantum theory has been most pronounced. Another possibility would be to retain the ring structure for atoms when they are in a dissociated form and emitting their spectra, and introduce a change in configuration to a three dimensional arrangement when the atom enters into chemical combination.

There is a further unsatisfactoriness which seems inherent in the Bohr model of the hydrogen atom. This model provides the hydrogen atom with an infinite number of stable rings in which the electron can rotate around the nucleus without loss of energy. Taking the energy of the electron in the innermost ring as zero, the energy in successive rings will have the values

$$0 \quad \frac{3}{4}hN \quad \frac{8}{9}hN \quad \frac{15}{16}hN \quad \dots \quad hN \tag{18}$$

Hence when the electron falls from one ring to another the energy emitted can always be expressed by the formula

$$\epsilon = hN \left(\frac{n_2^2 - 1}{n_2^2} - \frac{n_1^2 - 1}{n_1^2} \right) = hN \left(\frac{1}{n_1^2} - \frac{1}{n_2^2} \right) \tag{19}$$

and if we combine this with the equation $\epsilon = h\nu$ we account for the spectral frequencies of the hydrogen atom.

It must be pointed out, however, that such an explanation of these frequencies is entirely *formal*. Except for the special case of an electron falling from one of the outermost rings to the next ring, there is no actual frequency in the atom which corresponds to the frequency ν which is calculated. The frequency of rotation in the rings does not correspond to the frequency of the emitted light, and no mechanism is provided in the path connecting the rings which would have the desired frequency.

It would seem desirable to provide a mechanism which would produce oscillations of the required frequency ν when the energy emitted is $h\nu$. To illustrate this, I have constructed an apparatus provided with an electron in the shape of a one inch steel ball and energy levels, where the gravitational energy of the ball assumes the values

$$0 \quad \frac{3}{4} hN \quad \frac{8}{9} hN \quad \dots \quad hN$$

Each energy level is connected with every lower energy level by a cycloidal path where the frequency of oscillation of the ball is related to the energy dissipated by the equation $\epsilon = h\nu$.

This structure is in no sense a model of the hydrogen atom but rather a model which has some of the properties which it might be desirable to insert in the final model of the hydrogen atom.

Various interesting though tentative speculations can be based on this model,—as to the work necessary to produce any radiation at all,—as to the simultaneous appearance of lines in the different series,—as to the relative intensity of lines,—as to the creation of a field of force by the mutual interaction of nucleus and electron which will maintain the desired frequency of oscillation,—as to the work necessary in breaking chemical bonds,—and as to other matters which will suggest themselves to you. However, I do not wish to claim much for the model, especially as I am temperamentally opposed to the whole model method in theoretical physics.

Ladies and Gentlemen, I wish to thank you for the patience with which you listened to my prolonged remarks. In conclusion, I think that we must definitely state that the introduction of the quantum theory must be regarded as still an experiment, although an elaborate, courageous and hopeful one. But perhaps after all, life, itself, is always a bit experimental and only the boldest experimenters can achieve the greatest failures *and* the greatest successes.

FIXED NITROGEN RESEARCH LABORATORY
WASHINGTON, D. C.

MATHEMATICAL ASPECTS OF QUANTUM THEORY*

BY
H. B. PHILLIPS

1. *Fundamental Hypotheses.*—Without attempting to present the somewhat divergent views of the many writers on the subject, I propose in this paper to sketch a method of treatment (mainly following Sommerfeld) which suffices for the applications so far made. In the application existing theories, such as statistical mechanics, have been used. We are concerned only with the peculiarly quantum part of such applications.

There are two types of problems to which quantum theory has been applied, each being solved by making a fundamental hypothesis.

(1) To determine the frequency of the radiation emitted when an electron changes from one steady (non-radiating) state to another.

This is accomplished by the hypothesis of Planck and Bohr, that

$$W_1 - W_2 = h\nu, \quad (1)$$

where W_1 is the energy of the electron in the first state, W_2 its energy in the second, and h is Planck's constant. This may be briefly called the *hypothesis of energy quanta*.

(2) To determine the fixed orbits, or steady states, in which the electron can move without radiating.

To handle this with some degree of generality, consider a conservative system whose position is determined by r coordinates

$$q_1, q_2, \dots, q_r.$$

Let its kinetic energy by T and let

$$p_i = \frac{\partial T}{\partial \dot{q}_i}, \quad \dot{q}_i = \frac{dq_i}{dt}.$$

*Presented at Toronto, Dec. 29, 1921, before Joint Session of American Physical Society with Sections B and C of the American Association for the Advancement of Science.

Suppose further that its kinetic and potential energy

$$T = T(p_1, p_2 \dots p_r, q_1, q_2 \dots q_r),$$

$$V = V(q_1, q_2 \dots q_r),$$

do not explicitly contain the time.

Sommerfeld's hypothesis is that if the integrals are taken around a closed orbit described by the electrons in a steady state

$$\int 2T dt = \int \sum_1^r p_i dq_i = n h, \quad (2)$$

where n is an integer.

In the most important cases the variables can be separated, that is, each momentum p_i can be expressed in the form

$$p_i = f_i(q_i, c_1, c_2, \dots c_r)$$

where $c_1, c_2, \dots c_r$ are constants of integration. In general q_i then oscillates periodically between fixed limits a_i, b_i . In this case, Sommerfeld assumes that an equation of the form (2) applies separately to each coordinate, that is,

$$2 \int_{a_i}^{b_i} p_i dq_i = n_i h \quad (3)$$

where n_i is an integer.

Equations (2) and (3) express what may be called the *principle of action quanta*. Equation (2) expresses that the total action around a closed orbit is a multiple of Planck's constant. Equation (3) states that in case the variables separate, each component of action is a multiple of Planck's constant.

The orbits of the electrons are determined by ordinary dynamics, equations (2) and (3) being used merely to determine the constants of integration in terms of the quantum integers n .

It is interesting to note that if we apply (2) to the emitted radiation, (1) may be considered a consequence of (2) and so the whole theory may be considered a theory of action quanta. For in electrical systems magnetic energy is kinetic and electric energy potential. Since in radiation these are equal, the total energy is

$$W = 2T.$$

Apply (2) to the entire system of waves emitted by an electron

in a change from one steady state to another. The total energy of this system is the constant $W_1 - W_2$ and its period is

$$\tau = \frac{1}{\nu} .$$

Hence

$$\int_0^\tau 2T dt = \int_0^\tau (W_1 - W_2) dt = \frac{W_1 - W_2}{\nu} = n h .$$

This gives

$$W_1 - W_2 = h \nu$$

if we take $n = 1$. From this it might appear that radiant energy exists in only one quantum state, $n = 1$.

2. *Method of General Dynamics.*—Sommerfeld defines a function S by the integral

$$S = \int_0^t 2T dt, \tag{4}$$

the integral being taken along an orbit from the time 0 to t . It is a function of the initial values of $p_1, \dots, p_r, q_1, \dots, q_r$, and the time. If the total energy is

$$W = T + V = H(p_1, \dots, p_r, q_1, \dots, q_r), \tag{5}$$

the function S can be expressed in terms of q_1, q_2, \dots, q_r, W , and $r - 1$ constants of integration, a_2, \dots, a_r , in the form

$$S = S(q_1, \dots, q_r, W, a_2, \dots, a_r)$$

Then

$$\frac{\partial S}{\partial q_i} = p_i, \quad \frac{\partial S}{\partial W} = t. \tag{6}$$

Substituting these values in (5) it is seen that S is a solution of Jacobi's partial differential equation

$$W = H\left(\frac{\partial S}{\partial q_1}, \dots, \frac{\partial S}{\partial q_r}, q_1, \dots, q_r\right). \tag{7}$$

Conversely, Jacobi's theory shows that any solution of (7) in the form

$$f(q_1, \dots, q_r, W, a_2, \dots, a_r) + a,$$

will satisfy (6) and so can be used for S .

The most important cases are those in which the variables can be separated, that is, when

$$S = S_1 + S_2 + \dots + S_r,$$

S_i containing only the one coordinate q_i and the constants of integration. In this case

$$p_i = \frac{\partial S}{\partial q_i} = \frac{\partial S_i}{\partial q_i}$$

contains only one coordinate q_i . If this oscillates between the limits a_i, b_i , the quantum condition is applied in the form (3)

$$2 \int_{a_i}^{b_i} p_i dq_i = n_i h.$$

If one of the coordinates is an angle ϕ , this is naturally replaced by

$$\int_0^{2\pi} p_\phi d\phi = n h.$$

Systems of the kind just discussed are called conditionally periodic. Since all the cases so far treated on conditionally periodic, we might limit the hypothesis of action quanta to this case and leave the question whether the theory applies to any other cases undetermined.

As a simple example, consider the case of an electron of charge $-e$, moving around a nucleus of charge E . In this case

$$\begin{aligned} T &= \frac{1}{2} m [\dot{r}^2 + r^2 \dot{\phi}^2], & V &= -\frac{eE}{r} \\ p_r &= m\dot{r} & p_\phi &= mr^2\dot{\phi}, \\ W &= \frac{1}{2m} \left[p_r^2 + \frac{1}{r^2} p_\phi^2 \right] - \frac{eE}{r} \end{aligned} \quad (8)$$

If we take

$$\frac{\partial S}{\partial \phi} = p_\phi = \text{const.},$$

equation (8) shows that

$$\frac{\partial S}{\partial r} = p_r$$

will be a function of r only. The variables can therefore be separated. The quantum condition

$$\int_0^{2\pi} p_\phi d\phi = nh$$

gives

$$p_\phi = \frac{nh}{2\pi} \quad (9)$$

Substituting this value in (8) and solving for p_r , the second quantum condition

$$2 \int p_r dr = n_1 h$$

can be integrated between the limiting values of r and the result solved for W , giving

$$W = -\frac{2\pi^2 m e^2 E^2}{h^2 (n + n_1)^2} \quad (10)$$

Equations (9) and (10) express the constants of integration p_ϕ and W in terms of the quantum integers n and n_1 .

3. *Degenerate Systems.*—In some cases, called degenerate, the variables are separable in more than one system of coordinates. In case, for example, of the electron moving in an elliptic orbit around a nucleus, the variables can be separated in rectangular as well as in polar coordinates. The quantum conditions (3) obtained by using different systems of coordinates do not in general agree. This appears to violate the fundamental hypothesis. This is not actually the case; for, if the problem is treated exactly, the variables are always found to separate in only one way. Thus, in case of the elliptic orbit, if we take account of relativity, the variables are separable in polar but not in rectangular coordinates.

Geometrically, the orbit usually oscillates between a set of curves or surfaces. In the general case, the orbit is what is known as a space filling curve, that is, it traces over the entire area or volume of a cell. With change of initial conditions the size of the cell changes. Thus the walls of the cells define systems of parameter curves or surfaces. Using these as coordinate curves or surfaces, the variables can be separated. In case of a degenerate system the orbit lies in a lower space, and does not fill the interior of the cell. Hence the boundaries can be determined in more than one way.

Thus, in relativity the orbit about a center of force does not close but slowly precesses, and so fills the whole interior of a

circle. With change of initial conditions the circle changes size. The natural coordinates are therefore the system of concentric circles and the straight lines orthogonal to them, i. e., polar coordinates. If, however, we neglect relativity, each orbit is a definite ellipse. A series of curves tangent to the different ellipses can be determined in more than one way.

DEPT. OF MATHEMATICS
MASSACHUSETTS INSTITUTE OF TECHNOLOGY.

SOME RECENT APPLICATIONS OF THE QUANTUM THEORY TO SPECTRAL SERIES*

BY
SAUL DUSHMAN

Just about 21 years ago, almost to a day, Planck presented to the world a suggestion which has profoundly influenced the development of both physics and chemistry during the intervening period. The conception that energy is emitted or absorbed by atomic systems in multiples of a unit quantum $h\nu$, may be regarded from one point of view as quite similar to the atomistic ideas previously developed regarding the nature of matter and electricity.

The application of this energy concept in accounting for the apparent deviations in atomic heats from the deductions of the classical principle of equipartition and from the empirical law of Dulong and Petit, laid the foundations for a radical development in thermodynamics. The Nernst Heat Theorem and the derivation of a relation for the hitherto undetermined integration constant in the applications of the second law of thermodynamics, together with the quantum theory relations for specific heats, enable us to calculate accurately the available energy of chemical and physical reactions.

Not the least of the resulting developments in the field of thermodynamics is, however, the light which has been shed by these new conceptions on the nature of that hitherto little understood function known as entropy. Boltzmann had suggested long ago that from a kinetic theory point of view entropy must be regarded as indicating a probability. The second law of thermodynamics demands that in all energy transformations the entropy must either increase or not change at all. This means, according to kinetic conceptions, that nature prefers a more

*Presented at Toronto, Dec. 29, 1921, before Joint Session of American Physical Society with Sections B and C of the American Association for the Advancement of Science.

probable to less probable states. But it is obvious that probability can only exist where there are discontinuities. Now since the entropy of radiant heat may be considered from this point of view, it necessarily leads to an atomistic conception for radiation. In this manner it is therefore possible to correlate entropy with a quantum theory of radiation.

These achievements mark, as it were, the first stage in the application of the theory of energy quanta to physical phenomena. The beginning of the second stage was signaled by the appearance in January, 1913, of a paper by the Danish physicist N. Bohr, dealing with the application of the quantum theory to the problem of emission of spectral series and that of atomic structure. Of the profound impression made by this publication and its effect on the trend of scientific investigations during recent years, it is hardly necessary to speak at length on the present occasion.

In the following paper, we will rather discuss to a limited extent certain more recent developments of Bohr's point of view which bid fair to be of greatest importance, not only in the solution of some still outstanding problems regarding the origin of spectral series, but also in the determination with greater exactitude of the structures of atoms, which give rise to these spectral series.

As well known, Bohr's theory rests upon the experimental evidence obtained by Rutherford that the atom consists of a nucleus of positive charge, Ne , at the center and a number, N , of electrons distributed in one or more rings or shells around this nucleus. As shown by Moseley, the value of N corresponds to the place of the element in the Periodic Table.

The first assumption made by Bohr is that an atomic system of this nature can exist permanently only in a certain series of orbits of electrons corresponding to a *discontinuous* series of values for the total energy. These are known as stationary states and for such orbits Bohr assumes the validity of the ordinary laws of mechanics. In order to assure stability of positive and negative charges at a finite distance from each other Bohr assumes that the attractive forces between the charges are balanced by a

centrifugal force due to rotation of the electrons in circular (or elliptical) orbits about the nucleus. According to classical electrodynamics, such an arrangement is impossible, since the electron would radiate energy and thus gradually spiral into the nucleus. Bohr, however, assumes that an electron may revolve in an orbit without radiation of energy.

From the application of the laws of ordinary dynamics to such an orbit, we can obtain only a relation between the radius (major axis) and the frequency of revolution, which is similar to that derived by Kepler for planetary orbits. By means of a very fundamental assumption, the absolute magnitudes of these orbits may be calculated. This assumption is that the *angular momentum* of the electron in any one orbit is equal to $\frac{nh}{2\pi}$ where n is a whole number. Only such orbits are considered by Bohr as stationary states. We shall refer to this postulate again in a slightly modified form. It represents the most important guiding principle in all recent applications of the quantum theory to problems of emission of spectral series.

Bohr postulates that radiation is emitted or absorbed by an atomic system only during the transition of an electron from one orbit to another. According to classical theory, if the atom emits a certain energy $W_i - W_f$ corresponding to the difference in energy content for the initial and final orbits, the radiation would appear as light of continually increasing frequency, since the electron must approach the nucleus during this process. Bohr assumes, however, that the energy radiated is *unifrequent* or *monochromatic*, and the frequency, ν , is given by the quantum relation

$$h\nu = W_i - W_f \quad (1)$$

The conclusions based on these considerations were found to be in most satisfactory accord with the observed frequencies of the lines in the series spectrum of hydrogen and helium as expressed by the Balmer series

$$\nu = N \left(\frac{1}{m_1^2} - \frac{1}{m_2^2} \right) \quad (2)$$

where m_1 and m_2 are whole numbers. The value of N , the Rydberg constant, as calculated by Bohr, agreed excellently with the observed value.

The theory as first put forward in 1913 has since been modified by Bohr himself, Sommerfeld and others. This modification has proceeded mainly in the direction of making the theory more generally applicable to such cases as the spectral lines of atoms containing more than one electron and also towards accounting for the fine structure of the lines, and the phenomena observed in the Zeeman and Stark effects. Still more recently, Bohr has developed a principle by which, apparently, the gap between the classical electro-dynamical theory and the quantum theory as originally enunciated by Planck, has been partly, at least, bridged.

It is well, before proceeding with the discussion of this more recent development, to emphasize the two essential features in Bohr's theory, as first postulated.

The first one is the identification by Bohr of the frequencies of spectral lines with *differences* in energy levels corresponding to different stationary orbits of an electron in the atom. This is the significance of equation (1). Now it has been shown that the frequencies of spectral lines can be expressed by a generalized form of equation (2) of the type:

$$\nu = \frac{f(n_1)}{n_1^2} - \frac{f(n_2)}{n_2^2} \quad (3)$$

where n_1 and n_2 are whole numbers and $f(n)$ is a function of n and the Rydberg constant. According to Bohr's theory each of these terms in the equation corresponds to a certain amount of energy of the atomic system, which is the negative of the work required to remove the electron from the corresponding orbit to infinity.

The second essential postulate in the theory is that regarding angular momentum, which has been stated above.

In extending these postulates to more complex atomic systems, use has been made of a very important theorem of general dynamics due to Hamilton. According to this theorem there exist, for any conservative system, certain coordinates and corresponding

momenta such that in them the equations of motion assume the Hamiltonian canonical form. These coordinates are therefore of great utility in the treatment of dynamical problems where we know the total energy as a function of these canonical variables and the corresponding momenta.

Given a system undergoing periodic changes with such coordinates q_1, q_2, \dots, q_k , and the corresponding momenta, p_1, p_2, \dots, p_k , it was shown by Wilson and Sommerfeld that the assumption regarding angular momentum in a circular orbit may be generalized for all kinds of periodic orbits as follows:

For any co-ordinate q and the corresponding moment p ,

$$\int p dq = nh \quad (4)$$

where the integration is carried out over a complete cycle.

It is necessary to make one more observation regarding the number of these coordinates. It is evident that this will correspond to the number of degrees of freedom of the system in the conditions under consideration.

For an electron in a given circular orbit it is readily seen that only one coordinate (or parameter) is necessary. The position of the electron at any instant of time can be specified by the *azimuthal* angle ϕ with respect to any given initial position of the radius as axis of reference. In this case we have only one quantizing condition.

In the case of an ellipse, we require besides the azimuthal angle ϕ , also the length of the radius vector, r . We must therefore have two integrals, for each of which the values of n may be different, viz:

$$\int_0^{2\pi} p_\phi d\phi = n_1 h \quad (4a)$$

$$\int_{\phi=0}^{2\pi} p_r dr = n_2 h \quad (4b)$$

where n_1 is designated the azimuthal quantum number, and n_2 , the radial quantum number.

When we come to discuss the motion of an electron in an orbit under the influence of an external field in a given direction, we

obviously have to introduce a third quantizing condition, corresponding to the position of the orbit at any instant with respect to the direction of the field. Denoting the angle between the direction of the field as axis and the radius vector by ϑ , we have the additional equation

$$\int p_{\vartheta} d\vartheta = n_3 h \quad (4c)$$

where the integration is extended over the whole range of values $\vartheta_{\min.}$ to $\vartheta_{\max.}$ and back again to $\vartheta_{\min.}$

Applying Bohr's arguments to an electron rotating about a nucleus in an elliptical orbit, Sommerfeld derived an expression for the frequencies of the lines in the hydrogen spectrum of the form

$$\nu = \frac{N}{(n_1 + n_2)^2} - \frac{N}{(m_1 + m_2)^2} \quad (5)$$

where n_1 , m_1 , refer to the azimuthal, and n_2 , m_2 to the radial quantum numbers.

Since the terms in the denominators can have any integral values we choose, it would appear off-hand that this equation does not differ from Bohr's simpler equation (2). Sommerfeld's equation does, however, indicate different possible transitions which may lead to a particular frequency in the spectral series, corresponding to the different possible values of n_1 and n_2 for a given value of their sum. The same holds true for the term involving m_1 and m_2 .

Under certain conditions this difference in origin does appear. In an elliptic orbit the velocity of the electron changes as it passes from the perihelion to the aphelion position, and in accordance with the theory of relativity this affects the average energy of the atomic system. Hence the frequency of the radiation emitted when the electron passes from say an elliptic orbit of greater eccentricity to one of less eccentricity is slightly different from that obtained when the orbits are each circular, even though the sum of the two quantic numbers is the same for the elliptic and circular orbits corresponding to each stationary state. In this manner, Sommerfeld was able to account for the fine structure of the lines in the spectra of hydrogen and ionized helium.

Similar effects are produced in the case of more complex atoms by the action of the internal field due to the inner electrons. In fact, this accounts for the observation that the Balmer series for hydrogen and helium splits up in the case of more complex elements into a principal, sharp and diffuse series.

The same considerations also account for the phenomena observed in presence of electrostatic fields (Stark effect) and magnetic fields (Zeeman effect). In all these cases the individuality of the different modes of producing the same spectral line in the Balmer series is only brought out under the influence of any disturbing force, whether this be due to lack of symmetry, as in the effect of variation in the mass with velocity, or to an internal or external field of force.

Observations on both the Stark and Zeeman effects have shown that certain lines are circularly polarized and others linearly polarized, also that the number of components into which a single line in the undisturbed state splits up in the presence of a weak field is usually less than the number that might be expected from the consideration of purely arithmetical possible combinations between given values of $n_1 + n_2$ and $m_1 + m_2$.

Thus given $n_1 + n_2 = 3$, and $m_1 + m_2 = 4$, we might expect $3 \cdot 4 = 12$ components of this line. As will be shown below, a much smaller number is actually observed. The reason for this has been ascribed both by Rubinowicz and Bohr to the existence of a certain Selection Principle (Auswahlprincip). The considerations advanced by each of these in arriving at this result are, however, different, and to a certain extent Bohr arrives at this "principle" as a deduction from a much more general theorem which he has designated as the *Principle of Correspondence*.

Rubinowicz's argument is that in the emission of radiation during the transition of an electron from one stationary state to another there must be equivalence firstly, between the amount of energy emitted by the atomic system and that taken up by the ether as electromagnetic energy, (this, of course, follows from the Law of Conservation of Energy), secondly between the decrease in angular momentum of the electron and the increase in electromagnetic moment of momentum which can be ascribed

to the spherical wave system produced in the ether. That is, Rubinowicz postulates the laws of conservation both with respect to energy and also electromagnetic momentum. Calculating the electromagnetic moment of the momentum of the spherical wave radiated from the atomic system by the method of classical electro-dynamics, he arrives at the conclusion that only those transitions between stationary orbits are possible for which the change in azimuthal quantum number does not exceed unity. That is, if n_1 and n_2 denote the azimuthal quantum number for two different orbits, there are three possibilities, and *only three*, viz:

$$\begin{aligned} n_1 - n_2 &= +1) \\ n_1 - n_2 &= 0 \quad) \\ n_1 - n_2 &= -1) \end{aligned} \quad (6)$$

Furthermore an investigation of the nature of the radiation emitted under these conditions shows that for

$$\Delta n = \pm 1$$

the light emitted is circularly polarized. The case $\Delta n = 0$ is rather uncertain and two possibilities may arise. Either the light emitted is linearly polarized, or else there is no emission at all. As shown by Bohr, the latter alternative is the correct one.

We can illustrate the application of this principle by applying it to the case previously mentioned, of the spectral lines for which

$$\nu = \frac{N}{(n_1 + n_2)^2} - \frac{N}{(m_1 + m_2)^2} \quad (7)$$

where $n_1 + n_2 = 3$, and $m_1 + m_2 = 4$.

The following table shows the possible transitions by which such a frequency may be caused.

In this table are tabulated under ϕ and r the possible values of n_1 and n_2 respectively, for each value of $n_1 + n_2$, and similarly for $m_1 + m_2$. The values $n_1 = 0$, $n_2 = 3$ and $m_1 = 0$, $m_2 = 4$ are not permissible since these would correspond to a linear oscillation of the electron through the nucleus.

The values $n_1 = 3$, $n_2 = 0$, and $m_1 = 4$, $m_2 = 0$ correspond to circular orbits; all the others correspond to elliptical orbits with varying eccentricities.

Table 1

$n_1 + n_2 = 3$			$m_1 + m_2 = 4$	
ϕ	r		ϕ	r
3	0	←	4	0
2	1	←	3	1
1	2	←	2	2
			1	3

According to the Principle of Selection only those transitions can occur which are indicated by the arrows. Hence, instead of 12 possible components we actually find only 5. The polarization of the lines observed in the Stark and Zeeman effects also agrees with the rule given by Rubinowicz.

It must be observed that in presence of very strong fields of force it is no longer possible to equate the momentum lost by the atomic system with electromagnetic moment of momentum gained by the ether as radiation. Thus both energy and momentum may be transferred from one atomic system to another, or to an electron with high kinetic energy. Under these conditions therefore the Principle of Selection is no longer applicable.

As mentioned already, Bohr has also deduced a selection principle which, while agreeing in the main with that derived by Rubinowicz, is more stringent, although derived from more general considerations. Bohr himself designates this generalization as the *Principal of Correspondence*. Sommerfield in his latest edition of "Atombau and Spektrallinien" uses the term "Principle of Analogy." In broad terms, this principle "gives expression," according to Bohr,¹ "to the tendency in the quantum theory to see not merely a set of formal rules for fixing the stationary state of atomic systems and the frequency of the radiation emitted by the transitions between these states, but rather an attempt to obtain a rational generalization of the electromagnetic theory of radiation which exhibits the discontinuous character necessary to account for the essential stability of the atoms."

It will be remembered that in the derivation of the quantum theory of line spectra and in all its subsequent applications there

¹ Nature, Mch. 24, 1921, p. 104. See also Zs. f. Physik, 2, 423, 1920; and The Quantum Theory of Line Spectra, Copenhagen, 1918.

is a careful differentiation between the frequency of rotation (ω) of an electron in its orbit and the frequency (ν) of the monochromatic radiation emitted when the electron passes from this orbit to some other orbit. The frequency of rotation is given by the total energy of the system in the corresponding orbit, while the frequency of radiation is given by the difference in energy content of the two stationary states (or orbits).

In his first paper Bohr assumed that during the transfer of an electron from an infinite distance into its final position of equilibrium, the frequency of radiation emitted is the average of the initial and final values of the frequency of rotation, that is,

$$\nu = \frac{\omega}{2}$$

Subsequently he substituted for this assumption, the postulate regarding angular momentum, as this appeared much more logical. It indicates, however, that at the very beginning Bohr searched for some connection between the frequencies of rotation of the electron in orbits corresponding to two stationary states and the frequency of the radiation emitted during the transition. According to ordinary electro-dynamics such a relation ought to exist, and for an electron rotating in a circular orbit, the frequency of light emitted ought to be equal to the frequency of rotation.

It will be remembered that the relation derived by Planck on the basis of the quantum theory, for the relative distribution of intensities in black body radiation, agrees asymptotically with the Rayleigh-Jeans equation for low frequencies. In an analogous manner Bohr approaches the problem of deriving a relation between frequency of rotation and frequency of radiation, by the consideration of stationary states of the atomic system for which the quantum numbers n_1 and n_2 are very large compared to their difference $n_2 - n_1$.

Now it can be shown that for such orbits, the frequency of radiation emitted is connected with the frequency of rotation by the approximate relation

$$\nu \sim (n_2 - n_1)\omega, \tag{8}$$

where ω is the average frequency of rotation in the two orbits.

The values of n_1 or n_2 used in this equation correspond to the sum of the three quantum numbers referred to in equations (4).

Equation (8) is considered by Bohr to be of fundamental significance, as it shows that the frequency of the radiation is an integral multiple, or *harmonic*, of the frequency of rotation. Now in general it is possible to resolve a rotation in an elliptical orbit into harmonics by the method of Fourier series. According to ordinary electrodynamic theory, these harmonics ought to appear in the radiation emitted, and the above deduction shows that for large values of n this conclusion is in agreement with the results derived on the basis of the quantum theory of spectral series. Thus we find an agreement for these extreme cases between the results to be expected on the basis of classical electrodynamics and those derived on the basis of the quantum theory. Of course, as pointed out by Bohr, there exists a signal difference in the mechanism of the radiation in the two cases. While according to electrodynamic theory all the harmonics ought to appear simultaneously, the quantum theory postulates that these harmonics appear as the results of transitions between different orbits not in the same atom and therefore independent of each other.

Now Bohr considers that this correspondence or coincidence in the values of the frequency of radiation as calculated from the two points of view cannot be accidental; the coincidence must also extend to amplitude and polarization of the light emitted. If we consider again the resolution of the frequency ω into harmonic components by the method of Fourier series, it is known that the coefficients in this series represent the amplitudes of the corresponding components and therefore their intensities. Hence the intensity of the radiation corresponding to any particular frequency ν ought to be given by the corresponding coefficient in the Fourier series for the orbital frequency of the electron. This means that the *probability* of the existence of a certain value of ν in the frequency of the light emitted corresponds to the value of the coefficient of the corresponding harmonic component in the Fourier expansion. Thus *we obtain a criterion for determining the probability of a given transition between two stationary states.* If

the harmonic, corresponding to certain values of $n_2 - n_1$ is absent in the Fourier series for the rotational frequency of the electron, then it must be concluded that the transition corresponding to the difference $n_2 - n_1$ cannot occur, and the corresponding lines will therefore be absent in the spectrum.

This analogy must also extend to the polarization of the light emitted, since any single harmonic orbit must on the ordinary classical theory radiate circularly polarized light. Furthermore, Bohr holds that this analogy in polarization and intensity holds valid not only for low frequencies of orbital rotation, that is low frequencies of radiation emitted, but also applies to higher frequencies.

We thus obtain a rule by which we can calculate the possible frequencies of radiation emitted in any given case by one or more electrons rotating in any orbits whatever round a nucleus. Firstly, we study the orbit from the point of view of ordinary electrodynamics, and thus obtain a relation between orbital frequency of rotation of any electron and the various forces to which this electron is subjected. This orbital frequency is capable of resolution into harmonics, and from the nature of the coefficients it is possible to determine the relative intensities and polarization of the different frequencies that will appear as radiation. Since this calculation also gives the energy in any orbit as a function of the rotational frequency we then apply the quantum theory relation.

$$h\nu = W_i - W_f$$

in order to calculate the corresponding spectral series.²

Let us now consider from this point of view a simple hydrogen atom with an electron rotating in a *circular* orbit around a nucleus. If the diameters of the orbits corresponding to two stationary states are taken sufficiently large we obtain the relation

$$\nu \sim (n_2 - n_1)\omega \quad (8)$$

which connects the frequency of light emitted with the frequency of rotation. But for a circular orbit, there is no possibility of any harmonic component, that is $n_2 - n_1$ can only assume the values

² See Sommerfeld, *Atombau*, 2nd ed., pp. 527-537 for a mathematical discussion of this subject.

± 1 . The value $n_2 - n_1 = 0$ is obviously excluded. Thus we arrive at the Selection Principle derived by Rubinwicz for *azimuthal quantum* values of n .

A most interesting application of this correspondence principle has been made by Bohr in the determination of the effect on spectral lines of electrostatic and magnetic fields.

The simplest case for consideration is again that of a single electron rotating around a nucleus of unit positive charge at the focus (the hydrogen atom). Under the influence of an electrostatic field (Stark effect) both the eccentricity and position of the orbit (with respect to the direction of the field) vary continuously. This problem may be treated mathematically in terms of the three integrals, $\int p dq = nh$, corresponding to the three sets of quantum numbers, as has been done by Schwarzschild and Epstein. According to Bohr, however, this problem is much simplified if we investigate by the methods of electrodynamics the effect of an electrostatic field on a simple elliptical orbit such as that described above. This investigation shows that there will be superposed upon the orbital frequency of rotation ω another frequency of perturbation σ which is given by the relation

$$\sigma = \frac{3eF}{8\pi^2 m a \omega} \quad (9)$$

where F = strength of field
 $2a$ = major axis of orbit
 e = charge of electron
 and m = mass of electron.

We are therefore led to expect that this frequency will appear as a series of harmonic components in the light emitted when the electron passes from one stationary state to another. Hence the frequency of radiation emitted will be given for small values of both ω and σ by the approximate relation.

$$\nu \sim (n_2 - n_1)\omega + (k_2 - k_1)\sigma \quad (19)$$

where $k_2 - k_1$ is small compared to either k_1 or k_2 . Furthermore the intensities and state of polarization of the components corresponding to each line in the undisturbed state of the orbits can be derived by investigating the coefficients in the Fourier series expansion for the orbital frequency of rotation in the

disturbed state. In this manner Bohr shows that results are obtained which are in complete agreement with the phenomena actually observed.

It is evident that corresponding to any one stationary state of the undisturbed orbit there must be a number of stationary states in the disturbed state. For the transition from one of these states to any other, the change in energy will, according to the quantum theory, correspond to $kh\sigma$ where k is a whole number, that is the energy E corresponding to one of these states in the disturbed state will be related to the energy E_n in the undisturbed state by the relation

$$E = E_n + kh\sigma \quad (11)$$

This relation, together with the quantum theory relation for ω (by introducing the postulate for angular momentum) leads to an expression for the spectral series of hydrogen in the Stark effect which is in agreement with that derived by Epstein and Schwarzschild.

The effect of a magnetic field on the spectral lines of hydrogen is dealt with in a similar manner. An investigation of the problem from the point of view of classical electrodynamics leads to the conclusion that superposed upon the orbital rotation of the electron there is a uniform rotation of the entire system around an axis parallel to that of the field. The frequency of this rotation is given by the relation

$$\sigma = \frac{He}{4\pi mc} \quad (12)$$

where H = intensity of magnetic field in gauss

c = velocity of light.

This frequency must therefore appear as a harmonic in the spectral lines in accordance with equation (10) for the Stark effect.

A closer study of the effects to be observed shows that the only permissible values of $k_2 - k_1$ are ± 1 and 0. Thus each line in the undisturbed states of the orbits exhibits three components in the magnetic field, one of which, the unaltered component, is linearly polarized parallel to the field and the other two, circularly polarized in opposite directions when regarded along the direction of the field.

The same considerations are extended by Bohr to the case of atoms which contain more than one electron, by calculating the field due to the coupling action of the inner electrons and the outer one which is assumed to be at a considerable distance from the other electrons.

Sommerfeld has drawn attention to the fact that in deducing a relation between the relative intensities of the different spectral lines, Bohr really derives a statistical relation which enables us to determine the relative distribution of the atoms which are effective in the production of the different lines. As he puts it, "Although we are convinced that the quantum theory is correct in ascribing the different spectral lines to independent processes in the atom, and altho we know that the classical method of calculation is wrong in considering these processes as dependent upon the orbital velocities, we nevertheless trust the mechanical theory to this extent, that we derive by means of it the relations for the relative distribution of intensities of the lines."

Altho Bohr has not as yet published any details regarding further applications of the principle, he has intimated in two letters to *Nature* during the past year³ that it is of very general application indeed. The principle not only affords a detailed insight into the structure of the spectra produced during the binding of electrons in atoms of more complex structure than hydrogen, but also suggests definite arrangements of the electrons which are suitable for the interpretation of these lines as well as the high frequency spectra and the chemical properties. "If we consider," he writes, "the binding of a large number of electrons by a nucleus of high positive charge, this argument suggests that after the first two electrons are bound in one-quantum orbits, the next eight electrons will be bound in two-quanta orbits, the next eighteen in three-quanta orbits, and the next thirty-two in four-quanta orbits."

Bohr also distinguishes between the types of quanta-numbers involved in any one of the above groups. Thus corresponding to the fact that for $n_1 + n_2 = 2$, (where n_1 and n_2 refer to azimuthal

³ *Mch.* 24, 1921, p. 104; *Oct.* 13, 1921, p. 208.

and radial quantum numbers respectively) we may have two possibilities, viz:

$$\begin{aligned} n_1 = 1, \quad n_2 = 1 \\ n_1 = 2, \quad n_2 = 0 \end{aligned}$$

it follows that the group of eight electrons will consist of two sub-groups of four electrons each. Similarly the group of eighteen will consist of three sub-groups of six electrons each corresponding to the three different possibilities for $n_1 + n_2 = 3$.

Another feature that Bohr ascribes to these electrons is that owing to coupling action between different orbits, "the electrons from one sub-group may penetrate during their revolution into regions which are closer to the nucleus than the mean distances of the electrons belonging to groups of fewer-quanta orbits."

As a result of these considerations Bohr assigns in the first one of the above letters the following constitutions for the atoms of the rare gases:

He 2 ₁	Krypton 2 ₁ 8 ₂ 18 ₃ 8 ₄
Ne 2 ₁ , 8 ₂	Xenon 2 ₁ 8 ₂ 18 ₃ 18 ₄ 8 ₅
Argon 2 ₂ , 8 ₂ , 8 ₂	Niton 2 ₁ 8 ₂ 18 ₃ 32 ₄ 18 ₅ 8 ₆

The large figures denote the number of electrons in the groups starting from the innermost one, and the small figures the quantum-numbers of the orbits of electrons in each group.

Similar arrangements of electrons in the atoms of each of these elements has recently been suggested by Bury⁴ on the basis of chemical considerations.

In the second letter, Bohr modifies the above suggestion in this respect that for instance, the orbits in the outermost group of the niton atom must be described as six-quanta orbits instead of two-quanta orbits, although owing to the character of the motions of these electrons it will appear as if on the average they really were two-quanta orbits.

These conclusions which are no doubt supported by Bohr by many far-reaching considerations lead us to await the publication of his promised paper on this subject with a great deal of interest.⁵

RESEARCH LABORATORY,

GENERAL ELECTRIC CO., SCHENECTADY, N. Y.

⁴ J. Am. Chem. Soc. 43, 1602 (1921).

⁵ Since the above was written another paper has been published by Bohr in Z. f. Physik, 9, 1 (1922). This is a non-mathematical review of his conclusions on the structures of atoms.

THE EVALUATION OF QUANTUM INTEGRALS

BY
A. SOMMERFELD

In a paper of the above title Mr. Edwin C. Kemble¹ has criticized my method of evaluating the phase integral²

$$(1) \dots\dots\dots J = \oint \sqrt{f(q)} dq.$$

He concludes that this method is useful only when 'the higher order terms are negligible.' I wish to point out briefly here the grounds on which I hold this criticism to be erroneous; to facilitate comparison I use the same notation as Mr. Kemble.

The integral (1) is to be extended over a complete cycle of values of q , which oscillates between two roots a and b of $f(q)$. Let $f(q)$ be of the form

$$(2) \dots\dots\dots f(q) = \phi(q) + a\psi(q)$$

where a signifies any small constant; $f(q)$ is in practice a polynomial of the second degree in q or $1/q$. Since $f(q) = 0$ has two roots a, b it follows that $\phi(q) = 0$ must have two roots a', b' differing by an arbitrary small amount from a, b . We suppose that $\psi(q)$ is regular in the neighborhood of a and b and between them.

The real path of integration of $1 a \rightarrow b \rightarrow a$, is first of all deformed without previously developing $f(q)$ in powers of a , into a contour W of the complex q plane which encloses the points a, b as well as a', b' and which does not pass through any singular points of ψ/ϕ .

Throughout the whole of this path $\sqrt{f(q)}$ may be expanded binomially as follows

$$(3) \quad \sqrt{f(q)} = \sqrt{\phi(q)} \left(1 + a \frac{\psi(q)}{\phi(q)} \right)^{1/2}$$

$$= \sqrt{\phi(q)} \left\{ 1 + \frac{a}{2} \frac{\psi(q)}{\phi(q)} - \frac{a^2}{8} \left(\frac{\psi(q)}{\phi(q)} \right)^2 + \dots \right.$$

$$\left. + (-)^n \frac{1 \cdot 3 \cdot \dots \cdot 2n - 3}{2 \cdot 4 \cdot \dots \cdot 2n} a^n \left(\frac{\psi(q)}{\phi(q)} \right)^n \dots \right\}$$

¹ Proc. Nat. Acad. Sci., October 1921, p. 284.

² First given in Physikal. Zeitschrift, Vol. 17, p. 491, 1916. Also *Atombau und Spektrallinien* 2nd edition, p. 478. 3rd edition, p. 670 and p. 725; here also some observations on the convergence question are added.

Let M be the greatest value of $\left| \frac{\psi(q)}{\phi(q)} \right|$ on the contour W . We can then choose α so small that

$$\alpha M < 1.$$

The binomial series then converges absolutely and can be integrated term by term. One therefore obtains the likewise absolutely convergent series

$$(4) \quad J(\alpha) = J(o) + \alpha J'(o) + \frac{\alpha^2}{2!} J''(o) + \dots$$

$$J(o) = \oint \sqrt{\phi(q)} dq; \quad J'(o) = \frac{1}{2} \oint \frac{\psi(q)}{\sqrt{\phi(q)}} dq;$$

$$J''(o) = -\frac{1}{4} \oint \frac{\psi^2(q) dq}{\phi(q) \sqrt{\phi(q)}}; \text{ etc.}$$

Each of these integrals is to be extended over the complex contour. Mr. Kemble now says " $J(o)$ and $J'(o)$ are easily evaluated but unfortunately the higher derivatives of J with respect to α cannot be calculated by the usual methods because the higher derivatives of $\sqrt{f(q)}$ with respect to α become infinite at $q = a$ and $q = b$ ". This appears to me to be a misunderstanding. The path of integration W does not pass through the points $q = a$ and $q = b$. Also on the integration contour W the higher integrals J'' , J''' have perfectly definite and finite values. If for the evaluation of these integrals the integration contour is further deformed it will not return to the original path but will be contracted on the residues of the corresponding integrands. The question of convergence will then no longer arise. The series (4) is, as we saw, convergent. The further deformation of the integration contour does not alter the coefficients J'' , J''' of the series and is therefore without import as regards the convergence. I consider therefore the method developed by me to be free from objection in so far as the parameter α can be taken as small as desired. This is, for example, the case with the Stark effect where the external electric field is at our disposal, and in many other cases.

A difficulty arises only if the magnitude of α is fixed by the nature of the problem. In the general series spectra of the elements, with which I have dealt in the same way, the additional electric

field of the atom cannot be taken as small as desired but is determined in a definite way by the quantum conditions. In consequence it may happen³ that no contour W can be found for which the series (3) converges. This difficulty has, however, nothing to do with the mathematical objections of Mr. Kemble. The new and interesting method put forward by Mr. Kemble appears to me under these circumstances to be unnecessarily complicated and artificial.

UNIVERSITY OF MUNICH

³ As Dr. J. Weinacht has shown in his Dissertation, Munich 1921, see *Atombau und Spektrallinien*, Ed. 3, Appendix 13.

CRITICAL FREQUENCY RELATIONS IN SCOTOPIC VISION

BY
HERBERT E. IVES

INTRODUCTION

In his "Studies of Flicker,"¹ T. C. Porter discovered that the straight line representing the relation of critical frequency to logarithm of illumination underwent an abrupt change of slope at about .25 meter candles. At this same point, according to other evidence, vision changes from color vision to gray vision, or from "cone" to "rod" vision, if we accept the correlation indicated by the "duplicity theory." In investigating critical frequency phenomena by monochromatic light, the present writer discovered² that this change of slope is of such magnitude with *blue* light as to constitute a complete change in the character of the illumination-critical frequency relation. The straight line after its change of direction becomes parallel to the log *I* axis, that is, critical frequency becomes a constant independent of illumination. At the same time the blue hue of the light vanishes and is replaced by a colorless or gray appearance. The isolation of rod or scotopic vision appears to be complete, where in the case of white light, or monochromatic light of long wavelengths, it is only partial. This phenomenon of constant critical frequency for blue radiation of low intensity has since been confirmed by Frank Allen.³ In a later investigation by the writer and Mr. Kingsbury,⁴ testing a "diffusion" theory of intermittent vision, observations were made in this same region with discs of varying ratio of open to closed sectors. The constancy of critical speed was again found, and the ratios of speeds for different openings was entirely different from that holding at higher illuminations. Some support for the "diffusion" theory under

¹ T. C. Porter, Proc. R. S., 70, 313-329, 1902.

² Ives, Phil. Mag., Sept., 1912, p. 352.

³ Allen, Phil. Mag., July, 1919, p. 82.

⁴ Ives and Kingsbury, Phil. Mag., April, 1916, p. 290.

study was claimed because these new relations were clearly predicted by the theory when the term used in its expression to cover the effects of change of diffusivity with illumination was made constant.

In subsequent consideration of this isolation of rod vision, it has appeared to the writer that here was an exceptionally promising opening for studying the nature of vision. It is highly probable that colorless (rod) vision is the more primitive kind of vision, a survival of an earlier, less developed type. It should be easier to elucidate. When it is understood, and not until then, are we really justified in attempting to formulate theories of the far more complex phenomena of high intensity, color, vision.

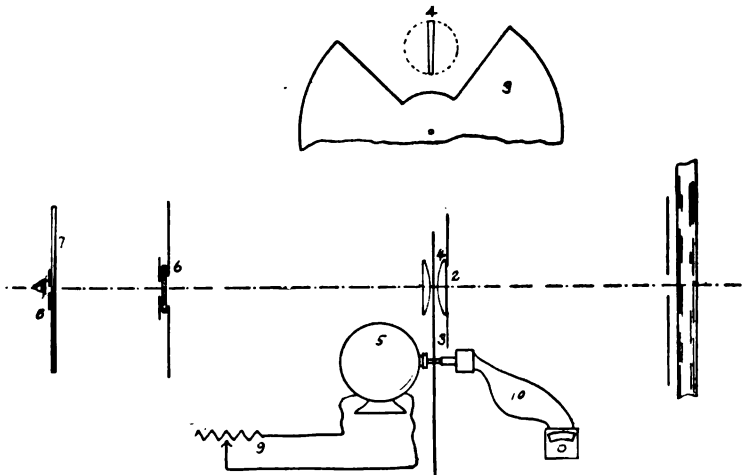

FIG. 1. Apparatus used for study of low intensity flicker phenomena

1. Extended light source.
2. Projection lenses.
3. Sector disc.
4. Slit.
5. Motor.
6. Diffusing screen.
7. Neutral tint wedge.
8. Artificial pupil.
9. Variable resistance.
10. Revolution counter.

The present study was, therefore, undertaken as forming a part of the study of "rod" vision, which from general con-

siderations appears a logical starting point for the investigation of vision. It was aimed more particularly at the *time relations* of such vision, as deducible from the effects of intermittent illumination. More specifically still, it is an investigation chiefly of the effects on critical frequency of the *form factor* of the intermittent illumination, thus extending the work above mentioned, on the effects of variation in the ratio of exposure to obscuration, to variation in the manner of rise and fall of the stimulus.

APPARATUS AND METHOD OF OBSERVATION

The essential features of the apparatus used are easily grasped from the diagram, Fig. 1. An image of an extended light source

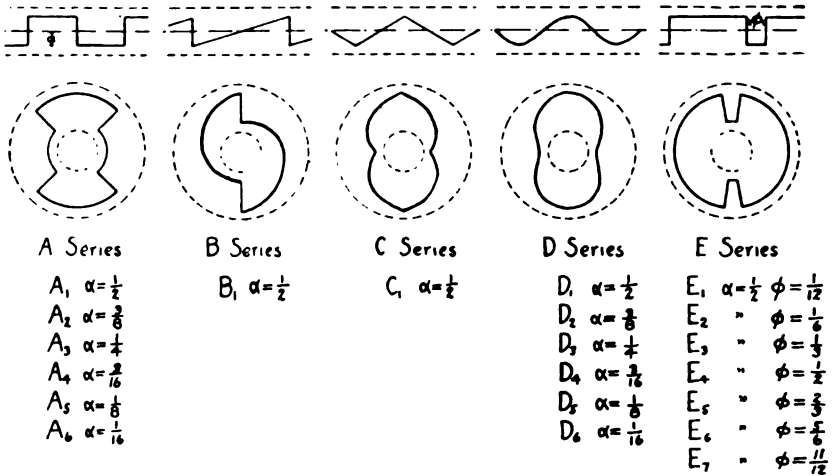

FIG. 2. Sector discs used to control the wave-form of the stimulus

1, is thrown by means of two lenses, 2, on a diffusing screen 6 (several sheets of finely ground glass) which is viewed by the eye through an artificial pupil, 8, of 2 sq. mm. area. The only portion of the lenses, 2, utilized is that limited by a narrow slit, 4, whose sides are radial from the axis about which discs 3 rotate. By varying the contour of the discs it is obvious that any desired variation of the brightness of the field 6 throughout a cycle may be obtained. The speed of rotation of the discs is altered roughly by a set of pulleys, finely by a variable resistance 9, in series with

the motor 5, and is read by the electric tachometer 10. The brightness of the image at 6 is altered by means of a neutral tint wedge 7, having a range of transmission of approximately 10 000 to 1.⁵

The discs upon whose shape depends the variation with time of brightness of the diffusing screen were cut from thin sheet aluminum, and after being drilled to fit the motor axle, were sandblasted and painted with dull black lacquer. They were made symmetrical to give two cycles per revolution. The shapes chosen are shown in Fig. 2. They are arranged in five series, lettered A, B, C, D, and E. The first number of the A series gives equal intervals of light and darkness, changing abruptly from one condition to the other; it is similar to the discs which have been most frequently used in experiments of this sort. The amplitude, α , is $\frac{1}{2}$ the total opening. The rest of the series consist of the variants on the first disc obtained by decreasing the amplitude to $\frac{3}{8}$, $\frac{1}{4}$, $\frac{3}{16}$, $\frac{1}{8}$, $\frac{1}{16}$, so that in place of an alternation of light and dark, the alternation is between $\frac{1}{8}$ light and $\frac{7}{8}$ dark, etc. In the second (B) and the third (C) series the contour of the time-brightness distribution is changed from "square topped" to "saw toothed"; in the B series one edge of each tooth is vertical, in the C both are equally inclined. Only the first members ($\alpha = \frac{1}{2}$) of these two series were cut. Series D is similar to series A, except that the wave-form is sinusoidal, the amplitude range from $\frac{1}{2}$ to $\frac{1}{16}$, as before. Series E consists of the variation of series A formed by altering the ratio of light to darkness. The openings (ϕ) made up were $\frac{1}{12}$, $\frac{1}{6}$, $\frac{1}{3}$, $\frac{1}{2}$, $\frac{2}{3}$, $\frac{5}{6}$, $\frac{11}{12}$. The only amplitude cut was $\frac{1}{2}$. It will be noted that E_4 is identical with A_1 , and that A_2 , A_3 , etc., are the variations of E_4 with respect to amplitude. Hence while every combination of shape, amplitude and opening was not provided, the whole set of discs covered fairly well the significant variations of wave-form.

In order to secure low intensity blue light a mercury vapor lamp was used as light source, the blue and violet lines being isolated by means of a blue filter⁶ placed at 6. An opaque screen in front

⁵ Made and calibrated by the Eastman Kodak Co.

⁶ Wratten monochromatic filter for isolating blue mercury lines.

of the mercury arc was pierced with a circular aperture of approximately $1\frac{1}{2}$ cm diameter. A circular portion 11.1 mm. in diameter of the image of this at 6, as limited by a diaphragm, was the observed bright field. This had a diameter of 4.5 degrees.—considerably larger than the fovea, and the attention was directed to the center of the field. The variable neutral tint wedge was moved to a point where the field appeared gray, and where the critical frequency is independent of brightness,—as determined by measurements described below.

The method of making measurements was as follows: After the five minutes or thereabouts in the dark laboratory, necessary for the eye to become dark adapted, the observer (H.E.I.) placed his eye at the observing aperture 8, started the motor, and slowly increased the speed by moving the sliding contact of the variable resistance 9, until the flicker at first observed vanished. This was announced by calling to an assistant who was simultaneously watching the speed, and who recorded the speed at the instant. The procedure of setting was then reversed, starting above the critical frequency the speed was reduced until flicker appeared. This alternation of direction of setting was continued until a complete group was obtained. Except where otherwise stated, a group consisted of ten settings. Each point of a series (set of discs) was measured twice in any run, the discs being put through first in one order and then in the reverse order. Consequently the determination of a point involved twenty settings. Extreme settings frequently varied as much as ten per cent in speed to either side of the mean, and the return series mean would often drift by as much as five per cent from the first series. Settings were fairly reproducible from one day to another; less so if an interval of several days intervened, although measurements belonging to the new period were in good agreement among themselves. It is therefore evident that all the measurements which are to be compared one with another for study, should be made as nearly as possible at the same time, and that nothing is gained by multiplication of measurements over a lengthened period during which a drift of values may occur, unless, of course, the period is so long and the measurements so numerous that all

the points to be determined have been equally affected. The main series of measurements here recorded (Fig. 4) and used for intercomparison were those made on six consecutive mornings, at the same hours, each of the series, A, D, E being carried through on two separate days. In spite of the factors above mentioned, which contribute to low precision, the critical speed values for the various wave shapes are believed to be established by the forty settings involved to within 3 per cent, as was evidenced by the fact that the values derived from the same points as they occur in the first and last series run (A_8 and E_4), are mutually consistent, indicating a reasonably constant state of the observer's vision during the six day period. Certain series made during the assembling and test of the apparatus, while not sufficiently consistent to be intercompared, were in general in agreement in their essential characteristics with the main series here chosen for presentation.

EXPERIMENTAL RESULTS

As a necessary preliminary to the study of the constant critical speed region it was necessary to establish what setting of the neutral tint wedge was required to insure that this region was actually being used, and, of course, to verify the non-dependence of critical speed on intensity for all the disc shapes used. To cover these points a series of observations was made early in the study on typical discs at different values of the neutral wedge. Only five settings were made on each point, as this number is sufficient to locate the reading well enough for the immediate purpose. The points, which are, for the reason just stated, somewhat scattering, are shown in Fig. 3 for the discs A_1 , A_5 , A_8 , D_1 , D_5 , D_8 , E_1 , E_7 , B_1 and C_1 . Abscissae are wedge scale units (each unit = a difference in log-brightness of .214), ordinates, critical speeds in cycles per second.

It will be seen that in every case the critical speed does become a constant beyond some wedge scale value. The wedge value necessary to use for each series was thus easily picked from this plot. Before leaving this figure, attention may be called to a feature which illustrates the discussion on precision above. By

comparing the critical frequency values of the various discs with the series shown in Fig. 4, which were made some time later, it will be noted that these preliminary values are all somewhat lower. They are, however, as a family mutually interrelated very closely as are the more precise final results.

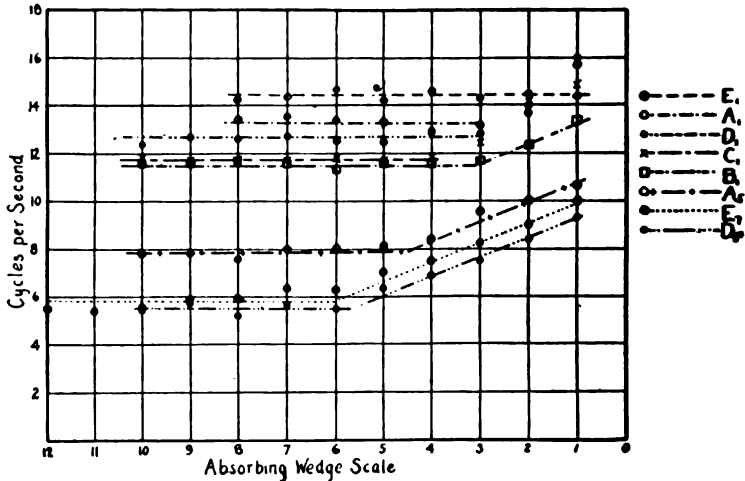

FIG. 3. Critical frequency—log brightness determinations for various wave-forms, showing wedge scale value necessary to insure observations falling in rod vision region

Critical Speeds for Discs A₁, B₁, C₁, D₁.—The several different shapes of amplitude = $\frac{1}{2}$, and average transmission $\frac{1}{2}$ were picked out as the first series to be studied. In all, three complete sets of measurements (each of 40 settings per disc as above explained) were made at intervals during two months. The experimentally determined critical speeds are shown in Table 1, in which are also calculated their *ratios* of speeds, compared to that of the simplest shape (sine curve “D”). In the last column are values of the ratios as computed by an empirical formula (to be discussed later).

It is evident that variation of wave-form unaccompanied by change of amplitude or of mean transmission has a well marked effect on critical speed. It is perhaps most striking that the lowest speed is not given by the disc whose shape changes most

TABLE 1. *Critical Speed in Cycles per Second*

Disc	1st Set	2nd Set	3d Set		
A ₁	12.6	12.4	13.30		
B ₁	10.6	10.3	11.5		
C ₁	11.5	11.2	11.8		
D ₁	11.9	11.7	12.6		
	Ratios to D ₁			Mean	Calculated by Empirical Formula
A ₁	1.06	1.06	1.06	1.06	1.06
B ₁	.89	.87	.91	.89	.88
C ₁	.96	.95	.93	.95	.94
D ₁	1.00	1.00	1.00	1.00	1.00

gradually, namely the sine curve (D_1) but by that one which combines both the slowest variation with the fastest, namely, the "saw-tooth" with one vertical edge of the tooth. Even more striking is the fact that the same speed is obtained whichever way the disc is run, whether the abrupt transition leads or follows. This is shown by the following table of measured speeds, from the first set used in Table 1:

TABLE 2

	Direction of Disc.	
	Abrupt Transition	Leading, Following
Mean of first ten settings	10.35	10.40
Mean of second ten settings	10.75	10.70
Mean, cycles per second	10.55	10.55

From the latter fact it is to be inferred that the significant factor in the speed is some feature of the shape which is unaltered by direction.

Speeds for the "A" Series.—These measurements constitute with those that follow on the D and E discs the "main" series, made on consecutive days as described in a previous section. The results obtained (with wedge set at 7) for the square topped wave forms of various amplitudes are shown in Fig. 4 (upper curve

to left). As the amplitude is decreased the critical speed falls off, the two approaching zero together. The rate of decrease of speed with amplitude is, as will be described below, *logarithmic*.

Critical Speeds for the "D" series.—These, determined with the wedge set at 8, are also shown in Fig. 4. For the higher amplitudes the relation of critical speed to amplitude is similar to that of the *A* discs, except that the values are lower. When, however, the amplitude drops to $1/8$, the critical speed has fallen to a value too low to fit on a smooth curve continued to the origin. At amplitude $1/16$, *no flicker can be produced at any speed and hence no critical speed exists*.

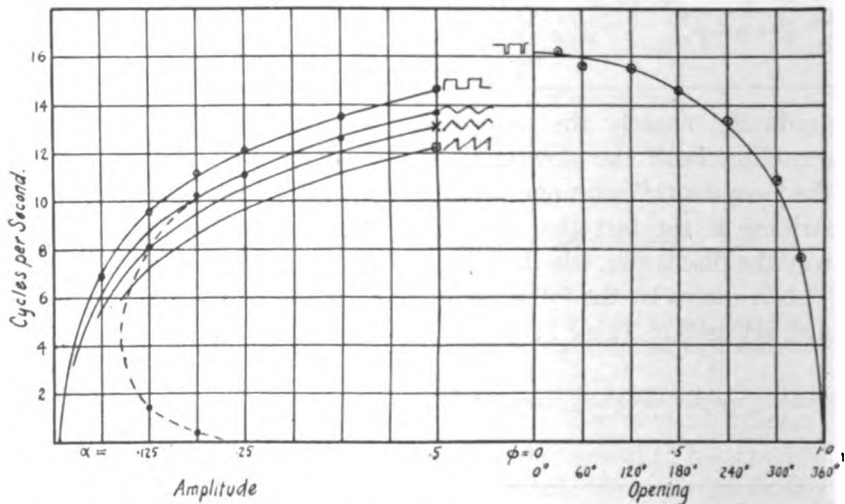

FIG. 4. Critical frequency against amplitude (left) and against opening (right). Full lines plotted from empirical formula.

This failure of flicker would be most simply explained by supposing that the amplitude of variation of visual sensation had dropped below the threshold. This explanation is inadequate, however, since the square topped disc of the same amplitude behaves normally. A more satisfactory idea of what happens is obtained by considering the phenomena with very low speeds, working up from zero. In the case of any small amplitude disc in which the transition from darker to lighter is gradual, it is obvious that if the speed is only low enough, the eye by continually

adapting will not appreciate the change of intensity, whereas the same amplitude of fluctuation if more rapid will be perceived. There should, therefore, for the sine curve discs, be *a speed below which the sensation of flicker is not produced*. This was easily found experimentally to be the case. With the $1/8$ and $3/16$ amplitude discs turning over once every three or four seconds, no fluctuations of intensity were visible. As the speeds increased, a point was reached where flicker began, then when the speed was much further increased, flicker disappeared once more, at the points already determined. The amplitude-critical speed curve is therefore completed not by continuing the curve through the large amplitude points to the origin, but by turning back, as shown, through the low speed beginning-of-flicker points toward the maximum amplitude axis. We may summarize these small amplitude phenomena by the observation that here we clearly have to do with *rate of change of amplitude*, whereas for the large amplitudes and with abrupt transitions it is possible that we are concerned primarily with the *magnitude* of the amplitude.

Critical Speeds of the E Series.—These are exhibited in Fig. 4 to the right, the abscissae being openings (in degrees and in fractional parts) the ordinates critical speeds. In making these, several different wedge values were used, always below the break in the straight line relation and chosen to keep the mean brightness fairly constant. This saved the observational discomfort of working with unnecessarily low intensities for the small openings, but, as Fig. 3 shows, would not affect the values of the readings.

The critical speeds are highest for the smallest openings and the relationship between speed and opening is in general logarithmic. This relationship is in marked contrast to the high intensity behavior,⁴ where the speeds are lowest for the largest and smallest openings, passing through a maximum at opening $1/2$.

The Transition from Low to High Intensity.—An interesting question that arises in considering the flicker phenomena at high and at low intensities is whether these are one phenomenon which passes through a change at some critical condition of brightness or are two entirely separate effects due to two different

processes. This comes down to the question whether the abrupt breaks in the inclined straight lines of Fig. 3 occur at (*A*), a definite peak brightness, (*B*), a definite average brightness, or (*C*) with no relation to the brightness of the observed field.

At once by reference to the data for 30 degrees (E_1 , $\phi = 1/12$) and 330 degrees (E_7 , $\phi = 11/12$) opening it is seen that the break in direction does not occur at a definite peak value since this is the same for both at the same wedge value, and the wedge values differ by over 5 units (log difference = 1.17) corresponding to more than a ten-fold change in brightness. Referring next to the data for discs D_1 and D_6 , we find a wedge scale difference of three units for the break point, although here the mean brightness is the same at the same wedge values. There is thus no connection between brightness and the transition from one relationship to the other. The data of Fig. 3 appear in fact to show that the sloped log *I*—critical frequency lines, occurring in the region of color vision, and the horizontal ones occurring in the region of colorless vision, belong to two quite separate coexisting processes. The critical speed for any brightness is roughly that corresponding to the process demanding the higher speed.

EMPIRICAL EXPRESSION OF RESULTS

Discussion of the theoretical aspects of these results is deferred to a subsequent communication and the present paper will be concluded by pointing out an empirical expression which has been found to represent the main series of observations just described with remarkable accuracy in terms of the Fourier analyses of the wave-form used. In order to make clear the statement of this relation, it is necessary first to assemble together the Fourier series expansions of the disc contours used. By reference to any comprehensive text on heat conduction we find the following expressions:

For the D_1 (sine curve discs), the variation of intensity with time is given by

$$I_t = \frac{I}{2} + I a \sin \omega t \quad (1)$$

where I_t is the instantaneous intensity, I is the intensity with the

disc removed, a is the amplitude and ω the frequency in cycles per second.

For the C series (saw-tooth symmetrical)

$$I_t = \frac{I}{2} + \frac{8Ia}{\pi^2} \left(\sin \omega t - \frac{1}{9} \sin 3 \omega t + \frac{1}{25} \sin 5 \omega t - \dots \right) \quad (2)$$

For the B series (saw-tooth with one abrupt transition)

$$I_t = \frac{I}{2} \pm \frac{2Ia}{\pi} \left(\sin \omega t + \frac{1}{2} \sin 2 \omega t + \frac{1}{3} \sin 3 \omega t + \dots \right) \quad (3)$$

the plus or minus sign applying to different directions of motion of the disc.

For the E series:

$$I_t = I_\omega + \frac{4Ia}{\pi} \left(\sin \pi \phi \cos \omega t + \frac{1}{2} \sin 2\pi \phi \cos 2\omega t + \dots \right) \quad (4)$$

If as is the case in our experiments $a = 1/2$ and ϕ is the fractional opening, the average value is $I\phi$, and (4) becomes

$$I_t = I\phi + \frac{2I}{\pi} \left(\sin \pi \phi \cos \omega t + \frac{1}{2} \sin 2\pi \phi \cos 2\omega t + \dots \right) \quad (5)$$

The A series constitute a special case of the E series for which $\phi = 1/2$, and $\sin \pi \phi = 1$, so that

$$I_t = \frac{I}{2} + \frac{4Ia}{\pi} \left(\cos \omega t + \frac{1}{3} \cos 3 \omega t + \frac{1}{5} \cos 5 \omega t + \dots \right) \quad (6)$$

Now the expression which has been found to represent the experimental data of the main series of observations with considerable accuracy is a simple function of the ratio of the coefficient of the first periodic term of the Fourier expansion to the constant term, or the average value. If we put

$$\frac{2 \times \text{coefficient of 1st periodic term}}{\text{constant term}} = W$$

we find that all the experimental points of this main series with the exception of the low amplitude sine curve values are given by the expression

$$\omega = c \log \frac{2W}{\delta} \quad (7)$$

in which ω is the critical speed, c is a scale constant, and δ is a small number of the order of a few hundredths.⁷ The constants

⁷ The constant 2 is introduced in order to have an expression in terms of the range of fluctuation, according to the diffusion theory.

c and δ are the same for all wave shapes, c being 8.07, and $\delta = .04$. Substituting in (7) we have,

$$\text{for the } A \text{ discs} \quad \omega = c \log \frac{(16 a)}{(\pi \delta)} \quad (8)$$

$$\text{for the } B \text{ discs} \quad \omega = c \log \frac{(8 a)}{(\pi \delta)} \quad (9)$$

$$\text{for the } C \text{ discs} \quad \omega = c \log \frac{(32 a)}{(\pi^2 \delta)} \quad (10)$$

$$\text{for the } D \text{ discs} \quad \omega = c \log \frac{(4 a)}{(\delta)} \quad (11)$$

$$\text{for the } E \text{ discs} \quad \omega = c \log \frac{(4 \sin \pi \phi)}{(\pi \phi \delta)} \quad (12)$$

The agreement of these formulae with the data is shown by the full curves drawn through the points in Fig. 4 and for the A_1 , B_1 , C_1 , D_1 , discs by the data in Table I.⁸

It will be seen that all the "square topped" stimuli points fall accurately on the curves given by the formulae; and that the formulae hold for all wave-forms for large amplitudes. The points corresponding to sine-wave forms of small amplitude lie entirely away from the (full) line indicated by the formula due to the absence of any critical speed for the lowest amplitudes. It is probable that the symmetrical saw-tooth wave-forms (C discs) would also give points lying on a curve distorted at low amplitudes from the curve of the formula, although if the explanation advanced for the peculiarity of the sine-wave form points is correct both saw-tooth forms must yield points which approach zero speed at zero amplitude, as do the square topped forms. The general formula (7) cannot, in view of these shown and suspected deviations from experimental fact, claim to be complete. It does, however, represent the more important low intensity critical speed relations with sufficient approximation to suggest that it must be very close to the true complete formula.

⁸ The points shown for discs B_1 and C_1 , in Fig. 4 which were not included in the main series, are extrapolated from the A_1 and D_1 values by utilizing the well determined ratio previously obtained.

It will perhaps make this formula more intelligible if a possible physical interpretation is put on it. Let us suppose that to a periodic stimulus $A \sin \omega t$ at the surface of incidence there corresponds at a certain depth in a conducting medium the periodic reaction $A e^{-\frac{\omega}{c}} \sin \omega t$. This is a degradation in amplitude similar to that occurring in heat conduction, according to the Fourier diffusion law, except that in the latter case the amplitude is reduced by the factor $e^{-x\sqrt{\frac{\omega}{2K}}}$, where x is the depth, and K the diffusivity.⁹ On this assumption we have, corresponding to the stimulus

$$\frac{I}{2} + I a \sin \omega t \tag{13}$$

the reaction
$$\frac{I}{2} + I a e^{-\frac{\omega}{c}} \sin \left(\omega t - \frac{\omega}{c} \right) \tag{14}$$

In this the range of fluctuation is

$$2 I a e^{-\frac{\omega}{c}} \tag{15}$$

The part this is of the whole reaction is

$$\frac{2 I a e^{-\frac{\omega}{c}}}{\frac{I}{2}} = 4 a e^{-\frac{\omega}{c}} \tag{16}$$

If now we take as the criterion for the disappearance of flicker that the fractional range must fall below some definite value, δ , we have, for the critical condition

$$4 a e^{-\frac{\omega}{c}} = \delta \tag{17}$$

⁹ The use of this factor, which is called for by the "diffusion" theory (see ref. 4) leads to formulae in which the first periodic term figures as a square. Actually, due to the short frequency range in which all the observations fall, the formulae involving the square fit the data nearly as well as (7). They demand, however, in order to fit, a value of δ of about .001. This is so far below the very large values of the Fechner fraction which hold at low intensities as to force the conclusion that the diffusion theory must be modified if it is to cover this illumination region.

or
$$\omega = c \log \frac{4a}{\delta} = c \log \frac{2W}{\delta} \quad (18)$$

where W is the quantity used in the empirical formula.

In the case of the more complicated wave-forms, the factor involving ω exponentially will enter with higher values of ω in the successive terms of the expansion, making them so small as to be negligible, so that formula (18) holds for all cases.

SUMMARY

1. At low intensities, with blue light, critical speed of disappearance of flicker becomes independent of the intensity, but different for each wave-form of the stimulus.
2. The relationship between critical speed and wave-form is approximately represented by the equation

$$\omega = c \log \frac{2W}{\delta}$$

where W is the coefficient of the first periodic term of the Fourier expansion representing the wave-form, divided by the mean value.

RESEARCH LABORATORIES

THE AMERICAN TELEPHONE & TELEGRAPH COMPANY

AND THE WESTERN ELECTRIC COMPANY INC., NEW YORK.

JUNE 24, 1921.

INSTRUMENT SECTION

A POCKET SIZE RANGE ESTIMATOR

BY
H. W. FARWELL

During the progress of the war there were various attempts to improve on the so-called Battery-Commander's Rule as a means of obtaining an approximate measure of the distance of an object. Such instruments hardly merit the name range-finders, but serve fairly well to obtain a result better than the ordinary observer could secure by the eye alone. The method described below was intended to be of assistance for this approximate work, but appeared too late to have any use in service.

One of the difficulties experienced in the use of a scale held, say, at arm's length is that the eye must be focused for two objects at different distances, and the apparent size of the object on the scale can hardly be measured with sufficient accuracy. To avoid this difficulty without the use of a telescopic system of lenses, which makes the instrument too expensive for general use, or without introducing a complicated mechanism, was the problem.

The first solution was very simple, and in actual use gave quite satisfactory results. The instrument was merely a narrow strip from a 1 diopter ophthalmic prism, the distance along the base of the prism being only one centimeter. The observer, of course, has to hold it in such way that the image seen through the prism is displaced with reference to the object seen directly. For example if observation is taken of a man standing, and the man's head appears one-third of his height above or below its real position, this means an actual displacement of about two feet; consequently the man is about two hundred feet away. Obviously such a method requires an estimate of the size of the object, but so does any approximate method used for such purpose.

For general use in this way a more satisfactory prism would be one with a smaller angle, preferably 1/10 prism diopter, since

this would give readings directly in mils. These, however, are not ordinarily made, and no attempt was made to obtain such a prism, since an extension of the method indicated that more satisfactory results could be obtained otherwise. One of my colleagues pointed out the fact that the displacement was dependent on the angle made by the base of the prism with the direction of desired displacement. This gave the idea of a small optical device with a circular scale on which the "multiplying factor" could be read, although the rotation of a small angle prism proved unsatisfactory.

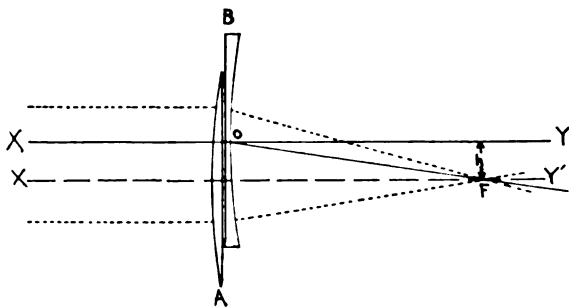

FIG. 1

Finally an application was made of the well known prismatic effect of a de-centered lens to secure a prism of variable angle. To keep a bundle of parallel rays still parallel a concave lens was used in conjunction with a convex lens of the same focal length with which it is placed in contact. If one is moved across the other the image is displaced an amount which depends upon the movement of the lens, and upon the distance of the object. For the sake of clearness this is shown in the diagram below, although the principle is well known in optics.

Let XY be the principal axis of the thin negative lens B , and let the thin positive lens A be moved so that its principal axis is $X'Y'$, distant h from XY . Then while A would bring rays parallel to $X'Y'$ to a point at F , its principal focus, these would all be rendered parallel again by B , but parallel to the secondary axis OF . The angular displacement is therefore $\alpha = \frac{h}{f}$, where f is the focal length of either lens.

Now suppose that A be moved until the image is displaced its own width, that is, until, say, the right edge of the image coincides with the left edge of the object. Then the angular displacement is $\frac{w}{D}$, where w is the width of the object (to be estimated) and D is its distance from the lens. Then

$$\frac{h}{f} = \frac{w}{D}, \text{ or } D = \frac{wf}{h}.$$

The quantity $\frac{f}{h}$ is the "multiplying factor," and for a given lens depends only on the movement of the lens A . In the instrument as constructed A and B were of 100 cm focal length, both being plano-lenses, with the plane surface mounted inwards, so that the distance between the lenses might be neglected. To obtain a satisfactory motion of the lens A , there were several methods tried, the following proving the most satisfactory: The lens B , which was a strip 1 cm. wide, was permanently mounted in an opening in a metal disc, so that its center was 5 mm. from the center of the disc. The lens A , also 1 cm wide, was in a carriage just wide enough which moved back and forth in a radial slot. A pin on this carriage engaged a circular slot in an upper disc, the center of the circular slot being 5 mm from the center of the lower disc. By rotating the upper disc about the center of the lower disc the carriage was thus moved across the lens B .

The magnitude of the motion of the carriage is easily found. For if O be the center of rotation, and O^1 the center of the circular slot, and CD the axis of the radial slot, the rotation of the upper disc turns the circle about O as a center, and the distance from O to the pin is the length of the radius vector from O to the circular slot. If the two lenses are centered when O' is in the position indicated in the diagram the displacement h is

$$h = R + a - a \cos\theta - \sqrt{R^2 - a^2 \sin^2\theta}$$

where R is the radius of the circular slot, and a the distance OO^1 .

The maximum displacement is $2a$, which in the case given was 1 cm. Now by measuring R and a in centimeters, a circular scale on the fixed disc may be marked, not in degrees as was the

preliminary model, but with the multiplying factor, so that after the setting is made, the observer has merely to multiply the estimated size by the factor on the disc.

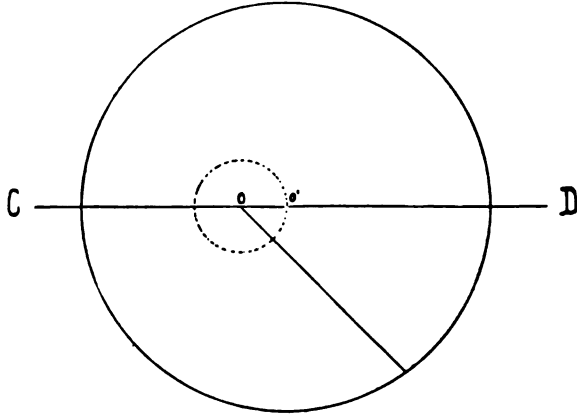

FIG. 2

Any suitable focal length may be used for the lenses, depending largely upon the distances which are to be measured. In any case the whole instrument is of vest pocket size, may be held at any distance from the eye, and is not easy to get out of order.

COLUMBIA UNIVERSITY
JANUARY, 1922.

A NEW FORM OF ELECTROSTATIC VOLTMETER

BY
J. E. SHRADER

For some time there has been a demand for a simple and reliable electrostatic voltmeter. There are objections to the two forms now in common use. The Braun electrostatic voltmeter of the pivoted and gravity controlled type is practically useless at its lower range because of friction in the bearings, and the errors over the other part of the range may be as great as 10%. The other form of voltmeter, the Kelvin multicellular type is often objectionable because of its large electrostatic capacity, and because of the extreme care that has to be exercised in its use.

The instrument here described which is really a modification of the Braun electrostatic voltmeter operates on the principle of electrostatic repulsion between a stationary and a movable vane. In the undeflected position the movable vane is held parallel to the stationary vane by a torsional suspension which constitutes the controlling force. The rotation of the movable vane takes place about a vertical axis. The movable vane is made of thin sheet aluminum and has but little inertia so that it comes to rest in a few seconds by air damping alone. The suspension is held under tension at each end by phosphor bronze springs. For high sensitivity the suspension consists of a single phosphor bronze strip. For less sensitivity a double or bifilar suspension is used. The sensitivity for any size suspension, especially for the double suspension is varied over a considerable range by the adjustment of the tension of the springs. The use of the torsional suspension eliminates error due to friction which is common to a pivoted instrument. Voltages are read by observing deflections of a mirror on the movable vane either by a telescope and scale or a lamp and scale, the scale having been previously calibrated. Since in this repulsion type of instrument the entire vane system is of one polarity and the case of the instrument of opposite polarity high insulation is easily secured by the proper spacing of

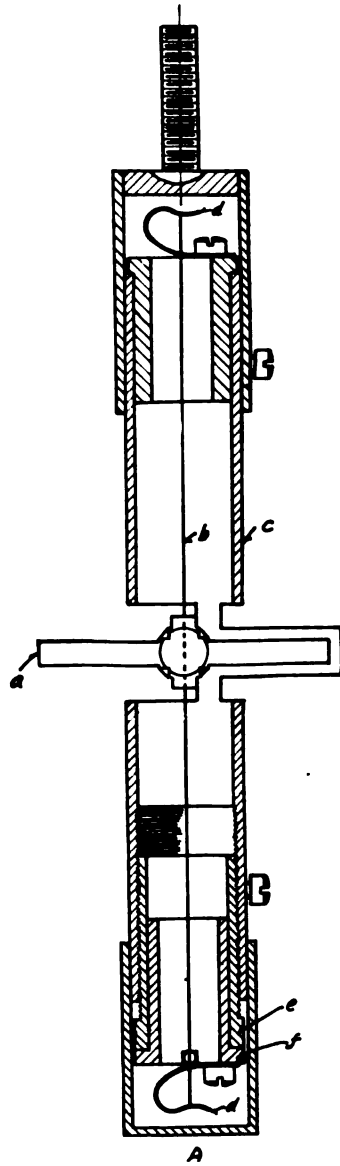
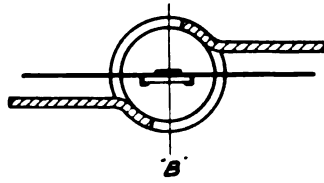

FIG. 1

the parts. For voltages above 10,000 the case of the instrument is filled with a good clear insulating oil.

Fig. 1 (A) shows the vane system of the electrostatic voltmeter. The movable vane (a) is held by the suspension (b) stretched axially through the tube (c). The tension on the suspension is controlled by the phosphor bronze springs (d d) which may be put under tension by turning the adjustable tube (e). The movable vane is adjusted to parallelism with the stationary vane by turning (f). Fig. 1 (B) shows a cross section of the vane system showing the relative positions of the fixed and movable vanes.

Fig. 2 is a photograph of a simple type of voltmeter having the vane system just described mounted in a case and insulated by a hard rubber bushing of sufficient insulation for 2000 volts. If the case is filled with oil the insulation is sufficient for 10,000 volts. With a single .0015 inch phosphor bronze strip a deflection of 230 mm. on a scale one meter distant was obtained for 250 volts. When replaced by a double .002 inch suspension, the range was extended to 400 mm. deflection for 1740 volts.

In Fig. 3 is shown a modification of the electrostatic voltmeter for higher A. C. voltages. This form takes the same vane system shown in Fig. 1 (A). It is mounted as shown in a larger case. A multiplier in the form of a variable condenser (a) is provided. This is placed in series with the vane system and by varying the capacity of the condenser the voltage range may be increased to any desired ratio by calibrating the variable condenser. A short circuiting device is provided for the condenser for using the voltmeter without the multiplier.

Fig. 4 shows calibration curves for an upper and the low range of an instrument just described. It is to be observed that the shape of the two curves is the same. By careful adjustment of the variable capacity, the upper ranges may be made any exact multiple of the low range.

The advantages of this type of electrostatic voltmeter may be stated as follows:

1. Accuracy of reading and permanency of zero.
2. Quickness of needle to come to rest by air damping alone and perfect damping in oil.

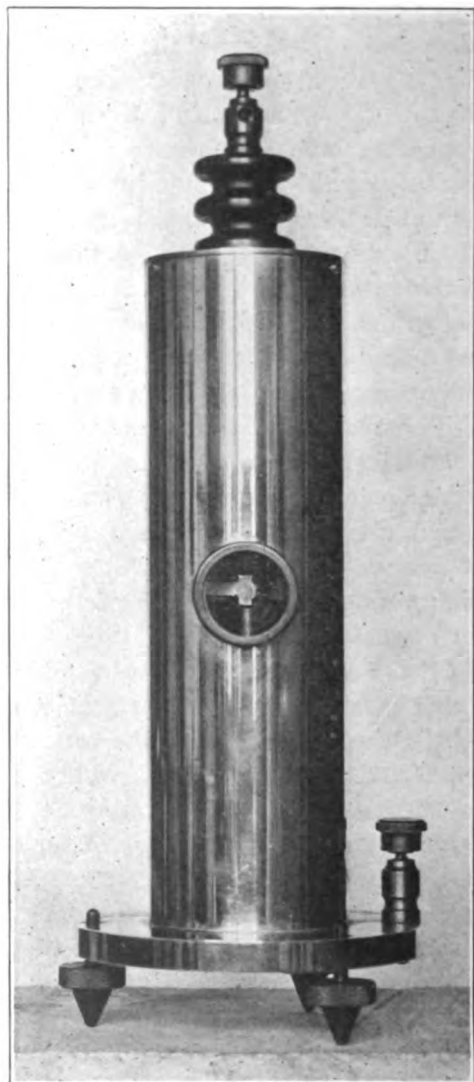

FIG. 2

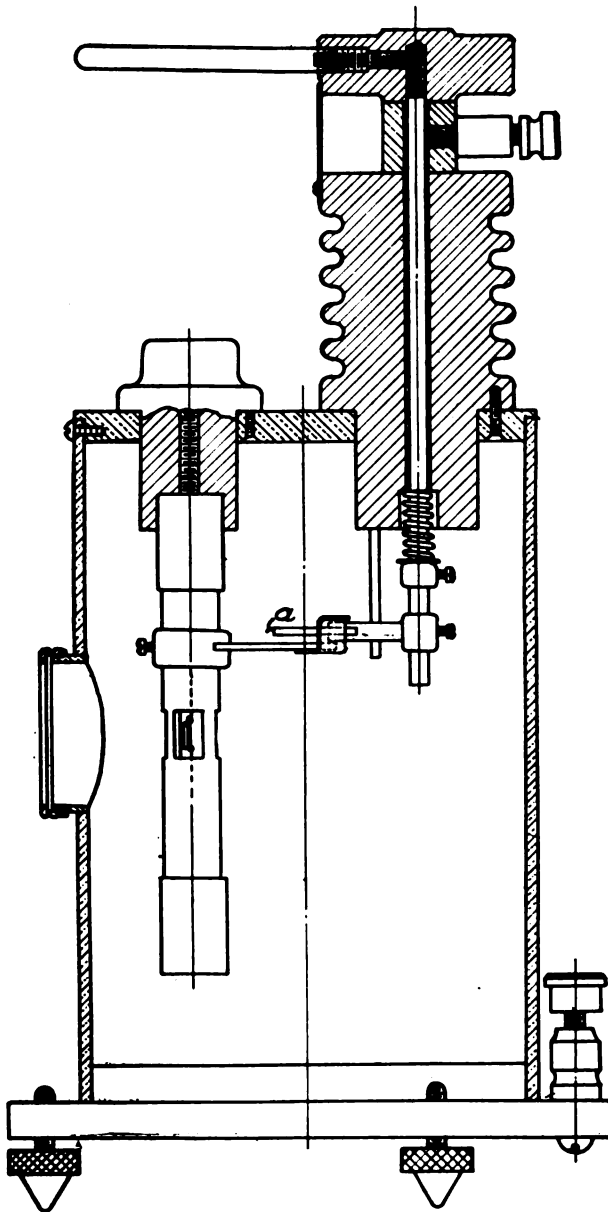

FIG. 3

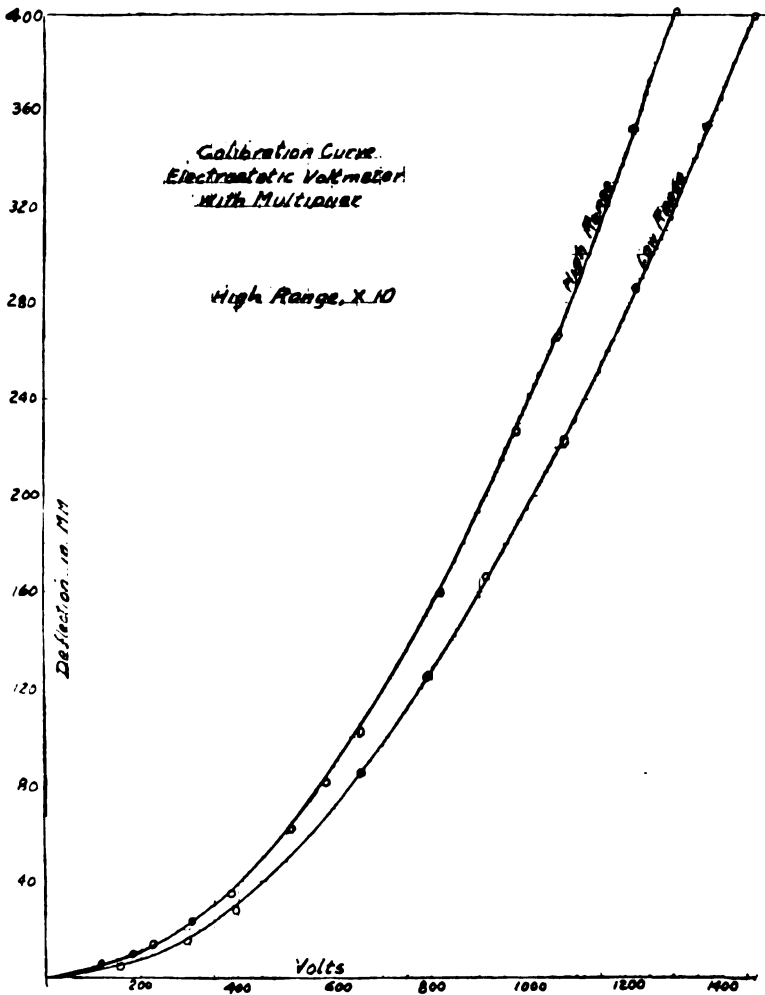

FIG. 4

3. Small electrostatic capacity.
4. Ruggedness when not containing oil because of extremely light moving parts.
5. Simplicity, no careful adjustments to be made.

WESTINGHOUSE RESEARCH LABORATORY,
EAST PITTSBURGH, PA.

THE PHONELESCOPE

BY
HERBERT GROVE DORSEY

The phonelescope has been devised for demonstration and research in Sound and Electricity, making visible either of these forms of wave motion.

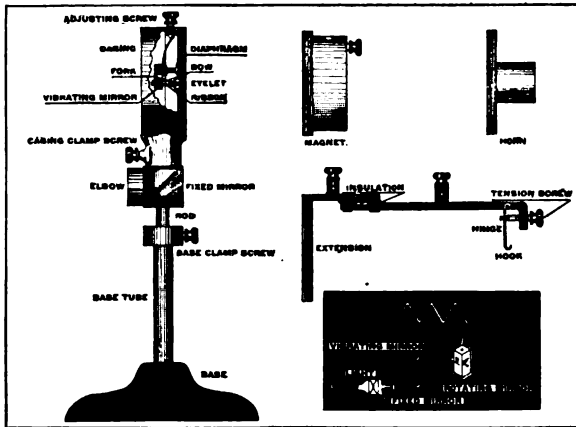

FIG. 1

A tiny steel shaft (Fig. 1) is mounted in jeweled bearings in front of a diaphragm, and any motion of the latter causes the shaft to rotate through a proportionate angle. A mirror on the shaft deflects a beam of light through twice this angle so that the motion of a spot of light gives a trace of the motion of the diaphragm magnified from one thousand to twenty thousand times.

The construction is such that the vibrating mirror may be adjusted about any of the three principal axes, two by the adjusting screw at the top, and the third by turning the casing on the elbow. The opening of the latter is pointed towards a strong source of light and a lens in the lid brings this light to a focus on the screen after it has been reflected upwards by the fixed mirror in the elbow and horizontally by the vibrating mirror in the

casing, both of which are at 45° to the vertical, reducing adjustments to a minimum.

With the horn attachment for sound the actual wave-forms may be easily shown to entire classes, such sounds as are produced by the voice, tuning forks, organ pipes, etc. There is also an electromagnet attachment or telephone receiver which may be screwed into the back of the casing, and by the attraction of the diaphragm it converts the instrument into a polarized D. C. galvanometer, an A. C. vibration galvanometer, or an oscillograph, showing all the ordinary characteristics of alternating current electricity, such as effects of capacity, and inductance and resonance, as well as the transient phenomena on closing a circuit of inductance and capacity.

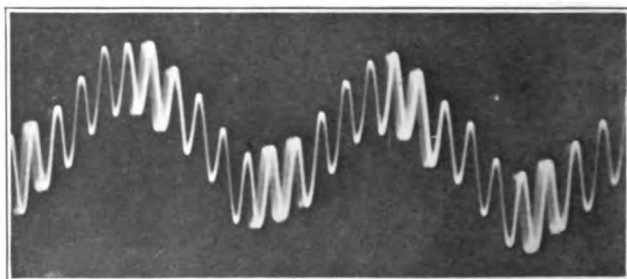

FIG. 2

Besides these usual phenomena of sound and electricity there may be shown unusual ones, such as the combination of a sound and electric wave as pictured by the curve (Fig. 2) where the sound wave from an organ pipe of about 660 cycles is superposed on a 60 cycle electric wave, the curve being made by light from an arc lamp on the same circuit.

GLoucester, MASS.

A DIFFERENTIAL ELECTRODYNAMOMETER

BY
E. D. DOYLE

The instrument shown below (Fig. 1) was developed several years ago for the purpose of rapidly and accurately measuring alternating current voltages of commercial frequencies ranging

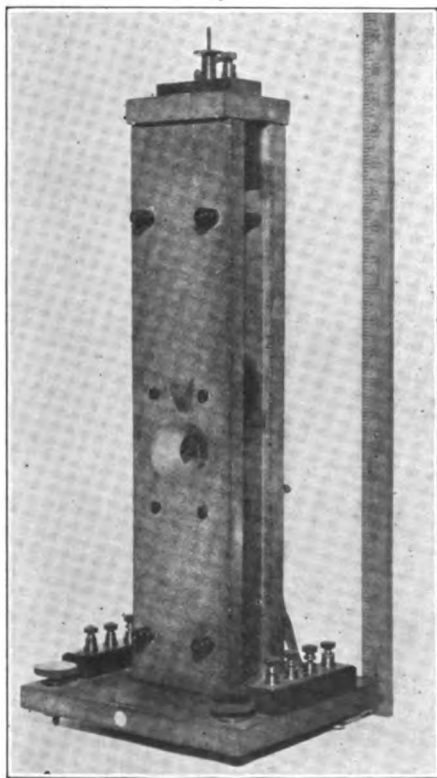

FIG. 1. Exterior view of first meter

from 2 to 300 volts. Fig. 2 shows the internal arrangement. From this it will be seen that there are two electro-dynamometers acting on a common indicator, the torques of the two elements

being opposed. The case is built of alberene stone from a design proposed by Dr. C. H. Sharp. The front plate is removable and carries half of the fixed coils, the connections to these coils being made through the four brass studs which hold the front plate in place. While glass sides afford an easy view of the interior, the clearances are so ample that little trouble is experienced in

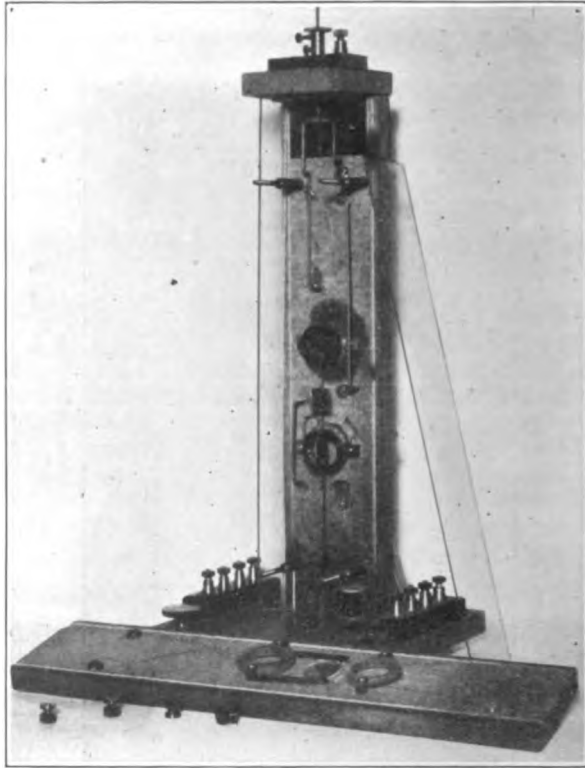

FIG. 2. Interior view of first meter

leveling. The coil arrangement, which is that proposed by Mr. J. T. Irwin, has the advantage of being astatic and having low self inductance in a small space. Silver oscillograph strips are used for leading-in wires. Damping is obtained from a plate swinging in a cup of oil.

The connections are indicated in Fig. 3. Element A is connected through a suitable variable resistor to a "comparison" voltage, while element B may be connected through the selector switch S to either a "standard" voltage or a "test" voltage. The switch P is used to connect the two elements simultaneously to their respective voltages.

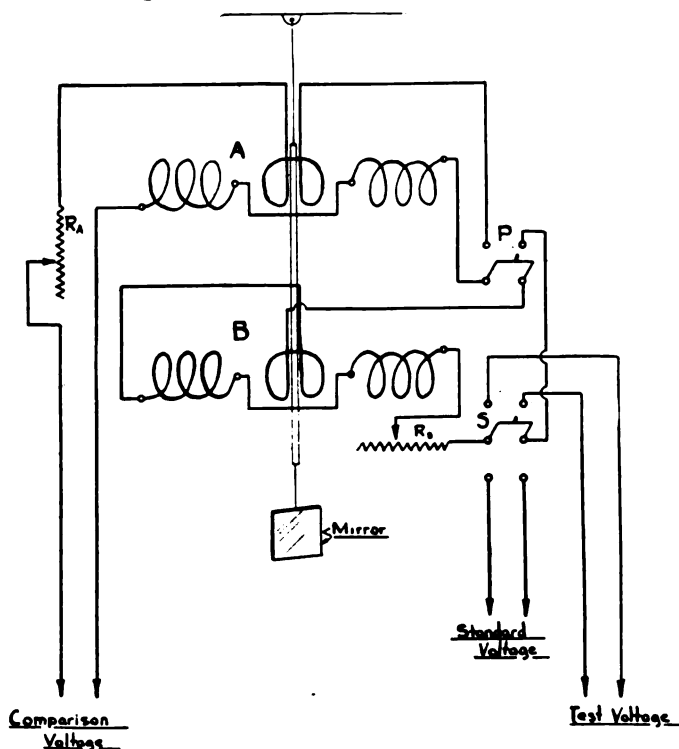

FIG. 3. Schematic diagram of connections

In making absolute determinations of voltages, the "standard" voltage should be a direct current which may be read with a potentiometer and standard cell. Where it is only desired to intercompare a group of ac. voltages, the "standard" may be derived from the same system as the voltages under investigation. The "comparison" voltage may be either alternating or direct current, its sole function being to supply a constant counter torque.

The steps to be followed in using the instrument are:

1. Set R_B to such a value that rated current will flow through B when connected to the "standard" voltage (switch S having been thrown to the "standard" side).



FIG. 4. Latest development of differential electro-dynamometer

2. Close P and adjust R_A until exact balance is indicated.
3. Open P and throw S to "test."
4. Set R_B to approximately the right value and close P .
5. Adjust R_B until an exact balance is indicated.

Since the currents flowing through B under the two conditions are equal to each other, it follows that the voltages are proportional to the corresponding impedances, or, since the reactance is negligible, the total resistances. The total resistance in each case is obtained by adding the resistance of element B to R_B . If the instrument is always operated at the same current, a scale may be drawn which will show variations in current from the nominal value. If such a scale is provided, it will not be necessary to obtain exact balances, slight deviations being observed on the scale, and suitable corrections applied. If the damping is satisfactory, the speed of reading will be increased at practically no reduction in accuracy.

The instrument described above was built by men who were not particularly skilled in instrument-making. Nevertheless it gave satisfactory service until replaced by the one shown in Fig. 4. This is a later development of the same idea, which was built by instrument makers. The constants of both dynamometers are given in Table 1.

TABLE I

CONSTANTS	No. 1 (Fig. 1)	No. 2 (Fig. 4)
Resistance per element, ohms	110	60
Self inductance per element, millihenries	24	10
Sensitivity—millimeters ¹		
At 5 milliamperes	3	4
At 10 milliamperes	12	21
At 15 milliamperes	27	65
At 20 milliamperes	48	225
Period—seconds ²	18	6

¹ Deflection at 1 meter scale distance for 1 per cent unbalance in current.

² Critical damping.

It will be noted that the sensitivity of No. 1 varies as the square of the normal current, whereas that of No. 2 increases at a more rapid rate. This apparent anomaly has been traced to a change in the elasticity of the suspension due to the heating effect of the current traversing the suspension.

Such instruments as these may have a wide field of application. With connections as shown in Fig. 3 they have been used to com-

pare voltages ranging from 2 to 300 volts, 60 cycles, with an accuracy better than 0.05 per cent. The accuracy of measurement of alternating voltages will, of course, depend on the steadiness of the supply. By substituting a condenser for one resistor it has functioned as a very sensitive frequency meter (1% change in frequency producing a deflection of 10 cm. at 1 meter scale distance). With one element connected as a watt-dynamometer and the other as shown in Fig. 3, ac. power may be compared directly against a standard cell. Other uses will suggest themselves to anyone working with the instrument.

ELECTRICAL TESTING LABORATORIES
NEW YORK CITY.

A PRECISION X-RAY SPECTROMETER

BY
H. M. TERRILL

The spectrometer described below was designed by Prof. Bergen Davis and constructed in the shops of the physical laboratories of Columbia University by the departmental mechanic, S. Cooley.

It includes no radical departures from the conventional designs, but is offered rather as an example of a modern instrument, embodying details that have been carefully worked out from accumulated experience in these laboratories.

The base is a cast iron tripod bolted to a triangular sub-base fitted with levelling screws. The graduated disc is of brass, fifteen inches in diameter, bolted to a heavy bronze upright which serves as a bearing for the rotating parts. The disc is recessed to provide a raised arc, graduated on both inner and outer edges to 20'.

Revolving on the bronze bearing is a spider, carrying the ionization chamber slit, its counterbalance and verniers, while within the bearing is a tapered steel spindle which carries the crystal table. The lower end of this spindle rests on a hardened steel set screw adjusted to take up part of the weight and prevent sticking.

Fitting in the top of the spindle, on a tapered shank, is the crystal table. The crystal verniers are not attached to the table but to the spindle itself. Both the crystal and chamber slit verniers read to 20". These verniers are in pairs, 180° apart, so that eccentricity may be eliminated when very accurate readings are required.

The main feature of the instrument is the slow motion worm gear used in connection with the crystal verniers. This is put in action by tightening a clamp surrounding the steel spindle, the clamp being part of an arm terminating in a toothed sector

which engages with an accurately cut worm. On the worm shaft is a graduated drum whose circumference is divided into 200 parts; the sector having 6 teeth per degree so that one division of the drum advances the crystal $3''$ of arc. The divisions being about 2 mm apart, single seconds are readily estimated. The teeth were cut by a master hob and the accuracy by actual test is one part in 7000. The worm is held against the sector and against its thrust bearing by springs, eliminating all lash.

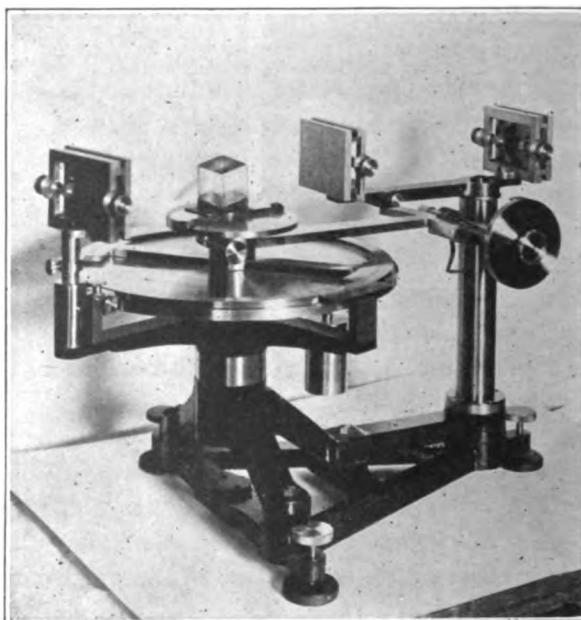

FIG. 1. Photograph showing worm gear and verniers

The worm gear is superior to the commonly used tangent screw particularly when the crystal angle has to be changed by a series of small amounts, as for example, when determining the position of a characteristic line. It is possible to use a tangent screw with divisions on the head to save reading the verniers for each setting but the errors accumulate rapidly, and after a few settings it is necessary to read the verniers and start afresh.

The worm gear, on the other hand, can be used to determine differences of angle accurately over its whole range. In several tests of this instrument, the crystal table was run through 30° by the slow motion, the accumulated error of the screw not being perceptible on the verniers.

The two forward slits are attached to an arm carried on a standard which is bolted to the base of the instrument. By means of opposing set screws, this arm may be adjusted to bring the slits into alignment, with the center of rotation. All

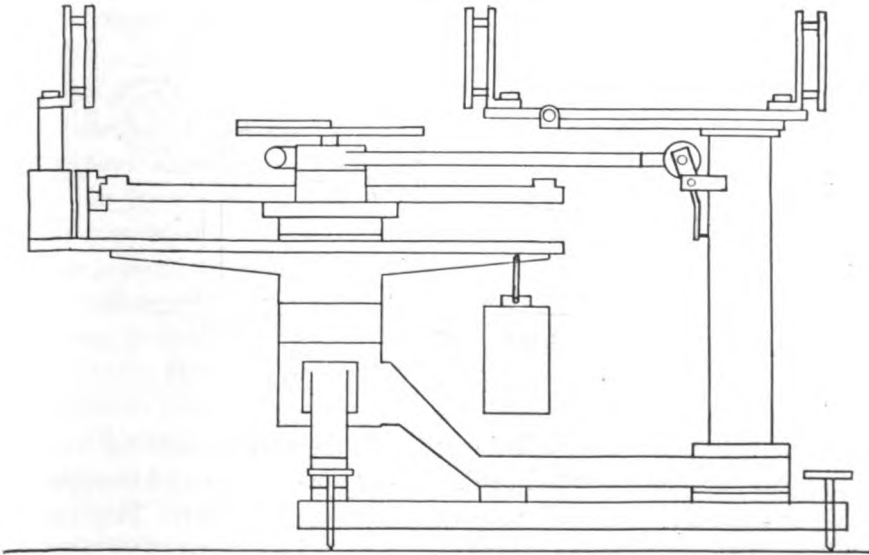

FIG. 2. Elevation showing details of base and uprights

three slits are alike in construction, being made of $3/8$ inch lead plates on brass backings which slide in dove tailed grooves in a brass frame.

Experience having shown that it is impossible to maintain the edges parallel when plates are drawn together by a right and left hand screw, mounted above or below, the plates are moved independently of each other by screws that bear on the centers of the backings. The screws are cut $1/2$ mm pitch and the heads divided into 50 parts, so the slits may be accurately set to $1/100$ mm.

The ionization chamber is not shown. Its weight is supported by a carriage travelling on a track in the form of a circular arc; the forward end of its frame is pivoted to the spectrometer directly beneath the main center. There can be no strain on the instrument from the weight of the chamber.

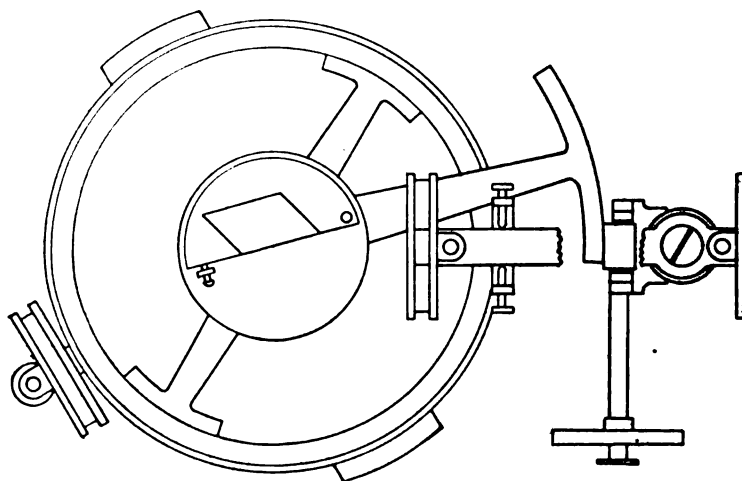

FIG. 3. Plan showing crystal mounting

The crystal is not attached directly to the crystal table but is held by a semicircular plate pivoted to the table at one corner and brought up against an adjustable stop at the opposite corner. This enables the crystal to be returned exactly to its original position after being swung aside for checking alignments or observations on the direct beam.

COLUMBIA UNIVERSITY
NEW YORK CITY

NOTICES

OPTICAL SOCIETY OF AMERICA, SEVENTH ANNUAL MEETING
WASHINGTON, OCT. 26-28, 1922

PRELIMINARY ANNOUNCEMENT

The Seventh Annual Meeting of the Optical Society of America will be held at the Bureau of Standards, Washington, Thursday, Friday and Saturday, Oct. 26-28, 1922.

The regular sessions for the reading of papers will be open to all interested persons.

Members and others desiring to communicate results in optical research are invited to submit titles of papers for the program to the Secretary any time before September 25th. *Titles received after that date cannot be included in the program. The Secretary requests that titles be submitted as early as possible.* No arbitrary time limit is set for the presentation of a paper, but each author is requested to estimate *carefully* the time which will be sufficient to present his paper briefly and intelligibly, and to submit this estimate with the title. *Authors will be expected to confine themselves to these estimates.* Each title must be accompanied by an abstract (100 to 200 words). Authors are urged to make every effort to present the *essence* of their papers as cogently as possible in these abstracts. It is expected that they will be printed in the program and in the minutes of the meeting. No titles will be printed to be presented "by title." Titles should not be submitted unless the author has a *bona fide intention* to actually present his paper orally or have it presented by some one else.

One session will be devoted to Vision and Physiologic Optics.

There will be an exhibit of optical instruments and apparatus at the Bureau of Standards in connection with this meeting. Communications relative to the exhibit should be addressed to Prof. C. A. Skinner, Bureau of Standards, Washington, D. C.

IRWIN G. PRIEST, *Secy.*,
c/o Bureau of Standards, Washington, D. C.

CORRECTION. At the top of page 402, Vol. V, *Joi Opt. Soc. Amer.* there is a typographical error in the formul β . Delete the symbol F inside the braces.

Journal of the Optical Society of America and Review of Scientific Instruments

Vol. VI

JUNE, 1922

Number 4

THE BEGINNINGS OF OPTICAL SCIENCE¹

BY
JAMES P. C. SOUTHALL

Optics shares with astronomy the distinction of being one of the oldest of the physical sciences. But while astronomy has amassed her vast fortune by long-continued industry and labour, optics has obtained hers in comparatively modern times by sagacious and happy speculations. It is possible that magnifying glasses were used by the Chaldeans about six thousand years ago. The cuneiform characters on the tablets found by LAYARD in the ruins of Nineveh which are now in the British Museum are singularly sharp and well-defined, but so minute in some instances as to be illegible to the naked eye. Specimens of the very implements used to trace these inscriptions were found in the ruins and curiously enough glass lenses were found also, but whether any of the latter have been preserved in the British Museum or elsewhere, I am unable to state.

Exactly what progress in optics was made by the Greeks it is difficult to say chiefly because the original works of the Greek philosophers have not come down to us. The teachings of PYTHAGORAS and even of PLATO have been transmitted more or less inadequately through their disciples, and when we know how even in modern times NEWTON's enthusiastic followers misrepresented or at least misunderstood his attitude, for example,

¹ Presidential Address before the Optical Society of America, in Rochester, N. Y., October 24, 1921; on the occasion of the Helmholtz Memorial Celebration.

towards the wave-theory of light, it is easy to conjecture that the doctrines of the old Greek philosophers may have fared much worse as they were communicated to a large extent orally from one generation to another. However, we do know in general that the science of the Greeks was based on the introspective and conjectural rather than the inductive and experimental method, and while this mode of reasoning may be very fruitful in the realm of philosophy, nobody knows better than those who are here present today that it does not help much in unlocking the riddles with which we are confronted in Nature.

The ancient philosophers had satisfied themselves that vision is performed in straight lines and they had fixed their attention upon those straight lines, or *rays*, as the proper object of optics. They had ascertained that rays reflected from a bright surface obey a perfectly definite and extremely simple law, and they were quite familiar with the geometrical properties of mirrors. The art of *perspective* which reached a very high degree of development among the Greeks is merely a corollary from the doctrine of rectilinear visual rays. This art was re-invented in modern times during the flourishing period of painting in Europe, that is, about the end of the fifteenth century.

But the notions of the Greeks concerning vision are vague and confused; although PYTHAGORAS and his followers who believed that vision was due to a material emanation of some kind which proceeded from the object and entered the eye, and that the colour of an object was to be explained partly by some peculiarity in the object itself and partly by some subjective process in the eye, were certainly more nearly in accord with modern ideas than EMPEDOCLES who flourished in the following century or ARISTOTLE a generation or two still later.

A few of the ancient writers tried to explain the appearance of a body immersed in a fluid like water, but not much progress was made towards understanding the phenomena of refraction. ARCHIMEDES is said to have published a book "On a ring seen under water," which it is a pity to have lost, because he at least would certainly not have been vague in his geometrical ideas. SENECA remarks that an oar in clear water appears broken at

that apples seen through a glass appear magnified, but he does not offer to throw any light on these familiar observations. The great Alexandrian astronomer PTOLEMY who lived during the reigns of the ANTONINES published a treatise on optics in which he wrote about atmospheric refraction, and he measured carefully the deflection of a ray of light in passing from air into water, for different angles of incidence, without, however, being able to ascertain the law which baffled all subsequent investigators for the next fifteen hundred years.²

With him the curtain falls on ancient science, and the intermission covers a long barren period in which it would seem that science had fallen into complete oblivion, indeed, had well-nigh perished from off the earth. The only effective link between the old and the new science is afforded by the Arabs. The dark ages come as an utter gap in the scientific history of Europe; for more than a thousand years there was not a scientific man of note except in Arabia and the lands under Mohammedan rule.

The first real progress in mathematical optics was made by ALHAZEN who died in Cairo in 1038. We must pause to devote some space to him, because, although he was distinguished in many branches of science, he is best known through his optical works which were translated into Latin. ALHAZEN was the first to correct the prevalent misconception as to the nature of vision and showed that the rays of light proceed from the external object to the eye and do not issue from the eye to impinge on the object,

² See a recent article on "The Law of Refraction" by Dr. R. A. Houstoun in *Science Progress*, xvi (1922), pp. 397-407; where is given an interesting account of the experimental methods of Claudius Ptolemy for measuring the angles of refraction corresponding to given angles of incidence, with a table showing the actual values which he obtained for air-water, air-glass and water-glass. Further on in the same paper, Dr. Houstoun tells about Kepler's work in this field and gives Kepler's refraction-formula in the form:

$$i = \frac{\mu r}{\mu - (\mu - 1) \sec r},$$

where i and r denote the angles of incidence and refraction, and μ the relative index of refraction; which (he adds) "like the modern formula,

$$\sin i = \mu \sin r,$$

is a one-constant formula." Houstoun subjoins a table of numerical values showing how closely this formula of Kepler's corresponded with the results of his measurements and with the earlier measurements made by Vitellio.

as EMPEDOCLES taught and ARISTOTLE also. His explanations are based on anatomical investigations as well as on geometrical considerations. He showed that the retina is the place where rays are delivered by the eye in order for the impressions produced there to be conveyed along the optic nerve to the visual center in the brain. He anticipated HUYGENS and more modern scientists by explaining that the reason why we see single with both eyes because the retinal images are impressed at corresponding places in the two organs of vision. ALHAZEN likewise pointed out that the sense of sight like our other senses is sometimes misleading, that we may have optical illusions in consequence of the reflection and refractions of the rays of light. He was perfectly aware that the density of the atmosphere decreases with increase of height and he deduced the fact that the path of a ray of light coming from a star not in the zenith (to employ one of the many terms with which the Arabians have enriched our European language) must be curvilinear after it enters the earth's atmosphere, consequently an observer on the earth will see the star nearer the zenith than it really is. He argued also that we must therefore see the stars for a short time before they have actually risen after they have actually set. He showed that it is this atmospheric refraction which accounts for the oval appearance of the discs of the sun and moon near the horizon. The apparent increase of the angular diameters of these bodies in this situation was attributed to a mental illusion arising from the presence in the field of view of intervening terrestrial objects. He showed that the effect of refraction is to shorten the duration of night and dark by prolonging the visibility of the sun—in fact a “daylight-saving” process which Nature has provided of her own accord. Taking into account atmospheric reflection, ALHAZEN deduced that beautiful explanation of twilight which is to this day the accepted theory. With extraordinary sagacity he applied these principles to a determination of the height of the earth's atmosphere, which he found to extend nearly $58\frac{1}{2}$ miles above the level of the sea—anticipating the epoch-making experiments of TORRICELLI and PASCAL by many centuries. “I join,” says DRAPER, “as doubtless all natural philosophers will do, in the pious prayer of ALHAZEN

that in the day of judgment, the All-Merciful will take pity on the soul of ABU-R-RAIHAN, because he was the first of the race of men to construct a table of specific gravities; and I will add ALHAZEN'S name thereto, for he was the first to trace the curvilinear path of a ray of light through the air."

Two centuries glide by before there is another book on optics worthy of note. VITELLIO (*c.*1270 A.D.), a native of Poland, wrote a treatise which is based apparently on the earlier work of ALHAZEN. He compiled a table of the angles of incidence and refraction of light at the surfaces of water and glass, of much greater accuracy than those given twelve hundred years before by PTOLEMY.

But a far more extraordinary man was living and flourishing in England about this same time, and that was ROGER BACON (*c.*1214-*c.*1294) or "Frier" Bacon as he was commonly called in the old English books. Of this eccentric genius whose fame continues to grow we still know too little, except that he must have been born out of due season and was probably centuries in advance of the knowledge of his day. He is credited with having ferreted out secrets of nature which remained hidden from everybody else until our own times. He may have invented spectacles (which appeared in Europe in the thirteenth century) and he is said to have made combinations of lenses which acted like a telescope. Undoubtedly he was familiar with the ordinary properties of a magnifying glass, and he speaks of an instrument by which "the most remote objects may appear just at hand" and with which "from an incredible distance we may read the smallest letters," "and thus a boy may appear to be a giant and a man as big as a mountain," and "so also the sun, moon and stars may be made to descend hither in appearance," "and many things of like sort which would astonish unskilful persons." No wonder he was suspected of being a sorcerer and a practicer of the Black Art. According to an old proverb, "A little knowledge is a dangerous thing," but in the time of ROGER BACON perhaps it was even more dangerous to know too much! At any rate he seems to have been constrained to hide his light under a bushel, and his meaning is often extremely obscure. Like that other famous BACON, the great Lord VERULAM in Queen ELIZABETH'S time, ROGER BACON

had a peculiar fondness, it would seem, for veiling his thoughts in ciphers. But the supposed cryptograms of FRANCIS BACON are mere child's play for difficulty as compared with the elaborate system of cipher piled on top of cipher which old "Frier" BACON is said to have invented to protect himself against the persecutions of his fellow-monks who already accused him of being in league with Beelzebub.

BACON was undoubtedly a prodigious scientific genius, but he was an isolated man without any followers. Now again we must wait patiently nearly two hundred years longer before another star of the first magnitude shines through the darkness of the Middle Ages and sheds its lustre on the fair vales of science. That was the renowned LEONARDO DA VINCI (1452-1519), one of the most versatile, gifted and original men who ever lived and certainly the most ingenious and scientific of all artists before since. The art of perspective which had been cultivated by the Greeks was re-invented by him and placed on a firm basis. It is curious to read now LEONARDO'S speculations about the nature of light and to recognize how modern it all sounds.

But the middle of the next century must be taken as marking the real dawn of modern science; for the year 1543 witnessed the publication of COPERNICUS'S great work and paved the way for TYCHO BRAHE (1546-1601) and KEPLER (1571-1630). TYCHO re-discovered and explained the phenomena of atmospheric refraction. In an interval in his astronomical studies KEPLER turned to optics with the zeal and industry which characterized everything he did. He gave a very accurate description of the action of the human eye (which will be alluded to again), and "made many hypotheses, some of them shrewd and close to the mark, concerning the law of refraction." His epoch may be said to be the real beginning of optical science in Europe.

GALILEO'S long life (1564-1642) overlapped that of KEPLER at both ends. The two men were kindred spirits though very different in many ways. I cannot pause here to speak in detail of GALILEO'S great achievements which are known to all students of science. When the telescope was invented at the beginning of the seventeenth century, the fame of it and of GALILEO'S discoveries

of the satellites of Jupiter ran round all Europe. I think we can hardly conceive today how men's souls were stirred and their imagination kindled by the almost illimitable prospects which this new instrument seemed to open to their gaze. As we read the writings of a man like HUYGENS (who belonged to the next generation), over and over again we seem to catch some spark of the joyous enthusiasm that possessed those eager men who first employed the telescope and the microscope. On the other hand, GALILEO's discoveries excited a great controversy, as we all know. Some of the most powerful and learned men denounced them as subversive of religion and all the venerable teachings that had been piously handed down through long generations from the time of ARISTOTLE; and not a few of the more orthodox even refused to look through a telescope at all and declared that the celestial appearances which GALILEO was alleged to have witnessed with the aid of this instrument were mere chimeras and hallucinations unworthy of credence and having no corresponding objective reality whatsoever. But KEPLER, the greatest living astronomer in Germany, could not conceal the joy with which he hailed the advent of this wonderful new optical device; he was quick to realize the importance and significance of GALILEO's services and he spared no effort to spread the new knowledge abroad through all the scientific channels of that day. Between him and GALILEO there sprang up an intimate correspondence which forms one of the most interesting records of this great epoch and which was characterized by mutual sympathy and admiration as long as KEPLER lived.

There was also another man in Germany who was keenly interested in the new science and who was likewise destined to have a distinguished share in the advancement of Astronomy and Optics, although outside his own country his fame has not reached the proportions which I think you will agree with me it deserves. He is entitled to take rank alongside of KEPLER and GALILEO as one of the founders of modern optical science. It is because so little has been written about him, that I wish to invite your particular attention to his work. If THOMAS YOUNG who came nearly two centuries later is rightly to be regarded as the father of physiologi-

cal optics, CHRISTOPH SCHEINER (1573–1650) may possibly be called its grandfather in the sense of being the original modern progenitor of this science. When the news of GALILEO's first discoveries was being heralded abroad, young SCHEINER was a student of Mathematics in the Jesuit College at Ingoldstadt. Already in 1603 he had invented the famous instrument which he called *pantograph* and which is extensively used for making reduced or enlarged copies of drawings and pictures. He read eagerly the accounts which GALILEO published in the Sidereal Messenger (*Nuncius sidereus*); and, while owing to his ecclesiastical environment and predilections he was a little wary of accepting some of the new ideas, he set to work with the greatest zeal and enthusiasm to test for himself this method of investigation. At that time there were only a few telescopes in Germany. KEPLER himself had not been able to verify GALILEO's observation of Jupiter's moons until the evening of August 30th, 1610. But meantime SCHEINER appears to have gotten hold of several of these instruments, because in the first publication of his researches he speaks of having eight tubes of different sizes. With these he straightway began to make a series of observations which were continued with indefatigable labour and which have won for him an honorable place in the history of Astronomy. In 1611 from the tower of the church in Ingoldstadt he turned his telescope towards the Sun whose blinding light was partially obscured by a thin cloud. To his great astonishment he perceived several dark spots on the Sun's disc, which he pointed out to his friend and pupil CYSAT who was present at the time and who likewise recognized them. Thus by one single glance through a telescope the doctrine of the peripatetic school of philosophy about the absolute purity of the Sun had been pierced in the heart! The two observers agreed at first not to speak of this discovery until they had carefully repeated and verified their observations. CYSAT suggested the use of screens of coloured glass which were in common use by mariners in taking the Sun's altitude at sea. Incidentally, it may be remarked that if GALILEO had employed this device in his solar observations, it is possible he might have been spared the blindness which afflicted his old age.

Although SCHEINER's observations of the sun-spots were repeatedly verified by him, he refrained from publishing his results for fear of arousing opposition, but communicated them to a friend in several letters which he permitted to be published in Augsburg in 1612 under the pseudonym of "Appelles latens post tabulam." It was these letters which formed the basis of the bitter priority-controversy afterwards between GALILEO and SCHEINER. I can merely allude here to the furious strife which they waged with each other through all the rest of their lives. A cynic might almost be tempted to quote VERGIL'S famous line and ask, "In heavenly minds can such wrath dwell?" GALILEO belittled and ridiculed everything that SCHEINER said or did; and SCHEINER entertained the current opinion among his jesuitical friends and colleagues that GALILEO was a dangerous heretic. As time passed SCHEINER rose to high eminence in the councils of the church; and one wonders what part he took in summoning GALILEO in his old age to appear before the High Court of the Inquisition and make public recantation of his errors. We know that even after GALILEO'S trial and humiliation, the stern priest was implacable towards him. Notwithstanding their common interests in the pursuit of truth, they were men of such widely different temperaments and training that it was impossible for either to do justice to the other. SCHEINER was a prodigious and untiring worker, in many ways a typical German, honest and persistent, but apparently without much charm of manner, intolerably prolix in his writings, the kind of fellow I fancy who means well but somehow rubs one the wrong way. GALILEO was just opposite—genial, brilliant, witty, clever, he was never able to recognize the solid good qualities of SCHEINER much less to appreciate the value and importance of his work. By long-continued observations of the sun-spots, SCHEINER established the fact that the Sun turns around an axis, and he found the sidereal period of rotation to be about $25\frac{1}{3}$ days, whereas modern measurements make it a little less than $25\frac{1}{4}$ days.³

³ Neither Galileo nor Scheiner can be said to be the original discoverer of the spots on the Sun, because as a matter of fact these appearances had been noted by the Chinese with the naked eye as long ago as the beginning of the fourth century (301 A.D.). Galileo seems to have seen them for the first time in August 1610, whereas

One of SCHEINER's lectures in the University of Ingoldstadt was on the telescope, which besides giving a minute description of the construction of that instrument contains suggestions about its use for military operations, land-surveying, and particularly in Astronomy. He invented an instrument called a *helioscope* designed especially for solar observations. He also employed a telescope to project the image of the Sun on a screen, as GALILEO did afterwards. At first SCHEINER used in this experiment an ordinary Dutch telescope, but subsequently he found that a telescope with a convex ocular answered the purpose much better. This was apparently the first practical trial of the *astronomical telescope* invented by KEPLER. He also describes a telescope with *equatorial mounting* for keeping the instrument focused at the same place in the heavens, essentially the same as is to be found in our modern observatories today.

At Ingoldstadt and afterwards especially at Innsbruck we find SCHEINER devoting much time to purely optical researches and the nature of vision. The results of these labours were published in 1619 in a very celebrated book called *Oculus sive fundamentum opticum*, of which there were three editions, one published in London in 1652 after SCHEINER's death. This is in every respect a very original and remarkable volume. It is divided into three parts, the first of which contains a description of the anatomical structure of the eye and experiments of various kinds; the second part is a study of the optical performance of the eye and its behaviour towards the rays of light which enter it; while the third part treats of vision, apparent size and questions that are distinctly of the nature of physiological optics. His methods in this treatise are beautifully scientific, every argument being based strictly on experiments.

Scheiner did not see them until March 1611. Meanwhile, however, they had been also observed entirely independently by a certain Johann Fabricius in December 1610, who published a book in June 1611 entitled "Narratio de Maculis in Sole Observatus," wherein the phenomena were minutely described. This was the first announcement in print; but neither Galileo nor Scheiner appears to have had the slightest knowledge of Fabricius's work. Scheiner's first letter on the subject, dated November 12, 1611, was published January 5, 1612. This was followed by Galileo's letter dated May 4, 1612 but not published until the following year.

As early as 1583 a Neapolitan philosopher JOHN BAPTISTA PORTA (1545–1615) who had invented the *camera obscura* compared the eye to it, but he was not sufficiently clear about the anatomical and optical structure of the eye, and he seems to have supposed that the image was received on the crystalline lens. KEPLER was the first of the European scientists to suspect that the retina was the screen where the image was focused, but he could never be sure that this opinion was correct. But SCHEINER established this fundamental fact by actual experiments first on the eyes of sheep and oxen and afterwards in Rome in 1625 on a human eye. Thus he ascertained beyond peradventure that the retina is the peculiar sensory organ of vision, and since he knew also that the retina is a ramification of the optic nerve, he had a very clear idea of how the perception of an external object is communicated through the eye to the brain. The fact that the image on the retina is inverted and that nevertheless the eye perceives the object as erect was correctly explained, as KEPLER had already explained it, by the circumstance that the eye has the faculty of referring each point of the retinal image to the corresponding external point of the object.

However, in order to obtain correct notions about vision, it was necessary, as we can readily understand, to be able to trace the paths of the rays exactly; and to this study SCHEINER devotes all of the second part of his treatise on the eye. He is careful to distinguish the different refrangibilities of the ocular media, comparing the aqueous humour with water in this respect and the lens with glass, whereas he regards the refraction of the vitreous humour as intermediate between the two. He was not able to determine these relations more exactly because even then the law of refraction was still an enigma. SCHEINER himself sought in vain to solve this puzzle, and he made a whole series of painstaking experiments on the refraction of water which were afterwards published in a table giving the values of the angles of refraction for different angles of incidence for every degree between 0° and 90° .

SCHEINER devised a great number of simple but exceedingly ingenious and instructive experiments for showing how the visual

rays arrive at the retina and form an image there. Several of these are classic, one of them in particular which is referred to in all the text-books as "SCHEINER'S Experiment." He was one of the first to call attention to the contraction or dilatation of the pupil which always accompanies the act of accommodation.

If I have seemed to dwell too long on SCHEINER'S work, it is because I have in mind the occasion which we are gathered to commemorate and because the contributions of this pioneer in Physiological Optics seem to bear very directly on some of the most important work of his great successor in Germany in the nineteenth century.

Some years after the publication of the first edition of SCHEINER'S treatise on the eye, but prior to 1626, a Dutch Professor in Leyden named SNELL announced the true *Law of Refraction*; but this law was first published by DESCARTES in 1637 who for a long time enjoyed the credit of having discovered it.⁴ SCHEINER and DESCARTES both died in 1650. In addition to his splendid achievements in Philosophy and Mathematics, DESCARTES (1596-1650) was famous also as a natural philosopher and in this department he made many notable contributions to the science of Optics and Vision. He had a remarkable grasp of the *modus operandi* and mechanism of the eye, although some of his optical writings are very vague and unsatisfactory. His great successor HUYGENS alluding to DESCARTES in connection with the theory of the telescope complains that although it is hard to believe it of a man who was so intelligent and well-informed in these matters, nevertheless he got off the track in his demonstrations of the nature and

⁴ Eleven years after the death of Snell, Descartes published his *Diotrics*, in which he announced the law of refraction in terms of sines as we have it now, without mentioning Snell's name. It is said that Descartes had access to Snell's manuscript; Huygens states that he himself had seen the whole manuscript volume of Snell, and that he believed that Descartes had also seen it. "Biot attempts to give the whole glory of the discovery to his countryman Descartes, but the preponderance of opinion is in favour of the view that Descartes' discovery was not independent." While it is probable that this is a question which can never be settled with certainty; it may be added that "Descartes was not generous in speaking of the work of others. In dealing with the invention of the telescope, for example, he does not mention the name of Galileo, and in treating of the rainbow he makes no reference to Antonio de Dominis." See R. A. Houstoun, "The Law of Refraction," *Sci. Prog.*, xvi (1922), pp. 397-407.

effect of the telescope and was sometimes guilty of writing things on this subject to which, to put it baldly, no meaning can be attached!

And now at length the stage is set and the greatest actors of all are ready to step out upon the scene. We have reached the period of that great outburst of optical science in the seventeenth century which followed the invention of the telescope and the discovery of the law of refraction, and which constitutes a kind of Elizabethan Era in the history of scientific achievement. The most illustrious names, of course, are those of HUYGENS (1629–1695) and NEWTON (1642–1727), but clustered around these stars of the first magnitude and forming with them a constellation such as has hardly been seen before or since in the firmament of science are the names of GRIMALDI (1618–1663), who investigated for the first time the difficult and obscure phenomena of Diffraction; ISAAC BARROW (1630–1677), one of the greatest geometers of his day, who had the honour of being NEWTON'S guide and preceptor; ROBERT HOOKE (1635–1703), whose misshapen body was the abode of one of the acutest intellects and who penetrated the secrets of nature with an insight that seems now almost like *clairvoyance*; and ROGER COTES (1682–1716), first Plumian professor of Astronomy in Cambridge University, of whom NEWTON is reported to have said, "Had COTES lived, we might have known something!" If one pauses to think about it, there is something very remarkable about the mutual interaction of pure and applied science in the wonderful story of human progress. For if it is true, especially in this complex modern world of ours with its amazing machinery and useful appliances of all kinds, that the cultivation of pure science stimulates the art of invention and leads to almost bewilderingly new processes of engineering, it is also abundantly manifest that, along with industrial development and the adaptation of the forces of nature, there comes always a higher appreciation of the utility and efficacy of pure science. If one has to look for a needle in a haystack, and has spent many weary hours in the fruitless quest, we may be sure that he will be duly impressed by the discovery that the little bit of steel will leap instantly from its hiding-place at the bidding of a magnet!

A notable illustration is afforded in the history of optics itself when the invention of the telescope and the hope of bringing it to greater perfection were perhaps the chief factors that contributed to the brilliant optical researches and speculations of HUYGENS and NEWTON and their contemporaries. "The practical application," as the late Professor SYLVANUS THOMPSON expressed it, "which we know was in the minds of each of these men, must surely have been the impelling motive that caused them to concentrate on abstract optics their great and exceptional powers of thought."

We all know of HUYGENS as the inventor of the wave-theory of light; but not many of us, I fancy, are familiar with his admirable and lucid explanation of that hypothesis, although it is now quite a long time ago since Dr. CREW (who is one of the speakers on the programme of the HELMHOLTZ Centennial Celebration) published a little volume which contains a translation of some of the most important chapters of HUYGENS'S famous treatise on light (1690) and a few years ago a complete English translation was brought out. HUYGENS had to take account of seven fundamental facts: (1) The rectilinear propagation of light; (2) the interpenetration of two beams of light where they cross each other; (3) the law of reflection; (4) the law of refraction; (5) atmospheric refraction; (6) the finite speed of light, discovered by ROEMER in 1676; and (7) the double refraction of Iceland Spar, discovered by BARTHOLINUS in 1669. As Professor THOMPSON remarks, the insight with which, by the aid of his conception of elementary wavelets building up an enveloping wave-front, HUYGENS succeeded in giving a consistent theory must excite our wonder and admiration. Of course, his wave-theory had to be developed further by YOUNG and FRESNEL long afterwards; but every reader of this work will marvel at the exquisite skill with which he unravelled the intricacies of double refraction in crystals and the anomalies of atmospheric refraction. I have not attempted here to give even an outline of the rich contents of this precious little volume. "HUYGENS was in many respects a notable man. A Dutch aristocrat, a friend in his youth of DESCARTES, he, like the philosopher SPINOZA, was a

grinder of lenses. With his own hands he built in 1665 the telescope with which he discovered the ring of Saturn and the fourth of his satellites."

It was recently my duty and privilege to look through the thirteenth volume of the monumental edition of HUYGENS'S Complete Works which was undertaken in 1888 by the Dutch Society of Sciences. This volume which contains HUYGENS'S contributions to Dioptrics was issued from the press in 1916 during the great war. With the introduction and notes it comprises more than a thousand pages and is wholly distinct from the treatise on light to which I have already alluded. It is worth noting with what elegance and skill—far in advance of his contemporaries in this respect—HUYGENS derives from the law of refraction the fundamental characteristics of optical imagery. He attached a very definite meaning to the magnifying power of an optical system and he was perfectly familiar with the convenience and importance of the so-called entrance-pupil and exit-pupil which ABBE used to such advantage in his optical studies. A theorem of HUYGENS'S which deserves to rank as one of the most beautiful generalizations of theoretical physics and which can be extended to the theory of radiation in general states that, "If an object is viewed through a system of any number of lenses, and if the places of the eye and object are mutually interchanged without disturbing the lens-system itself, the apparent size of the object will be the same as before, and the image will be erect or inverted as before." Every student of Geometrical Optics will recognize at once that this is equivalent to the theorem given by ROBERT SMITH in his *Compleat Systems of Opticks* published in Cambridge in 1738, as the first corollary to be deduced from ROGER COTES'S celebrated proposition about the "apparent distance" of an object viewed through a combination of thin lenses. SMITH does not mention HUYGENS'S name in connection with this corollary, perhaps inadvertently, possibly also because he considered it as a part of COTES'S theorem; for undoubtedly at that time (1738) SMITH must have known of HUYGENS'S proposition and in fact he quotes constantly from HUYGENS'S writings. There can be no question that HUYGENS is entitled to the priority here, although I never

heard his name mentioned before in connection with this particular matter. HUYGENS himself constantly makes use of this general principle in the solution of special problems, and modern workers will find it serviceable in the same way, just as we often take a short cut in physics by an application of the Principle of the Conservation of Energy.

I have become convinced also by a study of this huge volume that HUYGENS was certainly the first person to recognize clearly the essential fact about a telescope, that the magnifying power of a telescope is equal to the ratio of the focal lengths of object-glass and ocular. He gives three or four proofs of this theorem and attaches the utmost importance to it. It is certain that neither KEPLER nor DESCARTES had grasped clearly this fundamental and distinguishing property of the telescope.

Doubtless few persons are aware nowadays that HUYGENS made valuable contributions to science also in the realm of Physiological Optics. Most physicists are content, so to speak, to deliver radiant energy to the eye and there leave it to its fate; unfortunately, comparatively few of them, like YOUNG and HELMHOLTZ, have thought it worth while to pursue the investigation further and to study the intricate phenomena of vision. Not so HUYGENS; he at least was keenly alive to the fact that at the other end of his microscope or telescope a human eye was adjusted, and that visual perception is the chief thing after all. He was perfectly aware that the magnifying power of the instrument depended on the idiosyncrasies of the eye of the individual. Apparently far more accurately and minutely than DESCARTES or any of his own contemporaries, HUYGENS was acquainted both with the anatomical and optical structure of the eye; and he had the clearest notions about the office of the pupil in the mechanism of accommodation. He perceived that the marvellous power which the eye possesses of seeing either far or near was somehow essentially an affair of the crystalline lens alone; although he wavered in his opinion as to whether the change of focus was produced by a forward displacement of the lens as a whole or by a change in the convexity of the anterior surface or by a combination of both variations. He describes a simple experiment to

show how the pupil of the eye contracts on being exposed to bright illumination. It consists merely in looking through a telescope at a bright background after the eye has been kept in darkness for a suitable time. At the first glance in the instrument the extent of the visible field will be wider than usual, but as the eye gradually becomes adapted to the greater brilliancy, the field rapidly diminishes in consequence of the contraction of the pupil. The essential theory of binocular vision and depth perception was grasped by HUYGENS. He explains in the clearest manner how in order to see an object single with both eyes the two images on the retina must be formed at "corresponding points," just as ALHAZEN had explained it many hundreds of years before. Apparently, HUYGENS failed to perceive that a solid object looks differently to each eye, otherwise he might have anticipated WHEATSTONE and BREWSTER in the invention of the stereoscope. In the first part of the *Dioptrica* HUYGENS gives a description of a "*simplified eye*" formed by two concentric hemispheres of unequal radii. The curved surface of one of these hemispheres corresponds to the cornea and that of the other to the retina of the eye. There is a singular and most striking resemblance between HUYGENS's "*simplified eye*" and the "*reduced eye*" conceived by J. B. LISTING in 1845.

After all what impresses the reader most amid all this wealth of material is not so much the theories which are propounded with such rare insight and skill, but the marvellous versatility and resourcefulness of the author and the variety of observations and experiments which underlie the whole and form the solid structure of the edifice itself. To his extraordinary mechanical ability and ingenuity HUYGENS owed much of his remarkable accomplishments; with him to conceive was to execute, no matter what practical obstacles might lie in the way. To this day we read with astonishment of those prodigious "*aerial telescopes*" with their poles and pulleys which he constructed and mounted with his own hands and with which he made some of his great discoveries in Astronomy. HUYGENS's name is usually associated in our minds with refracting telescopes; but he devoted much study also to reflectors and preferred NEWTON's type of instrument to those

of GREGORY and CASSEGRAIN. Many pages in his *Dioptrica* are devoted to the theory of the compound microscope and his own original microscopical investigations. A whole section of the work is concerned with the intricate theory of spherical aberrations, and he deduced a number of modern formulas on this subject. Chromatic aberrations also received his attention, and he hailed with joy NEWTON'S theory of dispersion which enabled him to subject these aberrations to the same kind of mathematical analysis which he used in the study of monochromatic aberrations.

But enough, I fear more than enough, has been said to give you some idea of the character and scope of HUYGENS'S optical researches; although they represent only a part of his manifold scientific activities. No wonder that he published comparatively little during his busy lifetime! Before he could get his thoughts safely on paper, a whole vista of new ideas begins to distract and fascinate him. New discoveries give ever a new turn to his earlier imaginings, and so he hastens onwards still eager in the pursuit of knowledge when death overtakes him at last at the summit of his great career. *Felix qui potuit rerum cognoscere causas!*

And here I must stop abruptly in the very midst of this thrilling story when, if I have succeeded at all, your interest must be keyed to the highest pitch; because I find I have already exceeded the time which I ought to have on the programme of this meeting. To attempt to give even a brief outline of the history of optics and to abandon the project at the point where Sir ISAAC NEWTON appears upon the scene is like giving the play of Hamlet without the Prince of Denmark. I had hoped to tell not only of NEWTON'S influence and the origin and growth of the new science of Physical Optics as developed by YOUNG (1773–1829) and FRESNEL (1788–1827), perhaps also to dwell a little on FRAUNHOFER'S important achievements particularly in the direction of optical engineering; but above all it was my purpose to remind you of THOMAS YOUNG'S remarkable contributions to Physiological Optics and the work of DONDERS (1818–1889) in Holland which did so much to pave the way for the epoch-making researches and inventions in this

field of science which forms one of the achievements of the great modern scientist who, born in Germany a hundred years ago did so much for the advancement of human knowledge and conferred such blessings on all mankind that with one accord we have assembled here today to do honour to his memory.

COLUMBIA UNIVERSITY

HELMHOLTZ ON THE DOCTRINE OF ENERGY*

BY
HENRY CREW

Mr. Stevenson in one of his best known stories has ably portrayed the character of a man who led two different lives—lives so different, indeed, that one is apt to forget that Dr. Jekyll and Mr. Hyde are really one and the same individual.

Most men, I believe, lead two lives, though not in the sinister sense in which the phrase is employed by the newspapers. A striking illustration of this fact is the late Mr. Burnham, well known to a wide circle of friends as an eminent astronomer; equally well known to another group of friends as the genial and clever clerk of the Federal Court in Chicago. More than once have I met a man who knew about both of these Burnhams without ever suspecting that they were one and the same individual. So widely separated may the two sides of a man be that the public do not recognize them as belonging to the same mind.

A few of the members of this society will recall a volume which appeared many years ago, under the title of "Flatland by A. Square." Here all men were represented as polygons somewhat in the following manner: a thoroughly ignorant and uncultivated man was pictured as a triangle: an ordinary man as a square: a man of better training as a pentagon: a scholar as a hexagon: the perfect man as the circle; women, alas, were limited straight lines. This picture is not entirely bad, for the simple reason that everyone finds most of his own friends many-sided, and responsive to stimuli from many different directions.

The man in whose honor we are gathered to-day differs from most other men, not so much in the number of his sides, as in their high development, in their brilliancy and in their public character. Most men are known to us only through one line of achievement; Helmholtz was pre-eminent as a physicist, but very favor-

*Read October 24, 1921 at the Helmholtz Memorial Meeting, Rochester, New York.

ably known as a physiologist, a mathematician, a philosopher and an artist.

It is my privilege to say something on one of these lines of activity, namely, his earlier work in physics, especially that touching the doctrine of energy.

But before doing this I ought, perhaps to confess, as I have long ago done to your program committee, that my personal acquaintance with Helmholtz was quite brief. It began when I went to obtain his signature, in my *Anmeldungs-Buch*, for the course in Experimental Physics which he offered at Berlin during the winter semester of 1883-4. At the same time I was assigned a private room in the laboratory on the Wilhelm Strasse and the river, not for the purpose of research but simply to make good my lack of laboratory experience. Here the main instruction was given by *Privat Docent*, Dr. Ernst Hagen, later the director of the Second Division of the Reichsanstalt; but Helmholtz had the habit of strolling through the laboratory each day about noon visiting these separate work-rooms, usually inquiring as to what had been done since he was last there, always speaking idiomatic English and nearly always offering some kindly suggestion before leaving. It was here in this laboratory at this time that I first had the pleasure of meeting those two fine spirits, Brace and Keeler.

Helmholtz, as I remember him, had no more striking characteristic than his kindly simplicity. I was confirmed in this view during the summer just passed when in Heidelberg I had the pleasure of meeting Professor Leo Königsberger, the clever scholar and the genial biographer of Helmholtz. I had just asked this eminent mathematician what Helmholtz would think about a certain question. He began his reply with this remark "Helmholtz war ungeheuer einfach!" This simplicity of his showed itself in his dress, in his exposition, in his bearing, and in his method.

Near the end of the semester on going to Helmholtz's office to say good-bye, he was kind enough to give me a commendatory letter to Professor Rowland, which was far more effective than any merit of mine in securing for me a fellowship at Johns Hopkins University; for Helmholtz was one of that very small group of

men, (including Maxwell, Stokes, and Rayleigh), whom Rowland really respected. I saw Helmholtz for the last time at the International Electrical Congress, held at Chicago in 1893. The first session of this body met under the presidency of Elisha Gray, in the Art Institute, then a vacant hall used for public meetings; and it is safe to say that no scientific man, either before or since, has ever received at the hands of Chicago such a spontaneous, warm hearted, and enthusiastic reception as did Helmholtz on this occasion.

You will perhaps allow me to add just one other personal note. My interest in the events of to-day is all the greater because in 1897 at Evanston, we celebrated the 50th anniversary of the appearance of Helmholtz's essay "On the Conservation of Energy." The celebration took the form of a *conversazione* in our physical laboratory where a large variety of transformations of energy were shown experimentally and where President and Mrs. Henry Wade Rogers graciously received the friends of the University.

We come now to the place which this remarkable pamphlet, *Über der Erhaltung der Kraft*, occupies in the history of Physics. But the place which *any* work deserves can be appraised only after one understands the background of ideas which preceded it, and the foreground of results which have followed it. Let us therefore, as briefly as possible, discover the doctrine of energy as it was held just before the time of Helmholtz.

I

Early in the seventeenth century, the idea of force as the time-variation of momentum had been introduced by Galileo and adopted by Newton. Huygens had already introduced the new and appropriate idea of *mass* under the name of "solid quantity." Stevin who died in 1620 had already clearly grasped the principle of virtual work.

It was just here, during the half century, which is possibly the most brilliant known to science, that there arose the great debate between Leibnitz and the Cartesians concerning the nature of *vis viva*, a debate which was finally umpired by D'Alembert and

which resulted in a perfectly clear, workable, and appropriate definition of energy as we know it to-day.

To discover the idea which is appropriate for the description of any particular phenomenon is an extremely difficult matter; and for the very good reason that any physical phenomenon you may choose to select, even the simplest, is extraordinarily complex. Thus the quantitative description of the ordinary process of driving a nail by means of hammer baffled the civilized world for more than twenty centuries. These clouds were first removed in 1668 by the English mathematician, John Wallis, one of the founders of the Royal Society. Wallis pointed out that the decisive factor in the case of the hammer and nail, the battering ram, the base-ball bat, etc. is the product of the force by the time. The idea of an impulse measured by the time-integral of the force, proved to be the appropriate one. This view of Wallis' seemed to support the view of Descartes, that "momentum" is the proper measure of the force in a moving body.

But Leibnitz, just the year before the appearance of Newton's *Principia*, published a little tract with the following title: *A short Demonstration of a Remarkable Error of Descartes' and Others, Concerning the Natural Law by which they think that the Creator always preserves the same quantity of motion; by which, however, the Science of Mechanics is totally perverted.* Leibnitz based his criticism upon two common experiences; (1) that it requires the same "force" (using his terminology and that employed by Helmholtz as late as 1847) to raise a body weighing m pounds through a height of four feet as it does to lift a body weighing $4m$ pounds through *one* foot; and secondly, that a body can rise, in virtue of its velocity, only through a height which would produce this same speed by fall. But when a body falls through four feet, it acquires a speed which is just *twice*, (not four times) the speed acquired by falling through *one* foot. If, therefore, the "force" acquired (using the word again in its then current sense) is the same in each case, it follows that it must be measured by the square and not by the first power of the speed.

$$4m \times 1 = 1m \times 4 = \text{work.}$$

$$4m \times v^2 = 1m \times (2v)^2 = \text{vis viva.}$$

The whole discussion finally reduced itself to the question as to what is the proper measure of the "force" of a moving body whose mass is m and whose velocity is v . The Cartesians maintained that mv is the measure of the "force"; while the Leibnitzians were equally confident that it is mv^2 .

These differences were first composed when D'Alembert published his great treatise on dynamics in 1743. For, in his introduction to this work, D'Alembert showed that both sides were correct, *vis viva* being the proper measure of a force acting through a certain *distance* and *momentum* the proper measure of a force acting through a certain interval of *time*. Here is the shield with two sides giving us the two fundamental and thoroughly consistent definitions of force which are to-day everywhere used in physics, namely, *the space variation of energy* and *the time variation of momentum*. D'Alembert had taken a great step; the atmosphere was now clear.

The doctrine of energy—though not yet under that name—was now fairly launched. It had long been known that the speed with which a body reaches the foot of an inclined plane, depends, if we neglect friction, only upon the vertical height from which the body starts.

Huygens, as early as 1673, had assumed the constancy of *vis viva* as an axiom. John Bernouilli had coined the expression "conservation of *vis viva*" in 1729; but, as a definite mechanical principle, it appears first to have been used by his distinguished son, Daniel Bernouilli, in 1748.

The next important step in the doctrine of energy was taken by the French Academy in 1775 when by deciding not to entertain any more proposals for perpetual motion they expressed their appreciation of the fact that *vis viva* is uncreatable.

Next comes the word "energy," introduced by Dr. Thomas Young, in 1807, and defined by him as the product of the mass of a body into the square of its velocity. How incomplete this definition is will be seen from the fact that it includes only the mechanical energy of motion and also omits the factor " $\frac{1}{2}$ " which had been lost sight of in the scrimmage between the Cartesians and Leibnitzians. This neglect of the " $\frac{1}{2}$ " was owing, of course

to the fact that only ratios of energies were discussed by Leibnitz and his followers.

A few years later, in 1826, came the term "work," in its modern sense, suggested by Coriolis to the French engineer Poncelet. From this time on, forms of energy other than those of mechanical motion were rapidly recognized. In 1824, Carnot applied the energy equation for the first time to a non-mechanical phenomenon, viz. heat. Gauss, in 1828, applied it to the energy resident in a liquid surface.

Nevertheless, during all of Helmholtz's boyhood and early manhood, electricity was still the science of two electric fluids: the same was true of magnetism: heat was the science of caloric: light that of the luminiferous ether. The science of Physics was without form and void: it lacked connective tissue; it had no general and controlling principle such as Astronomy and Mechanics had long possessed.

But now evidence was accumulating to show that heat was "a mode of motion," that electrical and magnetic fluids were not unrelated, that light and radiant heat are not only the same sort of thing but that each is a form of energy. These invisible and imponderable substances which had been so lightly called into existence in order to cover our ignorance were being quietly but firmly thrust *out* of existence. In their stead was growing up the new and comprehensive science of energy which from the very beginning was to act as a bond not merely between the various branches of physics, but between all the physical sciences. The new science of energy is therefore something vastly wider than the domain of physics.

But the general equivalence of energy and work, the quantitative transformation of energy, was as yet by no means an accepted fact. It was indeed believed by very few.

Two important events intervened between the time just described and the appearance of Helmholtz's memoir. The first of these is the assumption of the equivalence of heat and work by Robert Mayer in 1842 and his computation of the mechanical equivalent of heat from the difference of the two specific heats of air. The second of these events is the well known experimental

confirmation of Mayer's views by Joule beginning with the year 1843. For Joule not only evaluated the mechanical equivalent of heat but he proved by experiment the truth of Mayer's assumption that the internal work of the expanding air was negligible. These two advances may be described as the establishment of what was later called the First Law of Thermodynamics.

Such is the background of the scene upon which the young army-surgeon of twenty-six appears in 1847, and reads his paper on the *Conservation of Force*. From the title of the memoir, it will be observed that even yet, forty years after Young had proposed the name "energy," the same word is used to denote *force* and the *space-integral of force*: so slow are we all to adopt a new nomenclature even when it is sadly needed to clarify thought. The reason for this delay is, however, not far to seek. The *concept* of energy could not, naturally, assume any great importance until the *principle* of energy had been established. If anyone thinks that accurate definition of scientific terms or the accurate use of them is a small matter, let him recall the terrible riot at Tulsa, Oklahoma, last year which cost many lives and which was precipitated entirely by the inaccurate use of *the word* "assault" by a newspaper reporter.

II

Let us now pass to a brief consideration of the contents of this celebrated essay *Über die Erhaltung der Kraft*.

No sentence in the entire discussion is more characteristic of Helmholtz than the first one in his introduction where he explains that the memoir is intended for physicists, that it is not therefore based upon any philosophical grounds, but upon a single physical assumption, the logical consequences of which he proposes to compare with the experimental laws of physics.

The introduction is mainly occupied with the explanation of this assumption, for which two alternative forms are given, namely, either that perpetual motion is impossible or that all effects in nature are ultimately explicable in terms of attractive and repulsive forces whose intensities depend only upon the distances which separate the particles acting upon each other.

Helmholtz expresses preference for the latter of these equivalent assumptions; but most of his successors, like Carnot and Clapeyron before him, have preferred the former.

Here also is to be found a brief outline of scientific method as Helmholtz understood it at the age of twenty-six. "The final goal," he says, "of scientific theory is, therefore, to discover the final and invariable causes of the processes which occur in nature." At the age of sixty-eight, however, when he annotated a reprint of this essay for *Ostwald's Scientific Series* he adds this note: "It was at a later date that I came to understand that the principle of causality is nothing other than the assumption that the phenomena of nature occur according to law."

This mature judgment of Helmholtz—this clear recognition of the one postulate of physical science—is all the more important because even to-day the idle inquiry as to *why* something happens often distracts the time and energy of the student from the more profitable inquiry as to *how* the thing happens.

The first chapter of the essay is devoted to the enunciation of the well known mechanical principle of the Conservation of *Vis Viva*, namely, that the kinetic energy acquired by a mechanical system in changing from one configuration to another is precisely equal to the work required to bring the system back into the original configuration. The author proceeds to prove that this principle can hold, in all its generality, only when the elementary forces of the material particles are central forces.

In the second chapter, the idea of potential energy is introduced under the name of "sum of the tensions," a quantity which is nothing else than a line-integral of the force. Then the result of the first chapter is generalized into the proposition that, for any system of natural bodies, acting upon one another by attractive or repulsive forces, not depending upon time or velocity, the sum of their kinetic and potential energies must be constant. The nomenclature—*vis viva* and *spannkraft*—is that of Leibnitz; the mechanical ideas are those of Newton; the introduction of potential energy is due to Helmholtz. This theorem is next applied to derive the principle of virtual displacements and thus to establish the whole science of statics. Two noteworthy features distinguish

the expression which Helmholtz here gives the energy principle. The first is that it is quantitative; the second is that it is placed in the form of an invariant similar to that of the conservation of matter.

The third section deals with problems in mechanics to which the energy principle has already been recognized as applicable. These problems are those of the heavenly bodies, falling bodies at the surface of the earth, motions transmitted by rigid solids or by frictionless liquids, the collision of perfectly elastic bodies, waves in elastic media, absorption, and interference.

Helmholtz here suggests that these problems which had hitherto been solved in a great variety of different ways are all capable of solution in terms of energy.

He then employs the fourth chapter in the discussion of a set of phenomena in which it had hitherto been assumed that there was an absolute loss—not merely a waste but an actual destruction—of energy, namely, inelastic collision and friction.

Here the whole question of the mechanical equivalent of heat is raised. Is there such an equivalence? If so, what is the value of the ratio? These questions and others, such as the nature of the heat developed in chemical combination are taken up and solved, as one might expect, in terms of Joule's experimental results and Clapeyron's theorem. His conclusion is that the conservation of energy holds good in every case where the conservation of caloric has, in the past, been found to hold; namely, in the phenomena of conduction, radiation, and change of state. A clear distinction is here drawn between sensible heat as a form of kinetic energy of the molecules and latent heat as work done against the attraction of the molecules. Helmholtz thus presented the modern view of sensible heat as kinetic energy and the so-called latent heat as potential energy which is a form of work, and hence not heat at all.

Attempting to go still farther into the mechanical theory of heat, Helmholtz assumes three kinds of atomic motion as possible; (1) a translation of the center of gravity; (2) a rotation about the center of gravity, and (3) a displacement of the various parts of the atom with respect to one another. But here his

abilities as a prophet fail him and he rests with the possibility of conceiving the phenomena of heat as produced by motion of *some* kind.

One interesting prediction of this chapter is the phenomenon, later discovered by James Thomson, of the lowering of the freezing point of water by increase of pressure. Unfortunately Helmholtz had not, at this time, heard of the work of Robert Mayer, upon which in a note, forty years later, he places a very high estimate.

In chapter five, the discussion is directed toward the mechanical equivalent of electrical processes. First of all the energy of the charged Leyden jar is computed by the standard method, supported by the then recent experiments of Riess; the heat of the discharge is recognized as Joule-heat in the wire joining the two coatings; and this, by means of the mechanical equivalent of heat, is reduced to mechanical units. Here also we find oscillatory discharges definitely predicted and the experimental evidence for expecting them clearly set forth.

The second electrical process considered is that of the galvanic cell. After discussing the two rival theories of the cell, he employs the energy principle to prove that the *e.m.f.* of the cell is proportional to the difference between the amount of heat developed by the combustion of the two metals and by their combination with the acids. The theory of polarization of the galvanic cell next follows; but the phenomenon does not prove amenable to quantitative description in terms of energy. The chapter closes with a demonstration of the fact that the thermo-electric effect of Seebeck is the converse of the Peltier effect.

The sixth and last chapter of the little book starts out by bringing magnetism into the range of conservative forces for the same reason that electrostatics belongs there, namely, each can be explained in terms of attracting and repelling fluids. The author then proceeds with electro-magnetism and succeeds, almost with a stroke of the pen, in deriving Neumann's expression for the *e.m.f.* of induced currents. This is done, as is well known to most of you, by simply equating the energy supplied by the cell during any small interval of time to the Joule-heat plus the change in the kinetic energy of a magnet attracted by the battery circuit. The

invariant sum contemplated by the energy principle is here made up of three items, namely, the chemical energy of the cell, the heat energy in the wire, and the kinetic energy of motion of the magnet. On the whole I should be inclined to reckon this the most brilliant achievement of the entire essay.

The work concludes with a clear and definite suggestion of the applicability of the energy principle to the vital processes of plants and animals, but also with a recognition of the enormous difficulty of actually carrying out such experiments.

From this hasty and imperfect sketch it will be clear to everyone that most of the topics which Helmholtz here takes up are the commonplaces of present day physics—problems whose proximate solutions at least are well known to every advanced student. Why, then, one asks was publication refused in the *Annalen der Physik*. The answer is to be found in the fact that there was as yet no generally accepted explanation of latent heat, no generally accepted definition of electromotive force, and no generally accepted mechanical theory of heat. The theorem that a given quantity of heat is equivalent to a perfectly definite amount of mechanical work is a very different proposition from saying that the heat of a system is simply the kinetic energy of its molecules. Poggendorff's explicit reason, however, for not publishing the paper was that it was not sufficiently experimental in character.

It is always interesting to learn how a genius estimates his own work. I want therefore to read you a paragraph from that remarkable autobiographical after-dinner speech which Helmholtz made on the occasion of his seventieth birthday. A good part of that day had been spent in listening to congratulatory addresses read by representatives of practically all the learned societies of the world. Each of these men emphasized, in his own way, the rare power and intuition of Helmholtz, and the far-reaching importance of the new ideas which we owe to him. In the evening, at the close of the dinner given at the Kaiser Hof in Berlin, Helmholtz rises and, in that modest quiet impressive style of his, tells how simply these ideas came to him, sometimes on first awakening in the morning, sometimes while climbing the mountainside, most frequently in the open air when his body was

rested and his mind fresh. These original ideas never came to the tired brain and never at the library table—*nicht am Schreibtisch*. “The least bit alcoholic drink seemed,” he says, “to scatter them.” *Die kleinsten Mengen alkoholischen Getränks aber schienen sie zu verscheuchen.*

Among other things he tells just how he came to write the essay now under review. His own words are as follows: “When I was a student in the Medical School in Berlin, I served as assistant in the library, and occupied my leisure moments in acquainting myself with the work of Daniel Bernouilli and D’Alembert. Here I was confronted with the question, as to how the forces of nature must be related in order to render perpetual motion an impossibility; also the further question, *are* the forces of nature, as a matter of fact, related in this way. My purpose in this little book *On Conservation of Energy* was merely to give a critical discussion and an orderly arrangement of the facts for the use of physiologists.

And I should have been perfectly resigned if scholars in this line had said: ‘But this is all very well known. What does the young doctor mean by explaining to us in such detail these familiar facts?’ To my astonishment, however, the physicists with whom I came into contact gave the matter a totally different reception. They were inclined to deny the truth of the principle and, in their eager fight against the *Naturphilosophie* of Hegel, to regard my work as a bit of fantastic speculation. Jacobi, the mathematician, was the only one who recognized the connection of my ideas with those of Bernouilli and D’Alembert. Jacobi also interested himself in seeing that I was not misunderstood. My young friend E. du Bois-Reymond also gave me his enthusiastic sympathy and support. It was owing to these two men that the recently established Physical Society of Berlin recognized me.

Concerning Joule’s work on the same subject, I knew at that time almost nothing, and concerning that of Robert Mayer nothing at all.”

III

We pass now to some of the changes which have been introduced into the doctrine of energy since the year 1847.

In 1851, Kelvin supported Helmholtz's view that the electromotive force of a galvanic cell is the mechanical equivalent of the chemical work which is done in the cell by unit current flowing for unit time.

In the same year, Joule set forth his reasons for thinking that the pressure exerted by a gas represents merely the momentum per second delivered to the walls of the containing vessel. In the following year appeared a series of papers by Kelvin in which he gives an exact definition of what is meant by the "heat of a body"—as distinguished from the *total* heat of a body, a definition which marks a long step in advance of Helmholtz, inasmuch as it permits one to assign a definite numerical value to a quantity of heat. The appearance of the first edition of Clausius' *Mechanical Theory of Heat* in 1864 may, perhaps, then denote the complete establishment of the modern view concerning the nature of heat, initiated by Daniel Bernouilli, adopted by Helmholtz and Joule, and made precise by Kelvin.

Leaving to one side the complicated question of the distribution of energy among the various degrees of freedom of the molecule, one may say that something like seventeen years of time was required to secure the general acceptance, by men of science, of the wide principle that heat is merely a special case of the kinetic energy of a system of bodies.

Another important change is in the formulation of the principle in such a way as to make it strictly analogous with the conservation of matter and to render perfectly clear the fact that the conservation of energy is not a mere assumption, not an axiom, not a definition, but an experimental result.

Such a formulation is the following one which follows the style of Kelvin's definition of the heat of a system: *The energy of a material system in any given condition, measured with reference to any other standard condition, is an invariant with respect to time.* Such a statement can be accepted as true only after experiment has shown that the same amount of work is required to bring the system from the given state to the standard state by different routes. Hundreds of such experiments sustain the formulation just given.

To pronounce this principle trippingly on the tongue is a much less difficult matter than to apply it to some particular material system.

Planck has recently pointed out much more forcibly than Helmholtz the difficulties of such an application. For example, one has first to be sure that he knows just what kinds of energy are included in the system; he has then to learn what the quantities are which define the state of the system: he has also to discover whether or not these variables are independent or whether they are related to each other; whether, when one energy element is varied, *all* the other types of energy, or only *some* of them, remain constant. One need only think of the various types of energy represented in a single rain drop; electrical, gravitational, thermal, molecular, atomic, capillary. It is the sum of all these, and perhaps others, which would make up the invariant whose time-variation is zero.

One has also to determine how completely his system is isolated from external influences. And if external influences are at work upon the system, one has then to equate the work done by these external influences to the energy gained by the system. Indeed it is not always an easy matter to define the system one is dealing with. Take, for example, the rain drop of which we were just speaking. Does its surface energy belong to the water or to the water plus the medium surrounding it?

The seat of the energy in any system is a question which Helmholtz did not raise and is one whose answer does not affect the validity of the principle. It is, however, a problem whose answer is engaging some of the alert minds of the present day. The ability to trace energy through its various forms, as we now trace matter through its successive positions, would form a powerful step in advance.

Just such a step as this is precisely what is contemplated in Planck's infinitesimal theory of energy. According to his view, energy can be transferred from the outside to the inside of any closed surface *only through that surface*; in other words there must be some physical process going on *at this surface* during the transfer. These quanta of energy correspond very nearly therefore to

atoms of matter. The conservation of energy becomes therefore a consequence of Planck's theory almost as naturally as the conservation of matter is a result of the atomic theory.

I need, however, hardly call your attention to the fact that the quantum theory of energy—and hence a deductive proof of the energy principle—still leaves much to be desired; and in spite of its fruitfulness is far from being completely established. How, for example, is it to be reconciled with the phenomenon of interference? Where is the seat of the potential energy of gravitational forces?

Let me close these hasty comments by saying that only once since the establishment of the energy principle in the middle of the last century has it ever been seriously called in question. This happened during the brief interval between the discovery of the heat emission of radium by Curie and Laborde in 1903 and the almost simultaneous acceptance of the disintegration theory of matter proposed by Rutherford and Soddy. But it was only for a few brief months that serious-minded men debated the question as to whether radium was a transformer of energy or a magazine of energy. Everything which has since been learned about the atom points to the latter view as the correct one and leaves Helmholtz's essay of 1847 one of the firmest foundation stones in the structure which we call physical science.

NORTHWESTERN UNIVERSITY

HELMHOLTZ'S CONTRIBUTIONS TO PHYSIOLOGICAL OPTICS*

BY
LEONARD THOMPSON TROLAND

The realm of physiological optics is one which borders upon, and indeed intersects, three great and distinct divisions of scientific effort. Its problems are such as to require for their solution a balanced knowledge of physiology, physics, and psychology, and its results figure almost equally in text-books of these three branches of science. The greatest names in the development of physiological optics have been those of men who in some measure at least combined an acquaintance not only with the facts of physiology but also with those of physics and psychology. Never, however, have the required qualities been so admirably united as in Hermann Ludwig von Helmholtz. A medical man—anatomist and physiologist—by early training, he was also the greatest physicist of his time and is reckoned by historians of the subject as one of the founders of modern psychology. He was at once a powerful mathematician, with a mind keen to theoretical implications, and a skilled disector of organisms with an eye which missed no empirical detail. Men in all of the diverse scientific domains in which he walked recognized him as a master and leader. From such a mind, given the impetus, we might well expect the great contributions to physiological optics and to physiological acoustics which Helmholtz actually made.

The phenomena of color and of tone have fascinated the thought of myriads of investigators, before the time of Helmholtz and since. These phenomena have been studied for many ulterior purposes as aids to artistic endeavor and to visual efficiency in everyday life. Some workers have even exploited the facts under the influence of egotistic ambition. The results which Helmholtz achieved in these fields, however, show that his own inter-

*Read October 24, 1921 at the Helmholtz Memorial Meeting, Rochester, New York.

ests were those of pure scientific understanding; he was obliged in his teaching to expound the principles of science and he found his knowledge of vision and of hearing to be full of lacunae. He hesitated to teach what he himself had not personally verified and his scientific curiosity was aroused by the mysteries which appeared before his penetrating mind. When he actually attacked the problems his method was characterized not only by the thoroughness of the average German investigator but by the directness which distinguishes the English mind, as well as by the succinctness of the French. Helmholtz's great text book on physiological optics covers the entire field with a degree of completeness which has never been approached in any subsequent treatment, and yet in no part of it do we find ourselves wading in words in the search of ideas. Helmholtz's German reads for us not like a foreign tongue but as the clear and universal language of science. (On account of the fact, however, that there are many for whom both the German and the French texts of this great work are necessarily closed books, the wish is aroused that as a fitting tribute to Helmholtz on the centenary of his birth we might before long be able to have prepared and published an English translation.)

Although Helmholtz's interest in his work was purely scientific its fruits were often of immediate practical importance. The *ophthalmoscope*, which was the outcome of the earliest of Helmholtz's endeavors in the field of physiological optics, opened the optical shutters of the living eye, so that the ministering hand of ophthalmology was no longer necessarily without the guidance of light and vision in attempts to remedy derangements of the visual function itself. This little instrument, although simple in nature, demanded for its conception a recognition of optical principles which had remained obscure to all previous workers. The practical value of the ophthalmoscope was at once appreciated by Helmholtz's contemporaries, and he had the rare satisfaction of seeing his invention become quickly the bearer of substantial fruits in ophthalmological practice. The medals and praise which came to him as a consequence, however, were received with characteristic modesty.

Helmholtz's earliest work in the field of physiological optics, dealing with the refractive apparatus of the eye, reveals at once that universal characteristic of his endeavors: a desire to penetrate the inner mechanism of nature's processes. Although his measurements of the various constants of the eye were made with the greatest care and accuracy, his fundamental aim was not the mere calibration of the organ for practical purposes but an understanding of its operation in terms of general optical theory, his own experiments being usually so chosen as to have a crucial bearing upon some conception of the ultimate nature of the visual mechanism. By means of two new instruments of his own invention, the phakoscope and the ophthalmometer, Helmholtz was able to work out quantitatively the operation of the eye as an optical instrument, or camera, and to make clear the mechanism of accommodation by which it focuses itself upon objects at different distances. He made the first accurate measurements of the radii of curvature of the cornea and of the two surfaces of the lens, showing that in accommodation there is an extensive alteration in the radius of curvature of the anterior surface of the latter. Helmholtz's theory concerning the neuro-muscular mechanism by which this change is accomplished has been subjected to severe criticism by certain subsequent investigators, but as in the case of the majority of other hypotheses which he advanced, no equally satisfactory alternative explanation has appeared. Even if Helmholtz should ultimately be proven in error in any of these cases he will at least retain the credit of having advocated hypotheses to which more than sixty years of labor on the part of others has contributed no substantial improvements or modifications. The general acceptance of Helmholtz's views regarding the dioptric mechanism of the eye is attributable directly to the quantitative nature of his work, to the manner in which he linked up the physical dimensions of the eye with its practical operation through the medium of general optical theory. Had he not been at once a skilled anatomist and a profound student of general optical science this would have been impossible for him.

Helmholtz's thoroughness did not permit him to be content with a demonstration of the grosser optical mechanisms of the

eye. He analyzed closely, with mathematical exactness, many minute details of the entoptic process. His theoretical treatment of acuity data in relation to the diameters of the rods and cones still provides the guiding text of all arguments concerning this topic. His analysis of the part played by diffusion circles and by chromatic aberration in normal vision has only in recent years been surpassed. To the understanding of various refractive defects of the eye he made important contributions, and in his great work on physiological optics he does not neglect to discuss and add to our understanding of the multitude of entoptic phenomena which had been so exhaustively described by his predecessor, Purkinje.

Just as Helmholtz's contributions to our knowledge of the dioptrics of the eye have become permanent portions of science because he was a great student of physical optics, so also have his ideas concerning the reactions of the retina and its attached nervous appendages become a standard content of our text-books because he was one of the pioneers in *nerve physiology*. As the first to demonstrate and actually to measure the velocity of the nerve impulse both in afferent and efferent paths, Helmholtz was well qualified to speculate concerning the neural processes involved in vision or audition, but his speculations here as elsewhere were always guided intimately by experiment. He repeated for himself most of the observations which had been made by his predecessors bearing upon different means by which the retina might be excited, paying particular attention to the various colors which appear as a result of the action of electric currents. In all of his thinking concerning visual sensation Helmholtz was guided by Müller's principle of the specific energy of nerves, according to which the sensation quality is independent of the manner of stimulation and rests wholly upon the identity of the nerve channel which is involved. In his adherence to this principle Helmholtz was not only faithful to the ideas of his own teacher but showed an appreciation of the actual character of the psychophysical nexus which is sadly lacking in many contemporary psychologists and physiologists. Specific energies in

psychophysics and the conservation of energy in physics were the major premises of all of Helmholtz's thinking.

That same interest in the ultimate mechanism of the visual function which led Helmholtz to delve deeply into the dioptrics of the eye caused him to advocate a definite hypothesis as to the physiological operations underlying color vision. It is characteristic of Helmholtz that in this field, where so little was proven with certainty, he did not insist upon a conception uniquely his own, but adopted the fundamental three-color analysis of Thomas Young because it appealed to him as fitting the facts in the case in a maximally satisfactory manner. There has been a great deal of discussion as to the amount of credit which should be given to Helmholtz in connection with the three-color theory; some have insisted that this hypothesis should be named exclusively after Young, while others have called it the Young-Maxwell Theory. The consensus of opinion as expressed in the predominating usage in scientific texts, however, must be regarded as the final judge in such matters, and this insists upon speaking of the Young-Helmholtz Theory. There can be little doubt that the work of Helmholtz with the three-color conception is mainly responsible for its firm establishment in the system of physiological optics. Helmholtz gave the hypothesis definite form in terms of established physiological conceptions, and he worked out its quantitative implications in such a way as to broaden its explanatory function far beyond the status in which it was left by Young.

Concerning the merits of the three-color theory as advocated by Helmholtz, a vast amount of literature has been produced *pro* and *con*. That it should not embrace the whole truth with regard to the color mechanism is inevitable. However, that it schematizes a very considerable body of truth is undeniable. Color vision certainly behaves from many points of view like a three unit system; even Hering's theory, the principal opponent of Helmholtz's hypothesis, conceives only three *integral* mechanisms and the response curves for Helmholtz's three primaries can be converted into those which characterize the primaries of the Hering theory by a mathematical transformation which consists simply in a change of reference axes. Existing theories which

appear to be improvements on the Young-Helmholtz conception actually incorporate all of its essential ideas in one form or another, modifications thus consisting essentially in theoretical accretions which are the normal requirements of augmented data, especially in the biological realm.

Science is indebted to Helmholtz not only for his theoretical development of Young's hypothesis and its application to many new problems but also for a large number of experimental studies upon color. He made clear the difference between the additive and subtractive mixture of colors; with his great mathematical ability he developed the color triangle, as a means of formulating the laws of color mixture, beyond the point to which it had been carried by his predecessors. He devised an elaborate and extremely ingenious instrument for the experimental study of color mixture, which was employed by his pupils König and Dieterici in their classical determination of the three-color sensation curves. Helmholtz is sometimes accused of having neglected the problem of brilliance or apparent brightness in visual sensation, but he devotes nearly one hundred pages to the consideration of this subject in the second edition of his *Handbuch*, discussing the principles of homo- and heterochromatic photometry in great detail. Helmholtz's explanation, based upon suggestions made originally by Fechner, concerning the basis of positive and negative after images has remained as the most plausible one which we know. However, his doctrine that simultaneous contrast is due to purely psychological operations, depending upon "unconscious judgment," has aroused a great deal of opposition and in general is not accepted at the present time, although there is a considerable body of evidence that contrast depends upon a cortical rather than upon an exclusively retinal process. However, the general conception of the influence of a so-called unconscious judgment upon the exact form taken by sensory and perceptual consciousness has apparently found a permanent place in psychological theory.

The universality of Helmholtz's intellect is illustrated in the limited field of physiological optics alone, by the fact that he did not confine himself to the sensory and merely physiological

aspects of the visual process, but extended his investigations over the entire field, including the problems of binocular vision and the theory of space perception. He was the first to show that although the retinal horizontals are parallel to the true horizon, the apparent verticals of the two eyes are inclined to one another at an angle of about two and one half degrees. On the basis of this new data he recalculated the form of the horopter or the locus of points which fall upon corresponding retinal points in binocular vision. He greatly advanced the mathematical analysis of this concept. His investigations in this field led him to considerations of the philosophy of space perception and to this subject also he made significant contributions. His wonderful power as a mathematician enabled him to analyze with great accuracy the movements of the eyes, and he brought to light certain involuntary adjustments of the latter which had not previously been recognized. He showed that the complicated adjustments of the two eyes are all governed by the fundamental principle that they shall see all objects singly so far as possible. Helmholtz's belief that the apparent fusion of the two images in binocular vision is not due to an anatomical confluence of the two optic paths but to a psychic act still finds powerful advocates at the present day. It was in connection with his studies on binocular vision that Helmholtz invented the *telestereoscope*, an instrument for magnifying the stereoscopic effects of objects seen at a distance and one which has had important practical applications. It is interesting that although in the latter period of his life Helmholtz's energies were mainly spent upon purely physical problems he was constantly recurring to visual questions, some of his last papers dealing with sensory matters.

It will not be out of place to say a word in this address concerning Helmholtz's contributions to physiological acoustics. His book on sensations of tone is scarcely less of a masterpiece in its own field than the *Handbuch der physiologischen Optik*. Like the latter it has found no rival in sixty years time. Helmholtz's investigations into the processes of audition were stimulated not only by his general physiological interests, and the analogy with vision, but also by his interest in music, being himself an accom-

plished pianist. The conceptions of timbre, harmony and the like with which he dealt were not to him mere theoretical ideas but were vivid realities of his experience, yet his attack upon the problem was that of the scientist rather than of the artist; his efforts passed with no embarrassment from a laboratory dissection of the delicate structures of the ear, through a mathematical analysis of their mechanics to applications of the results in the realm of music. It is small wonder that in the domain of physiological acoustics the peer of Helmholtz is yet to be found. His hypothesis concerning the operations of the cochlea was the first to provide any intelligible idea of the mechanism of auditory response, and although numerous rivaling theories have subsequently appeared, Helmholtz's views still hold their position as the most plausible.

When one with ambitions in ever so small a field of scientific effort surveys the work of Helmholtz he must necessarily feel stunned by the magnitude of this great man's achievements. He is faced by a mind masterful in the most diverse domains; in physics, in biology, in psychology, in mathematics, and even in philosophy, an accomplished specialist at one time in far separated, minute, subdivisions of scientific endeavor. Very few of us can hope to parallel his accomplishment even in a very restricted field, yet to recognize the greatness of Helmholtz and to assimilate at least to a certain extent his methods and aims should be one of the greatest aids possible toward a continuation of the character of work which he himself accomplished. On this centennial of Helmholtz's birth we should not only eulogize his name but we should turn back to a renewed study of his monumental works. How many students of visual physiology are there at the present time endeavoring to solve problems the solutions of which are to be found in the *Handbuch der physiologischen Optik*? How many are there working without the knowledge which this great book silently offers as a guide in their endeavors. How many are there, moreover, who are dealing with fictitious or impossible questions the absurdity of which would be apparent to any close student of Helmholtz? Let us, who are living investigators of the phenomena of vision, resolve to read and compre-

hend from one cover to the other that great Bible of physiological optics which Helmholtz so painstakingly prepared for us. By so doing we shall make a tribute to our great leader, of the sort which he himself would most keenly appreciate.

HARVARD UNIVERSITY
CAMBRIDGE, MASS.

REMINISCENCES OF HERMANN VON HELMHOLTZ*

BY
M. I. PUPIN

After graduating at Columbia in 1883 and after studying Mathematics and Dynamics at the University of Cambridge, England, for three semesters, I went to Berlin to study Physics with Helmholtz. Kirchhoff was still living and I heard him lecture on the Theory of Electricity during the Winter semester 1885-86. He died during the early part of 1886.

Helmholtz was then the director of the Physical Institute of the University of Berlin. His title, conferred upon him by the old Emperor, was Excellenz, and the whole teaching staff of the Institute stood in awe when his name was mentioned. The whole scientific world of Germany, nay the whole intellectual world of Germany, stood in awe when the name of Helmholtz was mentioned. Next to Bismarck and the old Emperor he was at that time the most illustrious man in the German Empire.

I had letters of introduction to him from President Barnard of Columbia University and also from Professor John Tyndall of the Royal Institution. Professor Arthur Koenig, the right hand man of Helmholtz and the senior instructor in the Physical Institute, took me to the office of Excellenz von Helmholtz and introduced me as Herr Pupin, a student from America. Koenig bowed before his master as if he wished to touch the ground with his forehead. I bowed American fashion, that is, with a bow of the head which did not extend below my shoulders, the same kind of bow which was practiced at the University of Cambridge at that time, and called it the Anglo-Saxon bow; it is entirely different from the Teutonic bow. Helmholtz seemed to notice the difference and he smiled a benevolent smile; the contrast evidently amused him. He had much of Anglo Saxon blood in his veins and was quite familiar with the manners of English polite society.

*Synopsis of an address presented October 34, 1921 at the Helmholtz Memorial Meeting, Rochester, N. Y.

He received me very kindly and showed deep interest in my plans of study. His appearance was most striking; he was then sixty-four years of age, but looked older. The deep furrows in his face and the projecting veins on the sides of and across his towering brow gave him the appearance of a deep introspective thinker, whereas his protruding scrutinizing eyes marked him a man anxious to penetrate the secrets of nature's hidden mysteries. The size of his head was enormous, and the muscular neck and huge thorax seemed to form a suitable foundation for such an intellectual done. His hands and feet were small and beautifully shaped and his mouth gave evidence of a sweet and gentle disposition. He spoke in the sweetest of accents and little, but his questions were direct and to the point. When I told him that I never had an opportunity to work in a physical laboratory and paid exclusive attention to theoretical physics, he smiled and suggested that I should make up this deficiency as soon as possible. "A few experiments successfully carried out usually lead to results more important than all the mathematical theories" he assured me. He then requested Professor Koenig to map out for me a suitable course in the laboratory and to look after me. Koenig did it and I shall always be grateful to the kind little man with the bushy red hair and distressingly defective eye sight. Helmholtz was always mellow hearted to Koenig, because, I think, Koenig reminded him of his own son Robert, who was deformed in hand and foot and back, but had the magnificently shaped head of his great father.

During my first year's study in Berlin I attended Helmholtz's lectures on experimental physics. They were most inspiring, not so much on account of the many beautiful experiments exhibited there, as on account of the wonderfully suggestive remarks which Helmholtz would drop every now and then under the inspiration of the moment. At these lectures Professors Koenig and Dieterici usually assisted; they attended to the purely academic elements of the experiments, whereas laboratory mechanic Noehde and Institute janitor Kabisch handled the apparatus and took most of the responsibility for their prompt operation. Helmholtz threw the searchlight of his giant intellect upon the

hidden meaning of the experiments. These lectures were attended not only by students in physics, mathematics, and chemistry, but also by medical students and army officers. The official world, and particularly the army and navy, paid close attention to what Helmholtz had to say, and I have much reason to believe that they consulted him at every step. I have been often called upon to correct the opinion that Helmholtz was a pure scientist par excellence. There is no doubt that his great work dealt principally with fundamental problems in scientific theory and in philosophy, but there is also no doubt that he was intensely interested in the applications of science to the solution of problems which would advance the industries of Germany and of the whole world. His earliest career is associated with his invention of the ophthalmoscope. His design and disposition of the coils in a galvanometer are well known. The optical glass of Germany was developed by his former students who led the world in geometrical optics, a part of Physics to which Helmholtz devoted much attention in his younger days.

One day I was on my way to the Institute; in front of me walked a tall German army officer, smoking a big cigar. When we reached the entrance to the Institute the officer stopped and read a sign which said: Smoking is strictly forbidden in the Institute building. The officer threw his cigar away and walked in. I recognized Crown Prince Frederick in the officer. I watched his footsteps and saw that he entered Helmholtz's office and stayed there over an hour. He undoubtedly consulted the great physicist on some scientific problem which was then interesting the German Army and Navy. Many a time I saw the great electrical manufacturer, Werner von Siemens, call at the office of Excellenz von Helmholtz and every time I saw him I grew more anxious to meet him personally. As a proof of great personal favor, Helmholtz gave me a letter of introduction to his distinguished friend, who received me most kindly and gave me an official to guide me through his great electrical plant in the Markgafenstrasse, in the heart of Berlin. Little I thought at that time that some day these great works would have a special department for the manufacture of some of my inventions, and that I would have the very honor-

able distinction of knowing personally the distinguished sons of the great Werner von Siemens.

The great Reichsanstalt in Charlottenburg, the first President of which was Herman von Helmholtz, is a memorial to the warm friendship which existed between Helmholtz and Siemens. It was a gift of Siemens to the physical science of Germany. This gift bore magnificent fruit. The study of black body radiation, first undertaken here by Wien, Lummer, and Pringsheim, under the direction of Helmholtz, led to Wien's formulation of the displacement law and to Planck's formulation of the Quantum theory. In return for this splendid gift Helmholtz gave to the Siemens works his pupils, Rapps, Francke, and Ebeling under whose directorship the Siemens works have grown to wonderful proportions, being one of the largest and best organized electrical plants in the world.

During my three years stay in Berlin Helmholtz was not engaged personally in experimental research. This was done under his direction and upon subjects suggested by him to candidates for doctor's degree and by his former students. Thus Koenig and Brodhun conducted experimental researches connected with Helmholtz's theory of colour and the theory of vision. Menzel, Rapps, and Max Wien were experimenting in accoustical vibrations, and Hertz was busy with the electrical problem which Helmholtz assigned to him, the problem, namely, of electrical vibrations. Hertz finished his experiments conducted on somewhat different lines than originally suggested by Helmholtz, and in the early part of 1887 he sent a preliminary report to Helmholtz, who discussed it at the next meeting of the Physical Society. I was present at the meeting and shall never forget the enthusiasm with which Helmholtz discussed Hertz' remarkable results. He congratulated German science for the distinction which fell to its share when one of its sons first revealed to the puzzled world the real meaning of Maxwell's great Electro-magnetic Theory. Kirchhoff, one of the great scientific stars of Berlin, had died a year prior to that, but DuBois Raymond, the great physiologist, and Hoffmann, the great chemist, were still living and were present at that historical meeting. Among the young men who

have since achieved distinction and who were present at that meeting should be mentioned: Willy Wien, Max Wien, Rubens, Pringsheim, Lummer, and Arthur Gordon Webster.

But although Helmholtz did not engage personally in experimental research he was deeply engaged in theoretical research. Thus in 1886 he published his great theoretical study entitled: "Thermodynamics of Chemical processes." It was a splendid supplement to Willard Gibbs' epoch making studies and with it forms the broad foundation of modern physical chemistry, which at that time became so popular among the physicists on account of the remarkable experimental results obtained by Arrhenins, Nernst, van't Hoff, and Ostwald. Helmholtz's theoretical work was the basis of my Doctor dissertation on "Osmotic Pressure and its relation to Free Energy." His advice to me to avoid strong statements which would involve me in a heated discussion with Nernst and Ostwald was the advice of a kind father to a pugnacious son. Towards the end of his life Helmholtz made several attempts to explain Electrical and Thermal Phenomena, by generalized Dynamics, paying much attention to the Principle of Least Action and to the Hamiltonian Principle. The question of the ether also received much attention, but with the exception of his simple and elegant Electromagnetic theory of dispersion one cannot say that these theoretical discussions had received from Helmholtz their last finishing touches. In 1893 he visited the United States as an official representative of the German Government at the Chicago Electrical Congress, at which he presided. He and Frau von Helmholtz spent one Sunday on the Jersey shore as my guests. I asked him on that occasion whether he intended to continue his theoretical studies in electrodynamics to which he had given so much attention and he said that he did not, having come to the conclusion that Maxwell had spoken the last word in the electrical theory concerning phenomena which were known at that time. Additional experimental results, with electrical motions exhibiting large accelerations were badly needed, he said. Had he lived two years longer he would have seen Roentgen's discovery and the discoveries which followed in the wake of the Roentgen rays. These would have shown him the great accelerations for which he like a prophet and a seer was looking.

During his three months stay in America in 1893 he was fêted and feasted everywhere. During a reception in his honor in the Columbia University library, an incident occurred which should be recorded here. Hundreds of distinguished people of New York attended and waited for their turn to shake hands with the great physicist. A mathematical physicist, well known at that time for his great erudition and remarkable lack of tact and common sense, begged me to introduce him to Helmholtz and to be sure to mention his accomplishments which I finally did and then stood by and watched. Helmholtz was suddenly attacked by the question: "What is your opinion, Excellency, about the negative curvature of space?" Helmholtz answered: "Just now I have no opinion on that subject," and his expression became a perfect blank. I rushed to his rescue by saying: "Excellency, Frau von Helmholtz is waiting for you with a cup of tea," and he followed me, getting rid of the negative curvature philosopher rejoicing in the feeling that he formulated a question which even the greatest living physicist could not answer. A few days later I met this philosopher and he informed me that in his opinion Helmholtz had the expression of a rather dull man. "Yes," said I, "Helmholtz always reflects the mental image of the people who are addressing him." There was more truth than jesting in what I said. I have often watched Helmholtz at receptions given by Frau von Helmholtz in her Berlin house. She would always assign a definite place for his Excellency and there he stood for several hours without budging, listening with stoical resignation to all kinds of remarks addressed to him by the guests. When a clever and interesting person addressed him his face looked as radiant as the Eastern summer sky at sunrise. When addressed by a stupid bore his face would remind you of a lead colored sky devoid of color and contour. A squad of young research men of the Institute were always present at these receptions and when we noticed in Helmholtz's face signs of despair one of us would step in and displace the bore who was subjecting Helmholtz to a mental torture.

The face of Helmholtz reminded one very much of the face of Bismarck. It had that massive and almost overpowering strength

which Bismarck's face had, but there was in it also the luminous light of spirituality which Bismarck's face did not possess. Helmholtz never prepared his lectures on theoretical physics; he worked his subject out during the lecture and thus gave us students a chance to see the expression in that magnificent face when the mind of the master was in full action. Knaus in his famous Helmholtz portrait, now in the National Gallery in Berlin, caught that expression, but it cannot be found in any other picture of Helmholtz. During his return voyage from America in 1893 Helmholtz met with an accident on the steamer, injuring his head. It looked like a slight injury, but in the following year he died from the effects of it. His death ended one of the most glorious scientific careers which the world has ever seen.

COLUMBIA UNIVERSITY

A THEORY OF INTERMITTENT VISION

BY
HERBERT E. IVES

INTRODUCTION

Through the work of Porter,¹ Kennelly and Whiting,² Luckiesh,³ Ives and Kingsbury,⁴ and others, there have been determined relationships between critical flicker frequency and the intensity and wave-form (intensity distribution with time) of the illumination of the observing target. These relationships are comparatively simple, the frequency occurring as a logarithmic function of the other variables. They constitute probably the most complete and definite data we have on the time factor in visual response. This being the case, it would appear that from these relationships it should be possible to form an idea of the kind of mechanism and processes involved in vision. It is the purpose of this paper to describe a mechanism and processes, which, on certain not improbable assumptions, would behave toward intermittent illumination substantially as does the eye.

REVIEW OF EXPERIMENTAL DATA

The theory to be developed is based on data already published, the only new data being certain sets of confirmatory observations which are used in the illustrations. The method employed to obtain the new data presents no points of striking novelty and need not be described.

The principal *high intensity* critical frequency relations as obtained by the experimenters quoted may be summarized as follows:

1. For all wave forms, critical frequencies plot against the logarithm of illumination as parallel straight lines^{1, 2, 3}.
2. If the flicker range is varied, the range factor (amplitude) enters as a multiplier of the illumination.²

¹ Porter, Proc. Roy. Soc. 113, p. 347, 120, p. 313, 136, p. 445.

² Kennelly and Whiting, National Electric Light Assn., 1907 convention.

³ Luckiesh, Physical Review 4, 1, p. 1; 1914.

⁴ Ives and Kingsbury, Phil. Mag. April 1916, p. 290.

3. If the ratio of exposure to obscuration is varied, critical speeds are to a close approximation the same for complementary openings^{1, 4}.

These relationships may be summarized symbolically as below: where ω is critical speed in cycles per second, I is illumination, or more properly brightness;

- for 1, $\omega = a + b[\log I + \log F]$ where F is some constant characteristic of the wave form.....(1)
- for 2, $\omega = a' + b' \log I$ where a is the amplitude (a special case of (1)).....(2)
- for 3, $\omega = a'' + b'' \log I + f[\Phi(1 - \Phi)]$ where Φ is the fraction of the period during which exposure occurs.....(3)

At *very low intensities*, using short wave radiation (scotopic vision) critical speeds are independent of intensity and vary only with the waveform.⁵ The experimental results may be summarized in the empirical formula

$$\omega = c \log \frac{2W}{\delta} \dots\dots\dots(4)$$

where W is the coefficient of the first periodic term of the Fourier expansion representing the waveform, divided by the mean value of the stimulus; c and δ are constants.

PREVIOUS THEORETICAL TREATMENTS

The writer knows of but three previous attempts to correlate these critical speed relations with specific theories of visual response. Their salient points may be briefly mentioned here, but the original papers should be consulted for details.

Kennelly and Whiting² state that their observations "conform substantially to the Weber-Fechner law of sensation and stimulus," that is that

$$\Delta S = \frac{\Delta I}{I}$$

⁵ Ives, Critical Frequency Relations in Scotopic Vision, J. Opt. Soc. Am. May, 1922, p. 254.

and are led from this to speak of the "sensation of visibly flickering illumination" as following the same law with relation to stimulus as does the sensation due to steady illumination. While this postulation of a "flicker sensation" introduces a conception exactly in accordance with the experimental facts (being but a restatement of them) it is questionable if it gives real aid in picturing a visual mechanism.

L. T. Troland⁶ assumes a process of decomposition and recombination which leads, in the case of equal light and dark intervals, to the experimentally obtained logarithmic relation. Upon applying the same line of reasoning to the case of unequal exposure and obscuration it will be found that the critical speed should be, for any illumination, a linear function of the fraction obscured instead of the symmetrical function of opening required by experiment and symbolized in (3).

The third derivation to be noticed is that by the writer and Mr. Kingsbury.⁴ In this the decrease of amplitude of a transmitted impression is ascribed to the process of conduction according to the Fourier diffusion law; change of illumination is supposed to cause a change in the diffusion constant. This theory indicates that the $\omega - \log I$ plots for different openings should be considerably inclined to each other, and that the small opening critical speeds should be higher than the complementary large opening speeds. These predictions are qualitatively verified, but the dissymmetry is less than the theory calls for.

NEW THEORETICAL TREATMENT

In seeking for a theory of visual response which would lead to the critical frequency relationships, the effort has been to make the theory harmonize as closely as possible with the probable nature of the visual process, as indicated by lines of study other than that of critical frequency. Thus it is probable from several lines of evidence that the relation between stimulus and response is approximately *logarithmic*; such a relationship should be included in a visual response theory. As another, and, indeed much

⁶ Troland, *Am. Jn. Physiology* 32, [May] p. 8; 1913.

more certainly established fact is the behavior summarized by Talbot's law, that the response (sensation) shall be the same for the same mean illumination, no matter whether this is steady or intermittent, provided the speed of intermittence is so high that flicker vanishes. The harmonizing of these two phenomena of response presents considerable difficulty.⁷ More specific ideas of visual response lately current⁸ indicate the initial reaction to be a photochemical one, followed by some relatively slow process of conduction.

The new theory here developed postulates three steps in the process of the perception of flicker. The *first step* consists of a photochemical (photoelectric) reversible reaction of such a nature that the equilibrium value under steady illumination is proportional to the logarithm of the stimulus. The *second step* consists of a conduction process, according to the Fourier diffusion law, as developed to cover conduction accompanied by leakage, or re-composition of the diffused substance. The *third step* consists in a perception process in which the criterion for perception is that the time rate of change of the transmitted reaction must exceed a certain constant critical value. These three steps will now be treated in detail.

The initial reaction is assumed to be of the kind occurring in photoelectric cells with liquid electrolytes (Becquerel effect). In these cells, as shown for instance by the work of Goldmann⁹ on metal electrode cells containing dye solutions, the primary emission of electrons is proportional to the intensity of the illumination. As the illumination continues there is an accumulation of charged ions which are continuously being neutralized, so that an equilibrium is reached under illumination which is, over a considerable range, proportional to the logarithm of the illumination.¹⁰ On the removal

⁷ See Drysdale, Proc. Optical Conv., p. 173, 1905.

⁸ Hecht, Science, April 15, p. 347, 1921.

⁹ Goldman, Ann. der Physik, 27, p. 449, 1908.

¹⁰ The electrical behavior of these photoelectric cells under illumination is strikingly like that of the excised eye, as studied by Waller and other. Notable resemblances are shown in the preliminary negative response on commencement, and terminal positive twitch on cessation of illumination, and in the reversal of the reaction with age. Bose ("Response in the Living and non-Living," p. 169) remarks "there is not a single phenomenon in the responses, normal or abnormal, exhibited by the retina, which has not its counterpart in the sensitive cell constructed of inorganic material."

of the illumination, the charge (potential) declines to its dark equilibrium. The potential variation of such a cell under intermittent illumination by a sector disc of open fraction Φ and period τ , is represented by a saw-tooth variation around the mean ($\propto \log I \Phi$) rising during the time $\Phi\tau$ and falling during the time $(1-\Phi)\tau$. The higher the speed the smaller the amplitude of variation, and the more nearly the two slopes of the saw-tooth potential variation plot approximate to straight lines.

In order to study this kind of reaction quantitatively, we may set down as representing the facts sufficiently closely, the following equation

$$c \frac{d\Theta}{dt} + b e^\Theta = f(I, t) \dots \dots \dots (5)$$

where c is the capacity of the "cell," Θ is the potential (concentration of ions), b a constant, e the logarithmic base, $f(I, t)$ the mathematical expression of the time and intensity distribution of the illumination. The equation states that energy is being received by the system at a rate represented by $f(I, t)$, is being stored (capacity factor), and is being lost or neutralized in such a way that if a steady state obtains ($\frac{d\Theta}{dt} = 0$)

$$b e^\Theta = f(I, t), \text{ or } \Theta = \log \frac{f(I, t)}{b} \dots \dots \dots (6)$$

The general solution of (5) may be obtained¹¹ by multiplying through by $e^{-\Theta}$; doing this, and substituting y for $e^{-\Theta}$ we get the equation

$$c \frac{dy}{dt} + y f(I, t) = b \dots \dots \dots (7)$$

of which general solution is

$$y = \frac{b e^{-\frac{1}{c} \int f(I, t) dt}}{e^{\int \frac{1}{c} f(I, t) dt + \text{const.}}} \dots \dots (8)$$

Before using this solution to get the relations between I , Φ and ω for particular values of $f(I, t)$, it is of importance to determine

¹¹ I am very greatly indebted to Mr. T. C. Fry for assistance in the mathematical work which follows, and for helpful discussions of the general problem.

whether the kind of reaction represented will take care of Talbot's law. To do this we note that any periodic stimulus such as that resulting from the interposition of a sector disc rotating at uniform velocity before a light source, may be represented by the general equation

$$f(I, t) = I\Phi + A \sin \omega t + B \sin 2 \omega t + C \sin 3 \omega t + \text{etc.} \dots (9)$$

where $I\Phi$ is the mean value of the stimulus. Introducing this into (8), and making $\omega = \infty$, we get, since $\int A \sin \omega t = -\frac{A}{\omega} \cos \omega t$

$$y = \frac{b}{c} e^{-\frac{1}{c} \int_0^t I\Phi dt} \left\{ \int e^{\frac{1}{c} \int I\Phi dt} dt + K \right\} \dots (10)$$

$$= \frac{b}{I\Phi} + K' e^{-\frac{I\Phi t}{c}} \dots (11)$$

so that after such time as the second term becomes negligible

$$e^\theta = \frac{I\Phi}{b} \text{ or } \theta = \log \frac{I\Phi}{b} \dots (12)$$

But from (6), this is the value of θ for a steady illumination of value $I\Phi$. Hence Talbot's law is obeyed. For speeds less than infinite, but still large, the fluctuations will be to either side of $\theta = \log \frac{I\Phi}{b}$, and Talbot's law will be more and more widely deviated from, with decreasing speed, as the difference between the mean position of the fluctuating potential corresponding to $I\Phi$ becomes greater and greater.

We may now proceed with the solution of (8). For the present we shall consider only the case of the "square topped" stimulus, of value I between $t = 0$ and $t = \Phi\tau$, and of value zero between $t = \Phi\tau$ and $t = \tau$, (i.e. for time $(1 - \Phi)\tau$). For this (5) becomes

$$c \frac{d\Phi}{dt} + b e^\theta = I\Phi + \frac{2I}{\pi} \left\{ \sin \pi\Phi \cos \omega t + \frac{1}{2} \sin 2\pi\Phi \cos 2\omega t + \frac{1}{3} \sin 3\pi\Phi \cos 3\omega t + \text{etc.} \right\} \dots (13)$$

where ω is the frequency in cycles per second $= \frac{1}{\tau}$. The exact

solution of (13) is obtained by inserting the right hand member in (8) for $f(I, t)$, and performing the integration for a series of values of I, Φ and ω . From plots of the values obtained it is then possible to find the desired factors, such as amplitudes, and slopes of the reaction. However, with the knowledge that the amplitude of the reaction must be kept small, (for Talbot's law to hold), we may obtain an approximate solution without resorting to graphical methods, as follows:

Consider a high speed of alternation with the potential, Θ , varying by a small amount to either side of the value given by $e^\ominus = \frac{I\Phi}{b}$. Now consider what happens immediately after a dark sector has covered the light. The potential will fall according to the relation.

$$c \frac{d\Theta}{dt} + be^\ominus = 0 \dots \dots \dots (14)$$

Now since for small fluctuations be^\ominus differs but little from $I\Phi$ we may write

$$c \frac{\Delta\Theta}{\Delta t} = -I\Phi \dots \dots \dots (15)$$

or

$$\Delta\Theta = -\frac{I\Phi}{c} \Delta t \dots \dots \dots (16)$$

Noting that $\Delta t = (1 - \Phi)\tau = \frac{1 - \Phi}{\omega} \dots \dots \dots (17)$

we get for the amplitude of the drop in potential before the light is again thrown on

$$\Delta\Theta = \frac{1}{c} \frac{I\Phi(1 - \Phi)}{\omega} \dots \dots \dots (18)$$

We have then, as the result of the intermittent illumination of our photoelectric cell, a fluctuating potential in which, for large values of frequency, the amplitude is proportional to the intensity, and inversely as the frequency.¹² The shape of the potential-time

¹² It will be noted that this result follows, whatever the form of the re-composition function. The choice of be^\ominus for this function is in deference to the generally accepted idea of a logarithmic response to a steady stimulus. The farther the re-composition function departs from a simple direct proportionality to the reaction strength the higher must be the frequency to insure Talbot's law holding. It is a fact of experiment that this law already holds at the critical frequency for flicker disappearance.

curve is that of a saw-tooth, varying from a long rise and short drop ($\Phi > 1 - \Phi$) to a short rise and long drop ($\Phi < 1 - \Phi$). (Fig. 1, *b*.)

It is obvious that this process alone does not yield the typical (logarithmic) critical frequency relationships. We proceed now to the second step, the conduction process. We assume *as our stimulus*, the potential or concentration of decomposition products of the photochemical reaction varying in the manner just described. How will a typical conducting medium transmit this stimulus?

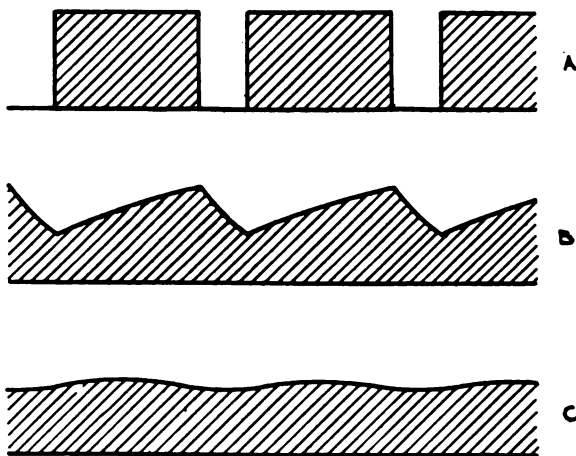

FIG. 1

Successive steps from stimulus to final reaction

- (a) Square-topped stimulus
- (b) Reaction of photoelectric cell
- (c) Reaction at far side of conducting medium.

The general expression for conduction according to the Fourier law is

$$\frac{\partial \Theta}{\partial t} = K \frac{\partial^2 \Theta}{\partial x^2} \dots \dots \dots (19)$$

where Θ is the potential (concentration) at a point distant x from the stimulated surface, and K is the diffusivity. This expression assumes no loss or re-composition of the conducted material. If we assume a leakage or process of neutralization we may modify (19) to¹³

$$\frac{\partial \Theta}{\partial t} = K \frac{\partial^2 \Theta}{\partial x^2} - \mu \Theta \dots \dots \dots (20)$$

¹³ See Preston's "Heat," 2d Ed., p. 654.

placing the loss, as the simplest possible assumption, proportional to the potential.

This equation is to be solved by introducing as the boundary condition at $x=0$, the proper expression for the saw-tooth stimulus, of which (17) is the fluctuating part. This expression consists in general, of a constant (S), representing the minimum value of the stimulus, to which is added the Fourier expansion of the fluctuating portion. For the symmetrical saw-tooth ($\Phi=1-\Phi$) the Fourier expansion of the fluctuating portion of amplitude $\Delta\Theta$, is

$$\frac{\Delta\Theta}{2} + \frac{\Delta\Theta}{2} \cdot \frac{8}{\pi^2} (\sin \omega t - \frac{1}{9} \sin 6 \omega t + \frac{1}{25} \sin 10 \omega t + \text{etc.}) \dots \dots (21)$$

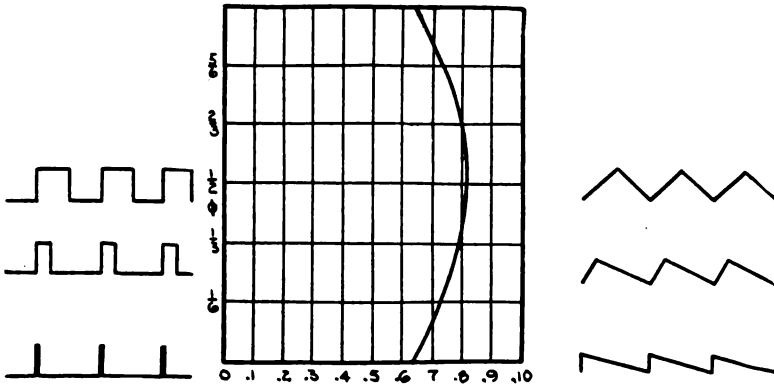

FIG. 2

The form factor for various ratios of rise and fall of a saw-tooth stimulus.

For the saw-tooth stimuli at the extremes of the series, where one arm of the tooth is vertical, the expansion is

$$\frac{\Delta\Theta}{2} \pm \frac{\Delta\Theta}{2} \cdot \frac{2}{\pi} (\sin \omega t + \frac{1}{2} \sin 2 \omega t + \frac{1}{3} \sin 3 \omega t + \dots) \dots (22)$$

In general, the expression for the complete stimulus is,

$$\Theta = S + \frac{\Delta\Theta}{2} + \frac{\Delta\Theta}{2} \cdot F(\sin \omega t + a_1 \sin 2 \omega t + a_2 \sin 3 \omega t + \dots) \dots (23)$$

where F is a form factor, depending on the ratio of the two arms of the saw-tooth, that is upon Φ . Values of this form factor are plotted in Fig. 2.

The solution of (20) for the boundary condition (23) is

$$\Theta = \left[S + \frac{\Delta\Theta}{2} \right] e^{-\frac{x}{\sqrt{2K}} \left(\frac{\mu}{\sqrt{2}} + \frac{\Delta\Theta}{2} \right)} F \left[e^{-\frac{x}{\sqrt{2K}} (\sqrt{\mu^2 + \omega^2} + \mu)^{\frac{1}{2}}} \left\{ \sin \omega t - \frac{x}{\sqrt{2K}} \left[\sqrt{\mu^2 + \omega^2} - \mu \right]^{\frac{1}{2}} \right\} \right. \\ \left. + a_1 e^{-\frac{x}{\sqrt{2K}} (\sqrt{\mu^2 + 4\omega^2} + \mu)^{\frac{1}{2}}} \left\{ \sin 2\omega t - \frac{x}{\sqrt{2K}} \left[\sqrt{\mu^2 + 4\omega^2} - \mu \right]^{\frac{1}{2}} \right\} + \text{etc.} \right] \tag{24}$$

Now if the amplitude of this function is small, the part contributed by the periodic terms after the first, involving higher multiples of ω in the exponential term, may be neglected. Discarding these, and putting in the value of $\Delta\Theta$ from (18) we have

$$\Theta = S' + \frac{1}{2c} \frac{I\Phi(1-\Phi)}{\omega} F \left[e^{-\frac{x}{\sqrt{K}} f(\omega, \mu)} \left\{ \sin \omega t - \frac{x}{\sqrt{2K}} \left[f'(\omega, \mu) \right] \right\} \right] \tag{25}$$

where

$$f(\omega, \mu) = (\sqrt{\mu^2 + \omega^2} + \mu)^{\frac{1}{2}} \dots \dots \dots \tag{26}$$

This expression states that we have, by the process of conduction, transformed our sharp saw-tooth stimulus, in general of unsymmetrical shape, into a reaction, (at depth x) of symmetrical sine-curve contour, of much smaller amplitude, the magnitude of the fluctuations dependent both on the amplitude and shape of the saw-tooth stimulus. The three steps from the original flat-topped stimulus, through the photoelectric reaction of unsymmetrical saw-tooth contour, to the finally transmitted symmetrical sine-curve reaction are shown diagrammatically in Fig. 1, *a*, *b*, and *c*.

At this point we must consider the third and last step. What criterion shall we adopt for the visibility of flicker? Several plausible ones suggest themselves, for instance the attainment of a definite range of fluctuation in the transmitted impression; the attainment of a definite fractional range; the attainment of a definite time rate of change of reaction; or any one of these, made to vary in some manner with the magnitude of the illumination

or the sensation. These three criteria, all perhaps of equal *a priori* probability, have been tried in the present case, with the result that the attainment of a definite rate of change appears to be the only one which, without introducing further complexity, will yield the desired final relations. It is therefore adopted on this strictly pragmatic basis, for which however some additional support is given later. From (25) we get

$$\frac{d\Theta}{dt} = \frac{1}{2c} I\Phi(1-\Phi)Fe^{-\frac{x}{\sqrt{2K}}f(\omega, \mu)} \cos(\omega t - \Psi) \dots\dots\dots(27)$$

the maximum value of which is

$$\left(\frac{d\Theta}{dt}\right)_{max} = \frac{I\Phi(1-\Phi)Fe^{-\frac{x}{\sqrt{2K}}f(\omega, \mu)}}{2c} \dots\dots\dots(28)$$

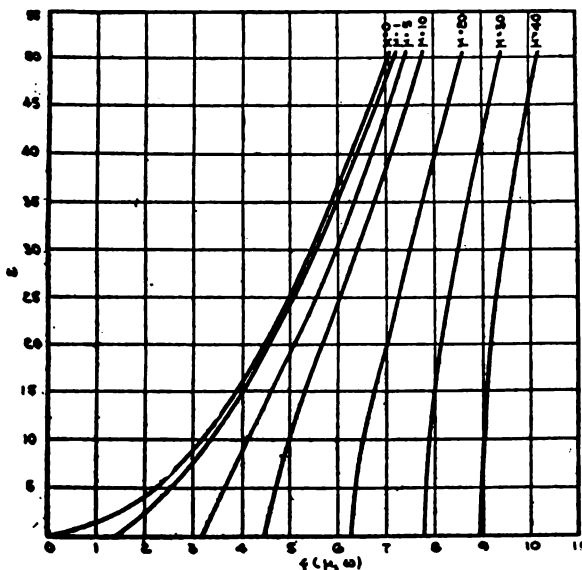

FIG. 3
Values of $f(\omega, \mu) = (\mu + \sqrt{\mu^2 + \omega^2})^{1/2}$, in terms of ω .

If our theory is correct we should be able to solve this expression for ω by placing $\left(\frac{d\Theta}{dt}\right)_{max} = a$ constant, and obtain the critical frequency-intensity relations. In order to do this it becomes necessary to investigate the character of $f(\omega, \mu)$ or $(\mu + \sqrt{\mu^2 + \omega^2})^{1/2}$. In Fig. 3 are shown calculated values of this function for

various values of μ . It will be seen that for all values of μ above 10, provided ω is greater than 20, $f(\omega, \mu)$ is proportional to ω , so that this function is practically indistinguishable from $(ma+n)$. Substituting this in (28) and solving for ω we get finally

$$\omega = \frac{\sqrt{2K}}{x} \frac{1}{m} \frac{\log I\Phi(1-\Phi)F}{c'} \dots\dots\dots(29)$$

(where c' is a constant involving $\left(\frac{d\theta}{dt}\right)_{\max}$, c and n) as our general expression for the case of alternating uniformly light and completely dark intervals.

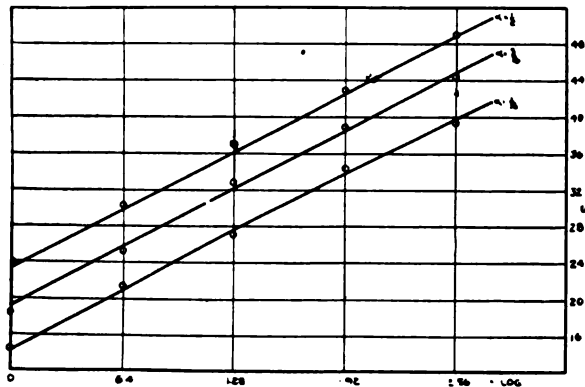

FIG. 4

Critical speeds (ω) versus log illumination for several flicker ranges, sine-curve stimuli.
 α = fractional excursion from mean position.
 Straight lines drawn to fit equation $\omega = 10 \log I\alpha + 26.4$.

By similar reasoning to that adopted in deriving (29) we find that if the original stimulus is of equal light and dark intervals, and fluctuates between $\frac{1}{2} + I\alpha$, and $\frac{1}{2} - I\alpha$, the amplitude α multiplies into I , giving finally

$$\omega = \frac{\sqrt{2K}}{x} \frac{1}{m} \log \frac{I \alpha F}{2c'} \dots\dots\dots(30)$$

where F has the value corresponding to $\Phi = I - \Phi$, namely, $\frac{8}{\pi^2}$.

These expressions state that critical speeds plot as straight lines against the logarithms of the illuminations; that the speeds for

different amplitudes vary from each other by a factor $\frac{1}{m} \log a$, that the speeds for different openings are represented by a logarithmic function of the ratio of exposure to obscuration. Comparing these findings with the summary of critical frequency relationships symbolized in (1), (2) and (3) it appears that the findings of the theory are in general agreement with the facts. How close this agreement is will be seen from Figs. 4, 5, and 6. In Fig. 4 the

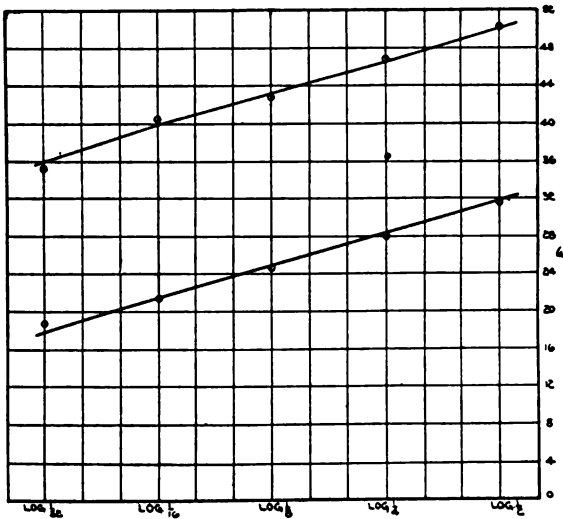

FIG. 5

Critical speeds (ω) versus logarithm of amplitude (α); sine curve stimuli.

circles represent experimental points for a sine curve wave form, the full lines values for various amplitudes calculated from the $\alpha = \frac{1}{2}$ line in accordance with (30), the numerical equation being $\omega = 10 \log I \alpha + 26.4$, where I is the arbitrary units. (Note that F , while different for a sine-curve stimulus than for a sharp transition one is alike for all amplitudes and so permits the derivation of various amplitude values from a given amplitude irrespective of the wave form of the stimulus). In Fig. 5 where the circles are again new experimental data, the straight line plot of $\log a$ against ω is exactly what is called for by (30). We have also for this

case the data of Kennelly and Whiting, who derive empirically the same equation.¹⁴

As for the speeds at different openings, in Fig. 6 the circles are the writer's 1916 data, the full lines the plot of (29) using the numerical equation $\omega = 10.7 \log IF\Phi(1+\Phi) + 30$ derived from the 1916 data; the crosses are new 1921 data. It is evident that the general character of the relationship is well represented by the formula. The writer's experimental data, as already noted, indicate higher speeds for the small openings than for the large, while (29) is symmetrical about $\Phi = \frac{1}{2}$. On the other hand T. C. Porter finds these curves symmetrical. His empirical expression $\omega = a + (b+c \log I) (\log \Phi) (1-\Phi)$ is clearly very like (29). It is to be noted that in the derivation of (29) and (30) no variability with

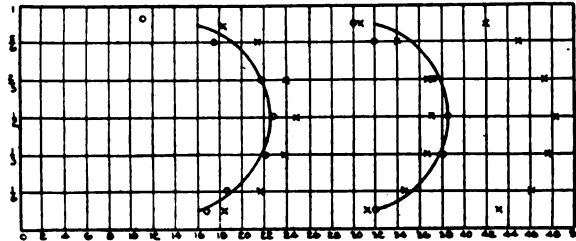

FIG. 6

Critical speeds (ω) versus sector opening (Φ).
 Circles, 1916 data. Full lines, calculated curves from equation
 $\alpha = 10.7 \log IF\Phi(1+\Phi)F + 30.1$.
 Crosses, 1921 data.

intensity has been ascribed to any of the factors. In all probability the diffusivity (K), the rates of recombination (b and μ) and even the critical rate of change used for the criterion of flicker visibility are functions of the intensity. It is to be remembered as well that the process of derivation of our expressions is approximate only. There would therefore appear to be ample opportunity to account for deviations from the exact relations indicated; the important thing is to account for the main characteristics of the critical frequency relations and this the theory appears to do for the high intensity conditions.

¹⁴ The mutually inclined ω - $\log I$ lines obtained by the writer previously for the case shown in Fig. 4 (Phil. Mag., April, 1917, p. 360) are apparently in error, due probably to the short range of intensities available for study in the apparatus then used.

Turning now to the low intensity phenomena, where critical speeds are independent of illumination, the obvious modification demanded if the same theory is to cover this region as well—a simpler one might be found adequate—is some assumption which will result in the “ I ” term dropping out of (29). Perhaps the simplest assumption is that the process of dark adaptation, which is operative in vision near the threshold, automatically increases the photoelectric sensitiveness (as by supplying more material, or exposing more surface), as the illumination is changed, so as to maintain the mean value of the reaction constant. This adaptation process may be supposed to be altogether too slow to follow the rapid fluctuations of the stimulus which constitute the periodicity to which flicker is due.

This assumption is introduced into the theory by multiplying the right hand side of (13) by the reciprocal of the mean intensity. It will be obvious, without going through the steps, that the various expressions derived for the flicker-wave form relations thereby become independent of the intensity. They reduce in fact to the empirical expression already quoted (4), with the exception that the expression for unequal exposure and obscuration becomes $\omega = \frac{\sqrt{2K}}{x} \frac{1}{m'} \log \frac{(1-\Phi)}{c''} F$, while the empirical expression⁵ is $\omega = c \log$

$\frac{\sin \pi \Phi}{\pi \Phi \delta}$. Upon plotting these two expressions however it is found

that they are quite indistinguishable in shape. Other expressions, included in the general empirical form, and applying to sine curve and other wave forms, are not handled by the present approximate treatment, but it is highly probable that an exact solution of our general equation (as altered to cover the low intensity condition) would yield results agreeing equally well with the empirical expression found to fit the experimental data. It may be pointed out that the observation of a lower limit to flicker speed in the low intensity investigation is exactly in accord with the criterion of a definite rate of change of transmitted impression as the critical condition for perception of flicker. At low speeds the transmitted impression rises and falls slowly because of the slowness of change

of the stimulus; at high speeds it rises and falls slowly because of the smoothing out processes at work due to conduction. These two limits of flicker speed may be considered as support for the adoption of the rate of change criterion.

ELECTRICAL MODEL ILLUSTRATING THEORY

In the theory as stated there is nothing which absolutely binds us to an electrical mechanism, probable although that may be. The initial reaction may be characterized simply as photochemical, the conduction process may be a diffusion of decomposition products, the criterion of visibility of flicker may be rate of change of concentration of these products. The mathematical treatment is general and is the same for electrical as for chemical processes and either may figure at some or all stages. It is, however, of some interest, as contributing to concreteness, to illustrate the theory by an electrical model which is governed by the equations used. In Fig. 7 let S be a photoelectric cell of the ordinary vacuum type. At L let there be a leak, of high resistance which

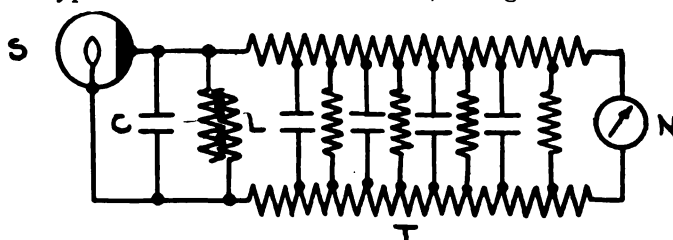

FIG. 7

Electrical model illustrating theory.

- S photoelectric cell
- C condenser
- L variable resistance leak
- T "Cable" with distributed capacity and leakage
- N sensitive receiver.

decreases as the applied voltage increases, in such a manner that the attained potential is approximately as the logarithm of the stimulus (certain loose contacts approximate this property). At C , close to the cell, let there be a capacity. The rest of the system T consists of a "cable" consisting of a resistance path, with distributed capacity and leakage,—the leakage in the cable being composed of ordinary non-varying resistances. At the far end of

the line is to be placed a detecting instrument N which starts to indicate when the rate of change of potential across the two arms of the cable reaches a certain critical value. The *amplitude* of an *induced* current would be a criterion corresponding to that postulated.

The two varieties of resistance leaks assumed for ease of description, can be reduced to one, the variable resistance kind,—since it would only be the resistances close to the cell which would be subjected to voltages high enough to utilize the departure from Ohmic character. Also the capacity pictured near the cell may be merely the normal capacity of the cable near the cell. The whole system may, therefore, be physically somewhat simpler than the coupling of photoelectric cell, capacity, leak, and special transmitting channel which must be considered as separate entities for purposes of mathematical treatment. It is, in fact, quite possible that all the recombination and diffusion properties required may be localized in the liquid photoelectric cell itself.¹⁵

NUMERICAL FORMULAS

The values of the constants to be used with the formulas above derived depend upon the illumination unit, the size of the observing field, the particular observer. Porter's formula for equal dark and light intervals has been rather widely copied; it appeared therefore worth while to calculate the constants for the new formulae to agree with his.

His formula for high intensities is

$$\omega = 12.4 \log I + 29.4 \dots \dots \dots (31)$$

where ω is in cycles per second and I in meter candles. [His slope, (12.4) is higher than Kennelly and Whittings (11) and that fitting Fig. 4, (10)]. Observing that according to our notation Ia must be substituted for I , a being $\frac{1}{2}$, we get for *equal light and dark exposures*, of amplitude a

$$\omega = 12.4 \log I a + 33.1 \dots \dots \dots (32)$$

For various openings (Φ), for $a = \frac{1}{2}$, we get similarly

$$\omega = 12.4 \log I \Phi (1 - \Phi) F + 38 \dots \dots \dots (33)$$

¹⁵ For the influence of diffusion on the response of a liquid photoelectric cell, see Samsonow, Zeits. f. Wiss. Phot. XI, 1912, p. 33.

where F is the fraction shown in Fig. 2. Making use of the observation that $\Phi(1-\Phi)F$ is practically equivalent to

$$\frac{\sin \pi \Phi}{\pi \Phi} \times \text{const.}$$

we get a handier working formula

$$\omega = 12.4 \log I \frac{\sin \pi \Phi}{\pi \Phi} + 35.6 \dots \dots \dots (34)$$

For *low intensities* (blue light), using the writer's own observations,⁵ for *various amplitudes*

$$\omega = 13.3 \log \alpha + 18.6 \dots \dots \dots (35)$$

for *various openings*

$$\omega = 13.3 \log (1-\Phi)F + 21 \dots \dots \dots (36)$$

or noting that $(1-\Phi)F$ is practically equivalent to $\frac{\sin \pi \Phi}{\pi \Phi} \times \text{const.}$

we get this working formula:

$$\omega = 13.3 \log \frac{\sin \pi \Phi}{\pi \Phi} + 17.2 \dots \dots \dots (37)$$

With these formulas a complete family of low and high intensity critical frequency curves, for abrupt transitions of illumination, may be plotted, which represent the experimental data closely in character and position.

DISCUSSION

The most serious objection to the theory of intermittent vision here presented appears to the writer to be the fact that the logarithmic relation between illumination and critical frequency is due to the special type of conduction assumed for the products of the light action. It would appear *a priori* much more likely that this is a more or less direct consequence of the logarithmic relation between stimulus and response. In that respect the lines of thought in the attempted theoretical derivations of Kennelly and Troland are preferable.

It may also be felt, owing to the somewhat lengthy mathematical development, that the processes assumed are unduly complex, and that some other simpler method of handling the variables at our command based on different assumptions might give the same results. It should be emphasized that the complexity is due to

the mathematical processes themselves, and that the assumed physical processes—an initial photoelectric or photochemical reaction, and a subsequent conduction—are simple and plausible. On the basis of these assumed physical processes the mathematical treatment cannot be much simpler, whatever direction it takes. Such ultimate explanation of the critical frequency phenomena as may be developed will unquestionably involve processes of reaction to light and transmission of the results of the reaction. The theory here presented should therefore be at least a guide to a more complete (and probably even more complex) theory which can be built up on a better knowledge than we now possess of photochemical reactions and of physiological conduction processes.

RESEARCH LABORATORIES OF THE
AMERICAN TELEPHONE AND TELEGRAPH COMPANY AND THE
WESTERN ELECTRIC COMPANY, INCORPORATED.
JULY, 1921.

THE VISIBILITY FUNCTION AND VISIBILITY THRESHOLDS FOR COLOR-DEFECTIVES

BY
MARGARET C. SHIELDS

Information with regard to the luminosity sense of color-defective eyes has seemed to the writer, interested because she is herself a deuteranope, meagre and contradictory. No adequate effort has been made to connect the type of color deficiency with the form of the luminosity curve, and the question of absolute luminosity has been, except for the work of Sir William Abney, untouched. The writer was recently accorded the privilege, as a guest of the Nela Research Laboratory, of obtaining her own visibility curve on the special equality-of-brightness spectrophotometer developed in that laboratory, and desires here to present the results of that work, together with a few observations upon similar data already on record.

The apparatus is essentially a Lummer-Brodhun spectrophotometer, the field of the ordinary size, and the collimators arranged so that brightness matches are made step by step through the spectrum for almost indistinguishable color differences. The writer acknowledges appreciatively her indebtedness for the use of assembled and calibrated apparatus, and also for the determination of the brightness temperatures of the sources, from which the energy distribution was computed. Both the apparatus and the experimental procedure were exactly as originally described.¹

There are on record carefully determined visibility functions for sixteen persons recognized to be color defective. Watson² has offered five cases, with the thesis that on the three process theory as represented by the Abney curves an observer, in proportion as he fails to get the green stimulus from white, should require more white to match in brightness a red than a normal observer, the

¹ *Astrophys. J.*, 35, p. 237, 1912; and 48, p. 65, 1918.

² *Proc. Roy. Soc.*, 88, p. 404.

effect being to shift his maximum visibility to the red; conversely, an observer who loses relatively more red than green, should have his maximum visibility shifted to the green. He failed, however, to demonstrate for his three cases which are shifted to the red, that they were actually found by other tests to be more

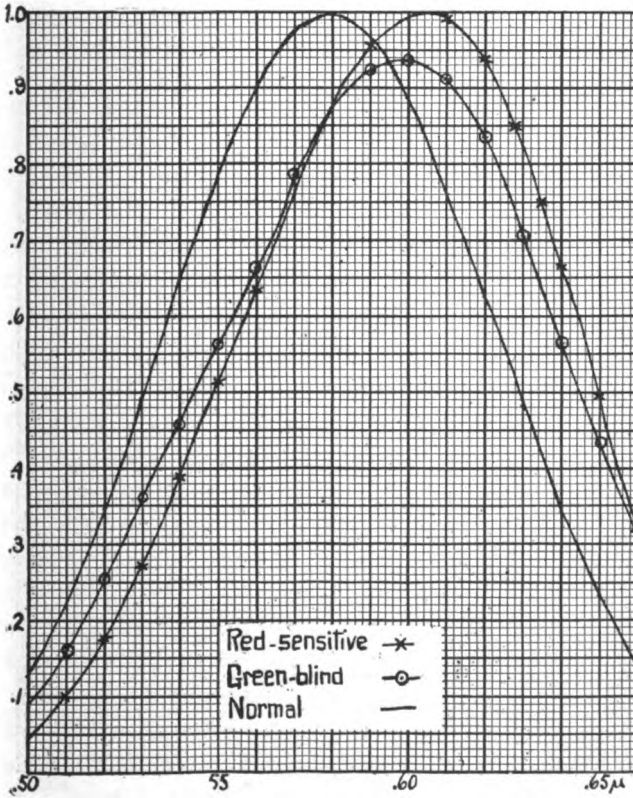

FIG. 1
Equal-area luminosity curves (Source at 2045°K).

blind to green than red, and for the two shifted to the green vice versa. Tufts³ presents three cases of color-defectives showing a shift to the red, and three to the green, with no attempt to correlate these shifts with the type of defect. Coblenz⁴ finding

³ Phys. Rev., 25, p. 433.
⁴ Bul. Bur. Std. 14, p. 167.

four cases of shift to the red and one to the green, specifies that two of the former were green-blind by the Nagel test, but makes no statement as to the other three.

The finding of the writer in her own case adds one more to the two cases of Coblenz which definitely conform with Watson's

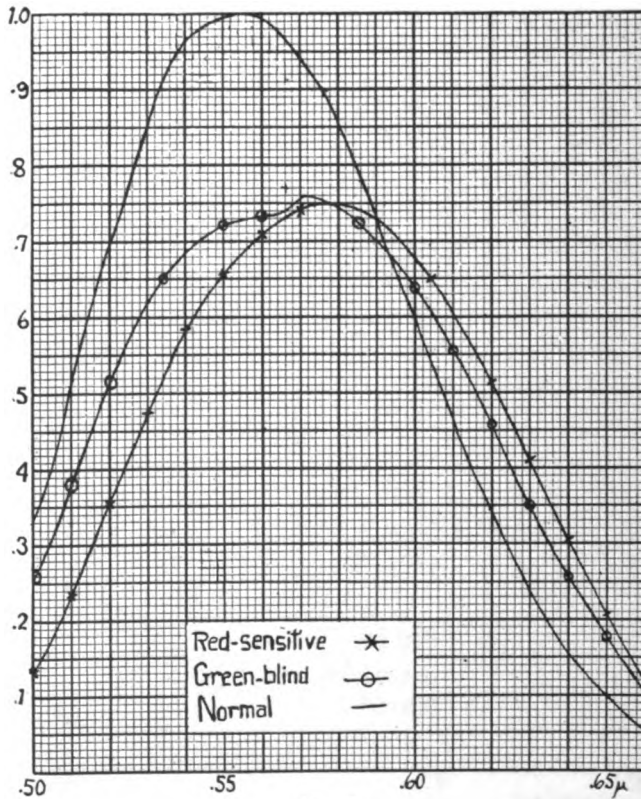

FIG. 2
Visibility functions derived from the luminosity curves of Fig. 1.

theory. She is a deuteranope, failing completely any perception of green, but undoubtedly seeing the quality red except when the saturation is fairly low,⁵ and her visibility curve has its maximum at 571 $m\mu$, as compared with 556-7 $m\mu$ for the normal eye. (See the green-blind subject of Fig. 2.) It seems to the writer unfortu-

⁵ See Hayes, *Am. Jour. Psych.*, 22, p. 369, case M.S. This opinion is also supported by Prof. Dunlap of Johns Hopkins.

nate that all these visibility studies were not accompanied by adequate quantitative tests of the color sense of the subjects, but that it is none the less fairly probable that relative blindness to red must somehow predicate a shift of the maximum visibility to the green, and vice versa.

There is this quantitative difference between the point of view of Watson and the measured cases, that the totally green-blind should have their maximum definitely in the red, (the Abney curve, assuming the temperature of the arc to be 3500°C , would bring the maximum at $590m\mu$) whereas the largest displacement found is one of Coblenz' cases at $578m\mu$. Moreover, contrary to the statement of Watson, it is to be noted that the integral luminosity of the green-blind may be arbitrarily made equal to the normal without giving rise to an abnormally high maximum luminosity in the red. (See Fig. 1.) This is true for the present case and for all four of Coblenz' cases having the maximum in the red. The form of the curve is indeed closely comparable with that of a normal red-sensitive subject, as shown in Fig. 1. The integral visibility derived from equal-area luminosity curves is of course below normal for any curve with its maximum in the red, but it is to be remembered that these curves represent luminosity for an equal energy spectrum, not the conditions of actual vision.

Further interest attaches to the correspondence of the present case with previous observations in that all the latter were taken by a flicker method in which the observer measured the brightness of the color in terms of white as he saw it, whereas this curve was taken by an equality-of-brightness photometer using red at $650 m\mu$ as a standard, since each wave length was measured in terms of a shorter, starting at this point. Ives and others have raised the question as to whether the two methods measure precisely the same thing, and have suggested that in flicker the cones are relatively more important. In such case, if color-blindness be at the same time rightly ascribed to a deficiency of the cones, the recognized divergence between the two methods might be found much more striking for color-defective eyes. The qualitative agreement between the two methods may therefore be taken as indicating that the two are none the less as nearly equivalent for

color-blind as for normal eyes, or that the observed shifts are not attributable to the method.

On the basis of the simple three process theory which makes the total luminosity sense at each point in the spectrum the sum of the ordinates of three color sensation curves, Abney was led to draw

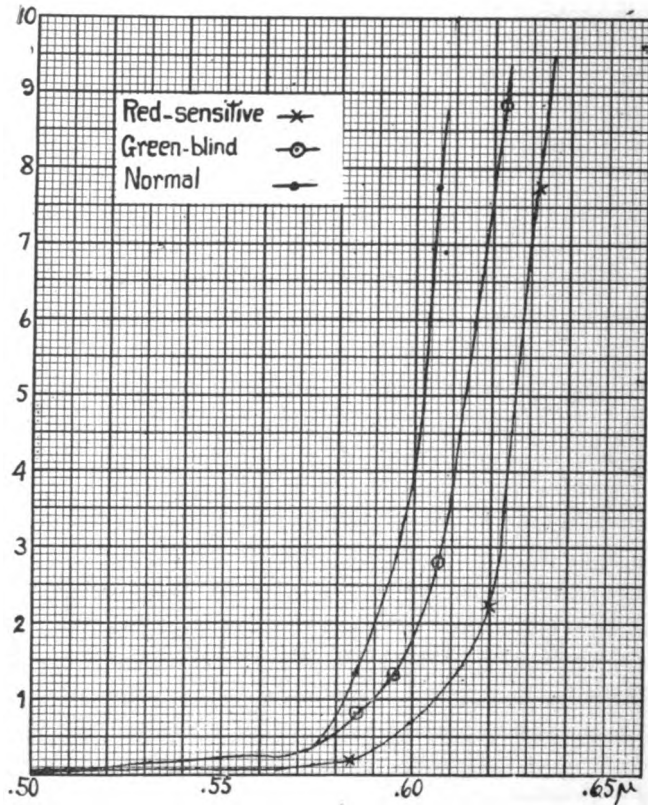

FIG. 3
Visibility thresholds.

curves giving for a person totally lacking the green sense an integral luminosity only .7 the normal, and for a red-blind person only .3. This extreme lowering of the absolute brightness sensibility of color-defectives he justified partly on the basis of threshold determinations. It was therefore a matter of considerable interest to test this by comparing the visibility thresholds for a

few persons whose visibility functions had been determined in the original investigation in the Nela Laboratory with that of the one available color-blind case. This was accomplished with the same spectrophotometer, using only one lamp, operating it at a low temperature, narrowing the slit, then allowing the observer

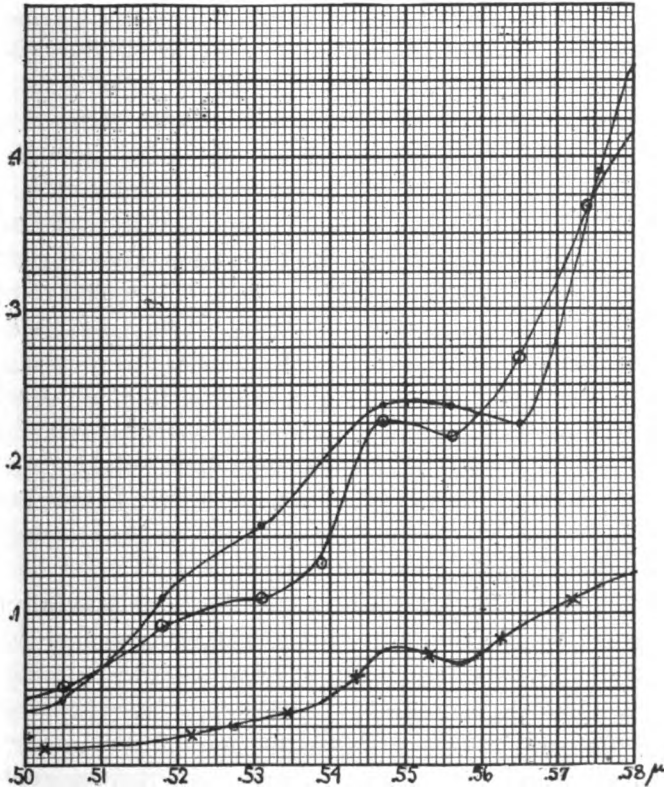

FIG. 4
Detail of Fig. 3.

to set the rotating disc so as just to extinguish the pattern, his eyes being in a stable state of dark adaptation. The energy distribution was determined as before from the equivalent black body temperature of the filament, 1375°K , with the correction applied for dispersion. The results are given for three typical cases in Fig. 3, showing in arbitrary units the minimum energy perceptible as a function of the wave length; Fig. 4 shows the

detail of the short wave length portion of the same curves. Judgments of what constitutes extinction are difficult to make with precision, but it is at least certain that in the case of the writer there is no evidence of marked loss of brightness sensibility. As compared with this one deuteranope, the red-sensitive subject of Figs. 1 and 2 with normal color vision has a somewhat lower threshold throughout; the third, a subject, whose visibility is close to the average has one somewhat higher throughout. Still another normal observer required the slit width to be doubled before he could see the pattern at all, obtaining then a curve nearly identical in form with that of the green-blind subject. The three threshold curves lie in the red in the inverse order to the corresponding visibility curves, but in the same order in the blue, so that they cannot be correlated absolutely. It would of course be desirable to measure the least discernable brightness difference for these subjects from the threshold up to ordinary levels; but even without this, if, contrary to Abney's assertion, a green-blind may actually perceive a smaller minimum of energy than a normal, not only in the spectral region where the relative visibility is high but beyond the green where his relative visibility is low, there is the possibility that his integral luminosity at ordinary brightness levels may not be markedly below normal.

The statement made by Tufts and by Coblenz is amply justified, that an abnormal visibility function is not necessarily associated with color-defective vision; but it is certainly equally true that there is no case on record of a color-defective with a normal visibility function. The existing evidence indicates, rather, that color-defective vision does condition a perfectly definite modification of the visibility function; it would therefore appear that a theory of vision should interrelate brightness sense and color sense to the extent of accounting for this. It seems doubtful, however, if color-blindness does involve a lowered brightness sense in the extreme fashion in which the Young-Helmholtz theory has been interpreted to involve it.

MOUNT HOLYOKE COLLEGE
SOUTH HADLEY, MASS.

RECALESCENCE IN ANTIMONY

BY
ENOCH KARRER, PHYSICIST

A common illustration of recalescence is found in iron. When an iron wire cools from an incandescent temperature, it will suddenly become brighter when the recalescent point is reached. A far more striking case of such recalescence is found in antimony. Many substances recalesce, but in order that the recalescence shall be easily seen with the unaided eye it must occur at or above a temperature giving a just sensible brightness. In general, for any given change of temperature brought about by the molecular rearrangement during recalescence the relative change in brightness is greater the lower the temperature. From this standpoint antimony offers advantages, since recalescence in it takes place at or below the melting point (630°C). This temperature is sufficiently higher than the minimum temperature¹ to make the luminous mass of metal easily visible. The usual method of detecting recalescence is in cooling curves.² Foote³ has already called attention to this phenomenon in antimony as used in pyrometric calibration. However, when the effect is observed indirectly, as by heating an enclosure, it cannot be so marked as when the surface of the metal itself is observed.

The recalescence in antimony is very striking when a globule of the metal is heated in a glass tube to a temperature above 630°C . Either the surface of the globule in contact with the glass or the opposite surface may be viewed. To make the measurements recorded in the curves of Figs. 2 and 3, a disposition of apparatus shown in Fig. 1 was satisfactory. The antimony globule was placed in a small furnace and in contact with a small thin-walled quartz tube into which a thermocouple (Pt-Pt Ir) was inserted.

¹ A black body subtending an angle of perhaps 1 radian is still luminous at a temperature of 530°C to a dark adapted eye.

² i.e., temperature vs. time.

³ *Met. and Chem. Eng.*, 11, p. 97, 1913.

The globule is also covered over with a thin piece of quartz plate. A photometer was placed a short distance above the surface of the antimony. Two observers⁴ read respectively the galvanometer connected with the thermocouple⁵ and the ammeter of the photometer,⁶ while a third observer matched the photometric fields as the metal cooled. The data given in the curves of Figs. 2 and 3 are the averages obtained from many samples of antimony. The

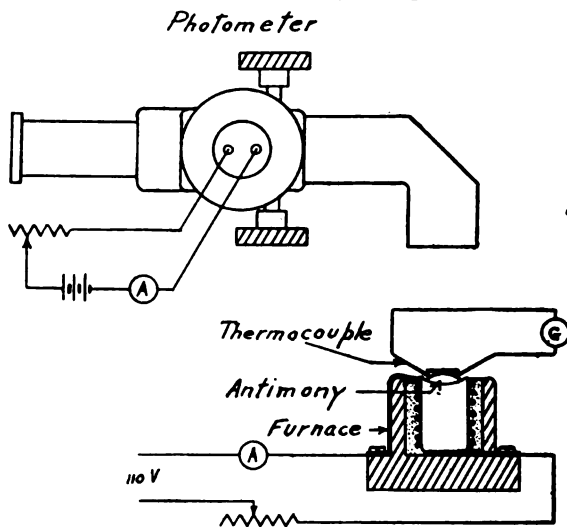

FIG. 1

Disposition of apparatus to observe the recalcence in antimony.

first results plotted in Fig. 2 were obtained in a very shallow furnace allowing the globule to cool very quickly. The recalcence occurs as nearly as can be determined at the melting point

⁴ I am indebted to Mr. R. H. Sinden and Mr. T. I. Angell for much assistance in these observations.

⁵ The thermocouple was calibrated by observing the deflection of the galvanometer when globules of equal sizes of antimony, lead and tin were in succession melted in the furnace. The calibration curve is a straight line whose intercepts depended upon the size of the globule and the position of the quartz tube and junction, and therefore changed with each sample. The calibration curve however could easily be adjusted for every new charge of the furnace by observing the melting point of the antimony under test.

⁶ The photometer was calibrated to give a relation between brightness in millilamberts (candles per $\text{cm}^2 = \pi$ lamberts) and the current through the photometer lamp. A red glass was used for color matching.

of the metal. The flashing was of rather too short duration, (20 to 35 seconds) for ease of observation. A new furnace was constructed slightly deeper than the first in order that the cooling may be less rapid (about 55 seconds) and in order that the temperature may more easily be controlled. Fig. 3 shows the results plotted, again the mean of a large number of observations. In this case the recalescence takes place far below the melting point. In fact in some cases the globule was no longer visible before the flashing occurred. The metal was likewise in a solid phase in such cases.

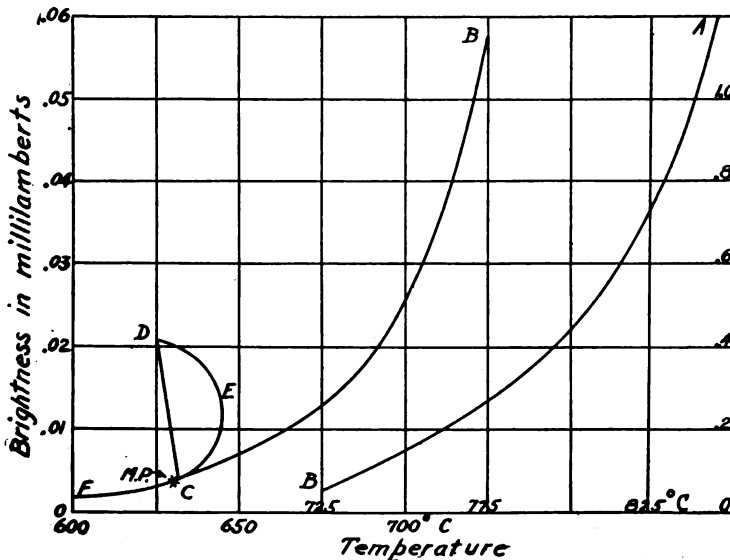

FIG. 2

Temperature-brightness curve of antimony.

In many instances the antimony was heated up to a temperature above 700°C . The brightness-temperature relation is given by the portion *AB* of the curve (Fig. 3). The cooling proceeds along this curve to point *F* where the average of all observations seems to indicate a slight retardation in the rate of decrease of the brightness until the flashing point *C* is reached where the brightness suddenly jumps to a high value, *D*, and remains so for an appreciable time while the temperature is rising. The tempera-

ture to which the metal rises always remains below the melting temperature. It is almost impossible to obtain a sufficient number of observations by ordinary photometry to determine accurately what the shape of the loop $FCDEF$, may be. On the return to the point F the brightness-temperature curve becomes continuous with the first (AB) portion of the curve.

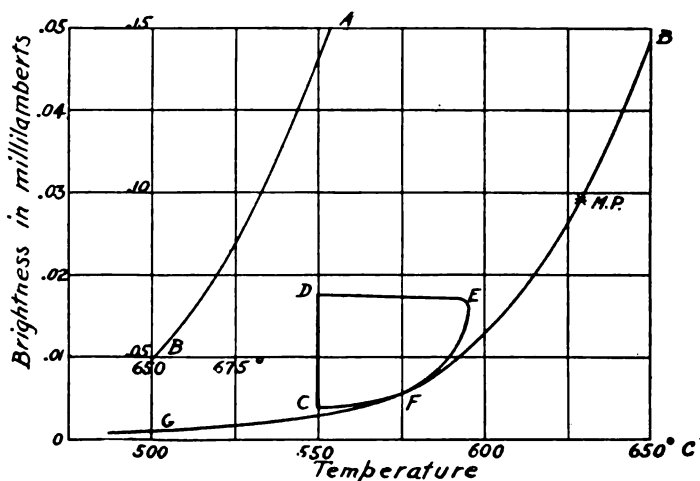

FIG. 3

Temperature-brightness curve of antimony.

The temperature may be kept at some value intermediate between the melting point (630°C) and the flashing point (580°C) for an extended time without in any way affecting the flashing when the ultimate cooling lowers the temperature to the flashing point.⁷ Such a temperature was maintained on one occasion for about one minute and on another occasion for eight minutes.⁸ In the latter case the uncertainty in the temperature equilibrium due to the lag in the thermocouple is eliminated. During this time the metal is solid. To test this point the cover was removed and the globule pricked with a small rod. The fact that the metal is solid before the flashing means that this case of recalescence is

⁷ I am indebted here to Mr. R. H. Sinden for carrying out several experiments to check this and other points.

⁸ It may be noted however that in one single case where the time was more than ten minutes no flashing was observed in subsequent cooling.

exactly analogous to that in iron and that it is not merely an under cooling of the liquid metal as has been thought heretofore.

This phenomenon was incidently observed while antimony and other metals were melted to make alloys for thermocouples. None of the other metals (tin, bismuth, cadmium) exhibit it. In one impure sample of bismuth it was noticed. Antimony is detectable by the recalescent phenomenon in bismuth when in such small proportions as 1:2000.

The recalescence takes place in an atmosphere of hydrogen and in vacuum in the same manner as in air.

LABORATORY OF APPLIED SCIENCE,
NELA RESEARCH LABORATORIES,
NELA PARK, CLEVELAND, OHIO, JANUARY 20, 1922.

INSTRUMENT SECTION

THREE-PLANE ORIENTATION CLAMP

BY
W. R. MILES

A small lens, writing point, microscopic slide or other such object may be adjusted freely and accurately in the three planes of geometric space by use of this special clamp. A top view is shown in diagram *A* and a side view in *B*. The device is composed of two principal parts, *C* and *D*, both of which are "slow motion" clamps regularly sold by well known instrument makers. It is the *combination* of the parts which is thought to be original and not previously described.

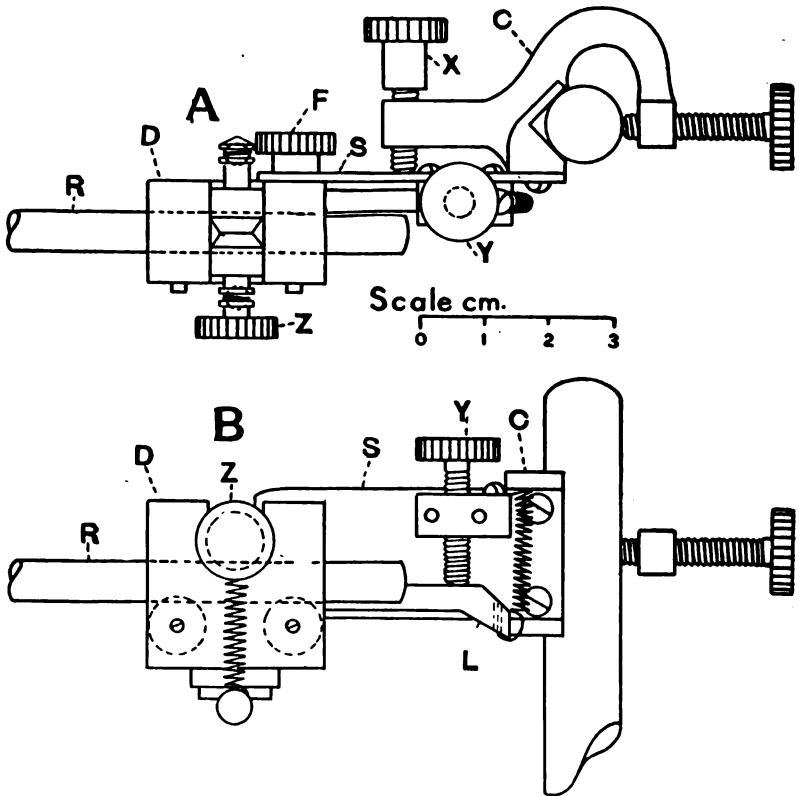

The part designated *C* provides for attachment to a suitable supporting stand and has an extension in the form of a leaf spring, *S*, which is acted upon by the adjusting screw, *X*. This provides for motion in one plane since *S* is rigidly attached to *C* at one end while the other carries part *D*. A rod, *R*, bearing the object to be adjusted passes between the three grooved rollers of *D* as seen in diagram *B*. The upper roller with knurled head *Z* is under tension from coil springs which act to pull it against *R*. The turning of *Z* causes *R* to move right or left and the movement is positive and delicate. The third plane of adjustment is about *F* as a fulcrum for *D*. The short lever, *L*, which is an extension of the frame of *D*, is held in contact with the screw, *Y*, by a small coil spring. The turning of *Y* thus causes the left hand end of *R* (sketch *B*) to be raised or lowered as desired. All three motions are free from backlash, are practically independent of each other, and as shown by the diagrams have considerable ranges of orientation.

NUTRITION LABORATORY
BOSTON, MASS.

NOTE ON A METHOD OF INCREASING THE CARRYING CAPACITY OF A RHEOSTAT

BY
W. E. FORSYTHE

When using an ordinary slide resistance to control a current it often happens that when the current is the largest, only a small part of the resistance is being used. This may be a disadvantage for two reasons: in the first place the smallest change possible in this small part of the resistance may greatly increase the current and in the second place the resistance may be very much overheated.

A method has been devised whereby it is possible to lessen both these difficulties by using both ends of the rheostat and thereby double its carrying capacity and at the same time make it much easier to control the current.

The working of the rheostat is best explained by a reference to the figure. In Fig. 1 the resistance is shown, by the heavy lines with the two main binding posts of the rheostat at *A* and *B*. In this case the rheostat is made up with sixteen steps. As such a rheostat is ordinarily used, the current enters at *A* passes through

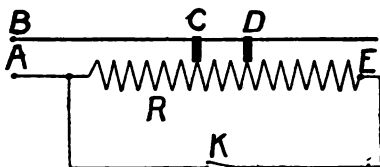

FIG. 1

the resistance *R*, then through some sort of a sliding contact, shown at *C*, and out through the binding post *B*. To increase the current, the sliding contact *C* is moved forward, thus short circuiting one or more turns of the rheostat. With the rheostat shown there are sixteen steps in the variation of the current. For a rheostat where each step is equal, as more and more of the steps are cut out a single step becomes a greater percentage of what

remains. For this reason the current control becomes very poor as the current is increased. There is another disadvantage in such a rheostat and that is this—when the current is increased by cutting out more and more of the resistance there is apt to be too large a current through the part of the resistance being used while a part of the rheostat is not in use at all.

To increase the carrying capacity of such a rheostat the additional sliding contact *D* is added and also another binding post *E* at the opposite end of the rheostat from the binding post *A*. The binding posts *A* and *E* are connected through the switch *K* so that by closing the switch *K* the two ends of the rheostat can be connected.

To operate the rheostat in this form proceed in the ordinary manner (switch *K* open) with the current entering at *A* passing through the resistance *R*, the sliding contact *C* and out at *B*. To increase the current move the sliding contact *C* towards *A* until it has passed over three-fourths of the distance from *E* to *A*, that is, until the resistance being used is one-fourth that of the entire rheostat. Now to obtain a larger current move both sliding contacts *C* and *D* to the center of the rheostat *R* and close the switch *K*. The resistance of the rheostat with switch *K* closed and the sliding contacts in this position is equal to about one-fourth of the total resistance of the rheostat, that is, the resistance will be about the same as before the sliding contact *C* was moved back to the center. The current will divide and one-half will enter at *A* and pass through one end of the rheostat and out through the sliding contact *C* while the other half will enter at *E*, pass through the other end of the rheostat and out through the sliding contact *D*. To increase the current move either the sliding contact *C* towards *A* or move the sliding contact *D* towards *E* or move both the sliding contacts *C* and *D* towards the ends *A* and *E*.

If a better control of the current is wanted, increase the current to about the desired value by moving but one sliding contact and then make the final adjustments by moving the other sliding contact in whatever direction necessary. By this method a very much better control of the current is possible and at the same time the carrying capacity of the rheostat is greatly increased.

Even for a rheostat when the resistance of the steps towards the end becomes less and less this method of use with two sliding contacts is very advantageous. In this case care will have to be taken not to send the same current through the two ends of the rheostat. However a very much better control will be obtained. Two rheostats connected as described above have been in use in this laboratory for the past three or four years and have been very satisfactory. One is a water cooled nichrome-ribbon rheostat intended to carry about forty to fifty amperes. When fitted with two sliding contacts and connected up as described above it will carry about eighty to one hundred amperes and at the same time it is possible to get good adjustment of the current.

It is quite obvious that this method can be carried a step farther by addition of two more sliding contacts and at the same time add a binding post at the center of the rheostat so that the center can be connected through another switch K' to the two ends A and E . In this case when the two sliding contacts C and D are brought to the center of the rheostat the other two sliding contacts G and H are to be moved to the center. The sliding contacts G and H are to be between C and D . To operate move but two of the sliding contacts C and D away from the center until each has passed over three-quarters of the length of that half of the resistance. Now move two sliding contacts to within one quarter of the distance to each end of the rheostat and close the switch K' . The resistance being used will be about the same as it was when the two sliding contacts were each within one-eighth of the distance from each end. To further increase the current move C and D towards opposite ends of the rheostat or move G and H towards the center. Since each sliding contact can be moved alone or in connection with any one or more of the others, it can be seen that this method with four sliding contacts will give a very good control.

NELA RESEARCH LABORATORIES,
CLEVELAND, OHIO.
MARCH 8, 1922.

CONSTRUCTIONAL DATA FOR A CEMENTED OBJECTIVE OF BARIUM CROWN AND FLINT

BY
I. C. GARDNER

The smaller optical fire control instruments used in the Army, viewed from the optical standpoint, consist essentially of a low power telescopic system designed to be as compact as is consistent with a large exit pupil. This in turn calls for a cemented objective of short focal length corrected for a large relative aperture. In view of this, it has been thought advisable to compute the following tables which have been obtained by graphic interpolation from a selected series of objectives which were carefully computed and checked by means of trigonometric ray tracing.

The usual type of construction has been assumed in which the crown component is in front. Standard thicknesses of .04 and .02 f have been adopted for the crown and flint components, these relatively large values being necessary to provide sufficient thickness at the edge for a short focus objective of large aperture. Furthermore, these thicknesses lead to economical production since ample margin is provided for repolishing if scratches should develop in the final finishing. Barium crown 1.570 to 1.580 and flint 1.610 to 1.622 have been selected as the glasses upon which the tables are based while the dispersion and indices for the C and F spectrum lines have been obtained by a smoothing process from sets of average values, determined from a large number of melts furnished the government during the war. For this reason, the specifications for the glass in these tables can be satisfied, almost identically, by glass of American manufacture readily obtainable. This range of glass includes those which were shown by Harting¹ to be most favorable for simultaneously eliminating spherical and chromatic aberration and satisfying the sine condition.

The arrangement of the tables is self evident. Table 1 gives the optical constants of the glass. Two barium crowns, numbers 1 and

¹ Harting, *Zeitschrift für Instrumentenkunde*, Vol. 18 p. 355 (1898).

2, and a single series of flint glasses are listed. Tables 2, 3, and 4 give directly the first, second and third radii for a lens of unit focal length corrected for spherical and chromatic aberration in such a manner that the edge ray for an aperture of $f/5$ and the paraxial rays for the D spectrum line have the same back focal length and in addition the paraxial rays for the C and F spectrum lines have the same equivalent focal lengths. The desired radius is found in each table at the intersection of the vertical column corresponding to the crown and the horizontal column corresponding to the flint glass. Four significant figures have been retained. This has not required an extravagant amount of extra labor and it has much facilitated the checking of the tables by a consideration of the differences. It is not meant to imply that the reproduction of radii to this accuracy is necessary in order to obtain satisfactory lenses.

Table 5 gives the values of the departure from the sine condition for the lenses listed. In all cases the lenses are undercorrected as regards departure from the sine condition, i.e., the height of the incident ray divided by the sine of the final slope angle is less for a ray distant from the center than for a paraxial ray.

TABLE 5

Departure from Sine Conditions for $F/5$ Double⁴ Corrected for Spherical and Chromatic Aberration

Indices	1.570	1.572	1.574	1.575	1.576	1.578	1.580
1.610	.0051	.0049	.0047	.0046	.0045	.0042	.0040
1.612	.0051	.0049	.0047	.0046	.0044	.0042	.0040
1.615	.0051	.0048	.0046	.0045	.0044	.0043	.0041
1.617	.0050	.0048	.0046	.0045	.0044	.0043	.0042
1.620	.0049	.0048	.0046	.0045	.0045	.0043	.0042
1.622	.0048	.0047	.0046	.0045	.0045	.0043	.0042

⁴ In the above table there is tabulated, in terms of f , the difference between the equivalent focal length of D rays entering at the axis and the value of $h/\sin a'$ for a ray incident at a point distant $f/10$ from the axis. In all cases there is undercorrection, that is, the equivalent focal length of the $f/10$ ray is less than that for the axial ray.

TABLE 1
Constants of Glass upon Which Tables are Based
 BARIUM CROWN, NUMBER 1

N_C	N_D	N_F	$N_F - N_C$	
1.56706	1.570	1.57708	.01002	56.88
1.56805	1.571	1.57811	.01006	56.77
1.56904	1.572	1.57913	.01009	56.66
1.57002	1.573	1.58015	.01013	56.55
1.57101	1.574	1.58118	.01017	56.44
1.57199	1.575	1.58220	.01021	56.33
1.57298	1.576	1.58323	.01025	56.22
1.57397	1.577	1.58425	.01028	56.11
1.57496	1.578	1.58528	.01032	56.00
1.57595	1.579	1.58631	.01036	55.90
1.57694	1.580	1.58734	.01040	55.80

BARIUM CROWN, NUMBER 2

1.56720	1.570	1.57703	.00983	57.99
1.56818	1.571	1.57805	.00987	57.85
1.56916	1.572	1.57907	.00991	57.72
1.57015	1.573	1.58010	.00995	57.59
1.57114	1.574	1.58113	.00999	57.46
1.57213	1.575	1.58216	.01003	57.33
1.57311	1.576	1.58318	.01007	57.20
1.57410	1.577	1.58421	.01011	57.07
1.57509	1.578	1.58523	.01014	57.00
1.57608	1.579	1.58626	.01018	56.88
1.57707	1.580	1.58729	.01022	56.75

MEDIUM FLINT

1.60541	1.610	1.62174	.01633	37.35
1.60638	1.611	1.62278	.01640	37.25
1.60735	1.612	1.62382	.01647	37.15
1.60832	1.613	1.62487	.01655	37.05
1.60930	1.614	1.62592	.01662	36.94
1.61027	1.615	1.62697	.01670	36.84
1.61124	1.616	1.62802	.01678	36.74
1.61221	1.617	1.62906	.01685	36.64
1.61318	1.618	1.63010	.01692	36.54
1.61415	1.619	1.63115	.01700	36.43
1.61512	1.620	1.63219	.01707	36.33
1.61609	1.621	1.63324	.01715	36.23
1.61706	1.622	1.63429	.01723	36.13

TABLE 2
First Radius of an F/5 Doublet Corrected for Spherical and Chromatic Aberration

Indices	1.570	1.571	1.572	1.573	1.574	1.575	1.576	1.577	1.578	1.579	1.580
1.610	.4656	.4681	.4707	.4733	.4761	.4790	.4820	.4851	.4882	.4914	.4946
1.611	.4660	.4685	.4710	.4736	.4764	.4792	.4820	.4849	.4878	.4908	.4938
1.612	.4664	.4689	.4713	.4739	.4766	.4793	.4820	.4847	.4875	.4903	.4930
1.613	.4669	.4693	.4717	.4742	.4768	.4794	.4820	.4846	.4872	.4898	.4923
1.614	.4674	.4697	.4721	.4745	.4770	.4795	.4820	.4845	.4869	.4894	.4917
1.615	.4679	.4702	.4725	.4749	.4773	.4797	.4821	.4844	.4867	.4890	.4912
1.616	.4684	.4707	.4729	.4752	.4776	.4799	.4821	.4844	.4866	.4887	.4908
1.617	.4690	.4712	.4734	.4756	.4779	.4801	.4822	.4844	.4865	.4885	.4905
1.618	.4696	.4718	.4739	.4760	.4782	.4803	.4823	.4844	.4864	.4884	.4903
1.619	.4703	.4724	.4744	.4764	.4785	.4805	.4825	.4844	.4864	.4883	.4902
1.620	.4711	.4730	.4749	.4768	.4788	.4807	.4826	.4845	.4864	.4883	.4902
1.621	.4719	.4737	.4755	.4773	.4791	.4810	.4828	.4846	.4865	.4883	.4902
1.622	.4727	.4744	.4761	.4778	.4795	.4813	.4830	.4848	.4866	.4884	.4902

* Barium Crown, Number 1, is to be employed in this series of lenses. The crown component faces the object (assumed at an infinite distance). In all cases the first radius is positive, i.e., convex towards the object.

TABLE 3
Second Radius of an F/5 Doublet Corrected for Spherical and Chromatic Aberration

Indices	1.570	1.571	1.572	1.573	1.574	1.575	1.576	1.577	1.578	1.579	1.580
1.610	.3248	.3228	.3207	.3186	.3164	.3142	.3119	.3095	.3070	.3044	.3017
1.611	.3279	.3259	.3238	.3217	.3195	.3173	.3150	.3127	.3102	.3077	.3052
1.612	.3309	.3289	.3268	.3247	.3226	.3204	.3181	.3158	.3134	.3109	.3083
1.613	.3340	.3318	.3297	.3277	.3256	.3234	.3211	.3188	.3165	.3141	.3117
1.614	.3370	.3348	.3327	.3307	.3286	.3264	.3242	.3219	.3196	.3173	.3150
1.615	.3400	.3378	.3357	.3337	.3316	.3294	.3272	.3249	.3227	.3204	.3182
1.616	.3429	.3408	.3387	.3367	.3346	.3324	.3302	.3280	.3258	.3236	.3213
1.617	.3458	.3437	.3416	.3396	.3375	.3354	.3332	.3311	.3289	.3267	.3245
1.618	.3486	.3465	.3445	.3425	.3405	.3384	.3362	.3341	.3320	.3298	.3276
1.619	.3513	.3493	.3473	.3454	.3434	.3413	.3391	.3370	.3350	.3329	.3307
1.620	.3540	.3520	.3501	.3483	.3463	.3442	.3421	.3400	.3381	.3360	.3338
1.621	.3567	.3548	.3530	.3512	.3493	.3472	.3452	.3431	.3411	.3390	.3368
1.622	.3593	.3576	.3559	.3541	.3523	.3503	.3483	.3463	.3442	.3420	.3397

* Barium Crown, Number 1, is to be employed in this series of lens. The second radius is negative in all cases, i.e., concave towards the object. Thickness of crown component .04 f.

TABLE 4
Third Radius of an F/5 Doublet Corrected for Spherical and Chromatic Aberration

Indices	1.570	1.571	1.572	1.573	1.574	1.575	1.576	1.577	1.578	1.579	1.580
1.610	5.654	5.772	5.902	6.046	6.207	6.385	6.583	6.799	7.034	7.300	7.611
1.611	5.766	5.893	6.029	6.168	6.341	6.521	6.717	6.930	7.159	7.404	7.676
1.612	5.897	6.033	6.178	6.333	6.500	6.677	6.867	7.069	7.284	7.511	7.747
1.613	6.054	6.194	6.345	6.505	6.675	6.853	7.037	7.226	7.420	7.618	7.818
1.614	6.242	6.396	6.555	6.717	6.882	7.048	7.215	7.384	7.554	7.725	7.895
1.615	6.467	6.632	6.794	6.953	7.109	7.261	7.411	7.558	7.701	7.843	7.982
1.616	6.734	6.913	7.076	7.223	7.361	7.491	7.616	7.737	7.855	7.970	8.082
1.617	7.044	7.216	7.364	7.499	7.622	7.735	7.840	7.938	8.031	8.120	8.207
1.618	7.395	7.551	7.685	7.801	7.904	7.997	8.083	8.162	8.234	8.301	8.366
1.619	7.785	7.917	8.027	8.122	8.204	8.277	8.342	8.403	8.460	8.514	8.567
1.620	8.208	8.298	8.378	8.449	8.513	8.571	8.624	8.674	8.721	8.766	8.810
1.621	8.649	8.698	8.745	8.792	8.838	8.882	8.925	8.967	9.009	9.050	9.090
1.622	9.082	9.102	9.124	9.150	9.178	9.209	9.244	9.281	9.320	9.360	9.400

⁴ Barium Crown, Number 1 is to be employed in this series of lens. The third radius is positive in all cases, i.e., convex towards the object. Thickness of flint component .02 f.

TABLE 6
First Radius of an F/5 Doublet Corrected for Spherical Aberration and Sine Condition

Indices	1.570	1.571	1.572	1.573	1.574	1.575	1.576	1.577	1.578	1.579	1.580
1.610	.6340	.6347	.6354	.6360	.6365	.6371	.6378	.6386	.6394	.6402	.6412
1.611	.6346	.6352	.6359	.6365	.6371	.6378	.6385	.6392	.6400	.6408	.6417
1.612	.6352	.6358	.6365	.6371	.6378	.6385	.6392	.6399	.6406	.6414	.6422
1.613	.6358	.6364	.6370	.6377	.6384	.6391	.6398	.6405	.6412	.6419	.6426
1.614	.6363	.6369	.6376	.6383	.6390	.6397	.6404	.6410	.6417	.6424	.6430
1.615	.6368	.6374	.6381	.6388	.6395	.6402	.6409	.6415	.6421	.6428	.6434
1.616	.6372	.6378	.6385	.6392	.6399	.6406	.6413	.6419	.6425	.6431	.6437
1.617	.6376	.6382	.6389	.6395	.6402	.6408	.6415	.6421	.6426	.6432	.6438
1.618	.6379	.6385	.6391	.6397	.6404	.6410	.6416	.6422	.6427	.6433	.6438
1.619	.6382	.6387	.6393	.6399	.6405	.6410	.6416	.6422	.6427	.6432	.6437
1.620	.6384	.6389	.6394	.6399	.6404	.6409	.6414	.6420	.6425	.6430	.6435
1.621	.6385	.6389	.6393	.6397	.6401	.6406	.6411	.6416	.6421	.6425	.6430
1.622	.6384	.6387	.6390	.6393	.6397	.6400	.6404	.6409	.6414	.6418	.6423

† The crown component faces the object (assumed at an infinite distance). In all cases the first radius is positive, i.e., convex towards the object.

TABLE 7
Second Radius of an F/15 Doublet Corrected for Spherical Aberration and Sine Condition

Indices	1.570	1.571	1.572	1.573	1.574	1.575	1.576	1.577	1.578	1.579	1.580
1.610	.3254	.3234	.3209	.3186	.3164	.3141	.3119	.3096	.3073	.3050	.3028
1.611	.3279	.3260	.3237	.3214	.3192	.3169	.3147	.3124	.3101	.3078	.3055
1.612	.3305	.3284	.3263	.3242	.3220	.3197	.3175	.3152	.3129	.3106	.3082
1.613	.3329	.3310	.3290	.3269	.3247	.3225	.3203	.3180	.3158	.3134	.3109
1.614	.3354	.3337	.3317	.3296	.3274	.3252	.3230	.3208	.3186	.3162	.3136
1.615	.3379	.3362	.3343	.3323	.3302	.3280	.3258	.3236	.3214	.3190	.3163
1.616	.3404	.3387	.3368	.3349	.3329	.3307	.3284	.3263	.3241	.3217	.3191
1.617	.3428	.3411	.3393	.3374	.3354	.3333	.3310	.3289	.3268	.3245	.3219
1.618	.3451	.3434	.3417	.3399	.3379	.3358	.3336	.3315	.3294	.3272	.3247
1.619	.3473	.3456	.3440	.3422	.3403	.3382	.3361	.3340	.3320	.3298	.3274
1.620	.3495	.3478	.3461	.3443	.3425	.3405	.3385	.3365	.3345	.3323	.3300
1.621	.3516	.3498	.3481	.3463	.3445	.3427	.3408	.3388	.3369	.3348	.3326
1.622	.3535	.3518	.3500	.3483	.3465	.3447	.3429	.3410	.3391	.3372	.3352

* The second radius is negative in all cases, i.e., concave towards the object. Thickness of crown component .04 i.

TABLE 8
Third Radius of an F/5 Doublet Corrected for Spherical Aberration and Sine Condition

Indices	1.570	1.571	1.572	1.573	1.574	1.575	1.576	1.577	1.578	1.579	1.580
1.610	2.663	2.698	2.733	2.768	2.806	2.845	2.884	2.924	2.965	3.013	3.065
1.611	2.636	2.670	2.704	2.738	2.775	2.813	2.851	2.890	2.930	2.975	3.023
1.612	2.610	2.643	2.676	2.710	2.745	2.781	2.818	2.857	2.897	2.939	2.982
1.613	2.584	2.616	2.649	2.683	2.717	2.751	2.788	2.825	2.864	2.905	2.945
1.614	2.559	2.591	2.623	2.655	2.689	2.723	2.759	2.796	2.834	2.872	2.911
1.615	2.535	2.566	2.598	2.630	2.663	2.696	2.731	2.767	2.804	2.842	2.880
1.616	2.512	2.542	2.574	2.605	2.637	2.670	2.704	2.739	2.776	2.813	2.851
1.617	2.490	2.520	2.551	2.581	2.613	2.646	2.679	2.714	2.750	2.787	2.826
1.618	2.469	2.499	2.529	2.560	2.591	2.623	2.656	2.690	2.726	2.764	2.803
1.619	2.450	2.479	2.509	2.539	2.570	2.602	2.635	2.668	2.703	2.741	2.783
1.620	2.432	2.461	2.491	2.520	2.550	2.582	2.615	2.649	2.685	2.722	2.765
1.621	2.416	2.445	2.474	2.503	2.532	2.564	2.598	2.633	2.669	2.707	2.749
1.622	2.402	2.430	2.459	2.488	2.518	2.550	2.583	2.619	2.655	2.694	2.734

† The third radius is negative in all cases, i.e., concave towards the object. Thickness of flint component .02 f.

TABLE 9
Axial Chromatic Aberration for F/5 Doublet^a Corrected for Spherical Aberration and Sine Condition

WHEN BARIUM CROWN, NO. 1, IS EMPLOYED						
Indices	1.570	1.572	1.574	1.576	1.578	1.580
1.610	.0028	.0027	.0026	.0025	.0024	.0022
1.616	.0028	.0027	.0027	.0026	.0025	.0023
1.620	.0028	.0027	.0026	.0026	.0025	.0024
1.622	.0027	.0027	.0026	.0026	.0025	.0024

WHEN BARIUM CROWN, NO. 2, IS EMPLOYED						
Indices	1.570	1.572	1.574	1.576	1.578	1.580
1.610	.0019	.0019	.0018	.0016	.0015	.0014
1.616	.0020	.0019	.0019	.0018	.0016	.0015
1.620	.0019	.0019	.0018	.0018	.0017	.0016
1.622	.0019	.0018	.0018	.0018	.0017	.0016

^a In the above table there is tabulated, in terms of f , the difference between the equivalent focal length for the F and C rays near the axis. In all cases there is under-correction, i.e., the equivalent focal length for the F ray is less than that for the C ray.

Tables 6, 7, and 8 give radii of a second series of lenses and parallels tables 2, 3, and 4 respectively with the difference that spherical aberration is eliminated and the sine condition satisfied for paraxial rays and the edge rays for a zone of aperture $f/5$. Table 9 gives the outstanding axial chromatic aberration of the equivalent focal length for this second series of lenses. Two sets of values are given, the one applying when the barium crown, No. 1, is utilized, the other when the No. 2 is used. In all cases there is under correction, that is, the equivalent focal length for the F is less than for the D spectrum line.

The accuracy of the computations is such that it is believed the aberrations which have been "eliminated" in each case will be found to be less than $.003 f$ over the greater part of the table and well under $.005 f$ in all parts.

Fig. 1 shows in the usual manner the spherical aberration and departure from sine condition for a typical lens selected from the center of tables 2, 3, and 4. Fig. 2 shows similar curves for the lenses of Tables 6, 7 and 8. Fig. 3 shows the curvature of field and

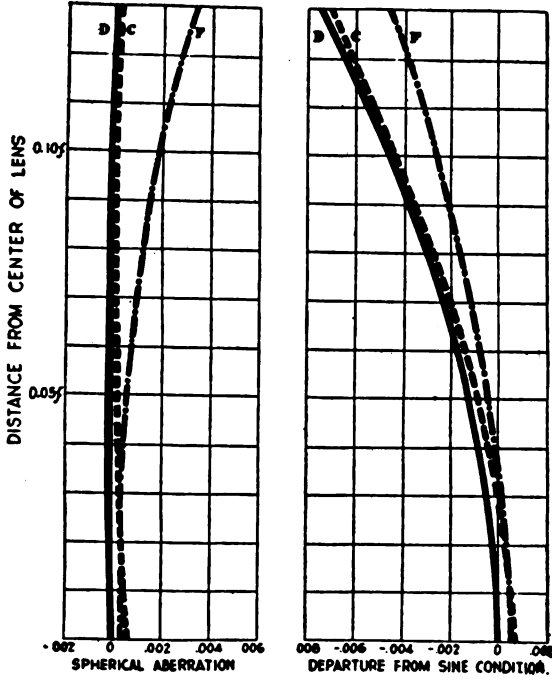

FIG. 1—Aberrations of lens corrected for spherical and chromatic aberration.

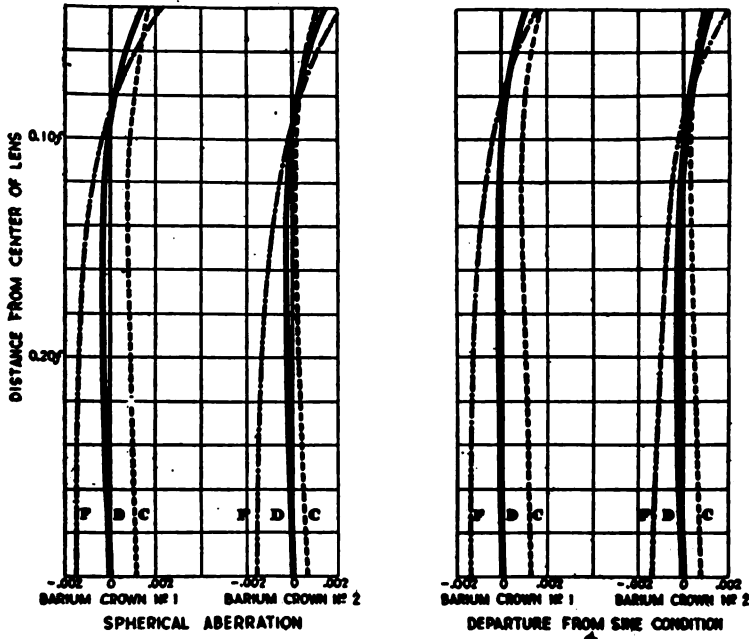

FIG. 2—Aberrations of lens corrected for spherical aberration and departure from the sine condition.

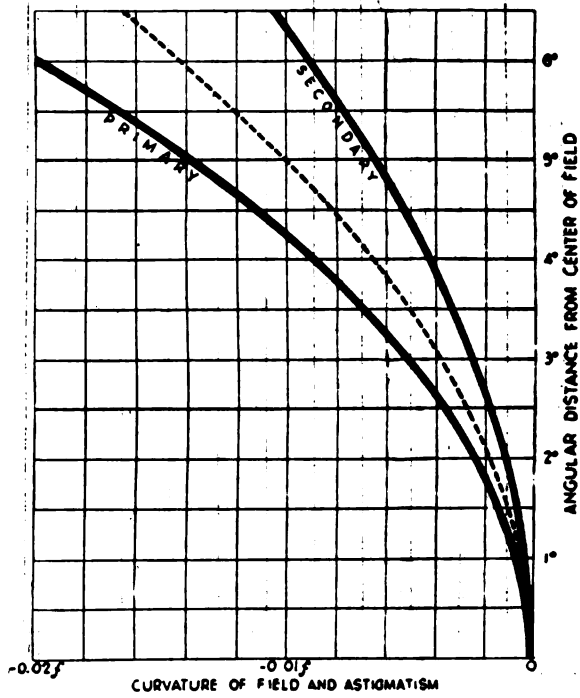

FIG. 3—Curvature of field and astigmatism.

astigmatism and may be considered as applying to either series of lenses since these aberrations are practically identical for the two sets of tables.

BUREAU OF STANDARDS,
WASHINGTON, D. C.

AN APPARATUS FOR STUDYING THE MOTION OF RELAYS

BY
HERBERT E. IVES
AND
T. L. DOWEY

In the study of the electrical phenomena accompanying the making and breaking of contacts by relays, it is of considerable importance to know definitely how the contact points move relatively to each other. The electrical methods which have been commonly employed for determining relay characteristics are quite inadequate for the kind of study here in mind. Oscillographic records of current tell merely whether contact is single or multiple, without any direct indication of the nature of the motions which result in contact. Methods for measuring the velocity of relay arms depending on time determination by the charging of condensers are only applicable to clean makes or breaks and so are impracticable for the study of the very important case of "chattering."

The apparatus which is illustrated in Figures 1 and 2 was designed for the purpose of obtaining photographic silhouettes, or "shadowgrams" of the moving contact points. The optical arrangement, while presenting no essentially new features, is one which is made eminently practical by the availability of an extended light source of high brightness, in the "pointolite" lamp. By reference to Fig. 1 the manner of its use will be made clear. First of all an enlarged image of the incandescent pointolite ball is thrown by means of a lens into the plane of the relay contacts. Then an image of the contacts and the pointolite image is formed by a second lens upon a narrow slit, parallel to the direction of motion of the contacts, and lying closely in front of a rapidly moving photographic film. It is clear that the shadow traced on the film will be a record of the relay's motion. The remaining problem is one of mechanical and electrical design to secure the proper control of film speed, the

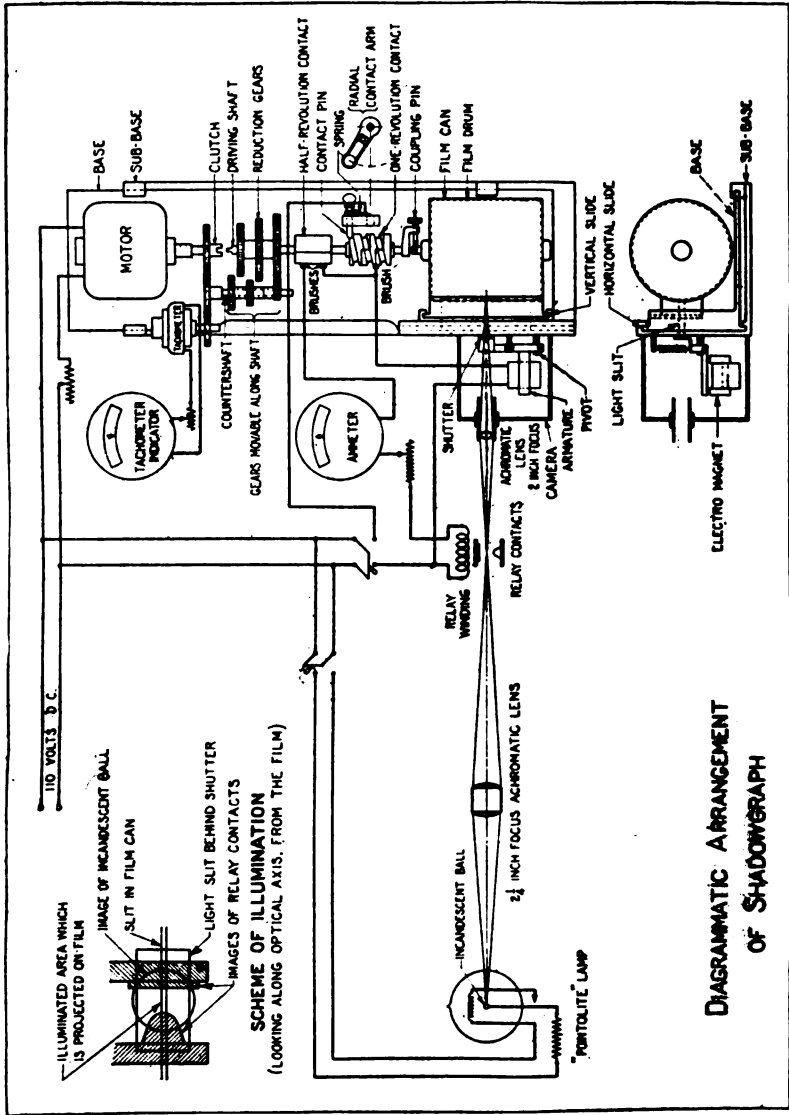

FIG. 1
Diagrammatic sketch of shadowgraph and connections.

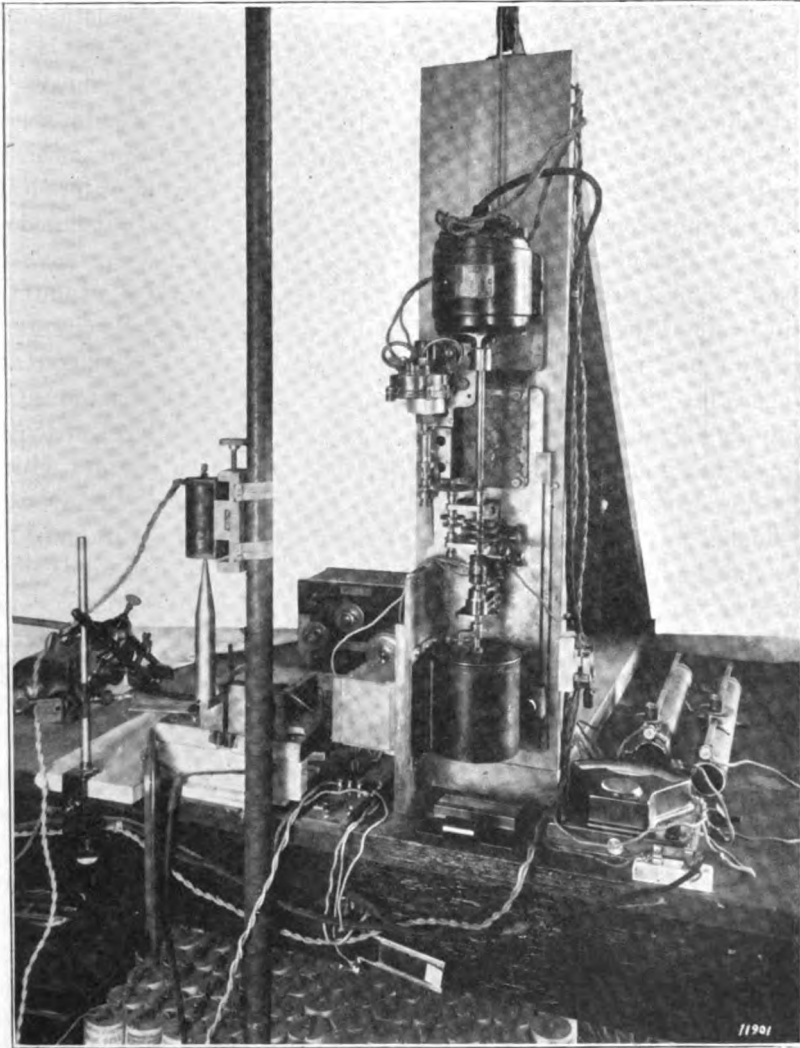

FIG. 2

Shadowgraph mounted in vertical position for photographing opening characteristics of relay operated by falling weight.

starting and stopping and proper synchronism of the various parts, and arrangements to facilitate the various operations involved.

As shown diagrammatically in Fig. 1 the film drum (a standard G. E. oscillograph part) is driven by a 110 volt 1/10 H.P. D.C. motor, either directly, or through trains of gears. By means of these gears, and by the insertion of series resistance the film speed may be varied from 15 to 1200 centimeters per second, as indicated by the electric tachometer mounted on the counter-shaft in combination with the known gear ratios. It is of course necessary to provide that the film be exposed only during one revolution. This is arranged by placing a magnetically controlled shutter in front of the film slit, which is only opened when the circuit is completed by dropping the pin carried on the "radial contact arm" into the helically grooved one revolution contact mounted on the driving shaft. Where the relay to be measured is electrically operated it may be controlled by a half revolution contact which is mounted on the same shaft. Proper timing of the relay and shutter may be effected by the angular setting of the full and half revolution contacts on the driving shaft. The film can and driving mechanism are arranged to slide parallel to the slit so that several shadowgrams may be made on the same film. The entire apparatus may be set up either horizontally or vertically (as shown in Fig. 2) depending on the mode of operation of the moving parts it is desired to photograph.

The performance of the apparatus is well shown by the selection of shadowgrams Figs. 3 and 4. The first set (Fig. 3) shows a series of opening characteristics all made in succession upon a single film of a lever relay operated by a falling weight. Here the zero opening is indicated by a strip of finite width because the shadow actually cast is that of two small knife edge "ears" carried by the contact pieces. The magnification of the relay opening here used was about five diameters, which is ample for measuring purposes and at the same time leaves the illumination quite adequate even with a very narrow slit (.1 mm) for the highest speed of rotation of the film can. Fig. 4 shows various cases of "chatter," in commercial relays with one or both relay arms vibrating. Simple inspection of these shadowgrams gives valuable information on

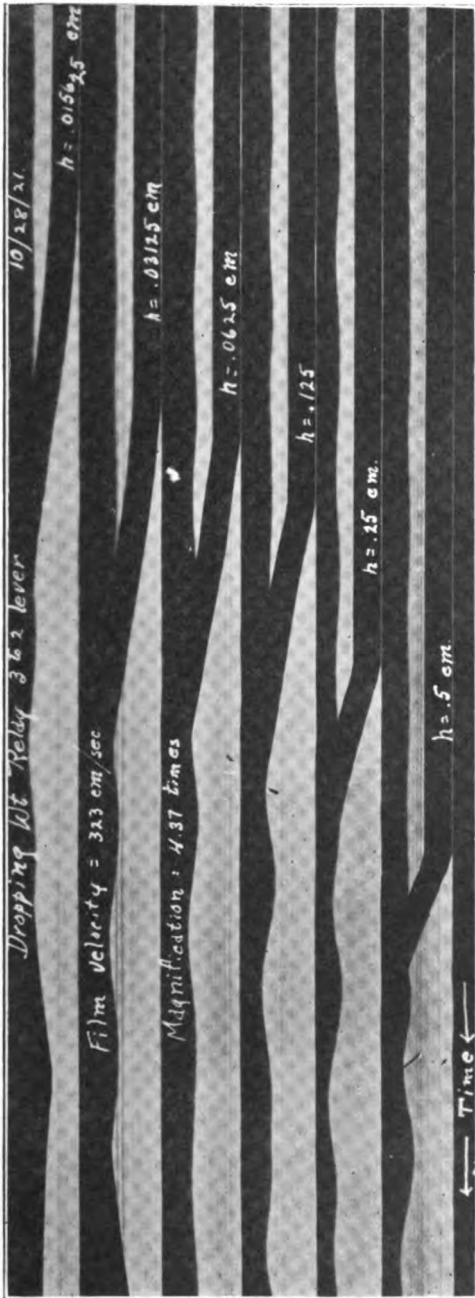

FIG. 3
Opening characteristics of falling weight operated relay for various heights of fall, as photographed on single film. (Long period vibrations at top of each record are caused by quivering of the pointolite ball image.)

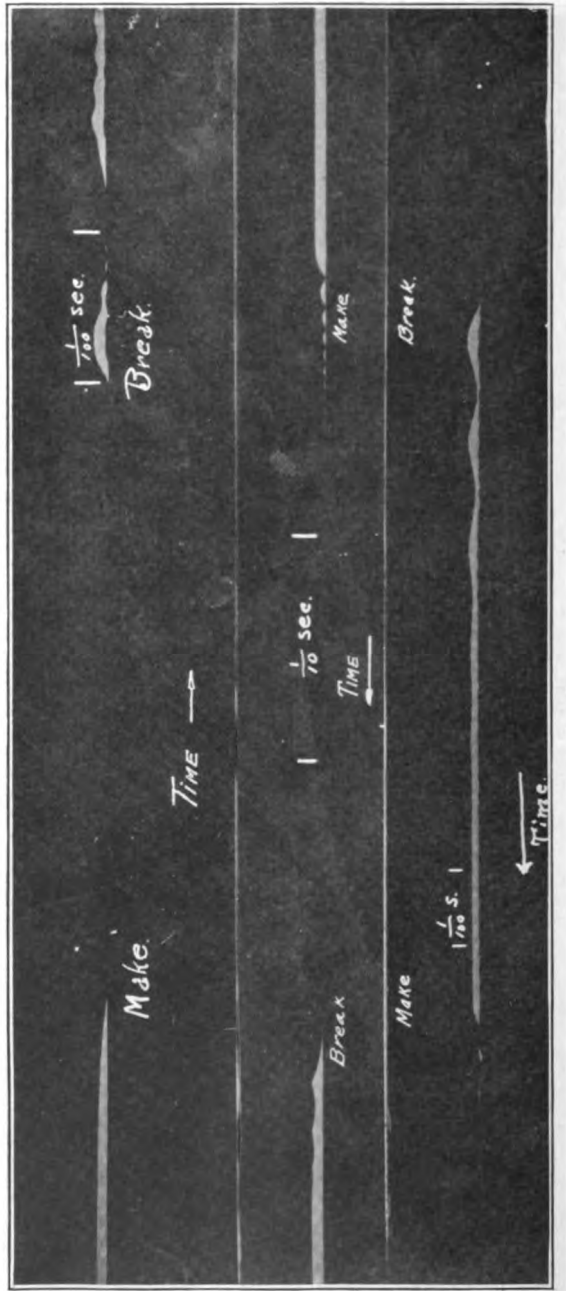

FIG. 4
Shadowgrams of poorly adjusted commercial relays showing various kinds of "chatter."

the performance of the relays photographed, while accurate measurements of the films open the way for quantitative analysis of the motions.

RESEARCH LABORATORIES OF THE
AMERICAN TELEPHONE AND TELEGRAPH COMPANY, AND THE
WESTERN ELECTRIC COMPANY, INCORPORATED.
MARCH 24, 1922.

INFRA RED TELEGRAPHY AND TELEPHONY

BY
T. W. CASE

During 1916–1917, a search was made for new light reactive materials which would change their electrical resistance on exposure to light. The list of materials examined has been published in the Physical Review.¹ One of the compounds in this list, lead antimony sulphide, was found to be somewhat active to the infra red. It was also noted that most of the new light reactive compounds found were sulphides. Therefore, further investigation was carried on having to do mainly with compounds containing sulphur. The most promising of these compounds was found to be a thallium sulphide. This substance showed a light action mainly due to the infra red.

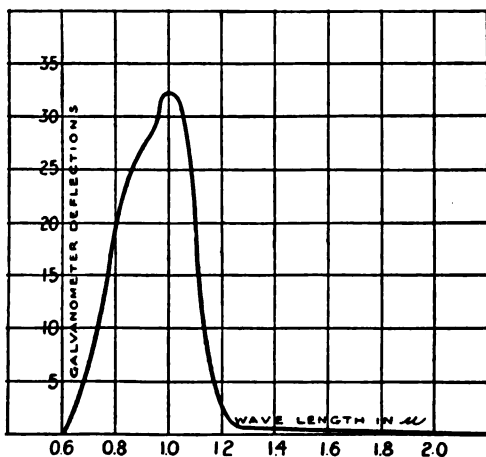

FIG. 1

Fig. 1 shows the spectral action of this thallium sulphide as measured by Dr. W. W. Coblentz.² The sensitivity of the material

¹ Physical Review, Vol. IV, No. 4, April, 1917.

² Bureau of Standards paper No. 380.

was greatly increased by a method of preparation in which the thallium sulphide was slightly oxidized and then placed in a vacuum.

Fig. 2 shows the finished cell which has been termed the "Thalofide Cell." The slightly oxidized thallium sulphide is coated upon a quartz disc, the disc having been previously heated to melt the material which is placed on it. Conducting lines of graphite are drawn over the coated surface and the element mounted in a glass tube, which is then evacuated.³

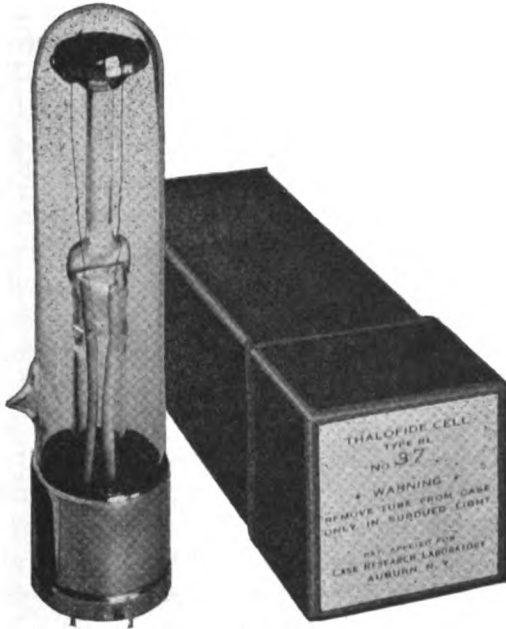

FIG. 2

The action of this cell is in a great many respects similar to the well known selenium cell except for the fact that its action is mainly due to the longer rays as shown in the spectral curve. It also differs in that the induction and deduction periods are more rapid than those of selenium. The resistance of the cells, (5 to 500 megohms) is very much higher than that of the ordinary selenium cell. This latter condition was sought because of the

³ U. S. Patent number 1316350.

attendant high (per cent) sensitivity attained between light and dark exposure. This makes the cells ideal for work in conjunction with audion bulbs where low resistance cells are at a disadvantage.

As this cell was developed with the idea of using it for infra red signaling, it was necessary to find an efficient light filter which would transmit the infra red, but not the visible rays. It was found that when Wratten filters, numbers 91, 45, and 53, were superposed, no visible light was transmitted and a high percentage of the infra red came through. This datum was sent to Dr. C. E. K. Mees of the Eastman Kodak Company's Research Laboratory with a request that he combine these three filters into one, which he was successful in doing. The gelatin film was coated on optical plate glass, and the film protected by a suitable cover glass. Ordinary plate glass or window glass, which shows a green color at the edge, was found unsuitable for the transmission of the infra red around 1 micron. The whole filter unit was sealed at the edges to prevent moisture from attacking the gelatin. The transmission of the infra red filter as finally developed is shown in Fig. 3. This curve was plotted by Dr. W. W. Coblenz.

To have an efficient infra red signaling system, it seemed desirable that the signals detected by the Thalofide cell should be made audible. To accomplish this, an audion arrangement was used. The method of interrupting the light at the sending end at an audible frequency was first tried and found to be impractical. Next, it was decided to interrupt the current through the Thalofide cell at the receiving end by mechanical means, for an audible frequency. Dot and dash signals would then be heard as changes in intensity of the audio frequency through the Thalofide cell. These could then be amplified by an audion bulb. This method was discarded a short time later, when it was found that certain connections with an audion bulb containing gas at a pre-arranged pressure could be made to produce an oscillating current through the Thalofide cell. In this latter arrangement, when the Thalofide cell changed in resistance, the pitch of the audio frequency current changed. This was found to be a very much more sensitive method of registering small changes of resistance in the Thalofide cell.

The audion bulbs used were of the Western Electric V type. To make these bulbs sensitive for use they were connected to a vacuum system, and baked, and exhausted to a very high vacuum.

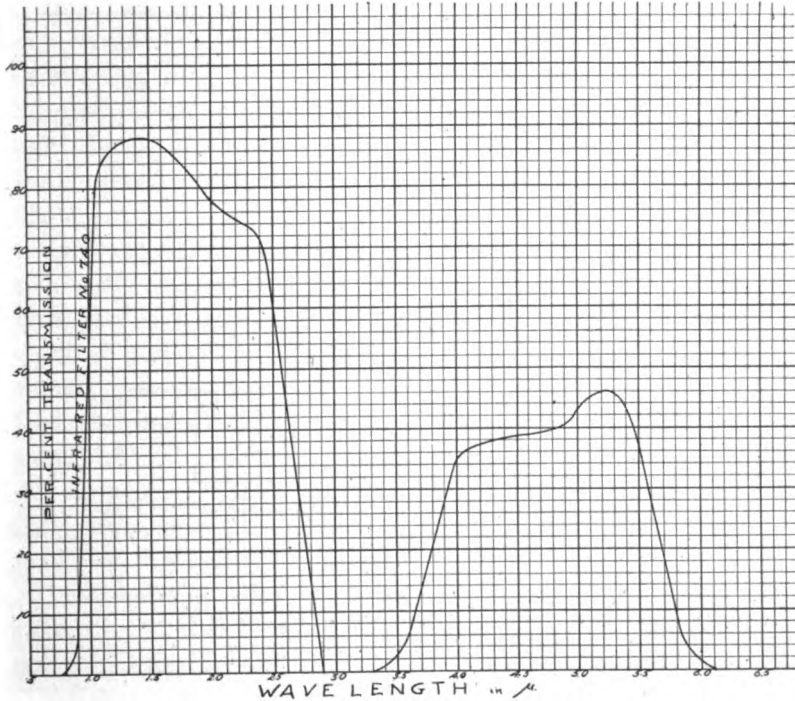

FIG. 3

Argon was then let in and the pressure adjusted until the bulbs oscillated freely at minimum voltage on a test circuit with a predetermined resistance in place of the Thalofide cell.⁴ The wiring used is shown in Fig. 4.

The phone potential is fixed at 120 volts. The cell potential is variable and totals 200 volts. This is to take care of the different dark resistances of the cells. In use, the audion filament is brought to a dull red and the voltage adjusted to give a note of the required pitch in the phones (usually about 1000 cycles) after which the pitch may be changed by slightly adjusting the filament rheostat.

⁴ U. S. Patent number 1379166.

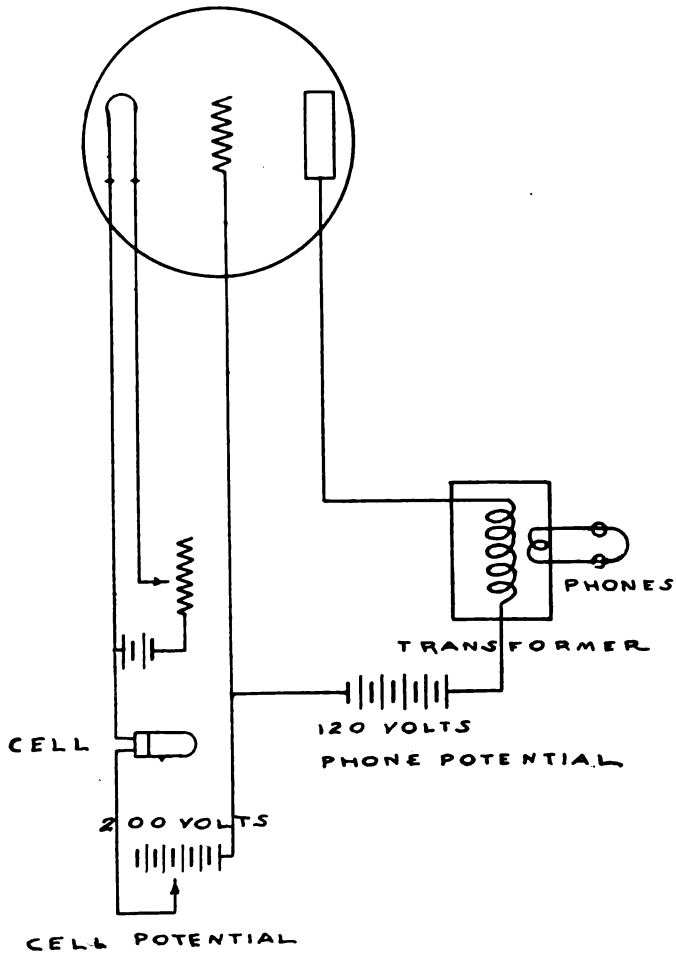

FIG. 4

The action of the Thalofide cell in this circuit may be likened to a valve through which a potential builds up on the plate until a discharge occurs through the gas of the bulb. A fraction of a second is then required until the potential builds up again through the cell. The time rate of building up of consecutive charges and discharges may be changed by increasing or decreasing the filament current with its consequent effect in the ionization of the gas. The sequency of charge and discharge causes the audio

frequency note heard continually in the phones. When the resistance of the Thalofide cell is lowered by a received signal, the time rate of charge and discharge is varied which is made evident by a change of pitch of the audio frequency note in the phones.

In actual signal work, the Thalofide cell is placed at the focus of a parabolic mirror which serves as a collector of the infra red beam. For a projector of the beam any suitable search light may be used which is properly screened with an infra red filter. A light beam is then projected which is invisible to the eye, and which may be detected by the above described receiving apparatus.

Some of the first official tests of this apparatus were made before representatives of the army and navy in October 1917 between Fort Hancock and the Woolworth building, a distance of about eighteen miles. Messages were successfully transmitted. The signals were so loud that they could be heard at some distance from the phones. These results were obtained in spite of the usual smoky atmospheric conditions between these two points.

The sending apparatus consisted of a Sperry 60 inch search light situated at Fort Hancock and screened by an infra red filter made for this light.

The receiving apparatus consisted of a 24 inch parabolic mirror with the Thalofide cell at its focus. The Thalofide cell was connected to the oscillating circuit described above.

Further tests were made in February, 1918 in conjunction with the coast artillery at Fort Monroe, Va.

At the end of the war, a four mile land set was constructed. This consisted of two eight inch drums, one for sending and one for receiving, rigidly mounted with their axes parallel. The sending projector was mounted at the top. It was made up of an eight inch parabolic reflector with a special eight volt signal lamp placed at the focus. Between the lamp and reflector, a small butterfly shutter was mounted. This could be operated by a key at the side of the apparatus, by means of which the signals could be sent. An infra red filter was placed over the front of the drum. The lower drum was used as the receiver. It contained an eight inch parabolic mirror and a Thalofide cell mounted at the focus of the

mirror. The Thalofide cell was connected, by means of a flexible lead, to the receiving box which contained the audion circuit. Power was furnished for the lamps and audion by a small storage battery.

The reason that the sending and receiving drum were mounted with parallel axes was to render it easy for two operators to pick each other up in the dark. If one operator sweeps the horizon with his receiving drum and hears a flash signal from the other operator, he leaves his apparatus at the point where he hears the flash signal. He then turns on the invisible beam in the sending drum. His invisible beam will now cover the point from which he received his signal and by sending dots the other operator locates him in like manner.

This portable set can be easily carried and operated by two men and has a range of about four miles.

The atmospheric transmission of the infra red as detected by the Thalofide cell and galvanometer, when compared with the visible as indicated by photometric readings taken with a Sharp-Millar photometer, is shown in the curves, Fig. 5.

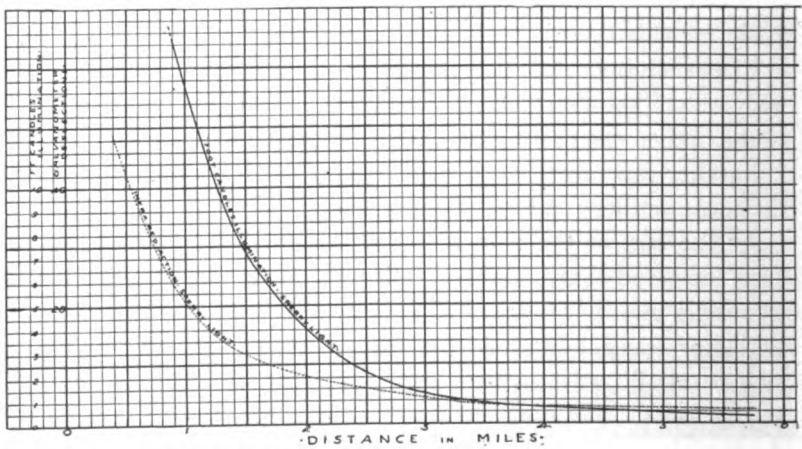

FIG. 5

These curves were taken on a fairly clear night and show that the infra red rays are transmitted through the atmosphere with less absorption than the visible rays.

During this time, work was also being done to adapt this system for actual telephony with the infra red. The first problem was the development of a suitable and constant high intensity light source, which could be easily varied by sound. The result of this research was a modification of the ordinary manometric flame principle, consisting of a special form of an oxy-acetylene burner in which the oxygen is directed obliquely against opposite sides of an acetylene flame. (See Fig. 6.) This makes a small intense light source, having an area of about .25 square inches and a candle-power of about one hundred and fifty.

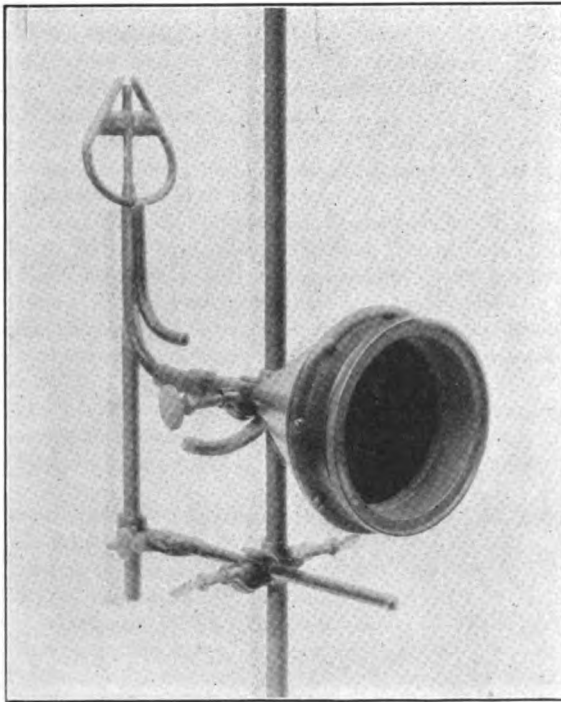

FIG. 6

For the receiving end, the Thalofide cell was connected to a straight audion hook-up for simple and direct amplification. On a clear night, using twenty-four inch sending and receiving projectors, with three step amplification the voice could be easily

understood at five miles. Similar small sets were made up, consisting of twelve inch projectors and receivers, which gave very good voice transmission at two miles.

It was realized, at this time, that there would be no demand for such apparatus or its further development except for war purposes, consequently it was decided to stop all further work along this line.

CASE RESEARCH LABORATORY,
AUBURN, N. Y.

NOTICES

THE OPTICAL SOCIETY OF AMERICA MINUTES OF SIXTH MEETING HELMHOLTZ MEMORIAL MEETING

The sixth meeting of the Optical Society of America was held in Rochester, N. Y., October 24, 25, 26, 1921. One hundred thirteen persons were registered in attendance. The attendance at various sessions varied from about 35 to 100 or more.

The most notable feature of the meeting was the Helmholtz Memorial Meeting held on the afternoon and evening of Monday, October 24. The following former students of Helmholtz were present: Prof. Henry Crew, Prof. C. R. Mann, Prof. Ernest Merritt, Prof. E. L. Nichols, Prof. M. I. Pupin, Dr. Ludwik Silberstein. The afternoon program was as follows:

A Brief Survey of the Historical Development of Optical Science, J. P. C. SOUTHALL
Helmholtz's Early Work in Physics—The Conservation of Energy. . . . HENRY CREW
Helmholtz's Contributions to Physiological Optics. L. T. TROLAND

Prof. Crew exhibited lantern slides showing Helmholtz at the time he wrote the essay on the Conservation of Energy (age 26) and also at later periods of his life.

At the evening session Prof. M. I. Pupin spoke informally and in a most interesting and delightful manner on his Personal Recollections of Helmholtz. Prof. E. L. Nichols, Prof. Ernest Merritt, Dr. Ludwik Silberstein, Mrs. Christine Ladd Franklin and Prof. C. R. Mann also spoke of their memories of Helmholtz as a teacher. Prof. Mann showed a lantern slide of a photograph which he himself made on July 7, 1894 showing Helmholtz at his lecture desk only a few days before his last illness.

The Helmholtz Memorial addresses will be published in the Journal of the Optical Society of America.

Various scientific societies were represented at the meeting by delegates as follows:

American Mathematical Society: Prof. A. S. Gale.

American Physical Society: Prof. M. I. Pupin, Dr. L. T. Troland, Prof. Henry Crew.

American Association for the Advancement of Science: Prof. M. I. Pupin.

New York Academy of Science: Prof. M. I. Pupin.

American Academy of Ophthalmology & Oto-Laryngology: Dr. R. S. Lamb.

American Medical Association, Section of Ophthalmology: Dr. W. B. Lancaster.

American Ophthalmological Society: Dr. Lucien Howe, Dr. George S. Crampton.

Society of Illuminating Engineers: Dr. George S. Crampton.

American Psychological Association: Dr. L. T. Troland, Mr. Prentice Reeves, Prof. C. E. Ferree, Dr. P. W. Cobb.

The following papers were presented at the regular sessions of the Society on October 25 and 26.

TUESDAY, OCT. 25, 9:00 A.M.

VISION AND PHYSIOLOGIC OPTICS

Photo-Electric Potentials from the Retina, E. L. CHAFFEE and W. T. BOVIE, Harvard

The photo-electric potentials from the retina are studied by the use of an improved measuring system utilizing two stages of vacuum tube amplification. This apparatus,

besides giving greater sensitivity, has the advantage of measuring the potentials produced in the retina irrespective of the resistance of the tissues.

A typical response of the retina, found by previous experimenters, when the retina is illuminated by a flash of light, consists of a small negative reaction followed by a rapidly rising positive potential which gradually subsides. There may follow a second very slow rise and fall of potential, lasting for several seconds for intense illumination. In the present work the response curves are found to be more complex, showing several maxima. Certain of these maxima are attributed to the scotopic mechanism, i.e., the rods, and others, to the photopic mechanism, i.e., the cones. Certain maxima of the observed curves are correlated with some psychological observations, such as recurrent vision, Bidwell's ghost, positive after image, etc.

Many curves have been taken showing the effect of varying the sensitivity and time of illumination. The laws connecting the height of the curves, considered to be a measure of the sensation, with intensity of illumination have been derived.

Intensity and Composition of Light and Size of Visual Angle in Relation to Important Ocular Functions. C. E. FERREE and GERTRUDE RAND, Bryn Mawr

The benefit of increase of illumination is shown for the following functions of importance to the working eye:—acuity, power to sustain acuity, speed of discrimination, and speed of adjustment of the eye for clear seeing at different distances. The benefit of the increase is considerably greater for eyes suffering from a slight defect of refraction than for the normal eye. A comparison is made of the effect of increase of intensity of illumination and increase in size of visual angle. The question of the most favorable intensity of illumination of test charts for different test purposes is discussed. The investigation is also extended to include the effect of variations in the composition of light on acuity, power to sustain acuity, and speed of discrimination.

A Theory of Intermittent Vision. HERBERT E. IVES, Western Electric Co., New York

An attempt to postulate a physical mechanism which will give the well-known logarithmic relations between critical frequency of disappearance of flicker and illumination and wave form of the stimulus. A system is studied consisting first of a photo-sensitive cell of considerable capacity, in which the material decomposed by light is replaced at a rate such that the equilibrium position is proportional to the logarithm of the intensity; second, of a conducting medium in which there occurs either a leakage or a regeneration of the conducted products of decomposition. If it is assumed that the perception of flicker is dependent on the attainment of a certain rate of change of the transmitted impression, this physical system will exhibit all the principal critical frequency relationships.

(Complete Paper, This Journal June, 1922)

An Analysis of the Visibility Curve in terms of the Weber Fechner Law and the Least Perceptible Brightness. ENOCH KARRER, Nela Research Laboratory

The possibility of getting an insight into some of the properties of the eye, by considering it as an instrument, has attracted the attention of many, among the first of whom are Fechner and Helmholtz.

Consider two instruments, designed to measure the same thing. If one instrument gives the same increase in deflection per unit of quantity measured at all points of the scale, as does the other (i.e., the sensitivity of the one is the same as that of the

other) and gives the same deflection under the reference condition as does the other (i.e., the same zero reading), then we may expect them to give the same deflection for the same arbitrary quantity measured.

The sensitivity is some function of the stimulus, while the deflection is the integral effect of the sensitivity at all points of the scale passed over. In case of the eye the sensitivity function may be obtained from the photometric sensibility (the least sensible increment of flux expressed in terms of the stimulating flux). We get then an expression for the sensation of brightness for any wave-length in terms of the flux and the photometric sensibility. For equal brightness at several wave-lengths there is a corresponding series of values of the flux. The visibility of radiation at any wave-length is inversely proportional to the flux when the brightness level is the same for all wave-lengths. We have then an expression for the visibility of radiation in terms of the photometric sensibility and several constants of the eye.

It is suggested that the determination of the least flux sensible to the eye, and of the photometric sensibility of eyes whose visibility curves are sought may be of great theoretical and perhaps practical value. It would for example be enlightening to find eyes having the same photometric sensibility and the same threshold visibility (the inverse of least sensible flux) and yet having under the same condition quite different visibility curves.

A Quantitative Determination of the Inherent Saturation of Spectral Colors. L. T. TROLAND, Harvard

Introspection, as well as the facts of color mixture, indicates that the spectral colors, although of equal physical purity, are of quite different subjective saturation. The same fact is strongly indicated by the differences between their flicker photometer frequencies at equal brightness. The flicker photometer frequency value presumably depends upon the degree of difference existing between the given color and the white with which it is rapidly alternated. The method of the present work was to mix with the various spectral lights the amount of white light required to give them all the same flicker photometer frequency. The differences between the amount of white required for this purpose by different spectral colors may be taken as indices of their respective saturations. The white employed as a standard and for admixtures was a color match with noon sunlight. Parallel measurements of the flicker photometer frequencies of the various spectral colors without admixture of white were made. The results show a minimum of saturation for the yellow, rapidly increasing toward either end of the spectrum, the blue showing the highest value and requiring an admixture of about eighty per cent white to bring it to the same frequency value as the yellow. The bearing of the results upon color sensation theories is discussed.

The Interrelations of Brilliance and Chroma Studied by a Flicker Technique. L. T. TROLAND AND C. H. LANGFORD, Harvard

Advocates, such as Abney, of the Young-Helmholtz Theory of Color Vision have assumed that brilliance, as represented by the visibility curve, is the sum of three separate chromatic excitations, as represented in the color sensation curves. This view is opposed by the Hering and other theories which suppose that at least part of the brilliance value is due to a mechanism which is independent of the chromatic processes. The present work endeavors to meet certain criticisms which render the

✓

experiments of Abney and others bearing upon this problem of doubtful significance. The general method which was employed was to fatigue the retina with a spectral red stimulus, to measure the degree of this fatigue in terms of brightness, and then to repeat these brightness measurements with the same fatigue conditions projected upon a minus red reacting stimulus field. The Young-Helmholtz interpretation demands distinctly different results for the two reacting stimuli, while the Hering view requires less difference, or possibly identical results, for the two. In order to reduce the uncertainties produced by the extreme saturation contrast generated in the experiment the flicker method was employed for establishing the brilliance equations. The results show that brilliance has, apparently, much less dependence upon the chromatic excitation than is ordinarily assumed in interpretations of the Young-Helmholtz theory. The independence, however, is not complete. The definite bearing of the results upon the three sensation curves of Abney and of König, as well as upon hypotheses similar to that of Hering is discussed.

COLORIMETRIC MEASUREMENTS

A Proposed Standard Method of Colorimetry. HERBERT E. IVES, Western Electric Co., New York

A method of color measurement is suggested which consists essentially of the spectro-photometry of adjacent patches of the spectrum, each patch of a width inversely as the hue sensibility, and the number of patches dictated by the kind of color and degree of accuracy required. An instrument is described by which the measurements can be made, and in which the color can be reproduced for study.

(Complete Paper, This Journal, Nov. 1921)

Accuracy in Color Matching. W. E. FORSYTHE, Nela Research Laboratory

Two tests have been made of the accuracy of color matching with an ordinary Lummer-Brodhun contrast photometer.

In the first test, several observers made color matches using two tungsten lamps so set that there was an illumination of 5.1 foot-candles on the photometer screen. It was found that experienced observers agreed in their setting to an accuracy of about 3°K, while inexperienced observers differed by only about 5°K.

There was also a test made to see if there was any difference in the accuracy depending upon the illumination on the photometer screen. Tests were made by several observers for illumination varying from 1.8 to 45 foot candles. There was no very definite difference in accuracy found for the different illuminations.

A lamp that had been calibrated for a color temperature of about 3000°K was sent to the Bureau of Standards and compared with their color standard. It was found that at this color temperature the two scales were in agreement within the accuracy claimed.

Measurement of the Color Temperature of the More Efficient Artificial Light Sources by the Method of Rotatory Dispersion. IRWIN G. PRIEST, National Bureau of Standards

A description of measurements of color temperatures from 3000° to 4000°K by means of the rotatory dispersion apparatus previously described by the author (J. Op. Soc. Am., 5, p. 179, Fig. 2; March, 1921). Particular attention will be given to (1) a consideration of the fundamental standard of color temperature for such measure-

ments, (2) a more careful temperature calibration of the apparatus than that previously published, (*J. Op. Soc. Am.*, 5, p. 182, Fig. 6). Experimental data will be given: (1) on the color temperature of the photometric standard gas-filled tungsten lamp as a function of efficiency from normal efficiency up to the failure of the filament; (2) on the color temperature of the crater of the carbon arc; and (3) on comparisons with the color temperature scale of the Nela Research Laboratory.

(Complete Paper, *This Journal*, Jan. 1922)

WEDNESDAY, OCT. 26, 9:00 A. M.

MISCELLANEOUS PAPERS

The Blue Glow. E. L. NICHOLS and H. L. HOWES, Cornell

The effect described in this paper is observable when certain oxides, notably MgO, CaO, BeO, ZrO, SiO₂ and Al₂O₃ are heated to incandescence. These transparent solids are very poor radiators. Below 800° C for example their radiation, as viewed through a red screen is a small fraction of one per cent of that emitted by a black body at the same temperature. Viewed through a blue screen, however, these oxides are found to radiate many times as intensely as a black body, so that they are visible at temperatures so low that a black body, thus viewed, is still invisible. At a "red heat," in other words, they appear blue.

That the blue glow is a case of luminescence is evident from the following considerations:

(1) For certain regions of the spectrum, as just stated, the radiation is in excess,—often greatly in excess of what a black body emits for the same wave-length and temperature.

(2) The change of intensity with temperature does not follow the laws of temperature-radiation. The effect occurs only within a definite and rather narrow temperature range and is confined to a definite band in the blue-violet region of the spectrum.

(3) a.—The effect is subject to fatigue.

b.—It is profoundly modified by previous heat treatment of the oxide.

c.—It is profoundly modified by the presence or absence of certain activating materials in which respect it resembles cathode-luminescence.

(4) The effect is much more marked when heating occurs by means of the H-O flame than otherwise and is affected as to its intensity by the excess or lack of free oxygen. In this respect it resembles the numerous types of luminescence which are known to involve reduction and oxidation.

The oxides under consideration undergo marked temporary changes in their physical properties when carried through the range of temperatures (500° to 1200° or 1400°) within which they show the blue glow. For example they become opaque, their power of temperature-radiation increases from a negligible value to almost unity and their electrical resistance—as is well known from the measurements of Somerville and others—falls from near infinity to the small values characteristic of metallic conductors.

The blue glow is a special case of the general phenomenon of luminescence of incandescent bodies now under investigation by the present authors.

(Complete Paper. *This Journal*, Jan. 1922)

The Optical Properties of a Cylindrical Enclosure with Specularly Reflecting Walls.
HERBERT E. IVES, Western Electric Company, New York.

A study of the multiple reflections occurring inside a hollow cylinder, such as a tube of platinum foil, with a narrow viewing slit in the side. For certain angles of observation such an enclosure is a practical black body, because the reflected images escaping through the slit are so diminished by successive reflection as to be of negligible intensity. A graphical solution is constructed by which the number, position, and size of the reflected images for any width of viewing slit may be found. From this can be found the best angle of observation and size of slit to choose in using an incandescent cylinder as a black body for such a purpose as determining the melting point of the material used.

The Relation Between Gloss and the Reflection Characteristics of Surfaces. LOYD A. JONES and M. F. FILLIUS, Eastman Research Laboratory.

A method and instrument for the measurement of the gloss of a reflecting surface is described. The measurement of gloss is based upon a comparison of the intensity of the diffuse and specularly reflected light. The surface considered is illuminated by a parallel beam of light incident at 45° from the normal. Under these conditions the ratio of the brightnesses of the surface when viewed at an angle of 45° on the other side of the normal and normally is taken as a measure of gloss. Numerous data on various well-known surfaces and upon a number of different photographic papers and stocks are given. The relation between the gloss values thus obtained and the complete distribution curve of light reflected from these surfaces is considered.

(Complete Paper, This Journal, March, 1922)

The Graininess of Photographic Materials. LOYD A. JONES and ARTHUR C. HARDY, Eastman Research Laboratory.

The theoretical considerations upon which the measurement and numerical specification of graininess are based are discussed. The previous work on the subject is reviewed briefly. Differences in the details of procedure used formerly and those adopted after further investigation of the problem are discussed. From a consideration of the data obtained it is shown that the precision obtainable under favorable conditions is of the order of plus or minus 2 per cent. Numerous data relating to the influence upon graininess of such factors as the nature of the photographic material, the constitution, concentration, temperature of the developing solution, and the time of development are given. The graininess resulting when a negative of known graininess is printed upon a positive material is also considered.

(Complete Paper, J. Frank Inst.)

The Design of Aspherical Lens Surfaces. P. G. NUTTING.

The use of a new system of ray triangulation leads to the differential equation of a lens surface which will produce a specified convergence in the refracted rays. The method will be outlined and several solutions and practical applications will be discussed.

On the Distribution of Light in Planes Above and Below the Image Plane in the Microscope. FRED E. WRIGHT, Carnegie Geophysical Laboratory.

In microscope image formation diffraction plays an important part. The phenomena produced by the diffraction have been investigated repeatedly, both experi-

mentally and mathematically; but in the mathematical treatment the effects resulting from diffraction in the image plane, conjugate to the object plane, alone have been considered. But in practical microscopic work, especially with the petrological microscope, the phenomena which develop at the margins of fine grains on raising or lowering the tube are of importance, particularly in the determination of relative refringence. In the present paper these phenomena are considered in some detail, and the bearing of the several factors, diffraction, interference, refraction, and reflection is emphasized.

The Factors Underlying the Measurement of Refractive Indices by the Immersion Method. FRED E. WRIGHT, Carnegie Geophysical Laboratory.

In this paper a brief discussion is given of the rôles played by refraction, dispersion, reflection, diffraction, and interference in the phenomena observed in the measurement of refractive indices by the immersion method; also a statement of the degrees of accuracy obtainable by this method, especially in its application to petrographic microscopic work.

Some Thermal Effects Observed in Chilled Glass. A. Q. TOOL and C. G. EICHLIN, National Bureau of Standards.

Glass, cooled rapidly through the temperature range of the endothermic effect observed on heating it, shows, on reheating, an exothermic effect also, which begins at a much lower temperature than the normal endothermic effect. It is a difficult matter to determine whether this exothermic effect is due to the dissipation of the strains caused by the chilling, or to some molecular regrouping delayed by it. On certain assumptions the maximum effect to be expected, resulting from a stress relaxation, would differ not widely from the exothermic effects observed. Certain phases of these effects, however, indicate that this can scarcely be their whole cause. This paper deals with results obtained in an investigation to determine the cause of these effects and the manner in which they are modified by different methods of re-annealing the glass until it becomes normal again.

A New X-Ray Diffraction Apparatus. WHEELER P. DAVEY, Research Laboratory, General Electric Co.

An apparatus is described by means of which the X-Ray diffraction pattern of fifteen powdered crystals can be taken simultaneously. A scale is also described by which the distance, in Angstrom units, between planes in a crystal may be read off directly from the diffraction pattern. The uses of such an apparatus in research and in factory-control work are pointed out, and a method is briefly described by which the structure of certain classes of crystals may be rapidly determined by the aid of plots, on a logarithmic scale, of the diffraction patterns.

(Complete Paper. This Journal, Nov. 1921)

APPARATUS DEMONSTRATIONS

Rotating Photometric Sectors of Adjustable Transmission While in Motion. CARL W. KEUFFEL and C. D. HILLMAN, Keuffel and Esser Co.

A description of apparatus recently designed and constructed by Keuffel and Esser, illustrated by demonstration of the apparatus. The combination of one of these sectors with a spectrometer forms an accurate direct-reading spectrophotometer of very simple design.

Euscope. WILLIAM G. EXTON, Prudential Laboratory.

The Euscope affords microscopy such physiological advantages as natural posture of body and head, normal function of ocular musculature, retinal relief, single binocular vision and enlarged images. It is a modified pyramidal viewing box mounted on a stand. The smaller or ocular end is shielded from side light and fitted with diaphragm and lens-holding device in front of which, on its floor, is an aperture for the removable mount of a reflecting prism. The design of the screen end is adapted for projection and photography. Drawing, demonstrating and photography are unusually convenient. Orthoscopic images or increased magnifications may be had with proper lenses, and good results are obtainable with other optical instruments as well as the microscope without change of technique. (Apparatus exhibited.)

Turbidimeter. WILLIAM G. EXTON, Prudential Laboratory.

Means of measuring the degree of cloudiness of a suspension are of interest because the fields of nephelometry and turbidimetry are constantly expanding. Such estimations are now made by comparing the unknown with freshly prepared standards which are read against themselves before matching, etc. In trying to find a simpler and more direct method for quantitating albumin in urine, experiments were made with a view to utilizing the obscuring power of a column of cloudy liquid as a measure of its turbidity. With suitable illumination and targets this was found practicable, and experiments indicated that the light extinguishing power of the column of cloudy liquid afforded perhaps a less subjective method. Laboratory and clinical models of self-standard turbidimeters have been constructed which work on either principle by giving vernier readings of the depth in millimeters at which a column of cloudy liquid obscures a design or extinguishes a light. Different interchangeable targets permit specialized application, allowance for color difference and checking results. (Apparatus exhibited.)

On Tuesday evening, October 25, visiting members were guests at a dinner entertainment given by the Rochester Section of the Society.

The very well conducted trips through the Research Laboratories of the Eastman Kodak Company and the glass plant, optical shops and observatory of Bausch and Lomb were also much appreciated by the visiting members.

The Rochester Section was given a hearty vote of thanks for its hospitality and the many courtesies extended during this very successful meeting.

Forty new members were elected. The membership is now about three hundred.

The Society's intention to cultivate actively the field of physiological optics was indicated by the following resolution, adopted October 26, 1921:—

WHEREAS, the Optical Society of America is devoted to the science of optics, pure and applied, a subdivision of which is the subject of Physiological Optics, with the several contributory sciences of physiology, psychology, physics and chemistry, representatives of which sciences have at the present time no common meeting ground for the discussion of problems of vision of mutual interest and

WHEREAS, the National Research Council, through its Committee on Physiological Optics, has recommended to the Optical Society of America the taking of such steps as may be necessary to further and encourage cooperative efforts in research in vision and allied phenomena, therefore be it

RESOLVED, that the Optical Society of America does hereby signify its intention of devoting one or more sessions of each annual meeting to papers on Physiological Optics and other appropriate subjects related to vision, and

Resolved that there be and hereby is established by the Society a Standing Committee of three the duty of which shall be

- (1) to prepare the program of the sessions on Vision,

(2) to coordinate the work of the Society in this field with the work of other Societies and
(3) to recommend, from time to time, such further steps as may be deemed effective in encouraging research in Physiological Optics and allied problems. And,

RESOLVED, further that the Optical Society, through its Committee on Physiological Optics, shall invite all those interested in research on Vision and allied fields to participate actively in these sessions.

The next meeting will be held at the National Bureau of Standards in Washington in the latter part of October 1922. It is tentatively planned to hold an exhibition of optical instruments in connection with this meeting.

IRWIN G. PRIEST, *Secretary*.

OPTICAL SOCIETY OF AMERICA

NEW MEMBERS

The following new members have been duly elected since October 26, 1921.

REGULAR

Herbert P. Hollnagel, 22 Hampden St., Swampscott, Mass.

Herbert M. Reese, Physics Bldg., Columbia, Mo.

Conway D. Hillman, 89 Harrison St., East Orange, N. J.

O. E. Conklin, Parlin, N. J.

Edward H. Kurth, Graduate College, Princeton University, Princeton, N. J.

Anthony Zeleny, University of Minnesota, Minneapolis, Minn.

Hans Harting, Albrechtstr. 12, Berlin-Schlachtensee, Germany.

L. F. Yntema, 357 Chemistry, University of Illinois, Urbana, Ill.

Royal A. Porter, 861 Ostrom Ave., Syracuse, N. Y.

Henri Pieron, à la Sorbonne, Paris, France.

E. LeRoy Ryer, 9 East 46 St., New York City.

Alpheus W. Smith, Dept. of Physics, Ohio State Univ., Columbus, Ohio.

Frederic C. Blake, 2107 Iuka Ave., Columbus, Ohio.

R. W. Cheshire, Admiralty Research Laboratory, Teddington, Middlesex, England.

James E. Ives, Office of Industrial Hygiene & Sanitation, U. S. Public Health Service,
Washington, D. C.

ASSOCIATE

Olive M. Lammert, Vassar College, Poughkeepsie, N. Y.

W. H. Fulweiler, 319 Arch St., Philadelphia, Pa.

Madelaine Ray Brown, 13 Charles Field St., Providence, R. I.

ASSOCIATE (continued)

George W. Sherman, Jr., No. 4 Murdock Apts., West LaFayette, Indiana.

Thomas R. Harrison, c/o Champion Porcelain Co., Detroit, Mich.

Donald M. Smith, Dept. of Physics, Iowa State College, Ames, Ia.

Casper L. Cottrell, Rockefeller Hall, Ithaca, N. Y.

John Arthur Spengler, 73 Seneca St., Geneva, N. Y.

IRWIN G. PRIEST,
Secretary.

WASHINGTON,
MAY 22, 1922

Journal of the Optical Society of America and Review of Scientific Instruments

Vol. VI

JULY, 1922

Number 5

FALSE SPECTRA FROM DIFFRACTION GRATINGS

PART I. SECONDARY SPECTRA.* BY W. F. MEGGERS AND C. C. KIESS

PART II. THEORY OF LYMAN GHOSTS. BY CARL RUNGE

PART III. PERIODIC ERRORS IN RULING MACHINES. BY J. A. ANDERSON

PART I. SECONDARY SPECTRA

1. INTRODUCTION

The ideal diffraction grating would be one which is free from all errors of ruling and in which the shape of the ruled groove is such that all the light is concentrated in a single spectrum. No such perfect gratings have ever been produced, although some very excellent instruments have been made and used since the epoch making work of Prof. Rowland. These instruments have contributed so enormously to the advance in spectroscopic knowledge, that it seems almost disrespectful to mention the errors into which they sometimes lead spectroscopists. However, there are at least two considerations in the use of diffraction gratings which call for extreme care and watchfulness to avoid spurious results.

One of these arises from the presence of different orders of spectra which overlap. This superposition of spectra has caused some spurious results¹ and it is probable that false data from this cause are even more abundant than has been admitted or exposed

* Published by permission of the Director of the Bureau of Standards.

¹Hale, Explanation of a Supposed Abnormal Solar Spectrum, *Astroph. Jour.* **46**, p. 291; 1917.

Walters, B. S. *Bulletin* **17**, p. 173; 1921, Wave-Lengths of Antimony by Kretzer, *Zeit. f. wiss. Phot.*, **8**, p. 56; 1910.

thus far. This difficulty which is inherent in the principle of the diffraction grating when the characteristics of the groove are such as to distribute the light among spectra of different orders can either be avoided by a careful choice of filters to remove overlapping orders, or the spurious lines can be detected by simple numerical relationships which they bear to the true spectra.

The second pitfall in the use of diffraction gratings has its origin in the periodic errors of ruling which are perhaps inevitable in machine made instruments. Errors from this source are not uncommon in spectroscopic literature² and more of them may exist than are now apparent. Spurious spectral lines arising from periodic ruling errors may also be regarded as superposed spectra of various orders, produced however by a secondary grating or gratings with different instrumental constants. In complex spectra such false lines or "ghosts" are indistinguishable from real lines and may occur in all regions of the spectrum with intensities equal to those of the fainter real lines. They can be identified only by their more or less complex numerical relationships to the true or parent lines, and can be predicted only if the constants of the superposed gratings are known. Although the superposed secondary spectra are usually much inferior to the primary spectrum in intensity they may nevertheless put in unexpected appearance and cause considerable embarrassment especially when unsafe filters are used or when long photographic exposures are made to record spectra in the ultra-violet or infra-red extremes of the spectrum.

A large concave grating which has been used for infra-red spectrum investigations at the Bureau of Standards since 1915 was found in 1919 to give types of secondary spectra, which had not been observed heretofore. This happened during an investigation of the spectrum of chromium when it was observed that strikingly characteristic groups of red lines were reproduced at several points in the infra-red. The ratios of these apparent wave-lengths to the real ones were then determined and applied to work pre-

² Kayser, *Handbuch der Spectroscopie*, I, p. 448.

Meggiers and Kiess, *B. S. Bulletin*, 14, p. 637; 1918. Note added April 16, 1919, p. 651.

viously done with this grating. Many lines already published for iron, nickel and cobalt³ were found to be related to lesser wave-lengths by these ratios as was stated in the note added to that paper on April 16, 1919 (*loc. cit.*, p. 651). This experience persuaded us to make a careful and thorough investigation of false spectra from diffraction gratings, a preliminary report⁴ of which work was presented in Sept., 1919. The completed results from the study of 4 large concave gratings are presented in the present paper.

2. TYPES OF SECONDARY SPECTRA

The secondary spectra or ghosts produced by diffraction gratings with periodic errors in ruling are of two kinds. Those first observed by Quincke⁵ in 1872 are now commonly known as Rowland ghosts. They occur in pairs symmetrically placed on opposite sides of the true spectral line and relatively near this parent line. Their symmetrical positions and proximity to the real line make their recognition easy in simple spectra, but in complicated spectra they may be interspersed among other real lines and often coincide approximately with some of the latter thus leading to erroneous results for the position and intensity of the true spectral lines. The separations of the Rowland ghosts from the parent lines are readily deduced from the characteristics of the ruling engine since these secondary spectra originate in a secondary grating whose spacing is a function of the pitch of screw of the ruling machine. Thus a grating ruled with 20 000 lines per inch on a machine having a screw of 1/20 inch pitch and 1000 teeth in the wheel which turns the screw, will show periodic errors at intervals of 1/20 inch or 1000 lines. This periodicity really constitutes a second grating superposed upon the first and possessing 1000 times the spacing constant of the first, i.e., a grating with 20 lines per inch is superposed on a grating with 20 000 lines per inch. The first order secondary spectral image will therefore be separated from the primary line by 1/1000 the wave-length of this

³ Meggers and Kiess, *B. S. Bulletin*, 14, p. 637; 1918.

⁴ Meggers, Kiess and Walters, *Pub. Am. Astron. Soc.*, 4, p. 101; 1920.

⁵ *Pogg. Ann.*, 146, p. 1; 1872.

line and successive higher orders of ghosts will be separated from each other by the same amount or by $\frac{2\lambda}{1000}, \frac{3\lambda}{1000}$, etc., from the primary spectrum line of wave-length λ . Similarly, gratings ruled 7500 lines per inch with a screw of $1/20$ inch pitch and skipping every other tooth of 750 in the wheel will produce ghosts at positions $\frac{\lambda}{375}, \frac{2\lambda}{375}, \frac{3\lambda}{375}$, etc. In the same way that different orders of the primary spectra may differ in intensity, the various orders of these secondary spectra may show wide differences in relative intensity, some being absent or very weak compared to others. The theory of these secondary spectra was discussed by Rowland who deduced that the intensity of the first order ghosts is proportional to the square of the order of the primary spectrum and to the square of the relative deviation from the ruled spacing of the primary grating.

Another type of secondary spectra or spurious lines was first described by Lyman⁶ and are now referred to as Lyman ghosts. They occur at wide intervals in the spectrum, at considerable distances from the true lines and are therefore generally difficult to distinguish from real lines in the same spectral region. The false lines to which Lyman called attention were produced by Rowland gratings with 14 438 lines per inch and occurred in pairs near positions in the spectrum corresponding to $\frac{1}{3}$ and $\frac{2}{3}$ the wave-length of true lines. Similar spurious lines have been found at the Bureau of Standards in an investigation of Anderson gratings ruled with 5000 and 7500 lines per inch. In the cases of these gratings the spurious lines appeared in groups, generally quadruplets near positions corresponding to $\frac{2\lambda}{5}, \frac{3\lambda}{5}, \frac{4\lambda}{5}, \frac{6\lambda}{5}, \frac{7\lambda}{5}, \frac{8\lambda}{5}$, and $\frac{9\lambda}{5}$. The origin of these types of secondary spectra has never been satisfactorily explained. Lyman attempted an explanation, suggested by Runge, to account for lines near $\frac{\lambda}{3}$ and $\frac{2\lambda}{3}$ but it was not definitely shown that the suspected periodic errors of ruling had any relation to the actual errors expected from the method of

⁶ *Phy. Rev.*, 12, p. 1, 1901; 16, p. 257, 1903.

ruling. Furthermore, the positions of these Lyman ghosts were generally in the extreme ultra violet or Schumann region where suitable wave-length standards were not available and the position or wave-length measurements were therefore not precise enough to test or develop any complete theory.

The investigations conducted at the Bureau of Standards resulted in fairly precise measurements of the apparent wave-lengths of the false spectra and some relations were found among the apparent wave-lengths which it seemed might be traced to certain known properties of the ruling engine used in the manufacture of the diffraction gratings. Some of the diffraction gratings used in this investigation will now be described and the experimental results of the investigation will be given.

3. EXPERIMENTAL RESULTS

Four different diffraction gratings with radii of curvature approximating $21\frac{1}{2}$ feet (640 cm) were investigated for false or secondary spectra of both types, i.e., Rowland and Lyman ghosts. The instruments were set up in parallel light on the same mounting which has been described previously.⁷ The results tabulated below were all obtained photographically, various sources, ray filters and photographic plates being used for different spectral regions. Only a summary of the observations is given in this paper. Further details and a complete record of the observational data will appear later in the Bulletin of the Bureau of Standards.

(1) The first grating employed in this investigation was ruled at the Johns Hopkins University by Dr. J. A. Anderson on May 1, 1912, and was tested by him on November 21, 1913. It received the serial number 222 and is described as a "6-inch" grating with a radius of curvature of $640 \pm$ cm. It has a ruled surface of 13.3×7.5 cm and has 7500 lines per inch (299 per mm) or a total of 39800 lines. The characteristics of its spectra were given by Dr. Anderson as follows:

Order of Spectrum	0	1R	1L	2R	2L	3R	3L	4R	4L	5R	5L
Relative brightness $\lambda 5890$	4	2	8	3	2	3	4	3	2	2	1
Resolving power % of theoretical	90 \pm throughout										
Ghosts relative intensity	Weak										

⁷ B. S. Bulletin, 14, p. 371; 1917.

The various false spectra actually observed in spectrum investigations with this grating, using the order of spectrum designated as 1L, are summarized in the following table in which λ_g represents the apparent wave-length of a ghost related to the true wave-length λ by certain factors:

(a) Rowland ghosts for grating No. 222, 7500 lines per inch:

$$\lambda_g = (1 \pm n/375)\lambda$$

Relative intensities in primary spectrum of first order:

$n=0$	1	2	3	4	5	6
$i=5000$	2	1-	1-	2	1-	1-

(b) Lyman ghosts for grating No. 222, 7500 lines per inch:

Group	Wave-lengths	Observed factors	Intensity
$\frac{\lambda}{5}$	Looked for but not found.		0
$\frac{2\lambda}{5}$	$\lambda_g = (2/5 - 1/1500) \lambda$	0.399294	3
	$\lambda_g = (2/5 + 4/1500) \lambda$	0.402640	1
$\frac{3\lambda}{5}$	$\lambda_g = (3/5 - 4/1500) \lambda$	0.597312	1
	$\lambda_g = (3/5 + 1/1500) \lambda$	0.600686	3
$\frac{4\lambda}{5}$	$\lambda_g = (4/5 - 7/1500) \lambda$	0.795307	1-
	$\lambda_g = (4/5 - 2/1500) \lambda$	0.798670	5
	$\lambda_g = (4/5 + 3/1500) \lambda$	0.802002	2
	$\lambda_g = (4/5 + 8/1500) \lambda$	0.805369	1
$\frac{5\lambda}{5}$	Primary spectrum of real lines		100 000
$\frac{6\lambda}{5}$	$\lambda_g = (6/5 - 8/1500) \lambda$	1.194651	1
	$\lambda_g = (6/5 - 3/1500) \lambda$	1.197995	2
	$\lambda_g = (6/5 + 2/1500) \lambda$	1.201355	5
	$\lambda_g = (6/5 + 7/1500) \lambda$	1.204705	1
$\frac{7\lambda}{5}$	$\lambda_g = (7/5 - 6/1500) \lambda$	1.396038	1
	$\lambda_g = (7/5 - 1/1500) \lambda$	1.399367	10
	$\lambda_g = (7/5 + 4/1500) \lambda$	1.402710	3
$\frac{8\lambda}{5}$	$\lambda_g = (7/5 + 9/1500) \lambda$	1.405964	1
	$\lambda_g = (8/5 - 9/1500) \lambda$	1.594082	1
	$\lambda_g = (8/5 - 4/1500) \lambda$	1.597362	2
	$\lambda_g = (8/5 + 1/1500) \lambda$	1.600698	8
$\frac{9\lambda}{5}$	$\lambda_g = (8/5 + 6/1500) \lambda$	1.604038	1
	$\lambda_g = (9/5 - 7/1500) \lambda$	1.795348	1-
	$\lambda_g = (9/5 - 2/1500) \lambda$	1.798680	5
$\frac{9\lambda}{5}$	$\lambda_g = (9/5 + 3/1500) \lambda$	1.802016	2
	$\lambda_g = (9/5 + 8/1500) \lambda$	1.805352	1

The relative intensities of these spurious lines within each group show some relation to their distances from the exact $\frac{n\lambda}{5}$ position. For example, in the $\frac{4\lambda}{5}$ group, $\lambda_g = (\frac{4}{5} - 2/1500)\lambda$ is the strongest ghost, $\lambda_g = (\frac{4}{5} + 3/1500)\lambda$ is second in intensity and the remaining two lines $\lambda_g = (\frac{4}{5} - 7/1500)\lambda$ and $\lambda_g = (\frac{4}{5} + 8/1500)\lambda$ are still fainter. Our methods of observing indicate that the $\frac{7\lambda}{5}$ and $\frac{8\lambda}{5}$ groups are the most intense, $\lambda_g = (7/5 - 1/1500)\lambda$ appearing most frequently in wave-length measurements and $\lambda_g = (8/5 + 1/1500)\lambda$ occurring very often.

The numbers assigned for intensities are estimated from the inverse ratios of exposure times necessary to reproduce all to the same photographic density. It is recognized that these numbers are only rough approximations but they probably represent the relative order of magnitude of the intensities. In general our practice in the preparation of spectral tables has been to assign numbers from 1 to 10 as representative of the relative intensity of spectral lines, the strongest lines being called 10 and those just visible in the measuring microscope are intensity 1. On this basis most of the false lines have intensity values of 1 or 2.

Typical examples of the two types of secondary spectra given by the grating described above are reproduced in Fig. 1.

(2) The second grating which was investigated for secondary spectra was also ruled at the Johns Hopkins University in 1912. It is referred to as No. 156—E-P since we received it in a box bearing that number. Dr. Anderson has informed us that this number belongs to a plane grating and suggests that the concave grating which we describe was placed in the wrong box. Since there is no way of determining the correct number of the grating, we will retain the above questionable number for convenience in referring to a concave grating of the following description. It has 5000 lines per inch on about 6 inches of ruled surface, and the radius of curvature is about 21 feet (640 cm). This grating was ruled on the same machine as No. 222 described above, that is, the ruling screw had 20 threads per inch and 750 teeth in the

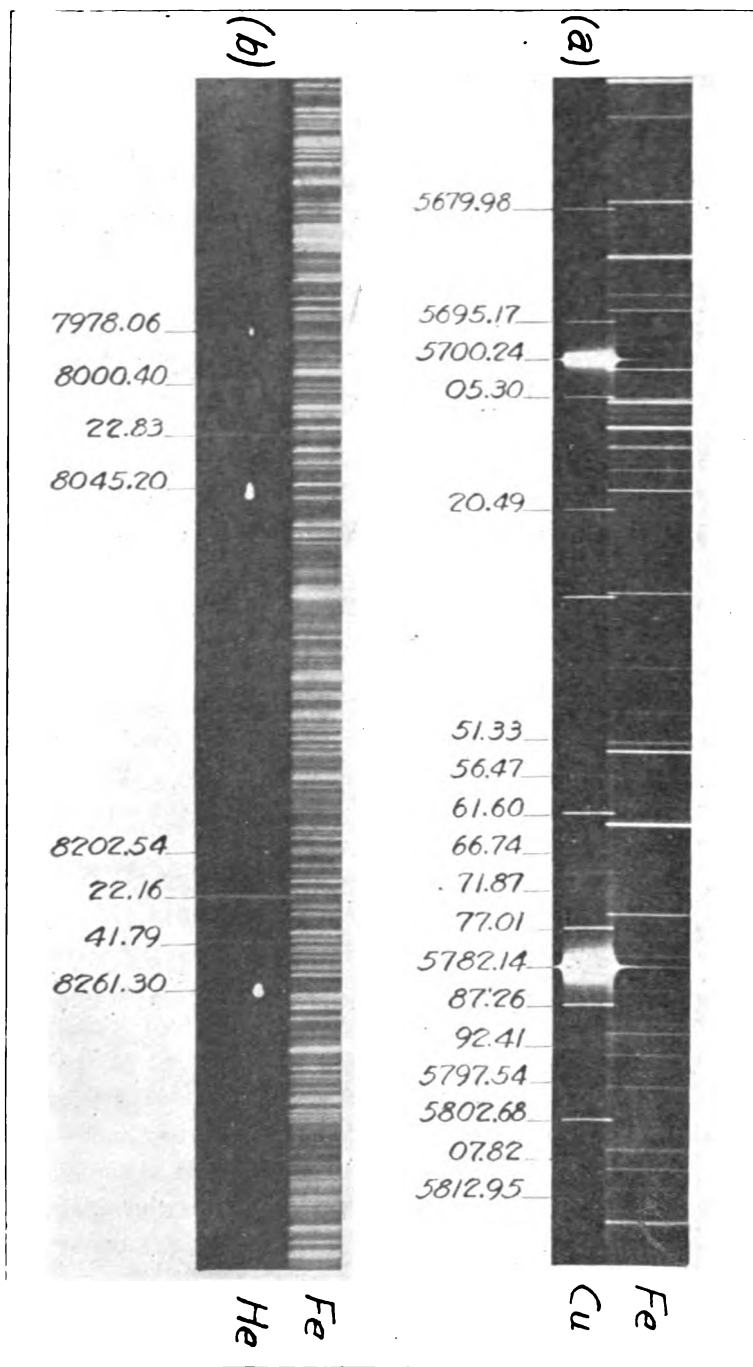

FIG. 1

False spectra: (a) Rowland ghosts, copper arc lines 5700.24 and 5782.14 \AA in 3rd order spectrum of grating No. 222. The apparent wave-lengths of the spurious lines may be computed from $\lambda_g = (1 \pm \frac{n}{3 \times 375}) \lambda$. It is seen that those for $n=1$ and $n=4$ are much brighter than the others. (b) Lyman ghosts, spurious infra red lines from strong helium lines in the visible spectrum, 1st order of grating No. 222. The apparent wave-lengths of the first group are approximately $\frac{6}{5}$ of 6678.149 while those of the group at the right are about $\frac{7}{5}$ of 5875.6184.

screw head of which every other one was omitted in ruling 7500 lines per inch and every third tooth was used in making 5000 lines per inch as in this case.

The Rowland ghosts were investigated in the first six orders of primary spectra and the intensities of these on the scale of 1 to 10 are as follows:

(a) Rowland Ghosts for Grating No. 156—E-P

5000 lines per inch

$$\lambda_g = \left(1 \pm \frac{n}{250m} \right) \lambda, \quad \begin{matrix} n = \text{order of secondary spectrum} \\ m = \text{order of primary spectrum} \end{matrix}$$

Relative intensities	$n=0$	1	2	3	4	5	6	7	8
1st order.....	10	1	0	0	0	0	0	0	0
2nd order.....	10	1	0	0	0	0	0	0	0
3rd order.....	10	1+	0	0	1	0	0	0	0
4th order.....	10	2	0	0	2	1-	0	0	0
5th order.....	10	3	0	0	3	1-	0	0	0
6th order.....	10	3	0	1-	3	1-	1-	0	0

(b) Lyman Ghosts from Grating No. 156—E-P

5000 lines per inch

Group	Wave Lengths	Observed Factors	Intensity
$\frac{\lambda}{5}$	Not found		0
$\frac{2\lambda}{5}$	Not found		0
$\frac{3\lambda}{5}$	$\lambda_g = (3/5 - 4/1750) \lambda$ $\lambda_g = (3/5 + 1/1750) \lambda$	0.597702 0.600562	1 3
$\frac{4\lambda}{5}$	$\lambda_g = (4/5 - 2/1750) \lambda$ $\lambda_g = (4/5 + 3/1750) \lambda$	0.798850 0.801697	2 1
$\frac{5\lambda}{5}$	Primary spectrum of real lines		100 000
$\frac{6\lambda}{5}$	Not found		0

Group	Wave Lengths	Observed Factors	Intensity
$\frac{7\lambda}{5}$	$\lambda_g = (7/5 - 1/1750) \lambda$	1.399397	1
	$\lambda_g = (7/5 + 4/1750) \lambda$		0
$\frac{8\lambda}{5}$	$\lambda_g = (8/5 - 4/1750) \lambda$	1.597700	2
	$\lambda_g = (8/5 + 1/1750) \lambda$	1.600565	5
$\frac{9\lambda}{5}$	$\lambda_g = (9/5 - 2/1750) \lambda$	1.798781	1
	$\lambda_g = (9/5 + 3/1750) \lambda$	1.801648	2

The first order primary spectra left and right given by this grating were much brighter than the higher orders and both of these first order spectra showed similar secondary spectra of the above type.

(3) In addition to the above described gratings which were ruled on a machine designed to rule a maximum of 15 000 lines per inch, we have examined two gratings which were ruled at the Johns Hopkins University on a different machine, designed to rule a maximum of 20 000 lines per inch. Both were "6 inch" gratings with radius of curvature of about 21 feet ($640 \pm$ cm), but one of them bearing the number 330 had 20 000 lines per inch while the other, No. 65-331, had 10 000 lines per inch. Rowland ghosts were observed in several orders of primary spectra for each of these gratings, but neither of them showed any secondary spectra of the Lyman type which we were able to observe. The observations of secondary spectra of the Rowland type are summarized as follows:

(a) Rowland Ghosts for Grating No. 330

20 000 lines per inch.

$$\lambda_g = \left(1 \pm \frac{n}{1000m} \right) \lambda$$

Relative intensities in first order primary spectrum:

$n=0$	1	2	3	4	5	6
$i=10$	1+	0	1-	0	0	0

Relative intensities in second order primary spectrum:

$n=0$	1	2	3	4	5	6
$i=10$	3	1	2	0	0	0

(b) Rowland Ghosts for Grating No. 65-331

10 000 lines per inch.

$$\lambda_g = \left(1 \pm \frac{n}{500 m} \right) \lambda$$

Relative intensities in first order primary spectrum:

$n = 0$	1	2	3	4	5	6	7	8	9
$i = 10$	2	1	1-	0	0	0	0	0	0

Relative intensities in second order primary spectrum:

$n = 0$	1	2	3	4	5	6	7	8	9
$i = 10$	4	3-	1.5	1-	1	1-	1	1-	0

Relative intensities in third order primary spectrum:

$n = 0$	1	2	3	4	5	6	7	8	9	10
$i = 10$	5	3	2+	1	2+	1	1+	1	1-	1

4. DISCUSSION

The theory of imperfect gratings has been dealt with by many writers;⁸ but these theoretical investigations are confined for the most part to ideal combinations of gratings, emphasize the distribution of intensity in the spectral images, and have little practical value in assisting a worker to detect and eliminate false spectra from his experimental results. No theory thus far advanced explains in a satisfactory manner the possible existence of false lines occurring at considerable distances from the parent. It seemed probable that an experimental study of the false spectra would make it possible in certain cases to indicate just what the constants of the secondary gratings must be and thus give clues as to the origin of the periods which actually occurred in the process of ruling the grating. Our experimental results were transmitted to Prof. Carl Runge, who promptly furnished a complete analysis which explained the Lyman ghosts as due to a

⁸ Pierce, *Ann. J. Math.*, 2, p. 330; 1879.Rowland, *Phil. Mag.*, (5), 35, p. 397, 1893; *Astronomy and Astro-physics*, 12, p. 129, 1893; *Physical Papers*, p. 525.Rayleigh, *Coll. Papers*, I, p. 415; III, p. 37.Cornu, *Comptes Rendus*, 116, p. 1215; 1893.Lyman, *Phy. Rev.*, 16, p. 257; 1903.Michelson, *Astroph. J.*, 18, p. 298; 1903.Kimbald, *Phil. Mag.*, (6), 6, p. 30; 1903.Sparrow, *Astroph. J.*, 49, p. 65; 1919.

double periodic error. His *Theory of Lyman Ghosts* is given in detail in the paper which follows. In Prof. Runge's theory assumptions are made as to the number of grooves in each period, and both the spacing of the ghosts and their relative intensities are thus accounted for. It was suggested that an examination of the ruling machine might disclose the origin of these periodic errors.

The problem was then transferred to Dr. J. A. Anderson who ruled the gratings in question and who is most intimately acquainted with the mechanical operation and vagaries of this grating ruling machine. His discussion of *Periodic Errors in Ruling Machines* follows the paper by Prof. Runge. We are pleased to express our appreciation for the interest which Prof. Runge and Dr. Anderson took in this problem and we thank them for the valuable assistance which they have given in unravelling the mystery of false spectra from diffraction gratings.

In the interests of precision spectroscopy the writers wish to warn all users of diffraction gratings against the false spectra of different kinds which are no doubt produced by all such instruments. There are only two ways in which spectrum tables are protected from the intrusion of these spurious results. One protection originates in the extremely low intensity of the secondary spectra from some gratings so that careful tests fail to detect their presence, while the other way is to test all observed wavelengths of the less intense lines with ghost factors derived from careful tests of the grating's performance. In either case it is necessary to fall back upon a thorough examination of the grating. This applies especially to spectrum investigations in the infra red and extreme ultra violet where relatively long photographic exposures to very intense sources are required. It may be assumed that secondary spectra of strong lines of the visible spectrum are always present in these out-lying regions and whether or not their intensities are negligible can be determined only by rigid test. For the visible and infra red regions a suitable method of testing for Lyman ghosts is to make a long exposure to an intense monochromatic source like the green line of mercury, the yellow line of helium or the red line of cadmium. The usefulness of a grating

for work in vacuum spectrographs for investigating the very short waves should be tested by making a long exposure with air in the apparatus while the grating is set so as to diffract to the plate a portion of the primary spectrum for which air is opaque. The importance of such tests has not been sufficiently emphasized heretofore and we trust that this discussion of the subject will put spectroscopists on guard against insidious spurious results of the various kinds which may be given by diffraction gratings.

BUREAU OF STANDARDS
WASHINGTON, D. C.

PART II. THEORY OF LYMAN GHOSTS

The Lyman ghosts can be explained satisfactorily by the superposition of two periods, a large one and a small one, the former not being a multiple of the latter. They are different from the period corresponding to one revolution of the screw and must arise from some other periodic arrangement in the machine. What this is, an examination of the machine should be able to tell.

For the grating No. 222, described by Meggers and Kiess in Part I, assume the large period of 298 grooves so that the whole grating is composed of a number of smaller ones of 298 grooves. In each of these smaller ones suppose a periodic error repeated every five grooves. The error need not necessarily be an error of spacing, it may as well be a difference in the form of the five grooves. The spectrum of a monochromatic light source of wave length λ produced by one of the smaller gratings will show the direct image of the slit and the lines of the different orders. But besides it will show ghosts corresponding to the period of five grooves.

Let $a\lambda$ be the mean difference of path of two light waves issuing from the light source and reflected from one groove and from the next and observed at a certain place of the spectrum. Then $5a\lambda$ is the difference of path of two resultant light waves reflected from one group of five grooves and the next group. This

group of five grooves is repeated 59 times and we shall have the 59 resultant waves,

$$a \cos\left(\frac{ct}{\lambda} 2\pi\right) + a \cos\left(\frac{ct}{\lambda} + 5a\right) 2\pi + \dots + a \cos\left(\frac{ct}{\lambda} + 58 \times 5a\right) 2\pi,$$

(in which c = the velocity of light and t = time) and the three waves from the three remaining grooves. I shall assume that these three grooves do not reflect or that the light reflected from them may be neglected.

The amplitude A of the resultant of the 59 waves, as is well known, may be represented in the form

$$A = a \frac{\sin(295a\pi)}{\sin(5a\pi)}$$

Now let the grating of 298 grooves be repeated n times; the n waves reflected from them and examined at the same point of the spectrum are:

$$A \cos\left(\frac{ct}{\lambda} 2\pi\right) + A \cos\left(\frac{ct}{\lambda} + 298a\right) 2\pi + \dots + A \cos\left(\frac{ct}{\lambda} + (n-1)298a\right) 2\pi.$$

The amplitude of this grand resultant is:

$$A \frac{\sin(n \times 298a\pi)}{\sin(298a\pi)} = a \frac{\sin(295 \times a\pi)}{\sin(5a\pi)} \cdot \frac{\sin(n \times 298a\pi)}{\sin(298a\pi)}$$

“ a ” is also a function of a and depends on the quality of the error in the ruling of the groups of five grooves and on the form of these grooves. But for small variations of a we may treat “ a ” as a constant. The intensity of the light at the examined point of the spectrum is measured by the square of the amplitude. We shall therefore find a considerable intensity only at those places of the spectrum where neither of the two factors $\frac{\sin(295a\pi)}{\sin(5a\pi)}$ and $\frac{\sin(n \times 298a\pi)}{\sin(298a\pi)}$ is very small relatively to its maximum.

The first factor is relatively small except where $5a$ is an integer or nearly so, and the second factor is small except where $298a$ is an integer or nearly so. A considerable intensity will therefore only exist at those places where both $5a$ and $298a$ are very nearly integers. The deviation of $298a$ from an integer must be some-

what smaller than $1/n$, for when the deviation is equal to $1/n$ the denominator $\sin(n \times a\pi)$ will vanish. The deviation of $5a$ from an integer for a similar reason must be somewhat smaller than $1/59$. Now let n be a number of times larger than 59. Then we may say that $298a$ will have to be equal to an integer m , while $5a$ may deviate from an integer ν by something less than $1/59$, or a from $\nu/5$ by something less than $1/295$. If the period of five grooves be ill-defined the maxima of A^2 will be broader. Say that the zeros of A^2 on both sides of the maxima will be filled up so that considerable values remain on either side about as far as

$a = \frac{\nu}{5} \pm \frac{2}{295}$ so that a may deviate to an amount somewhat less

than $2/295$ from $\nu/5$ without A^2 becoming very small. We shall then observe lines at those places where $298a = m$, m being an integer for which $m/298$ may deviate from $\nu/5$ to an amount somewhat less than $2/298$, that is to say, an integer between the limits $\frac{\nu 298}{5} - 2$ and $\frac{\nu 298}{5} + 2$. These lines will appear to have the wave lengths $\lambda' = a\lambda$.

In the following table the calculated line ratios $\lambda'/\lambda = m/298$ are compared with the observed line ratios.

The intensity of the line for which the deviation of a from $\nu/5$ is the smallest ought in each group corresponding to the same value of ν to be the strongest, because this place in the spectrum is close to the maximum of A^2 . But the intensities of the other lines of the same group need not necessarily be in the order of the deviation of a from $\nu/5$, as the value A^2 may have secondary maxima on both sides of $a = \nu/5$. The groups corresponding to the different values of ν may have different intensities owing to the different values of "a" in different directions.

In the grating mentioned as No. 156-E-P by Meggers and Kiess, the large period contains 348 grooves, while the small period again consists of five grooves. The limits of the integer m can here be reduced to $\frac{\nu}{5} 348 \pm 1$. Table 2 gives the calculated ratios of wave-lengths in comparison with the observed ratios.

TABLE I

ν	$\frac{\nu}{5} 298 \pm 2$	m	$\alpha = m/298$	α observed	obs. - calc.
1	57.6, 61.6	58	0.194631		
		59	0.197987		
		60	0.201342		
		61	0.204699		
2	117.2, 121.2	118	0.395973		
		119	0.399329	0.399294	-35×10^{-6}
		120	0.402684	0.402640	-44×10^{-6}
		121	0.406040		
3	176.8, 180.8	177	0.593960		
		178	0.597315	0.597312	-3×10^{-6}
		179	0.600671	0.600686	$+15 \times 10^{-6}$
		180	0.604027		
4	236.4, 240.4	237	0.795302	0.795307	$+5 \times 10^{-6}$
		238	0.798658	0.798670	$+12 \times 10^{-6}$
		239	0.802013	0.802002	-11×10^{-6}
		240	0.805369	0.805369	
5	296, 300	297	0.996644	} principal spectrum	
		298	1.000000		
		299	1.003356		
6	355.6, 359.6	356	1.194631	1.194651	20×10^{-6}
		357	1.197986	1.197995	9×10^{-6}
		358	1.201342	1.201355	13×10^{-6}
		359	1.204698	1.204705	7×10^{-6}
7	415.2, 419.2	416	1.395973	1.396038	65×10^{-6}
		417	1.399329	1.399367	38×10^{-6}
		418	1.402684	1.402710	26×10^{-6}
		419	1.406040	1.405964	-76×10^{-6}
8	474.8, 478.8	475	1.593960	1.594082	122×10^{-6}
		476	1.597315	1.597362	47×10^{-6}
		477	1.600671	1.600698	27×10^{-6}
		478	1.604027	1.604038	11×10^{-6}
9	534.4, 538.4	535	1.795302	1.795348	46×10^{-6}
		536	1.798658	1.798680	22×10^{-6}
		537	1.802013	1.802016	3×10^{-6}
		538	1.805369	1.805352	-17×10^{-6}

TABLE 2

ν	$\frac{\nu}{5} 348 \pm 1$	m	$\alpha = m/348$	α observed	obs. - calc.
1	68.6, 70.6	69	0.198276		
		70	0.201149		
2	138.2, 140.2	139	0.399425		
		140	0.402299		
3	207.8, 209.8	208	0.597701	0.597702	$+ 1 \times 10^{-6}$
		209	0.600575	0.600562	$- 13 \times 10^{-6}$
4	277.4, 279.4	278	0.798851	0.798850	$- 1 \times 10^{-6}$
		279	0.801724	0.801697	$- 27 \times 10^{-6}$
5	347, 349	348	1.000000	{ principal spectrum	
6	416.6, 418.6	417	1.198276		
7	486.2, 488.2	418	1.201149	1.399397	$- 28 \times 10^{-6}$
		487	1.399425		
8	555.8, 557.8	488	1.402299	1.597700	$- 10 \times 10^{-6}$
		556	1.597701		
9	625.4, 627.4	557	1.600575	1.600565	$- 10 \times 10^{-6}$
		626	1.798851	1.798781	$- 70 \times 10^{-6}$
		627	1.801724	1.801648	$- 76 \times 10^{-6}$

This is the same explanation that I gave to Mr. Lyman in 1902. The plate he sent me showed his grating to have a large period of 73 grooves and a small period of three grooves.

Notice that in the three cases:

Grating	Large period	Small period	1 Revol. of screw	Number of teeth of screw
Grating No. 222	298 grooves	5 grooves	375 lines	750
Grating No. 156	348 " "	5 " "	250 " "	750
Lyman's Grating	73 " "	3 " "	720 " "	720

the large period contains two grooves less than a round number, $298 + 2 = 300$, $348 + 2 = 350$, $73 + 2 = 75$. These round numbers,

300, 350, and 75, are each exact multiples of the associated small period and may have something to do with the mechanism causing the periods.

UNIVERSITY OF GÖTTINGEN

PART III. PERIODIC ERRORS IN RULING MACHINES

1. GENERAL CONSIDERATIONS

For simplicity consider a machine like that of Professor Rowland, good descriptions of which may be found in Baly's *Spectroscopy*, in Kayser's *Handbuch der Spektroskopie*, or in *Physical Papers of Henry A. Rowland*.

Since one line of the grating is ruled for each complete revolution of the drive shaft, it will be convenient to call such a revolution a cycle. The number of teeth on the spacing wheel will be denoted by N , the pitch of the screw by P , and the number of teeth spaced per cycle K , where K in general is equal to unity, but may be any other small whole number.

In each cycle the screw turns through an angle $\frac{2\pi K}{N}$, the nut which moves the grating carriage, advances parallel to the axis of the screw and with reference to a fixed point on this axis by the amount $\frac{KP}{N}$; and if the screw does not move in a direction parallel to its own axis with reference to the frame of the machine, the grating carriage will advance along its way by the same amount $\frac{KP}{N}$. This quantity is the grating space and it will be denoted by

a . In an ideal grating a must be constant, but in practice this is never the case. It will therefore be necessary to consider how much a may vary without interfering seriously with the quality of the grating. For this purpose let the distance of any line n from one edge of the grating, that is from the line $n=0$ be denoted by x_n . In the ideal grating

$$x_n = a n \tag{1}$$

While in actual grating

$$x'_n = a n \pm e_n \tag{2}$$

There are two important special cases, which in any actual grating will be found superposed, but which may be considered separately:

(1) The values of e_n for different values of n are distributed at random. Such errors may be spoken of as accidental, and it will be observed that the distance from one line to the next line will differ from a by a quantity equal to $e_r - e_{r+1}$, which, since plus and minus signs of e_n are equally probable will be often simply the sum of the two e 's. Now, according to a general theorem, a wave-front is not seriously impaired by accidental variations in phase provided these are smaller than $\pi/2$ or $1/4$ of a wave-length. For a reflection from a surface at normal incidence, this demands that the errors in the surface should not be greater than $1/8$ of a wave-length and in the case of a grating it will be seen that

$$e_r + e_{r+1} < \lambda/8 \text{ or,}$$

$$e_n < \lambda/16 = \text{roughly } \frac{1}{1\,000\,000} \text{ inch or } \frac{1}{400\,000} \text{ cm} \quad (3)$$

If accidental errors much greater than this are present, the quality of the grating will surely be impaired. It will be observed that as far as accidental errors are concerned the grating space may vary as much as e_n in equation (3) without doing any great harm.

(2) The values of e_n are periodic with a period N and may be expressed as a Fourier series of the form

$$e_n = b \sin \frac{2\pi n}{N} + c \sin \frac{4\pi n}{N} + d \sin \frac{6\pi n}{N} + \dots \dots \dots (4)$$

As is well known, this type of error in a grating gives rise to ghosts easily observable in a bright line spectrum. Due to the term $b \sin \frac{2\pi n}{N}$, a line of wave length λ will be accompanied by two ghosts

which in the spectrum of order s will occupy the position $\lambda \left(1 \pm \frac{1}{sN} \right)$

and whose intensity is given by

$$I_g = I_0 \frac{s^2}{4} \left(\frac{2\pi b}{a} \right)^2 \quad (5)$$

provided $b < \frac{a}{2\pi}$, I_0 being the intensity of the line λ . Similarly the term $c \sin \frac{4\pi n}{N}$ will give ghosts in the positions $\lambda \left(1 \pm \frac{2}{sN}\right)$ and whose intensity is $I_g = I_0 \frac{s^2}{4} \left(\frac{2\pi c}{4}\right)^2$ etc.

As it is desirable that the ghosts be not too strong, the condition may be imposed that in the first order $1000 I_g = I_0$, which substituted in (5) gives

$$b = \frac{a}{99.4} = \frac{a}{100} \text{ approximately.}$$

Evidently the same value holds for c , d , etc. Since by formula (5) the intensity of the ghosts varies as the square of the order, the intensity in the fifth order spectrum is $1/40$ of that of the primary lines. If the periodic error be doubled, the intensity of the ghosts becomes four times as great, in which case they would begin to be troublesome, especially in the higher orders of spectra. Hence, b , c , d , etc., should not be much greater than $a/100$. Since this is also the value of e_n in equation 2, it follows that, taking $a = \frac{1}{15\,000}$ inch (or $\frac{1}{6000}$ cm) the value of e_n comes out of the same order of magnitude as that given above the equation 3. In regard to the constancy of a , however, the case under discussion differs from that considered above. The greatest value of a will be given by $a + \left(\frac{de_n}{dn}\right)_{max}$ or, considering only the first term on the right side of equation (4),

$$a + (\Delta a)_{max} = a + \left(\frac{de_n}{dn}\right)_{max} = a + \frac{2\pi}{N} b \quad (6)$$

In Rowland's 15,000 machine, $N = 750$ and hence

$$(\Delta a)_{max} = \frac{2\pi}{750} b = \frac{a}{12\,000} \text{ approximately.}$$

Corresponding to the terms $c \sin \frac{4\pi n}{N}$, $d \sin \frac{6\pi n}{N}$, etc., the values of $(\Delta a)_{max}$ would be $\frac{2a}{12\,000}$, $\frac{3a}{12\,000}$ etc., respectively.

Ideal Rigid Machine. If all parts of the machine be regarded as perfectly rigid, then from purely geometrical considerations it is a simple matter to calculate how accurately the various parts must be constructed in order that the spacing errors shall be within the limits just derived. The only parts that need to be discussed are those that are involved in the motion of the grating carriage, for obviously no periodic errors are likely to be produced by the ruling carriage since it completes a cycle in the ruling of each line. These parts are: the spacing wheel; the thrust bearing; the pivots of the screw; the connecting mechanism between the nut and grating carriage; and the screw itself with its nut.

1. *The Spacing Wheel.* Let the radius of the wheel be r and the distance between two teeth on its circumference be s . Then if the spacing constant K is unity, the grating space a is given by

$$a = \frac{s}{2\pi r} P$$

Regarding s and r in turn as variables,

$$\Delta s = \frac{2\pi r}{P} \Delta a \text{ and } \Delta r = -\frac{2\pi r^2}{sP} \Delta a.$$

In Rowland's 15 000 machine $r = 7$ in, and $P = 1/20$ inch. Taking $a = \frac{1}{1\ 000\ 000}$ inch, the value found for allowable accidental

errors, the value $\Delta s = \frac{1}{1140}$ inch will make these errors sufficiently small, whereas there is no difficulty in making Δs as small as $\frac{1}{10\ 000}$ inch in practice. Periodic errors are likely to be introduced

by an eccentricity in the wheel and this is measured by Δr . Taking $\Delta a = \frac{1}{180\ 000\ 000}$ inch, $\Delta r = \frac{1}{1750}$ inch. There is no difficulty in

centering the wheel so accurately that the error will be only a fraction of this allowable amount. There remains then only periodic errors in the spacing of the teeth on the circumference of the wheel itself. Since a expressed in angular measure is 1728 seconds of arc, which corresponds to the grating space a , and since a periodic error of amplitude $\frac{a}{100}$ is relatively harmless it is

seen that periodic errors having an amplitude of 17.28 seconds are of little importance. There is no difficulty in reducing these errors to about 1/10 of this amount. Hence the conclusion that the spacing wheel presents no practical difficulties, is obvious.

2. *The Thrust Bearing.* As the screw rotates it will also move parallel to its own axis, due to imperfections in the thrust bearing. This motion is necessarily periodic, the period being one rotation of the screw. The amplitude of this motion must be made less than $\frac{a}{100}$ and this can be accomplished as follows: A plate of some hard material like ruby is worked and polished optically plane. It is mounted on the end of the screw so that its normal is as nearly as possible parallel to the screw axis. If the diameter of the plate is not less than $\frac{1}{4}$ inch this can be done to well within 2 seconds of arc. A convex steel surface rigidly mounted on the frame of the machine makes contact with this plate as nearly on the axis of rotation as possible. This coincidence will not be exact, but a departure of much more than 1/10 mm can easily be avoided. The amplitude of the motion parallel to the axis of the screw is then $1/10 \text{ mm} \times \sin 2'' = 10^{-7} \text{ cm}$, about, or about 1/40 of the allowable amount.

3. *The Pivots of the Screw.* If the axis of the pivots and the axis of the screw do not coincide, the nut will move in a spiral path instead of in a straight line, and since the axes can never be made to coincide exactly, the path is always a spiral. It is desirable to make the radius of this spiral as small as possible. This may be accomplished as follows: when the screw has been ground and polished it is mounted so that it can be rotated about the axis of its pivots. A well-fitting nut is made to carry one plate of an interferometer so adjusted that its reflecting face is parallel to the axis of rotation, the other plate being mounted on the frame supporting the bearings. The interference fringes are observed as the screw is rotated. By correcting the pivots until no motion of the interference fringes is observable, it is possible to reduce the radius of the spiral to a small fraction of a wave-length of light.

4. *The Connecting Mechanism between the Nut and Grating Carriage.* Since the spiral motion of the nut just discussed

cannot be entirely avoided and since it is impossible to have the axis of the screw *exactly* parallel to the grating-carriage way, it follows that a rigid connection between the nut and carriage can not be considered. In principle, the connection consists of two flat plates on the nut making contact with corresponding convex surfaces on the carriage. The plane of the plates is as nearly normal to the axis of rotation of the screw as possible. Since the radius of the spiral described by the nut is so very small, it follows that no appreciable periodic error is introduced here, assuming, of course, that all parts are perfectly rigid. (In an actual machine, where the parts are elastic and it becomes necessary to take friction into account the case is very different, as will appear later.)

5. *The Screw and Nut.* Only two points need to be considered: The axis of the screw must be straight, and its effective diameter must be constant throughout the length actually used. Only the first of these is of any importance for the case of periodic errors, since variations in the diameter of the screw can only introduce slow variations in the effective pitch.

In general if a screw is cut from a piece of well-annealed tool steel and is ground and polished by a long nut, its axis will be so nearly straight that the most refined interferometer method will fail to reveal any curvature. The sensitivity of the interferometer test may be deduced as follows: Let two nuts be mounted on the screw with their centers a distance l apart; one interferometer plate is mounted on each nut, and at a distance d above the axis of the screw. Let R be the radius of curvature of the screw axis, and let z be the maximum displacement of one plate with reference to the other in one rotation of the screw.

$$\text{Then } z = \frac{2dl}{R} \quad \text{or} \quad R = \frac{2dl}{z} \quad (8)$$

Taking $z = \frac{1}{500\,000}$ inch as easily observable, and $d=l=6$ in.,

it follows that $R = 36 \times 10^6$ inches or about 600 miles. A slight curvature of the screw axis, if present, will produce a variable spiral motion of the nut with reference to the grating carriage, but no periodic error in its motion *along* the axis of the screw.

(In the case of a screw and nut which have been fitted to each other by grinding and polishing, there can, of course, be no question of any periodic error in the screw threads themselves. If, indeed, any such error be present, it must be of a very different order of small quantities from those considered here.)

Given perfectly rigid materials, it is hence reasonable to say that a machine could very easily be constructed which would space lines with accidental errors less than $1/100$ of a wave length, and with no periodic errors as large as $1/500$ of the grating space (assumed as $1/15\ 000$ inch). The intensity of the ghosts in, say, the fourth order of a grating of this accuracy would be about $1/1600$ of that of the spectrum line itself.

3. ACTUAL MACHINE. EFFECTS OF FRICTION

Since all materials are deformable it is necessary to take into account the effects produced by forces due to friction, and as a result the conclusions stated above do not apply to an actual ruling machine. It is generally found that a machine which has been built and adjusted so carefully that both accidental and periodic errors ought to be less than $1/10$ of the allowable magnitude will, when tried, give errors so large that gratings ruled on it are practically of no value. To account for this is not difficult. Let the force required to move the ruling carriage along its ways after ruling has been in progress for a few hours be F . The time condition is important, for the force required to move the carriage increases rapidly at first becoming constant only after several hours of operation. The force F may be taken as a measure of the elastic deformation of the parts lying between the thrust bearing and the area of contact between the grating carriage and its way. Beginning at the thrust bearing, these are, the part of the screw between the nut and the thrust plate, the oil-film between the threads of the screw and nut, the nut itself, the connection between the nut and carriage, and the parts of the carriage. Given the value of F , the deformation of some of the parts can be computed; for example, if $F = 40$ lbs, as is usual with Rowland's $15\ 000$ machine, the compression of the screw when the nut is at its middle is about one half a wave-length of light. The deformation of the connecting mechanism between the nut and carriage is consider-

ably greater. The change in the oil-film is perhaps the most important and there is some evidence that this shows an appreciable lag. The sum of the deformations of all the parts was measured at various times, and was found to lie between five and ten wavelengths, depending upon the load on the carriage. If this quantity be denoted by ΔX , then by Hooke's law,

$$\Delta X = h F \quad (9)$$

where h is a quantity depending upon the nature of the parts just mentioned, being a constant or nearly so for a given machine in a given state of adjustment.

Since ΔX is of the order of $2a$, and must remain constant within $a/100$, it follows that during the ruling of any one grating F must remain constant to about $1/200$ of its value. Referring to paragraphs 3 and 4, section II, it will now be clear that a very small spiral motion of the nut, due to slight errors in the screw pivots, may produce considerable periodic errors of spacing. For such a spiral motion necessarily introduces a periodic variation in the value of F in equation (9). Perhaps it is fair to say that an important part of the problem of ruling good gratings is the problem of keeping F constant within a few tenths of one per cent of its value.

4. PROBABLE ORIGIN OF LYMAN GHOSTS

Professor Runge has shown that Lyman Ghosts may be accounted for analytically by assuming two periods, both of which in general are shorter than the fundamental period N of the machine. The same analysis would perhaps apply if the shorter of the two periods be assumed to change its shape in a periodic manner, thus introducing the second period required. The periods which have been found experimentally up to date are given in Table 1.

TABLE 1

No.	Observer	Grating Space	Size of Grating	Machine	Periods
1	Lyman	14 438	Concave 1 meter	14 438	3 and 73
2	Meggers & Kiess	7 500	" 21 feet	15 000	5 and 298
3	Meggers & Kiess	5 000	" 21 feet	15 000	5 and 348
4	Anderson	15 000	" 15 feet	15 000	5 and 277
5	Anderson	15 000	" 1 meter	15 000	5 and 277
6	Anderson	15 000	" 1 meter	15 000	5 and 320+

Observations Nos. 4, 5 and 6 have been made recently, using three gratings belonging to the Mount Wilson Observatory. The gratings used in observations 2 to 6 were all ruled by the writer on Rowland's 15 000 machine, some time between Dec. 1911 and August 1912. It will be observed that the period 5 is common to all of these, but that the longer period is variable.

Observations Nos. 5 and 6 were made in such a way that a fair estimate of the intensity of the Lyman Ghosts in terms of that of the line giving rise to them could be made. With both of these gratings the intensity of the strongest Lyman Ghost is of the order of $\frac{1}{50\,000}$ of that of the line itself. While formula (5) may not apply exactly to this case, it will at least give the order of magnitude of the amplitude b which, by placing $s = 1$, gives $b = \frac{a}{700}$. To produce this error, F , in equation (9), would have to vary in a period of 5 lines by only $\frac{1}{1400}$ of its value. Now, it happens that the driving belt of the 15 000 machine makes 2 revolutions for each 5+ cycles of the machine. The belt exerts an upward pull on the machine which will vary somewhat if the belt is not uniform in thickness, owing to the fact that the driving pulley is small, being only two inches in diameter. This varying pull with its resultant distortion of the frame of the machine may perhaps be sufficient to cause the required change in F . If so the period 5 and its constancy is accounted for. Slight variations in the length of the belt due to stretching with use might explain the variations in the length of the longer period.

The following quotation from a paper by Henry A. Rowland is of interest in this connection. (Physical Papers, page 536):

“So sensitive is a dividing engine to periodic disturbance that all the belts driving the machine must never revolve in periods containing an aliquot number of lines of the grating; otherwise they are sure to make spectra due to their period.”

MT. WILSON OBSERVATORY

ON THE PROPAGATION OF LIGHT IN ROTATING SYSTEMS, A REJOINDER TO DR. A. C. LUNN

By
LUDWIK SILBERSTEIN

Dr. A. C. Lunn in his comments¹ on my paper on this subject² proposes to deal "chiefly" with my main contention, but before doing so points out at some length a number of "minor items."

That contention was that a fractional shift effect as a possible outcome of the discussed terrestrial optical experiment, now conducted by Prof. Michelson, would be crucial, namely against Einstein's relativity theory *such as it is*³ (*i.e.* with the express inclusion of $ds = 0$ as the law of light propagation and of $\delta f ds = 0$, with the same ds , as the law of free motion), and favourable to the revival of an aether sharing in part the earth's rotation. Since Dr. Lunn has in the meantime admitted the essential correctness of this result, in a conversation at the recent Lorentz Colloquium at Madison,⁴ I need not insist here any more upon it. But the "minor items" are of such a nature as to call for an explicit reply.

In the first place then, Dr. Lunn, while granting readily the claimed necessity of a reference frame for rotation "in spite of appearances to the contrary" (5, p. 291), wonders what those appearances are. Now, such a clause (made, moreover, rather incidentally) has at the time of writing seemed worth making in view of the usual presentation,—even in such fine books as Poincaré's 'Science and Hypothesis,'—which is apt to leave the average reader under the impression that it has after all a sense to

¹ This Journal, 6, p. 112-120; March 1922.

² *Ibidem*, 5, p. 291-307; July, 1921.

³ It is manifestly impossible to assert anything against it as it might be, *i. e.*, against a modification of Einstein's theory which Dr. Lunn may have vaguely in mind but which he does not specify.

⁴ University of Wisconsin, where the subject was brought up by the present writer on March 30 in a paper entitled "The rotating earth as a reference system for light propagation," its conclusions being fully adhered to by Prof. H. A. Lorentz.

speak of the rotation, say, of a perpetually clouded earth, without reference to some assignable framework, such as that of the fixed stars. (See, *e.g.*, p. 141 of Poincaré's book, French edition.) But is it really necessary to say any more in justification of a few words of warning inserted in my paper against a possible misconception?

Secondly, in saying that the relativity theory proved unable to deduce the terrestrial *ds* as a gravitational effect, my intention was not to emphasise it as a "flaw in that theory," as Dr. Lunn thinks, but simply to refer to it as a matter of fact. I may be permitted perhaps to mention that, though not a fanatical relativist, I am the last man to be blind to the boldness and beauty of Einstein's theory, and certainly not hostile or prejudiced against it. As to my calling Thirring's solution, in this connection, a "complete failure" (p. 304), though, as I added, mathematically interesting, I do not share Dr. Lunn's impression that I have been unjust to Thirring. It is true that his solution is the result of an avowedly approximate method only, and in view of this one would certainly have to be lenient to some numerical discrepancies. But if these go so far as to yield for the numerical factor of the Coriolis force, as compared with that of the centrifugal one, the value *eight* instead of *two*, and more recently even *ten* instead of *two*,⁵ the solution is no more an approximation but simply a misrepresentation of the experimental facts, even if (as I did) one closes his eyes to the superfluous longitudinal force twice as large as the transversal or proper centrifugal force. And the failure seems "complete" indeed when one remembers how simply the correct formula for those experimental facts follows on the classical kinematics. Thirring's hollow spherical shell, rotating around our planet, is certainly not known to represent anything approaching the actual distribution of celestial matter. Yet it seems very doubtful whether anything short of a homogeneous distribution of matter throughout the whole space, which, moreover, has to

⁵ In Thirring's original paper of 1918 the factors of the two "forces" (accelerations) were $8/3$ and $1/3$, but after the amendment of an arithmetical error (*Phys. Zeitschrift* 22, p. 29, 1921,) they turned out to be $8/3$ and $4/15$, bearing to each other the ratio 10 instead of 2.

be assumed to be closed (elliptic), can essentially improve that solution. As I gather from a conversation with Einstein, this would, in his opinion, be the only possible way out. Now, although there are no serious objections to a finite, closed space, as first proposed in his 'Cosmological Contemplations' of 1917, the assumption of a homogeneous distribution of matter throughout the universe is very hard to adhere to. In fact, although Einstein's sensational formula, total mass of the universe equal to $\frac{\pi c^2}{4}$ times

the curvature radius of space,⁶ seems to be compatible with as small an average density as we like, yet the required homogeneity of its distribution could hold only on such a gigantically macroscopic scale for which the 'volume-element' would be a cube whose sides are $\frac{1}{2}$ to 10 million light years long, this being the order of the mutual distances of Shapley's island universes. Now, such a coarse homogeneity would suffice for the purpose in hand only if the number of those "island universes" themselves would still be enormous, which—for the present at least—is entirely beyond our knowledge. In fine, while Dr. Lunn sees here but a passing difficulty, which he compares with the (Newtonian) retouching of the errors of some early results of celestial mechanics, the present writer is impressed by the gravitational aspect of rotation as a very hard and perhaps unsolvable problem.

Thirdly, concerning the field of competency of special relativity, I must insist most decidedly upon what was said on page 302 of my paper. It is admitted on all hands that Einstein's older or restricted relativity theory, though it can and does consider any non-uniform motions of a particle within any of its privileged, *i.e.* inertial systems, yet does not as a matter of fact deal with any frameworks other than the inertial ones as *reference-systems*, nor has it ever proposed to deal with them. In fact, not a single one of the host of papers, pamphlets and text-books written on that subject deals with any but the inertial reference frames and, correspondingly, with any but the Lorentz transformation as the bridge from one to another such system. So much so that the last

⁶ See, for instance, the writer's *General Relativity and Gravitation*, Univ. of Toronto Press, p. 134, 1922.

edition (1919) of Laue's excellent book on special relativity has been entitled by him expressly the "Relativity principle of the Lorentz transformation." But it is not merely the sanction of the said restriction by general usage that supports my thesis. Einstein's older theory is by its very structure the geometry of a metrical four-fold determined by the line-element $ds^2 = c^2 dt^2 - dx^2 - dy^2 - dz^2$, and has, in harmony with this, all of its material (four-vectors, six-vectors, *lor* and other derived operators) defined in relation to the Lorentz transformations. The latter form a group, and the whole field of this group is exhausted by the privileged class of inertial systems and *vice versa*, leaving no place for other reference systems.

Next, concerning the rule of convexity of light rays, "clockwise" in the footnote on page 295 is a manifest misprint for "anticlockwise," as Dr. Lunn could readily see from Fig. 2 and Fig. 4 where the arrows indicating the rotation are drawn in the correct sense.⁷

Further, with regard to the diagram on page 300 illustrative of the optical circuit, the three pairs of (curved) rays were drawn only for the sake of simplicity between the same points A, B, C, but they need not be taken as splits of originally the same ray arriving from the collimator. As agreed upon in a conversation with Prof. Michelson, the ultimate interpretation of his pending experimental results will have to be based upon a careful tracing of rays or waves through the whole apparatus with due attention, of course, to the finite breadth of the light beam. But it will be time to undertake such a tracing, laborious though offering no essential difficulties, when the effect will, probably next summer, be measured by Michelson. For a first orientation the said diagram has seemed most appropriate, especially as it brings out the essential compensation of the effects of ray curvature upon the ultimate phase difference or shift effect.

Finally, that r on page 303 stands for a cylindrical coordinate, and that this also is referred to in the footnote on p. 306, is really too obvious to call for so many words.

⁷ Another shocking misprint, not noticed by Dr. Lunn, occurred on p. 292, where 10^{-8} in the value of $\bar{\omega}/c$ should read 10^{-12} . A few other misprints, attributable to a sudden change of the Press at that epoch, are too obvious to need a special mention.

It may still be mentioned, in reply to Dr. Lunn's last paragraph of p. 117, that speaking of the possibilities of a revived aether in the case of a fractional shift effect I had in mind a *non-rigid* aether, as will appear most clearly from page 292, where it is said that the spinning drag of the aether may vary from point to point.

ROCHESTER, N. Y.,
May 21, 1922

ON THE OPTICAL CONSTANTS OF SELENIUM IN THE FORM OF ISOLATED CRYSTALS

BY
L. P. SIEG

I. INTRODUCTORY

The optical constants of absorbing materials are of considerable interest in view of the information they may contribute toward the solution of the problem of the structure of matter. The optical constants usually referred to are the index of refraction, the coefficient of absorption, and, derived from these, the reflecting power. Many substances have been studied by various observers, and long lists of these constants are to be found in our reference tables. In view of the fact, however, that the crystalline state of matter is the normal and natural state, it would appear that more attention should be centered upon obtaining these constants, as far as possible, for single crystals of the substances. This matter becomes significant if one cites, for example, the metal zinc. The fundamental crystal form of this element is hexagonal, and as such we should certainly not expect it to possess merely one set of optical constants. In this case there should be two sets, and these should differ from each other in some manner not to be predicted without intimate study of an isolated crystal. And yet our tables contain data for the optical constants of zinc, in which only one set is assumed and recorded. This result is of course to be expected when we consider that the usual practice is to take a slab of the material in question, containing countless crystals, oriented in various ways, polish the specimen, and proceed to determine the constants. The results thus obtained can mean little unless perhaps they represent some intermediate value of the true constants.

As a rule the index of refraction and the coefficient of absorption for highly absorbing substances must be determined by some indirect means, because the substances are too dense to transmit

sufficient light for direct measurements. The regular procedure is to reflect plane polarized light, usually at an azimuth of 45° from the surface in question. By virtue of the absorption and conduction possessed by the medium there is a phase difference introduced into the reflected components of the polarized light. From a knowledge of the form of the reflected elliptically polarized light one can calculate the optical constants by well-known formulas.

It was some years ago, with these ideas in mind, that I set Mr. C. H. Skinner¹ the problem of determining the optical constants of a single crystal of selenium. Skinner followed the regular Babinet compensator method, and found, as was expected, that different results were obtained with a given azimuth and incidence, depending upon whether the long axis of the hexagonal crystal was perpendicular or parallel to the plane of incidence. In such a case the ordinary formulas do not serve, but in their stead we must employ some such expressions as those developed by Drude² for absorbing crystalline bodies. In fact Drude,³ and later Müller,⁴ tested these expressions for a natural crystal of antimony sulphide. As far as I am aware, however, this method, with the exception of Skinner's work, has not been applied to elementary substances.

The difficulties which Skinner had in employing so small surfaces, led me to the necessity of seeking some better apparatus for this type of work. Dr. L. D. Weld⁵ attacked the problem, and succeeded in devising and constructing an elegant apparatus for the work in question. While his chief problem was the development of the apparatus, he succeeded also in obtaining some data for the ellipticity of the light of various wave lengths, reflected from selenium crystals. His paper contains these data but, at the time of publication, as we were not satisfied that we fully understood Drude's⁶ expressions, it was thought best not to reduce

¹ Skinner, *Phys. Rev.*, *9*, p. 148; 1917.

² Drude, *Ann. d. Phys.*, *32*, p. 584; 1887.

³ Drude, *Ann. d. Phys.*, *34*, p. 489; 1888.

⁴ Müller, *Neues Jahrb. für Mineral. u.s.w.* *17*, p. 187; 1903.

⁵ Weld, *J. O. S. A. and R. S. I.* *6*, p. 67; 1922.

⁶ Loc. cit.

the elliptic constants to optical constants, but to publish them as they stood. Since then I have had some opportunity of examining the equations, and further of determining directly the reflecting powers of these crystals. The experimental results, which will be discussed later in the paper, seem to agree better with Skinner's results than with Weld's.

If one accepts Drude's postulates, one has in the derived equations complete expressions for determining the optical constants for any crystal, uniaxial or biaxial. The difficulties⁷ arise in the computations since direct application of the experimental data to Drude's equations yields simultaneous equations between complex quantities of high order. Drude⁸ and Müller⁹ simplified the equations by certain assumptions as to the relative magnitudes of certain terms. It was really to test the validity of these assumptions that the completion of Weld's work was deferred.

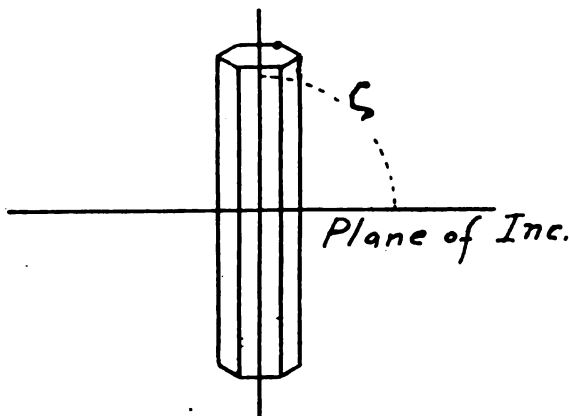

FIG. 1

Orientation of crystal with respect to plane of incidence.

⁷ In the Babinet Compensator method as employed by Skinner, no serious difficulties in reducing the results arose, because in that method one adjusts conditions until a phase difference of 90° is introduced. The formulas, for purposes of calculation, are thus vastly simplified. In Weld's apparatus, on the other hand, one obtains a photographic record, and from this calculates the phase differences. It would involve an inordinate labor to repeat observations until a value of 90° for the phase difference were found.

⁸ Drude, *Ann. d. Phys.* 34, p. 489; 1888.

⁹ Müller, *Loc. cit.*

II. THEORETICAL

One should consult Drude's¹⁰ classic paper for the full theory and the working equations there developed. Here only the few expressions pertinent to this discussion will be considered. In Fig. 1 suppose we have represented one face of the hexagonal crystal lying perpendicular to the plane of incidence, with the optic axis in this case also perpendicular to the plane of incidence. Let ζ be the angle between the optic axis and the plane of incidence. Denote by R_s and R_p the amplitude of the components of the reflected light perpendicular and parallel respectively to the plane of incidence. Then we have

$$r = \frac{R_s}{R_p} e^{i\Delta} = \tan \Psi \cdot e^{i\Delta} \tag{1}$$

where r is a certain useful function of the angle ψ , the azimuth of the reflected elliptically polarized light, and of Δ , the phase difference introduced upon reflection. If we denote by Φ the angle of incidence, and if further one always uses an azimuth of 45° in the incident plane polarized light, so that the incident components perpendicular and parallel respectively to the plane of incidence are equal, one obtains¹¹

$$\left. \begin{aligned} r_1 &= \frac{\cos \Phi - \sqrt{a} \sqrt{1 - a \sin^2 \Phi}}{\cos \Phi + \sqrt{a} \sqrt{1 - a \sin^2 \Phi}} \cdot \frac{\sqrt{\gamma} \cos \Phi + \sqrt{1 - \gamma \sin^2 \Phi}}{\sqrt{\gamma} \cos \Phi - \sqrt{1 - \gamma \sin^2 \Phi}} \\ r_2 &= \frac{\sqrt{a} \cos \Phi + \sqrt{1 - a \sin^2 \Phi}}{\sqrt{a} \cos \Phi - \sqrt{1 - a \sin^2 \Phi}} \cdot \frac{\cos \Phi - \sqrt{\gamma} \sqrt{1 - \gamma \sin^2 \Phi}}{\cos \Phi + \sqrt{\gamma} \sqrt{1 - \gamma \sin^2 \Phi}} \end{aligned} \right\} \tag{2}$$

where r_1 and r_2 refer respectively to the first and second principal positions of the crystal, i.e., where the optic axis is in the surface of the crystal in both cases, but in the first it is perpendicular to ($\zeta = 90^\circ$), and in the latter it is parallel to ($\zeta = 0^\circ$) the plane of incidence. Hereafter the subscripts 1 and 2 shall refer all quantities respectively to these two principal planes. In the above equations a and γ are complex quantities from which one can readily deduce the ordinary optical constants.

¹⁰ Loc. cit. 1887.

¹¹ Drude, loc. cit. pp. 618-620; 1887.

It is shown by Drude that the following equations (3) are

$$\left. \begin{aligned} R_1 &= \frac{1+r_1}{1-r_1} = \frac{\cos 2\Psi_1}{1-\sin 2\Psi_1 \cos \Delta_1} + i \frac{\sin 2\Psi_1 \sin \Delta_1}{1-\sin 2\Psi_1 \cos \Delta_1} \\ R_2 &= \frac{1+r_2}{1-r_2} = \frac{\cos 2\Psi_2}{1-\sin 2\Psi_2 \cos \Delta_2} + i \frac{\sin 2\Psi_2 \sin \Delta_2}{1-\sin 2\Psi_2 \cos \Delta_2} \end{aligned} \right\} \quad (3)$$

the final working equations for reducing the elliptical constants Ψ and Δ , for a given incidence Φ , to expressions which lead directly to the optical constants. In attempting to solve rigorously the simultaneous equations (3) one meets some difficulties. As Weld points out in his paper,¹² the suggestion was made that if one should take two different angles of incidence one could reduce the order of equations (3) to the second. Weld had, for one wavelength, used incidences both of 60° and of 45° . However, in attempting to employ these data in calculation it soon became evident that the data for 45° were useless, as they by chance yielded certain phase differences which made the errors involved too large for the method to be of service. I then tried the plan of expanding the equations (3) up to and including terms of the third degree, and a satisfactory solution was found. For simplification in equations (2) let us make the following substitutions:

$$\sin^2\Phi = A^2, \quad \cos^2\Phi = B^2, \quad \sqrt{a} = x, \quad \sqrt{\gamma} = y$$

Remembering that $R_1 = \frac{1+r_1}{1-r_1}$, and $R_2 = \frac{1+r_2}{1-r_2}$, we have after some reductions and simplifications,

$$\left. \begin{aligned} R_1 &= \frac{B^2y - x\sqrt{1-A^2x^2} \sqrt{1-A^2y^2}}{Bxy\sqrt{1-x^2A^2} - B\sqrt{1-A^2y^2}} \\ R_2 &= \frac{B^2x - y(1-A^2x^2)}{(xy-1)B\sqrt{1-A^2x^2}} \end{aligned} \right\} \quad (4)$$

Expanding, and assuming tentatively that both x and y are less than unity, we have

$$\sqrt{1-A^2x^2} = 1 - \frac{A^2x^2}{2} - \dots \quad (5)$$

¹² Weld, loc. cit. p. 90.

together with a similar expression for $\sqrt{1-A^2y^2}$. Putting (5) in (4) we have, carrying only to terms of the third degree,

$$\left. \begin{aligned} R_1 &= -By + \frac{x}{B} - \frac{A^2}{2B}x^3 - \frac{A^2B}{2}y^3 + \frac{x^2y}{B} - Bxy^2 + \dots \\ R_2 &= -Bx + \frac{y}{B} - \frac{BA^2}{2}x^3 + \frac{xy^2}{B} - \frac{A^2+2B^2}{2B^2}x^2y + \dots \end{aligned} \right\} \quad (6)$$

No second degree terms appear in (6). While Drude,¹³ and later Müller,¹⁴ in their applications of the general expressions to obtain the optical constants of antimony sulphide did not expand the equations in the above manner, the expressions they used were exactly what one would obtain by retaining only the first two terms on the right hand sides of equations (6). I have adopted their plan in reducing Weld's data, the results of which appear later in this paper. I have, however, for two wave-lengths employed equations (6) as they stand. The resulting optical constants so obtained are not very seriously different from those obtained by using the simpler expressions, but still they differ enough to cause one to have some doubt as to the accuracy claimed by both Drude and Müller. The method of approximating to the solution of equations (6) is in general similar to Newton's method of approximation, excepting that here we are dealing with quantities x and y which are complex. In view of all the pitfalls that ordinarily might appear in applying the following method to the complex plane, I feel that it was only by a fortunate chance that any results came at all.

To make clear the method of computation used, actual calculations from data for $\lambda = 0.55 \mu$, from Weld's¹⁵ paper, will be outlined. Weld¹⁶ gives for this wave-length, where $\Phi = 60^\circ$, the following:

$$\begin{aligned} \Delta_1 &= \pi + 20^\circ 41' & \Psi_1 &= 24^\circ 26' \\ \Delta_2 &= \pi + 4^\circ 26' & \Psi_2 &= 32^\circ 27' \end{aligned}$$

¹³ Loc. cit. 1888.

¹⁴ Loc. cit.

¹⁵ Loc. cit.

¹⁶ Weld gives Δ , as $20^\circ 41'$, etc., but if the light is viewed as it comes toward an observer, his expression ∇ , or $\pi + 20^\circ 41'$ must be employed. Drude's equations are developed on this basis.

Applying these data to equations (3) we have

$$\left. \begin{aligned} R_1 &= 0.386 - 0.156 i \\ R_2 &= 0.223 - 0.037 i \end{aligned} \right\} \quad (7)$$

Equations (6) become

$$\left. \begin{aligned} .386 - .156 i &= 2x - y/2 - 3/4 x^3 - 3/16 y^3 - xy^2/2 + 2x^2y \dots \\ .223 - .037 i &= -x/2 + 2y - 3/16 x^3 + 2xy^2 - 5/4 x^2y \dots \end{aligned} \right\} \quad (8)$$

Employing terms of the first degree only we get the following approximations, using primes to denote approximate values

$$\left. \begin{aligned} x' &= .236 - .088 i \\ y' &= .170 - .041 i \end{aligned} \right\} \quad (9)$$

Substituting the values of x' and y' in the terms of (8), which were previously omitted, we have, changing signs

$$\begin{aligned} \Delta R_1 &= -.0038 + .004 i \\ \Delta R_2 &= -.0009 - .0026 i \end{aligned}$$

From (8), taking the derivatives

$$-.0038 + .004i = (2 - 9/4 x^2 - y^2/2 + 4xy)\Delta x + (2x^2 - xy - 9/16y^2 - 1/2)\Delta y$$

$$-.0009 - .0026i = (2y^2 - 5/2 xy - 9/16 x^2 - 1/2)\Delta x + (2 + 4xy - 5/4 x^2)\Delta y$$

or substituting the approximate values x' and y' from (9)

$$\begin{aligned} -.0038 + .004i &= (2.0244 + .0015i)\Delta x + (-.4558 - .0505i)\Delta y \\ -.0009 - .0026i &= (-.5638 + .0572i)\Delta x + (2.0860 - .0469i)\Delta y \end{aligned}$$

whence, solving the above,

$$\Delta x = -.00207 + .00179i, \Delta y = -.00092 - .00073i$$

and the next approximations for x and y are

$$\left. \begin{aligned} x &= x' + \Delta x = .234 - .086i \\ y &= y' + \Delta y = .169 - .042i \end{aligned} \right\} \quad (10)$$

No closer approximation is needed, since substitution of the values from (10) in (8) yield the following

$$\left. \begin{aligned} R_1 &= .387 - .155i \\ R_2 &= .222 - .039i \end{aligned} \right\} \quad (11)$$

which are as close to the true values as the errors of experiment warrant.

As simple as the above is in theory, the actual computations, to insure accuracy, is a matter of several hours' work. In view of

this, but especially in view of the very small corrections necessary, this detailed method was used for only one other wave-length, $\lambda = .75\mu$. The full data were reduced by following the simpler course indicated by Drude. In table 1 are recorded the results

TABLE 1
 $\Phi = 60^\circ$

$\lambda(\mu)$	$\Delta_1 - \pi$	Ψ_1	$\Delta_2 - \pi$	Ψ_2	α	γ
.45	29°31'	24°25'	23°11'	35°22'	.03421 - .06887 <i>i</i>	.00318 - .04009 <i>i</i>
.50	27°54'	23°15'	11°52'	34°14'	.04685 - .06168 <i>i</i>	.01853 - .02566 <i>i</i>
.55	20°41'	24°26'	4°26'	32°27'	.04773 - .04156 <i>i</i>	.02729 - .01378 <i>i</i>
.65	21°49'	27° 7'	13°54'	34°12'	.03009 - .04382 <i>i</i>	.01451 - .02530 <i>i</i>
.70	14°38'	26° 7'	11°24'	31°13'	.04226 - .03180 <i>i</i>	.02755 - .02321 <i>i</i>

following the simpler calculations. For comparison, in table 2 are the results yielded by the more rigorous calculation.

TABLE 2

$\lambda (\mu)$	α	γ
.55	.0473 - .0402 <i>i</i>	.0268 - .0142 <i>i</i>
.70	.0417 - .0306 <i>i</i>	.0275 - .0225 <i>i</i>

It remains to calculate the optical constants from these values of α and γ . In Drude's¹⁷ dissertation we have

$$\alpha = a_{11} + ia_{12}$$

$$\beta = a_{21} + ia_{22}$$

$$\gamma = a_{31} + ia_{32}$$

With hexagonal crystals, β becomes equal to α , and so has not entered into our present discussion. Further, we have χ and ϵ which are two auxiliary angles defined by

$$\tan X = \frac{a_{32}}{a_{31}}, \quad \tan \epsilon = \frac{a_{12}}{a_{11}},$$

then the absorption coefficients are given by

$$k_1 = \tan X/2, \quad k_2 = \tan \epsilon/2,$$

¹⁷ Loc. cit. 1887. There is a change in the use of the letters α , β , and γ in Drude's two papers. Careful reading will obviate any confusion.

and the indices of refraction by

$$n_1^2 = \frac{2 (\sin X/2) (\cos^3 X/2)}{a_{32}}, \quad n_2^2 = \frac{2 (\sin \epsilon/2) (\cos^3 \epsilon/2)}{a_{12}},$$

and the reflecting powers by the usual expressions

$$P = \frac{n^2(1+k^2)+1-2n}{n^2(1+k^2)+1+2n},$$

using the subscripts 1 and 2 for the two cases. The results follow in Table 3.

TABLE 3

$\lambda(\mu)$	k_1	n_1	ρ_1	k_2	n_2	ρ_2
.45	.92	3.66	.56	.62	3.06	.39
.50	.51	5.00	.53	.50	3.22	.37
.55	.24	5.56	.50	.37	3.72	.39
.65	.58	5.07	.55	.53	3.84	.44
.70	.36	4.95	.49	.36	4.12	.40
and by the more accurate approximations						
.55	.25	5.57	.51	.37	3.77	.39
.70	.36	4.99	.49	.33	4.18	.42

These data are graphically represented in Figs. 2, 3, and 4.

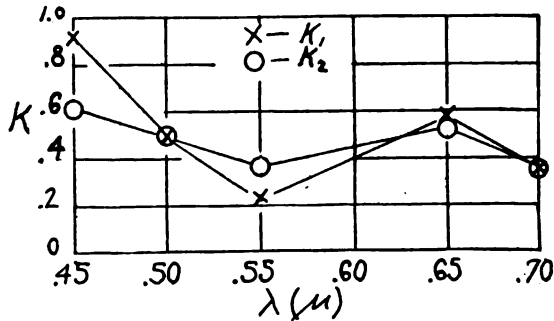

FIG. 2

Variation of the absorption coefficient with the wave-length, in the two principal positions.

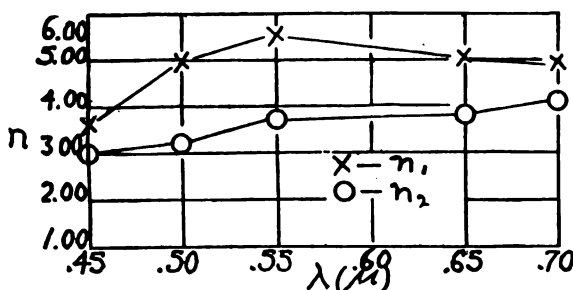

FIG. 3

Variation of the index of refraction with the wave-length in the two principal positions.

III. EXPERIMENTAL DETERMINATION OF THE PRINCIPAL REFLECTING POWERS

Some time ago, following the publication of Skinner's paper, I attempted to check his results by experiment. To measure k and n directly with crystals so small as these is practically out of the question. To use cast selenium as Wood¹⁸ did for the direct determination of n would be begging the whole question. However, the direct measurement of the reflecting powers seemed

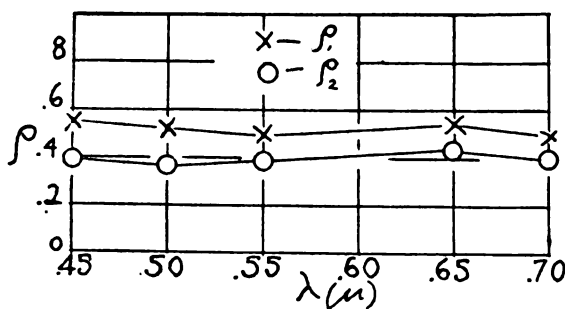

FIG. 4

Variation of the reflecting power with the wave-length in the two principal positions.

feasible and some preliminary results were obtained and published,¹⁹ but they were subject to considerable experimental error, and small reliance was placed in them. Last fall the problem was again attacked, and while it is felt that the results are still far

¹⁸ Wood, Phil. Mag. 3, p. 612; 1902.

¹⁹ Sieg, Proc. Ia. Acad. Sci. 23, p. 179; 1916.

from possessing the accuracy which I should like, they are still much more consistent than were the former values. They at least definitely prove the contention concerning the necessity of working with isolated crystals. The arrangement of the apparatus, shown in elevation is sketched in Fig. 5. Light of the desired

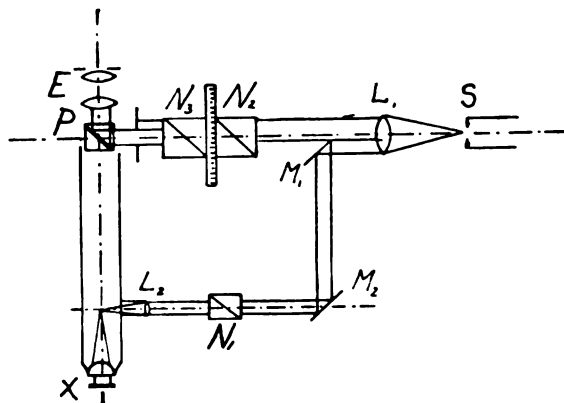

FIG. 5

Arrangement of spectrophotometer for determining the reflecting powers of small surfaces.

wave-length from the slit of the monochromatic illuminator S is made parallel by lens L_1 . A portion of this beam is intercepted by mirror M_1 , and then made by mirror M_2 to pass through Nicol N_1 to the opaque illuminator of the Saveur type in one of the regular metallographic microscopes of Bausch and Lomb. This plane polarized light with the electric vector horizontal was reflected through the objective system (usually an 8 mm objective was employed), and fell normally on the crystal X . In fact this is a cone of light which falls on the crystal, but the angle of the cone is only about 3° , and so for all practical purposes the incidence is normal. The crystal X is mounted on the stage in a special holder, and can be turned, without loss in centering, or in maintenance of plane, so that its long axis is either parallel or perpendicular to the electric vector of the incident polarized light. The reflected light passes up through the tube and forms a real image of the crystal surface on the interface of the double prism P . This image owes its intensity to the magnitude of the reflecting power of the crystal in the particular position it happens to

occupy. The double prism P consists of two small right angled prisms, one of them silvered with the silver film cut into a grid by removing alternate narrow strips of the silver. That portion of the image passing between the strips is viewed by the eyepiece E . The upper portion of the beam from L_1 passes through the two Nicols, N_2 and N_3 , illuminating the silver strips, which are viewed by the same eyepiece E . By adjusting the Nicol N_2 (N_3 set to make the electric vector horizontal) a match in intensity can be made for each wave-length, and for each position of the crystal. With this arrangement, as far as described, only the relative reflecting powers in the two principal positions can be determined. In order to obtain the absolute reflecting powers a piece of glass, backed with silver, is substituted for the crystal at X . The absolute reflecting powers of glass, backed with silver,

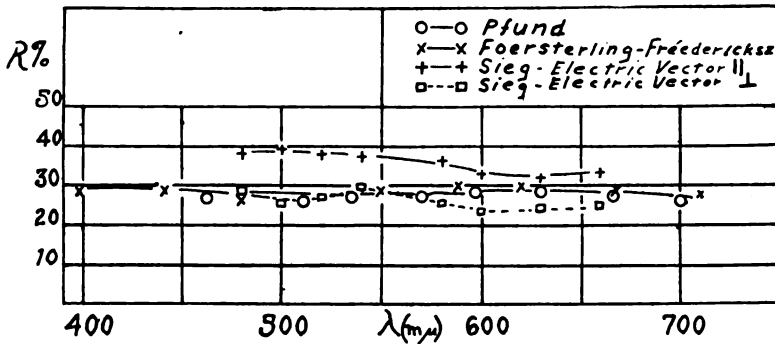

FIG. 6

Experimental determination of the principal reflecting powers of an isolated selenium crystal, compared with previous results on cast selenium plates.

being easily found in physical tables, it becomes a simple matter to translate relative reflecting powers into absolute ones. On account of the loss in light resulting from dividing the beam, and using fairly high magnification, it was not found possible to extend the results very far toward either the red or violet ends of the spectrum. Individual sets of observations were somewhat difficult to repeat with any great accuracy, but by making many different settings, and using several different crystals it is felt that the mean results are correct to 5 to 7 per cent. The extensive original

data will not be presented here. The final mean values are shown in graphical form in Fig. 6. The curves are largely self-explanatory. The data of Foersterling and Freedericksz,²⁰ and of Pfund²¹ are recorded for the sake of comparison with the results of other observers on crystalline selenium in the form of polished plates. The essential point to re-emphasize is that here we have double reflecting powers and that in previous work we have single reflecting powers. That former values are not exactly half way between these double values is of no great moment. An exact mean would imply that the crystals were all lying on their sides, and haphazardly arranged. If any crystals were inclined to the reflecting surface of the plate, then the smaller reflecting power would predominate. In fact recently Grippenber²² concludes that in the process of crystallizing selenium plates, most crystals are formed "end on" to the plane surface. This agrees well with the results shown in Fig. 6, as previous values are distinctly below the average position of my results.

It happens that my data agree somewhat better with Skinner's results than with Weld's, but there is no vast difference between them. Weld was chiefly concerned with the development of an accurate instrument for the determination of optical data for small crystals, and his results on selenium were largely intended to be illustrative. They were very accurate, but if one were to make that the chief job, he would have to obtain more data, particularly using various angles of incidence. At that, however, I consider the calculated values from Weld's data as more reliable than the experimental results. I have been pleased enough to find that experiment yielded results of the proper order of magnitude.

UNIVERSITY OF IOWA,
APRIL, 1922

²⁰ Ann. der Phys. 43, p. 1227; 1914.

²¹ Pfund, Phys. Zeit. 10, p. 340; 1909.

²² Grippenber, Phys. Zeit. 22, p. 281; 1921.

SOME OF HUYGENS' CONTRIBUTIONS TO DIOPTRICS,
WITH NOTES

BY
JAMES P. C. SOUTHALL

The beginning of the seventeenth century is a notable epoch in the history of optical science. The greater astronomer Tycho Brahe died in 1601 before the invention of the telescope which in the hands of Galileo (1564–1642) and his contemporaries and successors led to so many celestial discoveries. By 1604 Kepler (1571–1630), who is sometimes called the “father of modern optics” had published his “Paralipomena in Vitellionem seu Astronomiae pars optica,” in which after many painstaking efforts he had obtained with characteristic perspicacity and ingenuity a “one constant” formula for the law of refraction which had baffled all previous investigators, and which may be written as follows:

$$i - r = C \cdot i \cdot \sec r,$$

where i , r denote the angles of incidence and refraction and where C is a constant factor which expressed in terms of the so-called relative index of refraction (n) of the two media apparently has the following form:

$$C = \frac{n-1}{n},$$

as has been pointed out by Dr. Houston in a paper on “The Law of Refraction” published in *Science Progress* (January 1922). By means of this formula, Kepler, using the value $n = 1.317$ for the index of refraction of water, computed (by an ingenious process of successive approximations, as Houston states) the values of the angle of refraction (r) corresponding to arbitrarily assigned values of the angle of incidence (i); and was able to show that the calculated results were in fairly close agreement with the measurements which Vitellio had made about 1270. When the angles

are so small that we may write $\sin i = i$, $\sin r = r$, Kepler's formula becomes $i = n.r$, in perfect agreement, therefore, with the exact formula $\sin i = n.\sin r$ under the same circumstances. Both Alhazen (who is said to have died in 1038) and Vitellio tried to find by their experiments a law for the ratio of the corresponding angles of incidence and refraction, and they were aware that this ratio was approximately constant for comparatively small values of these angles. A Jesuit writer named Kircher in a book called "Ars magna" published in 1646 gives a table of corresponding values of the angles of incidence and refraction for air-water as found by Christoph Scheiner (1573-1650), who was a contemporary of Kepler and Galileo and like them one of the pioneers in the development of optical science. But although neither Kepler nor Scheiner succeeded in ascertaining the true law of refraction, it is indeed remarkable what keen insight into the nature of optical phenomena each of these men possessed and how accurate their conclusions were in most instances. No one can read Kepler's famous little treatise entitled "Dioptrice" (1611) or Scheiner's even more extraordinary work called "Oculus sive fundamentum opticum" (1619) without being impressed again and again by this fact. One explanation of their achievements may be found perhaps in the circumstance that the optical problems which they encountered were concerned chiefly with the procedure of the so-called paraxial or central rays for which the approximate formula $i = n.r$ is sufficiently accurate. In Prop. LIX of the "Dioptrice," for example, Kepler states that "the surface of a dense medium which will refract parallel rays to a real focus in a less dense medium is approximately hyperbolic." Had he but known the exact law of refraction, he could have omitted the word "approximately"!

Christiaan Huygens (1629-1695) was more fortunate in this regard than his predecessors mentioned above; for by the time he came of age the law of refraction in terms of the sines of the angles of incidence and refraction had been announced by Descartes (1596-1650), although the law itself was probably discovered first by Huygens' own countryman Snellius (1591-1626). At intervals during nearly the whole of an illustrious and fruitful

career in nearly every branch of natural philosophy Huygens was at work on a treatise on "Dioptrica" containing his theorems and original contributions in this domain of optical science. It was begun in 1652 when he was twenty-three years old, and he was continually adding to it, revising it, and sometimes planning to rewrite it entirely in consequence of new discoveries and new points of view; and so it was never actually completed. His famous "Traité de la lumière," which was written as early as 1678 but not published until 1690, does not attempt to go in detail into the theory of mirrors and lenses, and is entirely distinct from the "Dioptrica." This latter work in the imperfect state in which Huygens left it appeared first in the posthumous edition of his writings which was published in Leiden in 1703. In 1888 the Dutch Society of Sciences began the publication of the monumental edition of Huygens' complete works. The thirteenth volume¹ entitled "Dioptrique" was issued in 1916 and comprises, with introduction, notes, etc., more than a thousand pages. Besides containing some hitherto unpublished portions of the "Dioptrica," the valuable explanations and comments of the accomplished editor contribute to make this huge volume a veritable depository of varied and accurate information particularly in regard to the early development of optics.

Unfortunately, not a few of Huygens' original and sometimes most valuable theorems in optics did not come to light until long after they were obtained. Consequently, he lost the priority of a number of important discoveries. It would be beyond the scope of this paper to enumerate them all, much less to discuss each of them in detail.

In the very first part of the "Dioptrica," Huygens treats at great length the problem of refraction at a spherical surface. It is worth noting with what elegance and skill—far in advance of his contemporaries in this respect—Huygens derives from the recently discovered law of refraction the fundamental laws of optical imagery in the limiting case when the effective rays are nearly normal to the refracting surface. Thus, for example, for a

¹ Œuvres complètes de Christiaan Huygens publiées par la Société Hollandaise des Sciences. Tome treizième. Dioptrique. La Haye; 1916.

pair of conjugate points (M, M') on the axis of a spherical refracting surface (with its vertex at A and centre at C), Huygens gives the following general rule:²

$$MF : MA = MC : MM',$$

where F designates the position on the axis AC of the first focal point (Huygens calls the focal points "puncta concursus vel dispersus"); that is, the distances measured from the axial object-point M to each of the points F, A, C and M' taken in order form a proportion. Likewise, in the case of a lens of negligible thickness with its optical centre at a point which may be designated here equally by A or C, the rule becomes:

$$MF : MA = MA : MM'.$$

If these propositions had been published about 1653 when they were first obtained by Huygens, he would certainly have had the priority for them. They were communicated in an anagram to the Royal Society in 1669, but at that very time Dr. Isaac Barrow's "Lectiones Opticae" was in the press, in which were to be found essentially the same theorems derived in a different way. But Huygens had the idea of equivalent lenses which Barrow did not. When the "Dioptrica" was first published in 1703, other writers also, notably Molyneux and Halley³ in England, had given rules which were practically the same as those of Huygens.

Of much interest too is Huygens' way of defining and measuring the magnifying power of an optical instrument, by which he means the ratio of the apparent size of the object as seen through the instrument of its apparent size as presented to the unaided eye. This ratio is found by comparing the dimensions obtained by projecting the object in each instance on a fixed plane at right angles to the line of sight, for example, on a transversal plane in contact with one of the lens-surfaces. One advantage of this mode of reckoning is that it can be employed for any position of the eye, no matter whether the image can be seen distinctly or not by an

² *Loc. cit.*, pp. 40, foll.

³ Molyneux's "Dioptrica nova" (1692), pp. 42, 48, 63 and 68. Also article by Halley on "An Instance of the Excellence of the Modern Algebra, in the Resolution of the Problem of finding the Foci of Optick Glasses universally": *Phil. Transactions*, 17, pp. 960-969; 1693.

actual eye at the place in question. The general method can be illustrated in a simple way by an optical system composed of a thin lens in combination with the eye of an observer. Let O, O' designate the positions of a pair of conjugate points on the axis of the lens, and let f denote the focal length of the lens, reckoned positive or negative according as the lens is convergent or divergent, respectively. Suppose that the observer's eye (or, more exactly, a specified point in his eye) is placed at O' . An incident ray proceeding from a point Q in the object and directed towards (or away from) the point O will meet the lens at a point B and be bent there into the eye at O' . Let K designate the point where the straight line QO' meets the lens, and let A designate the optical centre of the thin lens; then the ratio $AB:AK$ is Huygens' measure of the magnifying power for this particular position of the eye. Finally, if M designates the foot of the perpendicular let fall from Q on the lens-axis, and if $u = AM$ and $c = AO'$ denote the distances of M and O' from the lens, it may easily be seen that for this optical system the following formula holds:

$$\text{Magnifying power} = \frac{AB}{AK} = \frac{(c-u)f}{uc + (c-u)f}.$$

This expression is entirely general and true for a convergent lens ($f > 0$) or a divergent lens ($f < 0$) and for a real or virtual object; provided only the abscissae u, c and f are reckoned positive or negative according as they are measured one way or the other along the axis. Naturally, in any actual case the point O' where the eye is placed will be always on the far side of the lens. Huygens himself treats each case separately, but, as has been said, the results can all be summed up in the above formula. Incidentally, it may be remarked that the points designated here by O, O' in nearly all actual cases of a single lens used in conjunction with the eye correspond to the centres of the so-called "entrance-pupil" and "exit-pupil" of the compound optical system. Huygens was perfectly aware of the convenience and importance of these points and of the effect of the pupils in limiting the apertures of the bundles of effective rays; and he constantly makes use of these ideas which are usually regarded as quite modern.

The beautiful theorem which states that the apparent size of an object as seen through a lens-system will not be altered when the positions of the eye and the object are mutually interchanged, and which is given in Robert Smith's "Compleat System of Opticks" (London, 1738), is to be found⁴ in the second book of the first part of Huygens' "Tractatus de refractione et telescopiis" (1635); and although it was not actually published until 1703, there can be no question that Huygens is entitled to the priority here.⁵ Moreover, he constantly makes use of this general principle in the solution of optical problems. For instance, in the third book of the treatise on refraction and telescopes (pp. 255-257, 261) this theorem is employed to show that the magnifying power of a telescope may be measured by the ratio of the diameter of the object-glass to that of the so-called "eye-ring" which is the image of the object-glass in the ocular. In fact, in order to see this, we have merely to suppose that the eye is placed at the centre of the "eye-ring" while the object is infinitely far away. If now the positions of eye and object are supposed to be reversed, a little reflection will show that according to Huygens' theorem the magnifying power of the instrument must be equal to the ratio above mentioned.

In connection with the problem of refraction at a spherical surface, Huygens repeatedly⁶ calls attention to the existence of a remarkable pair of points J, J' which lie on any straight line passing through the centre C of the surface and which are distinguished by the fact that *all* incident rays which intersect, "really" or "virtually," in J will, after refraction, intersect again, "virtually" or "really," respectively, in the corresponding point J'. The positions of these points may be precisely defined as lying on a straight line drawn through the centre C and at distances from C such that

$$CJ = n \cdot AC = n \cdot r, \quad n \cdot CJ' = AC = r;$$

where A designates the point where the straight line meets the side of the surface on which the light falls, and where n denotes the relative index of refraction from the first medium to the

⁴ *Loc. cit.*, pp. 198, foll.

⁵ See J. O. S. A. & R. S. I., 6, p. 293, 1922.

⁶ *Loc. cit.*, pp. 48, foll.

second and r , as usual, denotes the radius AC. The points J, J' are thus seen to lie both always on the same side of the centre and on the opposite sides of it from the point A. If the incident rays intersect "really" in J, the refracted rays will intersect "virtually" in J', and *vice versa*. According to the above definition, we must have the relation:

$$CJ \cdot CJ' = r^2;$$

which means geometrically that the points J, J' are the "inverse" points of the sphere and are therefore harmonically separated by the end-points A, B of the diameter AB on which they lie. The points J, J' on the optical axis are the pair of so-called aplanatic points of the spherical refracting surface; and in fact they are "aplanatic" not merely in the sense that the surface is absolutely free from spherical aberration with respect to them but also in the wider meaning of that term as it was afterwards employed by Abbe and his disciples; because the rays which are refracted at a spherical surface from J to J' likewise satisfy the so-called "sine condition."

The first portion of Huygens' "Dioptrica" in which particular attention is called to this unique pair of corresponding points in the case of a spherical refracting surface was composed by Huygens in 1653, but Huygens takes pains to say that they had been discovered by him "a long time ago," and recalls a letter which he wrote to van Schooten in 1652 wherein he explained how under certain circumstances one of the ovals of Descartes becomes "a perfect circle."

The first practical application of the properties of the aplanatic points of a spherical refracting surface was made by Amici (about 1840) in the construction of high-power microscope objectives. Perhaps this is why the discovery of these points was formerly attributed to him. But Thomas Young had called attention to them as early as 1802 and most modern writers assign the credit to him. A recent writer⁸ states that Young re-discovered them

⁷ He makes the same statement again in his "Treatise on Light," the last chapter of which is devoted to a discussion of the Cartesian ovals and the forms of aplanatic optical surfaces and aplanatic lenses. See S. P. Thompson's English translation, London, p. 114; 1912.

⁸ M. L. Dunoyer: "Optique ondulatoire et optique géométrique," *Journ. de Phys.*, Ser. VI, 2, pp. 258-264; 1921.

after Huygens and suggests that "perhaps Descartes himself was aware of them through his ovals."

Perhaps it will not be without interest to show that a sphere is a particular form of the general aplanatic surface. The condition that a refracting surface shall be aplanatic with respect to a given pair of points J, J' , that is, the condition that light proceeding from (or towards) a prescribed point J in one medium shall be accurately refracted to another prescribed point J' in a contiguous medium, is:

$$n \cdot PJ' - PJ = \text{a constant,}$$

where P designates the position of a point on the surface in question and n denotes the relative index of refraction. The form of the required surface may readily be found in certain special cases. For instance, when the constant above is equal to zero, the condition becomes:

$$n \cdot PJ' = PJ.$$

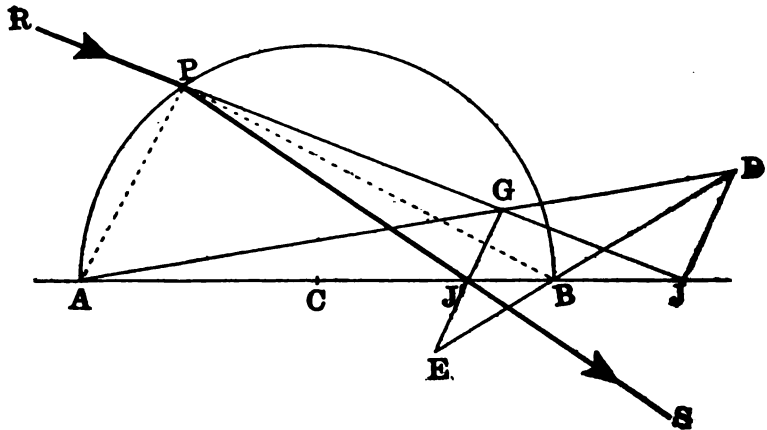

FIG. 1

Construction of Aplanatic Points J, J' of a Spherical Refracting Surface: $AC=r, CJ=nr, CJ'=r/n$.

The locus of the point P which satisfies this condition is a problem of elementary geometry which may be solved as follows:

Through the given points J, J' (Fig. 1) draw a pair of parallel straight lines $JD, J'G$. On the first of these lines take a point D , and on the other line find a point G on the same side of the straight line JJ' as D such that $JD : J'G = n$. Produce GJ' on the other

side of JJ' to a point E such that $EJ' = J'G$; and therefore also $JD : EJ' = n$. Draw the straight lines DG and DE meeting JJ' in A and B , respectively. Since the triangles AJD , $AJ'G$ and BJD , $BJ'E$ are two pairs of similar triangles, it follows that

$$\frac{AJ}{AJ'} = n = \frac{BJ}{J'B};$$

and consequently A and B are seen to be two points on the required locus. Suppose P is another such point; then by hypothesis $PJ : PJ' = n$; and therefore $PJ : PJ' = AJ : AJ' = BJ : J'B$. Accordingly, PB and PA must be the bisectors of the internal and external angles at P in the triangle JPJ' . Hence, the angle APB is a right angle and the locus of P is the circle described on AB as diameter. Therefore the aplanatic surface in this case is a sphere

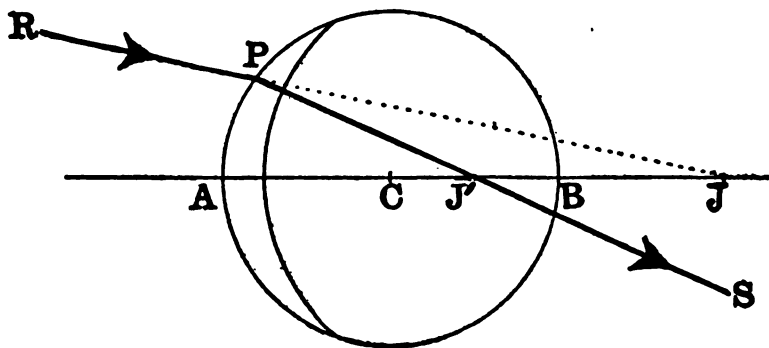

FIG. 2
Aplanatic Glass Lens: $AC=r$, $CJ=nr$, $CJ'=r/n$ (where n denotes index of glass).

It may be remarked that when the point P is so situated on the circumference of the circle that the sides PJ and CP of the triangle CPJ form a right angle, PJ' will also be perpendicular to CJ at J' . Consequently, the effective portion of the spherical refracting surface above the diameter AB will be the part comprised between the vertex A and this limiting position of the incidence-point P . Thus the maximum apertures of the two homocentric bundles of corresponding rays will be equal to twice the critical angle for the two media and the angle π or 180° .

Huygens was not content merely with discovering the existence of the pair of aplanatic points of a spherical refracting surface; but with characteristic thoroughness he proceeds to describe the

form of a glass lens with spherical surfaces which will be aplanatic with respect to a prescribed pair of points J, J' . The axis of the required lens will be determined, of course, by the straight line JJ' . Having divided the line-segment JJ' externally at A and internally at B in the same ratio so that $AJ : AJ' = BJ : J'B = n$, and having described a circle on AB as diameter (just as above), we may describe a second circle around J' as centre with a radius somewhat less than $J'A$. This circle will determine by its intersection with the first circle the form of a meridian section of a convex meniscus lens (Fig. 2) which will be aplanatic with respect to J and J' . Or merely interchanging the letters J and J' without changing the first circle, we may describe a second circle around J as centre with a radius somewhat greater than JA , and so determine the section of a concave meniscus lens which will be aplanatic with respect to J and J' , as shown in Fig. 3. In both forms the

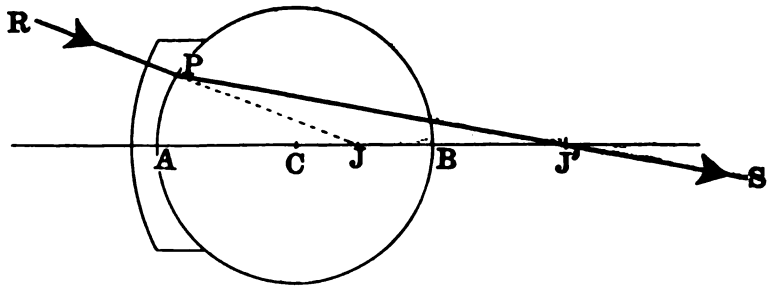

FIG. 3

Aplanatic Glass Lens: $AC = r$, $CJ = r/n$, $CJ' = nr$ (where n denotes index of glass).

two aplanatic points will lie on the same side of the lens, so that we can construct: (1) A convex meniscus lens which will render a converging (or diverging) bundle of incident rays more convergent (or less divergent); and (2) A concave meniscus lens which will render a converging (or diverging) bundle of incident rays less convergent (or more divergent); in each case supposing that the rays fall first on the convex (or concave) side of the lens.

One other point remains to be mentioned in connection with this subject. Both Huygens in his "Dioptrica" and Isaac Barrow in his "Lectiones opticae" (1669)⁹ are at pains to give a special

⁹ See Whewell's edition of Barrow's "Mathematical Works" (Cambridge, 1860), "Lectiones opticae," Lect. XI, II, p. 96.

geometrical construction for the important case when a ray is refracted at a spherical surface. Barrow's method is much more complicated than the simple and elegant construction which is to be found in Thomas Young's "Lectures on Natural Philosophy" (London, 1807) and which was obtained independently long afterwards by Weierstrass (1858) and still later by Lippich (1877). The accompanying diagram (Fig. 4) shows Huygens' own drawing

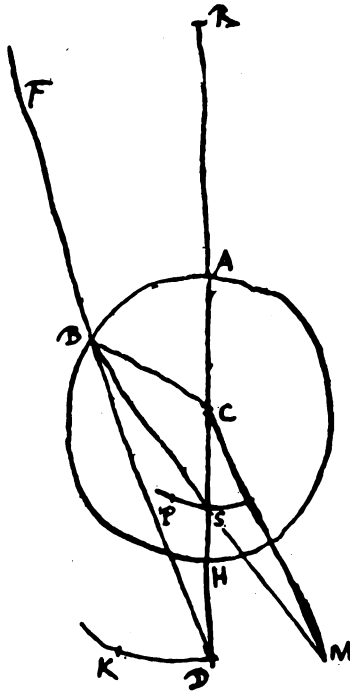

FIG. 4

Huygens' own diagram for showing construction of ray refracted at a spherical surface, by aid of aplanatic points D,S; reproduced from Fig. 27, Vol. XIII of Huygens' *Œuvres complètes*, p. 63.

and lettering in which the pair of aplanatic points on the axis RD of the spherical refracting surface are designated by D and S. Huygens says that if the straight line FB represents an incident ray directed towards the point D and meeting the spherical refracting surface in B, then BS will be the corresponding refracted ray; and "it is manifest that if two spherical surfaces are supposed to be described around the centre C with radii CD and CS, and

if we take two points K, P on these surfaces lying on the same radius CK, all rays aimed towards the point K will be refracted at the surface ABH of the transparent body so that they will converge exactly towards the point P." This is certainly entirely equivalent to Young's construction, although it should not be necessary to draw the straight line CM parallel to the incident ray FB, in order to prove it, as Huygens does.

The early telescope-makers, like Huygens, encountered the problem of spherical aberration in the object-glass of the instrument, and they bestowed much labour on trying to improve this troublesome source of error. Huygens devotes a large part of the "Dioptrica" to the study of this intricate subject and some of the formulæ which he derives are equivalent to those found in the modern treatises. But it would be impossible to go in detail into all these matters here. Huygens had also very clear and accurate ideas about the mechanism of vision and physiological optics which it would take a separate article to discuss properly.

In conclusion it may be remarked here that a very good idea of the spherical aberration of a lens-system can be obtained by calculating the difference between the lengths of the optical paths along a so-called "edge-ray" and along the optical axis. As this method does not appear to be generally known, perhaps a brief outline of it will not be out of place here, particularly as it is connected with the subject of aplanatism which has been discussed above in certain special cases.

Consider a centered system of m spherical refracting surfaces; let the centre and vertex of the k th surface be designated by C_k and A_k , respectively, where k may denote any integer from 1 to m , inclusive. Let n_k denote the absolute index of refraction of the medium comprised between the $(k-1)$ th and k th surfaces. The axial thickness of the medium of index n_{k+1} will be denoted by $d_k = A_k A_{k+1}$; and the radius of the k th surface by $r_k = A_k C_k$. A ray of light crossing the axis in the first medium at a point L_1 at an angle θ_1 meets the first surface at a point B_1 whose distance from the axis will be denoted by h_1 ; this ray is refracted from one surface to the next and crosses the axis before refraction at the k th surface at a point L_k making with the axis an angle $A_k L_k B_k = \theta_k$,

where B_k designates the point where the ray meets the k th surface. The distance of the point B_k from the axis is denoted by

$$h_k = r_k \cdot \sin(\alpha_k - \theta_k),$$

where α_k denotes the angle of incidence at this surface; the angles α_k and θ_k being both acute angles and reckoned positive or negative according as the sense of rotation is counter-clockwise or the reverse. Finally, the ray emerges at the last surface and crosses the axis at the point L_{m+1} . The length of the optical path from L_1 to L_{m+1} along the axis is:

$$n_1 \cdot L_1 A_1 + n_2 \cdot A_1 A_2 + n_3 \cdot A_2 A_3 + \dots + n_{m+1} \cdot A_m L_{m+1};$$

whereas the length of the optical path between the same two points along the "edge-ray" will be given by an identical expression except that the letter A is replaced by B .

Evidently,

$$L_1 B_1 = \frac{h_1}{\sin \theta_1}, \quad B_m L_{m+1} = -\frac{h_m}{\sin \theta_{m+1}},$$

and

$$B_k B_{k+1} = \frac{h_{k+1} - h_k}{\sin \theta_{k+1}}.$$

Consequently, if we put

$$A_1 L_1 = v_1, \quad A_m L_{m+1} = v'_m,$$

the difference in length between the optical paths along the "edge-ray" and along the axial ray, expressed in terms of the above symbols, will be:

$$n_1 \left(\frac{h_1}{\sin \theta_1} + v_1 \right) - n_{m+1} \left(\frac{h_m}{\sin \theta_{m+1}} + v'_m \right) + \sum_{k=1}^{k=m} n_k \left(\frac{h_k - h_{k-1}}{\sin \theta_k} - d_{k-1} \right).$$

Accordingly, first of all, the path of the "edge-ray" must be traced through the system by trigonometric computation, whereby the values of the angles α and θ will have been ascertained for each surface, so that these values, together with the corresponding values of h , can be substituted in the expression above. If one of the surfaces is plane, then for that surface $\alpha = \theta$ and h is to be calculated by the formula $h = -v \cdot \tan \theta$, ($r = \infty$), where v denotes the

distance from the plane surface of the point where the ray crosses the axis before refraction at this surface. If the expression above vanishes for the values found in this way, the system will be aplanatic, that is, free from spherical aberration, with respect to the points L_1 and L_{m+1} . In general, however, this will not be the case, that is, the system will be "spherically under-corrected" or "spherically over-corrected" according as the expression above is found to be positive or negative, respectively. It may be possible to make some more or less slight alteration in the optical system, for example, to change the curvature of one of the surfaces, that is, "bend the surface," in such fashion that the difference between the two optical routes will tend to be diminished; and thus gradually we may contrive to vary the system until the spherical aberration has been practically abolished. This is, indeed, a very serviceable method for this purpose. If the variations are introduced in the last member or in one of the latter members, the necessary trigonometrical computations will be reduced, because for all the preceding elements the calculation remains the same.

The expression given above for the difference in length of the optical paths along the "edge-ray" and along the axial ray may also be put in another form as follows:

$$-\sum \frac{n \cdot p \cdot E}{\Pi},$$

where the magnitudes denoted by n , p , E and Π must be known for each surface. Here p denotes the length of the perpendicular let fall from the centre of the surface on the incident ray and n denotes the absolute index of refraction of the medium which is traversed by the incident ray. The magnitudes E and Π are certain functions¹⁰ of the angles of incidence and refraction (α , α') and the slope-angles (θ , θ') of the ray before and after refraction at each surface, which are connected by the invariant-relation:

$$\alpha' - \theta' = \alpha - \theta.$$

These functions are defined as follows:

¹⁰ The function denoted here by E is precisely the same as was employed in a previous paper by the author: *Journ. Opt. Soc. Amer.*, 4, pp. 294-299; 1920.

$$\begin{aligned}
 E &= (\sin\alpha - \sin\theta) - (\sin\alpha' - \sin\theta') \\
 &= -4 \sin \frac{\alpha - \theta}{2} \cdot \sin \frac{\theta - \theta'}{2} \cdot \sin \frac{\alpha + \theta'}{2}; \\
 \Pi &= 4 \cos \frac{\alpha}{2} \cdot \cos \frac{\alpha'}{2} \cdot \cos \frac{\theta}{2} \cdot \cos \frac{\theta'}{2}.
 \end{aligned}$$

When one of the surfaces is plane, then $\alpha = \theta$, $\alpha' = \theta'$ and consequently both E and Π vanish. In this case it will be found that

$$\frac{n \cdot p \cdot E}{\Pi} = \frac{n \cdot h \cdot \sin\theta \cdot \sin \frac{\theta - \theta'}{2} \sin \frac{\theta + \theta'}{2}}{2 \cos^2 \frac{\theta}{2} \cos^2 \frac{\theta'}{2}}, \quad (r = \infty).$$

DEPARTMENT OF PHYSICS,
COLUMBIA UNIVERSITY, NEW YORK, N. Y.,
APRIL 15, 1922.

ACCURACY IN COLOR MATCHING OF INCANDESCENT LIGHT SOURCES

BY
W. E. FORSYTHE

The relative distribution of energy in the visible spectrum of various radiating bodies for different temperatures has long been a matter of interest. There are two methods for obtaining directly such relative distributions in the visible spectrum, the one is by using some form of a spectrophotometer where the comparisons are made by eye observations, the other by using one of the methods where the energy is compared by means of some sort of an energy measuring device.

Owing to the decreasing sensibility of the eye, observations with the spectrophotometer are very difficult at the extreme red or blue end of the spectrum. It is also very difficult to make accurate measurements with a bolometer or thermopile in the extreme blue end of the spectrum.

There is a third method of obtaining such relative distributions that has some advantages over the two mentioned above. This method consists in matching in color the light from the source studied with that from a black body or other standard source. Such comparisons can be very accurately made with the ordinary Lummer-Brodhun contrast photometer. To do this the source studied is mounted on one side of the photometer and a comparison lamp on the other side. Suppose that at the start the comparison lamp is too low; then when there is a brightness match the trapezoid that is illuminated by the comparison lamp will appear reddish as compared with the other, which appears bluish. If now the voltage applied to the comparison lamp is raised a small amount and at the same time the photometer moved so that there is an intensity match, as observed in the photometer, the comparison trapezoid will, if the change has not been too great, appear less reddish than before. By repeating this process the comparison

lamp can be very accurately matched in color with the source being studied. The source being studied is now to be removed and replaced with the standard lamp and the process repeated just as before excepting that in this case the voltage applied to the standard lamp is to be varied and the comparison kept constant at the voltage above obtained. Thus the standard source can be brought to a color match with the comparison source. In this way the source studied and the standard lamp are color matched by the substitution method. It has been found experimentally that a black body and most radiating solids can thus be color matched. Also most of the flames that have been used as light sources can be color matched with the black body. However, the Welsbach gas lamp and the sources that do not have a continuous spectrum cannot be so compared. For any source that can be color matched with the standard, the distribution of energy in the visible spectrum can be obtained much more accurately and with much less work than by either of the other methods, as will be shown below.

Color matching by different observers. In order to see how different observers would agree in their setting, two lamps were color matched by the substitution method by a number of observers. All the observers except one made three sets of five readings each on the voltage of the two lamps for color match with a third lamp of the same type held at a constant voltage.

In Table 1 are given the results of this test. The first three observers as listed in the table had had considerable experience with this kind of work. The fourth observer had had some previous experience while the last two had had no previous experience. The color temperature of the lamps used in this and the following test was about 2400° K. The illumination on the photometer screen for this test was 5.1 foot candles. The averages of the voltages obtained in each set by each observer for lamp No. 4 to color match lamp No. 5 at 105 volts are given. There is also given the mean variation in volts for the different readings for the different observers. An examination of the table will show that the maximum range in the three sets for any of the experienced observers is less than 0.4 volt. The range in the

TABLE 1

Values obtained for color matching lamp No. 5 against lamp No. 4 by a number of observers

Observer	Volts for color match mean of three readings	Mean of three sets	Mean variation in volts
F.E.C. 1	103.39	103.57	0.19
2	.60		
3	.71		
A.H.T. 1	103.72	103.69	0.25
2	.71		
3	.66		
W.E.F. 1	103.80	103.68	0.13
2	.45		
3	.79		
R. S. 1	103.78	103.63	0.31
2	.47		
R.D. 1	104.43	103.75	0.20
2	103.30		
3	.51		
I.K. 1	103.15	103.15	0.28
2	103.49		
3	102.81		

averages of the three sets for these same observers is only about one tenth volt. The maximum range in the averages for all the observers is only about five tenths volt. A change of one volt at this point corresponds to a change in color temperature of about 8° K. It can thus be seen that the maximum range for inexperienced observers corresponds to about 4° K. A range of 4° K at this temperature corresponds to an error of about 0.6% in relative energy between the red ($\lambda = .665 \mu$) and the blue ($\lambda = .467 \mu$). This is much better than the accuracy generally claimed in spectral distribution work.

The photometer used in making the color matches is of the Lummer-Brodhun contrast type having a contrast of about eight per cent. The reason for using this type is because it has been

found to be much easier to make color matches with a contrast photometer. However, such matches can be made with an ordinary equality of brightness photometer. To see if any differences would be obtained several sets were made with a photometer having a contrast of about three and one half per cent. Although it seemed much harder to make color matches with this photometer, the final results were in very good agreement with those obtained with the other photometer.

Color matching at different intensities of illumination on the photometer screen. A test was also made to find out what accuracy could be expected in such work for different intensities of illumination on the photometer screen. In this test, different observers made quite a number of color matches for different illuminations on the photometer screen using in every case two tungsten lamps so that there would be no question as to the exactness of color match. The range of illumination on the photometer screen was from 1.8 ft. candles to 45 ft. candles.

Since it would require too much time and be too great a strain on the eyes for an observer to make readings at each of the intensities of illuminations at one time the following method was adopted. A set of readings was made each time at an illumination of 2.8 ft. candles taken as the standard and at one other illumination. In this way, the readings for each of the illuminations can be compared with the standard illumination. Two complete sets of readings were made at each illumination by each observer. In the first set, five readings were made at the standard illumination and then five at one of the other illuminations. In the second set of readings, three sets of three readings each were made at the standard illumination and alternating with these two sets were made at one of the other illuminations. The mean variations in volts in the readings on lamp No. 5 for color match with a standard lamp operated at a constant voltage for the different illuminations are given in Table 2. The variations for the standard illumination is given along with the variations for the other illuminations taken in the same set. The observers in the test with one change were the same as those used in the first test. The additional observer had had no previous experience.

If there is any difference in the accuracy depending upon the illuminations, it is not very definitely shown by the data. There are slight indications that observer No. 1 sets better at low illumination and observer No. 3 better at high illumination. However, the difference is but little more than their error in setting.

The average variations of the entire group is given for the different illuminations and they show no very definite advantage for either the high or the low illumination. As before, one volt change corresponds to a change of about 8°K , color temperature.

TABLE 2
Mean variation in readings in volts for color matching at different intensities by a number of observers

Set..... Illumination in ft. candles.....	I		II		III		IV		V	
	2.8	45.1	2.8	25.8	2.8	11.3	2.8	6.3	2.8	1.8
Observers	Mean variations in volts in readings									
F.E.C.....	.16	.22	.17	.20	.10	.21	.22	.09	.18	.13
A.H.T.....	.22	.21	.24	.19	.15	.24	.28	.12	.17	.15
W.E.F.....	.21	.15	.20	.13	.21	.16	.18	.22	.24	.14
R.H.S.....	.22	.11	.32	.23	.42	.21	.22	.13	.15	.21
L.B.....	.22	.10	.26	.15	.29	.18	.25	.27	.25	.23
R. D.....	.20	.12	.16	.24	.23	.26	.17	.30	.10	.20
Average mean variation at each illumination....		.15		.19		.21		.19	.22	.18

From the above results it can be seen that very good agreement can be obtained in making color matches by different observers. There does not seem to be any great advantage in having a high illumination on the photometer screen. Ordinarily in this laboratory in making color matches an illumination of from four to eight foot candles on the photometer screen is used. As was mentioned above the Lummer-Brodhun contrast photometer having a contrast of about eight per cent is used because it seems easier to make color matches with that contrast than with a contrast of about three and one half per cent. It is our intention to test this matter out using different degrees of contrast both above and below this amount.

The color temperature scale above 2650°K used in this laboratory depends on readings made with an optical pyrometer having first a red and then a blue screen in the eyepiece on a black body. The black body was the one designed by Dr. Worthing¹ of this laboratory and consisted of a small tungsten tube with small radial holes for the purpose of observation.

The temperature of the black body was determined from the reading when the red glass was used as a screen and the ratio of the red to the blue brightness gave the color temperature scale. To explain this, suppose that at a temperature of 2800°K the readings on the black body gave a ratio of red to blue brightness, on an arbitrary scale, of 0.6. Now if at some unknown temperature tungsten was found to give the same red to blue brightness it would be said to have a color temperature of 2800°K. By taking a number of such readings both on the black body and on tungsten a color temperature scale for tungsten was determined. This method of determining color temperature together with the accuracy that can be obtained will be more fully discussed in a paper now in the process of preparation.

At the Bureau of Standards the color temperature scale in this region depends upon radiometric measurements made by Dr. Coblentz in the visible spectrum of a particular 500 watt gas-filled tungsten lamp.² Mr. Priest, by using the rotary dispersion of quartz, has extended the scale above the temperature corresponding to the energy distribution found by Dr. Coblentz.

Comparison of color scale of Nela Research Laboratories with that of the Bureau of Standards. Two tungsten lamps were color matched against the color standards of this laboratory and then sent to the Bureau of Standards, where they were color matched against their color standards by Mr. Priest. One of the lamps was then returned to this laboratory where it was again color matched. The Bureau of Standards also sent a high efficiency lamp to this laboratory for a like check. The results are given in Table 3.

¹ A. G. Worthing, *Phy. Rev. N. S.* 10, 377; 1917.

² *J. O. S. A., & R. S. I.*, 6, pp. 30-34; Jan., 1922.

TABLE 3
Intercomparison of Color Scales

LAMP	COLOR TEMPERATURE DEGREES KELVIN			
	Nela	Bureau of Standards	Nela	Bureau of Standards
900 watt movie	3091	3085	3083	
500 watt gas-filled			2848	2848

The good agreement obtained in the two laboratories (although the actual figures obtained were probably accidental) by two different methods in two different laboratories shows the agreement possible in such work.

SUMMARY

Two tests have been made of accuracy that can be obtained in color matching. The first test was for different observers. It was found that experienced observers agreed in their values for color match to about 3°K for a color temperature of about 2400°K. The second test was for color matching for different illuminations on the photometer screen. No very great difference was obtained in the accuracy for a range in illumination from 1.8 foot candles to 45 foot candles.

The color temperature scale for a temperature of about 2900°K of this Laboratory was compared with that of the Bureau of Standards and a very good agreement found.

NELA RESEARCH LABORATORIES,
 CLEVELAND, OHIO,
 MARCH, 1922

INSTRUMENT SECTION

COOPERATION BETWEEN THE MAKERS AND THE USERS OF APPARATUS IN AMERICA¹

BY
F. K. RICHTMYER

As I was thinking over some remarks which might be appropriate to this occasion, I chanced to recall the address given by Professor Anthony Zeleny upon his retirement as vice-president of Section B of the American Association for the Advancement of Science at the Columbus meeting in 1915. Dr. Zeleny spoke on "The Dependence of Progress in Science on the Development of Instruments." Although the address was written for presentation to a group of Physicists, its reading again at this occasion not only would be very appropriate, but would supply about all that need be said.

Two paragraphs from this address may well serve as the keynote for this evening's discussion:

"Real progress in science ultimately rests upon the establishment of facts. We are sure to stray from reality unless (our reasoning faculties) are continually guided by observation and experiment. Galileo, with his experimental methods contributed more to science than did all the generations preceding him.

"Observations made with our unaided senses limit us to the most superficial aspects of natural phenomena but when we bring scientific instruments to our aid—not only are we enabled to observe more accurately and more systematically all that our senses ordinarily perceive, but we become endowed with new senses that open up fields of knowledge of which otherwise we could not even have dreamed."

¹ Presented on the occasion of the joint dinner of the Association of Scientific Apparatus Makers of America and the American Physical Society in Washington, April 21, 1922. Published by request.

And then after calling attention to the debt which science owes to the chemical balance, the Rowland grating, precision temperature measurement, etc., he continues, "I wonder whether we appreciate what we owe to the great accessibility of manufactured materials. What a luxury we have in insulated wire! How could we do without glass tubing!" Research depends not only on good apparatus; but on the availability of high grade manufactured materials. The rapid progress of science today, as compared with fifty or one hundred years ago, is due in no small part to these conveniences. Faraday to energize his electromagnet, had to build up his battery fresh every morning. Today we close a switch, watch an ammeter, forgetting the source of our electrical energy.

But I take it that no one questions Dr. Zeleny's thesis that science owes much to scientific apparatus and materials; and if to these, then to the manufacturers of apparatus and materials. And this further statement likewise seems to me to need no proof: that one of the most important factors in promoting a healthy growth of Science in America is that these two groups, the makers of apparatus and the users of apparatus, should join hands in building up an industry for the manufacture of whatever the American scientist or teacher may need to supply his every demand.

One of the arguments frequently advanced for increasing our facilities for Apparatus manufacture is that in the event of war we should thereby be independent of foreign manufacturers and should be able to furnish our scientists with adequate facilities. One cannot deny the force of this argument, for it has been said that the next war will be a scientists' war and we shall need not only scientists of the highest calibre, but unlimited facilities for them to carry on their work. Three years ago many of us would have been inclined to scoff at this argument. The "Great War" was the last war that the human race would ever see.

But now we are less optimistic over the final abolition of war than we were on January 1st, 1919. We have seen the humiliating spectacle of party politics, of personal ambition, of national

* Science, 43, p. 185; 1916.

jealousy, both here and abroad, influencing men's votes and their better judgment on questions of humanity and world welfare. And we realize that, in spite of the awful experiences of four years, the human race is just what it was in 1914. Truly, we are settling down to "normalcy."

But I believe that arguments of this kind can be pushed too far. There are those of us who feel that one of our sister sciences (I am speaking as a Physicist) has rather over-emphasized the "war cry" reason for developing certain branches of that science. Surely no one will dispute the assertion that the fundamental object of science is not to prepare nations to fight each other, but instead to assist in advancing that rather indefinable thing which we call "civilization." We cannot expect American science to experience a healthy, normal growth unless we keep always foremost in our minds this fundamental object. If we must think of preparation for war, let us push this thought as far in the background as possible. For, just as the experience of a century has taught us that that scientist makes greatest progress who takes up his problems with never a thought as to the application of the results of his investigations to the every-day affairs of life, so American science, from apparatus manufacture to the research laboratory, must base its development on far higher motives than preparing for war. Perhaps the old Pilgrim exhortation "Trust in God, but keep your powder dry" is good modern philosophy.

I do not believe that we have to seek far to find weighty reasons for manufacturing in America all instruments needed by American scientists. I am going to pass over the argument that we must buy in America because our money is earned here, since, whether good economic theory or not, the argument is probably not taken seriously by the average investigator, even though he be intensely patriotic. Nor is the argument that American markets are much more accessible than foreign markets of importance, since it is no more trouble to write and mail an order to Europe than to New York City. And a box received from Europe is as easily unpacked as one from New York.

A far more important line of thought is that which is based upon the conviction, which I at any rate entertain, that a great day

will have been reached in American science when we achieve scientific independence in so far as the manufacture of our tools is concerned. Groups of people are strangely like individuals. The boy who builds his own wireless set gets infinitely more of pleasure and profit than if he were supplied with a ready made set. With the latter he may be able to get more radio. But if the object in providing him with a set is to develop his ingenuity and his general well being ten or twenty years hence he will be encouraged to build his own set even though it take more of his time and much more money.

As with the individual so with the group. With our limited financial resources, we may be able just now to buy more apparatus in the cheaper foreign markets than in America and therewith to do more research. But if we neglect or fail to encourage our own apparatus industry, what will be the effect on American science ten or twenty years hence? Perhaps foreign apparatus always will be cheaper. Perhaps we may always have a foreign supply available. But we must remember that apparatus alone does not make an investigator. Every European visitor to our laboratories marvels at the extent of our equipment. Yet it is universally conceded that, taken as a whole, American research lacks that real fundamental character found in so many centers in Europe. Why this is so I make no attempt to analyze. There are many contributing factors. But certainly the pride and satisfaction which would result from the stamp "Made in America" on all of our apparatus would produce a feeling of confidence which would materially assist our scientific growth. Or to put it in the negative, if one really stops to think of it, one must experience a slight feeling of chagrin when one's investigations, however fundamental, are made possible only by the availability of foreign made apparatus.

I do not wish to be understood as appealing to selfish patriotism. For scientists are perhaps more international than any other group. But nations, like individuals, must retain their own individuality. We can best contribute our quota to world science by contributing it as American scientists. For if, thereby, we can build up a national scientific spirit, we may be able to bring

about a larger appreciation on the part of our public of the value of and the necessity for scientific research. How many, who now pay one hundred dollars for a wireless set and from the morris chair at their own fireside listen to concerts, speeches, weather, market and crop reports, ever give a thought to the decades of research by thousands of men whose combined efforts have produced this modern marvel. The public has become so accustomed to these startling developments that it regards "inventions" as springing full grown from the brain of some scientific genius who locks himself up in his room, conjures with his scientific tools and—behold the result!

I believe, then, that American science will have taken a long step forward when the makers of apparatus, encouraged and supported by the users, set as their goal the manufacture of everything needed in this country, for research and teaching. But if this much desired condition is to be brought about, close and sympathetic cooperation between these two groups, the makers and the users, is absolutely essential. It is obvious that we cannot expect makers of apparatus to take much of an interest, except a financial one, in supplying the demands of the users, if the latter are indifferent or even hostile. On the contrary the users cannot be expected to support the makers if the former feel that financial gain is the sole object of the latter. As a matter of fact, all that is needed is that these two groups should come to know each other better, to appreciate each other's problems, and to view each other's work with sympathetic understanding. Such mutual misunderstandings, if any, as now exist are, I am sure, entirely the result of ignorance on the part of each group, of conditions which the other must face.

For example, to be perfectly frank, the makers of apparatus, quite naturally, are not at all pleased when they see users buying in foreign markets apparatus and supplies which might be purchased here in America. But it is human nature to buy where one can buy cheapest. And I am sure that if the makers of apparatus could see, in detail, the problem which our universities and colleges face, of making very limited financial resources cover the ever growing demand for adequate facilities for instruction and

research, they would realize the pressure thus brought to bear to buy where the market is cheapest.

On the contrary the user of apparatus very frequently underestimates cost of manufacture, particularly if special work is involved. This is perfectly natural since in universities and colleges where mechanics are at work on special jobs frequently the only costs *apparently* involved are those of materials. No overhead nor interest on investment need be charged; and, in many cases, even the salary of the mechanic is paid out of general university funds, so that no accounting of it need be made on the department budget. To cite a specific instance, a government Department—it was not the Bureau of Standards—recently asked a certain company to build a special piece of apparatus, asking that an estimate be submitted in advance. The quotation submitted was actually one-third of what the company estimated the probable cost to be, charging neither overhead nor profit. The bid was accepted, but with the statement that the price asked was exorbitant! We must not forget that makers of apparatus, in America at least, have neither endowment nor Government subsidy. But that on the contrary they must make a reasonable profit, otherwise their business cannot continue.

It may be possible artificially to stimulate the American apparatus industry by abolishing the privilege of duty-free importation. But I believe that this is not a matter of much importance so far as the present discussion is concerned. No tariff can possibly make the user of apparatus understand the problems which the manufacturer must face. Nor will it give to the maker of apparatus anything more than a passing interest in the user. Far better would it be ultimately to bring about such a condition of mutual understanding and support as would make a tariff *unnecessary*. Whether this can be done depends entirely on future cooperation, the beginnings of which have been made this evening. Cannot some definite steps be taken to get together, and to keep working together, the three groups of people interested in science in America: the manufacturers of apparatus, the scientists who use the apparatus, and, most important, the public which, in the long run, reaps the benefits of scientific work?

ITHACA, N. Y.

APRIL 21, 1922

A FIELD TELEMETER FOR APPROXIMATE SURVEYING¹

BY
I. C. GARDNER

In the construction of a map on a large open scale there are generally numerous details in the neighborhood of each station which must be located by some approximate method of surveying. To estimate the distances to the points is not sufficiently accurate and to occupy each point by a man with a stadia rod may in some cases be impracticable and in any case involves a large expenditure of time. The problem presented is an ideal one for the self-contained base range finder as developed for military fire control but such an instrument is expensive and furthermore involves the labor of an additional man in carrying it from station to station.

To meet these demands the very light portable device shown in the illustrations was designed. Each instrument consists essentially of a small telescope mounted on a base and with a slow motion screw affording a limited motion in azimuth. When the two instruments are clamped, one at each end of a stadia rod, the whole constitutes a simple self-contained range finder with the stadia rod as a base. Although the angular measurements are necessarily approximate with such a simple piece of apparatus yet the long base enables the requisite accuracy to be obtained for the short distances at which it is intended to be used.

The method of using the instrument is illustrated in Fig. 1. The length AB represents the stadia rod which serves as the base of the triangle. The two telescopes are at the two vertices C and D. After clamping the telescopes on the rod their optical axes are brought into parallelism by means of the slow motion devices on each instrument. The entire assembly comprising the stadia

¹ Published by permission of Director, Bureau of Standards. This instrument was designed and constructed by the Bureau of Standards, at the request of the Topographic Branch, U. S. Geological Survey, Department of the Interior.

rod and the two instruments is then rotated in azimuth as a unit until the telescope C bearing the fixed crosswire is brought upon the target. By means of the micrometer the angle m is measured and from this the distance to the target can be determined by reference to a table computed in advance giving range in terms of the reading of the micrometer screw.

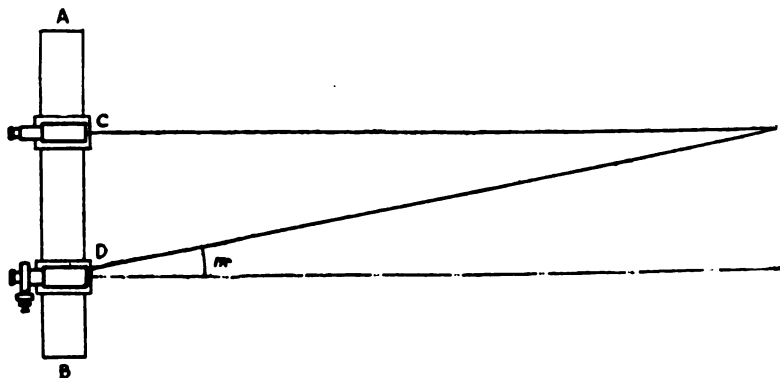

FIG. 1
Fundamental range finding triangle

Some special means is necessary by which the telescopes may be brought into parallelism and for this a device commonly used in the self-contained range finder is adopted. This is shown in Fig. 2. The two penta prisms E and F are placed in front of the telescopes and are of such thickness that they transmit light to the lower half of each objective. On the outer face of each penta prism there is cemented a positive lens as shown at G and H. The focal lengths of these lenses are equal to the distance between the two instruments when clamped on the stadia rod, i.e., 11 feet for the pair of instruments which have been constructed; and each lens bears a vertical mark. If the eye of the observer is placed in the upper half of the exit pupil of either telescope the mark carried on the lens of the other instrument will be in focus. When each instrument is directed so that its cross-wires coincide with the mark on the other instrument the two lines of sight will be parallel if the sum of the deviations of the two penta prisms is 180 degrees. If the penta prisms are not so matched the departure from paral-

lelism can be determined once for all and applied in the calibration table. It should be noted that this method of adjustment is independent of any displacement of the penta prism since any such displacement affects the alignment of both instruments equally. This arises from the fact that the black mark serving as target is carried by the lens. Consequently a shift of the lens moves the target for one instrument and moves the lens through which the other instrument views the target. These two effects compensate each other exactly.

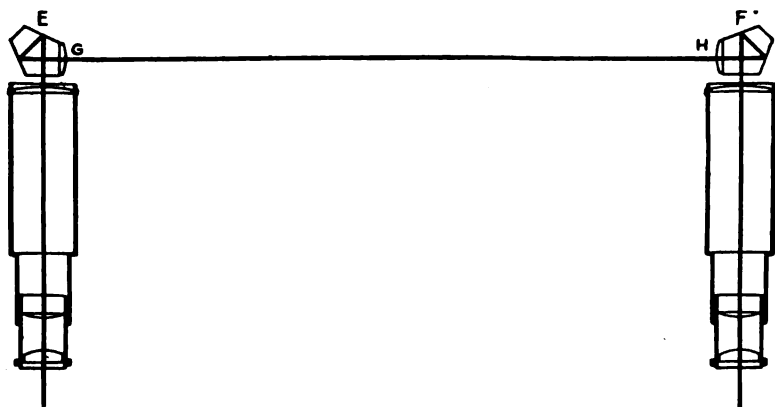

FIG. 2
Method of adjustment

In use the complete assembly will generally be supported at each end on tripods which will ordinarily be available and the observations will be made simultaneously by observers at each end of the stadia rod. The adjustment for parallelism is readily made before each observation. The penta prisms remain in front of the objectives when the observations are made upon a remote target, the upper half of each objective being used in the latter case. It was found convenient to place two washers with spherical surfaces between the base of each instrument and the stadia rod in such a manner that they form a simple ball joint with a restricted range of motion. By means of the ball joint any trouble due to sagging or twisting of the stadia rod is eliminated. It is necessary that the setting for parallelism and the setting on the target be

made at the intersections of the cross wires and the use of the ball joint greatly facilitates this adjustment.

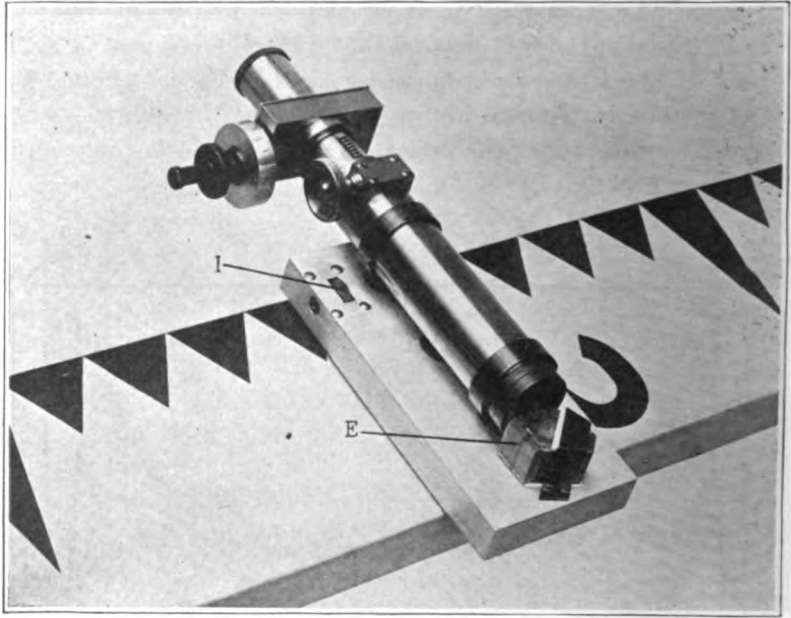

FIG. 3
Instrument mounted on stadia rod

With careful work under favorable conditions, it has been found that the error of angular measurement may be kept under thirty seconds. The corresponding range errors for different ranges will be as follows:

Range Ft.	Error Ft.
1000	13
2000	53
3000	119
4000	211

The telescopes which were used in the sample instruments have objectives 20 mm in diameter and magnify 5.5 times. Appropriate plates are mounted on the stadia rod for the attachment of

the instrument and a base length of 11 feet is provided. Fig. 3 shows one of the instruments on the end of the stadia rod and Fig. 4 shows the pair of telescopes. The penta prisms are at E

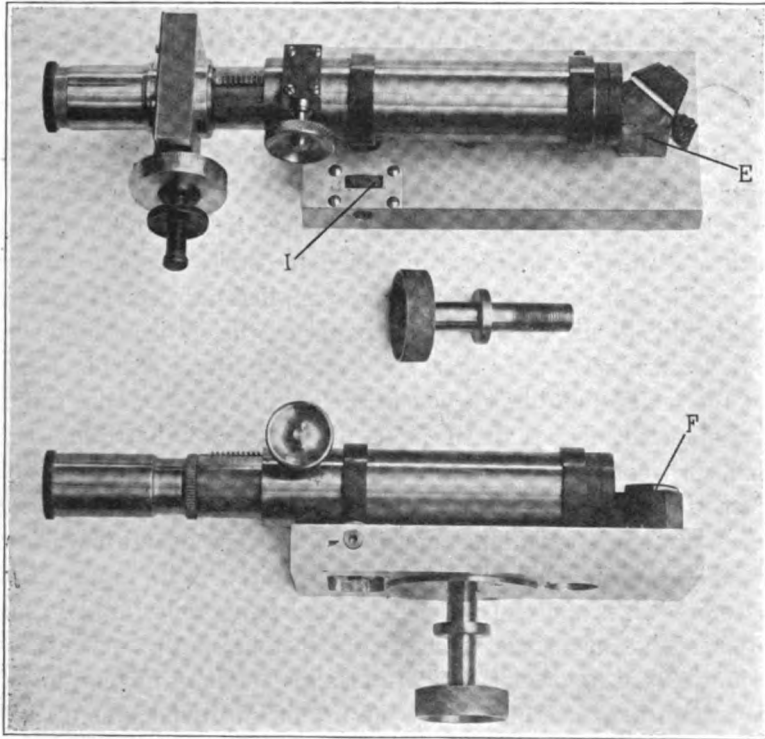

FIG. 4
The pair of instruments

and F. The slow motion screw by which the telescope is brought into parallelism is shown at I.

BUREAU OF STANDARDS,
MARCH 25, 1922

ON THE CHARACTERISTICS OF OPTICAL SYSTEMS FOR READING SMALL MIRROR DEFLECTIONS

BY
G. W. MOFFITT

Optical systems intended for use in reading angular displacements of the rotating parts of instruments may be grouped in two general classes—those in which the moving part is equipped with a concave mirror and those in which it carries a plane mirror. The problem of the concave mirror so applied has been treated in considerable detail, an interesting paper on the subject being that by E. H. Rayner.¹ One gathers from a perusal of this paper that the scale should be curved to the arc of a circle whose radius is considerably less than the scale distance, and that when this has been done the readable deflections may have large values before the optical performance breaks down. A system having these characteristics might conceivably be very useful in various special cases but would necessarily be limited in its application. Therefore it is proposed to consider in this paper only those optical systems suitable for use with instruments having plane mirrors. Various arrangements of optical parts are, or may be, employed. The advantages accruing from the use of improved systems will be pointed out.

The telescope and scale usually supplied with the ordinary galvanometer is quite satisfactory for small and moderate deflections. But while the length of scale appearing in the field of view is sufficient for the reading of steady deflections it may not be all that could be desired for the reading of ballistic excursions of comparatively short period. Moreover, if the scale be a straight one it goes more and more out of focus with increasing deflection. The blurring due to this cause may not be noticeable, for the accommodative power of the eye comes into play unconsciously,

¹ Proc. Opt. Convention, 1912.

but the parallax relative to the cross-wire remains and introduces uncertainty in the readings. Fortunately, at least in the case of many galvanometers, it is desirable to use a curved scale in order to render the calibration more nearly linear. This reduces the out-of-focus effects for large deflections but will not entirely eliminate them unless the scale be circular and with its center at the mirror. But all instruments are not galvanometers and sometimes the straight scale is the only correct one. Certainly it is the least troublesome to establish and maintain in adjustment. Thus the ordinary telescope and scale may not be as satisfactory as could be desired even in many of those cases where the dimensions of the mirror do not enter as a factor seriously affecting the performance of the system.

In nearly every instrument depending upon a central restoring couple for its action the moment of inertia of the moving part enters detrimentally. Sometimes the mirror is responsible for a goodly part of this inertia. Therefore a small mirror is desirable and sometimes absolutely necessary. To secure satisfactory results with small mirrors requires proper design of the reading system, and even when the system is properly designed the limitation on illumination imposed by the small mirror cannot be removed. For this reason a definite limit exists beyond which it is not practical to go in the reduction of the mirror size unless excessive scale illumination can be employed. It is easy to see that this is so. For in any system containing a small mirror (1 or 2 mm) this mirror will certainly be the limiting stop. From each point of the scale a certain quantity of light energy reaches the mirror. Nothing can be done after the light beam has been reflected from the mirror to increase this flux and therefore, with a given magnification, all arrangements which put this flux into the pupil of the eye will have the same theoretical image brightness. Assuming a total magnification of about two diameters, the best that can be had with a mirror 2 mm. in diameter is an image brightness about 1/40th of the scale brightness.

There remain for consideration (1) the elimination of mirror and of objective limitations on the field of view, (2) the elimination of out-of-focus effects, and (3) the control of calibration.

LAMP AND SCALE

While this paper is intended to be primarily a discussion of telescopic systems of scale reading a few words may be in order on the lamp and scale. This device has gained greatly in favor of recent years for it possesses all the convenience of projection methods in general. Unfortunately it is also afflicted with the limitations of these methods. It has comparatively low precision and in an attempt to overcome this limitation inconvenient scale distances are not infrequently employed. The problem of sufficient illumination is also troublesome if the mirror be very small, but in this respect all reading systems are closely limited. In spite of its faults it seems to serve quite well enough for ordinary purposes especially with zero methods. Small movements of a comparatively poor image may be easily detected when a precise reading of the setting would be impossible.

Personal preference and physical limitations sometimes enter into the choice of a deflection reading system. For instance, a near-sighted person would not be likely to choose the lamp and scale in preference to a good telescope and scale for with the latter he would be able to place the image where he could see it best.

The lenses used in conjunction with lamp and scale are usually simple uncorrected ones. Some improvement in definition, and therefore in precision, as well as a certain amount of control over the calibration may result from the use of properly designed corrected lenses. Even with the simple lens the correct form and position will help considerably.

SMALL ORDINARY TELESCOPE AND SCALE

The use of a small ordinary telescope may or may not result in satisfactory performance. When the scale and the objective are at approximately the same distance from the mirror the total length of scale which it is possible to see in the field of view is equal to the sum of the diameters of the mirror and of the objective. Obviously then a decrease in the diameter of these parts will produce a corresponding decrease in the available field. The width of the vignetted annular portion of the field will cover a length of the scale equal to the diameter of the objective, and it may

easily happen that no part of the field can be seen at full illumination. These effects become apparent when the dimensions of the mirror and of the objective are such that the field of view fixed by them does not fill the field of the ocular. They become serious when the mirror is smaller than that carried by the ordinary galvanometer.

MODIFIED SMALL TELESCOPE AND SCALE

Since the total available field obtainable with an ordinary small telescope may show a length of scale equal to the sum of the diameters of the mirror and of the objective one might be led to think that any decrease in mirror size could be compensated by a corresponding increase in the objective diameter. But such is not the case, for the objectives of ordinary telescopes should be, and usually are, of a diameter equal to the magnification multiplied by the diameter of the pupil of the eye. Thus the image of the objective fills the pupil and any light passing through the outer zones of a larger objective could not enter the eye.

It is, of course, well known that the image of the effective stop must fall in the pupil of the eye if stop limitations of field are to be removed. When the ordinary small telescope is used the mirror will be imaged so far forward that the pupil of the eye cannot be properly placed to receive it. The obvious remedy is to weaken the field lens of the ocular to such an extent that the image of the mirror will be brought back to the proper position. Full correction will often require the use of a negative field lens. Dispensing with the field lens helps considerably, and many of the telescopes supplied with the better grade galvanometers are so constructed. This leaves the ocular a simple magnifier with all the shortcomings of an eye-piece of that type. It is usually sufficiently good for the field of view required of it. If it does not prove satisfactory a properly designed achromat may be used instead.

Thus may the field limitations of the mirror be removed. But those of the objectives still remain. If the length of the scale visible in the field of view is not enough the size of the telescope may be increased. That is, the focal length of the objective may be increased and the telescope advanced towards the mirror, the ocular being simultaneously modified to hold the desired magni-

fication and exit pupil position. In this way the angle subtended at the mirror by the objective may be increased and the field limitations of the objective reduced or removed. It may not be necessary to increase the size of the objective to accomplish this result. The increase in general dimensions of the telescope will have a beneficial effect on the performance of the simple ocular.

BUILT-IN OBJECTIVE WITH OCULAR AND SCALE

There are limits beyond which it is not practical to go in the lengthening of a reading telescope. Moreover the tendency to go out of focus for large deflections with straight scale cannot be overcome in any of the systems already considered. Practically nothing can be done with them to modify the calibration curve of the instrument. It therefore occurs to one to do away with the traditional telescope and devise an optical system which may not look like a telescope but which will meet the desired requirements.

By the use of a correctly designed objective mounted on the instrument near the mirror in combination with a scale and a special ocular carried on the scale support it is possible to eliminate mirror and objective limitations on the field of view and at the same time to maintain the focus and freedom from parallax for large deflections, and also to gain some control over the form of the calibration curve. The problem of the design of this special objective is somewhat similar to that of the single achromat to be used with front stop as a photographic objective. The correction for the out-of-focus effects corresponds to the flattening of the field. The control of the calibration curve corresponds to the control of distortion. Just how much can be done in modifying the calibration curve actual design alone will determine.

Since the built-in objective works at practically unit magnification the demands on the ocular are light. And for the same reason the cross-wires may be made much coarser than in an ordinary telescope. If the scale is to appear twice as large as it does when viewed at reading distance by the unaided eye the focal length of the ocular will be about 10 cm. Double this power may be used if desired and still retain a good field of view.

Two ocular systems claim attention. The one consists of a simple lens of about 10 cm focal length mounted at the proper

place within a tube carrying the cross-wire at one end and the eye-ring at the other. With this very simple ocular good results may be obtained provided the field of view required is not too large. The second ocular is of the Kellner type with simple lenses of about 10 cm focal length and separation such that the cross-wires may be dispensed with and cross-lines ruled on the flat surface of the field lens instead. The advantage accruing from the use of the large Kellner ocular is the improved definition over a wide field of view which is very desirable in ballistic work. However, the field lens must be of considerable size for the image of the scale coincident with its flat face is of natural size and if 5 cm of the scale are to be seen the lens must have a horizontal dimension of the same magnitude. It need not be round however but may be narrow in the vertical dimension in order to avoid obstructing the view of the central portion of the scale. In this case the ocular housing would assume the form of a flat triangular box with the field lens as the front side and the eye-ring at the rear corner.

A scale reading device of this kind is also suitable for use with lamp and scale without change. In fact it should perform better than the ordinary lamp and scale because of the properly designed and corrected lens. It would have the same type of calibration and the flatness of field that it has when used with the ocular.

SUMMARY

1. The shortcomings of the various deflection reading devices in use with plane mirrors are considered. The use of an ordinary small reading telescope leads to a restricted field of view due either to mirror limitations, or objective limitations, or to both of these.

2. The mirror limitations on image brightness cannot be eliminated when very small mirrors are required.

3. All reasonable field limitations may be removed by proper design.

4. A special construction using a "built-in" objective on the instrument may have no limitations on field. Out-of-focus effects with straight scale are removed and a certain amount of control over the calibration realized. The system may be used with lamp and scale if desired.

ROCHESTER, N. Y.,
FEBRUARY, 1922

CONTACT RESISTANCE

BY
IRVING B. SMITH

The instrument maker's art while bound by certain conventions, has of necessity to conform to the requirements of science. Consequently there are various fundamentals of design and construction to be understood and embodied in every well conceived scientific instrument.

We are gradually ignoring many of those conventions which have in them no essential reason for existence. We have outdistanced the tailor, who still puts buttons on the backs of our coats, but we cannot, however, afford to consider only utilitarian purposes in design and construction. There are certain constructions that remain as the hall-mark of good work; constructions that give pleasure to the conscientious maker and satisfaction to the user; constructions that bring the maker and user together with a sympathetic feeling that some things are worth while for their own sake. We still make binding posts with carefully fitted parts although the expense of doing so is not returned in better operation or more useful application. We put our best efforts into producing materials of high finish and designs of pleasing appearance as a matter of pride while knowing that necessities of service do not require such work. These points offer a means of personal expression tending to elevate the instrument maker's art to an altruistic plane. We hope they will endure.

But, as stated before, there are certain fundamentals, dictated by science and good engineering, that we must always observe if we would produce apparatus of true worth. Knowledge of these requirements should be the common property of all instrument makers and it should be the duty of each of us to aid in the dissemination of this information. These prefatory remarks are a sufficient apology for offering, in the following pages, a rather fragmentary report on the subject of this paper namely, Contact

Resistance. Contacts between similar or dissimilar electrically conducting materials enter so largely into the construction of instruments as to warrant their careful consideration. The writer has not had sufficient experience to present the subject with the completeness that it warrants but he believes that there is contained herein a considerable amount of data that will be of value to those who design or construct electrical measuring instruments.

In many cases the method of measurement employed is such that the actual resistance values of one or more contacts enter as an error in the measured result. Consider, for example, the measurement of resistance by comparison with known resistances employing the method of Wheatstone's Bridge. This process of

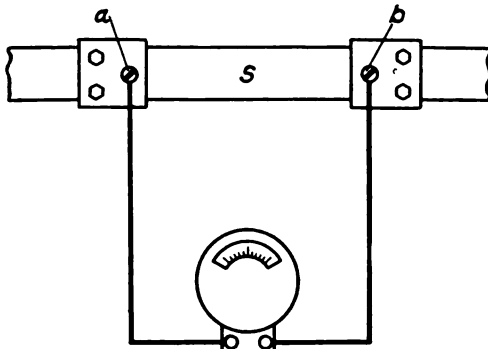

FIG. 1

Millivoltmeter and shunt for measuring heavy currents. Leads are clamped to shunt potential terminals and their resistance and also the contact resistances where attached to the shunt enter into the calibration of the meter.

comparison demands the adjustment of the standard resistances to equality with the unknown or to some determinate ratio. This adjustment may be made with plugs or switches and the result is affected by the actual contact resistances or by changes in contact resistance.

In the measurement of current, by noting the potential drop across a fixed low resistance carrying the current to be measured, errors may arise from contact resistance at the potential points or may be occasioned by a change in current distribution arising from varying resistance at the shunt terminals. For example, a millivoltmeter connected as indicated in Fig. 1 to a shunt S by

means of leads attached to terminal screws *a* and *b* will have its calibration affected if the contact resistances at *a* and *b* vary. Taking the millivoltmeter resistance including leads as 2 ohms, an increase of $.001\Omega$ at each contact point *a* and *b* would produce an error in calibration of $1/10$ of 1%.

On the other hand there are methods of measurement wherein the actual contact resistance does not cause a direct error. Take, as an instance, the measurement of a potential difference with a potentiometer. Here, the contact elements consisting of switches, plugs or sliders may have a considerable contact resistance without producing an appreciable error in the measurement since the variable contacts may be so arranged as to enter into the galvano-

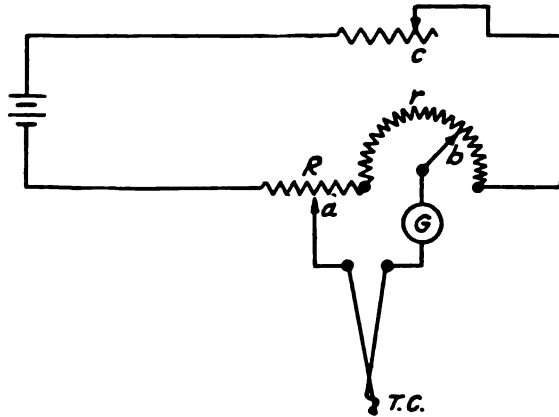

FIG. 2

Simple potentiometer circuit. Standard cell has been omitted. Contacts at *a* and *b* are in the galvanometer circuit and only introduce an error to the extent that they lessen the deflection of the galvanometer for a small unbalance.

meter circuit and not into the potentiometer circuit proper. The effect of this arrangement may be to reduce somewhat the sensitivity of the indicator but not the accuracy of the measurement. Referring to Fig. 2, which is a diagram of a simple potentiometer circuit such as one frequently employs for measuring temperature, the thermocouple T. C. is in series with the galvanometer G and the two sliding contacts *a* and *b* are adjusted until the galvanometer indicates no current through its circuit. Since the reading is taken at the time of no current through the contacts *a* and *b*, it is

not material whether these contacts vary in resistance excepting that if they increase too much in resistance they will reduce the sensitivity of the instrument and hence the precision of setting. For example, with a thermocouple circuit resistance of 40 ohms, an increase in resistance of 5Ω at each point *a* and *b* will reduce the sensitivity 25%. If, therefore, the instrument normally was sufficiently sensitive so that a variation of $.01^{\circ}\text{C}$. was noticeable, it will now be sensitive only to $.0125^{\circ}\text{C}$. It is evident from this that the contact variation impairs the measurement relatively but a small amount. In other cases the effect of contact resistance may be solely a mechanical one and its elimination or lessening may be demanded because of the chance of causing mechanical damage. Bus bars with insufficient area of contact, where clamped together, or where attached to other electrical apparatus, may occasion the production of an amount of heat at the junction great enough to exceed a safe operating temperature. It is evident from this brief discussion that many elements enter into the design and construction of contacts.

The writer, in line with his work for the company with which he is connected, has compiled a data book devoted to the subject of contact resistances. These data have served a useful purpose in the design of electrical measuring instruments. While it is recognized that the notes are fragmentary and the subject by no means exhaustively treated, it is hoped that a brief review of the more important items in this record may be of value to readers of this journal in presenting at least approximate values for the contact resistances usually encountered.

For convenience of reference, contacts have been classified under eight heads. This is arbitrary and more or less artificial since the various types of contact cannot be rigidly separated into classes, each possessing its own peculiar physical characteristics. For example, knife switches partake of the nature of clamped contacts when closed and sliding contacts when being opened and closed. As an approximate guide, resistance values have been set opposite various types of contact, in the following classification, to enable one to form a judgment of the probable value of the resistance to be expected.

CLASSIFICATION OF CONTACTS

A.— <i>Soldered, Brazed, Welded Contacts</i>	
Shunt Terminals	
Resistance Coil Terminals	
Thermocouples	
B.— <i>Clamped Contacts</i>	
Bus Bars	
Binding Posts0002Ω to .0004Ω
C. Clamp or Equivalent00008Ω to .0001Ω
Track Bond000025Ω up
C.— <i>Spring Contacts</i>	
Knife Switches, small0003Ω to .0001Ω
Dial Switches00004Ω to .0001Ω
Sliders on Wires012Ω to .003Ω
Sliders on Spirals021Ω to .00013Ω
D.— <i>Pressure Contacts</i>	
Keys01Ω to .0001Ω
Relays01Ω to .0001Ω
Knife Edges16Ω to .006Ω
E.— <i>Plug Contacts</i>	
Taper Plugs0007Ω to .00002Ω
Split Plugs	
F.— <i>Moving Contacts</i>	
Slip Rings5Ω to .0025Ω
Governors03Ω to .006Ω
G.— <i>Mercury Contacts</i>	
Copper Links000004Ω up
H.— <i>Earth Contacts</i>	
Rods and Plates	1000Ω to 10Ω

Ludwig Binder (Elekn. Masch. Sept., 1912) in testing between steel balls or between a steel ball and plates of copper, lead or carbon concludes that the nature of resistance at the point of contact is not that of an air or liquid film if the contacts are dry but a true ohmic resistance due to there being but a few points in actual contact. In many practical cases, however, the contact resistance arises from contamination of the surfaces in contact due to chemical action or the presence of foreign substances such as grease or dirt. This phase of the subject, however, we are not considering in the following pages.

In making the following measurements either a fall of potential method was employed or else a Kelvin Bridge method. When employing the first method the connections were as shown in Fig. 3 where the current was supplied by the battery B and measured

by the ammeter *A*. Potential points *C* and *D* were provided by drilling a clearance hole to the point indicated and soldering in insulated wires in such a manner that they were in contact only at their ends. The current was usually less than an ampere and the galvanometer *G* was calibrated to read microvolts. The battery current was reversed to eliminate Peltier effect. The resistance of the conductors between the potential points could in general be neglected. For example, when measuring the contact resistance between a brass block 1 inch in diameter and a brass plate there was less than 3/16 inch of length of brass between the potential points. Its resistance value, of about .0000008 Ω was neglected.

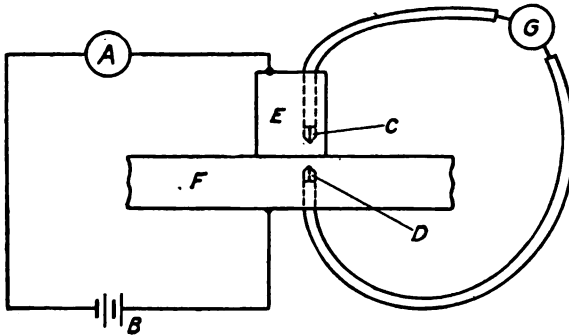

FIG. 3

The contact resistance between brass block *C* and brass plate *D* is determined by measuring the current through the contact by means of the ammeter *A* and the potential drop across the contact by galvanometer *G*. The block *C* was of round brass 2.5 cm in diameter milled off square and polished with emery cloth. The brass plate was commercial rolled plate with face polished with emery cloth.

In the determination of the contact resistance of switches and binding posts a similar method was employed. In measurements on binding posts the potential points were arranged as indicated in Fig. 4. The potential wires were of silk insulated copper No. 32 B. & S. Gage and the clearance holes small in order to change the current flow lines as little as possible. It will be noted that in this method the contact resistance measured is really that of two resistances in series whereas in actual use the two resistances are in parallel. It is assumed that a fair measure of contact resistance will be gotten by dividing the measured value by two rather than by four.

In the determination of the contact resistance of plugs the Kelvin Bridge method was used. The connections were in accordance with Fig. 5 where holes were drilled in the brass blocks at C and D to such a depth that the bottoms were within 1 mm of the

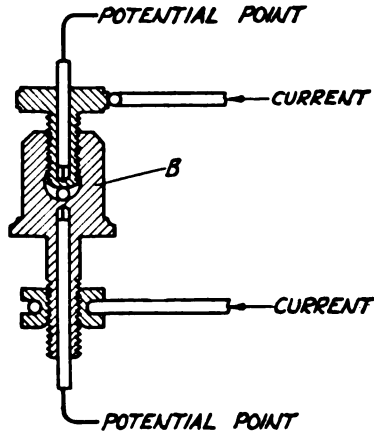

FIG. 4

In measuring the contact resistance of binding posts the current passes through the screw and wire clamped under the post, thence through the body of the post. Potential points are placed, one near the bottom of the screw and one near the bottom of the hole in the body of the post. It is assumed that the contact resistance so measured is double the value to be found in the normal use of the post.

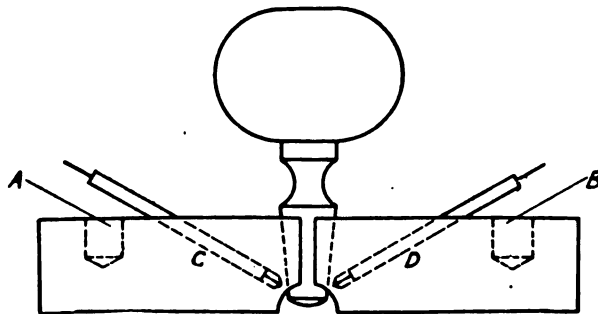

FIG. 5

In measuring plug resistances the potential points are brought close to the plug surface at C and D. The current terminals are at A and B.

surface of the plug. A very small amount of mercury was placed in each hole and insulated copper wires made contact only at their ends with the mercury. These served as potential points. The current entered the mercury cup at A and left at B. The measure-

ments were generally taken with a small current since most of the apparatus was for use in electrical measurements where the current values were practically always small. Variations in the measuring current, however, from $\frac{1}{2}$ to 3 amperes produced only a small change in the contact resistance measured. For example, in measuring the contact resistance of a phosphor bronze laminated dial switch, the measuring current was varied from 1 ampere to 2.5 amperes resulting in a change in contact from .000175 to .000184 ohms.

It was concluded from this and similar measurements that for the purposes of this investigation the variation of resistance with the current could be neglected since the current in actual service was in general small.

A. SOLDERED, BRAZED, WELDED CONTACTS

Pieces of round brass and copper rod were squared on the milling machine and joined butt on with commercial soft solder. The solder itself 2.5 mm in diameter had a resistance of .0003 ω per cm of length and as an element in the joint resistance of two quarter inch rods would be less than .8 microhm. Knife edge potential points at a fixed distance apart, were placed first so as to span a section of the rod not including a joint and then so as to include a joint. For two 6 mm diameter brass rods the joint resistance measured .000003 Ω . For two 3 mm diameter copper rods the joint resistance measured .000004 Ω . These measurements should have been repeatedly checked but time prevented. They will, however, serve to give one an idea of the order of magnitude of such resistance.

B. CLAMPED CONTACTS

To study the effect of pressure on clamped contacts, a number of brass blocks were squared off carefully and pressed against a smooth brass plate. The pressure was varied by means of weights and the area of apparent surface contact was varied by employing blocks of different diameter. The actual areas of opposed surfaces do not, of course, determine the area of the contacting parts since it is impossible so to machine the surfaces as to insure contact at all points. It is, therefore, difficult to determine the true

relations between contact resistance, area and pressure. However, most curves have the form shown in Fig. 6 where the resistance is comparatively high for light pressures and bears a nearly linear relation to the pressure until some value is reached where subsequent increase in pressure does not lower the resistance greatly. Curve A was obtained with surfaces that were polished just before testing. Curve B was for the same surfaces exposed to the atmosphere over night. The materials in contact were respectively a large brass plate and a brass block 2.5 cm in diameter. This in-

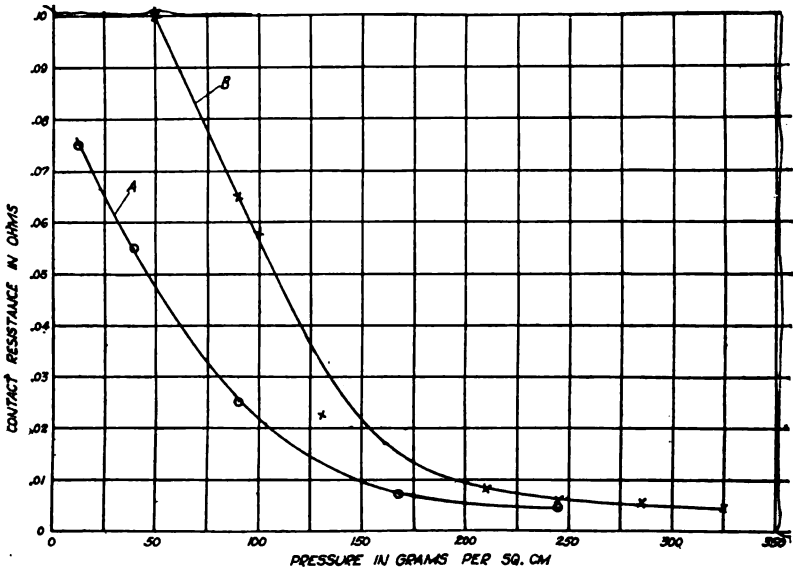

FIG. 6

These curves were the results of tests on the metal blocks shown in Fig. 3. The current was held steady at a known value and the fall of potential measured by a galvanometer. The blocks were both of brass.

indicates that at a pressure of about 200 grams per sq. cm of apparent contact surface the contact resistance reduces to $.005\Omega$. Additional experiments with more accurately finished contact surfaces resulted in reducing the contact resistance to $.00005\Omega$ for a pressure of 800 grams per sq. cm. A considerable variation in resistance was found for different tests. These variations could in general be eliminated by moving the contacting block sidewise while the pressure was on. This adds weight to the usual recom-

mentation that before finally setting up a clamped contact one of the elements should be driven sidewise slightly.

Binding Posts.—Binding posts are a form of clamped contact used perhaps more often than any other and more frequently employed where their actual contact resistance enters as an error in the measured quantity. If the contacting surfaces are clean, binding posts, when well screwed down, show a resistance usually much lower than the copper leads used to connect them in circuit. For example, two copper leads each of No. 8 B. & S. wire and each two feet long would offer a resistance of about $.0025\Omega$. A pair of binding posts suitable for No. 8 wire, if clean and well clamped, would present a resistance of about $.00008\Omega$. The danger in the use of binding posts resides of course in the fact that they may under various circumstances offer a fairly high resistance. If they are small or not firmly screwed up or dirty a materially higher resistance value results.

Running over all the values given in the writer's data book for large binding posts, small ones, posts with holes for the reception of either wire or flat stock and considering copper, brass, and nickel plated posts, the general conclusion may be reached that the contact resistance varies from $.0008\Omega$ for dirty and oxidized parts clamped together tightly to $.00004\Omega$ for clean surfaces firmly clamped. The figures of course vary considerably but assuming that reasonable care is taken to clean and clamp the wire or terminal into a binding post there should be no difficulty in keeping the contact resistance always below $.0002\Omega$. In exceptional cases where heavy clamps are used instead of binding posts the contact resistance can be kept below $.00001\Omega$. Flat grip binding posts particularly if not kept clean offer a higher resistance than the type of post where the connecting wire enters a hole and is clamped with the end of the binding post screw. The latter type of post tends to clean the contact elements as the screw is turned down. Brass binding posts offer a less resistance when clean than nickel plated ones but if not kept clean the nickel plated ones show a lower resistance.

C. SPRING CONTACTS

Under spring contacts we shall consider knife switches, dial switches, slider contacts, commercial connectors and generally, contacts whose elements are held together by spring pressure.

There is prevalent a belief that a switch, one element of which has many leaves or laminations is sure to have a low contact resistance. But such a conclusion is not warranted unless the individual laminations are so far independent as to permit each one to operate without interference from the rest. As a rule, when a switch has a large number of leaves, mechanical considerations require that they shall be so close together as to either touch each other or offer small crevices for the lodgment of dirt, particles of lint, etc. These are gradually worked up into the brush until finally the brush operates as though it were one solid structure; and moreover, the material forced between the laminations has lifted some of them so that the contacting face is no longer in proper bearing. On the other hand a laminated brush possessing say two or three or at most a half dozen leaves offers no serious mechanical difficulty in the way of proper spacing of the leaves with the result that such a brush shows consistently low in contact resistance, assuming of course that it is properly constructed, being more likely to improve itself with age because of the wearing in and more intimate fitting of the various parts. We have had occasion to measure the brush resistance of switches possessing a large number of laminations packed so closely as to prevent individual leaves from having really independent motion and have found the resistance to be higher than that of brushes of much simpler construction, and moreover, they tend to increase their contact resistance as stated above because of their picking up and holding lint, copper dust, dirt etc. When new, a switch of this type is low in resistance but as it wears it is likely to show a higher resistance. Another point for consideration is that when the laminations are closely packed and are in considerable numbers the brush has practically no elastic recovery. As a result the smallest wear eases up on the brush contact pressure and adds to the contact resistance. It has also been noticed that, when a brush of this type is mounted on a hard rubber plate, the continued

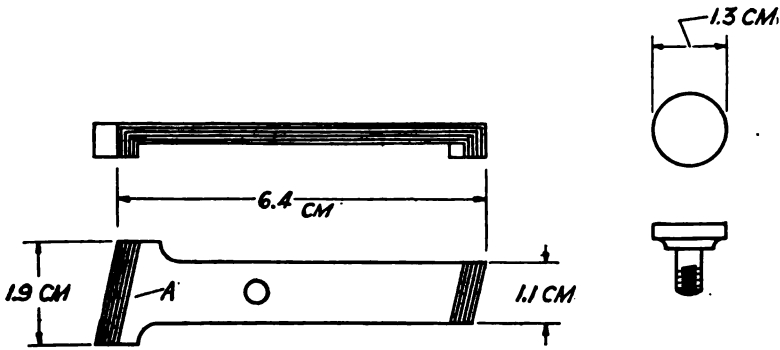

FIG. 7

Brush No. 102

Six phosphor bronze laminations .4 mm thick

For contact resistance at end A see Fig. 14, curve A. With this brush there was employed contact stud No. 87, Fig. 12. Stud was of brass. Normal pressure is such that the contact resistance is about $.00023\Omega$ at each end of brush. The same combination was tested when the stud was nickel plated. See Fig. 14, curve B. Normal resistance about $.00045\Omega$ at each end of brush.

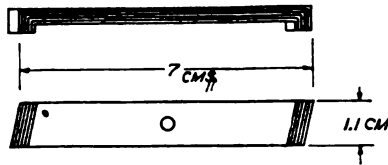

FIG. 8

Brush No. 101

Six phosphor bronze laminations .4 mm thick

For contact resistance at one end, see Fig. 14, curve C. With this brush there was employed contact stud No. 86. Nickel plated. See Fig. 13. Normal pressure is such that the contact resistance is about $.00045\Omega$ at each end of brush.

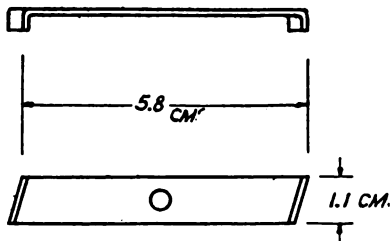

FIG. 9

Brush No. 100

Two phosphor bronze laminations .8 mm thick

For contact resistance at one end, see Fig. 14, curve F. With this brush there was employed contact stud No. 87 nickel plated, Fig. 12. Normal pressure is such that the contact resistance is about $.0008\Omega$ at each end of brush.

pressure has caused the rubber to give sufficiently to materially increase the contact resistance.

The contact resistances of various types of switches are indicated under Fig. 7 to 13 inclusive, together with curves showing the relation between pressure and resistance. Referring to Fig. 14 the conditions under which curves A, B, C, D, F and H were gotten are indicated under Figs. 7 to 13. Curve E was for the same brush

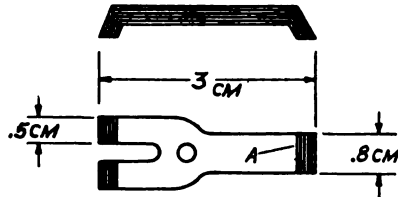

FIG. 10

Brush No. B

Nine phosphor bronze laminations .4 mm thick not spaced apart

For contact resistance at end A see Fig. 14, curve H. With this brush there was employed stud No. 86, Fig. 13. Stud of brass not nickel plated. Normal pressure of about 4 kg per sq. cm results in a contact resistance of about .0003Ω.

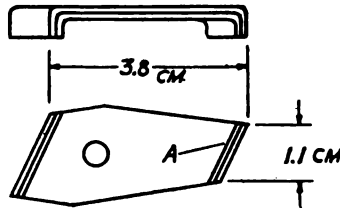

FIG. 11

Brush No. S

Three phosphor bronze laminations .4 mm thick

For contact resistance at end A see Fig. 14, curve D. With this brush was employed contact stud No. 87, Fig. 12. Stud was of brass. Normal pressure such that contact resistance at end A is about .0002Ω.

and stud as shown in Fig. 7 excepting that the stud was of bare copper. Curve G was for the same brush and stud also as indicated in Fig. 7 but the stud was of bare brass. It differed from the conditions of curve A only in the fact that it was new whereas the brush and stud corresponding to curve A had been used for some time.

In most instances we are interested in the variation in the contact resistance rather than in its actual value since the cali-

bration or adjustment of an instrument often takes account of the absolute value of the resistance at contacts but cannot compensate for variations in such resistances. With the switch parts used in determining curve C the contact resistance for a normal pressure

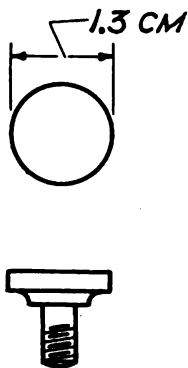

FIG. 12

Type of brass or copper switch stud employed. A potential point was located just under the top surface of stud.

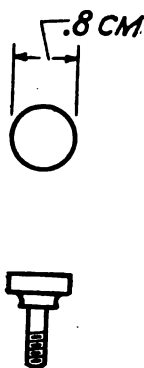

FIG. 13

This stud differed from that shown in Fig. 12 in that it was of smaller diameter.

of 2 kg was about $.0003\Omega$ and its variation approximately $.00006\Omega$. Brush pressures normally run from 1.5 to 3 kg. Contact resistances, therefore, may be expected to range from $.00045\Omega$ to $.00015\Omega$.

KNIFE SWITCHES—These are frequently employed in small sizes on measuring instruments. A 15-ampere commercial knife switch old and not used for some time varied in resistance from $.0001\Omega$ to $.0003\Omega$. A similar but new one varied from $.00007$ to $.0001\Omega$. A third familiar form whose clips were bent back on themselves varied

from $.00019\Omega$ to $.00024\Omega$ this high resistance being due to the fact that the doubled length of clip prevented securing an adequate pressure against the knife blade.

SMALL CONNECTORS.—The usual type of connector used in automobile head lights had a contact resistance varying from $.003$ to $.007\Omega$.

FAHNSTOCK CLIP.—When clamping a piece of nickel plated copper wire, No. 12 B. & S. Gage, Fahnstock clips varied in contact resistance from $.00005\Omega$ to $.0005\Omega$ depending upon the material of the clip and its size.

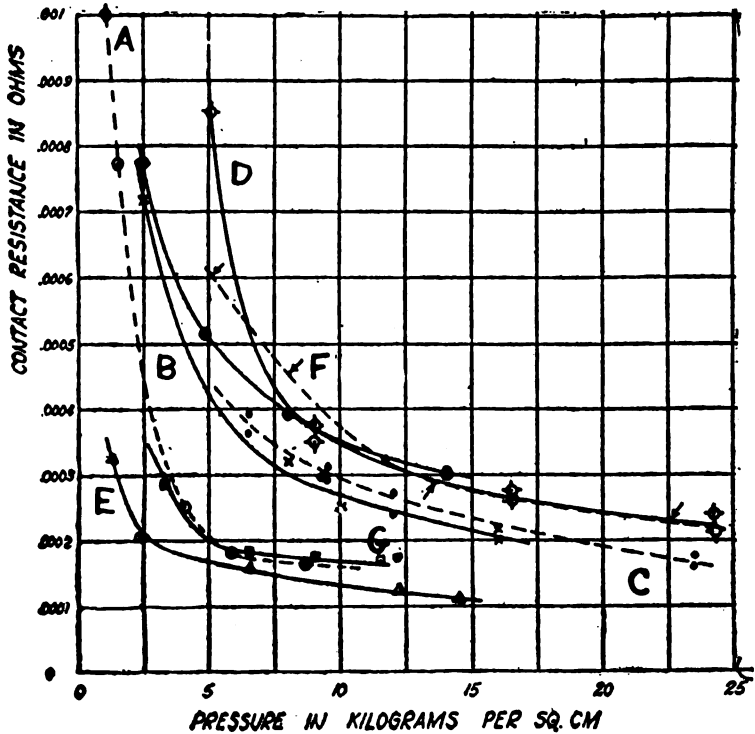

FIG. 14

The above curves were obtained with switches of various types. The previous Figs. 7 to 13 inclusive give the principal dimensions of these switches and reference is made by letter to the corresponding curve in Fig. 14.

SLIDER CONTACTS.—For many purposes a knife edge or small surface is used to make contact against a slide wire or a wire helix and it is held in contact with a nearly constant spring pressure. Motion occurs between the slider and the wire but the resistance of the contact enters for consideration only when the slider is at rest. As a rule, devices of this nature are employed in such a manner that the effects of contact resistance do not enter into the measurement excepting as they indirectly influence it by affecting the sensitivity of the indicating device. For this reason a fairly high contact resistance is often permissible.

Various materials have been used for the slider and for the slide wire or spiral. The following conclusions from a large number of tests were reached.

1. A Copper gauze slider tends to clean the wire upon which it slides.
2. A Steel slider is more variable than a gauze one but in some instances is to be preferred because of its better wearing qualities.
3. A Silver slider is best from the standpoint of low resistance and constancy but wears rapidly.

To review even briefly the numerous tests that have been made on slide wires and spirals would require too much space. A few figures, therefore, will be furnished to give one an idea of the range of contact resistance to be expected.

1. Steel Slider on Straight Therlo Wire.—Pressure 37 grams. Contact resistance varied from $.006\Omega$ to $.05\Omega$ when dirty and from $.006\Omega$ to $.012\Omega$ when cleaned by rubbing off with a piece of cloth.

2. The same combination but allowed to become very dirty by standing in a furnace room for five weeks. Without removing the dirt the contact resistance reached $.3\Omega$. When wiped off the highest value was $.03\Omega$ and a more careful cleaning reduced the resistance to $.008\Omega$ maximum.

3. A similar test to No. 2 for a steel slider on manganin wire showed contact resistances as high as $.12\Omega$ after wiping clean indicating that Therlo is better as far as this characteristic goes than manganin.

4. Silver Slider on Therlo Wire.—When new and clean the contact resistance varied from $.0017\Omega$ to $.003\Omega$ and when dirty the variation was from $.0025\Omega$ to $.008\Omega$.

5. Copper Gauze Slider on Therlo Wire.—When new and clean the contact resistance varied from $.002\Omega$ to $.003\Omega$ and when dirty the variation was from $.003$ to $.5\Omega$. This excessive resistance was due to dirt accumulating in the meshes of the copper gauze. After filling the gauze the variation was from $.002\Omega$ to $.003\Omega$ as it was when new.

6. Silver Slider on Silver Wire.—When new the contact resistance varied from $.00013\Omega$ to $.0002\Omega$ and while dirty it varied from $.00013\Omega$ to $.00022\Omega$. After about two months standing the resistance varied from $.0003\Omega$ to $.0009\Omega$.

Various other combinations were tried out but those cited above give one an idea of the contact resistance to be expected. In the above cases the slider pressure against the slide wire was about 40 grams. It is an interesting fact that if the slide wire is in the form of a closely wound helix the cleaning action of the slider as it moves over the wire from turn to turn is better than if the slide wire were straight.

D. PRESSURE CONTACTS

Under this rather vague title we include contacts which are held together by finger pressure or by electromagnetic devices, such for example as keys and relays. We will refer only briefly

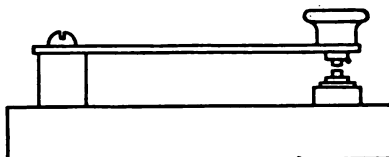

FIG. 15

This conventional type of key had silver contacts about 2 mm in diameter. The potential points were determined by drilling very fine holes in the silver contacts near their interface and peening copper wires .1 mm diameter in the holes.

to these. In an old standard type of key, Fig. 15, with silver contacts the following contact resistances were observed:

Before cleaning:

Pressure	Resistance
kg	Ω
.1	.085
.45	.0038
3.20	.0006

After cleaning (with fine emery):

Pressure	Resistance
kg	Ω
.1	.00095
.45	.00037
1.80	.00023
3.20	.0001

A telephone jack showed a contact resistance of .0025 Ω for one spring and .0075 Ω for another. These contacts were relatively high because the contacts are so constructed that the contact surfaces come together without sliding and therefore without any cleaning action.

Another interesting test was on a galvanometer used as a relay to close an electric circuit when the galvanometer pointer deflected against a fixed contact. Both contact elements were of platinum. The results are best shown by the curve in Fig. 16. It

might be well to add that the values shown in the curve were for clean contacts and they would be materially affected by even a small amount of dirt.

E. PLUG CONTACTS

The resistance of a plug contact varies, of course, with its condition, its construction and the degree of pressure exerted in seating the plug. Fig. 17 gives one an idea of the contact resistance of a

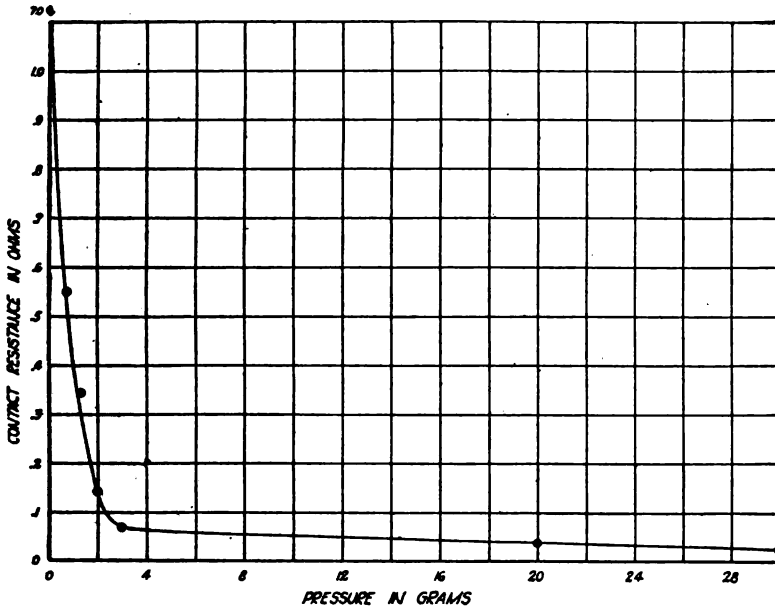

FIG. 16

Contact resistance between two crossed platinum wires of No. 22 B. & S. Gage. One wire was a pointer on a galvanometer used as a relay and the other wire acted as a stop to close a circuit when pointer was sufficiently deflected.

large taper plug in good condition set in with various degrees of pressure. For this test a plug and blocks were used of the dimensions indicated in Fig. 18. The potential points and current points were as shown in Fig. 5. While the pressure was applied and before each reading, the plug was given a slight twist. There is an appreciable reduction in contact resistance up to a pressure of 8500 grams after which the gain is small. At that pressure the resistance is about .000025. This is really a measure of two contacts

in series since the current path was from block A to block B in Fig. 5. Somewhat lower values than those shown on the curve of Fig. 17 were gotten in other tests but a fair allowance for the

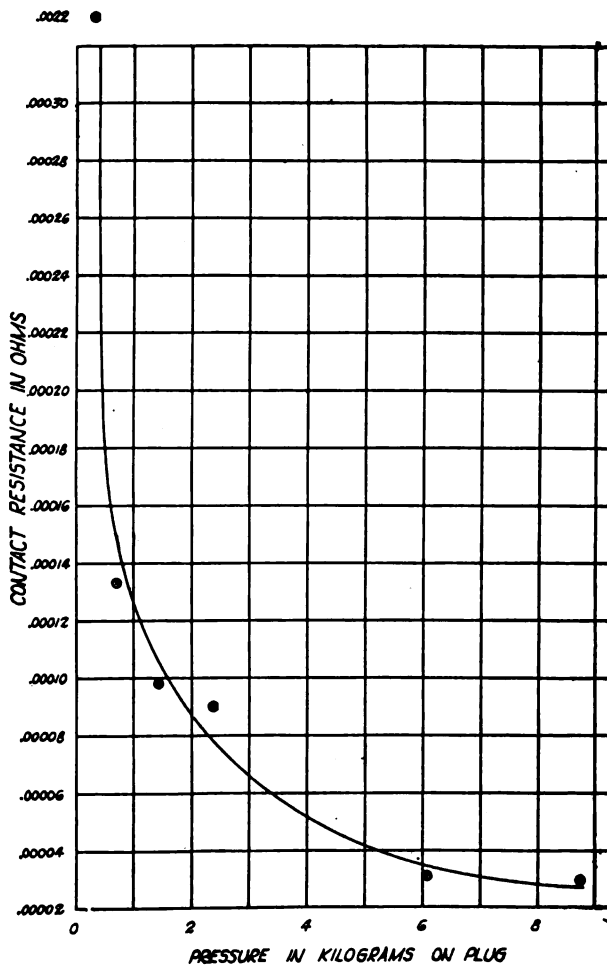

FIG. 17

Contact resistance between a standard taper plug and its block. In making the measurements plotted here the potential points were so located that two contacts were in series. See Fig. 5.

contact resistance of a large plug well fitting and firmly seated with a twisting motion is about .000025. To give one an idea of the resistance variation under these conditions the plug was taken

out and resealed before each instrument. Of thirteen measurements the mean value was $.0000212\Omega$ with variations $\pm .0000007\Omega$.

By way of comparison a similar plug was measured both when dirty and after reaming the hole and cleaning the plug. When dirty the resistance varied from $.0004\Omega$ to $.0008\Omega$. After cleaning it varied from $.0000205\Omega$ to $.0000251\Omega$. This variation of $\pm .000005$ is more likely to be encountered than that given above. From this and other tests it appears reasonable to assume the resistance of a good plug contact to be about $.000025\Omega \pm .000005\Omega$. A plug of the above size is normally set with a pressure around 12-13 kg. For a smaller plug and for blocks not capable of withstanding such pressure, the contact resistance may be about $.00005\Omega \pm .00001\Omega$.

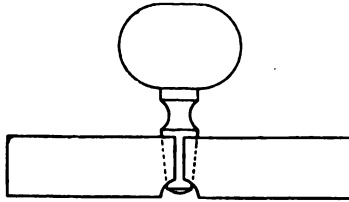

FIG. 18

Standard taper plug used in making measurements plotted in Fig. 17. The drawing represents actual size of plug and blocks. The plug taper was 1 mm increase in the diameter per cm length.

F. MOVING CONTACTS

From the standpoint of the instrument maker continuously moving contacts are of interest when carrying small currents and his interest rests more upon the constancy of resistance than the current carrying capacity. An illustration related to the instrument maker's art is that of slip rings and brushes used on rotating sockets in photometric measurements. The following is a test on such a piece of apparatus.

Contact resistance of slip ring

Slip rings brass.

Brushes copper gauze.

Pressure 150 grams.

Standing $.0019\Omega$.

180 rpm. $.026\Omega$.

450 rpm. $.035$ to $.05\Omega$.

A phosphor bronze leaf brush of 6 leaves was substituted.

Pressure 200 grams.

Standing .0022 Ω .

180 rpm. .0025 Ω .

350 rpm. .0029 Ω .

The contact resistance of phosphor bronze brushes on a copper slip ring was found to be $.0045 \pm .001\Omega$ when rotating at 80 rpm. and $.0004\Omega$ when standing. In this case the brush consisted of 3 leaves of .4 mm phosphor bronze 12 mm wide having a total brush pressure of 2 kg.

Contact resistance of bearing

A half inch cold drawn steel shaft running in a brass bearing $1\frac{3}{4}$ inches long at 2000 rpm. showed a contact resistance

when oiled of $.140\Omega$

not oiled of $.05\Omega$.

The bearing load was about 2.25 kg.

G. MERCURY CONTACTS

In Reprint (Sci. Pap.) No. 241 of the Bureau of Standards the subject of mercury contacts is considered. The resistance at the contact of one mercury contact may by proper design and construction be reduced to about $.000004\Omega$. When in poor conditions, however, owing to an accumulation of dirt a much higher value may result.

H. EARTH CONTACTS

The conditions may vary to such a degree that it is difficult to fix any limits on the resistance of earth contacts. Values were gotten as low as 10Ω when using ground plates 12 inches square in well watered earth and as high as 400Ω when using a half inch bright copper rod.

THE LEEDS AND NORTHRUP INSTRUMENT CO.,
PHILADELPHIA, PA.

AN APPARATUS FOR DEMONSTRATING THE ELECTRICAL PROPERTIES OF CONDUCTING GASES

BY
JOHN ZELENY

The apparatus to be described permits the easy demonstration in a few minutes of the following properties of conducting gases.

1. Persistence of conductivity after removal from agent producing it.
2. Gradual loss of conductivity with time. (Recombination of ions.)
3. Destruction of conductivity by passage of gas through an electric field.
4. Destruction of conductivity by passage of gas through a plug of glass wool.
5. Loss of conductivity by diffusion of ions to adjacent walls.
6. Difference in diffusion of positive and negative ions.

APPARATUS

The apparatus is shown in Fig. 1. An open cylindrical tube A, 10 cm long, carries a central electrode B which is insulated from the tube by an amber plug and is connected to the leaf of an oscillating leaf electroscope,¹ which is most conveniently used as an indicating instrument. The tube C telescopes into tube A and may be pulled out more or less as required. Air or some other gas may be blown through the apparatus by attaching rubber tubing to the inlet tube M. An offset D in C contains a plate E on which some radioactive material is placed, which serves to ionize the gas in the tube above. A convenient radioactive material for this purpose is a discarded radium emanation tube as commonly used in radium therapy. To make use of alpha rays the tube is broken into fragments which are sealed to the plate E with the inside surfaces pointing outward. F is a short open auxiliary cylinder which may be moved by means of the rod G and its handle H, so

¹ J. Zeleny. *Physical Review*, 32, p. 581, 1911.

as to occupy a position either to the right or to the left of D. F is used to hold either the cylinder I, which contains a plug of glass wool or the cylinder J which is compactly filled with wires 0.5 mm in diameter. Each of these cylinders carries a wire handle K, and a pin L which fits into a right angle groove in the left end of F (shown by dotted line in upper figure) and is thereby kept in position when air is blown through C. The short tube N, which

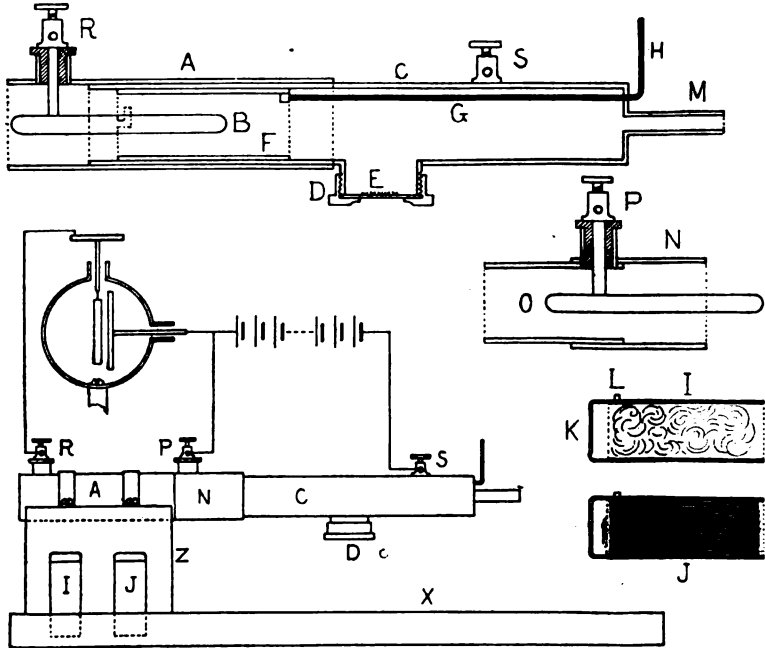

FIG. 1

may be inserted between A and C, contains an insulated electrode O with the binding post P. The apparatus is conveniently mounted on a wooden block Z attached to a wooden base X as shown in the lower left hand drawing.

PROCEDURE

1. Connect R to the plate and S to the case of the electroscope. The latter shows no action until air blown through M carries the ionized air from the neighborhood of D to B.

2. Keeping the stream of air constant, note qualitatively the rate of motion of the leaf of the electroscope. Next draw C out of A as far as possible, without breaking the union, so that a longer time is required for the gas to pass from D to B. The conductivity is much diminished owing to recombination of ions, as is made evident by the smaller frequency of oscillation of the leaf.

3. Insert N between A and C and blow gas through the tube. When P is connected to S, the gas reaching B is conducting; whereas if P is connected to the end of the battery charging the plate of the electroscope, (these connections are shown in the lower left hand drawing) thus producing an electric field between N and O, the gas coming to B is non-conducting. This arrangement can also be used to measure the mobilities of the two ions by measuring the mean velocity of the gas stream and applying different voltages to P until one is found which just permits some of the ions to get by O.

4. Remove N and place I into F. Starting with F to the right of D, the gas reaching B is conducting, whereas when F is pushed by means of H to a position at the left of D, the gas has to pass through the glass wool and loses its conductivity completely.

5. Remove I from F and replace it by J. With F to the right of D the gas reaching B has a conductivity indicated by the motion of the leaf. When F is pushed to the left of D the gas has to pass through the narrow channels between the wires which fill J and many of the ions diffuse to the walls and discharge themselves, and a marked decrease in conductivity is noted, although the time taken for the ions to reach B is somewhat diminished and there is consequently less loss of ions by recombination.

6. In the last case if the time required for the electroscope leaf to make any arbitrary number of oscillations is measured first when positive ions are pulled towards D and next when negative ions move towards B, it is found that the number of positive ions (in air) which get through the diffusion cylinder J is greater than that of negative ions owing to the greater mobility of the latter.

SLOANE LABORATORY,
YALE UNIVERSITY,
APRIL 13, 1922

REVIEWS AND NOTICES

Report on Series in Line Spectra. BY PROFESSOR A. FOWLER, THE PHYSICAL SOCIETY OF LONDON, 13/-. BOUND IN CLOTH 16/-. 182 pages, 12 figures, 5 plates.

"Although the spectra of elements and compounds were studied in the first instance chiefly as providing a powerful means of chemical analysis, it has long been recognized that a spectrum must contain an important clue to the structure and modes of vibration of the atoms or molecules which produce it. . . . The analysis of spectra has thus become one of the main objects of modern spectroscopy, stimulating the experimentalist to the extension of existing data, and providing material in a form suitable for the theoretical investigator."

"My purpose in the present report has been to give a comprehensive account of the development and present state of our knowledge of the regularities in spectra, as deduced from the spectra themselves, with but little regard to theories of their origin. The report is in two parts, the first of which gives a general account of spectral series, excluding those which occur in band spectra, while the second is intended to include the most authentic experimental data available in April, 1921."

The above sentences from the author's Preface briefly give the reason, purpose and scope of his Report on Series in Line Spectra which may no doubt be considered as the most timely and valuable contribution to spectroscopy in many years. The general account of series (Chapters I to IX) is a splendid introduction to the tables. In successive chapters, the Observational Data are outlined, an Historical Note 1869-1879 reviews the early discoveries, the Characteristics of Series are described in some detail and various Series Formulae, Rydberg's and others, are presented. Three chapters of more theoretical interest deal with Spectra and Atomic Constants, The Work of Hicks and Applications of Bohr's Theory. Two Appendices to Part I contain practical suggestions for the calculation of formula constants and Tables for computations.

Part II (Chapters X-XXI) devotes its first chapter to a summary Explanation of Tables, the spectra of hydrogen and helium because of unusual features are discussed in Chapter XI, and the following chapters deal with the series and general spectral characteristics of successive groups or sub-groups of similar elements according to their classification in the Periodic System.

Our knowledge of series was collected by Dunz (Dissertation, Tubingen, 1911) and Lorenser (Dissertation, Tubingen, 1913) using the notation proposed by Prof. Paschen, and for the past decade these tables have been of great service to spectroscopists. They have long required revision since something has been added to our knowledge of series, especially among enhanced lines, since 1914, and the observational data have been improved for nearly all spectra. Prof. Fowler's report not only fulfills the need of spectroscopists for accurate and comprehensive tables but also carefully analyzes many of the questions and problems involved and suggests lines of research which should give an impetus to the development of this subject.

It seems unfortunate, however, that no uniform and strictly consistent notation has been thus far agreed upon for the naming and representation of series. That used by Paschen and his followers has been widely quoted in connection with the recent developments in quantum theory of spectroscopy and the Ritz formula has been derived from theoretical considerations. In Fowler's tables, the Hicks formula is preferred and the constants, including the computed limiting frequencies of series, are different from those given by the Ritz formula and the numeration of the lines is different.

Four chief series are generally recognized, the three first discovered being named the Principal, Diffuse and Sharp series while the fourth, first observed by Bergmann in 1907, is often referred to as the Bergmann Series, but some writers follow Hicks in calling it the Fundamental Series. The latter word appears unfortunate since it conveys an idea of importance like that suggested by the word Principal and the series is probably less fundamental than any of the others. Physicists who have adopted the Paschen system will find little difficulty in translating one notation into the other if the important differences are compared. The four chief series are written in abbreviated notation as follows:

Fowler	Paschen
$P(m) = 1 S - m P, m = 1, 2, 3$	$P(m) = 1 S - m P, m = 2, 3, 4$
$S(m) = 1 P - m S, m = 2, 3, 4$	$S(m) = 2 P - m S, m = 3, 4, 5$
$D(m) = 1 P - m D, m = 2, 3, 4$	$D(m) = 2 P - m D, m = 2, 3, 4$
$F(m) = 2 D - m F, m = 3, 4, 5$	$B(m) = 3 D - m B, m = 4, 5, 6$

It should be noted that there is some inconsistency in the convergence frequency of $F(m)$, which is sometimes $2 D$ and in the other cases $1 D$ while for $B(m)$ it is $3 D$.

In order to distinguish series of different kinds, Paschen designated singlet systems by capital letters, doublets and triplets by small letters and series among spark lines by German capital letters. Prof. Fowler adopts Greek letters for doublets and small letters for triplets. Thus:

Fowler	Paschen
$P, S, D, F = \text{Arc Singlet system}$	$= P, S, D, B.$
$\pi, \sigma, \delta, \varphi = \text{Arc Doublet system}$	$= p, s, d, b.$
$p, s, d, f = \text{Arc Triplet system}$	$= p, s, d, b.$
$\pi, \sigma, \delta, \varphi = \text{Spark Doublet system}$	$= \mathfrak{P}, \mathfrak{S}, \mathfrak{D}, \mathfrak{B}.$

Satellites are designated by primed letters in both systems. Perhaps neither of the above notations is entirely satisfactory. In the interest of economy in publications both the German capital letters and the Greek letters should be eliminated and large and small Latin letters retained as sufficient. It is perhaps advisable to distinguish more carefully hereafter between arc and spark spectra, i.e., those arising from neutral atoms and those from atoms which have lost one or more electrons. Fowler indicates that in the cases of carbon and silicon in addition to the arc spectrum, the first, second and third spark spectra have probably been detected. Such enhanced spectra will no doubt be of still greater importance in the future and it seems appropriate to characterize the series as s^+ , etc., in a manner analogous to that in which the ionized atoms are symbolized.

Prof. Fowler hopes "that the tables of series lines, together with the references to lines which have not yet been classified, will suggest and facilitate further investigations." The tables show that of the 87 chemical elements whose spectra are more or

less well known, only 25 have thus far disclosed series, properly so-called, in their arc spectra and of these only 5 (or possibly 11 if the meager data on Ra, Zn, Cd, Hg, C, Si be considered) have had some of their spark lines organized into series. Aside from the advance in this class of series which have come in recent years principally from Fowler, there has been very little progress in the arrangement of spectra into series since the work of Kayser and Runge and of Rydberg over 30 years ago.

It is perhaps not an overstatement to say that in this period more irregularities have been discovered among so-called series than regularities in other spectra. The subject does not appear as simple now as it once did. Fowler has called attention to most of these special features in a discussion of negative wave-numbers, a chapter on "Abnormal" series (Chap. VI) peculiarities of the diffuse series of Al and of Mg, the P series of Ca, etc. The Rydberg number N which was once thought to be a universal constant now appears to be different for each chemical element. In addition to the regular series which in general account for only a part of the total number of spectral lines observed for an element, other types of regularities such as the "combination series" first discovered by Ritz, inter-combinations, and unclassified pairs or triplets with constant differences in frequencies are also found. In many spectra where no sequences have yet been detected, there are pairs or groups of lines with constant wave-number separations, which may possibly have their origin in combination terms between parallel series as has recently been shown by Paschen to be the case with Neon. With the single exception of Neon, practically all of whose 900 lines have been skillfully arranged in about 132 series, our knowledge of series is still confined to the simpler spectra, and even in some of these many of the observed lines are still unclassified. Elements of the iron group, the platinum metals, rare earths and others whose spectra are a wilderness of many thousands of lines must wait patiently for the discovery of series. In such complex spectra it is very difficult to detect related groups or to find a starting point for the series. The displacement law of Kossel and Sommerfeld is suggestive as to the kind of series to be expected in the spectrum of each element according to its position in the periodic table and a possible numerical relation between the spark spectrum of an element and the arc spectrum of the element which precedes it in the periodic table has been suggested by the same writers. Many investigations have been made to connect the progressive change in spectra with atomic weights, atomic volumes or atomic numbers, but the exact laws governing the changes are still unknown. It appears that for the present the "cut and try" methods of arranging observational data offer the chief hope for the disentanglement of complex spectra, with the possible assistance of further experimental results on the Zeeman effect, radiating potentials, the sensitive lines of spectro-chemical analysis, etc. For the development of such work, Prof. Fowler's report will be of enormous benefit. It points out the best data, gives a complete statement of our present knowledge, suggests problems which need further investigation and opens the field to all. The only severe criticism which can be offered is on the lack of an index to the vast material of this report. The table of contents is inadequate as a reference to the wave-length tables and remarks relating to the individual chemical elements.

W. F. Meggers

Journal of the Optical Society of America and Review of Scientific Instruments

Vol. VI

AUGUST, 1922

Number 6

REPORT OF COMMITTEE ON COLORIMETRY FOR 1920-21

BY
L. T. TROLAND, CHAIRMAN¹

CONTENTS

	PAGE
A. LIST OF TABLES.....	529
B. LIST OF FIGURES.....	529
I. INTRODUCTION.....	530
II. NOMENCLATURE.....	531
1. Psychological Terms.	
A. Color.	
B. The Three Attributes of Color. (<i>a</i>) Brilliance, (<i>b</i>) Hue, (<i>c</i>) Saturation, (<i>d</i>) Auxiliary Terms.	
C. Species of Colors.	
D. Psychological Primaries.	
E. The Measurement of Color.	
2. Stimulus Terms.	
A. Radiant Energy.	
B. The Physical Spectrum.	
C. Spectral Distributions.	
D. Homogeneous Radiant Energy.	

¹The Chairman of the Committee wishes to acknowledge his indebtedness to various members of his committee as follows: to Mr. Priest for a great mass of data, helpful criticisms and the suggestions drawn from his preliminary committee report of 1919 (not published, but copy may be borrowed from Bureau of Standards Library, Cf. J. Op. Soc., 4, p. 186; 1920); to Mr. Weaver for his elaborate computations of chromatic excitation values for many different classes of stimuli as well as for the development of the data upon which these computations were based; to Mr. Jones and to Dr. Ives for data and valuable criticisms.

	E. Purity.	
	F. Mode of Incidence.	
3.	Psychophysical Terms.	
	A. Psychophysical Functions.	
	B. Color Excitations and Physiological Primaries.	
	C. Visibility, Light and Luminosity.	
	D. Complementary Stimuli.	
	E. Colors of Objects.	
III.	STANDARD PSYCHOPHYSICAL DATA.....	542
	1. The Psychological Color Solid.	
	A. General Coördinates.	
	B. Reference Axes.	
	C. Boundaries.	
	D. Psychological Primaries.	
	2. The Spectral Chroma Scale.	
	3. The Saturation Scale.	
	4. Stimuli for the Psychological Primaries.	
	5. The Color Excitation Functions.	
	6. Complementary Colors and Wave-Lengths.	
	7. Standard Conditions for Pure Cone Vision.	
	A. Choice of Observers.	
	B. Size of Field.	
	C. Intensity.	
IV.	PHYSICAL STANDARDS.....	555
	1. The Criterion of Homogeneous Radiant Energy.	
	2. Standards of Spectral Energy Distribution.	
	A. Average Noon Sunlight.	
	B. Standard Artificial Sunlight.	
	C. Normal Gray Light.	
	D. Standard Illuminants.	
	3. Standards of Spectral Transmission.	
	A. Standard Three-Color Additive Filters. (a) Trichromatic Analyzer Filters, (b) Photographic Taking Filters, (c) Photographic Reproducing Filters.	
	B. Standard Solutions.	
	C. Lovibond and Other Colored Glasses.	
	4. Standards of Spectral Reflection.	
	A. Subtractive Pigment Elementaries.	
	B. Systems of Pigment Standards. (a) The Munsell System, (b) The Ridgway System, (c) The Ostwald System.	
V.	METHODS OF COLORIMETRY AND THEIR INTERRELATIONS.....	573
	1. Resumé of Available Methods.	
	A. Spectrophotometry.	
	B. Monochromatic Analysis.	
	C. Trichromatic Analysis.	
	D. Rotatory Dispersion Systems.	
	E. Planckian Distribution Analysis.	
	F. Comparator Methods.	

	Page
2. The Interconversion of Diverse Color Specifications.	
A. Spectrophotometric Data to Excitations.	
B. Monochromatic Analysis Data to Excitations.	
C. Trichromatic Analysis Data to Excitations.	
D. Rotatory Dispersion Data to Excitations.	
E. Planckian Distribution Data to Excitations.	
F. Comparator Data to Excitations.	
VI. SUMMARY AND CONCLUSION.....	592
C. BIBLIOGRAPHY.....	592

A. LIST OF TABLES

Table No.	Title	
1.	Equivalents in Terms of Fresnels of Wave-Lengths in Millimicrons.....	539
2.	Average Normal Visibility Values.....	541
3.	Spectral Chroma Scale.....	545
4.	Saturation Scale Data.....	546
5.	Comparative Saturations of Spectral Colors.....	547
6.	Spectral Colors in Terms of Elementary Excitations.....	549
7.	Relative Energy of a Black Body at Various Temperatures and Wave-Lengths.....	558
8.	Relative Intensity Values over the Visible Spectrum for Average Noon Sunlight.....	563
9.	Color Temperatures of Common Illuminants.....	565
10.	Color Temperatures of Vacuum Tungsten Filaments at Various Efficiencies.....	566
11.	Transmissions for Various Wave-Lengths of Ives Colorimeter Filters.....	568
12.	Transmissions of Approved Photographic Taking Filters.....	569
13.	Monochromatic Analyses of Certain Ridgway Colors.....	572
14.	Excitation Values for Representative Monochromatic Analyses	
(a)	Spectral Hues.....	586
(b)	Purple Hues.....	585
15.	Coefficients for Interconverting Ives Colorimeter Data and Excitation Values.....	588
16.	Excitation Values of Certain Rotatory Dispersion Colors.....	590
17.	Excitation Values for Black Body Colors.....	590
18.	Excitation Values for Certain Munsell Colors.....	591

B. LIST OF FIGURES

Figure Number	Title	
1.	The Dimensions of the Psychological Color Solid.....	543
2.	Elementary Color Excitations for Different Wave-Lengths.....	548
3.	Color Triangle, Showing Loci of Spectral and Black Body Excitations.....	552
4.	(a) Wave-Lengths of Complementary Hues.....	553
	(b) Frequencies of Complementary Hues.....	554
5.	Planckian Energy Distributions at Various Temperatures.....	557
6.	Spectral Energy Distributions of Natural and Artificial Sunlight.....	560
7.	Spectral Energy Distribution of Standard Lamp Used for Precision Artificial Sunlight.....	561
8.	Spectral Transmission of Tungsten-to-Daylight Filter (Wratten No. 78).....	562

9. Color Triangle, Showing Loci of Excitations for Various Monochromatic Analyses.....	575
10. Color Triangle, Showing Loci of Spectral and Certain Rotatory Dispersion Excitations.....	576

I. INTRODUCTION

That the nomenclature and standards of color science are in an extremely unsatisfactory condition is manifest to practically all workers in this field. It is the purpose of the present report to take an initial step towards remedying this state of affairs. That the result cannot be final as regards either nomenclature or standards is a natural consequence of the pioneer character of the effort.

The terminology which is proposed in the following pages represents an endeavor to crystallize the consensus of usage among experts, but where experts disagree and extant terms are vague, it has been deemed wise to introduce certain innovations. While the recommendations of this report are tentative, it is hoped that their careful consideration will assist in the clarification of ideas and the eventual unification of nomenclature. It is desired that all interested persons present their objections directly to the Committee, with a view to the resolution of possible disagreements. Every relevant idea will thus be thrown into the "melting pot" and the final product should be maximally satisfactory to all concerned.

In addition to its attempt (1) to outline a clear terminology, the following report endeavors (2) to summarize in usable form the best available psychophysical data relating color to its stimulus conditions, (3) to formulate or to define certain standard color stimuli—or intensity distributions of radiant energy (or allied quantities), (4) to outline briefly the principal methods of color measurement and (5) to establish fundamentally the relations between their respective scales. A detailed analysis of the techniques and terminologies of the special methods together with a discussion of the best instruments available, or proposed, for applying them, are reserved for a later report.

The incompleteness and imperfection of the data and methods of color science are only too apparent to the Committee, which

NOTE: The numbers within brackets in the text and footnotes refer to books and papers listed in the appended bibliography. The full face numbers are the serial bibliography numbers while succeeding numbers in ordinary type represent the pages in the given book or article to which reference is specifically made.

recognizes clearly that much must be added and many changes be made before the work can attain its final goal: the production of an authoritative and satisfactory text on colorimetrics. The present draft may serve not only as a presentation of the possessions, but also of the *needs* of the science, and become a stimulus—as well as an aid—to new contributions.

II. NOMENCLATURE

The discussion of the general terminology of colorimetrics may be divided into three sections dealing respectively with (1) psychological terms, (2) stimulus terms, and (3) psychophysical terms. In the present part of the report we shall consider only general conceptions, the detailed terminology and symbolism involved in special methods of color designation being presented—if at all—in connection with the discussion of the several methods.

1. PSYCHOLOGICAL TERMS

A. COLOR.—²Color is the general name for all sensations³ arising from the activity of the retina of the eye and its attached

²The definition of the term *color* which is advocated in the present report is the result of very careful consideration and protracted debate between various members of the Committee. It is unfortunate that in common speech the word *color* is employed, in different contexts, with at least two different meanings which are mutually inconsistent. The most common usage of the word makes it denote visual qualities which possess hue or have a finite degree of saturation, thus excluding all members of the gray series, including black and white. The second common usage of the word *color* is in harmony with the one recommended in the present report and causes it to embrace all visual qualities within its meaning. This second usage is most frequently found in the interrogative mood. For example, if we ask, "What is the color of a house?" it is as legitimate an answer to say "white" or "gray" as to say "red" or "green." On the other hand, the statement "the woman wore a colored dress" evidently excludes grays from the intended meaning. Such terms as color-photography, color-blindness, etc., have a similarly restricted meaning.

It is scarcely admissible in a scientific terminology to employ one term in two distinct and closely allied senses, since this will inevitably lead to confusion. Consequently, it is necessary to reject one of the common-speech meanings of the word *color*. A careful study of the situation shows, however, that the rejection of either meaning must result, in the beginning, in certain perplexities. If we employ *color* in the broader sense we not only sacrifice a well recognized distinctive term for the hue-saturation aspects of visual experience but we also seem to discard a large number of terms derived from the Greek root *chroma* which have been used in the same sense. On the other hand, if we define *color* in the restricted sense to exclude the gray series we find it necessary to exclude all considerations of brilliance from the field of colorimetry.

nervous mechanisms, this activity being, in nearly every case in the normal individual, a specific response to radiant energy of certain wave-lengths and intensities. It may be exemplified by an enumeration of characteristic instances, such as red, yellow, blue, black, white, gray, pink, etc.

This means that if we are asked to specify the color of a gray object we must state that it has no color, and hence lies outside of our province. Similarly, we should be compelled to affirm that certain browns are identical in color with certain yellows, oranges, and reds because they possess the same hue and saturation, although their brilliances are quite different. The necessity of reactions of this sort on the part of the scientific colorimetrician would cause serious embarrassment in practice. It seems necessary to permit a certain degree of overlapping of the provinces of colorimetry and photometry, and possibly it would be desirable to include the latter under the former as a special branch.

A way out of this dilemma appears possible to the chairman if we can decide to employ the Greek root, *chroma*, in a different sense from the Latin root, *color*. There seems to be no particular etymological reason for regarding these roots as exact equivalents, and it is in line with economy of terminology to differentiate between their technical meanings. We therefore propose that the root, *color*, and its derivatives be employed hereafter to designate all visual qualities, including those of the gray series as well as those possessing hue and saturation. (The German equivalent, *Farbe*, is already used in this sense.) The root, *chroma*, and its derivatives, on the other hand, will be used to designate visual qualities possessing hue and saturation and excluding the gray series, with its terminal members, black and white. Such a separation of meanings is far more defensible etymologically than many distinctions which have been formally established in scientific nomenclature; for example, the distinction between *physics*, the general science of material properties, and *physiology*, the special science of vital processes, both of which terms must be considered to have the same etymological significance because of the common Greek root which they contain.

In harmony with the above general recommendation the following subsidiary developments may be indicated. The word, *chroma*, may be substituted bodily for the word, *color*, when the latter is intended in the restricted sense, thus red, green, pink, lavender, etc., are chromas, while black, any gray, and white are not chromas, although all of these qualities are correctly designated as colors. This usage of the term *chroma* may involve a slight confusion with its use by some authorities as a synonym for saturation but it will be noted that the change involved is only a small one, being simply the substitution of a qualitative for a quantitative meaning in practically the same context. The present report recommends that *chroma* be not used as an equivalent of saturation. If we recognize the suggested distinction between the Greek and Latin roots it is not a contradiction in terms to speak of an "achromatic color" nor is it a tautology to refer to a "chromatic color." (cf. German: *bunten Farben*.)

The distinction in question has the advantage of preserving all of the derivatives of the root, *chroma*, in their accepted meanings, and there are so many of these derivatives so firmly fixed in scientific discussion as to make it practically impossible to eliminate or to modify them. All such terms as chromatic, achromatic, chromaphore,

It is impossible to identify color with radiant energy, or with wave-lengths of radiant energy, although radiant energy is the adequate stimulus for color. This is because color is known to depend upon the presence and character of the perceiving individual and because it is directly recognized to be something radically different in kind from its stimuli. Consequently, nothing but confusion can result from the use of the word "color" as a synonym

monochromatic, dichromatic, trichromatic, photochromatic, etc., will be taken to refer to colors possessing hue and saturation or to the stimulus or organic conditions underlying the production of such colors. The root, chroma, and its derivatives provide us with a well established and hence constantly available means for differentiating between color in a restricted sense and members of the gray series, while "color" and its derivatives provide us with a means for designating both of these meanings together.

Some difficulties of course arise and must be met courageously by bold changes in usage. Fortunately the cases in question are not very important. For example, "chromatics" can no longer be regarded as synonymous with "colorimetry," chromatics being strictly the science of hue and saturation coordinate with photometry, if the latter is also regarded as a sub-division of colorimetry. The term "colorless" cannot be regarded as the equivalent of "achromatic" and must be taken to indicate complete transparency as well as achromaticity in an object. This is probably already the most common meaning of the term. The equivalent of the phrase "a colored object" in the common restricted usage of the term color would be "a chromed object." The phrase "color vision" becomes redundant and must be replaced by "chromatic vision." The terms relating to "color-blindness" may need some revision but the most common forms of this disorder are already designated as *partial* color-blindness, a designation quite in harmony with our usage of the term color. However, "total color-blindness" would be the equivalent of "complete blindness" on this basis and hence the word *achromatopia*, already in use, will be necessary in this instance.

It is the opinion of the Committee that the above suggestions, although necessitating a number of radical changes, involve a minimum of such changes among the possibilities which are open to us in improving the nomenclature of color science. However, the recommendations of the present report are intended to be tentative and the Committee will be glad to listen to alternative proposals and to objections to the particular form taken by the present suggestions, which represent a compromise between strongly opposed factions, all well represented in the Committee.

³ The word sensation is used here to stand for an elementary form of experience or consciousness normally depending upon the operation of a sense organ. Although the existence of any sensation rests upon the operation of the nervous system, this should not lead us to *localize* it in that system. Although color is not a physical entity, it obviously exists outside of us on the surfaces of objects as we see them, such visual objects or perceptions being themselves nothing but arrangements of color areas in space. This statement, however, should not be misinterpreted to mean that the colors are physical or are located on physical objects. There is no reason for supposing that visual objects are identical or coincident with the objects of physical science.

of "wave-length" or "wave-length constitution."⁴ Color cannot be identified with or reduced to terms of any purely physical conception; it is fundamentally a psychological category.⁵

B. THE THREE ATTRIBUTES OF COLOR.—The nature of any color can be completely specified psychologically in terms of three fundamental attributes, this specification taking the form of an immediate description of the color, as such, *without any reference whatsoever to the stimulus*. The names employed for these three attributes by different authorities vary widely and frequently are such as to refer not only to properties of the color but also to related properties of the stimulus. Hence it seems necessary, in the interests of unambiguous thinking, to introduce certain refinements and possibly some innovations in terminology at this point. The Committee suggests the following nomenclature.

(a) **Brilliance**⁶ is that attribute of any color in respect of which it may be classed as equivalent to some member of a series of grays ranging between black and white. Synonymous terms, as used by various writers, are "luminosity" (Abney, 4, 4, 86) (Rood, 89, 33) (Troland, 93, 948), "brightness" (Luckiesh, 55, 1) (Helmholtz, 21, 243–245), "tint" (Titchener, 92, 61–64), "value" (Munsell, 61, 12–13), and "visual brightness" (Nutting, 63, 300).

(b) **Hue** is that attribute of certain colors in respect of which they differ characteristically from the gray of the same brilliance and which permits them to be classed as reddish, yellowish, greenish, or bluish. There is a very satisfactory agreement among authorities regarding the usage of this term, which seems not to have been corrupted by any definite physical application.

(c) **Saturation** is that attribute of all colors possessing a hue,

⁴ As, e.g. in the English Translation of Planck's "Theory of Heat Radiation," (74).

⁵ On the definition of color as a psychological entity see: (69, 1), (73, 21–23), (94).

⁶ The substitution of the word "brilliance" for the commonly used "brightness" and "luminosity" is necessitated by the fact that both of the latter terms have received technical definitions in connection with photometric measurements. It is impossible either to discard these technical definitions or to identify them with the definition here offered for the term "brilliance."

which determines their degree of difference from a gray of the same brilliance. Synonymous terms, as used by various writers, are "purity"⁷ (Rood, 89, 32; Nutting, 67, 139; Abney, 4, 4) and "chroma" (Munsell, 61, 12-14; Titchener, 92, 62-63).

(d) Auxiliary Terms: The term *chromaticity* may be used to characterize a color qualitatively without reference to its brilliance. Chromaticity is determined by hue and saturation together, a gray being specified by the statement that it has *no* chromaticity.⁸

(e) Interdependence of the Attributes: All colors except absolute black exhibit brilliance, but grays have zero saturation, and hence no hue. All colors which exhibit a hue must also exhibit saturation, and *vice versa*.

(f) *Species of Colors*. Colors can be classified into *chromatic* and *achromatic* species, according as they do or do not exhibit hue, respectively. The former may be designated briefly as *chromas* (including colors of all finite degrees of saturation) and the latter as *grays* (including black and white).

Median gray (= "mid-gray") is the middle member of a series of grays in which each member differs from its immediate neighbors by the least perceptible difference, and of which black and white are the terminal members. This gray furnishes the most practicable reference point for the achromatic as well as for the chromatic series of colors.

Median colors are all colors equivalent in brilliance to median gray, including the latter.

Tints and shades are colors, including grays and chromas, which are respectively lighter or darker than median gray.

D. PSYCHOLOGICAL PRIMARIES.—The psychologically primary colors are those which are necessary and sufficient, in minimum number, for the description of all colors by introspective analysis.

⁷ Many of the authorities mentioned fail to distinguish between the subjective attribute of color, which is designated in the present report by the term saturation, and the ratio of homogeneous to total radiation in the stimulus, or the *purity*.

⁸ The term *chromaticity* as applied to a color is a natural substitute for the term *quality* which is sometimes employed to distinguish that aspect of a color which excludes its "intensity." The use of *quality* in this context is undesirable on account of the more general meaning which it possesses in psychology.

For normal vision these primaries are: black, white, red, yellow, green, and blue. (73, 251-252; 94, 21). Red and yellow may be grouped together under the designation of "warm," while green and blue may be classified under the designation of "cold" primary chromas.

E. THE MEASUREMENT OF COLOR.—The three attributes of color can be treated as quantities and specified numerically, if all discriminable colors are conceived to be arranged into a system such that neighboring members differ from one another in each of the three attributes by just noticeable degrees (or threshold steps). (92, 207-215; 13, 1-10). Such a system (*vide infra*) is necessarily three-dimensional (61, 18-31), and three ordinal values, representing the positions of a given color in the several dimensions are needed to define the color. The spectral chroma scale, considered more in detail below, is an application of this principle of color measurement to the study of the dependency of chromaticity upon wave-length.

2. STIMULUS TERMS

A. RADIANT ENERGY.—The adequate stimulus of color consists of radiant energy of certain frequencies or wave-lengths which have various stimulus values depending on the type of visual response system under consideration. The term "radiation" is often employed as a brief equivalent of "radiant energy," although this usage tends to confuse the *process* of radiation with the outcome of the process.⁹

B. THE PHYSICAL SPECTRUM is an arrangement of radiant energies in order of their respective frequencies or wave-lengths. It should not be confused with the *color spectrum* which is a series of colors aroused by part of the physical spectrum.

C. SPECTRAL DISTRIBUTIONS. The properties inherent in any sample of radiant energy which determine its capacity as a color stimulus are completely specified by its *spectral distribution*, which expresses the "intensity" for any frequency (or wave-length) as a function of the frequency (or wave-length) in question.

⁹ Cf. (37).

(a) When plotted in the form of a curve, the *ordinates* of a spectral distribution represent "intensity" per abscissa unit (frequency or wave-length, as the case may be); and the intensity concept, for the essential case of the incidence of the radiant energy upon the retina, will be: energy per second per unit area. To be completely specific, the function must express absolute values, but this is often difficult in practice.

(b) The *wave-length unit* which is ordinarily employed in colorimetrics is the millimicron which is correctly symbolized by $m\mu$ (not $\mu\mu$).¹⁰

(c) It is to be noted that wave-length, strictly interpreted, does not furnish a reliable specification of the color-stimulating capacities of radiant energy, as the response of the visual system depends upon *frequency*, while wave-length may vary independently of frequency. Since wave-lengths can only be interpreted in colorimetrics as reciprocal representations of frequency, it would be desirable theoretically to employ frequency directly in formulating spectral distributions. A suggested unit of frequency is the *fresnel*, defined as one vibration per trillionth (10^{-12}) of a second. Table 1 provides means for interconverting between millimicrons and fresnels.

(d) Spectral distributions of *transmission, reflection, luminosity*, etc., which are often employed to specify "color," may be regarded as constituents or as developments of the essential distribution function (*vide infra*).

D. HOMOGENEOUS RADIANT ENERGY—for the purposes of colorimetrics—is radiant energy, sensibly all of the intensity of which lies within a single spectral region so small as to exhibit—under the conditions most favorable for discrimination—no perceptible hue difference within the region.

E. PURITY—The purity of any sample of radiant energy, with respect to any one of its constituents, may be defined in general as the ratio of the intensity of this constituent to the total intensity of the sample. By *physical purity* we may mean such a

¹⁰ On the use of the symbolism $m\mu$ instead of $\mu\mu$ see C. E. Guillaume, *Unités et Étalons*, p. 7, Paris, 1893; also Soc. Fran. de Phys., *Recueil de constants physiques*, p. 1; B. S. Tech. Pap. 119, p. 7.

ratio in which the intensity is measured in energy terms, while *photometric purity* may be defined as a similar quantity based upon evaluations in terms of light units. Although the choice of the particular constituent with respect to which the purity is to be estimated is necessarily more or less arbitrary, we may define—as a special case of considerable importance—the *colorimetric purity*, which is the ratio in luminosity terms, between the dominant homogeneous constituent and the total sample, where the “dominant homogeneous constituent” comprises a range of wavelengths not greater than that corresponding to a single chromaticity threshold in the given spectral region, and has a dominant hue identical with that of the total sample, the intensity of the homogeneous constituent being arbitrarily so adjusted with respect to the total intensity that it can be mixed with “gray light” in such proportions as to yield a color-match with the total sample. This last definition corresponds with that of “per cent. white” in the method of colorimetry by “monochromatic analysis,” but evidently involves psychophysical considerations in so essential a manner as to have very little physical significance.

F. MODE OF INCIDENCE—The color which is evoked by any adequate stimulus depends not only upon the spectral distribution of the latter, but also upon certain further conditions which may be called those of its *mode of incidence*. These conditions include: (1) the type of color system possessed by the observer, (2) the portion of the retinal field stimulated, (3) the size of the field, (4) the momentary state of adaptation of the optic nervous mechanism, and (5) the excitation processes in adjacent visual areas. In accurate work these factors require specification. In general, we assume pure cone vision of the normal trichromatic system, central fixation, a size not exceeding three degrees, and a gray contrast field of the same apparent brightness as the given stimulus light. (*vide infra*, for conditions of pure cone vision.)

3. PSYCHOPHYSICAL TERMS

This section deals with the terminology of the relation between color and its stimulus. The study of this relation constitutes the science of *color sensation*.

TABLE 1
Equivalents in Terms of Fresnels of Wave-lengths in Millimicrons

Wave-Length Millimicrons	Frequency Vibrations Seconds 10 ¹²	Wave-Length Millimicrons	Frequency Vibrations Seconds 10 ¹²	Wave-Length Millimicrons	Frequency Vibrations Seconds 10 ¹²		
	400	750.0	He 492.2	609.5	600	500.0	
Hg	404.7	741.3	500	600.0	610	491.8	
Hg	407.8	735.7	He 501.6	598.1	Hg 615.2	487.7	
	410	731.7	510	588.3	620	483.9	
	420	714.3	520	576.9	630	476.2	
	430	697.8	530	566.1	640	468.8	
H	434.1	691.1	540	555.6	650	461.6	
Hg	435.8	688.4	Hg 546.1	549.4	H	656.3	457.1
	440	681.9	550	545.4	660	454.6	
He	447.2	670.8	560	535.8	He 667.8	449.3	
	450	666.6	570	526.2	670	447.8	
	460	652.2	Hg { 576.9	520.0	680	441.2	
	470	638.4	579.1	518.0	690	434.8	
He	471.3	636.5	580	517.2	700	428.6	
	480	625.0	He 587.6	510.5	He 706.5	424.6	
H	486.2	617.1	590	508.5	710	422.6	
	490	612.3					
Hg	491.6	610.2					

A. PSYCHOPHYSICAL FUNCTIONS.—There are two important, general types of psychophysical functions which occur in colorimetrics, (1) a type which expresses a direct relation of dependency between a psychological color attribute (*vide supra*)—measured in threshold steps—and a stimulus variable, and (2) a type which formulates relations between two or more stimulus variables, such relations depending upon and expressing the conditions for the *equation* in one or more psychological dimensions, of the colors due to different stimuli.¹¹

B. COLOR EXCITATIONS AND PHYSIOLOGICAL PRIMARIES.—An example of the second type of function appears in the color excitation curves for various visual color systems, which curves show in what proportions of intensity a number of selected color

¹¹ A further type specifies the stimulus conditions for just-noticeable (or otherwise standardized) differences between the colors evoked by compared stimuli. On certain assumptions, functions of this type can be integrated to yield those of type (1).

stimuli must be mixed to match the homogeneous stimuli of the spectrum. (48; 4, 15, 223-247).

(a) Any set of component stimuli, thus applied, may be regarded as physiological primaries, but when they are so chosen for any or all visual color systems as to account for the maximum number of facts they may be called the *fundamental physiological primaries*. Such primaries are stimuli, not colors; although they may properly be said to "have" a color. They are of the *additive* type because the stimuli are *added* to produce the required effects.

(b) The corresponding *subtractive*, or "pigment," primaries are determined roughly by the spectrophotometric complementaries of the additive primaries. However, they do not consist of radiant energy but of absorbing mechanisms of one sort or another. In general they absorb from a "gray light" spectral distribution—of a certain intensity—(*vide infra*) portions which are as nearly as possible equivalent in color mixture value to the respective, additive primaries.

C. VISIBILITY, LIGHT, AND LUMINOSITY.¹² Another psychophysical function of the second type is the so-called *visibility curve*, which expresses reciprocally the intensities of radiant energy of different frequencies (or wave-lengths) which are required to match a standard in brilliance alone. The most recent average visibility values are given in Table 2.

(a) The conception of *light*, which is fundamental to *photometry*, is a psychophysical quantity defined as the product of the *absolute* power and visibility measures for any given sample of radiant energy.

(b) *Relative* light quantities are called *luminosities*.

D. COMPLEMENTARY STIMULI are stimuli which when mixed additively in certain required proportions evoke a gray.

(a) *Complementary colors* are the colors evoked by these stimuli, in the given proportions, separately.

E. The definition of color as a strictly psychological entity does not preclude the legitimate use of such convenient expressions

¹² For photometric concepts, see the report of the Committee on Nomenclature and Standards of the I. E. S. published each year in the Transactions of the Illuminating Engineering Society.

TABLE 2
Average Normal Visibility Values

Adopted as Standard by the Illuminating Engineering Society and the Optical Society of America 1919-1920.¹³

Wave-Lengths	Adopted Mean I. E. S	Absolute Visibility
400	0.0004	0.27
10	.0012	0.80
20	.0040	2.7
30	.0116	7.72
40	.023	15.3
450	0.038	25.3
60	.060	40.0
70	.091	60.7
80	.139	92.6
90	.208	139
500	0.323	216
10	.484	322
20	.670	446
30	.836	557
40	.942	629
550	0.993	662
60	.996	663
70	.952	641
80	.870	580
90	.757	502
600	0.631	421
10	.503	336
20	.380	253
30	.262	175
40	.170	113
650	0.103	68.8
60	.059	39.3
70	.030	20.0
80	.016	10.7
90	.0081	5.4
700	0.0041	2.7
10	.0021	1.4
20	.0010	0.67
30	.00052	0.35
40	.00025	0.17
750	0.00012	0.08
60	.00006	0.04

Wave-Length
of maximum 556

¹³ Cf. JOUR. OPT. Soc. of America, 4, p. 58; 1920.

as "*the color of light*," "*the color of a material*," "*spectral colors*," etc., since such expressions may be taken to imply a psychophysical linkage between stimulus and color which is reliable under normal conditions.

III. STANDARD PSYCHOPHYSICAL DATA

The purpose of the ensuing Part of this Report is to present data on certain laws or conditions which are fundamental to visual response and, in particular, to the science of colorimetrics. These data refer mainly to psychophysical relations of the two types defined in the preceding Part, but also to certain purely psychological and purely physiological laws. A great deal remains to be discovered and made definite in this field, and the following statements merely represent the best determinations available when the best are often far from good. Reference should be had to the Report of the Committee on Visual Sensitometry for a more detailed treatment of visual laws which are of interest mainly to the photometrician or the illuminating engineer.

1. THE PSYCHOLOGICAL COLOR SOLID

The three-fold attributive nature of color permits the symbolic arrangement of all possible colors in the form of a geometrical, or quasi-geometrical solid, neighboring members being separated by just noticeable differences. At present there are not sufficient data to permit of an accurate construction, but the following approximations would appear to be determined.¹⁴

A. GENERAL COÖRDINATES.—Since the hues are cyclical in their resemblances, they will be represented most appropriately by angular measures with reference to a fixed point and line in any plane. The saturation must then be determined—on the general principle of polar coördinates—by a distance in the plane from the fixed point, or pole. The third dimension, of brilliance, consequently becomes a distance perpendicular to the selected plane.

B. REFERENCE AXES.—The most natural origin of coördinates is the point on the axis of the figure which represents the median gray (*vide supra*), the axis itself (standing for all of the achromatic

¹⁴ For discussions of the Psychological Color Solid see (92, 60-64; 61, 22-25).

colors) serving as the reference line for saturation, while a plane passing through the axis and the extreme spectral red forms the reference plane for hue. (See Fig. 1.)

C. BOUNDARIES.—It is certain that the bounding surfaces of such a color solid will have an irregular contour. The axial dimen-

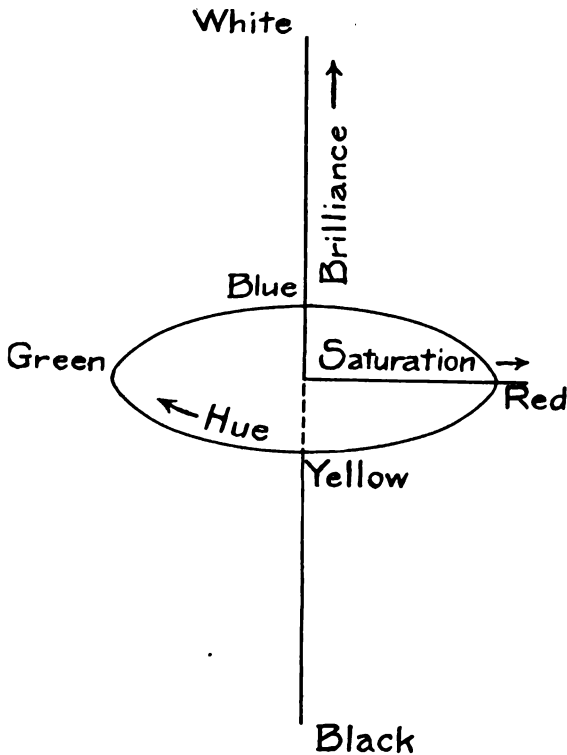

FIG. 1. The Dimensions of Psychological Color Solid

sion will be about thirty times the radial one at the greatest value of the latter. Both in the directions of high and low brilliance, there will be convergence towards a vertex. If the edges of planes perpendicular to the axis are regarded as determined by the saturations obtainable by *spectral stimuli*, these edges will be maximally near the axis at the yellow, receding on either side to find a constant value for the intermediaries of red and blue.

D. PSYCHOLOGICAL PRIMARIES.—It is not legitimate to represent the psychological primaries, as Titchener does, as corners in a quadrilateral construction, since there is no correlation between psychological primacy and saturation, which such a construction implies.

2. THE SPECTRAL CHROMA SCALE

The functions which link the attributes of color, expressed in threshold units (*vide supra*) with the characteristics of the stimulus have thus far been determined only imperfectly. Reference should be had to the Report of the Committee on Visual Sensitometry (68) for data on the relation between brilliance and stimulus intensity. Jones (42), utilizing measurements made by Steindler, Nutting and himself, has determined the function connecting the chromaticity of spectral colors with wave-length. Since the spectral colors, even for conditions of pure cone vision, are by no means of equal saturation (*vide infra*) Jones' so-called "hue scale" is in reality a resultant hue-saturation scale of a very special kind. However, as an index of the law of change of chromaticity with respect to wave-lengths of homogeneous radiation, his results are of fundamental importance. They are reproduced in Table 3. Each chromaticity unit corresponds to one just noticeable difference (both in chromaticity and in wave-length), and the reciprocal of the wave-length difference is the sensibility to change in wave-length. It will be noted that this sensibility has four distinct maxima in the spectrum, the two most important ones lying at 494 and 588 $m\mu$, respectively, where the wave-length threshold is approximately 1.0 $m\mu$. Jones finds 128 just noticeable chromaticity steps in the spectrum, and about 20 additional steps in the non-spectral purples and magentas, as determined by their complementaries.

Since the hues form a cyclic series, it would seem more appropriate to express the hue scale in angular than in linear notation. If there are H hue steps in the complete cycle, the angular unit will evidently be $2\pi/H$ radians. The magnitude of this unit, however—if it is to correspond always to an integral step—must vary with the saturation, so that the linear unit is probably the more convenient. No determinations have yet been made of the

TABLE 3
Spectral Chroma Scale

No.	$\lambda(\text{m}\mu)$	$d\lambda$	No.	λ	$d\lambda$	No.	λ	$d\lambda$
1	700.0	44	576.5	1.4	87	490.4	1.1
2	678.0	22.0	45	75.2	1.3	88	89.4	1.0
3	65.0	13.0	46	73.7	1.5	89	88.2	1.2
4	59.0	6.0	47	71.7	2.0	90	87.0	1.2
5	54.0	5.0	48	70.1	1.8	91	85.8	1.2
6	49.5	4.5	49	68.4	1.7	92	84.5	1.3
7	46.0	3.5	50	66.6	1.8	93	83.2	1.3
8	42.8	3.2	51	64.8	1.8	94	81.7	1.5
9	40.2	2.6	52	63.0	1.8	95	80.0	1.7
10	37.8	2.4	53	61.1	1.9	96	78.2	1.8
11	35.5	2.3	54	58.6	2.5	97	76.5	1.7
12	33.1	2.4	55	57.0	2.6	98	75.0	1.5
13	30.0	3.1	56	54.4	2.6	99	72.9	2.1
14	26.5	3.5	57	51.8	1.6	100	70.5	2.4
15	23.0	3.5	58	49.1	2.7	101	68.2	2.3
16	20.0	3.0	59	46.1	3.0	102	65.8	2.4
17	17.3	2.7	60	43.0	3.1	103	63.6	2.2
18	14.9	2.4	61	39.8	3.2	104	61.2	2.4
19	12.5	2.4	62	36.5	3.4	105	58.7	2.5
20	10.2	2.3	63	33.2	3.3	106	56.5	2.2
21	08.0	2.2	64	30.1	3.1	107	54.4	2.3
22	06.0	2.0	65	27.1	3.0	108	52.1	2.3
23	04.1	1.9	66	24.2	2.9	109	50.0	2.1
24	02.3	1.8	67	21.4	2.8	110	48.0	2.0
25	600.6	1.6	68	19.1	2.3	111	46.0	2.0
26	599.0	1.6	69	16.8	2.3	112	44.2	1.8
27	97.4	1.6	70	14.6	2.2	113	42.5	1.7
28	95.9	1.5	71	12.6	2.0	114	40.8	1.7
29	94.5	1.4	72	10.6	2.0	115	39.0	1.8
30	93.1	1.4	73	08.0	1.6	116	37.2	1.8
31	91.8	1.3	74	07.0	1.0	117	35.3	1.9
32	90.5	1.3	75	05.4	1.6	118	33.3	2.0
33	89.5	1.0	76	04.0	1.4	119	31.3	2.0
34	88.5	1.0	77	02.6	1.4	120	29.3	2.1
35	87.5	1.0	78	01.3	1.3	121	27.0	2.2
36	86.4	1.1	79	500.0	1.3	122	24.8	3.2
37	85.3	1.1	80	498.7	1.3	123	22.3	2.3
38	84.0	1.3	81	97.4	1.3	124	19.7	2.8
39	82.7	1.3	82	96.1	1.3	125	16.7	3.0
40	81.5	1.2	83	94.8	1.3	126	13.8	2.9
41	80.3	1.2	84	93.7	1.1	127	10.4	3.4
42	79.1	1.2	85	92.6	1.1	128	405.8	4.6
43	77.9	1.2	86	91.5	1.1

number of hue steps in cycles of color with uniform saturation, and it is quite uncertain whether the change in number of steps follows the simple geometrical analogy: $H = 2\pi s$, where s is the saturation measure in threshold steps from the equivalent gray. (This clearly raises the question as to whether the space of the psychological color solid is Euclidean.) The angular magnitudes in this system would preferably be measured from an axis through the normal hue of extreme spectral red, on account of the stability of this color in relation to its stimuli, and all functions of these magnitudes will be periodic.

The positions of the psychologically primary hues in the "hue scale" are matters of considerable interest. On Jones' spectral chroma scale, taking the zero in the violet and unity at extreme spectral red, the primary blue, green and yellow lie at .24, .41, and .68, respectively, the red having a value slightly in excess of 1.00, on account of the necessity of including a slight amount of blue in the stimulus for red. (95). It will be seen that the separations of the primaries on this scale are by no means equal.

3. THE SATURATION SCALE

Careful determinations of the number of just noticeable saturation steps between each maximally saturated color and white have not yet been made. Nutting and Jones (67; 68) find about 20 such steps for red, green and blue, the thresholds for change in the per cent. white varying with the given per cent. white as shown in Table 4.

TABLE 4
Saturation Scale Data

Per cent. white	0	10	20	30	40	50	60	70	80	90	100
Threshold white	4.7	4.6	4.5	4.4	4.2	4.0	3.7	3.4	3.0	2.5	2.1

These values, like those for wave-length sensibility, are independent of brilliance over a wide range of intensities.

The Chairman has attempted to determine the relative saturations of the spectral colors by an application of the flicker photometer. It is assumed that when any color is alternated with

a white of the same brilliance the critical flicker frequency is a function of saturation alone, so that colors possessing the same critical frequency will be of equal saturations. Since the spectral colors have radically different frequencies, with a minimum in the yellow at $575\text{ m}\mu$, it is necessary to add white to all except the latter to attain this equality. The per cents. of white (in terms of the total mixture) which were found necessary for the writer's right eye are shown in Table 5.

TABLE 5
Comparative Saturations of Spectral Colors

Wave-length, $m\mu$	419	438	458	479	497	517	537	556
Per cent. white.....	53.0	75.1	63.5	51.2	49.0	30.0	28.9	19.0
Wave-length, $m\mu$	575	595	614	634	653	673	692
Per cent. white.....	0.0	19.3	38.8	31.5	46.7	50.7	49.4

These figures are only tentative, as the sources of error in the experiment seem quite numerous. However, they indicate quite clearly that the differences in saturation of the spectral colors are of first order importance, so that it is highly improbable that the number of saturation steps from white is the same for them all. These conclusions appear to be corroborated by the relations of the spectral colors to white as represented on the color-mixture triangle (*vide infra*).

4. STIMULI FOR THE PSYCHOLOGICAL PRIMARIES

Westphal (98) has determined stimuli, as nearly as possible homogeneous, for arousing the psychological primaries in the average normal observer. They are: for red, extreme visible long-wave end of the spectrum plus a small amount of blue or violet; for yellow, $574.5\text{ m}\mu$; for green, $505.5\text{ m}\mu$; and for blue, $478.5\text{ m}\mu$. It is interesting to note that three of these stimuli (for red, green and blue) correspond quite closely with the three fundamental physiological primaries determined by König and Dieterici.

5. THE COLOR EXCITATION FUNCTIONS

Probably the most fundamental of all the psychophysical data relating to color are the *three-color excitation curves*, which represent

the laws of three-color mixture. Extant data on these relationships are due to Maxwell (57), Abney (4), and König and Dieterici (48), the results obtained by the first investigator, however, being at present of relatively little value. The remaining two investigations were made with quite different light sources and choices of reference points, but are capable of being reduced to a common denominator by appropriate calculations. This work has been carried out very painstakingly by Mr. E. A. Weaver of the present Committee, who finds that the two sets of data actually agree surprisingly closely, so that they may legitimately be averaged. The results, reduced to an equal energy spectrum and referred to average noon sunlight as an origin (in trilinear coordinates) are given in Table 6 and Fig. 2.

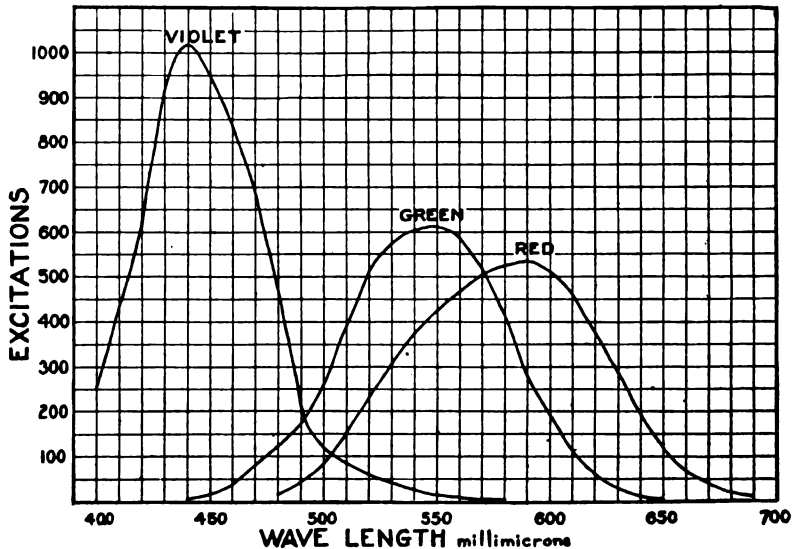

FIG. 2. Elementary Color Excitations for Different Wave Lengths
(The ordinates correspond with the values listed under "Excitations" in Table 6.)

A detailed account of the method employed in the reduction of the two sets of data will be given in a separate publication, but may be outlined briefly here as follows. Abney's luminosity curve values were first converted so as to refer to average noon sunlight

instead of to the carbon arc (as given), using Watson's data¹⁵ for the energy distribution of the latter and Abbot's (1) data on that of the former (*vide infra*). The corresponding luminosity and percentage color excitation values were then combined as products to yield excitation values referred to sunlight, rendering them com-

TABLE 6
Spectral Colors in Terms of Elementary Excitations

Wave- Length m μ	Excitations			Percentages		Wave- Length	Excitations			Percentages	
	Red	Green	Violet	Red	Violet		Red	Green	Violet	Red	Violet
400	253	100	550	424	612	18	40.2	1.7
410	433	100	560	466	578	11	44.2	1.0
420	614	100	570	505	517	7	49.5	.7
430	915	100	580	520	415	4	55.4	.4
440	7	1019	99.3	590	535	296	...	64.3
450	16	950	98.3	600	510	196	...	72.2
460	38	842	95.7	610	462	113	...	80.4
470	81	697	89.6	620	375	59	...	86.3
480	14	122	473	2.3	77.6	630	285	29	...	90.8
490	41	169	220	9.5	51.1	640	195	10	...	95.1
500	83	260	123	17.8	26.4	650	118	3	...	97.5
510	151	391	87	24.0	13.8	660	68	100
520	233	510	61	29.0	7.6	670	40	100
530	307	572	43	33.3	4.7	680	22	100
540	373	603	29	37.1	2.9	690	27	100
						750					

These values are for an equal energy spectrum. The relative magnitudes of the three elementary excitations have been chosen so that the curves for average noon sunlight have equal areas; that is, if the percentage values are plotted on a trilinear diagram, sunlight falls in the center. The absolute excitation values are based upon a convenient arbitrary unit. The percentage values are given for the red and violet only since those for the green can be found by subtracting the sum of the other two values from 100 in each case.

parable in this respect with the values given by König and Dieterici. The respective trilinear representations of both sets of values then coincided, except for the positions of the elementary "green" excitations and the sides of the two triangles joining the green and the "violet" elementaries. Although the relation between the two green elementaries could not be determined directly, it

¹⁵ See (5, p. 96, Table 1 and p. 97, Fig. 3).

was established indirectly by use of the known positions of the solar white in each of the triangles, this correlation permitting the reduction of the two sets of values to three common elementaries. The red and green values of each set were now tested separately against the data of independent color matches published by Priest (79; 81) in connection with his investigations of the leucoscope and camouflage paints, which accidentally provided materials for checking the results. Both sets checked equally well, so that they were given equal weight in the computation of average values. The violets were tested by data on complementaries and that of Abney was rejected. These best values were then retransformed to terms of elementaries determined by a triangle based on extreme spectral red and violet, with its sides as closely tangent to the locus of the spectral colors as possible. Finally the excitation values were reduced to terms of an equal energy spectrum. Thus expressed, the areas under the three curves are equal for the energy distribution of average noon sunlight, the magnitudes or "weights" of the three elementaries having been so chosen as to yield the solar white with equal excitations.

When quite differently weighted, in terms of the relative powers of the three elementary processes to generate brilliance, the three chromatic curves should summate to yield the visibility curve. It is a well-known fact that in this summation the value of the violet or blue excitation is extremely small compared with that of the red and green. König and Dieterici give no data from which these specific visibility coefficients of the chromatic processes can be deduced. Abney, however, provides data¹⁶ of this sort leading to coefficients by which the ordinates of the excitation curves must be multiplied in order that all three curves should summate to yield his own visibility curve. This latter curve, however, as derived from Abney's luminosity curve and carbon arc data, departs so widely from the average visibility function, as specified by the Standards Committee of the Illuminating Engineering Society, as to throw doubt upon the general validity of these values. Mr. Weaver and the writer have made

¹⁶ See (4, Table 38, p. 239, and Table 34, p. 17, Columns 7 to 9). Also (17).

new experimental determinations of the chromatic visibility coefficients for their own eyes and those of one other subject. The results not only differ from Abney's, but show such large variations among themselves as to indicate that these coefficients are subject to marked fluctuation among individuals. All three of our subjects agree perfectly on the proportions of the mixed stimuli required for the color matches (measured in energy units), but disagree on the photometry of the components. In other words, their visibility curves vary widely while their color curves remain constant. This may indicate either that the brilliance process is independent of the chromatic processes or that the latter, as constituents of the former, vary in weight without alteration in the mathematical form of their response functions. The average values for the factors obtained from our three subjects were: red, 0.370; green, 0.617; and blue, 0.012.

The stimulation values of all forms of radiant energy, simple or complex, can be completely specified in terms of the ratios of excitation of the three chromatic elementaries,—combined with one absolute measure of intensity, if the brilliance as well as the chromaticity of the color is to be taken into consideration. To arrive at the expression of the chromatic stimulation value of any given distribution of radiant energy in terms of the three elementaries, it is only necessary to multiply each of the values for the elementaries given in Table 6 by the corresponding ordinates of the distribution function throughout the spectrum and then to find the areas under the resulting three curves. The ratio of these areas determines the chromaticity of the color. The reduction of data in one system of color specification to data of another system (*vide infra*) can be accomplished with the greatest sureness of principle through the medium of a common expression in terms of the three elementaries. For the science of color the three elementaries are far more fundamental even than the spectrum, and the expression of the spectral colors in terms of these components (as in Table 6) is as natural as (say) the similar expression of various Planckian distributions (see Table 17).

It is, of course, improbable that the curves in Fig. 2 faithfully represent the actual resonance functions of the elementary chro-

matic mechanisms in the retina. There is also little doubt, however, that the curves in question and all specifications based upon them, are potentially convertible into terms of such actual response functions. The characteristic constants of these latter functions must be determined from data auxiliary to the facts

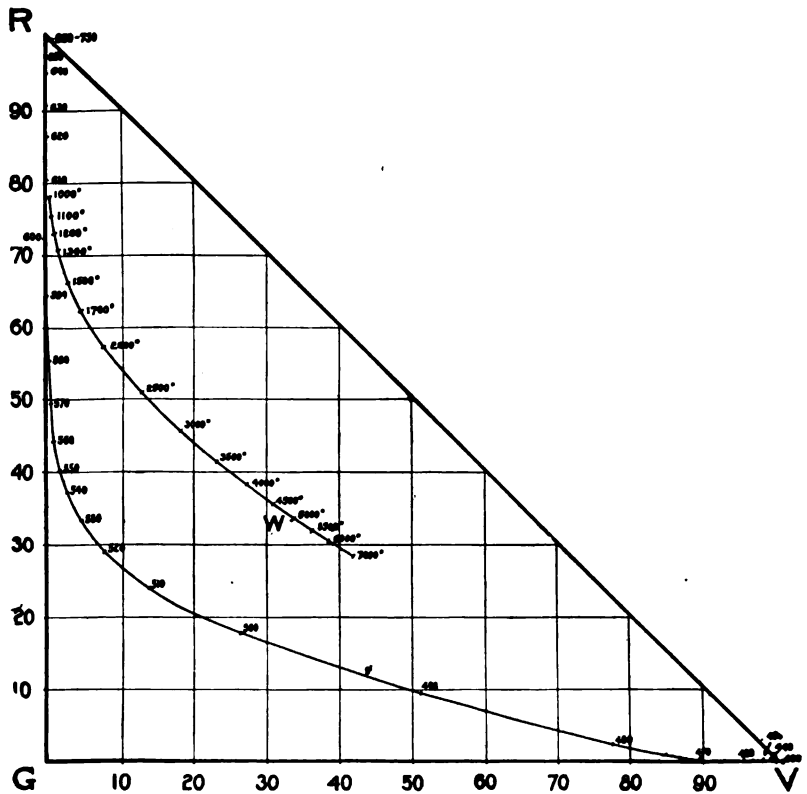

FIG. 3. Color Triangle, Showing Loci of Spectral and Black Body Excitations
(The ordinates give the percentage excitation values for Red and the abscissae those for Violet.)

of color-mixture for the normal eye, such as those of color-blindness and chromatic minuthesis. Attempts to arrive at so-called *fundamental excitations*, based upon these more comprehensive considerations, have been made by König, Abney, Exner (17) and others.

but the results cannot be regarded as sufficiently final to justify their adoption in place of a maximally straightforward representation of the facts of color-mixture, such as is given in Table 6.

Fig. 3 provides a graphical representation of some of the relations based upon Mr. Weaver's analysis, in terms of trilinear coördinates or a so-called color-mixture triangle. It will be noted that the triangle here given is rectangular rather than equilateral, as is ordinarily the case. The latter form bears the simplest relation to the representation of the three color excitation values in the familiar three-dimensional Cartesian coördinates, being a

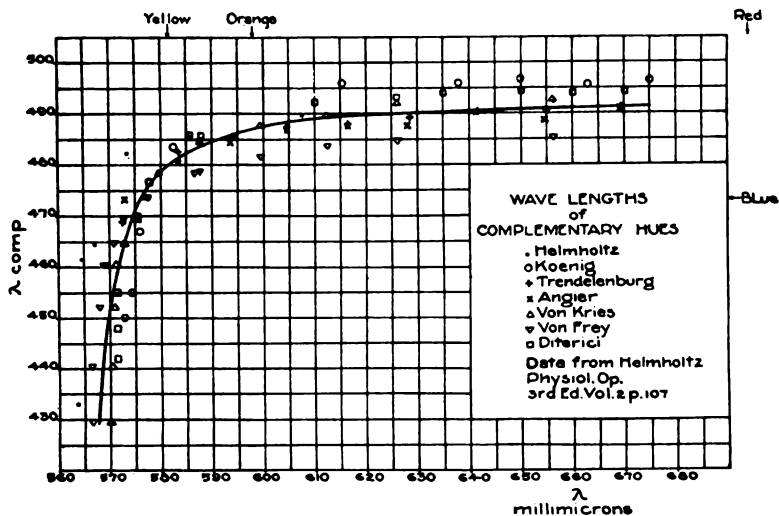

FIG. 4a. Wave-Lengths of Complimentary Hues

section of this system making equal angles with all of the reference planes. The rectangular form, however, is much easier to use either in plotting the loci of colors or in determining the excitation values of the colors lying on curves already plotted. The result of the mixture of stimuli represented by two or more points in the triangle is found by computing the position of the "center of gravity" or centroid, of the multiple-point system, in which the intensities of the components—expressed in relative units defined by the triangle—function as analogues of masses.

6. COMPLEMENTARY COLORS AND WAVE-LENGTHS

Among the most interesting results of the mixture of different stimuli are the identification of pairs of homogeneous radiations which, with the proper ratio of intensities, yield white. Such *complementary wave-lengths* can be found in the color-mixture triangle at the two intersections of straight lines, drawn through the central white, with the locus of the spectral colors. It is

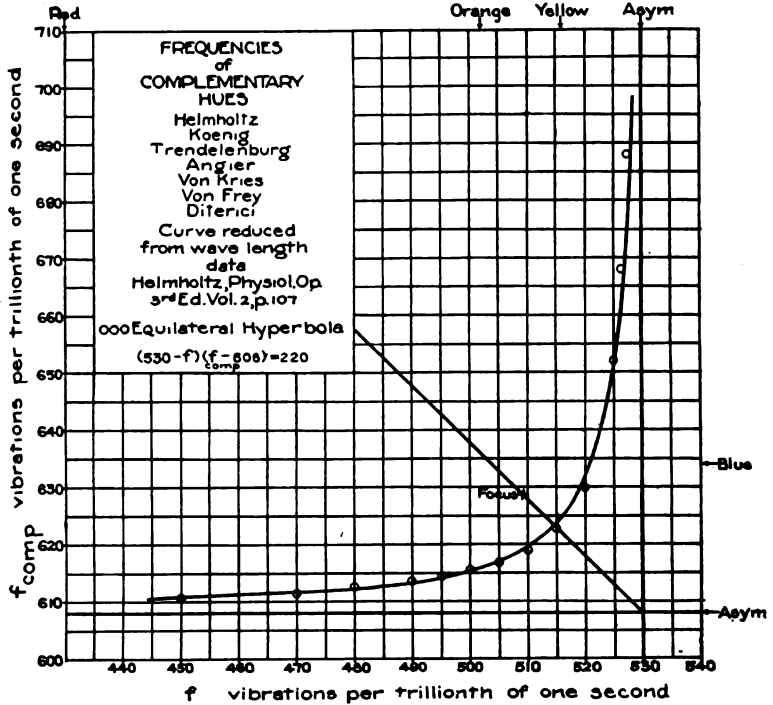

FIG. 4b. Frequencies of Complementary Hues

clear from an examination of the triangle that there is a range of spectral colors—in the green—which have no single spectral complementary, the complementaries of either end region of the spectrum being found in the other. Extant data on complementary wave-lengths are unsatisfactory because of indefiniteness in the specification of the white stimulus which was employed. Fig. 4a gives a plot of the best values which are available. In

Fig. 4b the plot of these values in terms of frequency shows how closely their relation fits the function expressing a rectangular hyperbola, having an equation:

$$(530 - f) (f_c - 608) = 220,$$

f being the given frequency and f_c its complementary. (80)

7. STANDARD CONDITIONS FOR PURE CONE VISION

In order to secure reliable conditions for complete color vision even in the normal observer, it is necessary to restrict the stimulus to the retinal cones, excluding the rods, which yield only achromatic colors. Pure cone vision can be secured by satisfying the following requirements.

A. CHOICE OF OBSERVERS.—Recent investigations by Abney indicate that a considerable number of individuals possess rods in the center of the retina as well as in the periphery, so that before relying upon the restriction of the stimulus to a central field, the observer should be tested for the Purkinje phenomenon in central vision.

B. SIZE OF FIELD.—The normal retina possesses no rods in an area slightly greater than three degrees in diameter, surrounding the intersection of the line of sight with the retina (73, 10). Consequently, in the case of an observer known to be normal in this respect, a field of three degrees, with fixation on the center of the field, insures pure cone vision at all intensities.

C. INTENSITY.—With all observers and all field sizes, pure cone vision is obtainable at intensities above approximately one hundred photons, provided the eye has not previously been exposed for a considerable time to a much lower intensity or assuming a condition of equilibrium adaptation to the given intensity level, which should be reached within ten minutes (75; 34). One hundred photons represents an external stimulus surface brightness of one hundred candles per square meter, used with a pupillary opening of one square millimeter, or equivalent conditions as regards retinal illumination.

IV. PHYSICAL STANDARDS

It is the function of the present Part of this Report to consider some physical standards which are of importance in colorimetrics.

These standards consist in certain typical forms of stimuli to color, or in factors or functions contributory to such stimuli. Some of the standards considered below are primarily of theoretical or research interest, while others are essentially of technical significance only.

1. THE CRITERION OF HOMOGENEOUS RADIANT ENERGY

As defined in a preceding Section, the criterion of homogeneity in a stimulus, for the purposes of colorimetrics, must rest upon wave-length sensibility, and hence upon the facts which are summarized in Table 3. In general, in order to be considered homogeneous, a given sample of radiation must have a range of wave-lengths not greater than the threshold for wave-length in the given region (defined by its mid-wave-length). As seen from the Table, this varies widely for different parts of the spectrum, e.g., being 22 $m\mu$ in the extreme red (680 $m\mu$), and 1.0 $m\mu$ for 588 $m\mu$.

2. STANDARDS OF SPECTRAL ENERGY DISTRIBUTION

Under this caption are included curves and constants indicating the distributions of "intensity" (*vide supra*) in the physical spectrum of certain frequently encountered or critically important forms of *heterogeneous* radiant energy. These distributions are all at least approximately of the so-called "black body," or Planckian type, i.e., they are determined by a general equation of the form,

$$E = \frac{c_1}{\lambda^5 \left(e^{\frac{c_2}{\lambda T}} - 1 \right)}$$

where E is the energy per unit wave-length, T the absolute temperature of the source, e the base of the natural system of logarithms, λ the wave-length, and c_1 and c_2 are constants. When our concern is only with chromaticity, we need consider merely *relative* energies, and any convenient value may be adopted for c_1 , such as a value which makes the maximum of the function equal to unity. The value of c_2 at present recommended is 14350 micron-degrees (19). This equation has been found to express very closely the energy distributions for the radiation

emitted by incandescent solids, such as those contained in natural and artificial illuminants, although in the majority of cases T is not the actual temperature of the material, but is a temperature determined by the distribution itself and known as the *color temperature*, this being the actual temperature of a theoretical black body which would yield that same relative distribution in the visible spectrum. Table 7 and Fig. 5 give the relative intensities for various representative wave-lengths for Planckian distributions at a considerable variety of temperatures.

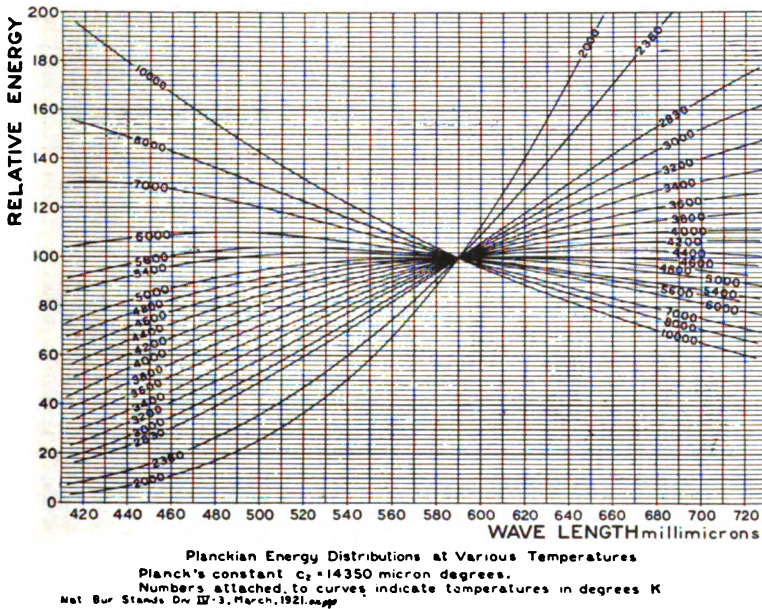

FIG. 5

A. AVERAGE NOON SUNLIGHT.—The most important standard of energy distribution, from the point of view of colorimetrics, is that which characterizes “daylight,” since it is with respect to deviations from this distribution that the chromatic processes of vision have been adjusted by nature. Unfortunately, however, the form of this distribution is highly variable. There is, in the first place, the radical difference between sky-light and direct sunlight, the former exhibiting that marked deficiency in long-

TABLE 7
Relative Energy of a Black Body at Various Temperatures and Wave-Lengths

Absolute Temperature	1000	1200	1400	1600	1800	2000	2200	2400	2600	3000	3600	5000	5000
	$\times 10^{-15}$	$\times 10^{-13}$	$\times 10^{-12}$	$\times 10^{-11}$	$\times 10^{-10}$	$\times 10^{-9}$	$\times 10^{-8}$	$\times 10^{-8}$	$\times 10^{-7}$	$\times 10^{-7}$	$\times 10^{-6}$	$\times 10^{-6}$	$\times 10^{-6}$
Wave-length $m\mu$													
400	26	101	727	1787	2158	1584	809	3148	994	6256	4612	7465	7482
410	54	186	1200	2728	3101	2168	1064	4005	1230	7403	5056	7872	7878
420	111	330	1926	4037	4368	2915	1378	5026	1502	8663	5782	8244	8252
430	214	568	3024	5949	6037	3856	1757	6220	1813	10038	6407	8591	8601
440	416	954	4642	8519	8204	5022	2212	7608	2163	11520	7051	8911	8923
450	766	1559	6946	11976	10965	6449	2747	9194	2555	13111	7724	9208	9222
460	1375	2490	10210	16550	14440	8171	3373	10995	2989	14798	8373	9475	9492
470	2396	3388	14740	22510	18750	10226	4096	13020	3464	16580	9041	9716	9737
480	4091	5947	20890	30140	24030	12650	4923	15280	3982	18450	9712	9933	9957
490	6776	8933	29130	39810	30420	15480	5860	17770	4544	19975	10378	10123	10151
500	10990	13169	40030	51890	38080	18760	6914	20500	5143	24410	11039	10286	10319
510	17460	19020	54170	66820	47140	22510	8087	23480	5784	24480	11688	10429	10466
520	27230	27090	72340	85020	57780	26770	9382	26690	6464	26614	12329	10544	10586
530	41740	38000	95450	107060	70160	31580	10810	30150	7180	28780	12954	10639	10686
540	62670	52550	124300	133400	84410	36950	12370	33830	7930	30980	13563	10712	10764
550	92730	71710	160200	164600	100720	42920	14050	37750	8712	33205	14148	10762	10820
560	134900	96660	203300	201200	119250	49520	15870	41900	9524	35444	14715	10797	10862
570	193500	128700	257700	243900	140060	56740	17820	46240	10364	37675	15260	10813	10882
580	274100	169400	322140	293400	163470	64640	19900	50790	11234	39920	15782	10811	10887
590	382600	220500	399000	349900	189430	73180	22110	55530	12112	42058	16280	10793	10877

TABLE 7—Continued

Absorptivity Temp. perature	1000	1200	1400	1600	1800	2000	2200	2400	2600	3000	3600	5000
Wave- length m μ	$\times 10^{-12}$	$\times 10^{-12}$	$\times 10^{-12}$	$\times 10^{-11}$	$\times 10^{-10}$	$\times 10^{-9}$	$\times 10^{-8}$	$\times 10^{-8}$	$\times 10^{-7}$	$\times 10^{-7}$	$\times 10^{-6}$	$\times 10^{-6}$
600	527500	284200	490100	414600	218200	82400	24430	60460	13012	44356	16752	10763
610	718400	362700	596700	487600	249800	92300	26880	65530	13936	46542	17197	10716
620	968400	458800	721500	569900	284300	102850	29450	70770	14868	48702	17618	10660
630	1291500	575300	866000	661800	321800	114100	32120	76120	15808	50804	18010	10590
640	1704100	715300	1032100	764000	362500	126000	34910	81620	16742	52880	18332	10510
650	2226100	882400	1221300	877200	406400	138500	37790	87200	17691	54900	18713	10420
660	2882000	1080200	1437500	1001600	453300	151700	40760	92850	18642	56990	19024	10323
670	3697900	1312900	1681400	1138200	503600	165500	43820	98610	19590	58770	19313	10218
680	4706000	1585900	1955500	1287000	557100	179900	46960	104410	20540	60640	19573	10101
690	5939800	1900800	2261700	1448000	613800	194900	50160	110290	21480	62400	19809	9985
700	7440500	2266700	2601900	1623000	673600	210400	53420	116140	22400	64090	20022	9861
710	9251200	2686000	2979200	1810000	736700	226500	56740	121980	23210	65740	20207	9732
720	11419000	3165000	3395100	2012000	803000	243000	60120	127860	24220	67320	20368	9600
730	14005000	3706800	3851300	2227000	872000	260000	63520	133720	25120	68820	20511	9462
740	17063000	4321700	4348600	2456000	944300	277300	66960	139570	25980	70230	20627	9323
750	20663000	5013000	4891000	2700000	1019500	295100	70420	145350	26840	71600	20725	9179
760	24874000	5785600	5480900	2957000	1097100	313300	73910	151100	27670	72870	20828	9035

All of the values in this table were calculated by means of Wien's equation with the exception of the last column, headed "5000x10⁻⁶" and that was calculated by means of Planck's equation. The values show the correct relationships for different wave-lengths at a single temperature, and between different temperatures if multiplied by the factors which are placed at the heads of the several columns. See Forsythe, Ref. 19, pp. 330-331.

wave radiations compared with the latter, which is responsible for the blue color of the sky. Direct sunlight, moreover, varies in the form of its distribution curve with the time of the day and year, and with latitude on the earth's surface. Different again, is the distribution which accompanies an overcast sky. (54, 37-39; 81).

It is necessary therefore to adopt as a standard an average curve, representing the conditions most frequently encountered.

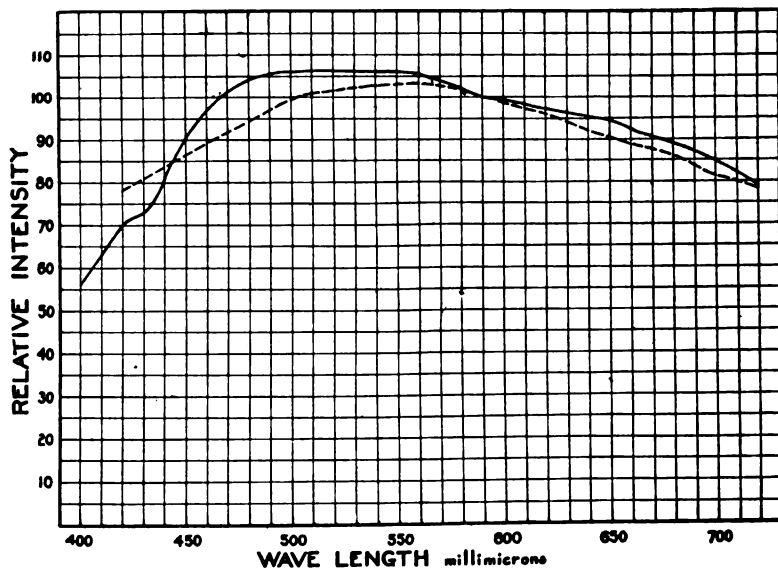

FIG. 6. Spectral Energy Distributions of Natural and Artificial Sunlight

(The solid line represents the distribution of average noon sunlight, while the broken line is that of Priest's precision artificial sunlight.)

Such an average, for noon sunlight at Washington, D. C., is given in Table 8 and the solid line in Fig. 6. It is the mean of forty determinations, half of which were made at the summer solstice (June 21) and the other half at the winter solstice (December 21), both high and low atmospheric transmissions being included. The authority is Abbot of the Smithsonian Astrophysical Observatory (1). Average noon sunlight, thus defined, corresponds roughly to a black body temperature of 5000°K. the distribution not being strictly Planckian.

B. STANDARD ARTIFICIAL SUNLIGHT.—There are various methods for producing artificially an approximate reproduction of average noon sunlight, as above specified. The most accurate is that of Priest which consists in passing the radiation from a gas-filled tungsten lamp, operated at a color temperature of 2848°K, (about 15.6 l. p. w., for concentrated filament lamp), through a pair of crossed nicol prisms between which is inserted

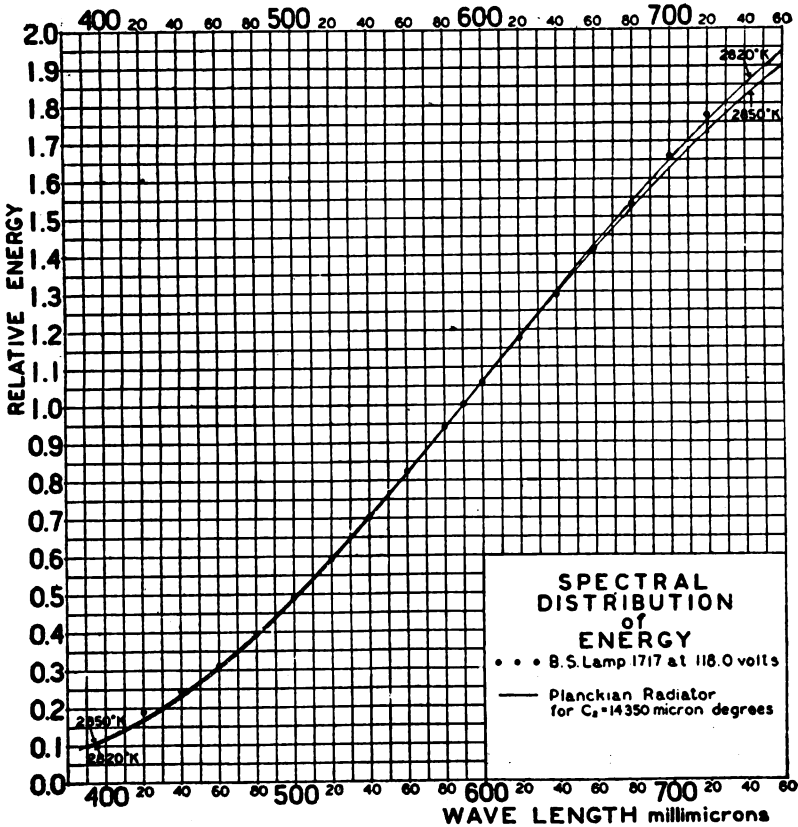

FIG. 7

a crystalline quartz plate 0.500 mm. thick with surfaces perpendicular to the optic axis of the crystal (78). The resulting energy distribution is shown, in comparison with that of actual sunlight, by the broken line in Fig. 6. The proper energy distribution for the radiation from the lamp, before passing through the nicol prisms and the quartz plate, is given in Fig. 7. Lamps yielding

this distribution at a specified voltage can be obtained from the Bureau of Standards, Washington.

Other methods of producing artificial daylight involve the use of blue glasses or gelatine filters before standard illuminants. The most available system of this sort at the present time consists of a No. 78 Wratten photometric filter (97) manufactured by the Eastman Kodak Company and a cylindrical acetylene flame (41) produced by a standard burner (also obtainable from the same

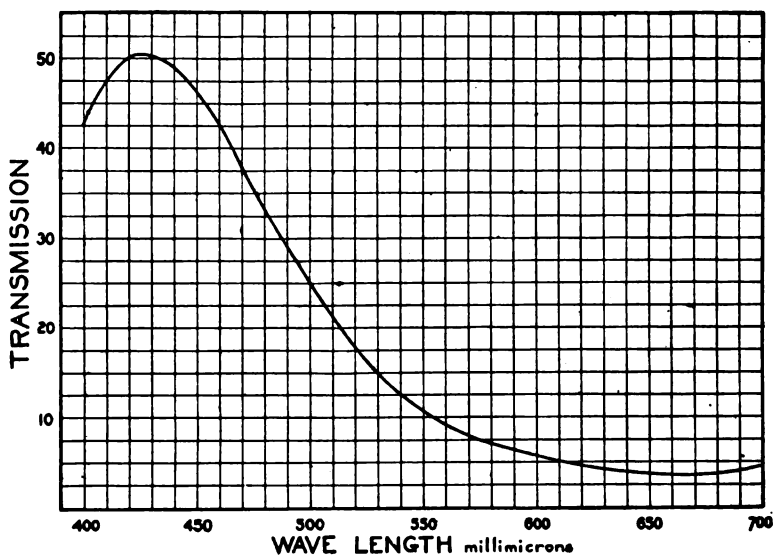

FIG. 8. Spectral Transmission of Tungsten-to-Daylight Filter (Wratten No. 78)
(According to the Wratten Light Filter Booklet.)

company). This combination yields a white closely approximating average noon sunlight, and gives a very satisfactory standard white for practical purposes. Figure 8 shows the spectral transmission of the original No. 78 Wratten filter. It is planned to make the "78" and "86" series of filters in the future a quite accurate means of converting one color temperature to others, the original filters having been only approximate means to this end. The color temperature of the standard acetylene flame is 2360 degrees K., which corresponds with that of a vacuum tungsten filament burned

TABLE 8
*Relative Intensity Values over the Visible Spectrum for Average Noon
 Sunlight (Computed from Abbot's data)*

Wave-Length m μ	Relative Intensities		
	June 21	December 21	Mean
400	63.0	48.0	56.0
10	71.0	54.0	63.0
20	79.0	60.0	70.0
30	82.0	64.0	73.0
40	90.0	72.5	81.0
50	98.5	82.5	90.5
60	104.5	89.0	97.0
70	107.5	95.0	101.0
80	109.0	98.5	104.0
90	110.0	101.0	105.5
500	110.5	102.0	106.0
10	110.0	103.0	106.5
20	109.0	103.5	106.0
30	108.5	104.0	106.0
40	108.0	104.5	106.0
50	107.0	105.0	106.0
60	106.0	104.5	105.0
70	104.5	103.0	104.0
80	102.5	102.0	102.0
90	100.0	100.0	100.0
600	98.5	100.0	99.0
10	97.0	99.5	98.0
20	95.5	99.0	97.0
30	94.0	98.5	96.0
40	92.5	98.0	95.0
50	90.3	97.5	94.0
60	88.0	96.5	92.0
70	86.0	95.0	90.5
80	84.0	93.0	88.5
90	81.5	92.0	87.0
700	79.0	90.0	84.5
10	76.5	87.0	82.0
20	74.5	84.0	79.0

at an efficiency of approximately 8 lumens per watt. This corresponds fairly closely with the color of an ordinary mazda B tungsten light burning at 1.25 watts per mean horizontal candle power. Other selectively absorbing glasses designed to make possible the production of artificial daylight include the Ives-Brady glass, a very satisfactory but rare product, the Luckiesh "Tru-tint" glass, and the Corning "Daylite" glass.

C. NORMAL GRAY LIGHT.—The conception of "white light" is one which is of fundamental importance to many of the purposes of colorimetrics, for example in colorimetry by the "monochromatic" method, in defining complementaries, etc. There are a vast number of characteristic intensity distributions of radiant energy which can be used with practical success to meet this need. Although the one most frequently employed is that of average noon sunlight, to be of the greatest theoretical as well as practical significance, the definition of "white light" should evidently determine a spectral distribution which will generate a pure gray by its action on the normal human visual apparatus in a normal condition. Since there are an infinity of conceivable distributions which would satisfy this requirement, it seems advisable to limit the general form of the distribution to a species of which only one member can excite a gray. Distributions of the Planckian type meet this requirement (32, 198-202), and are further to be recommended because of the approximate conformity of all natural and artificial radiant sources to the Planckian law, and the comparative ease with which distributions of this sort can be reproduced in the laboratory. Preliminary determinations by Priest, (82), using a system of nicol prisms and quartz plates as a filter to yield Planckian distributions representative of temperatures lying between 4200 and 6200°K, indicate 5200° as the value for the gray stimulus. This figure is regarded at present as highly tentative, on account of the small number of subjects tested and doubt as to the normality of certain of them. Criteria for the selection of the pure gray, other than that of the simple introspective judgments used by Priest, may also be advisable.

TABLE 9

Color Temperatures of Common Illuminants^a

Hefner amyl acetate lamp.....	1875
Pentane (10 c. p. standard).....	1914
Candle (paraffin).....	1920
Candle (sperm).....	1925
Kerosene lamp (round wick).....	1915
Kerosene lamp (flat wick).....	2045
Acetylene, ordinary (as a whole).....	2368
Acetylene, ordinary (central spot).....	2448
Acetylene (Eastman Standard).....	2360
4 W. P. M. H. C. Carbon (4.85 W. P. M. S. C.).....	2070
3.1 W.P.M.H.C. Treated Carbon (3.73 W.P.M.S.C).....	2153
2.5 W.P.M.H.C. Gem.....	2183
2 W.P.M.H.C. Osmium.....	2176
2 W.P.M.H.C. Tantalum.....	2249
1.25 W.P.M.H.C. Tungsten (Mazda B).....	2385
.9 W.P.M.H.C. Tungsten.....	2543
Carbon arc (solid carbon).....	3780
Carbon arc (cored carbon).....	3420

^a Hyde, E. P. and Forsythe, W. E., *Jour. Franklin Inst.*, 183, p. 354; Forsythe, W. E., *Phys. Rev.* (2), 17, p. 147, 1921; Priest, I.G., *Color Temperature*, Op. Soc. Am., Conv., Rochester, Oct., 1921, *J. Op. Soc. Am.*, Jan., 1922.

D. STANDARD ILLUMINANTS.—All common illuminants having a Planckian distribution are of course characterized by a temperature lower than that of the sun and of the black body which emits normal gray light, and hence evoke an unsaturated yellowish or orange color. The spectral distributions of these various illuminants can obviously be specified by a statement of their respective color temperatures. Table 9 lists these temperatures for a group of familiar light sources (28). The radiation from Welsbach gas mantles cannot be matched satisfactorily with that from a black body at any temperature, and varies quite widely in distribution with the proportions of ceria and thoria in the mantle as well as with the average degree of incandescence. Probably the illuminant whose characteristics are best established at the present time is the acetylene flame produced by a standard burner under specified conditions. The spectral distributions for vacuum tungsten electric lamps are determined by the efficiency, or lumens per watt, at which they are operated, and extensive measurements made at the Nela Research Laboratory (27), enable one to trans-

late an efficiency value into a corresponding color temperature and hence to ascertain the distribution. Table 10 shows the relation between efficiency and color temperature. Gas filled and carbon filament lamps have been less accurately calibrated and are inherently more variable.

TABLE 10
*Color Temperatures of Vacuum Tungsten Filaments at Various Efficiencies**

Lumens per Watt (Uncorrected)	Color Temperature (Uncorrected)	Lumens per Watt (Corrected)	Color Temperature (Corrected)
0.5	1644	0.58	1663
1.0	1777	1.14	1794
1.5	1866	1.70	1883
2.0	1939	2.26	1955
2.5	1998	2.82	2014
3.0	2050	3.37	2066
3.5	2096	3.93	2112
4.0	2138	4.48	2153
4.5	2175	5.02	2190
5.0	2208	5.57	2224
5.5	2241	6.12	2257
6.0	2269	6.66	2285
6.5	2299	7.21	2315
7.0	2327	7.76	2343
7.5	2354	8.30	2370
8.0	2380	8.85	2397
8.5	2406	9.39	2423
9.0	2431	9.94	2449

The first two columns show the lumens per watt and color temperatures as directly determined experimentally from a given lamp. The second two columns give these same quantities corrected for losses due to cooling effects of leading in and supporting wires and absorption of the lamp bulbs.

* Hyde, E. P., Cady, F. E. and Forsythe, W. E., Color Temperature Scales for Tungsten and Carbon, *Phys. Rev.*, (2), 10, Table I, p. 401; 1917.

3. STANDARDS OF SPECTRAL TRANSMISSION

The characteristics of physical objects which determine their colors, when viewed by radiation from other sources, can be expressed almost completely by means of spectral reflection or transmission curves, representing as a function of wave-length or frequency, the fraction of the original radiation impinging upon the object, which finally leaves it as reflected or transmitted rays respectively. Such curves are most readily determined by means

of a spectrophotometer. For the intercomparison of the color values of objects, without reference to the radiation by which they are viewed or the observer's visual system, reflection and transmission curves are of great utility in colorimetrics, although such curves represent properties of objects rather than of immediate stimuli to color. However, in view of Hering's principle of "the color-constancy of visual objects" (24), representing the tendency of the visual processes to compensate for variations in spectral constitution and intensity of the illuminating source, these curves attain some direct significance for consciousness. Although colors due to selective reflection are of more common occurrence than those due to selective transmission, the latter are of greater scientific importance because of the far higher degree of selectivity which is obtainable by transmission than by reflection.

The spectral transmission distributions for a number of technically important materials are considered below.

A. STANDARD THREE-COLOR ADDITIVE FILTERS.—There are several common applications of the principle of matching or of reproducing colors by the mixture of two or three stimuli, of constant relative spectral constitutions but varying proportions, which utilize selectively transmitting radiation "filters." Although their transmissions may be varied within certain limits without deleterious effects, it is desirable to specify the transmission curves of certain of these filters which have been found satisfactorily to fulfill their purposes.

(a) *Trichromatic Analyzer Filters.* Table 11 gives the transmissions of three filters employed in the Ives colorimeter (29; 30), which is employed for the designation of the colors of materials in terms of three mixed elementaries, determined by these filters.

(b) *Photographic Taking Filters.* Table 12 records the transmissions of four filters designed for making color separation photographic negatives on panchromatic emulsions. Rigid standardization of filters for use in this connection is not possible on account of the variations in sensitiveness to radiation of different wave-lengths exhibited by these emulsions, but the filters specified in the Table have been found to give fairly satis-

factory results with emulsions of average character. Nos. 1, 2, and 3 constitute the tri-color set, while Nos. 1 and 4 can be used successfully for two-color taking. The choice of three-color taking filter transmissions should in general be such as to duplicate

TABLE 11
Transmissions for Various Wave-Lengths of Ives Colorimeter Filters¹

$m\mu$	Percentage Transmissions		
	Red	Green	Blue
400	26.0
410	26.0
420	25.9
430	25.9
440	24.9
450	22.0
460	17.5
470	11.0
4809	6.9
490	3.7	2.5
500	7.8	1.2
510	11.2	.3
520	13.0
530	12.9
540	11.1
550	8.2
560	4.8
570	2.2
5808
590
600	.8
610	4.5
620	18.0
630	45.0
640	64.7
650	72.4
660	76.9
670	79.4
680	81.3
690	82.3
700	82.9
710	83.0

¹ The values given in this table were supplied by Dr. H. E. Ives. Ives colorimeter filters measured at the Bureau of Standards depart appreciably from the above specifications, as do those examined by E. C. Bryant, *Astrophys. J.*, 55, p. 9, 1922.

TABLE 12
Transmissions of Approved Photographic Taking Filters

λ = Wave-length in $m\mu$.

T = Fraction of incident radiation transmitted.

No. 1		No. 2		No. 3		No. 4	
λ	T	λ	T	λ	T	λ	T
700	.82	620	.01	400	.07	460	.02
680	.82	600	.03	410	.09	470	.09
660	.82	580	.18	420	.11	480	.19
640	.82	560	.30	430	.15	490	.35
620	.80	540	.46	440	.21	500	.49
610	.75	530	.53	450	.28	510	.58
600	.60	520	.57	460	.26	520	.59
590	.25	510	.52	470	.19	530	.55
585	.10	500	.35	480	.10	540	.49
580	.02	490	.12	490	.04	550	.38
.....		480	.02	580	.01	560	.25
.....						570	.74
.....						580	.07
.....						590	.02

photographically, as closely as possible, the mixing proportions of the corresponding reproducing filters which are required to match the colors of the photographed objects. The production of such photographic records of the values in question will evidently depend not only upon the transmissions of the filters but also upon the spectral distribution of sensitiveness of the given photographic emulsion. Similar general principles apply to the choice of two-color taking filters if the blue-violet values of the photographed objects are left out of consideration, since two-color taking filters are ordinarily selected so as to neglect those values of the scene which are poorly represented in yellowish, artificial illumination.

(c) *Photographic Reproducing Filters.* Filters necessary for three-color and two-color additive projection of photographic positives printed from color separation negatives, or for use in such instruments as the Ives Chromscope (54, 218) depend in quality upon the character of the light source which is employed. Since the sources vary widely, it is difficult to specify the transmissions of the filters very exactly. Filters for three-color addi-

tive reproduction should be so selected that mixtures of the transmitted radiations are capable of matching a maximal number of colors. This means that the radiations in question should evoke hues approximating as nearly as possible to spectral saturation, and so distributed in the color triangle that the lines joining them lie maximally close to the spectral locus. Two-color reproducing filters in practice usually resemble closely the red and green members of a three-color set but may have a somewhat reduced saturation, and the dominant hue of the green is usually shifted somewhat more towards the blue than is that of the red number.

B. STANDARD SOLUTIONS.—The spectral transmissions of dyes and inorganic salt solutions of known purity and concentration are in course of determination at the Bureau of Standards, and some of the most important of these will be presented in later Reports by the present Committee.¹⁷

C. LOVIBOND AND OTHER COLORED GLASSES.—Similar statements apply to the Lovibond glasses, which are widely used as technical standards in the ranking of oils and other materials as regards color. There are a very large number of these glasses, and the accuracy with which they are reproduced in different sets is often relatively low (77). The spectral transmissions of a considerable number of precision-made glass plates of various colors have been determined at the Bureau of Standards, and these plates can be borrowed under proper restrictions by those desiring to check their spectrophotometric equipment.

4. STANDARDS OF SPECTRAL REFLECTION

A. SUBTRACTIVE PIGMENT ELEMENTARIES.—A committee of the American Institute of Graphic Arts is at the present time working on the colors of inks for three- and four-color printing processes. Pending their findings the present Committee will offer no recommendations on this matter. As previously noted, the pigments or dyes required for the satisfactory rendering, by the subtractive method, of photographic "color separations" are in general the *physical complementaries* of the corresponding additive

¹⁷ Three notable atlases of absorption spectra are (39), (96), (58).

reproducing filters, i.e., they transmit or reflect those portions of the spectrum which the latter absorb, and *vice versa*.

B. SYSTEMS OF PIGMENT STANDARDS.—There are now available several notable systems of reflection color standards (6). Those which are best known to American workers are the Munsell system (61) designed for use by artists and the Ridgway system (87) intended for the ornithologists. More recently Ostwald (71; 72) in Germany has published an elaborate scheme of this sort. Each of these systems comprises pigments of various selective and total reflection spaced fairly evenly over the total field of possible pigment colors.

(a) *The Munsell System* is based upon ten hues and nine degrees of "value," or of light reflecting power. Each of the hues is represented at each level of reflectivity by as many different saturation steps as is feasible. The system as published includes a text on "Color Notation," (61) an atlas, (62) and a color sphere, as well as cards embodying the separate pigment values. Priest and his associates (83) have determined the spectral reflection curves of representative members of the pigment system, and have made recommendations for its improvement, although in general commending it as it stands. Evaluations of certain Munsell colors in terms of elementary sensations are given in the next Part of the present Report. For the spectral reflections reference should be had to Priest's original paper.

(b) *The Ridgway System* utilizes thirty-six hues, having approximately equal spacing on the spectral chroma scale, each of these being diluted with white in three degrees and with black in three degrees, making 1115 colors in all. Jones (42) has made careful monochromatic analyses of the undiluted colors, and has determined the separations of their dominant hues on the hue scale, the average for the spectral hues being 3.5 and for the purples 4.4 just noticeable steps. Considering the practical difficulties encountered in the preparation and reproduction of pigment samples the gradation of values exhibits excellent uniformity. The results of Jones' analyses are given in Table 13. Spectrophotometric measurements on the Ridgway pigments

TABLE 13
*Monochromatic Analyses of Certain Ridgway Colors**

1	2	3	4	5	6	7
No.	Name	$\lambda(m\mu)$	Per cent. Hue	$d\lambda$	d_s	d_h
1	Spectrum Red	633	55			
2		616	31	17	5.0	5.0
3		610	34	6	2.0	3.0
4		605	34	5	1.5	2.0
5						2.0
6	Orange Chrome	597	40	8	2.5	2.5
7		595	34	2	1.5	1.5
8		593	26	2	1.0	1.5
9		589	23	4	2.0	3.0
10		586	31	3	2.0	3.0
11		582	34	4	2.5	3.0
12	Lemon Yellow	579	29	3	3.0	3.0
13		577	34	2	2.0	2.0
14		574	39	3	2.0	2.0
15		569	42	5	3.0	3.0
16		566	42	3	2.0	2.0
17		548	47	18	6.0	8.0
18	Emerald Green	521	63	17	9.0	9.0
19		518	66	3	2.0	2.0
20		510	63	8	3.0	3.5
21		495	55	15	10.0	10.0
22		490	54	5	4.0	5.5
23		486	51	4	3.0	3.0
24	484	73	2	1.0	1.5	
25	Spectrum Blue	479	70	5	2.0	2.5
26		476	57	3	2.0	2.0
27		470	62	6	3.0	3.0
28		460	62	10	3.0	4.0
29	445	58	15	5.0	8.0	
30	Spectrum Violet . . .	425	60	20	7.0	10.0
Mean					3.2	3.8
31	Purples	570	22			
32		559	15	11	5	6
33		555	13	4	2	2
34		538	16	17	4	5
35		534	11	6	3	2
36		512	9.4	22	7	8
Mean					4.2	4.6

* The numbers in column 1 show the spectral order of the thirty-six undiluted Ridgway chromas. Column 2 gives the names assigned to certain of the colors by Ridgway. Column 3 shows the wave-length of the dominant hue and column 4 the per cent. hue. Columns 5, 6, and 7 list the differences between succeeding members in wave-length, Steindler "hue scale," and Jones "hue scale" units respectively (See Jones, Ref. 42, pp. 73-77).

are being made at the Bureau of Standards, and will be considered in later reports of the present Committee.

(c) *The Ostwald System*, besides having been elaborately described by its author in a number of publications, has been given two concrete exemplifications. The most elaborate one, "Der Farbenatlas," presents approximately twenty-five hundred colors which are systematically indexed in order of their color tone and content of black and white respectively. An abridged system, "Der Farbkörper," comprises seven hundred and sixty-eight of the principal colors used in the more comprehensive system. Ostwald's arrangement, like that of Munsell and Ridgway, is based upon psychological rather than physical criteria. Kohlrausch (44) has made a spectrophotometric analysis of sixty of Ostwald's colors taken from three of his color circles having different saturations or reflectivities. Kohlrausch has furthermore computed the excitation values of these colors on the basis of König and Dieterici's excitation curves. He has also made direct monochromatic analyses of the colors in question.

V. METHODS OF COLORIMETRY AND THEIR INTERRELATIONS

It is not our purpose in the present Report to consider in detail the various methods which are in use, or which have been proposed, for the practical measurement of color. This important task, which involves the description of instruments and the establishment of a terminology for each of the methods, is reserved for a later report. However, it is desirable here at least to catalogue the available systems of colorimetry, and to consider in a preliminary way some of the problems which arise in connection with them, especially that of the reduction of data obtained by the various methods to a common comparison basis.

1. RÉSUMÉ OF AVAILABLE METHODS

The color of an object, considered as an impression which the object produces on the observer, is determined by at least three general sets of factors: (1) the physical characteristics of the object, (2) the physical characteristics of the radiant energy falling upon or emitted by it, and (3) the nature and condition of the observer's visual apparatus. Our control over color in its

technical applications is confined almost exclusively to the first two sets of factors, although the ultimate goal is always to be found in the consciousness of some observer. Practical colorimetry is therefore concerned with means for the unambiguous designation of those properties of objects and radiation which determine color perception. Most of the means actually employed, however, utilize the visual apparatus of an observer as an essential element—in determining an equation of colors—and hence the results are frequently not independent of the nature and special condition of this apparatus. For this reason it is necessary as in photometry, that the observers should be tested as average and normal.

A. SPECTROPHOTOMETRY.—A method of specifying the physical characteristics of objects and samples of radiation, for the purposes of colorimetrics, which is actually independent of the observer is found in various applications of spectrophotometry or spectroradiometry. These devices enable us to establish the spectral distributions of reflection or transmission for objects, or of energy for radiation, and thus to specify perfectly the essential factors in their values as color stimuli. On the side of the stimulus, pure and simple, spectrophotometry is the fundamental method of colorimetric specification. All other methods (except spectroradiometry) fail to give an equally complete account of the stimulus characteristics. The excuse for their use, however, lies in the fact that the detail of spectral distributions is not actually required if our concern is solely with final color result produced in the observer's consciousness, and methods which dispense with this detail have the advantage of increased simplicity, both in practical application and in expression of results. (Since there is a special Committee of the Optical Society on the subject of Spectrophotometry, it can not be a function of the present Committee to consider this topic in detail.)¹⁸

Complete data based upon spectrophotometry specify the colorimetric value of a stimulus in terms of the identical radiant power actually evoking the color, both in regard to total amount and

¹⁸ On Spectrophotometry in general see (45).

spectral distribution. Other methods accomplish this result in terms of a complex stimulus, having general characteristics varying with the method, but seldom spectrally identical with the stimulus to be measured, which nevertheless is found empirically

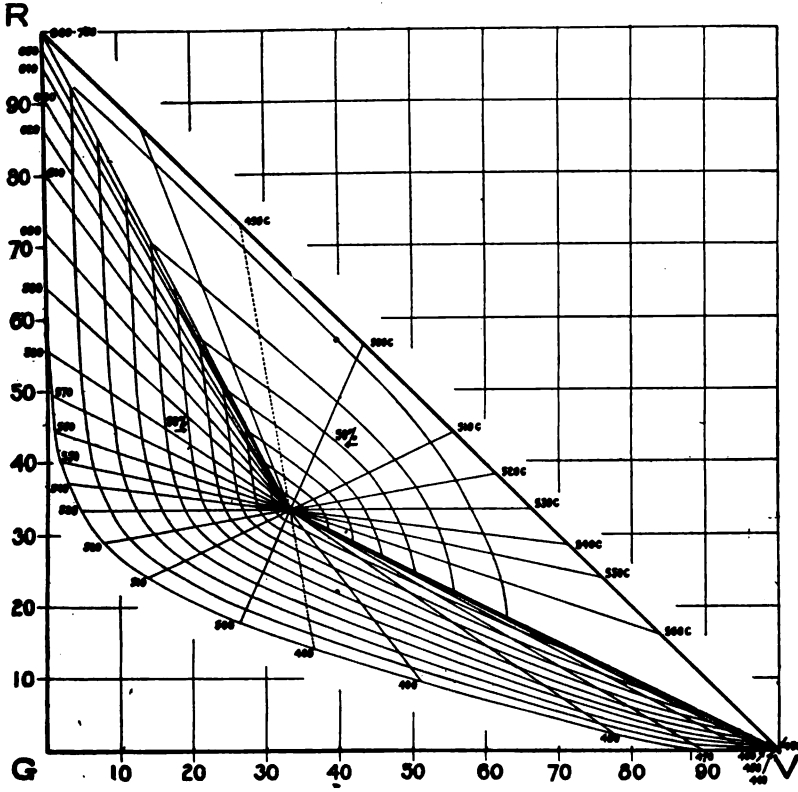

FIG. 9
 Triangle, Showing Loci for Various Monochromatic Analyses
 (The ordinates give the percentage excitation values for Red and the abscissae those for Violet.)

to evoke the same color as the latter. The most important of these methods which depend upon simple color matching are as follows.

B. MONOCHROMATIC ANALYSIS.—In this method the variable stimulus is composed of heterogeneous radiation, which by itself evokes white or gray, combined with homogeneous radiation of variable wave-length. The total intensity, ratio of homogeneous

to heterogeneous, and wave-length of the former, are adjusted until a match is obtained (66). The measured color is then designated in terms of (1) luminosity, (2) dominant wave-length, and (3) "per cent. hue." It is apparently not essential, although advisable, in this method that the heterogeneous radiation

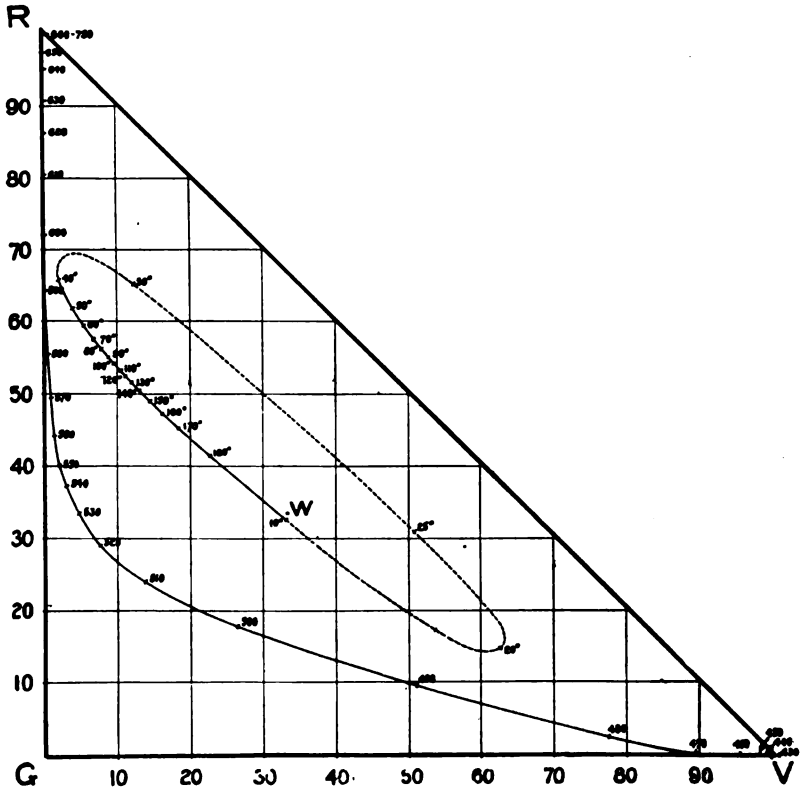

FIG. 10

Color Triangle, Showing Loci of Spectral and Certain Rotatory Dispersion Excitations
(The ordinates give the percentage excitation values for Red and the abscissae those for Violet.)

should have an invariable constitution, e.g., that of "normal gray light," so long as it always produces an achromatic color with the given observer. Results obtained by this method are subject to serious errors with deviations, of common occurrence, of the observers' visual systems from the average normal. It is

important, therefore, that the observers should be carefully selected so as to have standard visibility and color excitation curves. The direct application of this method is limited to colors possessing spectral hues. In order to specify purples, it is necessary to determine the wave-length of homogeneous radiation which when mixed with them matches the heterogeneous standard, i.e., which yields a gray of the given brilliance. It is clear, however, that the method is capable of dealing with colors of all degrees of saturation.

C. TRICHROMATIC ANALYSIS. (29; 30.) In this method the variable stimulus is composed of three constituents having appropriate spectral constitutions, which yield, respectively, colors corresponding in hue to the two end, and the middle regions of the spectrum. The colors ordinarily chosen are red, green and blue, and to render the field of applicability of the system as wide as possible the three stimuli should each be maximally homogeneous. Relative spectral distributions within the components remaining constant, their proportions and total luminosity are adjusted until a match is obtained. The measured color can then be designated by three intensity or luminosity values, one for each of the three components. If the spectral distributions of the components are determined by fairly narrow-banded filters, this method is capable of dealing with practically all reflection colors, which are relatively unsaturated, but is not satisfactorily applicable in its simplest form to many saturated filter or spectral colors. In order to extend the method to deal with the latter it is necessary to add a variable quantity of "white" to the sample which is being measured. If this is done the colorimetric significance of the added white can be recorded in the resultant measurements by subtracting its amount from each of the three-color readings, yielding a specification in terms of red, green and blue, with one minus coefficient, a mode of expression which is in no way incompatible with the trichromatic principle. The trichromatic analyses are of fundamental interest on account of their maximally direct relation to the triadic response mechanism which apparently underlies all color vision,

but the results which are obtained vary with the color excitation curves of the given observer.

A new and promising application of the trichromatic method of color analysis is to be found in Jones' subtractive colorimeter (43). Although the psychophysical principles involved in this instrument are substantially the same as in three-color analyzers based upon additive mixture, the physical operation of the instrument is quite different from that of a three-color additive color-matching device. White or tungsten light is passed in succession through three wedge filters which absorb respectively red, green and blue, and an adjustment of the three wedges can be found which yields a color-match with the sample which is under examination. A neutral wedge is also provided in the path of the beam, permitting a match to be obtained by the use of only two of the chromatic wedges in combination with the neutral one.

D. ROTATORY DISPERSION SYSTEMS.—Several partial systems of color specification have been based upon the rotatory dispersion of quartz, the degree of this dispersion being a function of the thickness of the quartz plate which is employed (76; 81). By placing such a plate properly between nicol prisms or other polarizing devices, variations in the relative angular positions of the latter with respect to their extinction positions may be employed to determine a wide variety of spectral transmissions, all of which, however, follow a definite law. Still greater flexibility is obtained by the use of two quartz plates and three nicol prisms. A radiation source of known energy distribution is ordinarily utilized. Instruments based upon this principle are the Arons chromoscope and the leucoscope, recently studied very thoroughly by Priest. The principle appears to have promise of very wide applicability, especially as a means of producing and of specifying a large variety of spectral distributions which it is difficult or impossible to obtain with filters or original sources of radiation. In general, however, the method depends upon the matching of apparent colors, rather than of identical energy distributions.

E. PLANCKIAN DISTRIBUTION ANALYSIS.—The series of spectral distributions determined by successive values of T in Planck's

equation (see page 556) for the radiation emitted by a "black body" provide a system of stimuli, easily specifiable, and evoking a characteristic series of colors (including gray).¹⁹ However, since the system is virtually unidimensional it can only be applied to a very limited range of colors, practically only to those due to stimuli whose relative spectral distributions fit the Planckian equation. The value of T required for the black body to produce the color match is used as an index of the color, being called the "color temperature."

F. COMPARATOR METHODS.—Methods of color specification based on color matching with arbitrary standards are at present of great technical importance. Such standards include selectively transmissive solutions of definite composition, as well as colored glasses—as in the Lovibond Tintometer—and variegated pigments—as in the Munsell, Ridgway, and Ostwald systems. The final results of measurement by means of one of these methods are expressed in terms of a number or numerical symbol, standing for the particular standard which most nearly approximates the sample in color. These devices are simple in their practical applications, but tend to be unreliable and inaccurate, while the results obtained by different systems are difficult of inter-comparison.

2. THE INTERCONVERSION OF DIVERSE COLOR SPECIFICATIONS

One of the main interests of the present Committee is to provide means by which color specifications in terms of different systems can be reduced to a common denominator and, so far as possible, be interconverted (36). Spectrophotometric data are potentially convertible into the data of any other system whatsoever, but no specifications which are based upon simple color-matching can be reduced to spectrophotometric terms, without additional information. However, a satisfactory common denominator for all systems is apparently provided by the *elementary color excitations*. Values of these excitations can be found which will specify completely the color characteristics of any stimulus, and each

¹⁹ Use of color temperature as a means of color specification has been developed extensively by E. P. Hyde and his collaborators (28).

member or possible specification in every color system can be reduced to such excitation values, and hence can be assigned a certain position on the color-mixture triangle. In this way the data of separate systems can be definitely intercompared, and can be interconverted in so far as the representations of the several systems overlap; with the obvious restriction that peculiarities of the stimulus—such as spectrophotometric details—which determine no characteristic excitation values, are necessarily lost.

It would therefore appear that the first step in our task is to provide means for transforming the data of each colorimetric system into elementary excitation values, and where possible, means for the reverse transformation. When such transformations have been made, it will be easy to determine the equivalents of one system in terms of any other system. The general principles underlying these computations have already been outlined briefly in our presentation of the excitation curves (*vide supra*). The spectral energy distribution of a given standard stimulus is required if the latter is to be dealt with directly, but can be dispensed with as soon as its combination with the elementary excitation curves has provided a specification of the stimulus in terms of the elementaries.

A. SPECTROPHOTOMETRIC DATA TO EXCITATIONS.—Spectrophotometric data are usually given in the form of spectral transmission or reflection curves. Such curves require combination with a certain energy distribution—representative of the particular source by which the object is viewed—in order that they should become determinative of a definite color. The process of reducing any given spectrophotometric specification to excitation values is therefore as follows. (a) Multiply each of the ordinates of the transmission or reflection curve by the corresponding ordinates of the energy distribution curve of the source. (b) Multiply each of the ordinates of the resulting curve by the corresponding ordinates of each of the color excitation functions as given in Table 6 (under "Excitations"), this being a separate operation for each of the three excitations, yielding three separate curves which represent the respective excitation values for each wave-

length of the given stimulus. (c) Determine separately the areas of the three curves thus found. This latter operation can be performed by applying a planimeter to a graph of the resultant curves or—with sufficient accuracy—by finding the sum of representative ordinates of each curve, taken separately at uniform, small, intervals—such as $10\text{ m}\mu$ —throughout the range of the curve in question. (4) Reduce the three areal values thus obtained to percentage form, so that their determined ratio remains unchanged but their sum becomes equal to 100. The color excitation values can now be expressed by means of two numbers, representing the red and violet excitation percentages, that for the green being obtainable by subtracting the sum of these two values from 100.

As already pointed out, it is in general impossible to reverse the above process, and to convert color excitation specifications into definite spectrophotometric form, because there are an infinite number of spectrophotometric conditions for the majority of color excitation ratios. However, it is possible by means of the color triangle to determine stimuli for given sets of excitation values. The most feasible method of procedure is to plot the position of the given color in the triangle and to note its relation to the locus of the spectral colors. If it lies outside of the area bounded—on two sides—by this locus it possesses no realizable stimulus. If it lies exactly on the locus, in a region of the latter which exhibits curvature, it possesses a unique condition, viz., the homogeneous spectral stimulus having a wave-length indicated by its position with respect to the wave-length scale plotted on the spectral locus. If it falls on a straight portion of the locus in question, it can be evoked by the homogeneous wave-length which immediately corresponds with its position, or by mixtures of any stimuli having wave-lengths represented on either side of it in the given straight portion of the locus, the proportions of these mixed stimuli being determined by the “center of gravity” principle (*vide supra*). If the point representing the given color lies *within* the area bounded by the spectral locus, the color can be produced by mixtures of spectral stimuli lying at the intersections, with the locus, of any straight line passing through the

point in question, the proportions being determined again by the "center of gravity" principle, applied to the segments of the line thus established. There are obviously an infinite number of such mixtures, not only of two components but of any number of components.

It is one of the functions of the present Report to provide the excitation values of characteristic stimuli, computed by the method outlined above. Tables of such values, for black body colors, colors obtained by rotatory dispersion, Munsell colors, etc., will be found below in conjunction with the discussion of the excitation equivalents of these various standards.

B. MONOCHROMATIC ANALYSIS DATA TO EXCITATIONS.—The general principles underlying the reduction of monochromatic analysis specifications to color excitation values are similar to those outlined above, but with certain complexities which are introduced by the use of a photometric method for establishing and expressing the ratio between the amounts of "white" and monochromatic stimulus in any given case. It is of course natural in practice to specify this ratio in luminosity terms, but these terms play no part in determining the excitation values given in Table 6. Consequently, in order to effect the requisite transformation, it is necessary to make use of the luminosity valencies of the several excitations, which were discussed on page 551. To simplify computation, these valences have been expressed so as to represent the fractional contributions of the three excitations to the luminosity of a white, taken as unity, the values being: for the red 0.370, for the green 0.617, and for the blue 0.012.

The actual steps which are involved may be outlined as follows. (a) It is first necessary to know the spectral distribution of radiant intensities for the stimulus which is employed as a white in the given measurements. In case the distribution in question is that of average noon sunlight—or a distribution which color-matches this—it is only necessary to multiply each of the luminosity valences above considered, by the "per cent. white" of the specification. If, on the other hand, the "white" departs in effective character from average noon sunlight, excitation values must be computed for it by the method described under

"A" above. Each of these values is then multiplied by the corresponding luminosity valence, and the products thus obtained are reduced, with ratios unchanged, so that their sum is equal to unity. These figures are now multiplied separately by the percentage measure specified for the "white." Either one of these operations—for average noon sunlight or the arbitrary "white"—yields a set of three figures, one for each of the excitations. (b) The next step is to treat the "per cent. hue" measure in a similar manner. The excitation values for the wave-length employed in the given match must first be looked up in Table 6. Each of the values thus found is next multiplied by the corresponding luminosity valence and the products are reduced so that their sum is equal to unity. Each of the resulting values must now be multiplied by the percentage measure of the monochromatic component in the original specification. (c) The corresponding members of the two sets of values, thus secured,—for the "white" and "hue" respectively—are now added. (d) The three resulting sums express the excitation values of the monochromatic specification in luminosity terms. In order to reconvert them into the color valence terms of Table 6, each of these sums must be divided by the corresponding luminosity valence, and the values thus obtained reduced to the usual percentage form.

In the case of specifications by monochromatic analysis, of colors possessing a purple hue, in terms of per cent. of the given color and the per cent. of its spectral complementary required to be mixed with it to match the standard white, the procedure for reduction of the data to excitation values differs from the above in the following way. (a) The "white" is treated exactly as described under "(a)" of the preceding paragraph, except that the final percentage employed as a multiplier is 100. (b) The complementary monochromatic stimulus is treated exactly as under "(b)" in the same paragraph, the final percentage multiplier representing the per cent. which this stimulus is of the mixture comprising it and the measured color. (c) The individual members of the set of values thus obtained for the complementary stimulus are then *subtracted* from the corresponding members of the set obtained for the white. (d) The three resulting differ-

ences may now be reconverted into color valence terms, as directed under "(d)" of the preceding paragraph.

At the present time, owing to the unreliability of the magnitudes assigned to the luminosity valences for the three excitations, the conversion of data obtained by monochromatic analysis into excitation values, and thence into terms of other methods of color specification, cannot be accomplished with as great an accuracy as could be wished for. Present indications, moreover, are that these luminosity valences vary considerably among individual observers, without parallel variations in the color valences. Such variations evidently accompany deviations in the form of the observer's visibility curve from normal, and demand that special care be taken in the selection of observers for use of the monochromatic method. In general, this method would appear to be more sensitive to the personal equation than the trichromatic and certain other methods.

The reverse conversion, of color excitation values into monochromatic specifications, is theoretically possible without ambiguity for all sets of values represented in the color triangle by points lying within the area determined by the spectral locus (*vide supra*). The easiest means for accomplishing this conversion consists in the use of a color triangle having represented upon it not only the spectral locus, but also the loci of the spectral colors, and purples, mixed with various proportions of white. In the absence of such a diagram, which is provided by Fig. 9, a cumbersome "trial and error" method is necessitated. To determine the monochromatic equivalents of any color excitation specification, its position should be plotted on the color triangle of Fig. 9, and a straight line drawn through this point and the point representing the white (the white of the given monochromatic system). The intersection of this line with the spectral locus will indicate the dominant hue or wave-length,—direct or complementary, as the case may be—, and the relation of the color point on this line to its intersections with the loci for various percentages of admixed white will serve to determine the "per cent. white."

Table 14 (A and B) gives the excitation values computed for a large number of representative monochromatic specifications, which were read off from Fig. 9. It should be borne in mind that all of these values are subject to correction with improved determinations of the luminosity valences.

C. TRICHROMATIC DATA TO EXCITATIONS.—Data obtained by the trichromatic method of analysis bear the most direct possible relation to color specification in terms of elementary excitations. However, no actual colorimeter based on this principle can duplicate in saturation the elementaries which were employed in computing the values of Table 6, at least in the case of the green excitation, and probably also in the cases of red and violet excitations. Extant three-color measuring systems naturally

TABLE 14B

Color Excitation Values for Representative Monochromatic Analyses; Purple Hues

Complementary Wave-Length	Per cent. Hue							
		10	20	30	40	50	60	70
495C	R	35.5	38.0	41.2	45.3	50.2	57.8	69.6
	V	32.9	32.5	32.0	31.3	30.5	29.2	27.3
500C	R	34.7	36.4	38.4	40.8	44.0	48.2	54.2
	V	33.8	34.6	35.5	36.6	38.0	39.8	42.5
510C	R	34.0	34.9	35.8	37.0	38.4	40.2	42.5
	V	34.7	36.6	38.6	41.0	44.0	47.8	52.6
520C	R	33.7	34.0	34.5	35.0	35.6	36.3	37.3
	V	35.0	37.2	39.8	42.6	46.2	50.5	56.0
530C	R	33.3	33.3	33.3	33.3	33.3	33.3	33.3
	V	35.3	37.7	40.5	43.6	47.4	52.3	58.1
540C	R	33.0	32.7	32.3	31.9	31.4	30.8	30.0
	V	35.5	38.0	41.0	44.2	48.3	53.5	59.9
550C	R	32.7	32.2	31.6	30.8	30.0	28.8	27.3
	V	35.6	38.2	41.3	44.7	48.8	54.2	61.0
560C	R	32.4	31.6	30.5	29.3	27.8	25.9	23.4
	V	35.8	38.4	41.7	45.3	49.6	54.9	62.2

TABLE 14A
Percentage Color Excitation Values for Representative Monochromatic Analyses: Spectral Hues.

Wave Length of Dominant Hue	Per Cent. White																			
	0		10		20		30		40		50		60		70		80		90	
	R	V	R	V	R	V	R	V	R	V	R	V	R	V	R	V	R	V	R	V
400	0	100.0	.2	99.6	.5	99.0	.9	98.3	1.3	97.5	1.9	96.2	2.8	94.5	3.9	92.1	6.4	87.3	11.6	76.7
410	0	100.0	.2	99.6	.5	99.0	.9	98.3	1.3	97.5	1.9	96.2	2.8	94.5	3.9	92.1	6.4	87.3	11.6	76.7
420	0	100.0	.2	99.6	.5	99.0	.9	98.3	1.3	97.5	1.9	96.2	2.8	94.5	3.9	92.1	6.4	87.3	11.6	76.7
430	0	100.0	.2	99.6	.5	99.0	.9	98.3	1.3	97.5	1.9	96.2	2.8	94.5	3.9	92.1	6.4	87.3	11.6	76.7
440	0	99.3	.3	98.7	.6	97.9	1.0	97.2	1.5	96.2	2.5	94.5	3.4	92.6	4.7	90.0	7.4	84.5	13.0	74.0
450	0	98.3	.3	97.8	.7	97.0	1.2	96.0	1.8	94.7	2.8	92.8	4.0	90.5	5.5	87.5	8.5	81.5	14.0	71.0
460	0	95.7	.5	94.9	1.0	94.0	1.7	92.5	2.6	90.9	3.9	88.4	5.5	85.5	7.3	82.0	10.8	75.5	17.6	63.0
470	0	89.6	.9	88.2	2.0	86.4	3.1	84.5	4.6	81.9	6.3	78.8	8.7	74.7	11.8	69.4	16.3	62.2	22.7	51.0
480	2.3	77.6	3.8	75.5	5.3	73.3	7.2	70.5	9.2	67.5	11.6	64.2	14.6	60.0	18.0	55.0	21.9	49.4	27.0	42.5
490	9.5	51.1	11.5	49.6	13.6	48.0	15.8	46.4	18.0	44.7	20.3	43.0	22.6	41.2	25.2	39.3	27.9	37.4	30.5	35.4
500	17.8	26.4	19.6	27.2	21.3	28.0	23.0	28.8	24.8	29.5	26.5	30.2	27.8	30.8	29.3	31.4	30.6	32.0	32.0	32.7
510	24.0	13.8	25.3	16.4	26.5	18.9	27.6	21.1	28.6	23.2	29.5	25.2	30.4	26.9	31.2	28.7	31.8	30.3	32.5	31.8
520	29.0	7.6	29.6	11.2	30.2	14.5	30.7	17.5	31.2	20.3	31.6	23.0	32.0	25.3	32.4	27.4	32.7	29.5	33.0	31.4
530	33.3	4.7	33.3	8.6	33.3	12.4	33.3	15.9	33.3	19.0	33.3	21.7	33.3	24.4	33.3	26.9	33.3	29.2	33.3	31.3
540	37.1	2.8	36.6	7.2	36.1	11.2	35.7	14.9	35.3	18.2	34.9	21.2	34.5	23.9	34.1	26.5	33.8	28.9	33.5	31.2

TABLE 14A—Continued

Wave Length of Dominant Hue	Per Cent. White																			
	0		10		20		30		40		50		60		70		80		90	
	R	V	R	V	R	V	R	V	R	V	R	V	R	V	R	V	R	V	R	V
550	40.2	1.7	39.3	6.2	38.4	10.3	37.5	14.1	36.7	17.6	36.0	20.8	35.5	23.6	34.9	26.3	34.3	28.8	33.8	31.1
560	44.2	1.0	42.6	5.5	41.2	9.6	40.0	13.5	38.8	17.2	37.7	20.4	36.7	23.3	35.7	26.0	34.9	28.6	34.1	31.0
570	49.5	0.7	47.2	5.2	45.0	9.3	43.2	13.0	41.4	16.6	39.8	20.0	38.3	23.0	36.9	25.8	35.6	28.5	34.4	30.9
580	55.4	0.4	52.5	4.7	49.7	8.8	47.2	12.6	44.7	16.2	42.3	19.6	40.3	22.7	38.4	25.5	36.6	28.2	34.9	30.8
590	64.3	0.0	60.4	4.3	56.6	8.4	53.0	12.3	49.7	15.9	46.3	19.3	43.4	22.4	40.6	25.3	38.2	28.0	35.7	30.7
600	72.2	0.0	67.2	4.1	62.6	8.1	58.1	12.0	53.9	15.6	50.1	19.0	46.2	22.1	42.7	25.1	39.5	27.9	36.3	30.6
610	80.4	0.0	74.7	4.0	69.1	7.9	63.8	11.7	58.9	15.3	54.0	18.7	49.6	21.8	45.2	24.8	41.1	27.7	37.2	30.5
620	86.3	0.0	80.0	3.9	74.0	7.7	67.8	11.5	62.3	15.0	57.1	18.4	52.0	21.5	47.1	24.6	42.4	27.5	37.8	30.4
630	90.8	0.0	84.1	3.9	77.6	7.6	71.4	11.4	65.3	14.8	59.6	18.2	53.9	21.3	48.5	24.4	43.3	27.4	38.2	30.3
640	95.1	0.0	88.0	3.9	81.2	7.5	74.6	11.3	68.2	14.6	61.9	18.0	55.7	21.2	50.1	24.2	44.3	27.3	38.7	30.3
650	97.5	0.0	90.2	3.8	83.0	7.4	76.1	11.2	69.4	14.5	62.8	17.8	56.5	21.1	50.4	24.1	44.5	27.2	38.8	30.2
660-700	100.0	0.0	92.4	3.8	85.0	7.4	77.9	11.2	70.9	14.4	64.1	17.7	57.6	21.0	51.2	24.0	45.0	27.1	39.1	30.2

differ also in the dominant hues of the three components which they employ. In order to convert the data obtained by the application of any such system to terms of our three elementaries, it is necessary to employ nine coefficients which represent the degree of participation of each of our elementaries in each of the components of the given system or vice versa. The reverse conversion involves nine reciprocal coefficients based upon the same relationship. The operations involved may be represented by the following equations:—

$$(1) R = ar + bg + cv$$

$$(2) G = dr + eg + fv$$

$$(3) V = hr + ig + jv$$

where a, b, c , etc., are the coefficients in question, r, g , and v are the values of the given trichromatic measuring system, and R, G , and V are the desired excitation values.

TABLE 15

Coefficients for Interconverting Ives Colorimeter Data and Excitation Values

If r, g , and b are the components of a color according to the Ives colorimeter, and R, G , and V are its values in terms of the elementary excitations used in this Report;

$$R = 1870r + 2080g + 14b$$

$$G = 134r + 3710g + 124b$$

$$V = 506g + 3460b$$

Conversely:

$$r = 1275R - 719G + 21V$$

$$g = -46R + 646G - 23V$$

$$b = 7R - 95G + 665V$$

There is an arbitrary factor in all of the above coefficients, so that the results are significant only as proportionalities.

The only trichromatic additive system which is in any way well known at the present time is that employed in the Ives colorimeter. Table 15 provides values for the coefficients which must be employed to convert color specifications in terms of the Ives system into excitation terms by use of the formulae given above. These coefficients were obtained by applying the excitation data of Table 6 to the spectrophotometric curves for the filters and light source employed in the Ives colorimeter in accordance with the principles outlined under Section A of the present part of this report. The light source assumed was average noon sunlight.

Table 15 also gives coefficients for the converse operations. Similar methods of calculation may be applied to any three-color system, such as, for example, that involved in the new subtractive colorimeter designed by Jones (43). In the special case of the subtractive colorimeter, however, it is not possible to assign fixed excitation values to the three primaries of the instrument, since the spectral distributions vary qualitatively for each individual setting of the instrument. The resulting necessity of applying the principles for the interconversion of colorimetric data to the spectrophotometric analyses of individual settings is a theoretical demerit of the subtractive as opposed to the additive trichromatic colorimeter.

It is clear that in order to compare the data obtained by trichromatic analysis with those due in any other system, such as the monochromatic, it is only necessary to convert both sets of data into color excitation values, in which condition they may be translated by a further operation into terms of any desired system.

D. ROTATORY DISPERSION DATA TO EXCITATIONS.—Colorimetric data based upon any rotatory dispersion system may be converted into color excitation terms by determining the spectrophotometric curves for the given dispersion stimuli and applying the methods outlined under A above. The reverse conversion is best accomplished by means of a plot in the color triangle of the loci for the various series of dispersion colors which are involved. Such reverse conversion is of course possible only when the given excitation values determine a point in the triangle which falls upon one of these loci, although the great flexibility of the rotatory dispersion method will permit the duplication of a wide variety of conditions of color excitation.

Table 16 gives the excitation values for the rotatory dispersion colors produced at various angles of the Nicol prisms for a quartz plate one mm in thickness. These values are plotted in the color triangle in Fig. 10. It will be seen that their locus is approximately elliptical in form and corresponds very closely with that of a certain range of black body colors (Cf. Fig. 3).

TABLE 16
Excitation Values of Certain Rotatory Dispersion Colors
 (Comparison source = acetylene color)
 (Quartz thickness = 1 mm.)
 (Φ = the angle between the Nicol prisms)

Φ	Per cent. R	Per cent. V	Nearest Black Body Color Temperature
0°	41.3	22.7	3494°
10°	32.6	33.1	5050°
20°	14.8	62.6
30°	65.1	12.3
40°	65.8	1.8
50°	61.7	3.7	1690°
60°	59.2	5.3	1840°
70°	57.5	6.8	1970°
80°	56.1	7.9	2070°
90°	55.0	8.9	2160°
100°	54.1	9.7	2227°
110°	53.2	10.5	2302°
120°	52.4	11.2	2370°
130°	51.5	12.1	2448°
140°	50.4	13.1	2543°
150°	49.0	14.4	2673°
160°	47.2	16.2	2850°
170°	45.1	18.4	3050°

TABLE 17
Percentage Excitation Values for Black Body Colors Computed by Means of the Planckian Formula ($C_2 = 14,350$)

Degrees Kelvin		0	100	200	300	400	500	600	700	800	900
1000	R	78.1	75.4	73.0	70.7	68.4	66.3	64.3	62.4	60.6	59.0
	V	0.6	0.8	1.2	1.7	2.3	3.0	3.8	4.7	5.6	6.5
2000	R	57.4	56.0	54.6	53.4	52.2	51.0	49.9	48.8	47.8	46.8
	V	7.5	8.5	9.6	10.6	11.7	12.8	13.8	14.9	16.0	17.0
3000	R	45.8	44.9	44.0	43.2	42.4	41.6	40.8	40.2	39.7	39.0
	V	18.1	19.2	20.2	21.2	22.2	23.1	24.0	24.8	25.7	26.5
4000	R	38.4	37.8	37.4	36.8	36.3	35.8	35.3	34.9	34.5	34.1
	V	27.2	27.9	28.6	29.3	30.0	30.7	31.3	31.9	32.4	33.1
5000	R	33.7	33.3	32.9	32.6	32.3	32.0	31.7	31.4	31.1	30.8
	V	33.8	34.3	34.8	35.3	35.8	36.2	36.7	37.2	37.6	38.1
6000	R	30.6	7000	28.4
	V	38.5	41.9

E. PLANCKIAN DISTRIBUTION DATA TO EXCITATIONS.—The various black body colors can evidently be reduced to color excitation values by means of their spectrophotometric representations, utilizing the methods already outlined. The reverse conversion is best accomplished by means of a plot of the positions for these colors in the color triangle.²⁰

Table 17 gives the color excitation values for a wide range of black body temperatures and these values are represented graphically in Fig. 3.

F. COMPARATOR DATA TO EXCITATIONS.—The conversion of color specification data, based upon color-matching with arbitrary standards, to color excitation terms will of course involve not only the spectral transmissions or reflections of the given standards but also the spectral distribution curve of the particular radiation source which is employed in making the given color-match. The reverse conversion is best accomplished by means of a representation in the color triangle of the values for the various arbitrary standards, and the possibility of such reverse conversion

TABLE 18
Percentage Excitation Values for Certain Munsell Colors*

D	E	D	E	D	E
R 7/5	39R 29V	R 5/5	44R 25V	R 3/2	40R 28V
Y 7/4	43R 19V	Y 5/5	47R 14V	Y 3/2	40R 23V
G 7/4	34R 29V	G 5/5	33R 26V		
B 7/4	30R 37V	B 5/5	26R 42V		
P 7/3	32R 36V	P 5/5	29R 43V		

* "D" is the designation of the given color in the Munsell System and "E" is the corresponding percentage excitation value.

²⁰ It is clear that since the black body colors form a single linear series the reverse conversion will seldom be possible.

will of course depend upon the scope of the given comparator system and in general will be only approximate.

In Table 18 will be found color excitation values for various Munsell pigments as seen under average noon sunlight. The equivalents of certain Ridgway colors in terms of monochromatic analysis have been given in Table 13. As already noted, the excitation equivalents of many colors in Ostwald's pigment system have been computed very carefully by Kohlrausch in a recent article. In subsequent reports the committee will endeavor to provide values for further standards, both in these two and other systems, such as that utilized in the Lovibond tintometer.

VI. SUMMARY AND CONCLUSION

The above report, being a more or less pioneer effort of its kind, must naturally be regarded as incomplete and tentative. However, the purpose of the report is an earnest one and is directed towards at least four ends; (1) the clarification and standardization of color terminology, (2) the compilation of data which are fundamental to color science, (3) the specification of standard stimuli and conditions, for use in practical color work, and (4) the encouragement of discussion and research along these lines. An outline of the contents of the present report is given at the beginning in the form of a Table of Contents. It is hoped in later reports by the present Committee to deal more specifically with details in the terminology and application of the various methods for colorimetry as well as with the design of instruments for the utilization of these methods. Finally, the Committee desires to express once more its wish that workers in the field of color science communicate freely their criticisms and specific needs.

NOTE: No attempt is made here to summarize the progress in color science during the years, 1920-21, since this topic has been treated by the Chairman of the Committee in general summaries published in the *American Journal of Physiological Optics*, October 1921, pp. 316-391, and forthcoming.

C. BIBLIOGRAPHY

1. Abbot, C. G., *Annals of the Astrophysical Observatory of the Smithsonian Institute*, 3, p. 135; and also Letter of Nov. 17, 1917, to the Bureau of Standards.
2. Abney, W. de W. *Color Measurement and Mixture*. London, 1891.

3. Color Vision. London, 1895.
4. Researches in Color Vision and the Trichromatic Theory. London, 1913.
5. Abney, W. de W. and Watson, W., The Threshold of Vision for Different Colored Lights. *Phil. Trans. of the Royal Soc.*, London, 1915-16, Ser. A, 216, 91-128.
6. Ames, A., Jr., Systems of Color Standards. *Jour. of the Opt. Soc. of Amer.*, 5, pp. 160-170; 1921.
7. Arons, L., Das Arbeiten mit dem Farbenweiser (Chromoskop) *Ann. der Physik*, 39, pp. 545-568; 1912.
8. Ein Chromoskop. *Ann. der Physik*, 33, pp. 799-832; 1910.
9. Baldwin, J. M., Dictionary of Philosophy and Psychology, New York, 1901.
10. Bezold, J. F. W. v., Theory of Color in its Relation to Art and Art-Industry. Eng. Trans. by Koehler, S. R., Boston, 1876.
11. Bloch, Kennzeichnung der Farbe des Lichtes. *Electrot. Zeitschr.* 46, 1306; 1913.
12. Blondel, M., Rapport sur les Unités photométriques. *L'Éclairage Électrique*, 8, 341-366; 1896.
13. Brown, W., The Essentials of Mental Measurement, Cambridge. (Eng.) 1911.
14. Church, A. H., Colour, An Elementary Manual for Students. London, 1905.
15. Dove, H. W., Darstellung der Farbenlehre. Berlin, 1853.
16. Edridge-Green, F. W., Color Blindness. London, 1909.
17. Exner, F., Über die Grundempfindungen im Young-Helmholtz'schen Farbensystem. *Sitzungsber. k. Acad. der Wiss., Wien, Math.-Nat. Cl.*, III, (2a), pp. 857-877; 1902.
18. Field, C. T., Chromatography, London, 1885.
19. Forsythe, W. E., 1919 Report of the Standards Committee on Pyrometry. *Jour. of the Opt. Soc. of Amer.*, 4, pp. 305-336; 1920.
20. Hagen, J. G., Various Scales for Color Estimates. *Astrophysical Jour.*, 34, pp. 261-276; 1911.
21. Helmholtz, H. L. v., Sensations of Sight, Popular Lectures, Eng. Ed., London, 1873.
22. Helmholtz, H. L. v., Handbuch der Physiologischen Optik. 2, 3rd ed., 1911.
23. Hering, E., Zur Lehre vom Lichtsinn. Berlin, 1878.
24. Grundzüge der Lehre vom Lichtsinn, in *Graefe-Saemisch Handb.* Th. I. bd. 3. Chap. 12; 1905.
25. Hitchens, A. B., Maintaining Photographic Standards. *Jour. of the Franklin Inst.*, 184, pp. 179-203; 1917.
26. Hurst, G. H., A Handbook of the Theory of Color. London, 1900.
27. Hyde, E. P., Cady, F. E. and Forsythe, W. E., Color Temperature Scales for Tungsten and Carbon. *Physical Rev.*, 10, pp. 395-411; 1917.
28. Hyde, E. P. and Forsythe, W. E., The Quality of Light from an Illuminant as Indicated by its Color Temperature. *Jour. of the Franklin Inst.* 183, pp. 353-354; 1917.
29. Ives, H. E., A New Color Meter., *Jour. of the Franklin Inst.*, 164, pp. 47-56; 1907.
30. A Color Screen Color Meter. *Jour. of the Franklin Inst.* 164, pp. 421-423; 1907.
31. The Ives Colorimeter in Illuminating Engineering. *Trans. of the Illum. Eng. Soc.*, 3, pp. 627-635; 1908.
32. Color Measurements of Illuminants—A Résumé. *Trans. of the Illum. Eng. Soc.*, 5, pp. 189-207; 1910.

33. The Relation Between the Color of the Illuminant and the Color of the Illuminated Object. *Trans. of the Illum. Eng. Soc.*, 7, pp. 62-72; 1912.
34. Studies in the Photometry of Lights of Different Colors. *Phil. Mag.*, 24, pp. 170-173, 178-181; 1912.
35. Suggested Definitions of Photometric Quantities. *Lighting Journal*, 1, Oct. 1913.
36. The Transformation of Color Mixture Equations from One System to Another. *Jour. of the Franklin Inst.*, 180, 673-701; 1915.
37. The Units and Nomenclature of Radiation and Illumination. *Astrophys. Jour.* 45, pp. 39-49; 1917.
38. The Photometric Scale. *Jour. of the Franklin Inst.*, 188, 217-235; 1919.
39. Jones, H. C. and Anderson, J. A., The Absorption Spectra of Solutions, Washington, 1909.
40. Jones, L. A., The Color of Illuminants. *Trans. of the Illum. Eng. Soc.*, 9, 687-709; 1914.
41. A New Standard Light Source. *Trans. of the Illum. Eng. Soc.*, 9, pp. 716-728; 1914.
42. The Fundamental Scale for Pure Hue and Retinal Sensibility to Hue Differences. *Jour. of the Opt. Soc. of Amer.*, 1, pp. 63-77; 1917.
43. A Colorimeter Operating on the Subtractive Principle. *Jour. of the Opt. Soc. of Amer.*, 4, pp. 420-431; 1920.
44. Kohlrausch, F. W. K., Beiträge zur Farbenlehre. *Physik. Zeitsch.*, 21, pp. 396-403, 423-426, 473-477.
45. Kohlrausch, F., Lehrbuch der Practischen Physik. 12th Ed., pp. 370-373.
46. Köllner, H. Die Störungen des Farbensinnes, ihre klinische Bedeutung und ihre Diagnose. Berlin, 1912.
47. König, A., Das Leukoskop und einige mit demselben gemachte Beobachtungen. *Ann. der Physik*, N. F., 17, pp. 990-1008.
48. König A. and Dieterici, C., Die Grundempfindungen in Normalen und Anormalen Farbensystem und ihre Intensitätsverteilung im Spektrum. *Zeitschr. für Psychol. und Physiol. der Sinnesorg.*, 4, 241; 1892.
49. Külpe, O., Outlines of Psychology. 1893; Eng. Trans., London, 1895.
50. Kries, J. v., Article: Die Gesichtsempfindungen in W. Nagel's Handbuch der Physiologie des Menschen. Bd. I, Braunschweig, 1906.
51. Ladd, G. T. and Woodworth, R. S., Elements of Physiological Psychology. New York, 1911.
52. Ladd-Franklin, C., On Theories of Light-Sensation. *Mind*, N. S. 2, pp. 473-489; 1893.
53. Lovibond, J. W., Measurement of Light and Color Sensation, London, 1894.
54. Luckiesh, M., Color and Its Applications, New York, 1915.
55. Light and Shade and Their Applications, New York, 1916.
56. The Physical Basis of Color Technology. *Jour. of the Franklin Inst.*, 184, 73-93, 227-250; 1917.
57. Maxwell, J. C., On the Theory of Compound Colors and the Relations of the Colors of the Spectrum. *Scientific Papers*, 1, pp. 410-444.
58. Mees, C. E. K., An Atlas of Absorption Spectra. London, 1909.
59. Merwin, H. E., Optical Properties and Theory of Color of Pigments and Paints *Proc. Amer. Soc. Test. Materials*, 17, Pt. II; pp. 496-530; 1917.

60. Meisling, A. A., Ein Polarisationskolorimeter. *Zeitsch. für Analytische Chemie*, 43, pp. 137-146, 1904.
61. Munsell, A. A., A Color Notation. Boston, 1907.
62. Atlas of Munsell Color System. *Munsell Color Co.*, New York.
63. Nutting, P. G., The Luminous Equivalent of Radiation. *Bull. of the Bur. of Stands.*, 5, pp. 261-308, 1908.
64. A Method for Constructing the Natural Scale of Pure Color. *Bull. of the Bur. of Stands.*, 5, pp. 261-308, 1908.
65. Outlines of Applied Optics. Philadelphia, 1912.
66. A New Precision Colorimeter. *Bull. of the Bur. of Stands.*, 9, 1; 1913.
67. The Retinal Sensibilities Related to Illuminating Engineering. *Trans. of the Illum. Eng. Soc.*, 11, p. 1-16; 1916.
68. 1919 Report of Standards Committee on Visual Sensitometry, *Jour. of the Opt. Soc. of Amer.*, 4, pp. 55-79; 1920.
69. Ostwald, W., Die Farbenfibel. Leipzig, 1917.
70. Die Farbenlehre. I, Leipzig, 1918, II, 1919.
71. Der Farbenatlas. Leipzig, 1918.
72. Der Farbkörper. Leipzig, 1919.
73. Parsons, J. H., An Introduction to the Study of Colour Vision. Cambridge (Eng.), 1915.
74. Planck, Max, The Theory of Heat Radiation. Eng. Trans. by M. Masius, Philadelphia, 1914.
75. Porter, T. C., Contributions to the Study of Flicker. *Proc. of the Roy. Soc. of London*, 70, 313-329, 1902.
76. Priest, I. G., A Proposed Method for the Photometry of Lights of Different Colors. (*Proc. Amer. Phys. Soc.*) *Physical Rev.* (2) 9, pp. 341-345; 6, pp. 64-66; 10, pp. 208-212.
77. Report on the Calibration of Sixteen Lovibond Red Glasses. *The Cotton Oil Press*, 4, 43-44; 1921.
78. A Precision Method for Producing Artificial Daylight. *Physical Rev.*, 11, pp. 502-504; 1918.
79. Preliminary Note on the Relation between the Quality of Color and the Spectral Distribution of the Light in the Stimulus. *Jour. of the Opt. Soc. of Amer.*, 4, pp. 388-401; 1920.
80. Note on the Relation between the Frequencies of Complementary Hues. *Jour. of the Opt. Soc. of Amer.*, 4, pp. 402-404, and 5, p. 513; 1921.
81. A New Study of the Leucoscope and its Application to Pyrometry. *Jour. of the Opt. Soc. of Amer.*, 4, pp. 448-495; 1920.
82. The Spectral Distribution of Energy Required to Evoke the Gray Sensation. *B. S. Sci. Paper No. 417*, Aug. 1921, Abstract in *Jour. of the Opt. Soc. of Amer.*, 5, pp. 205-209; 1921.
83. Priest, I. G., Gibson, K. S., McNicholas, H. J., An Examination of the Munsell Color System. *Technologic Paper, Bur. of Stands.* No. 167, 1920.
84. Rand, G., The Factors that Influence the Sensitivity of the Retina to Color. *Psychological Review Monograph No. 62*, 1913.
85. Rayleigh, Lord, Report of the Committee on Color-Vision. *Proc. of the Roy. Soc. of London*, 51, pp. 280-396; 1892.
86. Reports of the Committee on Nomenclature and Standards. Illuminating Engineering Society. *Trans. of the Illum. Eng. Soc.*, yearly.

87. Ridgway, R., *Color Standards and Color Nomenclature*, Washington, 1912.
88. Rood, O. N., *Constants of Color. Quart. Jour. of Sci.*, London, **13**, p. 458; 1876.
89. *Modern Chromatics*. New York, 1879.
90. Rosa, E. B., *Photometric Units and Nomenclature. Bull. of the Bur. of Stands.*, **6**, pp. 543-572; 1910.
91. Strutt, J. W., *Some Experiments on Color. Nature*, **3**, pp. 235-236; 1871.
92. Titchener, E. B., *A Text-Book of Psychology*, New York, 1911.
93. Troland, L. T., *Apparent Brightness; Its Conditions and Properties. Trans. of the Illum. Eng. Soc.*, **11**, p. 948, 1916.
94. *The Psychology of Color in Relation to Illumination. Trans. of the Illum. Eng. Soc.*, **13**, p. 21; 1918.
95. *The Heterochromatic Differential Threshold for Brightness. Psychol. Rev.*, **25**, pp. 324-329; 1918.
96. Uhler, H. S. and Wood, R. W., *Atlas of Absorption Spectra*, Washington, 1907.
97. *Wratten Light Filters*, 4th Ed. Revised, Eastman Kodak Company, Rochester, 1920.
98. Westphal, H., *Unmittelbare Bestimmungen der Urfarben: Zeitschr. für Sinnesphysiol.* **44**, pp. 182-230; 1910.

HETEROMORPHIES DUE TO THE VARIATION OF EFFECTIVE APERTURE AND VISUAL ACUITY¹

BY
K. HOROVITZ

1. By the use of optical apparatus the image of the surrounding space sometimes undergoes a complete change, as in some kinds of prisms and mirrors. But also in other cases, in which the instrument produces a perfect image, apparent alterations of space are perceptible. These apparent defects of the visual space are called heteromorphies.

Expert microscopists are always surprised that beginners are unable at first to find the image, or, when drawing it, always make it too small. And to each of us it is well known that the drawing or photograph of a microscopical object seems much bigger than really shown by the microscope. Impressions of this kind are also perceptible in other cases than when using an optical instrument. If, for instance, instead of through the microscope we look through an empty tube with one eye and fix it on a distant object² while the other eye is directed to the same object in the ordinary manner, the image seen through the tube appears much smaller than to the naked eye.³ Exactly the same thing can be observed by looking at a landscape through the finder of a camera or by holding a narrow stop before the eye. In all these cases the aperture of the rays of the optical system, consisting of the eye together with the effective stop, is changed.

The phenomena described can be observed by persons with normal vision (emmetropes), under certain conditions to be described later, by ametropes and, as already mentioned, in using optical instruments. The phenomena are therefore, as it seems, independent of the dioptrical properties of the system, but only

¹ Communicated by Dr. Ludwik Silberstein.

² It must be a distant object in order that the rays appear to come from infinity in the same manner as when using the microscope.

³ Cf. St. Meyer, *Phys. Zs.* 21, p. 124, 1920; and K. Horovitz, *Phys. Zs.* 21, p. 499, 1920.

so far as the dioptrical system remains unchanged and the image remains clear.

2. The effective aperture may influence the image in different ways. When the entrance-pupil is altered, the size of the image-forming diffraction-disks is also altered. The smaller the latter are, the sharper the images, but their brightness is reduced (case of a small diaphragm). A stop which reduces the aperture of the image-forming pencils without altering the entrance-pupil, changes the field of view. The image of the stop in the focal plane (in the case of the eye, on or before the retina) is the exit-window (case of the tube and the finder of a photographic camera).

An alteration of the entrance-pupil changes also the actual size of the image, for the circles of confusion become smaller. As the aberrations in the eye and the formation of the image by wide-angle pencils bring it about the size of the diffraction-disks depends not only on the size of the entrance pupil, this reduction of the image on the retina is difficult to perceive. Thus the diminution observed, when looking through a diaphragm, need not depend necessarily on the actual reduction of the image on the retina. When, the entrance-pupil remaining constant, the entrance-window or the stop of the field of view is changed, the structure of the image is only changed in those places where now, instead of the former images, the image of the exit-window is formed. If nevertheless the impressions brought about by the unchanged retinal images are changed, evidently this must be connected with the mutual influence of neighboring parts of the retina,⁴ especially with the influence of the simultaneous contrast-sensibility which brings about a change of the adjustment of the eye. Experiments have shown, that the diminution is as much increased as the stop of the field of view decreases (that is to say, in the case of the tube it would be a longer one). A diminution of the field of view also occurs with the replacement of the binocular by monocular vision, which transition also is connected with an apparent diminution of size.

⁴ This is Hering's induction.

But an alteration of the aperture is also connected with an alteration of the distribution of light in the image. This is caused by a change of the circle of confusion by variation of the entrance-pupil. We have, further, to consider a change of the simultaneous contrast, when, by an alteration of the stop of the field of view, parts of the image are covered either by light or darkness. The former case occurs when an object is observed through a glass-tube, which, by total reflection, forms on the retina a brightly illuminated background; the latter when looking through a tube blackened on the inside, in which case the part of the field of view around the retinal image is darkened. But this affects in a decisive way the acuteness of vision and this influence therefore must always be taken into account.

3. It is well known, that the acuteness of vision is diminished by a reduction of the intensity of illumination, by flooding the retina with useless light, by the darkening of simultaneous contrast and of course also by wrong adjustment.⁵ All these produce a reduction of the relative differences in the sensations of the brightness of two points. An increase of the visual acuity is caused by: a diminution of the entrance-pupil, a moderate increase of the intensity of light (provided that the peripheral portions of the retina are not sensibly illuminated by stray light), and the illuminating simultaneous contrast. Each change of the incident light alters the pupillary diameter leading to disturbing secondary phenomena (the acuteness of vision may be changed thereby and also focusing movements be liberated).⁶ Therefore, it was necessary to make experiments in which the influence of the size of the pupil was eliminated. For this purpose investigations were made on persons, whose pupils had lost the reaction to light. *The result was, that a reduction of the acuteness of vision is always followed by an apparent diminution in size and, at the same time, the removing and bringing nearer together of the objects observed.* On the other hand a sudden increase of the visual acuteness produces

⁵ In the latter case also dioptrics may be of importance as mentioned before.

⁶ Cf. E. Hummelsheim, Arch. f. Ophth. vol. 45, 1898, p. 357 and K. Horovitz, Ber. d. deutschen physik. Ges. 1921, 2, pp. 9-11 and Sitz. Ak. Wiss. Wien, vol. 1130, 1921, pp. 405-421.

an increase of size. With atropinized ametropes it could be observed that a small (stenopäical) stop which in the case of normal sight would cause a diminution, improves the acuteness of vision so much that an increase may be observed. Beside this *new* effect of the alteration of size in the field of vision, the known influence of the visual acuity must also be considered and also the influence of the aperture on the depth of focus of the image-space. The importance of the acuteness of vision for the resolving power of the microscope was pointed out by F. E. Wright.⁷ (Here the illuminating effect of the simultaneous contrast comes into play.) In the following I intend to deal with a series of contrivances, for which the above mentioned effects are of importance, and then set forth the theory of the phenomena.

4. For the series of readings a simple lens is used, before which a diaphragm is placed, to increase the distinctness. With a very small diaphragm (e.g., of 0.1 mm. diameter) the usual magnification cannot be observed. I made this observation myself with an Elster-Geitel-electroscope and found it confirmed by other observers: the scale and the leaves of the electroscope seem to be in one plane and far more distant than without a diaphragm. As these phenomena are not always perceptible with both eyes with the same intensity they are also of importance when first one eye is used and then the other in observing and above all in comparing the images with one eye aided and the other naked. This is the case with the well-known examination of the magnifying power of a telescope which consists in comparing the lines of a distantly suspended scale with one eye naked and the other aided by the telescope. If then the exit-pupil of the telescope is much smaller than the pupil of the eye, the phenomenon mentioned above is observed. Thus sometimes it is not sufficient to pull out the tube to diminish the parallax between the two images. A similar examination of the magnifying power of a microscope is open to the same difficulties. To avoid such faults, fix close to the instrument, whose magnifying power is to be examined, a diaphragm for the naked eye of the size of the exit-pupil of the

⁷ F. E. Wright, *Jour. of the Opt. Soc.* 2-3, p. 101, 1919.

instrument. The right perception of the increase, when using night-glasses depends also on the correct proportion between the exit-pupil of the instrument and the eye-pupil. A. Gehlhoff⁸ pointed out that the size of the field of view is also of psychological importance for the resolving powers of these instruments. By employing drawing apparatus, as for instance the well-known camera lucida, the influence of the opening of the stop is remarkable. On using this instrument the scenery appears smaller on the drawing paper than to the naked eye. *If the stop is made gradually smaller* (as far as it is possible without making the illumination of the image so faint, that it is no longer perceptible) *the image becomes smaller as well*. Qualitative tests, made with regard to this, have shown that the variation in size by stopping down the diaphragm from 3 mm to 0.1 mm is about 15%.

It is natural to take into account the variation of visual acuity by dazzling. Therefore every physicist or astronomer uses in exact measurements a dark eye-shield to cover the non-observing eye. Also blinding of this eye, as is easily proved, diminishes the acuteness of vision and for this reason apparently the magnification and the perception of depth for the observing eye. Therefore it seems necessary, not to change the conditions for the formation of image in the eye, in applying optical apparatus for subjective use.

5. According to the doctrines of physiological optics, the defective aperture of the rays and the acuteness of vision do not immediately determine the perception of size. But these factors do determine the depth of focus which depends on $\frac{p}{\sigma}$, where p denotes the diameter of the pupil and σ is the angular measurement of the visual acuity.⁹ If $\frac{p}{\sigma}$ diminishes, the depth of focus increases, and *vice versa*. The distinctness of the perception of depth is inversely as the optically defined range of distinct vision (depth of focus). On the other hand the sensation of size is con-

⁸A. Gehlhoff, Zs. f. techn. Phys. 66, p. 477 *et seq.*

⁹Cf. Rohr, Brit. Jour. of Phot. 48, p. 454, 1901, and S. Czapski, Grundzüge der Theorie der optischen Instrumente, p. 256, 267, 1904.

nected with the accommodation of the eye. Any object seems smaller in proportion as the accommodation is greater or even when the sense of greater accommodation is excited, and this is the case although the image on the retina is unchanged in size. We will assume now, that if anywhere a variation of the range of distinct vision takes place, the accommodation or the innervation of accommodation increases as far as possible without perceiving the image less sharply (*Principle of maximum accommodation*).¹⁰ If the range of distinct vision increases, a point is approached at which the depth begins to be practically infinite and it is, therefore, useful to focus at a nearer point. This does not mean that these focusing impulses are always connected with a real accommodation, for we would then see the nearer point as sharply as the point at which we focused previously. On the contrary, impulses to relax the accommodation take place if the depth of focus decreases again because points at a greater distance are now also distinctly visible and thus the depth of the visual space is enlarged. By this conception, all the experiments mentioned above are intelligible: whether the pupil p or the angular size of visual acuity σ are changed,¹¹ the innervation to focus begins and together with it a variation of the impression of size and depth.¹²

¹⁰ J. K. Horovitz, Sitz. Akad. Wiss. Wien. vol. 130, 1921; Beiträge zur Theorie des Sehraums.

¹¹ It is necessary to mention, that a change of the pupil also entails a variation of visual acuity (but not *vice versa*).

¹² It is partly due to the influence of limiting the field of view, that the diminution of the object, when seen through concave spectacles, is much more intensely felt (as shown by Isakovitz), than the diminution of the image on the retina alone could bring about. Therefore, the variation of the depth of focus also must be considered: the entire depth being greater than without spectacles, because $\frac{p}{\sigma}$ which determines the distinct-

ness is only $\frac{pB^2}{\sigma}$ ($B < 1$).—It may be mentioned here, that also other dysmegalopsies, micropsy after the injection of atropin, macropsy after the use of pilocarpin (eserin) are intelligible if we assume the principle of maximum accommodation. In the first case the innervation is unlimited, the apparatus of accommodation being paralysed: hence micropsy. In the other case the external eye is in a spasm of accommodation, the impulses are arrested: hence macropsy.—For these and also other cases of physiological interest see K. Horovitz, *loc. cit.* and further an article appearing in "Pflüger's Archiv" (Größenwahrnehmung und Sehraumrelief).

6. To show how these changes of our optical sensations are connected with normal sight, we proceed to consider the conception that the space as seen by us, is an optical transformation (in the sense of Maxwell and Abbe) of the physical space.

In this transformation any point of the object-space has a one to one correspondence with a point of the visual space and the lines of sight remain invariant, while the points at infinity are transformed into a plane at finite distance perpendicular to the axis of vision. Mathematically formulated these conditions give, instead of the usual optical transformation

$$x' = \frac{a_1x + a_2y + a_3z + a_4}{ax + by + cz + d}, y' = \frac{b_1x + b_2y + b_3z + b_4}{ax + by + cz + d}, z' = \frac{c_1x + c_2y + c_3z + c_4}{ax + by + cz + d}$$

the equations:

$$x_v = \frac{a_1x}{ax + d}, y_v = \frac{b_2y}{ax + d}, z_v = \frac{c_3z}{ax + d}, \text{ with the condition}^{13} b_2 = c_3 = d.$$

These are well known formulae of projective geometry and give analytically the geometry of a relief-perspective for the general case. The origin of the coördinates lies in the first eye-point.¹⁴ If $d = a_1$, the relief is the image of the real space which the *quiescent* eye sees, if the eye is contemplating the point at which it is focused (the point of view is identical with the first eye-point).¹⁵ If the eye is focused on a point, which is nearer than that which is contemplated, then it is necessary for the restoration of the previous conditions to displace forward the eye until the point of view will be so near to the contemplated point, that the latter again is a focused one. But if the eye remains in the place of the first eye point we must say that the point of view is shifted forward only *virtually*: the psychical adjustment of the eye and the innervation corresponds to a smaller distance. Then we have

¹³ As postulated by the invariance of the line of sight. It is not necessary for the visual space to be always symmetrical around the x axis, as in the case of astigmatism.

¹⁴ Cf. Burmester, Grundzüge der Reliefperspektive.

¹⁵ The case $d = a$ was developed by H. Witte, proceeding from experimental facts, without connection with the relief-formulae explained above. Physik. Zs. vol. 19, vol. 20, several articles "Über den Sehraum."

$d < a_1$ ($\frac{a_1 - d}{a}$ being the range of the virtual displacement of the

point of view) and the objects seem to be smaller and at a greater distance. Thus the conditions of variation of the visual space can be conceived by the rules given for normal vision.

For an exact theory it would be necessary to take into account these transformations only as a first approximation and to find the infinitesimal transformation which takes into account the apparent changes induced by the moving eye and the curvature on the margin of the field of vision.¹⁶

SUMMARY

The influence of the effective aperture and the acuteness of vision have been dealt with in reference to well-known facts regarding the eye in connection with an optical instrument. It has been shown, that a reduction of the visual acuity entails a diminution of the apparent size. The importance of these facts for some optical observations and measurements is explained. This explanation is based on the assumption that maximum impulses to accommodate are liberated in such a manner that the distinctness of the image is not blurred when the conditions of the formation of the image are altered. The optical transformation of the object-space into the visual space for a quiescent eye is defined by simple postulates of invariance and is proved to be a relief-perspective. Usually the point of view coincides with the first eye-point. The heteromorphies considered above may be constructed as a virtual shifting forward of the point of view.

FIRST PHYSICAL INSTITUTE OF THE UNIVERSITY,
VIENNA, FEBRUARY 15, 1922.

¹⁶ The present writer is pursuing these investigations in connection with Riemannian geometry.—The observations stated here are qualitative and it would be most interesting to obtain some exact investigations on these points, which it was impossible to undertake here.

THE ABSORPTION OF THE EYE FOR ULTRA-VIOLET RADIATION

BY
WINIFRED P. GRAHAM

The eye, as the most delicate sense organ, has always been of great interest, and any investigation adding anything to the sum total of knowledge concerning it, would seem to be worth while. Several investigations have been carried on to determine the relative sensibility of the eye for light of different wave-lengths, but data concerning the limits of the visible spectrum, and the absorption of the tissues of the eye, is conflicting and lacking in information regarding the source and condition of the material. It is, of course, a well-known fact that the eye is sensitive to only a very small portion of the total radiation. The question naturally arises as to whether the limits of our vision are determined by the wave-lengths that are able to affect the retina, or whether the fluids and tissues of the eye actually do not transmit these certain wave-lengths. Nutting says¹ that the retina is most sensitive to radiation in the blue green between wave-lengths $.50$ and $.55\mu$; that good seeing requires radiation between wave-lengths $.41$ and $.75\mu$; and if the source is sufficiently intense radiation as far out as wave-length $.321$ (ultra-violet) or 1.0μ (infra-red) may be perceived. F. W. Edridge-Green states² that the limits of the visible spectrum are practically the lines *A* and *H*, *A* wave-length $.764\mu$ for the red and *H* $.3968\mu$ for the violet. He also states that the wave-lengths vary with different persons. It may be seen that there is quite a discrepancy between these two writers.

The production of fluorescence in the eye is an important consideration. Wrong conclusions are likely to be drawn as to the limits of the visible spectrum from such experiments as those of Helmholtz and others. When a portion of the spectrum is exposed and produces merely the sensation of light, there is no

¹ Outlines of Applied Optics, p. 120.

² The Physiology of Vision, p. 136.

definite proof that the short wave-lengths actually reach the retina, as they might be transformed into long wave-lengths by the tissues of the eye. This would be equivalent to a source very close to the retina. On the other hand if a slit were used with some characteristic shape such as an arrow, for example, if a distinct image were formed with the slit illuminated with ultra-violet, it would seem to prove that we can see by means of ultra-violet light. Nutting's observation is borne out by a member of the Physics Department of this University who claims to have seen the doublet of the mercury spectrum ($.3132\mu$ and $.3126\mu$). It might be possible that about the same wave-lengths get through the average eye but that the sensitiveness to the ones near the absorption band vary with the individual.

Dr. Fritz Schanz studied³ the effect of the ultra-violet light on the eye and the absorption of the different parts. He used a quartz spectral photometer and a Nernst lamp. The corneas of three people of different ages were investigated. He found that the cornea begins to absorb at $.360\mu$, and at $.310\mu$ the rays of the Nernst lamp were absorbed completely. He studied the lenses of three different people of ages 40, and 28 years, and a child's. He states that the lenses begin to absorb in the blue and absorb extensively in the ultra-violet. Using a quartz spectograph he took photographs of the absorption of the cornea and the lens. The latter was pressed between two quartz plates to a thickness of 3 mm. Since the lens in the region of the pupil is considerably thicker than 3 mm, this would only give the partial absorption. His plates show that the cornea begins to absorb at $.360\mu$ and absorbs completely at $.300\mu$ and the lens absorbs completely at about $.350\mu$ on a forty-second exposure. This exposure varied from twenty to forty seconds.

In a second article⁴ in 1920, he apparently refutes the data given in the former discussion. This time he used a quartz spectograph. He states that nearly all the ultra-violet is absorbed but although

³ Über die Veränderungen und Schädigungen der Augen durch die nicht direkt sichtbaren Lichtstrahlen. *Archiv. für Ophthalmologie*, **86**, p. 549; 1913.

⁴ Der Gehalt des Lichts an Ultraviolett. *Archiv. für Ophthalmologie* **102**. 103 p. 158; 1920.

that which is left reaches the retina, it does not produce the sensation of light but of fluorescence. By using an intense source he says it is possible to perceive light up to $.392\mu$; and if there is light beyond this it is caused by the fluorescence of the retina.

Dr. W. E. Burge gives⁵ an absorption spectrum of the cornea of a rabbit which transmits wave-lengths as short as $.297\mu$.

The object of this experiment was to determine what wave-lengths in the ultra-violet region get through the tissues and liquids of the eye, or in other words, what light, in the ultra-violet region actually reaches the retina. It was also determined to compare the absorption of the various parts of the eye and to point out, as much as the material which could be procured would permit, the change in the absorption due to disease, solution in formaldehyde, etc.

The measurements are not as numerous as was wished on account of the difficulty of obtaining material. Human eyes were desired immediately after death and before embalming, or soon after removal in the case of enucleation operations. The specimens procured by the latter method can usually only be used in part because of some pathological condition.

APPARATUS AND MATERIALS

A quartz-prism spectroscope was used, with a dispersion of about 4 inches. A cadmium spark furnished the source of radiation. A transformer connected with nine storage cells gave a good spark across a gap of about a centimeter. The electrodes were sticks of cadmium formed by drawing the molten metal up into small glass tubes. These were stuck through a hollow cork and connected to some Leyden jars and thence to transformer.

A holder was made for the corneas examined out of thin copper sheeting. Two pieces were cut approximately two inches square and an oblong hole cut in each $\frac{1}{2}$ cm \times $1\frac{1}{2}$ cm. A fold of a half centimeter was then made along the edge of one and the other trimmed off an equal amount. Thus one slipped into the fold and the holes coincided. The cornea to be examined was cut off where it joined the sclerotic coat and placed between the two

⁵ "The Production of Cataract." *Archives of Ophthalmology*, 47, p. 12; 1918.

plates, covering the openings. The edges opposite the fold were then placed in a clamp.

Since the crystalline lens in a fresh condition is fairly soft, stiff paper was found very satisfactory as a holder. A cardboard screen was used about 8 by 10 inches with a circular hole of an inch diameter cut in it. The screen was then covered with black paper on each side. A round hole, slightly smaller than the lens to be examined was cut in either side of the black paper, concentric with the hole in the cardboard. This served as a very convenient socket for the lens.

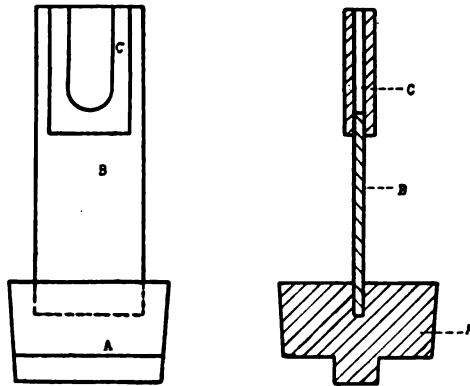

FIG. 1

The liquids of the eyes were put in a small quartz cell for examination. An oblong cut with a semicircular bottom was made in one end of a cover glass, see Fig. 1. Quartz plates of $2\frac{1}{2}$ mm thickness were fastened on either side of this with sealing wax. A small container was thus formed with $1\frac{1}{2}$ mm thickness, 1 cm width, $2\frac{1}{2}$ cm depth. This was very satisfactory as four or five drops could be examined.

The animal eyes used (specimen numbers 1-6) were those of cows, pigs, and sheep. These were mostly secured while they were yet warm, dissected and used the same day. Some were put on ice and dissected and used some four or five days later.

Specimen No. 7 of the human material was secured from an enucleation operation. It was the eye of a man aged twenty

years who had been struck in the eye two years previously with a pen point. The puncture seemed to be completely healed as there was no mark on the cornea which appeared to be normal. The aqueous humor also seemed normal. On dissecting the eye the lens was found to be completely calcified. The choroid had been nearly all absorbed and in its place was a layer of salt. The vitreous humor was very thin and resembled bloody water.

Specimen No. 8 was the lens taken out in a cataract operation. The cataract was mature.

Specimen No. 9 was a lens obtained from a cataract operation. This cataract was not so fully developed. Both these lenses were intact when received and both of the patients had the perception of light and darkness. The lenses appeared opaque in the center but seemed to transmit quite a good deal of light around the edges.

Specimen No. 10 was the lens of an infant of 4 months. The eye had been infected at birth. The lens only was used and it appeared perfectly normal. This view was corroborated by the physician and oculist in charge.

PROCEDURE

The method used in determining the amount of absorption was one of comparison. Plates were taken of the sparks of cadmium, zinc and tin. The wave-lengths on these were marked, see Fig. 2, by comparison with the photographs and data given by Eder and Valenta.⁶ Cadmium was found to be most satisfactory for this purpose, as has been mentioned before, because the groupings of the lines are very characteristic and the spark can be easily maintained for a comparatively long time. Spectral photographs were then taken with the material in front of the slit and compared with the original photograph. In some cases the material only covered part of the slit so that a comparison spectra was given on the same plate.

The plates were examined with a small lens and the last line toward the ultra-violet end of the spectrum was taken as the last

⁶ Atlas Typischer Spektren, J. M. Eder and E. Valenta.

wave-length to be transmitted, or the beginning of the absorption band.

A cut was made in the edge of the cornea and the aqueous humor was removed. The cornea was then cut off and the lens taken out. Then the posterior of the eye was cut into and a small amount of the clear vitreous removed.

The cornea was put in the holder mentioned above and placed before the slit of the spectroscope. Exposures of varying time were made in order to determine the amount of absorption.

The lens was placed in the cardboard screen and the light from the spark focused by means of it on the slit.

The humors were placed in the quartz cell and put directly in front of the slit and very close to it.

DATA AND RESULTS

The data obtained are given in Tables 1 to 4.

TABLE 1
Cornea

No. of Specimen	Kind	No. of Plate	Time of Exposure	Condition of Specimen	Last Wave-length
1	Cow	13	1½ min.	In formalin	3251
1	"	14	3 "	" "	3251
2	"	20	1 "	Fresh	3134
5	Pig	29	1 "	4 days on ice	3251
7	Human	36	30 seconds	Fresh	3066
7	"	37	45 "	"	2981
7	"	38	60 "	"	3066
7	"	39	1½ min.	"	2981
7	"	40	2 "	"	2981
7	"	41	25 "	"	2981

Seed dry plates number 26 were used except for spectrograms 15 and 16 for which Seed Process plates were employed. The lines were often very faint and at times it was hard to tell just exactly where the last line was located. The last wave-length toward the ultra-violet as given in the last column of the data is only a close approximation since when partial absorption has set in only the strong lines of the source show. Also it might be possible for the transmission to continue for several wave-lengths further and not

TABLE 2
Crystalline Lens

No. of Specimen	Kind	No. of Plate	Time of Exposure	Condition of Specimen	Last Wave-length
1	Cow	15	3 min.	In formalin	3613
1	"	16	3 min.	" "	3613
2	"	19	15 sec.	Fresh	3251
2	"	18	30 sec.	"	3251
3	sheep	21	45 sec.	Kept 3 hours	3251 (very faint)
3	"	22	60 sec.	Fresh	3134
3	"	23	18 min.	"	3134
3	"	24	45 min.	"	3134
10	Human infant	50	1 min.	Fresh	3134
10	"	49	20 "	"	3134
8	Human	44	25 "	"	4415
9	"	45	25 "	"	3404
6	Pig	33	45 sec.	5 days on ice	3251 Not very definite
6	"	34	45 "	"	3134
6	"	35	20 min.	"	3134

TABLE 3
Aqueous Humor

No. of Specimen	Kind	No. of Plate	Time of Exposure	Condition of Specimen	Last Wave-length
4	Sheep	27	15 sec.	Fresh— kept 3 hours	2145 (very faint)
4	"	26	30 "	"	2145
4	"	25	45 "	"	2145
4	"	28	60 "	"	2145
7	Human	42	20 "		2573
7	"	43	40 "		2573

TABLE 4
Vitreous Humor

No. of Specimen	Kind	No. of Plate	Time of Exposure	Condition of Specimen	Last Wave-length
5	Pig	31	15 sec.	4 days on ice	2265
5	"	30	30 "	"	2313
5	"	32	1 min.	"	2265

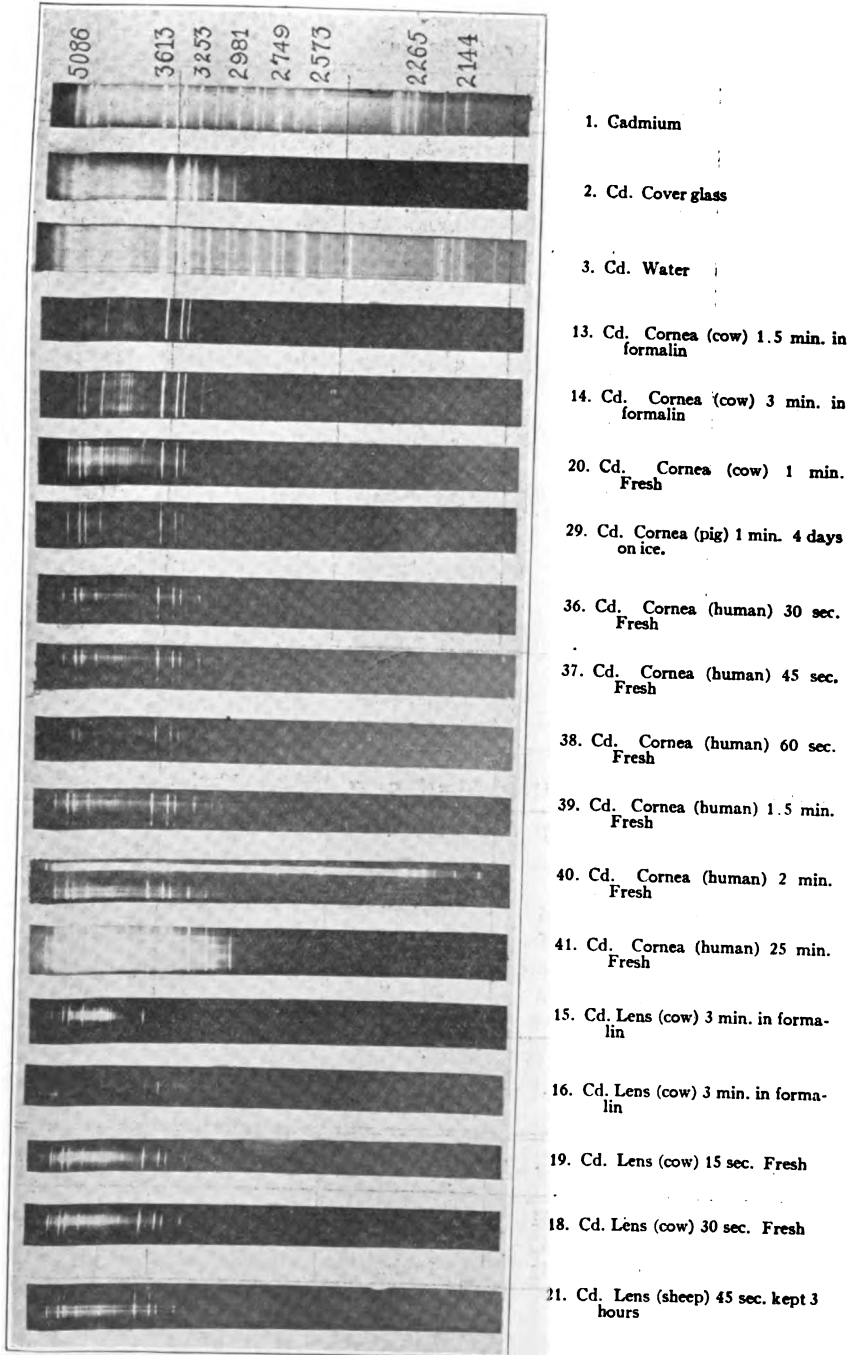
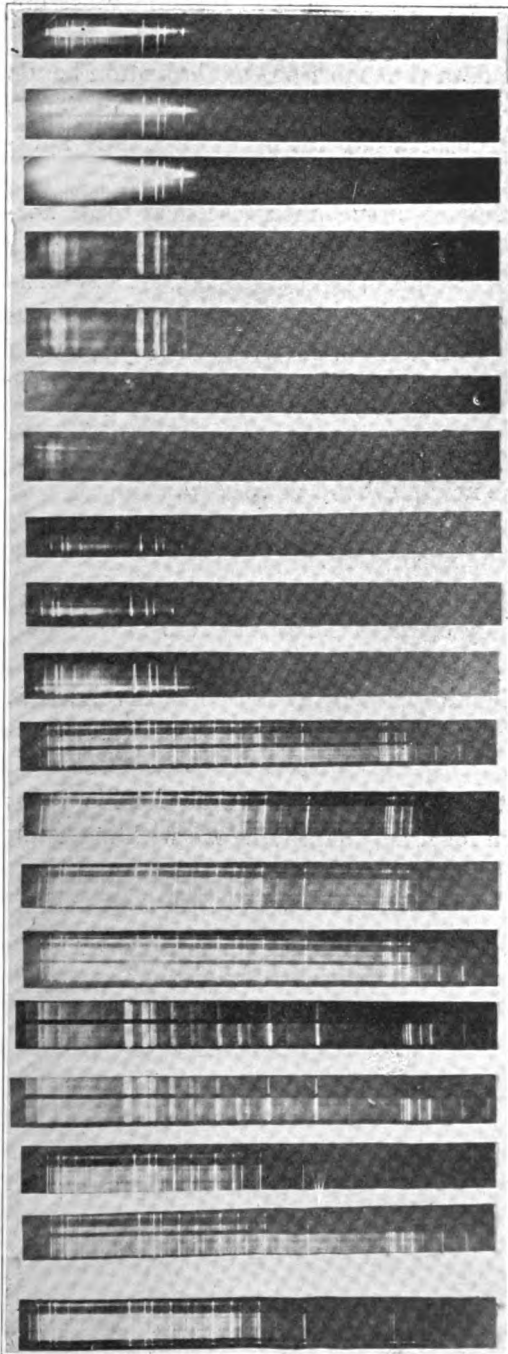

FIG. 2



- 22. Cd. Lens (sheep) 1 min. Fresh
- 23. Cd. Lens (sheep) 18 min. Fresh
- 24. Cd. Lens (sheep) 45 min. Fresh
- 50. Cd. Lens (human infant) 1 min. Fresh
- 49. Cd. Lens (human infant) 20 min. Fresh
- 44. Cd. Lens (human) 25 min.
- 45. Cd. Lens (human) 25 min.
- 33. Cd. Lens (pig) 45 sec. Kept 5 days on ice.
- 34. Cd. Lens (pig) 45 sec. Kept 5 days on ice.
- 35. Cd. Lens (pig) 20 min. Kept 5 days on ice.
- 27. Cd. Aqueous Humor (sheep) 15 sec.
- 26. Cd. Aqueous Humor (sheep) 30 sec.
- 25. Cd. Aqueous Humor (sheep) 45 sec.
- 28. Cd. Aqueous Humor (sheep) 1 min.
- 42. Cd. Aqueous Humor (human) 20 sec. Fresh
- 43. Cd. Aqueous Humor (human) 40 sec. Fresh
- 31. Cd. Vitreous Humor (pig) 15 sec. Kept 4 days on ice.
- 30. Cd. Vitreous Humor (pig) 30 sec. Kept 4 days on ice.
- 32. Cd. Vitreous Humor (pig) 1 min. Kept 4 days on ice.

FIG. 3

show on the plate if there was no line in the cadmium spectrum where the absorption began.

It can be seen from the data that most of the absorption bands begin rather abruptly, that is the region of partial absorption is not very great, as long exposures did not bring out many additional lines.

Although the aqueous humor of specimen 7 seemed to be normal, it is apparent from Table 3 that it was not. It seems very probable to suppose that it had absorbed additional salt as well as the posterior part of the eye and the lens. The cornea of specimen 7 (Table 1) seems to have been normal, or at least nearly so.

The following conclusions may be drawn from the foregoing data:

1. The combined tissues of the eye absorb the ultra-violet radiations up the neighborhood of $.3134\mu$.
2. The lens has the largest region of absorption.
3. Formalin changes the absorption.
4. Any injury or disease tending to increase the salt content in the eye radically changes the absorption.

Further, it might seem reasonable to suppose, although the data here given are scarcely definite enough to say conclusively, that the absorption in the animals' eyes does not differ radically from that in the human.

In conclusion, I wish to thank Dr. R. S. Minor for his help; Drs. L. D. and A. S. Green for kindly supplying me with material; and all others who made this work possible.

INSTRUMENT SECTION

A NEW PRINCIPLE AND ITS APPLICATION TO THE LUMMER-BRODHUN PHOTOMETER

BY
E. P. HYDE and F. E. CADY

With the development of different types of photometers from the 18th Century "shadow" form of Rumford through the Ritchie "wedge" and the Leeson-disk improvement of the Bunsen "grease spot," photometric accuracy increased until it reached what appeared to be the maximum in Lummer and Brodhun's contrast type of cube. This was some thirty years ago and the instrument is today quite generally accepted as the one capable of giving the best results where the highest accuracy is desired with the possible exception of those cases involving decided color differences. The secret of the sensitivity lies in the ability of the eye to detect small differences in contrast. While the principle and design of the instrument are well known to those engaged in regular photometric work it will be described for the benefit of others and in order to make the modifications more clear.

The cube, Fig. 1, is made of two triangular glass prisms ABC and ADC cemented together at their hypotenuse faces AC with canada balsam. At Aa , bc , de , the surface of one cube is cut away so that light from the right is reflected in the direction of sight, while light from the left is reflected out of the field of view. As a consequence the observer on looking in the eyepiece of the instrument sees a figure made up of two adjacent semicircles each containing a trapezoid.¹ In the position of balance or when the illuminations on the two sides of the photometer disk are equal, the two trapezoids stand out with equal sharpness from their surrounding backgrounds. If the photometer head is moved and thus thrown out of balance one of the trapezoids will tend to get darker and the other will tend to approach in brightness that of the surrounding background. A movement of the photometer

¹ Instruments made in this country use a segment of a circle in the place of the trapezoid.

head in the opposite direction will reverse this condition and make the other trapezoid less distinct. In the position sought for, the contrast between each trapezoid and the surrounding background is the same. This contrast results from the presence at *EA* and *FD* of two plain pieces of clear glass which by reason of surface reflection decrease the transmitted light by about 8 per cent.

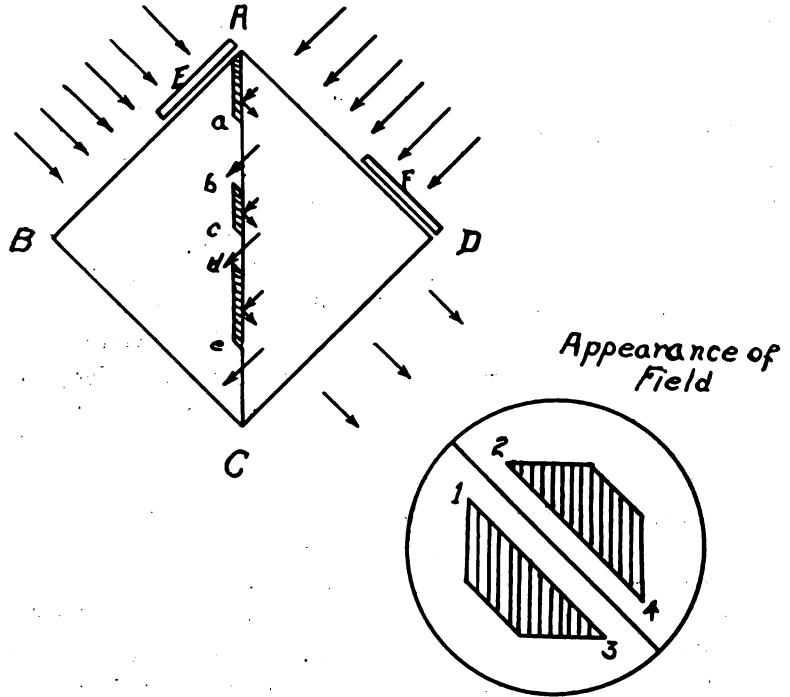

FIG. 1. Schematic diagram of Lummer and Brodhun Photometric Cube, Contrast Type.

These pieces may be removed if it is desired to dispense with the contrast principle and use the cube for a simple equality-of-brightness or match photometer.

It was while studying the Brace spectrophotometer that there occurred to one of the authors the possibility of increasing the accuracy of photometric settings by the introduction of a new principle. It may be recalled that in one form of the Brace spectrophotometer the photometric field is made up of three parts,

Fig. 2, the center receiving light from one source while the upper and lower portions receive it from the other source. In the condition of balance the field "B," which receives its light from the source S is of the same apparent brightness as the two fields "A" and "C" receiving light from the source R and which are of the same actual brightness if the instrument is in adjustment. If it is assumed that the eye can just detect a difference in brightness of 1% in a field of view of this kind, it is evident that there would be an apparent balance for all values of brightness of field "B" lying within $\pm 1\%$ of the brightness of "A" and "C." That is, the range of a setting would be $\pm 1\%$, or, in total, 2%.

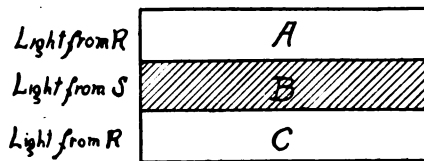

FIG. 2. Field of view in Brace Spectrophotometer

Suppose, now, that by some suitable optical means the brightness of field "C" were made definitely 1% less than the brightness of field "A." In a condition of balance the brightness of "B" obviously would now lie between the brightness of "A" and the brightness of "C" which has been made 1% less than the brightness of "A." For when "B" is in actual match with "A" it is, by hypothesis, 1% brighter than "C," and the difference in brightness between "B" and "C" would be detected. Similarly, where "B" is in actual match with the modified "C" it is 1% less bright than "A," and again the difference would be detected. Hence, with this modified field the range of error would be only 1% instead of 2% as in the original arrangement.

It is true that the center of balance is shifted from the brightness of "A" to a value $\frac{1}{2}\%$ less, but since for other obvious reasons the substitution method of measurement would always be employed this shift of $\frac{1}{2}\%$ offers no difficulty. It should be noted that this principle was subsequently used and described by

Pfund² in an article on a new photometer involving the use of mirrors.

Although this principle was thought of in connection with the Brace spectrophotometer it is of general application, and was first actually tried out in connection with the Lummer-Brodhun contrast photometer. Since with this instrument the condition of balance consists not in brightness equality but in equal brightness contrasts the application of the principle involves the establishment of unequal contrasts in different parts of the field. Thus if the contrast of the field 1-3 (Fig. 1) is made to decrease from 1 to 3, and that of the field 2-4 to increase from 2 to 4, by some chosen small amount, a resultant total field of view is obtained such that the range of balance is greatly reduced, as is apparent by a similar process of reasoning to that presented in the first case.

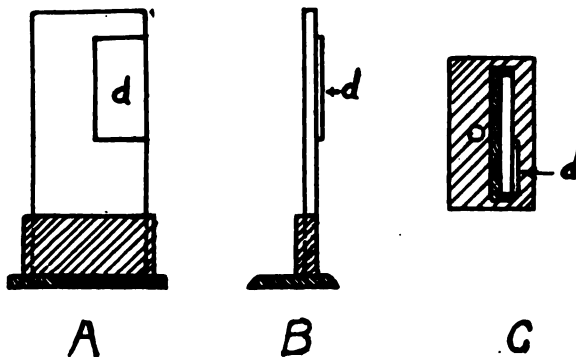

FIG. 3

A, B, C front, side and top view of enlarged strips showing attachment of small absorption piece, d

The practical difficulty of applying this principle to obtain a graduated contrast lies in the fact that the glass strips "E" and "F" absorb by reflection and any variation in thickness produces only negligible changes in the absorption and therefore in the contrast. This difficulty was overcome by enlarging the clear glass strips to cover the entire faces of the cube, and then attaching to these by canada balsam other strips of the same size as the original strips "E" and "F," but made of smoked glass, which would absorb in proportion to their thickness, see Fig. 3. By

² *Phys. Review* 4, p. 477, 1914.

making these strips wedge-shaped, a graded absorption and therefore a graded contrast could be obtained.

Moreover, by accomplishing the contrast in this way it is possible to make the average absorption, and, therefore, the average contrast any amount that might be desired, instead of having it determined by the reflection of clear glass strips which give a fixed absorption of about 8%. This led to another increase in sensibility. Lummer and Brodhun had found by experiment that 3½% contrast gave the most sensitive photometer, but they apparently thought of no easy way of accomplishing this, and satisfied themselves with the 8% contrast obtained by the clear glass strips. With the introduction of the scheme described above for getting graded contrast it was a simple matter to choose a density and thickness of smoked glass that would yield an average absorption of 3½% with the added feature of a properly chosen graded contrast.

Messrs. Franz Schmidt and Haensch of Berlin undertook to construct for us a photometer involving these two features, and delivered the instrument to us over ten years ago. Just what gradation in contrast was aimed at the authors have now forgotten. At that time some measurements were made using a photometric method to determine whether any gradation was present, but none was found. However, recent measurements using a much more sensitive method gave a difference in one direction of 0.7 per cent in one piece and in the opposite direction of 0.2 per cent in the other piece indicating an effort to have them comply with the principle. At the time of the latter measurements, readings were taken on six other pairs of low contrast strips, but in all these cases whatever variation was found was in the same direction from top to bottom or bottom to top on both strips and so would not show the application of the principle referred to. The absorption of these strips was such as to give a contrast of about 5 per cent. In spite of the lack of opposed variation in absorption, the instruments using these strips have shown a very much greater sensitivity than the ordinary type, doubtless due to the decreased contrast.

NELA RESEARCH LABORATORIES,
CLEVELAND, OHIO,
APRIL, 1922.

AN ELECTROMAGNETIC METHOD OF DETECTING
 MINUTE IRREGULARITIES IN CURVATURE OF
 SPHERES AND CYLINDERS AND OF CON-
 TROLLING THE OSCILLATIONS OF A
 MASS OF METAL SUSPENDED BY
 MEANS OF A TORSION FIBRE

BY
 ALEXANDER MARCUS

It is well known that a single unidirectional alternating magnetic field is equivalent to two constant fields revolving with equal angular velocities in opposite directions and it is commonly believed

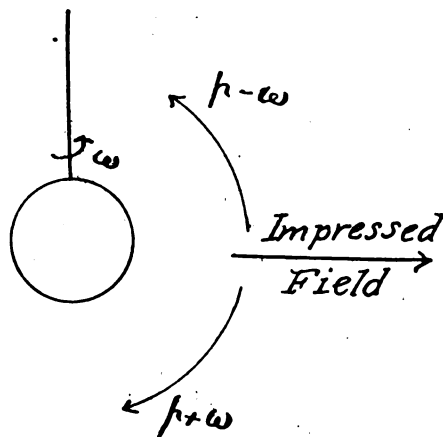

FIG. 1

that a coil of wire or a mass of metal placed in a uniform alternating field so that it can rotate will remain at rest if it happens to be at rest. The reason for this is that the two oppositely revolving fields which may be considered equivalent to the single impressed alternating field, induce two¹ symmetrical polyphase systems of currents of the

same frequency and amplitude. Therefore, the mechanical reactions between these currents and their corresponding fields are equal and opposite and the body experiences no resultant torque. If the body be given a start in either direction the opposite torques will no longer balance. For, suppose the body be given an angular velocity ω , and the angular velocities of the fields are p , and $-p$ respectively, then relative to the body one of the fields

¹ Steinmetz: A. C. Phenomena, 4th Ed., pp. 639-642.

will revolve with angular velocity $p-\omega$ and the other with angular velocity $p+\omega$. The two systems of induced currents now have frequencies proportional to $p-\omega$ and $p+\omega$ respectively and have different amplitudes. Therefore the mechanical reactions between the currents and the fields inducing them will no longer be equal and opposite. This is in essence the theory of the single-phase induction motor and explains why such a motor is not self-starting.

However, the writer has recently found in the course of an experiment with a copper ball suspended by means of a torsion fibre perpendicular to a uniform alternating magnetic field, that the ball will start to rotate even if it be perfectly stationary when the field is thrown on. It seemed to act like a self-starting induction motor, and inasmuch as according to well established electrodynamic theory such a motor cannot be self-starting, it became a matter of importance from theoretical as well as practical considerations to explain the existence of the extra torque. It was apparent that the starting torque was not an effect of the free electromagnetic oscillations produced by the sudden application of the field, for, as long as steady conditions in the field were maintained, the ball continued to oscillate about a definite new zero position. On repeating the experiment with both solid and hollow spheres and cylinders of different non-magnetic materials, it was found that the extra torque varied directly as the intensity of the "skin effect" for the different samples. Owing to the fact that all the spheres and cylinders had highly uniform curvature, it seemed difficult to attribute the effect to irregularities in curvature. Nevertheless this was assumed as a working hypothesis and two identical hollow circular cylinders were suspended alternately in the field. The observed deflections from the normal zero position were nearly equal for the two samples. When one of the samples was compressed so as to have an approximately elliptic cross-section, with the long axis about twice as long as the short one it gave a deflection many times larger than before distortion. Furthermore, the torque was always in such a direction as to tend to bring the long axis into coincidence with that of the field. A bronze ball-bearing was then suspended in the field and no starting torque was detected.

On linking together the two facts, first, that the torque on the asymmetric body increased with the "skin effect" and, second, that the torque always tended to make the body set its long axis in the direction of the uniform field the writer came to the conclusion that his discovery was only a new illustration of a fact already established but not generally known, namely:—

A conductor placed in a variable magnetic field tends to behave like a diamagnetic substance both in the way it disturbs the field and in the way it tends to move under the influence of that field.² The reason for this is that as the frequency of the impressed field rises the induced currents and magnetic fields tend to become concentrated in a thin layer near the surface and consequently the space within the body is traversed by a weaker field than before the introduction of the conductor. The higher the frequency the weaker will be the internal field. Indeed even in the case of iron the penetration of the field and currents may be so small at high frequency that the total flux through the space occupied by the body may be less than what it would be, were the iron removed. Dr. Louis Cohen³ has proved that in an iron cylinder of one centimeter radius subjected to an alternating magnetizing force having a frequency of a million cycles per second the total flux through the iron is only seven-tenths as much as the flux through that space before the introduction of the iron. It should also be remembered that whenever any body of a given permeability is immersed in a medium of a different permeability it will tend to move toward the region of lowest potential.⁴ For this reason a diamagnetic substance in a uniform magnetic field tends to turn its longest dimension in the direction of the field in contradiction to the statement frequently made that a diamagnetic substance turns its longest dimension across the field.

This diamagnetic behavior of a conductor in an alternating field has two practical applications. First, it affords a very sensitive method of detecting irregularities in curvature in metal spheres and cylinders and secondly, may serve as a means of

² J. J. Thomson: *Recent Researches in Electricity & Magnetism*, pp. 556-7.

³ *Calculation of Alternating Current Problems*, p. 38.

⁴ *Poynting & Thomson: Electricity & Magnetism*, pp. 257-259.

starting, stopping, and of controlling the oscillations of a mass of metal in experiments involving torsional oscillations of such a mass. In both of these applications a pair of Helmholtz coils will be found convenient for the production of a uniform field. The ball should be suspended midway between the coils. The mean distance between the centers of the latter should be about equal to the radius of the coils. If it be desired to test the ball for irregularities in curvature suspend it like a galvanometer coil with a small mirror attached to the suspension fibre for the purpose of observing the deflections of the ball. Before applying the field let the ball come to perfect rest and note the position on a scale of the reflected beam of light.

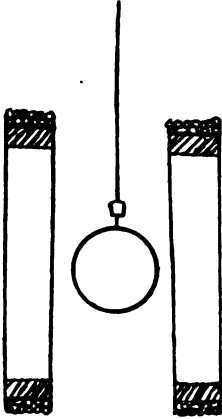

FIG. 2

Throw on a field of ordinary frequency and determine the new zero about which the oscillations occur. The sensitivity of the method depends upon the magnitude of the "skin effect" for different materials and hence varies directly as the square root of the frequency of the impressed field and inversely as the square root of the resistivity of the material. In this case as with galvanometers the sensitivity depends also upon the stiffness of the suspension fibre and upon the distance of the scale from the mirror. Since the torque on the ball depends upon the reaction between the impressed field and the currents induced by that field, it will vary directly as the square of the amplitude of the field.

The writer had a mass of pure copper cast into the shape of a ball about two inches in diameter. It was then turned down and polished to be as nearly spherical as possible. Measurements with a vernier caliper showed deviations of any single diameter measurement from the mean, of about one-half of one per cent. On suspending the ball in a field alternating with a frequency of sixty cycles per second and having an effective intensity of about thirty gauss the torque due to the diamagnetic behavior of the

ball gave a deflection of several centimeters on a scale about a meter from the mirror on the suspension.

The second practical application of the diamagnetic behavior of a conductor in an alternating field is to the control of the oscillations of a torsion pendulum. There are some electrodynamic experiments and others of a purely mechanical nature based on the use of the torsion pendulum and require that the motion shall be purely torsional. For example, from the decrement of the oscillations of a mass of metal vibrating as a torsion pendulum in a constant field, it is easy to compute the resistivity of the material. Or one may wish to determine the coefficients of viscosity and of rigidity of a substance in the form of a fibre by the method of the torsion pendulum. In such experiments, mechanical methods of starting the oscillations are quite apt to produce a variety of undesirable modes of vibration. Moreover, in order to avoid troubles due to tremors of the building, it is often necessary to mount the apparatus in places not readily accessible. The magnetic control of the oscillations makes it possible to start the motion and to establish any amplitude by the mere closing of a switch. The only extra apparatus required is a pair of field coils, the metal being placed midway between them. The increase or decrease in amplitude is produced by closing the switch when the motion is either in the same direction as the torque due to the field or in the opposite direction.

The writer wishes to acknowledge his indebtedness to Mr. Robert Dressler, Mechanician of the Department of Physics of the College of the City of New York for his valuable assistance in winding the field coils and in preparing some samples of metal for the experiments.

COLLEGE OF THE CITY OF NEW YORK

AN IMPROVED FORM OF NICHOLS RADIOMETER

BY
B. J. SPENCE

Abstract. The improvement over the customary forms of the Nichols radiometer consists in the reduction of the moment of inertia of the rotating system to such a value that the system has a period of eight seconds and a sensitivity equal to that of the thermopile or bolometer under their best working conditions. A comparison of the thermopile and the radiometer is given.

Numerous articles have been written dealing with the descriptions and relative merits of the radiometer, thermopile, and bolometer. Investigators who have used these instruments are familiar with the difficulties in the way of zero drift and fluctuations when the bolometer or thermopile is used in conjunction with the sensitive Thomson astatic galvanometer. The system of the astatic galvanometer is of small mass and moment of inertia. It is suspended by a fine quartz fibre in a relatively strong non uniform control field. Slight building vibrations or tremors cause a displacement of the system to other positions in the field of different intensity and directions giving rise to an amplification of these disturbances.

In the course of a study of some infra-red absorption spectra, using a grating of relatively large dispersion and resolving power and small energy of the radiating source, it was found necessary to abandon the thermopile and bolometer and attempt to develop a radiometer of the Nichols type which was free from the usual objection of the long period possessed by such an instrument.

The Nichols¹ radiometer as customarily constructed consists of a pair of mica vanes of comparatively large dimensions and mass fastened by fine glass rods to a glass staff with a mirror attached for purposes of observation. The system is suspended by a fine quartz fibre in a container pumped out to a pressure of approximately .02 mm Hg. Such a system has a large moment of inertia and when suspended by a sufficiently fine fibre to give a sensitivity of the order of magnitude similar to that of the bolometer,

¹ Ann. der Physik, 60, p. 402; 1897.

the period in some cases is 60 seconds or more. This constitutes the main objection to its use in spite of the remarkable stability and freedom from zero drift.

Accordingly, it seemed feasible to attempt to reduce the moment of inertia of the system and thus its period. To this end two strips of phosphor bronze ribbon .13 mm wide, .018 mm thick and 15 mm long were used for vanes. These strips were laid parallel about 4 mm apart and between them a finely drawn glass staff 40 mm long. The strips and glass staff were held together by finely drawn glass cross pieces by means of the smallest amount of shellac. To one end, which we shall designate as the tower end, was fastened a plane mirror of about 1 mm². One face of each strip was blackened with lamp black and alcohol containing a trace of shellac to cause the lamp black to adhere to the strips. The system was suspended from its upper end by means of a quartz fibre in a thick walled iron chamber cylindrical in shape and then pumped out to a pressure of approximately .02 mm Hg. The iron chamber, Fig. 1, mounted on a base with leveling screws had a bore of 25 mm, with 10 mm wall thickness and a length of 20 cm. Near the bottom and opposite each other were cut two windows. The one covered with quartz or rock salt was 3 mm wide and 20 mm long, the other for observation purposes and covered with glass was 5 mm wide and 35 mm long. The top of the chamber was provided with a ground iron plug and mercury seal. The plug served to suspend the system and by rotation to adjust the zero of the instrument. Near the top projected a tube carrying a carefully ground glass stop cock for evacuation purposes. The thick walled iron chamber was used to smooth out possible temperature fluctuations. As an extra precaution against temperature fluctuations the chamber was covered with a layer of felt 10 mm thick. The system thus protected was free from zero drift. It could be operated for a period of hours without a drift of more than 1 mm with a scale at 2.5 meters distant. In addition, it was free from fluctuations due to building disturbances.

It is difficult to make a rigorous comparison of the sensitivity of the radiometer with the bolometer or thermopile. It is cus-

tomary to state the sensitivity of those instruments in terms of the deflection produced by a candle at a meter distance and scale 1 meter distant. Incorrect conclusions may be drawn from such a rating. It does not indicate clearly the working sensitivity. Drift and fluctuations are not usually considered. The thing most desired in infra-red spectroscopy along with sensitivity is reliability of deflection.

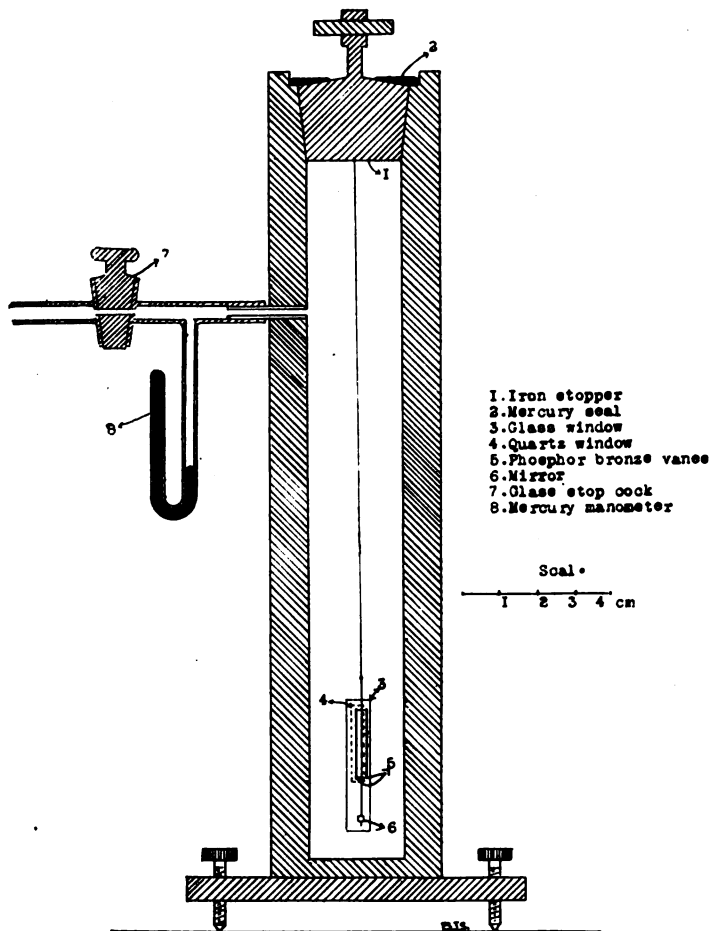

FIG. 1

A comparison was made of a bismuth-antimony bismuth-tin thermopile of 20 receiving junctions and 6 mm² receiving surface,

in series with a low resistance astatic galvanometer of 3×10^{-10} amperes sensibility, with a salt window radiometer of 2 mm^2 receiving surface and a period of six seconds. The comparison was made by subjecting the instruments in turn to the region of the spectrum near the sodium lines. The spectrum was produced by passing the radiation from a Nernst glower through an infra-red spectrometer. Deflections of approximately 50 mm were obtained in both cases. The radiometer deflection was free from zero drift and fluctuation.

In studying transmission spectra, it is customary to return to the zero reading after each deflection but with no zero drift this procedure is not necessary and the objection to the period of eight seconds as compared to a period of 1.5 seconds for the thermopile galvanometer combination is not serious.

In conclusion it may be stated that a radiometer of sensitivity equal to that of the thermopile or bolometer and a period of eight seconds has been developed. The instrument is free from zero drift and fluctuations that would ordinarily prohibit the use of the bolometer or thermopile. It is recognized that such an instrument has not been developed to obtain quantitative measurement of the small amounts of energy such as may be done with the bolometer.

The radiometer was developed in the course of an investigation for which funds were appropriated by the Rumford Committee of the American Academy of Arts and Sciences. Acknowledgment is hereby made of the courtesy of the Rumford Committee for the appropriation.

NORTHWESTERN UNIVERSITY
EVANSTON, ILLINOIS

A PORTABLE SEISMOMETER

BY

P. G. NUTTING

Vibrations in buildings due to nearby machinery or traffic constitute today a serious engineering problem. Troublesome noises are usually readily traceable to their sources through their pitch. Jars and vibrations are far more difficult to trace. Laboratory forms of seismographs, used in recording earthquake tremors, are of little service because of lack of portability. Stethoscopes and other forms of delicate sound detectors are ineffective in observing vibrations of slow period. The portable seismometer here described was designed for engineering purposes. It weighs but a few pounds and can safely withstand rather rough handling, yet is of ample sensibility for detecting and measuring all ordinary tremors.

The amplitudes to be measured lie in the range from 0.001 mm to 0.1 mm, the former being just perceptible to the hand, the latter being decidedly annoying. Preliminary determinations of amplitudes were made with a very simple form of seismometer assembled in a few minutes from two paper weights, two pieces of drill rod, a galvanometer mirror and a pocket flash lamp. Two strips of plate glass about 2 x 6 inches would serve quite as well as the two paper weights. The lower plate is placed upon the table or desk whose vibration is to be observed. Upon this plate are laid the two pieces of drill rod, 2 or 3 inches long, parallel with each other; then the upper plate placed face down on these as shown in Fig. 1.

A half inch galvanometer mirror is attached to the projecting end of one piece of rod, throwing on a wall the image of the filament of a flash lamp. The two rollers of drill rod or wire must of course be straight, round, and free from burrs. About 1 mm is a suitable diameter. Soft wire may be used if carefully rolled straight. Some drill rod requires grinding to give it a sufficiently circular section.

In operation the upper plate remains stationary while the lower moves with its support. The angular displacement of the reflected light beam is of course twice that of the roller carrying the mirror. Hence the relative linear displacement of light and test plate is in the same ratio as distance of light spot to radius of roller. A vibration of 0.005 mm (easily perceptible to the hand) will give an angular displacement of 0.01 to a roller of 0.5 mm radius and therefore will cause a displacement of 0.2 foot in a spot of light reflected 10 feet away. With rollers 0.2 mm in diameter the sensibility is 5 times as great. Frequencies at least as high as 100 per second are readily observed. Three or four components in a vibration may easily be detected.

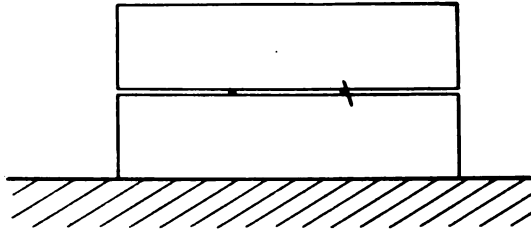

FIG. 1

Such a simple form of seismometer as that just described, although quite serviceable in horizontal positions, is quite useless for determining vertical components. The form of portable instrument finally developed is of very different design although essentially the same in principle (Fig. 2). A mass of lead supported by a diaphragm forms the stationary member while the case moves with the object with which it is in contact. Both rollers project and carry mirrors reflecting light from a miniature flash lamp upon an attached scale.

Fig. 2 shows the construction of the instrument in sectional diagram. The base is a hollow circular box 6 inches in diameter and 1 inch thick of light stiff material such as bakelite micarta. The interior is $\frac{1}{2}$ by 5 inches diameter. Between the halves of this box is clamped a circular diaphragm of similar material about $\frac{1}{32}$ inch in thickness, just sufficient to support the lead weight in zero position yet permit the housing to vibrate independently.

The lead inertia weight, 20 x 35 mm in section and 6 inches long, is attached at one end by a thin nut to the center of this diaphragm by means of a brass rod passing longitudinally through it. At the head of the lead weight is a brass block of the same section milled out on either side to carry the glass plates forming the bearing surfaces for the two rollers. On either side of the lead weight are heavy L shaped uprights of heavy strap brass forming the stem of the seismometer. These are firmly screwed to the top of the circular base and are also recessed near the top for bearing surfaces of plate glass at the top; each is screwed to a milled top plate of

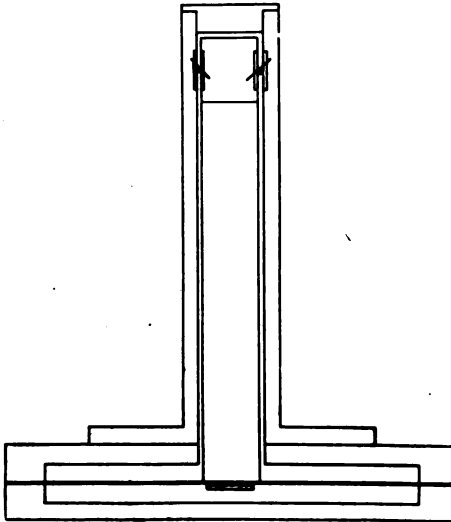

FIG. 2

heavy brass. An axial screw (not shown) through this top plate bearing against the top of the inertia bar serves to clamp its vibrations when the instrument is not in use.

The plate glass bearing surfaces must of course be set accurately parallel but if mounted in a fusible cement such as de Khotinsky's, their setting (before assembly) presents no great difficulty. Final adjustment of separation to the rollers is made by means of shims under the top ends of the brass side plates. When the adjustment is correct the rollers can just be slid into position with the fingers and will remain in place. The rollers may be quickly ad-

justed to parallel horizontal position by means of a steel scale or try square.

Hard steel rod such as drill rod is preferable for this instrument. Such stock is usually not quite round and must be ground between hard flat surfaces in a fixed position. A pair of fine carborundum stones clamped together with a wedge shaped opening between serves very well. A rod diameter of about 1 mm is preferable. The mirrors used are carefully selected half inch plane galvanometer mirrors attached by means of soft wax (to avoid distortion) to a thin light metal plate which is in turn cemented to the roller with fusible cement.

The optical system (not shown in Fig. 2) is simple and readily attached to the top plate. The illuminator is a small pocket flash lamp having the bulls eye lens replaced by a corrected lens forming an image of the lamp filament about 6 inches distant on a printed scale attached at the rear of the top of the instrument. The upward beam after reflection from the second roller mirror is reflected horizontally across the top of the instrument by means of a fixed mirror mounted at an angle of 45° . The beam being twice reflected by rotating mirrors, the sensibility of the portable type of seismometer is of course double that of the simple form shown in Fig. 1.

This instrument registers deflections of from 2 to 40 mm for vibrations ordinarily met with. It is readily portable and has been extensively used by laymen without being damaged. Used on a vertical wall (held in the hand by the stem) it reads as well as on a horizontal table surface, the shift of zero position being of no consequence in reading amplitudes. A simple form of photographic registering attachment has been designed, but this and other refinements have been found superfluous in ordinary engineering observations.

This instrument was designed at the request of the Westinghouse Electric and Manufacturing Co., East Pittsburgh, for their own use and was developed in the Research Laboratory of that company during the winter of 1920-21.

SCHENECTADY, N. Y.

AN INSTRUMENT FOR THE GAMMA RAY MEASUREMENT OF THE RADIUM CONTENT OF WEAKLY ACTIVE MATERIALS

BY
N. ERNEST DORSEY

For the determination of the radium content of a material of unknown composition the emanation method is the only one that can be considered as thoroughly satisfactory. This method, however, requires careful preliminary chemical treatment of the material, and consequently, is quite time consuming. On the contrary, a gamma ray measurement requires no chemical treatment whatever, is expeditious, and when satisfactory precision can be obtained, answers every purpose in all those cases in which it is known from other evidence that the material contains no radio-active material other than those belonging to the uranium-radium family.

The main difficulties encountered in the application of the gamma ray method to weakly active materials are (1) the securing of satisfactory sensitivity, (2) the determination of the correction for the volume distribution of the material, and (3) the determination of the correction for the absorption of the radiation by the material itself. If unlimited amounts of material are available, the first of these difficulties is not serious, and several modus operandi may be devised that will permit of a satisfactory determination of the two corrections mentioned. But the necessity of handling large amounts of material is in itself a disadvantage, and frequently only a small amount of material is available.

It was to meet these conditions that Walter Bothe¹ devised the double cylinder apparatus shown in Fig. 1. The material under test is placed in a thin walled test tube 2.6 cm in diameter, the latter is hermetically sealed and is placed in the cylinder B. The test tube is in all cases filled to a height of 12 cm. The cylinder B is of 3 mm brass covered externally with lead $\frac{1}{2}$ mm thick.

¹ Physik, Zeits., 16 p. 33-36, 1915.

It is 2.8 cm in internal diameter and is 16 cm long; it is carried by the leaf support, and the whole is insulated by the sulphur ball, S. In the figure, the radium standard is shown suspended in the center of B. The correction for the volume distribution is determined by a direct survey, a small tube of radium—essentially a point source of radiation—being placed successively at different points in B, and the corresponding rates of drift being determined. By a similar survey in which the radium tube is

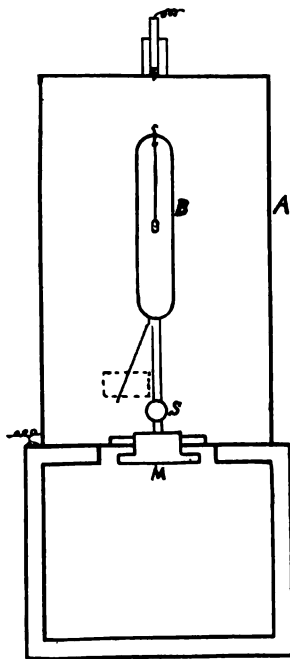

FIG. 1. Bothe's electroscope

buried at various points in fine sand contained in a test tube placed in B, the ratio of the resultant absorption of the radiation by the specimen to the absorption corresponding to the central point of B was determined. This, combined with the observed absorption by the material under test of the radiation from the small tube of radium buried in it so as to lie at the center of B, gives the correction for the absorption of the radiation by the material itself.

For an instrument of this type, Bothe's instrument can scarcely be improved upon from an electrical standpoint, and in the hands of a skilled experimenter should give excellent results. But it has two annoying disadvantages that make it unsuitable for routine work. (1) The opening of the electroscope for every change in the specimen, with its attendant disturbance of the leaf, change in the air in the electroscope, and changes in the convection currents arising from slight changes in the temperature of *B*, keeps the observer doubtful of the confidence that can be placed in the results, and necessitates numerous repetitions. (2) Any slight escape of emanation from the specimen, either from an imperfect sealing of the tube or from a soiling of its exterior with the material, will produce a marked effect upon the observed rate of drift. Consequently in the determination of the correction for absorption, the tube has to be carefully sealed and cleaned at every step. Furthermore, throughout these manipulations care must be taken to prevent the introduction of radium emanation into the air of the room containing the instrument.

It was to obviate these disadvantages that the instrument shown schematically in Fig. 2 was devised. It may be described as a triple cylinder, or reentrant, ionization chamber attached to an electroscope. As in Bothe's instrument, the material under test is sealed in a test tube and placed in the cylinder *B*. The specimen can be introduced and removed readily without disturbing in any way either the insulated system or the air contained in the instrument. If the joints of the instrument are reasonably tight, a small amount of emanation in the air of the room will produce but a minimum effect, and this effect will change in a fairly regular manner and can be readily eliminated from the observations. Consequently, if the material is first aerated in another room, the tube containing it may remain open during the determination of the correction for the absorption of the radiation by the material itself. This greatly facilitates the work. If the instrument were made strictly air tight, it would be unaffected by the presence of emanation in the air, and all the manipulations of the material could be carried out in the same room. These advantages have been secured at the expense of the sensitivity, the electrostatic

capacity of this instrument being much greater than that of Bothe's. But experiments with a tentative instrument of this type show that even with its reduced sensitivity it has a wide field of practical use.

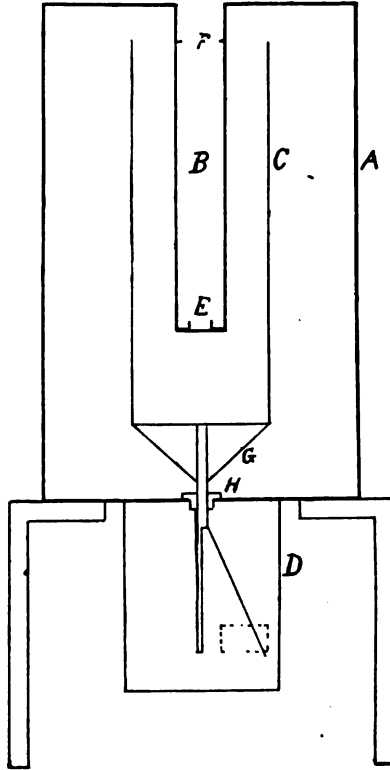

FIG. 2. Triple cylinder electroscope

In the tentative instrument, the cylinder A (Fig. 2) is 33 cm long and 21 cm in diameter; it is lined with lead 3 mm ($\frac{1}{8}$ in.) thick; lead of the same thickness is used in the construction of B, which is 21.5 cm long and 3.2 cm ($1\frac{1}{4}$ inch) in internal diameter. C is a cylinder of aluminum 0.3 mm thick, it is 25.4 cm long, 9 cm in diameter, and is open at both ends; it is supported below by a spider which is carried by a brass rod passing through and supported by the sulphur casting, H. Guy wires, G, give the spider

the necessary stiffness. The electroscope case, *D*, is of thin metal and is covered with felt; a heavy lead covered case would be preferable. The insulated system is charged by means of an insulated bell crank switch passing through the walls of *D* and not shown in the figure. In the bottom of *B* and coaxial with it is a pasteboard cylinder *E* about a centimeter long, and near the top of *B* is a pasteboard ring, *F*, 1 inch in internal diameter. These serve to center the tube of material and to lift it slightly above the bottom of *B*. The lead walls of *B* exert an excessive absorption upon the radiation from material situated extremely near them; consequently it is undesirable for the test tube containing the material to fit *B* snugly or to rest upon its bottom.

Corrections for the volume distribution of the material and for the absorption of the radiation by the material itself were determined in the general manner described by Bothe, except that the absorption surveys were made in the materials under test. As was to be expected, the transverse surveys show that while the curve showing the relative change in the effective absorption as the radium tube is moved along a radius is essentially the same for all sections throughout a relatively long central section of the column, it becomes much flatter as the ends of the column are approached. For these surveys, a small glass tube containing about 0.1 mg of radium was used.

The sensitivity of the instrument as used was about 2.8 divisions per second per milligram of radium. Specimens of radium concentrates (crude sulphates and carbonates) containing from 7 to 60 micrograms and small preparations containing as much as 300 micrograms of radium have been satisfactorily measured with it to a precision of at least one percent; and with considerable difficulty, duplicate specimens containing only 0.7 microgram were measured with a concordance of 2% and with a departure from the results of an emanation measurement of less than 10%. In one case, 4 samples of the same material dried to different extents were measured. One sample consisted of the material as received and contained over 50% of moisture; two contained about 7%; and one was dry. The actual radium contents of the specimens varied from 9 to 13 micrograms. The four determina-

tions thus made of the radium content per kilo of the dry material covered an extreme range of only 0.7%.

Selected one-inch test tubes were used and these were always filled to a height of 6 inches; this amount of material weighed between 40 and 110 g, depending upon its nature. After the desired amount of material had been placed in a tube, a thin cork disc to which was attached a wire hook was pushed down firmly against the material and was covered with a thick layer of melted sealing wax. After the tube has been sealed, it may be put aside until the radiation has reached its maximum value before a gamma ray measurement is made, or the maximum value of the radiation may be determined, by the well known method of extrapolation, from a series of measurements made at suitable intervals. In the latter case, the graphical method² described by the author some years ago is very convenient.

Assuming that 70 g. of material is used, a 5 microgram specimen will correspond to material containing about 7×10^{-8} gm Ra per g of material. The tentative instrument can therefore be satisfactorily used for materials containing between 7×10^{-8} and 4×10^{-6} g Ra per g, and can, though with difficulty, be used with a precision of at least 10% for material containing only 7×10^{-9} g Ra per g. The last is a little less than the radium content of ore containing 3% U_3O_8 .

Though the instrument is well suited to the determination of the radium content of concentrates, it is not suitable for work with low grade ores. For such work a more sensitive instrument, or one utilizing a larger amount of material is required.

WASHINGTON, D. C.

² Phys. Rev., (2), 14, p. 173, 1919.

THE EFFECT OF A PHOTO-ELECTRIC MATERIAL ON THE THERMO-ELECTRIC CURRENT IN HIGH VACUUM AUDION BULBS

BY
THEODORE W. CASE

The author in his work on barium and strontium photo-electric reactions, which were first noted in Audion bulbs of oxide-coated filament type,¹ has observed peculiar effects of these light reactive substances on the thermo-electric current when the active coating is somewhere between the plate and filament. The active material can be used as a light reactive grid and made to control the thermo-electric current flowing between filament and plate. The outstanding feature of placing an electro-positive photo-electric material near the plate is to very greatly reduce the thermo-electric current to the plate when the photo-electric material is in comparative darkness.

In this latter condition it requires considerable voltage to get any thermo-electric current to the plate. If light is allowed to fall on the photo-electric material, the effect is to instantly allow the thermo-electric current to pass to the plate, and consequently large changes in the thermo-electric current may be easily induced by moderate changes in light intensity. The observed increase of thermo-electric current for low light intensities is not of the trigger action variety, but the maximum current obtainable is limited by the possible thermionic current which would obtain if the light active substance were not present in the bulb; therefore the current obtainable cannot be directly proportional to all light intensities.

It is quite easy to construct cells of this type by including an oxide-coated filament opposite a plate in a vacuum bottle and introducing potassium distilled from a glass side tube upon a grid, or upon the glass wall of the bulb if it be made tubular between the filament and plate. In operation, the voltage between the

¹ Paper before A. E. S., April 21, 1921.

heated filament and plate (which latter is made positive) should be so adjusted that very little thermo-electric current flows when no light is on the potassium. Upon illuminating the potassium the increase of the thermo-electric current will be observed.

The author believes that this type of action warrants the trial of many substances, either conductors or non-conductors near the plate in the form of a grid, which may be thus studied for reaction to different types of radiation, including X-rays, with possibly very interesting results. Electro-negative elements should also be tried with a decrease of thermo-electric current looked for upon illumination.

CASE RESEARCH LABORATORY
AUBURN, NEW YORK

DIRECT CAPACITY MEASUREMENT

BY

GEORGE A. CAMPBELL

Synopsis: Direct capacity, direct admittance and direct impedance are defined as the branch constants of the particular direct network which is equivalent to any given electrical system. Typical methods of measuring these direct constants are described with especial reference to direct admittance; the substitution alternating current bridge method, due to Colpitts, is the preferred method, and for this suitable variable capacities and conductances are described, and shielding is recommended. Proposed methods are also described involving the introduction of electron tubes into the measuring set, which will reduce the measurement to a single setting or deflection. This gives an alternating current method which is comparable with Maxwell's single null-setting cyclical charge and discharge method. Special attention is drawn to Maxwell's remarkable method which is entirely ignored by at least most of the modern textbooks and handbooks.

The object of this paper is to emphasize the importance of direct capacity networks; to explain various methods of measuring direct capacities; and to advocate the use of the Colpitts substitution method which has been found preëminently satisfactory under the wide range of conditions arising in the communication field.

About thirty years ago telephone engineers substituted the so-called "mutual capacity" measurement for the established "grounded capacity" measurement; this was a distinct advance, since the transmission efficiency is more closely connected with mutual capacity than with grounded capacity. Mutual capacity, however, can give no information respecting crosstalk and accordingly, about twenty years ago, I introduced the measurement of "direct capacity" which enabled us to control crosstalk and to determine more completely how telephone circuits will behave under all possible connections.

For making these direct capacity measurements alternating currents of telephone frequencies were introduced so as to determine more exactly the effective value of the capacity in telephonic transmission, and to include the determination of the associated effective direct conductances which immediately assumed great importance upon the introduction of loading.

Telephone cables and other parts of the telephone plant present the problem of measuring capacities which are quite impossible to isolate, but which must be measured, just as they occur, in association with other capacities; and these associated capacities may be much larger than the particular direct capacity which it is necessary to accurately measure, and have admittances overwhelmingly larger than the direct conductance, which is often the most important quantity. This is the interesting problem of direct capacity measurement, and distinguishes it from ordinary capacity measurements where isolation of the capacity is secured, or at least assumed.

The substitution alternating current bridge method, suggested to me in 1902 by Mr. E. H. Colpitts as a modification of the potentiometer method, has been in general use by us ever since in all cases where accuracy and ease of manipulation are essential.

After first defining direct capacities and describing various methods for measuring them, this paper will explain how this may all be generalized so as to include both the capacity and conductance components of direct admittances, and the inductance and resistance components of direct impedances.¹

DEFINITION OF DIRECT CAPACITY

It is a familiar fact that two condensers of capacities C_1 , C_2 , when in parallel or in series, are equivalent to a single capacity $(C_1 + C_2)$ or $C_1 C_2 / (C_1 + C_2)$, respectively, directly connecting the two terminals. These equivalent capacities it is proposed to call direct capacities. The rules for determining them may be stated in a form having general applicability, as follows:

Rule 1. The direct capacity which is equivalent to capacities in parallel is equal to their sum.

Rule 2. The direct capacity between two terminals, which is equivalent to two capacities connecting these terminals to a concealed branch-point, is equal to the product of the two capacities divided by the total capacity terminating at the concealed branch-point, i.e., its grounded capacity.

¹ Proofs of the mathematical results included in the present paper will be supplied in an appendix which will be added to the reprint of the paper which is to appear in an early number of the "Bell System Technical Journal."

These rules may be used to determine the direct capacities of any network of condensers, with any number of accessible terminals and any number of concealed branch-points. Thus, all concealed branch-points may be initially considered to be accessible, and they are then eliminated one after another by applying these two rules; the final result is independent of the order in which the points are taken; all may, in fact, be eliminated simul-

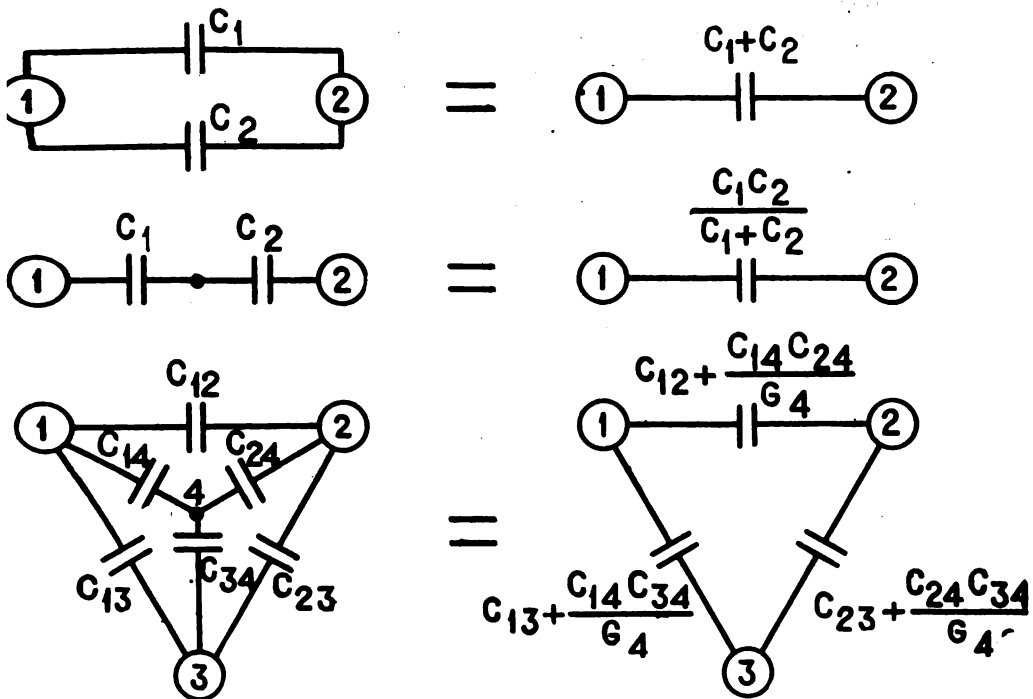

FIG. 1. Equivalent direct capacities. $G_4 = C_{14} + C_{24} + C_{34}$ = grounded capacity of branch-point 4

taneously by means of determinants;—a network of capacities, directly connecting the accessible terminals, without concealed branch-points or capacities in parallel, is the final result. Fig. 1 shows the two elementary cases of direct capacities and also, as an illustration of a more complicated system, the bridge circuit, with three corners 1, 2, 3 assumed to be accessible, and the fourth

inaccessible, or concealed. Generalizing, we have the following definition:

The direct capacities of an electrical system with n given accessible terminals are defined as the $n(n-1)/2$ capacities which, connected between each pair of terminals, will be the exact equivalent of the system in its external reaction upon any other electrical system with which it is associated only by conductive connections through the accessible terminals. The total direct capacity between any group of the terminals and all of the remaining accessible terminals, connected together, is called the grounded capacity of the group.

This definition of direct capacity presents the complete set of direct capacities as constituting an exact, symmetrical, realizable physical substitute for the given electrical system for all purposes, including practical applications. Direct capacities are Maxwell's "coefficients of mutual induction," but with the sign reversed, their number being increased so as to include a direct capacity between each pair of terminals.

In considering direct capacities we exclude any direct coupling, either magnetic or electric, from without with the interior of the electrical system, since we have no concern with its internal structure; we are restricted to its accessible, peripheral points or terminals; some care has been taken to emphasize this in the wording of the definition.

ADDITIVE PROPERTY OF DIRECT CAPACITIES

Connecting a capacity between two terminals adds that capacity to the direct capacity between these terminals, and leaves all other direct capacities unchanged. Connecting the terminals of two distinct electrical systems, in pairs, gives a system in which each direct capacity is the sum of the corresponding two direct capacities in the individual systems. Joining two terminals of a single electrical system to form a single terminal adds together the two direct capacities from the two merged terminals to any third terminal, and leaves all other direct capacities unchanged with the exception of the direct capacity between the two merged terminals, which becomes a short circuit. Combining the termi-

nals into any number of merged groups leaves the total direct capacity between any pair of groups unchanged, and short-circuits all direct capacities within each group.

These several statements of the additive property of direct capacities show the simple manner in which direct capacities are altered under some of the most important external operations which can be made with an electrical network, and explain, in part, the preëminent convenience of direct capacity networks.

Since the additive property of direct capacities is sufficient for explaining the different methods of measuring direct capacities we may now, without further general discussion of direct capacities, proceed to the description of the more important methods of measurement.

COLPITTS SUBSTITUTION BRIDGE METHOD, FIG. 2

The unknown direct capacity is shifted from one side of the bridge to the other, and the balance is restored by adjusting the capacity standard so as to shift back an equal amount of direct

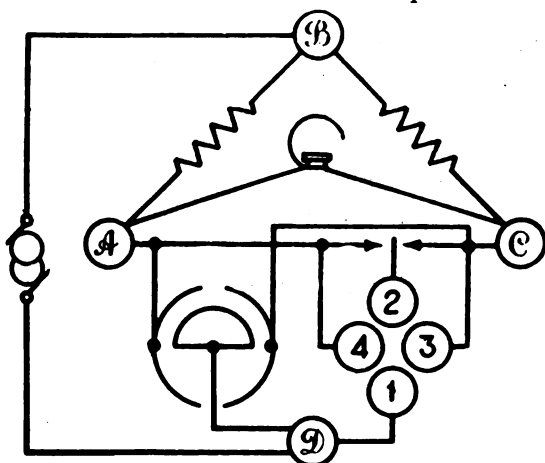

FIG. 2. Colpitts substitution bridge method for direct capacity

capacity. The method is therefore a substitution method, and the value of the bridge ratio is not involved. Both the standard and the unknown remain in the bridge for both settings, so that the method involves transposition rather than simple, ordinary substitution.

Details of the method as shown by Fig. 2 are as follows: To measure the direct capacity C_{12} between terminals 1 and 2 connect one terminal (1) to corner D of the bridge, and adjust for a balance with the other terminal (2) on corner A and then on C , while each and every one of the remaining accessible terminals (3, 4, . . .) of the electrical system is permanently connected during the two adjustments to either corner A or C . If the direct capacities in the standard condenser between corners A and D are C' , C'' in the two balances,

$$C_{12} = C'' - C',$$

and if the bridge ratio is unity,

$$C_{13} - C_{14} = C' + C'' - 2C^\circ$$

where C° is the standard condenser reading when the bridge alone is balanced.

Two settings are required by this method for an individual direct capacity measurement, but in the systematic measurement of all the direct capacities in a system the total number of settings tends to equal the total number of capacities, when this number becomes large. The number of settings may always be kept equal to the number of capacities by employing an equality bridge ratio, and using the expression for the direct capacity difference given above. The same remarks also hold for the group of direct capacities connecting any one terminal with all the other terminals.

In general, ground is placed upon corner C of the bridge, but is transferred to corner D , if it is connected to one terminal of the required direct capacity. The arbitrary distribution of the other terminals between corners A and C may be used to somewhat control the amount of standard capacity required; or it may be helpful in reducing interference from outside sources, when tests are made upon extended circuits. The grounded capacity of a terminal, or group of terminals, is measured by connecting the group to C , and all of the remaining terminals together to D .

The excess of one direct capacity C_{12} over another C_{14} is readily determined by connecting terminals 1 and 5 to corner D , terminals 3, 4, 7, 8, . . . to corner C or A , and then balance with

terminals 2 and 6 on *A* and *C*, respectively, and repeat, with their connections reversed.

The required direct capacity C_{12} is balanced against one of its associated direct capacities, augmented by a standard direct capacity C' , and the measurement is repeated with the required

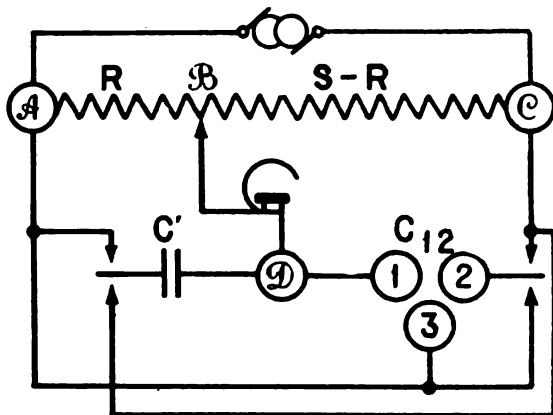

FIG. 3. Potentiometer method for direct capacity

POTENTIOMETER METHOD, FIG. 3

direct capacity and standard interchanged. Let R' , R'' be the resistance required in arm *AB* of the bridge for the first and second balance, then, S being the total slide wire resistance and G_1 the grounded capacity of terminal 1:

$$C_{12} = \frac{R'}{R''} C'$$

$$G_1 = \frac{S - R''}{R''} C'$$

This ratio method requires for the bridge a variable or slide wire resistance and a constant condenser, and it may be employed as an improvised bridge, when sufficient variable capacity is not available for the Colpitts method. Not being a substitution method, however, greater precautions are necessary for accurate results. There must be no initial direct capacity in arm *CD*, or a correction will be required. Possibly variable capacity ratio arms would be preferable to resistances.

NULL-IMPEDANCE BRIDGE METHOD FOR DIRECT CAPACITY, FIG. 4

Assuming that the electron tube supplies the means of obtaining an invariable true negative resistance, Fig. 4 shows a method which determines any individual direct capacity from a single bridge setting. The bridge arms are replaced by a Y network made up of two resistances R , R and a negative resistance $-R/2$; the Y has then a null-impedance between corner B and corners A , C connected together. The three terminals 1, 2, 3 of the network to be measured are connected to corners D , C , B and a balance obtained by adjusting the variable standard condenser C' .

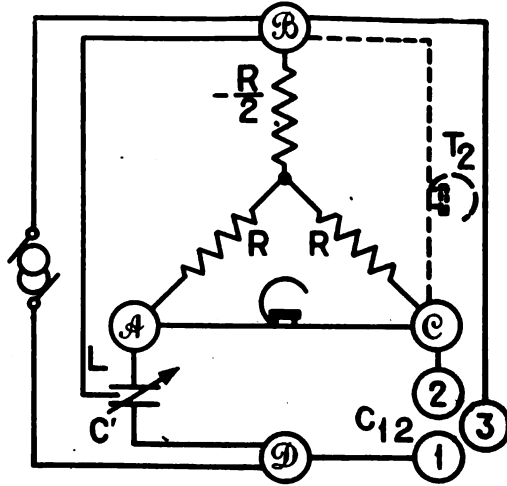

FIG. 4. Null-impedance bridge method for direct capacity

Then $C_{12} = C'$ regardless of the direct capacities associated with C_{12} and C' , since these capacities either are short-circuited between corners B , A or B , C or are between corners B , D and thus outside of the bridge.

Correct adjustment of the negative resistance may be checked by observing whether there is silence in telephone T_2 after the balance has been obtained. Assuming invariable negative resistance, this test need be made only when the bridge is set up, or there is a change in frequency. The bridge may be given any ratio Z_1/Z_2 by employing a Y made up of impedances Z_1 , Z_2 , and $-Z_1Z_2/(Z_1+Z_2)$.

MAXWELL DISCHARGE METHOD,² FIG. 5

Connect the terminals between which the direct capacity C_{12} is required, to A , B and the remaining accessible terminals of this electrical system to D . The adjustable standard capacity is C' and any associated direct capacities in this standard are shown as C'' , C''' . If C_{12} is a direct capacity to ground, interchange C' and C_{12} . Balancing involves the following repeated cycle of operations:

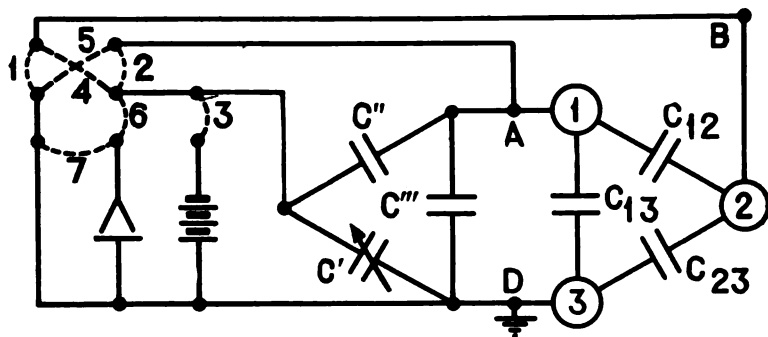

FIG. 5. Maxwell discharge method for direct capacity

1. Make connections 1, 2, 3 and 7 for an instant (thus charging C_{12} , C_{13} , C''' , C' and discharging the electrometer).
2. Make connections 4, 5 and then 6 (to discharge condensers C_{12} , C''' , mix charges of C_{12} , C' with polarities opposed and connect electrometer).
3. Adjust C' to reduce the electrometer deflection when the cycle is again repeated.

When a null deflection is obtained $C_{12} = C'$; the required direct capacity is equal to the standard direct capacity irrespective of the magnitudes of the four associated direct capacities. If all capacities are free of leakage and absorption, this remarkable method accurately compares two direct capacities by means of a single null setting, and it requires the irreducible minimum amount of apparatus.

² Electricity and Magnetism, v. 1, p. 350, (ed. 1892).

BALANCED-TERMINAL CAPACITY MEASUREMENT, FIG. 6

This is defined as the direct capacity between two given terminals with all other terminals left floating and ignored, after a hypothetical redistribution of the total direct capacity from the given pair of terminals to every third terminal which balances the two sides of the pair. The balanced-terminal capacity, as thus defined, is equal to the direct capacity between the pair augmented by one-quarter of the grounded capacity of the pair, neither of which is changed by the assumed method of balancing.

As illustrated in Fig. 6, terminals 1, 2 are the given pair and terminal 3 includes all others, assumed to be connected together. A bridge ratio of unity is employed, and the entire bridge is

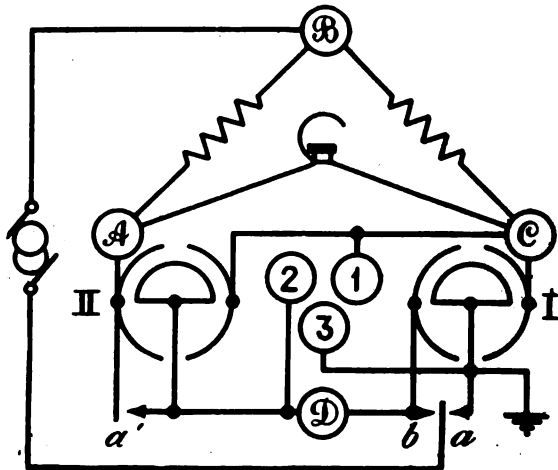

FIG. 6. Bridge for determining hypothetical capacity between two terminals with other terminals balanced and ignored

shielded from ground with the exception of corners *C*, *D* which are initially balanced to ground within the range of variable condenser *I*. The following two successive balances are made:

(1) With contacts *a*, *a'* closed and *b* open, balance is secured by varying condenser *I* (the total capacity of which is constant) giving the reading *C'* for its direct capacity in parallel with terminals 1, 3.

(2) With contacts a , a' open and b closed, balance is obtained by varying condenser II, obtaining the reading C'' for its direct capacity in AD .

If C_o' , C_o'' are the corresponding readings without the network, the balanced-terminal capacity C_b and the grounded capacity unbalance of the given pair of terminals are:

$$C_b = 2(C'' - C_o'')$$

$$G_2 - G_1 = 2(C' - C_o')$$

Any failure to adjust condenser I to perfectly balance the given pair of terminals, will decrease the measured capacity C_b . This fact may be utilized to measure the capacity with the second bridge arrangement alone, (contacts a , a' open and b closed) by adjusting condenser I so as to make the reading C'' of condenser II a maximum. This procedure presents no difficulty, since the correct setting for condenser I lies midway between its two possible settings for a balance with any given setting of condenser II; furthermore, C'' is not sensitive to small deviations from a true balance in C' .

Balanced-terminal capacity is of practical importance as a measure of the transmission efficiency to be expected from a metallic circuit, if it is subsequently transposed so as to balance it to every other conductor. In practice, when the unbalance of the section of open wire or cable pair, which is being measured, is relatively small, it is sufficient to set condenser I, once for all, to balance the bridge itself and ignore the unbalance of the pair. This favors an unbalanced pair, however, by the amount $(G_2 - G_1)^2 / 4(G_{12} + G_{CD})$ where $G_{12} + G_{CD}$ is the grounded capacity of the pair augmented by that of the bridge. For rapid working, condenser II is graduated to read $2C''$ and by auxiliary adjustment C_o'' is made zero, so that the required capacity is read directly from the balance.

ADDITIONAL METHODS OF MEASURING DIRECT CAPACITY

Measurement of the capacity between the terminals, taken in pairs with all the remaining terminals left insulated or floating, gives $n(n-1)/2$ independent results, from which all the direct capacities may be derived by calculation of certain determinants.

Practically, however, we are in general interested in determining individual direct capacities from the smallest possible number of measurements, and the first step is naturally to connect all of the remaining conductors together, so as to reduce the system to two direct capacities in addition to the one the value of which is required. Three measurements are then the maximum number required, and we know that two, or even one, is sufficient if particular devices are employed.

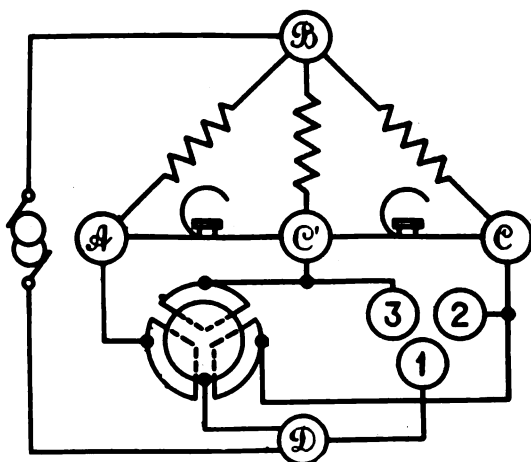

FIG. 7. Double bridge for direct capacity

The three measurement method of determining direct capacities from the grounded capacities of the two terminals taken separately G_1 , G_2 , and together G_{12} , is given by Maxwell.³

$$C_{12} = \frac{1}{2}(G_1 + G_2 - G_{12}) \\ = \frac{1}{2}C'''$$

if $G_1 = C'$, $G_{12} = C' + C''$, and $G_2 = C'' + C'''$; which indicates a method by which large grounded capacities can be balanced against three variable capacities, only one of which need be calibrated, and that one need be no larger than the required direct capacity.

Two-setting methods, as illustrated by the Colpitts and potentiometer methods, rest upon the possibility of connecting one

³ Ibid., p. 110.

of the associated direct capacities between opposite corners of the bridge where it is without influence on the balance, and not altering any associated direct capacity introduced into the working arms of the bridge. Numerous variations of these methods have been considered which may present advantages under special circumstances. Thus, if conductors 1, 2, 3 of Fig. 7 are in commercial operation, and it is not permissible to directly connect two of them together, a double bridge might be employed with a testing frequency differing from that of operation. A telephone is shown for each ear, and a constant total direct capacity is divided between the three branches in the proportion required to silence both telephones.

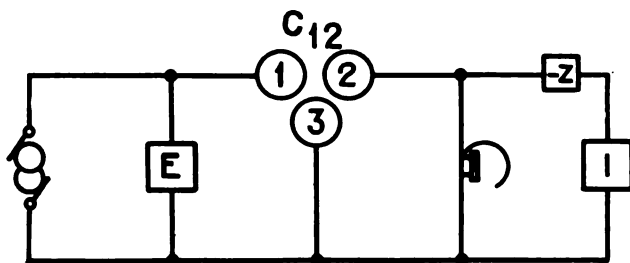

FIG. 8. Ammeter circuit for determining direct capacity

One-setting methods attained ideal simplicity in the Maxwell discharge method, but we found it necessary to use alternating current methods, and here negative resistances make a one-setting method at least theoretically possible, as explained above. Of possible variations it will be sufficient to refer to the ammeter method Fig. 8. Terminals 1 and 2 of the required direct capacity C_{12} are connected to the voltmeter and ammeter terminals, respectively, and all other terminals go to the junction point at 3. Then

$$C_{12} = \frac{I}{2\pi f E}$$

provided the ammeter actually has negligible impedance. The method is well adapted for rapid commercial testing. The ammeter impedance may be reduced to zero by a variable negative

impedance device ($-Z$), adjusted to reduce the shunted telephone to silence.

SHIELDING

In the discussion of the bridge, it has been assumed that the several pieces of apparatus forming the six branches of the bridge have no mutual electrical or magnetic reaction upon each other, except as indicated. In general, however, a balance will be upset by changes in position of the pieces of apparatus, or even by movements of the observer himself, whereas these motions cannot affect any of the mutual reactions which have been explicitly considered. The skillful experimenter, understanding how these variations are produced by the extended electric and magnetic fields, will anticipate this trouble and take the necessary precautions, possibly without slowing down his rate of progress.

Where hundreds of thousands of measurements are to be made, however, substantial savings are effected by arranging the bridge so that reliable measurements can be made by unskilled observers, and here it is necessary to shield the bridge so that any possible movements of the observer and of the apparatus will not affect the results. Magnetic fields of transformers are minimized by using toroidal coils with iron cases. Electrostatic fields are shielded by copper cases; the principles of shielding were explained in an earlier paper,⁴ Fig. 13 of this paper showing the complete shielding of the balance as constructed for the measurement of direct capacity by the Colpitts method. Over five million capacity and conductance measurements have been made with the shielded capacity and conductance bridge and in a forthcoming paper Mr. G. A. Anderegg will give details of actual construction of apparatus and of methods of operation as well as some actual representative results.

DIRECT ADMITTANCE MEASUREMENTS

For simplicity, the preceding definitions and methods of measurement have been described in terms of capacity, but everything may be generalized, with minor changes only, for the definition and measurement of direct admittances with their capacity and

⁴ The Shielded Balance, *El. W.*, 43, 1904, (647-649).

conductance components. The essential apparatus change is the addition, in parallel with the variable capacity standards employed, of a variable conductance standard, which shifts direct conductance from one side of the bridge to the other, without changing the total reactance and conductance in the two sides of the bridge. This may be practically realized in a great variety of ways as regards details, which it will suffice to illustrate by Fig. 9, where C' , C'' , C''' , G' , G'' , indicate the continuously variable capacity and conductance standards with enough step-by-step extensions to secure any desired range.

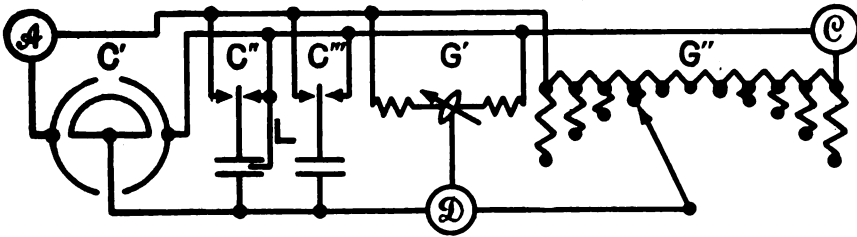

FIG. 9. Variable direct conductance and capacity standard for direct admittance bridge

For the continuously variable conductance standard a slide wire is represented, with a slider made up of two hyperbolic arcs so proportioned that, as the slider is moved uniformly in a given oblique direction, conductance is added uniformly on the left and just enough of the wire is short-circuited to produce an equal conductance decrease on the other side. The arcs are portions of the hyperbola $xy = (L^2 - S^2)/4$, where L , S are the total length of the wire and of the portion to be traversed by the slider, and the coordinate axes are the slide wire and the direction of the motion of the slider as oblique asymptotic axes. $L = GS/g = 4G/\rho(G^2 - g^2)$, where G is the total conductance and $(G \pm g)/2$ the limiting direct conductances on either side.

If an ordinary slider replaces the hyperbolic arc slider, and the scale reading is made non-uniform so as to give one-half of the difference between the direct conductances A to D and C to D , the conductance standard will still give absolutely correct results

with the Colpitts method, provided the bridge ratio is unity. This simplification in connection with the balancing capacity I of Fig. 6 would, however, not be strictly allowable. For improvised testing we have found it sufficient to use two equal resistances (R) with a dial resistance (r) in series with one of them, and take the defect of conductance introduced by the dial resistance as equal to r/R^2 or to $10^{-2}r$, $10^{-1}r$, r , micromho according as R was made 10 000, 3 162, or 1 000 ohms.

For a step-by-step conductance standard, Fig. 9 shows a set of ten equal resistances, connected in series between corners A , C , to the junction points of which there is connected a parabolic fringe of resistances, the largest of which is 2.5 times each of the ten resistances. With this arrangement the direct conductance in AD may be adjusted by ten equal steps, beginning with zero, while the conductance in CD is decreased by equal amounts to zero. The total resistance required for this conductance standard is only $21/25$ of the resistance required to make a single isolated conductance equal to one of the ten conductance steps; the ratio may be reduced to $1/2$ by doubling the number of contacts, and using one fringe resistance for all positions. Resistance may be still further economized by using as high a total conductance as is permissible in the bridge, and securing the required shift in conductance from a small central portion of the parabolic fringe.

Fig. 9 shows the variable capacity standards as well as the variable conductance standards and a few practical points connected with the capacity standards may be mentioned here.

The revolving air condenser standard has two fixed plates connected to A and C , so that the capacity will increase as rapidly on one side as it decreases on the other side. Since perfect constancy of the total capacity is not to be expected, on account of lack of perfect mechanical uniformity, the revolving condenser should be calibrated to read one-half of the difference between the capacities on the two sides, as explained above in connection with conductance. The capacity sections employed to extend the range of the revolving condenser include both air condensers

C'' and mica condensers C''' , the latter being calibrated by means of the air condensers and the conductance standard.

A novel feature of our standard air condensers is a third terminal called the leakage terminal, and indicated at L in Figs. 4, 9. Attached to it are plates so arranged that all leakages either over, or through, the dielectric supports from either of the two main terminals, must pass to the leakage terminal. There can be no leakage directly from one of the main terminals to the other. There is thus no phase angle defect in the standard direct capacity due to leakage, and that due to dielectric hysteresis in the insulating material is reduced to a negligible amount by extending the leakage plates beyond the dielectric, so as to intercept practically all lines of induction passing through any support. This leakage terminal is connected to corner C of the bridge; in the revolving condensers, it is one of the fixed plates.

DIRECT IMPEDANCE MEASUREMENTS

The reciprocal of a direct admittance is naturally termed a direct impedance; substituting impedance for capacity, the definition of direct capacity, given above, becomes the definition of direct impedance. The complete set of direct impedances constitute an exact, symmetrical, physical substitute for any given electrical system. Direct impedances are often, in whole or in part, the most convenient constants since many electrical networks are made up of, or approximate to, directly connected resistances and inductances. To make direct impedance measurements which will not involve the calculation of reciprocals, we naturally employ inductance and resistance standards in series, the associated direct impedances being eliminated as with direct capacities.

CONCLUSION

It has been necessary to preface the description of methods of measuring direct capacities by definitions and a brief discussion, since direct capacities receive but scant attention in textbooks and handbooks. By presenting direct capacities, direct admittances, and direct impedances as alternative methods of stating the constants of the same direct network, employed as an equiva-

lent substitute for any given electrical system, it is believed the discussion and measurement of networks has been simplified. In another paper the terminology for admittances and impedances will be still further considered, together with their analytical correlation.

DEPARTMENT OF DEVELOPMENT & RESEARCH,
AMERICAN TELEPHONE & TELEGRAPH COMPANY,
JUNE 10, 1922.

NOTICES

PRELIMINARY REPORT OF COMMITTEE OF THE OPTICAL SOCIETY OF AMERICA ON THE PROPOSED ENGLISH TRANSLATION OF HELMHOLTZ'S PHYSIOLOGICAL OPTICS

COLUMBIA UNIVERSITY, New York, N. Y., June 1, 1922

To the President of the Optical Society of America:

Dear Sir: The Committee appointed by the Council of the Optical Society of America to make arrangements for bringing out an English translation of Helmholtz's "Handbuch der physiologischen Optik" begs to submit the following preliminary report showing the progress of this project up to the present time.

After an extensive canvass of the situation, partly by advertisements in various journals but chiefly by direct correspondence with a large number of prominent scholars and scientists, for example, members of the Optical Society and of the Physical Society, besides psychologists, physiologists, ophthalmologists, oculists, etc., who from different angles and in different degrees might be presumed to be interested in the publication of an English version of this great treatise on physiological optics, the Committee finds that there is a very decided consensus of opinion favorable to going ahead with this enterprise. It is true that a few persons have expressed some doubt as to whether this book which admittedly ranks as one of the classics in science is sufficiently modern to be worth while; but the answer to that objection seemed to be that the third edition at any rate had been brought completely up to date a little more than a decade ago and that it was hardly to be supposed that the permanent value of this authoritative work had been seriously impaired by recent advancements in science, important as these may have been in some instances. However, for this and other reasons the opinion was practically unanimous that the third and, so to speak, definitive edition, edited by Gullstrand, von Kries, and Nagel, and published by Leopold Voss in Leipzig in 1910, was the only one to be considered for reproduction in English.

Accordingly, the Committee proceeded immediately to negotiate with Herr Leopold Voss about obtaining the rights of translation of the third edition in English. He responded to these overtures in a most generous and cordial spirit; and the outcome was that the Committee purchased these rights for the Optical Society at an extremely reasonable price. Herr Voss has also offered to sell the electrotype plates for the engravings and illustrations at a fair figure. The Committee has this offer still under consideration.

Estimates have been obtained from the printers of the cost of manufacturing one thousand copies of the third edition, perhaps in two volumes instead of in three as in the German edition. With additional incidental and unavoidable expenses the total cost will probably amount to ten thousand dollars. The Committee is reliably informed that it is not unreasonable to suppose that about five hundred copies can be disposed of to libraries and institutions in this country and in Great Britain and her dominions. It is fair to assume that an equal number of copies will be sold to individuals, chiefly scholars and professional men, both here and abroad. The retail price of the complete work will be at least \$15 per copy. The Committee has received already a little more

than \$1000 in advance subscriptions and contributions; and there is at least a possibility of one or two large contributions which may aggregate as much as \$1000 more.

As a purely business proposition it might be easily possible to get a reliable firm of publishers to take the work off our hands. Some tentative proposals of this kind have been under consideration. However, the Committee is disposed to think that it will be better for the Optical Society to undertake this business alone and to retain complete control.

In brief the Committee is persuaded that this task can and ought to be brought now to a successful completion, and they have every intention of doing so. Several competent scholars have offered to aid in the work of translation and this work has now been actually begun; but additional helpers are needed, and above all additional contributions are needed. The responsible editors should be chosen without delay. Neither the editors nor their assistants in the work of translation will receive any pecuniary compensation for their labors.

Appended to this report is a complete list of subscribers at the present time. One or two of these subscriptions were for fifty dollars but most of them averaged about fifteen dollars. Anyone subscribing as much as fifteen dollars will be entitled to receive a complete copy of the English edition when published but it is not necessary to send the money in advance. Subscriptions or orders should be sent to Adolph Lomb, Esq., 635 Saint Paul Street, Rochester, N. Y.

The list below contains also the "starred" names of those who are helping to prepare the English translation. The chairman of the Committee would be glad to know of other competent persons who might be willing to contribute in this most serviceable way.

Respectfully,

ADOLPH LOMB,
JAMES P. C. SOUTHALL, *Chairman*,
LEONARD T. TROLAND.

LIST

The following is a complete list of actual subscribers up to June 1, 1922, most of whom have already paid their subscriptions. "Starred" names indicate those who have offered to help with the work of translation.

C. G. Abbot	E. L. Elliott
American Philosophical Society	Samuel W. Fernberger
Adelbert Ames, Jr.	C. E. Ferree
J. A. Andrews	Wm. S. Foster
Roswell P. Angier	C. W. Frederick
Wm. L. Benedict	Wm. Gaertner
Conrad Berens, Jr.	*Henry S. Gradle
Wilfrid Blackham	Julia A. Greaves
E. V. L. Brown (for Eye Dept., University of Illinois)	Joseph Hagerty
Bryn Mawr College Library (C. E. Ferree)	G. E. Hale
J. McKeen Cattell	*Otto G. Haussmann
Cheney Brothers (per Frank Cheney, jr.)	H. L. Hollingworth
Colorado University Library	T. B. Holloway
Henry Crew	*Davenport Hooker
A. Jay Cross	Lucien Howe
John H. Darling	Illuminating Engineering Society (per C. L. Law)
*M. Dresbach	James Jerome Hill Reference Library
Gano Dunn	M. E. Javitz
	Kansas University Library

C. H. Kerr	Thomas Hall Shastid
Edward H. Kraus	John S. Shearer
*Wm. Kunerth	Clark W. Sloan
George F. Kunz	Admiral Smith
Walter B. Lancaster	Francis H. Smith
*Henry Laurens	*James P. C. Southall
Adolph Lomb	C. M. Sparrow
Los Angeles School of Optometry (per Wm. M. Ketchum)	W. Leconte Stevens
M. Luckiesh	Swarthmore College Library (per J. A. Miller)
Theodore Lyman	Syracuse University Medical Library (per F. W. Marlowe)
Thomas McBurnie	Arthur H. Thomas
McGill University Library	Elihu Thomson
Michigan University Library	Richard C. Tolman
Minnesota University Library	L. T. Troland
*G. W. Moffitt	Vassar College Library
Mount Wilson Observatory (G. E. Hale)	*E. J. Wall
Munsell Color Company	Howard C. Warren
National Research Council (R. M. Yerkes)	E. W. Washburn
Nela Park Research Laboratory Library (F. E. Cady)	John E. Weeks
New Jersey Zinc Company (per Henry Green)	*L. D. Weld
Ohio State University Library	*W. Weniger
Gilbert H. Palen	Western Electric Company Library (per E. H. Calpitto)
T. P. Pendleton	W. H. Wilmer
Ernest Petry	Wisconsin University Library
Pittsburgh Plate Glass Co.	Claude Wolcott
C. A. Proctor	F. A. Woll
M. F. Pupin	Yale University Library (per James R. Angell)
Rice Institute Library	W. G. Young
Wm. Lispenard Robb	Alexander Ziwet
Rochester University Library	Max Zwillinger
Dunbar D. Scott	

CORRECTIONS

The following changes should be made on page 360 of this volume.

Line Two:

In the expression $\phi (1 - \phi) F$ delete the first ϕ

Equation 34:

Delete the ϕ in the denominator

Equation 36:

Last term should read 19.8 instead of 21.

OPTICAL SOCIETY OF AMERICA**EXHIBIT OF OPTICAL INSTRUMENTS AND APPARATUS
NATIONAL BUREAU OF STANDARDS**

Oct. 26-28, 1922

Arrangements are now being completed for the exhibit of optical instruments and apparatus to be held at the National Bureau of Standards, Washington, in connection with the annual meeting of the Optical Society of America, Oct. 26-28, 1922.

The leading manufacturers of optical equipment have already signified their intention of participating. However, the exhibit will not be limited to standard commercial types. Individuals and research laboratories are also invited to exhibit special research apparatus. Brief descriptions of instruments and their purposes supplied by the exhibitors will be printed in the program and published later in the minutes of the meeting in the *JOURNAL OF THE OPTICAL SOCIETY*. The exhibit of new apparatus will thus constitute just as definite a contribution to science as a paper communicated to the meeting. The authors of papers communicated at this meeting are urged to supplement their papers by an exhibit of apparatus in case such an exhibit is suitable and practicable.

Exhibitors are urged to prepare their exhibits and descriptions so as to give them the maximum educational value.

Exhibits must be listed with the committee at the Bureau of Standards not later than Sept. 20, 1922. Blank entry forms for this purpose may be obtained from Prof. C. A. Skinner, Chairman, Exhibit Committee, O. S. A., Bureau of Standards, Washington, D. C. Exhibits may be installed Oct. 24-25 and installation should be completed not later than noon, Oct. 28.

IRWIN G. PRIEST, *Secretary*.

Journal of the Optical Society of America and Review of Scientific Instruments

Vol. VI

SEPTEMBER, 1922

Number 7

MAGNETIC ROTATION IN VARIOUS LIQUIDS IN THE SHORT INFRA-RED SPECTRUM

BY L. R. INGERSOLL

Introduction. This paper describes the results of measurements of magnetic rotation on some forty different liquids in the spectral region between the wave-lengths $.56\mu$ and 2.3μ . Approximately half the substances worked with have been aqueous solutions of various salts—mostly of the ferromagnetic metals—and the others pure liquids. Also, mainly to assist in checking the foregoing results with theory, refractive index determinations have been made on the same materials and over the same wave-length range.

While a great deal of work has been done in the field of magnetic rotation in liquids most of the measurements have been confined to the visible spectrum, and in some cases,—e.g. practically all the extensive work of Perkin¹—to a single wave-length. No attempt will be made at a comprehensive survey of previous results² but the work of Quincke,³ Becquerel,⁴ Castleman and Hul-

¹ W. H. Perkin, Jour. Chem. Soc. 36, p. 330, 1882, and numerous succeeding papers.

² For extensive list of references see W. Voigt, Art. "Magneto-optik" in Graetz, "Handb. d. Elektr. u. Magn. vol. 4. Leipzig; 1915.

³ G. Quincke, Wied. Ann. 24, p. 606; 1885.

⁴ H. Becquerel, C. R., 90 p. 1407, 1880; 100, p. 1374, 1885; 125, p. 683, 1897. Ann. Chim. Phys., (5) 12, p. 42; 1877.

burt,⁵ and particularly of Siertsema⁶ must be mentioned. Each of these investigators studied a variety of materials, including in some cases negatively rotating liquids such as titaniumtetrachloride and solutions of ferric chloride and potassium ferricyanide. The conclusion was reached that in this latter class of materials the rotation dispersion is much greater than that given by the approximate Verdet law of the inverse square of the wavelength (which holds for the vast majority of substances) and is indeed more nearly proportional to the inverse fourth power.

In the matter of correlation of experiment with magneto-optic theory in this field, Siertsema, among others, has made some interesting progress. Voigt's theory⁷ of magnetic rotation on the basis of the inverse Zeeman effect can be shown, on certain assumptions to yield in a region of small absorption the formula

$$\phi = \frac{eH\lambda}{2cm} \cdot \frac{dn}{d\lambda}$$

ϕ being the rotation in radians, n the refractive index, c the velocity of light and e the electronic charge in e.m.u. Lorentz⁸ deduces a similar formula. This is of the same type as the Becquerel formula

$$\phi = \kappa \lambda \frac{dn}{d\lambda}$$

With this Siertsema⁹ has calculated values of e/m from measurements of magnetic rotation (sodium light) and ordinary dispersion, for a variety of substances. They vary from 1.77×10^7 (approximately the value now accepted on the basis of other determinations) in the case of hydrogen, to somewhat less than half of this for carbon bisulphide. Similar calculations with the aid of an extension of the Lorentz theory have been made by Castleman and Hulburt.¹⁰

⁵ R. A. Castleman, Jr. and E. O. Hulburt, *Astrophys. Jour.* 54, p. 45; 1921.

⁶ L. H. Siertsema, *Leiden Comm.* No. 62, 80, 82, 90, 91, and Supp. No. 1. *Amst. Proc.*, 4, p. 339, 1901-2; 5, pp. 243, 413, 1902-3; 6, p. 760, 1903-4; 18, pp. 101, 925, 1916. *Arch. Neer.*, (2) 5, p. 447, 1900; 6, p. 825, 1901.

⁷ W. Voigt, *loc. cit.* p. 572.

⁸ H. A. Lorentz, "Magneto-optische Phänomene," *Ency. d. Math. Wiss.* vol. V, p. 251.

⁹ *Leiden Comm.*, No. 82, p. 5.

¹⁰ *Astrophys. Jour.*, 54, p. 63; 1921.

The present investigation was undertaken for several different reasons. The extension of our knowledge of rotation dispersion over the increased wave-length range afforded by the spectrobolometric method of measurement hardly needs justification. The question of the effect of infra-red absorption bands is one whose answer should be looked for with considerable interest. Also, as indicated by the above formulas, magneto-optic theory connects in intimate fashion magnetic rotation with other optical properties, e.g., ordinary dispersion. These two quantities have as a rule been determined at different times and by different observers with some consequent difficulty and uncertainty in correlating results. It would seem highly desirable, then, to carry out two such series of measurements on the same specimens and over this relatively wide spectral range.

This near infra-red spectral region is also worthy of study in this connection for reasons other than the mere fact that we are thereby enabled to check theory over a wider extent of wave-length than visual observations alone could accomplish. As is well recognized, optical phenomena in the ultra-violet and possibly throughout the visible spectrum are, in general, conditioned by electronic vibrations. For wave-lengths longer than about 3μ , on the other hand, we have ample evidence—e.g., molecular rotation spectra and certain absorption investigations—that the vibrators may be of atomic or molecular dimensions. The short infra-red may then be regarded as a sort of transition region in which we must look to experiment to indicate something as to the coupling of the short wave-length and long wave-length theory—a region accordingly in which investigation is particularly desirable.

One way in which we may seek to throw light on this question of size of vibrator is to calculate e/m for as wide a frequency range as possible by substituting observed values of rotation and dispersion in the above formula. Such a series has been calculated out to 2μ and will appear in the results.¹¹

¹¹ Too much must not be expected from such calculation. As Professor Lorentz remarked to the writer in a recent conversation on this subject, no very definite conclusions can be based on the Becquerel type of formula when it breaks down. It is of interest, however, to note the general trend of results for the large variety of liquids tested, and one or two inferences may be safely drawn.

Experimental Details. A full account of the spectrobolometric method of measuring magnetic rotation has been given in previous papers by the writer¹² and need not be repeated here. The apparatus was practically the same as that formerly used, with the exception of the substitution of a small eight coil Thomson galvanometer (made in this laboratory) for the former four coil. It was carried on a special pier built on a massive concrete block cushioned on five sides with sawdust. The liquids were contained in a cell 9.54 mm thick with thin strain-free plate glass ends, whose rotation was, of course, measured and allowed for. This was located between the poles of the large electromagnet in a field of approximately 12050 gauss. A tungsten strip filament lamp (from the Nela Laboratory) served as source and gave sufficient energy to allow rotation measurements on the more transparent liquids for the region between $.56\mu$ and 2.3μ .

Satisfactory temperature control proved difficult and was not, indeed, entirely attained. The best results were obtained by water-jacketing the magnet pole pieces and by blowing a stream of chilled air at the cell. In this way the temperature could usually be kept within a degree of 23°C , which was the mean aimed at throughout this work. Tests indicated that the errors due to uncertainty in temperature were smaller than the unavoidable ones from other causes.

Visual measurements, by way of check, were made with a Lip-pich tri-field polariscope, using sodium light. In practically every case the point determined in this way fitted very closely indeed on the bolometric rotation dispersion curve.

The refractive index measurements were made by the method of double dispersion, using a small spectrometer and hollow prism, in connection with the large spectrometer—minus, of course, its polarization auxiliaries. Large scale plots were made of these indices and the dispersion was determined by drawing tangents to the curves.

Accuracy. In this matter the rotation measurements were an

¹² L. R. Ingersoll, *Phil. Mag.* (6) *11*, p. 41, 1906; *18*, p. 74, 1909. *Phys. Rev.* *23*, p. 489, 1906; (2) *9*, p. 257, 1917.

improvement over any previously made with this apparatus. One or two small and hitherto unsuspected sources of error were traced out and corrected. The runs were almost all made at night to secure the freedom from vibration so necessary in bolometric work. The results were plotted on large size section paper and the measurements listed here were taken from the smooth curve. As nearly as can be estimated the resultant accuracy of the rotation measurements is of the order of 1% through the middle of the spectral range, with a somewhat larger probable error at the ends where the available energy is small. Considering the difficulties involved this is considered quite satisfactory.

In view of the fact that the refractive index measurements were a somewhat secondary consideration the highest order of accuracy was not aimed at in them. In the few cases possible the values determined were compared with the infra-red indices determined by other observers. While the accordance in absolute values was not in all cases such as might be desired, the *slopes* of the curves, giving the dispersion, were in good agreement, and it is to be noted that for the purposes of this research the absolute value is secondary to the dispersion, which is the quantity entering into formulas of the type above noted. Moreover as regards formulas into which n enters directly the situation is equally good; for the probable error of n , measured in per cent would in any case be almost negligibly small.

Materials. As already noted these were divided into two classes—pure liquids and aqueous solutions of metallic salts. The liquids studied were chosen to give as great a variety as possible. They ranged from heptane with a density of only .68 and correspondingly low refractive index, to methylene iodide, the heaviest organic liquid known, with a density of 3.31 and refractive index over 1.7; from the chemically simple carbon bisulphide to α -monobromnaphthalene. In most cases they were purified by redistillation, or otherwise, shortly before use, and for this service I am greatly indebted to several members of the Chemistry Department of this University, particularly to Professor F. Daniels.

The salts of the ferromagnetic metals used in the aqueous solutions were as pure as could be readily obtained. The solutions were in general very nearly saturated.

RESULTS

The results are shown in the accompanying tables and curves. The tables give for a selected series of wave-lengths Verdet's constant R (rotation in minutes of arc for unit length in unit field), the refractive index n , and (Table 1 only) values of e/m calculated with the formula given above, in the form

$$e/m = \frac{6 \times 10^{10} \pi R}{180 \times 60} \lambda \frac{dn}{d\lambda}$$

The complete series of values of rotation measurements can be taken from the curves—which, to make evident the law of dispersion are plotted with inverse squares of the wave-lengths as abscissas—and the dispersion for the five wave-lengths listed may readily be found, if desired, by calculating backwards from R and e/m . Hence material is here available for a very extensive test of magnetic rotation theories.

The densities of all the liquids, with a few exceptions, were carefully measured at the chosen working temperature, viz., 23°C, with a calibrated specific gravity bottle. Exceptions are ethyl iodide and tin and titanium tetrachlorides, the densities of which were taken from tables. The percentages of salt in the solutions are by weight, the figures being taken from tables, with the aid of the density determinations. They checked satisfactorily with calculations based on weights. In the few cases where density determinations are lacking the solutions were what would ordinarily be called "saturated."

It will be found that, with one or two exceptions, the values of density, and of the rotation and refractive index at $.6\mu$ are in satisfactory agreement with such as can be drawn (by interpolation or extrapolation) from standard tables. Xylene does not show as good agreement as most of the other liquids in this particular. It was not of the highest purity, being mainly ortho- but with more than a trace of para- and meta-xylene.

DISCUSSION OF RESULTS
DISPERSION OF ROTATION IN PURE LIQUIDS

The first thing which strikes the attention in glancing at the curves of Figs. 1 to 3 is the rather remarkable way in which the rotation dispersion follows the simple law of proportionality to

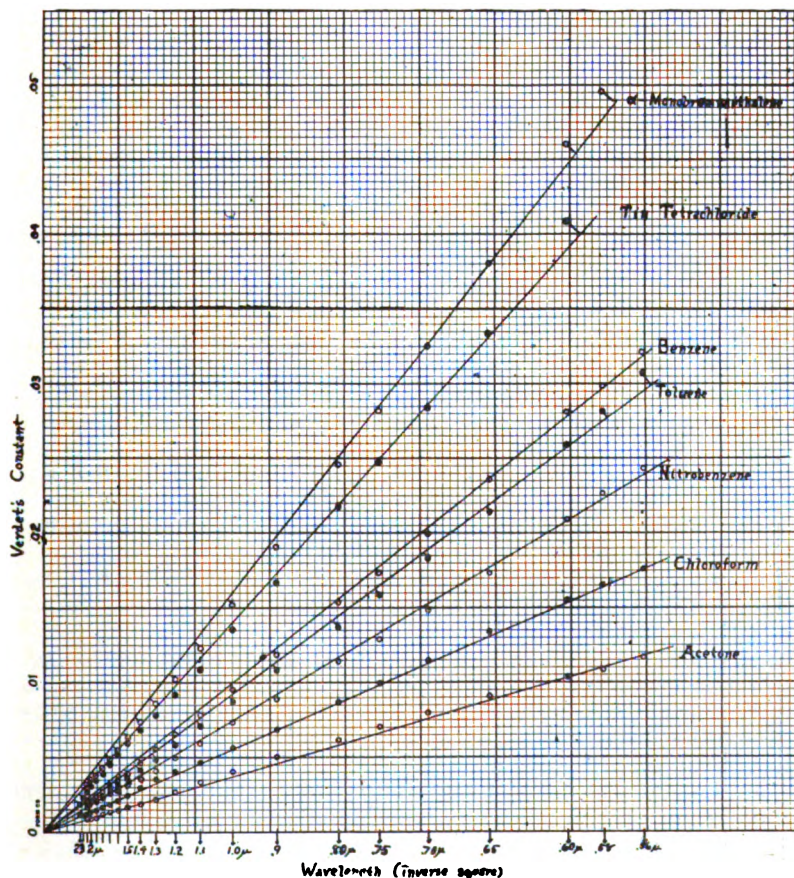

FIG. 1. Curves plotted with magnetic rotations as ordinates and inverse squares of the wave-lengths as abscissas. For convenience the actual wave-lengths in microns are indicated

the inverse square of the wave-length. For the alcohols, ether, chloroform and heptane the departure of the points from a straight line is not much greater than the probable experimental error. The other curves, however, with the exception of acetone,

TABLE 1.—Summary of data for pure liquids at 23°C

Liquid	Carbon Tetrachloride C Cl ₄	Tin Tetrachloride Sn Cl ₄	Titanium Tetra- chloride Ti Cl ₄	Ether C ₄ H ₁₀ O	Chloroform C H Cl ₃	<i>n</i> -Heptane C ₇ H ₁₆	Acetone C ₃ H ₆ O	Carbon Bisulphide CS ₂	α -monobrom- naphthalene C ₁₀ H ₇ Br	Water H ₂ O	
Density	1.583	2.22	1.74	.713	1.475	.681	.791	1.260	1.486	.997	
$\lambda = .6\mu$	<i>R</i>	.0161	.0408	-.0131	.0102	.0155	.0119	.0103	.0394	.0460	.0126
	<i>n</i>	1.4599	1.5079	1.5951	1.3505	1.4425	1.3850	1.3569	1.6227	1.6558	1.3324
	$\frac{e}{m \cdot 10^7}$.99	1.4695	1.08	1.03	1.12	.72	.79	1.25
$\lambda = .8\mu$	<i>R</i>	.0089	.0217	-.0050	.0058	.0086	.0066	.0061	.0214	.0245	.0070
	<i>n</i>	1.4539	1.4993	1.5764	1.3465	1.4370	1.3811	1.3527	1.6031	1.6375	1.3280
	$\frac{e}{m \cdot 10^7}$.96	1.7988	1.01	1.13	.88	.80	.99	.80
$\lambda = 1.0\mu$	<i>R</i>	.0057	.0135	-.0026	.0036	.0056	.0043	.0040	.0135	.0152	.0044
	<i>n</i>	1.4509	1.4952	1.5689	1.3444	1.4343	1.3791	1.3506	1.5947	1.6296	1.3247
	$\frac{e}{m \cdot 10^7}$.87	1.7086	.94	1.03	.73	.75	.95	.50
$\lambda = 1.5\mu$	<i>R</i>	.0025	.0060	-.0010	.0016	.0024	.0018	.0017	.0058	.0063	*.0029
	<i>n</i>	1.4479	1.4911	1.5613	1.3419	1.4314	1.3768	1.3479	1.5858	1.6222	1.3210
	$\frac{e}{m \cdot 10^7}$.76	1.1636	.93	.56	.50	.65	.94	*.29
$\lambda = 2.0\mu$	<i>R</i>	.0013	.0031	-.0005	.0008	.0013	.0009	.0009	.0031	.0035	
	<i>n</i>	1.4463	1.4895	1.5585	1.3402	1.4301	1.3752	1.3464	1.5819	1.6192	
	$\frac{e}{m \cdot 10^7}$.38	1.4811	.44	.15	.20	.39	.48	
											* $\lambda = 1.25 \mu$

TABLE 1 (continued)

Liquid		Density	$\lambda = .6\mu$			$\lambda = .8\mu$			$\lambda = 1.0\mu$			$\lambda = 1.5\mu$			$\lambda = 2.0\mu$			
			R	n	$\frac{e}{m \cdot 10^9}$	R	n	$\frac{e}{m \cdot 10^9}$	R	n	$\frac{e}{m \cdot 10^9}$	R	n	$\frac{e}{m \cdot 10^9}$	R	n	$\frac{e}{m \cdot 10^9}$	
Methyl Alcohol	CH ₃ O	.790	.0093	1.3285	.88	.0051	1.3245	.80	.0032	1.3222	.56	.0019	1.3180	.25	.0013	1.3135	.12	
Ethyl Alcohol	C ₂ H ₅ O	.788	.0111	1.3609	1.22	.0060	1.3566	.85	.0038	1.3542	.70	.0019	1.3506	.29	.0010	1.3470	.12	
n- Butyl Alcohol	C ₄ H ₁₀ O	.807	.0120	1.3992	1.05	.0067	1.3950	.94	.0043	1.3928	.90	.0018	1.3896	.32	.0014	
Benzene	C ₆ H ₆	.874	.0281	1.4970	.99	.0153	1.4869	1.02	.0095	1.4823	1.00	.0039	1.4774	.88	.0022	1.4756	.43	
Nitrobenzene	C ₆ H ₅ NO ₂	1.198	.02090114	1.5355	.59	.0073	1.5295	.60	.0031	1.5234	.50	.0018	1.5204	.30	
Toluene	C ₇ H ₈	.863	.0258	1.4932	.97	.0137	1.4839	.97	.0087	1.4796	1.17	.0035	1.4751	.67	.0020	1.4734	.29	
Xylene	C ₈ H ₁₀	.861	.0232	1.4933	1.09	.0128	1.4842	.87	.0080	1.4799	.97	.0035	1.4757	.71	.0019	1.4737	.35	
Ethyl Iodide	C ₂ H ₅ I	1.93	.0279	1.5085	1.13	.0151	1.4994	1.15	.0097	1.4947	.95	.0041	1.4901	.84	.0024	1.4880	.35	
Methyl Iodide	CH ₃ I	2.263	.0318	1.5262	1.15	.0178	1.5157	1.12	.0112	1.5108	1.13	.0048	1.5064	1.10	.0027	1.5043	.49	
Methylene Iodide	CH ₂ I ₂	3.310	.0476	1.7376	.73	.0268	1.7164	.99	.0169	1.7073	.95	.0073	1.6987	.88	.0040	1.6956	.73	

show a distinct tendency to fall below the straight line for the middle part of the spectral region investigated and to rise at the short wave-length end. Toluene and carbon bisulphide are good examples.

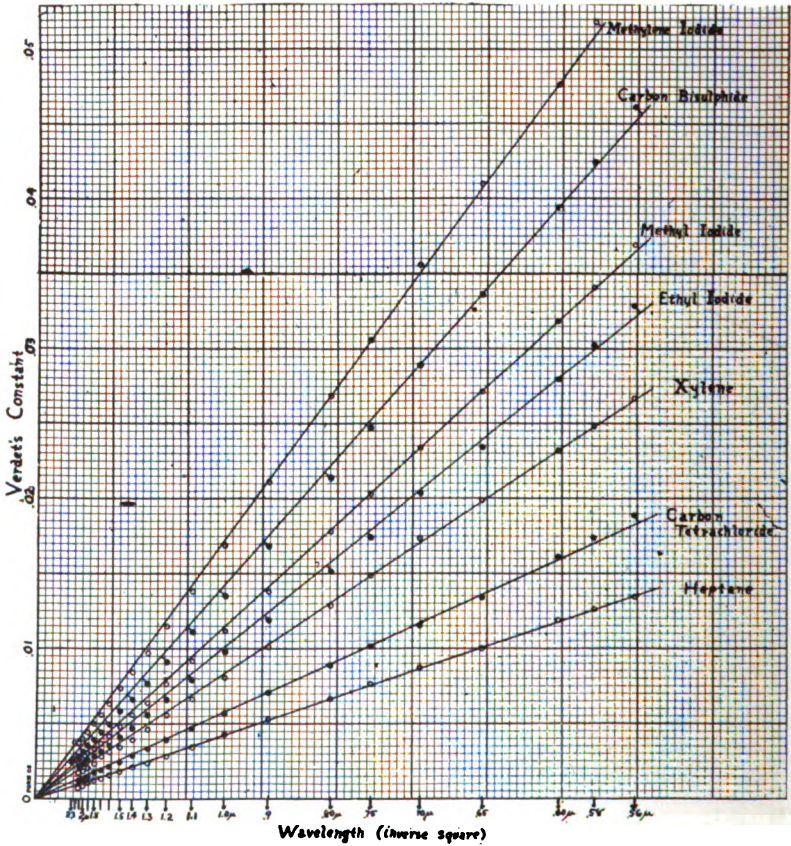

FIG. 2. For explanation see Fig. 1

Rotation Formulas. Of the many rotation dispersion formulas we shall discuss in connection with these curves only three, viz.,

$$\phi = n \left\{ \frac{a}{\lambda^2} + \frac{b}{\lambda^2 - \lambda_1^2} + \frac{c}{\lambda^2 - \lambda_2^2} \right\} \tag{1}$$

$$\phi = \frac{1}{n} \left\{ \frac{a'}{\lambda^2} + \frac{b'\lambda^2}{(\lambda^2 - \lambda_1^2)^2} + \frac{c'\lambda^2}{(\lambda^2 - \lambda_2^2)^2} \right\} \tag{2}$$

$$\phi = \kappa \lambda \frac{dn}{d\lambda} \tag{3}$$

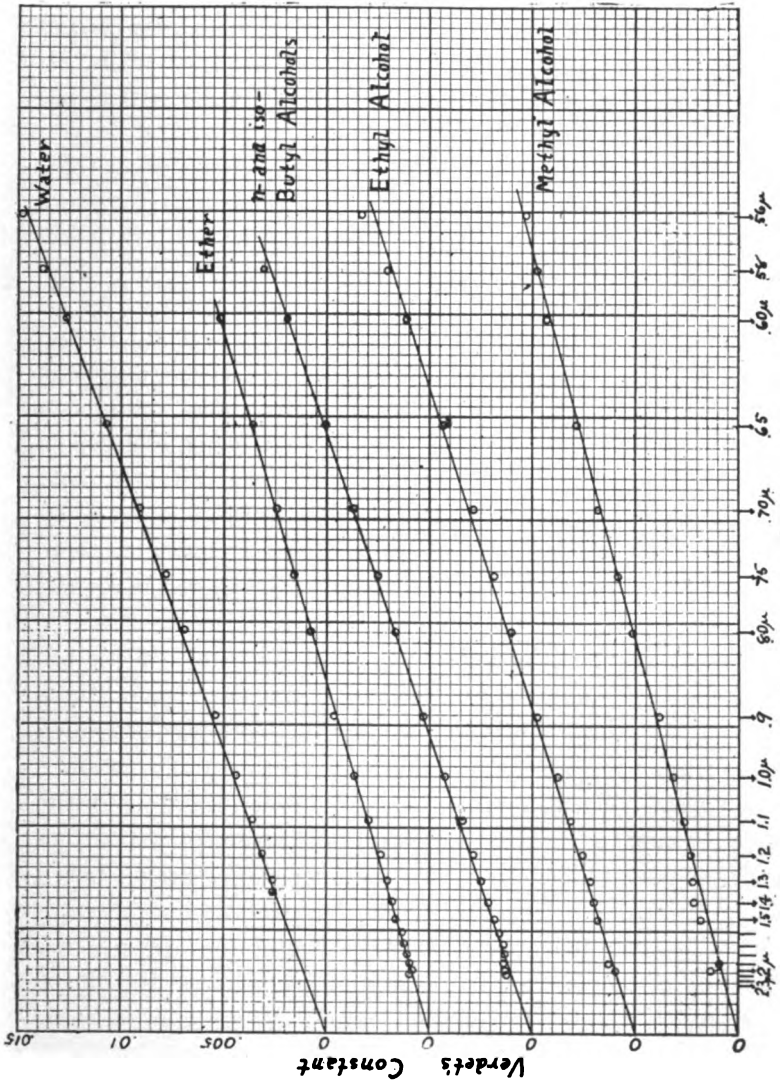

Wavelength (inverse square)
FIG. 3. For explanation see Fig. 1

The first two are based on what might be termed the older magneto-optic theory and are simple extensions—by the addition of a third term—of those derived by Drude (Lehrbuch d. Optik) on the hypothesis of molecular currents, and of the Hall effect, respectively. λ_1 is the wave-length of an ultra-violet absorption line and λ_2 of an infra-red.

Now a little study of these formulas will make it apparent that, except for the long wave-length end, the three constants (five if we do not specify λ_1 , and λ_2) could be chosen so that either formula would fit the observed curves—save for acetone—very well. This is not true, however, for the longer wave-lengths. As we approach, from the short wave-length side, an infra-red absorption band, that is, one—if there be such—which affects the magnetic rotation, formula (1) calls for a *decrease* of rotation. Similarly the Hall effect formula predicts an *increase*—it being assumed in both cases that the constants c and c' are positive. While in most cases the rotation dispersion shows a slight upward tendency on the long wave-length end, calling for the second formula, there are one or two liquids, notably tin tetrachloride, where the reverse is true.

It may be remarked, however, that it is not safe to place too much dependence on these measurements for the two or three longest wave-lengths. While a great deal of effort was expended to make them as accurate as possible the experimental difficulties were very great. The same may be said of determinations in the absorption region in the neighborhood of 1.7μ shown by many of the hydrocarbons. The conclusion we can safely draw—based on the fact that the departure from the straight line (inverse square law) on the long wave-length end is of the order of the experimental error—is that, in the region investigated the effect, on the rotation, of infra-red bands is *small*. There is no observable effect traceable to the 1.7μ absorption region in any case.

Becquerel Formula. Calculation of e/m . As already mentioned the more modern point of view in magneto-optic rotation theory leads to a formula of the type of (3) and this has been applied to the substances listed in Figs. 1–3. The results are given in

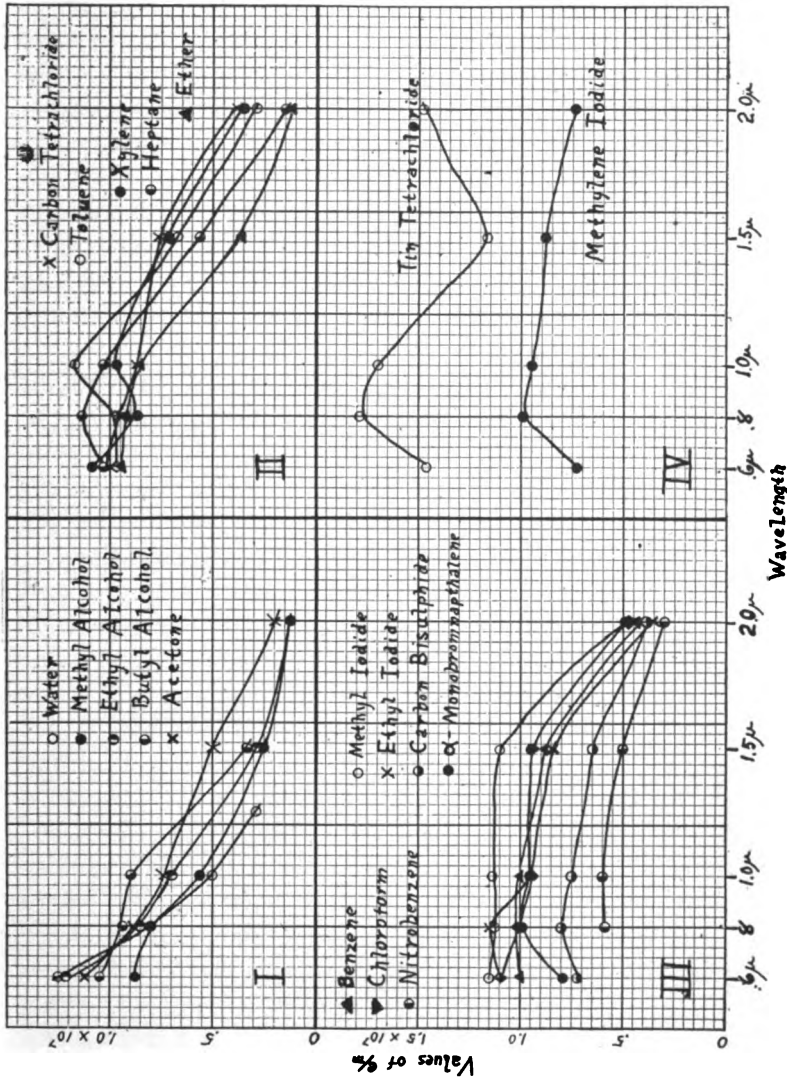

FIG. 4.

Table 1 and Fig. 4 not, however, as a comparison of observed and computed rotations, but by reversing the formula as previously explained and calculating e/m . In this way we are led—subject to the reservations already mentioned in the footnote—to some interesting conclusions as to the size of vibrator. When e/m shows a reasonably constant value (i.e. the Becquerel formula is obeyed) of the same order of magnitude as that found in other ways, as shown by tin tetrachloride and methylene iodide, we may assume that the vibrators are electronic in size. When, however, as in water and the alcohols, e/m decreases rapidly with longer wavelength we infer that the proportion of atomic vibrators is making itself felt. A *discontinuous* change from electronic e/m to atomic e/m is, of course, not to be expected.

It may be remarked that, in view of the fact that these liquids all obey substantially the same law of rotation dispersion the marked changes in the e/m curves between the four types are largely due to differences in the ordinary dispersion curves. This means that certain infra-red bands which are influencing the refractive index curves *have no effect* on the magnetic rotation.

Solutions. The results on solutions are shown in Fig. 5 and Table 2. It will be seen that the inverse square law also holds here in a general way, but not as well as for pure liquids. The spectral range is also considerably shortened by the fact that the absorption of water prevents measurement for wave-lengths longer than about 1.35μ . Considerable effort was spent in calculating corrections for the effect of the solvent (water) in an attempt to secure results characteristic of the salts alone. The curves obtained were in many cases most irregular and hardly justify reproduction. In general it may be said, however, that where the salt solution shows a smaller rotation than that of water (curve below the dash line) the salt itself may be considered to show a negative rotation, but there may be exceptions to this statement.

Thoulet's solution ($2KI + HgI_2 + aq$) is of interest as showing one of the highest known rotations. As used it had a density of only 2.45 and this could be increased by concentration with doubtless a corresponding increase in its Verdet constant.

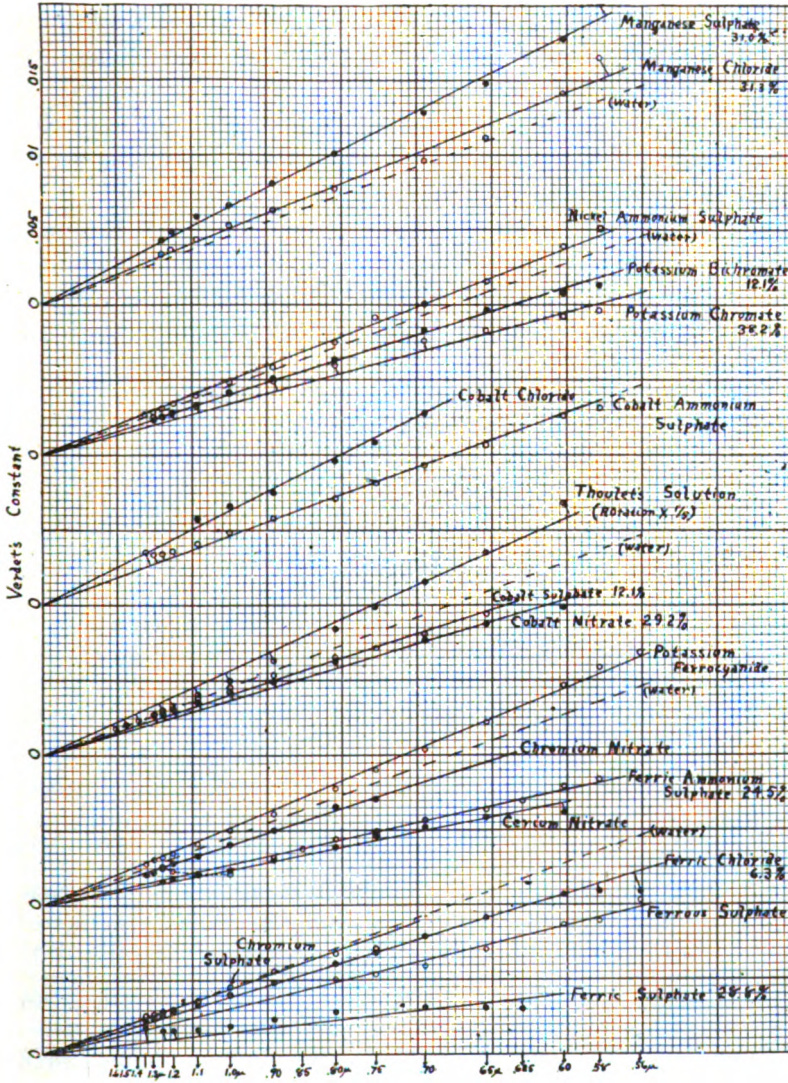

FIG. 5. Rotation curves for concentrated aqueous solutions. For explanation of plotting see Fig. 1

In a previous research the writer¹³ found that films of iron showed a magnetic rotation which increased out to a wave-length of 1.5μ and then stayed nearly constant to 2μ . The fact that only the slightest trace of such behavior is exhibited by iron salt solutions is a bit of evidence for this particular phenomenon of magnetism being regarded as molecular rather than atomic in character.

A series of e/m calculations was also carried out for these solutions. In general the values fall off rapidly with increasing wave-length, as in the case of pure water.

Negatively Rotating Liquids. Our previous discussion has been entirely on positively rotating liquids. Fig. 6 shows the measurements on the three negatively rotating liquids tested, viz., strong solutions of ferric chloride and potassium ferricyanide, and the

TABLE 2.—Summary of data for aqueous solutions at 23°C

		Ferric Chloride (1)	Ferric Chloride (2)	Potassium Ferricyanide	Potassium Ferrocyanide	Ferric Sulphate	Ferrous Sulphate	Ferric Ammonium Sulphate	Cobalt Sulphate	Cobalt Chloride	Cobalt Nitrate
Density		1.523	1.049	1.187	1.446	1.250	1.322	1.296	1.308
%		47.8	6.3	31.4	24.5	29.2
$\lambda = .6\mu$	R0107	-.0233	.01470087	.00780099
	n	1.3487	1.3878	1.4234	1.3881	1.3892
$\lambda = .8\mu$	R	-.0399	.0061	-.0056	.0078	.0029	.0050	.0044	.0065	.0096	.0060
	n	1.4941	1.3442	1.3810	1.4160	1.3817	1.3816	1.3985	1.3835
$\lambda = 1.0\mu$	R	.0215	.0040	-.0017	.0051	.00200021	.0046	.0066	.0043
	n	1.4860	1.3407	1.3768	1.4113	1.3779	1.3778	1.3945	1.3796
$\lambda = 1.25\mu$	R	-.0110	.0026	-.0001	.0032	.001600260029
	n	1.4803	1.3366	1.3731	1.4061	1.3730

¹³ Phil. Mag. (6) 18, p. 74; 1909.

TABLE 2.—(Continued)

	Cobalt Ammonium Sulphate	Nickel Ammonium Sulphate	Cerium Nitrate	Manganese Chloride	Manganese Sulphate	Chromium Nitrate	Chromium Sulphate	Potassium Chromate	Potassium Bichromate	Thoulet's Solution	
Density	1.106	1.054	1.202	1.326	1.369	1.087	1.140	1.372	1.085	2.445	
%	31.3	31.0	38.2	12.1	
$\lambda = .6\mu$	R	.0126	.0139	.0062	.0141	.01780092	.0108	.0841
	n	1.3552	1.3438	1.3650	1.3948	1.4276	1.3540
$\lambda = .8\mu$	R	.0071	.0075	.0039	.0078	.0101	.0066	.0067	.0060	.0064	.0422
	n	1.3505	1.3397	1.3594	1.4069	1.3896	1.3468	1.3553	1.4180	1.3487	1.5685
$\lambda = 1.0\mu$	R	.0049	.0048	.0024	.0054	.0066	.0041	.0045	.0041	.0042	.0249
	n	1.3470	1.3362	1.3460	1.4030	1.3857	1.3431	1.3514	1.4127	1.3447	1.5590
$\lambda = 1.25\mu$	R	.0035	.0030	.0016	.0034	.0043	.0025	.0028	.0026	.0025	.0152
	n	1.3432	1.3324	1.3419	1.3987	1.3811	1.3391	1.3472	1.4079	1.3407	1.5525

fuming liquid titanium tetrachloride. This last is of interest in that it is the only known diamagnetic substance showing negative rotation.

As already mentioned several investigators, notably Siertsema¹⁴ have concluded on the basis of visible spectrum measurements that the rotation dispersion of such substances is much greater than in positively rotating liquids, being more nearly proportional to the inverse fourth power of the wave-length. Now the curves of Fig. 6 show that over this wider spectral region both titanium tetrachloride and the strong ferric chloride solution obey fairly closely an *inverse cube law*. Potassium ferricyanide, on the other hand, shows a much greater dispersion than this—greater even than the inverse fourth power.¹⁵

¹⁴ Amst. Proc. 18, p. 925; 1916.

¹⁵ Cf. Siertsema, Arch. Neer. (2) 5, 447, 1900.

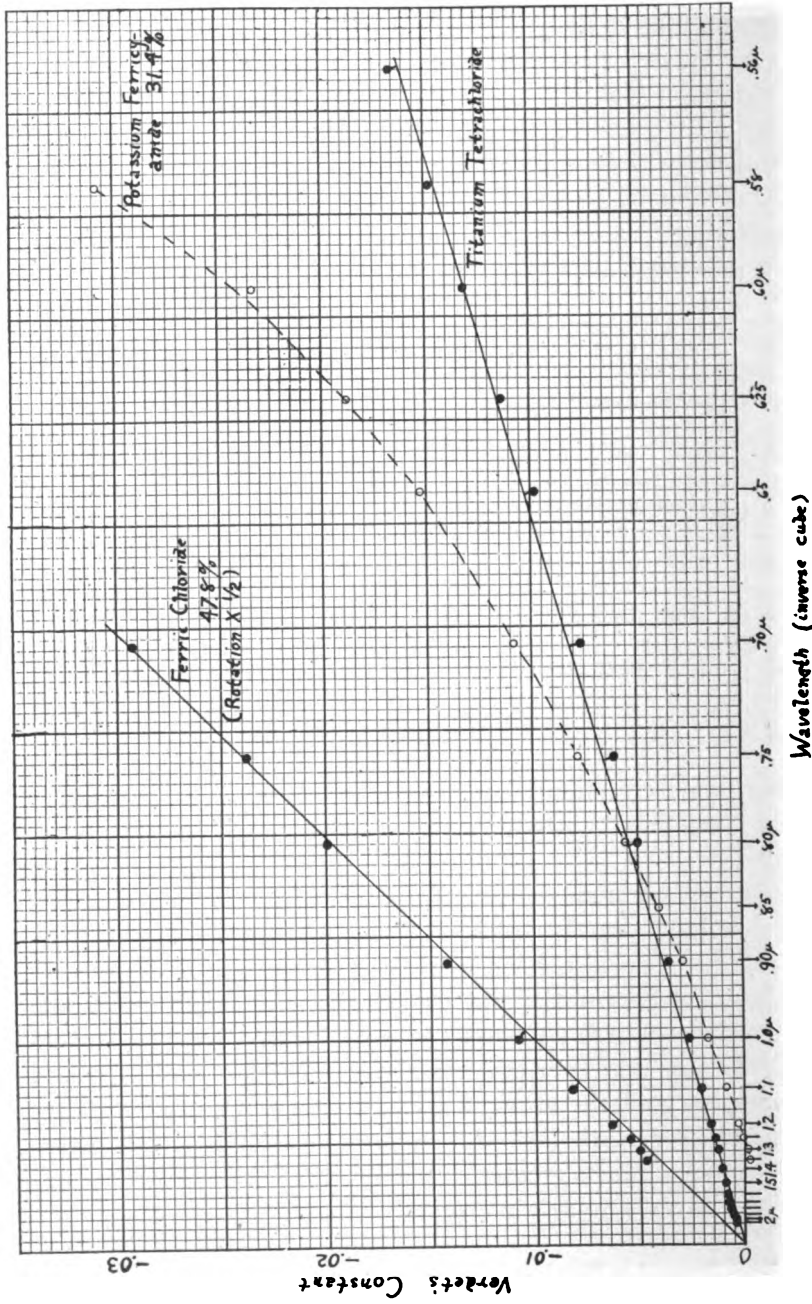

FIG. 6. Curves for negatively rotating liquids. For explanation of plotting see Fig. 1

Other details. A carbon bisulphide solution of iodine gave rotation and refractive index measurements almost the same as the pure solvent. The rotation curve for colloidal iron oxide in water could not be definitely distinguished from that for pure water. Similarly *n.*- and iso-butyl alcohols gave practically identical curves.

Two solutions of nickel salts, viz., the nitrate and chloride, were tested but were found to absorb too strongly for measurement save in relatively narrow transmission bands at $.8\mu$ and $.9\mu$, respectively. Incidentally it may be remarked that these salts in concentrated solution would constitute admirable filters if it was desired to utilize only this portion of the infra-red.

In conclusion I am glad to acknowledge my indebtedness to the Rumford and American Association funds for grants; to members of the Chemistry Department, as already mentioned, for their kindness in preparing pure liquids; and to Professor H. A. Lorentz, who, on the occasion of his recent visit to this laboratory, was good enough to give the writer the benefit of his criticism. I should like also to express my appreciation of the work of my assistant Mr. N. G. E. Sharp, who made all of the observations with painstaking care.

SUMMARY

1. The magnetic rotation and refractive index of twenty pure liquids and as many aqueous solutions of metallic salts have been measured for the spectrum range between $.56\mu$ and 2.3μ .

2. Positively rotating liquids show a rotation very nearly proportional, in most cases, to the inverse square of the wave-length, indicating that infra-red absorption bands have small influence on the rotation in this region.

3. The few negatively rotating liquids show a much greater rotation dispersion. This is nearly the inverse cube for titanium tetrachloride and concentrated ferric chloride solution, while for potassium ferricyanide solution it is almost as the inverse fifth power of the wave-length.

4. Values of e/m calculated from these measurements on positive liquids show in general a diminution for longer wave-length, as might be expected. Several types of curves may be distinguished in this connection.

PHYSICAL LABORATORY,
UNIVERSITY OF WISCONSIN.
JULY 12, 1922.

INSTRUMENT SECTION

THE CLASSIFICATION OF OPTICAL INSTRUMENTS

By T. SMITH

ABSTRACT

Exception is taken to the classification of optical instruments by the signs of their powers, and an alternative division comprising five classes is proposed, based upon the separation of the four Gaussian constants into two groups according to their signs. This classification cannot be modified by the addition to the system of inverting prisms and the like, and the properties usually associated with the sign of the lens in reality depend upon its class according to the new system. Each class may have systems of positive or of negative power.

The elementary theory of optical instruments which we owe to Gauss has the great merit that attention may be given wholly to the events which take place in the object space and the image space, the method by which the rays are altered in direction and position, and even the position of the instrument which causes these changes, being unimportant. This treatment is highly advantageous when the purpose is to consider the general correlation between incident and emergent rays, but in the practical applications of the theory to the construction and use of real instruments the position of the instrument is of the greatest importance. This would be rendered more apparent if it became customary at a later stage of the theory to consider the position of the instrument in relation to the cardinal points; such a development leads naturally to a classification of instruments in which there are five groups, important special cases such as telescopes being regarded as borderline cases or as members of two groups. The division proposed is more fundamental than the usual separation of lens systems into positive and negative combinations, a distinction which is not generally correct as regards many of the properties usually associated with them.

The properties of a system, including the positions of the extreme surfaces relative to the cardinal points, are given by the four Gaussian constants A, B, C, D ,¹ which satisfy the identity $BC - AD = 1$. The ordinary division depends wholly on the sign of A , the power of the system. The essential theoretical distinction between positive and negative lenses is indicated in Figs. 1 and 2 by means of three incident parallel rays identified by the letters P, Q, R : the position of the instrument is immaterial and both object space and image space are supposed to extend to

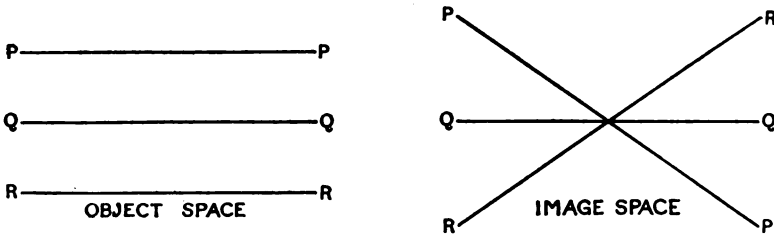

Fig. 1. Positive Lens.

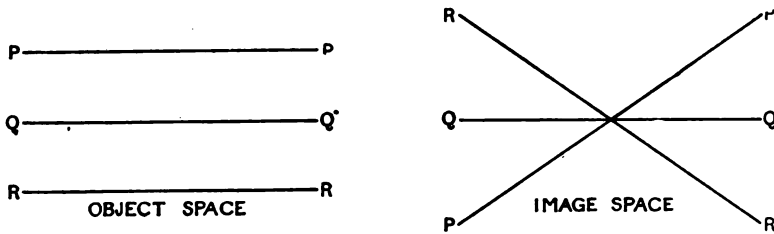

Fig. 2. Negative Lens.

infinity in every direction. In the classification now proposed the basis is the grouping of the constants according to agreements or disagreements of sign. Let the constants of one sign be included in one bracket, and those of another sign in another bracket. There are then six possible groups $[ABCD], [ABC] [D], [A] [BCD], [AB] [CD], [AC] [BD], [AD] [BC]$, it being of no consequence which bracket of a pair corresponds to

¹ These constants A, B, C, D are respectively $\kappa_{1,n}, \frac{\partial \kappa_{1,n}}{\partial \kappa_1}, \frac{\partial \kappa_{1,n}}{\partial \kappa_n}, \frac{\partial^2 \kappa_{1,n}}{\partial \kappa_1 \partial \kappa_n}$ in the notation used in calculations.

a positive and which to a negative sign. An algebraically exhaustive list would include the groups $[ABD] [C]$ and $[ACD] [B]$, but these must be excluded since they require $BC - AD$ to be negative. The actual number of classes is one less than the number of these groups, for if a system is considered in the reverse direction B and C are interchanged. It follows that the two groups $[AB] [CD]$ and $[AC] [BD]$ correspond to a single class of instrument.

The positions of pairs of conjugate points on the axis are given in terms of A, B, C, D , by the relation

$$Axx' - Bx' - Cx + D = 0, \dots\dots\dots(1)$$

where x is the distance from the first surface to the object point, and x' is the distance from the last surface to the image point, both considered positive when measured away from the system into the surrounding medium. It is at once evident from this equation that the positions of conjugate points depend upon the ratios of these constants, and that their relative signs rather than their absolute signs are important. The particular property affected by a change of all the signs without a change of magnitude of these four quantities is the inversion of the image of an object occupying a particular position, but in modern instruments the designer need pay little attention to this feature of a system as he has several devices which he may adopt to modify this result without altering the values of the four constants. The properties represented by the ratios of the constants on the other hand are fundamental and cannot be influenced by such devices as the introduction of reflecting surfaces.

From the equation connecting x and x' it is easy to see what properties are associated with each of the groups that have been described. Suppose that F (Figs. 3 to 8) is the point at which incident parallel rays are brought to a focus, that U is the image of the vertex of the first surface in the system, and that V is the vertex of the last surface. Then F, U, V are three points on the axis in the image space of which V is necessarily real while F and U are only real if they are encountered by a wave which has traversed the system after it has passed through V . There are six cases to consider. For U may be encountered by the wave

before it reaches F or after it has passed through F , and V in either case may precede both, fall between or follow both U and F . If the points are placed in the order in which they are met by the wave, the following correspondences may be derived at once from equation (1):

$$\begin{aligned} VUF &= [ABCD], & VFU &= [AC] [BD], \\ UVF &= [ABC] [D], & FVU &= [A] [BCD], \\ UFV &= [AB] [CD], & FUV &= [AD] [BC]. \end{aligned}$$

The general properties of members of any class may be inferred either from equation (1) or from the order of the letters F , U , V if it is remembered that the image of the real part of the object space axis extends from F in the positive direction (through infinity if necessary) to U . Either method shows that in every group with the exception of the last, $[AD] [BC]$, there is a range of the axis in which a real image of a real object may be formed. The portion of the image axis which corresponds to the real object space axis is indicated by a thicker line in the image.

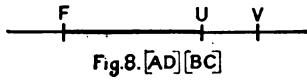
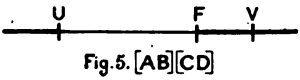
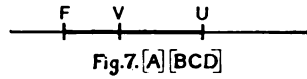
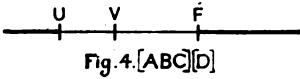
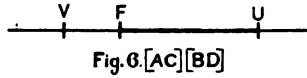
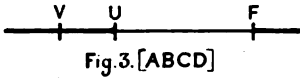

Among the special cases it will be noted that thin lenses, which have $B=C=1$ and $D=0$, are members, if the power is positive, of groups $[ABCD]$ and $[ABC] [D]$; if the power is negative they belong to groups $[A] [BCD]$ and $[AD] [BC]$. When the thickness are small without being exactly zero the groups are those mentioned second in each case. It is because the negative lenses ordinarily used belong to the class $[AD] [BC]$, and not because the power is negative, that all the images they form are virtual.

It is not difficult to construct positive combinations which have this property.

Other special classes comprise the telescopes. For instance, prismatic binoculars, gun-sighting telescopes and astronomical telescopes belong to either $[ABCD]$ or $[A][BCD]$. On the other hand, Galilean binoculars belong to $[ABC][D]$ or $[AD][BC]$, and their undesirable properties are wholly attributable to the class to which they belong and have no connection with the erectness of the images they yield.

The adoption of this classification will lead naturally from the Gaussian treatment of rays to the consideration of entrance and exit pupils, an important branch of geometrical optics which has not until lately, in this country at all events, received a proper amount of attention. It would be convenient to have short descriptive titles for each group, but the writer wished to have the opportunity of hearing the views of other workers before making any proposals of this kind.

EDITORIAL NOTE

The above paper on "The Classification of Optical Instruments" was read by the author before the Optical Society of London, June 8, 1922. It is published here by arrangement between the Optical Society of London and the Optical Society of America, in hopes that the author's proposal will have as wide discussion as possible.

For the benefit of such readers as may perhaps not be familiar with Mr. Smith's other optical writings, it may be well to state that "the four Gaussian constants A , B , C , D " which he employs have the following meanings (as he explains also in a footnote):

A denotes the refracting power of the system, usually denoted in this Journal by F or $F_{1, m}$, if the system is supposed to consist of m refracting surfaces; (however, Mr. Smith uses κ instead of F and n instead of m .)

$$B = \frac{\partial A}{\partial F_1}, \text{ where } F_1 \text{ denotes the refracting power of the first surface;}$$

$$C = \frac{\partial A}{\partial F_m}, \text{ where } F_m \text{ denotes the refracting power of the } m\text{th surface;}$$

$$D = \frac{\partial^2 A}{\partial F_1 \partial F_m} = \frac{BC - 1}{A}.$$

Now if the vertices of the first and last surfaces are designated by A_1 and A_m , respectively, it may be shown (*cf.* *J.O.S.A.*, IV, pp. 246, 247; 1920) that the positions of the focal points, (F , F') are defined by the simple relations:

$$A_1 F = -\frac{B}{A}, \quad A_m F' = \frac{C}{A}.$$

If M, M' designate the positions of a pair of conjugate points on the optic axis, the symbols x, x' employed by Mr. Smith may be defined as follows: $x = MA_1, x' = A_m M'$. Assuming that the optical system is surrounded by air on both sides, and employing the Newtonian abscissa-equation, we derive immediately the relation:

$$\left(\frac{B}{A} - x\right) \left(x' - \frac{C}{A}\right) = -\frac{1}{A^2},$$

which, by virtue of the relation $BC - AD = 1$, reduces to the equation given by Mr. Smith, namely:

$$Axx' - Bx' - Cx + D = 0.$$

For the three points which Mr. Smith calls F, U and V, it follows that

$$VF = \frac{C}{A}, \quad VU = \frac{D}{B}, \quad UF = \frac{1}{A \cdot B}.$$

The five classifications above are evident from these relations.

J. P. C. S.

SUMMARY OF THE LITERATURE RELATIVE TO THE FORMATION OF FILM ON POLISHED GLASS SURFACES

BY GEORGE W. MOREY

The stability of polished glass surfaces is of prime importance in the design and manufacture of optical instruments, and all factors affecting their stability are worthy of careful consideration. Some glasses are inherently inferior in their resistance to the corrosive action of water and weak acids, and such glasses are to be avoided whenever possible. Experience has shown the relative reliability of different glass types and glass compositions, and tests have been devised which enable the optician to avoid actually inferior types.¹ But glasses possessing a high degree of resistance to such "weathering" action often give trouble by becoming covered with a coating resembling that produced by the weathering of an inferior glass, but actually due to entirely different causes. This particular type of coating has been called "film," and the following report summarizes the information contained in the literature on the formation, appearance, cause, and prevention of "film" on polished glass surfaces.

The phenomenon in question is thus described by Ryland:² "In every type of enclosed optical instrument, instances, more or less numerous, of film will be found. By film is meant the coating of lens and prism surfaces with what is apparently a thin deposit of moisture. This has caused much trouble and annoyance, many instruments being rendered quite useless until taken apart and cleaned. The film appears to have several characteristics. It apparently consists of a series of globules of moisture, forming patterns on the surface similar to those made by cleaning with a linen rag which has seen much service. Often a series of larger globules will occur, each surrounded by a clear space.

¹ G. W. Morey, *J. Soc., Glass Technology*, 6, p. 20-30; 1922.

² H. S. Ryland, *Trans. Opt. Soc.*, 19, p. 178-83; 1918-19.

Parts of a surface under pressure from mounts will be clear for a small space surrounding the points of contact, the clear space being fringed by a denser deposit. Prisms will often show a distinct pattern of the seat, the part covered by metal having a fairly dense deposit, a fairly clear space occurring where the surface is free, becoming again more dense away from the metal. A cut, scratch or hole in the surface is generally surrounded by a clear space, beyond which the deposit is again more dense.

"If a drop of water from a pipette is allowed to run over a filmed surface, it will leave a track which is quite free from any trace of scum. Microscopic examination shows no injury to the surface after filming. Instruments such as telescopes, in which the air is occasionally changed, very seldom film. When they do it is generally the case that they have been out of service for some time."

The above description of filming agrees well with that of other writers. That, even in cases in which the film appears uniform to the unaided eye, it actually consists of tiny discrete drops, is stated by Ryland (*loc. cit.*, p. 183) and by Jones.³ The tendency of film to form on reticules ("graticules") and similar etched surfaces is often mentioned;⁴ an excellent photomicrograph of such a deposit in a reticule from a prism binocular is given by Martin and Griffith.⁵ That such deposits are usually found in instruments which after assembly are made air and water tight as opposed to those in which there is opportunity for circulation of air is brought out by Jones, by Ryland and by Beck. The latter also states that "The Admiralty informed him that they have never met with it (film) inside submarine periscopes which are hermetically sealed and filled with dry air. He was told that it had not been met with in the Aldis unit sight when properly sealed, except in some experimental cases when a coating of

³ Remarks on the filming of glass. By H. S. Jones of the Inspection Dept., D. I. O. S. Report submitted by Lt. Col. A. C. Williams, Dept. of Scientific and Industrial Research, Standing Committee on Glass and Optical Instruments.

⁴ Discussion on the filming of glass held by the British Optical Instrument and Manufacturers Association.

⁵ L. C. Martins and C. H. Griffiths. *Trans. Opt. Soc. London*, 20, p. 135-54; 1920.

glycerine had been placed on the internal surfaces to pick up floating dust particles." Martin and Griffiths state that film is most often found in reticules, next in field lenses of eye pieces, next in prisms.

It follows from the above that in enclosed optical instruments a deposit, consisting of more or less discrete drops, tends to form on the glass surfaces, most especially on reticules. It also follows, e.g., from the data furnished by Beck, that such film is not met with even in enclosed instruments, when such instruments are assembled with great care, as is the case with periscopes. The important conclusion that the film is not a permanent attack of the glass surface, but on the contrary the original surface appears unchanged even when examined under the microscope after washing off the film with distilled water, is confirmed by Martin and Griffiths. The latter report: "As far, at least, as the globular deposit is concerned, the surface of the glass shows no trace of corrosion, when examined under the microscope, after the deposit of film has been washed off."

The cause of film has not yet been established. Two factors, however, seem to be necessary; the presence of water (moisture) and the presence of dirt or grease, especially the latter. French,⁶ Chalmers,⁷ and Wright⁸ emphasize this point. Ryland writes, "A number of experiments have been tried in order to determine the cause of film. Certain types of black, notably the japan black and those containing pitch or bitumen, almost always cause film; aluminum machined and not cleaned afterwards; a small trace of animal matter or beeswax in the closed space will give trouble." Martin and Griffiths state that "moisture alone has no affect in producing the globular deposit" and that "the presence of lubricants does not produce globular deposit nor disintegration of surfaces unless moisture is present." The consensus of opinion is that, irrespective of the stability of the glass, elimination of dirt, grease and moisture are essential to the prevention of film.

⁶ See discussion of the paper by Ryland, loc. cit.

⁷ See discussion of the paper by Martin and Griffiths, loc. cit.

⁸ "The Manufacture of Optical Glass and of Optical Systems," Lieut. Col. F. E. Wright. Ordnance Dept. Document No. 2037.

Ryland, after outlining precautions to be taken in cleaning, writes, "The use of these precautions will apparently make even poor glass remain free from film." French, Beck, Chalmers, Jones and Wright all agree as to the imperative necessity of meticulous cleanliness in assembly. Jones states that, "Generally speaking, it may be said that those firms who had taken the greatest care with the cleaning to ensure absolute cleanliness had the least trouble with film, whilst those who had taken fewest precautions to ensure cleanliness had most trouble." He also cites this case: "One firm who have had very considerable trouble from film, noticed that not a single instrument in which lenses etc. had been cleaned by the foreman of the assembly department had been rejected for film, and that the ordinary cleaning methods were used, i.e., without special precautions."

The nature of the glass, however, is probably not without importance. While Ryland asserts that proper precautions will prevent film on even poor glass, he states that "Different glasses however appear to have different susceptibility to film; the most troublesome glass I have found to be one made of borosilicate crown." In the discussion on filming held by the British Optical Instrument Manufacturers Association, it was brought out that "generally speaking, glasses showing the greatest affinity for water give the most trouble," though in this connection it should be noted that borosilicate crown, designated by Ryland as the most troublesome, is not especially susceptible to weathering. In addition to laying stress on cleanliness in assembly it is stated that "Care should be taken in the choice of glass. Hygroscopic glasses are to be avoided." Martin and Griffiths in a series of experiments on the formation of film, were unable to detect any difference between ordinary crown and light flint. On the other hand they state that no film had ever been observed on reticules made by a certain German firm, who used a light barium flint, Jena O 463. The evidence collected by Jones on this point is mainly negative, with the exception of an instance cited in which, "One firm had a lot of trouble with the graticulated discs of prismatic binoculars owing to the formation of globular deposits. This has been entirely overcome by simply changing from plate

glass to baryta light flint, without alteration of methods of cleaning." This latter case is probably one in which an actually poor glass had been used, as opposed to the majority of cases in which film was formed on fairly resistant glass, as a result of careless cleaning. It shows the necessity of choosing a good type of glass for the manufacture of such parts as reticules, though the light barium flint is probably not superior to many other glasses in common use.

Following are the precautions enumerated by Ryland as a complete preventative of filming:

1. No japan or bitumen black to be used on interior surfaces.
2. No pitch or beeswax to be used within the case.
3. All interior surfaces must be thoroughly cleaned and free from all animal matter such as finger marks. In the case of aluminum or other porous metal, heat treatment is necessary after machining to remove all trace of grease.
4. The lenses and prisms after ordinary cleaning to be dipped in hot running water with a pair of tweezers and wiped dry with clean linen (see 5 and 7) without being touched by the fingers again.
5. After washing the linen used for cleaning purposes, it must be well rinsed in hot water until all trace of soap is gone.
6. Dust must be removed with a clean camels hair brush and not by blowing.
7. The linen used for cleaning must be used in such a way that no part of it which has been touched by the fingers is brought into contact with the lens or prism surfaces.
8. All surfaces must be well polished and free from "orange peel" effect. If the pitch polisher leaves a trace of scum, a small quantity of glacial acetic acid added to the pitch when melted will prevent it."

While all writers do not agree that the above precautions will absolutely prevent film (Martin and Griffiths, Beck) there seems to be no doubt as to their being efficacious in most cases. In regard to the individual precautions, in some cases japan or bitumen do not appear to be at fault: "The black used by some American firms has not been found to be satisfactory in some instances,

and improvement had resulted in the use of a black with a reliable composition" (Jones). That precaution No. 3 is essential appears to be without dispute. Precaution No. 4, dipping lenses, after ordinary cleaning, is recommended by Martin and Griffiths, whose experiments show clearly its efficiency.

From the facts enumerated, the following conclusions can be drawn with some degree of assurance.

1. Filming, i.e., the formation of more or less isolated drops on the polished surfaces of glass instruments, is a result of the deposition of water contaminated by greasy matter.

2. Both water and grease are essential to the formation of film, and hence the utmost care must be taken to thoroughly clean the glass surfaces themselves, to ensure that no moisture or grease, or material which may yield moisture or grease, is contained in the space within which the glass surfaces are confined.

3. The glass should be of good quality, at least as good as Class 3 as determined by the iodeosine test.

GEOPHYSICAL LABORATORY,
CARNEGIE INSTITUTION OF WASHINGTON,
JULY, 1922.

A SUSPENSION TO ELIMINATE MECHANICAL DISTURBANCES

BY ALBERT P. CARMAN

The writer recently was stopped for weeks in an investigation by troublesome vibrations due to various causes, but principally to the passing of heavy motor trucks. The laboratory is a brick building with very heavy masonry walls and with numerous masonry cross walls, and delicate instruments are not in general disturbed by mechanical disturbance even in the upper stories, but heavy motor trucks rolling over neighboring brick pavements with their concrete foundations shake the earth for considerable distances and with it the whole building. These earth vibrations seem to be particularly troublesome in the basement. Numbers of devices were tried to eliminate the vibrations, including a modified Julius suspension, but without success. Finally attention was called to a paper by Airy (Royal Astron. Society Monthly Notices, 17, p. 160; 1856), which has suggested the solution which we have worked out for our difficulty. Airy devised a support for the mercury vessel of the reflex-zenith tube at Greenwich Observatory, using a series of platforms suspended by broad bands of vulcanized caoutchouc, platform number one, carrying the mercury vessel, being suspended from supports carried on platform number two, and this being in turn suspended from supports carried on platform number three. Fig. 1 shows our scheme. A series of triangular wooden boxes, *A*, *B*, and *C*, were loaded with scrap lead. Box *A* was suspended from a rigid support resting on the concrete floor by three fine piano wires *DDD*; the box *B* was suspended from supports on *A* by pure gum tubing *EEE*; and the box on platform *C* was suspended from supports erected on *B* by another size and length of pure gum tubing *FFF*. The platforms were also connected at a number of points by small rubber bands hooked over tacks, so as to dampen quickly swaying motions. On each piano wire, there was a cylindrical weight of about 500 grams that could be clamped at any desired

point on the wire, so as to eliminate some particular vibration which might be otherwise transmitted. The galvanometer rested on platform C. It is a high sensitivity Leeds and Northrup moving coil galvanometer of the ballistic type and is extremely sensitive to small mechanical vibrations. The device has proved to be effective in eliminating our vibration difficulties and it is reported here, with the thought that it may aid others who have

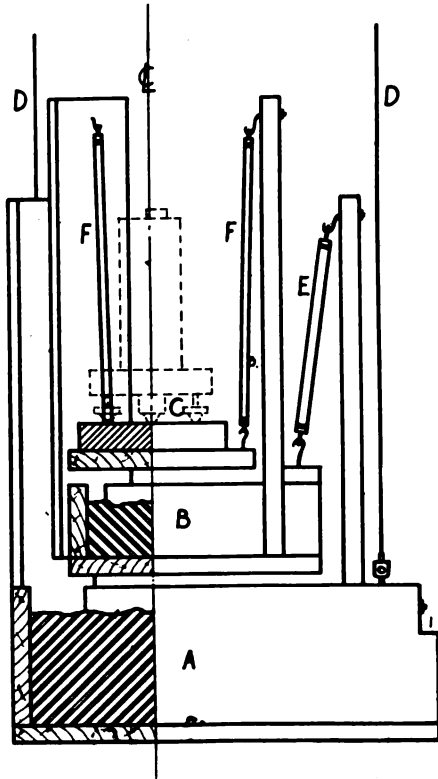

FIG. 1

similar disturbances. The device has the merit of being quickly and easily made, and of requiring no long tedious adjustment such as is demanded in setting up the usual Julius suspension. By changing lengths and sizes of suspension tubing and weights of platforms, and by adding one or more platforms, it ought to be possible to eliminate small vibrations in any case.

LABORATORY OF PHYSICS,
 UNIVERSITY OF ILLINOIS,
 MAY, 1922.

A FORM OF IRON CLAD THOMSON ASTATIC GALVANOMETER

BY B. J. SPENCE

ABSTRACT

A form of iron clad Thomson astatic galvanometer of high sensibility is described. It differs from the types described in the literature in that it is semi-portable, has a removable core containing coils and suspended magnetic system, has comparatively small weight and is easily adjusted to a high sensibility.

The early forms of the iron clad Thomson astatic galvanometer of high sensibility as used for radiometric study in connection with the bolometer or thermopile were bulky, heavy, and difficult to adjust for a maximum sensibility. The galvanometer has undergone a number of modifications diminishing somewhat the weight and bulk. More recently Coblenz¹ has designed a galvanometer of this type in which he has embedded the coils in soft iron. This galvanometer appears less bulky and is perhaps easier of adjustment than the earlier forms. In connection with the development of this galvanometer he has investigated the effect of coil construction, magnetic shielding, of different types of magnetic systems and of evacuating the region in which the system is suspended. For further details the reader is referred to the Coblenz article.

The writer has attempted the development of an iron clad galvanometer in which the coils and rotating magnetic system may be removed as a unit from the shielding and which may be adjusted to a high sensitivity with more facility than the earlier forms. The attempt has been also to embody in the design the results of the Coblenz investigation.

The four coils each 13 mm in diameter and 4 mm thick were wound on a mandrel whose surface was shaped approximately according to the expression of Maxwell.² Instead of winding the

¹ Bureau of Standards Scientific Papers, No. 282.

² Maxwell, *Electricity and Magnetism*, vol. 2, p. 360.

coils in sections of double silk covered wire, they were wound with 12 ohms of No. 36 B. S. gauge enameled wire, boiled in half and half (50% resin and 50% bees wax) removed from the mandrel and the faces covered with gold leaf. The four coils were mounted in the two sections of a split hollow brass cylinder 15 cm long, 16 mm outer diameter and 10 mm bore (see Fig. 1). At 45 mm and 60 mm respectively from the bottom of each section were cut two circular holes 14 mm in diameter into which were cemented the four coils. When the sections of the cylinders were placed together the centres of the faces of the coils were opposite each other and 1.5 mm apart. The leads from each coil were carried to the top of each section along the flattened surface of each cylinder. At the top of one of the sections of the hollow cylinder was a removable head containing a screw which carried the suspended magnetic system. The screw could be raised or lowered and rotated for adjustment of the position of small magnets relative to the centres of the coils. When the magnetic system had been suspended by means of a fine quartz fibre the second section of the cylinder could be set in place without danger of breaking the fiber.

The magnetic system consisted of two groups of six each of tungsten steel magnets 1.2 mm long and fastened to a fine glass staff with a trace of shellac. At 30 mm from the lower group of magnets was fastened a mirror 1 mm \times 1.5 mm. The system was magnetized and astaticized in the usual manner.

The shielding consisted of a cylinder of Swedish iron 18 cm long and 7.5 cm in diameter. Along the axis of the cylinder was bored a hole a trifle over 16 mm in diameter to a distance 4 cm from the bottom. A conical hole of small dimensions, 13 cm from the bottom was bored through the cylinder wall to the interior to observe the rotation of the mirror attached to the magnetic system. Over this hole was cemented a glass plate. After all machine work had been completed the cylinder was carefully annealed in an electric furnace and then kept away from contact with magnets. It was then mounted carefully on a suitable base with leveling screws. The coils and magnetic system were slipped into the shield and the whole properly adjusted until the magnetic

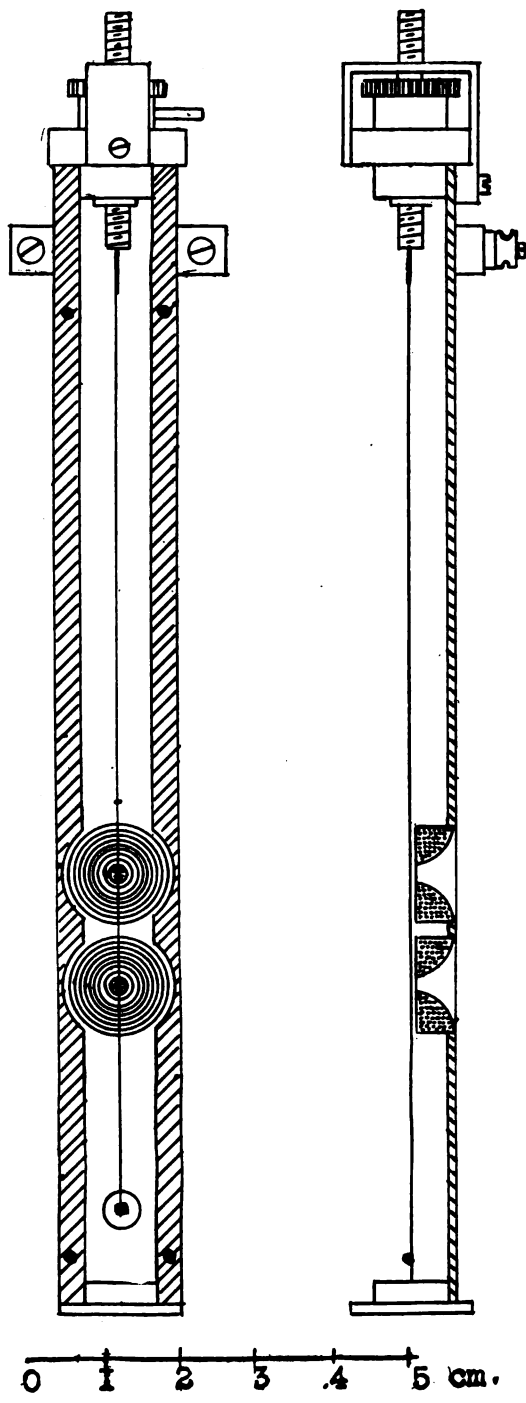

FIG. 1

system swung freely. The ease of this adjustment to a large extent depends upon the care with which the machine work has been done. If the axis of the core contained in the cylinder is perpendicular to the plane of the base the adjustment can be carried out by placing a good level on the base.

In order to control the zero and adjust the instrument for high sensitivity a weak magnet of watch or clock spring was covered with paper and shellaced and slipped about over the cylinder.

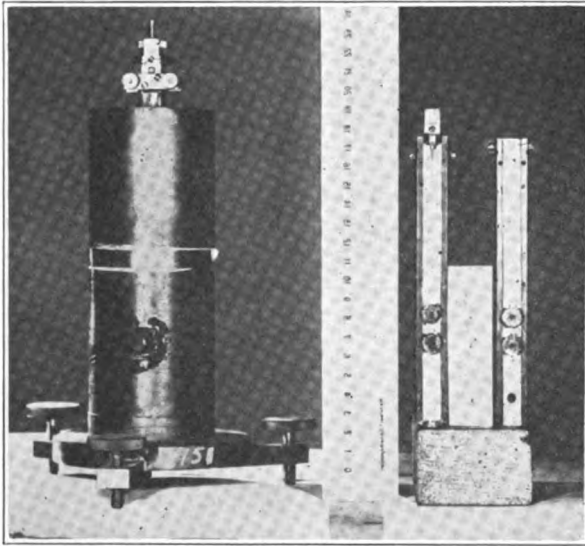

Fig. 2

By carefully manipulating this control magnet a high degree of sensitivity was attained in a comparatively short time. With this instrument of 3 ohms (coils in parallel) a sensitivity of 5×10^{-10} amperes with a scale at a meter distance could be attained readily. The period was about 1.5 seconds. The shielding appeared to be ample for this sensitivity. No zero drift manifested itself due to external magnetic disturbances. There was, however, considerable rapid zero fluctuation of about 2 mm due to building vibrations. These disturbances were amplified by the rotating system owing to the fact that the control magnet intro-

duced a non-uniform field in the core. A slight displacement due to building vibrations shifted the system slightly into a field of different strength and produced and amplified vibration of the system. The sensitivity was increased to 8×10^{-12} amperes with a period of 3 seconds by increasing the shielding and operating the system in vacuo. The additional shielding was made of a roll of stove pipe iron 20 cm wide with the turns separated by paper and then placed on the base concentric with the Swedish iron. A cap was cemented on top of the Swedish iron shield and the pressure in the core lowered to 1 mm.

In conclusion it may be stated that a semi portable form of iron clad Thomson astatic galvanometer of high sensibility has been developed which is comparatively simple of construction, has small bulk and is comparatively easy to adjust. It had embodied in it the feature of removable core containing system and coils. I am indebted to Mr. F. Kung, our mechanician, who patiently worked out many details of the instrument.

NORTHWESTERN UNIVERSITY,
JUNE 7, 1922.

A LOW VOLTAGE CATHODE RAY OSCILLOGRAPH

By J. B. JOHNSON

ABSTRACT

A sensitive cathode ray oscillograph tube is described which operates at a low voltage. The electron stream comes from a thermionic cathode, and is focused by the action of the ionized gas in the tube. Illustrations show examples of the use of the tube.

A cathode ray oscillograph tube operating at a comparatively low voltage was described by the writer some time ago before the American Physical Society.¹ Since then, the tube has been further improved and its operation studied so that now both the structure of the tube and the principles which have made the construction possible can be described in greater detail.

In the older types of Braun tubes the electron stream is produced by a high voltage discharge through the residual gas in the tube. This requires a source of steady potential of from 10 000 to 50 000 volts, an installation which is expensive, non-portable, and dangerous. In the new type of tube the low voltage operation has been obtained by the use of a Wehnelt cathode as the source of electrons, so that the lower limit of voltage is set by the effect of the electrons on the fluorescent screen and not by the voltage needed to obtain the electrons. At 300 volts the electrons produce quite bright fluorescence on the screen and the tubes are therefore designed to operate at 300 to 400 volts.

The external appearance of the tube is shown in Fig. 1. The electrodes are located at one end of the pear-shaped bulb, and the fluorescent material is deposited on the inside of the larger, flattened end. The tube is provided with a base which fits into a bayonet socket such as is used for vacuum tubes, and all the connections are made through the base. There are two orthogonal pairs of deflector plates inside the tube for electrostatic deflection, while magnetic deflection is produced by applying a field from the outside.

¹ *Phys. Rev.* (2), 17, p. 420; 1920.

The internal structure differs considerably from that of previous forms of Braun tube and it will therefore be described somewhat fully.

THE FOCUSING

In some forms of Braun tube a sharp spot has been secured by using a very high voltage, and therefore high electron velocity,

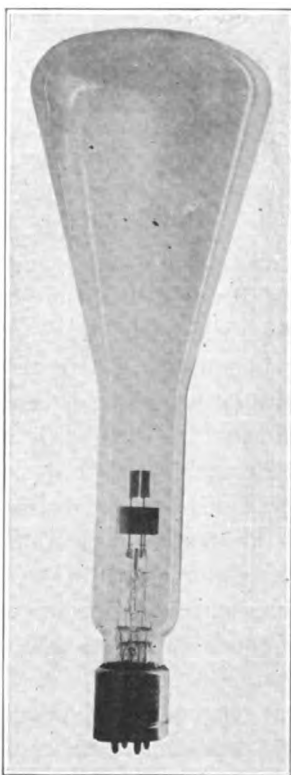

FIG. 1. The Cathode Ray Oscillograph Tube

so that after the electrons have passed through one or two fine apertures to make the beam parallel there is not time enough for the mutual repulsion to spread the beam again appreciably before the electrons strike the screen. With other tubes an external

“striction” coil has been used which maintains a strong longitudinal magnetic field in the region between the anode and the cathode and which brings the electrons to a focus on the screen. In the low voltage tube the spreading of the electron stream is greater than in high voltage tubes because of the greater time during which the mutual repulsion of the electrons acts, so that some means of focusing must be used. The electrons can be brought to a focus by a longitudinal magnetic field so adjusted that each divergent electron makes very nearly one complete turn of a spiral and in travelling the length of the tube returns to the axis at the screen. In this way a very sharp spot can be produced, but the sensitivity of the beam to deflection is reduced very much by the directing magnetic field.

The method of focusing that is used in the present tubes grew out of the suggestion by Dr. H. J. van der Bijl, that a small amount of gas be introduced into the tube. This gas, at a pressure of a few thousandths of a millimeter of mercury, serves to reduce to 1 mm diameter a spot which would be 1 cm across in a high vacuum tube. The sharpness of the spot depends also upon the current in the electron stream so that the focus may be controlled by the cathode temperature. The mechanism of this focusing action will be explained later.

The presence of this slightly ionized gas also serves the purpose of preventing the accumulation of charges on the glass, and it provides for the discharging of the fluorescent screen so that the electrons can drift back to the metallic circuit.

THE ELECTRODE UNIT

With gas present in the tube, steps have to be taken to guard against arcing and the injurious effects of positive ion bombardment on the cathode. This is done by making the volume of gas surrounding the electrodes very small. For this purpose the cathode and anode, themselves small, are sealed into a short and narrow glass tube so that the volume exposed to both electrodes in common is less than 1 cm³. All paths between the electrodes are then so short that at this low pressure there is not sufficient ionization to build up an arc.

The structure of this unit, or "electron gun" is shown in Fig. 2. The cathode, *f*, is an oxide coated platinum ribbon of the same kind as the filament in our audion tubes. The anode, *a*, is a thin platinum tube 1 cm long and 1 mm in diameter, one end of which is about 1 mm from the top of the filament loop, the other end opening into the main tube towards the fluorescent screen.

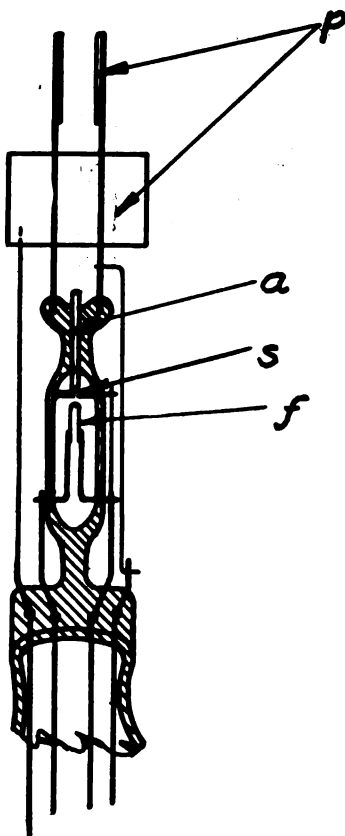

FIG. 2. The Electrode Unit

Between the cathode and the anode and connected to the cathode is a metal shield, *s*, with a small aperture through which the electrons must pass in going to the anode. Nearly all of the electrons must then go to the inside of the tubular anode, and a

small fraction of them passes through the whole length of the anode and form the beam in the main part of the tube.

The deflector plates, p , are also mounted rigidly on this unit. In order to avoid large differences of potential in the tube, one plate from each pair is permanently connected to the anode, the variable potentials being applied to the other plates. The complete unit is mounted at the small end of the tube with the anode and deflector plates toward the fluorescent screen.

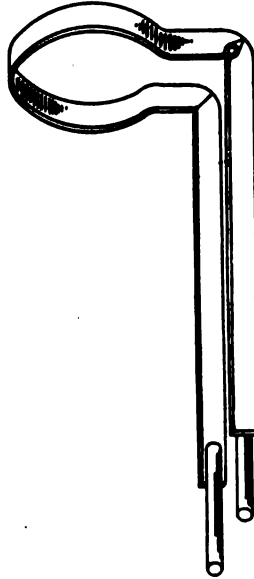

FIG. 3. The Thermionic Filament

THE FILAMENT

In some early forms the filament was bent into a simple hair pin loop which was placed close to the aperture in the shield. It was then found that the positive ions striking the filament from the direction of the anode soon destroyed the oxide coating and left the filament inactive. This trouble was largely overcome by placing the filament out of the direct path of the positive ions. The flat filament is now shaped into a ring as shown in Fig. 3, slightly larger in diameter than the aperture in the shield and is

placed coaxial with the anode. The momentum of the positive ions then carries them past the active part of the filament and they strike where little damage can be done. The length of service of the tube is still limited by the filament life, but this has been increased by the above artifice so that the tube now gives around 200 hours of actual operation.

THE DEFLECTOR ELEMENTS

The deflector plates are made of German silver, which is non-magnetic and which has a high specific resistance that diminishes the effect of eddy currents when magnetic deflection is used. The plates are 13.7 mm long in the direction of the tube axis and the separation between them is 4.7 mm.

The sensitivity of the tube is such that the deflection of the spot is about one mm per volt applied between the deflector plates. When using magnetic deflection, a pair of coils 4 cm in diameter placed on the sides of the tube at the level of the deflector plates produce a deflection of approximately 1 mm per ampere-turn flowing in the coils.

The electrons striking the screen drift back to the anode structure, and most of them are collected by the deflector plates. There is also a small ionization current flowing to the plates. The tube is therefore not strictly an electrostatic device, and this must be kept in mind when using it. Fig. 4 shows the current flowing to the two free plates at various voltages with respect to the anode. With the large positive values of plate voltage the current to the plates is practically equal to the current in the electron stream and consists largely of the returning electrons. The small current in the other direction when the plate voltage is negative is a measure of the ionization in the tube.

THE FLUORESCENT SCREEN

The screen is spread on the inner surface of the large end of the tube, using pure water glass for binder. The active material consists of equal parts of calcium tungstate and zinc silicate, both specially prepared for fluorescence. This mixture produces a generally more useful screen than either constituent alone. The

pure tungstate gives a deep blue light which is about 30 times as active on the photographic plate as the yellow-green light of the silicate, while the silicate gives a light which is many times brighter visually than that from the tungstate. By mixing the two materials in equal parts a screen is produced which is more than half as bright visually as pure zinc silicate and more than half as active photographically as pure calcium tungstate.

For mechanical strength the end of the bulb which carries the screen is rounded outwards so that the screen is not a plane sur-

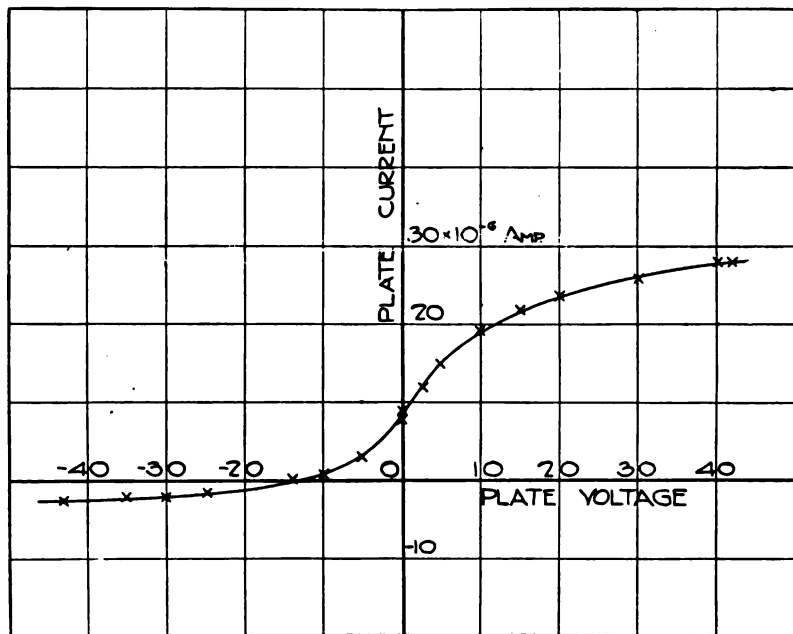

FIG. 4. Current to Deflector Plates

face. This introduces a distortion of the fluorescent pattern which in most instances is negligible. If the pattern is recorded by a camera whose lens is D cm. from the end of the tube, then the apparent reduction of the deflection produced by the curvature of the bulb is given in terms of the deflection y approximately by

$$\Delta y = \frac{20 + D}{400D} y^3 \text{ cm.}$$

THE FUNCTION OF THE GAS

The part which the gas plays in focusing the beam of electrons is an interesting phenomenon which depends upon the difference in the mobilities of electrons and positive ions. The electrons of the beam are pulled toward the common axis by a radial electric field produced by an excess of positive electricity in the electron stream and an excess of negative electricity in the space outside the beam. This distribution is produced as follows. Some of the electrons of the stream, in passing through the gas, collide with gas molecules and ionize them. Both the colliding electrons and the secondary electrons leave the beam but the heavy positive ions receive very little velocity from the impact and drift out of the beam with only their comparatively low thermal velocity. Positive ions therefore accumulate down the length of the stream and may exceed in number the negative charges passing along. At the same time, electrons are moving at random outside the stream, producing negative electrification. There is then a field surrounding the stream which tends to pull the electrons inward. If there were only the mutual repulsion between the electrons to compensate for, this would be done when the number of positive ions in the beam equals the number of electrons. There is in addition an original divergence of the beam which must be overcome. If this divergence is assumed to be one degree from the axis and the electron current 2×10^{-5} amp, then a simple calculation shows that the radial field required to pull the beam to a focus at the usual distance is about one volt per cm. This field strength is produced, with beams of the ordinary intensity, if there are four positive ions for each electron in the stream, a condition which seems not unreasonable.

The number of ions per electron in the stream is probably constant as the current in the stream is varied, since the conditions of collision and recombination are not altered. When the current is increased, therefore, the total positive ionization of the beam increases, the field around the beam becomes stronger, and the electrons are brought to a focus in a shorter distance.

These deductions have been confirmed experimentally. That the focusing of the stream depends upon the current flowing

was one of the earliest observations made in developing the tube and this method had been used ever since to obtain a sharp spot. The point of convergence can be seen moving in the manner expected when the current is changed, and the effect has been further verified by using a tube with a movable fluorescent screen so that the length of the electron beam could be varied. The presence of the electric field around the beam was shown by the effect of two beams on each other, in a tube in which there were two electron streams crossing each other at right angles at their mid-points, each falling on a fluorescent screen. When one beam was moved away from the other by a field between the deflector plates, the second beam moved as if attracted by the first. The directed electrons in each beam were attracted toward the positive ionization in the other, and for one particular adjustment of the tube the displacement was such as would have been caused by a field of about 3 volts per cm, a result not far different from that previously calculated.

Since the beam must produce its own positive ionization some time must elapse before it can produce by collisions the required number of positive ions. Calculation shows this time to be of the order of 10^{-6} second. When the beam moves it has to build up the ionization as it goes along, and we should expect that when deflected very rapidly it might no longer be focused, due to lack of positive ions in its path. A test was made of this by applying a high frequency potential on the deflector plates so that the spot described an elliptic pattern. At a frequency of 10^5 cycles per second the line was still sharp, but at 10^6 cycles there was a noticeable widening of the line which is probably to be ascribed to imperfect focusing at this high speed.

In these experiments the evidence all points to the view that the focusing of the electrons is caused by an excess of positive charge in the beam itself, produced by the ionizing collisions of the electrons with the gas molecules. Further confirmation is found in the fact that a focus is much more readily obtained in the heavier gases having slow molecules, such as nitrogen, argon or mercury vapor, than in hydrogen and helium where the mean velocity of the molecules is greater. The tubes are therefore

filled with argon, the heaviest available permanent gas which does not attack the electrodes. The best pressure for the length of tube adopted and for the current which can be obtained in the beam is 5 to 10 microns, and this leaves considerable latitude for the adjustment of the electron current to get a sharp focus.

EXAMPLES OF THE USE OF THE TUBE

Because of the small amount of auxiliary apparatus required with this form of Braun tube it has proved to be a very convenient

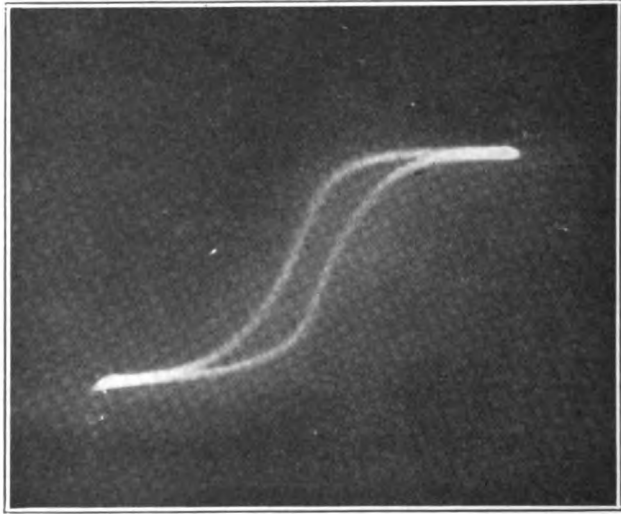
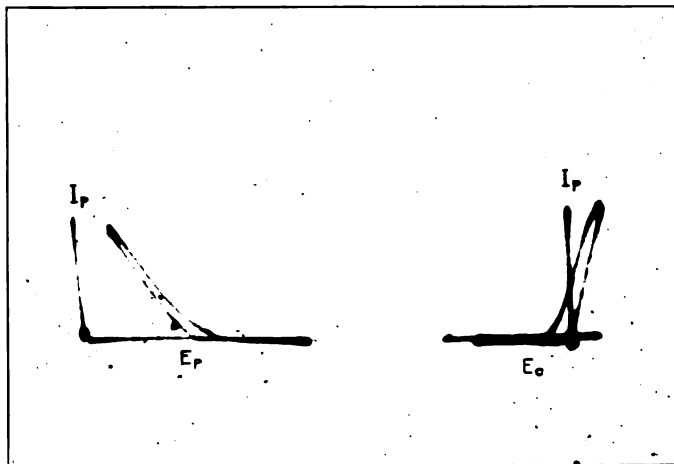

FIG. 5. Iron Hysteresis Curve

laboratory instrument. It has found application in studying the behavior of vacuum tubes and amplifier and oscillator circuits, of gas discharge tubes, of relays, and of numerous other kinds of apparatus, both at low and at high frequencies. Some reproductions of photographs of various types of curves are given below to illustrate the kind of results which are possible with this oscillograph.

Fig. 5 shows the hysteresis curve of a sample of iron wire. The wire was placed in a small solenoid with one end toward the side of the tube. The magnetizing current passed through a resistance,

the voltage drop of which was applied to one pair of deflector plates so as to give a deflection proportional to the magnetizing field. The stray magnetic field from the iron itself produced the deflection proportional to the induction. Alternating current was used, and the exposure was 20 seconds with lens opening f 6.3 and speed roll film.



a b
 FIG. 6. Characteristics of Oscillating Vacuum Tube

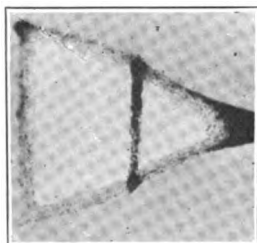

FIG. 7. Modulation of High Frequency Current

In Figs. 6a and 6b are shown the current-voltage relations of an oscillating vacuum tube. The axes were obtained by grounding one or the other deflector element.

The measurement of modulation in a radio transmitting set has been reduced to a fairly simple process by means of the cathode ray tube. The low frequency modulating voltage, controlled by the voice, is applied to one pair of deflector plates, while the radio frequency output, with amplitude varying according to the low frequency voltage, is applied to the other pair of deflector plates. The resulting pattern on the screen is a quadrilateral of solid fluorescence, since the two frequencies are not commensurate. The two vertical sides indicate the greatest and the least amplitude of the high frequency, while the other two sides show the current-voltage characteristic of the transmitter. Fig. 7 shows such a pattern (retouched), the edges being much brighter than the center. The exposure was two minutes using a Seed 23 plate and f 6.8 lens opening.

RESEARCH LABORATORIES OF THE
WESTERN ELECTRIC CO., INC. AND THE
AMERICAN TELEPHONE AND
TELEGRAPH COMPANY
NEW YORK CITY

SPECIFICATIONS FOR RECORDING VAPOR-PRESSURE THERMOMETERS AND FOR PRESSURE GAGES

BY FREDERICK J. SCHLINK

The specifications for recording thermometers and for reference standard pressure gages, the first of which are presented below, are believed to be the first specifications applying to these instruments ever published, although with respect to pressure gages of the more usual or service types, some codes of specifications more limited to constructional arrangements and details have been available heretofore. The present specifications for service pressure gages will be found to differ from existing codes in many important essentials, and to extend the scope and precision of specified requirements to a significant degree. Points of marked difference from common practice will be noted in the following: the zero stop pin eliminated, permitting secular changes of the Bourdon tube to be noted on the dial, as they occur; graduation circles required to fill substantially the whole dial diameter; the rated maximum pressure capacity established as the actual upper operating limit of the gage, rather than 100% higher, as is now a common practice with some makers; anomalous graduations in the zero region of the dial eliminated (for instance, four graduations in the first five pound interval have been almost the regular practice in American made gages, following some traditional error of an early gage maker; the present specifications prefer to permit omission of these first few graduations, in the region where the scale factor is not constant, and backlash is a special source of difficulty). Other points are the restriction of the radial length and thickness of graduation lines so as to increase the accuracy of readings; and the basing of the tolerances of error on the value of the minimum graduation. This latter, in a very real sense, the maker holds out as a measure of the precision of his instrument and to this therefore the tolerances should be clearly related

when once the user has decided how small the minimum graduation need be to meet the requirements of his service. It may be said in passing that the tolerances herein set down are perfectly practical and attainable ones in respect to new gages of good manufacture with the types of graduation customary in the United States (40 to 80 graduations in 270° of arc). Considerable purchases have been made under the requirements of these specifications at little or no increase in price, but with a very significant increase in quality over the ordinary product, which experience and extensive investigation have shown to be surprisingly variable as between different makers and even between different samples of a given maker's product.

These specifications were used to control purchases of all instruments of the types named, employed in production departments of the Firestone Tire and Rubber Company at Akron, Ohio; and the marked success met with in their application in spite of the radical changes in construction and details which in some respects they require, has led to their publication in the hope that they may be of general interest and utility.

The degree of precision attainable with properly selected instruments of these two types under proper conditions of use, is quite surprising, and such as to make them adaptable to many of the uses of the physicist. For instance pressure gages, when used under proper cyclicization before reading, or when jarred energetically by a securely mounted buzzer, can give results accurate to $\pm 0.1\%$ under laboratory conditions when a calibration curve is used; while a recording thermometer of the vapor-pressure type, meeting these specifications in all essentials, will record temperatures over a limited range, say 25° , within $\pm 0.1^\circ$ C, when a calibration curve is used, and the instrument is occasionally checked at some convenient reference temperature. In fact there are applications wherein the vapor-pressure recording thermometer, in view of its freedom from variable stem immersion errors, may afford a net accuracy definitely superior to that of a good mercurial thermometer.

JUNE 25, 1922.

SPECIFICATIONS FOR VAPOR-PRESSURE TYPE RECORDING
THERMOMETERS AND CHARTS

June 11, 1920.

1. GENERAL REQUIREMENTS

a. *Type.* These recording thermometers shall be of the vapor pressure type, so as to be substantially unaffected in their readings by the temperature of the tube connecting the bulb and the registering element.

b. *Use.* These recording thermometers are to be used to determine the temperature of (here define conditions of use fully and specifically to permit of proper design and choice of material of bulb, etc.)

2. IDENTIFICATION OF INSTRUMENTS

a. Each recording thermometer shall be equipped with an identification plate plainly visible without requiring the removal of any part of the mechanism, on which shall be clearly and permanently inscribed: the type and maker of the instrument; the month and year of manufacture; the range of registration; identification number of the chart used; and the intended relationship between the elevation of the bulb and that of the recording element. The information furnished shall be at least as complete as in the following specimen:

Recording thermometer, vapor-pressure type.
Maker: The Jones Company—Mar. 1919, (or 3-'19.)
200–300°F. Chart 721.
Bulb 10 ft. below Bourdon Tube.

3. CASE CONSTRUCTION

a. *General.* The construction of the case, in respect to strength, rigidity and dust tightness, shall be the equal of that used on ——— recording thermometers, as described and illustrated (name catalog and page or other defining reference).

b. *Door and Hinge.* The door hinge shall be of strong and durable construction with an adequate amount of metal to withstand such bending and twisting strains as the door may commonly be subjected to in plant service. The door shall be equipped with plate glass of good quality so set into the door frame as to comply substantially with the requirements as to dust tightness provided for above. The hasp and staple of these recording thermometers shall be adapted to take, easily, a lock having a staple diameter of $7/32''$, the radius of the center line of this lock staple being approximately $5/16''$.

c. *Finish.* The surface finish of these instruments shall be neat and shall afford a protective coating of such thickness and durability as to protect the material of the case from the effects of moisture and abrasion in reasonable plant service.

d. *Holes for Mounting.* These recording thermometers shall be provided with at least three screw holes approximately 0.25 inch in diameter, by which the instrument may be secured to a supporting surface. If the case is of circular outline, the screw holes shall be spaced at equal angles, one of these holes to be located exactly at the top or bottom position.

4. RESPONSIVENESS

a. *Time response.*

The time-quickness of response of these recording thermometers to changes of temperature shall be the maximum possible without requiring too great reduction of

the bursting strength of the bulb. The minimum wall thickness and maximum heat conductivity of the bulb shall be employed consistent with the requirements of strength, corrosion resistance, and other essentials.

b. Temperature response.

These recording thermometers shall respond to a change of temperature of 0.3°F. or less; that is, the passiveness, as defined on page 745 of Bureau of Standards Scientific Paper 328¹ shall not exceed 0.3° F. over the temperature region between ——— and ———° F. The present specification refers to the minimum change of temperature as the result of which the instrument will show a discernible change of indication, regardless of the direction or amount of the antecedent movement of the recording pen. This factor is to be clearly discriminated from that covered by the preceding specification, which refers to the promptness of response.

5. ARRANGEMENT OF BULB

a. The sensitive and active portion of the bulbs of these recording thermometers shall be so constructed and so isolated by the distance of their projection beyond the union or by necking down of the bulb wall back of the bulb or by these and other suitable means,—from the remainder of the instrument tubing and connections, that when the bulb connection is screwed within a standard pipe fitting or the walls of a vessel containing saturated steam in movement past said bulb, the temperature readings will be substantially unaffected by the temperature of the walls of the vessel at and adjacent to the point where the bulb fitting is applied. The maker shall specify the minimum radial distance to be provided around the bulb when the stem is screwed longitudinally into a standard pipe fitting in order that the temperature readings will not be affected to the extent provided for in the tolerance hereinafter to be specified. No separable sockets are to be furnished or used in calibration. A union, to avoid the necessity of twisting the capillary tubing in applying the instrument, shall be provided, of standard pipe thread size not in excess of $\frac{3}{4}$ ".

6. ARMORING OF CAPILLARY

a. The protecting armor, if any is employed, around the capillary tube, shall be similar and equal to that used in the ——— Company's flexible, bronze-armored capillary tubing. Protecting armor will not be essential provided that a sufficiently rugged solid wall copper or bronze tube of reasonable flexibility is furnished, subject to prior approval of sample by the purchaser. The capillary tube and its armor, at the point where these enter the case of the instrument shall be reinforced and rigidly and permanently secured to the case in such a manner as to protect the capillary tube from strains of a character likely to deteriorate or otherwise damage it.

7. CLOCKS

a. The clocks to be furnished in these recording thermometers shall be of such construction that they will run at least 50 hours on one winding and during the first 24 hours of running their deviation from correct time shall not exceed 5 minutes at a temperature of 80° F., while during the second 24 hours the deviation shall not exceed 10 minutes. The clock movements shall be enclosed in dust-tight metallic boxes within the case of the recording thermometer.

¹ Variance of Measuring Instruments and its Relation to Accuracy and Sensitivity, by the present author.

8. RECORDING PENS

a. The pens of these recording thermometers shall be of the V-type and shall be made of material that will not corrode under the action of an ink composed of an aqueous and glyceric solution of dye. These pens shall be accurately and carefully finished and rigidly and neatly secured to the pen arm. The means of attachment of the pen to the pen arm is preferably to be one that will permit of removal without the necessity of unsoldering a joint.

9. QUALITY OF RECORD

a. The pen line drawn by these recording thermometers shall be of uniform width not exceeding .005 inch and the pen shall draw a full, solid line at any speed of travel relative to the chart not exceeding 2 inches per minute.

10. PEN ARM LIFTER

a. These recording thermometers shall be equipped with a pen lifting device so constructed and positioned that the chart may be readily removed without danger of straining the pen movement or pen arm, and operating so as to return the pen to the recording position automatically on closing the door of the case.

11. PEN ARM ADJUSTMENT

a. The pen arm adjusting device used on these recording thermometers shall be of such construction that it will require no lock nut or equivalent device. Its movement shall be sufficiently stiff, or so restrained by the action of a split nut or screw or other permanently effective means, that it can be accurately controlled in its movement, and will maintain its setting permanently.

12. ATTACHMENT OF CHART CLAMPING SCREW

a. The chart clamping screw or other device used to secure the chart to its driving arbor, shall be loosely connected to a fixed part of the case of the recording thermometer, by a convenient length of chain, so as to prevent inadvertent loss of this screw during the chart-changing operation. This chain must be so arranged as not to interfere in any way with the movement of the recording pen, or the clock arbor, or with the closing of the case door.

13. ACCESSORIES

a. Each recording thermometer shall be accompanied by 100 charts of the proper type, one bottle of non-corrosive, slow-drying ink, and a clock winding key. No padlocks or other locks for the cases are to be supplied unless specifically stated in the order.

14. CHARTS

a. *Paper and Printing.* The charts shall be made of a quality of paper such that excessive alteration of dimensions with changes in atmospheric humidity, and lateral spreading of the record line, will not occur. The arrangement and numbering of lines and graduations shall be such as to afford a maximum of ease and accuracy in reading. Preference will be given to charts printed in olive green or gray or other neutral tint.

b. *Centering.* There shall be no measurable difference between the diameter of the centering hole of the chart and that of the arbor or spindle upon which it is mounted when in use on the instrument. The burring of centering holes or of peripheries in any charts or eccentricity of punching in excess of .003 inch, will constitute cause for rejection of the whole lot of which they form a part.

15. TOLERANCE

a. These recording thermometers shall exhibit no error at any point of their graduated scale, due to any cause, greater than $\pm 1^\circ\text{F}$.; nor greater than $\pm 0.5^\circ\text{F}$.² at any single point of their range of graduation specified in the order; provided that in respect to the former value no tolerance smaller than that equivalent to .03 inch of pen movement and in respect to the second value no tolerance smaller than that equivalent to .015 inch of pen movement, shall be applied.

16. PERMANENCE OF ADJUSTMENT

a. The quality and aging of the Bourdon tubes shall be such that no secular change of reading at a given temperature subsequently applied, greater than that equivalent to .015 inch of pen movement, will occur during an interval of one month, during which the instrument is out of use or in stock. Moreover when subjected to an oscillatory temperature test having an amplitude between the innermost graduation of the chart and an upper limit lying 10°F . or more below the outermost graduation circle carried out at a rate not to exceed one cycle every five minutes, over a period of twenty-four hours, these instruments shall develop no errors in excess of the tolerances provided in the foregoing specification.

AMERICAN ENGINEERING STANDARDS COMMITTEE,
29 W. 39TH ST., NEW YORK CITY.

² These limits applicable, like that in Specification 4-b, to instruments operated through a temperature interval not exceeding 250°F . For larger intervals of indication, the tolerance will need be proportionately increased.

SIEVE TESTING APPARATUS

BY L. V. JUDSON AND R. E. GOULD

There has recently been developed at the Bureau of Standards a new projection apparatus intended primarily for the testing of sieves, but readily adaptable to various other purposes.¹

The Bureau has found by experience that in testing sieves for conformity to the "Standard Specifications for Sieves," the most reliable results are obtained by measuring the wire diameters and determining the number of wires per centimeter, and then computing the opening by the formula

$$O = \frac{10}{N} - W$$

where O = average opening in millimeters

N = number of wires per centimeter

W = average diameter of the wires in millimeters.

Until recently the wires have been measured directly by means of a micrometer microscope. As this process is both tedious and fatiguing to the eyes, a better method was sought. The projection method developed is much quicker and much less wearing on the observer than was the method formerly used. Measurements can be taken on any number of the warp and of the shoot wires of the cloth, and the cloth also examined for maximum openings in a small fraction of the time formerly required.

The final development of this apparatus consisted of several steps: The construction of a suitable light-tight box of proper dimensions; the selection of a microscope combination to give the best general results, of the light source and its location, and of the screen on which the image is cast; the development of a method of measuring this image so as to avoid parallax, of a means of reducing to a minimum the color bands on the edge of the image, and of

¹ The final form of this apparatus was developed after seeing photographs of a projection apparatus developed by Mr. Schoof of the Greenfield Tap & Die Corporation.

a device for focusing and for moving the sieve at right angles to the beam of light. The apparatus at present consists of a light-tight box about 40 cm square and a meter long with a microscope mounted on one end and a ground glass plate 2 mm thick in the other end. The source of illumination is a microscope illuminator containing a concentrated filament lamp, 6 volts, 108 Watts, connected through a transformer to a 110-volt alternating current supply circuit. The light passes through a lens in the end of the illuminator and is focused on the objective of the microscope.

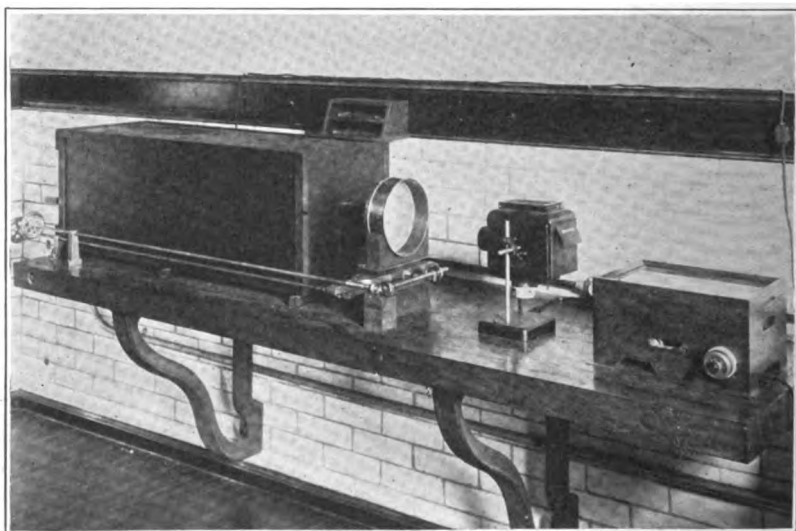

FIG. 1. Sieve Testing Apparatus

After passing through the microscope it diverges to the ground glass plate which is mounted with the ground side in. A 50-cm steel scale is mounted against the inner face of the ground glass screen in such a way that the graduations of the scale may be seen through the glass. The position of the scale allows a direct reading on the edges of the image cast by the wire of the sieve and avoids parallax due to the thickness of the glass. It was found that by oiling the ground surface slightly, the visibility was greatly increased without diminishing the distinctness of the image.

A frame for holding the sieve is placed on a platform so ar-

ranged as to permit a lateral motion of about 8 inches, and also motion at right angles for focusing. Long rods, extending to the end of the apparatus at which the observer is seated, enable the observer to move the sieve without leaving his place, the lateral motion being accomplished by means of a rack and pinion and the focusing by the use of beveled gears. A green filter is held before the objective by means of a clamp fastened to the tube of the microscope. The filter relieves eye strain very considerably and practically eliminates the color bands otherwise appearing on the edges of the image.

In use, the sieve is mounted in its holder on the focusing platform, between the illuminator and the objective of the microscope, and is focused by the observer until a sharp image is seen on the ground glass. Measurements are then taken in millimeters by reading the positions on the steel scale where the two edges of the image of the wire cross it, a reading glass being sometimes used. The sieve is then moved across the field, readings being taken at several places on the cloth, until the whole diameter of the sieve has been covered, care being taken at the same time to watch for the uniformity of spacing and to measure any excessively large openings. The sieve is then rotated through 90° and the process repeated.

The magnification of the apparatus may be determined by placing a standard wire of known diameter in place of the sieve and making several readings on its image. This should be done at least twice a day to guard against any possible change in magnification while the apparatus is being used.

By using a microscope having a tube about 15 cm long and an eyepiece with a magnifying power of approximately three diameters, together with a 16 mm objective, a magnification of about 260 diameters is obtained. This is found to be very satisfactory for the fine-mesh sieves. Measurements good to 0.2 mm can be made of the image as seen on the ground glass plate, individual readings repeating to 0.5 mm or better. This gives an accuracy of better than 0.001 mm for the average wire diameters and width of opening.

BUREAU OF STANDARDS,
WASHINGTON, D. C.,
JULY 24, 1922.

THE FILM METHOD OF MEASURING SURFACE AND INTERFACIAL TENSION

BY A. W. FAHRENWALD

Many methods of measuring surface tension are available. The most important among them are (1) the drop-weight method (2) the capillary rise method (3) the Jaeger or capillary bubble method (4) vibrating jet methods (5) methods measuring the tension required to detach a ring, sphere or disc from the surface of the liquid, and (6) the film method.

More attention has been given to the drop-weight method than to any one of the other methods mentioned. The work of Morgan, Richards, Ferguson and of Harkins and his students has resulted in a high refinement and reliability of this method. However, it should be pointed out that there are factors that enter into its accuracy that cannot be overlooked if trustworthy results are to be obtained. They are (1) the rate of dropping (2) the diameter, shape, and material of dropping tip, and lastly the proper corrective factors must be applied if absolute figures are desired. Further the drop-weight method measures the tension in relatively fresh surfaces, and it is, therefore, not satisfactory when the tension of relatively older surfaces is desired. A method that measures the tension of fresh surfaces is not nearly as sensitive to slight changes in interior concentration of a liquid as one that measures the tension in older ones. Another serious objection to the drop-weight method when working with many liquids, each having different rates of adsorption of certain surface tension lowering constituents in its surface, is the strict requirement of rate of dropping. Even though the rate of dropping be absolutely constant for all measurements there is still the uncertainty of reliability of the relative value of the results due to the different rates at which the different substances go into the water surface. For the above reasons it proved to be unsatisfactory in working with oil and water emulsions and solutions in the determination of oil adsorption by minerals.

The second method is accurate but considerable skill and care are required in making measurements by its use. Clean and uniform capillary tubes and zero contact angles are pre-requisites. It is rather slow and is not a good method for every day laboratory work.

The Jaeger or capillary bubble method¹ depends on the measurement of the maximum pressure required to force out a bubble of gas from a capillary tube whose circular knife edge opening dips just below the surface of the liquid. As Ferguson² has pointed out, this method is more accurate than the capillary rise method.

Ferguson's work was on pure liquids and it is doubtful if this statement would apply in the case of liquids containing contaminants.

As with the drop-weight and vibrating jet methods, it measures the tension of fresh surfaces only. The tension in an old surface in which adsorption of the surface tension lowering constituent has been partially or entirely complete, cannot be determined by this method. It is therefore unsuitable for determining the adsorption of oils by minerals where the surface tension method is used.

To illustrate how the surface tension of an oil-water emulsion depends upon the age of the surface the following figures are given for the surface tension of an emulsion of a steam-distilled pine-oil in water (23 mg in 100 cc water) by three different methods:

Jaeger Method	65	dynes at 20° C
Drop-weight Method	63	“ “ “ “
Film Method on circulation ³	57.5	“ “ “ “

¹ "Investigation on Temperature Coefficients of the Free Surface Energy of Liquids." Part I Methods and Apparatus F. M. Jaeger, *Verstag Akad. Weten Schap-pen*, 23, 330-65; 1914.

² "Surface Tensions of Liquids in Contact with Different Gases." *Phil. Mag.*, 28, Series 6, p. 403; 1914.

³ The surface tension of an oil-water emulsion is brought to equilibrium by circulating the emulsion with a pipette. The emulsion is drawn up a number of times, into the pipette and allowed to discharge under the surface of the emulsion. This gives efficient circulation to the body of the emulsion without disturbing the surface film. This treatment is necessary with all oil-water emulsions, in order to get readings that can be duplicated. It takes from 1 to 15 circulations to bring the surface to a point where the surface tension remains constant.

To further illustrate the advantage of the film method over the other two methods for the determination of adsorption of the oil from the above emulsion by minerals the following experiment is given:

Oil in Water mg	Surface Tension of Emulsion		Difference	Method
	Before Treatment Dynes	After Treatment Dynes		
23	65.0	65.2	.2	Jaeger Drop-Weight Film
23	63.0	65.3	.3	
23	57.5	60.5	2.0	

In many cases the Jaeger method will not show more than from .1 to .3 dynes increase in the surface tension of an emulsion before and after adsorption of some of the oil by mineral particles.

Vibrating Jet methods are entirely unsuitable for general work.

Methods under (5) give values in all cases higher than the actual surface tension. To obtain theoretical values a complicated formula has to be used. The reason is, that a column of the liquid is raised, by the ring or bar, above the surface of the liquid and in the case of a ring or bar values higher by from 1 to 10 per cent of the tension in the surface, depending upon the thickness of the edge pulled from the liquid, will be obtained.

Fig. 1 shows what happens when a straight edge is pulled from the surface of a liquid that wets it. The liquid in the portions *a*, raised above the plane surface of the liquid is that due to capillary attraction of the liquid for the metal and is a measure of the tension in the liquid film. The liquid in the rectangular portion *b* is due to the attraction of the metal plate for the liquid molecules and the width and weight of this hydraulic column depends upon the thickness of the edge pulled from the surface, and surface tension measurements are too high by amounts which increase with the thickness of the edge used. For an edge ground to the thinness of a safety razor blade, the surface tension for water as measured by this method will be approximately one dyne too

high. The liquid in the rectangular space b disappears to a negligible degree when the film forms.

The film method of measuring surface tension was first used by Mickaelson and Hall.⁴ Their method or device for forming the films was essentially the same as that used by the present writer; however, they did not extend it to the use of measuring interfacial tensions. Physicists have recognized the sensitiveness of the method of measuring the tension in films. Allan Ferguson⁵ includes it among the most sensitive of methods but states that owing to the impossibility of forming films of sufficiently long life for an accurate measure of the tension, it has never found practical application. Hall used an analytical balance for weighing

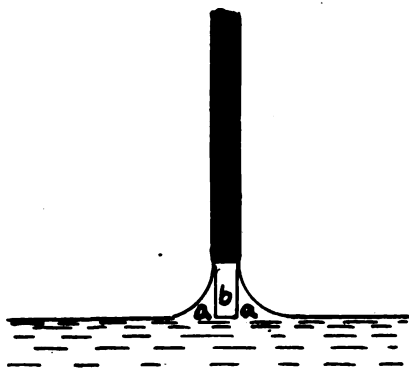

FIG. 1. Showing condition of the Liquid just before the Film is formed

the tensions in the films he worked with. This method is slow and cumbersome and the weighing process is too slow in the case of most liquids, to weigh accurately the tension in the formed film which in many cases endures for not more than a second.

This method of measuring surface tension, has, however, been taken advantage of and made practical by the use of an automatic balance, the sensitiveness of which is not quite as great as that of an analytical balance, but measurements reproducible to 1/10

⁴ "New Methods of Measuring the Surface Tension of Liquids." T. Proctor Hall, *Phil. Mag. Fifth Series*, 36, p. 385; 1893.

⁵ "Critical Review of Some Twenty Methods of Measuring Surface Tension," *Science Progress*. Jan. 1915, p. 428.

dyne per cm are easily possible. This is sufficiently close for a rather wide variety of technical work.

In text books on physics, values for the surface tension of water ranging from 73 to 81 dynes per centimeter at 20°C are found. The values in many cases the writer has found have been determined by one of the methods of measuring the force required to detach a ring or bar from the surface of the water. With this method zero contact angles between the object and the liquid are necessary, otherwise, low results will be obtained. For relative work these methods are satisfactory.

SURFACE TENSION BY THE FILM METHOD

The instrument is shown in Fig. 2. The knife edge to engage the liquid, can be made out of aluminum, copper, silver, platinum or other metal foil. It has been found that all of these metals, when thoroughly cleaned, have zero contact angles with water. The plate should be thin, not over .015 cm thick, and geometrically as nearly perfect with respect to the point of suspension as possible. The projections or horns *A* are to prevent the pulling of the liquid away from the ends of the edge and a correction has to be made for these as will be later explained.

The balance proper consists of a main support which is composed of tripod stand *B* and shaft *D*. To the latter is fastened the piece *C* that supports the swinging member *E*. The swinging member is a cork wheel about 2½ to 3 inches in diameter. Cork is used on account of its extreme lightness which adds to the sensitiveness of the instrument and because the axis on which it turns can be readily put through it. A steel bar 1½ mm in diameter passes axially through the cork, the ends of which are carefully ground to knife edges, and rest on steel or glass bearings. Around the periphery of the cork wheel is machined a small V shaped groove. Over the wheel and in this groove is hung a No. 50 silk thread (thread is used as its weight is negligible). To one end of the thread is hung the knife-edge which forms the liquid film. It must come down just below the graduated scale to be described later. To the other end of the thread is suspended a light aluminum pan into which enough fine sand is placed to just

balance the knife-edge and other weight at that end of the string. Into the periphery of the cork wheel is stuck a light aluminum pointer about .85 mm in diameter and of sufficient length to provide a weight a little more than sufficient to just balance the maximum tension that will come on the knife-edge. A pointer of this diameter and about eight inches in length will be deflected through about an 85 degree arc if a gram of weight is placed in

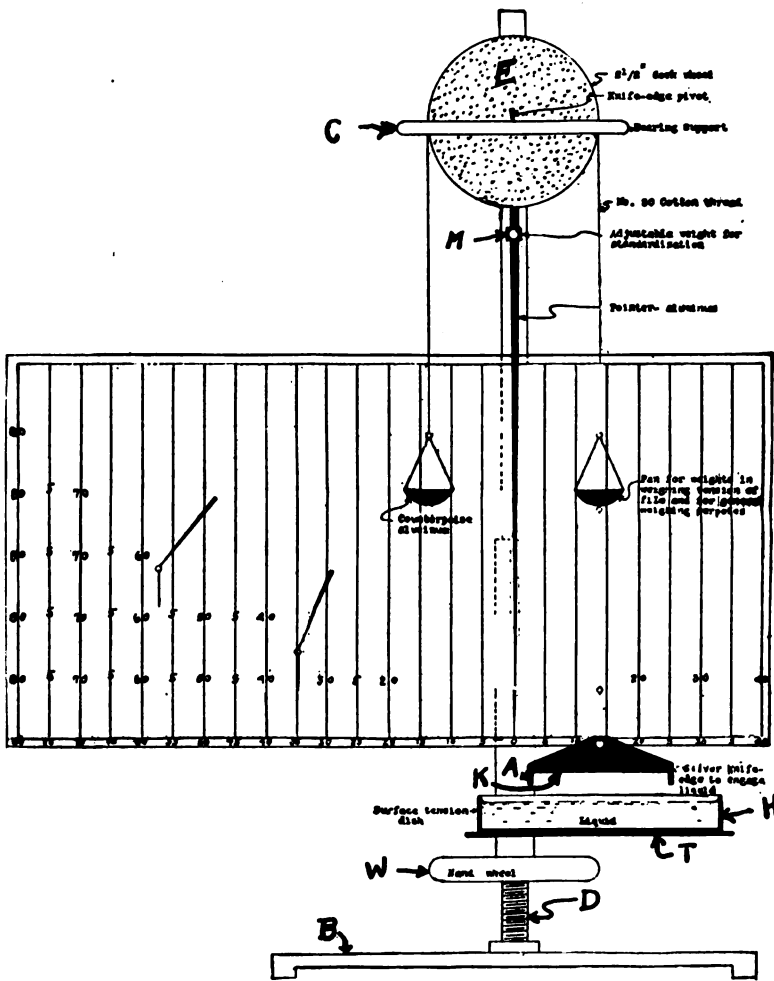

FIG. 2. Instrument for Measuring Surface Tension by the Film Method

the little pan on the knife-edge side of the spring. At the end of this aluminum pointer is hung a second very light and short aluminum pointer (about $1\frac{1}{2}$ cm long and about .3 mm diameter) which hangs freely in a loop as shown. This secondary pointer maintains a vertical position through all angles of the main pointer.

The use of the secondary pointer obviates the necessity of graduating the arc of a circle, when the straight pointer is used, the divisions of which have to increase from the zero position of the pointer to a horizontal one, and makes the use of plain cross section paper as a scale possible. On this scale equal horizontal distances traveled by the secondary pointer represent equal tensions on the knife-edge. The secondary pointer which remains in a vertical position through all angles of the main pointer is easily read against the vertical graduation lines from the scale, low-powered reading glass is of assistance in reading the position of the pointer.

A part of the instrument not yet described is the mechanism for raising and lowering the dish⁶ that contains the liquid to be tested. It consists of a table *T* and a sleeve which slides up and down on the shaft *D* when a thumb-wheel *W* is operated.

PROCEDURE IN MAKING A SURFACE TENSION MEASUREMENT

A single measurement which takes less than two minutes time is as follows:—

The liquid to be tested is placed in the dish *H* which has vertical walls. By the use of the thumb-wheel *T* the dish is raised until the knife-edge is pulled into the liquid. The dish is then lowered rapidly by turning the thumb-wheel until it is seen that the edge is just about to become detached from the liquid, from this point on (now watching the pointer) the dish is lowered very slowly until the pointer is seen to slip back a few divisions. The slip indicates that the column of water raised above the surface is letting go and that the film is being formed. This is the hydraulic column of water mentioned under the fifth method of measuring

⁶ In the case of volatile liquids and with other liquids when the best results are desired, covered vessels are used. For general work this precaution is hardly justified.

surface tension which has to be corrected for in all methods using a ring or bar. For water and pure liquids the film lasts several seconds holding the pointer motionless at a given point on the scale. The tension is thus automatically measured. A film $\frac{1}{2}$ inch long can sometimes be pulled out.

In making the correction⁷ for the capillary rise of the liquid against the horns of the knife-edge which are actually dipping into the liquid at the time the tension in the film is being read, after the film has broken, the dish is again raised until the horns dip into it and until the surface of the liquid comes very close to the straight edge. The dish is then lowered a few turns. This is to insure a zero contact angle or to insure the same contact angle as existed at the time the film broke. The deflection resulting from the capillary action of the liquid on the metal horns which amounts to from two to four dynes depending upon the degree of wetting and the width and thickness of the metal horns should be subtracted from the first reading. The difference in the two readings, if the instrument is accurately standardized, is the surface tension of the liquid.

With volatile liquids measurements are made in closed vessels with a small opening through which the string, to which the silver knife edge is fastened, passes. No difficulty is experienced in forming films with volatile liquids such as benzene and alcohol.

If difficulty is experienced in forming a film for certain liquids practically the same result can be obtained by using a slightly thicker knife edge and by the same procedure as in the formation of the film with the exception that the plate is not pulled or detached from the liquid, but is pulled, by lowering the dish, until the pointer appears to remain constant through a turn or so of the thumb-wheel. At this point the lower edge of the plate is in the plane of the surface of the liquid and the question of the liquid in the portion *b* in Fig. 1 has been eliminated and we are

⁷ The correction by dipping the horns into the liquid a second time may be avoided, by simply taking the reading for the film, and then allowing the pointer to come to rest after the film has broken, reading again and taking the difference. This procedure is less sure than the one described above.

weighing the tension in the films on either side of the plate which is equal to the weight of the liquid in the portions *a a*.

This is the procedure that was used in showing that the contact angle between the various metals mentioned earlier and water is zero degrees. This method calls for zero contact angles and we have never had to resort to it as films are usually easily obtained.

By this method the surface tension of water has been determined to be 72.8 dynes per centimeter at 20° C. This is in very close agreement with the most reliable figures so far obtained. This method checks well with the drop-weight and Jaeger methods, for all pure liquids tried.

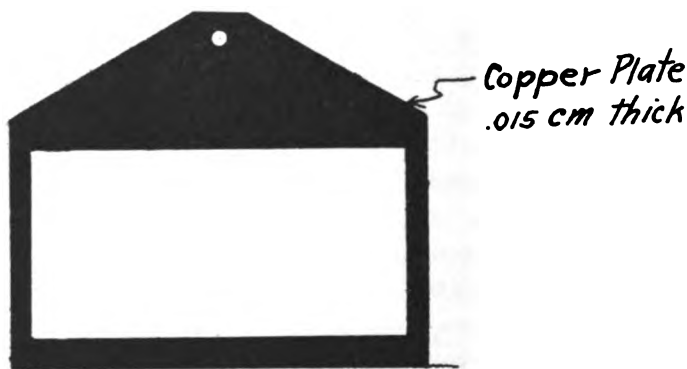

FIG. 3. A form of Frame used in Interfacial Tension Measurements

INTERFACIAL TENSIONS BY THE FILM METHOD

By the use of this instrument, the tension existing at a liquid-liquid interface can be almost as readily determined as for a liquid-air surface. A slightly differently constructed knife edge for forming the film is used. The design used is shown in Fig. 3.

The usual knife edge is removed, and the one shown here suspended in its place. It should be pointed out, however, that the knife edge or frame as used for interfacial tension measurements may be used also for surface tension work. A measurement is made as follows: If the interfacial tension oil-water, or benzene-water is to be determined, about 100 cc of water are put into a

beaker and on top of this is placed a layer of benzene or oil about 1/16 inch thick. The beaker with its contents as explained is put on the adjustable stand T which is raised by means of the thumb-wheel W until the knife edge, Fig. 3, has passed below the level of the interface, forming and pulling the oil film with it. The film formation is shown in Fig. 4.

The deflection of the pointer, which will be to the right on the scale is read before and after the breaking of the film. The difference gives the interfacial tension in dynes per centimeter. The same results are obtained whether the film is pulled from the water to the oil (water film) or whether it is pulled from the oil to the water. When a metal knife edge is used, it is better to go from the oil to the water as the oil more easily wets the metal plate. If it is desired to go from the water to the oil, the plate should be put in the water before the oil layer is added.

To measure the interfacial tension between water and a liquid heavier than water the same procedure is used. The oil should be first put in the beaker, and a shallow layer of water poured on top of it. The knife edge is allowed to pass through the water pulling a film of it into the oil. For measuring the tension at an interface between two liquids of equal specific gravity, the oil is placed in a smaller rectangular vessel which is set into the beaker and the water is poured around and over it.

METHODS OF STANDARDIZATION

In calculating the theoretical surface tension of a liquid the simple formula $Y = \frac{980 \times W}{2L}$ where W is the weight required to

swing the pointer through the same number of divisions of the scale as $2L$ cm of the film, where L is the length of the straight edge between the horns and Y the surface tension of the liquid.

The instrument is standardized to read direct in dynes per centimeter by raising or lowering the adjustable weight M on the pointer until a film of pure water swings the pointer just through 72.8 divisions of the scale. This requires several trial measurements. However, the instrument need not be actually standard-

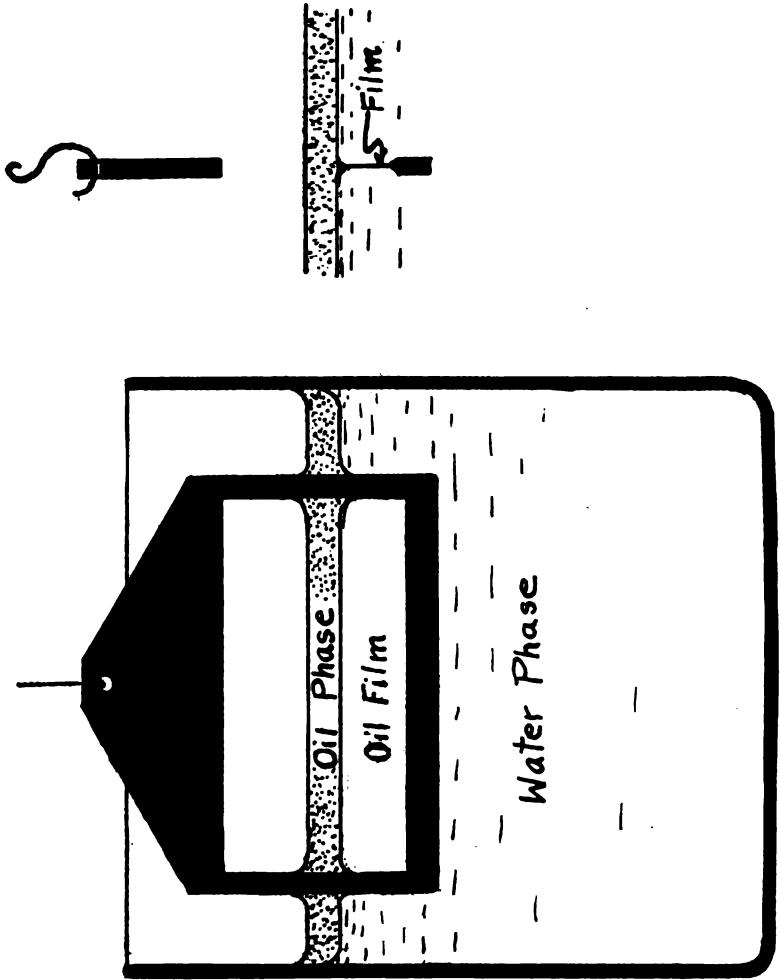

FIG. 4. Showing Film Formation Stage in an Interfacial Tension Measurement

ized; the surface tension of water can be taken as 72.8 or for practical purposes 73.0 and a factor used.

Several thousand surface tension and interfacial tension determinations have been made with this instrument in studying the theory of flotation. It has been found that with oil-water emulsions it is the only instrument that will give true static surface tension, that is, surface tension at the point where equilibrium⁸ between surface concentration and interior concentration exists. Most other methods measure the surface tension of relatively fresh surfaces and for emulsions give values from 1 to 15 dynes higher than that at equilibrium.

The instrument should find a wide application for general laboratory use and in institutions in the teaching of molecular physics for which it is eminently suited. It is simple of construction and the average operators can get consistent and reliable results with it. It is independent of contact angle and maintains perfect adjustment from day to day. It easily gives values reproducible to 1/10 dyne/cm. It works well on volatile liquids and measurements are conveniently made in atmospheres other than air. It is also convenient for measuring interfacial tension between liquids.

A brief description of this instrument and its application to one problem involving the study of surface tension was given in the August 13, 1921, issue of the Mining & Scientific Press, San Francisco, California.

The writer is greatly and pleasantly indebted to Mr. R. B. Elder of the School of Mines, University of Idaho, for his helpful suggestions, and assistance in checking the instrument against other methods; to Professor A. A. Knowlton of Reed College, Portland, Oregon, for his critical examination of the instrument, and to Mr. S. N. Shanfeld for his assistance in carrying out many of the experiments which have established the reliability of this method of measuring surface tension.

BUREAU OF MINES,
WASHINGTON, D. C.

⁸ To maintain this equilibrium the emulsion must be circulated frequently. When the point of constant surface tension is reached, the emulsion will, on standing and without circulation, show either an increase or decrease in surface tension. The surface tension usually rises.

THE PASSAGE OF HYDROGEN THROUGH QUARTZ GLASS

BY J. B. JOHNSON AND R. C. BURT

SYNOPSIS

The *Rate of Flow of Hydrogen Through Quartz Glass* has been measured over the range of 300°C. to 900°C. Some measurements were also made with *Nitrogen and Argon*. A perceptible diffusion starts with hydrogen at about 300° C. and with the nitrogen at 600° C., and then in each case increases rapidly with the temperature.

A brief discussion is given on the *Possible Nature of the Flow* of gases through fused silica.

The heat resistive property of fused quartz has made this material valuable for the construction of many kinds of scientific apparatus. In some cases, however, its usefulness has been limited by the porosity to various gases at higher temperatures. O. W. Richardson¹ found that hydrogen and helium, and to a less extent neon, diffused through a quartz glass tube at 800°–1200° C. The rate of the diffusion has been measured when the pressure on both sides of the material was fairly high,² but the results thus obtained cannot safely be applied to high vacuum apparatus. The increased importance of electronic discharge tubes of larger power opens a new field for the use of fused silica, provided the material is used with proper regard for its limitation. The experiments to be described were therefore done to get more definite knowledge of the behavior of this material under conditions of high vacuum and high temperature. While the flow of hydrogen was studied more fully, some measurements were also made with nitrogen and argon.

The method used in making the measurements was to observe the pressure rise in an evacuated silica glass tube around which the gas flowed. A diagram of the apparatus is shown in Fig. 1. The furnace was an iron pipe around which was wound a heater of resistance wire and a covering of asbestos. A thermocouple

¹ Phil. Mag., 22, p. 704; 1911.

² E. C. Mayer, Phys. Rev., 6, p. 283, 1915; H. Wüstner, Ann. d. Phys., 46, p. 1095, 1915.

placed near the center of the furnace was used to measure the temperature. The gas from a commercial tank was passed through the furnace at a slow steady rate at atmospheric pressure. The quartz glass tube Q was placed axially in the furnace and was connected to a vacuum pump, a McLeod gauge and a volume bulb V , the total volume of the system being about 1500 cc. A side tube T with a volume of about 3 cc could be immersed in liquid air for freezing vapors out of the system. The difference in level of the capillary mercury columns of the gage at the time of taking a pressure reading was kept less than the vapor pressure of water. No condensed water, therefore, existed in the closed capillary, so that when the side tube was not cooled the gauge indicated

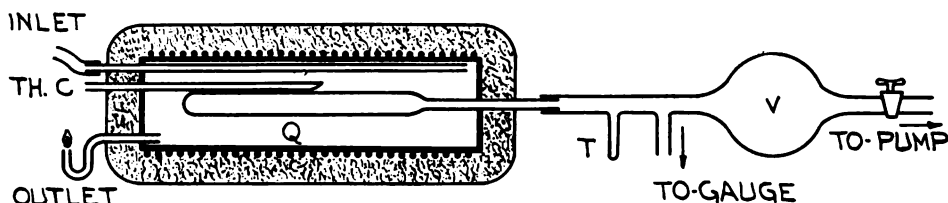

FIG. 1. Apparatus

approximately the total pressure, including that of water vapor. After the tube was pumped out the connection to the pump was closed during a run and the pressure read at short intervals while the temperature was kept nearly constant.

The materials tested were furnished by the Thermal Syndicate, Ltd., and were in the form of tubes 35 cm long, 1.5 cm in outside diameter and 1.5 mm wall thickness. Rough tests on several opaque varieties of fused silica, made from quartz sand, showed that these are unsuited for high vacuum apparatus even in the air at room temperature. The lowest rate of pressure increase observed was, for one of the tubes, about .001 mm of air per hour at room temperature and other tubes gave as high as ten times this value under the same conditions. The final work was therefore confined to the clear fused silica made from quartz crystals.

After the clear silica tubes had been heated up to drive off the vapors on the inner surfaces, no leakage of air or hydrogen at room temperatures was detected in as long a time as two weeks at a

pressure of less than .001 mm. Upon again heating the tube a measurable leak of hydrogen started first at about 300° C, and then increased rapidly with the temperature. Fig. 2 shows a summary of the results obtained with three tubes. R is the rate in cc per hour at which gas leaked into the tube per unit area, reduced to one mm pressure and room temperature, corrections being made for the temperature of the quartz and of the tube T .

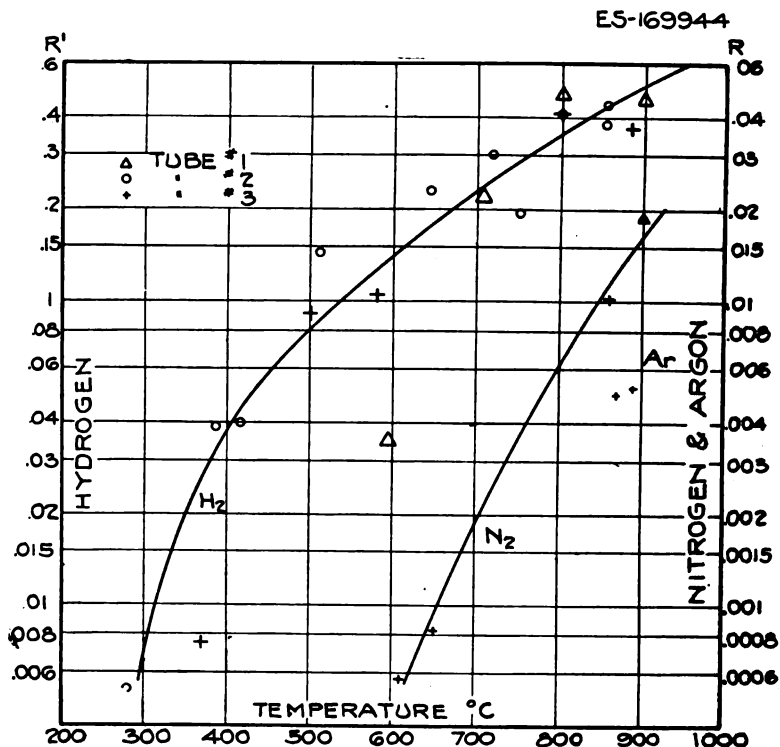

FIG. 2. Rate of Flow of Hydrogen, Nitrogen and Argon

The tubes were not quite of the same average thickness and the results have been reduced to correspond to a wall thickness of 1.5 mm, on the assumption that the leak is inversely proportional to the thickness. The runs with nitrogen and with argon are also shown in this figure. At 400° and 500° no leak of nitrogen as large as 5×10^{-4} mm was detected in 24 hours.

The result of changing from one gas to another is shown in Fig. 3, which makes clearer the difference between leakage of hydrogen and the heavier gases. The curve at the top of the figure gives the temperature of the oven during the course of the experiment. The upper pressure curve gives the total pressure in the system, while the lower curve gives the pressure of permanent gas measured when the small side tube was immersed in liquid air. The difference between the two curves represents the pressure of condensible vapors, about 90% of which was water vapor as was shown by exposing the gas to a small amount of

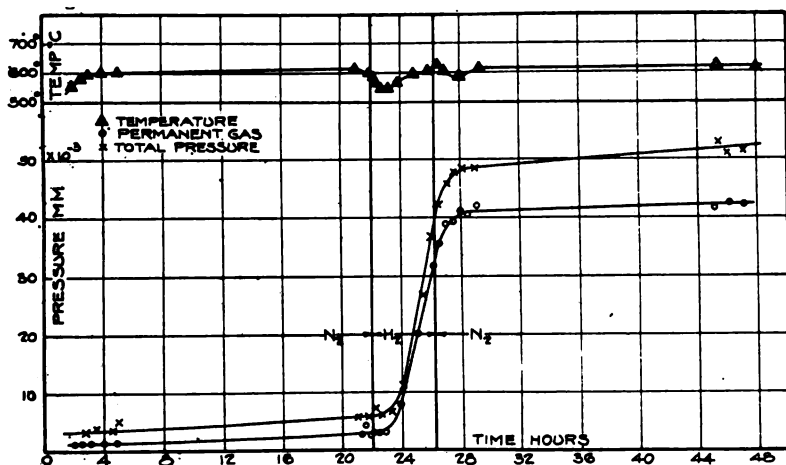

FIG. 3. Change of Gas Surrounding the Tube

phosphorus pentoxide. The presence of this condensible gas suggests the possibility that the rise in pressure was caused by gases continually given off from the walls of the tube rather than by a leakage through the walls, but the changes in slope show conclusively that there is a leakage of hydrogen at least. The constancy with time indicates that the lower rate of increase of pressure is caused by leakage of nitrogen as has been assumed and only to a small extent by release of gases from the inner surface of the tube.

The results of these experiments, though incomplete, justify a brief discussion of the nature of the flow of gas through fused silica. It seems improbable that a clear, dense substance such as

quartz glass is porous to gases in the sense that chalk is porous. It is equally improbable that in this inert material there is a chemical diffusion as in rubber. An assumption which might readily be made is that there is a flow of gas through very fine holes or tubes in the material. This view gains apparent support from the fact that even clear fused silica is not quite free from fine striations, caused by drawn out air bubbles, a condition which is so obviously present in the satin finish material. According to the kinetic theory, however, the volume of gas passing through a tube when the diameter of the tube is small compared with the mean free path of the gas molecules is inversely proportional to the three-halves power of the molecular weight and directly proportional to the square root of the absolute temperature. When the experimental rates for the three gases are compared, their ratios fall within the correct range for the molecular weight relation, but the increase of rate with temperature is very much greater than that shown by flow through tubes and apertures, and indeed varies as the third or higher power of the temperature, so that we must look for some other explanation than simple flow along capillary tubes. The transfusion begins at the temperature at which structural changes are known to occur in crystalline silica, and this fact suggests that the passage of the gas may accompany a modification in the structure of the non-crystalline material.

The data enable us to judge what to expect with tubes and bulbs of ordinary dimensions. The curves show that at the same outside pressure hydrogen passes through the walls about 100 times faster than nitrogen or argon. Under normal conditions, however, the hydrogen content of the atmosphere is small, about four parts in 100,000 by volume, so that in air the rate of admission of nitrogen should be of the order of 250 times larger than that of hydrogen. To take a concrete example which may be met with in practice, we can probably say that a well evacuated bulb of one liter capacity can be kept in the air at 400° C for one hundred hours before the pressure reaches 10^{-4} mm, and the transfused gas will be largely nitrogen.

RESEARCH LABORATORIES OF THE
WESTERN ELECTRIC COMPANY, INC.,
AND THE AMERICAN TELEPHONE AND
TELEGRAPH COMPANY, NEW YORK CITY.

A SIMPLE APPARATUS FOR COMPARING THE THERMAL CONDUCTIVITY OF METALS AND VERY THIN SPECIMENS OF POOR CON- DUCTORS

BY M. S. VAN DUSEN

The apparatus to be described here has been recently used by the author to measure the thermal resistance of various contacts between metals, either with or without the addition of some cementing material, and to compare the thermal conductivity of metals and thin specimens of poor conductors. The method consists essentially in comparing the temperature gradients in two materials placed in series, the rate of heat flow in each being the same. Heat flow in any direction other than that in which the

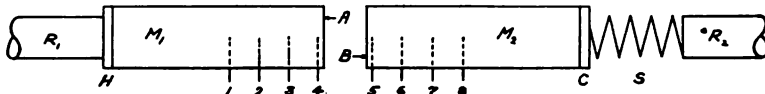

FIG. 1. Sketch of Apparatus

temperature gradients are measured as well as contact thermal resistances between the materials compared are made relatively small.

Fig. 1 shows a sketch of the apparatus as it has been used by the author, the particular object being to determine the thermal resistance of contact between metal surfaces under certain conditions. M_1 and M_2 are two solid brass cylinders, about 3 cm in diameter and 10 cm long, mounted coaxially. An electric heating unit H , consisting of a spiral of small copper tubing enclosing an insulated resistance wire, is soldered to one end of the cylinder M_1 , and a water cooled cell C is placed on the opposite end of the cylinder M_2 . Means are thus provided for producing a heat flow from H to C along the bars and through any material placed with the surfaces A and B . The rods R_1 and R_2 together with the spring S are used to apply a known force between the

surfaces *A* and *B*. Measurements of axial temperature gradient in the brass cylinders are made by means of the copper-constantan thermocouples (No. 36 wire) numbered 1, 2, 3, 8, inserted in 0.7 mm radial holes drilled 1.5 cm deep at definite intervals along the bars. Thermal contact between the thermocouple wires and the brass was improved by filling the holes with oil. It was found that under these conditions the depth of immersion was sufficient to eliminate the effects of lead conduction, no appreciable change in the temperature indication occurring when the junction was moved 1 cm away from the axis. The couples 4 and 5 are placed near the surfaces *A* and *B* so that the temperature of these surfaces can be found by extrapolation of the temperature versus distance curves along the axis of the system. A small amount of insulation on the two cylinders will serve to reduce heat loss from the convex surface to a very small value relative to the heat flow parallel to the axis. If now the surfaces *A* and *B* are put in contact, a constant current supplied to *H*, and a constant flow of water to *C*, temperature measurements after the steady state is attained will serve to compare the thermal resistance of the contact with that of a unit length of the brass itself. Similar experiments can be made with the surfaces cemented together by any means whatever. Furthermore the effects of pressure can be found by the means provided for varying the force holding the cylinders together. The influence of the character of the metal surface can be determined by roughening or grinding in various ways. It was found that if the surfaces were ground fairly flat, (convex with radius of curvature about 40 meters) the thermal resistance of a dry contact with a pressure of about 1 to 5 kg/cm² was equivalent to the resistance of from 1 to 1.5 cm of brass. When the surfaces were wrung together with water or a glycerine solution the effect of the contact could not be detected, being equivalent to less than 0.5 mm of brass.

This fact suggested that the apparatus could be used to compare the conductivity of various metals or alloys with some standard metal the conductivity of which is known. The heat flow would not be seriously distorted by the contacts. There is no difficulty in grinding the surfaces on a flat lap to a sufficient degree of flat-

ness. Cylinders of pure tin, lead, zinc, and 99.7% aluminum were prepared, each about 3 cm long and having the same diameter as the brass cylinders. The conductivities of these metals were compared at a mean temperature of about 40°C, the contact resistances being eliminated by the use of a dilute glycerine solution since pure water partially dries out on the hotter side in two or three hours. A specimen of brass cut from the same bar from which the apparatus was made was also compared, and no effect of the two contacts could be detected. Table 1 shows the results obtained, together with other values given in Landolt Bornstein tables. Zinc has been used as the standard and its conductivity has been assumed to be 0.265 cal sec⁻¹ cm⁻¹ deg⁻¹.

TABLE 1—*Comparison of Thermal Conductivity of Several Metals*

Metal	Thermal conductivity cal sec ⁻¹ cm ⁻¹ deg ⁻¹	Probable best values at about room temp. taken from Landolt-Bornstein
Zinc (Standard)	0.265	0.265
Aluminum (99.7%)	0.52	0.48
Tin	0.160	0.155
Lead	0.085	0.083
Navy Brass	0.28

No great accuracy was anticipated when the apparatus was designed, but the results seem to indicate a precision within 5%. The variation of the thermal conductivity with temperature was disregarded, since it is within the experimental error in the small temperature range investigated.

The apparatus can be also used to determine the thermal resistance of very thin sections of poor conductors, such as mica, paper, etc., as well as thin films of liquids. In the latter case the brass cylinders are held a fixed distance apart by three very small mica separators, and the liquid remains between the ends of the bars by capillarity. The typical curves in Fig. 2 illustrate the general nature of the experiments, and in particular some results on wet and dry contact. The fact that the curves are sensibly straight and have the same slope on each side of the

break shows that the heat loss from the convex surface is negligible. The magnitude of the discontinuity in terms of the abscissa (i.e. distance along the axis) gives directly the thermal resistance of the contact or specimen in terms of centimeters of brass. Table 2 gives some results obtained with various contacts, as well as with layers of mica and paper. It will be noted that mica split into thin layers and subsequently squeezed together has a considerably greater thermal resistance than unsplit material.

TABLE 2—*Thermal Resistance of Miscellaneous Contacts or Thin Layers*

Nature of contact	Thermal Resistance in cm of brass	Pressure	Thickness of film	Remarks
		$\frac{kg}{cm^2}$	mm	
Dry	5.0	2.6	Rough ground surfaces
Wet with water	0.2	2.6	" " "
Dry	1.30	0.9	Finely ground flat surfaces
Dry	1.15	2.6	" " " "
Dry	0.85	4.4	" " " "
Wet with water	0.10	0.9	" " " "
" " "	0.00	2.6	" " " "
Light mineral oil	0.20	0.9	" " " "
" " "	0.10	2.6	" " " "
" " "	2.05	0.028	Spaced by 3 small mica chips
" " "	5.70	0.066	" " " " "
1 layer mica	3.30	2.6	0.024	
2 " "	4.85	2.6	0.048	
3 " "	6.05	2.6	0.075	
4 " "	7.20	2.6	0.100	
5 " "	8.70	2.6	0.125	
1 " "	5.80	2.6	0.234	
1 " "	0.80	2.6	0.025	Wet with water
1 layer paper	13.5	2.6	0.103	
2 " "	27.0	2.6	0.205	
3 " "	38.0	2.6	0.310	
4 " "	48.5	2.6	0.412	

It is believed that this form of apparatus can be employed in schools, either in class room demonstrations or laboratory work.

The undergraduate student does not ordinarily obtain very clear conceptions in the subject of thermal conductivity, usually because he is not shown by actual experiment the analogy between electrical and thermal conduction. Experiments similar to the kind described in this paper follow closely certain experiments

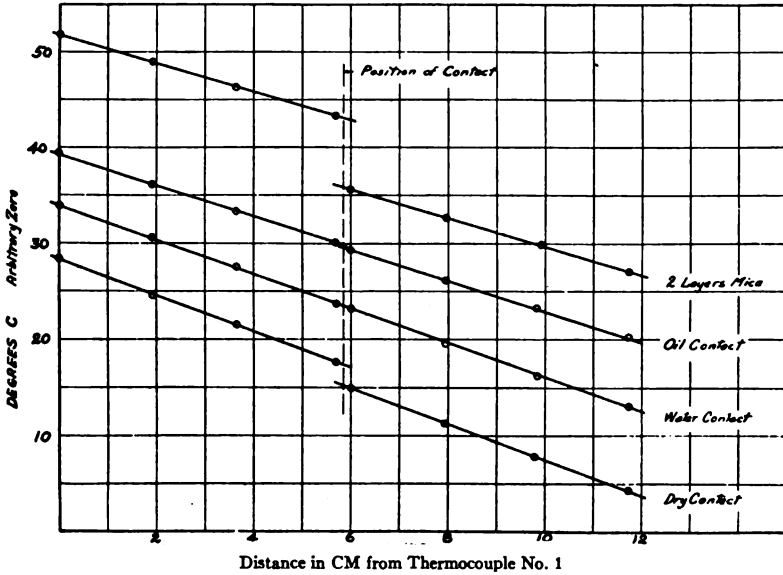

FIG. 2. Typical Temperature—Distance Curve

on Ohm's law which the student always performs in his first course in physics. Furthermore the student will obtain in a rather vivid manner correct ideas of the relative magnitude of various thermal resistances.

BUREAU OF STANDARDS,
 WASHINGTON, D. C.
 JULY 22, 1922.

AERONAUTIC INSTRUMENTS

By FRANKLIN L. HUNT

CONTENTS

	PAGE
Introduction.....	744
Altitude Instruments.....	745
Altimeters.....	745
Barographs.....	747
Statoscopes.....	747
Speed Instruments.....	749
Air Speed Indicators.....	749
Ground Speed Indicators.....	759
Rate of Climb Indicators.....	762
Orientation Instruments.....	764
Compasses.....	764
Turn Indicators.....	767
Inclinometers.....	772
Engine Instruments.....	777
Tachometers.....	777
Pressure Gages.....	781
Gasoline Gages.....	782
Gasoline Flow Meters.....	785
Thermometers.....	785
Navigating Instruments.....	787
Maps and Charts.....	789
Dead Reckoning Instruments.....	789
Astronomical Instruments.....	794
Radio Direction Finder.....	797
Special Instruments and Accessories.....	797
Oxygen Instruments.....	798
Recording Instruments.....	803
Strut and Gas Temperature Thermometers.....	807
Time Pieces.....	807
Manometers and Hydrogen Leak Detectors.....	808
Conclusion.....	811

The instrument equipment of modern aircraft ordinarily consists of a group of ten or more instruments which are located on an instrument board in front of the pilot. They serve to assist him in the control of the altitude, speed and orientation of his aircraft and the behavior of the engine. In addition to the regu-

lar equipment special instruments are frequently installed, such as navigating instruments where long distance flights are to be made, experimental instruments for airplane performance tests, or instruments for military use. The purpose of this paper is to describe briefly the various types of aircraft instruments which have reached a state of practical development such that they have found extensive use in service.¹ These may be conveniently considered in the order mentioned above. A group of typical airplane instruments is shown in Fig. 1.

ALTITUDE INSTRUMENTS

Altimeters. Altimeters are used to indicate the altitude of aircraft. They are the same in principle as aneroid barometers and have as the essential working element a corrugated metal capsule from which the air is exhausted and which is maintained distended by an external or an internal spring. With decreasing atmospheric pressure, such as is experienced when an aircraft climbs, the evacuated capsule expands under the action of the spring. This motion which is very small, amounting to a few thousandths of an inch only, is multiplied by a suitable transfer mechanism and used to operate a pointer moving over a circular dial. The dial is graduated either in feet or in meters in accordance with some empirical mathematical relation between the atmospheric pressure and the altitude. The dial is rotatable so that the zero of the instrument can be adjusted for fluctuations in ground level barometric pressure. The pressure-altitude relation used in calibrating American altimeters is based on the assumption of a uniform air column temperature of 10°C and the corresponding mean humidity. It is calculated from the constants used in Smithsonian Meteorological Tables 51 and 54, 4th revised edition, and neglects the small effect due to the variation of gravity. It may be expressed by the relation

$$H = 62900 \log_{10} \frac{759.6}{P}$$

where H is the altitude in feet and P the barometric pressure in

¹ For a more detailed discussion see Reports No. 125-132, inclusive, of the National Advisory Committee for Aeronautics, 1922.

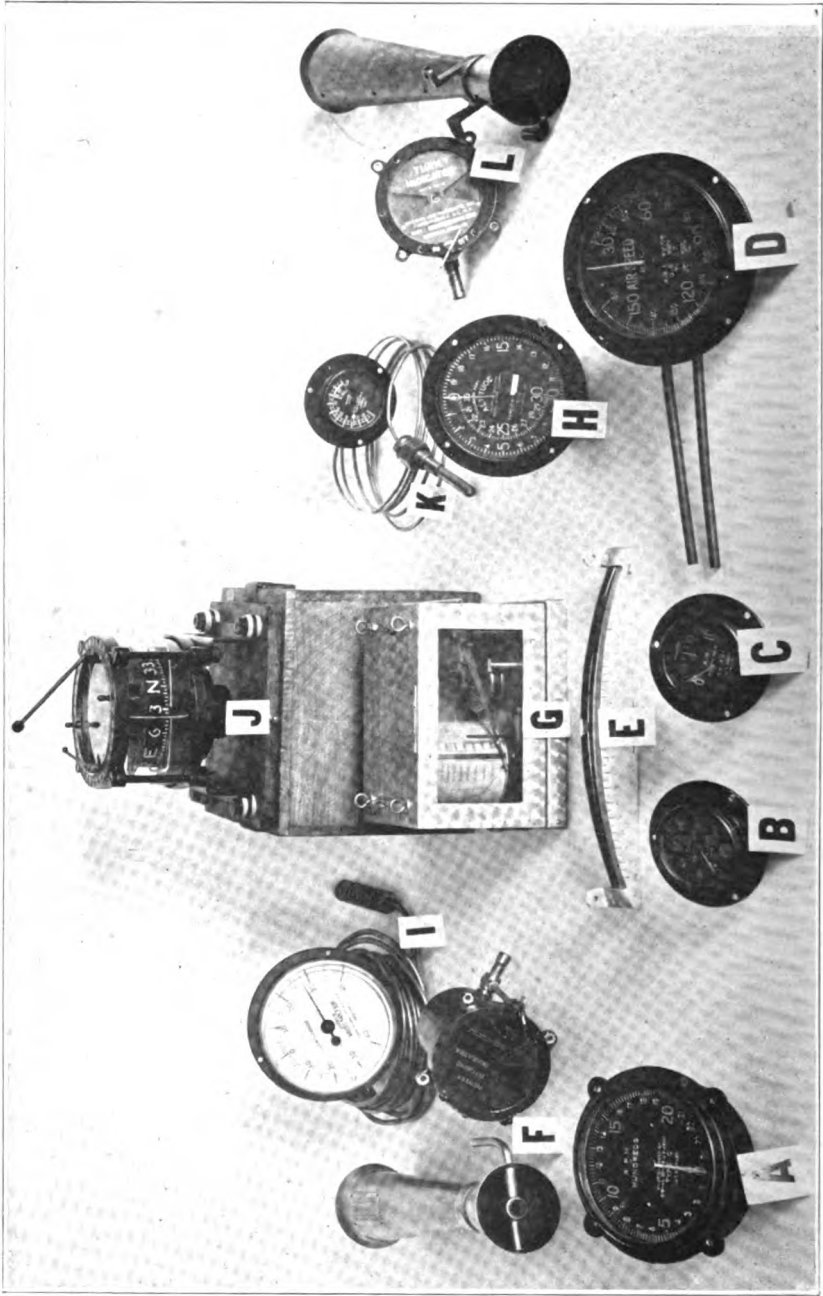

FIG. 1. AERONAUTIC INSTRUMENTS
 A Tachometer, B Oil Pressure Gage, C Air Pressure Gage, D Airspeed Indicator, E Bubble Inclinometer, F Gyroscopic Pitching Indicator, G Barograph, H Altimeter, I Strut Thermometer, J Compass, K Radiator Thermometer, L Gyroscopic Turn Indicator.

millimeters of mercury. Practically the same formula is used in Great Britain. A typical altimeter is shown in Fig. 2.

Barographs. Barographs are the same in principle as altimeters but are provided with a recording mechanism which gives a continuous and permanent record of the altitude thruout flight. A battery of corrugated evacuated capsules is ordinarily used instead of a single capsule as in the altimeter, and interior springs are more frequently used than exterior ones. The expansion of the battery of capsules with decrease of external pressure operates

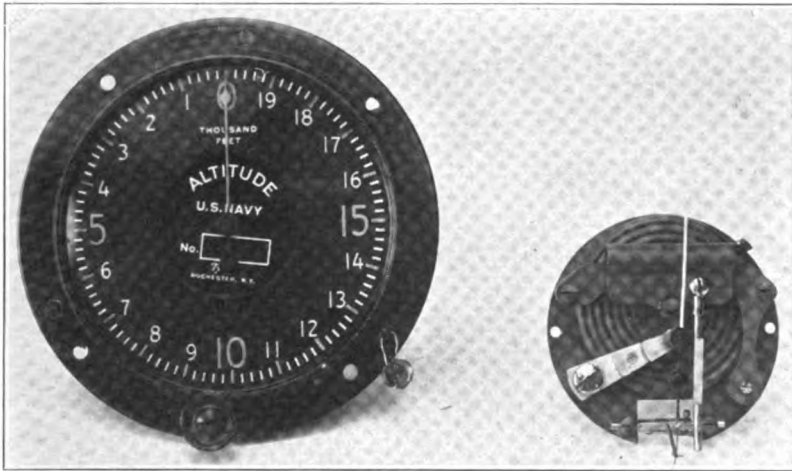

FIG. 2. Tycos Altimeter

a pointer which carries a pen and makes a record on a chart on a drum rotated by clockwork. The chart is graduated in feet or meters in accordance with some mathematical pressure-altitude relation, usually the same as that used on altimeters. Fig. 3 shows a typical aviation barograph.

Statoscopes. Statoscopes are used more frequently in lighter-than-air craft than on airplanes. They provide a sensitive means of indicating qualitatively whether an aircraft is rising or falling and help the aviator to maintain horizontal flight. The ordinary type consists of a closed air-chamber which is connected to the exterior air through a glass U-tube containing a

small quantity of colored liquid, thus forming a trap which seals the air in the container. Heat insulation is used to prevent the expansion and contraction of the confined air with changes of external temperature. When the aircraft rises or falls the pressure of the air inside the container becomes greater or less than that of the external air, according as the aircraft is ascending or descending, and the liquid in the trap which is visible to the avia-

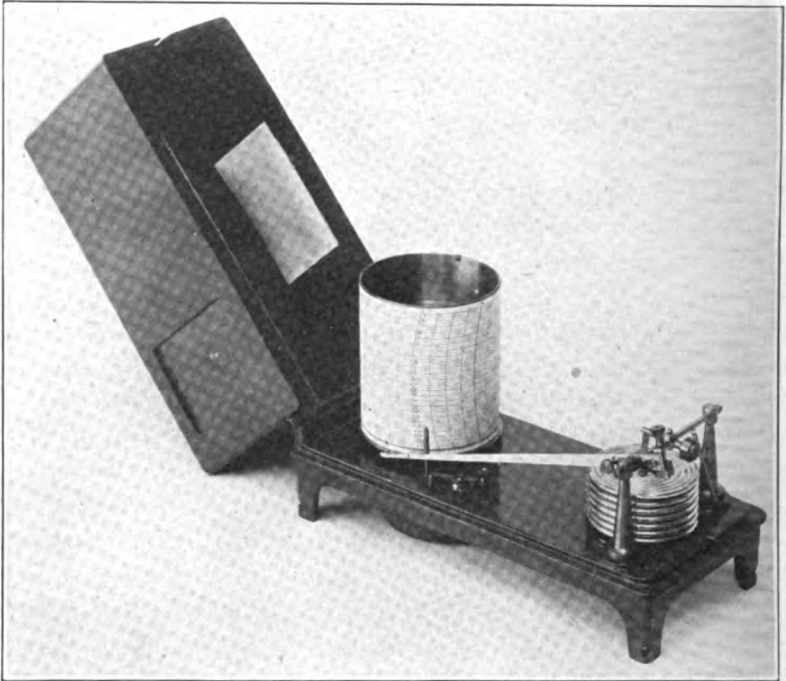

FIG. 3. Friez Barograph

tor is forced in one direction or the other, indicating a change of level. When the difference in pressure becomes sufficiently great equilibrium is re-established by air being forced past the liquid in the trap, after which the liquid again collects in the trap as previously. The frequency with which the air is forced past the liquid or as it is ordinarily expressed the rate at which the bubble

breaks is a rough measure of the rate of ascent or descent. Statoscopes can be made to detect changes in level of from five to ten feet. A typical instrument is shown in Fig. 4.

SPEED INSTRUMENTS

Air Speed Indicators. Air speed indicators show the speed of aircraft relative to the air. They give the speed with reference to the ground only in the absence of wind. The most commonly used types depend for their action on the pressure developed by the impact of the air stream caused by the motion of the airplane, or on the speed of rotation of small cup anemometers or air propellers. The indications of the pressure type are proportional to the density of the air so that the readings depend on the altitude. The anemometer type on the other hand shows practically no altitude effect. In the most usual form of the pressure type the pressures developed by a Pitot or Venturi nozzle located on one of the struts of the airplane is indicated by a sensitive gage on the instrument board. Usually it is also necessary to determine the static pressure at the point where the Pitot or Venturi nozzle is located. This is effected by using what is known as a static head which consists of straight tube closed at the end with a concentric ring of small holes or narrow slots at the sides. This tube is pointed in the direction of motion so that pressure within is maintained equal to that of undisturbed air without, the rush of air past the opening at the side of the tube being at right angles to these openings. Typical Pitot and Venturi nozzles are shown in Fig. 5A-B.

The indicator which is in effect a sensitive pressure gage ordinarily consists of one or more corrugated metal capsules enclosed in an air tight case or of an air tight case separated by a membrane of rubber or doped fabric into two air tight chambers. In early instruments a liquid manometer was sometimes used. The dynamic head of the pressure nozzle is connected to the diaphragm capsule and the static head to the air tight case, or in the doped fabric diaphragm type one head is connected to each of the air tight chambers. In some cases a combination of Pitot and Venturi nozzles is used to take advantage both of the pressure develop-

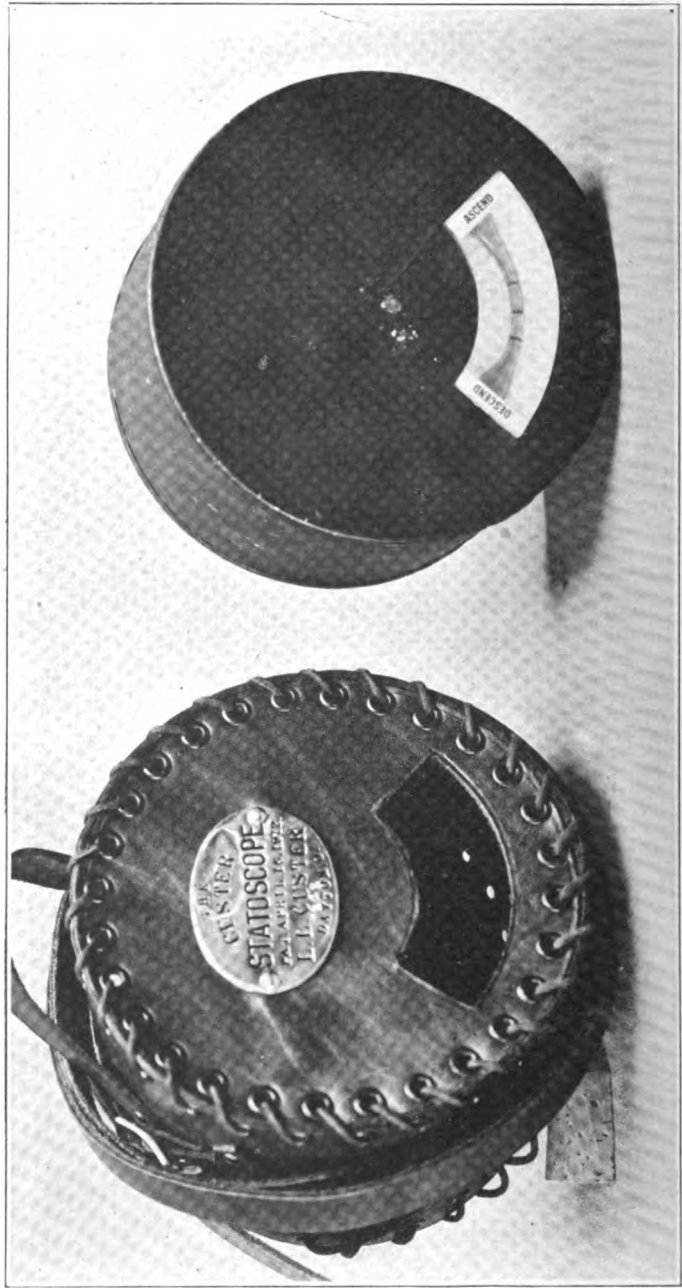

FIG. 4. Custer Statoscope

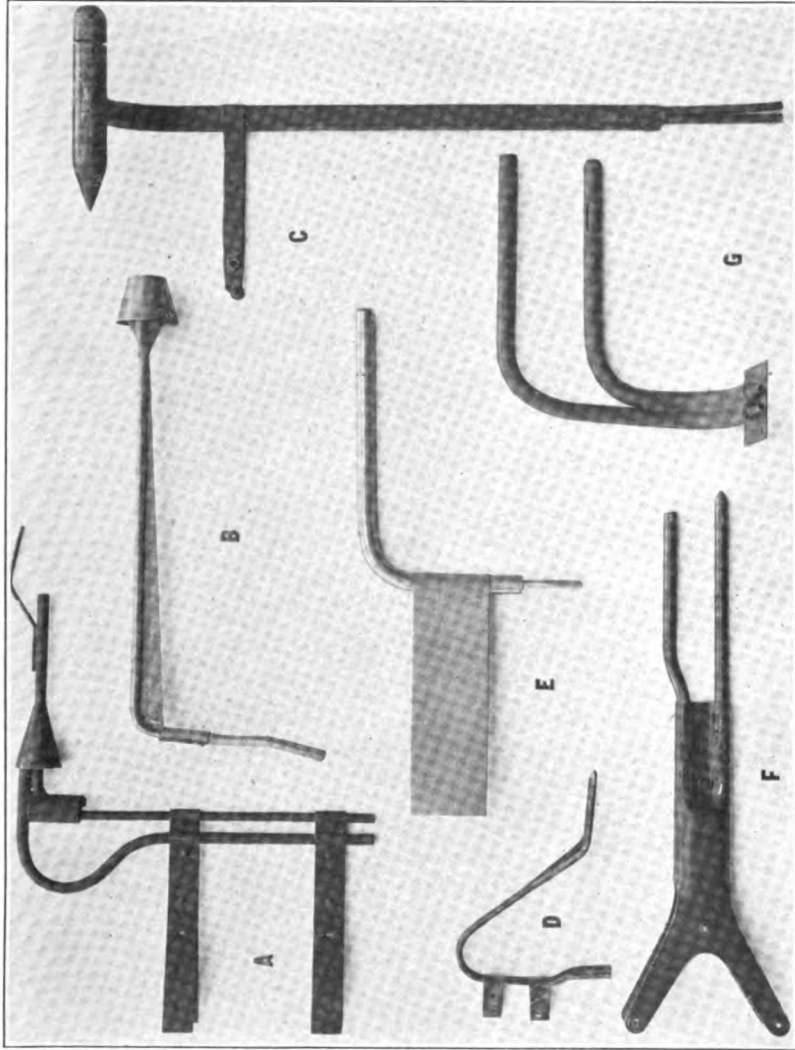

FIG. 5A. PITOT NOZZLES
A and B Nozzles with Static hoods, *C and E* Nozzles with concentric static heads, *D, F and G* Nozzles with separate static heads.

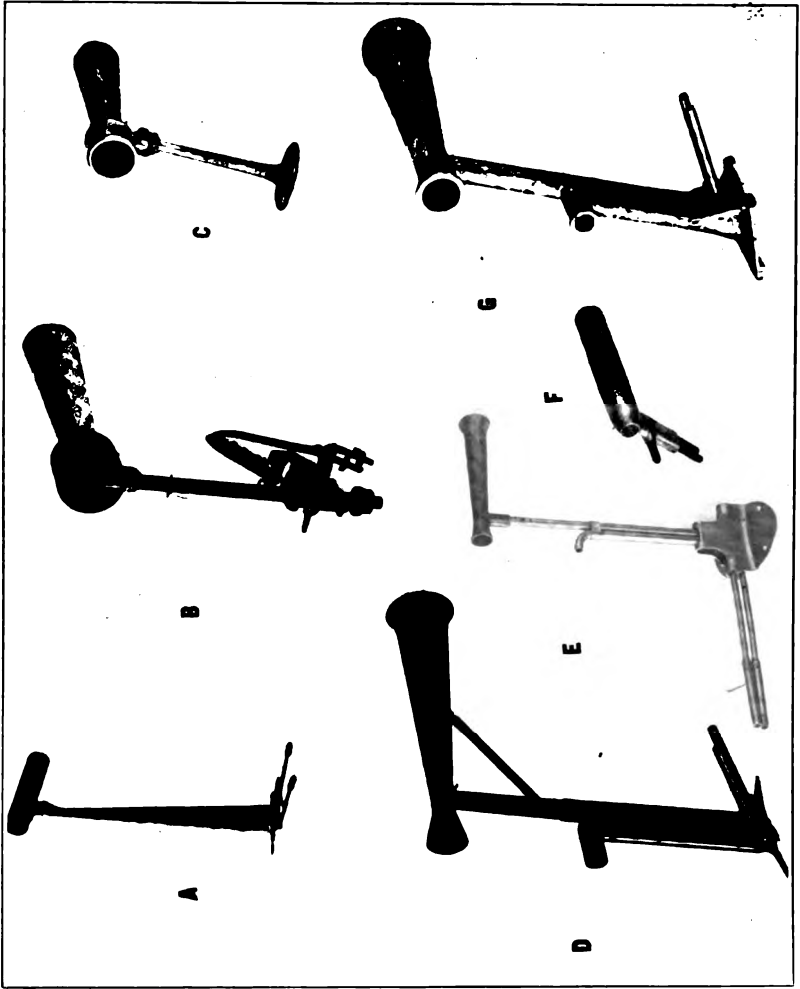

FIG. 5B. VENTURI NOZZLES
 A, Single Venturi nozzle with concentric static head, B and C double Venturi nozzles, D, E, F and G, Pitot-Venturi nozzles

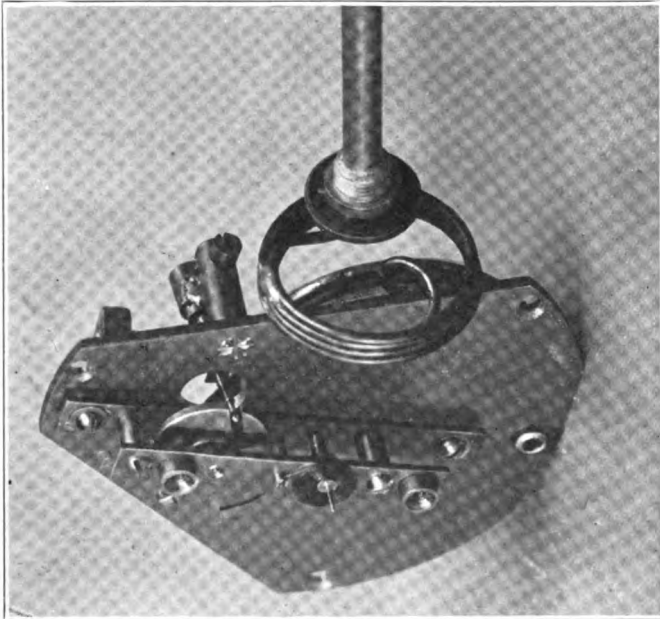
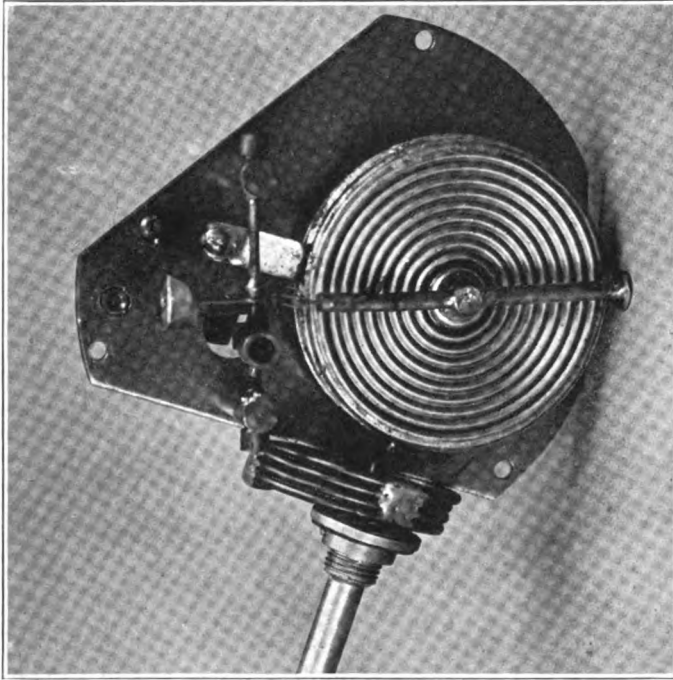

FIG. 6A. Bristol Double Diaphragm Air Speed Indicator

ment by the former and the suction by the latter. Under these circumstances no static head is used, the Pitot nozzle being connected to one of the air tight chambers and the Venturi to the

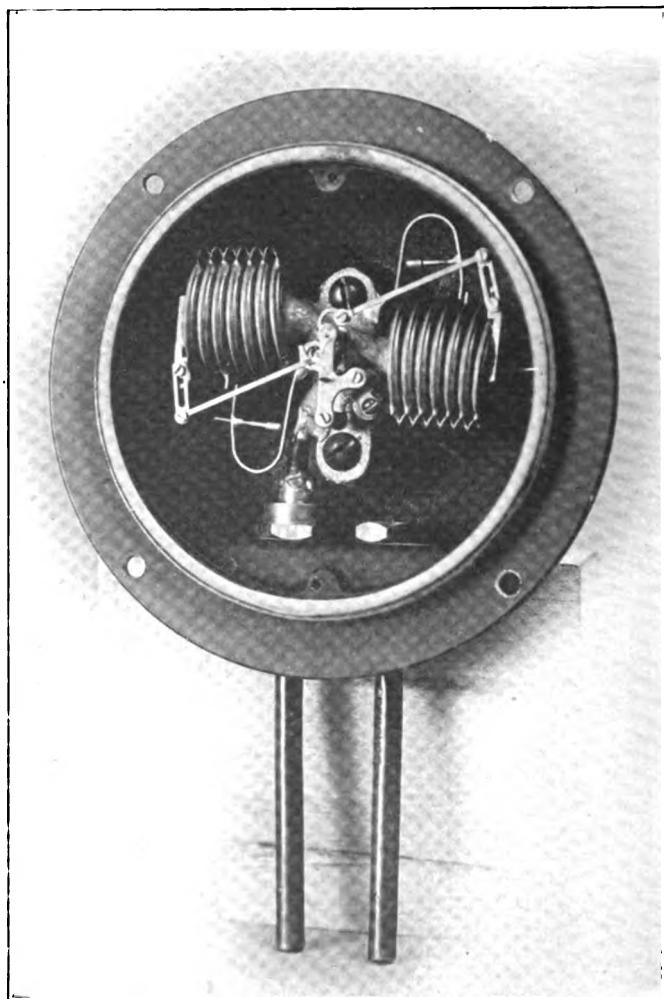

FIG. 6B. Foxboro Bellows Diaphragm Air Speed Indicator

other. The differential pressure developed by the nozzle causes the diaphragm to expand or contract according to the magnitude and direction of the excess pressure. This motion is carried by a

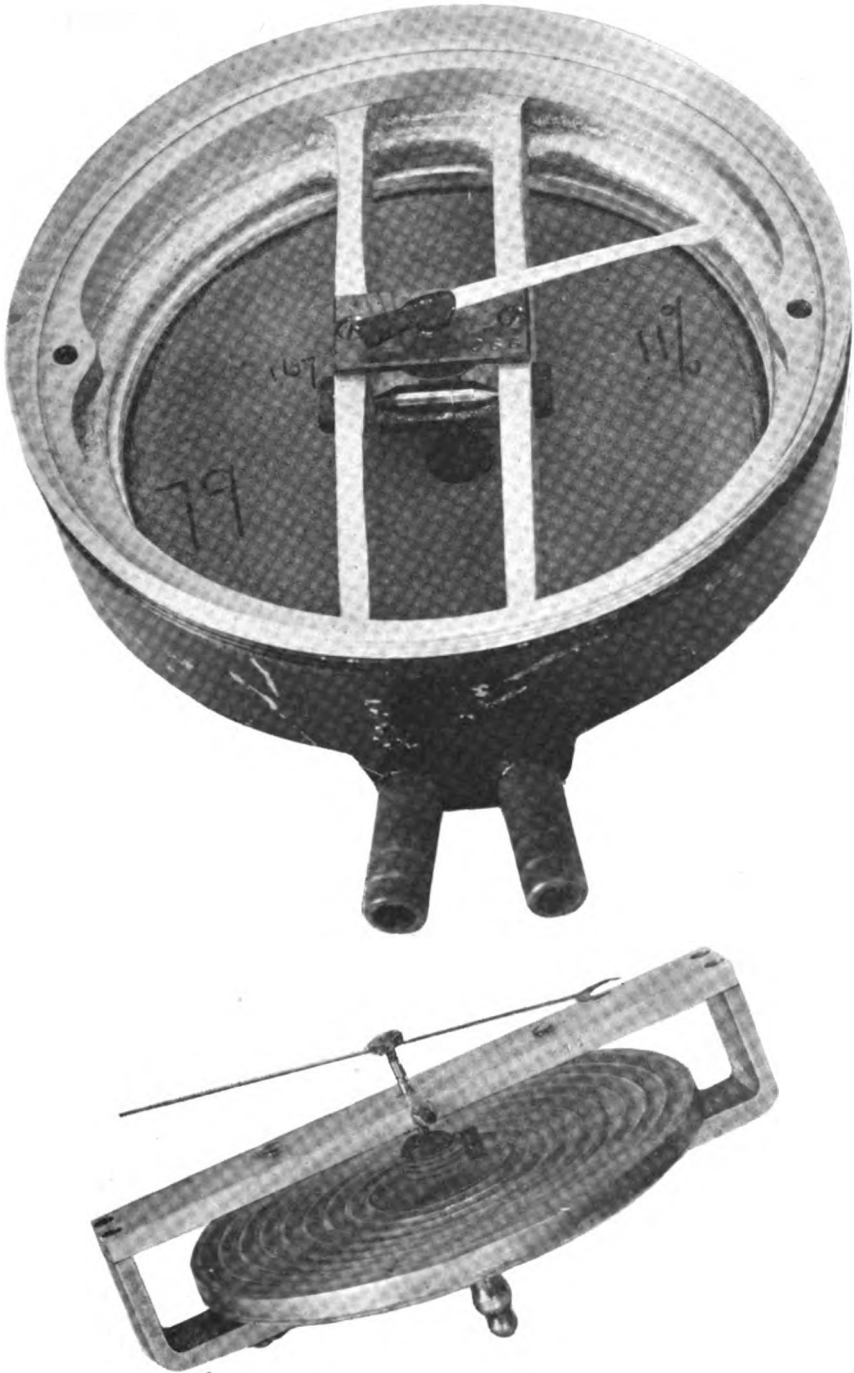

FIG. (C). Ogilvie rubber diaphragm (above) Sperry single diaphragm (lower) Air Speed Indicators

suitable transfer mechanism to the pointer, indicating corresponding speeds on a dial which is graduated in miles per hour or kilometers per hour in accordance with the pressure-speed relation of the nozzle used. Most nozzles of the Pitot and Venturi type obey the so-called ρv^2 law, i.e., the pressure developed is proportional to the density of the air and the square of the velocity of motion.

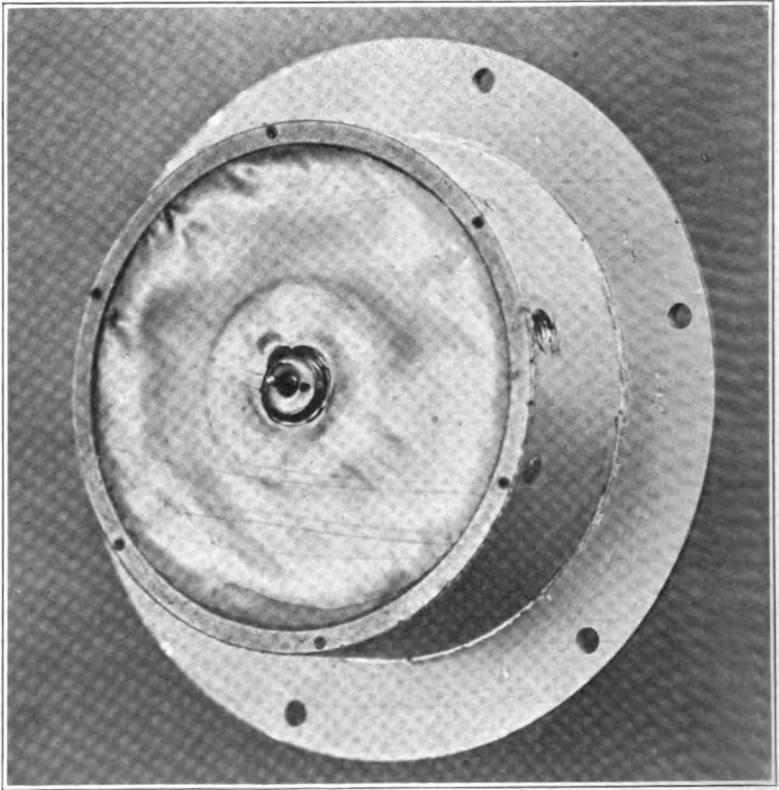

FIG. 6D. Clift Doped Fabric Diaphragm Air Speed Indicator

Typical air speed indicators of the Pitot and Venturi type are shown in Fig. 6A-E.

Instruments in which a flat plate perpendicular to the direction of motion is used to measure the air pressure have also been constructed. In these the plate is attached to a lever whose motion

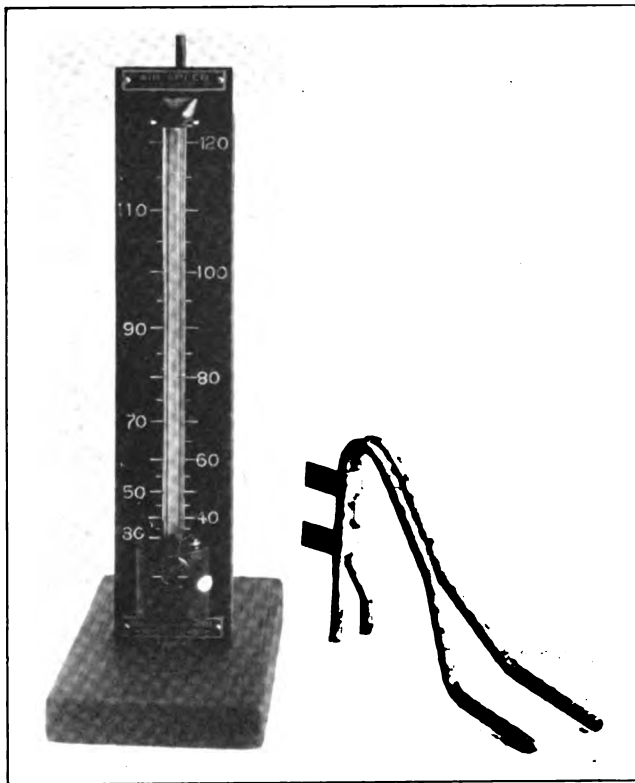

FIG. 6E. Pioneer Liquid Manometer Type Air Speed Indicator

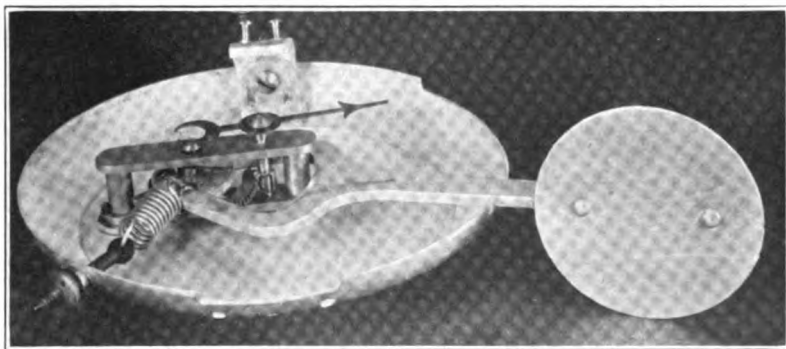

FIG. 7. Pensuti Pressure Plate Air Speed Indicator

is resisted by a spring. The displacement of the lever which depends upon the speed is used to indicate the air speed directly or it may be attached to a sector and pinion and a dial and pointer added. An instrument of this type is shown in Fig. 7. The pressure developed by these instruments also obeys the ρv^2 law.

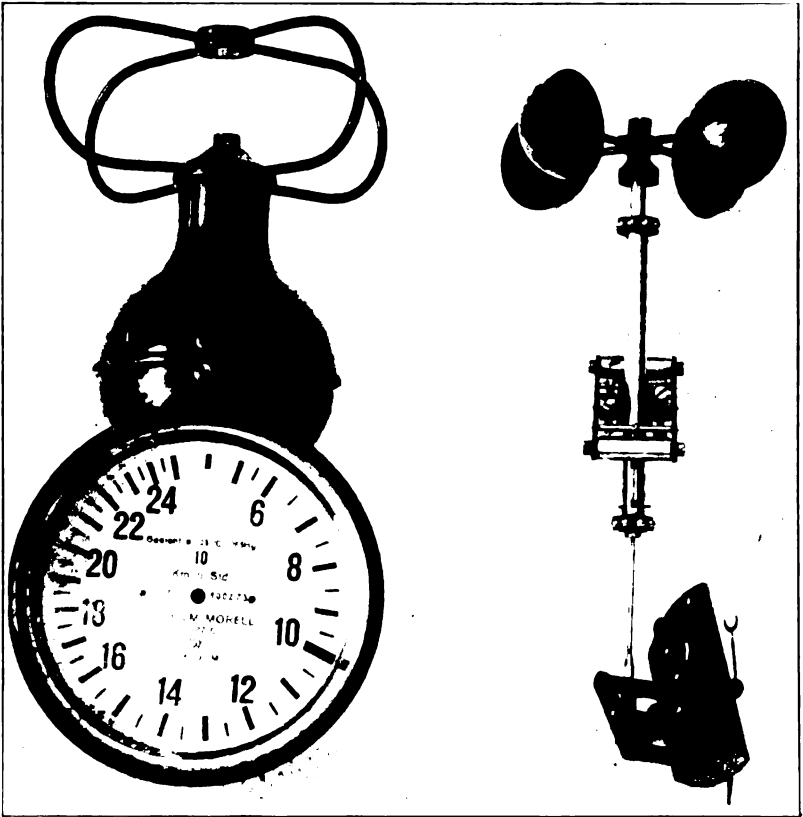

FIG. 8A. Morell Anemometer Air Speed Indicator

In instruments of the anemometer type the air speed is determined by the rate of revolution of a cup anemometer or air propeller. In most cases the rate of revolution is determined by attaching the rotating element to a centrifugal tachometer similar to that used in indicating the rate of revolution of the engine.

(See below). These instruments are ordinarily located on one of the struts of the airplane and are read from this position by the pilot. Instruments of the anemometer type with electrical distant control have recently been developed in which the anemometer alone is located on the strut. Wires lead from a specially designed commutator operated by the anemometer to the indicator which is on the instrument board. Typical anemometer air

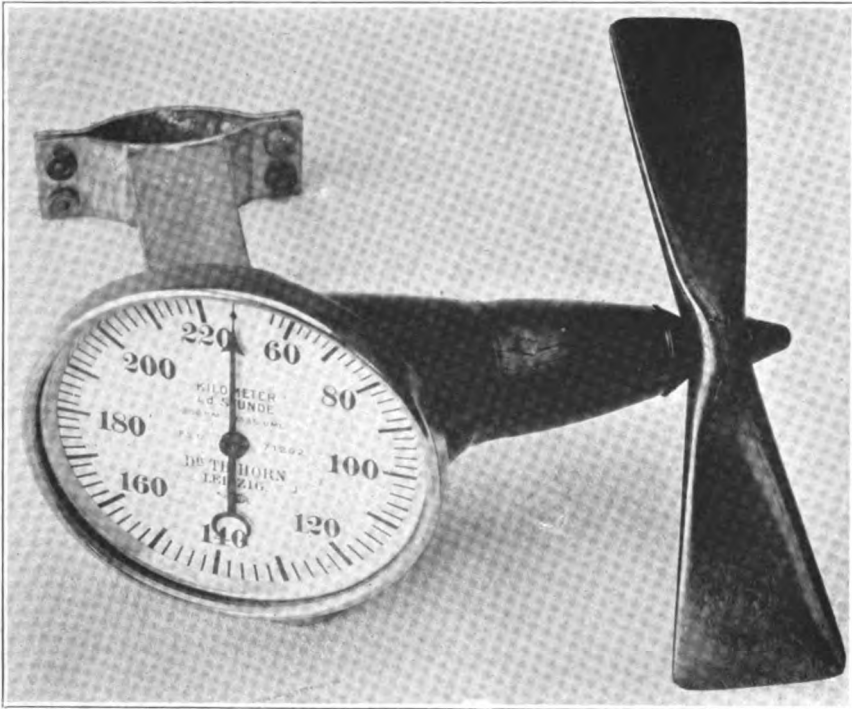

FIG. 8B. Horn Propellor Air Speed Indicator

speed indicators are shown in Fig. 8A-B. Hot wire anemometers in which the cooling effect of the air on an electrically heated wire grid have also been used to a limited extent but the device is complicated and not suited for ordinary use in determining the speed of the aircraft.

Ground Speed Indicators. The measurement of speed of aircraft relative to the ground is of importance in connection with

aircraft performance tests, long distance flying and military operations such as bombing. In case of aircraft performance tests the ground speed attained is ordinarily determined by flying the aircraft over measured courses or by sighting upon the aircraft from the ground with theodolites. These methods will not be considered in detail here, since we are primarily interested in the instruments carried by the aircraft itself. The methods of determining ground speed from the aircraft such as are used in long distance flying and in bombing are fundamentally either optical, dynamical, or electrical in principle. The actual instruments are still for the most part in an experimental state so only the methods of their operation will be considered here.

The simplest type of optical ground speed indicator depends upon determining with a stop watch the time for some object on the ground to pass between two sighting points in a horizontal line on the instrument. The ground speed can then be calculated from the separation of the two sighting points, the distance from the horizontal line defined by them to a third sighting point at the observer's eye, and the altitude of the aircraft. The principle may be demonstrated as follows:

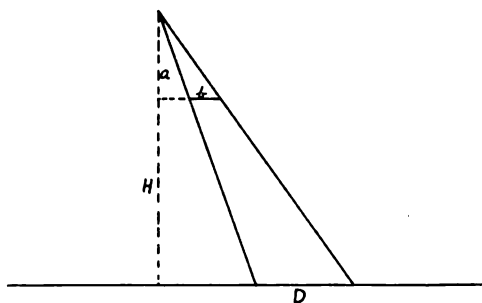

Let a = distance from line b to the eyepiece.

H = the altitude.

b = distance between the two sighting points.

D = the distance traversed by the aircraft while the object on ground appears to move between the two sighting points.

t = time in seconds required.

S = speed of the aircraft.

Then

$$\begin{aligned} \frac{a}{H} &= \frac{b}{D} \\ \therefore S &= \frac{H}{a} \frac{b}{t} \\ &= \text{const.} \frac{H}{t} \end{aligned}$$

Another method is to use a rotating or reciprocating optical arrangement to neutralize the apparent motion of objects on the ground as seen through a telescope, or to cause a reference line in the telescopic field to move at the same rate as the image of the object on the ground. If then the rate at which the telescope or the image in the telescope field is moving is determined and the altitude of the aircraft is known the ground speed may be found. Several devices of this kind have been tried.

A modification of the last method is to introduce by means of a rotating telescope or similar device an artificial drift at right angles to the actual drift of the aircraft relative to the ground. From the direction of the resultant apparent drift and the magnitude of the artificial drift the ground speed can be computed. The principle may be illustrated as follows:

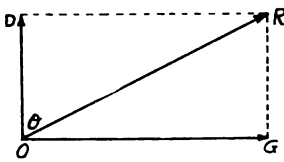

Let OG represent the ground speed of the aircraft the magnitude of which is to be found and the direction of which is shown by the use of a drift indicator, and OD the known artificial drift introduced at

right angles to the ground speed OG by the rotating telescope or other device. Then OR will represent the resultant apparent drift as seen thru the rotating telescope and if the angle θ between the artificial drift and the resultant apparent drift is measured the magnitude of the ground speed can be calculated by the relation

$$OG = OD \tan \theta$$

Theoretically it would be possible to find the ground speed of an aircraft by determining the time integral of the accelerations to which it is subjected from the beginning of the flight. It has been proposed to do this by supporting a mass between springs

so that it is free to move in a horizontal plane in a fore-and-aft direction. The displacement of the mass under these circumstances will be proportional to the acceleration of the aircraft. If then the time integral of this displacement can be obtained mechanically and shown on a direct reading dial, the ground speed at any given instant will be known. Actually the inherent friction of the integrating mechanism and the inevitable accumulation of errors in integration make the device impractical. It is also necessary that the mass move only in a horizontal plane to prevent accelerations of the mass due to gravity. This can be brought about apparently only by gyroscopic stabilization which means much added weight and complication. No practical instrument of this type has been made.

Directional radio telegraphy has recently presented another possibility for ground speed measurement. With a directional receiving apparatus, the position of the aircraft with reference to two sending stations of known distance apart may be determined at successive time intervals and from these observations the ground speed computed. This is at present the only practical method of determining the ground speed of aircraft when the ground cannot be seen.

Rate of Climb Indicators. Rate of climb indicators are used to determine the component in a vertical direction of the velocity of aircraft. Like statoscopes they usually depend for their operation on the expansion or contraction of a volume of air confined in a heat insulated container. This container is connected to the external air through a fine capillary tube. When the aircraft rises the pressure of the air in the container becomes greater than that of the surrounding atmosphere owing to the lag in the pressure equalization caused by the capillary tube. The magnitude of the excess pressure is a function of the rate of climb. If then means is provided for measuring the excess pressure this can be used to indicate the rate of climb. The method ordinarily adopted is to make one side of the container a flexible metal diaphragm connected to an indicating mechanism or to connect to the container a U-tube filled with colored liquid. An instrument of the former type is shown in Fig. 9. Motion of the flexible dia-

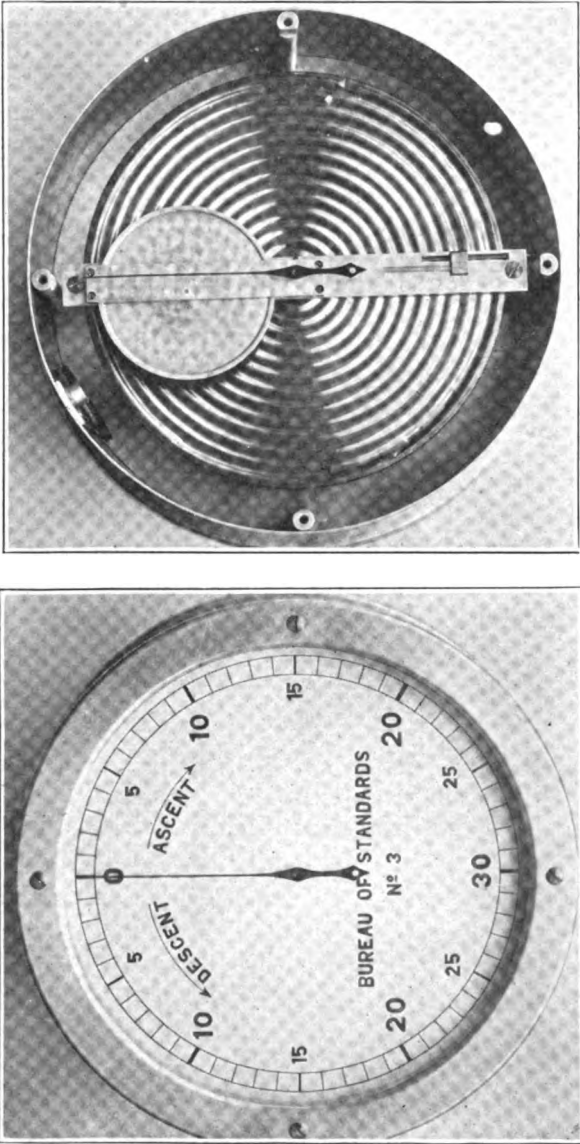

FIG. 9. Bureau of Standards Rate of Climb Indicator

phragm is multiplied by a system of aluminum pulleys and phosphor bronze strips and used to operate a pointer which moves over a dial graduated to indicate the rate of ascent or descent in feet per minute. An instrument of liquid manometer type is shown in Fig. 10. In this case the height of the liquid column is used as a measure of the vertical velocity.

ORIENTATION INSTRUMENTS

Compasses. The adaptation of the magnetic compass to use in aircraft presents serious difficulties because of the violent accelerations to which the instrument is subjected and also the unavoidable proximity of large moving masses of magnetic material in the aircraft. Liquid filled compasses are used almost exclusively because heavy damping is required. Aircraft compasses are in general quick-acting instruments with periods varying from 10 to 20 seconds. Compasses with longer periods are less disturbed by small transient accelerations but in general those with a period between the above mentioned limits are preferred especially when used in connection with turn indicators (see below) which have recently reached a practical state of development. Efforts have been made to overcome the unsteadiness and swirling of the liquid of airplane compasses by mounting the magnet and card in the center of a spherical bowl. Another method recently developed is to make the compass aperiodic by eliminating the ordinary card and mounting the needles on a light spider made of small straight wires projecting radially from the point of support in the damping liquid. Standard compasses of former types are shown in Fig. 11A-B and of the latter type in Fig. 12. Some are provided with both horizontal and vertical cards, others with inclined cards. The aperiodic compass dispenses with the card entirely and uses parallel wires on a rotatable bearing plate over the flat cover glass to sight on the needle.

The disturbing effect of masses of iron in the vicinity of the instrument board have led to an effort to develop distant reading compasses in which the compass proper can be located far away from the motor, for instance, in the fuselage, near the tail of the airplane, while the indicator is located on the instrument board.

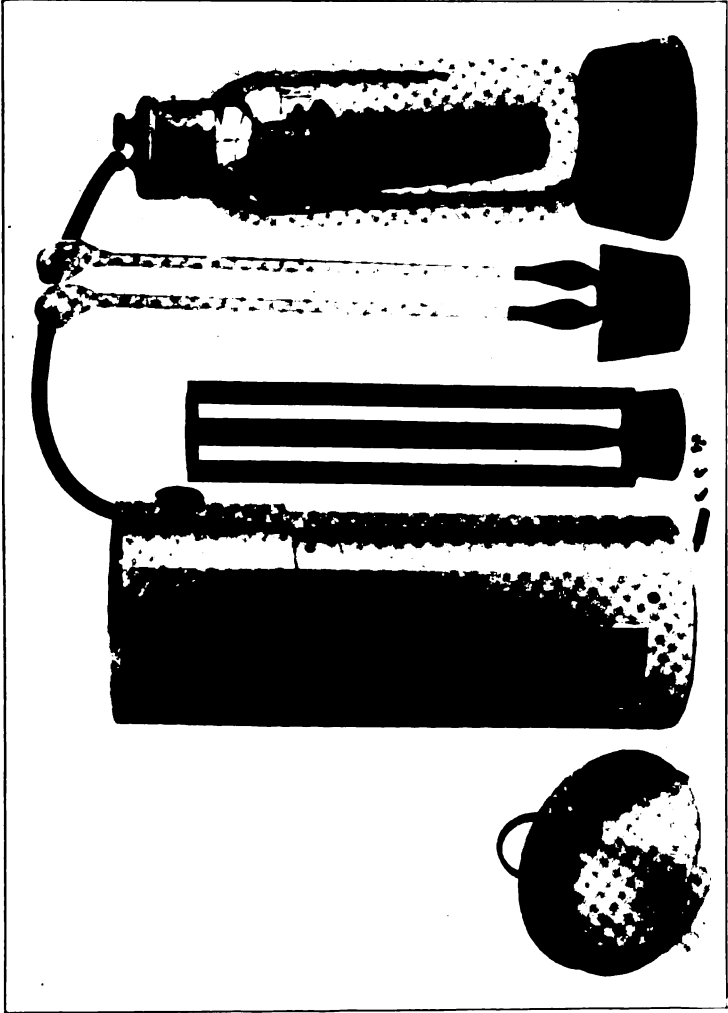

FIG. 10. Wright Rate of Climb Indicator

One method which has been tried is to use the current developed by a coil of wire rotating in the earth's magnetic field. This can be used to indicate direction since the magnitude of the induced current is a function of the orientation of the coil with respect to the earth. This device is known as an earth inductor compass.



FIG. 11A. General Electric Company Compass

Another method takes advantage of the change of resistance of selenium when exposed to light by providing two selenium cells located at diametrically opposite points above the compass card. Below each cell is an incandescent lamp. The card shields the

selenium cells to a greater or lesser extent according to the direction of the compass needle thereby changing the resistance of the selenium cells which constitute two arms of a Wheatstone bridge. This unbalances the bridge and indicates on a galvanometer on the instrument board the amount of displacement of the compass



FIG. 11B. Sperry Compass

card. This device is complicated and with its auxiliary attachments much heavier than an ordinary aircraft compass (See Fig. 13.)

Turn Indicators. Turn indicators are used to inform the aviator when he is deviating from a straight line course. The essential working element is a gyroscopic rotor which in accord-

ance with the principle of gyroscopic action tends to maintain its direction in space when the airplane deviates. The resultant relative motion is made evident to the pilot by the motion of a pointer connected to the rotor thru a lever system. The rotor is ordinarily driven either by the impact of an air stream on the serrated edge of the rotor itself or by making the rotor an induction motor. In the air-driven type the air stream is maintained by a



FIG. 12. Campbell-Bennett Aperiodic Compass

Venturi tube which exhausts the air from the case in which the rotor is enclosed. Small orifices are provided in the case opposite the serrated edge of the rotor. Thru these the air streams in from outside the case impinging on the wheel and causing it to rotate. The electrical type can be connected to the storage battery which is a part of the standard equipment of modern aircraft, or it can

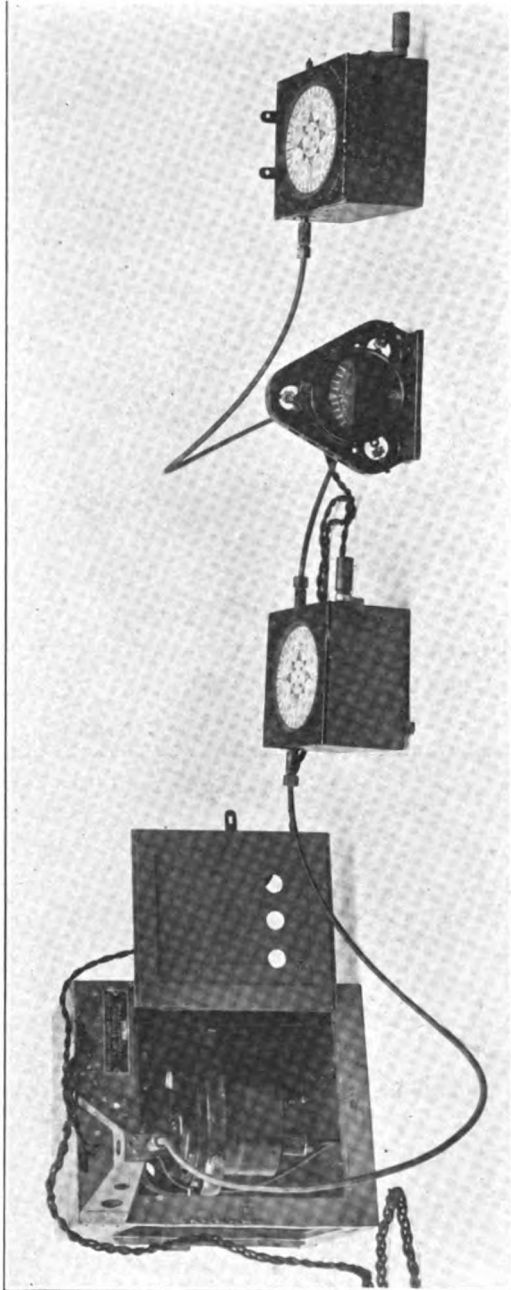

FIG. 13. Bamberg Distant Reading Compass with Indicator and Course Setters

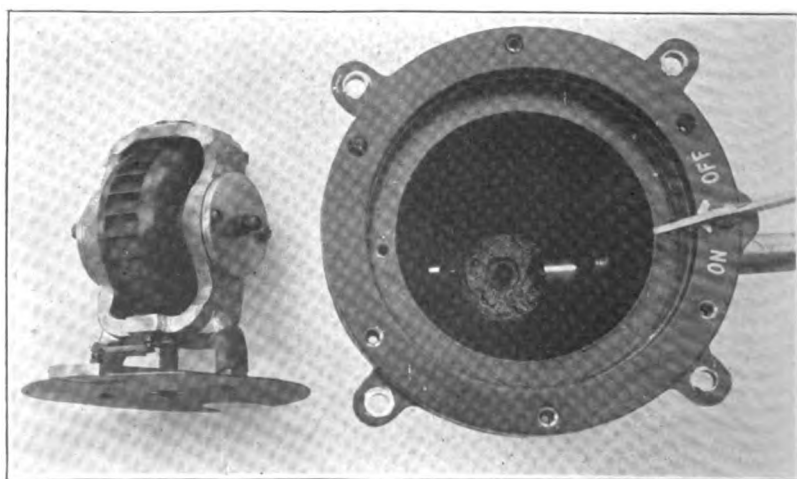

FIG. 14A. Perry Air Driven Gyro-Turn Indicator

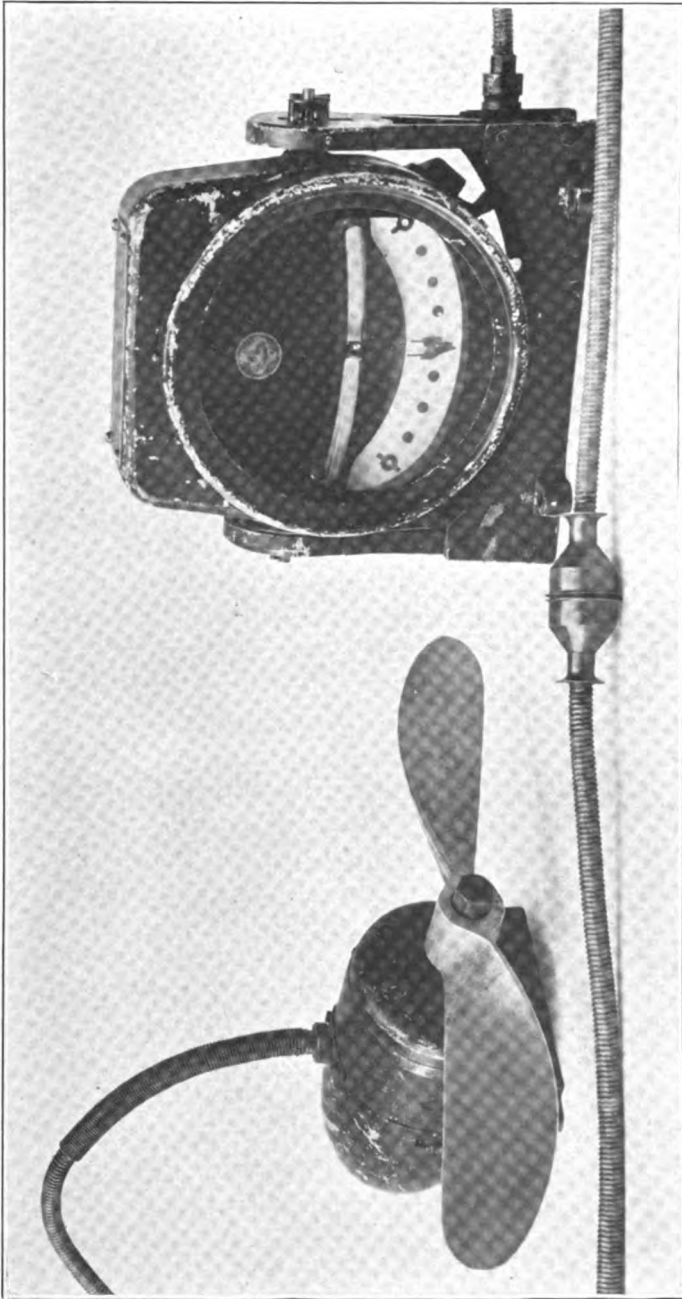

FIG. 14B. Drexler Electric Gyro Turn Indicator

be operated by a small auxiliary generator driven by a wind propeller. Instruments of both types have reached a practical stage of development and are an invaluable adjunct to the compass, particularly for use in cloud flying, since they can be made more sensitive to slight deviations than the compass and moreover function when the turn commences, at which time the compass is ordinarily temporarily useless because it is oscillating. Turn indicators of both types are shown in Fig. 14A-B.

Inclinometers. Inclinometers are used to indicate the inclination of aircraft with reference to the true vertical or to the resultant of gravity and forces of acceleration acting on the aircraft. There are two general types, those involving the principle of the liquid bubble level which indicate the aspect of the air plane with respect to resultant gravity and gyroscopic instruments which indicate the position of the airplane with reference to the true vertical. The former is much the simpler and more frequently used type. Representative inclinometers of liquid type are shown in Fig. 15A-F. These are designated by the name lateral and fore and aft inclinometers according as they refer to the condition of the airplane with reference to rolling and pitching. The liquid lateral inclinometer is essentially a curved glass tube filled with colored liquid in which a bubble forms. The displacement of the bubble indicates the inclination. The fore and aft inclinometer is the same in principle except that in this case it consists of a triangular shaped closed circuit of glass tubing partially filled with liquid. The liquid changes its level in the front arm of the circuit when the airplane pitches. See Fig. 15C. Liquid inclinometers of sector type are shown in Fig. 15D. In these a disk shaped receptacle with a circular glass face is half filled with colored liquid. The position of the surface of the liquid with reference to the normally horizontal diameter of the dial indicates the inclination of the aircraft. Liquid and air damped pendulum devices have also been used instead of instruments of the liquid bubble type. These are shown in Fig. 15E and F where 15E is a lateral inclinometer and 15F a fore-and-aft inclinometer.

An instrument of gyroscopic type is shown in Fig. 16. It is essentially a spinning top mounted on a pivot near its center of

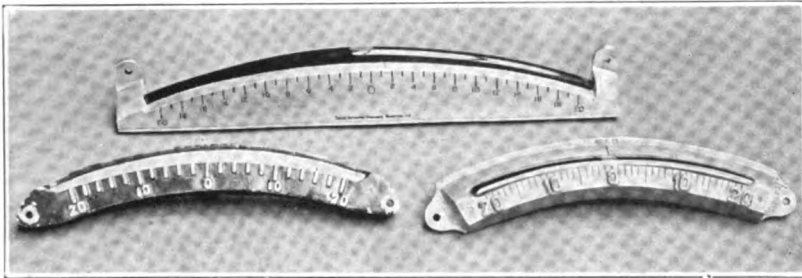

FIG. 15A. Liquid-Bubble Lateral Inclinometers

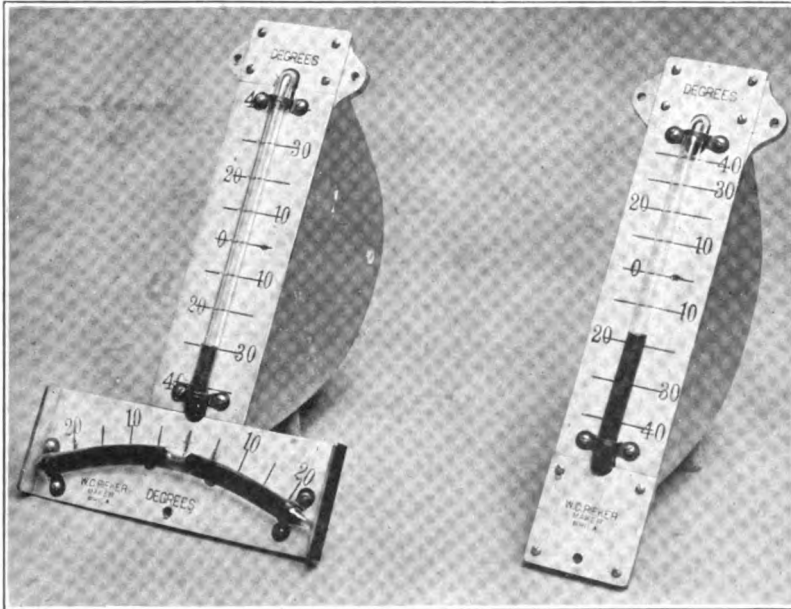

FIG. 15B. Ricker Liquid Fore-and-Aft Inclinometer and Combined Liquid Fore-and-Aft and Lateral Inclinometers

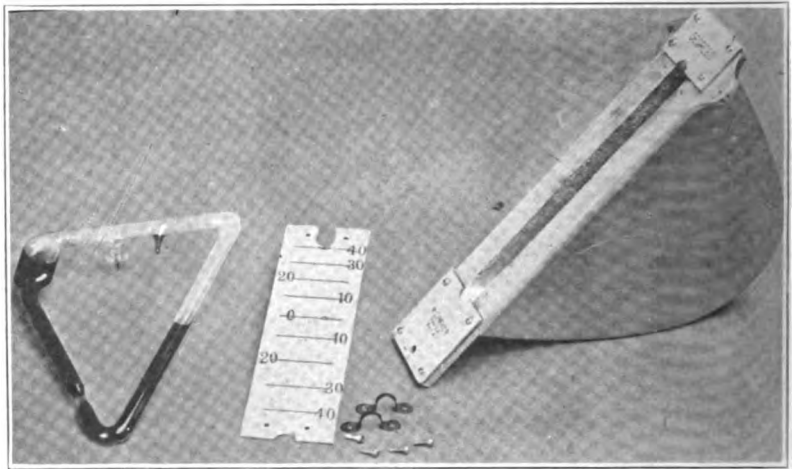

FIG. 15C. Ricker Liquid Fore-and-Aft Inclinometer—Disassembled

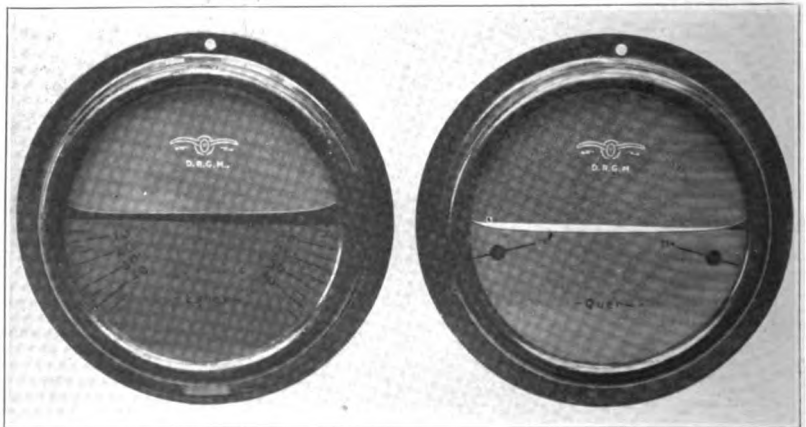

FIG. 15D. D.R.G.M. Sector Type Lateral Inclinometer

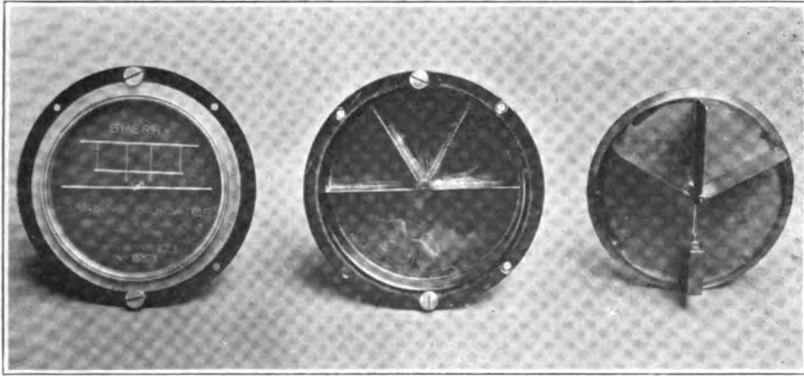

FIG. 15E. Sperry Pendulum Lateral Inclinometer

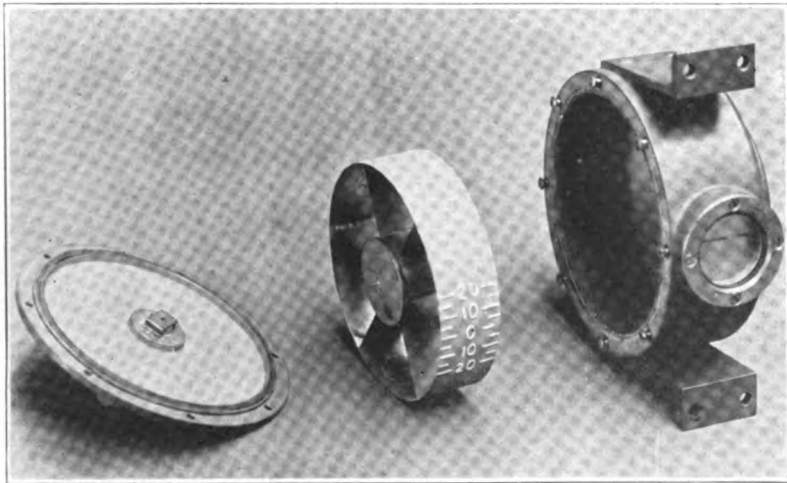

FIG. 15F. Sperry Pendulum Fore-and-Aft Inclinometer

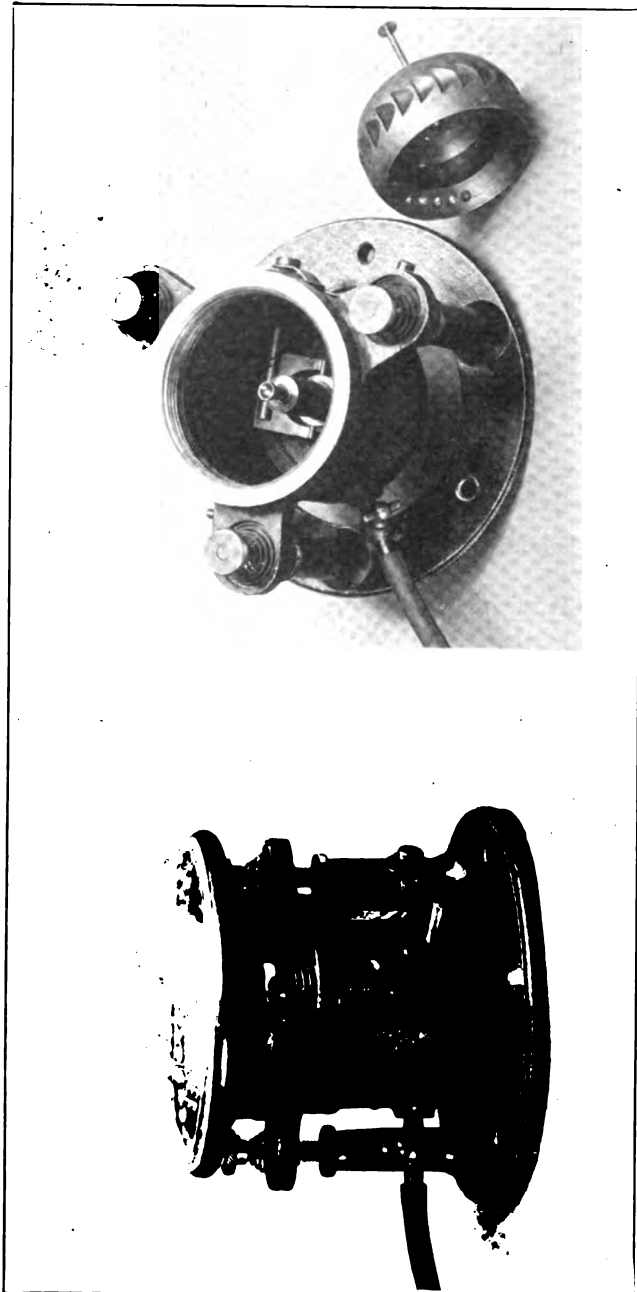

FIG. 16. Garnier Gyroscopic Top Inclinometer

gravity. It is rotated rapidly by an air stream impinging upon the serrated edge of the top. The gyroscopic action of the top tends to maintain its position vertical when the airplane pitches or rolls. The amount of displacement either laterally or longitudinally is indicated by the position of the pin of the top relative to the spherical cover of the instrument which is graduated in degrees. The power to drive the top is supplied by a Venturi tube which exhausts the air from the case and rotates the top as in the air-driven turn indicator described above.

ENGINE INSTRUMENTS

Tachometers. Tachometers are used to indicate the rate of revolution of the crank or propeller shaft of aircraft engines. They are usually driven by a flexible shaft which runs from the engine to the instrument board where the tachometer itself is located. The two types most commonly used are the centrifugal and the chronometric.

The centrifugal tachometer is the same in principle as the familiar ball governor and depends upon the tendency of a mass to move away from the axis of rotation under the action of centrifugal force. This tendency is resisted by a spring. The amount of motion which is a measure of the rate of rotation, is applied through a transfer mechanism to the pointer which moves over a dial graduated in revolutions per minute. A centrifugal instrument of standard design is shown in Fig. 17. In some centrifugal tachometers the centrifugal element consists of two or more small weights connected to the shaft by links as in Fig. 17, and in others of a single inclined weight which tends to assume a horizontal position under the action of centrifugal force. Centrifugal instruments are much simpler in construction and more durable than the chronometric type but are not so accurate as the latter.

In chronometric tachometers the speed is measured by the amount of motion of a toothed rack or gear system in a measured interval of time, usually one or two seconds, which is determined by a clockwork escapement. This motion is communicated to the pointer which is deflected in the given time interval an amount depending upon the speed of rotation of the driving shaft. The

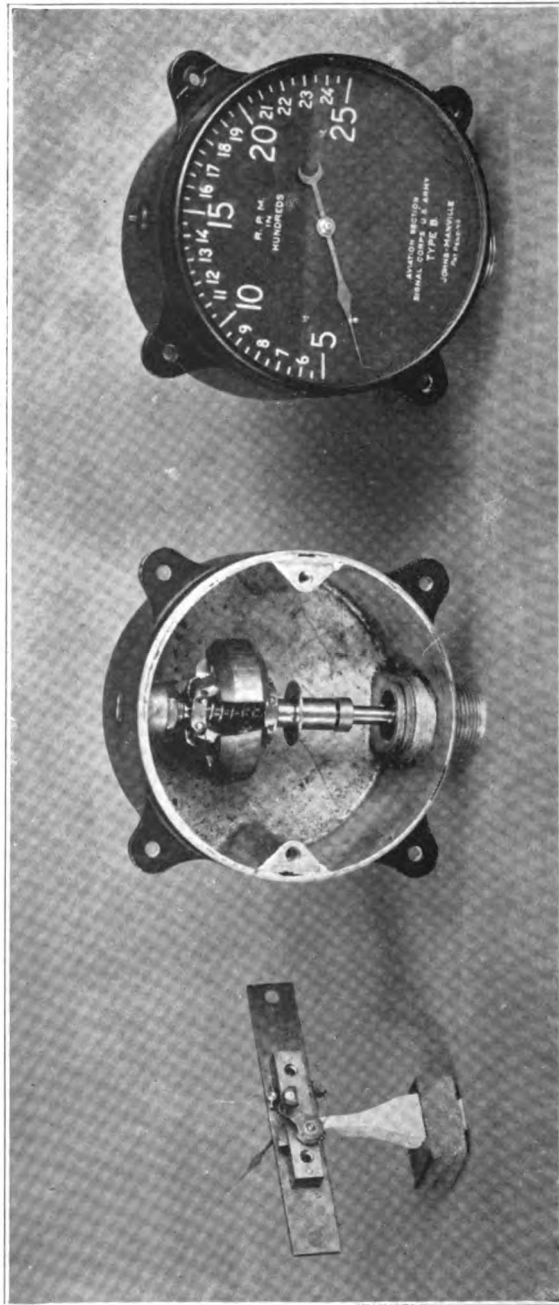

FIG. 17. Johns Manville Centrifugal Tachometer

mechanism is so designed that the pointer is locked in position during each succeeding time interval while the toothed rack or gears are in action. At the end of each time interval the pointer is released and suddenly jumps to its new position which is determined by the rate of rotation of the engine shaft during the time interval just ending. The result is that the pointer of the instrument moves by discontinuous jumps instead of continuously, as in instruments of the centrifugal type. A representative tachometer of the chronometric type is shown in Fig. 18. As stated

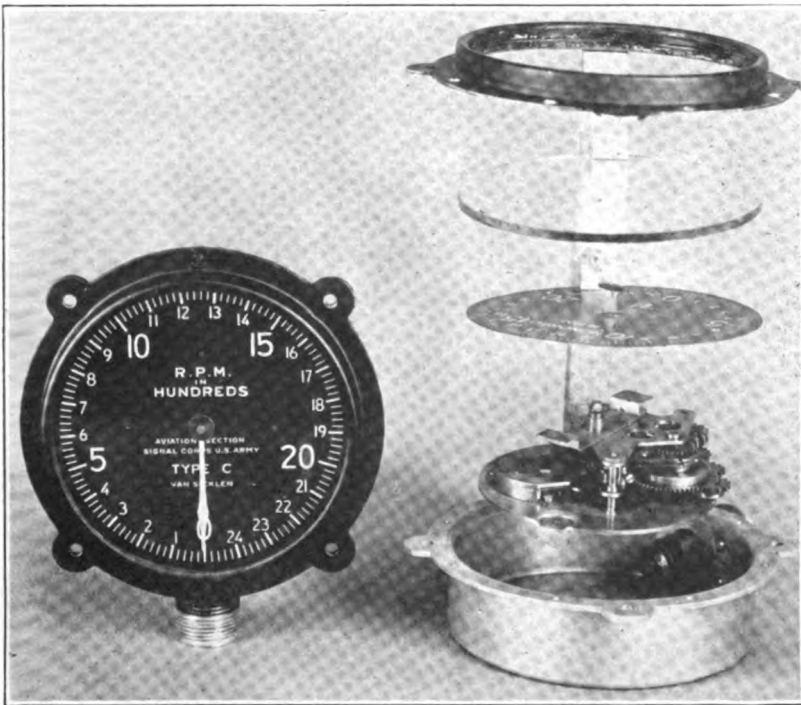

FIG. 18. Van Sicklen Chronometric Tachometer

above they are more accurate than the centrifugal tachometer but they involve complicated clockwork mechanism which easily gets out of order and is difficult to repair. However, a number of satisfactory instruments of this type have been made.

Several other types of tachometers have been used to a limited extent. Among these may be mentioned magnetic and electro magnetic tachometers, air viscosity and air pump tachometers. In the magnetic tachometer a permanent magnet is rotated near a conducting disk thereby dragging the disk, by virtue of the induced eddy currents, in opposition to a resisting spring an amount depending upon the rate of rotation. A pointer attached to the disk moves over a scale graduated in miles per hour. An instrument of this type is shown in Fig. 19.

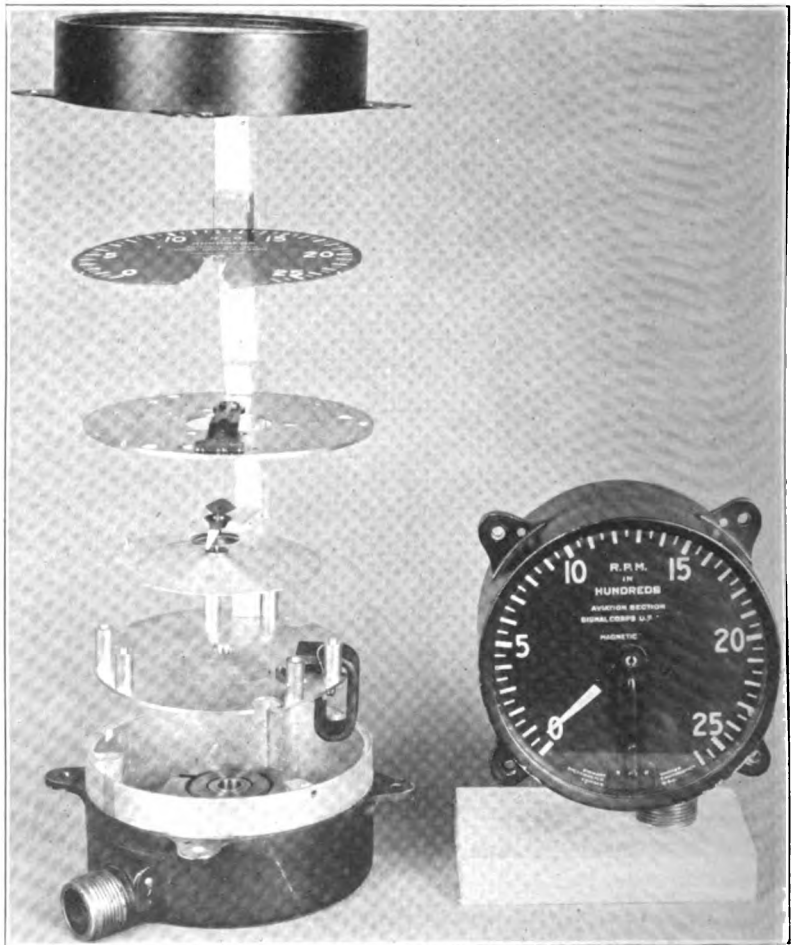

FIG. 19. Stewart-Warner Magnetic Tachometer

In the electromagnetic type a small magneto is attached to the engine shaft and connected to a galvanometer on the instrument board. The voltage developed by the magneto and hence the deflection of the galvanometer is proportional to the rate of revolution of the engine. The galvanometer is graduated to read in revolutions per minute. Magnetic and electromagnetic tachometers show larger errors than the centrifugal and chronometric type instruments and do not maintain their calibration as well.

The air-drag or viscosity tachometer consists of two concentric cylinders separated by a thin film of air. One cylinder which is attached to the engine shaft tends to rotate the other by virtue of the viscous action of the air film between them. This tendency to rotation is opposed by a spring. A pointer is attached to the second cylinder and the amount of deflection is a measure of the rate of revolution of the first cylinder. The deflection in this case however is not proportional to the speed. The temperature errors of these instruments are large.

The air-pump type consists essentially of an air pump which forces air into a chamber provided with a leak orifice. The pressure developed in the chamber depends upon the rate at which the pump, which is connected to the driving shaft, rotates. In escaping from the chamber the air deflects a vane whose motion is opposed by a restraining spring. The amount of the deflection of the vane is thus a measure of the speed of revolution of the driving shaft. Air-pump tachometers are subject to large altitude errors caused by the change in air density.

Pressure Gages. Oil and air pressure gages are used in aircraft to indicate the air pressure in the gasoline tank and the oil pressure of the engine lubricating system. Both gages are ordinarily of the Bourdon type but of different range, air pressure gages having a range of approximately 0 to 5 lb. sq. in. and oil pressure gages from 0 to 100 lb. sq. in. A group of representative oil and air pressure gages is shown in Fig. 20. The essential working element is a Bourdon tube, one end of which is rigidly attached to the instrument case and the other to the indicating system, which is either a sector and pinion or a system of levers. With increase of internal pressure the Bourdon tube expands, thereby causing the

pointer to move across the scale. In some of the instruments the pointer is concentric and in others eccentric, the advantage of the former being that it is given a much more open scale.

Gasoline Gages. Gasoline gages are used to indicate the depth of gasoline in the gasoline supply tank. The most common type consists of a float of cork, wood, or hollow metal which rests on the surface of the gasoline and which is connected to the indicating



FIG. 20. Air and Oil Pressure Gages

mechanism by a metal rod or a flexible cord (See Fig. 21). Where it is possible to mount the indicator on the tank the float is allowed to travel up and down between two vertical fixed rods. A stiff twisted metal ribbon or inclined rod is rotated by the float as it changes its position, thereby operating the indicator which is mounted above the float and attached to the moving rod through

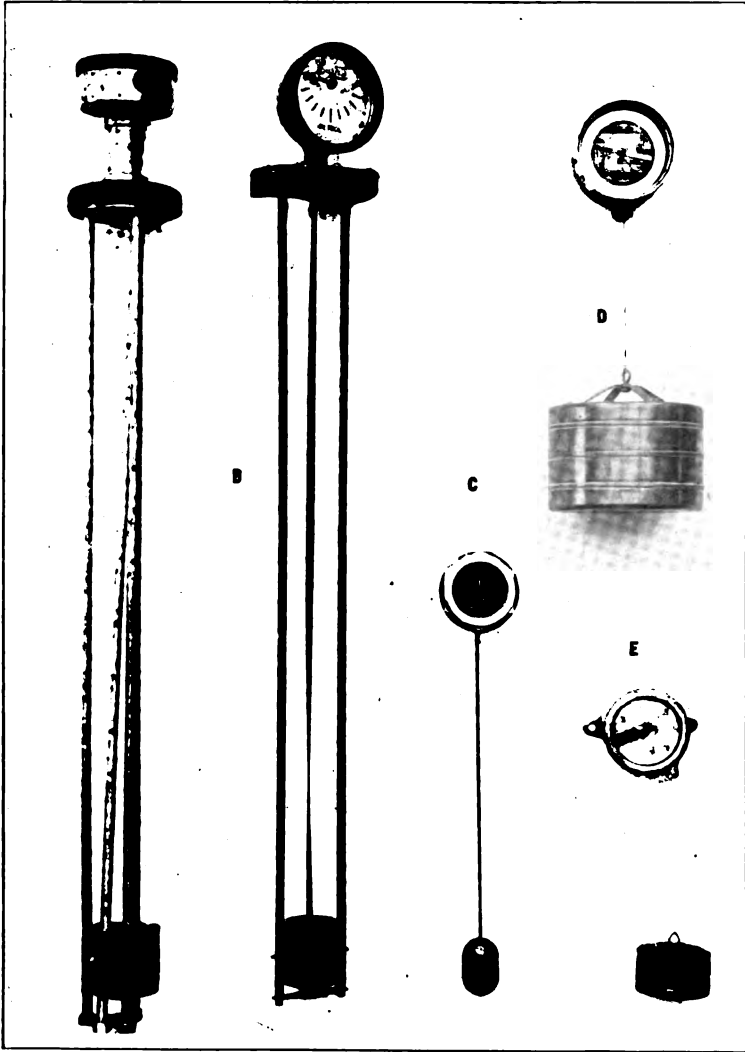

FIG. 21. Float Type Gasoline Gages

a system of gears. A disadvantage of this type of gage is that the float is likely to stick between the guide rods if they get out of alignment. Another method is that shown in Fig. 21 C, in which the indicator is mounted at the center of the side of the tank facing the aviator. In this case the float is attached to a long metal rod and rotates about the indicator. At the end of the floating rod is a small magnet which drags the iron pointer about as the float follows the level of the gasoline. Between the magnet and the pointer there is a metal disk which protects the cover glass from the hydrostatic pressure of the gasoline.

Float gages in which the float is connected to the indicator by a light weight silk cord, are shown in Fig. 21 D and E. The float consists of an air-tight, hollow, brass cylinder which moves up and down in a metal tube which reaches from the top to the bottom of the tank and whose diameter is slightly greater than that of the float. When the indicator is located at a distance from the float the connecting cord passes through a metal tube with roller fittings at the angles. The gage itself consists essentially of a drum on which the cord winds and unwinds and a system of gears which connects the drum to the indicating pointer. The cord is always maintained taut by a coiled spring which is attached to the drum. The indicator shown in Fig. 21D has a magnetically controlled pointer similar to that described above. One shown in Fig. 21E is provided with a spiral scale and by means of a rack and pinion mechanism the tip of the pointer is made to follow the convolutions of the spiral as it rotates. This makes it possible to allow the pointer to make several complete revolutions without confusing the indications.

Another type of gasoline gage which has been used to a limited extent depends upon the hydrostatic pressure of the head of gasoline in the tank. This pressure is measured by an indicator with corrugated flexible metal diaphragm capsules similar to those of an airspeed indicator. The gage is operated by connecting the case of the indicator to the air space above the gasoline tank and the diaphragm capsule to a tube extending to the bottom of the tank. Air is caused to bubble through the tube either by the use of a handpump or automatically by the use of a power pump

thereby impressing on the indicator a differential pressure equal to the head of gasoline. With this type of gage it is possible to have the indicator on the instrument board and connected to the gasoline tank by metal tubing. A disadvantage particularly from the military point of view, is that a rupture in the connecting tube is likely to cut off the fuel supply from the engine. A group of gages of this type is shown in Fig. 22.

Gasoline Flow Indicators. The rate of gasoline consumption in aircraft engines is found by the use of flow indicators. Typical instruments are shown in Fig. 23. In the one at the left of the figure a metal vane restrained by a coiled spring is deflected by the gasoline as it flows through the instrument. The gasoline flows past the vane in the space between the vane and the case. The case is provided with a cam surface which varies the space between the vane and the case as the vane rotates so that the deflection of the vane is made proportional to the rate of flow of gasoline. A pointer attached to the vane indicates the rate of flow in gallons per minute. In the indicator at the right the gasoline is forced out thru a slit in a vertical metal tube surrounded by a concentric glass tube. A small rider shown at the left floats on the gasoline. The height reached by the gasoline as it flows thru the slit and consequently the reading indicated by the rider is proportional to the rate of gasoline consumption.

Thermometers. Thermometers are used in aircraft to indicate the temperature of the radiator water and oil supply of the engine, the temperature of the atmosphere, and on lighter-than-air craft the temperature of the gas in the bags. The last two mentioned types are described below under Special Instruments. Thermometers for measuring the temperature of water and oil ordinarily consist of a metal bulb partially or completely filled with liquid which is located at the point whose temperature is to be determined and which is connected by means of a capillary tube to some form of pressure gage, usually of the Bourdon type, located on the instrument board. Two types of pressure thermometers are used. These are known as the vapor pressure and liquid filled type, according as they depend upon measuring the variation of the pressure of the vapor of a volatile liquid or the expansion of a

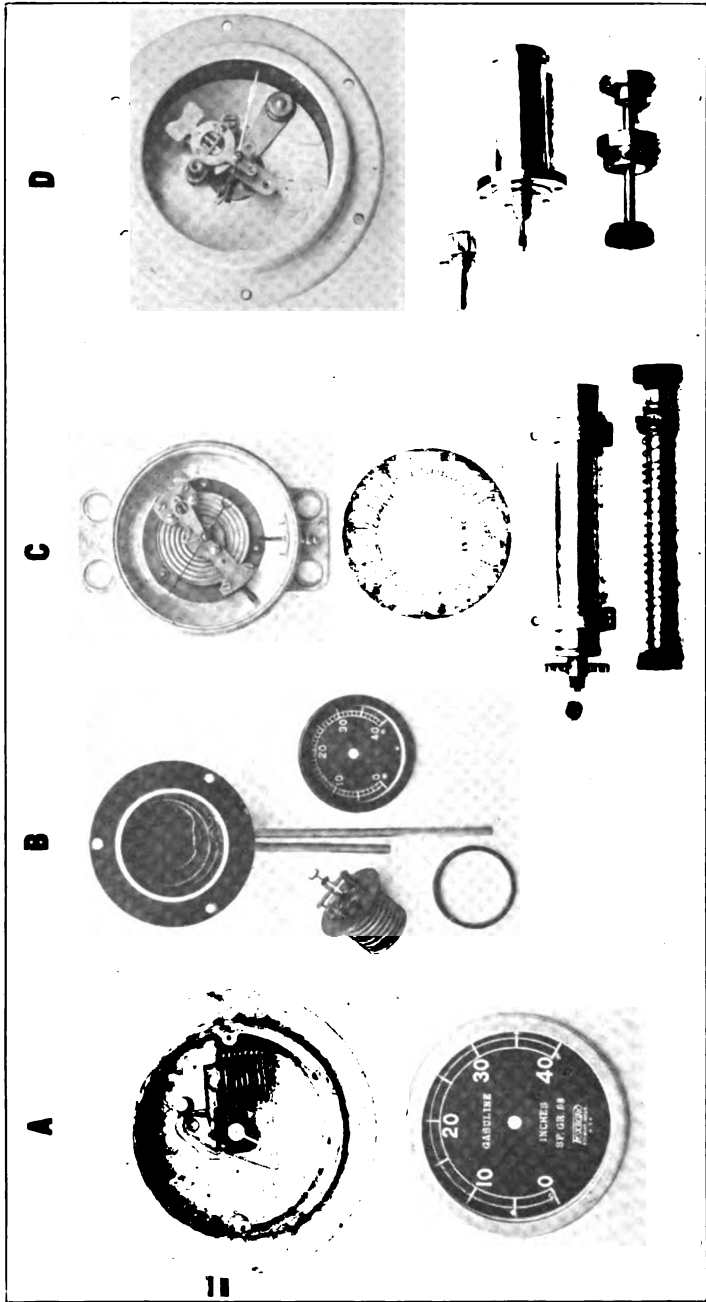

FIG. 22. Pressure Type Gasoline Gages

liquid with change of temperature. In the former case the bulb is only partially filled with liquid and the connecting capillary tube and gage is filled with vapor, while in the latter case the entire system including the bulb, capillary tube and gage is completely filled with liquid under pressure. Ethyl ether and methyl chloride are the most frequently used as the volatile liquid. Ethyl alcohol is the liquid usually used in the liquid filled type. The vapor pressure type is affected by changes of altitude. The liquid filled type on the other hand, gives erroneous readings if the temperature of the gage and the capillary tube differ from that at which the instrument was calibrated. Typical thermometers of both types

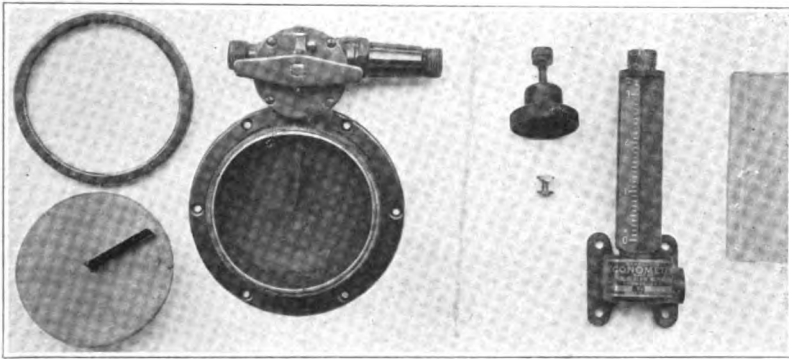

FIG. 23. Gasoline Flow Meters

are shown in Fig. 24. The vapor pressure instrument has an ordinary Bourdon tube which is connected to the indicating mechanism by a sector and pinion, such as that used in the pressure gages previously described. The liquid filled thermometer has a coiled Bourdon tube with several convolutions. It is also provided with a bimetallic temperature compensator which is connected between the Bourdon tube and the indicating mechanism.

NAVIGATING INSTRUMENTS

The use of aircraft for long distance flights over both land and water and for night flying has required the development of aerial navigating instruments. The methods applied are fundamentally



FIG. 24. Liquid and Vapor Pressure Thermometers

the same as those used in the navigation of ships at sea, the most important difference being the necessity of adapting the instruments to the relatively swift and unstable aircraft and, also, the uncertainty introduced by swift air currents which change rapidly in magnitude and direction, not only with time but also with altitude. It has thus been found impracticable to chart air currents as is done in the case of ocean currents at sea.

The simplest method of air navigation is that in which maps of the territory traversed are used and the course is guided by following landmarks known to the pilot. More general methods which involve calculating the course of the aircraft are (1) dead reckoning in which position at a given time is calculated from a previous known position by determining the direction of flight and speed with reference to the earth, and (2) astronomical observations in which the altitude or azimuth of the sun or stars is measured and the position computed from the Greenwich sidereal time, the equation of time and the position of the sun or stars. Still another method recently developed is the use of the radio direction finder in which the position is determined with reference to radio stations by the use of a radio direction finder on the aircraft.

Maps and Charts. When maps are used they are frequently mounted on rolls in a map case (See Fig. 25A) so that a number of maps can readily be made accessible. Sometimes the map is mounted on a board and protractors and parallels provided for convenience in locating directions and measuring distances. Such a device is shown in Fig. 25B.

Dead Reckoning Instruments. The factors involved in the method of dead reckoning are the direction of the aircraft as determined by a compass, the air speed, the ground speed, and the drift with reference to the earth. Instruments used in making the first three measurements have already been discussed in this paper. Drift indicators usually depend upon determining by sighting wires or parallel lines in the instrument or in the focal plane of a telescope the apparent direction of motion of objects on the ground or on the water or even of the waves of the sea whose motion is so slow compared with that of the aircraft that it can

be neglected. Instruments of this type known as drift bearing plates are shown in Fig. 26. These consist of a rotatable graduated circle with diametral sighting wires which are turned parallel to the direction of drift. The vertical attachment is used in determining the ground speed and carries an eyepiece which is adjusted for altitude by the graduated scale on the attachment.

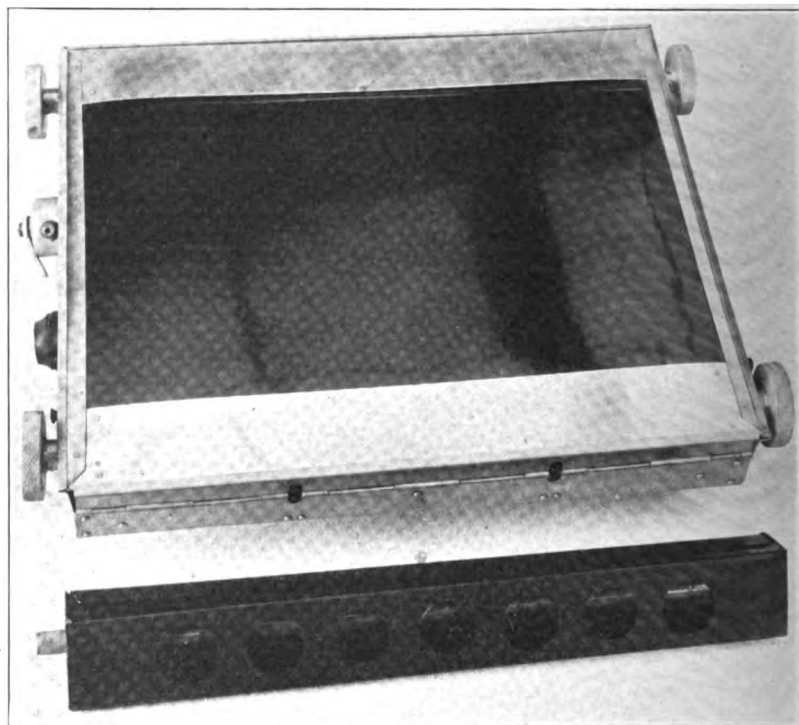

FIG. 25A. Map Case

The ground speed is determined by finding with a stop watch the time required for an object on the ground to pass between two ball sights on the instrument. A more complicated device with attachment for adjustment of the lubber-line of the compass is shown in Fig. 27. In this case the direction of drift is determined by adjusting a system of parallel lines in the focal plane of the

telescope, shown at the left of the figure, to the direction of drift. This automatically changes the position of the lubber-line of the compass.

The drift indicator shown in Fig. 28 in addition to determining the direction of drift and the ground speed has adjustments which

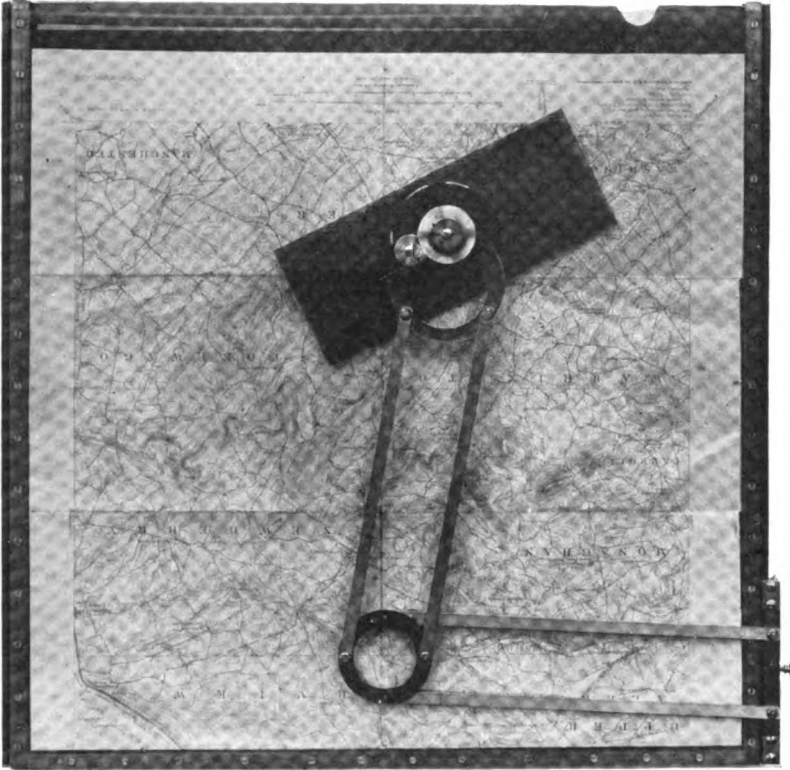

FIG. 25B. Bigsworth Chart Board

when the instrument is also set for the airspeed automatically determines the magnitude and direction of the prevailing wind, or as it is ordinarily expressed, solves the velocity triangle. The ground speed is determined as in the drift bearing plate just described by placing the eye at the eyepiece and noting the time

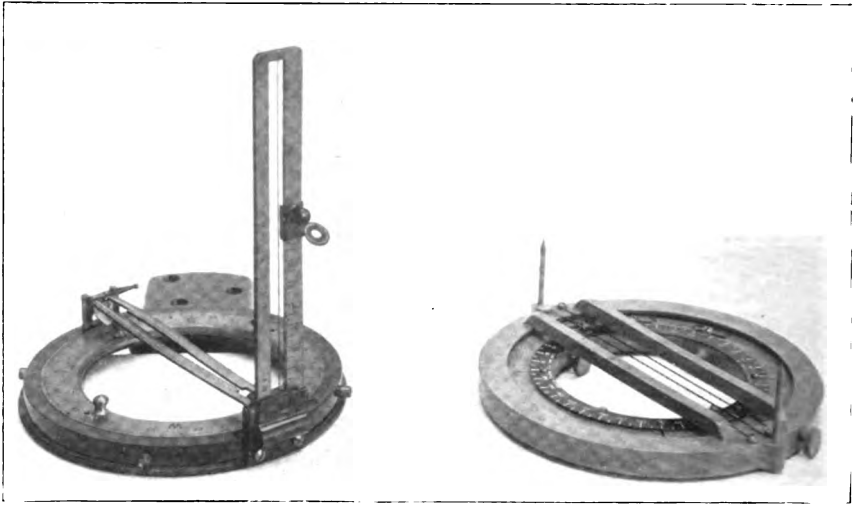

FIG. 26. Drift Bearing Plates

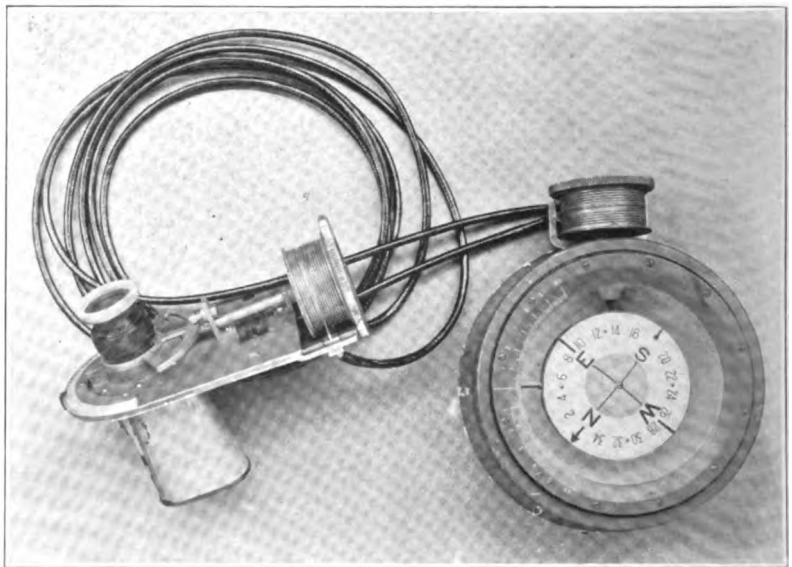

FIG. 27. Sperry Synchronized Drift Set

required for an object on the ground to pass between two points on the sighting arm.

The device shown in Fig. 29 is a synchronized drift sight which determines the wind vector from the direction and magnitude of drift and the air speed. The repeater which is attached to the main instrument indicates the result to the pilot. The unique feature of this device is the method used to determine the drift. An object on the ground is followed by means of the telescope at the right of the figure and a series of points plotted on the paper by depressing the pencil which is maintained parallel to the

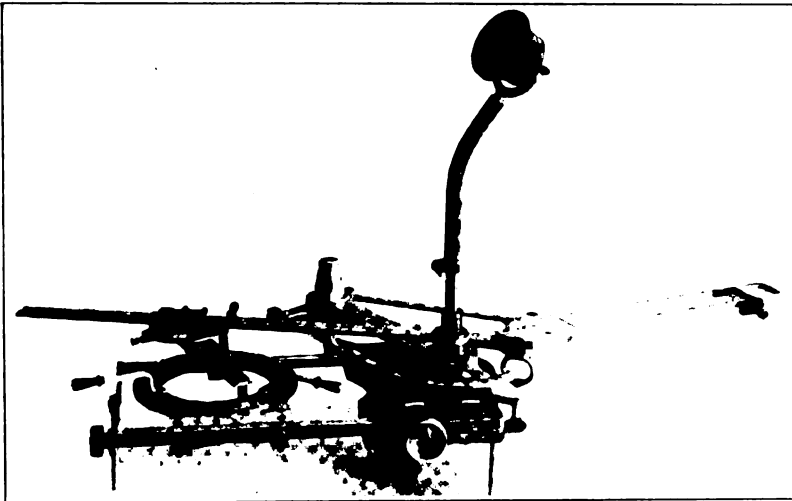

FIG. 28. Crocco Drift Indicator

telescope by a lever system. A series of points showing the direction of drift is thus obtained, defining a line in which the irregularities of the individual observations due to the rolling and pitching of the aircraft are eliminated.

A number of simple devices have been invented to aid in solving the velocity triangle. Three of these are shown in Fig. 30. They are used by setting the adjustable arms in the direction of the two known velocities of the velocity triangle, setting the adjustable sliders for the magnitude of these velocities and rotating the

disk until the arrow on it is parallel to the line through the two sliders. The direction of the arrow is the direction of the third velocity component. Its magnitude is determined from the scale on the disk by the distance between the two adjustable sliders.

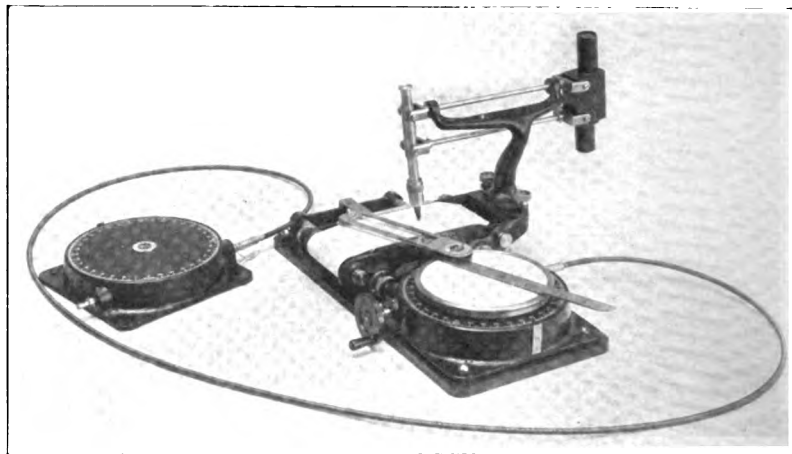

FIG. 29. Le Prieur Navigraph

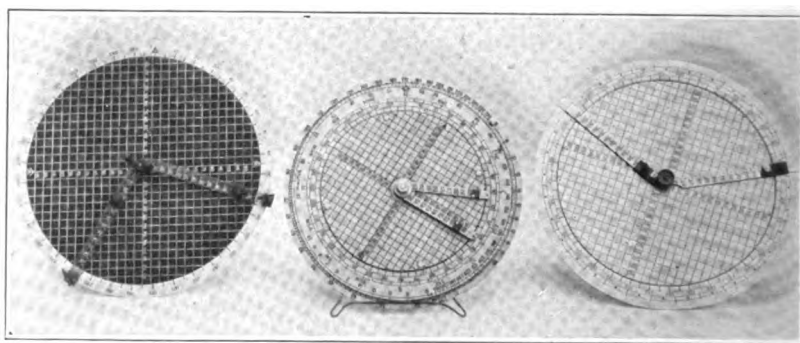

FIG. 30. Course and Distance Calculators

Astronomical Instruments. When astronomical methods are employed the requisite observations are almost always made with sextants which the observer uses to determine the altitude of the

sun or some star. This enables him to calculate his position from the Greenwich solar time which is read from a chronometer, and the time equation and declination of the sun as determined from the Nautical Almanac. The sextants used (see Fig. 31A-D) differ from marine sextants principally in that an artificial horizon is used. In most cases this consists of a liquid bubble level which is so arranged that it can be seen in the optical field simultaneously with the sun or star on which the instrument is set. Sextants have also

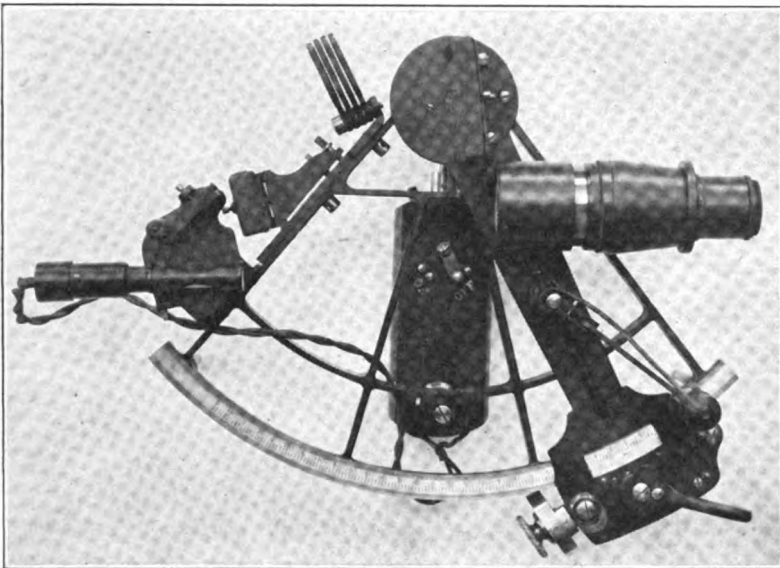

FIG. 31A. Byrd Bubble Sextant

been constructed in which pendulums have been used instead of a bubble level. Another method which has been tried is to establish an artificial horizon by mounting a mirror on the upper surface of a gyroscopic top and arranging the optical system so that the image of the sun or star as reflected from the mirror and also viewed directly are simultaneously seen by the observer. An auxiliary apparatus is required to drive the gyroscope. Usually the gyroscope is air driven, in which case the auxiliary apparatus

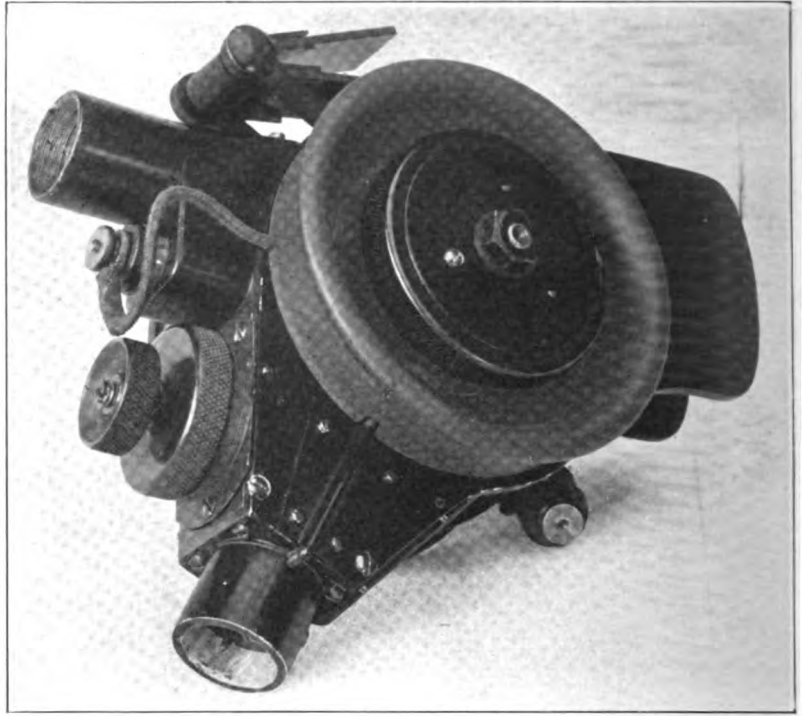

FIG. 31B. Booth Bubble Sextant with Rotating Drum Scale

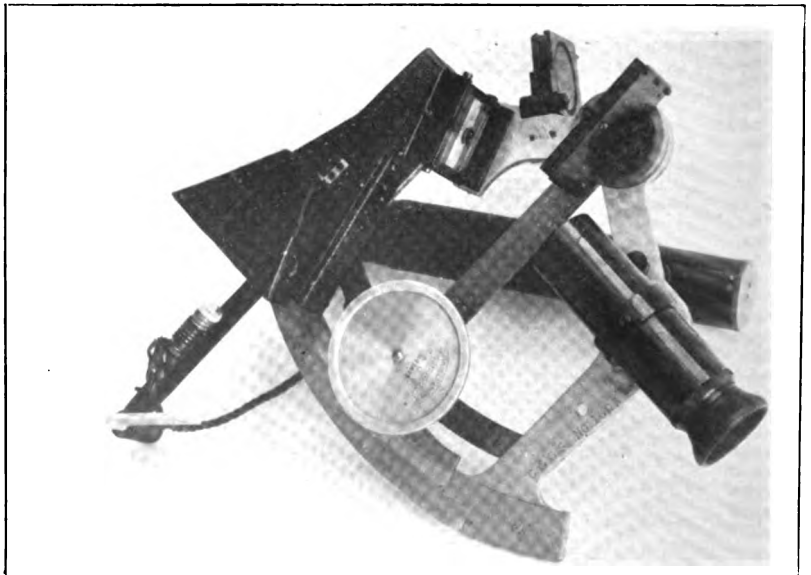

FIG. 31C. Schwartzschild Bubble Sextant

is a pump, or Venturi tube. An instrument of this type is shown in Fig. 31 D. With good piloting and a skillful observer the error of bubble sextant observations ordinarily varies from 10 to 20 minutes.

Radio Direction Finder. The use of radio direction finders in aerial navigation is of recent origin and still in the experimental stage. These devices consist essentially of a radio receiving

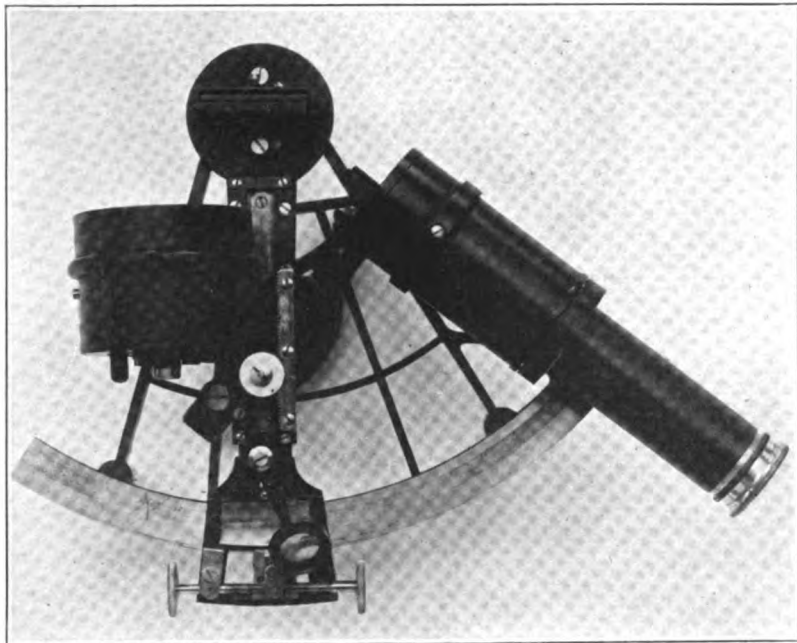

FIG. 31D. Derrien Gyroscopic Sextant

apparatus with a coil antenna which the pilot orients to determine the direction of the radio sending stations which are identified by the character of the signals sent. One important advantage of this method is that it can be used when both the earth and sky are obscured.

SPECIAL INSTRUMENTS AND ACCESSORIES

In this category may be included apparatus to supply oxygen to aviators at high altitudes, instruments used in airplane per-

formance tests which in general are of the recording type, time pieces, and instruments pertaining particularly to the navigation of lighter-than-air craft such as manometers, ballast gages and hydrogen leak detectors.

Oxygen Instruments. The physical condition of aviators is seriously affected from lack of oxygen when altitudes above 15,000 feet are maintained for extended periods of time. This difficulty can be almost entirely overcome by supplying the aviator artificially with oxygen during flight. The oxygen is carried either in the form of compressed gas in steel cylinders or in liquid form in vacuum jacketed receptacles. A supply sufficient for a flight of two or more hours is ordinarily required. It has been found that four liters of oxygen per minute is not an excessive amount to supply in view of the aviator's physical activity and inevitable losses at the mask in breathing. The expression for the correct delivery at any altitude then becomes

$$V = 4 \left(1 - \frac{P}{760} \right)$$

where V is the volume delivered in liters and P is the pressure of the atmosphere in millimeters of mercury.

An essential feature of the oxygen equipment is a device for controlling the amount of oxygen delivered to the aviator. In the earliest types this was simply a hand controlled valve attached to the oxygen supply tank which the aviator operated to deliver the gas according to his needs. In later forms an automatic barometric control is provided for regulating the amount of oxygen supply to the aviator according to his altitude. The instrument also has a pressure gage to indicate the pressure of the oxygen in the supply tank and a flow indicator to show when oxygen is being delivered by the apparatus. An automatic regulator of American design is shown in Fig. 32. It is provided with two pressure chambers; a high pressure chamber into which the oxygen flows from the supply tank to reduce the pressure from 150 atmospheres nearly to atmospheric pressure, and a low pressure chamber to control the delivery to the masks. The pressure in each of these chambers is controlled by the action of valves oper-

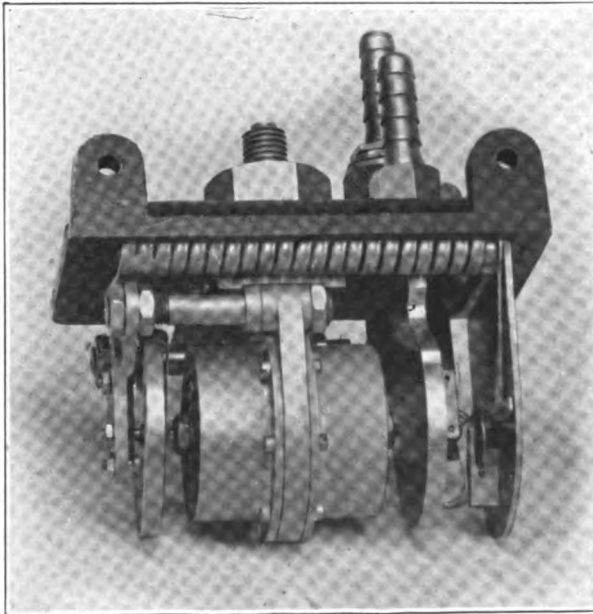
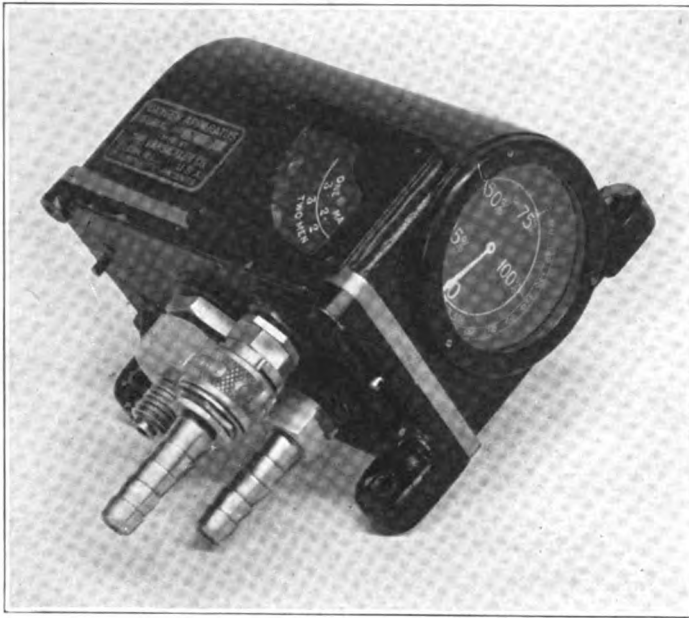

FIG. 32. Van Sicklen-Prouty Oxygen Regulator

ated by corrugated metal diaphragms one of which forms one end of each chamber. The valve of the low pressure chamber is also acted upon by an aneroid capsule which expands with increasing altitude and thereby allows more oxygen to flow thru the apparatus, the amount increasing in accordance with the above mentioned altitude delivery formula. The helical coil gage shown in the figure at the right is used to indicate the pressure in the supply tank. The rate of flow is shown by the action of the pressure of the outgoing gas on another corrugated diaphragm capsule connected between the low pressure chamber and the masks.

Another instrument of the compressed oxygen type is shown in Fig. 33. It was originally of British design but was made in this county during the recent war. In this instrument the pressure of

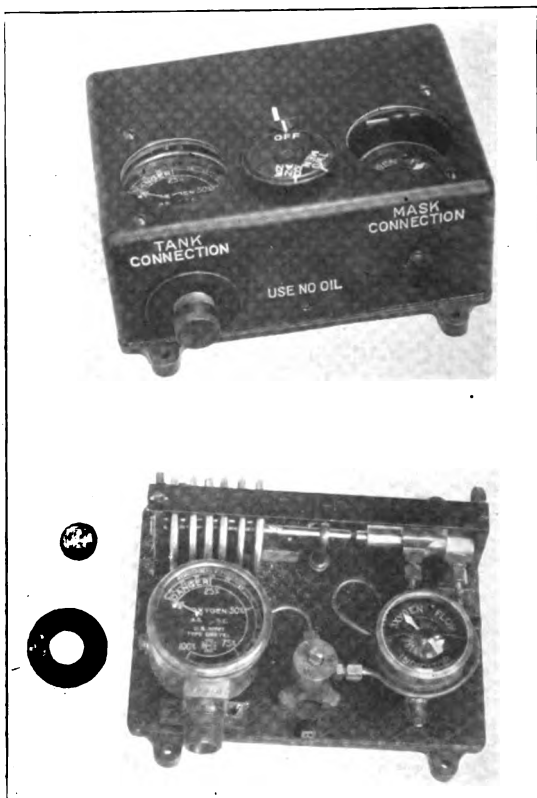

FIG. 33. Dreyer Oxygen Regulator

the gas as supplied by the tank is reduced by passing into a chamber in which the pressure is controlled, as in the device described above, through the action of a valve connected to a corrugated metal diaphragm. This reduces the gas from a pressure of 150 atmospheres to a pressure of approximately one atmosphere above atmospheric pressure. From the reduced pressure chamber the gas passes to a piston valve controlled by a battery of aneroid capsules. With increase of altitude this battery of capsules expands under the action of internal springs thereby increasing the delivery of oxygen thru the piston valve. The amount delivered is determined by the size of the port in the piston valve which varies so as to deliver oxygen in accordance with the previously mentioned altitude-delivery formula. From the piston valve the oxygen passes thru a flow indicator, which is a sensitive anemometer on which the gas impinges as it passes to the masks. A Bourdon tube pressure gage to indicate the pressure of oxygen in the supply tank is also provided. The essential difference between this instrument and the one previously described is that in this device the supply of oxygen is increased by enlarging the port of the control valve while in the previous instrument the same result is effected by increasing the pressure under which the oxygen is forced from the reduced pressure chamber thru an outlet of constant size.

Where liquid oxygen is used the supply is ordinarily carried in double walled spherical copper vessels with an evacuated space between the inner and the outer walls and polished surfaces facing the evacuated space to prevent loss thru heat radiation. A typical instrument of this type is shown in Fig. 34. It has a capacity of from three to four liters of liquid oxygen which corresponds to from two-thousand to three-thousand liters of gas. The neck of the bottle is a long metal tube closed at the top and connected to a pressure gage and safety valve, shown on the instrument board, which are used to control the pressure of the gas which evaporates. This pressure forces the liquid oxygen out thru evaporating coils which surround the neck of the bottle. From these coils the gas passes thru flow indicators on the control board and thence to the masks. Liquid oxygen apparatus has the advantage of being

considerably lighter and more compact than the complete equipment necessary when compressed oxygen is used. On the other hand there is an inevitable loss of gas due to evaporation when

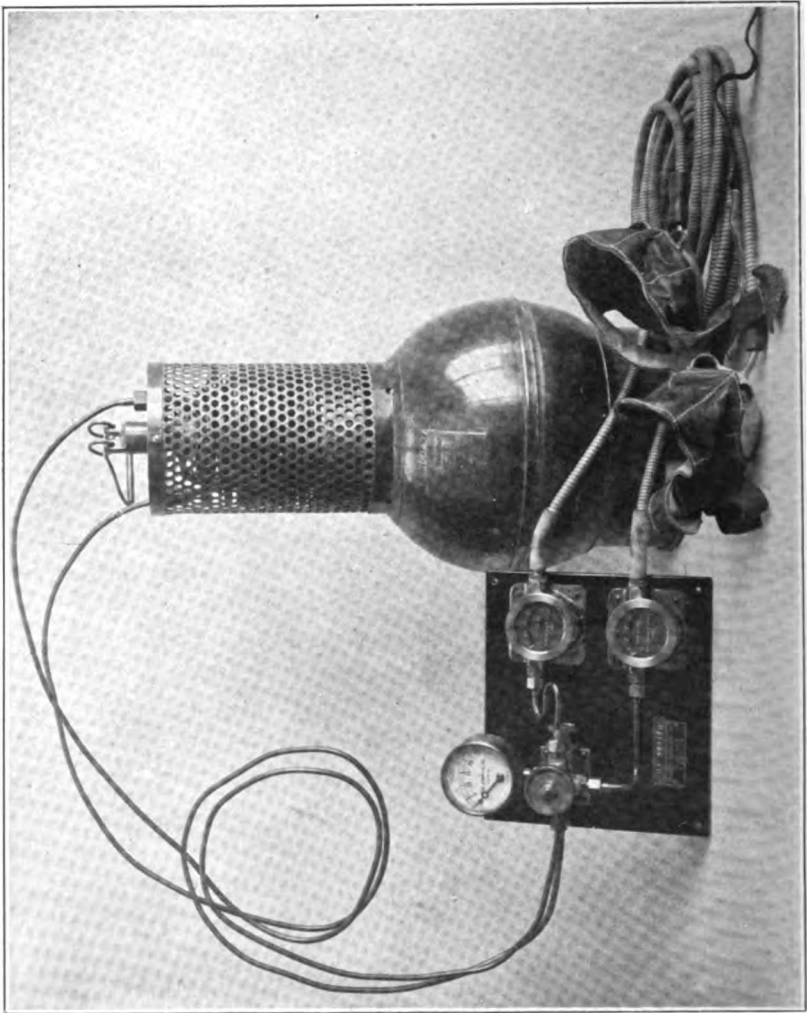

FIG. 34. Liquid Oxygen Apparatus

the supply is not actually being breathed. On this account it is necessary that the apparatus be filled within a relatively short

time before using and that a liquifying plant be available in the vicinity.

Recording Instruments. For experimental work and airplane performance tests permanent records of altitude, air speed, rate of revolution of the engine, rate of ascent or descent, temperature, and humidity are sometimes required. To this end special instruments have been designed which are the same in principle as indicating instruments of the corresponding type previously described but which are provided with recording attachments. Typical instruments of this class are described below.

The air speed recorder shown in Fig. 35 is of the Pitot-Venturi type. It was designed for use with the nozzle shown in Fig. 6B-F and is provided with two pressure chambers, one of which is connected to the Pitot head and the other to the Venturi head of the nozzle. Rubberized silk diaphragms constructed like bellows are used. Under the action of the differential pressure these operate the lever system which controls the recording pen. The excursion of the diaphragms is resisted by a coiled spring.

A recording tachometer is shown in Fig. 36. In this instrument a long pointer with attached pen is substituted for the indicating element of a Tel chronometric tachometer. The pen rests on a circular chart graduated in revolutions per minute which is rotated uniformly by the clockwork mechanism shown in the right-hand figure.

Rate of climb recorders have been made which are the same in principle as the rate of climb indicators previously described except that the excursion of the diaphragm is made to deflect a small mirror from which a beam of light is reflected onto a photographic film moved by clockwork. In this way a permanent record of the rate of ascent and descent of the airplane is obtained. The photographic record is used instead of a pen and ink recording device because the force available for operating the recording mechanism is too small to give satisfactory results with a pen and ink recorder of the ordinary type.

An instrument which gives records of temperature and humidity and in addition the barometric pressure is shown in Fig. 37. The lower pen is operated by the aneroid capsules of an ordinary

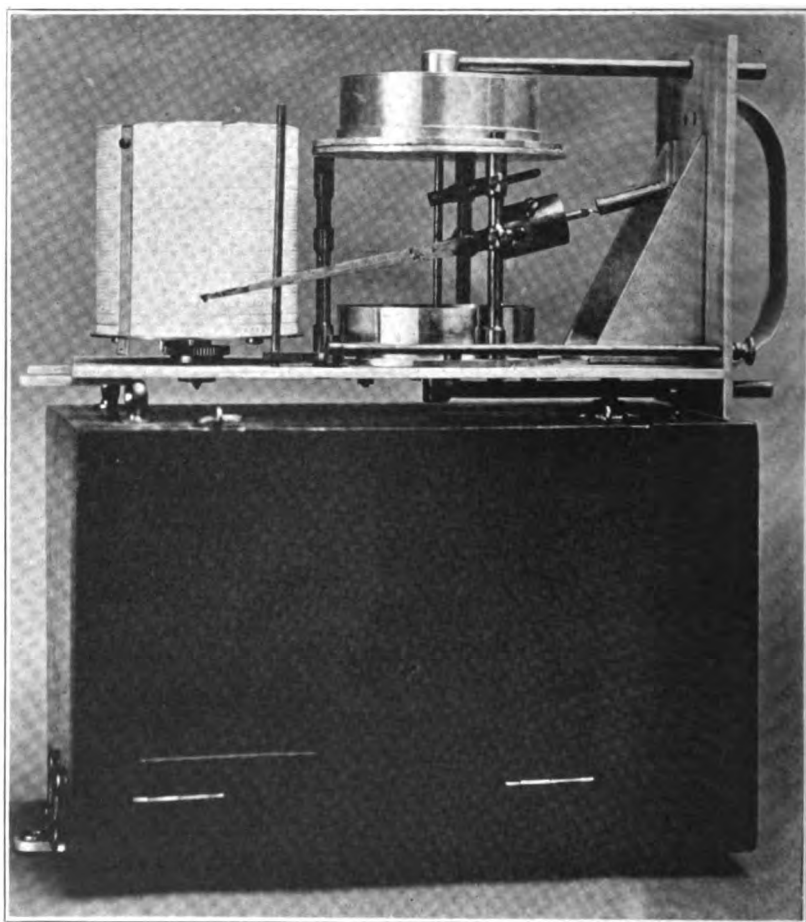

FIG. 35. Toussaint-Lepère Recording Air Speed Indicator

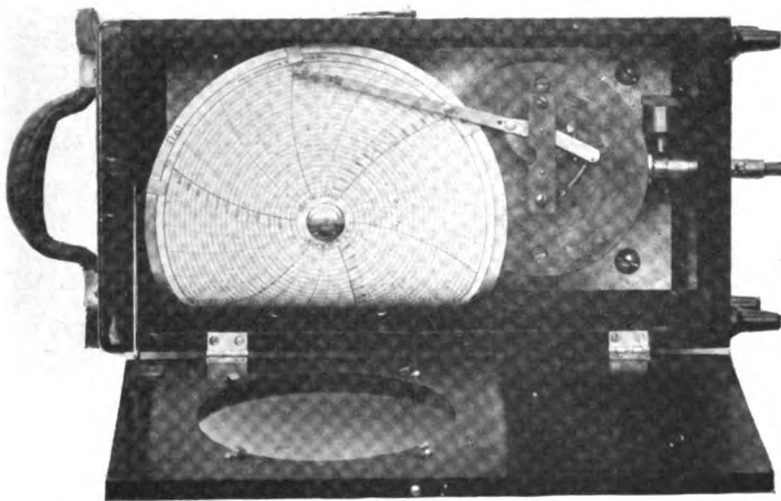
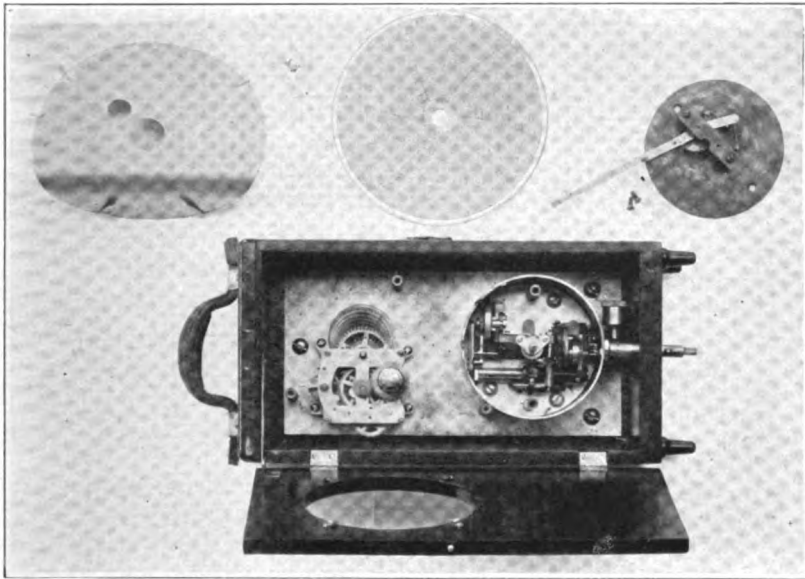

FIG. 36. Bristol Recording Tachometer

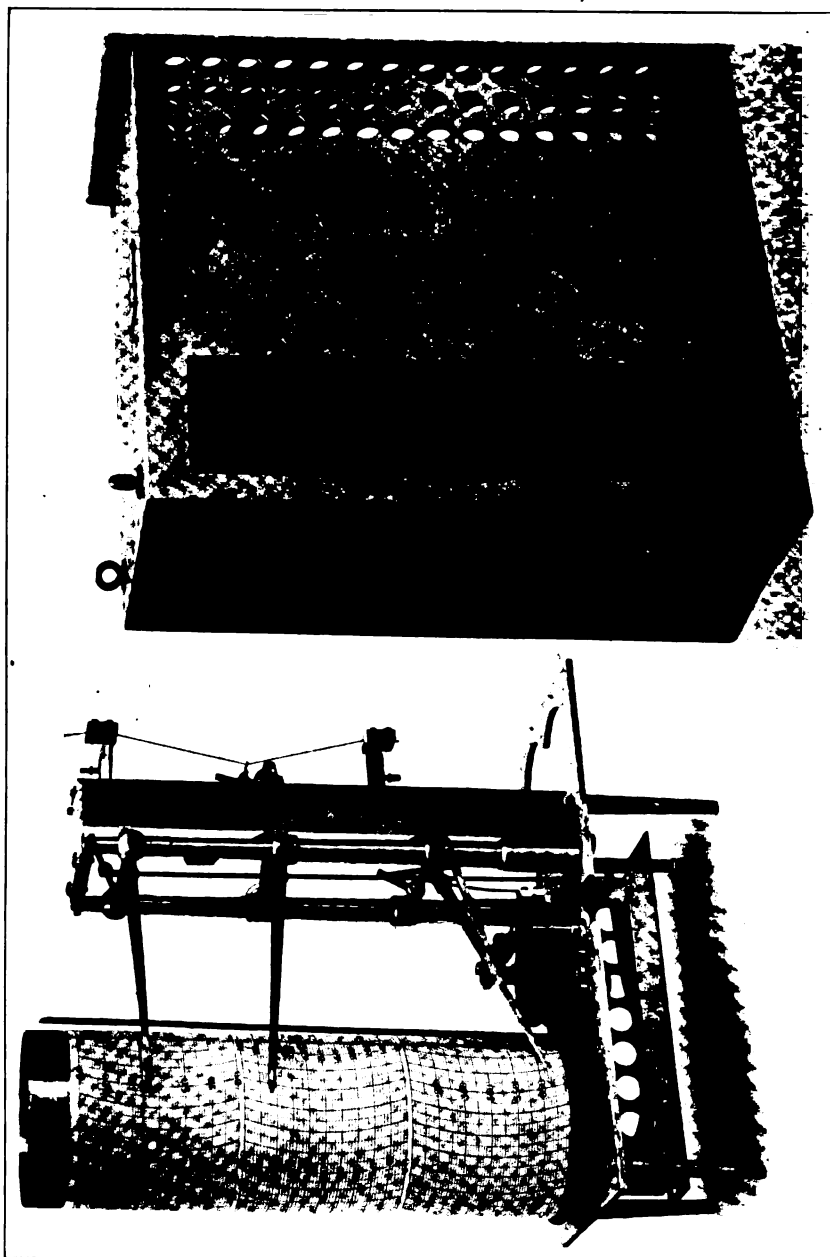

FIG. 37. Richard Baro thermo-hygrograph

barograph and gives a record of the atmospheric pressure. The middle pen is controlled by the bundle of human hairs shown at the right of the figure and gives a record of the relative humidity, in consequence of the expansion and contraction of the fibres with changes of the moisture content of the atmosphere. The top pen is connected by a lever system to a bimetallic strip shown beneath the instrument and gives a record of the temperature thruout the flight.

Strut and Gas Temperature Thermometers. In performance tests on airplanes it is necessary to determine the temperature of the surrounding air at intervals during flight. This is effected by strapping a pentane or other liquid type thermometer, which can be read at a distance, to one of the struts of the airplane, or of fastening the bulb of a liquid filled or vapor pressure type thermometer to the strut and locating the indicator on the instrument board. Instruments of both types are shown in Fig. 38. They are called strut thermometers.

Electrical resistance thermometers are also used in aircraft, more commonly on lighter-than-air craft to determine the temperature of the atmosphere and the gas. These consist of resistance coils of fine wire, located at the point whose temperature is to be determined, which are connected to an indicator graduated directly in degrees. An ohmmeter serves as an indicating element. Several resistance elements may be located at different parts of the aircraft and the temperature of each part determined in succession by making suitable connections at the indicator.

Time Pieces. A clock or watch is part of the standard equipment of most aircraft. Any reliable make of clock mechanism can be used for the purpose provided it is sufficiently rugged to withstand the shocks of landing and the inevitable vibration experienced in aircraft. Chronometers of precision are ordinarily not required. The only clocks peculiar to aircraft are reversing stop watches used in bombing. These are so constructed that when the stem is pressed for the second time the pointer starts to move back to zero instead of stopping as in a stop watch of the usual type.

Manometers and Hydrogen Leak Detectors. Among the special instruments pertaining particularly to the control of lighter-than-air craft may be mentioned water ballast gages, manometers and hydrogen leak detectors.

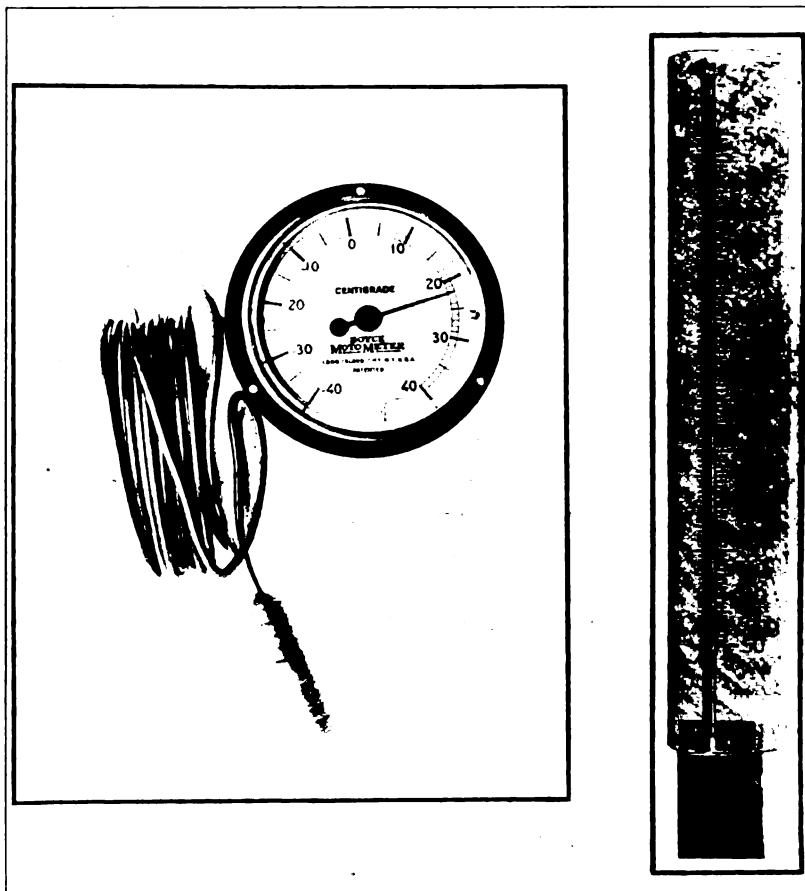

FIG. 38. Strut Thermometers

A typical water ballast gage is shown in Fig. 39. It consists of a corrugated metal diaphragm capsule enclosed in an airtight case and is used to indicate the pressure of the head of ballast water. The dial is graduated in inches of water.

A manometer to show the pressure of the gas in the bags of lighter-than-air craft is shown in Fig. 40. It is provided with a thin colon leather diaphragm which indicates the difference in pressure between the gas in the bags and the external air through the intermediary action of a lever system which operates a pointer which sweeps over a vertical linear scale. The distinctive characteristic of this type of pressure gage is the extreme sensitiveness required. In the one shown three inches of water gives full scale deflection.

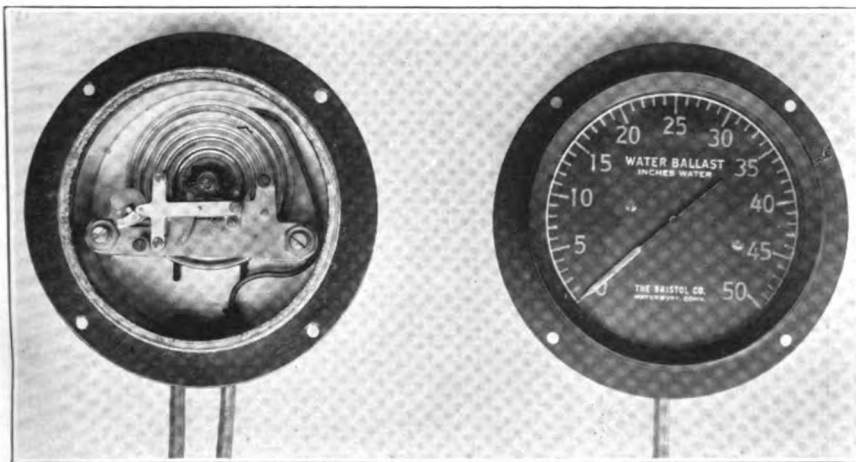

FIG. 39. Bristol Water Ballast Gage

A hydrogen leak detector is shown in Fig. 41. This instrument is used to indicate when gas is escaping from the bags of lighter-than-air craft. It is provided with a disk shaped air chamber the back face of which is made of semi-permeable porcelain. The front face is provided with a flexible corrugated metal diaphragm. When the porcelain face is placed near a leak, owing to the difference in the rate of diffusion of hydrogen and air, the hydrogen diffuses through the porcelain into the closed chamber more rapidly than the air diffuses out thereby increasing the pressure in the chamber which causes the diaphragm to expand. This motion is used to operate the indicating mechanism.

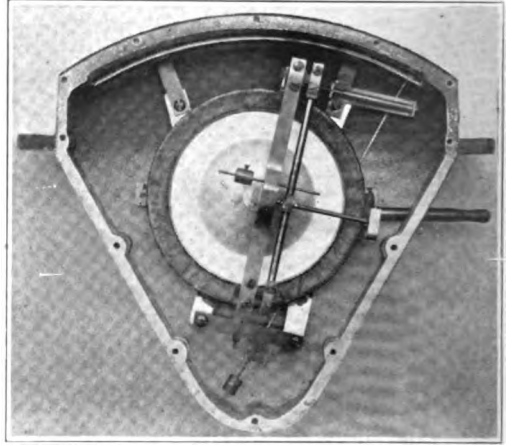
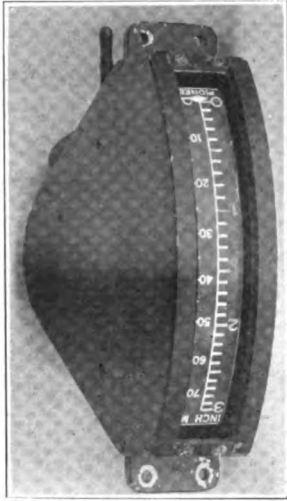

FIG. 40. Pioneer Gas Pressure Manometer

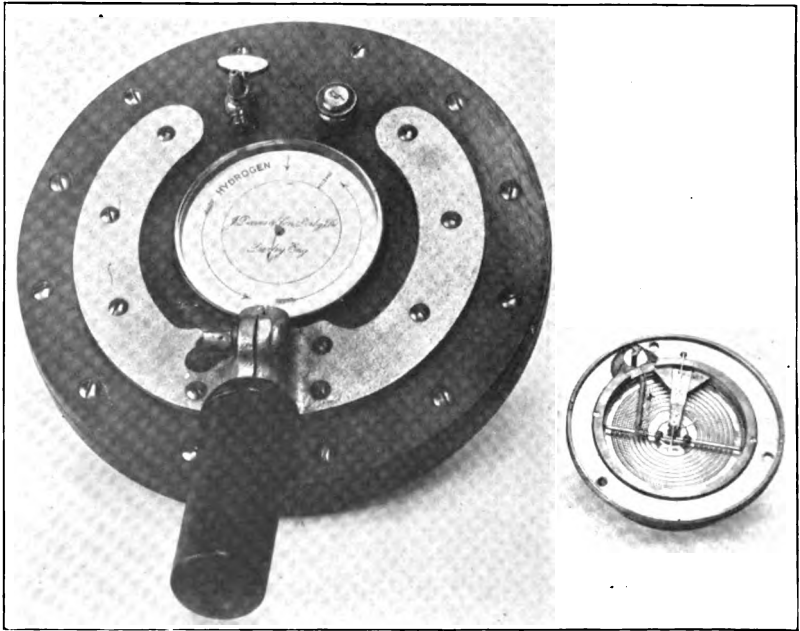

FIG. 41. Davis Hydrogen Leak Detector

CONCLUSION

The recent origin of aeronautic instruments is emphasized by the fact that practically all of the instruments described in this paper have been invented or adapted to the special needs of aircraft within the past decade. The equipment of early airplanes and dirigibles was extremely meager and in many cases entirely lacking, the pilot depending on his individual skill and experience in the maneuvering of his craft, but with the increase in size and complexity of aircraft the need of instruments became apparent and has stimulated a rapid development. Improvements in existing instruments and the development of new types are continually being made as the rapid growth of aviation creates new needs.

NATIONAL BUREAU OF STANDARDS,
DEPARTMENT OF COMMERCE
WASHINGTON, D. C.
JULY 29, 1922.

BOOK REVIEW

RESEARCH IN INDUSTRY. By A. P. M. FLEMING, C. B. E., M. Sc., M. I. E. E. and J. G. Pearce, B. Sc., A. M. I. E. E. Published by Sir Isaac Pitman and Sons, (New York), XVI+244 pages. \$4.00 net.

This book is written primarily as a guide to industrial concerns in establishing and developing research laboratories. The authors point out that "ethical and moral progress is closely related to material progress" and that the latter, in turn, "depends essentially upon the acquisition, development and application of new knowledge." Then follows a discussion of the nature of research and a classification of the agencies engaging in research. Considerable attention is given to the factors which must be considered in planning a research laboratory, in selecting workers, relative number of investigators and assistants, costs and size of building needed. Exteriors' and floor plans of a number of typical existing research laboratories are given. These include such well known laboratories as those of the Metropolitan-Vickers Electrical Company in England, the A. D. Little Company in Boston, and the Westinghouse Electric and Manufacturing Company in Pittsburgh. One of the most valuable chapters is one on "The Research Worker" in which is discussed the training and characteristics of the investigator, opportunities which he should have, and his general relation to the organization of which he is a part. Not the least important part of the book is a very comprehensive, classified bibliography, containing some 250 titles.

While the book is written primarily from the British standpoint, it should nevertheless prove valuable to any industrial organization confronted with research problems.

F. K. R.

Journal of the Optical Society of America and Review of Scientific Instruments

Vol. VI

OCTOBER, 1922

Number 8

A PHOTO-ELECTRIC THEORY OF COLOR VISION

BY
JANET H. CLARK

INTRODUCTION

The principal theories of color vision so far advanced, the Young-Helmholz, Hering, and Ladd-Franklin theories, have all assumed photochemical changes in the retina as the basis of vision. This is probably due to the fact that, at the time these theories were formulated, the only known results of the absorption of light energy by matter were the production of heat and the production of photochemical changes. A great deal is now known about another reaction between matter and light, namely the emission of electrons on the absorption of light energy. This phenomenon is called the photo-electric effect. There is the normal effect, seen, usually, only with ultraviolet light, in which the number of electrons emitted increases rapidly with decreasing wave-length of the exciting light. Some substances, the alkali metals, show the selective effect in which the photo-electric current has a marked maximum at some wave-length in the visible. (See Fig. 1.) This selective effect is due to light that is polarized in the E|| plane. The maximum in the curve is, however, still marked when unpolarized light is used as is shown by the curve for rubidium in Fig. 2. The chief facts of photo-electricity are these:—(1) Uniform maximum velocity of electrons for light of a

given wave-length, (2) velocity of electrons independent of intensity of light, (3) number of electrons increases with intensity of light, (4) velocity of electrons increases with decreasing wave-length, (5) in the normal effect the number of electrons increases with decreasing wave-length, (6) with increasing wave-length the effect eventually becomes zero.

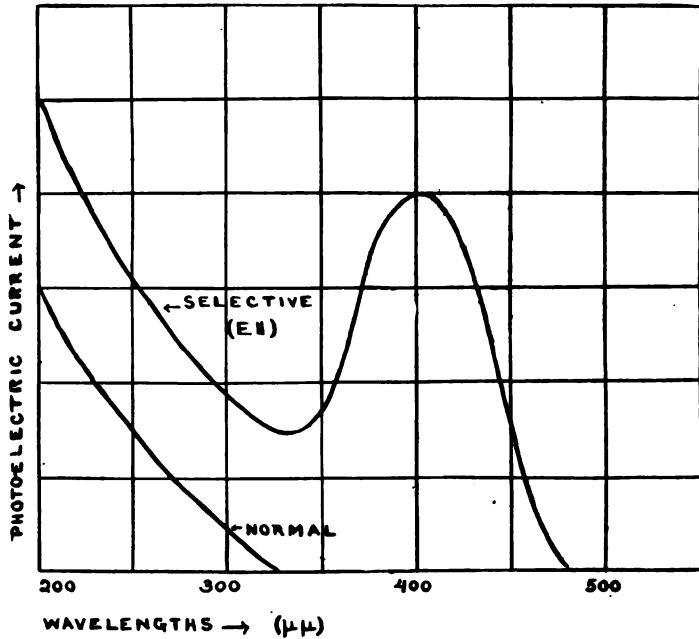

FIG. 1. Typical curves showing the normal and selective photo-electric effects.

Photo-electrons can escape from the surface of an illuminated substance only when the light is absorbed in a surface layer. If it penetrates to any depth, the emitted electrons do not reach the surface and the absorption of light results in an increased conductivity. The electrons may eventually become attached to other atoms or groups of atoms and this redistribution of valency electrons usually results in photo-chemical reactions. I think it can be safely stated that the foundation of all photo-chemical reactions is the emission of photo-electrons on the absorp-

tion of light. This statement is supported by Lewis¹ who says: "At the present time there appears to be a somewhat general tendency to regard photo-chemical reactions as primarily due to a photo-electric effect. The close relationship between photo-electric conductivity and photo-chemical sensitiveness confirms the theory that a loosening of electrons is the immediate cause of photochemical reactions."

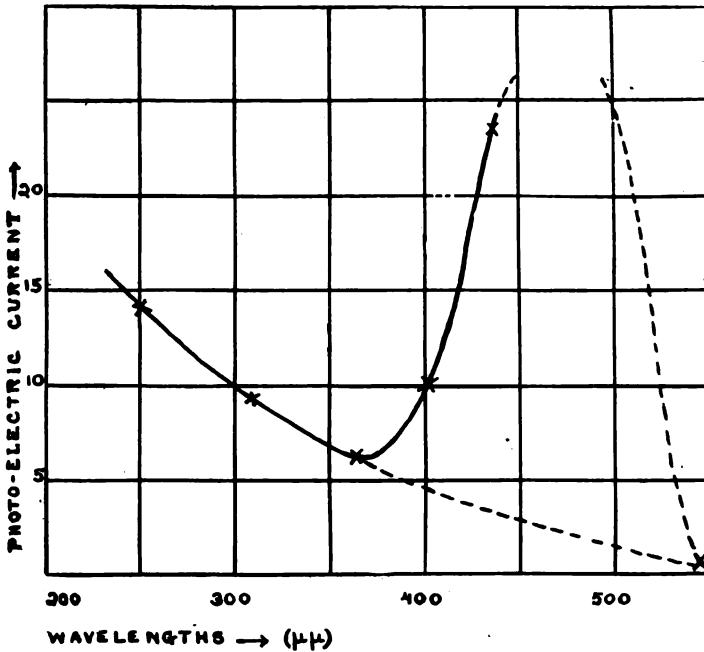

FIG. 2. The photo-electric current from rubidium with unpolarized light, showing the selective and normal photo-electric effects superposed—(from Hughes "Photo-Electricity").

It seems certain then that the photo-chemical theories of vision must eventually be supplanted by a photo-electric one. Several photo-electric theories have been proposed, for the most part by physicists, and have met with little or no encouragement from the physiologists. The most noteworthy of these theories is by Joly.²

¹ Lewis, W. C. M., "A System of Physical Chemistry," Vol. 3, p. 134, London; 1918.

² Joly, J., *Phil. Mag.*, 41, p. 289; 1921. *Proc. Roy. Soc., B.* 92, p. 219; 1921.

Joly assumes that rhodopsin is the one photo-active substance in the retina and exists in the rods, between the rods and cones, and between the cones in the fovea. It is generally believed that there is no rhodopsin in the fovea, so Joly's fundamental assumption will undoubtedly be denied. However, that does not invalidate his further reasoning. The rhodopsin may be regarded merely as a sensitizer for dim lights, playing no part in color vision, and still one may assume that an unknown photo-electric substance lies between the cones. Joly further assumes that there is but one nerve fibril leading from the rod and nine leading from the cone, these nine being grouped in three bundles of 2, 3, 4 fibrils respectively. These bundles are capable of responding respectively to stimulation by electrons emitted from the photo-sensitive substance around the cones by red, green, and blue light. The energy carried by these electrons is shown to be, from the quantum relation, in the ratio 2:3:4, so that the 2 fibril bundle responds to electrons emitted by red light, the 3 fibril bundle to green light, the 4 fibril bundle to blue light. Stimulation of one fibril in the rod or nine fibrils in the cone gives a sensation of white light.

After reading Joly's theory with great interest, I looked up the histological evidence on the subject and found that Greef,³ in his exhaustive work on the histology of the eye, mentions no neurofibrils in the rods and cones and doubts the existence of an axial filament in their outer segments. Cajal⁴ found no neurofibrils in the rods and cones or in the outer nuclear layer. According to him the first neurofibrils occur in the outer plexiform layer. However, Leboucq⁵ gives a detailed description of a system of intracytoplasmic filaments arising near the centrosome at the base of the external segment, spreading out to form the ellipsoid, then condensing into a single filament in the rods and into a bundle of three or four filaments in the cones. So the histological evidence seems to bear out Joly's hypothesis.

³ Greef, Graefe-Saemisch Handbuch d. gesamten Augenheilkunde, 2 Aufl. vol. 1, ch. 5; 1899.

⁴ Cajal, S. R., Internat. Monatschr. f. Anat. und Phys., 21, p. 369; 1904.

⁵ Leboucq, G., Arch. d'Anatomie Microscopique, 10, p. 555; 1908-09.

The Young-Helmholz theory upheld the doctrine of specific nerve energy, assuming one type of fiber capable of carrying one type of nerve impulse, so that the ending in the brain alone would be responsible for differences in sensation. The Hering and Ladd-Franklin theories assumed that the same nerve fiber can carry two or more types of nerve impulse. Joly's theory assumes that each cone contains three different types of nerve fiber, each capable of carrying only one type of nerve impulse. On this hypothesis he offers an explanation of how one cone can respond to three different stimuli. Nothing is said however of the nature of the nerve impulse itself and there is no explanation of why the sensation of white can be aroused either by stimulation of the one fibril in the rod or of the whole nine fibrils in the cone.

In view of my own difficulties with Joly's very suggestive and interesting theory, I wish to propose another photo-electric theory of color vision which probably has as many difficulties in the path of its acceptance as his, but which I hope will also be suggestive of future developments in the search for a thoroughly tenable and satisfactory photo-electric theory of vision.

THEORY OF COLOR VISION

The following are the fundamental hypotheses made in the development of the theory:

1. Vision is produced by the emission of photo-electrons from a light sensitive substance occurring in both rods and cones. This substance shows the selective photo-electric effect with a maximum corresponding to the wave-length of maximum luminosity in bright light.

2. Quantitative differences (i.e., differences in luminosity) depend on the number of electrons emitted. Qualitative differences (differences in color) depend on the velocity of the emitted electrons, it being a definite fact that each wave-length causes the emission of electrons with a characteristic velocity.

3. Chromatic vision is possible only in the cones. Rhodopsin, being found in the rods alone, is therefore concerned only with achromatic vision. It acts as a sensitizer to dim lights and, in the presence of the sensitizer, the maximum of the curve of photo-electric sensitivity is shifted to wave-length 535m μ .

In considering the structure of the retina (Fig. 3) it is evident that there is one clear anatomical difference between the rods and cones. Each cone is connected directly to the brain through one nerve fiber, whereas several rods are connected through one fiber. Therefore, if by any means a characteristic disturbance were set up in a cone, it would reach the brain with its character unchanged. But characteristic disturbances starting from several rods and traveling along the same fiber to the brain would undoubtedly reach the brain as a confused disturbance. From the anatomical picture of the retina one would, therefore, expect the cone alone to be capable of chromatic vision.

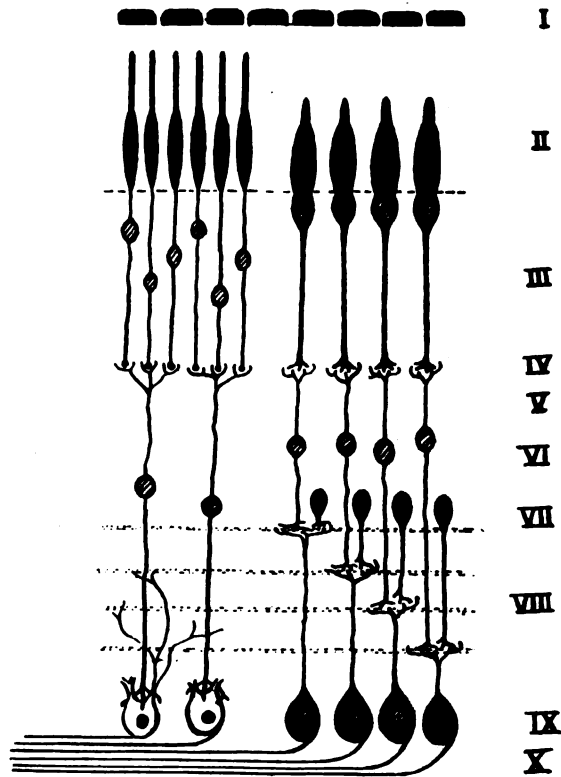

FIG. 3. Schema of the structure of the human retina—I Pigment layer; II rod and cone layer; III outer nuclear layer; IV external plexiform layer; V layer of horizontal cells; VI layer of bipolar cells (inner nuclear); VII layer of amacrine cells; VIII inner plexiform layer; IX ganglion cell layer; X nerve fiber layer.

A disturbance characteristic of a certain wave-length of light might be set up in the following way. When monochromatic light falls upon the rods and cones they emit electrons with a maximum velocity characteristic of the wave-length of the exciting light. These electrons would move out a certain distance, which Joly (2) calculates to be 5×10^{-7} cm for yellow light. These electrons may be supposed to attach themselves to the molecules of the dielectric medium around the cone and come to rest at a certain distance from the cone, this distance depending on their mean velocity, and therefore on the wave-length of the exciting light. They would, therefore, form negatively charged layers around the rods and cones, which are left positively charged. For this conception I am indebted to Joly's theory of the latent image in a photographic plate (see H. Stanley Allen's Photo-electricity).⁶ The layer of negatively charged electrons and the positively charged cone or rod will form the plates of a condenser. When the charge built up is great enough there will be a discharge and a high frequency alternating current will pass to the brain. If the resistance of the circuit is small the current would be oscillatory if great it would be a single pulse. It is immaterial whether there would be oscillations or a single pulse, the important point is that the high frequency current produced by the discharge has a distinct character. The frequency is given by the formula

$$f = \text{frequency} = \frac{1}{2\pi} \sqrt{\frac{1}{LC} - \frac{R^2}{4L^2}}$$

where C is the capacity of the condenser, R the resistance of the circuit, and L the inductance. C , the capacity of the condenser is different for each wave-length of light, since for each mean velocity of electrons emitted there would be a different distance between the charged layers (condenser plates). Therefore the frequency of the current sent to the brain would be different and specific for each wave-length of exciting light. If now we think of each illuminated rod and cone as a condenser system connected to the brain through a number of spark gaps (synapses), the cone

⁶ Allen, H. Stanley, "Photo-electricity," London; 1913.

system will be similar to the diagram in Fig. 4 and the rod system to the diagram in Fig. 5.

If the condenser in a system like Fig. 4B is charged, *a* negative and *b* positive, there will come a point where a discharge will pass across the spark gaps and the condenser will discharge giving a high frequency current. In the cone, Fig. 4A, since each cone

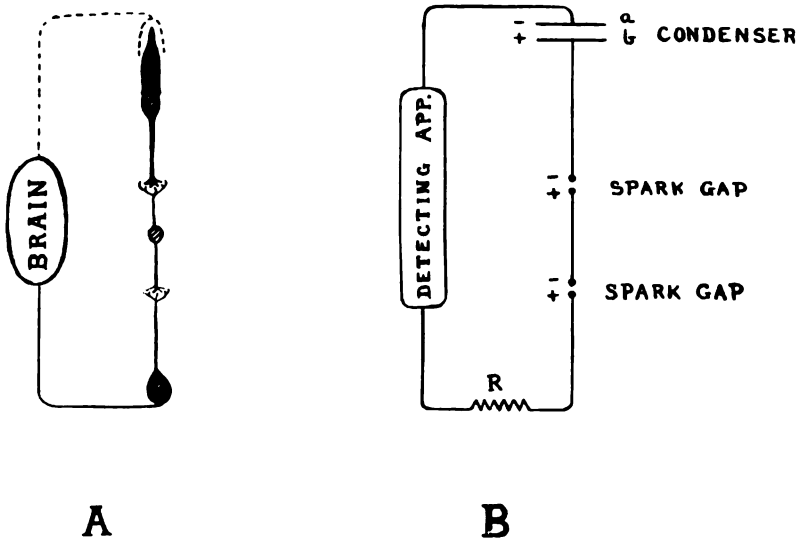

FIG. 4. (A) Cone circuit to the brain.
(B) High frequency circuit containing one condenser, analogous to the cone, and spark gaps, analogous to the synapses in the cone circuit.

is connected directly to the brain through one nerve fiber, the oscillations will reach the brain unchanged for the whole system in Fig. 4B would break down at once sending its characteristic frequency to the detecting instrument. In the rods, where several are connected to the brain through one fiber, conditions are similar to Fig. 5B. In this system condenser I will discharge when the potential difference between its plates is sufficient to break down the resistance of spark gaps 1 and 4, condenser II when it can break down 2 and 4, condenser III when it can break down 3 and 4. Therefore the discharges from the three rods will not pass simultaneously to the brain but will occur irregularly, producing an irregular current made up of the three overlapping frequencies.

Therefore, although one and the same photo-electric substance may be supposed to exist in both rods and cones, their method of connection with the brain makes color vision possible in the cones and only achromatic vision possible in the rods. The rhodopsin may be looked upon as an auxiliary photo-electric substance, existing only in the rods, and active as a sensitizer so that, in its presence, the photo-electricity of the rods is increased and vision

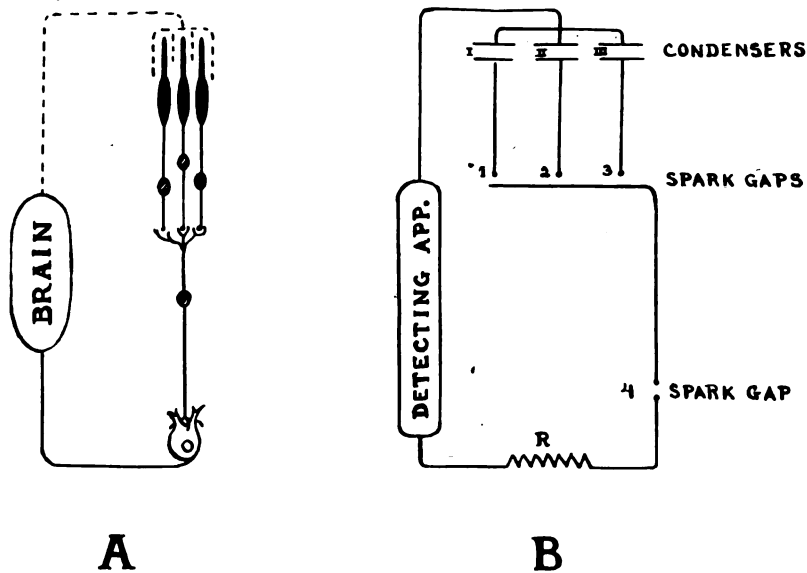

FIG. 5. (A) Rod circuit to the brain.
 (B) High frequency circuit containing three condensers in parallel, analogous to the rods, and spark gaps analogous to the synapses in the rod circuit.

in dim lights is made possible. In support of the view that rhodopsin acts by virtue of its photo-electricity, it may be said that Parsons⁷ calls attention to the fact that, although rhodopsin is very sensitive to light, it is extremely resistant to the chemical action of strong oxidizing and reducing agents.

This theory as outlined above has, I believe, this strong point. It suggests a mechanism whereby different wave-forms characteristic of monochromatic light may be started in a single cone and

⁷ Parsons, J. H., "An Introduction to the Theory of Color Vision," p. 12, Cambridge; 1915.

conducted to the brain along one nerve fiber. Also it definitely suggests that nerve impulses consist of high frequency alternating currents, which may be a series of damped oscillations or, if the resistance is great enough, a single pulse. The time necessary for the propagation of a nervous impulse would, therefore, consist of two parts (1) the time necessary to charge a condenser system sufficiently to break down the resistance of the spark gaps in the circuit, (2) the time for the propagation of an electric oscillation along a nerve. The velocity of an electric wave may be nearly anything, since it depends on the resistance, capacity, and inductance of the system in which it travels and on the sensitivity of the receiving instrument. Short waves, along wires where the resistance is negligible, travel with the velocity of light, but the velocity of electric oscillations along a nerve fiber would be of a different order of magnitude, so that there is no reason why the nervous impulse should not be an electric oscillation or pulse in spite of its relatively slow velocity of transmission. One obvious objection to the theory is this. Since the characteristic frequency of the alternating current set up by the absorption of the mono-

chromatic light is $f = \frac{1}{2\pi} \sqrt{\frac{1}{LC} - \frac{R^2}{4L^2}}$ it is necessary to assume that

the resistance of the circuit is the same for every cone in the retina in order that the frequency may vary only with the capacity (i.e. with the distance between the layer of electrons and the cone). It is not necessary to assume that the resistance is the same in different individuals. The frequency excited by the ab-

sorption of yellow light may $= f_1 = \frac{1}{2\pi} \sqrt{\frac{1}{L_1 C_1} - \frac{R_1^2}{4L_1^2}}$ for one individual

and may $= f_2 = \frac{1}{2\pi} \sqrt{\frac{1}{L_2 C_2} - \frac{R_2^2}{4L_2^2}}$ for another. So long as it is a defi-

nite and characteristic frequency in each individual he will interpret the stimulus as yellow light. It is, however, necessary that the resistance in the path from every cone to the brain should be the same in any one individual, and this may be an unjustified assumption.

Granting this assumption however, this theory is able to explain how different qualities of sensation can be stimulated in one nerve fiber by different wavelengths of light. When it is applied to explain the observed facts of color fusion, color blindness, and after images it is somewhat less successful, but since no theory has been entirely successful in explaining all phenomena, it fares perhaps no worse than the rest.

POSITIVE AFTER IMAGES

The positive after image is produced by a short exposure with subsequent occlusion of light. It is easily explained by assuming that cones which are charged by the stimulation of light, but have not quite reached the point of discharging, discharge after the occlusion of light.

NEGATIVE AFTER IMAGES

After stimulation of the retina with strictly monochromatic light the electrons would practically all occupy one layer. It seems safe to assume that there are a limited number of these stable positions possible. If the electrons are stimulated by different monochromatic lights there might be a fairly large number of stable positions possible. If white light is used, giving electrons of many different speeds, probably only a few stable positions would be simultaneously possible. I am inclined to think that it would simplify the whole conception to assume that when electrons of various speeds are emitted they can only occupy two stable positions at a time, there being a number of these coupled layers possible. A certain distance between these stable layers would account for the frequency difference between complementary colors. Then, on stimulation with yellow light containing some white light, most of the electrons would fall into the yellow layer. Those coming off with a slower velocity would be slowed down by repulsion of the yellow layer and fall back into the cone. Those emitted with a velocity great enough to pass through the yellow layer would, after passing through, be accelerated by the repulsion of this layer and take up a position corresponding to the blue layer. A simultaneous discharge from these two layers would give a sensation of yellow mixed with a small amount of its com-

plementary color and the effect would be that of yellow mixed with some white. Owing to the scattered light in the instrument, even spectral colors contain a certain amount of white light.

If it were possible to suppose that one layer might discharge without the other, we might get a sensation of yellow from the discharge of the yellow layer leaving the blue one partly charged. Subsequent stimulation by white would charge up this blue layer further and a discharge would give the negative after image. This does not seem likely and it seems more possible to suppose that, after the discharge of the heavily charged yellow layer, that particular layer would represent a condition of temporary instability so that electrons emitted on subsequent stimulation with white would none of them fall in the yellow layer, but would all fall in its coupled or complementary layer, which would, on discharge, give the negative after image.

COLOR FUSION

If the retina is stimulated simultaneously by two complementary colors the emitted electrons will fall into two stable layers, and a discharge from the two rings will give a sensation of white. If however the colors are closer in the spectrum than complementary ones, if for instance the retina is stimulated simultaneously by red and yellow, the electrons will fall into one intermediate layer, their two separate layers not being simultaneously stable, and on discharge will give the sensation of orange.

COLOR BLINDNESS

To explain color blindness one could assume that in some eyes certain stable positions are not possible for the emitted electrons. That red should be most frequently absent is natural since the layer lying nearest to the cone would be the most unstable. The coupled layer for green might be supposed to drop out along with the red. This would amount to assuming a congenital defect in the medium between the cones. A congenital defect in the cones themselves might be a more attractive hypothesis. If, in certain eyes, the photo-active substance in the cones gave a photo-electric curve in which the maximum and the long wave-length limit were both shifted to shorter wave-lengths, the result would be red-

blindness and a shift in the luminosity curve towards the blue. Since the red-blind eye does show a shift in its luminosity curve towards shorter wave-lengths, it seems quite possible that the various types of abnormal color vision are due to abnormalities in the photo-electric emission of the light active substance in the cone.

COLOR FIELDS

On the foregoing theory one would expect color vision all over the retina (i.e., wherever cones were present). As the cones become fewer and fewer towards the periphery it would take greater and greater intensities of light to stimulate color vision as the stimulus passes outwards from the fovea. It has recently been shown (Ferree and Rand⁸) that the far periphery of the retina is not blind to red, blue and yellow. With stimuli of sufficient intensity the limits of red, blue and yellow coincide with the limits of white light vision.

EXPERIMENTAL EVIDENCE

Poole⁹ has recently investigated the retina for photo-electric activity, and, finding none, considers Joly's theory and all other photo-electric theories of vision untenable. However, in the retina, the escape of electrons under light is not in the surface layer of nerve fibers but down in the rod and cone layer, so that emission of electrons from the surface would not be expected. Evidence should be looked for in a change in conductivity of the retina under light, which would be expected if electrons are emitted from the rods and cones. This is precisely what is shown by the experiments of Einthoven, Sheard, Bovie, etc. (Sheard "Physiological Optics"),¹⁰ in which the current of injury, obtained by connecting the cornea and the cut end of the optic nerve to a galvanometer, is found to undergo a positive variation on exposure to light.

CONCLUSION

The theory as stated above seems to explain the main facts of color fusion, after images, and color blindness reasonably well,

⁸ Ferree, C. E. and G. Rand, *Amer. Jour. Physiol. Optics*, 1, p. 185; 1920.

⁹ Poole, J. H. J., *Phil. Mag.*, 41, p. 347; 1921.

¹⁰ Sheard, C., "Physiological Optics," Chicago; 1918.

and it does so by means of only one photo-active substance which is undoubtedly a much to be desired simplification.

It undoubtedly explains more satisfactorily than any other theory how different qualities of sensation can be stimulated through one nerve fiber by different wave-lengths of light.

The entire truth in regard to color vision is certainly far from being known as yet but, feeling confident that the correct theory, when found, will be a photo-electric one, I suggest the above outlined theory hoping that it will lead to investigation, criticism, and further speculation towards that end.

SCHOOL OF HYGIENE AND PUBLIC HEALTH
JOHNS HOPKINS UNIVERSITY
BALTIMORE, MD.

EARLY PIONEERS IN PHYSIOLOGICAL OPTICS

BY
JAMES P. C. SOUTHALL

Among the ancient Greek philosophers, notably Pythagoras, Empedocles, and Aristotle who flourished in the sixth, fifth and fourth centuries, respectively, before the Christian Era, various theories of vision, all more or less vague and confused, were propounded. According to certain of these conceptions an object was visible by virtue of emanations which it discharged into the eye; whereas another view was that the emanations proceeded from the eye to the object whence they were reflected back into the eye. Whether these emanations were incorporeal or not was a subject of speculation. Pythagoras and his disciples taught that the colour of a body was partly objective and partly subjective, being a concurrent effect of certain peculiarities in the object and corresponding disturbances which these produced in the mechanism of the eye itself; but apparently they were not able to differentiate clearly between the external and internal causes and effects. The only point on which all agreed was that light proceeded in straight lines or rays, and hence the Greek geometers were able to explain the phenomena of shadows and to develop the science and art of perspective representation.

But until the epoch of the great Arabian philosopher Alhazen (c. 1100 A. D.) it is hardly possible to speak of a science of vision. The influence of his notions which were singularly clear and correct continues to the present time. In the first book of his celebrated treatise "Opticæ Thesaurus" (which is the title of the Latin translation made long afterwards) Alhazen gives an anatomical description of the eye which is perhaps the earliest detailed account of the structure of that organ. The names which he applied to the various parts of the eye are practically the same as those by which they are called today. He distinguished three transparent fluids or humours, namely, *humor*

aqueus, *humor crystallinus*, and *humor vitreus*; and four membranes, namely, *tunica adharens*, *cornea*, *uvea*, and *tunica reti similis*. Single binocular vision he explained as being due to the fact that the images formed in the two eyes were somehow united and made to overlap in the common optic nerve so as to produce an unique composite impression in the brain itself.

In the historical development of optical science it is difficult to estimate the place of Roger Bacon (1214–1294), because from Bacon's own writings one never can tell whether the extraordinary optical contrivances to which he alludes were actual inventions or merely the exuberant fancies of a very rare scientific imagination and insight into natural phenomena, as seems far more probable. In one place, for example, Bacon tells us of the possibility of constructing an airship (*instrumenta volandi*) whereby a human being sitting in the midst thereof and revolving a mechanism which was attached to artificial wings could ascend from the earth like a bird; with as much assurance as if he himself had actually made such a machine and tested it. Apparently he was acquainted with the use of spectacles which were probably invented about his time, but almost certainly not by Bacon himself.

A very celebrated book which went through many editions and was translated in various European languages was the "Magia naturalis" written by Johann Baptista Porta (1538–1615), who was the inventor of the *camera obscura* which is described in this work.¹ After explaining the principle of the simple pinhole camera, the author proceeds with a certain air of mystery to reveal something marvellous, and tells how when a convex glass lens is inserted in the aperture of the instrument the image depicted on the screen will be so much brighter and sharper than before that it is possible to distinguish the very countenances of the passers-by in the street outside. Porta attached much impor-

¹ The title of the edition of 1591 is: "Jo. Baptistæ Portæ Neapolitani Magiæ Naturalis Libri Viginti, Ab ipso quidem auctore ante biennium adaucti, nunc vero ab infinitis, quibus editio illa scatebat mendis, optime repurgati; in quibus scientiarum Naturalium divitiæ & deliciae demonstrantur. Accedit Index, rem omnem dilucidâ repræsentans, copiosissimus. Francofurti, Apud Andreæ Wecheli heredes, Claudium Marnium & Joann. Aubrium. MDXCI."

tance to the manifold applications of this invention; and then he adds significantly: "There can be no doubt that the human eye is such a *camera obscura* into which the light comes from outside; the pupil acts like the aperture in the window-shutter, and the crystalline lens performs the office of the white wall or screen" on which the image is cast. The analogy here suggested is indeed very striking, but it is hard to see how, knowing the action of lenses as he did, Porta could have supposed that the ocular image was completed in or on the crystalline lens.²

In another one of his books, namely, "De refractione,"³ published in 1593, Porta again compared the eye with a *camera obscura*; and also called attention to the contraction of the pupil in bright light and to its dilatation in feeble illumination. However, this important observation had been mentioned by Leonardo da Vinci (1452-1519) apparently as a well ascertained fact in his time. A certain Fabricius ab Aquapendente, who was very nearly contemporary with Porta, relates that Fra Paoli Sarpi had communicated to him the fact that both pupils are affected simultaneously in the same way depending on the degree of illumination. Concerning singleness of binocular vision, Porta inferred that only one eye was used at a time and that, somewhat after the manner of birds, the right eye was employed when the object was a little to the right and the left eye when it was to the left.

The subject of colour was another matter which greatly interested Porta and which he says he had studied with much curiosity for more than forty years, although it was so intricate and difficult as to be almost beyond mortal ken. No wonder the poets had called the many-coloured rainbow the daughter of Thaumal! But Porta believed he had at last found some clues to this mystery also.

² According to Porta the seat of vision had to be between the pupil and the centre of the eye where the visual rays from the various points of the object intersect, if the object was to be seen erect; and consequently he inferred that the seat of vision was in the crystalline lens, which, as he says, is "extra oculi centrum."

³ "Joan. Baptistæ Portæ Neap. de Refractione, Optices Parte Libri Novem. Ex officina Horatij Salviani. Neapoli. Apud Jo. Jacobum Carlinum & Antonium Pacem, 1593."

Among the pioneers in physiological optics the name of Francisus Maurolycus (1494-1577) deserves a place chiefly on account of one of his numerous writings called "Photismi de lumine et umbra" published near the end of his life in 1575. It is only a small volume but it contains several discoveries which are important in the theory of optics. Incidentally, Maurolycus seems to have been the first to show that a ray of light issues from a transparent isotropic plate bounded by plane parallel faces in the same direction as it was going before it entered. He gave also an explanation of the circular arc of the rainbow and distinguished in it four principal colours which he called *croceus* (yellowish like saffron), *viridis* (green), *cæruleus* (sky-blue), and *purpureus* (purple), together with three other colours which he regards as transitions or *connexiones*. It is usually stated that Newton was the first to distinguish seven colours in the prismatic spectrum.

Knowing only the general effect of glass lenses as convergent or divergent, Maurolycus deserves much credit for being the first to explain the action of the crystalline lens in the human eye by analogy with artificial lenses; and although he assumed (like Porta) that the image in the eye must be erect since that was the way the object appeared, he was at least nearer the truth in insisting that the rays were not converged in the crystalline lens itself, but beyond it. From the fact that a far-sighted eye requires a convex correction-glass, Maurolycus argued that the curvature of the crystalline lens in an eye of this kind was not sufficient, whereas in a near-sighted eye it was too great.⁴

But it was Kepler (1571-1630) who, far in advance of his predecessors, began to formulate clear and precise notions as to the *modus operandi* of the eye and the science of vision. In his famous treatise known as the "Supplements to Vitellio,"⁵ which in spite of

⁴ Another work on optics by this same author written in 1553 but apparently published many years after his death has the following title: "R. D. Francisci Maurolyci Abbatis Mersanensis mathematici celeberrimi Diaphanorum partes seu libri tres; in quorum primo, de perspicuis corporibus; in secundo, de Iride, in tertio: de organi visualis structura, & conspiciolorum formis, agitur. Lugduni Apud Ludovicum Hurilion, MDCXIII, cum privilegio."

⁵ "Ad Vitellionem paralipomena; quibus astronomiae pars optica traditur, etc." Frankfurt, 1604. (The writer has recently seen an extract from a letter by Dr. M. von Rohr stating that he is preparing a German translation of this noteworthy volume.)

certain manifest faults and obscurities is a work of great originality and importance, Kepler gives a minute description of the anatomical structure of the eye. The *cornea* is the transparent and more convex portion of the tough outer coating of the eye called from its hardness the *sclerodes tunica*. The anterior side of the *sclerodes* and even the *cornea* itself are contained in a very thin transparent membrane called the *tunica adnata* or *adhærens*. The posterior dark-coloured side of the second coating of the eye with its numerous arteries and blood-vessels constitutes the *choroides tunica*, while the anterior part on the outside forms the *iris* diaphragm with its central round window or pupil. The third coating is the *retina* on which the images of external objects are focused. The *humor crystallinus*, contained between the *humor aqueus* in the anterior and the *humor vitreus* in the posterior chamber of the eye, is suspended in a transparent capsule called *arana* (*arachnoides*) *tunica*, whereas the vitreous humour is enclosed in the *hyaloides tunica*. No special capsule is provided for the aqueous humour which is comprised between the *cornea* and the *arana* and the *processus ciliares*. These latter proceed from the *uvea* on the posterior side of the membrane whose front surface is the *iris* and form a kind of radial collar surrounding the crystalline lens.

Kepler is very explicit about the retina (*retiformis tunica*) as the surface on which the optical image in the eye is projected. This "reddish white" surface he supposes to be a portion of the inside of a hollow sphere, which acts like a screen (*papyri vice*) for receiving the image and partly surrounds the crystalline lens. Thus he says that the pupil is the common base of cones of incident rays emanating from the various points of the object, and that these rays emerge finally from the crystalline lens converted by refraction into bundles whose vertices lie all on the retina where consequently a small inverted image resembling the object is depicted point by point. So firmly was Kepler convinced of the essential correctness of this theory that he affirmed that if the other membranes of the eye could be removed so as to expose the transparent retina from behind, an observer might see traced on it a minute image of the external field of view. The experiment

which is here suggested was actually made some years later by Kepler's contemporary, Christoph Scheiner, who cut a hole in the upper sclerotic coating of a freshly enucleated eye and then removed all the opaque portions whereby he was enabled to perceive the image of a luminous object focused on the retina. These experiments were made first with the eyes of sheep and oxen, but later in 1625 in Rome Scheiner performed the same experiment with a human eye.⁶

Kepler's later book on "Dioptrics,"⁷ which is as distinguished for its logic and clearness as the "Supplements to Vitellio" is lacking in these respects, likewise contains many acute and original speculations in regard to the process of vision. By this time Kepler was so certain that it was necessary for a sharp image to be focused on the retina in order for the eye to see distinctly, that he inferred that the posterior surface of the crystalline lens must be hyperbolic in form instead of spherical; although unless the rays inside the lens were parallel to the axis it is difficult to see what particular advantage is to be gained by an hyperboloidal rear surface. But it is worth noting here that Kepler anticipated Descartes in conceiving of an aspherical lens for uniting a bundle of rays exactly in one point.⁸

In Prop. LXI of the Dioptrics Kepler asserts that vision is a sensation stimulated in the visual substance ("Sehgeist" or "plena spiritus") which he conceives to form a sort of sensitive layer over the surface of the retina. The coloured delineation of the external world which is traced on the retina by the action of the optical system of the eye on the rays of light which come into it, according to Kepler, not a mere superficial effect like that of light playing over the surface of an ordinary screen or wall, but it is a selective and penetrating influence which produces some change or photochemical action (as we would say) in the visual

⁶ See Caspar Schott's "Magia universalis naturæ et artis" (Würzburg, 1657), p. 87. Also, Dr. Joseph Priestley's "Geschichte und gegenwaertiger Zustand der Optik," Klügel's German edition (Leipzig, 1776), p. 93.

⁷ "Johannis Kepleris, Sæ. Cæ. Mtis. mathematici Dioptrice. Augustæ Vind., 1611" (small quarto, 79 pages). See also "Johannes Keplers Mathematikers Sr. Kaiserlichen Majestaet, Dioptrik," Nr. 144, Ostwalds Klassiker, Leipzig, 1904.

⁸ See "Dioptrik," Props. LIX, LX, pp. 27, 28.

substance contained in the retina. Kepler says he was led to infer this from the nature of light itself which, when it is powerful and concentrated, has so-called focal properties and may even cause combustion; and so he argues that between the comparatively minute quantities of light which in the eye are directed towards the delicate fine-grained structure of the retina there is the same connection in kind as exists outside the eye when a beam of sunlight is focused on the ordinary gross matter of an inflammable body. In support of this conception he alludes to the case where the eye has been fatigued and strained by being exposed to a bright illumination, sometimes to such an extent that even when the source of excitation has been removed a strong after-image of it persists for quite a time; indicating that the impression made on the retina must have been a curiously deep-seated effect. These remarkable opinions which anticipated Boll's discovery of the so-called visual purple by more than two centuries and a half bear testimony to Kepler's original and remarkable genius.

But the impression produced on the retina is by no means the whole of the visual act, and Kepler explains that this sensation has now to be transmitted to the brain in an unbroken current where it is communicated to the centre of consciousness. However, owing to the imperfect state of the knowledge of the anatomy of the nerves and the brain in his day, Kepler was not able to form an entirely correct picture of the actual route of transmission from the organ of vision to the visual centre of the brain. He wonders also if perhaps the subtle visual material which he assumes to be spread over the retina is itself conveyed along the optic nerve from the eye to the brain.

On the other hand, Kepler was obviously at a loss in trying to explain why objects appear to be erect although their images on the retina are inverted. He touches on this question in the "Supplements to Vitellio" and uses some metaphysical language about "how the passive must lie opposite to the active," and adds that the movements of the eye enable us to distinguish the top of an object from the bottom, since the eyes must be directed upwards towards a lofty monument or downwards in gazing at the sea from a high cliff.

Without being aware of the previous speculations and hypotheses of Maurolycus concerning near-sight and far-sight, Kepler finds the explanation of these defects in the fact that the length of the eye is either too great or too small (axial ametropia); as Scheiner believed also. In a near-sighted (myopic) eye the rays are focused in the vitreous humour and produce blur-circles on the retina; whereas in a far-sighted eye the rays are not bent enough and are focused therefore beyond the retina, producing blur-circles on it as before. Kepler guesses that in either case, assuming the eye to be otherwise normal, the trouble is due to the mode of life and occupations of the individual and not to any natural or inherent defect. Elderly folks are usually far-sighted or presbyopic because they are feebler than in youth and because it is easier and more natural to maintain the axes of the two eyes parallel than to turn the eyes inwards in order to see near objects distinctly.

According to Kepler, a perfectly healthy eye has the faculty of seeing equally well both near and far. On the other hand, when a person is quite unable to see anything distinctly, there is some pathological or diseased condition of the eye which may be partial or total blindness (Prop. LXIV of the Dioptrics). He supposes that accommodation is produced by varying the interval in the vitreous humour between the crystalline lens and the retina until the image is sharply focused on the latter, whether the object in question be far or near. Just as it is possible to vary involuntarily the size of the pupil depending on the degree of illumination, Kepler believed also that the eye could be stretched equatorially so as to shorten the eyeball and reduce the interval between lens and retina; or, conversely, that the eyeball could be elongated by equatorial contraction so as to increase this interval. The seat of this mechanism was supposed to be located in the web-like structure which supports the crystalline lens and connects it with the uvea by the dark radial branches called the ciliary processes, which appear to be formed like a comb to enable each muscle to act by itself. When all these muscles contract together and are shortened, the pupil becomes smaller and at the same time the lateral parts of the eye are drawn inwards while the eye-

ball as a whole is elongated. The reverse process occurs when the ciliary processes are lengthened.

Concerning binocular vision, Kepler says (Dioptrics, Prop. LXII) that when the retinas of the two eyes are stimulated in equal fashion, the two images are fused and the object is seen single; whereas under unequal stimulation fusion does not take place and the object appears double. Again, in the "Paralipomena," Kepler explains that it is by an unconscious process of triangulation in which the distance between the two eyes is the constant and essential factor that we are enabled to form more or less imperfect estimates of distance; and he even suggests that for very short distances a similar method may serve in the case of monocular vision, the fundamental base-line being the diameter of the pupil itself. However, this latter observation would appear to be rather far-fetched, not merely on account of the comparatively small dimensions of the pupil but particularly also because these dimensions are variable.

Another remarkable man of this epoch whose name has been mentioned already and who ranks alongside of Kepler as one of the founders of physiological optics was Christoph Scheiner (1573–1650). A professor in one of the colleges of the Society of Jesus in Germany, he rose to high eminence in the councils of that great religious order. While he was still only a student of mathematics at Ingoldstadt, he read with eagerness the Sidereal Messenger in which Galileo announced those wonderful astronomical discoveries that excited such a fierce controversy through all the learned world of that day. Partly owing to his naturally prudent temperament but perhaps more to his religious training and associations, Scheiner did not espouse the Galilean philosophy and points of view with the same ardour as his countryman Kepler; and yet he was one of the first to extend those new methods in physics and astronomy, with so much industry and ability that his name will always be called in company with the most illustrious men of that notable era in the history of the intellectual development of Europe. Strange to say, his remarkable achievements have remained comparatively unknown.

When Galileo began to publish his discoveries in 1610, there were only a few telescopes available in Germany. Kepler himself had not been able to get a glimpse of the "Medicean Stars" until August 30, 1610. But Scheiner immediately procured or made for himself a number of these new instruments, and in his first scientific announcement he speaks of having as many as eight "tubes" of different proportions. Kepler described in his *Dioptrics* the optical construction of the astronomical telescope which is today called by his name, but as his peculiar genius lay rather in conceiving than in executing it is doubtful whether he ever saw an actual instrument of this type. Scheiner, on the other hand, possessed unusual mechanical ability and ingenuity, and undoubtedly it was he who constructed the first astronomical telescope composed of a combination of two convex lenses, probably about 1614;⁹ although Rheita in a book entitled "*Oculus Enoch et Eliæ*" (1645) claims to have been the first to have made a telescope according to Kepler's description. Scheiner also constructed for Duke Maximilian of Tirol a so-called terrestrial telescope composed of three convex glasses which gave a magnified erect image of distant objects.

Scheiner was indeed a prodigious and indefatigable worker and his writings cover a wide range of subjects. Several years ago Dr. von Rohr to whom modern optical science is indebted for so many valuable contributions and extensions of our knowledge, edited and published a German translation of selected portions of Scheiner's very original and noteworthy treatise entitled "*Oculus sive fundamentum opticum*,"¹⁰ the first edition of which was issued at Innsbruck in 1619. A third edition was published in London in 1652 after Scheiner's death. It is only possible to give here an exceedingly brief and necessarily very inadequate summary of the general character and main conclusions of this volume which, composed more than three centuries ago, was perhaps the first formal treatise on physiological optics. The entire work is

⁹ See Scheiner's "*Rosa Ursina*," Bracciani, 1626-1630.

¹⁰ *Ausgewählte Stücke aus Christoph Scheiners Augenbuch; übersetzt u. erläutert von M. von Rohr: "Zft. f. ophthalm. Optik, 7, pp. 35-44; 53-64; 76-91; 101-113; 121-133; 1919.*

divided into three principal parts, the first of which contains a kind of *résumé* of what was known at that time concerning the eye and vision, more particularly as to the anatomy of the eye with an account of various related experiments; the second part is concerned with the manner of the refraction of light and the procedure of the visual rays in the eye itself; while the last part treats particularly of vision and the appearances of objects. The most striking characteristic is the consistent use of the method of observation and experiment which Scheiner employs to explain and support his hypotheses and opinions.

He succeeded in obtaining at least an approximate measurement of the curvature of the cornea by observing the image of a window or other suitable object reflected therein and comparing this appearance with the similar image seen in a small glass sphere placed as near the eye as possible on the temporal side. A number of little glass marbles or bulbs of various sizes enables the experimenter to select by trial that one which shows an image of the object as nearly as possible equal to that which is reflected in the cornea and thus to compare the curvature of the latter with the known curvature of the test globe.

That Scheiner was an accurate and painstaking observer is abundantly manifest. He noted the minute forward displacement of the pupil in the act of accommodation; together with the fact that accommodation is invariably accompanied by a modification of the diameter of the pupil. As to the ciliary processes, he supposes that these muscles are capable of tension and relaxation perhaps for the purpose of producing a slight alteration in the total length of the eyeball in the process of accommodation. With singular acumen he suggests that there may be likewise a concomitant change in the form of the crystalline lens itself. This seems to have been the first conjecture of the essential factor in accommodation as Thomas Young endeavored to prove long afterwards (1793). Certainly, there is no allusion to it in Kepler's writings.

In order to explain the procedure of the visual rays inside the eye and how the image is formed on the sensitive retina, Scheiner devised numerous simple and ingenious experiments, models of

their kind, some of which indeed have become classic. He was particularly fond of stenopæic tests of various kinds; one of which, usually referred to as "Scheiner's Experiment," is still to be found in modern text-books on physiological optics. In another experiment he shows how distant objects will generally be seen double when they are viewed through two pinhole apertures in a cardboard held close to the eye, provided the interval between the holes is less than the diameter of the pupil. In fact, there will be as many images as there are pinholes comprised within an area of the card not greater than that covered by the pupil of the eye. By the help of these simple devices he was able to trace the general procedure of the visual rays without knowing the precise law of refraction.

Entoptic phenomena and likewise the curious effects of irradiation receive much attention in Scheiner's book. He endeavors to explain why a piece of white-hot iron appears to be about three times as large as when it is cool; which leads Dr. von Rohr to comment that Leonardo da Vinci had also observed that part of an iron bar heated to incandescence appeared thicker than the cold portion.

Scheiner devised also a simple experiment for locating approximately the position of the pivot or centre of rotation of the eye. Finally, he was at some pains to determine the refractive powers of the various ocular media, reaching the conclusion that the aqueous humour and the crystalline lens act nearly as if they were composed of water and glass, respectively; whereas he inferred that the refractive power of the vitreous humour was intermediate between those of the other two.

The process of vision as expounded by Descartes (1596-1650) seems to be based on the views of Kepler and Scheiner with whose writings he was undoubtedly familiar, although he makes little, if any, allusion to either of these authors. For an extremely interesting account of Descartes' opinions on this subject the reader is referred to the first section of a paper by J. W. French entitled "The unaided eye," published in the *Transactions of the Optical Society* (London), XX, pp. 209-236 (1919); which contains a translation of Descartes' description of the human eye taken

“from the work entitled *Renati Descartes Opera Philosophica* dated 1656,” together with *facsimile* reproductions of two of the original diagrams.

When Christiaan Huygens (1629–1695) began his famous work on Dioptrics in 1653, which was never completed and which was published first in more or less fragmentary form a few years after his death and again recently in a complete annotated edition in both Latin and French,¹¹ the keenest scientific minds of that day were concentrated on the phenomena of light and vision. The law of refraction had at last been discovered. Huygens' contributions in the domain of physiological optics are perhaps not generally known, especially as they are to be found scattered here and there in the main body of the “Dioptrica,” but in the aggregate they form a considerable mass of solid achievement in this field. Huygens indeed touched nothing which he did not adorn, and he was never satisfied until he had gotten to the bottom of the matter. His admiration of the marvellous mechanical construction of the eye and its adaptation to human needs frequently breaks forth in some of the most eloquent and famous passages of this work. In the first part of the Dioptrics¹² and afterwards in the article “On the eye and vision,”¹³ Huygens gives a description of a “simplified eye” formed of two concentric hemispheres one of which has a radius three times as great as that of the other. They are placed in juxtaposition with their flat surfaces in contact. The curved surface of the smaller hemisphere represents the cornea, while that of the other portion represents the retina or rather the choroid which Huygens was inclined to regard as the seat of vision.¹⁴ The entire cavity inside the two superposed hemispheres is supposed to be filled with an aqueous

¹¹ “Christiani Hugenii Zelemii, dum viveret, Toparchae Opuscula Postuma, quae continent Dioptricam. Commentarios de Vitris Figurandis. Dissertationem de Corona & Parheliis. Tractatum de Motu. De Vi Centrifuga. Descriptionem Automati Planetarii. Lugduni Batavorum, Apud Cornelium Boutesteyn, 1703.”

“Œuvres complètes de Christiaan Huygens publiées par la Société Hollandaise des Sciences. Tome treizième. Dioptrique. 1653; 1666; 1685–1692. La Haye, Martinus Nijhoff, 1916.”

¹² Œuvres complètes, Tome XIII, pp. 128–134.

¹³ *Loc. cit.*, pp. 787–802.

¹⁴ *Loc. cit.*, p. 795.

humour of refractive index $\frac{4}{3}$; the actual dimensions being of no particular consequence but the relative dimensions such that rays of light proceeding from a distant object-point and undergoing refraction at the transparent surface of the smaller hemisphere will be accurately focused on the inner surface of the larger hemisphere. In order to get rid of the faults of spherical aberration as much as possible, Huygens provides also something in the nature of a pupil by making the plane surfaces of the two hemispheres opaque where they are in contact except for a small circular area right around their common centre. Huygens' simplified eye, as above described, bears a striking resemblance to the so-called "reduced eye" conceived long afterwards by J. B. Listing.¹⁵ In both cases the optical system of the eye is replaced by a single spherical refracting surface with its centre at the nodal point of the eye, the relative index of refraction being $\frac{4}{3}$. But while the geometrical similarity of the two conceptions is well-nigh perfect, the purposes for which they were devised were quite different. Listing's "reduced eye" was intended merely as an aid to oculists and ophthalmologists for the simplification of their calculations and constructions; but Huygens' aim was primarily to study the essential *modus operandi* of the actual eye with its pupil in place; and afterwards he is careful to point out how inferior this crude contrivance is to the marvellously delicate and adapted mechanism of the living eye. Subsequently, in 1691, when, partly in consequence of certain careful ophthalmic measurements made by the physician Pecquet in 1667 in his presence, Huygens was more familiar with the actual dimensions of the human eye, he described a "schematic eye" which more nearly represented the optical system of the actual eye,¹⁶ but which was considerably more complicated than his original "simplified eye."

As to the mechanism of accommodation, Huygens supposed that this power might be produced by a forward movement of the crystalline lens or by an increase in the convexity of the lens (as Scheiner had imagined) or by a combination of both of these

¹⁵ Beitrag zur physiologische Optik (Göttingen, 1845), pp. 16-18.

¹⁶ *Loc. cit.*, pp. 800-802.

causes.¹⁷ At the time of Pecquet's measurements referred to above he was struck with the flexibility of the crystalline lens and how its form changes under the pressure of the fingers,¹⁸ and hence he concluded that the act of accommodation was effected by a change of curvature of the lens. Subsequently, however, in 1670 he returned again to the explanation of the forward movement of the lens without change of form.¹⁹

Another thing which constantly excited Huygens' admiration was the contrivance of the pupil of the eye which remained always circular in form whether it was big or little.

He was an empiricist concerning the old question as to how we see objects erect when their images on the retina are upside down. Our judgments of appearances, he says, are largely a matter of habit, and even if everything had to be viewed through a glass which inverted them, we should still speak of seeing things erect and should experience no difficulty in pointing to the top or bottom of an object.²⁰

Huygens found the ideas of myopia and presbyopia in Kepler's writings, and he formulated very definite rules for determining the powers of lenses for the correction of these defects of vision.²¹ It is interesting to compare his way of treating these problems with that of Barrow (1630-1677) in his lectures on Optics.²²

Concerning emmetropia also Huygens says "there is nothing in nature which shows the geometry of the Creator more than the eyes" and it is indeed "admirable that the surfaces of the cornea and the crystalline lens are just of that degree of convexity to bring parallel incident rays to a focus in the fundus of the choroid. Perhaps it is different in the case of little children who may be able to adjust their eyes in some manner; but that is also no less marvellous."²³

¹⁷ *Loc. cit.*, p. 133.

¹⁸ *Loc. cit.*, p. 789.

¹⁹ *Loc. cit.*, p. 794.

²⁰ *Loc. cit.*, p. 745; also p. 829.

²¹ *Loc. cit.*, pp. 134-138.

²² "Lectiones XVIII Cantabrigiæ in Scholis publicis habitæ in quibus opticorum phenomenon genuinæ rationes investigantur, ac exponuntur. Etc. Ab Isaäco Barrow. Londini, MDCLXIX." Pp. 102, 103.

²³ *Loc. cit.*, p. 756.

Notwithstanding that there is an image formed in each eye, Huygens tells us that Nature has taken particular pains to prevent us from seeing double; for each point in the fundus of one eye has its "corresponding point" in that of the other eye, and it is only when an object-point is imaged in a pair of corresponding points in the two eyes that it is seen single as it really is.²⁴ These corresponding points according to him lie both on the same side of the optic axes and similarly placed with respect to the two optic nerves; and hence it is plain that a distant object will be seen double when the eyes are converged on a nearer one, and *vice versa*. Huygens' theory of corresponding points on the retinas of the two eyes is indeed as complete as that to be found in modern text-books. Robert Smith (1738) in his "Compleat System of Opticks" entertains exactly the same views, and he observes also that Leonardo da Vinci had explained how the most accurate painting can never give a plastic impression of relief as perfect as that which is obtained from looking at real objects, because the images of a solid object in the two eyes are necessarily somewhat different. If Huygens had only recognized this fact clearly, he might have anticipated Wheatstone (1838) in the invention of the stereoscope.

The secure foundations of the science of physiological optics were laid principally by the genius and penetration of Kepler, Scheiner, and Huygens. It was chiefly through their labours in this field that their great successors, Young (1773–1829), Donders (1818–1889), and Helmholtz (1821–1895),—to mention only a few of the most illustrious names—were enabled to develop and extend the theories of light and vision in all their manifold ramifications with other branches of human knowledge.

DEPARTMENT OF PHYSICS
COLUMBIA UNIVERSITY
NEW YORK, N. Y.
JUNE 1, 1922.

²⁴ *Loc. cit.*, p. 796.

INSTRUMENT SECTION

THE MECHANICS OF OPTICAL POLISHING

BY
ELIHU THOMSON

The problem of how it is that, for example, a glass surface which has been smoothed or finely ground can, by proper means, be polished not only so as to be invisible ordinarily, but so that under the severest tests it shows no diffusion of light (as of the sun's rays falling on it) has at times engaged the attention of the ablest physicists. The late Lord Rayleigh studied the matter and his paper¹ on the subject is well known. He properly explains the polishing process on the principle of removal, by a process similar to grinding, of the high points of the surface, and progressively so until the whole ground surface has been cut away, but the cutting is by an action so fine that the grain produced is beyond the power of resolution by a microscope or other powerful optical means.

It is the purpose here to show that while this view is measurably correct it does not go far enough, and that the polishing is a unique mechanical process; a self regulated planing down of the surface to a real level without even the finest scratches or other character which would lead to diffusion of any light falling on the surface.

Some have most erroneously tried to explain the result of the process, by assuming that the glass has, during the polishing, actually flowed; or that there was some peculiar plastic condition brought about which allowed the glass surface being polished, to take on the characteristics of a liquid surface. There is no need for such hypotheses and no validity in such assumptions. This will be made clear.

In burnishing of plastic metals by a hard burnisher, there is, of course, such flow, but with hard, brittle, non-malleable materials like glass, the process is decidedly not like burnishing.

¹ Lord Rayleigh, Proc. Roy. Inst. Gr. Britain, March, 1901; Trans. Opt. Soc. 19, October, 1917.

Glass may receive an optical polish in either the wet or dry way. Other materials of a brittle, non-malleable nature are dealt with similarly; such are quartz, agate, calcspar (Iceland), and many jewels and minerals.

In the manufacture of plate glass, the ground surfaces (the last, or smoothing stage, being often called *mud ground*) are not worked by grinding to so fine a grain of surface as in the better class of accurate optical work, and the polishing is done by runners of felt charged with rouge (crocus) and water moved over the plate by machinery. The result is that the surface obtained is not an optical one; it has a smoothness and polish similar thereto, but is wavy throughout, as can easily be discerned by a skilled eye in regarding the reflection of an edge from such surface; and, of course, by other simple tests. It is neither optical in the large or in small elements of surface. The yielding felt runners have swept out indiscriminately the hollows, small and large, and have not held the surface to a definite figure. Similar yielding polishers are used in finishing the very irregular surfaces of cut glass. The cheaper kind of lenses, where accuracy of figure is not needed, are often cloth polished, a process which, if carefully conducted, gives a result intermediate between the plate glass surface and the true optical surface, such as is obtained by a pitch polisher with rouge and water. The considerations as to the true nature, the mechanics, of the polishing process are applicable to all such cases, but will be given in connection with the pitch polishing, most usual in good work. They apply, too, to the case of dry or paper polishing with paper faced tools charged with tripoli (diatomaceous earth) a method of polishing which has been used to some extent in France for medium grade lenses.

In rouge polishing with pitch for a carrier, as is usual, the surface of the pitch is moulded to fit the glass and is divided (usually) into small square facets by grooving. It is worked over the glass, or the glass worked upon it by movement in all directions or such innumerable paths are given that no definite course is repeated. This is essential to the best result.

The conditions as found, in successful work, are as follows. The rouge, though very hard, is friable and breaks down to a very

fine powder. Too hard (non-friable) rouge will tend to fine scratches. These scratches are not like grinding or crushing, but are smooth bottomed grooves, discoverable by a magnifier.

The pitch is at all times yielding. It is made so by tempering and testing. If too hard, it tends to cause fine scratches, all over the surface which is being polished. These, with very hard pitch, may resemble grinding, but ordinarily they show no crushing, but are smooth cuts.

In grinding, on the contrary, the surface is crushed, while in polishing it is clean cut. Smooth cutting is the rule. The polishing is indeed a kind of planing process; the particles of rouge set themselves into the pitch surface and cut smoothly; they do not roll or grind. There are millions of fine planing or cutting edges at work fixed in position by becoming, at least temporarily, embedded in the pitch surface, which readily yields to receive them. They make smooth cuts as can readily be seen by examination of the scratches when the pitch is overhard or the rouge too hard and nonfriable. Good rouge is friable without apparent limit, and rouge washed out of a used polisher may be so fine as to float for days in colloidal solution.

All the above considerations are fairly well known and recognized, but there is one additional condition, or circumstance, which, so far as the author knows, is worthy of record, no attention having been hitherto drawn to it.

It is this: by the very nature of the case the particles which are doing the cutting in polishing are all *automatically adjusted*, in successful work, to cut to the *same depth* during any stroke. The yielding nature of the pitch surface not only ensures this, but makes it a necessary consequence, for any particle of rouge riding higher than another is at once depressed to the proper level by sinking into the pitch surface. The innumerable cutting edges of all the particles reach a common level, and with motion of the polisher in all directions, and cutting smooth (no crushing or grinding) the result cannot fail to be what it is, an optical surface without grain or irregularity. The rouge is friable without limit, so that the polishing particles may, in the process, become finer and finer. With felt, cloth, or paper as a carrier for the

polishing powder, the effect is much the same; the particles are held to position when cutting, as planing tools. Even fine washed carborundum will polish glass if held in the surface of soft wood or cork, and the author has even produced a fair polish on a glass lens by a soft metal tool charged with fine carborundum. In such case, the polishing takes place in a few seconds, but the technical difficulties are very great. In dry polishing, a sheet of paper is pasted down on the surface of the polishing tool, and a special high grade pure paper, rather heavy and uncalendered, is used. This is charged by gently rubbing its surface with a lump of fine tripoli selected for the purpose, the fine silicious skeletons composing which constitute the polishing powder. The first application to the smoothed surface, as of a lens, which surface has the fine grain usual in such a case, is to show innumerable fine scratches, criss-crossing in every direction. They are, however, smooth scratches. As the work goes on, the tripoli works down to finer and finer conditions, while the polishing comes up gradually, no new application of the powder being required after the start. It is manifest that here too is the condition of smooth cutting and particularly a self adjustment of cutting depth, owing to the yielding character of the paper surface, so that at the end all the cutting is done in one surface of movement. It is believed that this dry paper process is much less used than formerly. It cannot be expected to yield the high accuracy that may be obtained with the wet pitch.

It is thought that in pointing out the mechanics of the polishing process, and more especially the smooth cutting and self-adjustment of cutting particles above described, the interesting process of the production of an optical surface may be relieved of something of the mystery which has been its accompaniment.

The author has drawn upon an experience of more than fifty years in occasional working of optical surfaces on glass of many kinds and on media, such as crystal quartz and fused quartz, Iceland spar and others.

The amount of material removed from the surface under treatment, is, of course, seen to be almost infinitesimally small per stroke, and it is only by the long continuance of this action that

at last there is a sufficient removal to secure an optical surface. Time is saved by carrying the fine grinding or smoothing as far as possible before applying the polisher. As Rayleigh has stated, and it is of course the common experience, polishing begins on the highest or most elevated parts of the surface, seen only under a magnifier, and these are removed while the polished spots widen out, and, if the surface has been well prepared, or *bottomed*, as it is termed, spread to include the whole surface. If the surface has not been well bottomed, there will remain pits which the slow planing action of the polisher is incompetent to remove in reasonable time, and if the polishing is continued too long, the surface is more than likely to have lost its truth, or has been seriously deformed. This, however, depends on the polisher itself keeping its form. Too soft pitch is a guard against polisher scratches from particles of grit, but not conducive to accuracy. Accuracy can be helped by remolding the polisher at intervals by slight warming of its surface and application to a true surface of the same character as that being produced, while moistening the said surface to prevent adhesion.

No matter what degree of smoothness has been attained in polishing, the continued smooth removal of the glass surface goes on as long as there is rouge, pitch and water applied; a fact which is, of course, taken advantage of in parabolizing a concave astronomical glass mirror.

GENERAL ELECTRIC CO.

LYNN, MASS.

JULY 20, 1922

A VARIABLE RESISTOR OF LOW VALUE¹

BY
C. N. HICKMAN

In making electrical measurements there is often a great need for a continuously variable resistor of low value. Variable resistors consisting of a copper wire sliding in an insulating tube containing mercury² have been used in the Resistance Measurements Section of the Bureau of Standards for several years. The Inductance and Capacitance Section has constructed a number of them with a surrounding copper tube on which the current returns, thus decreasing the inductance of the circuit.

These instruments are very useful for varying the resistance of a circuit provided the current is small. However, they cannot be used when the value of the resistance must be known with a high degree of accuracy on account of the high temperature coefficient of mercury. Also, where careful measurements are being made, the continuous change of resistance due to heating makes a mercury resistor unsuitable for carrying large currents.

The resistor described in this paper is a modification of these instruments which reduces the temperature coefficient to a negligible quantity by using manganin instead of mercury. This instrument is equipped with a calibrated scale from which the resistance may be read accurately. Within reasonable limits the resistance is independent of the current.

Fig. 1 shows a sketch of the instrument. A copper and a manganin wire of the same diameter are welded together and slide on the inside of a thin glass tube G_2 . This glass tube is surrounded by a thin copper tube T . All of this apparatus is inside of another glass tube G_1 . The glass tubes are provided with reservoirs

¹ Published by permission of the Director of the Bureau of Standards of the U. S. Department of Commerce.

² F. Wenner, *Phy. Rev.* **32**, p. 614, 1911. This Bulletin Vol. 8, p. 584. *Sci. Paper No.* 181.

J. H. Dellinger, *Phy. Rev.* **33**, p. 215; 1911.

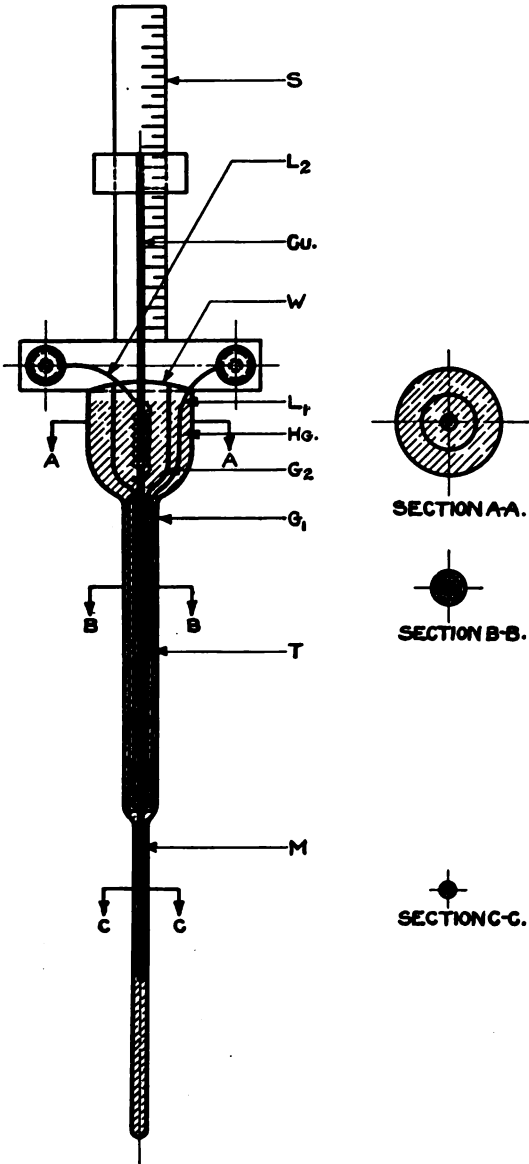

FIG. 1. Manganin Slide Resistor

through which the leads enter (Sec. AA). The entire system of tubes is filled with mercury. Thus the current flows in on lead L_1 , down the copper tube T , through a thin film of mercury to the copper or manganin wire, and up to the inside reservoir, then through another thin film of mercury to L_2 .

When the slide is down, the copper and manganin junction is at the lower end of the copper tube. If the slide is raised on the scale S , a portion of the manganin wire will replace an equal length of the copper wire. Thus resistance may be added continuously until the slide is at the top of the scale S , in which position the maximum resistance is obtained.

A resistor of this type having a range of one one-hundredth of an ohm has been used at the Bureau of Standards for about three years. The diameters of the wires are each about 0.260 cm. Their lengths are each approximately 15 cm.

The total inductance of the instrument is only about 0.023 microhenry. Since the copper and manganin wires each have the same diameter, there would be no change of inductance as the slide is moved were it not for the fact that the manganin, having a higher resistance than the copper, causes a little more current to flow through the thin film of surrounding mercury. The maximum change in inductance resulting from this change in current distribution is less than 0.001 microhenry.

The resistor has been calibrated a number of times during the last three years with currents of from 0.001 ampere to 5 amperes, and the calibrations are consistent to 0.0001 ohm. The calibration curve is a straight line, the calibrated points seldom being off the line more than a few hundred-thousandths of an ohm.

SUMMARY

A continuously variable resistor which is suitable for carrying a large current and which permits the use of an accurately calibrated scale is described. The variation of the resistance is accomplished by substituting a manganin wire for a copper wire of the same length and diameter.

Readings may easily be repeated to one ten-thousandth of an ohm on a resistor having a range of .01 ohm and the instrument

remains constant to this degree of accuracy. The variation of inductance as the resistance is changed is negligible, being less than 0.001 microhenry for the total range of the resistor.

BUREAU OF STANDARDS

WASHINGTON, D. C.

JULY 25, 1922

A ROTARY SLIDE-WIRE FOR PRODUCING UNIFORM VARIATION IN POTENTIAL DIFFERENCE¹

BY
S. J. MAUCLY

One of the requirements in the calibration of certain atmospheric-electric apparatus is a device for varying the potential difference between the two members of a condenser at a constant and definitely known rate.² A special form of "rotary potentiometer," which was devised for this purpose and constructed in the instrument-shop of the Department of Terrestrial Magnetism, is described here in the hope that it may be found applicable to other uses.

The description will be facilitated by a preliminary statement of the principal requirements to be satisfied. Briefly, these are as follows: (*a*) A slide-wire of sufficiently high resistivity and low thermal expansion to allow the use of the required terminal potential differences without objectionable expansion and other thermal effects. (*b*) A supporting cylinder which, in addition to satisfactory insulation, has approximately the same thermal expansion as the wire. (*c*) A traveling contactor which maintains good electrical contact; likewise, suitable brushes at the ends of the cylinder. (*d*) A driving mechanism for turning the cylinder uniformly at desired speeds. (*e*) Provisions for altering the speed of the cylinder. (*f*) Means for accurately determining the speed of rotation of the cylinder. (*g*) Convenient regulation of the potential difference applied to the slide-wire. (*h*) Such co-ordination of the various details that the rate of change in the potential difference between the traveling contactor and either terminal of

¹ Published by permission of the Director, Department of Terrestrial Magnetism.

² See, for example, "An Apparatus for Automatically Recording the Electrical Conductivity of the Air" by W. F. G. Swann, in "Annual Report of the Director of the Department of Terrestrial Magnetism" for the year 1917, Yearbook of the Carnegie Institution of Washington, 1917, p. 279. As indicated in the paper referred to, a preliminary form of the apparatus here described was used by Swann in 1917.

the slide-wire may be known and kept constant to about one part in 250 for observation periods of at least 5 minutes.

Fig. 1 shows a general view of the apparatus and its control equipment. (Only the upper half of the switchboard is involved

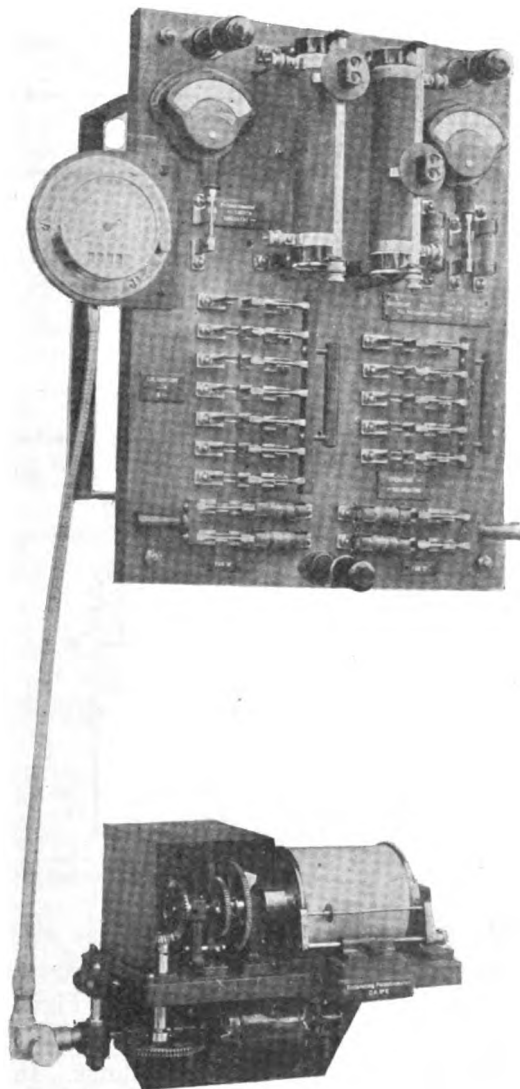

FIG. 1. General View of Constant-rate Slide-wire and Control Equipment

in the control of the slide-wire; the lower half is related to apparatus associated with the slide-wire for calibration and does not concern us here.) Fig. 2 is a schematic diagram of the slide-wire connections, exclusive of motor control, while the drawings reproduced in Fig. 3 give plan, and front and side elevations, drawn to scale, showing the more important details of construction. The

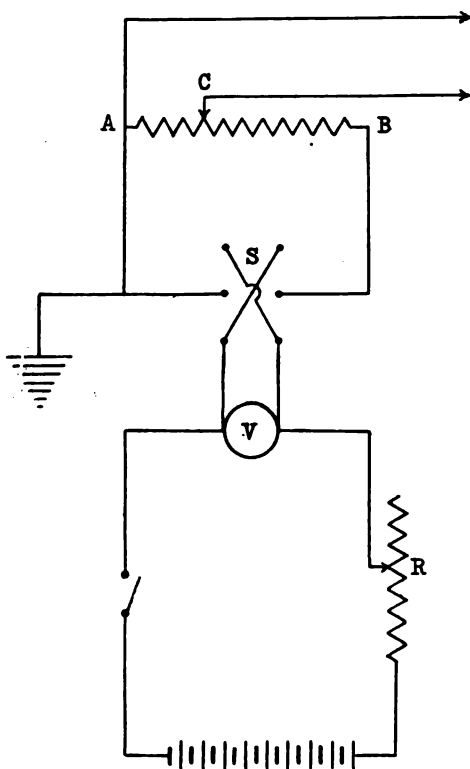
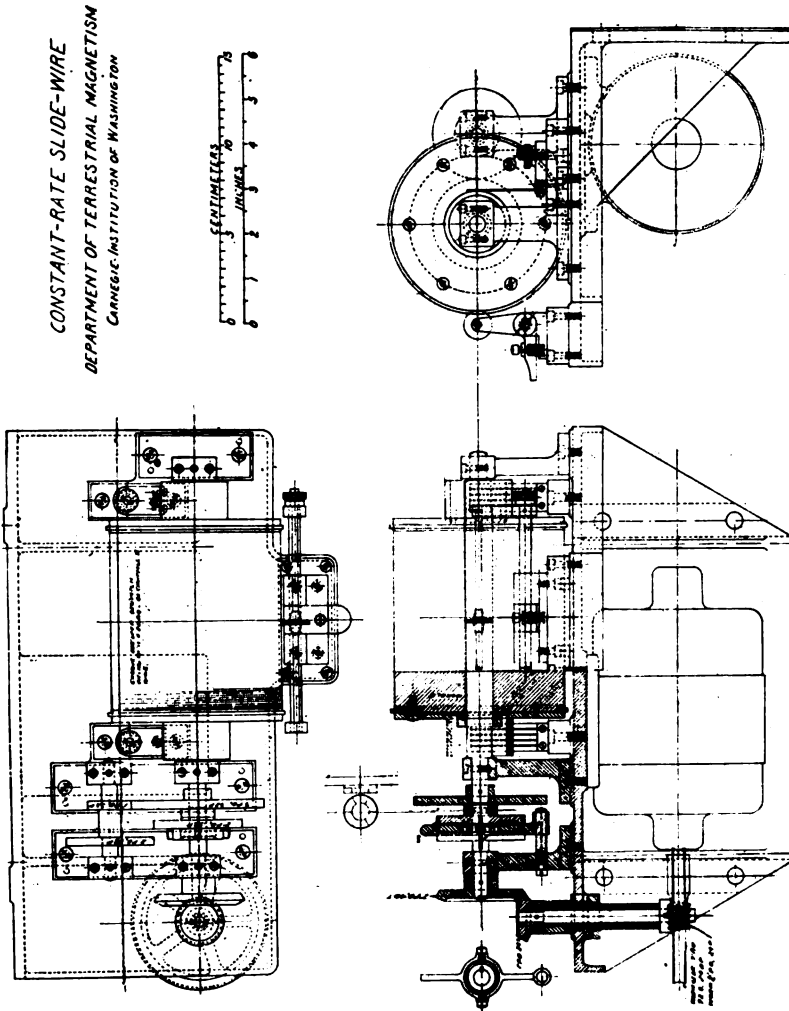

FIG. 2. Schematic Diagram of Slide-Wire Connections

photograph in Fig. 4 shows the apparatus as seen from above, with protecting cover removed, and gives certain mechanical details not shown elsewhere. As shown in Figs. 1 and 3, the present apparatus was constructed for wall mounting, but this is merely a detail of adaptation to surroundings. In what follows attention will be limited mainly to matters not brought out by the

figures, or which are of first importance for the proper functioning of the apparatus.

The slide-wire *AB* of Fig. 2, consists of about 25 meters of No. 25 (B. and S. gauge) annealed chromel wire. This is wound under



moderate tension, in a screw-cut spiral groove of 80 turns, on an accurately-turned white marble cylinder whose diameter and length are each approximately 10 cm. The spiral groove has a

pitch of about 1.25 mm (20 threads per inch) and is cut to a depth of 0.15 mm with a round nose tool of 0.225 mm radius. The resistance of the wire is about 150 ohms, and heating effects are negligible for applied voltages of the order of 30 volts. Even with 36 volts there is no perceptible loosening of the wire although there is noticeable warming. The marble cylinder was first bored to receive its shaft. After being rigidly mounted and

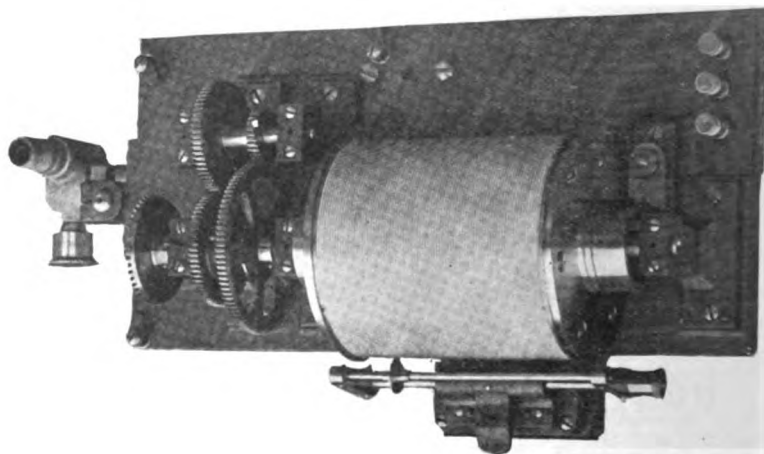

FIG. 4. View of Slide-Wire from Above

keyed to the shaft it was turned into final shape, on its own shaft, by means of a diamond tool. The cylinder is faced at each end by a combination face-plate and slip-ring, secured to the cylinder by screws tapped into the marble. As shown in Fig. 3 (front elevation) the clearances between the slip-rings and the lock-nuts of the shaft are such as to provide ample insulation. In order to eliminate all uncertainty as to the effective length of the slide-wire, the first two turns, at either end, are securely soldered at one point to the adjacent face-plate. Careful determinations, made after the wire was wound, show the resistance per turn to be practically uniform for the entire length of the cylinder.

Each of the brushes connecting the slip-rings to the binding-post terminals, consists of a single piece of phosphor bronze (No. 28, B. and S. gauge), slotted for the greater part of its length into five 3-millimeter strips. The brushes and binding posts are

mounted on hard rubber blocks of which the details are shown in Fig. 3.

The traveling contactor, represented by *C* in Fig. 2, consists of a brass wheel 15 mm. in diameter with a 60° V-shaped groove, about 0.2 mm deep, for engaging the wire. It is mounted on a steel axis which is parallel to the axis of the cylinder and along which it slides as it follows the wire spiral. The axis of the contactor forms part of a rigidly-hinged frame which is insulated from the base by a slab of hard rubber. Figs. 1 and 4 show the general construction of the contactor and its supporting frame. Firm contact with the wire is maintained by means of a stiff spring, and a simple thumb lever at the middle of the hinged frame, enables one to raise the contactor for shifting its position to any part of the cylinder. The location of the contact spring, under the thumb lever, is best shown in Fig. 3, side elevation. With moderate care to keep contact surfaces clean, both the contactor and brushes have given very satisfactory service.

The cylinder is operated by a 1/40 h.p. direct-current, shunt-wound motor with a normal speed of 1800 r.p.m. Suitable speeds for the cylinder are secured by means of a steel worm, attached to the motor shaft, and a double train of cut brass gears. The two reductions in speed thus obtained are 144 to 1 and 432 to 1, respectively, and are controlled by a shift-lever. Further changes of speed and all close adjustments are made by means of a rheostat in series with the armature. In the present form of the apparatus the time required for the contactor to travel the entire length of the slide-wire may be varied from 5 minutes to 25 minutes. The motor is energized by a storage battery in order to avoid the irregular fluctuations of commercial circuits. There is, however, the usual slow initial increase in speed so that the best conditions for constant speed are not reached until after the motor has been running for a time. This slow change of speed is, however, easily controlled by the rheostat and causes no trouble.

A tachometer of a type used for indicating speeds of air-plane propellers is attached to the motor shaft, as shown in Fig. 1. By this means the actual speed of the cylinder is readily determined

to one part in 300, or even better, and the sensitivity of the tachometer is such that, by aid of the control rheostat, the speed may also be kept constant to about one part in 300.

The rheostat indicated by *R*, in Fig. 2, is used for the control and adjustment of the over-all potential difference. With this in mind, one might be led to question the need of providing more than one speed for the operation of the cylinder, since the applied potential difference may be reduced at will. However, it is preferable to obtain the lower rates of change in potential difference by reducing the speed of the cylinder in order to keep the readings of the voltmeter well removed from the lower part of its range and to reduce the importance of contact effects. The use of the pole-changing switch *S* (Fig. 2) is obvious from the diagram.

The apparatus described has been in use for nearly a year and has been found well adapted to the work for which it was designed. With the present form it is possible to secure variation in potential difference, uniform to 1 part in 250, for values ranging from several millivolts per second to about 0.1 volt per second, with the absolute values known to somewhat higher accuracy. This, naturally, does not indicate the limit of merit to be secured by this type of apparatus. With greater care in the selection of the resistor, special treatment of the marble, greater attention to contacts and motor control, both the constancy and the accuracy could be considerably increased if needed.

The author is under obligation to Mr. C. Huff for the design of many of the details and for the preparation of the drawings; the apparatus was constructed under his general supervision, in the instrument-shop of the Department, with the assistance of Mr. W. F. Steiner. Valuable assistance was also received from Mr. O. H. Gish in the determination of the attainable accuracy and degree of constancy.

DEPARTMENT OF TERRESTRIAL MAGNETISM
CARNEGIE INSTITUTION OF WASHINGTON
WASHINGTON, D. C.

A SIMPLE DIRECT-READING POTENTIOMETER FOR STANDARD CELL COMPARISONS

BY
MARION EPPLEY AND WILLIAM R. GRAY

Of the many types of potentiometer that have been described¹ there are but two which are available for the direct comparison of the electromotive forces of standard cells. They are the "slide-wire" type, and the "Feussner" type.

The "slide-wire" type is the better of the two theoretically, on account of the absence of contact resistances in the measuring circuit. However, it possesses an uncertainty due to the inability of adjusting a slide-wire to uniformity of resistance over its entire length. Also, it is impracticable to manufacture an instrument of this design reading to more than five figures. In the range required for standard cell measurements, this makes the fifth decimal place an estimated one. This place can be estimated to about 20 microvolts upon high-grade instruments. Thus, their precision is approximately .002%, while their accuracy is usually guaranteed to .02% at their full scale reading.

The "Feussner" potentiometer is expensive to make owing to the great number of coils and the need of their being accurately adjusted to each other to insure a measuring current of constant value. The contacts also must be most carefully designed, made, and cared for, if the intended accuracy of the instrument is to be maintained. White² states that an error of ten microvolts or more may result from lack of care of the contacts in the Feussner potentiometer as made by Otto Wolff, a maker noted for his elaborate and smooth-working switches. The Feussner potentiometer could be made with an infinite number of dials in so far as theoretical

¹ White, *J. Amer. Chem. Soc.*, 36, p. 1868-1875; Laws, *Electrical Measurements*, p. 273-288; Watson, *Practical Physics*, p. 495-498; Griffiths, *Methods of Measuring Temperature*, p. 60-66.

² White, *Ref. 1*, p. 1871.

considerations are concerned. From the practical standpoint, six figures are all that can be secured owing to the total resistance being fixed at its upper limit by galvanometer sensitivity and insulation leakage, and at its lower limit by the resistance of the dial switches.

There are ways³ in which the residual emf of two opposed standard cells can be measured to ten microvolts or better without any very great accuracy in the resistance and ammeter forming the set-up. Difference methods, however, do not give final results without calculation, an objection when a large number of routine measurements must be made.

If an accuracy of ten microvolts or better is desired, without the need of calculation, some such arrangement as that described below is necessary. In this design the two potential-point feature of the slide-wire type of potentiometer is retained with its advantage of absence of contact resistances in the measuring circuit. The uncertainty due to lack of uniformity in the slide-wire is eliminated by the use of coils throughout. The use of coils is made possible by limiting the range of the instrument to that required for comparing standard cells. No originality is claimed, except perhaps for the self-checking feature.

DESCRIPTION: The diagram gives all salient features of the potentiometer circuit. The reproduction of the photograph of the top shows the arrangement of dials and switches. The self-checking device is perhaps not so evident, for in adjusting the measuring current no coils are used other than those of the potentiometer circuit proper.

Each stud is drilled, on a radius greater than that of its switch-arm, with a hole reamed to receive a plug. A flexible connector with plug S_1 is attached through the standard cell to one pole of a double-throw switch. Another flexible cord with plug S_2 is attached directly to the other of this pair of poles. The opposite two poles of the double-throw switch and its two middle poles are connected as is usual in self-checking potentiometers. When the two plugs are inserted in the holes in the two studs corresponding to the

³ Lindeck and Rothe, *Zeitschr. f. Instrumentenkunde*, 20, p. 293, 1900.

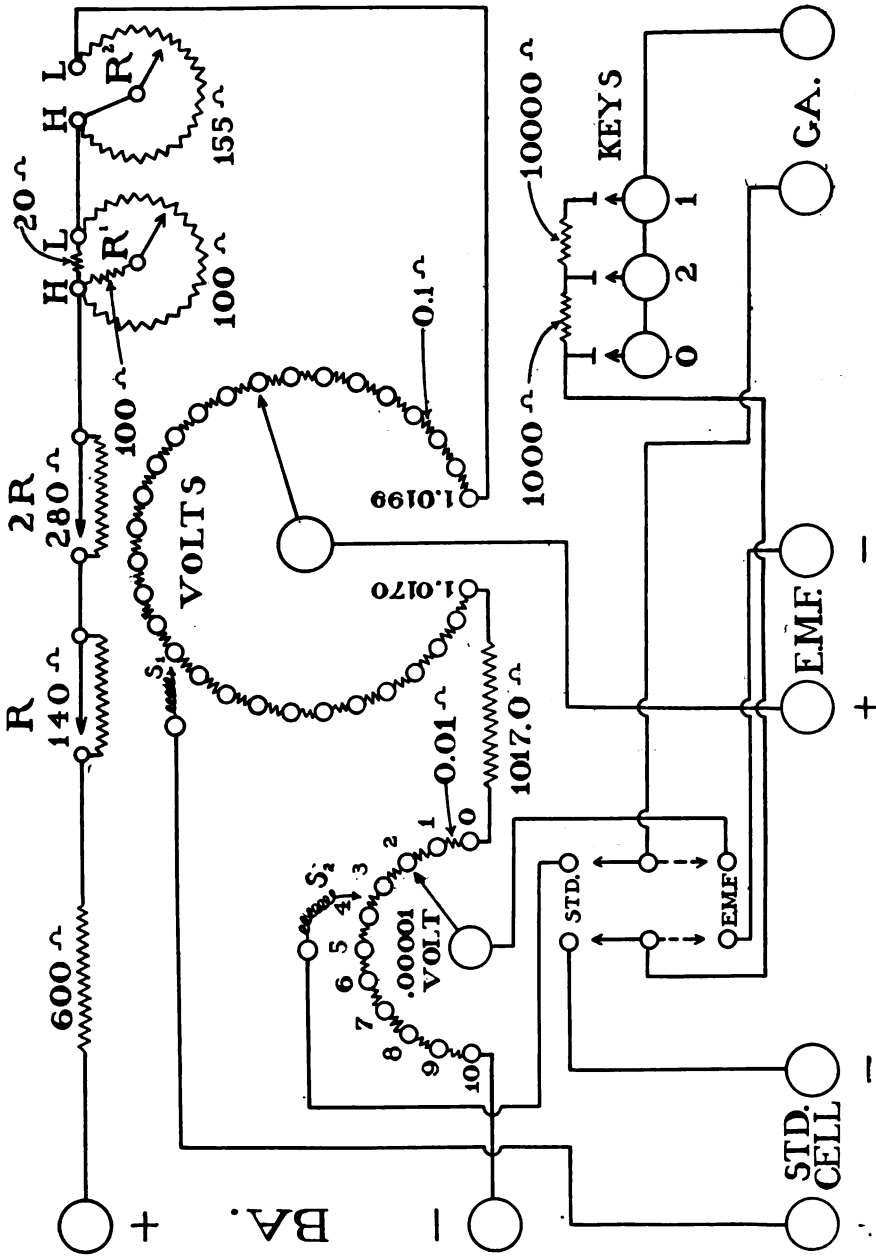

FIG. 1. Diagram of Potentiometer Connections.

electromotive force of the standard, and the double-throw switch is thrown to the "Standard Cell" side, the cell is in series with the galvanometer, and is across the resistance proportional to its value. By simply throwing the switch to the E.M.F. position, the unknown is thrown in series with the galvanometer, without disturbing the standard cell connections. In this way, convenience is secured without the need of adjusting a "standard cell coil" to proportionality with the coils of the measuring circuit.

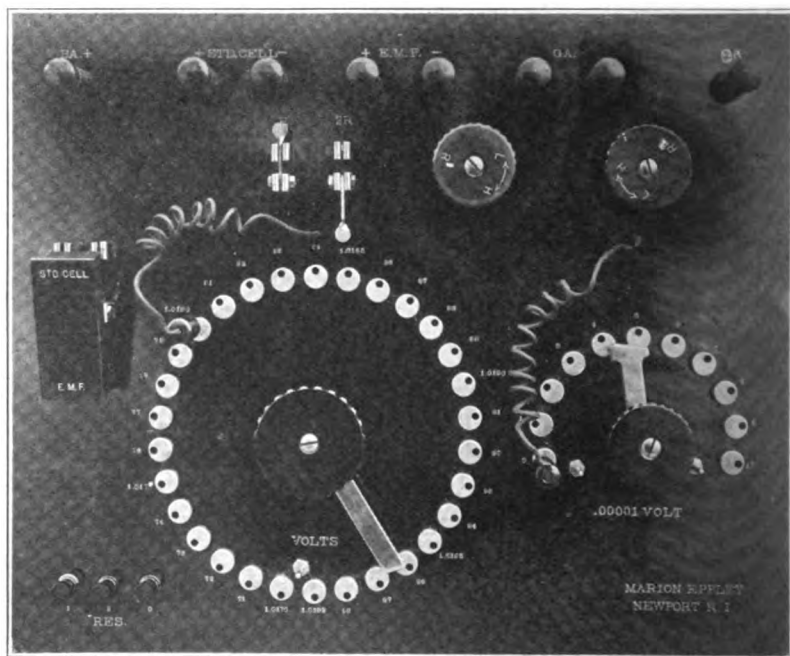

FIG. 2. Top of Potentiometer

The comparison of a cell having a value falling at the uppermost point of the range of the instrument, with a standard whose value lies at the lowest limit of the range, presents the worst condition for accuracy. An error of 0.1% in the resistance of the 1017.0 ohm coil of the potentiometer circuit would, under the above conditions, introduce an error of 3 microvolts. The same would be true of a 0.1% error in the same direction in all the resistances of the two dials, the 1017.0 ohm coil remaining constant.

To secure uniformity of temperature, the instrument is immersed to the bottom of the ebonite plate in a stirred oil-bath.

A highly sensitive galvanometer is necessary. Most excellent results have been secured with a Leeds & Northrup Company Type HR galvanometer having the following characteristics; sensitivity 2460 megohms; 2.03 mm per microvolt; 102 ohms resistance, 12 seconds period.

The parasitic electromotive force across the standard cell binding posts, with the battery disconnected, but the galvanometer connected as usual and the key O closed, was less than five microvolts, the checking switch being closed at the "Standard Cell" position. With the checking switch at the "E. M. F." position, the parasitics across the E. M. F. binding posts were about five microvolts. Swinging the long arm over its entire range of travel twenty times, as rapidly as possible, produced an E. M. F. of 18 microvolts which in thirty-five seconds sank to 5 microvolts. Swinging the short arm twenty times in the same manner produced an E. M. F. of 10 microvolts which sank to five microvolts in thirty seconds. Measurements were made with a Leeds & Northrup Company Type K potentiometer using the "low range."

A storage cell was found to drift too rapidly for satisfactory results. A standard battery was therefore made differing from that described by Hulett⁴ in the following details: A crystallizing dish 17 cm in diameter and 9 cm deep was placed in the center of another crystallizing dish 25 cm in diameter and 12 cm deep. The inner dish was partially filled with mercury and mercurous sulfate. Into the annular space molten $12\frac{1}{2}\%$ cadmium amalgam was poured to a depth of about 2 centimeters. Crystals of cadmium sulfate were placed in both dishes and both dishes filled with a saturated, acidified solution of cadmium sulfate. A cover was provided, and suitable connectors of platinum wire in glass tubing.

⁴ Hulett-Phys. Rev., 27, 33.

Two of these cells have proved sufficient.⁵ After the lapse of two hours or more after adjustment of the measuring current, not more than a millimeter deflection of the galvanometer is customary if the current had been flowing for half an hour before the adjustment. When not in use, the circuit is kept open. Two such cells have been in use for 7 months and are still giving the same service as originally. They have received no attention.

Check-measurements on standard cells, made with this potentiometer, by the opposition method of Lindeck and Rothe,⁶ and by the Bureau of Standards, usually agree to ten microvolts or better.

THE EPPLEY LABORATORY,
NEWPORT, R. I.

⁵ Note: These two cells would not operate a Leeds & Northrup Company Type K potentiometer satisfactorily.

⁶ See reference 3.

ON CONSTRUCTION OF PLATINUM THERMOMETERS AND OF RESISTANCE COILS

BY
J. R. ROEBUCK

While zeros of platinum thermometers are generally much steadier than are those of mercury-in-glass thermometers, nevertheless the most serious difficulty in work of high precision is the zero shift. Such observed shifts may be due to many different causes. For example; (a) to shift of lead resistance with temperature or handling, (b) to shift of insulation resistance, (c) to shift of reference coils resistance, and (d) shift in resistance of the thermometer coil itself.

Causes (a) and (b) can be located with certainty and eliminated by well known methods. In this connection it might be emphasized that lamp cord is a very unsuitable material for such leads. But (c) and (d) are very difficult, indeed, to separate. In fact, what one observes always is the difference between shifts due to these two causes. Approximate separation of the shifts may be obtained by imposing temperature excursions on the thermometer, so that the time for which it is away from the reference temperature is short. This is limited to the detection of shifts in the thermometer due to temperature change. Secular shifts are also important and here the only means of separating and measuring is by reference to a non-varying resistance. The proportional variation involved in thermometer work, say for 0.001°C at room temperature, is of the order of 3 parts in a million which is probably beyond the limit of steadiness of the best standard resistances.

The causes of resistance shift of reference coil and of thermometer coil are necessarily very much alike. They may be summarized thus: (a) gradual relief from mechanical strain due to previous handling, (b) both imposition of and relief from strain during use, (c) changes in the composition of the resistance

material from the outside as oxidization of the surface of the resistance wire, or attack by acid in the bath liquid, or contamination of the platinum wire by silicon or metallic vapors, (d) changes in the internal character of the material due, for example, to crystal growth, or to concentration changes of solid solution and so on.

Cause (a) is usually met by annealing at a temperature well above that at which the coil is to be used. This may be made fully adequate for the Pt coil by heating electrically in air. For the resistance wires, usually manganin, this is difficult to do on account of oxidization of some components in the wire which not only changes the total resistance but also its temperature coefficient. It is undoubtedly one of the principal causes of resistance shifts in newer coils and may easily remain of very objectionable magnitude over the time for which such coils are used.

Cause (b) is one of the main reasons for shift of resistance of both coil and thermometer. Thus standard resistances are wound embedded in shellac, on a metallic cylinder. The coefficients of expansion of the wire, of the shellac, and of the cylinder are all different. The result of temperature change is to impose strains on all the parts and these may or may not remain entirely elastic. If any permanent deformation occurs anywhere, it will show itself by a shift in the resistance when the reference temperature is again attained. It is easily conceivable that the readjustment of the resistance to the reference temperature state might take time and the resistance therefore drift for hours or days.

Or consider the standard method of construction of platinum thermometers.¹ The wire is wound in notches on the edges of 4 mica strips, so that it makes a square. It is wound tight at room temperature. A rise in temperature allows the wire to become loose on its support, in annealing for instance, and on cooling it grips the points of support again. If it has shifted on the support any minute amount, the bends have to accommodate it, that is, the wire is being continually re-strained. Experimentally, it was found that a wire wound in a thread cut in a nonconductor was

¹ See Summary by T. S. Sligh, Bur. of Stand. Sci. Paper, No. 407.

even worse in its erratic zero shifts, which is to be explained in the same way.

These conditions require that for the platinum thermometer, the wire be supported in such a way as not to strain it either from handling or from temperature change. As the wire must be of very small diameter to give the required resistance the supporting points must be close together. On the other hand, the support must not be a constraint. Some experimental work which the writer has had under way for years required the measurement of small differences of temperature at not exceeding 300°C. The difficulties encountered led to much experimental work. The following procedure for the construction of a thermometer for this range is a summary of this phase of the work.

A spool of metal for carrying four strips of mica is constructed as in Fig. 1, which shows, also, cross sections at the important

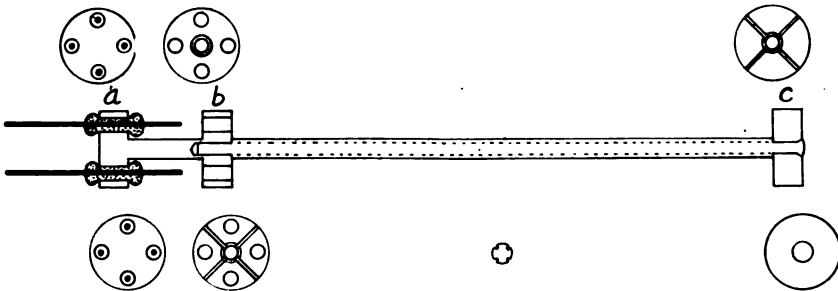

FIG. 1

places. The dimensions used are set by the space and resistance requirements. A cylinder of 3-4 cm long and 5 mm diameter can carry a meter of 0.05 mm platinum wire having about 50 ohms resistance at 0°C. The narrow and thin strips of mica are slipped into the radial slots of the spool bc, so that the outside edge of the mica is about flush with the cylinders. The strips need support over their length by the slots in the central rod. A light prick with a center punch beside the slot on the cylinders b and c will hold the mica in the slot during handling. The cylinders b and c have four holes, alternating with the slots, as indicated in the figure. Pieces of platinum wire about No. 20 and 2-3 cm long are covered with lead glass fused on to let it slip into the hole in "a" up

to a knob at one end. A little ring of the lead glass is slipped over the wire and fused on using a small pointed flame, with the result shown at "a." By crowding the soft glass close to the brass it is possible to leave very little play. Four such leads are each silver-soldered to a copper wire long enough to reach out of the thermometer case. These are then bound together while the coil itself is constructed. The four leads thus make a very substantial support for the spool carrying the thermometer coil with very little chance for straining the fine wire.

The spool bc with the mica strips in place is cast in wax, forming a cylinder out as far as the edges of the mica. Half beeswax—half resin is a suitable wax. This cylinder is turned down in the lathe till the surface is slightly below the ends of the spool. A double thread is cut in the wax and mica with a very pointed threading tool, the number of threads being determined by the length of wire to be carried and the diameter and length of the available spindle. It is possible to use 100 threads per inch successfully both in the cutting and subsequent use. It is, of course, not necessary that the space between the threads be cut to a sharp edge, but the groove must be sufficiently wide and deep to hold the thermometer wire securely.

The compensating lead connection of the fine platinum wire is put in first. It is led through the hole in cylinder b around a semi-circumference and back to the diametrically opposite lead. It is insulated from the metal around the holes by a thin tube of glass either fused down on the wire for its length through the hole, or only at one end to prevent it slipping along the wire. Care must be taken that the wire has slack enough not to be broken by whatever looseness the leads may have. This is only important during the handling as when the coil is in the protecting tube, the leads will be unable to move materially. It is possible to proceed here to the silver soldering of the fine wire to the heavier platinum leads but it is difficult to avoid some fusion of the wax. It is safer to seal the wire in place by bringing near the wax a warm point, and proceed to wind the main coil. The two ends of the wire are insulated and held in place, as for the short wire. The spindle is mounted in the lathe and the wire stretched in a loop from the two

fastened ends by a piece of thread tied to the loop, passed over a round bar and loaded with a weight of a few grams. The wire is annealed at a dull red heat by a suitable electric current. The two wires are then wound in the double thread with care to assure that the wires go well down into the groove and that no small shavings of wax support it irregularly. The wire near the end of the loop is caught in place by a hot point held near the wax, and the loop is then fastened at leisure by a piece of the same platinum wire passed through a fine hole bored through one of the mica strips.

All four wires are then silver soldered to their respective leads with a fine pointed flame. The operation goes more readily if the leads have been prepared with a little silver solder on the end so it is only necessary to have the fine wire in contact with the fused silver to make the joint. A little silver solder may be readily transferred from another bit of platinum wire if necessary. The making of the four joints without fusing the wax seriously required some practice and care. The wax may be protected from fusing by holding the cylinder *b* in a vise and slipping a narrow piece of mica under the wire being heated. An oxy-gas flame may be made very small and yet give the required heat and hence does the best work. The making of these joints may be delayed till the wax is removed, but the coil is then very easily injured. The wax is removed by a suitable solvent, hot turpentine serves well for the half-and-half and the turpentine can be removed by a volatile solvent like carbon tetrachloride.

The annealing just before winding assures that the coil will do no springing on removal of the wax. If it be now annealed by passing an electric current, the coil squirms all out of place. This may be entirely avoided by warming the coil gradually inside a hard glass tube by heating the tube with one or more gas flames. While hot a small current will make the wire incandescent and complete the annealing.

This results in a perfectly cylindrical coil with the wires as exactly spaced as the thread was cut. The wires are well supported at four points without any unusual bend at the point of support. Any adjustment due to temperature changes can result only in long radius bends which will not exceed the elastic limit. Ex-

perience over several years with such coils shows that they have very steady zeros, the steadiest in fact of any arrangement yet tried here. Any numerical statement of the zero shift is of little value since it is complicated by the unknown variation of the reference coils and of course though probably to a smaller extent, by the variability of the ice bath temperature.

Conduction along the leads may be minimized by threading the wire through holes in short metal cylinders which fit the case and are separated from each other by nonconductors. The leads are insulated from the metal cylinders by thin glass tubes. In between the metal cylinders these are made of much thicker glass and so serve to space the metal cylinders. The result is to improve the radial conductivity without affecting the axial, so that at each point the leads will be kept near the temperature of the material surrounding the stem. The 4 platinum-copper junctions are arranged to come in the middle of the first or second metal cylinder. These four junctions are thus held together in temperature even during changing temperature. These junctions are the main location of thermals in the circuit, and this arrangement excludes them practically completely. In the set-up used by the writer for years there are no erratic motions of the light spot with a galvanometer sensibility of 10^{-9} , and almost no zero shift. It should be added that the galvanometer circuit in the bridge is entirely copper (no brass binding posts) and is never opened: the bridge is operated by manipulating the applied potential and the slide wire contact is in the battery circuit.

The introduction of a metal spindle in the thermometer and of the metal about the leads, increases the heat capacity of the thermometer and therefore of the lag when measuring a changing temperature. Where the reduction of lag is of primary importance this type of construction may not be the best. In all cases the steadiness of the zeros is of primary importance for precise work and in many cases lag is quite secondary. It is these cases where this type of construction is particularly suitable.

It is evident that a similar type of construction should improve the steadiness of the resistance coils. The conditions are somewhat different, however. The coils can be made much larger and

longer before the size gives rise to difficulty. The manganin wire is very stiff and a very hard wax would be needed around which to bend the wire. The difficulty of preventing surface oxidization makes it desirable to use a much coarser wire. Coils were consequently built as follows.

Four grooves are milled out of a brass cylinder $\frac{1}{2}$ inch diameter and 5 inches long to give it the cross section indicated in Fig. 2a. These four grooves are filled with paraffin wax by slipping this cylinder inside a brass tube, filling with melted paraffin and after

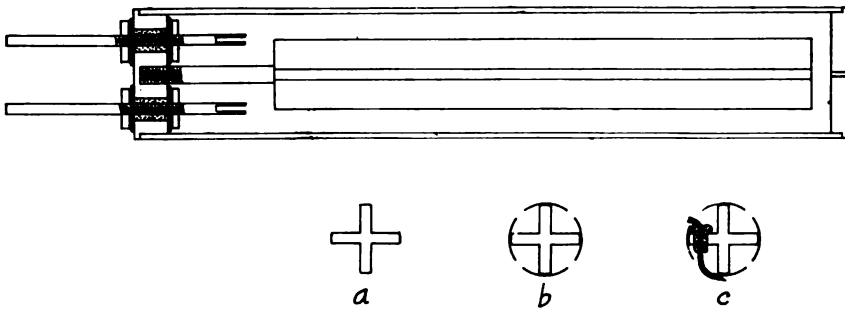

FIG. 2

thorough cooling slipping the tube off by heating it rapidly. Four strips of mica are laid along the cylinder as indicated in Fig. 2b. The edges of the strips do not meet so that the wire when wound on does not have a complete cylindrical support but may spring in and out in each quadrant as required by the temperature conditions.

The wire is doubled for non-inductive winding and a copper wire hard soldered to the bend. This may be done with very little heating of the resistance wire by holding both wires together end on in clamps. A gas flame fed with a little oxygen enables one to heat the joint very rapidly and transfer the liquid solder from another wire with the minimum heating of the resistance wire—when done successfully less than $\frac{1}{4}$ inch of the resistance wire may show the effects of heat. The copper wire is passed through a glass sleeve inserted in a hole in a wing of the supporting cylinder as indicated in Fig. 2c. A sharp bend in the copper wire is sufficient to hold it. The ends of the resis-

tance wire are fastened in a similar manner by hard soldering each end to two copper wires, one to serve for fastening and the other as current lead.

The mica strips are bound in place with a series of ties of string or wire. The winding of the resistance wire is begun at the doubled end and the ties removed successively as they are replaced by wire. The paraffin is then melted and washed out by suitable solvents.

There is no need for covering on the wire if it be carefully spaced in winding. Also there is nothing in the construction to prevent the coil being heated to 400-500°C. With suitable vacuum protection this should be the best treatment. The procedure so far used has been to heat the coil to about 135°C for many hours in air in a space heated by boiling xylol. The surface of the wire becomes slightly discolored at this temperature which is therefore as high a temperature as one should use in the presence of air. After this treatment the wire still remains very stiff and will spring uncoiled strongly if unfastened. This is a good reason for thinking that this annealing is a long way from adequate and that a considerable portion of unrelieved strain remains in the wire. The resistance changes show also that considerable strain has been removed.

After annealing the coil is dipped in a good grade of shellac dissolved in pure alcohol, so as to make a fairly thick varnish. It is dried by holding a few hours at near 100°C. This gives a comparatively thin coating of shellac, hardly sufficient to distort the wire materially. If the shellac penetrates between the wire and the mica it can produce scarcely any strain. Nor can the change of hygroscopic condition of the shellac produce material changes in the strain.

To minimize any effect of moisture as well as to protect the wire from mechanical injury it is best to enclose each coil in a container with acid-free dry kerosene as indicated in Fig. 2. The leads are insulated from the container by mica disks under the nuts and a glass sleeve in the holes. The whole joint is set in fused shellac which is also fused on over the outside finally. The stout copper leads have small holes bored into them axially at the coil

ends and the copper leads from the resistance wire are soft soldered in these holes using resin dissolved in pure alcohol as flux. The brass cylinder is slipped on and soft soldered together with an iron using resin. The kerosene is put in through a small hole in the bottom which is finally closed with a lump of solder. The stout copper leads can be used for supporting the coils.²

Experience with such coils shows them to be materially better in steadiness than the older form. But there still remains relative variation of such a size as to be distinctly objectionable. The actual variation may easily be greater and it is these latter which come into the thermometer work.

The order of variation reached by many workers gives a fundamental interval constant to a few parts per 100 000, so that for this factor the accuracy is almost certainly better than any other associated physical measurement. But when one desires to read a small temperature difference to 0.001° or 0.0001°C the erratic or continuous variation from day to day makes such data very uncertain. This has been the writer's personal experience. Improvement in the steadiness of the system would increase one's confidence in the data very materially.

In this connection further work on manganin is very necessary. The writer has made up many coils with variations of many conditions, e. g., with and without shellac on silk insulation, with and without metallic calcium as a drying agent, oxygen and acid absorbing agent in the kerosene; on metal cylinders, or with four points of support, or without any support. Having no steady comparison resistance it has not been possible to conclude anything about the actual variation. There was always relative variation of a magnitude much greater than the limit of measurement and great enough to be very undesirable in thermometric work.

About the only experimental attack would appear to be the careful study of groups of coils made up in different ways till some means was found for reducing greatly the relative variation within a group. Differential treatment of members of the group would

² See this JOURNAL, 6, p. 175, 1922.

then enable one to judge of the effect of the different conditions. For example, how quickly does a manganin coil attain a steady resistance after a change of temperature. The writer has followed the steady drift of resistance of an iron wire coil for more than 24 hours after its resistance was changed by raising the temperature about 30°C for a short time. The change was of the order of 10^{-4} and large enough to render the coil absolutely worthless for its proposed use as a thermometer.

PHYSICS LABORATORY
UNIVERSITY OF WISCONSIN
MAY, 1922

THE DRAINAGE ERROR IN THE BINGHAM VISCOMETER¹

BY
WINSLOW H. HERSCHEL

1. INTRODUCTION

For the accurate determination of absolute viscosity it is usual to employ instruments with glass capillaries, more or less modified from the original form of Ostwald. These instruments differ in the arrangement of the bulbs in which the liquid is measured, and in the manner of filling with a definite working volume. In the instruments of Ostwald, and of Traube² there is a drainage error due to the variation, with the viscosity, of the volume discharged from the bulb. This error is avoided in the apparatus of Lidstone³ by the use of mercury which does not wet the bulb, while in the Ubbelohde form of instrument the flow is into a dry bulb, and the measured volume is independent of the viscosity of the liquid tested.

The Bingham viscometer⁴ shown in Fig. 1, is similar to the Ubbelohde in having two bulbs so arranged as nearly to eliminate the effect of variations in the density of the liquid, and in the use of a constant air pressure to cause the flow. The working volume is contained between the mark H and the overflow into the trap at A. When the temperature is raised, the volume is again adjusted by causing the surplus to run into the trap.

The volume of flow is contained in the bulb C, between the marks B and D. This bulb is alternately emptied and filled, if check tests are run, but it should be noted that from the method

¹ Published by Permission of the Director, U. S. Bureau of Standards.

² Holde-Mueller, *Examination of Hydrocarbon Oils*, p. 117; 1915.

³ F. M. Lidstone, *Jour. Soc. Chem. Ind.*, 36, p. 270, 317; 1917.

⁴ E. C. Bingham and R. E. Jackson, *B. S. Scientific Paper No. 298*, p. 64; 1917. E. C. Bingham, *Proc. A.S.T.M.*, 18, part 2, p. 373; 1918. The word viscometer is used by Bingham and will be used throughout this paper to avoid confusion, even for instruments usually called viscosimeters.

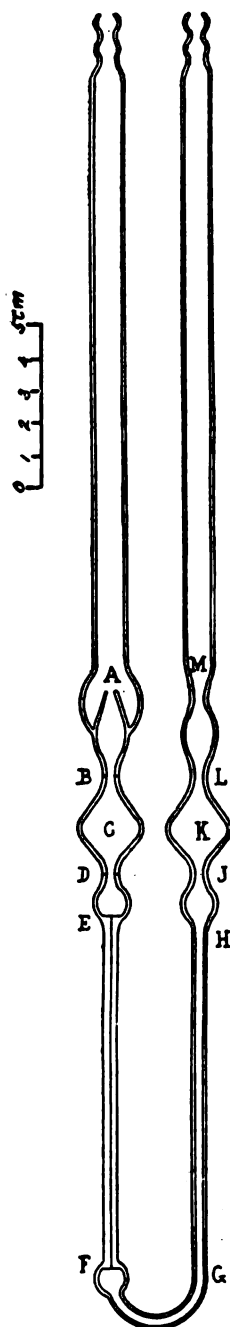

FIG. 1. The Bingham viscometer

of adjusting the working volume, the bulb is already wet before the first run can be made, so that a comparison can not be made between the capacity of the bulb to deliver, and of a dry bulb to receive.

Since the Bingham viscometer is used only where great accuracy is required, and since it is claimed that it is "accurate to a tenth of one per cent,"⁵ an error which might be of no importance in another type of instrument can not be considered as negligible. It is evident that the drainage error will increase with the viscosity, or with the amount of liquid which clings to the walls of the bulb, and the error might be considerable when the instrument is used for testing lubricating oils, with viscosities up to 20 poises and over. Thorpe and Rodger⁶ who used a similar instrument, concluded that for the comparatively fluid liquids with which they had to deal, with a maximum viscosity of 0.14 poise, a cylindrical form of the bulbs was preferable, in order that the contained liquid might the more readily acquire the temperature of the bath, although with spherical bulbs, as used by Ubbelohde, less liquid adheres to the walls. In the Thorpe and Rodger instrument there is a trap on both sides and each bulb is graduated, so that the working volume may be adjusted after the first run to allow for possible evaporation.

Barr⁷ used an Ostwald viscometer for testing glycerin, with a viscosity of 1.26 poise, and remarks,

The viscometer was filled by a pipette, the time of drainage of the pipette necessary for the accuracy sought being determined by experiment.

He does not appear to have considered whether the time of flow of his viscometer was sufficient or not to eliminate drainage error.

The object of this paper is to consider evidence of drainage error in the Bingham viscometer, and to estimate the magnitude of this error, or the time of flow necessary to render it negligible, with a bulb of 4 cubic centimeters capacity. While Bingham

⁵ Proc. A. S. T. M., loc. cit. The effect of the uncertainty in regard to end effects, upon the demonstrable accuracy of the instrument, is considered in the discussion of this paper.

⁶ T. E. Thorpe and J. W. Rodger, *Phil. Trans. R. S.*, 185, part 2, p. 423; 1894.

⁷ Guy Barr, *Reports and Memoranda*, No. 755; *Aeronautical Research Com.*, p. 4; London; 1921.

apparently paid most attention to correctness of average pressure and of working volume, he recognized⁸ the danger of imperfect drainage, for he says:

Our theoretical investigation proves therefore that the bulbs of the viscometer should be as short as convenient, but with a large radius. The constricted portions should be both narrow and short. These objects may be best achieved without sacrificing good drainage, by having each bulb like two filtering funnels placed with their ends together.

2. CALIBRATION OF THE BINGHAM VISCOMETER

In the Bingham viscometer flow is caused by air pressure applied first to one side and then to the other when a check determination is desired. In an ideal instrument the time of flow would be the same in each direction, and there would be no hydrostatic head correction, but this is rarely attained in practice.

The calibration of the instrument has been fully described in B. S. Scientific Paper No. 298, to which the reader is referred for further details than can be given here. The usual assumptions are made that there is no turbulence and that the capillary is very long in proportion to its diameter. Then the coefficient of the kinetic energy correction is equal to

$$C' = \frac{1.12 Q}{8 \pi l} \quad (1)$$

where Q is the volume of the bulb in cubic centimeters, and l is the length of capillary in centimeters.

In the equation

$$h' = \frac{\mu}{2 C \gamma} \left(\frac{1}{t_1} - \frac{1}{t_2} \right) + \frac{C'}{2 C} \left(\frac{1}{t_1^2} - \frac{1}{t_2^2} \right) \quad (2)$$

h' is a constant of the instrument used in correcting for hydrostatic head. t_1 and t_2 are the times of flow in the two directions, and could only be equal if the bulbs were absolutely alike. μ is the viscosity in poises, and γ is the density in grams per cubic centimeter of the calibrating liquid.

Before using equation (2) it is necessary to calculate an approximate value of C from the equation

$$C = \frac{\mu + \frac{C' \gamma}{t}}{p t} \quad (3)$$

⁸ E. C. Bingham, H. I. Schlesinger and A. B. Coleman, Jour. Am. Chem. Soc., 38, p. 32; 1916.

where p is the pressure causing flow, in grams per square centimeter. For this purpose only, p may be taken equal to h = average manometer reading reduced to grams per square centimeter, or centimeters of water column, and then, after h' has been obtained, p and C may be corrected and h' recalculated if necessary.

The absolute viscosity in poises, is calculated from equation (3) in the form

$$\mu = C p t - C' \gamma / t$$

where p is the corrected manometric pressure, and is equal to

$$p = h \pm h' \gamma - K \pm L \quad (5)$$

where h' has the plus sign when t has the lower value, and the minus sign when the flow is in the opposite direction and t is greater. K is a correction due to change in density of water with the temperature and to weight of air in the manometer, and its value depends upon the manometric head and the room temperature, while L is a minor correction due to difference in elevation of the center of the manometer and of the viscometer. Tables for K and L are given in *Scientific Paper* No. 298.⁹

For the instrument used in this work, C' was calculated to be 0.01229 by equation (1) with the approximate values, $Q = 4$ cc and $l = 14.5$ cm. The diameter of capillary was approximately 0.07 cm. The two other instrumental constants, C and h' , were found as shown in Table 1.

The capillary was almost too large to calibrate with water, so that it was necessary to use very low manometric pressures. In some cases the manometer reading of only 11 centimeters was not large in comparison with h' whereas Bingham¹⁰ implies that for the most accurate work the manometer reading should be at least 30 h' . The value of .00000898 was obtained for C four times out of the fifteen tests, and as it agrees fairly well with the average, it was taken as the most probable value. In calculating Table 1, p was found and C calculated separately for each direction of flow, and the values given are the averages of the two values thus obtained.

⁹ For similar tables for use with a mercury manometer, see paper by E. C. Bingham and Henry Green, *Proc. Am. Soc. Test. Mat.*, 19, II, p. 651; 1919.

¹⁰ Bingham, Schlesinger and Coleman, *loc. cit.*, p. 32.

TABLE 1. *Calibration of Bingham viscometer*

Calibrating liquid	Temperature	$C \times 10^6$	h'
	° C		
Distilled water.....	5	886	.95
Distilled water.....	5	920	.88
Distilled water.....	10	889	.93
Distilled water.....	10	919	.87
Distilled water.....	15	898	.94
Distilled water.....	20	899	.93
Distilled water.....	25	898	.94
Distilled water.....	25	898	.83
Distilled water.....	25	909	.87
Distilled water.....	25	904	.87
40% sucrose solution.	25	913	.85
60% sucrose solution.	20	868	.86
60% sucrose solution.	25	896	.87
60% sucrose solution.	30	898	.85
60% sucrose solution.	30	901	.88
Average.....		900	.89

3. USE OF THE BINGHAM VISCOMETER

After h' has been determined, it is not necessary to refer again to equation (2), but p has to be determined for every test, by equation (5), since it varies slightly with the room temperature even if the manometer reading is not changed. The viscosity is then determined from equation (4).

A series of blends were made for use in calibrating technical viscometers, and their viscosities are shown in Table 2.

TABLE 2. *Viscosities of calibrating liquids*

Sample No.	Temperature ° C	Density g/cc	Viscosity Poises
1	20	.854	.1847
	40	.840	.0873
	55	.830	.0559
2	20	.894	.3927
	40	.881	.1573
	55	.871	.0928

TABLE 2 (continued)

Sample No.	Temperature ° C	Density g/cc	Viscosity Poises
3	20	.884	.4702
	40	.871	.1854
	55	.861	.1072
4	20	.874	.603
	40	.860	.2315
	55	.850	.1313
5	20	.909	1.680
	35	.899	.664
	40	.896	.511
	50	.889	.320
	55	.886	.2592
6	20	.875	.872
	40	.861	.3198
	55	.851	.1787
7	10	.970	25.06*
	15	.967	15.89*
	20	.963	10.21*
	23	.961	8.00*
	25	.960	6.84
	30	.956	4.795
	35	.953	3.312
	40	.950	2.338
8	20	.875	1.232
	40	.861	.440
	55	.851	.2395
9	20	.819	.02878
	40	.805	.01860
	55	.794	.01571
10	20	.849	.1232
	40	.835	.0620
	55	.825	.04147
11	20	.859	.2307
	40	.845	.1023
	55	.835	.0638

TABLE 2 (continued)

Sample No.	Temperature ° C	Density g/cc	Viscosity Poises
12	20	.882	.531
	40	.869	.1851
	55	.859	.1064
13	20	.876	.714
	40	.856	.2638
	55	.846	.1466
14	20	.872	1.038
	40	.858	.3691
	55	.848	.2009
	90	.832	.0690
15	20	.887	1.563
	40	.874	.4491
	55	.864	.2211
16	20	.901	1.333
	40	.888	.4175
	55	.878	.2141
17	20	.873	1.266
	40	.859	.4435
	55	.849	.2387
18	20	.911	1.686
	40	.898	.634
	55	.888	.3557
19	20	.911	2.361
	40	.898	.829
	55	.888	.445
	90	.870	.1611
20	20	.882	1.429
	40	.869	.502
	55	.859	.2701
21	20	.926	2.599
	40	.913	.935
	55	.903	.514

TABLE 2 (continued)

Sample No.	Temperature ° C	Density g/cc	Viscosity Poises
22	20	.892	3.20
	40	.879	.951
	55	.869	.4856
23	40	.873	1.325
	55	.863	.639
24	40	.873	1.446
	55	.863	.692
25	40	.873	1.546
	55	.863	.728
	90	.842	.1982
26	40	.878	2.250
	55	.868	1.014
27	40	.881	3.221
	55	.871	1.415
	90	.848	.3360
28	20	.930	6.725
	25	.927	4.215
	30	.923	2.764
	37.8	.918	1.508
	45	.914	.933
	50	.910	.712
	54.4	.907	.554
	60	.904	.4143
	70	.897	.2714
	80	.890	.1790
90	.884	.1236	

Sample No. 5 is a French oil used in standardizing the Barbey viscometer. Sample No. 7 is castor oil, the viscosities marked with an asterisk having been estimated by comparison with another sample. No. 28 is the U oil referred to by Bingham.¹¹ A blown vegetable oil was used in mixing some of the more viscous samples, and the change of viscosity with the temperature is thereby decreased.

¹¹ E. C. Bingham, Bureau of Standards, Tech. Paper No. 204, p. 58; 1922.

4. THE SCOTT VISCOMETER

In previous work of calibrating viscometers¹² use was made of water and ethyl alcohol solutions which are not suitable for instruments with outlet tubes of large diameter, such as are used for determining the viscosity of varnishes or fuel oils. The Scott viscometer was the first of these large tube instruments to be calibrated with liquids whose viscosity had been determined by the Bingham viscometer, and a difficulty experienced in the calibration was ascribed to the drainage error of the Bingham instrument.

The Scott viscometer¹³ is not essentially different from other technical efflux instruments, such as the Saybolt, Engler, and Redwood.

Table 3 gives dimensions of the Scott viscometer, according to the designer, and also gives dimensions of two particular instruments, one as measured by the Bureau of Standards, and the other as reported by the Ordnance Department.

TABLE 3. *Dimensions of Scott viscometers*

Dimension	B. S.	Ord. Dept.	Scott	
	Cm.	cm.	inch	cm.
Diameter of oil container, at top.....		8.66		
Av. diameter of oil container.....	8.738	8.74	3½	8.90
Diameter of outlet tube.....	.275	.267	.108	.274
Diam. of conical valve seat, at top.....	.956	.864		
Length of outlet tube and lower conical flare.....	.628	.686	¾	.953
Length of lower conical flare.....	.05			
Length along axis of conical valve seat... ..	.567			
Depth of upper end of conical valve seat below surface of water with 200 cc of water in container.....	3.47			
Mean diam. of widest part of flare at lower end of outlet tube.....	.385			

¹² Bureau of Standards, Tech. Papers Nos. 100, 112, and 125.

¹³ Proc. Am. Soc. Test. Mat., Vol. 10, p. 117-146, 1910: A. H. Gill, Oil Analysis, p. 164; 1913: Wm. M. Davis, Friction and Lubrication, p. 42; 1904: W. G. Scott, Drugs, Oils and Paints, Vol. 13, p. 50; 1897-8.

According to Scott the outlet tube must be made by using a new No. 35 twist drill, and the time of discharge for 50 cc of water at 60°F (15°.6C) is between 10 and 11 seconds.

There is no filling mark so 200 cc of the liquid to be tested is measured in a graduated cylinder and poured into the container, the cylinder being left 10 or 15 minutes to drain if necessary. The data of table 4 were obtained with oils selected from table 2.

Fig. 2 shows a Higgins diagram¹⁴ calculated from data of Table 4. The graph represents the equation

$$\text{kinematic viscosity} = \frac{\mu}{\gamma} = 0.0178 t - \frac{2.74}{t} \quad (6)$$

but since the outlet tube has a flare at both ends, it is not to be

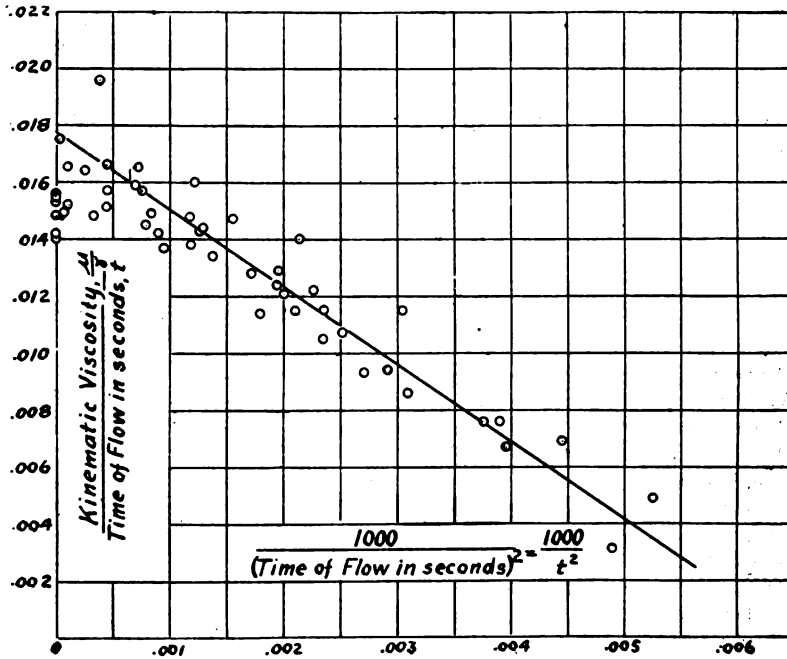

FIG. 2. Higgins diagram for Scott viscometer

expected that two instruments will have exactly the same time of flow or that equation (6) would be of general application. On account of the impossibility of accurately estimating the average

¹⁴ W. F. Higgins, Jour. Soc. Chem. Ind., 32, p. 568, 1913.

diameter of outlet tube, no attempt was made to check equation (6) by a Herschel diagram similar to Fig. 5.

TABLE 4. *Tests of Scott viscometer, B. S. 6452*

Sample No.	Temperature	Time	Sample	Temperature	Time
	° C	Seconds	° C		Seconds
water	15.6	11.2	12	40	19.9
				55	16.3
1	20	20.6	13	40	24.1
	40	15.0		55	18.5
	55	13.8			
2	20	32.2	14	40	29.1
	40	19.2		55	20.6
	55	15.9			
5	20	129.8	15	20	118.1
	35	46.9		40	34.5
	40	36.3		55	21.0
	50	26.9			
	55	22.6			
6	20	51.0	16	40	23.1
	40	25.2		55	21.3
	55	18.4			
7	10	1865.7	17	20	95.4
	15	1139.7		40	35.5
	20	707.8		55	22.7
	23	546.3			
	25	464.8			
	30	320.9			
	35	227.5			
	40	166.3			
11	40	16.0	18	40	46.8
	55	14.3		55	28.0

It will be noted that very viscous oils, giving points at the extreme left of Fig. 2, show too low a value of the ordinate $\frac{\mu}{\gamma t}$. As there was a possibility that this was due to some peculiarity of the laws of flow through so short a tube of variable diameter,

it seemed that this should not be accepted as an indication of drainage error in the Bingham instrument without confirmation.

5. OTHER POSSIBLE CAUSES OF THE LOW VALUES OF $\frac{\mu}{\gamma t}$

Various possible causes for the low values of the ordinates of Fig. 2, at very high viscosities, seemed worthy of consideration. The error could not be due to the contraction of the oil after leaving the outlet tube of the Scott viscometer, because the error is most marked when tests are run at temperatures lower than room temperature. A drainage error in the Scott viscometer would lower the average head, increase t and thus decrease the ordinate, but it seemed unlikely that the error would be appreciable in an instrument having such a large, shallow container. The tests for drainage error were therefore made on a Saybolt Universal viscometer tube.

After making a run in the usual way, vacuum was quickly applied to the bottom of the outlet tube to draw out all the oil except that clinging to the walls. The maximum film thickness, calculated from the difference in weight of the dry and wet container, was 0.011 centimeter, with an oil of 5000 seconds viscosity. Further tests were made by filling the container to the level reached at the end of a normal run, 8.8 cm below the overflow rim, and applying a vacuum as before. The results showed that only 8 per cent of the oil which adhered to the walls in the first series of tests, was above the 8.8 centimeter level, so that the average film thickness on the walls exposed during a normal run would be only 0.0009 centimeter. Although this value does not strictly apply to the Scott viscometer, it seems safe to regard the film thickness as inappreciable in comparison with the 9 centimeter diameter of this instrument.

6. INDICATIONS OF DRAINAGE ERROR OF BINGHAM INSTRUMENT BY COMPARISON WITH SAYBOLT AND REDWOOD VISCOMETERS

Figs. 3 and 4 show calibration diagrams for Saybolt Universal viscometer No. 109. Fig. 3, like Fig. 2, shows too low an ordinate at high viscosities, while in Fig. 4 values of the abscissas near the

bottom of the graph are too large. Figs. 5 to 7 show Higgins diagrams for the Redwood No. 1, Redwood Admiralty, and Saybolt Furol viscometers, respectively. It will be noted that they all show the same signs of drainage error in the Bingham instrument, or some cause producing the same effect, so that it may be concluded that the evidence noted in Fig. 2 is not due to any peculiarity of the Scott viscometer.

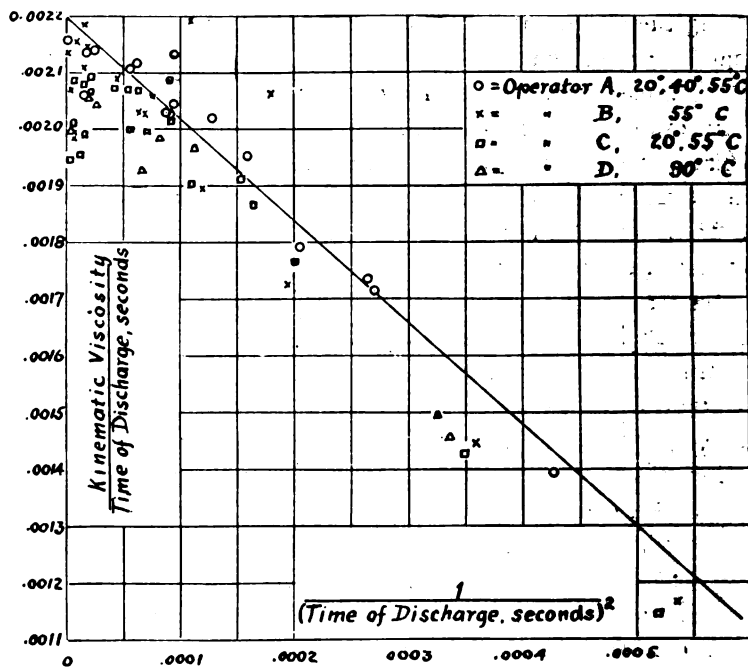

FIG. 3. Higgins diagram for Saybolt Universal viscometer No. 109

Fig. 8 shows another method of indicating the drainage error and was suggested by a diagram of Higgins.¹⁵ The upper graph, from the work of Higgins, shows the relation between the time of flow of the Redwood viscometer and the kinematic viscosities obtained with a viscometer similar to that used by Thorpe and Rodger. The lower graph shows results obtained in calibrating

¹⁵ W. F. Higgins, *Collected Researches, National Physical Laboratory, 11*, p. 12: 1914.

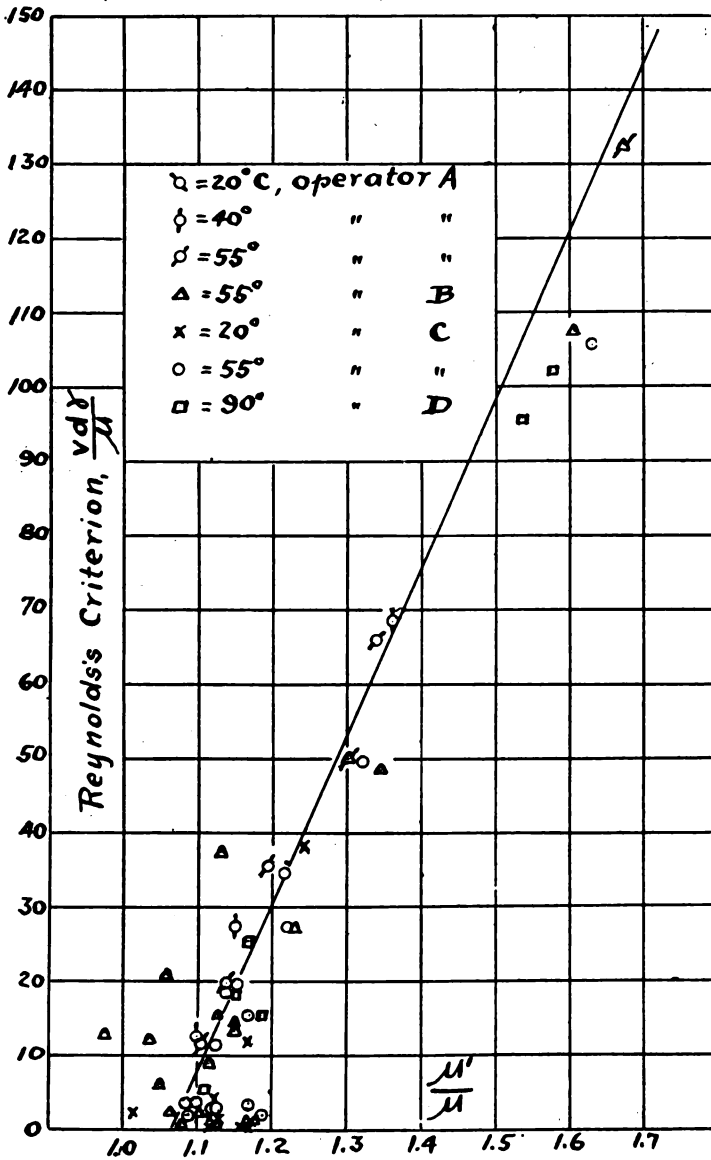

FIG. 4. Herschel diagram for Saybolt Universal viscometer No. 109

the Redwood viscometer at the Bureau of Standards,¹⁶ the kinematic viscosities being obtained by an instrument of the Bingham type. The curve at the lower end of the graph is due to kinetic energy, but the rest of the graph should be straight, since the equa-

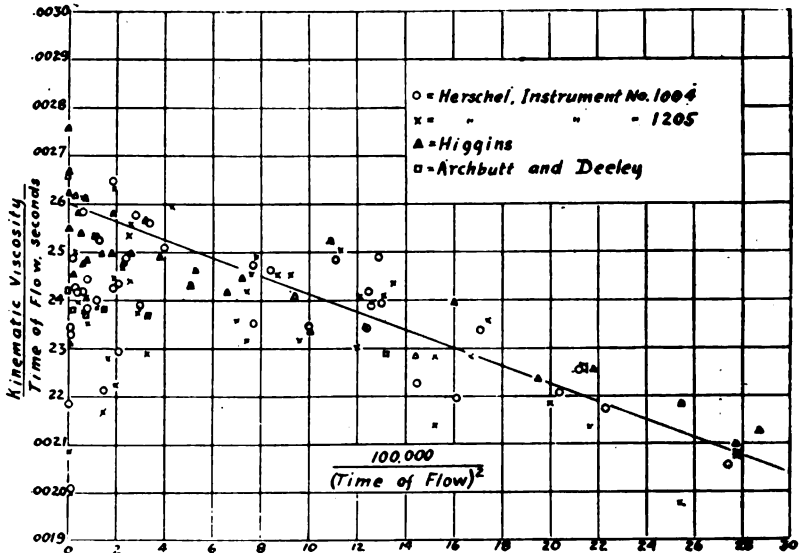

FIG. 5. Higgins diagram for Redwood viscometer

tion for the Redwood viscometer is of the same form as equation (6). The upper part of the line from Higgins tests is straight, but the lower line bends downward at the upper end. This difference in the two lines shows that the drainage error of Higgins's instrument with cylindrical bulbs, is less than the drainage error due to the specially shaped bulb in the Bingham instrument.

7. CALIBRATION OF BULB OF BINGHAM INSTRUMENT BY OILS OF VARIOUS VISCOSITIES

In order to get a more direct and accurate measurement of the drainage error, a special jacketed pipette was built with a bulb of the same size and shape as in the Bingham viscometer used in the work above recorded. There was no capillary and the rate of dis-

¹⁶ Winslow H. Herschel, B. S. Technologic Paper No. 210; 1922.

charge could be regulated by a stop cock. The volume discharged could be readily determined from the density of the oil and the weight discharged.

Since the viscosity, by equation (4), is proportional to C, or inversely proportional to the volume discharged, the true viscosity will be to the apparent viscosity (as calculated from a value of C

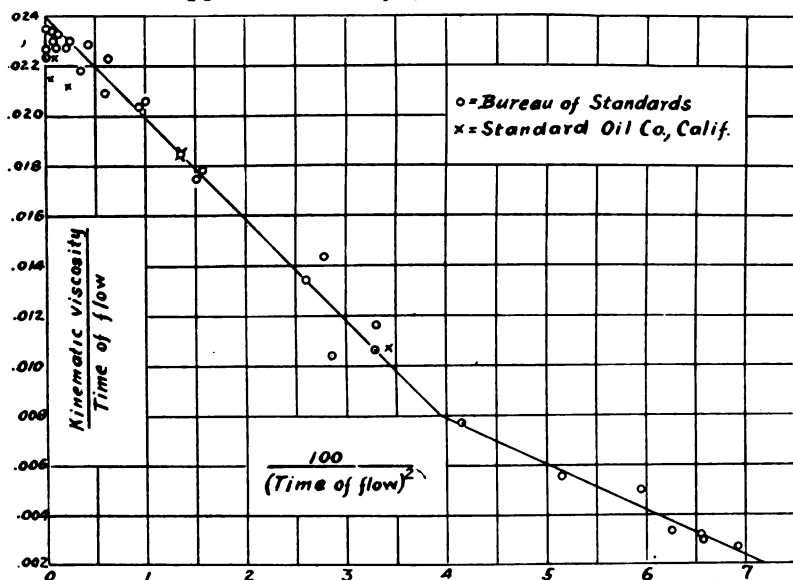

FIG. 6. Higgins diagram for Redwood viscometer, Admiralty type

determined by calibration with water) as the volume of water discharged from the bulb is to the volume of oil. The capacity of the bulb when calibrated with water was 4.232 cubic centimeters.

Table 5 gives results of calibration of the bulb with oils of various viscosities, the correction factor being the ratio of capacity of the bulb to discharge water and oil.

Fig. 9, from data of table 5, may be used in estimating the drainage error in a given test, or in selecting a time of flow so that the error will be negligible. The numbers on points indicate the correction factors, and lines of equal factors have been drawn. Data has been added from the work of Bingham and Young¹⁷

¹⁷ E. C. Bingham and H. L. Young, paper presented before the Birmingham, Ala., meeting, A. C. S.; April, 1922.

TABLE 5. Factors to correct for drainage error of Bingham viscometer

Corrected viscosity	Time	Factor	Time	Factor	Time	Factor	Time	Factor	Time	Factor
Poises	Sec.		Sec.		Sec.		Sec.		Sec.	
.1278	463	1.000								
.242	58	1.003	255	1.000						
.430	80	1.005	312	1.001	900	1.000				
.722	87	1.007	400	1.000						
1.247	103	1.012	240	1.007	420	1.000				
2.140	150	1.015	212	1.010	585	1.007	1524	1.003		
3.642	296	1.012	600	1.011	1280	1.007	1070	1.009	2332	1.005
6.473	300	1.013	420	1.012	1181	1.007				
9.560	343	1.018	846	1.010	1491	1.008				
12.160	744	1.015	1168	1.011	1680	1.010	2862	1.006		
17.960	728	1.019	1351	1.012	2700	1.010				

showing a somewhat smaller drainage error, due it is believed to the use of a larger bulb.

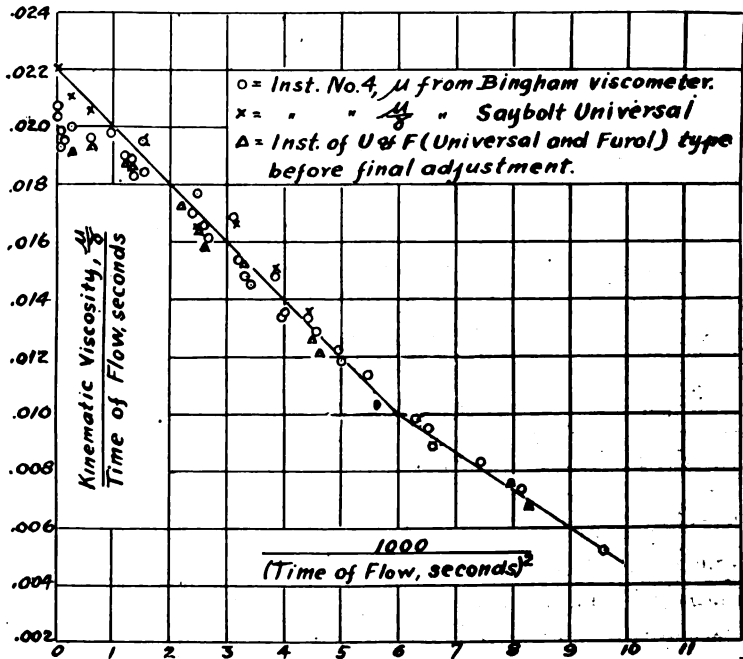

FIG. 7. Higgins diagram for Saybolt Furol viscometer

8. METHODS OF AVOIDING DRAINAGE ERROR

Drainage error may be avoided by using torsional viscometers; but these instruments are outside the scope of this paper. In the Lidstone viscometer, previously referred to, the liquid to be tested rests upon mercury, and the separation of the two liquids would

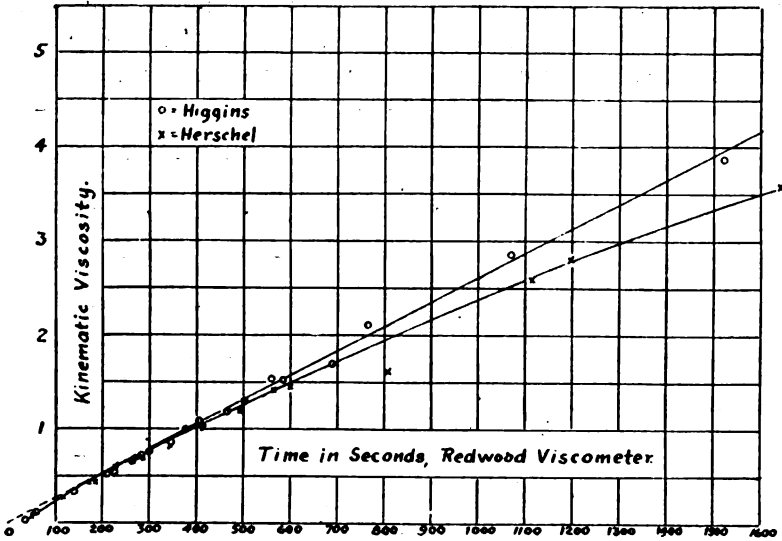

FIG. 8. Relation of kinematic viscosity to time of flow of Redwood viscometer

apparently offer considerable difficulty. In technical instruments for oil, of which the Saybolt Universal and Furol may be taken as examples, there is no drainage error, but there is another error, due to the contraction of the oil after it leaves the outlet tube, which may be called the cooling error. Barbey avoids both the drainage and the cooling errors by using a constant hydrostatic head, and running a test for the constant time of ten minutes. The receiving flask is heated in the bath to the nominal temperature of test, before reading of the volume discharged is taken, and results are expressed as "fluidity" or the rate of discharge in cubic centimeters per hour.

Bingham¹⁸ suggests that the drainage error may be avoided in his instrument if the flow begins in the neighborhood of the trap

¹⁸ E. C. Bingham, Fluidity and Plasticity, p. 66; 1922.

opening, for then a certain amount of liquid may flow into the measuring bulb after the record of time has begun, and this will tend to offset the effect of any liquid left in the bulb at the end of the time of flow.

The Ubbelohde form of Ostwald instrument has, as ordinarily used, the disadvantage that it is necessary to refill it before running a check test, but there is no drainage error. This advantage and that of ease in running a retest may both be retained by the

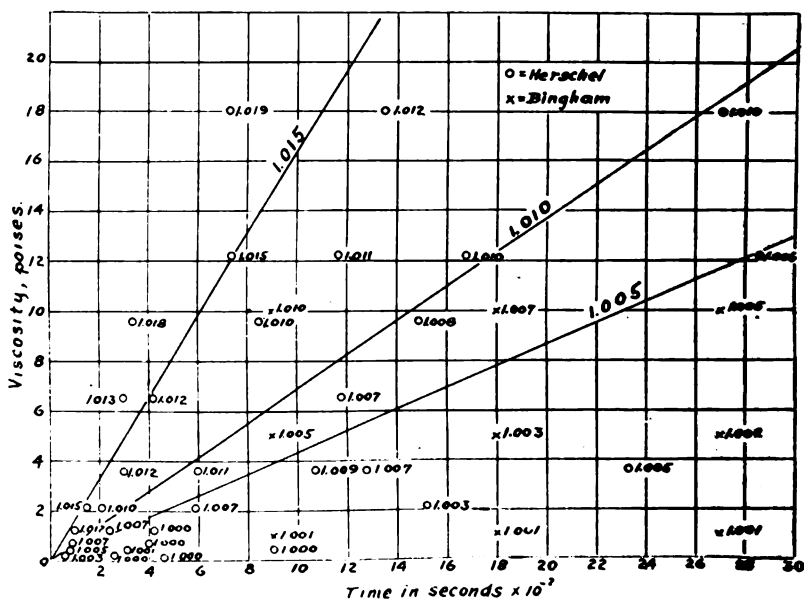

FIG. 9. Correction factors for Bingham viscometer

following slight changes. Referring to Fig. 1, graduate bulb K with marks similar to B and D. Fill from A to H, keeping the bulb K dry, and empty the trap. Apply air pressure on the left limb and make the first run into the dry bulb. Apply air pressure on the right limb and make the second run into bulb C which will be wet, and the third run will be into bulb K which will also be wet. The difference in the time for the first and third runs will be due to drainage error.

It should be noted that there is normally a difference in time between a run from left to right and one from right to left, so that

the difference in time between the first and second runs would not usually be due entirely to the drainage error. The drainage error could however be calculated as the per cent difference between the viscosities as calculated from the first and second runs, the instrumental constant h' allowing for the difference in time of flow in the two directions when the volume is measured both times in a wet bulb.

9. CONCLUSIONS

1. The drainage error is negligible only for comparatively light oils when a sufficiently long time is taken for the discharge. A diagram is given to show the relation between viscosity, time of flow and per cent drainage error.

2. The drainage error may be avoided by having the trap on the opposite limb from the bulb which measures the volume discharged.

APPENDIX. COMPARISON OF VISCOSITIES AS OBTAINED BY THE SCOTT VISCOMETER, AND BY THE PLUMMET METHOD OF BASSECHES¹⁹

The investigation to be described was undertaken in the hope of explaining the difficulty in calibrating the Scott viscometer, afterwards shown to be due to drainage error of the Bingham instrument used in determining the viscosity of the calibrating liquids. While the results are somewhat discordant, this may be attributed largely to the rapid change of viscosity with the temperature in the case of such highly viscous substances. Even with lubricating oils, an error of one per cent in viscosity, will be caused by an error of 0.2 to 0.1°C, depending upon the viscosity and upon the source of the crude oil.

While the tests were inconclusive as far as proving or disproving that there was a serious drainage error in the Bingham instrument, it is believed that a description of the Basseches method will be of interest since this method seems to be unsurpassed as a very rapid though approximate method of measuring the consistency of very viscous or plastic substances.

Basseches method is as follows. The liquid or soft plastic substance to be tested is placed in a shallow dish on a stand under a

¹⁹ Based upon unpublished manuscript of J. L. Basseches, formerly of the Bureau of Standards.

plummet hung from the arm of a chemical balance the beam of which can be lifted. The plummet is of cylindrical shape with a conical base, the juncture of cylinder and cone forming the line to which the plummet is immersed by raising the stand. The beam is then lifted and if necessary the stand is readjusted so that the pointer comes to the first division on the right end of the scale. A weight is placed on the pan of the balance, causing the plummet to be pulled out of the material under test, and the time required for the pointer to traverse five scale divisions is taken by means of a stop watch. The pan also contains the counter-poise for the plummet. As will appear later, this operation must be repeated with a different weight on the pan, in order to find both of the numerical values determined by the test.

It will be assumed that two properties or groups of properties are to be measured, one of which, viscosity, causes a resistance in proportion to the velocity, or inversely as the time, while the second group of properties causes a resistance which is independent of the velocity. Let W_v be that portion of the weight required to overcome viscosity, and W_s the portion required to overcome the constant resistance. Then

$$W = W_v + W_s \quad (7)$$

Basseches regarded W_s as a measure of surface tension only, believing that the "yield value" of plastic materials is only a form of surface tension manifested in the adsorbed liquid films on the surfaces of the solid particles. Without attempting to decide this matter, W_s will be considered here as a measure of all other resistances than viscosity, which may include surface tension, yield value and friction of the balance. Part of the weight must also be expended in lifting the film which adheres to the plummet.

If all the weight were exerted in overcoming viscosity, t would be inversely proportional to W , or for two trials,

$$W_1 t_1 = W_2 t_2 = \text{constant} = V \quad (8)$$

where W_1 and W_2 are the weights used in the two trials, and t_1 and t_2 are the corresponding times, the units employed being grams and seconds. But since surface tension, or some similar resistance must also be overcome, the net weight expended in overcoming

viscosity, and which must be inserted in equation (8) is $W - W_s$, so that the equation becomes

$$(W_1 - W_s) t_1 = (W_2 - W_s) t_2 = V \quad (9)$$

from which

$$W_s = \frac{W_2 t_2 - W_1 t_1}{t_2 - t_1} \quad (10)$$

After W_s has been found from equation (10), V may be found from equation (9).

Two terms which are used to indicate the consistency of printing inks are "tack" or "tackiness" and "length" and Basseches proposed that VW_s should be used as a measure of the former, and $\frac{V}{W_s}$ as a measure of the latter.

Since V is proportional to the viscosity in poises, if the liquid is truly viscous, this method may be used to determine viscosity if the plummet is calibrated with a liquid of known viscosity. If μ is the viscosity of the calibrating liquid in poises, then

$$\mu = KV \quad (11)$$

where K is an instrumental constant.

For example a sample of sodium silicate gave the following results at 22°C (71.°6F) using the 3 centimeter plummet.

W in grams	t in seconds
1.874	6.0
1.904	5.0

Then $W_s = \frac{11.244 - 9.520}{1.0} = 1.724$ and by equation (9), $V = 0.90$.

Since under the same conditions castor oil gave $W_s = 0.88$ and $V = 0.78$, and since the viscosity of castor oil at 22°C is about 8.34 poises, from equation (11), $K = \frac{8.34}{0.78} = 10.7$

In a comparison of the plummet method using another sized plummet, with the Scott viscometer, and with the falling ball method,²⁰ the results were obtained as shown in Table 6 and Fig. 10.

²⁰ S. E. Sheppard, Jour. Ind. and Eng. Chem., 9, p. 523; 1917; W. H. Gibson and L. M. Jacobs, Jour. Chem. Soc. London, p. 473; May, 1920.

The viscosity by plummet was calculated from equation (11) using a value of 65.7 for K as obtained with blown rape seed oil at 30°C.

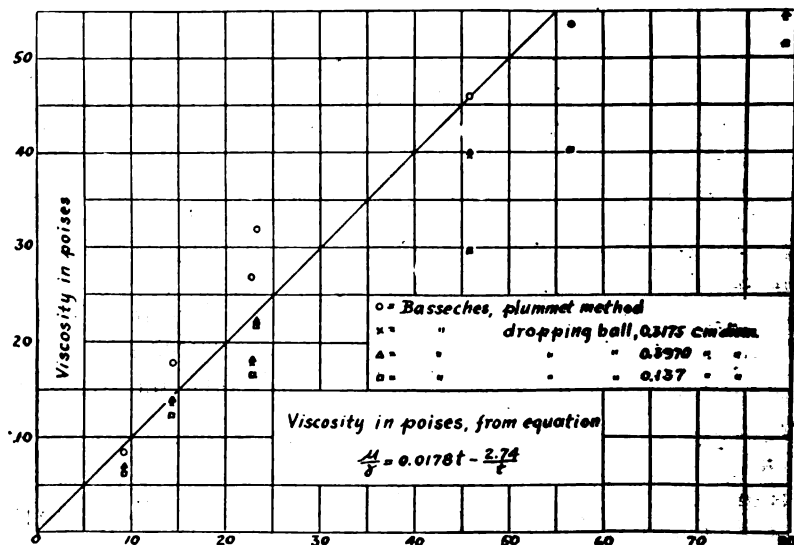

FIG. 10. Comparison of different methods of measuring viscosity

TABLE 6. Comparison of different methods of measuring viscosity

Liquid	Temp.	Basseches					Herschel Viscosity in poises by equation (6)
		V	Absolute viscosity, poises.				
			Plummet	Dropping ball of diameter in cm.			
				.3175	.3970	.137	
	° C	Sec/g					
Castor oil	23	.128	8.4	6.7	6.9	6.3	9.3
Burnt litho No. 1 . . .	30	.270	17.7	13.5	13.8	12.3	14.4
Burnt litho No. 1 . . .	23	.408	26.8	17.9	18.1	16.5	22.7
Rosin oil	30	.487	31.9	22.2	22.3	21.8	23.3
Blown rape	30	.698	45.8	39.6	39.9	39.6	45.8
Rosin oil	23	.817	53.6	38.4	37.9	40.3	56.6
Blown rape	23	1.15	75.5	54.2	54.6	51.4	78.9
Half tone varnish . . .	23	5.00	328.0				

BUREAU OF STANDARDS, WASHINGTON, D. C.

SPECIFICATIONS FOR BOURDON TUBE PRESSURE
GAGES FOR AIR, STEAM, AND WATER
PRESSURES, AND FOR USE AS
REFERENCE STANDARDS

BY
FREDERICK J. SCHLINK

This constitutes the second and concluding installment of specifications for recording thermometers and pressure gages begun in the September number of this JOURNAL. The specifications now presented cover pressure gages for ordinary service, and those for reference or test purposes. It is found desirable to differentiate the construction and accuracy requirements of these two types of gages in a number of respects, though common commercial practice has been to make the difference between them mainly a matter of richer appearance and of more detailed individual marking of graduations in the case of reference or test gages.

The other more important differences from common practice in these specifications are itemized in the introductory note preceding the first installment of the specifications, in the September number of this JOURNAL, to which reference should be made also for information as to the practicability and the use hitherto made of these specifications, the rationale of the statement of tolerance adopted, and the rather surprising precision that may be expected of good Bourdon tube gages under controlled conditions of use.

SPECIFICATIONS FOR BOURDON SINGLE TUBE
PRESSURE GAGES FOR STATIONARY
SERVICE: AIR, STEAM, WATER

1. GENERAL

a. *Size.* The gage diameter as given in the order will be construed to refer to the available or effective diameter, that is, in the usual case, the smallest diameter of the bezel ring.

b. *Capacity.* The limit of graduation or capacity referred to in the order is the actual maximum working limit of operation of the gages, and the construction shall be of such rigidity and the parts so stressed, as to carry pressures approximating but

not exceeding the capacity pressure named, for an indefinite period if necessary, without permanent set beyond the limits of the tolerance hereinafter provided.

c. *Minimum Graduation.* The minimum graduation as called for in the order will require that at all parts of the graduated scale, the pressure equivalent of a single graduation interval shall be the same, and will be construed to prohibit the anomalous number and arrangement of graduations commonly and erroneously provided on pressure gages between the zero graduation and the first major graduation; provided, however, that the omission of all intermediate graduations between the zero and the first major graduation will be permitted; for example, in the case of a gage marked from zero to 80 lbs. by 1 lb., intermediate graduations between the zero and the 5 lb. graduation may be omitted at the option of the supplier.

d. *Marking.* Each gage shall bear the name of the actual manufacturer and a distinctive serial number, the latter to be legibly stamped, engraved or etched either upon the dial or the case flange, preferably the former.

e. *Items not Supplied.* The maker is not to supply gage cocks, nipples, or siphons.

f. *Delayed Rejection.* In case it is found expedient not to remove the dials and pointers of new gages at the time of the acceptance test, the purchaser reserves the right to return such gages at any later time for correction in case internal defects of such character are found as to make it certain that defective construction or workmanship existed in the gages at the time of delivery.

g. *Transportation Costs on Rejected Gages.* All costs of transportation on gages rejected for non-compliance with these specifications shall be borne by the supplier.

2. MECHANICAL CONSTRUCTION

a. *General.* These gages shall be of the bottom-connected type, of single-tube construction, with accurately cut and finished segmental gear and pinion. The linkwork shall be so arranged as to permit of general adjustment to correct multiplication and a secondary adjustment to correct for angularity of the linkwork connections.

b. *Mounting.* The mounting of the Bourdon tube and pointer mechanism is to be a single unit rigidly secured to the case. On gages of 500 lb. per sq. in. capacity or over, solder shall be employed only to secure tightness of joint.

c. *Permanence.* The materials and construction of these gages shall be such that a reasonable permanence of the initial adjustment will be maintained in service; gages which show any considerable secular change of the zero upon being placed in normal service or when given a reasonable oscillatory-pressure test within their rated capacity, will be returned for replacement. The materials are to be such that no corrosion interfering with the appearance or accuracy of the gage will occur in ordinary service.

d. *Linkwork—General.* Connections in the linkwork shall be either of the fork-and-pin type or shall consist of shouldered screws seated solidly in the members to which they are affixed. The length of the segmental gear and the properties of other elements of the movement, including the length of the hair-spring, shall be such that the pointer, in case of accidental overload, may move to the extent of 100% of the total graduated arc above the upper limit of graduation, and to the extent of 50% of the total graduated arc below the zero graduation, without in either case causing disengagement of the segmental gear and the pointer pinion.

e. *Links.* The connecting links used in the movement shall in no case be less than .05 in. in thickness, and bending of these links flatwise in order to obtain adjustment of the gage shall not be permitted.

f. *Gearing.* The segmental gear and pinion shall have working faces not less than .09 in. in width.

g. *Fit and Finish.* All spindles and bearings are to be neatly and accurately fitted, and excessive side or end shake will be deemed sufficient cause for rejection. The surface of the pointer spindle upon which the pointer is applied shall be smoothly finished and true in order that in adjusting the gage the pointer may be readily set in the exact position desired.

h. *Hair-Spring.* These gages shall be equipped with the usual hair-spring to minimize the backlash error, this hair-spring to be of a non-rusting alloy. It shall be so tensioned that at any reading of the pointer on the dial, it will be effective in eliminating backlash by turning the pointer pinion into contact with the mating gear teeth. The coils of the hair-spring must not at any position of the pointer within the interval of graduation, be in contact with other coils or with the parts of the gage itself except at the points where the spring is secured to the movement frame and to the pointer spindle respectively.

i. *Holes for Mounting.* The mounting flange shall have three uniformly spaced holes for attaching the gage to its support, one hole to be located at the top of the gage diametrically opposite to the pipe connection.

j. *Glass and Bezel.* The cover glasses shall be clear and free from visible blemishes; the means of securing glass in bezel and bezel to case shall be such that the case will be substantially dust tight.

k. *Type of Case.* These gages shall be supplied in flanged iron case with nickel-plated close bezel ring without ogee flare¹ (similar to figure —, page —, — Co's. Bulletin.—)

3. POINTER, DIAL, AND GRADUATIONS

a. *Range of Graduation.* The total range of graduation shall cover an angular interval of not less than 270 degrees.

b. *Graduations—General.* The dials shall be of nicked or silvered metal, with permanent black graduations, deeply incised; numerals to be neat, simple in outline, disposed horizontally and entirely within the circle of graduations. The minor graduations shall not be less than .01 inch nor more than .02 in. in width. The major graduations shall not be less than two nor more than three times as wide as the minor graduations. The major graduations shall be suitably distinguished also by an increase in length over the minor graduations.

c. *Length of Graduations.* The length of the minor graduation lines, or the difference between the radii of the outside and inside graduation circles, shall not exceed the mean graduation interval; that is to say, the radial length of the minor graduation lines shall not exceed the mean center to center interval between these lines.

d. *Diameter of Outside Circle.* The diameter of the outside graduation circle of the dial shall not be less than 90% of the smallest diameter of the bezel ring, referred to in specification a, Section 1.

e. *Attachment of Dial.* The dial screws shall fit the holes in the dial accurately, with a diametral clearance not exceeding .005 in. and they shall also be snugly fitted as to their threads so that they may not be readily jarred loose by vibration. The

¹ This requirement relating to appearance only, is subject to modification to meet individual taste or the need of uniformity with other equipment.

manner of attaching the dial to the gage is to be such that it will be securely and permanently affixed.

f. *Pointer Clearance.* The pointer shall be so pivoted as to travel parallel to the dial, and the clearance between pointer and dial shall be not less than .03 in. and not greater than .09 in. at any point of the graduated scale.

g. *Shape and Length of Pointer.* The pointer shall be symmetrical about its longitudinal axis, shall be of neat appearance, and slender and sharp as to its index end. Its length shall be such that the index end will not entirely cross both circles limiting the graduation lines but will stop somewhat short of the outer circle, in order that, when desired, fractional intervals can be estimated.

h. *Stop Pins Omitted.* The gages furnished on this order are to be without zero stop pins.

4. ACCURACY

a. *Test Cycle—Tolerance.* These gages shall be calibrated and adjusted at a temperature of 80 deg. F.² approximately. The tolerance to be allowed in excess or deficiency shall not exceed one-half of one of the minimum graduations, as specified in the order, at any point within the range of graduation. The foregoing allowance of error is to include that due to friction and imperfect elasticity, the test being carried out, at the purchaser's option, without tapping or jarring the gage. The test to be performed will consist of a cyclic calibration through a range from zero to the upper limit of graduation and back to zero. Before the acceptance calibration is begun, the gage may be subjected to a pressure 25% in excess of its rated capacity, for a period not to exceed one hour, followed by a rest period not to exceed one-half hour.

SPECIFICATIONS FOR BOURDON TUBE PRESSURE GAGES TO BE USED AS REFERENCE STANDARDS FOR TEST PURPOSES

1. GENERAL

a. *Size.* The gage diameter as given in the order will be construed to refer to the available or effective diameter, that is, in the usual case, the smallest diameter of the bezel ring.

b. *Capacity.* The limit of graduation or capacity referred to in the order is the actual maximum working limit of operation of the gages and the construction shall be of such rigidity and the parts so stressed, as to carry pressures approximating but not exceeding the capacity pressure named, for an indefinite period if necessary, without permanent set beyond the limit set by the tolerance hereinafter provided.

c. *Marking.* Each gage shall bear the name of the actual manufacturer and a distinctive serial number, the latter to be legibly stamped, engraved, or etched upon the dial. The units in which and the temperature at which the gage is calibrated shall be clearly marked upon the dial in the following form: . lb. per sq. in. at 80° F.

d. *Items not supplied.* The maker is not to supply gage cocks, nipples, or siphons.

e. *Transportation costs on rejected gages.* All costs of transportation on gages rejected for non-compliance with these specifications shall be borne by the supplier.

2. MECHANICAL CONSTRUCTION

a. *General.* These gages shall be of the bottom-connected type, of single-tube construction, with accurately cut and finished segmental gear and pinion. The link-

work shall be so arranged as to permit of general adjustment to correct multiplication and a secondary adjustment to correct for angularity of the linkwork connections. In the gages as delivered, there shall remain not less than one fourth of the adjustment interval on each of the two adjustments referred to in this specification, to provide for carrying out readily such subsequent adjustments as may be required during the life of the instrument.

b. *Mounting.* The mounting of the Bourdon tube and pointer mechanism is to be a single unit rigidly secured to the case. On gages of 500 lb. per sq. in. capacity or over, solder shall be employed only to secure tightness of joint.

c. *Permanence.* The materials and construction of these gages shall be such that a reasonable permanencè of the initial adjustment will be maintained in service; gages which show any considerable secular change of the zero upon being put into use or when given a reasonable oscillatory-pressure test within their rated capacity, will be returned for replacement.

d. *Linkwork-General.* Connections in the linkwork shall be either of the fork-and-pin type or shall consist of shouldered screws seated solidly in the members to which they are affixed. Smaller diameters and bearing lengths of spindles than those employed in the usual service gages are desired in these test gages since the conditions of service favor a much lower rate of depreciation, due to the less severe usage and handling than in the case of ordinary pressure gages. The segmental gear and pinion shall have a minimum working face consistent with reasonable durability, not less than .04 in. and not more than 0.10 in. The length of the segmental gear and the properties of other elements of the movement, including the length of the hair-spring, shall be such that the pointer, in case of accidental overload, may move to the extent of 50% of the total graduated arc above the upper limit of graduation, and to the extent of 25% of the total graduated arc below the zero graduation, without in either case causing disengagement of the segmental gear and the pointer pinion.

e. *Links.* The connecting links used in the movement shall in no case be less than .05 in. in thickness, and bending of these links flatwise in order to obtain adjustment of the gage shall not be permitted.

f. *Fit and Finish.* All spindles and bearings are to be neatly and accurately fitted, and excessive side or end shake will be deemed sufficient cause for rejection. The surface of the pointer spindle upon which the pointer is applied shall be smoothly finished and true, in order that in adjusting the gage the pointer may be readily set in the exact position desired.

g. *Hair-Spring.* These gages shall be equipped with the usual hair-spring to minimize the backlash error, this hair-spring to be of a non-rusting alloy. It shall be so tensioned that at any reading of the pointer on the dial, it will be effective in eliminating backlash by turning the pointer pinion into contact with the mating gear teeth. The coils of the hair-spring shall lie substantially in a plane and must not at any position of the pointer within the interval of graduation, be in contact with other coils or with the parts of the gage itself except at the points where the spring is secured to the movement frame and to the pointer spindle respectively.

h. *Glass and Bezel.* The cover glasses shall be clear and free from visible blemishes; the means of securing glass in bezel and bezel to case shall be such that the case will be substantially dust tight.

i. *Type of Case.* No special details of case design are required, but the screw bezel construction will be given preference. Either brass or iron cases will be accept-

able, but in any event the finish is to be of the best quality, with smooth surfaces, well japanned if of iron, and of neat appearance throughout. A narrow bezel ring without flare is preferred, and the glass should lie as close to the pointer as practicable.

3. POINTER, DIAL, AND GRADUATIONS

a. *Arc of Graduation.* The total range of graduation shall cover an angular interval of not less than 270° .

b. *Graduations—General.* The dials shall be of nicked or silvered metal, with permanent black graduations, cleanly incised; numerals to be neat, simple in outline, disposed horizontally and entirely within the circle of graduations. The surface finish of the dial shall be such that clear marks and graduations can be made upon it with an ordinary lead pencil and that such marks can be easily erased if necessary. The graduations are not to exceed .01 in. in width and the major graduations shall be distinguished from the minor graduations not by an increase in width of line but by moderate extension of their length alone. The emphasizing and numbering of the graduations shall be upon a decimal basis and the fifth and tenth graduations rather than the second or fourth shall be emphasized.

c. *Length of Graduations.* The length of the minor graduation lines, that is, the difference between the radii of the outside and inside graduation circles, shall not exceed the mean graduation interval; that is to say, the radial length of the minor graduation lines shall not exceed the mean center to center interval between these lines.

d. *Diameter of Outside Circle.* The diameter of the outside graduation circle of the dial shall not be less than 90% of the smallest diameter of the bezel ring, referred to in specification a, Section 1.

e. *Attachment of Dial.* The dial shall be attached to the case or movement in such manner as to be securely and definitely fixed in position, independently of the friction under the heads of the holding-down screws, its accurate and permanent centering being assured either by accuracy of fit of the holding-down screws or by dowel pins.

f. *Pointer Clearance.* The pointer shall be so pivoted as to travel parallel to the dial, and the clearance between pointer and dial shall be not less than .03 in. and not greater than .05 in. at any point of the graduated scale.

g. *Shape and Length of Pointer.* The pointer shall be symmetrical about its longitudinal axis, shall be of simple design and neat appearance, and slender and sharp as to its index end. Its length shall be such that the index end will not entirely cross both circles limiting the graduation lines but will stop somewhat short of the outer circle, in order that when desired, fractional intervals can be estimated.

h. *Stop Pins Omitted.* The gages furnished on this order are to be without zero stop pins either on the dial or within the case, except that a special locking device capable of being disengaged at will may be provided in order to secure the gage against damage due to the shocks incident to shipment and handling.

4. ACCURACY

Test Cycle—Tolerance. These gages shall be calibrated and adjusted at a temperature of 80°F. ² approximately, the naming of this temperature being necessary in

² Subject to variation to suit special requirements.

order to give definiteness to the meaning of the tolerance of error below. The tolerance to be allowed in excess or deficiency on the gages as delivered, shall not exceed one-fourth of one of the minimum graduations as specified in the order,—at any point within the range of graduation. The foregoing allowance of error is to include that due to friction and imperfect elasticity, the test being carried out, at the purchaser's option, without tapping or jarring the gage. The test to be performed will consist of a cyclic calibration through a range from zero to the upper limit of graduation and back to zero. Before the acceptance calibration is begun, the gage may be subjected to a pressure 15% in excess of its rated capacity, for a period not to exceed one hour, followed by a rest period not to exceed one-half hour.

AMERICAN ENGINEERING STANDARDS COMMITTEE,
29 W. 39TH ST., NEW YORK CITY.

A METHOD OF MAINTAINING SMALL OBJECTS AT
ANY TEMPERATURE BETWEEN -180°C
AND $+20^{\circ}\text{C}$

BY
P. P. CIOFFI AND L. S. TAYLOR

In the determination of the crystal structure of solid mercury by X-Ray analysis,¹ difficulty was encountered in the formation of ice, condensed from the atmosphere around the tube containing the mercury. Since the presence of the atmosphere was not otherwise objectionable, a method was devised which may readily be adapted to any small object within the temperature range between -180°C and $+20^{\circ}\text{C}$, by which the temperature may be maintained constant for many hours to within about 4° . The method consists in surrounding the object to be cooled by a stream of cold dry air, while keeping any surfaces exposed to the free atmosphere above 0°C .

The cold dry air is obtained by evaporating liquid air in a Dewar flask (Fig. 1) by an electric heater immersed therein. The cold air is forced by the pressure thus created past the substance under examination through a vacuum heat-insulated delivery tube. The design of the delivery tube may be varied widely depending upon the nature of the problem. If visual observation is not necessary, the whole delivery tube may be of silvered glass, and may extend beyond the point where the measurements are taken, thus minimizing the expenditure of liquid air. Where visual observation is necessary or where, as in the case of X-Ray analysis no crystalline material other than the substance being analyzed can be permitted to be in the X-Ray beam, the part of the delivery tube surrounding the substance may be of clear glass. To reduce X-Ray absorption, the walls of the tube in the path of the beam should be pyrex or borosilicate glass drawn very thin. Absorption may be reduced still further if the sample is small and

¹ L. W. McKeehan and P. P. Cioffi. *Phys. Rev.* (2), 19, 444-446; 1922.

of streamline shape, by placing it just beyond the open end of the delivery tube. It is necessary that the cold air be conveyed across the substance as an unbroken stream, without mixing with the surrounding air, which is relatively warm and moist. The necessary conditions can be maintained for several diameters of the delivery tube beyond its open end by placing at this distance

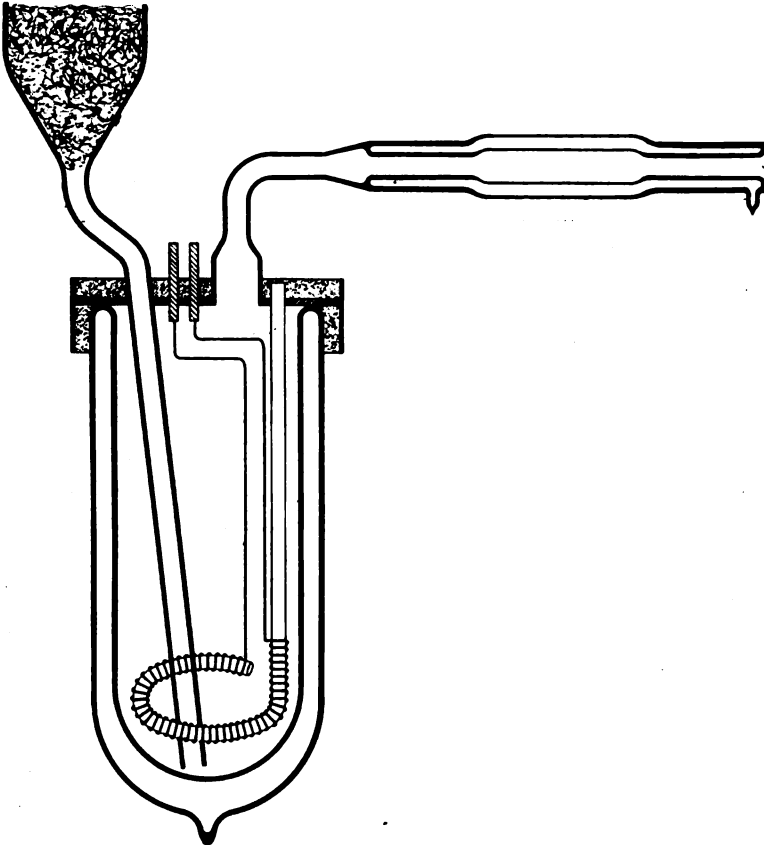

FIG. 1. Section of Complete Apparatus

the mouth of a tube connected to a rough vacuum pump of sufficient capacity (Fig. 2). This tube should have a diameter about twice that of the inner delivery tube, and a length about twice that of the gap. The connection to the vacuum pump must be warmed to prevent clogging by ice condensed

from entrained air. Flaring the mouth of the delivery tube preserves the integrity of the stream, and prevents fringes of frost from building across the gap. The vacuum heat insulated delivery tube may be vertical but where a horizontal section is required, the construction of the right-angled double walled tube (Fig. 3) is a matter of some nicety. If tubes over

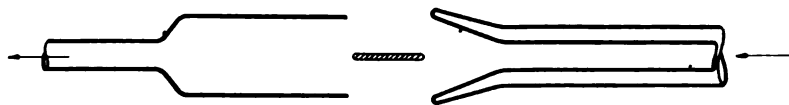

FIG. 2. Arrangement for Cooling in Open Air

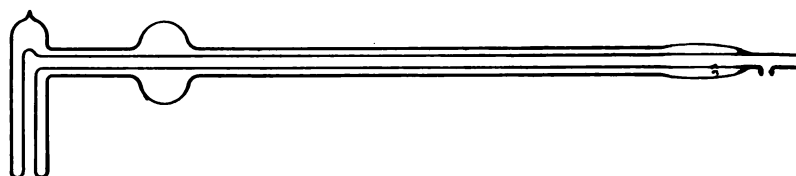

FIG. 3. Section of Long Horizontal Delivery Tube

25 cm long are required, flexibility of construction is necessary owing to the difference in expansion between the outer and inner walls. This may be obtained by including a flattened bulb section in the outer tube to serve as an expansion joint. The use of pyrex glass has here the additional advantage of reducing the difference in expansion between the two tubes. The heater is a coil of resistance wire with a low temperature coefficient of resistance. It is wound around a horizontal glass ring supported from the cover of the flask so as to hang near the bottom of the flask, and has its leads brought thru the cover. The cover makes airtight sealing-wax joints with the neck of the flask and with its connections, is conveniently made from a fibre disk suitably perforated, and is flanged on both sides by the addition of a short length of tubing. The Dewar flask requires frequent replenishment and occasional cleaning, both of which processes are facilitated by leaving it unsilvered. The flask is charged with liquid air by means of a funnel passing through the cover and reaching nearly to the bottom. This funnel is provided with a plug of glass wool for filtering out ice and solid carbon dioxide. In spite of this precaution particles of frozen impurities gradually accumulate and

finally make it difficult to observe the liquid air level, so that it becomes necessary to interrupt the experiment and clean out the flask. This is most easily done by maintaining a small current thru the heater, while passing air thru the system.

Temperature regulation is effected by changing the rate of evaporation of the liquid air, i. e., by changing the current thru the heater, and the mean temperature may be varied over a range from just below room temperature to a minimum depending upon the dimensions and heat insulation of the delivery tube. The regulation being electric can easily be made automatic if constancy of temperature is essential. Where considerable work is to be done covering a wide range in temperature, it is advantageous to make a temperature calibration of the apparatus in terms of the heater current, replacing the sample with a resistance thermometer of about the same dimensions and thermal capacity. In special cases the sample itself may be used as a thermometer, or the temperatures may be measured during the experiments by a thermometer adjacent to the sample. In a particular case, with a tube about 50 cm long and 1 cm inside diameter, a temperature of -150°C was maintained at the outlet with an expenditure of 94 watts in the heater, and this required a supply of about 2 liters of liquid air per hour. The maintenance of a constant temperature required the recharging of the flask when the level of the liquid air reached to within 3 cm of the heater. At this rate of boiling the system required cleaning about once in six hours which was therefore the limit for continuous operation.

RESEARCH LABORATORIES OF THE
AMERICAN TELEPHONE AND TELEGRAPH COMPANY
AND THE WESTERN ELECTRIC COMPANY, INCORPORATED
JULY 21, 1922.

A TUNGSTEN FURNACE FOR EXPERIMENTS ON DISSOCIATION AND IONIZATION

BY
K. T. COMPTON

Requests have been received from several sources for a description of the tungsten furnaces in use in this laboratory for the investigation of radiating and ionizing potentials and for the excitation of spectra of dissociated diatomic gases. The accompanying sketch gives the details of construction of the furnace used by Dr. Duffendack in his work on low voltage arcs in hydrogen, nitrogen and iodine. The figure is drawn to scale.

The furnace is made of sheet tungsten, which may be obtained from the Elkon Works of the General Electric Company at Weehawken, New Jersey, in thicknesses down to 0.002 inch or less. A piece, cut to the right dimensions, is bent into the form of a cylindrical tube and clamped by the end pieces. Each of these consists of a small steel "napkin ring" fitting in the split rectangular steel block. The tungsten sheet is held between the "napkin ring" and the block. These blocks are mounted on water-cooled brass tubes, which serve as leads for the heating current. These leads pass into the surrounding glass or metal vessel through brass tubes which pass through the water-cooled brass end pieces (not shown). Short glass tubes surround the water-cooled leads for purposes of insulation. The tungsten tube furnace is encircled, at two or three points between the end blocks, by loops of fine tungsten wire drawn tight enough to prevent bulging of the tungsten sheet along the line of the cut. The central electrode is a straight length of 20 mil tungsten wire, welded to heavier molybdenum leads. By adjusting the length of this wire, it is possible to secure equal potential drops along the furnace and the filament, so that they act essentially as equipotential electrodes.

Although we have used steel clamps, molybdenum clamps would have been preferable, since the steel at the ring of contact melts

and alloys with the tungsten before the highest temperatures possible with the furnace have been reached. Molybdenum blocks can be machined to required dimensions and can be secured from the Elkon Works of the General Electric Company at a very reasonable price. We first tried seamless brass tubing for the water-cooled leads, but these invariably spring leaks after continued use, causing the burning out of the tungsten electrodes. This occurred even when the tubing was thoroughly "tinned" with

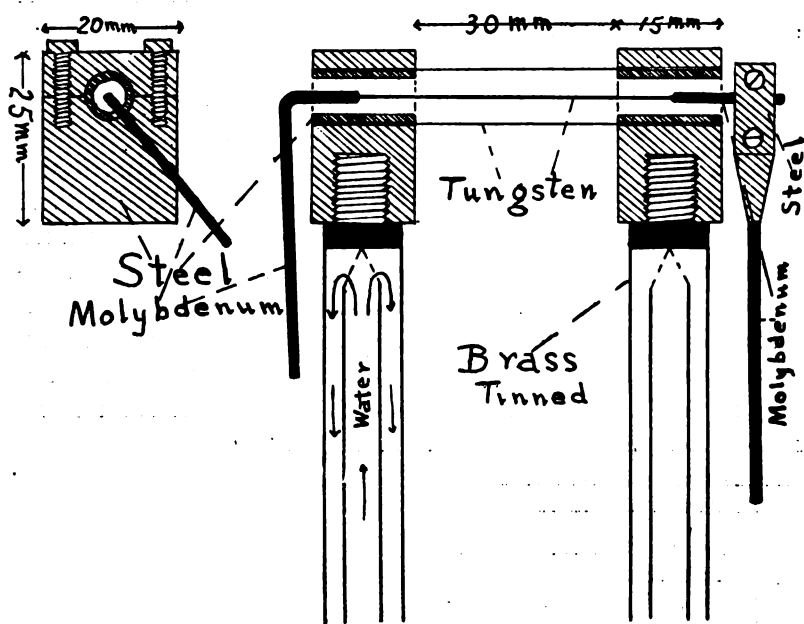

FIG. 1. Detail of Tungsten Furnace

solder, inside and out. With the outer tube bored out of solid brass rod and thoroughly "tinned," no appreciable leakage developed. The molybdenum leads to the filament were held in clamps and bent slightly so as to keep the filament under sufficient tension to prevent its sagging at high temperature. The temperatures of the furnace were estimated from its resistance, after making allowance for the resistance of the leads. The degree of dissociation of any gas in the furnace may be calculated by

means of Nernst's equation of the "reaction isobar."¹ if the heat of dissociation is known and if the chemical constant is known² or can be calculated.³

The furnace of the dimensions shown above required about 200 amperes, with a potential drop of 6 volts, to reach its melting point. It reached a good white heat with 100 amperes. We used storage batteries, but it should be possible to use a transformer, being careful that the phases of the heating currents in the furnace and the filament were equal, so as to insure their equivalence to equipotential surfaces.

In addition to its use in studying low voltage arcs, it has been used to investigate conditions of spectral excitation, observations being made through the open end of the furnace. By mounting parallel plates, alternately, positively and negatively charged, just beyond the open end of the furnace, ions may be prevented from passing from the furnace into the region beyond these plates. Another plate placed in this ion-free region so as to receive radiation excited within the furnace acts as a photoelectric detector of this radiation. By this means Dr. Olmstead and the writer have proved the excitation of the first four and the convergence members of the Lyman series in atomic hydrogen at the successively higher voltages 10.1, 12.0, 12.6, 13.0, 13.6.⁴

PALMER PHYSICAL LABORATORY,
PRINCETON, NEW JERSEY.

¹ W. Nernst, "Theoretische Chemie."

² Nernst, loc. cit.

³ Schames, *Phys. Zeit.* 21, p. 41; 1920.

⁴ Not yet published.

Journal of the Optical Society of America and Review of Scientific Instruments

Vol. VI

NOVEMBER, 1922

Number 9

NOTE ON THE ENERGY EXCHANGES IN THE FORMATION OF THE LATENT IMAGE OF A PHOTOGRAPHIC EMULSION¹

BY S. E. SHEPPARD AND E. P. WIGHTMAN

A number of determinations have been made of the energy of light of different wave-lengths necessary to produce, on development, a blackening of unit density of various photographic plates; and also the energy necessary to produce the least perceptible visible blackening has been found for many commercial plates.

Not so many calculations have been made, however, of the energies involved in the formation of the latent image itself. Mees,² in 1915, gave certain calculations of Nutting as to the amount of energy necessary, after full development, to produce a deposit of unit density and from this deduced that "the energy incident on a grain during exposure may be sufficient to affect only one molecule in the grain, and the latent image," he said, "may be composed of grains in each of which, on the average, only one molecule has lost an electron by the action of light."

Lately, Volmer³ made some calculations, based on the measurements of Leimbach,⁴ of the ratio of altered to unaltered moles of

¹ Communication No. 151 from the Research Laboratory of the Eastman Kodak Company.

² C. E. K. Mees, *J. Franklin Inst.*, 179, p. 164; 1915. A recent recalculation of Nutting's value shows that it is probably much too small.

³ M. Volmer, *Phot. Korr.* 58, p. 226; 1921.

⁴ G. Leimbach, *Z. wiss. Phot.* 7, 181; 1909. A preliminary determination in this laboratory of a similar value gives an amount of energy of the same order of magnitude.

silver bromide in a grain of a certain size. He used for this purpose, however, the energy of blue light, λ = about $450\mu\mu$, which would produce a density of unity, and failed to take into account that only about $\frac{1}{2}$ the total surface of the grain would be exposed. He assumed the grain to be spherical, whereas in most emulsions, grains of the size which he used for his calculations are tabular with an average thickness from $\frac{1}{2}$ to $\frac{1}{12}$ the mean width.

Instead of the energy used by Volmer for his calculations let us take Leimbach's value for the "Schwellenwert," that is, the visible threshold value after development for the Schleussner plate—upon which the former made his calculations.

For $\lambda = 450\mu\mu$ this is given as .

$$\epsilon_1 = 10.5 \times 10^{-11} \frac{\text{watt}}{\text{cm}^2} \text{ sec.}$$

which in ergs is

$$= 10.5 \times 10^{-3} \text{ ergs/cm}^2$$

Assume, for convenience, that the grain has the shape of a square tablet with length of side = 10^{-4} cm, and thickness = 10^{-5} cm (this is much nearer the average size grain in photographic emulsions than that assumed by Volmer). The energy per quantum is

$$\epsilon_2 = h\nu = \frac{hc}{\lambda} = \frac{6.6 \times 10^{-27} \times 3 \times 10^{10}}{4.5 \times 10^{-5}} = 4.37 \times 10^{-12} \text{ ergs.}$$

Then from Einstein's photochemical law, the number of molecules affected by the light will be

$$n = \frac{\epsilon_1}{h\nu} = \frac{\epsilon_1}{\epsilon_2} = \frac{10.5 \times 10^{-11}}{4.37 \times 10^{-12}} = 24.0 \text{ molecules per grain.}$$

The total number of molecules per grain may be calculated in either of two ways, from its weight or from the lattice structure. Both give the same result. Take the first case and assume the above values for width and thickness and the density of silver bromide crystals to be 6.47. The volume is then

$$v = 10^{-4} \times 10^{-4} \times 10^{-5} = 10^{-13} \text{ cc.}$$

and its weight is,

$$M = 6.47 \times 10^{-13} \text{ g}$$

Dividing by the weight of one molecule of AgBr, $m = 1.66 \times 10^{-24} \times 188 = 3.12 \times 10^{-22}$, we get for the number of molecules of AgBr in the grain

$$N = 2.07 \times 10^9$$

On the other hand if we calculate from the lattice structure and use Wilsey's value⁵ of the lattice constant, 2.89 A. U. = 2.89×10^{-8} cm, then

$$N = \frac{10^{-4}}{2 \times 2.89 \times 10^{-8}} \cdot \frac{10^{-4}}{2.89 \times 10^{-8}} \cdot \frac{10^{-5}}{2.89 \times 10^{-8}} = 2.06 \times 10^9 \quad \text{molecules per grain}$$

The number of molecules in the surface on which the light falls is of course obtained by omitting the last factor, the thickness, in the preceding equation, and is

$$N_s = 6 \times 10^8 \text{ molecules per surface exposed}$$

The ratio of altered to unaltered molecules is therefore

$$n : N = 1 : 8.6 \times 10^8$$

and

$$n : N_s = 1 : 2.5 \times 10^5$$

This ratio is different, of course, for every different sized grain but for this particular grain it is still too large,⁶ that is, if we consider, not the visible threshold value, but the actual threshold value, which could only be detected by the high power microscope.

As a matter of fact, work in the last few years on crystal structure in general, and on the crystal structure of AgBr in particular, by means of X-ray analysis; and on the applications of the quantum theory of light, have changed our views of the mechanism of the formation of the latent image.

It is certain that we cannot regard the grain of AgBr any longer as a heterogeneous clumping of molecules, and hence in speaking of "molecules per grain" all we mean is the number of pairs of (Ag^+ , Br^-) that occur in the grain.

⁵ R. B. Wilsey, *Phil. Mag.*, 13, p. 262; 1921.

⁶ If just 1 molecule is affected by 1 quantum of energy then $n = \frac{\epsilon_1}{\epsilon_2} = 1$, and the ratio for the exposed surface becomes $n : N_s = 1 : 6 \times 10^8$. It might be of interest in this connection to note that R. Gans (*Ann. d. Physik.* 52, p. 291; 1917) has detected quantities of light smaller than the quantum, but it is not known if these would be sufficient to affect a photographic plate.

The mechanism itself of latent image formation, we shall not discuss here but would refer to two papers⁷ by one of us recently published.

Let us consider the possible energy changes which can occur when light falls on the grain:

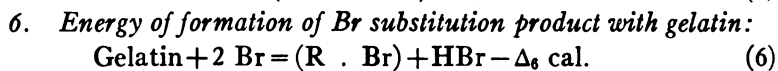
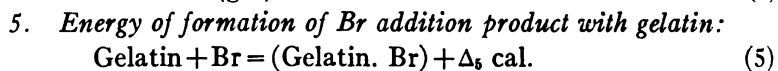
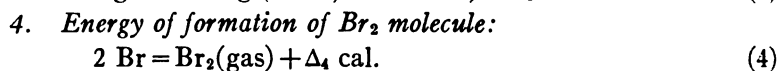
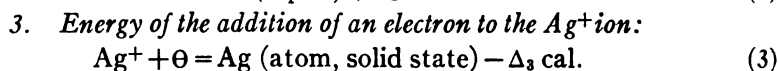
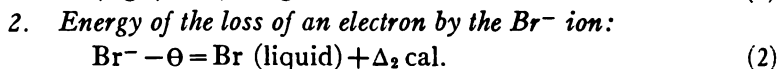
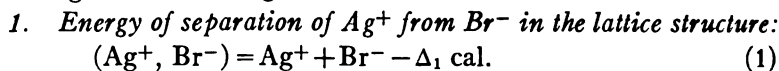

NOTE: The gelatin- Br substitution product would probably be an endothermic compound but the formation of HBr is exothermic to a greater extent, hence Δ_6 cal. is positive.

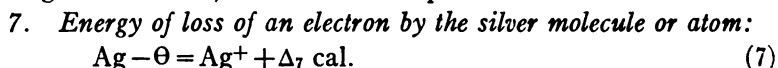

Of these seven possibilities the first five appear to be the most probable; the seventh may play an important catalytic part, however, in that silver metallic silver atoms may supply the electron for reversing equations (3) and (2), and assist the local surface concentration of the latent image. Under such conditions, therefore, the previous energy changes become of less relative importance. We shall return to the evaluation of these energy changes in a later paper.

EASTMAN KODAK COMPANY,
 ROCHESTER, N. Y.,
 JULY 31, 1922.

⁷ S. E. Sheppard, Silver nucleus theory of development, *Phot. Korr.*, Jan.-April, 1922, p. 76. The action of soluble iodides and cyanides on the photographic emulsion, *Phot. J.* 60, p. 88; 1922.

THE OPTICAL CONSTANTS OF ISOLATED TELLURIUM CRYSTALS

BY GEORGE DEWEY VAN DYKE

This paper is a brief report on one phase of an extended research which is being conducted by Dr. L. P. Sieg of the State University of Iowa, on the optical properties of small metallic crystals. The information obtained from such investigations should reveal much in regard to the crystalline structure of the pure metal and possibly throw some light on the atomic structure of metals in general.

Skinner¹ has published results on the optical constants of a selenium crystal, finding the crystal doubly refracting, the index when the principal axis of the crystal is parallel to the plane of incidence being higher than that of any other known element. Skinner employed the ordinary polarimetric method of determining the elliptic constants. Weld² has made a fairly extensive study of the elliptic constants of light reflected from a small selenium crystal using the "Crystelliptometer," a special apparatus designed by himself. The same apparatus was used by the writer in obtaining the optical constants of tellurium crystals. The crystals were made by sublimation at the State University of Iowa, by Dr. A. R. Fortsch.

Drude³ has developed the theory of metallic reflection for crystalline bodies.

Let Φ_1 , Δ_1 , Ψ_1 , be respectively, the angle of incidence, phase difference, and azimuth when the principal crystal axis is parallel to the plane of incidence;

Φ_2 , Δ_2 , Ψ_2 be, respectively, the angle of incidence, phase difference, and azimuth when the principal axis of the crystal is perpendicular to the plane of incidence, and

n_1 , n_2 , k_1 , k_2 , ρ_1 , ρ_2 , be the indices of refraction, absorption coefficients, and coefficients of reflection, respectively, for the

¹ Skinner, *Phys. Rev.*, N. S., *9*, p. 148; 1917.

² Weld, *Journal of the Optical Society of America*, *6*, p. 67; 1922.

³ Drude, *Ann. d. Physik*, *34*, p. 529; *32*, p. 616, 1887; *35*, p. 518; 1888.

two principal positions of the crystal axis, n_1 , referring, for example, to the index of refraction when the electric vector agrees with the principal axis.

Then

$$\frac{\sqrt{a}}{\cos \phi_1} - \sqrt{\gamma} \cos \phi_1 = \frac{\cos 2\Psi_1 + i \sin 2\Psi_1 \sin \Delta_1}{1 - \sin 2\Psi_1 \cos \Delta_1}$$

$$\frac{\sqrt{\gamma}}{\cos \phi_2} - \sqrt{a} \cos \phi_2 = \frac{\cos 2\Psi_2 + i \sin 2\Psi_2 \sin \Delta_2}{1 - \sin 2\Psi_2 \cos \Delta_2}$$

where a and λ are auxiliary complex constants employed in determining the final optical constants. The letter i represents $\sqrt{-1}$.

Let the values of a and γ as given by the above equations be

$$a = a_{11} + i a_{12} \qquad \gamma = a_{31} + i a_{32}$$

Then if we define X by $\tan X = \frac{a_{12}}{a_{11}}$,

and E by $\tan E = \frac{a_{32}}{a_{31}}$, we have

$$k_1 = \tan \frac{X}{2},$$

$$k_2 = \tan \frac{E}{2},$$

$$n_1^2 = \frac{2 \sin \frac{X}{2} \cos^3 \frac{X}{2}}{a_{12}},$$

$$n_2^2 = \frac{2 \sin \frac{E}{2} \cos^3 \frac{E}{2}}{a_{32}}$$

$$\rho_1 = \frac{n_1^2(1+k_1^2) + 1 - 2n_1}{n_1^2(1+k_1^2) + 1 + 2n_1}, \text{ and}$$

$$\rho_2 = \frac{n_2^2(1+k_2^2) + 1 - 2n_2}{n_2^2(1+k_2^2) + 1 + 2n_2}$$

It should be noted that the values of a and γ do not depend upon the angles of incidence, hence for each wave-length we are able to determine a and γ for several angles of incidence and average the results.

The optical constants for five different wave-lengths in the visible spectrum were obtained. The results of the investigation (c. f. Figs. 1, 2, and 3) show that a crystal of tellurium is doubly refracting, the index of refraction being higher in the horizontal than in the vertical position. The reflecting power of the crystal

Table of Elliptic Constants

λ ($\mu\mu$)	Φ	Δ_1	$2\Psi_1$	Δ_2	$2\Psi_2$
437	60°	141°30'	74°	136°	66°48'
437	65°	126°6'	73°48'	119°24'	64°12'
437	70°	108°54'	72°12'	103°54'	60°36'
437	75°	89°42'	69°48'	78°54'	61°
450	60°	127°30'	69°12'	120°24'	63°24'
450	65°	117°12'	68°48'	113°36'	61°12'
450	70°	99°30'	66°24'	86°30'	62°48'
508	60°	136°30'	73°36'	133°24'	61°12'
508	65°	122°6'	67°24'	119°48'	58°24'
508	70°	108°36'	62°24'	105°	56°
508	75°	84°12'	61°48'	76°36'	55°12'
590	60°	137°36'	71°	133°	67°
590	65°	132°12'	65°12'	117°18'	60°24'
590	70°	108°6'	64°48'	100°36'	57°12'
590	75°	89°18'	59°24'	80°6'	54°24'
650	60°	127°54'	68°48'	115°12'	57°24'
650	65°	115°30'	65°	102°24'	55°48'
650	70°	102°24'	62°	92°42'	55°36'

Averages of Crystal Constants

λ	α	γ
437	.0528 + .0503i	.0513 + .0811i
450	.0751 + .0918i	.0800 + .1232i
508	.0493 + .0738i	.0391 + .0967i
590	.0416 + .0688i	.0426 + .0896i
650	.0659 + .1034i	.0641 + .1532i

Table of Optical Constants

Crystal Axis Horizontal				Crystal Axis Vertical		
λ	n_1	κ_1	ρ_1	n_2	κ_2	ρ_2
437	3.44	.399	.33	2.52	.551	.30
450	2.62	.466	.28	2.29	.543	.26
508	2.96	.535	.31	2.57	.672	.30
590	3.07	.563	.34	2.68	.632	.30
650	2.50	.548	.29	2.05	.666	.27

varies very little for the two positions and for the various wave-lengths used, a fact verified by Sieg⁴ by direct measurement of the reflecting power. The curve obtained from plotting the index of refraction against the wave-length shows a distinct

⁴ Unpublished results.

minimum and maximum over the range investigated. This characteristic is also shown in Skinner's⁵ results for selenium,

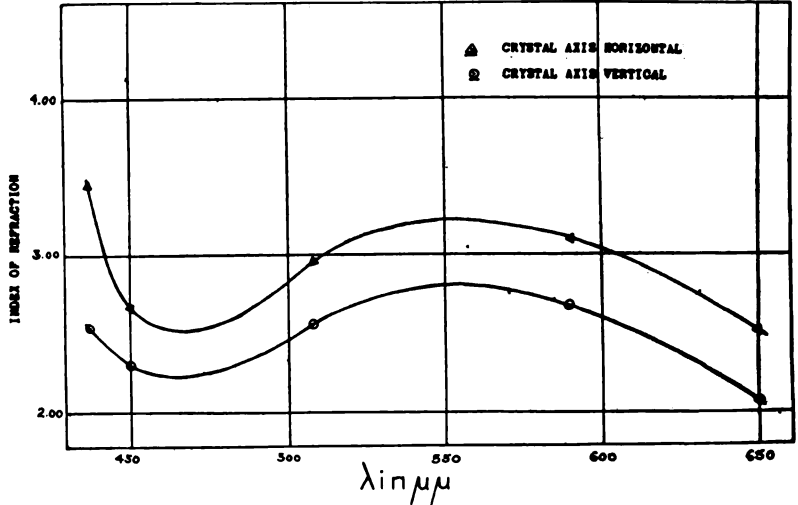

FIG. 1. Principal indices of refraction of an isolated tellurium crystal for various wave-lengths.

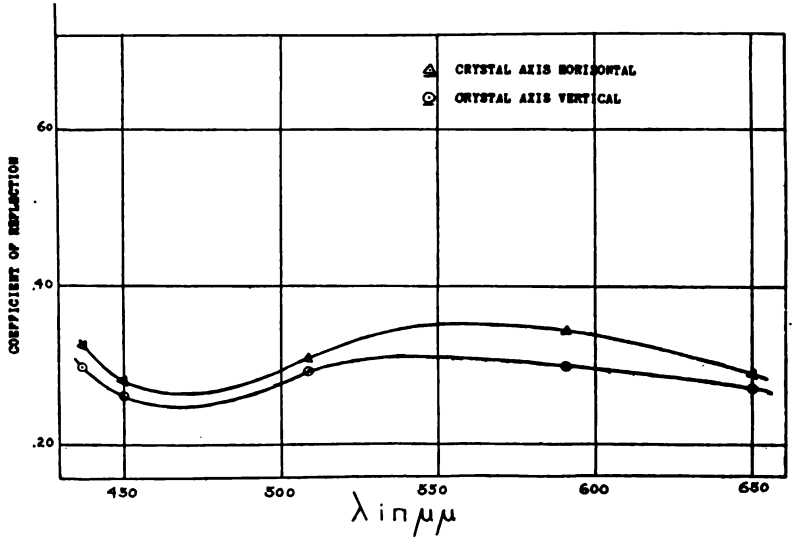

FIG. 2. Principal reflecting powers of an isolated tellurium crystal for various wave-lengths.

⁵ Loc. cit.

although to a far less degree. The peculiarity found in the index in the horizontal position was not evident in tellurium, the two indices following almost similar curves.

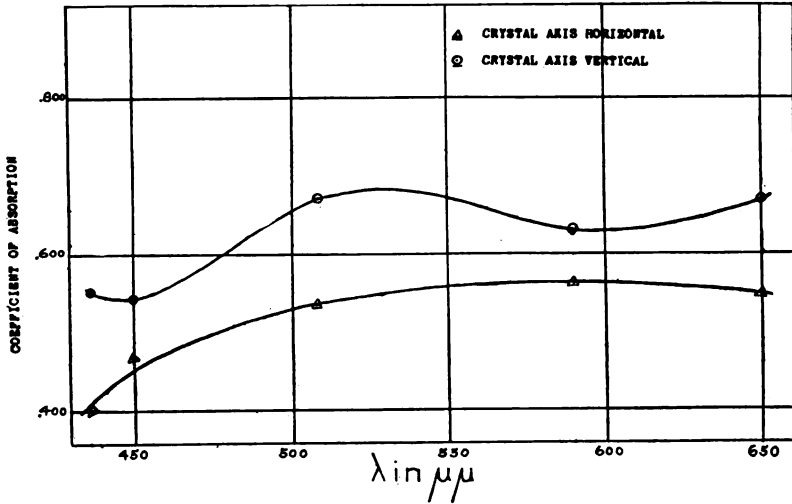

FIG. 3. Variation in the coefficients of absorption of a crystal of tellurium with a variation in the wave-length.

The above problem was suggested to me by Professor L. P. Sieg, to whom I wish to express my appreciation.

STATE UNIVERSITY OF IOWA,
AUGUST, 1922.

THE STUDY OF VISUAL PROCESSES BY MEANS OF MOMENTARY RETINAL SHADOWS

BY FREDERICK W. ELLIS

In 1901 I made an extensive series of experiments in the study of certain visual phenomena,¹ and I have recently supplemented and extended these researches with others in which new methods have been employed. It is the object of this paper to call attention to what seems to be a new method of studying several visual phenomena.

In 1891 Jastrow and Moorehouse² published an article describing an interesting phenomenon which had been brought to Jastrow's attention by Münsterberg some time before. When a slender horizontal rod is moved vertically in front of a rapidly revolving disc having a white or colored sector of greater luminosity than that of the rest of the disc, a number of horizontal bands are seen. Jastrow and Moorehouse studied this phenomenon under varying conditions, but gave no explanation of it, and spoke of it as an optical illusion. The word illusion does not apply to it, for it is due to well known optical and physiological laws. It demonstrates in a rather novel way the persistence and independence of visual perceptions, and affords a method of measuring the duration of the perceptions. The bands are due to the perception, and the persistence of the perception of the retinal shadow of the rod which is formed at each passage of the sector behind it. The word shadow is used here to denote an area of diminished luminosity irrespective of color.

In order to obtain a clear understanding of the mode of production of the bands it is best to use a white sector on a black ground. The sector should be comparatively narrow; one of twenty degrees is sufficiently broad. When the disc revolves rapidly enough to eliminate flicker it assumes a uniform dark gray shade. If a

¹ Studies in the Physiology and Psychology of Visual Sensations and Perceptions, American Journal of Physiology, Vol. 5.

² American Journal of Psychology, Vol. 4.

slender black rod or strip, held horizontally, is now moved up and down at the rate of about once in a second, a number of very distinct black bands are seen on the dark gray background. If the motor to which the disc is attached is stopped, and then slowly turned by hand while the rod is held in its horizontal position, it is easy to study the way in which the retinal shadows are formed. It is only necessary to recall that what we see is the projection of the retinal image. As the white sector sweeps behind the rod a variable portion of it is covered by the rod at successive instants, and the retinal image or shadow of the rod is formed in successive sections. When the disc revolves rapidly the continuously varying parts of the shadow are perceived as a whole, owing to the persistence of vision. At each revolution of the disc the sector encounters the moving rod in another position in the field, and, consequently, another shadow is formed. As the persistence of vision is a considerable part of a second, several bands are seen at the same time. The number of the bands perceived depends upon the rate of revolution of the disc, and the distance between them is governed by the rate at which the rod is moved across the disc.

Figs. 1 to 9 illustrate the mode of formation of the bands. The oblique lines of the first four figures represent the fusion color or shade of the rapidly revolving disc; the vertical shading of the remaining figures indicates that the disc is at rest, or moving so slowly that it can be readily followed with the eye. The heavy horizontal line, extending beyond the disc on either side, corresponds to the horizontal rod, and the other broad lines, which are parallel to this line and terminate at the border of the disc, represent the shadows that we are studying. In Fig. 1 the rod is not moving; in Fig. 2 the rod is moving downward, and in Fig. 3 upward. Fig. 4 illustrates the appearance when the rod moves downward more rapidly than in Fig. 2. No sectors are seen in these four figures, for, in accordance with Talbot's law, the color of the sector is lost in the uniform fusion color of sector and ground. It is evident that none of these four figures represents a real retinal image. We may regard the four as psychic images due to the composite blending in the brain of

successive retinal images. The formation of these images is easily explained by referring to the remaining figures.

If the disc revolves clockwise, Fig. 5 will be an instantaneous view of it when the sector has just passed behind the rod. That part of the image of the rod which crosses the sector obliquely divides the sector into two parts separated by a retinal shadow,

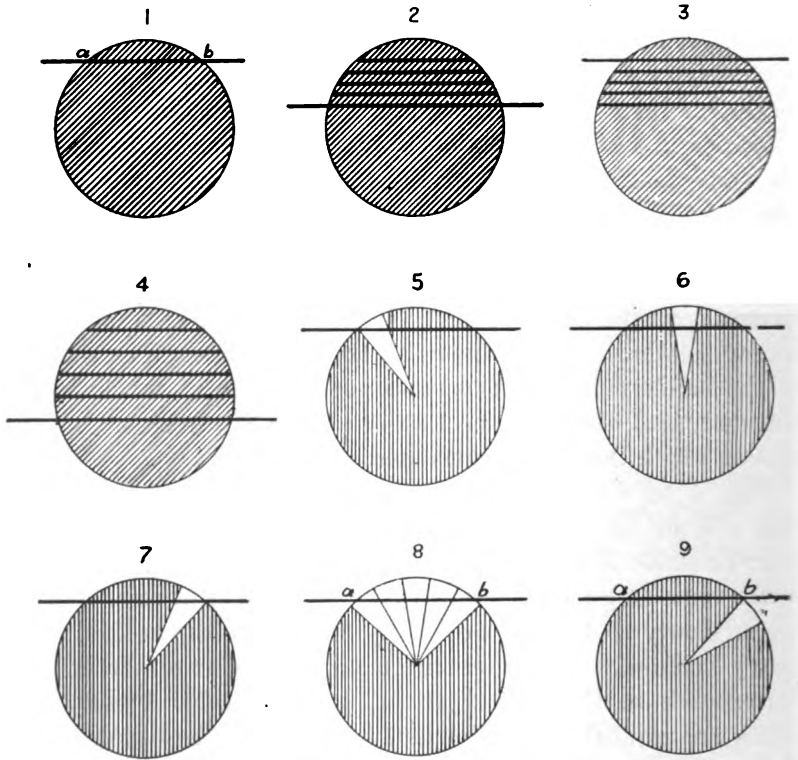

or an area of less luminosity. Fig. 6 is a retinal image at a little later period, and the next figure one still later at the instant when the sector begins to emerge from behind the rod. In these instantaneous views it will be seen that the retinal shadows occupy varying positions with respect to the radial axis of the sector. Fig. 8 represents a composite of five different images in which it will be seen that the retinal shadows lie on the same straight line. Owing to the combination and persistence of the

changing impressions a shadow seems to extend from *a* to *b*. In Fig. 1 the projected shadow coincides with the stationary rod. If the rod is moved vertically downward while the disc completes its revolution the shadow will be seen behind the rod. When the disc makes the next revolution another subjective shadow is formed, and is seen directly behind the rod, while the first shadow still persists, and forms the second band. If the first shadow persists during five revolutions, the rod and bands will have the appearance shown in Fig. 2, and the band farthest from the rod will be the one first formed. It is evident from Fig. 9 that no retinal shadow will be formed while the sector continues its revolution from *b* back to *a*, and, if the rod moves during this period, it will give rise to another band when the sector again passes behind it.

The dark bands can also be shown very distinctly when a part of the revolving disc is a colored sector of considerable luminosity, and the ground is black. The distinctness of the bands varies with the brightness of the colored sector. When the colored disc is placed on a gray disc of the same luminosity the bands almost entirely disappear. Based upon this fact is a method of color photometry first employed by Rivers³ in measuring the luminosity of colored papers by comparing them with a series of gray papers. He found that the bands nearly or completely disappeared when the gray had the same luminosity as the sector, and the results that he obtained in this way were nearly the same as those in a parallel series of experiments with the flicker method.

A complementary experiment with a slit in a sheet of black cardboard demonstrates in a striking way the mode of formation of the bands which we have been studying, and confirms my previous statements regarding their origin. The slit should be 4 or 5 mm wide, and of any convenient length. When the slit is held horizontally, in front of the revolving disc, and the screen is moved up and down about once in a second, a series of light bands corresponding to the dark ones of the previous experi-

³ The Journal of Physiology, 22, 1897.

ments, and having a color resembling that of the sector, is seen. The colored sector as it passes behind the slit illuminates its different parts at successive instants, and these partial views are blended into an impression of the entire slit by the persistence of vision. The point to emphasize in this connection is that these images of the slit correspond to the dark bands of the rod experiment, and prove that the explanation of the origin of these bands given above is the correct one, and that they may be illustrated by the same figures.

It is possible to demonstrate another set of subjective shadows of different origin from that of those which we have described, if the revolving disc is placed in a darkened room, and is illuminated by a single lamp placed at a little distance in front of it. When the white sector is behind the rod, under these conditions, a real shadow of part of the rod is cast on the sector at each instant while it passes behind the rod. This comparatively short objective shadow sweeps across the disc in a nearly straight line, and gives rise to the subjective impression of a dark band extending across the disc, when the disc is regarded from one side. When the position of the observer is favorable two sets of bands may be seen; those due to retinal shadows, and those caused by the projection of a real shadow on the sector. It is evident that both kinds of bands may be similarly explained by the figures already given. The bands due to the retinal shadows of the rod are the more important, as they may be obtained under a greater variety of conditions, and are the ones best adapted for utilization in experimental work.

It is evident that the experiments which have been described afford the basis for two methods of measuring the duration of visual perceptions. In this instance, as in a former paper, I am impelled to emphasize the difference between visual perceptions and sensations. This is especially necessary in studying the subject of visual persistence. Vision is always accompanied by a perception, and it is the duration of the perception that ordinarily interests us. The duration of a visual sensation apart from a perception cannot be measured, for it has no existence. It seems preferable, therefore, to speak of the duration of visual perceptions

rather than that of sensations. An added reason for this distinction is that I have shown, in the paper which I published in 1901, that the duration of visual perceptions may be decidedly affected by psychological conditions, but comparatively little by the intensity of the luminous stimulus. This would appear to indicate that the persistence of vision is largely due to the activity of the higher visual centers. It is evident that, if we could count the number of the bands in the rod experiment, knowing the rate of revolution of the disc, we could estimate their duration. This cannot be done satisfactorily, but it is quite possible to measure the duration of the perceptions by employing another method. When one end of the rod or strip which casts the shadow is held so that the end coincides with the prolongation of the axis of the disc, and the other end is made to describe a circle slowly, the bands are radial. If the rate of revolution of the rod is properly adjusted the bands can be made to cover the entire disc. The slowest rate of revolution of the rod which enables us to complete the circle of bands is the measure of the duration of the perceptions, and I have found this to be about four-tenths of a second. The essential part of the mechanism employed for this purpose is illustrated by Fig. 10.

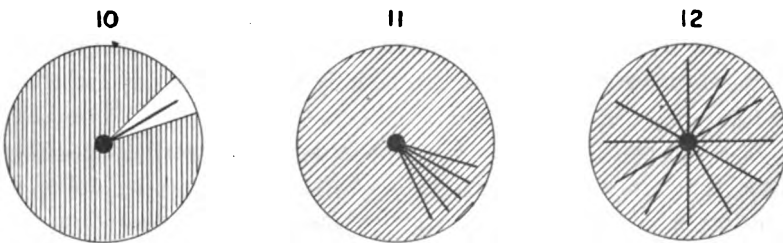

The small black circle in the center of Fig. 10 represents a section of a cylinder to which one end of a slender rod is attached, which is seen projecting radially over the middle of the sector. The axis of the cylinder is the prolongation of that of the disc. The cylinder with the rod may be revolved independently of the disc about the common axis, and in either direction. The rate of revolution of the rod may be varied continuously within the required limits. If the rod revolves slowly, clockwise, while

the disc revolves with sufficient rapidity, the subjective bands will be radial, as in Fig. 11. If the disc revolves clockwise, the first radial line in this figure represents the rod, and the remaining four radii the dark bands which we are studying. When the rod revolves more rapidly, the bands may be made to extend completely around the circle, as is shown in the last figure. In Fig. 11 the band farthest from the rod is the one formed first, and is about to disappear. As the rate of revolution of the rod increases the oldest band recedes from the rod until it is diametrically opposite. When the bands cover more than a half circle, and the rod revolves still faster, the disappearing band approaches the rod on the other side of the disc until it finally coincides with it, as in Fig. 12; the rate of revolution of the rod is then the measure of the duration of the band. When the rate of revolution of the rod remains constant, the number of bands seen will depend on the rate of revolution of the disc. If the disc revolves at constant speed the radial bands will become more widely separated when the rate of revolution of the rod increases, but it will also be noted that a greater number of bands will be seen when they extend entirely around the disc. This depends upon the fact that the mind can note and retain a larger number of the visual impressions which give rise to the bands when they are widely separated in space. As I have noted before, the duration of visual perceptions is chiefly affected by psychological factors.

The successful use of the apparatus just described requires some practice and concentration of attention, and, in using it, it is especially important to resist the tendency to follow the revolutions of the rod with the eye. As the perception becomes less vivid before it entirely disappears, an allowance has to be made for this fact in determining when the shadows are distributed entirely around the disc. It requires but little experience with the apparatus to demonstrate that with 150 revolutions of the rod per minute, and probably with a rate somewhat less, the perception of the shadow persists during an entire revolution. This indicates a duration of at least four-tenths of a second. This result is in accordance with those obtained with other

methods, and recorded by me in a former paper. It has been amply proven that this duration is much longer than has been generally supposed, and that it depends comparatively little on the intensity of the stimulus. The factors that abridge the duration are especially those that interfere with attention. By the use in a dark room of the apparatus to which I have given the name of Prism Stroboscope, which was described in the paper which I published in 1901, it has been shown that luminous impressions may last three-fourths of a second. In a dark room all distracting influences are at a minimum, and there is the greatest possible contrast between the image and the field. In the shadow experiments just described the whole field of vision is receiving simultaneously many impressions which cannot be ignored, and which lessen contrast.

The attentive study of the results of the band experiment sheds light on a number of important visual processes. Visual inhibition is most clearly demonstrated in the bands. In the case of a white sector on a black ground the fusion color is a dark gray, but the radial bands are nearly or completely black. By reducing the angular extent of the sector it is possible to lessen the duration of the retinal shadow to a thousandth of a second, or even to a period much less than that. When this is done the resulting gray is very dark, but the bands are distinct and much darker. Unless the illumination is very intense there will be complete fusion of the black and white without flicker, nevertheless, the withdrawal from the light of the sector of the shaded portion of the retina for a thousandth of a second is sufficient to inhibit the previous white constituent of the gray, which persists in the unshaded region with nearly undiminished intensity. In other words the previous gray sensation is inhibited, and a perception of a black band corresponding to the retinal shadow remains. This inhibition of a sensation can be shown even more strikingly by using a colored sector of considerable brightness on a colored ground of feeble luminosity. The brighter color will then be inhibited, and the bands will have the color of the ground, or one closely approaching it.

Another condition, known in physiology as the refractory state, plays a part in the production of the bands. It should be remembered that when the retinal shadow lasts only the thousandth of a second, the perception of the shadow continues for four-tenths of a second, or possibly a little longer. I have even succeeded in obtaining with a very narrow white sector distinct bands due to shadows that lasted less than three-thousandths of a second, and the duration of the bands was as given above. It is, therefore, easy to prove that under appropriate conditions the perception may outlast the retinal shadow more than a thousand times. During the period of four-tenths of a second the part of the retina upon which the shadow fell was stimulated at least twelve times by the repeated passages of the sector without evoking any sensation in the corresponding part of the visual field. The perception of the shadow made that part of the visual field refractory to stimulation by the reflected light of the sector. This indicates that in the complicated processes of vision sensations which interfere with the clearness of perception may be suppressed or prevented. Visual perceptions are due to the activity of the higher visual centers, and it is in these centers that it is most probable that inhibition and the refractory state occur. The evidence of the band experiments is in accord with that furnished by my early experiments, and authorizes the same conclusions.

If we replace the revolving rod with a black disc having a narrow radial slit, and view the other disc as it revolves rapidly, through the slit, gray or colored bands will be seen if the object disc is well illuminated. These bands correspond to the dark ones due to the revolving rod, and their duration may be estimated in the way that has been described. This duration seems to be slightly longer than with the rod, or about one-half of a second. A white or colored sector may be used on a black or colored ground. The distinctness of the bands depends on the size of the slit and of the sector, the difference in the luminosity of the sector and ground, and the illumination of the object-disc. In order to insure sufficient illumination, the object-disc, revolving at the rate of about 1,800 revolutions a minute, should be placed

20 or 30 cm behind the slit, and near a window, or a lamp in a darkened room if artificial illumination is desired. It is desirable that the slit should be adjustable, and it should be viewed at a distance of one or several meters. This makes a convenient arrangement for measuring the persistence of vision, and for proving that this persistence is very constant under widely varying conditions.

FROM THE AUTHOR'S LABORATORY
MONSON, MASSACHUSETTS.

A COMPARISON OF THE FECHNER AND MUNSELL SCALES OF LUMINOUS SENSATION VALUE

BY ELLIOT Q. ADAMS

A critical study of the Munsell scale of (luminous sensation) value has been made by Priest, Gibson, and McNicholas.¹ Their results "verify in a remarkable manner the consistency of the Munsell values for different hues . . . considering the uncertainties of heterochromatic photometry which were necessarily involved in Munsell's work." They establish that "the squares of the Munsell value numbers are directly proportional to the reflection of sunlight"—as might be expected from the construction of the Munsell photometer, which employs an Aubert diaphragm,²—and object that "the implication that values, read directly as the diagonal of the shutter, are proportional to sensation in the sense of Fechner's law is quite wrong." Since it is well known³ that Fechner's law is only an approximation to the law relating brightness and sensation, and an equation which constitutes a closer approximation has recently been published,⁴ it will be well to examine, in the light of this newly-found relation, both the Fechner and the Munsell (or Stefanini)⁵ scales.

Before proceeding to a quantitative comparison, it will be well to point out anew⁶ the difference between the range of valid-

¹ I. G. Priest, K. S. Gibson, and H. J. McNicholas, Technological Paper No. 167, Bur. Stds. (Sept. 1920) "An Examination of the Munsell Color System. I. Spectral and Total Reflection and the Munsell Scale of Value."

² H. Aubert, *Grundzüge der physiologischen Optik*, pp. 489, 547. Leipzig, W. Englemann, 1876.

³ And is explicitly conceded by the authors on page 29 of the reference in footnote 1.

⁴ E. Q. Adams and P. W. Cobb, *J. Exp. Psych.*, 5, pp. 39-45; 1922.

⁵ A. Stefanini, *Nuov. Cim.* (3) 22, p. 97; 1887 (for sound). *Atti della R. Acc. Lucc. di Sc. Lett. ed Arti.*, 25, pp. 383-400 (for light and weight). The Stefanini formula is the special case of Plateau's formula $E = kR^\epsilon$, in which $\epsilon = 0.5$.

⁶ See for example, A. Elsas, *Wundt's Philos. Stud.* 4, 162-79 (1888), also E. B. Titchener, *Experimental Psychology, Instructor's Manual, Quantitative*, pp. 210-32. §29. New York, Macmillan, 1905. The method of equal sense distances: historical and critical.

ity of Weber's law, and the range over which Fechner's sensation law holds. This comparison can be made more concrete by the analogy of the measurement of current by a tangent galvanometer⁷ provided with an assortment of shunts. Such an instrument gives greatest percentage precision when the scale reading is in the neighborhood of 45°, and the percentage precision at that (or any other constant) angular deflection is the same whenever the shunt is selected so that the current measured gives that deflection. Hence with a sufficiently varied supply of shunts the percentage precision may be made constant over the range covered by the shunts, that is:

$$\Delta I = \frac{\Delta s}{b} I = cI \quad (1)$$

where ΔI is the least detectable increase in current, I ; b and c constants, and Δs the least perceptible change in scale reading, s . At the same time *with any one shunt the* scale reading, s , is related to the current by the equation:

$$I = I_m \tan s \quad (2)$$

where I_m is the current which for that shunt gives a scale reading of 45° and hence maximum precision. Yet the equation obtained by integrating (1), in the form $I ds = b dI$;

$$s = b \ln I \quad (3)$$

does not hold at all, for over the range of validity of (1), the scale reading is always near to 45°. Now if I represent light intensity and s sensation, (1) and (3) become Weber's and Fechner's Laws respectively.

The analogy is, of course, not perfect, for while equation (1) in the form

$$\Delta B = cB \quad (4)$$

holds over a considerable range of brightness, the equation⁸

⁷ This instrument is chosen because its deflections follow a simple mathematical law and remain finite as the current is indefinitely increased. For the sake of continuous variation of the shunt resistance a slide wire might be used.

⁸ Equation (2) of the article referred to in footnote (4), based on the assumption that visual impressions are transmitted along each fiber of the optic nerve by a series of impulses whose effect depends only on their frequency,—the All-or-None hypothesis of Keith Lucas, "The Conduction of the Nervous Impulse," p. 9, London; 1917. Cf. also L. T. Troland, J. Opt. Soc. Am., 4, p. 160; 1920.

which has been found to relate sensation to brightness *at constant adaptation*, (the analog of galvanometer readings with a given shunt) is not of the form of equation (2), but is

$$s = \frac{B}{B+k} \quad (5)$$

where k is a constant dependent on the state of adaptation, being equal to the brightness at which photometric precision is a maximum (for the given state of adaptation).

s expresses sensation as a fraction of the maximum possible range of sensation; if it is desired to express it in other units, a coefficient, a , must be inserted in equation (5). Similarly if sensation is to be measured from any other point of reference than the sensation corresponding to (physically) complete blackness, a term, s_0 , for that sensation, must be introduced into equation (5) which thus becomes

$$s = s_0 + a \frac{B}{B+k} \quad (6)$$

The relation between sensation and brightness thus assumes an infinite number of forms according to the value of k . Since in equation (6) s becomes independent of B at both limits, $k \doteq 0$ and $k \doteq \infty$, the law of variation in these limiting cases may be found as follows. For $k \doteq 0$, i.e., for dark adaptation

$$s = s_0 + a \frac{B}{B+k} = s_0 + a \frac{(1)}{1+k/B} \doteq s_0 + a \left(1 - \frac{k}{B}\right) = (s_0 + a) - \frac{ak}{B} \quad (7)$$

while for adaptation to infinite brightness, $k \doteq \infty$,

$$s = s_0 + a \frac{B}{B+k} \doteq s_0 + \left(\frac{a}{k}\right) B \quad (8)$$

that is, the sensation approaches in the first case a linear function of the reciprocal of brightness, in the second a linear function of brightness itself.

Many of the other formulas which have been found empirically are special cases of the Plateau equation

$$s = k' B^\epsilon \quad (9)$$

where ϵ is an exponent lying between 0 and 1, and k' a constant.

If ϵ be given the value $\frac{1}{2}$, equation (9) becomes the Stefanini⁹ equation, on which the Munsell scale is based:

$$s = k' \sqrt{B} \tag{10}$$

If sensation be not measured from the sensation produced by the physical absence of light, a term, s_0 , must be added in equation (9) as in the case of equations (5) and (6), giving

$$s = s_0 + k' B^\epsilon \tag{11}$$

If ϵ be made equal to unity, this becomes the Merkel⁹ proportionality law:

$$s = s_0 + k' B \tag{12}$$

which is identical with (8).

When ϵ approaches 0, (11) becomes

$$s = s_0 + k' e^{\epsilon \ln B} \doteq s_0 + k' (1 + \epsilon \ln B) = (s_0 + k') + k' \epsilon \ln B \tag{13}$$

that is, Fechner's law, which is, therefore, the other limit of the Plateau equation.

It will be noted that equations (5) and (9),—and hence also the equations derived from them,—retain their form if B be measured in other units, provided the appropriate changes are made in the constants of the equations. Since for any constant illumination the relation between sensation and test object *albedo*¹⁰ (the brightness relative to that of a perfect diffusely reflecting surface similarly illuminated) will depend upon the albedo of the surroundings but will be independent of the illumination,—within the range of brightnesses for which Weber's law holds,—equations (4) to (13) may be made the same for the relation between sensation, s , and test object *albedo*, as for the relation between sensation and brightness. In what follows the symbol, B , and the term "albedo" will both signify *test object albedo*.

Priest, Gibson, and McNicholas give in their Fig. 16, (on p. 31), a comparison of the Merkel, Munsell, and Fechner scales, made to coincide for Nos. 1 and 9 of the Munsell scale.

⁹ Julius Merkel, Wundt's Philos. Stud., 4, pp. 117-60, 251-91, 541-94, 1888; 5, pp. 245-91, 499-557, 1889; 10, pp. 140-59, 203-48, 369-92, 507-22 especially p. 517; 1894.

¹⁰ This term is used habitually by astronomers in stating the reflecting powers of the planets.

TABLE 1. Relation Between Sensation and Test Object Albedo, According to Various Scales and Theories

Sensation No.	Albedo according to:								
	Munsell Scale		Merkel $\epsilon=1$	Fechner $\epsilon=0$	Plateau $\epsilon=2.3$	Adams and Cobb			
	meas. by Priest <i>et al</i>	Theoretical (Stefani-ni)				k=0	k=0.01	k=0.09	k=0.50
0.00000580089	.0078	0
0.1	.018	.01	≡ .01	≡ .01	≡ .01	≡ .01	≡ .01	≡ .01	≡ .01
0.2	.041	.04	.11	.0173	.0578	.0114	.0128	.0225	.0522
0.3	.090	.09	.21	.0300	.126	.0133	.0165	.0386	.102
0.4	.161	.16	.31	.0520	.211	.0159	.0215	.0600	.162
0.5	.234	.25	.41	.0900	.310	.0198	.0290	≡ .09	.234
0.6	.343	.36	.51	.156	.420	.0261	.0412	.135	.325
0.7	.465	.49	.61	.270	.542	.0386	.0656	.210	.441
0.8	.602	.64	.71	.468	.670	.0736	.1267	.360	.595
0.9	.772	.81	≡ .81	≡ .81	≡ .81	≡ .81	≡ .81	≡ .81	≡ .81
1.0	1.00	.91	1.403	.958	1.130
Equation No.	10	8,12	13	13	11	7	6	6	6
S_0	0	.09	.938 ^b	2.147 ^a	.0549	.91 ^b	-.72	0	.0738
Coefficient ^a	1	1	1	1	1.972	-.0081	1.64	1	1.336

^a The coefficient, in the appropriate equation, of B, log B or 1/B respectively. For Fechner's Scale the coefficient is that for common logarithms.
^b These values are that for s_1 , the sensation for unit albedo, in the case of the Fechner scale, and that for S_∞ , the sensation for infinite relative brightness, for the limiting case $k=0$, since in both s_1 is infinite.

A similar comparison is given in Table 1 and Fig. 1 of this paper. The figure differs from that of Priest *et al*,—besides giving curves for several other formulas than the three named,—in two respects; sensation (or value) has been plotted against log albedo, instead of log albedo against sensation, and the theoretical curves have been made to agree at numbers 1 and 9 of the *theoretical* Munsell scale, (equation 10) while the *albedo* of the Munsell papers, as measured by Priest *et al*, is indicated by crosses. Solid lines indicate formulas derived from that of Plateau (equations 9 to 13) for the indicated values of the exponent ϵ , dotted lines show the relations given by the equation of Adams and Cobb

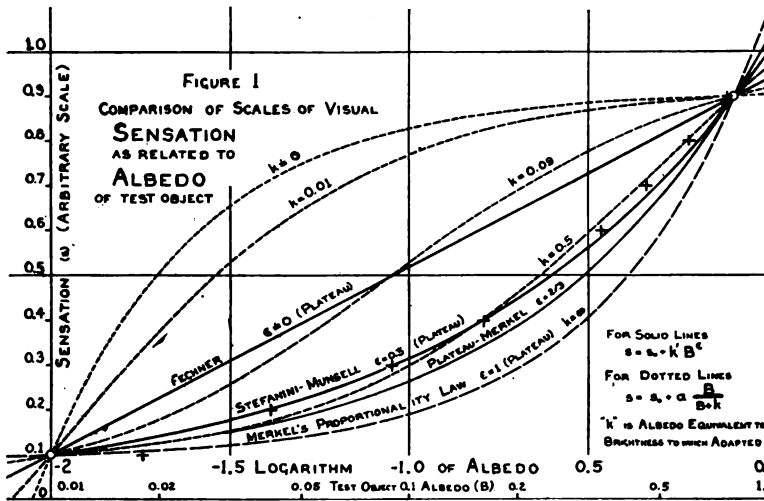

(equations 4 to 8) for various values of k , the brightness to which the eye is adapted, (expressed in *albedo* units). The Merkel proportionality law, being a limiting case of both the foregoing, is indicated by a dashed line.

From the figure it can be seen that all the other curves lie within those representing the limiting cases of constant adaptation to zero and infinite brightness, respectively; hence, by an appropriate constancy or variation in the state of adaptation during the measurements, any of the relations shown could be obtained experimentally. Again, it will be noted that with adaptation to the

geometric mean ($k=0.09$) of scale numbers 1 and 9 (of the theoretical Munsell scale) the relation between sensation and albedo approximates the scale of Fechner, whereas with adaptation to the arithmetic mean¹¹ of the same brightnesses ($k=0.41$), it agrees well with the Stefanini equation on which the Munsell scale is based. It is noteworthy that the actual Munsell scale agrees fully as well with the equation of Adams and Cobb (for $k=0.5$), as with the Stefanini equation.

In view of the criticisms by Priest, Gibson, and McNicholas it may be well to point out the *physical basis* of the Munsell scale. Its numbers represent the *amplitude* of the light waves from a diffusely reflecting surface relative to that of the waves from a *perfect* diffuse reflector, similarly illuminated.

In view of the marked dependence of the subjective scale of (luminous sensation) value on the state of adaptation, it is doubtful if the axiom of Priest, Gibson and McNicholas (p. 29): "It will probably be agreed by all who are interested in the subject and consider it carefully, that the steps in the value scale should be apparently equal; that is, the visual contrast between the cards of any two adjacent numbers should equal that between any other adjacent two,"—can be applied to the grading of the series of grays. It may well be preferable to use the actual albedo of the surfaces, since this scale is one of the *limits* of the subjective scale, namely that approached as the adaptation brightness is increased.

SUMMARY

1. Only if the state of adaptation of the eye is maintained constant, is it proper to speak of luminous sensation as a function of brightness.

2. With constant adaptation, k , the functional relation between sensation, s , and brightness, B , is well represented by the equation of Adams and Cobb.

$$s = \frac{B}{B+k} \quad (5)$$

¹¹ The curve for $k=0.41$ in the equation of Adams and Cobb has not been represented on Fig. 1, but it can easily be seen that it would lie only slightly above that for $k=0.50$.

3. All the equations connecting sensation and brightness are of such a form that,—within the range of validity of Weber's law,—the relation between sensation and test object *albedo* may be made independent of the absolute level of brightness (for any constant illumination of test object and surroundings) but will depend on the albedo of the surroundings to which the eye is adapted.

4. Between numbers 1 and 9 of the Munsell scale of (luminous sensation) value, the sensations of an eye adapted to a brightness corresponding to the arithmetic mean¹¹ of the albedo of those scale numbers (i.e., 0.41) approximate the values of the Munsell scale.

5. Within the same limits, the sensations of an eye adapted to a brightness corresponding to an albedo of 0.09,—the *geometric* mean of the albedos corresponding to Munsell scale numbers 1 and 9,—approximate the values of the Fechner scale.

6. In view of the marked dependence of subjective value on the state of adaptation of the eye, grays should be rated according to their *albedo*, which is a physically determinate property.

NELA RESEARCH LABORATORIES
CLEVELAND, OHIO
AUGUST, 1922.

INSTRUMENT SECTION

THE MEASUREMENT AND SPECIFICATION OF OPTICAL CHARACTERISTICS IN PROJECTOR PERFORMANCE

By G. W. MOFFITT

In order to facilitate further improvement in the art of optical projection it has become desirable to definitely recognize those optical characteristics of projector performance which should be the basis for judging the merits of any projector of whatever construction. The measurement and specification of these characteristics should also be considered and a system adopted which will not only make possible a critical study and comparison of the various types of projector but will also make the results of such study and comparison generally available instead of leaving this information entirely with a few.

Optically the performance of projectors may vary in definition, in screen illumination, and in quality. In addition to these there are certain other phenomena—such as shutter effects and vibration—that affect the optical performance but which are due to causes entirely mechanical. For the presence of these defects the optical system should not be blamed, but nevertheless account must be taken of them in the specification of the optical characteristics of projector performance. Moreover, it is obvious that a consideration of the fine points in the optical performance of projectors may be profitably taken up only after the objectionable mechanico-optical effects have been reduced to an inoffensive degree.

DEFINITION

The first demand on the optical system of a projector is that it produce a well-defined screen image. Usually the projection lens is held entirely accountable for the definition, but unless it is properly supported by the machine good results may not be obtained even with the best of lenses. If the film is not maintained in a proper fixed position relative to the optical system, or if it is not allowed to remain stationary during the projection

intervals, then the performance will be unsatisfactory no matter how excellent the lens may be. Moreover, there are certain optical relations between condensing system and projection lens that may affect the definition to some extent. This matter will be considered in a subsequent paragraph.

Of recent years the increasing use of the motion picture in the home and in the school at rather short viewing distances and with small screens has resulted in the production of apparatus using miniature films. On the basis of conservative study of this matter the conclusion is justifiable that there is a proper place for films of this kind. In some cases there has been a tendency to crowd on the magnification and make these miniature outfits project a picture much larger than was necessary for satisfactory results. This practice requires a film magnification as high—sometimes higher—than that required for standard projection of very large pictures where the viewing distance is great. It means that the miniature film demands a degree of correction in the projection lens hitherto not called for in the standard sizes. If these small films come into general use a very superior type of projection lens will be required.

Formerly the specifications for good projection lenses did not tax the resources of the designers. But now the increasing demands for higher efficiency have made refinement necessary. Relative apertures have been increased until—as seems to be the opinion of many—further advance in this direction is limited by the decreasing depth of focus in its relation to the mechanical limits in maintaining the film position and contour. More and more we find designers turning their attention to improvement in definition, in transmission, and in quality of image. Along with these advances in projection lens design the need has arisen for a workable system of measurement and specification of projection lens performance and of the optical characteristics of projector performance in general.

No doubt there are those who would advocate the use of precision lens bench tests as the basis for the specification of definition in projector performance. But while it is true that the lens bench is a very useful aid in the critical study of the

performance of lenses intended for use as visual or as photographic objectives it does not necessarily follow that it is universally applicable, except in the hands of an experienced worker. Because of the power of the instrument to show up the defects of a lens system there is sometimes a tendency to judge too critically when examining a lens in this manner, and the necessity for making allowances in the interpretation of the results gives an opportunity for bias and temperament to affect the judgment. Of course this ability to reveal image defects makes the instrument indispensable to the progressive designer who wants to know *in what way* the lens is failing. Lens bench tests are made with a uniform distribution of light over the aperture of the objective whereas in actual projection this might be, but usually is not, the case. In fact the intensity distribution over the area of a projection lens aperture is usually very far from uniform. This lack of uniformity is such that the performance of a projection lens will often be better than a lens bench test would lead one to expect. Obviously then, the projection lens should be tested in position and under actual working conditions. Illuminating systems differ considerably in the matter of uniformity of intensity at the lens. Therefore a lens possessing considerable zonal aberration may show up better on some projectors than on others. As higher and higher optical efficiency is attained the opening of the projection lens will become more and more uniformly and completely filled. Here again, it may be noted, the conditions for improved efficiency demand better correction of the aberrations of the projection lens.

The definition tests should be made when the machine is completely adjusted for showing a picture of normal size at normal screen distance. If the sum total of optical performance as affected by the mechanical defects is desired the machine should be running at full speed while readings are being made. If it is suspected that the mechanical effects are of considerable magnitude and that therefore the test may not be a fair one for the optical system the readings should also be made with the mechanism at rest. Thus whether the tests be made with the machine in motion or stationary depends on whether one is

testing the *individual complete machine* or the *optical system of the machine*.

A suitable standardized plate, such as is shown in Fig. 1, of sufficient rigidity to prevent warping may be placed in the film-gate and the focus set for the best delineation of the central hole. It is then a simple matter to find the position, with respect to the screen plane, of the primary, the secondary, and the best image, and also the distortion for any or all of the field points. This may easily be done with a white card and a meter scale.

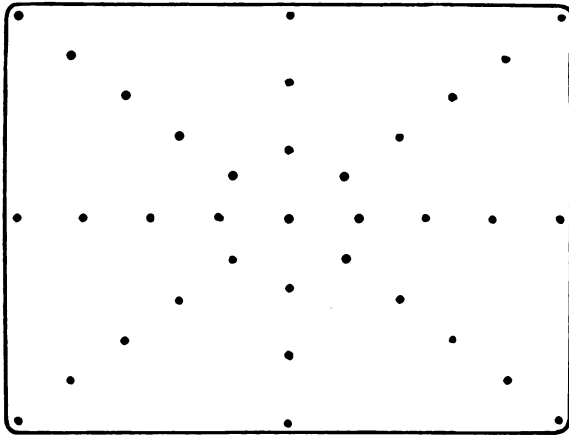

FIG. 1. Showing the arrangement of pin-holes in a proposed film-gate stencil plate suitable for the study and measurement of the aberrations of a projection lens.

If any of the desired images fall behind the screen one may place the focus for the central spot at a suitable small distance in front of the screen and all of the images which it is desired to measure may thereby be made accessible. Thus all that is necessary to map the field is the standardized plate, a meter stick, and a white card to serve as a search screen. Coma, as usual, refuses to submit to numerical specification and we must be content with a more or less qualitative statement regarding it.

In case the quality of the axial definition is in question one may resort to a consideration of the best image size—after making proper allowance for the geometrical magnification—or to resolving power tests carried out in the usual way although

resolving power tests of this kind made under conditions of uniform flux density at the lens should be accepted here with some reserve for the reasons already pointed out. The design of a satisfactory resolving power test slide to fit into the film-gate is a matter that might well receive considerable attention.

SCREEN ILLUMINATION

The measurement of screen illumination is comparatively easy but deductions from such measurements should be drawn cautiously for the contrast rendering ability is sometimes affected by gain in illumination. Illumination gained at the expense of contrast rendering ability may be no net gain at all. In order that the illumination measurements may be complete it is necessary to determine the intensity, the uniformity, the screen size and distance. Measurements should always be taken with the machine running for there are certain types of shutter that have a vignetting action. Since the screen brightness always depends on the characteristics of the screen itself it is obvious that *screen illumination* and not *screen brightness* should always be measured when the performance of the projector alone is under consideration. Machines with freak shutters having translucent blades, or blades otherwise diffusive, offer some difficulty in the determination of effective screen illumination and unless care be exercised the conclusion may be reached that the effective illumination is higher than is actually the case, the apparent gain being only diffuse light that can do nothing but fog the screen and degrade the quality of the projected picture. On the other hand perforated flicker blades, or flicker blades regularly transmitting a portion of the light, may actually increase the effective illumination to some extent.

Uniformity of screen illumination is, perhaps, best expressed by stating the ratio of the illumination at the various screen points in question to that at the center of the screen. It would be advisable to select and standardize a certain set of screen points to be used in this connection. A stencil to fit the film-gate could be made that would indicate on the screen the points at which to make illumination readings. Fig. 2 shows a proposed stencil

of this kind that is easily made of fine wires stretched on a frame. The illumination is to be read in the small squares, these areas being so chosen that a good idea of the distribution is obtained. Whatever the arrangement of such a set of selected points may be they should be so chosen that any lack of symmetry either along horizontal or vertical lines will be apparent. There are a number of factors entering into the question of the best distribution of screen illumination which would seem to indicate that a uniform distribution, or even a symmetrically vignetted distribu-

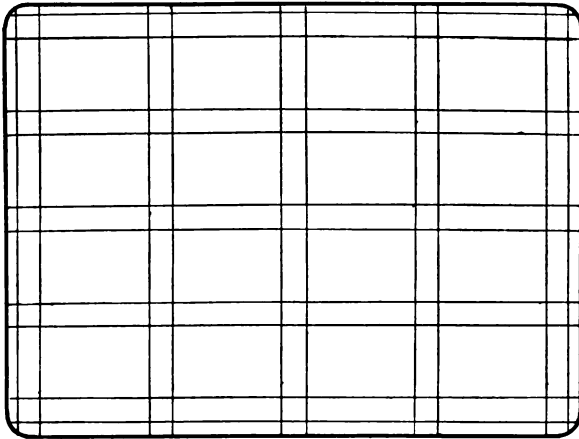

FIG. 2. Stencil of fine wires for use in the measurement of screen illumination. Readings are made on the centers of the small squares.

tion, is not generally the best, and that there is no one type of distribution that is best for all installations. Therefore a rather complete statement of the distribution is desirable, in order that one may estimate correctly the performance of the projector in any given auditorium.

The results of a screen illumination test should be accompanied by a statement of screen size and distance, for both the distribution of the light and the intensity may be changed in a manner other than the size of the screen would lead one to expect. The change in focus for different distances may necessitate slight readjustments of the illuminating system and so change slightly the effective diaphragming. And, of course, the performance of a given machine for a given picture size with a projection

lens of one focal length should not be taken to apply to the performance of the same machine with a projection lens of the same make but of another focal length the distance being changed so that the picture size is maintained. It is well known that the illumination falls off for a given picture size as the focal length of the projection lens is increased. But it does not seem to be so well known that there is no fundamental theoretical reason for this and that present-day machines have this characteristic simply because manufacturers have gotten into the habit of making them that way.

Qualitative statements as to color effects, local patchiness, and striations not revealed by the values of illumination at the standardized points should also be included in the complete statement of screen illumination, although no projector can be considered good if it is not possible to eliminate such defects.

QUALITY

Quality in projection is determined by those characteristics of a projector which affect its ability to render faithfully the contrasts of the film. It deserves more attention than it has received in the past. Under this head we find the defects generally known as "flare-spot" and "flare." Scattered light which does not come through the lens but reaches the screen by other paths need not be considered here for such light can always be controlled.

Fortunately nearly all good projection lenses are of a type especially free from inherent flare-spot and flare, that is, the design is such that reflection images are few in number and advantageously located. But with the newer trend toward higher relative aperture and higher film magnification a tendency may be noted in some quarters to depart from the time-tried types and exploit others neither so well suited to give high transmission of image-forming light nor so fortunate in the small number and desirable position of their reflection images.

Flare-spot.—This defect is noticeable whenever an image of a strongly radiating point is formed by reflection between some of the lens surfaces, the image so formed falling near the screen. The result is that irregular areas of fog and more or less concen-

trated spots of light may play about on the screen, their position, intensity, and motion depending on the character of the film being shown. They may be more conspicuous with some condensing systems than with others.

To detect the presence of flare-spot in a projector place the definition test slide in the film-gate precisely as in the definition test. Any other opaque slide having a number of small distributed holes will serve. If splotches of light appear among the screen images of the holes the system is afflicted with flare-spot. Obviously nothing more than a qualitative statement can be made as to the extent to which this defect is present.

Flare.—Flare is usually due to out-of-focus flare-spot. That is, the light which in some cases goes to make a flare spot is so much out of focus that it is quite uniformly distributed over the screen. Another source of degraded contrast in projection is found in poorly polished surfaces and surfaces that are not clean. Obviously all these causes of flare are more marked in their effects the greater the number of air-glass surfaces.

If the machine is equipped with a shutter having any of its blades translucent, or otherwise diffusing, the tests for flare should be made with the machine running. Solid blades with edges blackened would not be expected to have any noticeable influence on the quality of the picture, but shutters with some of the blades of diffusing material add to the total illumination only by the amount of scattered light they throw onto the screen with the result that the picture is degraded thereby.

The specification of flare may best be made by stating the maximum contrast which the projector is capable of rendering in the most unfavorable case, that is, when a small opaque object is depicted on a fully illuminated screen. The necessary measurements can be made by placing a small opaque and well-blackened disk or strip in the film-gate as shown in Fig. 3, and then determining the ratio of full illumination on the screen adjacent to the image of the disk or strip to that in the image itself. Care must be taken to see that the measuring instrument is capable of measuring the contrast obtained with the best lenses. Furthermore it must be used in such a way that there is no question of

diffusely reflected light getting into the dark half of the photometer field. A statement of the full illumination and of the picture size should also be included.

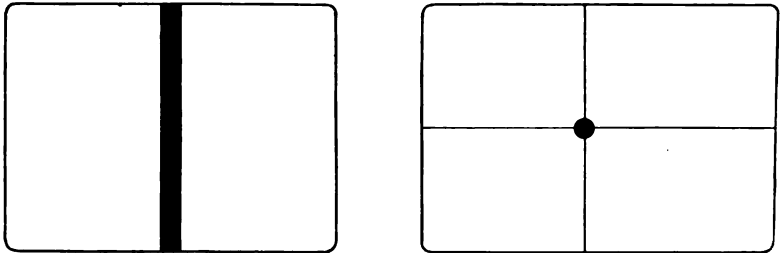

FIG. 3. *Proposed stencils for flare determination.*

CONCLUSION

By the use of some system of measurement and specification, such as that here outlined, the optics of projection may be placed on a definite basis quite as readily as has already been done for the photographic objective. The improvement of the performance by the improvement of one or more of the component parts is, of course, a matter for the designer and its consideration is beyond the scope of this paper.

FRANKFORD ARSENAL,
PHILADELPHIA, PA.
JULY, 1922.

AN ELECTRON TUBE TUNING FORK DRIVE*

BY E. A. ECKHARDT, J. C. KARCHER AND M. KEISER

In view of the increasing use of tuning forks, both in research and in industry, the maintenance of tuning fork vibrations has become a matter of some practical importance. Applications of the tuning fork (1) as a sound source; (2) as a small scale time standard; (3) as a frequency or pitch standard; (4) as a current interrupter, and (5) as a synchronizer or speed-controlling device, are suggestive of the general wide field of usefulness of the tuning fork as a research and engineering instrument.

The invention of the electrically-maintained tuning fork is probably due to Lissajous,¹ although frequently ascribed to Helmholtz.² The method used by both involves the periodic opening and closing of the electrical circuit by the vibrating forks. Many modifications of detail involving this general principle, however, are to be found described in the literature. The difficulties encountered in the microphonic behavior of the interrupting contact were made the basis of the microphonic method of maintenance by Appleyard.³ Until 1919 the interrupted contact and the microphonic methods for maintaining tuning fork vibrations electrically were practically the only ones available, the former being almost universally used.

During 1919 papers appeared by Abraham and Bloch⁴ and Eccles and Jordan⁵ describing methods for maintaining tuning fork vibrations electrically without circuit interruptions, by means of electron tube circuits. Contemporary work by the present authors⁶ led to similar results. The purpose of this paper is to describe apparatus and circuit arrangements which we have found advantageous and to point out advantages of this method.

It is well known that the maintenance of tuning fork vibrations by means of circuit interrupters is more difficult the higher the

*Published by permission of the Director of the Bureau of Standards of the U. S. Department of Commerce.

frequency of the fork. Beyond 300 cycles the difficulties are very great.⁷ Helmholtz⁸ vibrated a series of eight tuning forks, whose respective frequencies were 120 and integral multiples thereof, by means of an interrupter fork of frequency 120 cycles per second. This procedure of driving a high frequency fork by means of a sub-harmonic interrupter fork has recently been used by Curtis and Duncan⁹ for maintaining the vibrations of a 500-cycle fork in a tuning fork chronograph. The driving and driven fork frequencies must be adjusted to have a precise multiple ratio. This adjustment is quite critical and is not easily maintained, particularly if the frequency ratio is high. We have applied the electron tube drive to a large number of forks in the frequency range from 50 to 2,000 cycles. There has been no occasion to attempt higher frequencies, but the experience with the 2,000-cycle fork indicates that it is entirely feasible to go higher in the frequency scale.

THE PRINCIPLES OF THE ELECTRON TUBE CIRCUIT TUNING FORK DRIVE

The electron tube circuit in general consists of a plate or power circuit and a grid or control circuit. Both are completed through the electron tube and have common circuit elements therein. These circuits may be coupled externally in such a manner that the total action becomes regenerative. This is the case when the coupling is such that the current rise in a plate circuit is followed by a potential rise of the grid which, operating through the tube, will serve to augment the current rise in the plate circuit which started the action. The current thus generated is oscillatory because of the nature of the circuit and soon reaches a maximum which is determined by the closeness of coupling and the characteristics of the vacuum tube.¹⁰

A characteristic form of regenerative circuit is shown in Fig. 1. The external coupling between the grid and plate circuits is here inductive. If the circuit constants are suitably related¹¹ such a circuit will act as a generator of electrical oscillations the frequency of which may be controlled by an adjustment of the circuit constants.

Forced vibrations of a telephone diaphragm or a tuning fork are obtained if the windings of the telephone receiver or the driving electromagnet of a tuning fork are included in the plate circuit of such an oscillation generator or coupled to it through a transformer. By adjustment of the oscillator frequency to resonance relatively large vibration amplitudes may be obtained. The

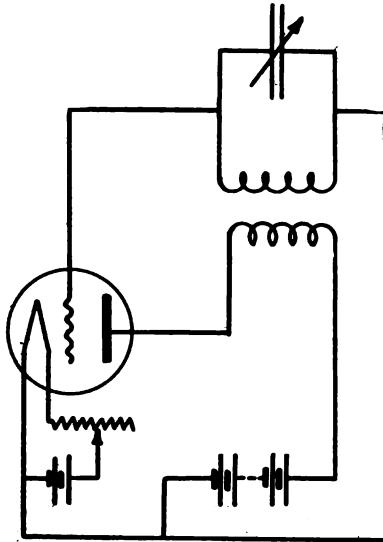

FIG. 1. *Regenerative electron tube circuit.*

maintenance of tuning fork vibrations in this manner is not satisfactory, however, because it is more or less difficult to maintain the frequency of an oscillator circuit sufficiently constant while yielding sufficient power to assure an adequate amplitude of vibration.

As pointed out by Eccles and Jordan the coupling in a regenerative circuit may be wholly provided by a vibrating mechanical system, the interaction between the regenerating circuit elements being due to the mechanical motion, or the coupling may be partly due to the mechanical system, and partly electrical. In the apparatus developed by the authors the mechanical coupling predominates and the inductive coupling between the grid and plate circuits is adjustable. The arrangement is shown

schematically in Fig. 2. Moving the laminated iron yoke which carries the grid coil up to or away from the driving electromagnet changes the electrical coupling within suitable limits. The variability of the coupling thus provided is of importance in adjusting the circuit for any one fork or in making the same circuit available for driving forks of different frequencies. The complete

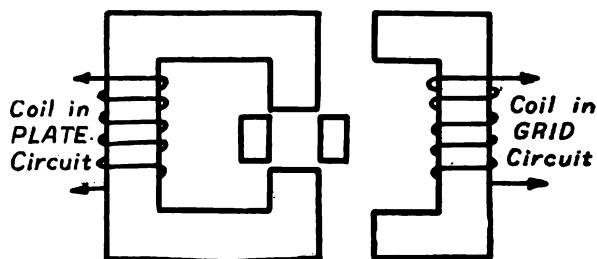

FIG. 2. Schematic diagram of tuning fork drive.

circuit in idealized form is shown in Fig. 3, and Fig. 4 shows an equipment with a 500-cycle tuning fork mounted for driving.

The functioning of the circuit is in brief as follows: The closing of the plate circuit (with filament bright) starts the plate current through the driving electromagnet. The fork-prongs are pulled together and thereupon vibrate feebly. Inspection of Fig. 2 will

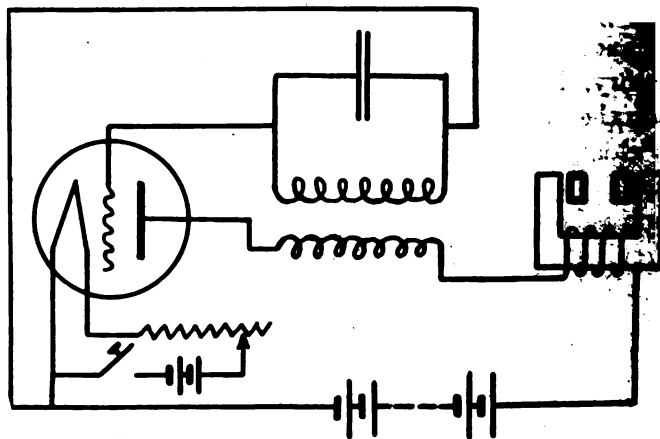

FIG. 3. Idealized tuning fork drive circuit.

indicate that this feeble motion of the fork has a relatively large effect on the reluctance of the magnetic circuit. The reluctance

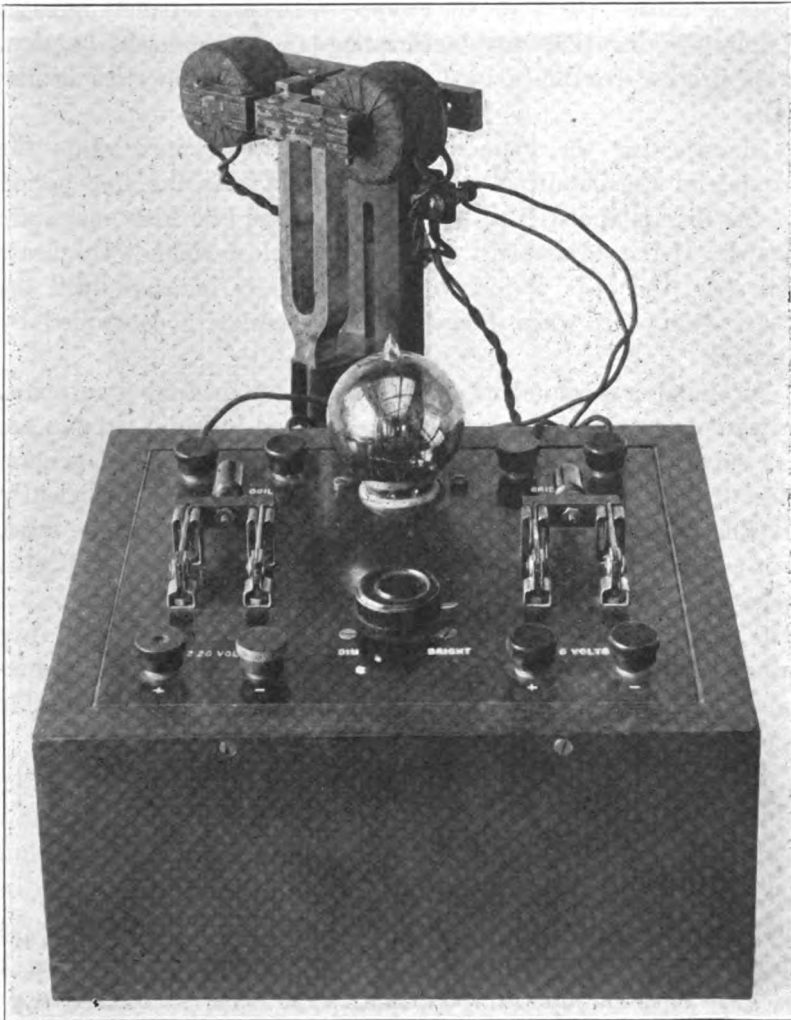

FIG. 4. 500 cycle tuning fork unit.

changes are determined by and are in synchronism with the free period of the fork. Corresponding variations in the plate

current result, which by virtue of the coupling existing between the plate and grid circuits are regeneratively amplified. The alternating component of the plate current, as its growth progresses, causes the fork to vibrate with progressively greater amplitudes, in this way accelerating the regenerative action. This process continues until limited by the properties of the tube.

In adjusting the filament current to the proper value the singing of the circuit is a valuable guide. As the free period of the fork is approached beats between the two frequencies are heard. If the adjustment is sufficiently close so that the beats are slow, the beat period will automatically increase until the beats disappear, when the circuit is completely controlled by the fork.

A condenser is connected across the grid coil for tuning purposes. Mica condensers of the type generally used in radio circuits are far superior to paper condensers for this purpose. In general the driving arrangement illustrated in Fig. 4 is sufficiently flexible so that commercially available condensers may be used. For a 500-cycle fork the plate coil has 1,200 turns of No. 28 B. & S. gage silk-enamel wire and the grid coil 3,000 turns of No. 30. The tuning condenser has a capacity of 0.25 microfarad. Any tube of 5-watt rating, providing a steady plate current of approximately 50 milliamperes with 220 volts on the plate is suitable for use in the circuit.

Fig. 5 shows a circuit arrangement in which all the necessary power for operation is derived from a 220-volt power circuit. The diagram is practically self-explanatory. The 3,300-ohm rheostat permits the adjustment of the grid to positive mean potentials, which is sometimes advantageous. The ammeters shown in the filament- and plate-circuits are very convenient because once the operating currents have been established they facilitate adjustment when the power line voltages are not uniform.

The drive discussed for tuning forks is adaptable for maintaining the vibrations of a diaphragm at its natural frequency.

Fig. 6 shows the method of drive applied to a Webster phone. Fig. 7 shows the phone with the cylindrical resonator case removed. A small piece of iron is mounted on the diaphragm. Its position is adjusted to correspond to that of the right hand prong of the tuning fork in Fig. 2. The position of the driving magnet M is adjustable by sliding along the guide rods R_1 and R_2 .

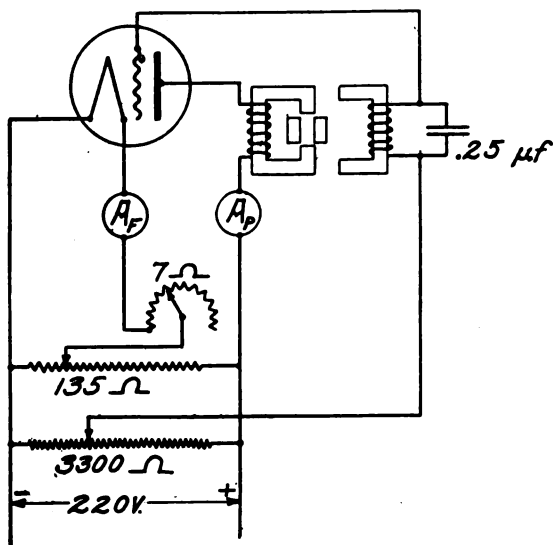

FIG. 5. Circuit for operation from 220 volt power supply.

The clamp screws C_1 and C_2 hold it firmly in the chosen position. The grid magnet G is mounted behind the driving magnet to slide on the same guide rods, the relative position being adjustable during operation by means of the adjusting screw S .

This type of tuning fork drive is especially available for use with tuning fork chronographs where precision of frequency is a matter of great importance.¹²

BIBLIOGRAPHY

1. A. & V. Guillet, Nouveaux modes d'entretien des diapasons, C. R. 130, pp. 1002-1004; 1900.
2. E. A. Kiehlhauser, Die stimmgabel (Teubner, 1907), p. 43.

3. R. Appleyard, On a method of driving tuning forks electrically. *Proc. Phys. Soc.*, *10*, pp. 288-290. *Phil. Mag.*, (5) *28*, p. 490; 1889.

4. Abraham and Bloch, *C. R.* pp. 1197, 1198, June 16, 1919; *Jour. d. Phys.*, Ser. V, *9*, pp. 225-233; 1919.

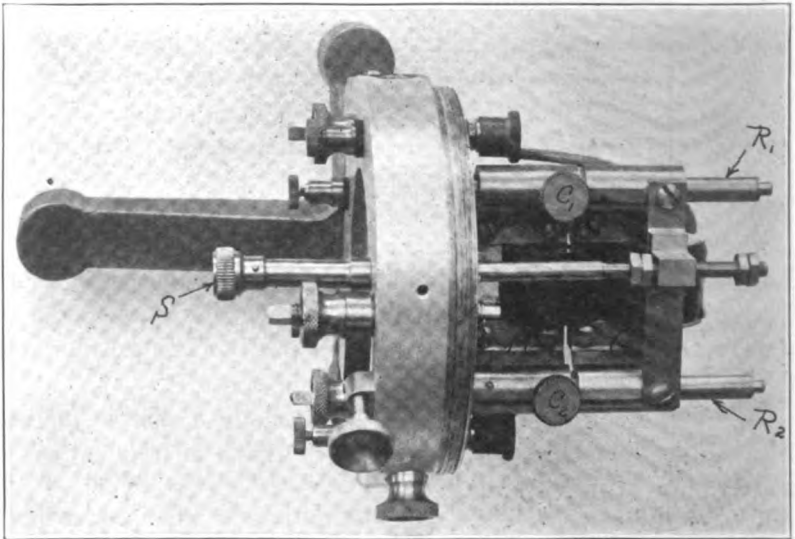
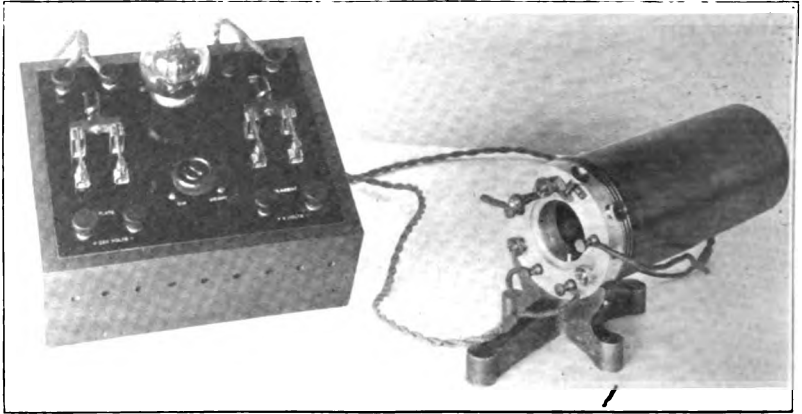

FIGS. 6-7. Webster Phone with electron tube circuit drive of diaphragm.

5. Eccles and Jordan, *The Electrician*, *82*, p. 704, June 20, 1919.

6. Eckhardt, Karcher, Keiser, *Phys. Rev.*, Ser. 2, *17*, pp. 535-536; 1921.

7. Rayleigh's Sound, *1*, (2d ed.), p. 456.
8. Helmholtz, Die lehre von den tonempfindungen, 3d ed., pp. 183-185; 1870.
9. H. L. Curtis and R. C. Duncan, Jour. Wash. Acad. Sc., *9*, p. 642; 1919; Phys. Rev. 2nd Ser., *15*, pp. 511-512; 1920.
10. See Bureau of Standards Circular No. 74, Radio instruments and measurements, secs. 56-58.
11. L. W. Turner, The oscillatory valve relay, The Electrician, *83*, pp. 4-5; 1919.
12. E. A. Eckhardt, A precision high speed oscillograph camera, Jour. Frank. Inst., *194*, pp. 49-67; 1922.

A LABORATORY HYSOMETER*

BY E. F. MUELLER AND T. S. SLIGH, JR.

A very simple form of hypsometer, consisting of a nearly closed space into which steam from a boiler can be admitted, will serve to maintain, in the steam space, a temperature which differs, at most, by a few hundredths of a degree from that corresponding to saturated steam at atmospheric pressure. The well known Rudberg or Regnault hypsometer is a very simple piece of apparatus and is capable of serving the requirements of all but the most precise thermometric measurements.

Of the various more elaborate forms of hypsometers which have been devised for precise measurements two were designed at the International Bureau, while most of the remainder originated at the Reichsanstalt. In the Chappuis hypsometer¹ which was an improved and simplified form of a very elaborate instrument devised by Pernet,² the design was determined almost entirely by the requirement for facility in changing the position of the thermometer from vertical to horizontal, while in the steam. In this hypsometer, the steam is lead from the boiler through piping to a tube in which the thermometer is placed, thence into an annular space surrounding the tube, and thence to the condenser. A water manometer is used to measure the difference between the pressure in the steam space and that of the atmosphere. A copy of this instrument has been in use for many years at the Bureau of Standards, and the only feature of it to which objection might properly be made, is the water manometer.

Thiesen, Scheel and Sell³ describe a very elaborate hypsometer, which was a modification of an earlier instrument described by Pernet, Jaeger and Gumlich.⁴ The hypsometer as modified con-

*Published by permission of the Director, Bureau of Standards.

¹ Described by Guillaume, *Trav. et mem. du Bur. Int.*, 5, p. 39; 1886.

² *Trav. et Mem. du Bur. Int.*, 1, p. B-15; 1881.

³ *Wiss. Abh. der Phys. Tech. Reichsanstalt* 2, p. 138; 1895.

⁴ *Wiss. Abh. der Phys. Tech. Reichsanstalt* 1, p. 87; 1894.

sisted of a large gas heated fire tube steam boiler, from which the steam was piped through a pressure regulator, to the space in which the temperature was to be measured. In the bottom of this space was a water seal, through which the entering steam was made to pass in order to ensure saturation. The steam escaped from the steam space through a second pressure regulator. An important feature was the manometer for measuring the excess pressure in the steam space. The one limb of this manometer which was in contact with the steam, was surrounded by water which was kept boiling violently by means of steam supplied by a separate boiler. The other limb of the manometer included a water surface of large area.

In the description of this apparatus, the errors due to possible superheating, and to incorrect measurement of the pressure in the steam space, are emphasized, and it is evident that elaborate measures were considered necessary to eliminate such errors. It is reported that the apparatus functioned satisfactorily.

A later apparatus described by Guitzmacher⁵ has the general appearance of the Regnault hypsoneter, but differs from it in provision of special means to eliminate superheating. The steam from the boiler flows through a number of short tubes, through a water seal forming the bottom of the thermometer space, and thence past the thermometers. A number of water manometers were connected for indicating the excess pressure of the steam, but evidently it was not considered necessary to boil them as in the apparatus previously described.

It does not appear necessary to refer to all of the various other forms which may be found described in the literature. It will be sufficient to refer to the hypsoneter used by Henning & Heuse⁶ in their recent determination of the expansion of gases. Steam was generated in a small boiler, heated by an electric heating coil immersed in the water. The steam was piped to the top of the annular space surrounding the thermometer space, flowed downward in the annular space and up past the thermometer

⁵ *Wiss. Abh. der Phys. Tech. Reichsanstalt*, 3, p. 259; 1900.

⁶ *Zs. für Physik* 5, p. 295; 1921.

and thence to the condenser. The excess pressure was read on a water manometer. All parts were thoroughly insulated to avoid fluctuations of temperature due to drafts.

The last two forms of apparatus are noteworthy as indicating a tendency to depart from the somewhat monumental form attained in earlier instruments. It is also noteworthy that the last apparatus while omitting the very elaborate precautions observed in the design of earlier forms, was used with platinum resistance thermometers, which would have made it possible to detect errors and irregularities so small as to escape detection entirely in work with mercurial thermometers.

The above brief review will indicate that in the design of hypsometers, in addition to the essential precaution of steam jacketing for the space in which the thermometer is placed, which is the feature that makes the distinction between the Rudberg or Regnault hypsometer and an ordinary tin can, the refinements which have been emphasized are (1) avoidance of superheated steam in the space around the thermometer, (2) accurate measurement of the pressure in this space, (3) provision for securing constancy of pressure and temperature in this space. To these the authors would add purity of material as an essential feature, to be attained by rapid and thorough removal of air from the steam.

In designing a new hypsometer⁷ for general laboratory use, it appeared that an improvement on the instruments already described could be obtained by introducing the steam into the thermometer space and the surrounding annular space at the top, allowing the steam to flow downward in parallel in the two spaces. This arrangement secures steam jacketing of the thermometer space, avoidance of superheat in the steam, since the boiler is located at a distance and ample cooling surface can be provided between boiler and thermometer space, and eliminates entirely the necessity for a water manometer to measure the excess pressure of the steam. The density of steam being less than that of air, a column of steam flowing downward in a pipe

⁷ Briefly described in *Jour. Wash. Acad.* 11, p. 167; 1921.

open to the air at the bottom, is stable, while if the steam is flowing upward in a pipe, stability can only be attained by restricting the escape of steam sufficiently to cause the pressure in the pipe to exceed that of the atmosphere. The downward flow of the steam also greatly facilitates the removal of air from these spaces.

The details of construction will be evident upon reference to the photograph, Fig. 1 and the schematic line drawing, Fig. 2. Electric heating was chosen for convenience. The boiler is made of a brass tube 5 cm in diameter and 20 cm high, the outside reservoir serving to maintain a nearly constant water level. The steam pipe from the boiler is a 13 mm brass tube, which enters the steam space around the thermometer tangentially. The small boiler makes it possible to heat up rapidly, and its small cross section and the small steam pipe provide for relatively rapid steam flow in these portions thus facilitating rapid removal of air. The upper 5 cm of the thermometer space are uninsulated to provide surface for condensation, while the remainder of the space is provided with an air jacket which is apparently sufficient to prevent fluctuations due to drafts. The steam after passing through the thermometer space, escapes into the air or may be condensed and returned to the boiler.

All parts in contact with steam or water were tinned. The heating coil consists of two sections which may be connected by means of the switch, either in series or parallel. With the coils in series on a 110-volt circuit the input is about 125 watts which is sufficient to maintain just a trace of steam escaping into the air. Increasing the input up to 640 watts produced no determinable change in the indications of a resistance thermometer in the steam, thus indicating the absence, both of superheating and of excess pressure.

A series of steam point determinations with a resistance thermometer, using both the new hypsoneter and the Chappuis hypsoneter, indicated no systematic difference between the two, although the precision was slightly in favor of the new instrument. Fortuitous errors of about 0.005° persisted and are apparently due

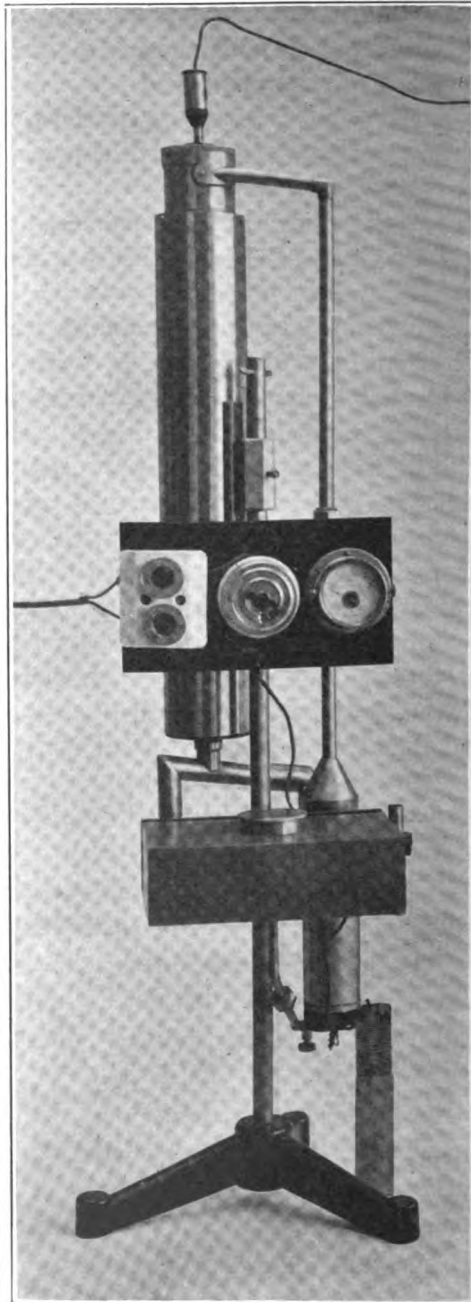

FIG. 1. *Laboratory Hypsometer*

to irregular fluctuations in atmospheric pressure or to errors in measurement of barometric pressure indicating that improve-

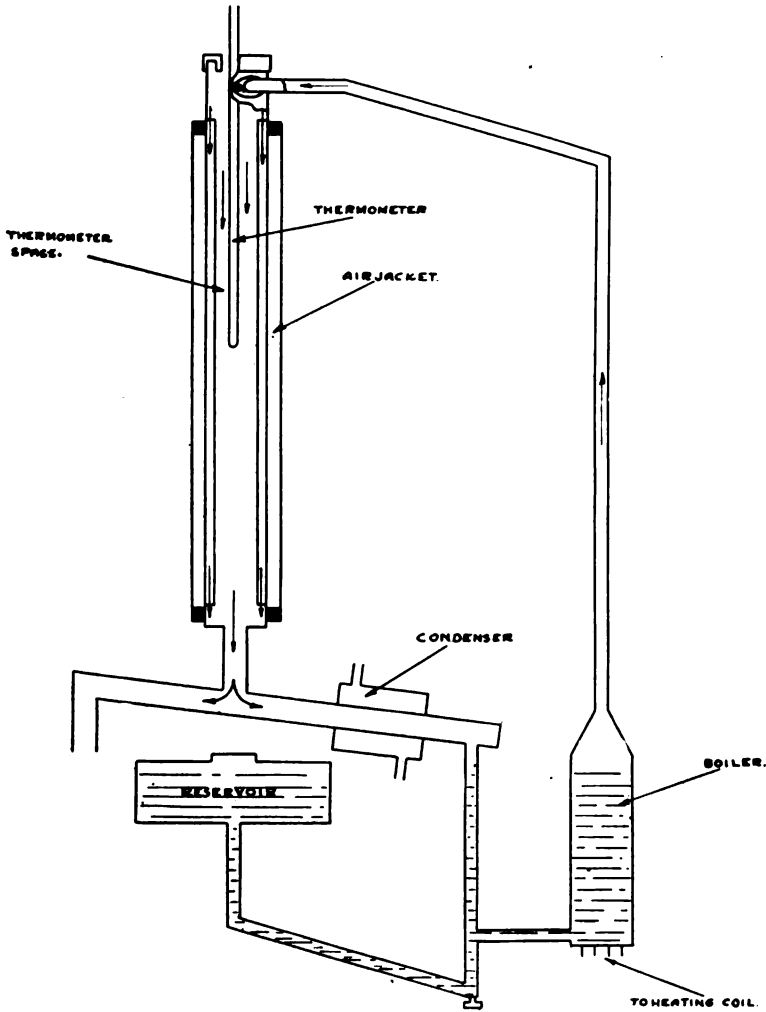

FIG. 2. Schematic Diagram of Hypsometer

ments in this respect will require the use of a closed system and better temperature control of the barometer.

While there is no indication that results hitherto obtained with other hypsometers are in error, it is believed that the principles

applied in the design of the present instrument can be used to advantage in the construction of new equipment.

BUREAU OF STANDARDS,
WASHINGTON, D. C.

A HIGH TEMPERATURE REGULATOR FOR USE WITH ALTERNATING CURRENT

BY HOWARD S. ROBERTS

For many processes, in the factory as well as in the laboratory, elevated temperatures must be held within narrow limits for considerable periods. Where this can be accomplished automatically a part, at least, of the personal element is eliminated and more satisfactory results are secured. Sometimes, where electrical heating is used, the voltage of the power available fluctuates to such an extent that hand regulation is out of the question, and without automatic regulation no processes that involve close temperature control can be employed.

In a recent publication¹ the author described a furnace temperature regulator for direct current resistance furnaces, depending on the temperature coefficient of resistance of the heating element of the furnace. The heating element formed one arm of a Wheatstone bridge and its change of resistance with temperature caused the heating current to be increased and decreased alternately by a system of relays replacing the galvanometer of the bridge. Adams and White² had previously described a regulator operating on this Wheatstone bridge principle; while Haagn³ has described one in which the ratio of current to voltage-drop thru the furnace is maintained constant by a differential relay.

The present paper has to do with the adaptation of the author's direct current regulator for use with alternating current, thus meeting the limitation that direct current is not everywhere available. A possible advantage of using alternating, rather than direct current is that the effect of leakage on the readings of thermoelements at high temperatures is considerably reduced.

¹ J. Wash. Acad. Sci. *11*, pp. 401-409; 1921.

² Phys. Rev., *14*, pp. 44-48; 1919.

³ Elektrotech. Zs. *40*, pp. 670-672; 1919. Zs. Instrumentenk., *41*, pp. 92-93; 1921.

OPERATION OF THE REGULATOR

Since the fundamental principles underlying the operation of regulators of this type have been discussed elsewhere,⁴ the present paper will include only those matters peculiar to the alternating current apparatus.

The various parts are essentially the same as were used in the direct current apparatus, except that a more satisfactory relay has been developed and a simple rectifier placed in the galvanometer circuit, thus making possible the use of the original direct current galvanometer.

The functions of the various parts of the regulator will be sufficiently clear from the diagram, Fig. 1, to admit of postponing their detailed description until the operation of the regulator has been described.

We shall ignore, for the moment, the effect of self induction in the heating element and in the other resistors that together form the bridge, and assume that at a given instant the temperature of the heating element, and therefore its resistance, is such that the bridge is balanced. There is now no current flowing from *a* to *b* thru the galvanometer circuit. If the temperature of the heating element rises, its resistance increases and an alternating emf is set up between *a* and *b* which may be considered as in phase with the current flowing thru the bridge; if the temperature falls from this higher value, the emf *ab* passes thru zero and becomes 180° different in phase; i.e., it reverses just as would be the case if the bridge were supplied with direct current.

The current for the galvanometer passes thru a rectifier which, as will be shown later, causes a direct current to flow thru the galvanometer in one direction when the emf *ab* is in phase with, and in the opposite direction when the emf *ab* is 180° from the bridge current. Thus, the current thru the galvanometer passes thru zero and reverses as the temperature of the heating element passes a particular value, determined by the positions at which the contact arms *a* and *b* have been placed. The boom of the galvanometer (in the figure) tends to swing toward the right with rising temperature and toward the left with falling temperature.

⁴ Roberts, *op. cit.*, pp. 405-407.

The actual control of the temperature is brought about by cutting in and out a fixed series resistance, the "regulating resistance" in Fig. 1, as the temperature falls and rises, respec-

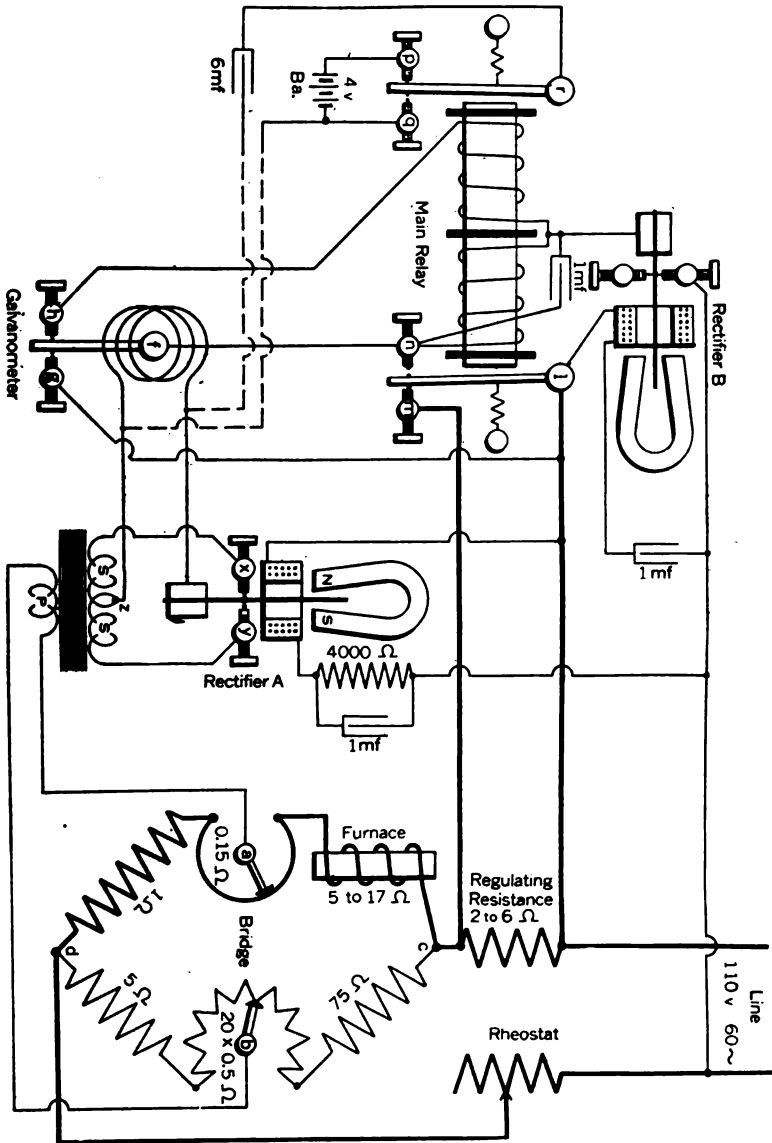

FIG. 1

ively. The outside rheostat must therefore be set to such a value that the temperature will fall when this resistance is in, and rise when it is out.

With the main relay in the position shown in Fig. 1 the "regulating resistance" is short circuited, the temperature is rising and the boom of the galvanometer is moving toward the right. When the boom reaches the right hand contact *g* a circuit is completed thru the right hand coil of the main relay, causing the relay to close. This does two things (we are not at present considering the contacts shown at the left hand end of the relay): it removes the short circuit thru *m* around the regulating resistance; and provides an alternative path, at *n*, thru which the energizing current of the relay may flow after the galvanometer contact *g* has opened.

The removal of the short circuit around the regulating resistance causes the heating element to cool, and the boom of the galvanometer begins to move toward the left. As has been pointed out, the current continues to flow thru the main relay because of the alternative path thru *n* and is not interrupted when the boom leaves contact *g*. When the boom reaches contact *h* a circuit is completed thru the second coil of the relay; the two coils oppose each other and the relay opens. By this action the whole supply of current to the relay coils is interrupted at *n*, and the short circuit around the regulating resistance restored at *m*. The latter causes the temperature of the heating element to rise, completing one cycle of the operation of the regulator.

Thus the temperature of the heating element oscillates between two fixed limits, a very few degrees apart. The thermal lag between it and the body whose temperature is to be held constant is usually sufficient practically to prevent oscillations in the temperature of the latter.

Where the bridge is supplied with direct current, it is quite obvious that for any position of the sliders *a* and *b*, there is a critical value of the resistance of the heating element for which the difference of potential between *a* and *b* is zero, and that this difference changes sign as the resistance of the heating element varies from a value slightly less to one slightly greater

than the critical value. In the case of alternating current, this potential difference can only be zero in the particular cases where the reactances as well as the resistances of the four arms of the bridge are in proportion, or where the resistances are in proportion and the reactances are zero. As is customary in dealing with alternating currents, the potential ab may therefore be represented by a vector whose magnitude and direction will, in general, both vary with the temperature of the heating element. If, however, we resolve this vector into a component in phase with, and one at 90° from the potential impressed on the bridge (from the potential cd), there will, as before, be some critical value of the resistance of the heating element for which the former (in-phase) component of ab is zero. Further, this component must change sign as the resistance of the heating element varies from a lower to a higher value than the critical value. On separating this component selectively from the 90° component and rectifying it, we obtain a pulsating direct current whose sign changes as the temperature of the heating element passes the particular value for which the sliders a and b are set. The selection and rectification may be accomplished by means of the synchronous vibrator described herewith or, for example, by means of a commutator driven in synchronism with the line voltage. The same result might also be obtained without rectification by making use of the electro-dynamometer principle (alternating current galvanometer).⁵ In any case the apparatus must be adjusted so that the component of ab selected by it is in phase with the voltage impressed on the bridge, in order to eliminate the effect of reactance in the bridge resistors.

So long as the reactances of the four arms of the bridge remain unchanged, the magnitude and direction of the vector potential ab is definitely fixed by the resistance of the heating element; but if they vary, because of a change in frequency, for instance, ab must also vary. It has already been shown that the galvanometer is affected only by changes in the power component of ab (the component in phase with cd). The effect of small changes in

⁵ As suggested in the author's previous paper, op. cit., p. 407.

reactance on the power component is small compared to the effect on ab as a whole; and where, as will usually be the case in practice, the ratio of reactance to resistance is itself low, the absolute change in ab as a whole is so small that the effect, of changes in reactance, on its power component can be neglected.⁶ We should therefore expect the temperature of the furnace or bath to be practically unaffected by any accidental variation in the frequency of the alternating current supply.

This expectation was verified, in the case of a resistance furnace, by comparing the temperature at which the regulator held it when supplied with alternating current, and with direct current. The temperature in the first case was 1081.1° and in the second, 1081.6° , a difference of 0.5° . This corresponds to the maximum possible frequency change of 100 per cent.

DESCRIPTION OF APPARATUS

The details of the bridge, indeed of the apparatus as a whole, will depend on the particular conditions under which it is to be used, but it may be worth while to take up certain general considerations, as well as to describe one form of the regulator.

The heating element should be made of some material having a rather high temperature coefficient of resistance, and should not oxidize readily at the temperature at which it is used. Copper and iron are satisfactory at low temperatures; nickel up to about 500° . The alloy "alumel" is said to have a high temperature coefficient and might prove satisfactory up to 800° or 900° . At still higher temperatures platinum is probably best.

Although the various resistance coils need not be wound non-inductively, the use of iron in their construction had better be avoided; this is particularly true of the bridge coils. The fine adjustment a , Fig. 1, may be a piece of heavy resistance wire bent into an arc of a circle, and the contact a short piece of the same wire set radially on a pivoted arm. In the case of the coarse adjustment b , a dial switch whose points are connected to the resistances is to be preferred to a rheostat whose slider makes contact directly with the turns of wire on a resistance coil: in

⁶ All of this can be shown rather simply by means of a vector diagram.

the latter case the contact arm is very likely to shunt one or more turns of the wire and, as the contact resistance changes, the setting of the bridge is disturbed.

As the apparatus is capable of responding to changes of 1 part in 20,000 in the resistance of the heater, the apparatus should be so constructed that the change in bridge setting from all other causes is considerably less than this. This means that the bridge resistances must be made from one or another of the low temperature coefficient alloys such as manganin, therlo, constantan, ideal, advance, etc.; the temperature coefficients of nichrome and chromel are a little too high. The connections within the bridge circuit should be of one of these alloys or of heavy copper and the joints should be soldered wherever possible. In order to prevent electrical or magnetic leakage from affecting the galvanometer, the connections to it should be thoroly insulated and the transformer must not be located too close to any of the resistance coils.

In the apparatus used by the author the values of the various resistances and capacities are those given in Fig. 1. These are chosen for use with any suitable heating device whose resistance, when in use, lies between 5 and 17 ohms. Power is supplied at 110 volts, 60 cycles, and the main relay has a capacity of about 10 amperes.

The galvanometer is the same instrument used in the direct current temperature regulator described elsewhere.⁷ It is a Weston "Model 30, five binding post galvanometer," having a resistance of 50 ohms and a period of about $\frac{2}{3}$ second. It is essentially a millivoltmeter in which the pointer is replaced by an arm carrying a contact button of "iridium alloy" which makes contact with one or the other of two contact screws, depending on the direction of the current in the coil. A potential of 1 millivolt across the coil terminals causes the contact button to move about $\frac{1}{2}$ mm.

When the apparatus is running continuously, each of the galvanometer contacts may be called upon to operate as often as

⁷ Roberts, *op. cit.*, p. 404.

40,000 times per day, and, unless the current flowing thru them is very small they quickly become pitted and stick. With a current of about 10 milliamperes, however, the contacts seldom stick for more than a few seconds before breaking loose, and will usually run for several days without attention. Contacts of Acheson graphite have been found very satisfactory; they need to be cleaned much oftener than the alloy contacts but have the advantage that they may be cleaned off with a nail file without interrupting the regulator.

Sticking of the galvanometer contacts when it does occur causes temperature fluctuations, so that for very precise control of the temperature some means must be adopted to prevent it. The inductive device as used in the direct current apparatus⁸ can not be used here, therefore we make use of the energy stored up in a condenser by a small dry battery.

This device is shown at the left hand end of Fig. 1, and for simplicity that portion of the relay is represented in the diagram as an additional armature r . With this armature in the position shown, there is a circuit from the battery B thru the 6 mf condenser and the galvanometer back to the battery, so that the condenser is charged to the potential of the battery. When the armature of the relay is attracted this connection thru the battery is broken and another made around the battery, at q , causing the condenser to discharge thru the galvanometer. When the armature drops back against p , the condenser is again connected to the battery and the charging current flows thru the galvanometer but in the opposite direction to the discharging current. The polarity of the battery is such that there is in either case a momentary deflection of the galvanometer away from the particular contact thru which it has just caused the main relay to operate.

In practice the contacts seldom fail to close the circuit promptly. When they have failed, it has invariably seemed to be due to a coating of charred dust and the trouble has disappeared when this was removed.

⁸ Roberts, op. cit., p. 402.

The rectifier, Fig. 2, consists of a reed *R* of clock spring, clamped to a support at one end. The reed passes thru a coil *C* of about 1500 turns of No. 36 B. & S. gage (0.13 mm) copper wire wound on a hollow bobbin of vulcanized fiber. The free end of the reed swings between the poles of a permanent magnet *NS*. The coil *C* receives current from the line and induces an alternating magnetic field in the reed. This causes the end of the reed to be attracted alternately by the north and by the south pole of the magnet *NS*, so that the reed vibrates with a pitch equal to the line frequency. A short distance from the clamped end the reed carries a contact button of molybdenum which may make contact with either

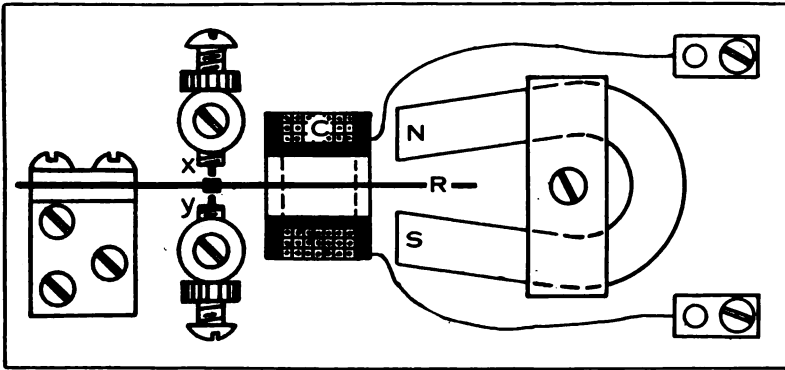

FIG. 2

of the molybdenum tipped contact screws *x* and *y*. Thus a circuit is closed thru one contact screw during the positive half of the reed's cycle and thru the other contact screw during the negative half.

The emf to be rectified is that of the split secondary of the transformer shown in Fig. 1. Here the emf's measured from the center *z* to the two ends are opposite in phase. Thus if the difference in phase between the vibration of the reed and the emf of the secondary as a whole is either 0° or 180° , a unidirectional emf is set up between the reed and the middle tap *z* of the

split secondary and a pulsating direct current flows thru the galvanometer. The direction of this current depends on whether the difference in phase referred to above is 0° or 180° .

If the difference in phase between the vibration of the reed and this emf is not 0° or 180° , it can be shown that, while the *instantaneous* value of the rectified emf may change sign during its cycle, the *average* value is equal to that which would be obtained by rectifying only that component of the secondary in phase with or 180° from the vibration of the reed.

The transformer has a primary winding having 1,000 turns of No. 24 B. & S. gage (0.51 mm) copper wire and two secondaries having 1400 turns each of No. 28 B. & S. gage (0.32 mm) copper wire. Each of these is wound in two equal parts, one on each of the longer sides of a rectangular core of laminated silicon steel; the latter has a cross section 12 mm square and an opening 25 mm by 45 mm. This is a transformer of the "core type" and for this purpose is much less affected by the stray magnetic fields emanating from the rest of the apparatus than is the "shell type," where the winding is all on one branch of the core. In the former type the useful magnetic flux flows thru the two windings in opposite directions while the stray fields set up a flux having the same direction in each; thus the emf's resulting from the latter neutralize each other. With a particular shell type transformer the effect of the magnetic field caused by the regulating resistance was so large that it caused the relays to operate as this resistance was cut in and out even when the transformer was disconnected from the bridge.

Owing to the fact that the resistance of the primary circuit of the transformer is not low in comparison with its reactance, the phase of the secondary emf leads that of the emf impressed on the primary. It has already been shown that it is desirable that the vibration of the reed be in phase with the particular secondary emf that would be induced by a primary emf in phase with that impressed on the bridge. This may be brought about by inserting a condenser and parallel resistance in series with the magnetizing coil *C* and the phase may be adjusted by varying the amount of parallel resistance. The correctness of this adjust-

ment may be tested while the regulator is running by placing a bar of iron in or close to any one of the bridge resistances. This changes the inductance of that particular coil and, unless the adjustment of the reed is correct, causes a halt in the otherwise steady clicking of the relay.

In the case of Rectifier *B* it seemed better to dispense with a transformer (chiefly because no suitable transformer was available) and to replace it with a condenser in parallel with the relay. Under these conditions the condenser supplies current to the relay during that half of the cycle when the rectifier contact is open. This particular rectifier works satisfactorily with only a condenser in series with the magnetizing coil, and under these conditions the relay receives about 80 per cent of the current it would take if connected directly to a direct current line of the same voltage as the alternating current line.

The "main relay," which is operated by direct current obtained from Rectifier *B*, is a converted "main line" telegraph relay. There are two spools of about 20 000 turns each of No. 40 B. & S. gage (0.08 mm) enameled copper wire on either leg. The two spools nearer the yoke, connected in series, form the left hand winding in Fig. 1; and the other two, also connected in series, the right hand winding. The resistance of each of the two windings is about 11 000 ohms. The separate windings must be thoroly insulated from each other and from the iron core on which they are wound.

The left hand armature of Fig. 1 is the original armature found on the relay, while what is represented in the figure as the right hand armature is in reality a strip of spring brass, attached to the original armature and insulated from it. This spring should be rather stiff and the contact screws should be so adjusted that there is considerable pressure on contact *m* when the relay is open. These contacts, *l*, *m*, and *n*, are of molybdenum, 1.5 mm square and may be used to break currents up to 10 amperes at 40 volts. For heavier duty it is better to break the current by means of a second, heavier relay operated by this one.

Where the occasional sticking of the galvanometer is not an objection, the contacts *p*, *q*, and *r* may be omitted along with their

battery and condenser shown in Fig. 1. In this case the original armature may be used for l .

If the current thru the heating element exceeds 10 amperes, or the temperature must be controlled for periods longer than about 24 hours without supervision, it will usually be more satisfactory to turn over the control of the heating current to a second, more rugged relay. This may be one of the stock relays ("remote control switches") built for heavy duty, or a telegraph relay may be fitted with two or more sets of contacts connected in parallel through suitable resistances. By the latter means the shunt around the regulating resistance may be removed in several steps and the emf, available to cause sparking at the various contacts, reduced to a negligible amount. In either case the energizing current for the second relay passes through the contacts l and m of the differential relay in Fig. 1.

The use of this second relay reduces the current through the contacts of the main relay to $\frac{1}{2}$ ampere or less, so that the main relay may be adjusted to operate on a much smaller current. This slows down the deterioration of the galvanometer contacts, and the apparatus may be run for longer periods without attention.

As was the case with the direct current apparatus a variable shunting resistance may be connected in parallel with one of the arms of the bridge in order to vary the temperature of the furnace or bath continuously in either direction.⁹ In the present apparatus this takes the form of a rheostat giving steps of 10 ohms from 1000 to 2000 ohms and connected in parallel with the 75 ohm coil of the bridge. The heating and cooling curves obtained with this are not quite linear, but are entirely satisfactory for most purposes.

PERFORMANCE

The sensitivity of the regulator is about the same as that of the author's direct current apparatus described elsewhere. The hot resistance of the winding of a furnace wound with platinum and insulated with magnesia is held constant to the equiva-

⁹ Op. cit., p. 409.

lent of $\pm 0.1^\circ$ at 1000-1400°. The actual temperature of the furnace falls less than 1° per day when it is maintained about 1200°. At 1400° it may fall as much as 10° per day. This fall in temperature is quite steady and seems to be due to changes in either the heating element or in the insulation of the furnace itself.

Although the regulator has been used with an oil bath, no numerical data of its performance with such a bath are available. There seems no doubt, however, that with a heater of large area and with effective stirring, temperature fluctuations should not exceed 0.05° at 200°.

GEOPHYSICAL LABORATORY,
CARNEGIE INSTITUTION OF WASHINGTON,
WASHINGTON, D. C., JUNE 12, 1922.

AN INTEGRAPH BASED ON PARALLEL DOUBLE TONGS

BY VLADIMIR KARAPETOFF

An integraph¹ is a mechanical device which draws a differential or integral curve to a given curve. Referring to Fig. 1, let $y=f(x)$ be a given curve plotted against OO as the axis of abscissae, and let $z=\phi(x)$ be another curve plotted against NN as the axis of abscissae. Let e and e' be two points on these curves corresponding to the same x . In other words, let the origin on NN be shifted by the amount A to the right, with respect to the origin on OO . The absolute positions of the two origins are of no consequence.

Let the curve $\phi(x)$ be such that its ordinate, say z , at e' be equal, on a certain arbitrary scale, to the slope, dy/dx , of the curve $f(x)$, at the corresponding point e . Then $\phi(x)$ is the *differential curve* of $f(x)$. Conversely, $f(x)$ is an *integral curve* of $\phi(x)$. If the curve $f(x)$ is given, then by tracing it with a stylus fixed at e , the integraph is made to draw the corresponding differential curve $\phi(x)$. If $\phi(x)$ is given, then by guiding the integraph stylus e' along it, the instrument is made to draw the integral curve $f(x)$.

The differential curve gives values of the slope, or rate of change, of the given curve. The integral curve gives areas between the differential curve and its axis of abscissae. The position of the integral curve with respect to OO depends upon the point at which the area is to be equal to zero. In other words, there is a constant of integration, denoted by C . This constant must be determined by some given initial conditions, like in any problem in integration.

The best known integraph is that invented by Abdank-Abakanowicz and described in many mathematical books.² This device

¹ The investigation upon which this paper is based was supported by a grant from the Heckscher Foundation for the Advancement of Research, established by August Heckscher at Cornell University.

² See, for example, A. Galle, *Mathematische Instrumente*, Teubner, 1912, p. 157.

has proved to be of very limited practical use on account of its price and of delicate adjustments of parts. At the same time, there is a great need for an integraph in a number of engineering

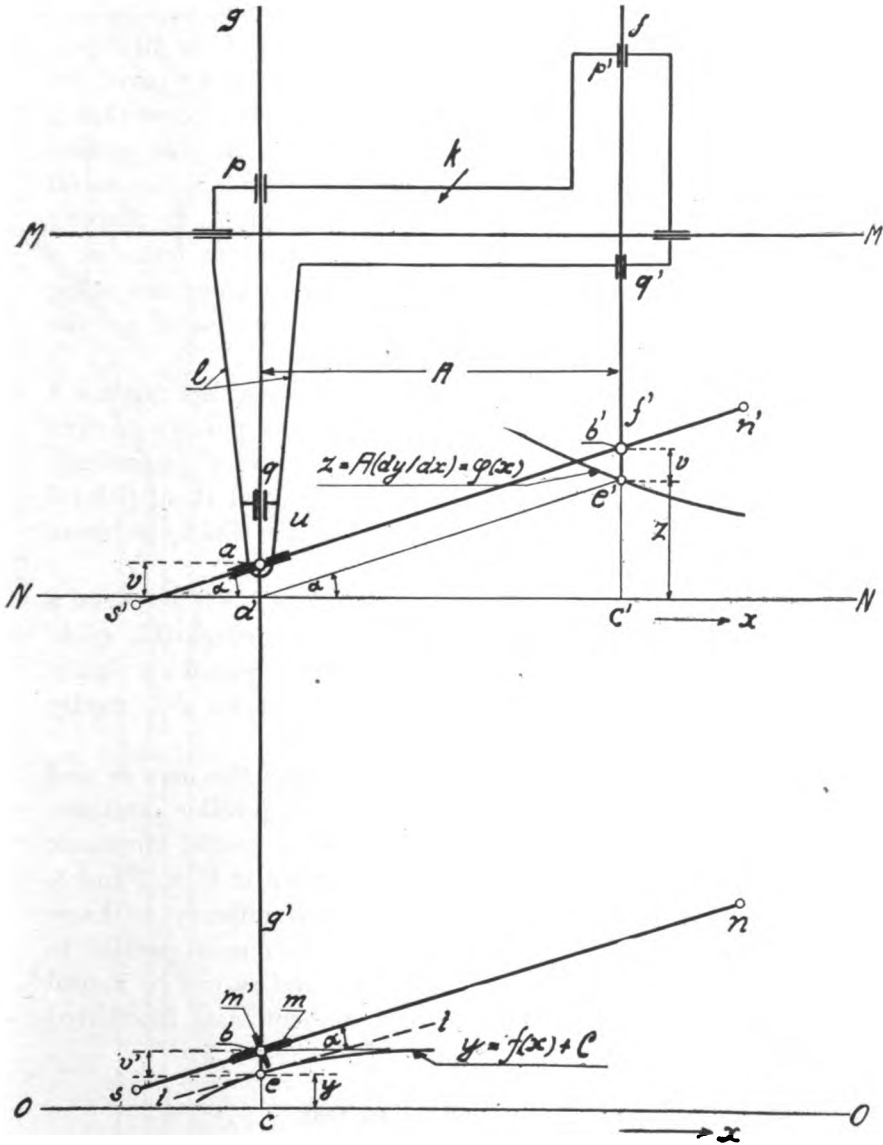

FIG. 1. The principle of the Integraph.

and scientific problems, involving an integration or differentiation of a given irregular curve.

The present writer was led to the development of his integraph through his interest in the hunting of synchronous machinery.³ In this problem the determination of the size of the fly-wheel requires a double integration of the tangential-effort curve, an operation which in practice is quite tedious. He found that a simple and robust integraph can be built by using his parallel double tongs, previously described.⁴ An integraph is also useful in determining the stability and flooding of ships, in plotting time-speed curves of electric trains, in computing losses in a machine by the retardation method, and in numerous other problems in which a differentiation or an integration of a given curve is necessary.

In Figs. 1 and 2, MM is a guide rail along which a carriage k can roll with very little friction. The rod gg' is movable at right angles to MM , in the guides p and q . The rod ff' is similarly guided at p' and q' . The bar sn may be rotated about point b as a center, and it carries a sharp-edged wheel m which can rotate about the axis m' perpendicular to sn .

The bracket l , firmly attached to the carriage k , has at its end a guide u , pivoted at a . The bar $s'n'$ passes through this guide and is pivoted at b' to the bar ff' . The stylus or pencil e is rigidly connected to the bar gg' , and the pencil or stylus e' is rigidly attached to the bar ff' .

For the proper functioning of the integraph the bars sn and $s'n'$ must remain parallel to each in all their possible positions. This parallelism is preserved by means of a special kinematic linkage called the parallel double tongs, shown in Figs. 2 and 3, and described below. For the present it is sufficient to know that the bars sn and $s'n'$ are constrained to remain parallel to each other, but that both can be turned, and sn can be moved nearer to $s'n'$ or farther away from it, without being interfered with by the parallel double tongs.

³ Sibley Journal of Engineering, v. 34, No. 3:3, 1920.

⁴ The American Machinist, v. 55, p. 1050, 1921.

To draw a differential curve $\phi(x)$, corresponding to a given curve $f(x)$, the latter is traced by the stylus e , say to the right, by so guiding the bar sn that the wheel m rolls on the paper, without slipping sidewise. The axis of sn is then parallel to the tangent tt to the curve at the point e which the stylus is touching at that particular instant.

Let, in the position shown, the bars sn and $s'n'$ form an angle α with the axis NN , so that

$$\tan \alpha = dy/dx \dots\dots\dots (1)$$

The axis NN is drawn at the distance v from the center a , where

$$aa' = b'e' = v \dots\dots\dots (2)$$

Hence, from the triangle $a'e'c'$ we have

$$c'e' = a'c' \tan \alpha \dots\dots\dots (3)$$

or
$$z = A(dy/dx) \dots\dots\dots (4)$$

In other words, the ordinate of the curve $\phi(x)$, at point e' , is proportional to the first derivative or slope of the curve $f(x)$ at the corresponding point e . The coefficient of proportionality is A , equal to the distance between the centers of the bars ff' and gg' . In the actual device this distance is adjustable within certain limits, so that a convenient scale can be had for either curve.

The kinematic arrangement of the parts is convertible, that is, when the stylus e' is guided along $\phi(x)$, a pencil attached at e will draw an integral curve $f(x)$. The edge of the wheel m traces a curve identical with $f(x)$, at a distance v' above it. Since the bar gg' can be moved up and down in its guides p and q , without disturbing $s'n'$, the initial ordinate of the curve $f(x)$ is arbitrary, as it ought to be, because of a constant of integration. The distance of the center a from the rail MM is also adjustable within certain limits, so that the differential curve may be raised or lowered at will.

The device can be best checked by drawing some simple curves beforehand. For example, if the given curve is an inclined straight line, $\phi(x) = Bx$, where B is a constant, its integral curve is a parabola, $f(x) = \frac{1}{2} Bx^2$. The integral curve of a sine wave is a cosine wave; etc.

The parallel double tongs (Figs. 2 and 3) consist of two identical articulated parallelograms, 1234 and 5678 , with pivot joints at all

e vertices. The two parallelograms are pivoted together at the middle point *o*. The opposite short sides of the parallelograms are extended, and connected to the integraph bars at *s*, *n'*, and *s'*, the lengths *ns* and *n's'* being equal. The extended lengths must satisfy the condition

$$n4 = s'3 = n'6 = s5 \dots \dots \dots (5)$$

The bars *ns* and *n's'* are then constrained to remain parallel each other, without their position or motion being otherwise impeded by the parallel double tongs.

The construction details of the experimental integraph made in Cornell University are shown in Fig. 3, the lettering being the same in Figs. 1 and 2. The device was constructed and the mechanical details worked out by Mr. O. K. Marti, to whom the author wishes to express his sincere appreciation for the valuable assistance rendered.

CORNELL UNIVERSITY,
ITHACA, NEW YORK.
SEPTEMBER, 1922.

In
of
Di
ce
Di
M.
Ex

reac
any
tool
tra
man
pate

I

Ray
of M
Isotr
1922
refer
in sc
subj

1922

1922
tary

22, 1

REVIEWS AND NOTICES

Patent Essentials for the Executive, Engineer, Lawyer, and Inventor. A Rudimentary and Practical Treatise on the Nature of Patents, the Mechanism of their Procurement, Scientific Drafting of Patent Claims, Conduct of Cases and Special Proceedings, Including Forms. John F. Robb of the Cleveland and District of Columbia Bars with Papers by G. P. Tucker, L. W. Maxson, E. C. Reynolds, L. A. Sadler, and Edward Collins, Patent Examiners. 436 pp., Funk and Wagnalls, New York, 1922.

This book was written for the layman and presents, in nontechnical, or at least readily understood, language, the fundamental principles of patent law with which any scientist, who intends to file a patent application, should be acquainted. The book is written in a most interesting style, not at all in the dry-cut form of most treatises on legal subjects. A few hours spent in reading this work will be saved many times in the elimination of unnecessary discussion and correspondence between patent applicant and his attorney.

PAUL D. FOOTE.

Isotopes. By F. W. Aston, 152 pp., Arnold (London) 1922.

Titles of the main chapters are as follows: The Radio-active Isotopes; Positive Rays; Neon; The Mass-Spectrograph; Analysis of the Elements; The Electrical Theory of Matter; Isotopes and Atomic Numbers; The Spectra of Isotopes; The Separation of Isotopes; Various Tables. The work summarizes all data and experiments to January, 1922. Every scientist interested in the subject should have a copy of this book for reference. The book is so clearly and simply written that one who is not specializing in science will be able to read it readily and to understand the greater portion of the subjects treated.

PAUL D. FOOTE.

OPTICAL SOCIETY OF AMERICA

MINUTES OF THE EXECUTIVE COUNCIL

A meeting of the Executive Council was called to meet in Washington, Jan. 28, 1922. Present: Troland, Ives, Foote, Priest. No quorum.

A meeting of the Executive Council was called to meet in New York, Feb. 25, 1922. Present: Troland, Ives, Lomb, Gale, Southall. No quorum. (Southall Secretary, protem.)

An informal conference of the following members was held in Washington, April 22, 1922: Foote, Forsythe, Gale, Merritt, Priest.

As a result of these conferences and correspondence, President Troland on May 4, 1922, declared the following resolutions adopted by unanimous vote of the Council:

To amend Article II, Section 2 of the By-Laws to read as follows: "No officer or member of the Society except the editor-in-chief and the assistant editor-in-chief and business manager of the Journal shall receive any remuneration for his services."

To Amend Article V of the By-Laws by inserting after editor-in-chief the words "and the assistant editor-in-chief and business manager."

RESOLVED that a ballot be mailed to the members of the Society to vote upon an amendment to the constitution to read as follows: "The assistant editor-in-chief and the business manager of the Journal shall be ex officio a member of the Executive Council."

RESOLVED that Mr. Adolph Lomb, as treasurer of the Optical Society, is hereby designated by the Executive Council to sign the agreement between the Optical Society of America and the Association of Scientific Apparatus Makers relating to the financing and publication of the JOURNAL OF THE OPTICAL SOCIETY OF AMERICA AND REVIEW OF SCIENTIFIC INSTRUMENTS.

RESOLVED that the agreement between the Optical Society of America and the Association of Scientific Apparatus Makers relating to the publication of a Journal to be known as the JOURNAL OF THE OPTICAL SOCIETY OF AMERICA AND REVIEW OF SCIENTIFIC INSTRUMENTS for a period of two years beginning April 1, 1922, when signed by the authorized representatives of the said Society and Association, be hereby ratified confirmed and approved by the Executive Council acting for the Optical Society of America.

RESOLVED that the financial transactions of the Optical Society of America and of the JOURNAL OF THE OPTICAL SOCIETY OF AMERICA AND REVIEW OF SCIENTIFIC INSTRUMENTS shall hereafter be separately managed, those of the Society remaining in the hands of the treasurer whereas those of the Journal shall be entirely under the control of the business manager of the Journal, that the business manager of the Journal shall be responsible for all collections and disbursements involved in the publication of the Journal and that contributions or payments made by the Society towards the expenses of the Journal should be made by the treasurer to the business manager of the Journal in a manner mutually agreed upon by said officers.

RESOLVED that the disbursement of the contribution of \$2,500 made by the National Research Council towards the support of the JOURNAL OF THE OPTICAL SOCIETY OF AMERICA AND THE REVIEW OF SCIENTIFIC INSTRUMENTS shall be entirely in the hands of the business manager of the Journal, who shall be authorized to sign all vouchers and requisitions connected with this appropriation.

RESOLVED that the business manager of the Journal shall make an annual report as of April 1st of each year and that this report shall be duly audited and published in the Journal.

RESOLVED that the committee on membership be authorized to drop from membership the names of such persons as are in arrears in accordance with Article I, Section 5, of the By-Laws.

RESOLVED that the business manager of the Journal be directed and authorized to revise the contract with the George Banta Publishing Company of Menasha, Wisconsin, and to submit the same to the president and the editor-in-chief for approval, and that after receiving such

approval the business manager be empowered to sign the contract on behalf of the Optical Society.

RESOLVED that the printed reports of the sub-committees of the Optical Society committee on nomenclature and standards shall be advertised in the Journal as for sale at a price per copy depending upon the number of pages, the number of such reprinted reports and price to be determined by the publication committee, and the proceeds of such sales to go to the treasury of the Optical Society.

IRWIN G. PRIEST,
Secretary.

WASHINGTON, D. C.
AUG. 14, 1922.

OPTICAL SOCIETY OF AMERICA

NEW MEMBERS

The following new members have been duly elected by the Executive Council:

REGULAR

- No. 325. William L. Benedict, Mayo Clinic, Rochester, Minn.
- No. 326. George Walter Stewart, Hall of Physics, Iowa City, Iowa.
- No. 327. Arthur Edward Ruark, 6010 Henderson Avenue, Govans, Baltimore, Md.
- No. 328. Francis G. Pease, Mount Wilson Observatory, Pasadena, Calif.
- No. 329. Frank Walter Weymouth, Stanford University, California.

ASSOCIATE

- No. 330. Ting Supoa, 38 M. D. Hall, University of Chicago, Chicago, Ill.

BY TRANSFER FROM ASSOCIATE TO REGULAR

Reinhard A. Wetzel has been transferred to Regular Membership.

David Rines, who was elected to Associate Membership at Rochester, October 24, 1921, through lack of complete information as to his qualifications, has been made a Regular Member.

IRWIN G. PRIEST,
Secretary.

August 31, 1922.

NOTICES

OPTICAL SOCIETY OF AMERICA

TELLERS' REPORT

To Irwin G. Priest, Secretary:

We, the undersigned regular members of the Optical Society of America, have counted the ballots cast on the following proposed amendment to the Constitution:

"The assistant editor-in-chief and business manager of the JOURNAL shall be ex-officio a member of the Executive Council."

We have verified our count and certify the following to be the true result:

In favor of the amendment 95

Opposed to the Amendment 0

(Signed) { K. S. GIBSON
M. K. FREHAFFER
Tellers.

September 2, 1922.

In accord with the above report and the Constitution's provision for its amendment, the above amendment is hereby declared adopted.

(Signed) { LEONARD T. TROLAND
President
IRWIN G. PRIEST
Secretary

September 5, 1922.

Journal of the Optical Society of America and Review of Scientific Instruments

Vol. VI

DECEMBER, 1922

Number 10

EXTRAORDINARY DIFFRACTION OF X-RAYS

By L. W. MCKEEHAN

The term "Extraordinary Diffraction" is here proposed for the directed emission of characteristic X-rays from the atoms of a crystal placed in a narrow beam of X-rays containing sufficiently short wave-lengths. The theory here presented was developed in attempting to explain the occurrence, on photographs taken for the crystal analysis of iron, nickel, and copper, of spots, evidently diffraction images of the source, at places, and in positions, quite inexplicable by the ordinary theory of X-ray diffraction in crystals. Before admitting the explanation here offered attempts were made to explain the observed effects by postulates less radical in their implications than those finally adopted, but it was found, for example, that no number of successive reflections within a single crystal, or within a twinned pair, could be made to account for the observed effects. The new physical hypothesis given below does permit an explanation of the new phenomena, and that, at present, is its sole justification.

The effects of "extraordinary diffraction" are always associated with the effects of what may, for distinction, be termed "ordinary diffraction." It seems clearest, therefore, to present the analysis in a form covering both sorts of diffraction at once, there being, of course, nothing novel in the results so predicted for the ordinary case.

In order to avoid the wholly formal complexity inseparable from equations applying to the completely general case of a triclinic crystal, the analysis will be undertaken for the simplest possible crystal, in which the mean positions of the atom-centers are the points of a simple cubic space-lattice, and in which the atoms are all alike. There is no known crystal as simple as this, but crystals of potassium chloride approach it closely, and the crystals of many metals, including those which clearly show the new effects, can be regarded as composed of two or four interpenetrating arrangements of exactly this type. Further to simplify the mathematical expressions involved, the incident X-rays will be taken as forming a plane-parallel beam, and the dimensions of the crystal will be taken as negligibly small in comparison with the radius of the sphere, centered at the crystal, on which the diffraction effects are studied. To simplify the description of these effects it will be supposed that they produce a photographic record, so that it will be appropriate to speak of spots, lines, bands, and the like. The modifications due to non-parallelism of the incident beam, to lack of circular symmetry in it, and to the finite extent of the source of primary X-rays, will be discussed only qualitatively.

Take the origin, O , at any point of the space-lattice, and lay the axes of X , Y , and Z along the edges of that one of the eight cubical cells which meet at O which includes the prolongation of the incident ray through O . Let the orientation of the crystal with respect to this incident ray be unrestricted, so that its direction-cosines l_1 , m_1 , n_1 , in addition to being all positive as required by the choice of axes, are restricted only by the geometrical requirement that $l_1^2 + m_1^2 + n_1^2 = 1$. Let a be the parameter of the space-lattice, so that adjacent points along each of the three axes are separated by this interval.

Assume (1) that the incident beam contains wave-trains long in comparison with their wave-length λ_1 , and (2) that each diffracted beam consists of wave-trains long in comparison with their wave-length λ_2 . The wave-lengths λ_1 and λ_2 are, in the practically important cases, of the same order of magnitude as a .

Assume (3) that at a time $t = \tau + \frac{n\lambda_2}{c}$ after the time $t = 0$ when some particular wave of a primary wave-train had phase ϕ_1 at the lattice-point P , that a secondary wave, if emitted from P as a result of the primary wave having passed through it at time $t = 0$, will have phase ϕ_2 at a distance $n\lambda_2$ from P . In the last assumption ϕ_1 may be called the primary phase at excitation, τ the delay between excitation and emission, and ϕ_2 the secondary phase at emission. The integer n is introduced to obviate the awkwardness of talking about the phase at the origin of a divergent beam, and c is the velocity of propagation in vacuo. Assume (4) that the values of ϕ_1 , τ , ϕ_2 do not depend upon the coordinates x , y , z , of P , nor upon events at other lattice-points, and (5) that the variations among the individual values of ϕ_1 , $\frac{c\tau}{\lambda_1}$, $\frac{c\tau}{\lambda_2}$, ϕ_2 are small in comparison with 2π . Assume (6) that secondary waves from P have appreciable amplitude in directions considerably inclined to the prolongation of the incident ray.

The only assumption which can be dropped in the case of ordinary diffraction is the first and this is therefore the new physical hypothesis here advanced. The third assumption can be suitably modified for the ordinary case so as to eliminate reference to a primary wave-train, the origin of time being changed to the instant when a particular singularity of the incident disturbance reaches the point P . In ordinary diffraction, also, $\lambda_1 = \lambda_2$; in extraordinary diffraction $\lambda_1 < \lambda_2' < \lambda_2$, where λ_2' is the wave-length of the absorption limit corresponding to the emission of the characteristic wave-length λ_2 .

It is possible that the fifth assumption could be better expressed by requiring rigorous constancy of ϕ_1 , τ , and ϕ_2 , if these quantities were defined with respect to points P' , P'' , near P , where the absorbing and the emitting mechanisms concerned were at the times $t = 0$ and $t = \tau$. As written above the phase differences, due to thermal agitation displacing atom-centers from the lattice-points, have been included in $\phi_2 - \phi_1$.

The elementary theory of diffraction now states that appreciable energy in the form of secondary waves will only be emitted

in those directions along which, at great distances, the secondary waves from all the points of the space-lattice agree in phase. These directions do not depend upon the mean values of ϕ_1 , ϕ_2 , and τ , so that all three of these quantities may conveniently be put equal to zero in discussing the geometry of emission. Referring to Fig. 1, which diagrammatically represents the incident and

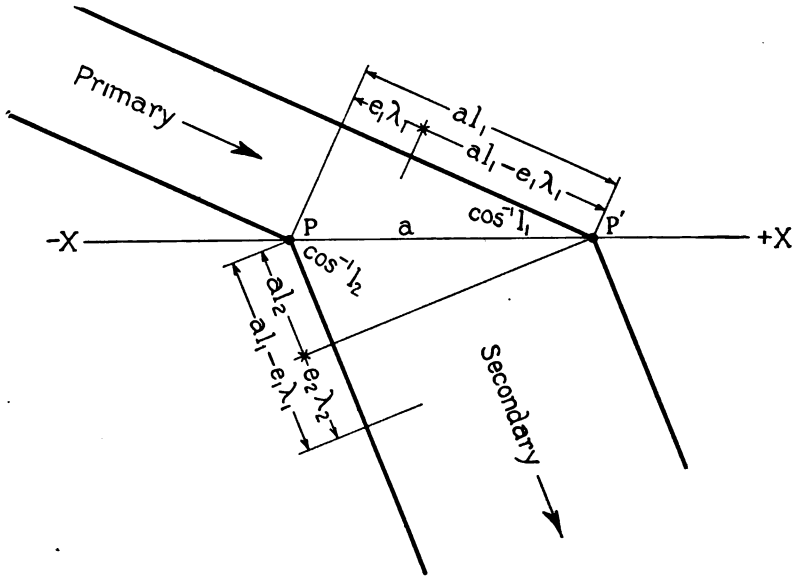

Fig. 1

Extraordinary Diffraction at Two Atom-Centers.

diffracted rays and wave-fronts near two adjacent atoms on the X-axis, it will be seen that the direction-cosines of the emitted secondary rays are given by

$$\left. \begin{aligned} l_2 &= l_1 - \frac{e_1 \lambda_1}{a} - \frac{e_2 \lambda_2}{a}, \\ m_2 &= m_1 - \frac{f_1 \lambda_1}{a} - \frac{f_2 \lambda_2}{a}, \\ n_2 &= n_1 - \frac{g_1 \lambda_1}{a} - \frac{g_2 \lambda_2}{a}. \end{aligned} \right\} \dots \dots \dots (a)$$

In these equations l_2, m_2, n_2 are not limited as to sign, but $l_2^2 + m_2^2 + n_2^2 = 1$. The quantities, e_1, f_1, g_1 are integers positive, negative, or zero, which may be called the orders of incidence with respect to the three axes, and e_2, f_2, g_2 are integers which may similarly be called the orders of diffraction with respect to the axes. It will be noted that Fig. 1 is drawn for the special case $n_1 = g_1 = g_2 = 0$. In the general case the diffracted ray will not lie in a plane determined by the incident ray and one of the three axes.

For ordinary diffraction, putting $\lambda_1 = \lambda_2 = \lambda$ and $h = e_1 + e_2, k = f_1 + f_2, l = g_1 + g_2$, where h, k, l are, of course, integers,

$$\left. \begin{aligned} l_2 &= l_1 - \frac{h\lambda}{a}, \\ m_2 &= m_1 - \frac{k\lambda}{a}, \\ n_2 &= n_1 - \frac{l\lambda}{a}. \end{aligned} \right\} \dots\dots\dots (b)$$

These formulas, as they should, represent the directions of the transmission ($h = k = l = 0$), of specular reflection in the various lattice-planes (h, k, l mutually prime) and of so-called reflection in higher orders (in order w if h, k, l have w as highest common factor). Examination shows that h, k, l are, in fact, the Miller indices of the reflecting planes in the last two cases. The appropriate wave-length for any particular choice of l_1, m_1, n_1 and h, k, l is found by eliminating l_2, m_2, n_2 . This gives

$$\lambda = \frac{2a(l_1h + m_1k + n_1l)}{h^2 + k^2 + l^2} = \frac{2a\Sigma(l_1h)}{\Sigma(h^2)} \dots\dots\dots (b')$$

In the case of extraordinary diffraction no simplification of the general formulas (a) is possible, and, using notation similar to that in (b')

$$\lambda_1 = \frac{1}{\Sigma(e_1^2)} \left[a\Sigma(l_1e_1) - \lambda_2\Sigma(e_1e_2) \pm \sqrt{a\Sigma(l_1e_1) - \lambda_2\Sigma(e_1e_2) - \lambda_2\Sigma(e_1^2)[\lambda_2\Sigma(e_2^2) - 2a\Sigma(l_1e_2)]} \right] \dots (a')$$

The ambiguity of signs is resolved by the condition $\lambda_1 < \lambda_2$. In both

cases the number of real diffracted rays for a given range in λ_1 is limited by the condition that l_2, m_2, n_2 must be real and must lie between $+1$ and -1 . The ray for which $e_1=f_1=g_1=e_2=f_2=g_2=0$ is coincident with the prolongation of the incident ray for all values of λ_1 and λ_2 and for amorphous as well as crystalline arrangements.

It is fairly obvious that the general case of extraordinary diffraction permits values of l_2, m_2, n_2 not possible in the special case of ordinary diffraction, but an arbitrary numerical example may serve to make this clearer.

$$\begin{aligned} \text{Let } a = 3.60 \times 10^{-8} \text{ cm} \quad e_1 = 1, f_1 = 0, g_1 = 0, \\ e_2 = 0, f_2 = -1, g_2 = 0 \\ l_1 = \frac{4}{5}, m_1 = \frac{3}{5}, n_1 = 0 \end{aligned}$$

It is seen that $h=l, k=-1, l=0$.

In the case of ordinary diffraction, by (b')

$$\lambda = 0.720 \times 10^{-8} \text{ cm}$$

and by (b)

$$l_2 = \frac{3}{5} \quad m_2 = \frac{4}{5} \quad n_2 = 0$$

The ray has clearly been reflected in the (110) plane. In the case of extraordinary diffraction we must take a value of λ_2 , e.g., $\lambda_2 = 0.600 \times 10^{-8}$ cm. Substituting in (a') gives

$$\lambda_1 = 0.569 \times 10^{-8} \text{ cm}$$

and using this in (a) gives

$$l_2 = 0.642, \quad m_2 = 0.767, \quad n_2 = 0.$$

It will be found that both λ_1 and λ_2 must be less than λ and that the extraordinary ray therefore diverges less from the transmitted ray than does the ordinary ray. This is generally true.

The observed effects depend upon the range of wave-lengths present in the incident beam, and upon the number of crystals dealt with. If there is one crystal, fixed in position, and a wide range of incident wave-lengths, the ordinary diffraction gives the familiar spot-pattern (Laue pattern). The extraordinary diffraction gives additional spots which in the usual experimental arrangements wherein λ_1 is very much less than λ_2 would be relatively faint. The spots of the ordinary pattern are formed by beams of various wave-lengths, those of the extraordinary pattern by beams all of a single wave-length or of a few definite

values corresponding to the strong lines in the characteristic X-ray spectra of the elements present. This case has not been experimentally tested.

If the crystal is rotated about any line as an axis the spots of the pattern move along paths which are, in general, curved. If attention is confined to a single direction of emission, and if the axis of rotation is perpendicular to this direction and to the incident ray, the conditions are those obtaining in the ordinary X-ray spectrometer. The customary orientations of the crystal are those in which the axis of rotation lies in one of its important planes. That both ordinary and extraordinary diffraction occurs in this case is apparently shown in results recently reported by Clark and Duane¹ for the case of *KI* crystals. The peak *X* which they obtain would be an extraordinary diffraction maximum in the sense of this analysis. Its location with respect to the ordinary maxima would, of course, depend upon the fixed sum of the angles of incidence and diffraction which would not, as in the ordinary case, be equal.

If the incident radiation is monochromatic there are no diffracted spots of either sort except for particular values of l_1, m_1, n_1 , and no extraordinary diffraction for any direction of incidence if $\lambda_1 > \lambda_2'$. This case is of no practical importance, but if the single crystal is replaced by a great number, oriented at random these particular values of l_1, m_1, n_1 occur and the ring-pattern (Hull or Debye-Scherrer pattern) is obtained. Both ordinary and extraordinary patterns can occur. It was, in fact, phenomena observed in this case that led to the explanation here offered.

Both the ordinary and extraordinary spots obtained in the last mentioned type of experiment are, if the individual crystals are not too small, replicas of the source in the aspect which it

¹ Clark, G. L., Duane, Wm., N. A. S. Proc. 8, pp. 90-96; May, 1922.

There is a curious error in this paper at the point where the spacing for lattice-planes making an angle of $17^\circ.84$ with the planes (100) is calculated, apparently by the formula $d = a \sin 17^\circ.84$. There are no lattice planes with low indices inclined at this angle to the (100) planes of a cubic space-lattice and if we find integral values of h and k such that $\tan 17^\circ.84 = h/k$ the spacing of these planes ($h \ k \ 0$) would be given by

$$d = \frac{a}{\sqrt{h^2 + k^2}} = \frac{a}{h} \sin 17^\circ.84.$$

presents to the crystals, i.e., narrow elliptical outlines. The extraordinary spots are distinguishable from the ordinary spots, however, by several peculiarities. They are not so sharply defined, which may be attributed to the comparative rarity of atoms which emit characteristic X-rays as compared with those which merely scatter the incident beam. The greater complexity of the process in extraordinary diffraction may also account for greater variability in ϕ_1 , ϕ_2 , and τ , and consequent diffuseness in that case. The extraordinary spots can be inclined at greater angles to the lines joining them with the trace of the incident rays upon the film. This is due to the greater complexity in the extraordinary case of the expressions for l_2 , m_2 , n_2 which causes the direction of emission to vary less directly with the direction of incidence. The extraordinary spots frequently form parallel groups which are in fact characteristic emission spectra where the different values of λ_2 have been resolved by diffraction. This resolution, like all the extraordinary effects, is better for pure metals than for alloys, even if the ordinary diffraction for the two materials is equally sharp indicating crystals of similar size and regularity. The extraordinary spots are more absorbable than the ordinary spots, and are relatively more reduced in intensity by filters designed to improve contrast in the ordinary pattern. This prediction of the theory has been checked experimentally by omitting the filters and thereby reducing the exposure necessary to obtain marked extraordinary effects. The most striking peculiarity of the extraordinary spots is, however, that they can be found closer to the center of the pattern than can the ordinary spots. This closeness in itself enhances the intensity of the photographic effect by superposing the spots from various crystals within a more limited area, so that the first extraordinary ring of the combined pattern may even exceed in intensity the first ordinary ring. That this is not a spurious effect due to imperfect screening is conclusively shown by its complete absence under identical experimental conditions when the crystals contain no atoms of low enough atomic number to yield characteristic K -radiations when exposed to the molybdenum K -radiations available. No extraordinary diffractions of the molybdenum

radiations have been observed with silver, palladium, or gold, while they are always present to some extent with iron, nickel, and copper.

If the proposed explanation be accepted as sound, it appears probable that all the entities causing characteristic secondary emission are exactly alike, and that such secondary emission only occurs when these entities meet the atoms under a very limited range of conditions. The evidence that extraordinary diffraction takes place is then in favor of the existence of spatially limited energy quanta in the incident beam, and also in favor of cyclic motions within the atom which cause occasional recurrences of configurations unstable when coincident in time with the presence of a passing quantum of sufficient energy. A quantitative study of the new phenomena may be expected to give valuable information regarding its possible dependence upon the direction of incidence, the nature of inter-atomic bonding and other factors of interest to students of atomic structure and the nature of luminous radiations of all wave-lengths.

I desire in conclusion to express my appreciation of the interest and helpful suggestions of my colleague, Dr. K. K. Darrow, in the analysis here presented.

RESEARCH LABORATORIES, OF THE
AMERICAN TELEPHONE AND TELEGRAPH COMPANY AND THE
WESTERN ELECTRIC COMPANY, INCORPORATED,
SEPTEMBER 5, 1922.

ON THE QUANTITY OF LIGHT ENERGY REQUIRED TO RENDER DEVELOPABLE A GRAIN OF SILVER BROMIDE

By P. S. HELMICK¹

The work of Kinoshita² seems³ to be one of the first published researches to permit a maximum estimate of the energy required to render developable a grain of silver bromide. His work shows: (1), that each silver bromide grain is rendered capable of development when struck by an alpha-particle from Radium C; and (2), that the reduction of developable grains cannot extend to neighboring un-ionized grains. As the kinetic energy possessed by an alpha-particle of Radium C is 1.31×10^{-5} ergs⁴ this value gives a maximum limit to the energy per grain necessary to form a developable image.⁵

Two years later Einstein developed his photo-chemical Equivalence Law⁶ which requires the absorption of a mean energy of effective radiation $h\nu$ for the photo-chemical decomposition of a molecule.⁷

By the application of the Equivalence Law, Henri and Wurmser⁸ submitted the results of Leimbach⁹ to a quantitative examina-

¹ National Research Fellow in Physics.

² Proc. Roy Soc., *83A*, p. 432; 1920.

³ In 1891, Hurter and Driffield (Memorial Volume, Royal Photo. Soc., p. 151) calculated the energy per cm² necessary to produce a *latent image*. They were subsequently led to the conclusion (*ibid.* p. 228) that the light causes some change in the molecular structure of silver bromide.

⁴ Smithsonian Physical Tables. 7th Ed. p. 396.

⁵ Svedberg and Andersson (Phot. J. *61*, p. 325, 1921) have lately quoted the opinions of Michl, and St. Meyer and v. Schweidler, which indicate that only a certain fraction of silver halide grains in the track of an alpha-particle are made developable. However in a recent critical review of the entire evidence, Muhlestein (Arch. Sci. Physiques et Naturelles, *5*, p. 38; 1922) comes to the conclusion supported by his own work, that the results of Kinoshita are in accordance with the facts.

⁶ Ann. der Phys. *37*, p. 832; 1912.

⁷ Plotnikow (Zeit. wiss. Phot. *21*, p. 134; 1922) calls the Einstein relation a *formula* rather than a *law*.

⁸ Journ. de Physique. *3*, p. 305, 1913.

⁹ Zeit. wiss. Phot., *7*, pp. 157, 181; 1909.

tion in order to find the number of quanta necessary to render developable a molecule of silver bromide. Leimbach found that for monochromatic light made up of wave-lengths between 0.415μ and 0.475μ , 0.63 ergs/cm² were necessary for unit density.¹⁰ Taking unit density as equivalent to 0.000103g of silver per cm² of plate surface,¹¹ or 7×10^{17} molecules of silver per cm², his results indicate that 9×10^{-19} ergs are required per molecule of silver bromide. Henri and Wurmser seem to consider the wave-length 0.415μ responsible for the photochemical process, consequently at this frequency a quantum is equal to 4.74×10^{-12} ergs. Thus it appeared that a quantum could render developable 4 million times as many molecules as Einstein's Law would predict.¹² Consequently Henri and Wurmser concluded that light seems only to act as a catalyser, placing the molecules in a state where they will react by themselves.

$$^{10} \text{Density} = \log_{10} \frac{\text{light incident on plate.}}{\text{light transmitted by plate}}$$

¹¹ Cf. Sheppard and Mees. *Investigations on the Theory of the Photographic Process*. Longmans, 1907, p. 41.

¹² Baly (Phil. Mag. 40, p. 15, 1920) believes that this divergence is due to the reabsorption of energy which the molecules have radiated internally. However, an alternative explanation of this divergence might be based upon the fact demonstrated by Svedberg (Nature. 109, p. 221, 1922), that from one to four nuclei or "centres," formed inside a silver bromide grain by the action of light, are effective in making developable all of the molecules in the grain. Assuming: (1), that by the action of a quantum, c "centres" are formed in each grain; (2), that each grain is a circular disc of thickness equal to $1/14$ of its diameter,—this is the thickness found by Trivelli and Sheppard (*The Silver Bromide Grain*. Van Nostrand. 1921, p. 94); and (3), that the density of a silver bromide grain equals the density of precipitated silver bromide as found by Karsten (*Handbuch Anorgan. Chemie*. Friedheim u. Peters. 1914. Vol. 5, Div. 2, p. 108), 6.35 gm/cm³, the following mean diameters (d) of grains result from Henri and Wurmser's figures, depending upon the number of "centres" (c) assumed present per grain: $c=1$, $d=0.16\mu$; $c=4$ (maximum number yet found by Svedberg), $d=0.25\mu$; $c=78$, $d=1.5\mu$ (mean diameter found by Trivelli and Sheppard). From the point of view of Svedberg's work, the results would seem more logical if it be assumed that more than one quantum at wave-length 0.415μ is necessary to form a "centre." For example, the observed quantity of silver would be accounted for, if an average of 6 "centres" were formed in each grain with energy equal to 13 quanta per "centre." However, the work of Eggert and Noddack which will be considered at a later point indicates that as many as several hundred "centres" can be formed in a grain.

In the same year, Nutting¹³ calculated the energy required to render developable a grain of silver bromide. He considered a photographic plate which required an energy of 10^{-7} ergs/cm² to produce a deposit of 1/10 mgm of silver per cm², or 10^7 grains 3μ in diameter. Therefore, each grain receives 10^{-14} ergs to make it developable, although to produce a gaseous ion only about 5×10^{-12} ergs are required. No data are given regarding the frequency of the light,¹⁴ but the wave-length must lie outside the range 0.450μ to 0.650μ , for in that region Leimbach¹⁵ and also the writer¹⁶ have found that energies of the order of 1 erg/cm² to 4000 ergs/cm² are required. Consequently Nutting concludes that it is a reasonable hypothesis to consider a latent image as composed of a halide salt, from each of whose grains one electron has been liberated by exposure to light.¹⁷

Another determination of the energy required to make a grain of silver bromide developable is found in the work of O. H. Smith¹⁸ with retrograde rays from a cold cathode. The power of a moving particle to affect a photographic plate seemed to be a function of the kinetic energy possessed by the particle. The minimum energy required to produce the faintest trace visible to the naked eye was about 7.4×10^{-9} ergs for the heaviest particles,— a value greater than the energy required to produce a gaseous ion. As the work of Kinoshita¹⁹ and others²⁰ proves that the grain of silver bromide is the photo-chemical unit in the photo-

¹³ Nature, 92, p. 293, 1913.

¹⁴ Mees (Jour. Frank Inst., 179, p. 141, 1915), states that these figures refer to violet light.

¹⁵ Loc. cit.

¹⁶ Phys. Rev. 17, p. 135, 1921.

¹⁷ As opposed to this view, Renwick (Jour. Soc. Chem. Ind. Trans. 39, p. 156; 1920) believes that the latent image is formed by a change in the highly unstable and light-resonant form of colloidal silver existing in a solid solution in the crystalline silver bromide of the emulsion.

¹⁸ Phys. Rev., 7, p. 625; 1916.

¹⁹ Loc. cit.

²⁰ Joly Nature, 72, p. 308; 1905.

Mees, Jour. Frank. Inst. 179, p. 141, 1915; 191, p. 631, 1921.

Slade and Higson, Roy. Soc. Proc. 98A, p. 154; 1920.

Svedberg, loc. cit.

graphic plate, the results of Smith would indicate that about 7.4×10^{-9} ergs or less²¹ are required to render a grain developable.

Very recently Eggert and Noddack²² made a preliminary measurement of the energy of wave-length 0.408μ necessary to produce a developable grain of silver bromide. In their first experiments it was found that after exposure to light a small amount of silver was separated from the silver bromide of the emulsion. It may thus be possible that these atoms of separated silver correspond to the "centres" mentioned by Svedberg.²³ Chemical analysis showed that for each quantum absorbed by the silver bromide one atom of silver was liberated. Other measurements indicated that in order to produce a developable grain, "a few hundred" quanta must be absorbed. The conclusion was reached that only those silver bromide grains would be developed in which the separated silver atom was directly located on the outside surface of the grain, and grains which possessed silver atoms in their interior would behave as if unilluminated. To support this theory they mentioned that one silver bromide grain of the kind found in their plates contained one surface molecule to 300 interior molecules. They have stated as their conclusion: not every quantum gives a grain of silver, but each grain of silver corresponds to one and only one quantum.

THE NATURAL ULTRA-VIOLET FREQUENCY OF SILVER BROMIDE

Before dealing further with the question of the energy necessary for the production of a developable grain of silver bromide, an attempt will be made to predict a natural frequency of silver bromide for the ultra-violet by calculating the ultra-violet maximum of the selective photo-electric effect.²⁴

²¹ It is possible that this value should be somewhat reduced because of the phenomenon mentioned by Sheppard and Mees,—(loc. cit. p. 279), that an image may be invisible to the eye, but still contain numbers of grains easily counted under the microscope.

²² *Physikal. Zeit.*, 22, p. 673; 1921.

²³ Loc. cit.

²⁴ Cf. Pohl and Pringsheim, *Verh. d. Deutsch. Phys. Ges.* 13, p. 474, 1911.

It is possible to calculate the free period of silver bromide in the ultra-violet by making use of the quantum relationship given by Lubben:²⁵

$$\nu_{\text{ion}} = \nu_{\text{undissolved salt}} + 2Q/Nh$$

where ν is the critical frequency, Q is the heat of solution of the substance, N is Avagadro's constant, and h is Planck's element of action. He states that in general the dispersion of colorless salt solutions in the visible and ultra-violet is attributable to the free periods of the anions. The kations possess free periods in the infra-red and farthest ultra-violet, whose influence very seldom extends into the visible or attainable ultra-violet regions. As a result of his measurements, the free period of the bromine anion was found to be 1.61×10^{15} sec⁻¹, which corresponds to 0.186μ .

Setting $Q = -20,100$ calories,²⁶ $N = 6.06 \times 10^{23}$,²⁷ and $h = 6.55 \times 10^{-27}$ erg sec.,²⁷

$\nu_{\text{undissolved salt}} = 2.03 \times 10^{15}$ sec⁻¹, which corresponds to a wave-length of 0.148μ .

Another quantum relationship which can be used to obtain the ultra-violet frequency of silver bromide, is the expression $Q = Nh(\nu_{\text{resultants}} - \nu_{\text{reactants}})$. This expression may also be written Q equals critical increment of the resultants minus critical increment of the reactants. Haber²⁸ and Lewis²⁹ have shown that this formula is in good agreement with experimental results.

Following Lewis,—the observed heat of formation of liquid bromine and solid silver is 22,700 calories per gram molecule.³⁰ As the Haber-Lewis formula assumes that the bromine is in the gaseous form,³¹ the heat of vaporization of bromine or 3470 calories³² must be taken into consideration, consequently the heat of formation of solid silver and gaseous bromine is 26,170 cal per gm mol.

²⁵ Ann. der Physik. 44, p. 977, 1914.

²⁶ Thermo Chemistry. J. Thomsen. Tr. by Burke. Longmans p. 137, 1905.

²⁷ Millikan. Phil. Mag. 34, p. 1, 1917.

²⁸ Ber. Deutsch. Physik. Ges., 13, p. 1117; 1911.

²⁹ Jour. Chem. Soc., 111, p. 1086; 1917.

³⁰ Landolt-Bornstein. Tabellen. P. 868; 1912.

³¹ Lewis, loc. cit., p. 1092.

³² Tabellen. P. 834.

No direct data seem to exist regarding the critical ultra-violet frequency of silver, so recourse must be had to calculation. Probably the best value of the mean infra-red frequency of silver is that given by the Nernst-Lindeman formula, $\nu_r = 4.5 \times 10^{12} \text{ sec}^{-1}$.³³

A rule due to Haber³⁴ enables the characteristic ultra-violet frequency to be found:

$$\nu_v/\nu_r = \sqrt{M/m}.$$

ν_v is the characteristic frequency corresponding to the maximum of the selective photoelectric effect, ν_r is the characteristic infra-red frequency of the substance, M is the weight of an atom of the substance, and m is the mass of an electron.

Taking $M_{\text{Ag}}/M_{\text{H}} = 107.88/1.008$,

$$M_{\text{H}} = 1.662 \times 10^{-24} \text{ g.},^{35}$$

$$\text{and } m = 9.01 \times 10^{-28} \text{ g.},^{36}$$

As Lewis postulates that an ultra-violet quantum breaks the bond between two adjacent atoms, the critical increment for one gram atom of silver equals $Nh\nu_v/2$, or 94864 cal.

From a consideration of the heat of dissociation and the ultra-violet absorption band of bromine, Lewis³⁷ takes the value 28,500 calories for the critical increment of one gram-atom of gaseous bromine.

As substitution in the expression $Q =$ critical increment of resultant—critical increment of reactants gives

$$\nu_{\text{AgBr}} = 1.58 \times 10^{15} \text{ sec}^{-1},$$

the wave-length corresponding to the critical ultra-violet frequency of silver bromide equals 0.190μ .

A more direct determination of the critical ultra-violet frequency of silver bromide can be made by the sole use of Haber's formula, as already stated:

$$\nu_v/\nu_r = \sqrt{M/m},$$

³³ Zeit. Elektrochem. 17, p. 822; 1911.

Cf. Lewis.

³⁴ Ber. Deut. Physikal. Ges., 13, p. 1117; 1911.

³⁵ Millikan. Phil. Mag. 34, p. 1; 1917.

³⁶ Smithsonian Tables, p. 408; 1920.

³⁷ Loc. cit.

or its equivalent,

$$\lambda_v/\lambda_r = \sqrt{m/M},$$

where λ_v and λ_r are the wave-lengths corresponding respectively to the critical ultra-violet and the critical infra-red frequencies of the substance, m is the mass of an electron and M is the molecular weight of the substance.

Taking $M_{\text{AgBr}}/M_{\text{H}} = 187.80/1.008$, assuming Rubens³⁸ mean value of 112.7μ for the characteristic residual ray from silver bromide, and giving to the other constants the same values as have been used in the preceding paragraphs, the wave-length corresponding to the critical ultra-violet frequency of silver bromide is equal to 0.192μ .

Finally, the ultra-violet frequency entering into the selective photo-electric effect will be calculated for silver bromide according to Lindeman's formula:³⁹

$$\nu_v = \sqrt{ne^2/mr^3}/2\pi,$$

where n is the valency of the atom to which the electron belongs, m and e are the mass and the charge of an electron, and r is one-half the distance between two neighboring atoms.

By X-ray analysis, Wilsey⁴⁰ has found that silver bromide gives a diffraction pattern of a simple cube with sides of 2.89A , one atom being associated with each point of the lattice.

Taking $r = 2.89/2 \text{ A}$, $m = 9.01 \times 10^{-28} \text{ g}$,⁴¹ and $e = 4.774 \times 10^{-10} \text{ e. s. u.}$,⁴¹ $\nu_v = 1.45 \times 10^{15} \text{ sec}^{-1}$, or $\lambda_v = 0.207\mu$.

To recapitulate, by means of the formulas given below the following values of the free ultra-violet period of silver bromide have been calculated:

- 1) Lubben's expression.

$$\nu_{\text{ion}} = \nu_{\text{undissolved salt}} + 2Q/Nh.$$

$$\lambda_v = 0.148\mu.$$

- 2) Haber and Lewis.

$$Q = Nh(\sum \nu_{\text{resultants}} - \sum \nu_{\text{reactants}}).$$

$$\lambda_v = 0.190\mu.$$

³⁸ Sitz. Akad. Wiss. Berlin, p. 513; 1913.

³⁹ Ber. Deutsch. Physikal. Ges., 13, p. 1107; 1911.

⁴⁰ Phil. Mag., 42, p. 262; 1921.

⁴¹ Loc. cit.

3) Haber's rule.

$$\nu_v/\nu_r = \sqrt{M/m}.$$

$$\lambda_v = 0.192\mu.$$

4) Lindeman's formula.

$$\nu_v = \sqrt{ne^2/mr^3}/2\pi.$$

$$\lambda_v = 0.207\mu.$$

Thus it appears that the critical frequency of silver bromide corresponds to a wave-length of about 0.190 μ .

Some of the existing experimental work indicates that this value of 0.190 μ is of the right order of magnitude. In 1893 Schumann⁴² stated that the indications were that the absorption of silver bromide reaches a maximum at 0.210 μ . Eight years later he found⁴³ that the ultra-violet sensibility of Schumann plates first becomes particularly noticeable at 0.220 μ and increases very rapidly towards the ultra-violet. Thus his work shows a region of resonance in the neighborhood of the calculated value of 0.190 μ .

Nutting⁴⁴ states that a photographic plate is practically uniformly sensitive from 0.5 μ to the ultra-violet, and Mees⁴⁵ finds that the photographic sensitiveness of pure silver bromide is constant for wave-lengths less than 0.480 μ .

Compton and Richardson⁴⁶ have shown theoretically and experimentally that if the wave-length λ_0 corresponds to the threshold photo-electric or photo-chemical sensitiveness, then the maximum of the selective effect should occur at wave-length $\lambda_m = 2\lambda_0/3$. In the case of silver bromide, this would indicate resonance at a wave-length of 0.320 μ , a value which is not in very good agreement with previous calculations.

The latest work throwing light upon the critical ultra-violet frequency of silver bromide seems to be that of Slade and Toy.⁴⁷ Investigating the change in the extinction coefficient of silver

⁴² Ber. Wien Akad. Wiss. 102 IIA, p. 465; 1893.

⁴³ Ann. der Physik. 5, p. 373; 1901.

⁴⁴ *Outlines of Applied Optics*. p. 223; 1912.

⁴⁵ Jour. Frank. Inst., 179, p. 141; 1915.

⁴⁶ Phil. Mag., 26, p. 553; 1913.

⁴⁷ Proc. Roy. Soc., 97A, p. 181; 1920.

bromide with wave-length, they found that the coefficient increased from a value of 270 cm^{-1} at a wave-length of 0.450μ to a value of 6700 cm^{-1} at a wave-length of 0.360μ . Therefore, a resonance frequency for silver bromide must exist farther out in the ultra-violet than 0.360μ .

Thus all of the experimental evidence predicts a resonance frequency of silver bromide in the ultra-violet,—the work of Schumann fixes the corresponding wave-length at about 0.210μ or in the region of the calculated value, while the work of Mees indicates a greater value.

EXPERIMENTAL DETERMINATION OF ENERGY REQUIRED TO BLACKEN A GRAIN OF SILVER BROMIDE

Having this knowledge of the resonance frequency of silver bromide it was now thought of interest to measure the quantity of light energy which is necessary for the transformation of a grain of silver bromide to a developable condition. For a preliminary experiment, a wave-length of 0.540μ ,—much longer than the wave-length corresponding to the critical frequency of silver bromide, was chosen, so that no particular difficulty would be experienced in the energy measurements.

To carry out the experimental manipulations, an ordinary photographic film was first exposed to a known quantity of approximately monochromatic light energy, then developed at constant temperature, fixed and washed, and finally the number of reduced grains was determined by direct microscopic counting.

A photographic film furnished the silver bromide grains. It must, of course, be borne in mind as Mees⁴⁸ has pointed out, that these elementary "silver bromide" grains contain some silver iodide, with possibly some absorbed gelatine and soluble bromide. Some workers, as for example Slade and Higson,⁴⁹ have prepared experimental emulsions by dissolving and diluting commercial plate-emulsions and coating glass slips with this diluted emulsion. This method produces a slide containing but a

⁴⁸ Jour. Frank. Inst., 191, p. 631; 1921.

⁴⁹ Loc. cit.

single layer of grains, but possesses according to Renwick,⁵⁰ through dissolving and diluting the emulsion, the grave danger of inducing chemical fog.

LIGHT SOURCE

The primary source of monochromatic light made use of in these experiments was a carbon strip-filament lamp operated with a constant storage battery current of 10 amperes. Light from this lamp traversed the optical system of a Hilger Ultra-Violet Monochromatic Illuminator⁵¹ of aperture about $f/5.4$ at 0.540μ , and the emergent beam formed a spectrum in the focal plane of the instrument.

With a linear thermopile inserted in the arm of the illuminator the light intensity of a small portion of the spectrum was measured in absolute units. A low-power microscope with micrometer eyepiece focussed upon the rear of the thermopile strips, permitted the adjustment of the wave-length drum and enabled the accumulation of data used in calculating the amount of spectral overlapping. A very large slit of 4 mm width was used in order that its image should cover the whole receiving surface of the thermopile.

Interchangeable and of the same size as the thermopile was a film holder which could also be placed in the arm of the illuminator, allowing a piece of photographic film to be exposed in the focal plane of the illuminator. In order to reduce reflection from the back surface of the film, the holder was coated with a layer of gelatine and lampblack or in some cases black laboratory wax, and the film was attached in optical contact to this absorbing layer.

Exposures were made by hand with a sliding shutter, while listening to a watch ticking fifths of seconds. An exposure of two seconds was the shortest given, and for this most unfavorable case the maximum error of exposure amounted to about 8 per cent.

⁵⁰ Phot. Jour., 61, p. 333; 1921.

⁵¹ For the purpose of this work, Professor W. M. Clark of the Hygenic Laboratory, Washington has very kindly loaned this instrument through the medium of the National Research Council.

ENERGY MEASUREMENT

The linear thermopile already referred to in connection with the monochromatic illuminator was also made by Hilger, and had a resistance of 13 ohms. Both before and after energy determinations it was directly calibrated against a standard lamp whose radiant flux⁵² in a definite direction at a given distance had been certified to by the Bureau of Standards with an accuracy of 1 per cent.

By using a D'Arsonval galvanometer whose figure of merit was 2×10^{-7} amp/mm, and by taking the mean of ten or fifteen observations, it was possible to maintain a value of the relative error less than 1% or $\frac{1}{2}\%$.

An error far greater than that entering into the thermopile calibration was caused by the spectral overlapping due to the use of a very large slit width. A slit width of 4 mm was employed in order that the image of the slit should cover the whole receiving surface⁵³ of the thermopile.

This spectral impurity manifests itself both upon the photographic film and upon the thermopile.

In the measurement of the photographic film, only those silver bromide grains were chosen which were situated along a vertical line in the geometrical center of the photographic image formed by the spectral band. The illuminator was adjusted for the experiment so that when illuminated by light of wave-length 0.540μ , the entire image of the collimator slit was in coincidence with the thermopile strips.

Now when an exposure was made with the carbon lamp in front of the illuminator a small area ΔA in this median line received an *ensemble* of light energy approximately proportional to

$$E = \int_{\lambda=0.540-\frac{w}{2h}}^{\lambda=0.540+\frac{w}{2h}} E_{\lambda} d\lambda,$$

where $E_{\lambda} d\lambda$ is the energy in the spectral region between λ and

⁵² The radiant flux for this lamp was $(63.8 \pm 0.64) \times 10^{-8}$ watts/mm²

⁵³ 4 mm by 20 mm.

$\lambda + d\lambda$, w is the width of the spectral image of the collimator slit, and k is the dispersive power of the instrument in mm. displacement of spectral image per μ of wave-length.⁵⁴

For a rough application of this formula assume; (1), that the temperature of the carbon lamp is 1775°C ⁵⁵ a normal temperature which corresponds to an efficiency of 3 watts per candle; (2), that the emissive power of the carbon filament is constant for each wave-length; and (3), that absorption in the apparatus and in the glass envelope of the lamp is constant for each wave-length.

Calculating the distribution of energy E_λ in the spectrum by Planck's formula⁵⁶ it is found that the relative energies of wave-lengths actually incident upon ΔA range as follows:

$$\begin{aligned} \lambda < 0.505\mu, & \quad E_\lambda = 0.00, \\ \lambda = 0.505\mu, & \quad E_{0.505} = 0.57, \\ \lambda = 0.540\mu, & \quad E_{0.540} = 1.00, \\ \lambda = \bar{\lambda} = 0.549\mu, & \quad E_{0.549} = 1.14, \\ \lambda = 0.580\mu, & \quad E_{0.580} = 1.71, \\ \lambda > 0.580\mu, & \quad E_\lambda = 0.00. \end{aligned}$$

The "mean" wave-length

$$\lambda = \int E_\lambda \lambda d\lambda / \int E_\lambda d\lambda$$

is found to be

$$\lambda = 0.549\mu.$$

Thus according to these data, the silver bromide grains were exposed to a band of wave-lengths comprised between 0.505μ and 0.580μ , the "mean" wave-length of the band corresponding to 0.549μ .⁵⁷

To calculate the effect of spectral impurity on the readings of the thermopile, consider that the slit image caused by light of wave-length $\lambda \neq 0.540\mu$ is of the same size as the image $\lambda = 0.540\mu$, but displaced from it a distance $d = k(0.540 - \lambda)$. As the thermopile strips are the same width w as the 0.540μ image, for small

⁵⁴ At $\lambda = 0.540\mu$, the dispersive power is $56 \text{ mm}/\mu$.

⁵⁵ Cf. J. A. Fleming. Art. "Lighting." Encyc. Britt. 11 Ed.

⁵⁶ $c = 14320$ micron degrees. Coblentz., Jour. Opt. Soc. of Am., 5, p. 131; 1921.

⁵⁷ It is interesting to note that Toy (Proc. Roy. Soc., 100A, p. 109; 1921) finds that for a spectral range of 0.030μ , radiations of different frequencies do not act independently in producing photo-chemical change, but probably as a total amount irrespective of any difference in quality.

displacements the displaced image will overlap them by an amount $w - k | 0.540 - \lambda |$,

where $0 \leq |d| \leq w$.

Accordingly, the amount of energy between the limits λ and $\lambda + d\lambda$ which the thermopile receives is

$$E'_{\lambda} d\lambda = E_{\lambda} \{ 1 - k | 0.540 - \lambda | / w \} d\lambda.$$

As a consequence, when exposed to the whole slit image the thermopile receives energy equal to

$$E'' = \int E_{\lambda} (1 - k | 0.540 - \lambda | / w) d\lambda.$$

$$d = -w.$$

Taking the same values for constants as above, some of the relative energies E''_{λ} for the different wave-lengths as received by the thermopile are given by:

$$\begin{aligned} \lambda \leq 0.470\mu, E''_{\lambda} &= 0.00, \\ \lambda = 0.500\mu, E''_{0.500} &= 0.21, \\ \lambda = 0.540\mu, E''_{0.540} &= 1.00, \\ \lambda = \bar{\lambda}' = 0.558\mu, E''_{0.558} &= 1.03, \\ \lambda = 0.600\mu, E''_{0.600} &= 0.60, \\ \lambda \geq 0.620\mu, E''_{\lambda} &= 0.00. \end{aligned}$$

The "mean" wave-length $\bar{\lambda}'$ is found by taking the center of gravity of the curve in a manner corresponding to the previous example. Thus the thermopile received energy of wave-length from 0.470μ to 0.620μ , the mean wave-length of the band corresponding to 0.558μ .

It is interesting to note that with a value of $c_1 = 3.86 \times 10^4$ watts/cm²,⁵⁸ assuming that the filament acts as a black body radiator, and with the above assumption as to temperature of filament, and no absorption in the apparatus, the calculated energy incident (E'') upon the thermopile was 2.0×10^{-7} watts/mm², whereas the energy actually measured was 1.9 times this figure, or 3.8×10^{-7} watts/mm². To account for this discrepancy, it is possible that the filament temperature has been assumed too low, but in any case, the figures above give some indication of the nature of the errors in both the photographic and the thermopile measurements.

⁵⁸ Smithsonian Physical Tables, 7th Ed. p. 247.

USE AND CONSTRUCTION OF ABSORBING SCREENS

In order to reduce the intensity of light to a very small value, a series of lamp-black-in-gelatine absorbing screens was made for insertion between the collimator lens and the prism of the illuminator. These screens were prepared by coating levelled squares of plate glass 5.5 cm \times 5.5 cm. with 0.2g. of gelatine dissolved in 4 cm³ of water. A certain quantity of lamp-black suspended in alcohol was added to the gelatine solution, depending upon the opacity desired for the screen. A small quantity of carbolic acid was added as a preservative, and after drying, the two gelatine surfaces were cemented together with Canada Balsam.

The screens of greatest transparency were directly calibrated in the illuminator by means of the thermopile, but this proceeding was impossible with the denser screens. But by measuring once for all with a spectrophotometer the ratios of the transparencies T_2/T_1 , T_3/T_1 , . . . , T_n/T_1 , of n screens to any wave-length, and then measuring T_1 , T_2 , and T_3 by means of the thermopile, for the wave-length to be used in the illuminator, the transparencies of the n different screens were determined for the illuminator wave-length.

For the purpose of this calculation assume three plane-parallel plates P_1 , P_2 and P_3 , of the same isotropic absorbing material of thicknesses d_1 , d_2 , and d_3 . If I_0 is the intensity of incident light of wave-length λ , and I_1 , I_2 , and I_3 are the respective intensities of light transmitted by the three plates, the following equations hold:

$$\begin{aligned} \text{For } \lambda = \lambda, I_n &= aI_0e^{-kd_n}, & n &= 1, 2, 3, \\ \text{and for } \lambda = \lambda', I_n &= a'I'_0e^{-kd'n} & n &= 1, 2, 3, \\ \text{If we set } D_n &= \log_{10}(I_0/I_n), & n &= 1, 2, 3, \\ \text{and } D_n' &= \log_{10}(I'_0/I_n'), & n &= 1, 2, 3, \\ \text{then (1), } D_3 &= D_1 + (D_2 - D_1) (D'_3 - D_1') / (D_2' - D_1'). \end{aligned}$$

This formula can be applied to the case of the absorbing screens by the following argument. As there is the same thickness of glass, Canada Balsam, and gelatine in the case of each absorbing screen, it is possible to choose a 's, and a' 's which will

take this condition into account. Now if the d 's and d 's be considered "equivalent thicknesses," i.e., the number of cms. of standard substance which has the same absorption as a thickness d or d' of the carbon of the screen, the formula is directly applicable to the case of the screens. It is true that the formula assumes that the density measurements are made with monochromatic light, a condition approximated very closely in the case of the spectrophotometer, but not very closely in the case of the illuminator. However, the work of Toy and Ghosh⁵⁹ shows that lamp-black has practically equal absorption for all wave-lengths within the range here used.

The spectrophotometer used in the calibration of the absorption screens was made up of two Pointolite lamps which furnished illumination for two spectroscopes. The spectroscopes were oriented so that the emergent pencils of light were at right angles to each other and came to a focus upon the silvered plane of a photometer head viewed with a suitable eyepiece.

To construct the photometer head, the hypotenuse of a right-angled prism was silvered in strips 0.75 mm. wide and the same distance apart. Another right angled prism was then cemented to the strip-silvered prism with the two hypotenuses in contact.

The field of view was consequently a set of adjacent slit-images situated one above the other. Each slit-image could be made to match its neighbors by the relative rotation of a pair of nicol prisms placed in the path of one of the light-beams. When an absorbing screen was placed in the path of one of the light-beams, its transmission could be found from the reading of the nicols.

The arrangement was such that there were no errors introduced as the nicols were rotated due to changes in angle between the plane of polarization of the light and the normal to any surface struck by the polarized light.

The accuracy attainable with the instrument was such that in a series of 25 readings the probable error in setting the nicols for extinction amounted to 3' of arc.

⁵⁹ Phil. Mag. 40, p. 775; 1920.

DEVELOPMENT APPARATUS

After the film had been exposed, it was immediately developed and fixed in total darkness. The developer was of amidol, as used by Slade and Higson⁶⁰ who found that at 18° C. the exposed grains were completely developed in 3 minutes, but that unexposed grains were not affected in 5 minutes. Fresh developer was mixed up for each film. In this work it was decided to develop at a temperature of 23° C. for a period of three minutes.

In order to provide for a constant temperature, a metal developing box was constructed, which was attached inside a tank containing 50 litres of water,⁶¹ in such a manner that the water was in contact with five sides of the box. The whole was enclosed in a wooden box provided with a door giving access to the developing box. To ensure uniformity of temperature throughout the bath, the water was kept in motion by an electrically driven stirrer.

A mercury regulator was arranged to control the temperature of the bath. A thin steel tube 1 cm. in diameter and 1 m. in length was filled with mercury and coiled about inside the bath, one end protruding from the tank. Expansion of the mercury forced a slender column of mercury through a constriction in the tube until electric contact was made against an adjustable nickel contact point, and electric lamps submerged in the water of the tank would operate until contact was again broken. Tests showed that the temperature regulation was carried out to an accuracy of at least 0.°01 C.

After developing and fixing, and thorough washing, the film was ready for a microscopic examination.

MICRO-PROJECTION

The determination of the number of silver bromide grains per unit area of film was made with the use of a micro-projection apparatus. An enlarged image of the film was cast upon a screen,

⁶⁰ Loc. cit.

⁶¹ This developing apparatus was constructed by the writer at the State University of Iowa.

and the grains through the various layers of the film were counted by progressively varying the focus of the microscope.

The source of light was a commercial reflecting 400 watt gas-filled microscope lamp. A 1.8 mm oil-immersion objective with 12.5 times eye-piece was used in the microscope.⁶²

To absorb heat rays which would otherwise start immediate combustion of the film, a water cell with a 7.5 cm thickness of water was placed between the lamp and the condenser. A micrometer eyepiece ruled in 1 mm squares was placed in the eyepiece, and thus a co-ordinate system was furnished. A magnification of about 1000 was used for visual counting. One mm on the scale of the eyepiece micrometer represented 15μ upon the stage of the instrument.

With small blackenings it was a very simple matter to count the grains, for most of them lay near the surface, and they were not in close proximity. But with the greater densities there was a tendency for many of the grains to occur in groups, and because of the inevitable overlapping of grains as viewed in the microscope, it was sometimes difficult to decide whether one or more grains were visible.

It was assumed that the net number of developed grains could be approximated by counting the number of developed grains upon the unexposed portion of the film, and deducting this "fog reading" from the total number of developed grains as counted upon the exposed portion of the film.

The following table gives the results of the work. If it be assumed that equal light energies give equal blackenings,⁶³ then the number of quanta per grain should be the same, no matter whether the flux of light energy be great or small. If, then, the number of quanta per grain be averaged over all the experiments, it is found that about 2.3 quanta of incident light⁶⁴ of mean wave-

⁶² The writer is indebted to the Department of Biology of Princeton University for the loan of this microscope.

⁶³ For references see, Helmick. *Phys. Rev.*, *9*, p. 372; 1918.

⁶⁴ Preliminary results of work now in progress show that the diffuse reflection from a silver bromide emulsion is of the order of 10% for wave-length 0.540μ , while the amount of light transmitted by the film is roughly 5%. At this wave-length the absorption of light by the gelatine is negligible.

length 0.549μ are necessary to render developable a grain of silver bromide.

EXPERIMENTAL RESULTS

Film number	FOG READING		EXPOSED READING		Net Grains Developed per mm ²	Length of Exposure sec.	Light Energy in Quanta (at 0.549μ) per mm.	Quanta (at 0.549μ) per Grain	Fraction of Grains Fogged
	Grains counted	Grains per mm ²	Grains counted	Grains per mm ²					
27	277	49200	2629	467400	418200	2	213000 ± 2200	0.51	0.11
60	255	45330	2513	446800	401470	20	413000 ± 5600	1.03	0.10
61	218	40370	982	174600	134230	10	207000 ± 2800	1.54	0.23
62	240	35550	882	145200	109650	4	82700 ± 1100	0.76	0.24
63	239	42490	626	111300	68810	2	41400 ± 560	0.60	0.38
64	251	46630	526	93520	48890	2	41400 ± 560	0.85	0.48
65	242	43020	649	115300	72280	2	41400 ± 560	0.57	0.39
66	330	39640	958	115100	75460	10	207000 ± 2800	2.75	0.34
67	341	38860	889	106800	67940	4	82200 ± 1100	1.21	0.36
68	276	32270	884	106200	73930	4	82200 ± 1100	1.11	0.30
69	337	38410	499	56880	18470	2	41400 ± 560	2.24	0.68
70	381	43420	493	56180	12760	2	41400 ± 560	3.25	0.77
71	304	34650	526	59950	25300	2	41400 ± 560	1.64	0.58
77	361	41140	2539	304900	263760	64	730000 ± 14000	2.88	0.13
78	277	31570	1990	245700	214130	64	730000 ± 14000	3.30	0.13
79	300	34190	1219	146500	112310	32	366000 ± 5600	3.26	0.23
80	322	36700	1232	148000	111300	32	366000 ± 5600	3.29	0.25
81	349	39770	722	82280	42510	16	182000 ± 2800	4.28	0.48
82	298	33960	432	49230	15270	8	91000 ± 1700	5.97	0.69
							Mean	2.27	
								±0.25	

PALMER PHYSICAL LABORATORY,
PRINCETON UNIVERSITY,
PRINCETON, NEW JERSEY.

RECENT MEASUREMENTS OF STELLAR AND PLANETARY RADIATION¹

BY W. W. COBLENTZ

CONTENTS

I. PHOTOELECTRIC PHOTOMETRY, II. STELLAR AND PLANETARY RADIOMETRY: 1. Reflecting telescopes; 2. Galvanometers and magnetic shielding; 3. Bolometers; 4. Thermocouples; 5. Stellar spectroradiometry; 6. Stellar spectral energy distribution by means of transmission screens; 7. Stellar radiation intensities; 8. Variable stars; 9. Stellar temperatures; 10. Planetary radiation measurements; 11. Bibliography.

In a previous report,² a summary and bibliography were given of measurements of thermal radiation from stars prior to 1920. The bibliography to the present report is given at the end of this paper.

I. PHOTOELECTRIC PHOTOMETRY: As indicated in the preceding report, the potassium hydride photoelectric cell is a useful instrument for photometering celestial objects, such as for example, variable stars.

Stebbins,^{1, 2} after many trials has succeeded in developing a potassium photoelectric cell of fused quartz, which is much more sensitive than the selenium photometer previously used, thereby enabling him to study sixth-magnitude stars with a 12 in. telescope.

With this device, Stebbins¹ was able to show that the variability in brightness of a certain star is not caused by eclipsing, but that the variation is caused by a change in the ellipsoidal shape of the components, resulting from their mutual attraction.

¹ Section of 1922 Report of Standards Committee on Spectroradiometry, W. W. Coblentz, Chairman.

² Coblentz, *Jour. Opt. Soc. Amer.*, 5, p. 269 (see p. 276); 1921.

In a recent photoelectric study of the variability of Algor Stebbins³ found new results showing an effect due to the ellipsoidal shape of the components of the system.

Rosenberg⁴ describes a stellar photometer consisting of a photoelectric cell and amplifying tubes. Measurements are given on several stars and planets.

II. STELLAR AND PLANETARY RADIOMETRY: Under this caption are described recent developments in nonselective stellar radiometers as well as recent measurements of the radiation from stars and planets.

1. *Reflecting Telescopes.*—Recent press dispatches tell of generous gifts of a 6 ft. reflector to be used primarily by students in a certain college in the state of Ohio, and of a 10 ft. reflector to be located in the state of Washington.

The gifts seem to be made through local pride for the hometown without consideration of the number of clear nights that will be available for observation and without thought of attainment of the maximum usefulness.

The needs of stellar radiometry are reflecting mirrors 15 or more feet in diameter, situated in a dry cloudless climate, such as obtains in Arizona and California. Some years ago, the writer had the temerity to inquire into the feasibility of constructing such a mirror by piling up a number of sheets of polished plate glass, and bringing them to the annealing temperature, when they will coalesce. By placing them in a suitable mold, they will sag to the proper curvature, so that in the polishing there will be no cutting through of the first layer.

The production of a large disk of glass by this method would obviate the difficulty of obtaining a sufficient amount of molten glass for casting in one piece, which is homogeneous and free from local imperfections. From a discussion of the matter with a large-scale plate-glass producer, it appears that the suggestion of building up a glass disk from polished, selected sheets of plate glass may not be as foolish as it appears on first thought.

2. *Galvanometers and magnetic shielding.*—For stellar radiometry Abbott,⁷ proposes to use a 2-coil galvanometer, in magnetic

shielding, instead of the 16-coil instrument heretofore employed in his solar radiation work.

The use of a 2-coil non-astatic galvanometer is, of course, not new, similar instruments having been used by duBois and Rubens.¹⁰ Modern conditions require so much magnetic shielding that the astatic magnet system is relatively unimportant. In his improved type of iron-clad Thomson galvanometer (in a vacuum) with the coils imbedded in blocks of soft iron and with an inner laminated shield of transformer iron, Coblentz,¹² ⁶ found that the old type of 4-coil galvanometer with its astatic magnet system can be displaced by a 2-coil galvanometer with a single set of magnets, reducing the weight of the suspension by one-half and thus practically doubling the sensitivity.

The use of an inner shield of laminated transformer iron separated by equal thicknesses of paper has recently been described by Wentz.¹⁴ In the interest of historical accuracy, it is relevant to add that Esmarch,¹³ used shields consisting of fine iron wire wound upon cardboard instead of transformer iron as one would infer from the above quoted paper.¹⁴

The writer has tried the laminated shields, lightly wound (hence small air spaces between the lamina) without the intervening cardboard, and with the intervening spaces uniformly separated by cardboard, and has found no marked difference in the shielding efficiency. A considerable quantity of the metal close to the galvanometer, with the top of the laminated iron cylinder covered with a laminated lid seems most effective. In this connection, it is interesting to recall that from his theoretical calculations, of magnetic shielding, Rücker,¹¹ concluded that, under certain conditions, the resultant magnetic shielding obtained by the best use of a given quantity of material can be still further improved by filling up the spaces between the shells with additional material.

3. *Bolometers*.—From his theoretical studies, Abbot⁸ concludes that contrary to the conclusions arrived at by him in determining the best dimensions for a solar vacuum bolometer, the most effective stellar vacuum bolometer must be exceedingly thin, say 0.0005 mm in thickness (length 8 mm, width 0.12 mm).

Material of this thickness or even thinner, has been extensively used in black body spectral energy measurements. Owing to its small heat capacity, it is easily disturbed by air currents and hence must be used in a vacuum when refined measurements are attempted.

In view of the feeble intensity of the stellar radiation, it is evident that receivers of low heat capacity should be used. It seems to have been overlooked by users of bolometers that there is considerable loss of heat radiation from the rear side of a bolometer receiver, even when it is unblackened. By placing a second bolometer receiver directly back of the front one, Coblenz⁹ found that the radiation sensitivity was greatly increased (amounting to 50 per cent in receivers which were blackened on both sides).

Johansen¹⁵ has shown experimentally that heat conduction from the ends of a platinum bolometer strip (0.001 mm in thickness) greatly reduces the radiation sensitivity, extending out 3 to 4 mm from the electrodes. Coblenz and Emerson¹⁶ using a platinum bolometer from one-half to one-third of this thickness, found appreciable heat conduction and hence loss in thermal radiation sensitivity extending 1.5 to 2 mm back from the ends of the bolometer receiver. From this and from Abbot's⁸ calculations, it appears that a bolometer receiver for stellar radiometry cannot be made much less than 5 to 6 mm in length without loss in radiation sensitivity by heat conduction to the electrodes.

4. *Thermocouples*.—In a recent study¹⁷ of thermocouple material to be used instead of a bolometer for stellar radiometry, it was found that the radiation sensitivity was closely proportional to the thermoelectric power (which was to be expected) but there was no great gain in sensitivity from reduction in thermal conduction by reduction of the heat capacity of the material as compared with that previously employed.⁵ The chief gain was in quickness of action and hence increased accuracy of observation.

The height of the spectrum of a star is only a small fraction of a millimeter. Hence, by placing the connecting wires of the thermocouple vertical, so as to coincide with the spectral image of the entrance slit of the spectroradiometer, it seems that the

thermocouple could advantageously replace the spectro-bolometer, in view of the fact that the latter is heated by the battery current, which renders the galvanometer reading unsteady. For measuring the radiation from small areas, as for example the dark spots on Mars, the (vacuum) thermocouple seems more suitable than the (linear) bolometer.

5. *Stellar Spectroradiometry*.—The hundreds of photographs of stellar spectra, obtained by astronomers, show dark absorption lines and bands (also in some cases, bright emission lines) of hydrogen, helium, etc. From this, it is evident that a smooth spectral energy curve, without deep indentations, cannot be obtained. Our inferences as to the probable spectral energy distribution and inferred effective temperatures must therefore be obtained by smoothing over the depressions in the observed spectral energy curve. Then assuming that the stellar envelope radiates like a gray or black body, the effective temperature may be calculated.

Equipped with a spectroscope attached to a powerful telescope and the above mentioned improvements in radiometers, Abbot and Aldrich⁸ expect to obtain the spectral energy curves of stars. Indeed, recent press dispatches announce this as now an accomplished fact. They find the effective temperature of a blue star (Betelgeux) to be 10 000°, confirming the observations of Coblenz,¹⁷ which is to be expected in view of the fact the transmission screen method employed by the latter simply integrates wider regions of the spectrum in a single measurement.

While the discussion of stellar spectroradiometry has been mainly in connection with the determination of spectral energy curves, it should not be overlooked that the device may prove useful in mapping the spectral emission and absorption lines and bands of stars, in the infra-red spectrum to which the photographic plate is not sensitive. Spectroscopists will no doubt find use for any information pertaining to the wave-lengths and intensities of the bright and dark lines in this part of the infra-red spectrum.

6. *Stellar Spectral Energy Distribution by Means of Transmission Screens*.—At best a spectroscope is an inefficient device (Abbot,⁸ *loc. cit.*, p. 59, places the loss at the slit jaws at 40 per cent) for

utilizing the incoming stellar radiation, and recently Coblentz¹⁷ determined the feasibility of obtaining the spectral energy distribution of a star by means of a series of transmission screens, placed in front of a vacuum thermocouple which was used as the radiometer.

Screens were selected which, either singly or in combination, had a uniformly high transmission over a fairly narrow region of the spectrum, terminating abruptly in complete opacity in the rest of the spectrum. By proceeding in this manner, the observations required no correction other than that for surface reflection, which amounts to about 9 per cent for the two surfaces of the screen. Corrections were made for absorption by the telescope mirrors; also for atmospheric absorption, using the spectral transmission factors for the sun, as observed by Abbot and Fowle.

By means of these screens (of red and yellow glass, quartz and water) it was possible to obtain the radiation intensity in the spectrum (from the extreme ultra-violet, which is limited by atmospheric transmission and the low reflectivity of the telescope mirrors) at 0.3μ to 0.43μ ; 0.43μ to 0.60μ ; 0.60μ to 1.4μ ; 1.4μ to 4.1μ ; and 4.1μ to 10μ .

By this novel means the distribution of energy in the spectra of 16 stars was determined, thus obtaining for the first time an insight into the radiation intensities in the complete spectrum of a star. From press dispatches, it appears that Abbot's recent spectrobolometric measurements verify the results obtained by Coblentz which is to be expected in view of the similarity of the principles involved.

This method may be open to criticism in view of the fact that it integrates the energy present in a certain spectral region and hence does not indicate the amount lost in the spectral absorption lines. The same criticism is true also of the direct spectroradiometric method which is no doubt limited to a few of the brightest stars, and if the dispersion is small, cannot properly evaluate the spectral intensities. Hence, the transmission screen method should prove useful in supplementing the spectroradiometric measurements, on fainter stars not measurable by the latter method. By integrating the spectrobolometric energy

curves, a relation ought to be obtainable with the data observed with the transmission screens and in this way a comparison obtained of the spectral energy distribution of bright and faint stars of the same spectral class.

The measurements made by Coblentz⁵ with the water screen show that, in blue and yellow stars, practically all the energy lies in that part of the spectrum to which the photographic plate is sensitive. Hence, since the effect on the photographic plate is cumulative, and the time for exposure is relatively unlimited, the spectral energy distribution of many weak stars and nebulae can be mapped, which will not be possible by any other methods known to us at the present day: Indeed such a beginning has been made by Plaskett.¹⁹ But the measurements made through the water cell show that, if astronomers had known it, they could have used the photographic method long ago for determining the spectral energy distributions of blue and yellow stars. For this purpose, the photographic plate must, of course, be standardized by exposing it to the spectrum of a source of known spectral energy distribution as was done, for example by Ives and Coblentz²⁴ in determining the spectral energy distribution in the light of the firefly.

7. *Stellar Radiations Intensities.*—The thermocouple measurements of the total radiation from stars, made by Coblentz,^{5, 17} in 1914, at Mt. Hamilton, Calif., (Lick Observatory, altitude 4000 ft.) were verified in 1921 at Flagstaff, Ariz. (Lowell Observatory, altitude 7250 ft.), showing that the early-type (Class M) red stars are losing heat 3 to 4 times as fast as the more dense, but hotter late-type (class B, A) blue stars. The least dense, class M, stars must therefore be losing heat by radiation, in which conduction does not contribute very materially in maintaining the surface at a given temperature.

In the dense stars the shape of the spectral energy curve, and hence our inferences of the effective temperature is determined by the spectral emissivity of the surface; while in the less dense stars the radiation emanates from great depths.

The water cell measurements open up a new line of thought on stellar evolution, showing, as already stated, that red stars are

losing heat 4 times as fast as blue stars. From present theories, it appears that, in the Giant, red-star stage of evolution, a star may be rising in temperature, while it is decreasing in temperature on its return to the Dwarf (red star) stage.

A question of interest is whether, when the star is passing through the high temperature, blue, class B, A-stage of development (and is losing heat one-fourth as fast as when it is in the red, class M-stage) the interval of time of transition is relatively much longer (say 3 to 4 times longer) than when the star is in the low temperature, red, class M, N stage of evolution.

8. *Variable Stars*.—When the vacuum thermocouple and water cell were first used successfully,⁵ in separating the infra-red from the visible radiation from stars, the usefulness of this device was apparent in studying the heat from double stars and from planets.

Recent reports from the Mt. Wilson Observatory, where Pettit and Nicholson¹⁸ are using the 100 inch reflector, show that the vacuum thermocouple and water cell are rapidly becoming useful for routine study of variable stars of long period. However, from the viewpoint of the physicist it would seem preferable to tabulate the water-cell absorption in per cent of the total radiation received instead of in difference of stellar magnitude as given by these observers (or give both). For example it seems simpler to state that the water cell absorbs 25 per cent of the total radiation from Vega than to state that the water cell absorption, in difference of magnitude, is 0.3. The field of stellar radiometry is practically new and the adoption of a simple nomenclature and a simple tabulation of data should be begun now.

The water cell, having the property of absorbing the invisible infra-red rays, which are emitted by stars of low luminosity, will be a useful device for studying double stars, like Sirius, which have companions of low luminosity, and in searching for double stars which many have dark companions. This will form a new field of investigation.

9. *Stellar Temperatures*.—Data on the spectral energy distribution and temperature of stars as related to that of a black body are very meager. They are the results practically of the spectrophotometric measurements of Wilsing,²⁰ and of Nordmann,²¹ and

the spectral energy curves determined photographically by Plaskett,¹⁹ all of which relate to the visible spectrum. From the data obtained on the radiation intensities in the visible spectrum, these experimenters have obtained estimates of stellar temperatures of 3000° for red stars to 25 000° or even higher for blue stars.

The temperature measurements of Wilsing, Scheiner and Münch²⁰ of various stars of class B (blue) vary from 7000° to 15 000° K; class A, from 8000° to 12 000° K; class F from 5000° to 8000° K; class G, (solar type) from 4000° to 7000° K; and class M (red) 3000° to 3500° K.

By means of his transmission screen device, Coblentz¹⁷ found that, in the class B and class A (blue) stars, the maximum radiation intensity lies in the ultra-violet (0.3μ to 0.4μ) while in the cooler, class K and M (red) stars, the maximum emission lies at 0.7μ to 0.9μ in the infra-red. From this it appears that the black body temperature (i.e., the temperature which a black body would have to attain in order to emit a similar relative spectral energy distribution) varies from 3000° K for red, class M, stars to 10 000° for blue, class B, stars.

This estimate of the effective temperature of a star was obtained by comparing the observed spectral radiation components with the calculated values for a black body at various temperatures.

In Table 1, are assembled various determinations of the effective stellar temperatures by Nordmann,²² and by Nordmann and le Morvan;²¹ also by Wilsing, Scheiner, and Münch,²⁰ and calculated values by Saha²³ on the basis of ionization theory.

While it is to be expected that the various methods must give different results, it is interesting to find a rather close agreement in the estimated stellar temperatures. The agreement is especially close for stars of classes G, K, and M, that is, stars having a low temperature.

10. *Planetary Radiation Measurements.*—By planetary radiation is meant the emission of thermal radiation from a planet as a result of warming of its surface by exposure to solar radiation, including heat that may be radiated by virtue of a possible high internal temperature of the planet itself.

TABLE 1.—*Stellar Temperatures*

Star	Class	Coblentz	Wilsing, Scheiner & Munch	Nord- mann & Morvan	Nord- mann	Saha
		°K	°K	°K	°K	°K
ϵ Orionis	Bo	13 000	18 000
β Orionis	B8p	10 000
α Lyrae	Ao	8 000	9 400	12 200
α Canis Majoris....	Ao	7 000	12 000
α Cygnii	A2	8 000	9 400
α Aquilae	A5	8 000	8 100
α Canis Minoris....	F5	6 000	7 200
α Aurigae	Go	6 000	7 100	7 000
α Boötis	Ko	4 000	3 700
β Geminorum.....	Ko	5 500	4 900
α Tauri	K5	3 500	3 500	3 600	3 500
α Orionis	Ma	3 000	3 000	5 000
α Scorpii	Map	3 000
β Andromedae	Ma	4 000	3 200	4 300	3 700
μ Geminorum.....	Ma	3 500	3 100	3 200
β Pagasi	Mb	3 000	2 800
Sun	Go	{ 5 800* to 6 200	5 320

* Recalculated from Abbot & Fowle, Jour. Opt. Soc. Amer., 5, p. 272; 1921.

The temperature of the surface, due to absorbed solar radiation and due to internal heat, at most, is probably not much higher than several hundred degrees centigrade and hence the reradiated energy will be predominately of long wave-lengths,— 7μ to 12μ . Hence by means of a 1 cm. water cell interposed in the path of the total radiation emanating from the planet, this long-wave-length radiation can be separated from the reflected solar radiation, and in this manner a measurement obtained of the planetary energy radiated. If there is planetary radiation then the water cell transmission will be less than that of the direct solar radiation.

During the past June, (1922) the writer made further measurements (at the Lowell Observatory) of the thermal radiation emitted by the major planets.

By comparing the transmission of the direct solar radiation, through a water cell, with the transmission of the radiation emanating from the planet, a measurement was obtained of the intensity of the planetary radiation.

Radiometric measurements were made on Venus, Mars, Jupiter, Saturn, and the Sun, and in cases where similar measurements had been made at Mt. Hamilton, Calif. in 1914, the data were found in good agreement.

The water cell transmissions of the radiations from Jupiter and from the Sun were practically the same, indicating (1) that the outer atmosphere of Jupiter does not become heated (either by the Sun's rays or by internal radiation) and emit long-wavelength infra-red radiation and (2) that any radiation emanating from its interior is entirely trapped by surrounding atmosphere. Hence, we cannot determine the internal condition of Jupiter.

The intensity of the planetary radiation increases with decrease in the density of the surrounding atmosphere and, as interpreted from the water cell transmission, is as follows: Jupiter (0), Venus (5), Saturn (15), Mars (30), and the Moon (80).

The intensity of the planetary radiation from the northern hemisphere of Mars was found to be less than from the southern hemisphere. This is to be expected in view of the observed cloudiness over the northern hemisphere which is approaching the winter season, and hence is at a lower superficial temperature.

The radiometric measurements on Mars are of especial interest in view of the question as to its temperature, etc. Lowell's²⁶ calculations of the surface temperature of Mars give values much higher than those obtained by Poynting,²⁵ who obtained a value of -38° C.

The calculations of Lowell, based on the heat retained, give a mean temperature of 9° C for the surface of Mars; while another calculation gives a temperature of 22° C. He points out that owing to cloudiness, only 60 per cent of the incident solar radiation is effective in warming the earth while 99 per cent is effective in warming the surface of Mars. Other meteorological data of interest are that on Mars, water boils at 44° C; that the amount of air

per unit surface is 177 mm ($2/9$ the earth's) and that the density of the air at the surface is 63 mm ($1/12$ the earth's).

In a recent discussion of climatic conditions on Mars, Pickering²⁷ inferred from phenomena generally observed on the planet, estimates the mean annual temperature at $+20^{\circ}$ F as compared with the mean annual temperature of the earth of $+59^{\circ}$ F (15° C). At night, the Martian temperature is below 32° F (0° C) and at noon it is perhaps 60 to 70° F (15° to 20° C). These estimates are arrived at from the appearance and disappearance of snow and frost during the course of the Martian day, and from the fact that snow is never seen on the equator at Martian noon.

The writer's radiometric measurements are in agreement with the calculations of Lowell, and with the arguments set forth by Pickering, showing a considerable rise in temperature of the surface of Mars.

Probably the most convincing experimental observations of the range of temperature of the moon are those of Langley and Very²⁸ and later, those of Very.²⁹ These measurements indicate inferred effective lunar temperature ranging from 45° C to over 100° C. The calculated value³⁰ using recent data on the solar constant, indicate a lunar temperature of 82° C.

When we consider that 30 per cent of the total radiation emanating from Mars is of planetary origin, as compared with 80 per cent from the moon, and that all the evidence shows that the lunar surface becomes appreciably warmed it appears that there is also a considerable temperature rise (10 to 25° C.) of the surface of Mars as calculated by Lowell. So whether or not we accept the view that vegetation can exist on Mars, the radiometric measurements confirm other meteorological data, showing that at Martian noon the snow is melted, which could not happen if the temperature were -39° C as some have calculated.

As for the views held by some, of the possibility of vegetation growing on Mars, much depends upon whether we think of palm trees growing in our tropics, or the mosses and lichens which thrive on the apparently bare piles of volcanic cinders of Arizona and under our Arctic snows.

In conclusion, it may be noted that there is a divergence of opinion as to the spectral character and the intensity of the solar radiation, the "solar constant," outside of our own atmosphere. The unexpected observation of a considerable heating of the surface of Mars, raises the question whether the calculations of planetary temperatures are in error, or whether the solar radiation intensity (the "solar constant") outside our atmosphere is higher than the present accepted value.

BUREAU OF STANDARDS,
WASHINGTON, D. C.

II. BIBLIOGRAPHY

II. *Photoelectric Photometry.*

1. Stebbins, *Astrophys. Jour.*, *51*, p. 218; 1920.
2. Stebbins, *Astrophys. Jour.*, *51*, p. 193; 1920.
3. Stebbins, *Astrophys. Jour.*, *53*, p. 105; 1921.
4. Rosenberg, *Die Naturwissenschaften*, *9*, p. 359; 1921.

III. *Stellar and Planetary Radiometry.*

5. Coblentz, *Bull. Bur. Standards* *11*, p. 613; 1915 and Lick Observatory (Stellar Radiometry)
6. Coblentz, *B. S. Bull.* *13*, p. 442; 1916. *14*, p. 519; 1918. (Galvanometers)
7. Abbot, *Annals Astrophys Obs.*, *4*, p. 60; 1922 (Galvanometers).
8. Abbot, *Annals Astrophys Obs.*, *4*, p. 64, (Bolometers).
9. Coblentz, *B. S. Bull* *14*, p. 532; 1918 (Multiple Bolometer) (Magnetic Shielding).
10. duBois & Rubens, *Electrotech. Zeit.*, *15*, p. 321; 1894.
11. Rücker, *Phil. Mag.*, (5) *37*, p. 95; 1894.
12. Coblentz, *B. S. Bull.*, *9*, p. 60; 1911.
13. Esmarch, *Ann. der Phys.* (4), *39*, p. 1540; 1912.
14. Wentz, *Phys. Rev.*, (2) *16*, p. 137; 1920.
15. Johansen, *Ann. der Phys.* (4), *33*, p. 517; 1910 (Bolometers).
16. Coblentz & Emerson, *B. S. Bull.* *12*, p. 503; 1916 (Bolometers).
17. Coblentz, *B. S. Sci. Paper* *17*, p. 725; 1922 (Thermocouples, Stellar temperatures.)
18. Pettit & Nicholson, *Pub. Astron. Soc. Pacific* *34*, p. 181; 1922.
19. Plaskett, *Monthly Notices, R.A.S.* *80*, p. 771; 1920.
20. Wilsing, Scheiner & Münch, *Pub. Astrophys Obs.*, Potsdam, *24*, No. 74; 1920.
21. Nordmann & Le Morvan, *Compt. Rend.*, *173*, p. 72; 1921.
22. Nordmann, *Compt. Rend.*, *149*, p. 1038; 1909.
23. Saha, *Proc. Roy. Soc., London (A)* *99*, p. 135; 1921.
24. Ives & Coblentz, *B. S. Bull.*, *6*, p. 321; 1910.
25. Poynting, *Phil. Trans. Roy. Soc.* *202A*, 525; 1903. *Jahrbuch der Radioaktivität*, *2*, p. 42; 1905.

26. Lowell, *Phil. Mag.*, (6) *14*, p. 161; 1907.
27. Pickering, *Pop. Astron.*, *30*, p. 410, 1922.
28. Langley & Very, *Nat. Acad. Science*, *3*, (1884) and *4* (1887).
29. Very, *Astrophys. Jour.*, *8*, pp. 199 and 284, 1898; *24*, p. 351, 1906.
30. Coblentz, *Pub. 97*, (p. 135, 1908) of the Carnegie Institution of Washington.

INSTRUMENT SECTION

THE LENSOMETER

AN INSTRUMENT FOR THE MEASUREMENT OF THE EFFECTIVE OR VERTEX POWER OF OPHTHALMIC LENSES

BY CHARLES SHEARD AND E. D. TILLYER

INTRODUCTION

The significance of the difference between thin and thick lenses, as well as the meaning of the terms nodal point, principal point, focus, equivalent focus and back focal length of a lens are well known to those interested in physical optics. These points and foci may be determined in laboratories by various experimental methods more or less elaborate as the case may be. Their mathematical calculation, through the use of appropriate equations, has constituted for some time a part of the domain of science commonly spoken of as geometrical optics.

But the science of physiological optics, insofar as this field of scientific endeavor and research has to do with the problems of ocular refraction, has not until more recent years found it necessary to take cognizance of measurements of the true corrective or effective powers of ophthalmic lenses. This has been true for the reason that the prevalent forms of ophthalmic lenses worn until the opening years of the twentieth century were either double convex and double concave, or plano-convex and plano-concave, or were at best what are commonly called "flat" lenses in ophthalmic optics.

In the construction of the trial case lenses in our standard test sets, the forms of lenses used have been quite commonly of the double convex and double concave type. About 1899 the question as to why strong contrageneric (convex and concave) lenses of equal curvatures—but of opposite signs—did not neutralize was raised by Charles F. Prentice. As a result standard trial case lenses were so made that the *thin* biconcave lenses¹ con-

¹ Commercial "thin" negative lenses were compensated so as to agree with the theoretical thin negative lenses in their effects on the biconvex forms.

stituted the master lenses and the positive, or biconvex, lenses were so modified in curvatures that they might be neutralized by these lenses. In this manner, therefore, the trial lenses were made such that they were at all times the equivalents of thin lenses whose powers were determined through neutralization. In reality, therefore, all ophthalmic lenses of the biconvex or biconcave form were so manufactured that their powers were measured in units of back focal length, or in other words their designation was in terms of effective or vertex refraction. For example, a plus 20 diopter lens was not made with a plus 10 diopter curve on each side, but with a reduced curvature, so that the lens marked +20.00 D. S. was neutralized by the -20.00 D. S.—the thin, master lens. Fig. 1 illustrates the fact that

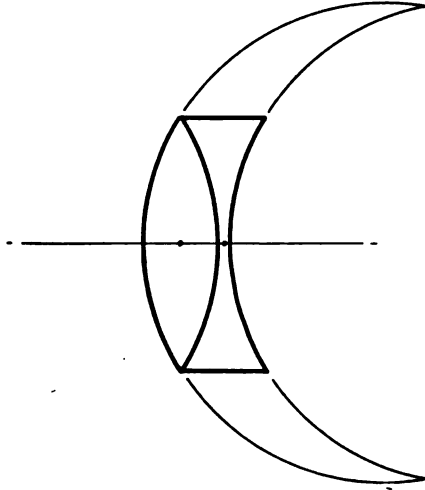

FIG. 1. *Illustrative of the statement that biconvex and biconcave lenses of the same curvatures cannot neutralize.*

biconvex and biconcave lenses of equal curvatures would give as a resultant a weak positive power lens.

With the advent of meniscus and so called toric lenses—in which various base curves might be employed and which, as a result, gave various shapes of lenses having powers which were said to be the same—the elements of *thickness* and *shape* of lens

had to be taken into account. The application of neutralization methods—which involve the addition of such a quantity of opposite character or power of lens as will give a resultant of zero—to the determination of the true power of ophthalmic lenses of different thicknesses and shapes was not strictly scientific, for if the neutralization lens from the trial set was applied to these menisci and torics one or the other of two possible results was evidently obtainable: (1) the *front focal* length, or its true corrective effect or power if it were to be worn in a manner the reverse of that in which it is worn, and (2) its *back focal* length, which would be determined as the resultant of two lenses, one an air lens between glass surfaces and the second the supposedly correct biconcave neutralizing lens. Fig. 2 illustrates the method

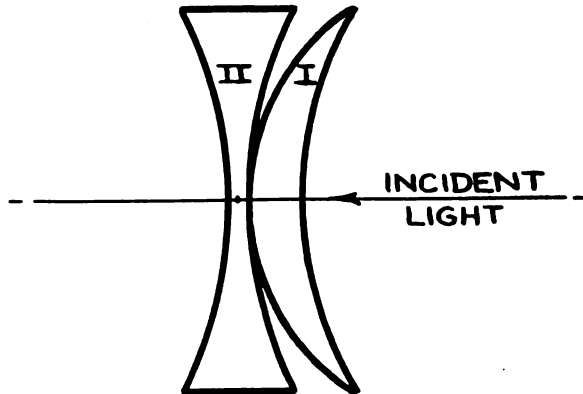

FIG. 2. *Neutralization from the front surface. This means that the front instead of the back focal length is determined.*

of finding the front focal length by neutralization. Fig. 3 shows the error in the method of neutralization as applied to finding the back focal length or the true corrective power of meniscus and toric shapes of lenses.

It is evident, therefore, that methods of neutralization as applied to the finding of the true corrective powers of ophthalmic lenses are in error except insofar as they are used when biconvex and biconcave forms of lenses are to be measured. In the case

which is mentioned as the exception, the true corrective (i. e. back focal) power, or effective power or vertex refraction is determined. We prefer the term *effective* as it is self-explanatory.

Menisci and toric lenses are quite commonly prescribed at present for the general reason that the field of useful vision is greater and wider than in the earlier, equal curvature forms of lenses. At the present time the curvatures employed, or the base curves of toric lenses, are being quite widely varied—depending

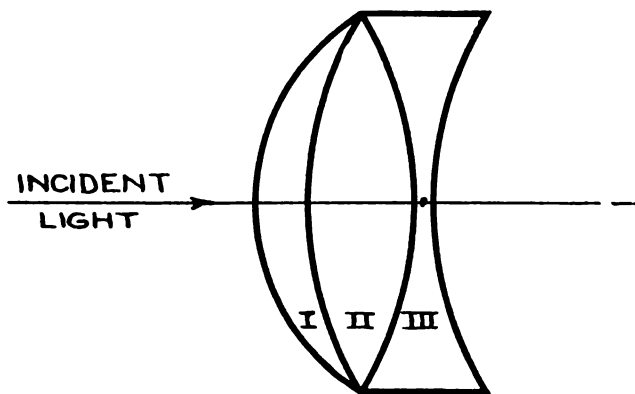

FIG. 3. *Neutralization of meniscus and toric forms of lenses from the ocular side of the lens means that three lenses will be involved in the procedure.*

upon the desired power of lens as a criterion—in order to give as wide-angled correct focus fields as possible. In ophthalmic optics it has therefore become imperative to devise an instrument which would quickly and accurately measure the *back focal power* of any lens, irrespective of its shape (i. e. curvatures), and thickness, as well as being capable of measuring the back focal length of any combination of spheres and cylinders that might be inserted in an ophthalmic trial frame. To accomplish the designing and perfecting of such an instrument the Research Division of the American Optical Company, and chiefly its physical optician, Mr. E. D. Tillyer, have devoted a large amount of time and effort.

THE LENSIOMETER

The lensometer, therefore, measures a lens in *effective power* or *vertex diopters*. The term *vertex refraction* was introduced by von Rohr about a dozen years ago in writings in which he emphasized the well-known fact that the true unit of measurement of ophthalmic lenses should be in terms of the distance from the ocular side of the lens to its focal point, i.e., back focal length. The use of this term *vertex refraction* did not, however, introduce any new or novel conception as to lens measurement.

The optical system of the lensometer is given in the accompanying figure (Fig. 4). The observer's eye (A) is placed at the exit pupil of the telescopic system, composed of an adjustable Rams-

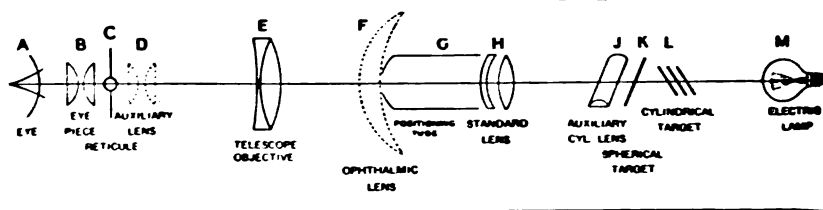

FIG. 4. The optical system of the lensometer.

den eyepiece (B) which is focused on the reticule (C) to compensate for errors in (A), while (E) is a telescope objective so adjusted as to bring the images of distant objects to a focus at (C).

The lens (D) is an auxiliary lens system² which may be inserted at the will of the operator. The optical system A, B, D, and E, is therefore a very low power compound microscope, imaging the spectacle lens (F) at the reticule (C) for the purpose of geometrically positioning the ophthalmic lens with high precision.

The positioning tube (G) is adjusted and set with lock screws for holding the ophthalmic lens (F) at the exact distance required from the adjusted standard lens (H) which projects the image plane of the targets (K) and (L) into the required back focal distance from the ocular surface of the lens (F) which is under test.

²This auxiliary lens system is free from certain angular errors which render it valuable in the optical laboratory for many purposes, such as aligning a spectrometer prism and so on.

As ophthalmic lenses are in general composed of both spherical and cylindrical powers, two targets are used at right angles to each other. The cylindrical target (L) is permanently positioned at right angles to the spherical target (K) and for the sake of permanence both are made by milling fine slots in thin brass. The cylindrical lens (J) is permanently fastened to the target (K) to add a definite and constant cylindrical power and the scale reading of (K) is correspondingly shifted so that for a spherical lens at (F), targets (K) and (L) will not come into contact. For cylindrical lenses the separation will naturally be much greater.

The positioning tube (G) is adjusted so that the ocular surface of the ophthalmic lens (F) is held exactly in the principal focal plane of the standard lens (H), so that the distance (x) from this point to the image of the target is given by the optical equation

$$x x' = f^2$$

where x' is the distance of the target from the other focal plane of (H) and (f) is the equivalent focal length of the standard lens (H). This equation can then be put in the form

$$x' = f^2 \left(\frac{1}{x} \right) = f^2 D.$$

from which it is obvious that the reciprocal of the back focus of the lens (F) is read as a linear term, x' , in units depending for their values upon the value of (f). It is thus seen that linear changes in position of the targets may be translated into dioptric values.

The standard lens (H) must be accurate. Even if the curves were to be exactly correct, two lenses made from different ends of the same piece of glass might differ in index sufficiently to produce an error which could not be permitted in the lensometer. The standard lens is consequently made adjustable in power by a slight change in the separation between the positive combination and an auxiliary negative lens, the cell of which is threaded into the positive lens cell. After accurately adjusting the power, the two cells are sealed together.

The precision of the protractor on the lensometer is tested by means of a marked plano cylinder placed face up and then face

down. The average readings will then give the 180° point regardless of the actual axis of the cylinder.

The centering is tested by positioning a slightly decentered lens in four ways, so that a marked point is first "in," then "out," and if the reading "in" is the same as the reading "out," the horizontal center is correct. The procedure for the "up" and "down" centering is similarly carried out.

The lensometer is so adjusted that readings made with each lensometer on the primary standard lens set agree with the values as certified by the Bureau of Standards. This makes the lensometer the duplicate of the primary standard lenses insofar as power is concerned.

The lensometer as a working instrument is pictured in Fig. 5.

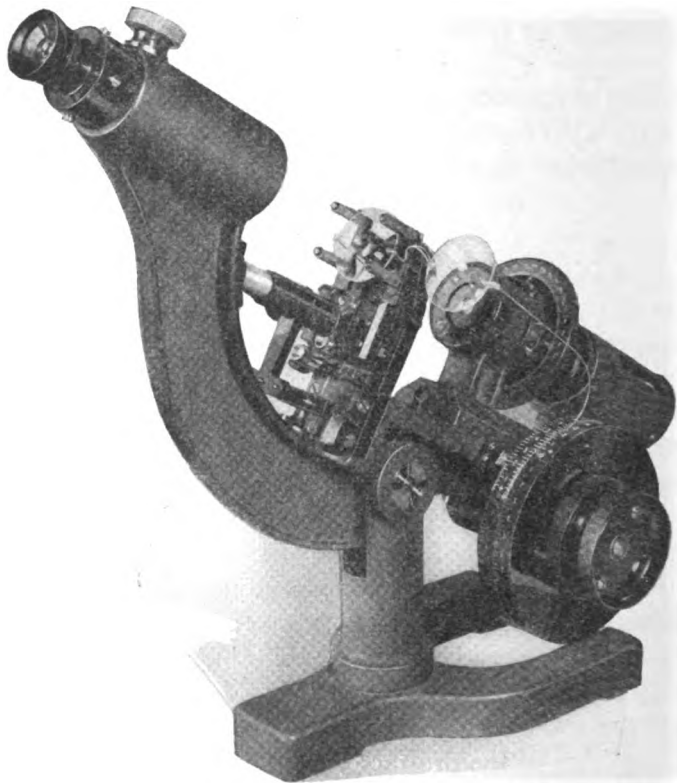

FIG. 5. *The Wellsworth lensometer.*

Fig. 6 shows the wheels (L and K) by means of which the spherical and cylindrical targets (J, K, L in Fig. 4) are changed in position. The effective or vertex power readings are given by the division marks (both spherical and cylindrical) directly under the indicator line marked S.

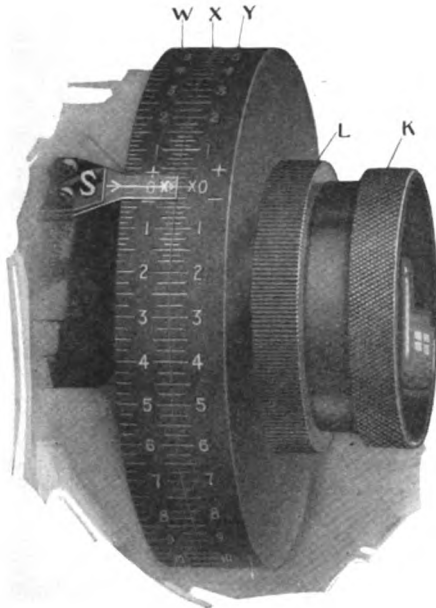

FIG. 6. *Showing the wheels and scales used in getting the spherical and cylindrical powers of lenses.*

Fig. 7 shows in (A) the dial, which may be revolved, for the determination of the cylindrical axis; the carriage for holding the lens (or lenses) is shown as D1, D2, D3, D4; at V and H are shown the two scales for determining the amount of decentration, or prism power, up or down, in or out; while B shows the ophthalmic lens in proper position for measurement just as illustrated in the diagrammatic sketch given in Fig. 4.

The reproductions which follow, and which are labelled as Figs. 8a and 8b, show a family of images of the targets obtainable under varying conditions of sphere, cylinder or both sphere and cylinder being in or out of focus.

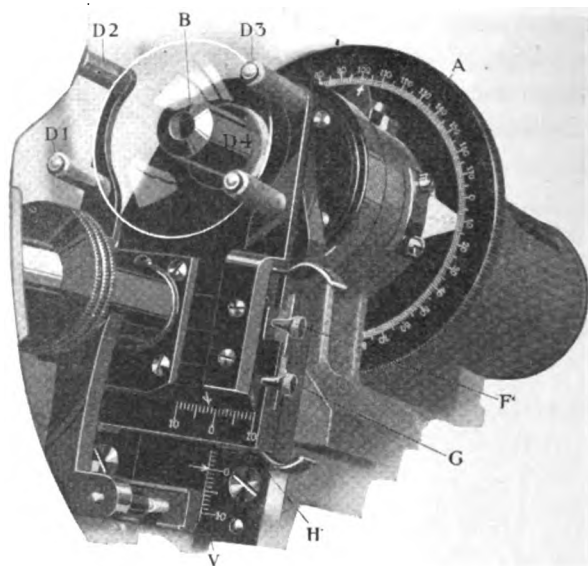

FIG. 7. Showing the carriage for holding lenses, the protractor for determining the axis of the cylinder and the device for finding the amount of decentration or prismatic element incorporated.

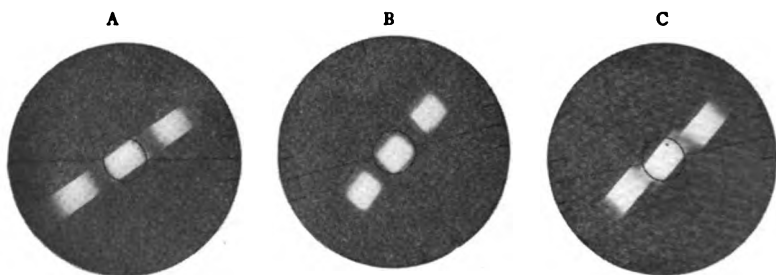

FIG. 8a. (A) Sphere in focus: cylinder out of focus: axis correct.
 (B) Sphere out of focus: no cylinder.
 (C) Sphere in focus: cylinder out of focus: axis off a few degrees.

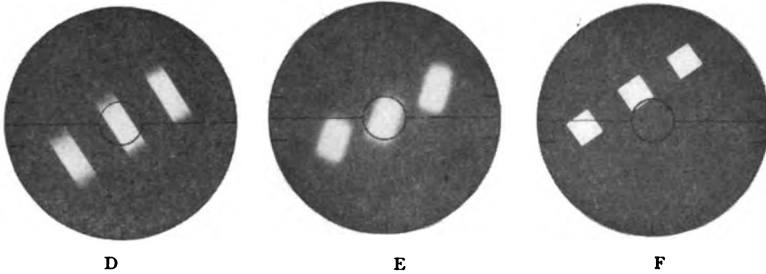

FIG. 8b. (D) *Sphere in focus: cylinder out of focus: axis 90 degrees off.*
 (E) *Sphere out of focus: cylinder out of focus: axis off.*
 (F) *Normal image, decentered.*

The lensometer measures the effective power (back focal length) of any lens or combination of lenses which falls within the range of plus 20 diopters (focus, 2 cm) or minus 20 diopters (focus,—2 cm) and a cylindrical power up to 8 diopters (focus 12.5 cm). The instrument may, therefore, be used for the determination of the back focal length or effective power of any single or combination lens or lenses, irrespective of the use to which the lens or lenses may be put, provided it falls within the limits of the instrument. Its chief value without doubt lies in the field of physiological optics as applied to ophthalmic lenses, for it provides a universal device for the measurement of the true corrective effects and powers of any ophthalmic lens, simple or compound, or any combination of such lenses.

RESEARCH DIVISION, AMERICAN OPTICAL COMPANY,
 SOUTHBRIDGE, MASS.

A HEMISPHERICAL PHOTOMETRIC INTEGRATOR

BY FRANK BENFORD

CONTENTS

	PAGE
Synopsis.....	1040
Introduction.....	1040
Compensating mirror.....	1041
Interference by test unit.....	1043
Position of test unit in plane of opening.....	1046
Calibration for searchlight tests.....	1048
Accessories for searchlight tests.....	1053
Beam analysis.....	1054
Analysis of motion picture beam.....	1056
Analysis for crater brilliancy.....	1058

SYNOPSIS

A study of the errors in spherical photometry due to the presence of the lamps and screens in the Ulbricht sphere led to the development of a fixed convex mirror to be used in place of the two larger screens. A further development of the theory of interference within the instrument led to the adoption of a hemisphere in place of the complete sphere. It is shown how the instrument is calibrated and used for the testing of

- (a) Reflectors for indoor or street illumination
- (b) Large searchlights
- (c) Small searchlights, headlights, etc.
- (d) Motion picture projectors
- (c) High intensity arcs (for brilliancy).

The various accessories that go with the instrument are described and illustrated

INTRODUCTION

Some seven years ago the writer started an investigation of the optical action within an Ulbricht sphere when it contained a standard source of light, a test unit of considerable size as compared with the sphere and the three screens ordinarily used is this instrument. The investigation led to the development of a new type of compensating screen¹ and the elimination of some of the most troublesome variables encountered in practice. In order to construct the compensating screen, which was a convex mirror

¹ Benford, *The Integrating Sphere and a New Type of Compensating Screen*. *Transactions I. E. S. I.*, p. 997-1005; 1916.

placed close to the photometric window so that it concealed the opposite hemisphere of the Ulbricht sphere, it was necessary to remove the concealed hemisphere in order to get working room for the calibrating light. While engaged in the work of exploring the surface with a spot light and at the same time altering the mirror surface so that all parts of the hemisphere would give equal photometer readings for equal amounts of incident light, quite naturally there occurred the thought—If a hemisphere can be made to integrate properly for a light source at the center of the plane of the opening, would it not be possible to extend the optical corrections so that a searchlight beam could be received and photometered? If this is possible, then we have a solution for one of the most difficult and laborious problems in all photometry.

COMPENSATING MIRROR

If a small spot of light covering less than 10° arc on the spherical surface is moved around to various positions on the diffusing surface the photometer reading will vary, being greatest when the spot is farthest from the reading window and least when it is closest to the window. The variation depends upon the diffusing characteristics of the Keene cement used to surface the integrator and upon the transmission characteristic of the window. Thus, if the reading when the spot is 90° from the window is 100, it will be about 70 for a position as close as possible to the window. If the convex mirror is placed so that an image of the entire adjacent hemisphere may be seen it becomes possible to collect light from all parts of the hemisphere over two paths, that is, direct light from *A* to *C*, Fig. 1 and reflected light over path *ABC* in the same figure, and the sum of the two beams may be controlled by reducing the average reflectivity of the mirror at the zone *B* on the mirror.

Compensating mirrors have been made for the hemispherical integrator now in use and one of them is illustrated in Fig. 2. A star-shaped area in the center of the convex side is covered with a shell of oxidized copper spun to fit the convex surface. The reflectivity of the center of the mirror is perhaps as low as 3% and in the circular zones cutting the points there is a gradual

increase of average reflectivity up to 86% where the mirror is entirely exposed. This form was obtained² by trial and error, using an exploring spot 5° in width. It was found to be impractical to attempt to compute the needed reflectivity of the various

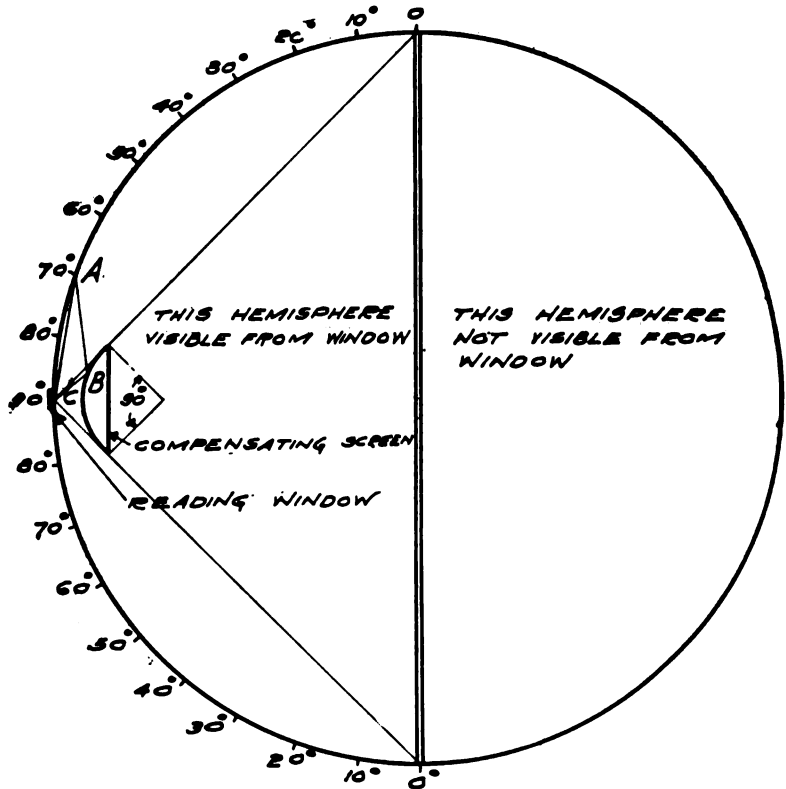

FIG. 1. Diagram showing arrangement of compensating screen within sphere.

zones on account of the strong secondary action of light reflected back and forth between the mirror and the adjacent surface of the hemisphere.

In Fig. 3 is shown how, after the mirror was finished and adjusted, the photometer reading varied as the spot was moved from the position of incidence on the back of the mirror outward to the edge of the hemisphere. At incidence on the back of the

² Benford—A Universal Photometric Integrator Transactions I.E.S. 15, pp. 19-27; 1920.

mirror (the spot really overlapped slightly) the reading was 67. At a point 7° outward the reading rose to 145 and then fell to 100 at 12° . At 14° it was 92 and then it rose to 100 at 30° and remained at this value out to the edge of the hemisphere. (If a complete sphere is used the identical form of star would be used

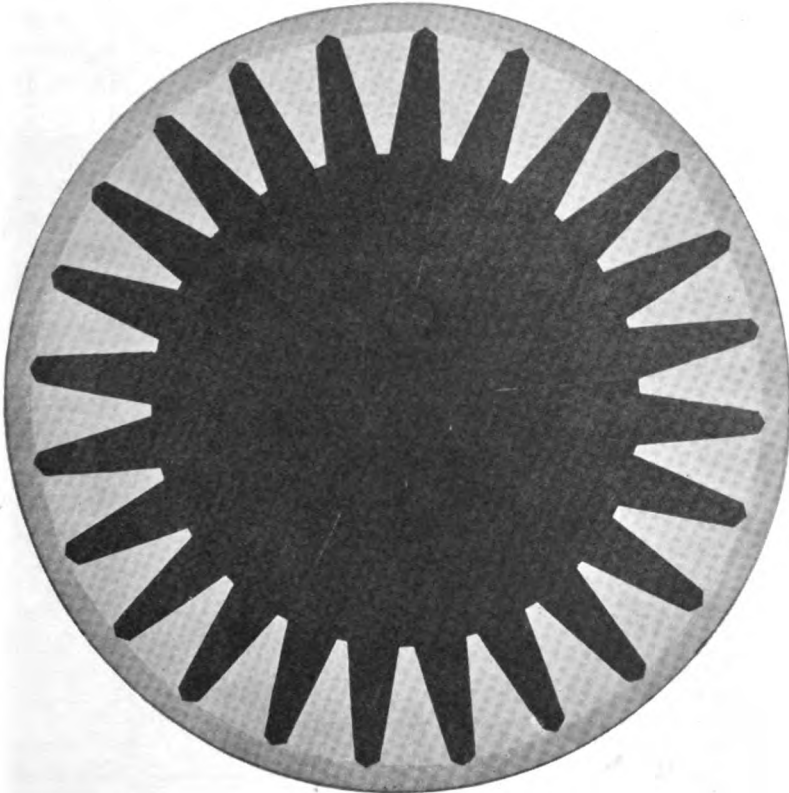

FIG. 2. *Compensating mirror for hemispherical integrator.*

and the variations from the average reading would all be scaled down to about one quarter). The areas of positive and negative errors around the screen are balanced against one another so that a spot of uniform illumination covering 25° around the axis will be read correctly.

INTERFERENCE BY TEST UNIT

In the photometering of a lighting unit in a sphere there must be an experimental determination of the light absorbed by the

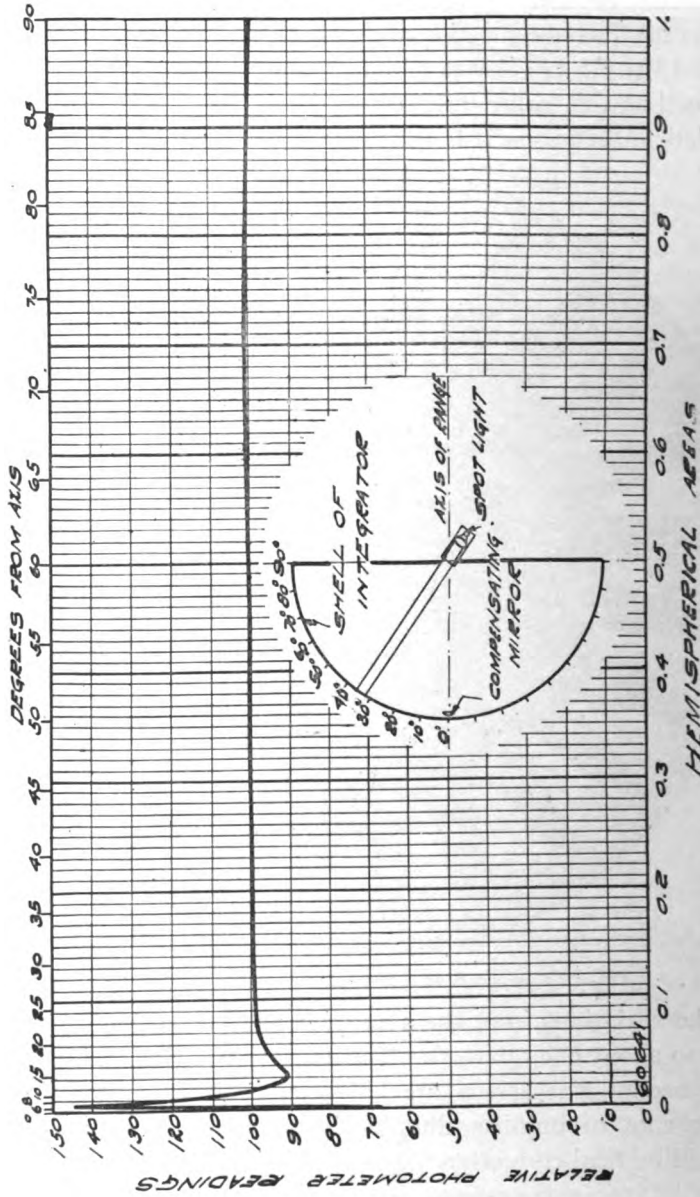

FIG. 3. Spot calibration of hemispherical integrator for light originating in plane of opening.

unit. This determination is not always exact because the absorption of light from the standard lamp is not the same as for light from the test unit. The difference here arises from the different distribution of brightness over the sphere wall given by the two sources. The action of the test unit results in a reduction of the reading below its proper value. If a hemisphere is used and the test unit is placed in the plane of the opening, as shown in Fig. 4, there are two opposing actions that under certain conditions



FIG. 4. *Front view of integrator showing location of compensating screen, optical wedges and bridge for use of operator in mounting test unit.*

nullify one another. Light reflected from edge to edge of the hemisphere is interfered with by the test unit and the photometer reading is reduced, but light reflected outward through the plane of the opening is reflected by the test unit and returned to the instrument, increasing the reading.

The interference of the test unit depends upon its average coefficient of reflection and on its size relative to the instrument. Some theoretical brightness factors are plotted in Fig. 5, showing how the brightness and photometer reading varies for both sphere and hemisphere of equal diameter. The influence of the lighting unit is seen to be relatively small in the latter instrument, and this feature is important for two practical reasons: First, certain of the experimental errors of test are probably reduced in somewhat the same proportion as the interference, and second, the interference becomes so small that ordinarily it can be neglected, thus saving considerable test work.

A series of tests³ made with both types of integrators (of the same diameter) and various lighting units gave the data tabulated in Table 1, where the positive signs indicate an increased reading due to the presence of the unit in the integrator, and the negative sign indicates a decreased reading. Note the change of sign in the data on the hemisphere.

TABLE 1

Reflectors	Change of Photometer Reading	
	Sphere	Hemisphere
	Per cent	Per cent
Group 1	- 7.5	+1.6
2	-17.5	+2.3
3	-25.9	+0.7
4	-33.3	-0.3
5	-42.4	-2.3

POSITION OF TEST UNIT IN PLANE OF OPENING

The spot calibration for the mirror was carried out with light coming from the center of the plane of the opening. A number of

³ Benford, An Integrating Hemisphere. Transactions I.E.S. 23, pp. 323-356; 1918.

Brightness Factors for Sphere and Hemisphere when containing Lighting Unit

$$\text{For sphere } F = \frac{1-K}{1-K \left[1+C \left(\frac{r}{R} \right)^2 - \left(\frac{r}{R} \right)^2 \right] \left(1 - \frac{K}{2} \right)}$$

$$\text{For hemisphere } F = \frac{1-\frac{K}{2}}{1-\frac{K}{2} \left[1+1.2C \left(\frac{r}{R} \right)^2 - 0.8 \left(\frac{r}{R} \right)^3 \right]}$$

where K = Reflectivity of Integrator = 0.833.

C = " " Lighting Unit

R = Radius of Integrator

r = " " Lighting Unit.

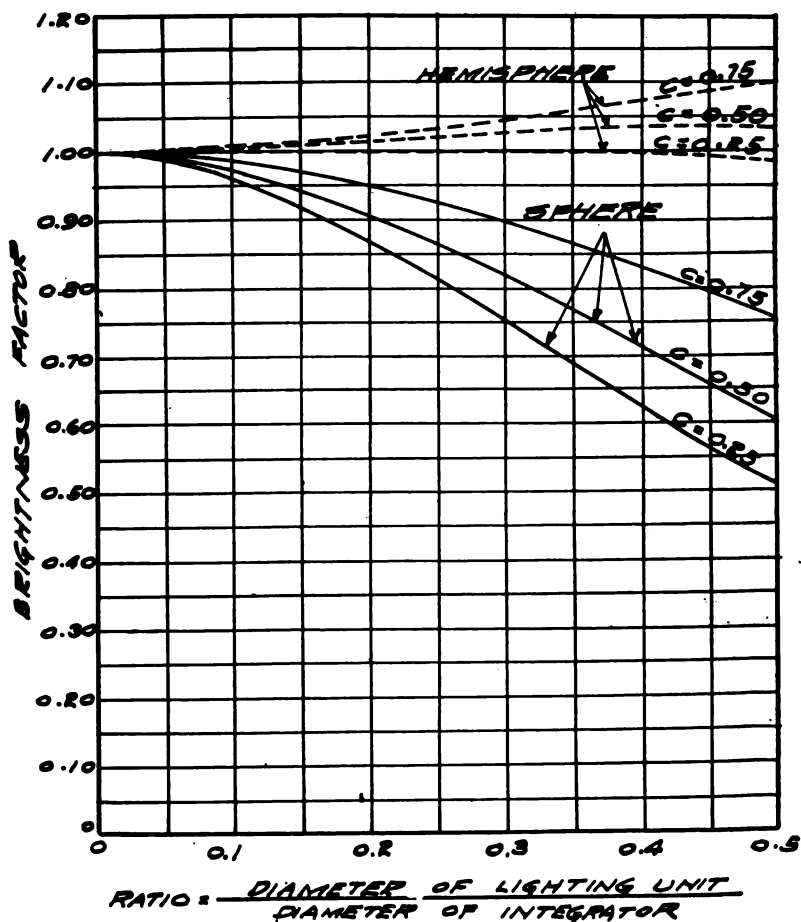

FIG. 5. Brightness factors for Sphere and Hemisphere when containing lighting unit.

tests since made with various lighting units show that they may be placed anywhere in this plane within 36 inches of the center without appreciable influence on the photometer reading. This allows the standard lamp and test unit to be well separated and a screen between them is not needed. In Fig. 4 the standard lamp, which is under the bridge upon which the operator is standing to adjust the test unit, is separated from the latter by 65 inches, and it is not necessary to have a screen between them.

The test unit is tested and then rotated through exactly 180° and tested again so as to include all the light; this rotation is made by means of the handwheel and gearing shown in Fig. 6. The handwheel for the standard lamp is on the platform but does not show in the illustration.

CALIBRATION FOR SEARCHLIGHT TESTS

The particular service for which the hemispheres in this laboratory were designed and built was the testing of searchlights. This type of photometry has many difficult features and ordinarily the cost is so high as to discourage any thorough investigation of the larger sizes of projectors. It is true that an indoor test on a searchlight has its limitations, principally because the beam does not get into its approximate final shape at short distances such as the 150 feet available in the indoor range, but on the other hand, the determination of the total quantity of useful light in the beam may be safely made at this distance. The smaller arc searchlights and incandescent 'floodlights' can be completely analyzed for total light and beam intensity at 150 feet, and there are many other types of projection units, such as motion picture machines, spot lights and automobile headlights that can be similarly tested in all details.

When light is projected into the hemisphere from a considerable distance, the angle of incidence is no longer nearly identical with that of the light used in calibrating for the compensating screen. In general, light projected along the axis will give readings higher than light radiated from the center of the instrument, and at the extreme edge of the instrument where projected light strikes near grazing incidence the readings will be as much as 33%

high. After the surface and mirror were tested for action under parallel light the wedges shown in Fig. 4 were designed so as to reduce all circular zones to equality. It is assumed that the

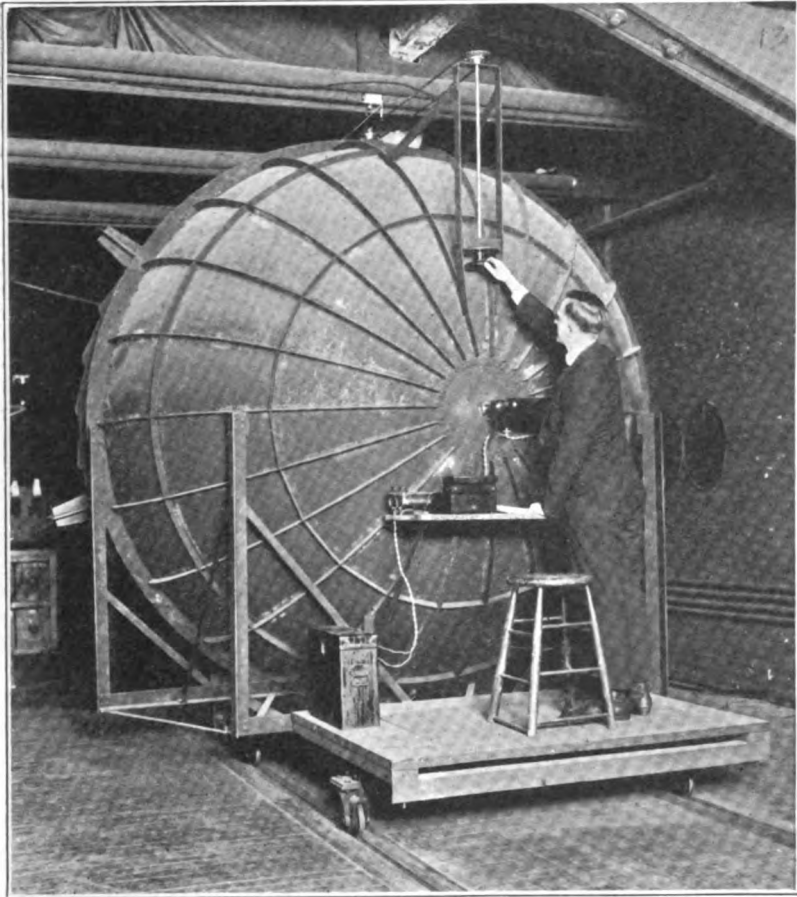

FIG. 6. *Rear view of integrator showing photometer and hand wheels for rotating test unit.*

test unit will give sufficiently uniform illumination so that each wedge will correct for the 20° arc on which it is centered. The illustration shows the wedges to be alternately long and short. This was done as a matter of expediency. The instruments

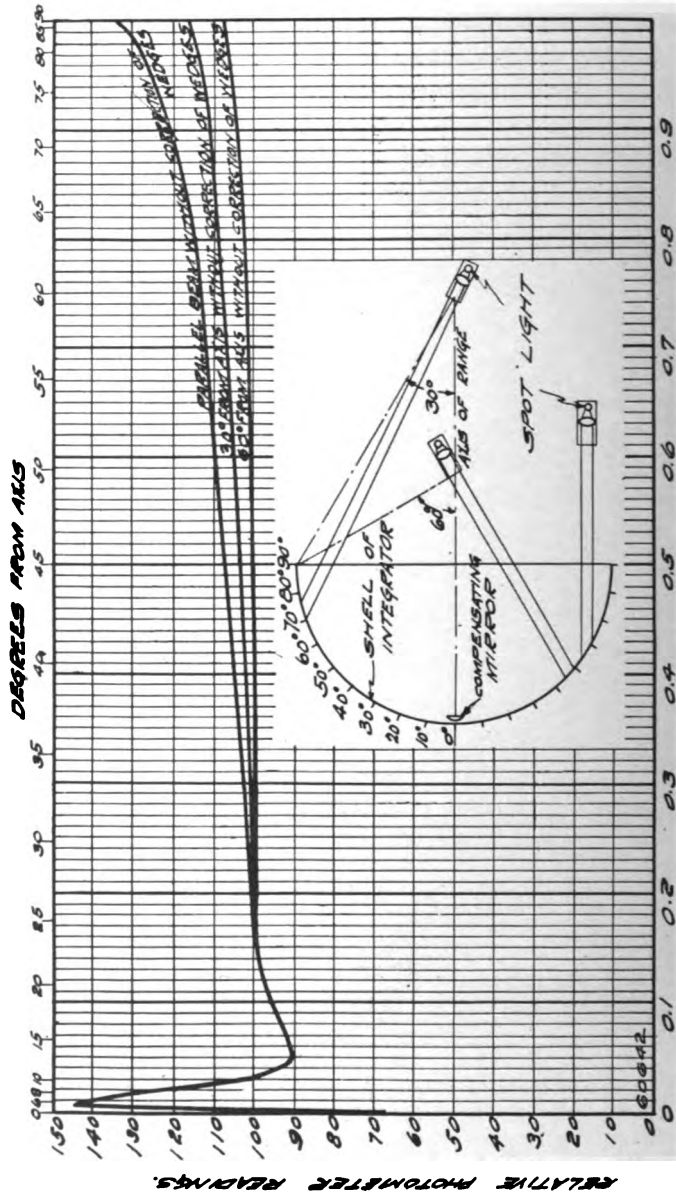

FIG. 7. Spot calibration for parallel light, and for light originating on the axis at short range.

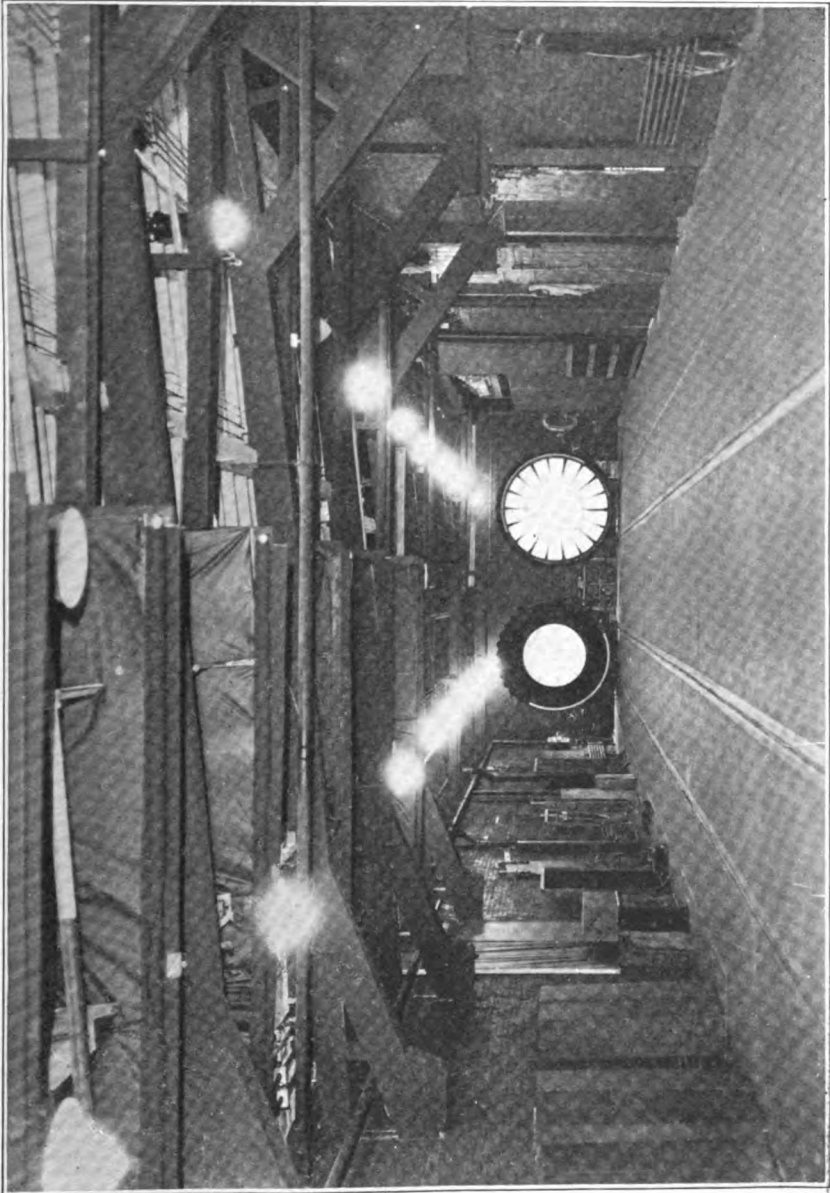

FIG. 8. A view of the indoor searchlight range with the curtains raised. One integrator is diaphragmed down to half opening.

were constructed under great pressure during the war and the shop work was kept as far as possible abreast of the computations and calibration data. The wedges were originally all the size of the larger ones, following data on a previous small model with a paint surface, and the width in excess of the needs of the present plaster surface was removed from every other wedge. This not only saved time, but it made it mechanically possible to taper off the correction to a smaller value at the inner zones.

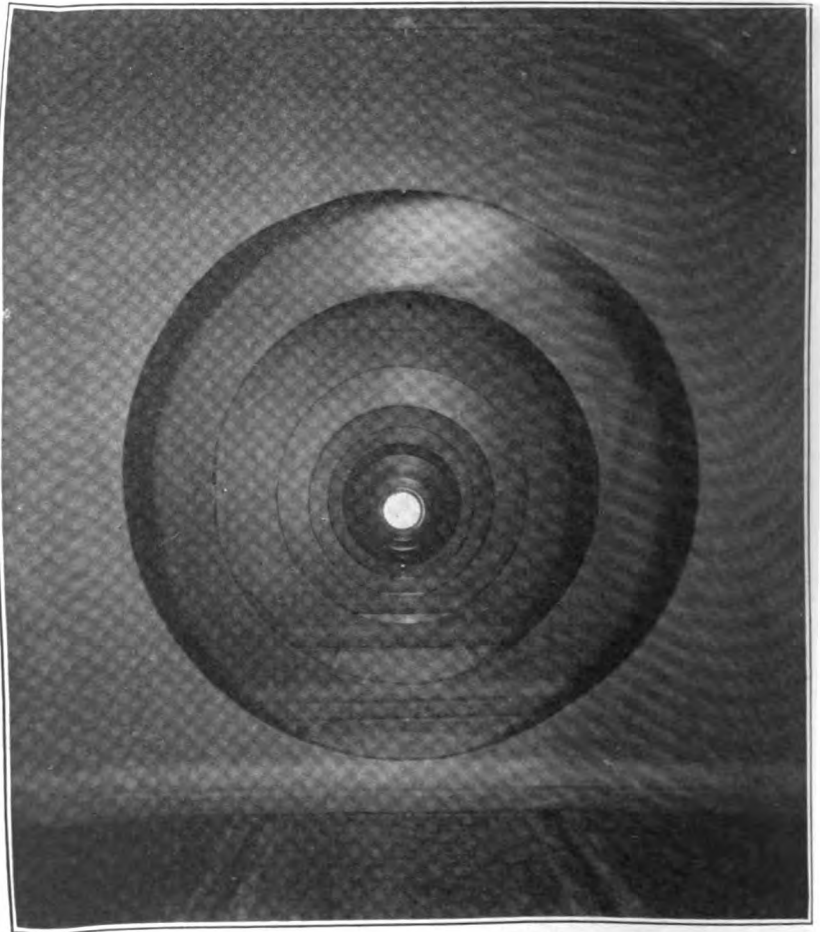

FIG. 9. *An integrator as viewed from the searchlight through the curtain diaphragm.*

ACCESSORIES FOR SEARCHLIGHT TESTS

The indoor searchlight range is a room 170 feet long, 31 feet wide and about 13 feet high. The two integrators are mounted on parallel tracks that run the length of the room, and the distance between test unit and integrator may be any desired distance up to 150 feet. It is often necessary to use both instruments at the same time on work that requires an open iris shutter,

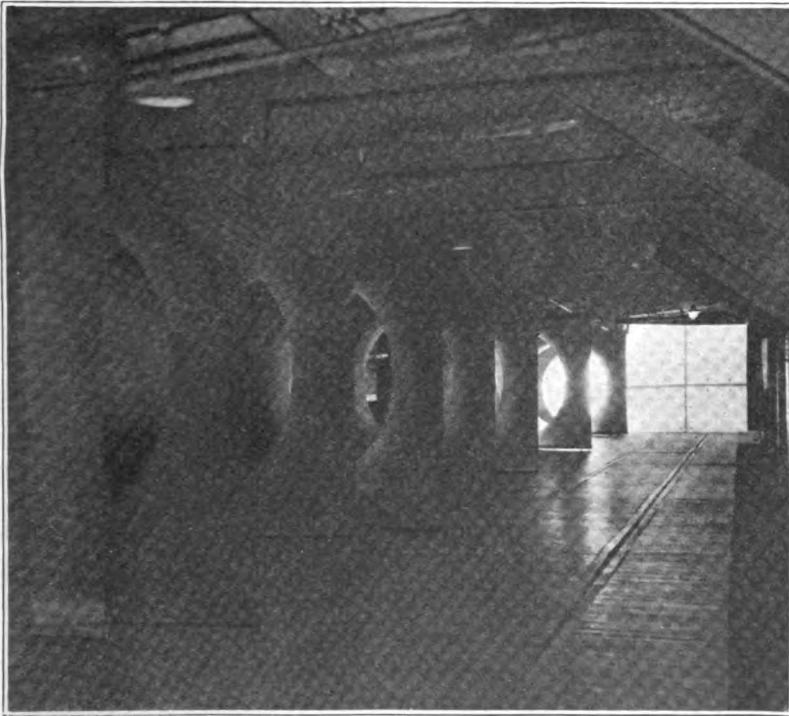

FIG. 10. A view of the indoor searchlight range showing light tunnel, and integrator when testing a 60" searchlight for light outfit. The focusing curtain is down in front of the other integrator.

and obviously unless some precautions are taken there will be an exchange of stray light, and also, a certain amount of light will be reflected from the floor and walls. A series of curtains with circular holes in the centers are suspended above each track, and when these curtains are down the holes form a tunnel that

effectually prevents the exchange of light and cuts off direct reflection of the floor and walls.

The floor presents the most favorable surface for undesired reflection, coming as it does closer to the light collecting shell than either the walls or ceiling, and to prevent light being reflected back into the instruments it is essential to have the floor as black as possible, or if not black then specular in reflection characteristic so that the light will not be diffused in the backward direction. This feature has worked out well, for as the floor becomes lighter through traffic it also becomes more specular. It has been found by trial with a constant amount of light directly incident on the shell that the reading is practically independent of the shutter opening, the greatest observable effect being about one half per cent. This shows that the effectiveness of the black inner surface of the iris shutter and the cylindrical shell between it and the hemispherical surface is not greatly different from the effectiveness of the room in returning light to the photometric surface.

As a preliminary to every searchlight test, it is necessary to see that the beam is circular in sections and properly focussed. To aid in this determination a white curtain with horizontal and vertical scales marked in degrees is lowered in front of the integrator and the illuminated area is then inspected for size, shape, regularity of outline and other characteristics that are related to the arc and its adjustment. (In taking the photograph of the indoor range in operation extra light was thrown on the white curtain in order to make it visible.)

The opening of the hemisphere is covered by an iris shutter that can be varied in opening from 4 to 110 inches. This shutter is operated by a handwheel which drives a sprocket wheel and chain that passes around the outer ring of the shutter.

BEAM ANALYSIS

There are a large number of short range units such as flood lights and motion picture projection arcs that may be completely analyzed for intensity at short range, and for this type of service the hemispherical integrators have been particularly valuable. A point-by-point analysis of any projected beam is always a

physical possibility, except in the rare cases where the available supply of electrodes or the short life of an incandescent lamp prevents any extended test, so that it is hardly fair to claim that anything really new in the way of testing can be done, but the process of testing has been speeded up to the point where the time of actual test becomes a minor part of the whole time of preparation and time of burning necessary to establish an accurate average for varying arcs.

It was the former practice of this laboratory to test an incandescent flood light in at least four radial lines and occasionally in as many as eight lines about the center of the beam, and even then a repetition of the test would not always give a reasonably close check. There are two types of variations in any projected beam, a variation in space, as illustrated by the spots of high and low intensity in the beam from an incandescent lamp, and variations with time in an arc beam. It is evident that by taking zones completely around the axis of the beam the difficulty due to spots will be eliminated, but variations due to time can be overcome only by extending the test over a period that will allow the variations to average out. For this reason all arc tests are repeated from one to five times, but an incandescent test may be completed with a single exploration of the field of the beam.

In analyzing a projected beam six or more concentric zones are tested for average intensity and this average is plotted in the center of the zone on the curve sheet. Thus, a beam 10° in total width would be separated into zones as in the following table. The opening of the iris shutter and the distance from projector to integrator are given in the two last columns.

TABLE 2.—*Beam Analysis*

Zone	Zone Center	Iris Opening	Distance
Degrees	Degrees	Feet	Feet
0 to 0.5	0.33	2.62	150.0
0.5 to 1.5	1	7.86	150.0
1.5 to 2.5	2	9.17	105.0
2.5 to 3.5	3	9.17	75.0
3.5 to 4.5	4	9.17	58.2
4.5 to 5.5	5	9.17	47.6

The angular opening of the integrator is increased by steps and the increment of reading is a measure of the increment of light in the added zone. The method thus depends upon successive differences and if the steps are too small the data points will be uneven and alternately above and below a smooth curve. With a proper selection of zone width this is prevented and it is not difficult to duplicate a test with good agreement between points.

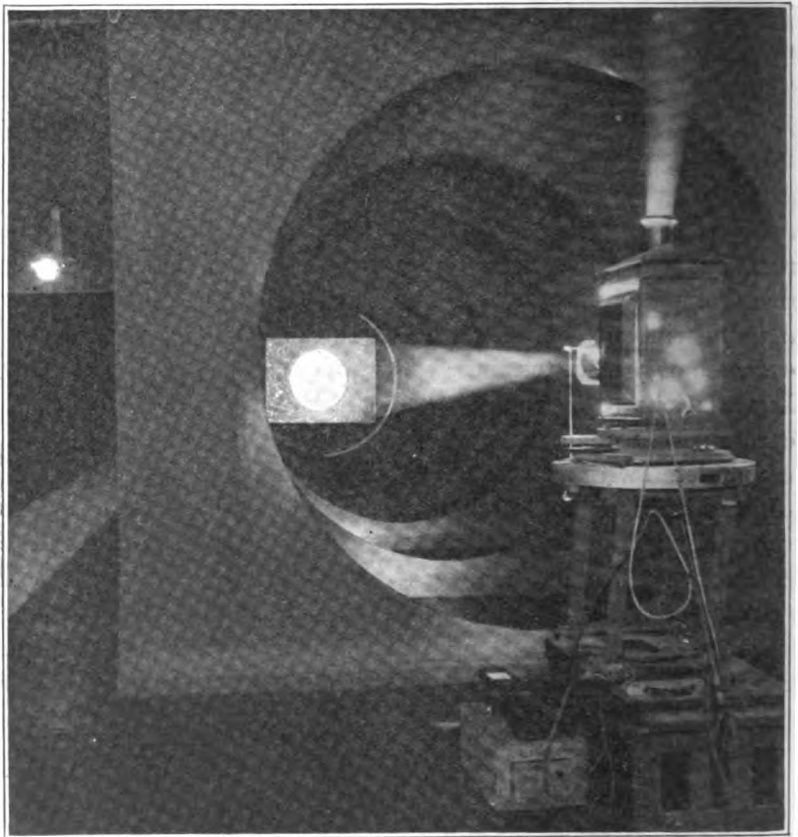

FIG. 11. *A test on the quantity of light in the central part of a motion picture projector beam.*

ANALYSIS OF MOTION PICTURE BEAM

A test on a motion picture lamp or lens is best made with all parts of the optical system in normal operating position. The

collecting and projecting efficiencies of condenser and objective are obviously dependent upon the relations of the lenses to lamp and aperture, and the size of the integrator allows the measurement of the entire beam at nearly normal curtain distances, thus insuring data that apply directly to theatre practice.

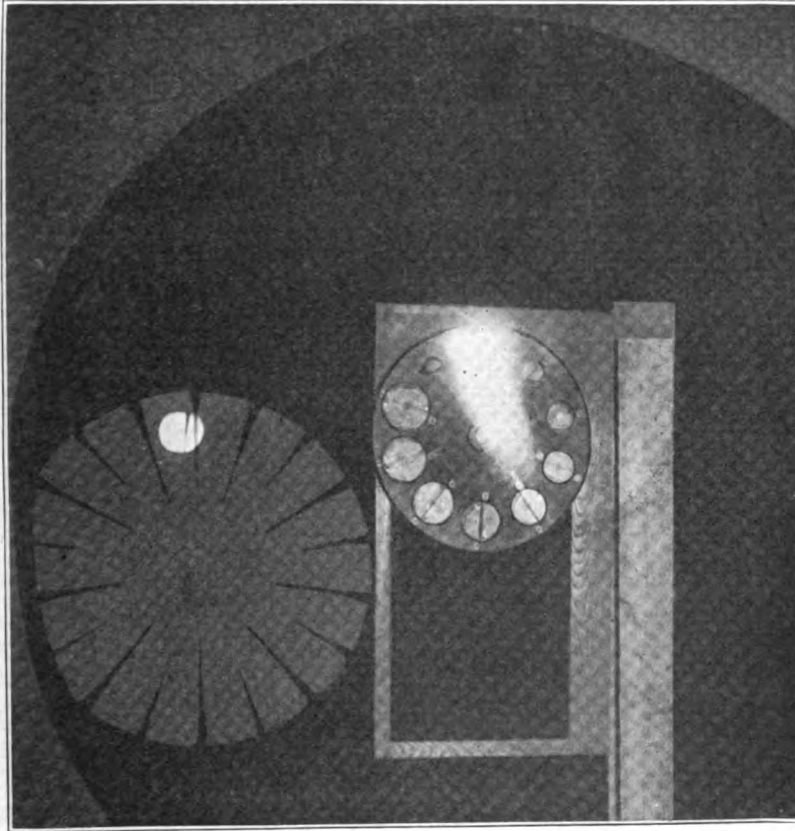

FIG. 12. *Integrator being used in the analysis of a high intensity crater for brilliancy in various zones.*

The analysis for distribution of intensity on the screen is carried out by concentric zones as in the case of the searchlight, but this method, while perfectly satisfactory for arc lamps, is not so well suited for incandescent projection lamps, and plans are

now under consideration for providing each integrator with four curtains that may be arranged to diaphragm off any desired rectangular space and thus allow an analysis of the screen illumination in sections more suited to the general outline of the screen itself.

ANALYSIS FOR CRATER BRILLIANCY

The high intensity arc offers some peculiar problems in photometry, particularly if an attempt is made to find the distribution of brightness over the area of the gas filled crater. The gas is always in motion and while this motion is not at all violent it makes it rather difficult to read brightness for local points of small area. A method of testing for brilliancy in concentric zones (which may be circular or elliptical according to the purpose of the test) has been worked out in connection with the hemispherical integrators.

A lens of 18 inches focal length is set up in front of the bare arc and an image is projected onto an analyzing disk some 15 feet away. This disk is pierced around its periphery with ten annular zones of equal area, but different radii, so that if all were superimposed they would form concentric zones dividing the area of the outside circle into ten equal parts. The light of the image is allowed to pass through these zones one at a time and enter the integrator. The light through each disk zone divided by the corresponding zone area at the crater is obviously a measure of the zone brilliancy. This analysis can be carried out for any angle of radiation from the arc, and the resultant data give the true crater brilliancy and separates out all arc and flame light that originates outside of the area of useful generation.

ILLUMINATING ENGINEERING LABORATORY, GENERAL ELECTRIC COMPANY,
SCHENECTADY, N. Y.
SEPTEMBER 8, 1922.

A TELEPHONE RECEIVER AND TRANSMITTER

By C. W. HEWLETT

In previous publications [Phys. Rev., *17*, p. 257, 1921; and *19*, p. 52, 1922] the writer has described an instrument which lends itself to the reception and generation of voice currents. It consists of two coaxial pancake coils held by an insulating frame a short distance apart on either side of an electrically conducting diaphragm. Figs. 1 to 4 inclusive show reproductions of photographs of two of these instruments.

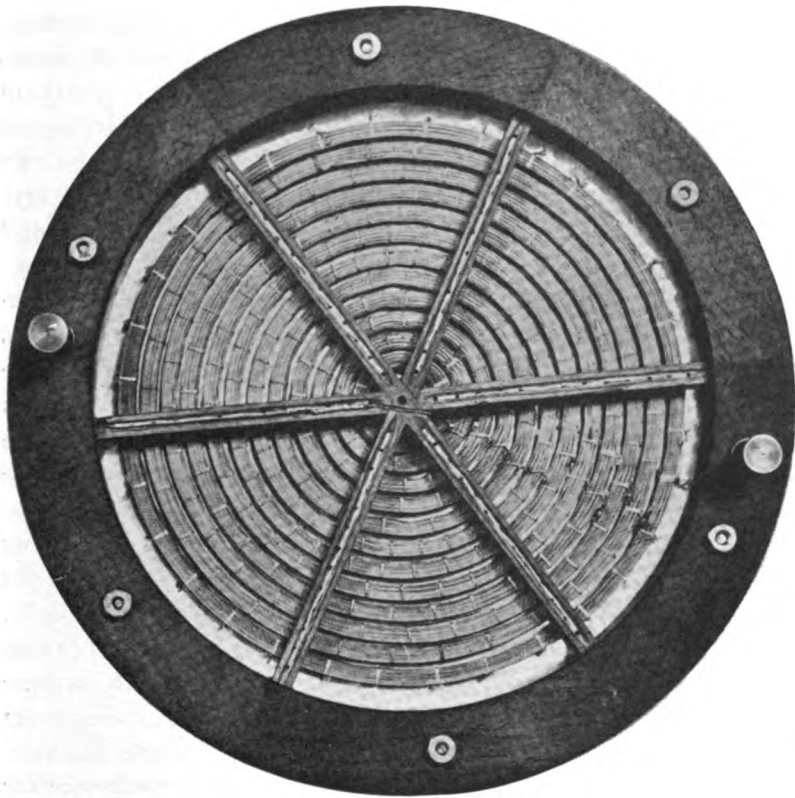

FIG. 1

1059

In order to use the instrument a direct current is sent through the coils in such a way that their magnetic fields oppose, the result being a radial magnetic field in the space occupied by the diaphragm between the coils. Fig. 5 shows an arrangement of circuits for using two of the instruments, one as a generator, and the other as a receiver of voice currents. In practice the circuit is somewhat simplified since one or two batteries can be used to supply all the currents. If generators are used instead of batteries, filters are necessary. *LLLL* are the coils, and *DD* the diaphragms of the voice current generator and receiver. *AA* are two amplifying tubes; *CC*, coupling condensers; *rr*, grid leaks; and *RR*, coupling resistances. C_1 is an output condenser coupling the second tube with the receiver of voice currents.

The generator of voice currents, shown on the left, functions as follows: Sound waves, striking *D*, cause it to vibrate across the radial magnetic field. This generates voice currents in the diaphragm which in turn induce voice electromotive forces in the coils *LL*. The induced electromotive forces in the two coils are in multiple supplying the grid-filament circuit of the first tube. The condensers *CC* should have an impedance small compared to the grid-filament resistance for all frequencies concerned. The twice amplified voice current is fed through the condenser C_1 to the receiver of voice current where it induces voice current in the diaphragm. The reaction between the voice current in the diaphragm and the radial magnetic field causes the diaphragm to vibrate and produce sound waves of the same character as the original ones striking the diaphragm of the generator of voice currents.

To avoid diaphragm resonance, which is one of the chief factors giving rise to distortion in the usual telephone apparatus, the diaphragm is thin and is held without tension between the coils. Calculation shows that the amplitude of motion of the diaphragm is nearly independent of its thickness, but increases with increase of its conductivity and decrease of its density. An aluminum diaphragm from 1 to 2.5 mils thick has been found suitable. Electrical resonance has been found to be of no importance for telephonic purposes, as with the low-inductance instruments

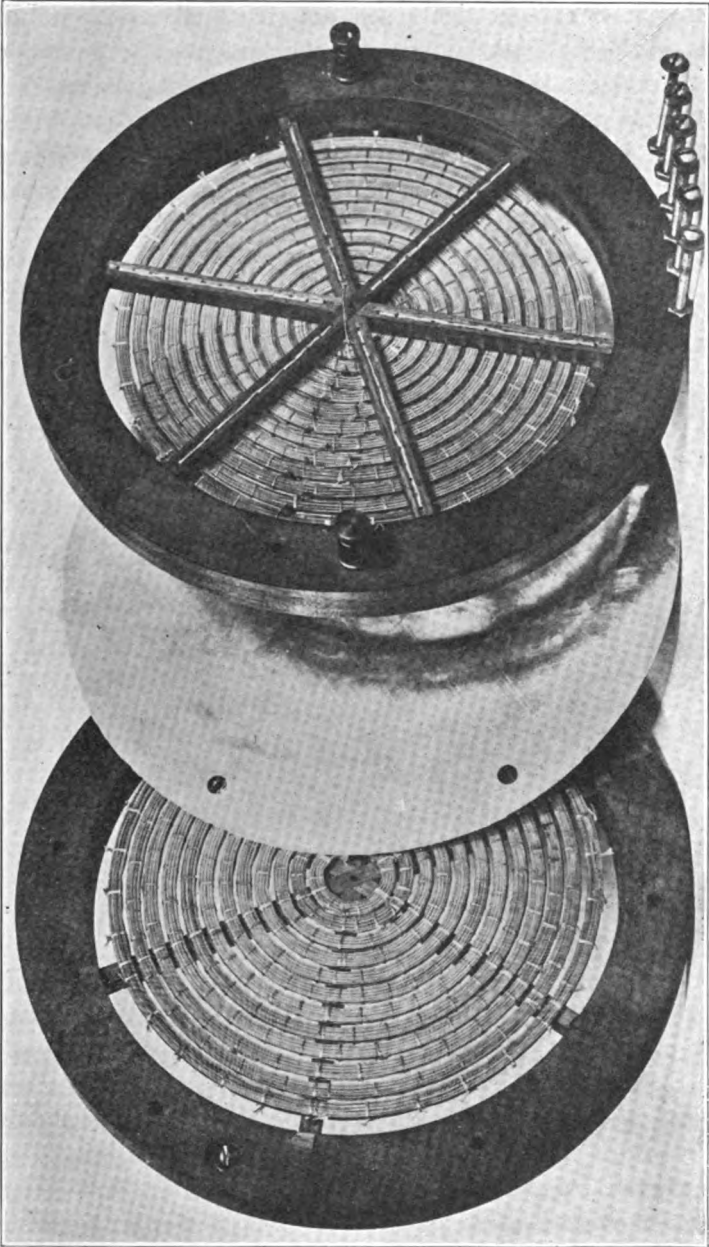

FIG. 2

the frequencies of electrical resonance are usually above audibility, while with the high inductance instruments the resistance is usually so large that there are no sharp resonance peaks.

Another point of advantage in this type of instrument when used as a receiver of voice currents is that the diaphragm is acted upon fairly uniformly over its surface by the varying force due to the interaction between the voice current in the diaphragm and the radial magnetic field. This is unfavorable to the production of resonance as the diaphragm is urged to and fro somewhat

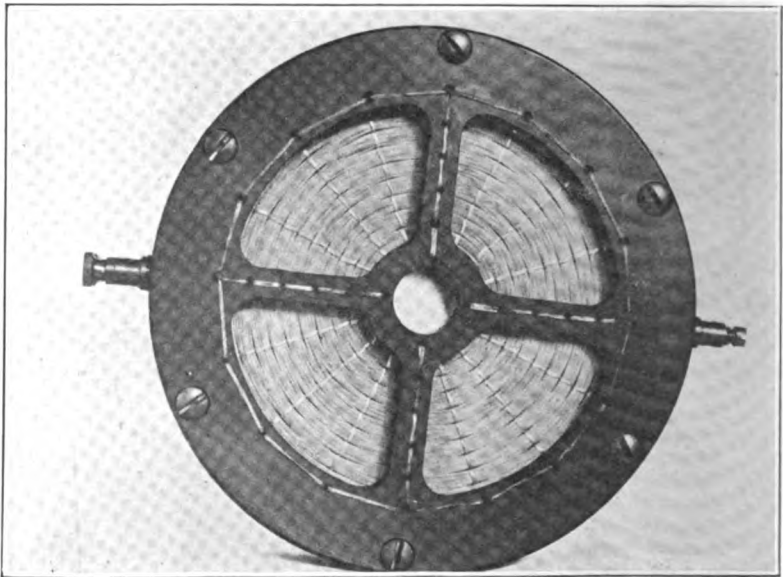

FIG. 3

like a piston. Calculation shows that the magnitude of the electrodynamic forces acting on the diaphragm is large compared to the reaction of the air due to the emission of sound waves.

In the ordinary forms of telephone apparatus there is a certain amount of distortion which arises from the magnetic behavior of the iron used in its structure. The instrument described in this paper is free from this defect.

On account of being able to use a large diaphragm which is acted upon fairly uniformly over its whole surface, the use of a

horn for intensifying the sound is of less advantage than in the usual forms of speakers. The use of a horn while greatly intensifying the sound always introduces distortion due to resonance in the horn. The quality of the speech given by this instrument is remarkably like that spoken into the voice current generator when a properly designed amplifier connects the two.

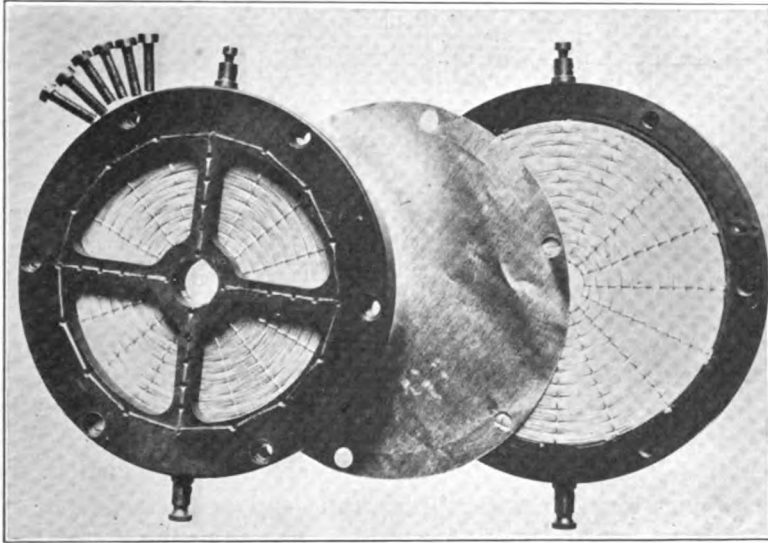

FIG. 4

The pancake coils of the instrument shown in figures 1 and 2 are each composed of twelve annular coils. Each annular coil is composed of eight layers five turns wide of No. 22 A. W. G. single silk covered copper wire, bound at intervals with silk thread. The outside diameter of each pancake is 7.5 inches. The resistance of each pancake is 8 ohms and the inductance 16 millihenries. The diaphragm is 2.5 mil sheet aluminum, and is spaced 30 mils from each coil. The frame is of laminated walnut. This instrument is used as a speaker on receiver of voice currents. When excited by a direct current of 1.5 amperes and a voice current of 0.1 ampere it produces speech that is comfortably audible at all points in a room 20 ft. square. Another instrument wound

with No. 34 A.W.G. double silk covered wire containing nine times as many turns, but with otherwise the same geometry and construction as the above is frequently used as a generator of voice currents. Each pancake has a resistance of 1200 ohms and an inductance of 1.2 henries. This instrument may also be used as a speaker if the output of the amplifier has a high impedance.

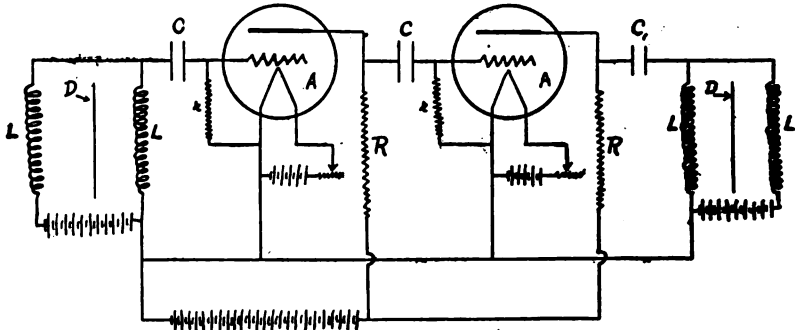

FIG. 5

The instrument shown in Figs. 3 and 4 consists of two compact pancake coils. Each wound of 3300 turns of No. 34 A.W.G. double silk covered wire. The coils are not impregnated, but are woven together with silk threads and are attached in the same manner to the hard fiber framework supporting them. Each pancake is 4 inches in diameter, is 0.2 inch thick, has a resistance of 540 ohms, and an inductance of 0.5 henry. The diaphragm is 1 mil sheet aluminum and is spaced 30 mils from the coils. The performance of this instrument differs only in magnitude from that shown in figures 1 and 2. It appears that the coils do not much cut off the sound waves to or from the diaphragm.

In case the amplifier used has an output impedance much different from that of the speaker at voice frequencies, it may be best to sacrifice quality of reproduction to a certain extent in order to obtain more intensity. This may be done by using a transformer as shown in figure 6. P and S are the primary and secondary of a transformer. The impedances of P and S are designed to fit the output of the amplifier and the coils LL of the speaker respectively. B is a direct current supply for polarizing the coils.

It is possible by the use of choke coils and condensers inserted at the proper places to use the plate current of the amplifier tube as the polarizing current of the speaker, provided this plate current is large enough. This has not been found very useful, however, on account of the large choke coils required. A high impedance head set has been used in which the plate current of a

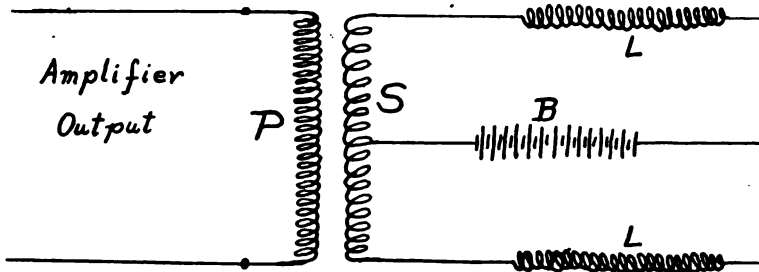

FIG. 6

single amplifier passing through the two halves of the instrument in series (one half held at each ear, and each half having a diaphragm) is sufficient to polarize the instrument. When the two halves are separated in this way, the choke coils and condensers mentioned above are of no use, and to avoid appreciable distortion the variations of the plate current during amplification must be small.

Compared to other forms of receivers and transmitters, particularly the microphone and ordinary magnetic receiver, the instrument described above is very insensitive, but it gives an excellent quality of reproduction of speech and music.

The writer takes pleasure in acknowledging the help in the construction of these instruments and in the experimental work in connection with them rendered by Messrs. J. B. Dempster and Harlan Porter.

STATE UNIVERSITY OF IOWA,
IOWA CITY, IOWA,
JULY 20, 1922.

A SMALL HIGH INTENSITY MERCURY ARC IN QUARTZ-GLASS

By L. J. BUTTOLPH

The unique value of the mercury arc as a source of monochromatic light has been known for some twenty-five years. Until recently it has been available only to the physical laboratory either as the large size low intensity Cooper Hewitt lamp, as the large capacity mercury arc in fused-quartz designed primarily for commercial use and for ultra-violet radiation, or as home-made Aron's types.



FIG. 1

A small quartz mercury arc lamp, Fig. 1, has been designed specifically to combine all the advantages of these lamps with special provisions for safe and convenient use in the laboratory.

This lamp has an effective light source area of $\frac{1}{4} \times 1\frac{3}{4}$ inches which is ample for the illumination of such slits or filters as are ordinarily used. It is enclosed in a metal casing to protect the observer from stray light and is provided with a removable mica filter to absorb the far ultra-violet when it is not needed. It emits relatively so little radiant heat that it may be used near to accessory optical apparatus. It has the same high intrinsic brilliancy as the larger quartz lamps sold for commercial use.

It is provided with an adjustable slit set close to the light source, but any standard slit with fine adjustment may be used where necessary. A light-tight removable filter holder is provided. The lamp outfit is made as a single standard unit for operation on 110 volts either alternating or direct current. The arc proper is connected to the auxiliary electrical equipment in the base by a separable connector and standard laboratory fixtures. Thus, it is easily adjustable, removable, and adaptable to a variety of set-ups by means of standard clamps and supports.

Two operating conditions are clearly defined. When running with sufficient additional resistance in series it is a low pressure arc and the light column appears to fill the whole arc tube uniformly. In this condition only the strongest spectrum lines show and no continuous spectrum is visible. When, on the other hand, the arc is adjusted for operation at high intensity it starts as a low pressure arc, but as it heats up, changes to the high pressure condition. This change may be observed through a dark filter and is indicated by an apparent concentration of the light into a narrow thread of great intensity in the axis of the arc tube. In this condition a continuous spectrum is superposed upon the mercury line spectrum, several additional mercury lines become visible and the ultra-violet is greatly intensified.

In this connection it is well to recall the kinds of radiation available with a mercury arc in fused quartz. This lamp emits the same characteristic radiation as the large quartz-glass lamps. The principal lines are a 10,140 A line in the infra-red; yellow, green, blue and violet lines in the visible for the isolation of which Wratten monochromatic filters have been developed; and a very

complete series of ultra-violet lines extending out to the limits of transmission of clear fused quartz.

Because of its brilliancy, its high spectroscopic purity and its location at maximum visibility the green line at 5461 Å is the most valuable source of monochromatic light now available. Its specific impurity of one part in a million is so low as to permit its use in interferometry.

The blue line of wave-length 4359 Å is also unique in being the most powerful available source of monochromatic light for work at that end of the spectrum. While not so spectroscopically pure as the green line, the satellites are of so much lower intensity as to introduce no appreciable errors in polarimetric readings up to 100° rotation.

The two yellow lines are separated by some 21 Å as compared with the 6 Å separation of the sodium doublet. They are of value as reference points in spectrometry but superfluous for polarimetry as they are intermediate between the indispensable mercury green and cadmium red lines.

The 10,140 Å infra-red line is of value to the physicist as a reference point for work in a part of the spectrum where instrument calibration is particularly difficult.

By removing the mica screen there are available some twenty-five ultra-violet lines so characteristic in their prismatic spectrum groupings and relative intensities as to be readily identified on a fluorescent screen or on a photograph without measurements. Of these, 3656, 3342, 3132-26 and 3025 are transmitted by the glass optical system of the ordinary spectroscope and may be identified by fluorescence on uranium glass or upon anthracene coated paper. The lines of wave-length less than 3,000 Å are best studied with a quartz spectrograph or a monochromatic illuminator for the ultra-violet.

For the isolation of the various mercury lines two general methods are available. For ordinary polariscopic and general laboratory work filters will be found highly satisfactory. Three types of filters are available as listed in Table 1. Only the Corning glass or the liquid filters can be used close to the mercury arc because of the heat. The equipment recommended is the G555P

and G34 combination for 5461 and the Noviol A and G585 combination for 4359. Gelatine and liquid filters must be kept as nearly as possible at room temperature. Table 1 and Fig. 2, show available filters and their transmissions. The liquid filters, all of which are two cell combinations, are best adjusted for the desired effect at the time of use. A spectroscope, preferably a small, direct-vision one, is a necessity in making this adjustment.

TABLE 1. *Selective Filters*

Radiation	Corning Glass	Eastman Wratten	Liquid Filters
5769	G34-5 mm red shade	22-E2 Hg Yellow 72%	Chrysoidine and Eosine
5461	G5552-10 mm and G34-5 mm yellow shade	62 Hg Green 12% or 77 Hg Special 72% or 77A. Hg Special 50% for Interferometry	Neodymium Ammonium Nitrate and Potassium Dichromate
4359	Noviol A-3.0 mm. and G585-L or M.	50 L.Hg Violet	Cobalt blue glass and Quinine Sulphate
4047-78	G586A-4 mm. and Noviol 0-5 mm.		Methyl Violet and Quinine Sulphate
3650 3656 3663	G586AW-10 mm	18 Ultra-Violet	Methyl Violet and Acid Green
Infra-red	G585-5 mm and G24 Red-5 mm.		
To absorb Infra-red	2% solution of Cupric Chloride or Corning Heat Absorbing Glass.		

For exact physical measurements, however, an optical method of spectrum line isolation and purification is necessary and several standard methods are described in the literature. There are on the market several highly developed monochromators of the constant deviation spectroscope type while the simplest device for use with the mercury arc is a direct-vision prism, calculated for

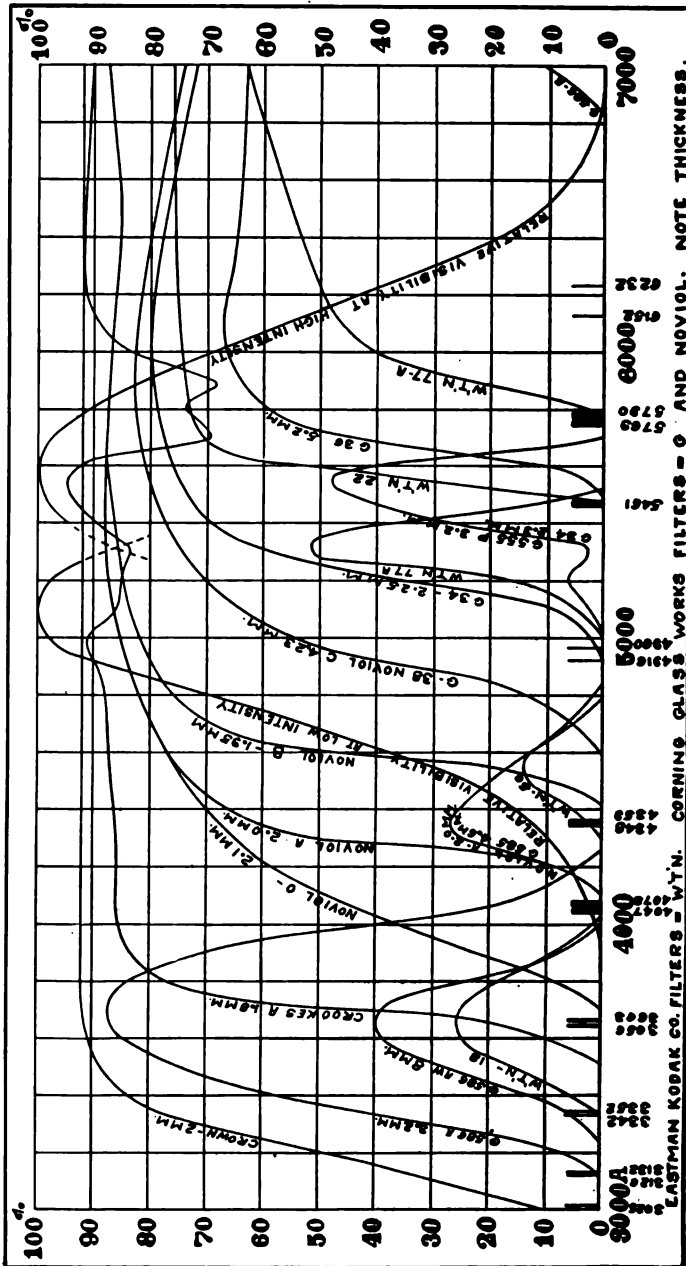

Fig. 2. Transmission Curves. EASTMAN KODAK CO. FILTERS - W.T.N. CORNING GLASS WORKS FILTERS - O AND NOVIOL. NOTE THICKNESS.

the green line, for example, and a long focus lens, or two collimating lenses for more exact work.

It is believed that this small high intensity mercury arc will have many applications in polarimetry, interferometry, and photomicrography, and while it was designed to meet these special requirements, its greatest field of usefulness is in the physical laboratory.

Through filters, it supplies a reliable source of monochromatic light for experiments with the diffraction grating, diffraction patterns from double slits, monochromatic polarized light, fluorescence and spectrometry. Also for general spectroscopic observation, where a wave-length scale is not available, the mercury spectrum can be used for comparison and for the determination of the limits of filter transmissions.

ENGINEERING DEPARTMENT,
COOPER HEWITT ELECTRIC Co.,
HOBOKEN, NEW JERSEY,
AUGUST 25, 1922.

CORRELATION OF ELEMENTARY PROOFS OF THE FUNDAMENTAL PROPERTIES OF OBLIQUE DEVIATION BY PRISMS

By H. S. UHLER

The object of the present note is to indicate how the general properties of deviation produced by triangular prisms surrounded by a single medium may be deduced without making use of either spherical trigonometry or the calculus of infinitesimals. The chief advantage of so doing is to enable the authors of elementary books on optics to generalize the usual discussions of prismatic refraction without increasing either the grade or the difficulty of the text. The notation and symbolization will be those found in James P. C. Southall's "The Principles and Methods of Geometrical Optics" (2nd Edition).

(a) The formulas of oblique refraction at a single plane interface will be assumed.¹ For a single triangular prism,—or for any number of triangular prisms having all the refracting edges mutually parallel,—the condition that the refracting faces are in contact with the same medium leads at once to the fact that the incident and emergent rays are equally inclined to the plane of the principal section.

(b) Let D denote the oblique (or actual) deviation produced by the prism, that is, the smallest angle through which the emergent ray can be turned to bring it into parallelism with the incident segment of the same complete ray. Let E symbolize the projected deviation or, in other words, the angle between the orthogonal projections of the incident and emergent rays on a principal section of the prism. Let η_1 stand for the angle which the oblique incident (or emergent) ray makes with its projection on the principal plane (the angular altitude or elevation of the oblique ray). Then the formula

$$\sin \frac{1}{2} D = \sin \frac{1}{2} E \cos \eta_1$$

¹ Southall, pp. 28-31. Heath, p. 21.

may be proved by very elementary methods.² It shows that, for $\eta_1 > 0$, the oblique deviation is less than the projected deviation ($D < E$, $\cos \eta_1 < 1$). Also, for η_1 constant, if either D or E passes through a stationary value (D_0 or E_0) so will the other member of the pair attain the same kind of value simultaneously.

(c) A new formula derived by the writer,—a proof of which will be given below after the general outline of the theory has been explained,—is as follows:

$$\frac{\sin^2 \frac{1}{2} \beta}{\sin^2 \frac{1}{2} (\beta + E)} = \frac{1}{\nu^2} - \frac{4 \sin \frac{1}{2} E \sin (\beta + \frac{1}{2} E) \sin^2 \lambda}{\sin^2 (\beta + E)},$$

where β means the refracting angle of the prism, λ is a convenient acute angle (defined in the proof), and ν represents the "artificial relative index of refraction" of the material of the prism or, in symbols, $\nu = n \cos \eta_1' / \cos \eta_1$.

The three terms or fractions in the formula are positive since the angles $\frac{1}{2} E$ and $\beta + \frac{1}{2} E$ are each less than 180° , and all the remaining factors are squared. When η_1 is assigned a definite value, ν is uniquely determined and fixed ($\sin \eta_1 = n \sin \eta_1'$). As λ decreases arithmetically the term subtracted from $\frac{1}{\nu^2}$ decreases and vanishes when λ becomes zero. Hence, when η_1 is kept constant, the right hand side of the equation attains its greatest value when $\lambda = 0$. Therefore, since $\sin \frac{1}{2} \beta$ is constant, the denominator of the left member of the formula must pass through a least value when $\lambda = 0$. Accordingly E experiences a minimum value E_0 when $\lambda = 0$. We then have³

$$\nu = \frac{\sin \frac{1}{2} (\beta + E_0)}{\sin \frac{1}{2} \beta}$$

which shows that the (partial) minimum value E_0 decreases as η_1 decreases, since ν decreases as η_1 becomes smaller,

$$[\nu = \sqrt{n^2 + (n^2 - 1) \tan^2 \eta_1}].$$

² Southall, pp. 125–127. Uhler, Amer. Jour. Science, 27, p. 224; March, 1909.

³ The negative root is not consistent with the definitions of the quantities involved.

For $\eta_1 = 0$ we have the classical laboratory formula for a ray in a principal plane, namely

$$\nu_0 = n = \frac{\sin \frac{1}{2}(\beta + \epsilon_0)}{\sin \frac{1}{2}\beta}$$

(d) The next step is to follow Southall's elegant proof⁴ that $D_0 > \epsilon_0$. Hence, [by (b) above], $E_0 > D_0 > \epsilon_0$. Thus ϵ_0 is an absolute minimum, that is, a minimum of all the partial minima E_0 of E .

(e) Finally, the relation

$$\sin \frac{1}{2}D = \sin \frac{1}{2}E \cos \eta_1$$

may be extended to a train of any number of prisms immersed in a single homogeneous medium by simply continuing the construction given in figure 1.⁵ In fact the angles $B'' OF''$ and $B''' OF'''$ may be interpreted respectively as the total oblique deviation effected by all the prisms of the train and as the algebraic sum of all the separate projected deviations.

To derive the formula of item (c):

$$\beta = \gamma_1' - \gamma_2 \quad (1)$$

$$E = \gamma_1 - \gamma_2' - \beta \quad (2)$$

$$\sin \gamma_1 = \nu \sin \gamma_1' \quad (3)$$

$$\sin \gamma_2' = \nu \sin \gamma_2 \quad (4)$$

For convenience, introduce an angle⁶ λ defined by

$$\lambda = \frac{1}{2}(\gamma_1' + \gamma_2)$$

Then, by (1), $\gamma_1' = \lambda + \frac{1}{2}\beta$

and $\gamma_2 = \lambda - \frac{1}{2}\beta$

hence (3) and (4) become

$$\sin \gamma_1 = \nu \sin (\lambda + \frac{1}{2}\beta), \quad (5)$$

$$\sin \gamma_2' = \nu \sin (\lambda - \frac{1}{2}\beta) \quad (6)$$

Adding equations (5) and (6) we get

$$\sin \frac{1}{2}(\gamma_1 + \gamma_2') \cos \frac{1}{2}(\gamma_1 - \gamma_2') = \nu \sin \lambda \cos \frac{1}{2}\beta \quad (7)$$

Subtracting equation (6) from (5) we obtain

$$\cos \frac{1}{2}(\gamma_1 + \gamma_2') \sin \frac{1}{2}(\gamma_1 - \gamma_2') = \nu \cos \lambda \sin \frac{1}{2}\beta \quad (8)$$

⁴ Pp. 127a, 127b.

⁵ Amer. Jour. Science, *loc. cit.*

⁶ For geometrical interpretations of λ see Uhler, Amer. Jour. Science, 35, pp. 392, 393; April, 1913; and also Amer. Math. Monthly, 28, pp. 6, 7, Jan. 1921; where λ is replaced by x .

Replacing $\gamma_1 - \gamma_2'$ by $\beta + E$, [conformably with (2)], and substituting from (7) and (8) in the identity.

$$\sin^2 \frac{1}{2}(\gamma_1 + \gamma_2') + \cos^2 \frac{1}{2}(\gamma_1 + \gamma_2') = 1$$

we find

$$\begin{aligned} \frac{1}{\nu^2} &= \frac{\cos^2 \frac{1}{2} \beta \sin^2 \lambda}{\cos^2 \frac{1}{2} (\beta + E)} + \frac{\sin^2 \frac{1}{2} \beta \cos^2 \lambda}{\sin^2 \frac{1}{2} (\beta + E)} \\ &= \frac{\sin^2 \frac{1}{2} \beta}{\sin^2 \frac{1}{2} (\beta + E)} + \left\{ \frac{\cos^2 \frac{1}{2} \beta}{\cos^2 \frac{1}{2} (\beta + E)} - \frac{\sin^2 \frac{1}{2} \beta}{\sin^2 \frac{1}{2} (\beta + E)} \right\} \sin^2 \lambda \\ &= \frac{\sin^2 \frac{1}{2} \beta}{\sin^2 \frac{1}{2} (\beta + E)} + \frac{4 \sin \frac{1}{2} E \sin (\beta + \frac{1}{2} E) \sin^2 \lambda}{\sin^2 (\beta + E)} \end{aligned}$$

YALE UNIVERSITY,
NEW HAVEN, CONNECTICUT,
SEPT. 18, 1922.

INDEX TO VOLUME VI

A

- Absorption of the Eye for Ultra-Violet Radiation (Winifred P. Graham), 605.
- ADAMS, ELLIOT Q.: A Comparison of the Fechner and Munsell Scales of Luminous Sensation Value, 932.
- Aeronautic Instruments (Franklin L. Hunt), 744.
- American Apparatus (F. K. Richtmyer), 483.
- Amplifier for Direct Current (H. A. Snow), 186.
- ANDERSON, J. A.: False Spectra from Diffraction Gratings, 417.
- Aspherical Lens Surfaces (P. G. Nutting), 412.
- Atmospheric Scattering, Sky Polarization, and Allied Phenomena (F. E. Fowle), 99.
- Audion Bulbs, Effect of a Photo-Electric Material on the Thermo-Electric Current in (Theodore W. Case), 639.

B

- BENFORD, FRANK: A Hemispherical Photometric Integrator, 1040.
- BOVIE, W. T. and E. L. CHAFFEE: Photo-Electric Potentials from the Retina, 407.
- Brilliance and Chroma (L. T. Troland and C. H. Langford), 409.
- BURT, R. C. and J. B. JOHNSON: The Passage of Hydrogen Through Quartz Glass, 734.
- BUTTOLPH, L. J.: A Small High Intensity Mercury Arc in Quartz-Glass, 1066.

C

- CADY, F. E. and E. P. Hyde: A New Principle and its Application to the Lummer-Brodhun Photometer, 615.
- CADY, W. G.: A Method of Testing Plates from Piezo-Electric Crystals, 183.
- CAMPBELL, GEORGE A.: Direct Capacity Measurement, 641.
- Capacity, Measurement of Direct (Geo. A. Campbell), 641.
- CARMAN, ALBERT P.: A Suspension to Eliminate Mechanical Disturbances, 694.
- CASE, THEODORE W.: The effect of a Photo-Electric Material on the Thermo-Electric Current in High Vacuum Audion Bulbs, 639.
- CASE, THEODORE W.: Infra Red Telegraphy and Telephony, 398.

- CHAFFEE, E. L. and W. T. BOVIE: Photo-Electric Potentials from the Retina, 407.
- CIOFFI, P. P. and L. S. TAYLOR: A Method of Maintaining Small Objects at any Temperature Between -180°C ; and $+20^{\circ}\text{C}$, 906.
- Clamp, Three-Plane Orientation (W. R. Miles), 374.
- CLARK, JANET H.: A Photo-Electric Theory of Color Vision, 813.
- COBLENTZ, W. W.: Recent Measurements of Stellar and Planetary Radiation, 1016.
- Colorimetry (H. E. Ives), 410.
- Colorimetry, Report of Committee on (L. T. Troland), 527.
- Color Matching, Accuracy in (W. E. Forsythe), 410, 476.
- Color Temperature (Irwin G. Priest), 410.
- Color Temperature of Aluminates (Irwin G. Priest), 27.
- Color Vision, A Photo-Electric Theory of (Janet H. Clark), 813.
- Color, Zone Theories of (Leonard Thompson Troland), 3.
- Committee Reports, Report on Atmospheric Scattering, Sky Polarization, and Allied Phenomena, 99.
- Committee Reports, 1921 Report on Standard Wave-Lengths, 135.
- Committee Reports, Report on Colorimetry for 1920-21, 527.
- COMPTON, K. T.: A Tungsten Furnace for Experiments on Dissociation and Ionization, 910.
- Corrections, 292, 661.
- COX, R. T.: Standard Radio Wavemeter Bureau of Standards Type R 70B, 162.
- CREW, HENRY: Helmholtz on the Doctrine of Energy, 312.
- Crystalliptometer (LeRoy D. Weld), 67.
- Curvature, Method for Measuring Irregularities in (Alexander Marcus), 620.

D

- DAVEY, WHEELER P.: A New X-Ray Diffraction Apparatus, 413.
- Dioptrics, Huygens' Contributions to (James P. C. Southall), 461.
- Dispersion, Invariant Ratios and Functions in Glass (P. G. Nutting), 109.
- Dispersion of Glass (T. Smith), 57.
- DORSEY, HERBERT GROVE: The Phoneloscope, 279.
- DORSEY, N. ERNEST: An Instrument for the Gamma Ray Measurement of the

- Radium Content of Weakly Active Materials, 633.
- DOWEY, T. L. and HERBERT E. IVES: An Apparatus for Studying the Motion of Relays, 391.
- DOYLE, E. D.: A Differential Electrodynamometer, 281.
- DUSHMAN, SAUL: Some Recent Applications of the Quantum Theory to Spectral Series, 235.
- E**
- ECKHARDT, E. A., J. C. KARCHER and M. KEISER: An Electron Tube Tuning Fork Drive, 949.
- EICHLIN, C. G. and A. Q. TOOL: Some Thermal Effects Observed in Chilled Glass, 413.
- Electrical Properties of Gases, Apparatus for Demonstrating (John Zeleny), 521.
- Electrodynamometer, A Differential (E. D. Doyle), 281.
- Electroscope, Gamma Ray (N. Ernest Dorsey), 633.
- ELLIS, FREDERICK W.: The Study of Visual Processes by Means of Momentary Retinal Shadows, 922.
- Energy Exchanges in the Formation of the Latent Image of a Photographic Emulsion (S. E. Sheppard and E. P. Wightman), 913.
- Energy Required to Render Developable a Grain of Silver Bromide (P. S. Helmick), 998.
- EPPLEY, MARION and WILLIAM R. GRAY: A Simple Direct-Reading Potentiometer for Standard Cell Comparisons, 859.
- Euscope, (William G. Exton), 414.
- EXTON, WILLIAM G.: Euscope, 414.
- EXTON, WILLIAM G.: Turbidimeter, 414.
- F**
- FAHRENWALD, A. W.: The Film Method of Measuring Surface and Interfacial Tension, 722.
- FARWELL, H. W.: A Pocket Size Range Estimator, 269.
- FARWELL, H. W.: A Simple Form of Laboratory Potentiometer, 193.
- Fechner and Munsell Scales of Luminous Sensation Value (Elliot Q. Adams), 932.
- FERGUSON, WALTER F. C.: Note on Mr. F. E. Wright's Article for Determining Prism Angle Errors, 108.
- FERREE, C. E. and GERTRUDE RAND: Intensity and Composition of Light and Size of Visual Angle in Relation to Important Ocular Functions, 408.
- FILLIUS, M. F. and LOYD A. JONES: The Relation Between Gloss and the Reflection Characteristics of Surfaces, 412.
- Film on Polished Glass Surfaces (George W. Morey), 688.
- FLEMING, A. P. M. and J. G. PEARCE: Research in Industry, 812.
- FOOTE, PAUL D. and F. L. MOHLER: The Significance of the $\frac{1}{2}$ Terms in Spectral Series Formulae, 54.
- FORSYTHE, W. E.: Accuracy in Color Matchig, 410.
- FORSYTHE, W. E.: Accuracy in Color Matching of Incandescent Light Sources, 476.
- FORSYTHE, W. E.: Note on a Method of Increasing the Carrying Capacity of a Rheostat, 376.
- FOWLE, F. E.: Report on Atmospheric Scattering, Sky Polarization, and Allied Phenomena, 99.
- FOWLER, A.: Report on Series in Line Spectra, 524.
- Fringes, Photography of Moving Interference (Augustus Trowbridge), 195.
- Furnace, Tungsten (K. T. Compton), 910.
- G**
- Gages, Specifications for Pressure (Fredrick J. Schlink), 713, 899.
- Galvanometer, Iron Clad Thomson Astatic (B. J. Spence), 696.
- GARDNER, I. C.: A Field Telemeter for Approximate Surveying, 489.
- GARDNER, I. C.: Constructional Data for A Cemented Objective of Barium Crown and Flint, 379.
- Ghosts, Lyman (W. F. Meggers, C. C. Kiess, Carl Runge, and J. A. Anderson), 417.
- Glass, Filming of (George W. Morey), 688.
- Glass, The Dispersion of (T. Smith), 57.
- Glass, The Manufacture of Optical, (F. E. Wright), 92.
- Gloss, Characteristics of Photographic Papers (L. A. Jones), 140.
- Gloss, (Loyd A. Jones and M. F. Fillius), 412.
- GOULD, R. E. and L. V. JUDSON: Sieve Testing Apparatus, 719.
- GRAHAM, WINIFRED P.: The Absorption of the Eye for Ultra-Violet Radiation, 605.
- Graininess of Photographic Materials (Loyd A. Jones and Arthur C. Hardy), 412.

GRAY, WILLIAM R. and MARION EPPLEY: A Simple Direct-Reading Potentiometer for Standard Cell Comparisons, 859.

H

HALL, E. L. and J. L. PRESTON: A High-Voltage Storage Battery for use with Electron Tube Generators of Radio-Frequency Currents, 177.

HARDY, ARTHUR C. and LOYD A. JONES: The Graininess of Photographic Materials, 412.

Helmholtz on the Doctrine of Energy (Henry Crew), 312.

Helmholtz, Reminiscences of (M. I. Pupin), 336.

Helmholtz's Contributions to Physiological Optics (Leonard Thompson Troland), 327.

HELMICK, P. S.: On the Quantity of Light Energy Required to Render Developable a Grain of Silver Bromide, 998.

HERSCHEL, WINSLOW H.: The Drainage Error in the Bingham Viscometer, 875. Heteromorphies (K. Horovitz), 597.

HEWLETT, C. W.: A Telephone Receiver and Transmitter, 1059.

HICKMAN, C. N.: A Variable Resistor of Low Value, 848.

HILLMAN, C. D. and CARL W. KEUFFEL: Rotating Photometric Sectors of Adjustable Transmission While in Motion, 413.

HOPKINS, B. S. & L. F. YNTEMA: Observations on the Rare Earths, XI: The Arc Spectrum of Yttrium, 121.

HOROVITZ, K.: Heteromorphies Due to the Variation of Effective Aperture and Visual Acuity, 597.

HOWES, H. L. and E. L. NICHOLS: The Blue Glow, 42, 411.

HUNT, FRANKLIN L.: Aeronautic Instruments, 744.

HYDE, E. P. and F. E. CADY: A New Principle and its Application to the Lummer-Brodhun Photometer, 615.

HYPSONETER, A Laboratory (E. F. MUELLER and T. S. SLIGH, Jr.), 958.

I

Index to Vol. VI. 1077.

INGERSOLL, L. R.: Magnetic Rotation in Various Liquids in the Short Infra-Red Spectrum, 663.

Integrapp Based on Parallel Double Tongs (Vladimir Karapetoff), 978.

IVES, HERBERT E.: A Proposed Standard Method of Colorimetry, 410.

IVES, HERBERT E.: A Theory of Intermittent Vision, 343, 408.

IVES, HERBERT E.: Critical Frequency Relations in Scotopic Vision, 254.

IVES, HERBERT E.: The Optical Properties of a Cylindrical Enclosure with Specularly Reflecting Walls, 412.

IVES, HERBERT E. and T. L. DOWEY: An Apparatus for Studying the Motion of Relays, 391.

J

JOHNSON, J. B.: A Low Voltage Cathode Ray Oscillograph, 701.

JOHNSON, J. B. and R. C. BURT: The Passage of Hydrogen Through Quartz Glass, 734.

JONES, LOYD A.: The Gloss Characteristics of Photographic Papers, 140.

JONES, LOYD A. and ARTHUR C. HARDY: The Graininess of Photographic Materials, 412.

JONES, LOYD A. and M. F. FILLIUS: The Relation Between Gloss and the Reflection Characteristics of Surfaces, 412.

JUDSON, L. V. and R. E. GOULD: Sieve Testing Apparatus, 719.

K

KARAPETOFF, VLADIMIR: An Integrapp based on Parallel Double Tongs, 978.

KARCHER, J. C., M. KEISER and E. A. ECKHARDT: An Electron Tube Tuning Fork Drive, 949.

KARRER, ENOCH: An Analysis of the Visibility Curve in Terms of the Weber Fechner Law and the Least Perceptible Brightness, 408.

KARRER, ENOCH: Recalescence in Antimony, 369.

KEISER, M., E. A. ECKHARDT, and J. C. KARCHER: An Electron Tube Tuning Fork Drive, 949.

KEUFFEL, CARL W. and C. D. HILLMAN: Rotating Photometric Sectors of Adjustable Transmission While in Motion, 413.

KIESS, C. C. and W. F. MEGGERS: False Spectra from Diffraction Gratings, 417.

KINSLEY, CARL: A High Speed Precision Relay, 199.

L

LANGFORD, C. H. and L. T. TROLAND: The Interrelations of Brilliance and Chroma Studied by a Flicker Technique, 409.

Lensometer (Charles Sheard and E. D. Tillyer), 1030.

- Luminescence, The Blue Glow (E. L. Nichols and H. L. Howes), 42, 411.
LUNN, A. C.: The Propagation of Light in Rotating Systems, 112.

M

- Magnetic Rotation in Various Liquids in the Short Infra-Red Spectrum (L. R. Ingersoll), 663.
MARCUS, ALEXANDER: An Electromagnetic Method of Detecting Minute Irregularities in Curvature of Spheres and Cylinders and of Controlling the Oscillations of a Mass of Metal Suspended by Means of a Torsion Fibre, 620.
MAUCHLY, S. J.: A Rotary Slide-Wire for Producing Uniform Variation in Potential Difference, 852.
MCKEEHAN, L. W.: Extraordinary Diffraction of X-rays, 989.
MEGGERS, W. F.: Report on Series in Line Spectra (Review), 524.
MEGGERS, W. F.: 1921 Report of Committee on Standard Wave-Lengths, 135.
MEGGERS, W. F. and C. C. KIESS: False Spectra from Diffraction Gratings, 417.
Mercury Arc in Quartz-Glass (L. J. Buttolph), 1066.
Microscope, On the Distribution of Light in Planes Above and Below the Image Plane in the (Fred E. Wright), 412.
MILES, W. R.: Three-Plane Orientation Clamp, 374.
MOFFITT, G. W.: On the Characteristics of Optical Systems for Reading Small Mirror Deflections, 494.
MOFFITT, G. W.: The Measurement and Specifications of Optical Characteristics in Projector Performance, 940.
MOHLER, F. L. and PAUL D. FOOTE: The Significance of the $\frac{1}{2}$ Terms in Spectral Series Formulae, 54.
MOREY, GEORGE W.: Summary of the Literature Relative to the Formation of Film on Polished Glass Surfaces, 688.
MUELLER, E. F. and T. S. SLIGH, Jr.: A Laboratory Hypsometer, 958.
Munsell and Fechner Scales of Luminous Sensation Value (Elliot Q. Adams), 932.

N

- NICHOLS, E. L. & H. L. HOWES: The Blue Glow, 42, 411.

- Notices, 1, 93, 208, 291, 407, 659, 985.
NUTTING, P. G.: A Portable Seismometer, 629.
NUTTING, P. G.: Invariant Ratios and Functions in Glass Dispersion, 109.
NUTTING, P. G.: The Design of Aspherical Lens Surfaces, 412.
NUTTING, P. G.: The Manufacture of Optical Glass and of Optical Systems (Review), 92.

O

- Objective of Barium Crown and Flint, Constructional Data for (I. C. Gardner), 379.
Ocular Functions, Intensity and Composition of Light and Size of Visual Angle in Relation to (C. E. Ferree and Gertrude Rand), 408.
Optical Constants of Selenium (L. P. Sieg), 448.
Optical Constants of Tellurium Crystals (George Dewey Van Dyke), 917.
Optical Instruments, Classification of (T. Smith), 682.
Optical Properties of A Cylindrical Enclosure (Herbert E. Ives), 412.
Optical Science, The Beginnings of (James P. C. Southall), 293.
Optical Systems for Reading Deflections (G. W. Moffitt), 494.
Optics, Early Pioneers in Physiological (James P. C. Southall), 827.
Oscillograph, Cathode Ray (J. B. Johnson), 701.

P

- PEARCE, J. G. and A. P. M. FLEMING: Research in Industry, 812.
PHILLIPS, H. B.: Mathematical Aspects of Quantum Theory, 229.
Phoneoscope, The (Herbert Grove Dorsey), 279.
Photo-Electric Potentials from the Retina (E. L. Chaffee and W. T. Bovie), 407.
Photographic Papers; Gloss Characteristics of (L. A. Jones), 140.
Photometer, Lummer-Brodhun (E. P. Hyde and F. E. Cady), 615.
Photometric Integrator, A. Hemispherical (Frank Benford), 1040.
Piezo-Electric Crystals, A Method of Testing Plates from (W. G. Cady), 183.
Polariscopic Analysis (Le Roy D. Weld), 67.
Polarization, Sky (F. E. Fowle), 99.
Polishing, The Mechanics of Optical (Elihu Thomson), 843.

- Potentiometer for Standard Cell Comparisons (Marion Eppley and William R. Gray), 859.
- Potentiometer, Simple Laboratory (H. W. Farwell), 193.
- PRESTON, J. L. and E. L. HALL: A High-Voltage Storage Battery for use with Electron Tube Generators of Radio-Frequency Currents, 177.
- PRIEST, IRWIN G.: Measurement of the Color Temperature of the More Efficient Artificial Light Sources by the Method of Rotatory Dispersion, 27, 410.
- Prism, Angle Errors (Walter F. C. Ferguson), 108.
- Prisms, Oblique Deviation by (H. S. Uhler), 1072.
- Proceedings of Fifth Annual Meeting of The Optical Society of America, 407.
- Projector Performance, G. W. Moffitt, 940.
- Propagation of Light in Rotating Systems (A. C. Lunn), 112.
- Propagation of Light in Rotating Systems (Ludwik Silberstein), 443.
- PUPIN, M. I.: Reminiscences of Hermann Von Helmholtz, 336.
- Q**
- Quantum Integrals, Evaluation of (A. Sommerfeld), 251.
- Quantum Theory (Saul Dushman), 235.
- Quantum Theory (H. B. Phillips), 229.
- Quantum Theory (Richard C. Tolman), 211.
- Quartz, Passage of Hydrogen Through (J. B. Johnson and R. C. Burt), 734.
- R**
- Radiation, Stellar and Planetary, (W. W. Coblentz), 1016.
- Radiometer, An Improved Form of Nichols (B. J. Spence), 625.
- Radio Wavemeter (R. T. Cox), 162.
- RAND, GERTRUDE and C. E. FERREE: Intensity and Composition of Light and Size of Visual Angle in Relation to Important Ocular Functions, 408.
- Range Estimator, A Pocket Size (H. W. Farwell), 269.
- Recalescence in Antimony (Enoch Karer), 369.
- Refractive Indices (Fred E. Wright), 413.
- Relay, High Speed Precision (Carl Kinsley), 199.
- Relays, An Apparatus for Studying the Motion of (Herbert E. Ives and T. L. Dowey), 391.
- Research in Industry (A. P. M. Fleming and J. G. Pearce), 812.
- Resistance Box Plugs, Mercury Lubricated (J. R. Roebuck), 169.
- Resistance, Contact (Irving B. Smith), 500.
- Resistance Thermometers and Coils (J. R. Roebuck), 865.
- Resistor, Manganin Slide (C. N. Hickman), 848.
- Reviews, 92, 524, 812, 985.
- Rheostat, Method of Increasing the Carrying Capacity of a (W. E. Forsythe), 376.
- RICHTMYER, F. K.: Cooperation Between the Makers and the Users of Apparatus in America, 483.
- RICHTMYER, F. K.: Research In Industry (Review), 812.
- ROBERTS, HOWARD S.: A High Temperature Regulator for Use with Alternating Current, 965.
- ROEBUCK, J. R.: Mercury Lubricated Resistance Box Plugs, 169.
- ROEBUCK, J. R.: On Construction of Platinum Thermometers and of Resistance Coils, 865.
- Ruling Machines, Periodic Errors in (J. A. Anderson), 417.
- RUNGE, CARL: False Spectra from Diffraction Gratings, 417.
- S**
- Saturation of Spectral Colors (Leonard Thompson Troland), 409.
- SCHLINK, FREDERICK J.: Specifications for Bourdon Tube Pressure Gages for Air, Steam, and Water Pressure, and for use as Reference Standards, 899.
- SCHLINK, FREDERICK J.: Specifications for Recording Vapor-Pressure Thermometers and for Pressure Gages, 713.
- Scotopic Critical Frequencies (Herbert E. Ives), 254.
- Sectors, Rotating Photometric (Carl W. Keuffel and C. D. Hillman), 413.
- SEISMOMETER, A. Portable (P. G. Nutting), 629.
- Series in Line Spectra (A. Fowler), 524.
- Series, Quantum Theory of Spectral (Saul Dushman), 235.
- SHEARD, CHARLES and E. D. TILLYER: The Lensometer, 1030.
- SHEPPARD, S. E. and E. P. WIGHTMAN: Note on the Energy Exchanges in the Formation of the Latent Image of a Photographic Emulsion, 913.
- SHIELDS, MARGARET C.: The Visibility Function and Visibility Thresholds for Color-Defectives, 362.

- SHRADER, J. E.: A New Form of Electrostatic Voltmeter, 273.
- SIEG, L. P.: On the Optical Constants of Selenium in the Form of Isolated Crystals, 448.
- Sieve Testing Apparatus (L. V. Judson and R. E. Gould), 719.
- SILBERSTEIN, LUDWIK: On the Propagation of Light in Rotating Systems, A Rejoinder to Dr. A. C. Lunn, 443.
- Slide-Wire, Rotary (S. J. Mauchly), 852.
- SLIGH, JR. T. S. and E. F. MUELLER: A Laboratory Hypsometer, 958.
- SMITH, IRVING B.: Contact Resistance, 500.
- SMITH, T.: The Classification of Optical Instruments, 682.
- SMITH, T.: The Dispersion of Glass, 57.
- SNOW, H. A.: An Electron Tube Amplifier for Amplifying Direct Current, 186.
- SOMMERFELD, A.: The Evaluation of Quantum Integrals, 251.
- SOUTHALL, JAMES P. C.: Early Pioneers in Physiological Optics, 827.
- SOUTHALL, JAMES P. C.: Some of Huygens' Contributions to Dioptrics, with Notes, 461.
- SOUTHALL, JAMES P. C.: The Beginnings of Optical Science, 293.
- Spectra, False, from Diffraction Gratings (W. F. Meggers, C. C. Kiess, Carl Runge and J. A. Anderson), 417.
- Spectral Series Formulae, Significance of the $\frac{1}{2}$ Terms in (Paul D. Foote and F. L. Mohler), 54.
- Spectrum, Arc, of Yttrium, (L. F. Yntema and B. S. Hopkins), 121.
- SPENCE, B. J.: A Form of Iron Clad Thomson Astatic Galvanometer, 696.
- SPENCE, B. J.: An Improved Form of Nichols Radiometer, 625.
- Storage Battery, A High-Voltage (E. L. Hall and J. L. Preston), 177.
- Suspension to Eliminate Mechanical Disturbances (Albert P. Carman), 694.
- T**
- TAYLOR, L. S. and P. P. CIOFFI: A Method of Maintaining Small Objects at any Temperature Between -180°C and $+20^{\circ}\text{C}$, 906.
- Telegraphy and Telephony, Infra Red (T. W. Case), 398.
- Telemeter, Field (I. C. Gardner), 489.
- Telephone Receiver and Transmitter (C. W. Hewlett), 1059.
- Temperature, Color, of Aluminates (Irwin G. Priest), 27.
- Temperature Regulator, A High, (Howard S. Roberts), 965.
- Tension, Surface and Interfacial (A. W. Fahrenwald), 722.
- TERRILL, H. M.: A Precision X-Ray Spectrometer, 287.
- Thermal Conductivity (M. S. Van Dusen), 739.
- Thermal Effects in Chilled Glass (A. Q. Tool and C. G. Eichlin), 413.
- Thermometers, Specifications for Recording Vapor-Pressure (Frederick J. Schlink), 713.
- Thermostat for Operation Between -180°C and $+20^{\circ}\text{C}$ (P. P. Cioffi and L. S. Taylor), 906.
- THOMSON, ELIHU: The Mechanics of Optical Polishing, 843.
- TILLYER, E. D. and CHARLES SHEARD: The Lensometer, 1030.
- TOLMAN, RICHARD C.: Review of the Present Status of the Two Forms of Quantum Theory, 211.
- TOOL, A. Q. and C. G. EICHLIN: Some Thermal Effects Observed in Chilled Glass, 413.
- TROLAND, LEONARD THOMPSON: A Quantitative Determination of the Inherent Saturation of Spectral Colors, 409.
- TROLAND, LEONARD THOMPSON: Brilliance and Chroma in Relation to Zone Theories of Vision, 3.
- TROLAND, LEONARD THOMPSON: Helmholtz's Contributions to Physiological Optics, 327.
- TROLAND, L. T.: Report of Committee on Colorimetry for 1920-21, 527.
- TROLAND, L. T. and C. H. LANGFORD: The Interrelations of Brilliance and Chroma Studied by a Flicker Technique, 409.
- TROWBRIDGE, AUGUSTUS: Photography of Moving Interference Fringes, 195.
- Tuning Fork Drive, An Electron Tube (E. A. Eckhardt, J. C. Karcher and M. Keiser), 949.
- Turbidimeter (William G. Exton), 414.
- U**
- UHLER, H. S.: Correlation of Elementary Proofs of the Fundamental Properties of Oblique Deviation by Prisms, 1072.
- V**
- VAN DUSEN, M. S.: A Simple Apparatus for Comparing the Thermal Conductivity of Metals and Very Thin Specimens of Poor Conductors, 739.
- VAN DYKE, GEORGE DEWEY: The Optical Constants of Isolated Tellurium Crystals, 917.

Viscometers, Drainage Error in (Winslow H. Herschel), 875.
 Visibility (Enoch Karrer), 408.
 Visibility for Color Defectives (Margaret C. Shields), 362.
 Vision, A Theory of Intermittent (Herbert E. Ives), 343, 408.
 Vision, Zone Theories of (Leonard Thompson Troland), 3.
 Visual Processes (Frederick W. Ellis), 922.
 Voltmeter, Electrostatic (J. E. Shrader), 273.

W

Wave-Lengths, Standard (W. F. Meggers), 135.
 Wavemeter, Radio (R. T. Cox), 162.
 WELD, LE ROY D.: The Crystalliptometer, An Instrument for the Polariscopic Analysis of Very Slender Beams of Light, 67.
 WIGHTMAN, E. P. and S. E. SHEPPARD: Note on the Energy Exchanges in the Formation of the Latent Image of a Photographic Emulsion, 913.

WRIGHT, FRED E.: On the Distribution of Light in Planes Above and Below the Image Plane in the Microscope, 412.
 WRIGHT, FRED E.: The Factors Underlying the Measurement of Refractive Indices by the Immersion Method, 413.
 WRIGHT, FRED E.: The Manufacture of Optical Glass and of Optical Systems, 92.

X

X-Ray Diffraction Apparatus (Wheeler P. Davey), 413.
 X-Ray Spectrometer (H. M. Terrill), 287.
 X-Rays, Extraordinary Diffraction of (L. W. McKeenan), 989.

Y

YNTEMA, L. F. and B. S. Hopkins: Observations on the Rare Earths, XI: The Arc Spectrum of Yttrium, 121.

Z

ZELNY, JOHN (An Apparatus for Demonstrating the Electrical Properties of Conducting Gases, 521.

Journal of the Optical Society of America and Review of Scientific Instruments

EDITOR-IN-CHIEF: PAUL D. FOOTE
BUREAU OF STANDARDS, WASHINGTON, D.C.

ASSISTANT EDITOR-IN-CHIEF AND BUSINESS MANAGER: F. K. RICHTMYER
CORNELL UNIVERSITY, ITHACA, N. Y.

CONSULTING BUSINESS MANAGER, M. E. LEEDS, Philadelphia, Pa.

Associate Editors:

Term Ending
Dec. 31, 1923
H. D. CURTIS
E. P. HYDE
PAUL E. KLOPSTEG
L. SILBERSTEIN
L. T. TROLAND
F. E. WRIGHT

Term Ending
Dec. 31, 1925
G. K. BURGESS
K. T. COMPTON
L. R. INGERSOLL
C. E. K. MEES
C. E. MENDENHALL
D. C. MILLER

Term Ending
Dec. 31, 1927
W. T. BOVIE
H. G. GALE
HERBERT E. IVES
W. B. LANCASTER
P. G. NUTTING
J. P. C. SOUTHALL

DECEMBER, 1922

Extraordinary Diffraction of X-rays.....	989
L. W. MCKEEHAN	
On the Quantity of Light Energy Required to Render Developable a Grain of Silver Bromide.....	998
P. S. HELMICK	
Recent Measurements of Stellar and Planetary Radiation.....	1016
W. W. COBLENTZ	

INSTUMENT SECTION

The Lensometer.....	1030
CHARLES SHEARD and E. D. TILLYER	
A Hemispherical Photometric Integrator.....	1040
FRANK BENFORD	
A Telephone Receiver and Transmitter.....	1059
C. W. HEWLETT	
A Small High Intensity Mercury Arc in Quartz-Glass.....	1066
L. J. BUTTOLPH	
Correlation of Elementary Proofs of the Fundamental Properties of Oblique Deviation by Prisms.....	1072
H. S. UHLER	
Index to Vol. VI.....	1077

Published Monthly by the
OPTICAL SOCIETY OF AMERICA

OFFICE OF PUBLICATION:
GEORGE BANTA PUBLISHING COMPANY
MENASHA, WISCONSIN

Entered as second-class matter May 31, 1921 at the postoffice at Menasha, Wis., under the act of March 3, 1879.



Bausch & Lomb Lenses in Microscopy

The Microscope is a wonder instrument, to which the medical and biological sciences owe their definite knowledge of the infinitesimal. By revealing the hitherto unseen it has performed an inestimable service to humanity.

As an optical product it is a work of high precision. Its system of lenses, some of them as small as a pinhead, must be most accurately computed and correlated, then ground and finished with corresponding exactness.

In this important work we have been pleased to serve the laboratory and research worker satisfactorily since 1874, some of our first instruments having been exhibited at the Centennial Exposition in 1876. Since then we have developed the line to meet every requirement of microscopy, until today Bausch & Lomb Microscopes are recognized as standard in the laboratories not only of America, but of the world.

Whatever your microscope requirements may be, therefore, you may be assured that Bausch & Lomb can satisfy them.

Bausch & Lomb Optical Co.

NEW YORK
CHICAGO

WASHINGTON
ROCHESTER, N. Y.

SAN FRANCISCO
LONDON

Makers of Microscopes and Microtomes, Projection and Photomicrographic Apparatus, Photographic Lenses, Metallographic Equipment, Optical Measuring Instruments, Telescopes, Stereo-Prism Binoculars, Ophthalmic Lenses and Instruments, Military Instruments, Optical Glass and Other High-Grade Optical Products

Apparatus for Organic Analysis

According to Dr. H. L. FISHER

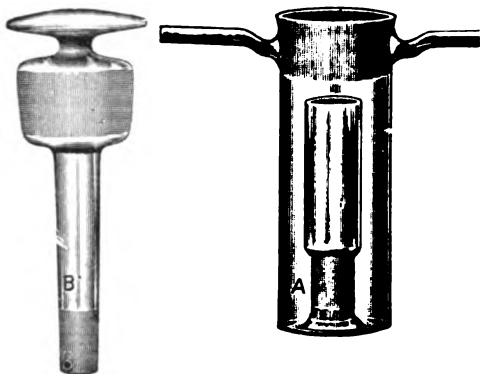

Fisher Absorption Bottle Patented

THE FISHER ABSORPTION BOTTLE has the same rapid absorption qualities as the U tube. The principle of design is the same, but the arms, instead of being alongside of each other, are placed one inside the other.

This bottle is very desirable in any combustion work where dry reagents are used and has proved itself to be of particular value in rapid organic work where Accuracy is Essential.

ADDITIONAL ADVANTAGES

One turn shuts off inlet and outlet and also chambers A from B. Easily charged and cleaned. Small and compact in size. Light in weight. Stands solidly on the balance pan.

Fisher Precision Thermometers (Set of Three)

Especially intended for organic work. The entire scales are exposed to the vapors of the liquids which are being boiled or distilled. Errors due to cooling of the mercury column are thus eliminated and very accurate readings can be made. Graduation is not covered by rubber stopper. Length of each thermometer, 18 cm. Diam. 6mm. Enclosed porcelain scales.

- 6791—No. 1 15-135° C. in 1/1
- No. 2 95-215° C. in 1/1
- No. 3 175-295° C. in 1/1

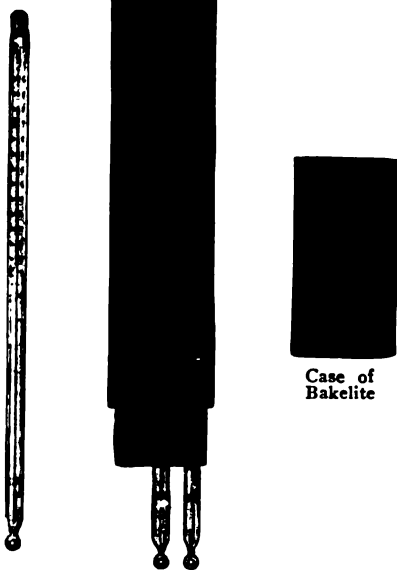

EIMER & AMEND

Established 1851

Headquarters for Industrial and Educational Laboratory Supplies

Main Office and Showrooms

Third Ave., 18th to 19th St., NEW YORK CITY

WASHINGTON, D. C., DISPLAY ROOM
Suite 601, Evening Star Bldg.

PITTSBURGH, PA.
4048 Jenkins Arcade



“Aside from the expense think of the annoyance Pyrex saves me”

“I want to tell you this constant re-ordering of high-priced chemical glassware was a nuisance. It seemed I was issuing a never-ending stream of requisitions for new beakers, new flasks, new test tubes. Since we’ve equipped our laboratories with Pyrex, aside from a few rare accidents through carelessness, the new glassware we bought over a year ago is still giving service today.”

The experience of this laboratory head isn’t an isolated instance. We are continually receiving enthusiastic letters, praising Pyrex laboratory glassware.

Specify **Pyrex** and you cut expenses. Reduced glass bills and increased efficiency will prove that **Pyrex** is the world’s finest laboratory glass.

Pyrex is remarkable in its resistance to heat, and its resistance to mechanical shock is described as “Far superior of any of the other wares,” in Technical Paper No. 107, U. S. Bureau of Standards.

In addition to its high resistant qualities to alkali carbonates and caustic alkalis, **Pyrex** is superior to other glasses in resistance to water, acid, ammonia and phosphoric acid. In resistance to alkali carbonates and caustic alkalis, **Pyrex** is in the same class with other high-grade glasses.

Pyrex is of simple chemical composition. A low expansion borosilicate glass, it contains no metal of the magnesia-lime-zinc group, and no heavy metals. The complete line of **Pyrex** Laboratory Glassware includes shapes and vessels to meet every laboratory requirement.

Special apparatus will be made from your sketch or blue print. **Pyrex** is carried by all reliable dealers in laboratory apparatus throughout the U. S. Illustrated catalog showing complete line of **Pyrex** Laboratory Glassware mailed upon request.



CORNING GLASS WORKS, Corning, N.Y.

Chemical Glassware Division

**World’s Largest Makers of Technical Glassware
NEW YORK OFFICE, 501 Fifth Avenue**



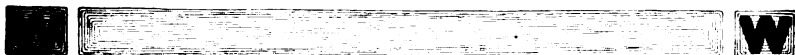

*Portable Direct
Reading
Ohmmeter
Model 1*

A DISTINCTIVE INSTRUMENT WITH MANY UNIQUE FEATURES

YOU can not fully know the condition of your electrical equipment without taking frequent and accurate resistance measurements. To give you these measurements most dependably and with greatest speed, ease and convenience, Weston Model 1 Direct Reading Ohmmeter offers you special features that are characteristic of the well-known and long established Weston standards. This ohmmeter operates with dry cells. No troublesome or expensive storage batteries—nor auxiliary rheostat, voltmeter or other apparatus required. Instrument and cells may be readily carried from place to place as a unit. A direct reading in ohms is instantly made by merely making proper connections with binding posts and pressing contact key. This instrument has a double and triple range, and is guaranteed to be accurate within $\frac{1}{4}\%$. Capable of instant checking which establishes accuracy at time of using.

Full information contained in our Bulletin 501-C. Send for it.

WESTON ELECTRICAL INSTRUMENT CO.

175 Weston Ave., NEWARK, N. J.
Branch Offices in all Principal Cities

WESTON

"STANDARD" The World Over

ELECTRICAL INSTRUMENTS



"THE SUN
NEVER SETS
ON THE
WESTON"

An Indicating
Instrument for
Every Individual
Need and Industrial
Purpose

A reliable oscillograph is as essential to the electrical engineer as the X-ray is to the surgeon

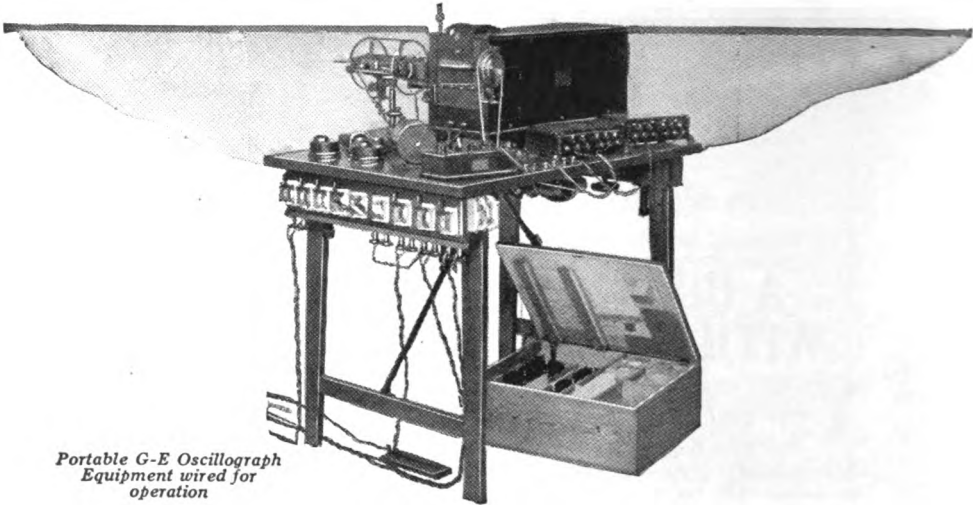

*Portable G-E Oscillograph
Equipment wired for
operation*

An oscillograph is the only instrument suitable for the exact analysis of electrical phenomena and the operating characteristics of electrical apparatus. The oscillograph record is the most useful and readily understood form in which the results of an investigation may be recorded permanently for study or publication.

The oscillograph built by the General Electric Company employs a compact form of the vibrating loop type of galvanometer and combines photographic and tracing features in one apparatus. Its working parts are accessible and are of sufficient size to be renewed and repaired by persons ordinarily skilled in the handling of testing instruments. With ordinary care and precautions it can be used as well on a moving car or ship as in a laboratory.

Complete description in Bulletin 46111A.

General  **Electric**
 General Office Schenectady, N.Y. **Company** Sales Offices in all large cities 348-20C

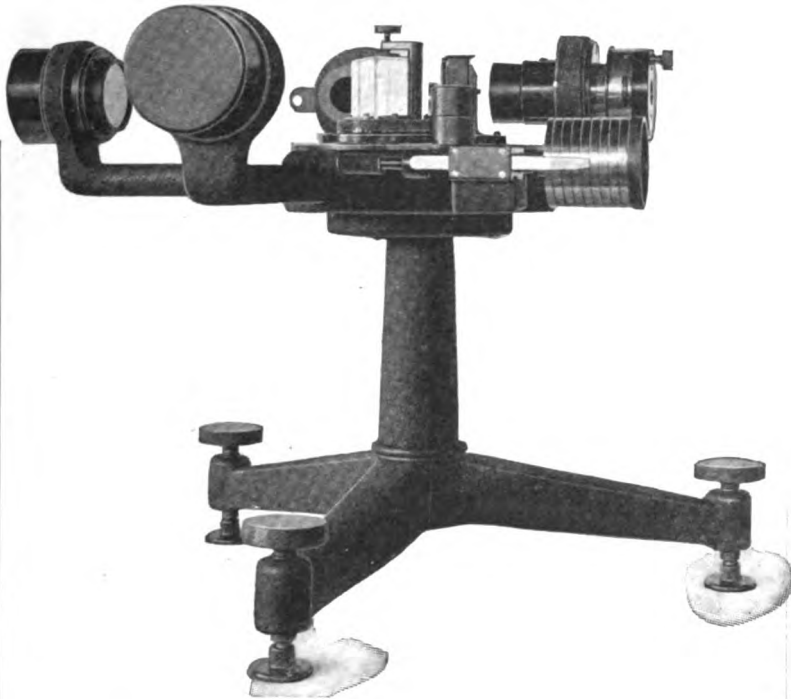

L235 Infra-Red Spectrometer and Monochromator

A Constant Deviation Spectrometer of the Wadsworth type.

Constant deviation is secured by mounting the prism together with a plane mirror on a rotating table, the telescope and collimator being fixed in position. The prism is of rock salt with faces 35 x 45 mm. and the mirror a cathodic deposit of gold on glass. The collimator and telescope have concave mirrors of 300 mm. focus and 40 mm. aperture, also of gold on glass, and are provided with symmetrical micrometer slits. The telescope, or exit, slit has its beveled face outward to avoid reflections from the jaws and is provided with a Coblentz thermopile which has found great favor owing to its sensitivity and freedom from drift. The thermopile is mounted on a hinged plate so as to be easily turned to receive the radiations or allow them to pass unobstructed. The prism table is rotated by a micrometer screw which carries a spiral drum graduated directly in wavelengths from .700 to 12 μ . Each instrument is individually calibrated with the highest accuracy permitted by the published data on rock salt.

WM. GAERTNER & CO.

5345-49 Lake Park Avenue

CHICAGO, ILLINOIS

The Peerless Simplicity Test Set

—VAWTER TYPE—

A New Testing Set



"SIMPLICITY TEST SET"

THE NAME TELLS THE STORY

If you measure Resistance it
is worth while investigating.

BULLETIN ON REQUEST

THOMPSON-LEVERING COMPANY

57th Street & Westminister Ave.

PHILADELPHIA, PA., U. S. A.

The Highest Priced Testing Instruments BUT—The Least Expensive in the End

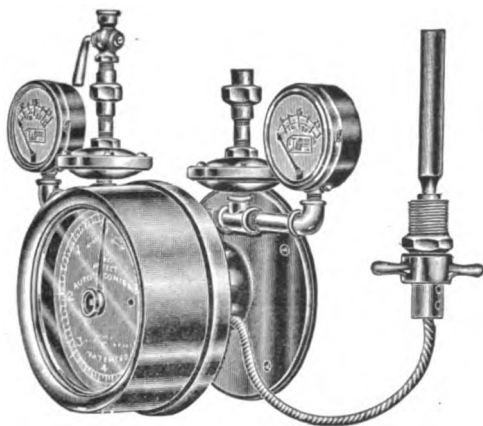

THE OLD RELIABLE OF THE TAG LINE

The TAG Automatic Perfect Temperature Controller.

A time-tried device, typically TAG in simplicity and reliability of operation and construction.

Which automatically and with infallible accuracy maintains a desired temperature.

And is the record-holder throughout the world for extensiveness of applications to industrial processes demanding a rigid control of temperature.



C. J. TAGLIABUE MFG. CO.

Automatic Controllers for Temperature, Pressure, Humidity, Time and Level; Indicating and Recording Thermometers; Hydrometers; Oil Testing Instruments; TAG-MONO Recorders for Gas Analysis.

BROOKLYN, N. Y.



COMMERCIAL
TRADE MARK

These Trademarks

Are a Guarantee of Accuracy, Quality and Uniformity



PRECISION
TRADE MARK

KIMBLE GLASS COMPANY

VINELAND, N. J.

CHICAGO, ILL.

NEW YORK, N. Y.

Glassware for Biology, Chemistry and Metallurgy



Stocked by Responsible Laboratory Supply Dealers

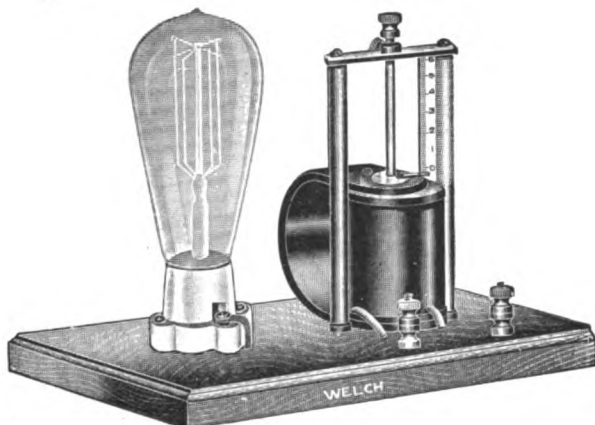

No. 2601

CHOKE COIL

A newly designed instrument illustrating one of the most fundamental principles of electricity. Consists of a coil of many turns of wire connected in series with an incandescent lamp. The coil is wound around an iron core and a U-shaped armature or iron completes the magnetic circuit. The iron core may be withdrawn from the coil and thus the magnetic circuit may be broken and the air gap lengthened and shortened at will. When this instrument is connected to alternating current the current is varied by withdrawing or inserting the core in the coil. This shows most effectively that the "equivalent resistance" of the coil depends on the arrangement of the magnetic circuit outside—there is no change of the length or size of wire as in an ordinary rheostat. Ohm's law does not fully apply here and this apparatus shows this definitely and demonstrates the existence of the quantity known as "impedance."

As a demonstration piece it may be used before a class and show this principle to all at the same time; since, when the core is withdrawn or inserted the lamp grows alternately bright and dim.

As a student piece it presents a very valuable test for the student to make measurements on, and the current and voltage in this coil when the core is in different positions may be measured. This will enable the student to calculate the apparent resistance and he will find the "resistance" is not constant as Ohm's law only would show. The instrument is provided with a scale on one side so that the student may know exactly the length of air gap existing in the core, and some very definite ideas may be gained as to the choking effect of an alternating current.

When direct current is used this instrument does not show this effect and when comparing the use on direct current to the use of it with alternating current it shows very forcibly this quantity of "impedance."

By far the greater part of the commercial work is with alternating current and an increasing number of texts are including the teaching of these principles. This instrument will fill this very important need.

Entire instrument is 20 cms. high, mounted on a mahogany finished base about 15 x 20 cm. Complete coil mounted as shown and with incandescent light.

QUALITY
CA Sign of Quality **WELCH** *CA Mark of Service*
 SERVICE

W. M. WELCH SCIENTIFIC COMPANY
 1516 Orleans Street Chicago, Ill., U. S. A.

LABORATORY APPARATUS

AND

REAGENTS

SELECTED FOR LABORATORIES OF

CHEMISTRY, METALLURGY AND BIOLOGY

IN THEIR APPLICATION TO

EDUCATION, THE INDUSTRIES, MEDICINE

AND THE

PUBLIC SERVICES



THE TEST

IN OUR STOCK FOR IMMEDIATE SHIPMENT

OF SERVICE



828-PAGE CATALOGUE



ARTHUR H. THOMAS COMPANY

WHOLESALE, RETAIL AND EXPORT MERCHANTS

WEST WASHINGTON SQUARE

PHILADELPHIA

U. S. A.

CABLE ADDRESS, "BALANCE," PHILADELPHIA

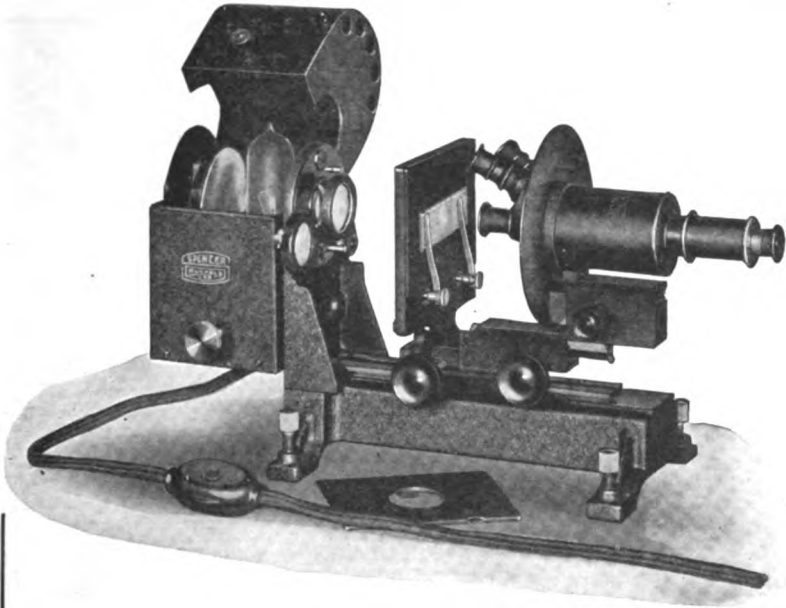

New Spencer Micro-Projector

makes it possible for microscopic slides to be projected on a screen so that a company of persons may view the same object simultaneously. The value of such projection either for classroom demonstration or class "quizzes" or for popular lectures is obvious.

This instrument, with microscope of standard size, having coarse and fine adjustments, adjustable to and from the condensing system by rack and pinion, is light, compact, easy to operate and efficient. It's illuminant is by Mazda bulb, enclosed in a light-tight, well ventilated hood and is instantly attached to any standard lighting circuit. The condensing system and reflector are so constructed and placed as to double the usual available illumination. It has numerous original and unique features making it abundantly satisfactory.

New Booklet K-16 Just Ready

SPENCER LENS COMPANY
BUFFALO, N. Y.

BRANCHES:

70 Fifth Avenue
New York City

417 Market St.
San Francisco



The F. & F. Optical Pyrometer

Patents
June, 1903—August, 1916—November, 1918
Other Patents Pending

A Direct Reading Optical Pyrometer for
Measuring Temperatures from 1,600 to 4,000° F.

ACCURATE—SIMPLE—RUGGED

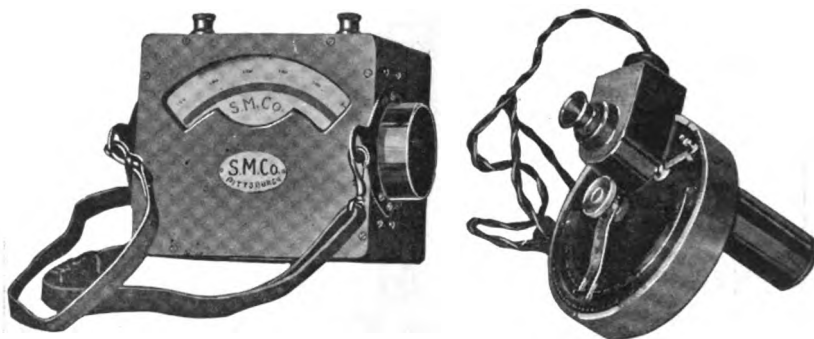

This Pyrometer offers many advantages:—

The temperature is read directly from the Instrument without referring to any tables.

Small objects can be observed.

Lamp burns at low temperature, has a long life and can be replaced for \$5.00.

Temperature readings are made by varying the field by means of a constant and carefully measured wedge and are not dependent upon the readings of a delicate ammeter.

The operator can correct for any depreciation in the lamp or the battery by simply adjusting the Rheostat until the ammeter reading corresponds to the normal point given.

Price, complete—\$175.00

Designed, Manufactured and Distributed by

SCIENTIFIC MATERIALS COMPANY
"Everything for the Laboratory"

PITTSBURGH, PA.

High Frequency Inductive Apparatus No. 95-335

Designed for a comprehensive study of the high frequency field, including wireless telegraph waves and kindred subjects.

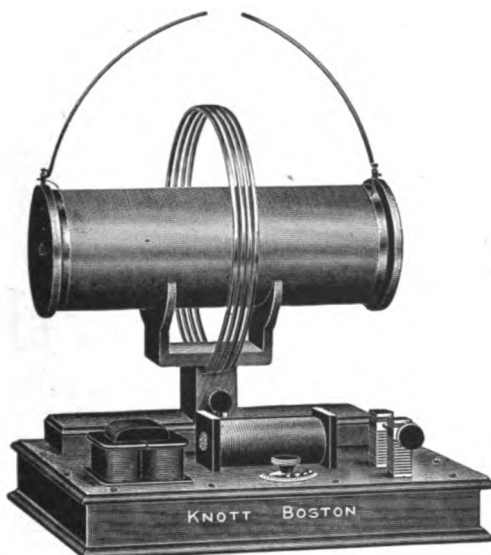

This apparatus combines open type of resonator with closed core type of transformer and silver self-cooling spark gap.

Will excite all types of vacuum tubes and will produce X-Rays of surprising power and penetration.

Connected on a 110 volt A. C. circuit, will furnish a discharge of any desired value up to full capacity—12 inches.

Price \$160.00

L. E. KNOTT APPARATUS COMPANY
CAMBRIDGE, MASS.

Form 27-10-OSA

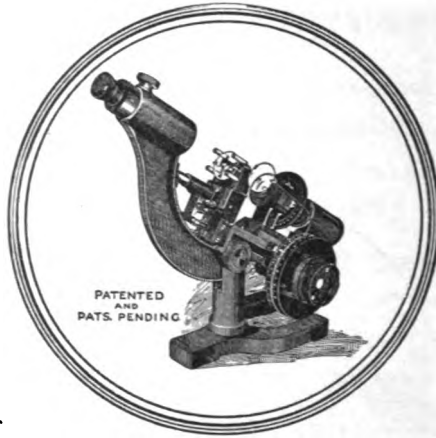

The Wellsworth Lensometer

TRADE MARK REGISTERED U.S. PATENT OFFICE

WITH absolute accuracy this, the latest development for Precision in Ophthalmic Science, measures and records the True Power of a Lens as worn, the Spherical Power, the Cylindrical Power, the Axis of Cylinder, Decentration and the Distance and Reading Power of a Bi-focal Lens. It accurately checks, for the first time in Ophthalmic Practice, the resultants called for by the prescription.

We have prepared a brochure describing the Wellsworth Lensometer. This will be sent upon request.

American Optical Company

Southbridge, Massachusetts, U. S. A.

New York

Chicago

San Francisco

SCIENCE ADVANCES

AND with its advance comes one of the greatest inventions in the history of Ophthalmic Science—The Wellsworth Lensometer. This instrument is the culmination of years of research and experiment by Wellsworth scientists. It comes to remove any possibility of error from the verification of lenses. With cold, mechanical eye it tells you and records exactly on graduated scales the true power of a lens as worn.

Its operation is simple. Place the lens, any form of ophthalmic lens, in the lens holder; make a few simple adjustments to secure proper definition of the target and you verify absolutely for the time the resultants called for by the prescription.

The Wellsworth Lensometer is an exclusive Wellsworth product. Write for detailed Literature.



American Optical Company

Southbridge, Massachusetts, U. S. A.

New York

Chicago

San Francisco

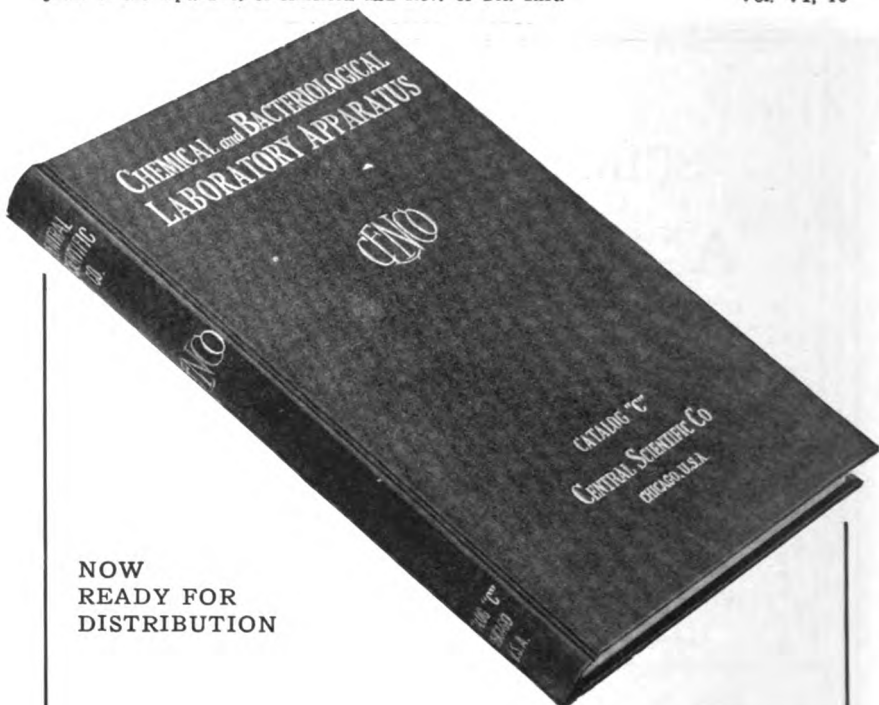

NOW
READY FOR
DISTRIBUTION

The Cenco 1922 Catalog of Quality Chemical Laboratory Apparatus

CONTAINING a comprehensive and complete listing of all the articles used in industrial, educational or bacteriological laboratories.

From absorbent cotton all the way down the alphabet to zinc wire there are over 6,000 articles classified—all of which are either manufactured by us or supplied direct from large stocks on hand.

A copy of this complete reference book will be mailed upon application Free to any laboratory director, chief chemist or executive with buying power. Ask for your copy today.

—THE REASONS WHY—

The Central Scientific Company employ the largest technical staff of any laboratory apparatus company in America—they carry the largest stock of supplies in the West and manufacture more general laboratory apparatus than any other company in America.

CENTRAL SCIENTIFIC COMPANY

LABORATORY  SUPPLIES
Apparatus Chemicals

460 E. Ohio St.

Chicago

U.S.A.

Journal of the Optical Society of America and Review of Scientific Instruments

Published monthly beginning May 1922.

Annual Subscription \$5.00

The JOURNAL of the Optical Society of America was first published in January 1917. Four separate issues appeared in 1917, and two issues in 1919. During the years 1920 (Vol. IV) and 1921 (Vol. V) the JOURNAL was published bi-monthly. Copies of back numbers may be secured from the Business Manager for \$1.00 each. The total charge for all members from Vol. I to Vol. V, 1921 inclusive, is \$16.00. Only a small stock of the earlier issues remains. The six numbers comprising Vols. I to III will not be sold except in complete sets with Vol. IV and V.

By cooperation with the Association of Scientific Apparatus Makers of the United States of America the scope of the JOURNAL was enlarged beginning January 1922. As indicated by the present title the JOURNAL now publishes original papers on instruments of every description as well as papers on experimental and applied optics. The new JOURNAL is published monthly beginning May 1922, making 10 issues for 1922.

Annual Subscription \$5.00 dating from January of the current year. Single copies \$0.60. Remittances for subscriptions and back numbers should be made to "F. K. Ritchmyer, Manager," Cornell University, Ithaca, N. Y.

All correspondence on the following subjects must be made with the Business Manager: (1) Application for, and checks in payment of annual subscriptions other than those of members of the Optical Society; (2) Change in mailing address; (3) Missing numbers: these will be replaced free of charge only when notification is made within 30 days from date of the immediately succeeding issue; (4) All advertising accounts and applications for space and rates.

THE OPTICAL SOCIETY OF AMERICA

President—L. T. TROLAND,
Harvard University,
Cambridge, Mass.

Vice-President—H. E. IVES,
Western Electric Co.,
New York, N. Y.

Secretary—IRVING G. PRIEST,
Bureau of Standards,
Washington, D. C.

Treasurer—ADOLPH LOMB,
Rochester, New York.

The Council consists of the above officers, the Editor-in-Chief and the Assistant Editor-in-Chief and Business Manager of the JOURNAL, the past President, James P. C. Southall, Columbia University, and the following elected members: Adelbert Ames, Dartmouth College, H. G. Gale, University of Chicago, Ernest Merritt, Cornell University and W. E. Forsythe, Nela Research Laboratories.

The object of the Optical Society of America is to serve the interests of all who are engaged in any branch of optics from fundamental research to the manufacture of optical goods.

The Constitution provides that anyone who has contributed materially to the advancement of optics shall be eligible to regular membership in the Society with the privilege of voting and holding office. Any individual or corporation interested in optics is eligible to associate membership. Annual dues including subscription to the JOURNAL are five dollars for individual membership and fifty dollars for corporation membership. Further information may be obtained from the Secretary.

Made in Philadelphia—"the World's Workshop."



CALORIMETER THERMOMETERS

for
Parr,
Emerson,
Sargent,
&
Junker
Calorimeters



Precision Thermometer & Instrument Co.

1434-36-38 Brandywine St.

PHILADELPHIA



For Experimental Work

If your experimental work calls for the application of a clean, constant heat, at temperatures up to 1800° F., this Hoskins furnace may meet the requirements.

The heating unit is one continuous length of coiled wire, and is wrapped around a refractory muffle having grooves on its surface. It is easy to renew—but hard to wear out. The furnace is controlled by a rheostat, and operates on A. C. or D. C. at line voltages.

It is described in Catalog 130. We'd be pleased to send it to you.

HOSKINS MANUFACTURING CO., Detroit
Boston New York Cleveland Chicago San Francisco

HOSKINS THE METALS THAT MAKE ELECTRIC HEAT POSSIBLE **PRODUCTS**
HEAT RESISTANT ALLOYS *Chromel* ELECTRICAL RESISTOR ALLOYS
ELECTRIC FURNACES PYROMETERS



Jagabi Dial-Pattern Resistance Boxes and Wheatstone Bridges

For use in Research, Industrial and Educational Laboratories we invite particular attention to these new instruments, of American manufacture.

No plugs are used; and the dials are arranged to be "*direct-reading*," a matter of quite some importance.

The boxes are dust-proof, with hard rubber tops. The coils are of manganin wire, wound bi-filar on meal spools, and are calibrated within 1/10 of 1%.

In the Resistance Boxes each dial controls 9 coils of like value—which plan eliminates "kicks" in a telephone receiver or galvanometer when the switch is being rotated.

The Wheatstone Bridge includes four sets of coils, 9 x (1+10+100+1000 ohms), and the bridge coils have a dial control which multiplies by .001, 01, 0.1, 1, 10, 100 or 1000—thus simplifying construction and operation as compared with two separate "arms."

Write for illustrated descriptive bulletin O1000.

James G. Biddle

1211-13 Arch Street

PHILADELPHIA, PA.

COORS PORCELAIN COMPANY

Manufacturers of

COORS---U.S.A.

CHEMICAL AND SCIENTIFIC PORCELAIN

GOLDEN, COLORADO

If you want catalog or anything special that can be made of porcelain, write us.

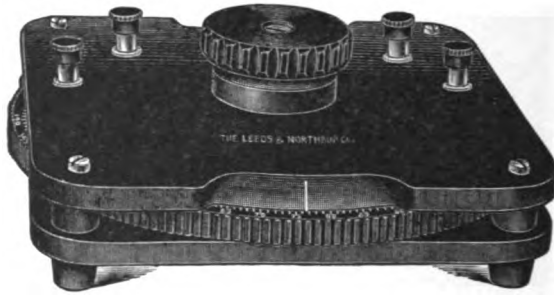

THE BROOKS INDUCTOMETER

Designed by H. B. Brooks and described
in N. B. S. Scientific Paper No. 290.

This instrument provides a continuous variation of inductance with constant resistance. It is also a very satisfactory mutual inductor. It is applicable to measurements made with alternating current up to and including currents of audio frequency.

Two features are peculiar to the Brooks Inductometer: First, the arrangement of the fixed coils above and below the coils in the rotating disc practically eliminates errors caused by displacement of the disc through wear in the bearings. Second, the careful design of the link-shaped coils results in a scale that is very nearly uniform. This makes for accuracy and ease of reading.

The instrument has a high degree of astaticism, so that when the usual precautions regarding location are observed it is not affected by stray magnetic fields.

The scale can be graduated in terms of self or mutual inductance or both, or in degrees. There are several standard ranges from 1.2-10 millihenrys to 60-500 millihenrys. Other ranges in henrys or microhenrys can be furnished.

*Catalog 10J describes the
Brooks Inductometer.*

LEEDS & NORTHRUP COMPANY
ELECTRICAL MEASURING INSTRUMENTS
4901 STENTON AVE. PHILADELPHIA



*What's "Under the Hood"
of
Brown Pyrometers*

**Ground, Hardened, Tempered
and finally polished and
inspected under a microscope**

(3rd of a series)



When you consider that a diminutive pill box holds nearly 5,000 pivots for the movable element bearings of Brown Pyrometers, you will appreciate what problems are involved in their production and inspection. In making these pivots of a superior quality, special drill rod .020" diameter is taken and ground to a point with a 50° angle. The pivots are then hardened and tempered, placed under a microscope and carefully polished. The pivots are finally inspected under a microscope in the hands of an inspector.

The jewels are made of imported sapphire of the finest quality, ground to a conical hole at an angle of 80°, then carefully polished and inspected.

You can readily understand that the fifty degree angle glass-hard pivot bearing in an eighty degree smooth sapphire jewel, produces a system that is as nearly frictionless as possible to obtain. In a vertical pivoted system the lower pivot takes the small weight of the movable element and the top pivot is only a guide. It is frictionless—the system is floating—so to speak.

This is another example of the methods employed in the manufacture of Brown Pyrometers which has made them pre-eminent in the measurement of high temperature.

THE BROWN INSTRUMENT COMPANY

4530 Wayne Avenue, Philadelphia, Pa.

New York Pittsburgh Boston Cleveland Detroit Chicago
Denver St. Louis Birmingham Los Angeles San Francisco Montreal

Brown Pyrometers
Most used in the world

Do You Guess at Temperatures?

Bristol's Pyrometers Will Measure and Record Them

You can trust a Bristol's because they have been thoroly tested by over 30 years service in industrial processes.

They are the only pyrometers which give accurate direct readings, for the reason they are equipped with Patented Automatic Internal Cold-End Compensator.

Our salesman are engineers They will come to you and discuss your temperature problems without any obligation on your part.

You should at least have a copy of our new 68 page Pyrometer Catalog F-1401. It is a real textbook on the subject.

The Bristol Company, - Waterbury, Conn.

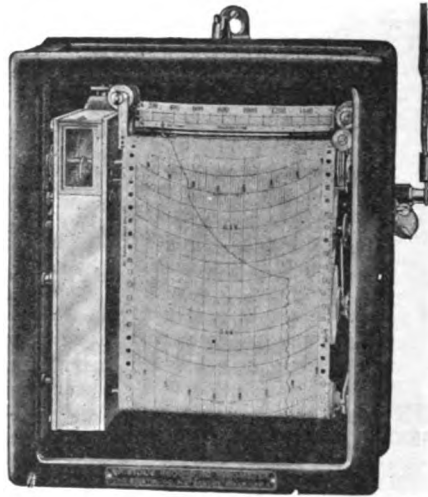

TRADE MARK
BRISTOL'S
REG. U. S. PAT. OFFICE.

Serological Water Bath of Precision

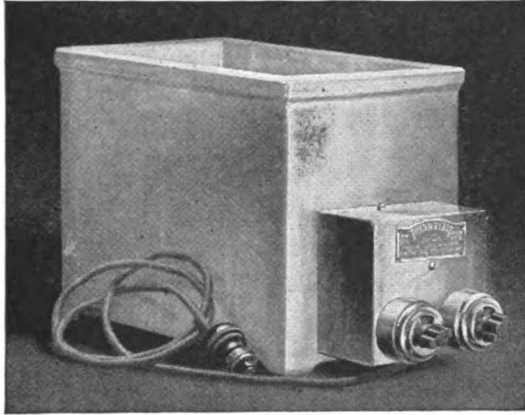

Electrically heated and temperature controlled serological water baths capable of operating at 37.5 degrees Centigrade or 56 degrees Centigrade, either temperature may be obtained by a simple turn of the indicative snap switch. The Wasserman test and inactivating work may be accomplished in the same bath. An Immersion electric heater which is entirely surrounded by water and extends the full length of the bath is used. The thermostats are the multiple contact type, capable of repeated heating and cooling without changing the adjustment. Should other working temperatures be desired the adjustment screw on the thermostat permits the temperature to be readily changed. Baths may be had from stock in the following sizes:—Specify voltage when ordering.

PORCELAIN BATHS:

12½ in. x 6 in. x 5 in. Double temperature, Price \$55.00
12½ in. x 6 in. x 5 in. Single temperature, Price 50.00

COPPER NICKEL PLATED BATHS; DOUBLE TEMPERATURE:

18 in. x 12½ in. x 5 in. Price \$90.00
24 in. x 12½ in. x 5 in. Price 95.00

SINGLE TEMPERATURE:

18 in. x 12½ in. x 5 in. Price \$75.00
24 in. x 12½ in. x 5 in. Price 80.00
26 in. x 12½ in. x 5 in. Price 85.00

BRAUN-KNECHT-HEIMANN-CO.

Founded 1852

Laboratory Supplies
Apparatus-Chemicals
Scientific Instruments

Inventors—Exporters—Manufacturers—Distributors

"We know how to pack for Export"

576-584 MISSION ST.
Cable Address—"BRAUNDRUG"
all codes used.

SAN FRANCISCO, U. S. A.
Los Angeles House,
The Braun Corporation

BAKER PLATINUM WORKS, NEWARK, N. J., U. S. A.
Platinum for every purpose

FINE WIRE

LESS THAN .0007" DIAMETER

We are prepared to supply wire of the following metals and alloys drawn to very fine sizes.

PLATINUM	90% Platinum - 10% Rhodium	SILVER
PALLADIUM	60% Gold - 40% Palladium	COPPER
GOLD		ALUMINUM

Made by the cored-wire (Wollaston) process in jackets removable without damage to core.

FULL DIRECTIONS SENT WITH WIRE
Quotations on Request

BAKER & CO., INC.,	NEWARK, N. J.
Refiners and Workers of Platinum, Gold and Silver	
CHICAGO OFFICE 5 SO. WABASH AVE.	NEW YORK OFFICE 30 CHURCH STREET

J. B. McDOWELL

Successor to

JOHN A. BRASHEAR CO., Ltd.
PITTSBURGH, PA.

Maker of

High Grade Astronomical Telescopes
Visual and Photographic Objectives
Wide Angle Camera Lenses for Stellar
Photography

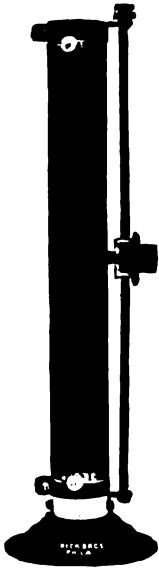

“BECBRO” RHEOSTATS
for Every Service

**Made in Tubular, Stone and Carbon
 Types**

SEND FOR CATALOGUE

BECK BROS.

**3641 N. 2nd St.
 PHILADELPHIA, PA.**

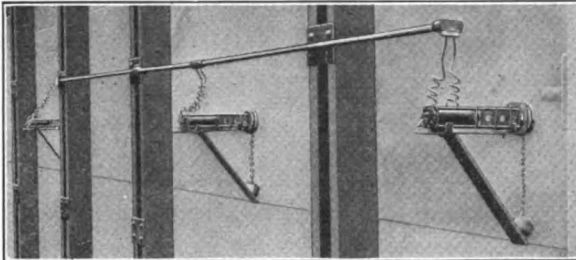

**Measure
 Temperatures
 by
 Radiation**

With a Thwing radiation pyrometer the highest known temperatures can be measured with accuracy—quickly and without focusing or leveling.

For metallurgical, ceramic, cement, coke and boiler work, and for measuring accurately the temperatures of flowing metals, etc., that could not be measured with thermocouples Thwing pyrometers are unexcelled.

Any of your men can use Thwing Radiation Pyrometers—in absolute comfort. Reference to tables or interpolation of values are unnecessary!

**Thwing
 PYROMETERS**

**THWING INSTRUMENT CO., 3367 Lancaster Ave., Philadelphia, U. S. A.
 110**



Hickok Precision Milli-Ammeters

This is one of the many models of HICKOK Precision instruments.

The instrument shown is a double range Milli-ammeter for precision X-Ray work made in two sizes, diameter 7 and 9 inches.

Write for our catalogue, also state type of instrument desired.

**THE HICKOK ELECTRICAL INSTRUMENT CO.
CLEVELAND, OHIO**

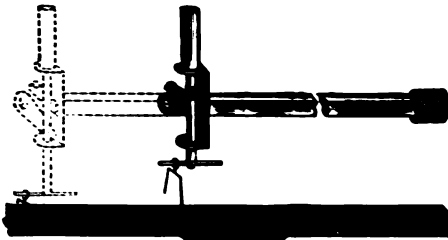

Patented

Rider Carrier on Analytical Balance Number 100

Without wasted motion, rapidly, smoothly, and accurately, this rider carrier picks up the rider and replaces it on the beam. The rider can be shifted even while the beam is oscillating. The carrier automatically "retreats" out of the way of the beam the instant its duty is performed.

The carrier is part of the standard equipment of our Number 100 Balance.

Send for Descriptive Circular

SCHAAR & COMPANY
556 W. Jackson Blvd. Chicago

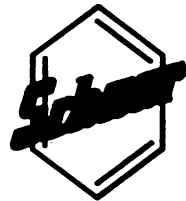

Switchboard and Service Types

Meters for Every Electrical Need



A. C. Watthour Meters
D. C. Watthour Meters
Amperehour Meters
Distant Dial Mechanisms
Shunts

Ask for Bulletins Giving Full Details

Sangamo Electric Company
Springfield, Illinois

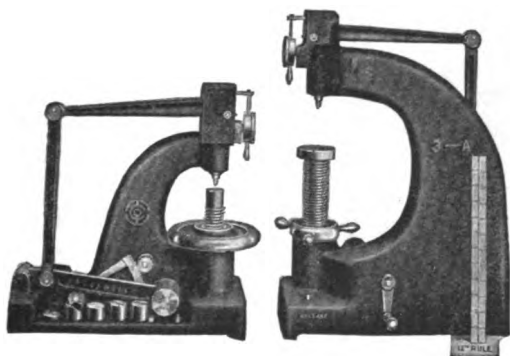

Rockwell Direct-Reading Hardness Tester

The cut shows
2 of 3 Standard
Sizes.

Steel Ball of $1/16$ " , $1/8$ " , $1/4$ " or $1/2$ " diameter is impressed into material under test with load of 60 Kg. or 100 Kg., after an initial pressure of 10 Kg. has first been applied. The hardness number shown on dial is a function of the differential depth. Diamond points and 150 Kg. load for very hard steel now available also.

WILSON-MAEULEN CO., St. Mary's St., N. Y., Makers

Some Notable Examples of Scientific Instruments Which We Have Developed

STANDARD TUNING FORKS, RESONANT BOXES and HELMHOLTZ RESONATORS,—an extensive assortment of regular ranges and pitches, adapted for every use to which Tuning Forks are put.

FARWELL-STIFLER OPTICAL BENCH—a complete system with Optical Parts and Accessories (Bulletin 16). An efficient portable equipment at low cost.

ZELANY OSCILLATING ELECTROSCOPE, with accessories for experiments in Ionization and Radioactivity (Bulletin 15).

AUTOMATIC ELECTRIC DRIVEN TUNING FORK AND PRECISION FREQUENCY GENERATOR, operating forks of wide frequency range on 110 or 220 volt circuit (Bulletin 17). Of greatest value for acoustic and electrical work.

When planning any laboratory equipment our catalogs should be consulted:
Catalog 3 (1920), Scientific Instruments, including Physical Apparatus.
Catalog 4 (1921), Laboratory Apparatus, including Chemical and Biological Apparatus.



STANDARD SCIENTIFIC COMPANY

Suite 722, 342 Madison Ave.

NEW YORK CITY

Uses of the Standard Cell

The electromotive force of the normal cadmium standard cell, for all but theoretical purposes, defines the value of the International Volt. In all potentiometric methods a standard cell is essential. Measurements of temperature by means of the thermocouple, determinations of hydrogen ion concentrations, measurements of capacity and voltage by the ballistic galvanometer, and measurements of voltage by the electrometer, all require a standard cell.

The calibration of deflection instruments measuring voltage is ultimately based upon this standard.

*Bulletin No. 1, "Standards of Electromotive Force,"
sent on request.*

THE EPPLEY LABORATORY

MARION EPPLEY, Owner

NEWPORT, R. I.

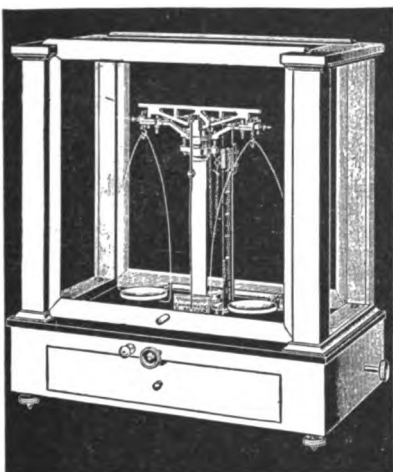

No. 15 Chainomatic

CHAINOMATIC
**Analytical
 and
 Specific Gravity
 Balances**

greatly reduce
 time consumed in
 weighing. Accurate
 and sensitive.

CHRISTIAN BECKER, Inc.

Main Office: 92 Reade Street, New York City
 Factory: 147-153 Eighth Street, Jersey City, N. J.
 Branch: 49 California Street, San Francisco, Cal.
 Branch: 31 West Lake Street, Chicago, Ill.

**STEBBINS
 STRING
 ELECTROMETER**

—A highly accurate instrument of small capacity, short period and excellent sensitivity. This electrometer, and several others, will be found described in our new catalog CO-19. A copy awaits your request.

**PYROLECTRIC
 INSTRUMENT CO.**

636-640 East State St.
 TRENTON, N. J.

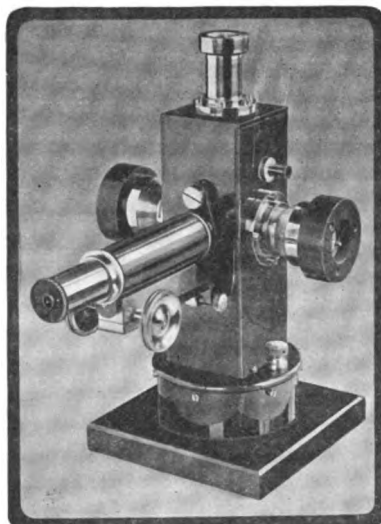

Stebbins String Electrometer
 Cat. No. 1900

Kewaunee

Kewaunee Laboratory Furniture has been the standard for a generation. It ideally meets the exacting requirements of America's largest and most critical users.

The correct design, superior materials and skilled workmanship which go into every piece of Kewaunee Equipment are making this furniture standard in the Industrial Laboratory field.

Kewaunee Laboratory Furniture is built for the teaching of Physics, Chemistry, Biology, Agriculture, Electricity, Manual Training or Kindergarten Work. Ask for a copy of the Kewaunee Book. It is free. Address all inquiries to the factory at Kewaunee.

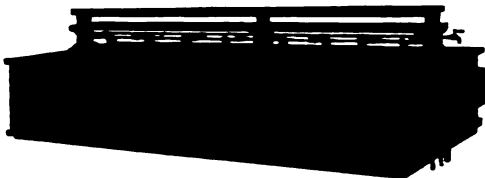

Industrial Analysis Desk. There is no better design on the market today. The small drawers extend through the desk, making an excellent place to store long condensers, etc.

Kewaunee Mfg. Co. LABORATORY FURNITURE EXPERTS

C. G. CAMPBELL, Treas. and Gen. Mgr.

146 Lincoln St., Kewaunee, Wis. New York Office, 70 Fifth Avenue
Branch Offices: Chicago, Minneapolis, Kansas City, Baton Rouge, Columbus, Denver, Houston, Little Rock, Omaha, San Francisco, Spokane, Phoenix, Oklahoma City, Greensboro, N. C., Jackson, Miss., Toronto, Canada, Albuquerque, Salt Lake City.

TRANSACTIONS OF THE OPTICAL SOCIETY (OF LONDON)

Price per number, 10s

Subscription per vol., 50s

Principal Contents of Current Number (Vol. xxiii, No. 3)

- "The Structure of Abraded Glass Surfaces." By F. W. Preston, B.Sc., A.M.I.C.E.
- "Some Measurements of the Stresses Produced at the Surfaces of Glass by Grinding with Loose Abrasives." By A. J. Dalladay, A.Inst.P.
- "The Barr and Stroud 100 ft. Self-contained Base Range-finder." By James Weir French, D.Sc.
- "A Criticism of the Nodal Slide as an Aid in Testing Photographic Lenses." By T. Smith, M.A., F.Inst.P. and John S. Anderson, D.Sc., F.Inst.P.
- "A Non-Polarising Spectrophotometer." By A. J. Bull, M.Sc., F.Inst.P.
- "The Photometry of Optical Instruments." By J. Guild, A.R.C.Sc., F.R.A.S., F.Inst.P.
- "A Projective Treatment of the Submarine Periscope." By T. Smith, M.A., F.Inst.P.

PUBLISHED BY THE OPTICAL SOCIETY
IMPERIAL COLLEGE OF SCIENCE AND TECHNOLOGY
SOUTH KENSINGTON, LONDON, S. W. 7

"Freas Electric Constant Temperature Ovens are most serviceable in that they maintain a constant temperature within close limits, over long period of unattended operation.

For sale by all dealers.

Manufactured by
The Thermo Electric Instrument Co.
8 Johnson St., Newark, N. J.

Fine Glassblowing



*Glass
Apparatus
to Your
Specifications*

CATALOG ON
REQUEST

Complete Line of Laboratory Supplies
Hydrometers and Thermometers

The Emil Greiner Company
Manufacturers & Dealers
Established 1881
55 Fulton St. New York, N. Y.

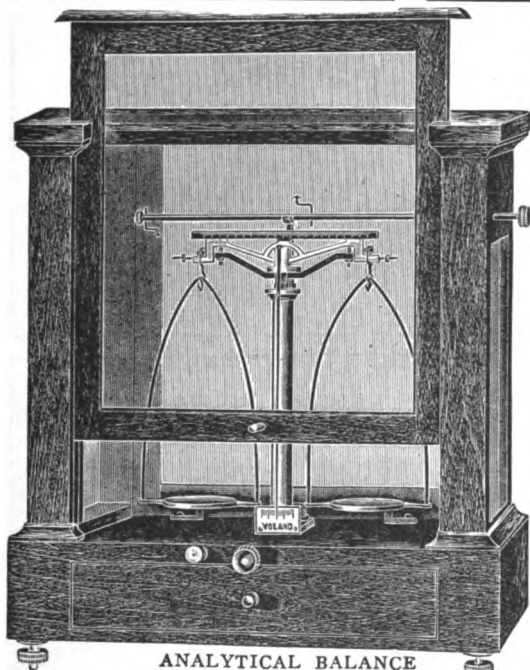

ANALYTICAL BALANCE
No. 1006-"B"

Voland Balances

This is the most popular priced analytical balance. Thousands have been made and sold throughout the world. Prices quoted on application.

Voland & Sons
Inc.
New Rochelle, N.Y.
U. S. A.

XXXIII

Repairs to Disabled Instruments

The RUBICON REPAIR DEPARTMENT is devoted exclusively to the repair and rebuilding of electrical and physical laboratory instruments.

We solicit work on all standard makes of apparatus, as well as special instruments of both American and foreign manufacture.

RUBICON COMPANY

Manufacturers of

ELECTRICAL AND PHYSICAL INSTRUMENTS

923 Walnut Street

Philadelphia, Pa.

Eberbach & Son Co.

Inc.

(Established 1843)

Ann Arbor, Michigan



Manufacturers of Physical, Chemical,
and Physiological Apparatus

STANDARD OF EXCELLENCE

ANALYTICAL—ASSAY—BALANCES

WEIGHTS OF PRECISION

HENRY TROEMNER

911 Arch St.

PHILADELPHIA, PA.



Ainsworth Precision Balances

When equipped with our Multiple and Keyboard Weight Carriers and with the Vernier Rider Carrier and variable sensitivity attachment offer the most rapid means for accurate weighing.

Send for bulletin A-2

WM. AINSWORTH & SONS

THE PRECISION FACTORY

Denver, Colo., U. S. A.

NOTES FOR CONTRIBUTORS

Manuscripts may be sent to the Editor or Assistant-Editor-in-Chief. They should be clearly typewritten, and in suitable form for printing without essential changes. References should appear only as footnotes, and should include year of publication and volume number thus: *Phil. Mag.* 27, p. 102, 1914.

Special care should be given to the writing of mathematical formulæ. The grouping of the magnitudes, the lining up of equality signs, fraction lines, etc., should be such that the arrangement could not be misunderstood by the compositor.

Unless a special typewriter is used, it is necessary to insert formulæ with pen and ink. For the sake of uniformity, contributors are requested to use in formulæ of geometrical optics, the symbols and designations given in the first issue of the *JOURNAL*.

Diagrams should be made with black drawing ink to allow photographic reproduction.

Curves should be drawn on plain paper or blue-lined-section paper and all coördinates to be reproduced must be drawn with jet-black ink. Lettering should be of sufficient size to be legible after reduction, requiring no printing from type.

A page containing the captions for all figures should accompany the manuscript.

Authors must give special attention to presenting papers in as concise a manner as possible. Tabular and descriptive matter and illustrations should be reduced to a minimum consistent with clarity.

Papers are published in English only.

Ten copies of the *JOURNAL* are sent free of charge to the author or to the joint authors of each original contribution, when so requested on the instruction sheet accompanying the proof.

Reprints are furnished at cost, as shown below, requests for which should be sent to the editor.

COST OF REPRINTS WITHOUT COVER

	4p	8p	12p	16p	20p	24p	28p	32p
50	5.03	6.31	9.84	11.62	16.65	17.87	22.40	23.24
75	5.17	6.59	10.26	12.18	17.35	18.71	23.38	24.36
100	5.31	6.87	10.68	12.74	18.05	19.55	24.36	25.48
125	5.45	7.15	11.10	13.30	18.75	20.39	25.34	26.60
150	5.73	7.71	11.94	14.42	20.15	22.07	27.30	28.84
200	6.01	8.27	12.75	15.54	21.55	23.75	29.26	31.08
300	6.57	9.11	13.90	16.94	23.23	25.71	31.50	33.60
400	7.03	9.55	15.02	18.34	24.91	27.67	33.74	36.12
500	7.59	10.79	16.14	19.74	26.59	29.63	35.98	38.64
600	8.15	11.63	17.26	21.14	28.27	31.59	38.22	41.16
700	8.71	12.47	18.38	22.54	29.95	33.55	40.46	43.68
1000	10.39	15.83	23.42	29.26	28.35	43.63	52.22	57.12

If cover is wanted, the extra cost will be as follows:

On Lots of.....	100.....\$4.00	200.....\$4.50	500.....\$6.00
-----------------	----------------	----------------	----------------

National Research Council

INFORMATION SERVICE

The National Research Council maintains a Research Information Service which places at the immediate command of individuals, institutions and firms, information concerning scientific instruments, apparatus, lantern slides—laboratory construction and equipment—bibliographies and references, both published and unpublished—research problems, projects, methods, funds, personnel, and other subjects of interest to investigators.

Scientific Apparatus

A file of over 500 catalogues—representing the manufacturers of and dealers in scientific apparatus and instruments, both domestic and foreign—is maintained for the purpose of quickly supplying information as to source and availability of apparatus and instruments to those scientists who can specify their needs, but who lack full information as to who can best meet them.

Available information is promptly furnished, without charge.

Correspondence should be addressed

RESEARCH INFORMATION SERVICE

NATIONAL RESEARCH COUNCIL

WASHINGTON, D. C.

INDEX TO ADVERTISERS

Name	Page
Wm. Ainsworth & Sons.....	XXXIV
American Optical Co.....	XIV-XV
Baker & Company.....	XXVI
Bausch & Lomb Optical Co.....	Cover 2
Beck Brothers.....	XXVII
Christian Becker, Inc.....	XXXI
James G. Biddle.....	XX
Braun-Knecht-Heimann-Co.	XXV
Bristol Co.....	XXIV
Brown Instrument Co.....	XXIII
Central Scientific Co.....	XVI
Coors Porcelain Co.....	XXI
Corning Glass Works.....	II
Eastman Kodak Co.....	Cover 3
Eherbach & Son, Co.....	XXXIV
Eimer & Amend.....	I
Eppley Laboratory.....	XXX
Wm. Gaertner & Co.....	V
General Electric Co.....	IV
Emil Greiner Co.....	XXXIII
Hickok Electrical Instrument Co.....	XXVIII
Hoskins Mfg. Co.....	XIX
Kewaunee Manufacturing Co.....	XXXII
Kimble Glass Co.....	VIII
L. E. Knott Apparatus Co.....	XIII
Leeds & Northrup Co.....	XXII
J. B. McDowell, Inc.....	XXVI
National Research Council.....	XXXVI
Precision Thermometer and Instrument Co.....	XVIII
Pyroelectric Instrument Co.....	XXXI
Rubicon Co.....	XXXIV
Sangamo Electric Co.....	XXIX
Schaar & Co.....	XXVIII
Scientific Materials Co.....	XII
Spencer Lens Co.....	XI
Standard Scientific Co.....	XXX
C. J. Tagliabue Manufacturing Co.....	VII
Taylor Instrument Co.....	XXXVIII
Thermo Electric Instrument Co.....	XXXIII
Arthur H. Thomas Co.....	X
Thompson-Levering Co.....	VI
Thwing Instrument Co.....	XXVII
Transactions of the Optical Society (of London).....	XXXII
Henry Troemner.....	XXXIV
Voland & Sons.....	XXXIII
W. M. Welch Manufacturing Co.....	IX
Western Electrical Instrument Co.....	III
Wilson-Maeulen Co.....	XXIX



Temperature Instruments

Air Meters
Anemometers
Aneroid Barometers
Aviation Barometers
Base Metal, Rare Metal and Radiation Pyrometers
Electric Contact Thermometers
Fery Radiation Pyrometers
Fever Thermometers
Hand Levels
Hydrometers
Hygrometers
Inclinometers
Mercurial Barometers
Mercurial, Recording and Index Thermometers for
all industrial and laboratory applications
Mercury Column Vacuum Pressure and U Gauges
Mineral Oil Testing Instruments
Pocket Compasses
Rain Gauges
Recording Barometers
Sphygmomanometers
Surveying Compasses
Temperature, Pressure and Time Regulators
Thermometers of all kinds for home and general use
Thermographs
Urinalysis Glassware

An exhaustive catalog may be obtained by stating
firm connection or specific booklets on any of the
above lines will be furnished you.

Taylor Instrument Companies

Rochester, N.Y.

There's a *Tycos* or *Taylor* Thermometer for Every Purpose

Eastman Products For Scientific Use



Kodak Auto-Focus Enlarger

Slide the camera up and the image grows, down and it shrinks, but the focus is automatically kept sharp—no bellows to rack, or further adjustments to make.

*Easily adjusted holders
keep the paper flat—no
thumb tacks, no slipping.*

A new apparatus which changes enlarging into a simple printing process. It takes film or plate negatives up to 4 x 6 inches and makes prints on Bromide Paper up to 14 x 21 inches. No photographic dark room is complete without one of these enlargers.

Price (Including Excise Tax) \$35.00

Panchromatic Films and Plates

Wratten and Wainwright Filters

Eastman Tested Chemicals for Photographic Use

Eastman Synthetic Organic Chemicals (over 1400) for Research Work

Send for descriptive literature

Eastman Kodak Company

Rochester, N. Y.

The Kodak City

STATE J.
LIBRARY
UNIVERSITY OF
MICHIGAN
ANN ARBOR

In the SECTION ON SCIENTIFIC INSTRUMENTS of this JOURNAL we shall endeavor to present to the American Scientific Public up-to-date information on scientific instruments of all kinds for *Research, Instruction, and Industrial and Professional Work in Physics, Chemistry, Biology, and other Sciences.*

The Editors invite articles for publication describing new devices, new methods, theory of instruments and other pertinent material. If you do not have an article to send, perhaps there is some instrument or method you would like described. *Send us suggestions.* We invite your cooperation and your criticisms, *constructive or otherwise.* Communications and manuscripts may be sent to either of the following:

PAUL D. FOOTE, Bureau of Standards, Washington, D. C.

F. K. RICHTMYER, Cornell University, Ithaca, N. Y.

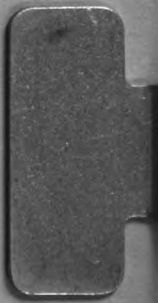

UNIVERSITY OF ILLINOIS-URBANA
Q.535 .05J0 C001
JOURNAL OF THE OPTICAL SOCIETY OF AMERIC
6 1922



3 0112 007412759