

KANSAS CITY PUBLIC LIBRARY



0000102080645

535 582

Keep Your Card in This Pocket

Books will be issued only on presentation of proper library cards.

Unless labeled otherwise, books may be retained for four weeks. Borrowers finding books marked, defaced or mutilated are expected to report same at library desk; otherwise the last borrower will be held responsible for all imperfections discovered.

The card holder is responsible for all books drawn on his card.

Penalty for over-due books 2c a day plus cost of notices.

Lost cards and change of residence must be reported promptly.



PUBLIC LIBRARY

Kansas City, Mo.

Keep Your Card in this Pocket

KANSAS CITY, MO PUBLIC LIBRARY



0-0001 0208064 5

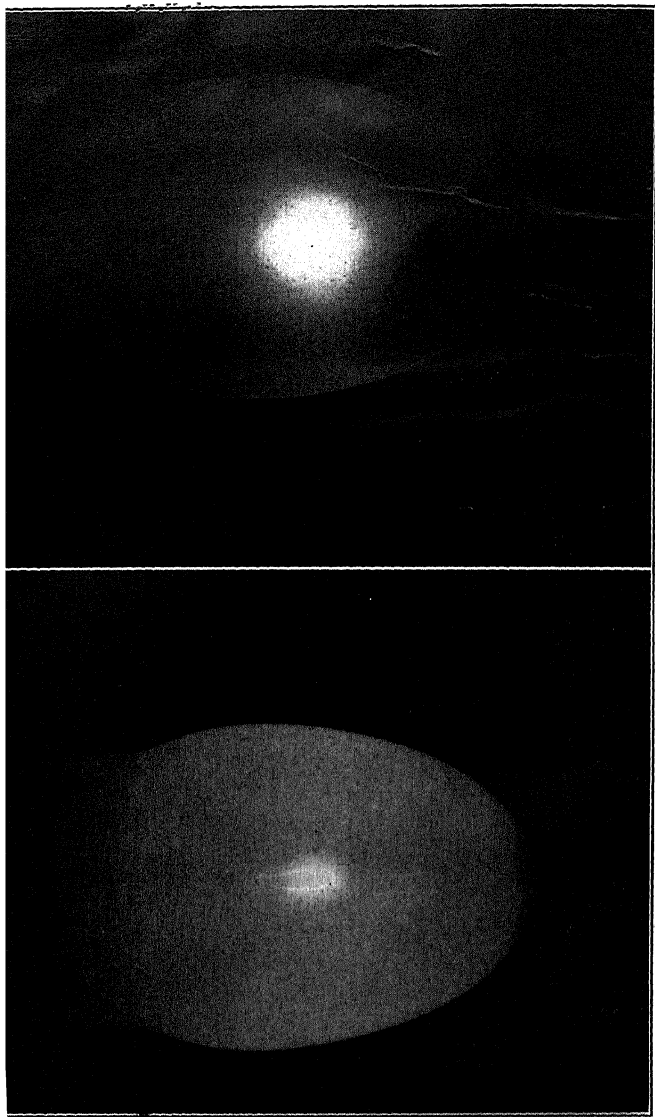

Diffusion and diffraction illustrated by photographs of a two-candle power lamp enclosed first by an opal globe (right), and then by a sand-blasted globe (left). Exposure, 15 seconds. See page 221.

RADIATION, LIGHT AND ILLUMINATION

A SERIES OF ENGINEERING LECTURES
DELIVERED AT UNION COLLEGE

BY

CHARLES PROTEUS STEINMETZ, A.M., PH.D.

COMPILED AND EDITED BY

JOSEPH LEROY HAYDEN

THIRD EDITION

McGRAW-HILL BOOK COMPANY, INC.
239 WEST 39TH STREET. NEW YORK

LONDON: HILL PUBLISHING CO., LTD.
6 & 8 BOUVERIE ST., E. C.

1918

COPYRIGHT, 1909, 1918, BY THE
MCGRAW-HILL BOOK COMPANY, INC.

AUTHOR'S PREFACE.

THE following lectures were given as a course of instruction to the senior students in electrical engineering at Union University.

They are however intended not merely as a text-book of illuminating engineering, nor as a text-book on the physics of light and radiation, but rather as an exposition, to some extent, from the engineering point of view, of that knowledge of light and radiation which every educated man should possess, the engineer as well as the physician or the user of light. For this purpose they are given in such form as to require no special knowledge of mathematics or of engineering, but mathematical formalism has been avoided and the phenomena have been described in plain language, with the exception of Lectures X and XI, which by their nature are somewhat mathematical, and are intended more particularly for the illuminating engineer, but which the general reader may safely omit or merely peruse the text.

The lectures have been revised to date before publication, and the important results of the work of the National Bureau of Standards, contained in its recent bulletins, fully utilized.

CHARLES PROTEUS STEINMETZ.

SCHENECTADY, *September*, 1909.

COMPILER'S PREFACE.

A SERIES of eight experimental lectures on "Light and Radiation" were delivered by Dr. Steinmetz in the winter of 1907-8 before the Brooklyn Polytechnic Institute. Unfortunately no stenographer was present and no manuscript prepared by the lecturer. A far more extended course of experimental lectures was however given by Dr. Steinmetz at Union University in the winter of 1908-9, on "Radiation, Light, Illumination and Illuminating Engineering," and has been compiled and edited in the following.

Two additional lectures have been added thereto by Dr. Steinmetz to make the treatment of the subject complete even from the theoretical side of illuminating engineering: Lecture X on "Light Flux and Distribution" and Lecture XI on "Light Intensity and Illumination." These two lectures give the elements of the mathematical theory of illuminating engineering.

With the exception of the latter two lectures the following book contains practically no mathematics, but discusses the subjects in plain and generally understood language.

The subject matter of Lecture XII on "Illumination and Illuminating Engineering" has been given in a paper before the Illuminating Engineering Society; the other lectures are new in their form and, as I believe, to a considerable extent also in their contents.

In describing the experiments, numerical and dimensional data on the apparatus have been given, and the illustrations drawn to scale, as far as possible, so as to make the repetition of the experiments convenient for the reader or lecturer.

Great thanks are due to the technical staff of the McGraw-Hill Book Company, which has spared no effort to produce the book in as perfect a manner as possible.

JOSEPH L. R. HAYDEN.

SCHENECTADY, *September*, 1909.

CONTENTS.

	PAGE
LECTURE I. NATURE AND DIFFERENT FORMS OF RADIATION.	
1. Radiation as energy.	1
2. Measurement of the velocity of light.	2
3. Nature of light.	4
4. Difference of wave length with differences of color. Measurement of wave length and of frequency. Iridescence. The ether.	6
5. Polarization proving light a transversal vibration. Double refraction.	7
6. The visible octave of radiation. Ultra-red and ultra-violet radiation.	9
7. The electric waves.	15
8. The spectrum of radiation covering 60 octaves.	16
LECTURE II. RELATION OF BODIES TO RADIATION.	
9. Electric waves of single frequency, light waves of mixed frequency.	20
10. Resolving mixed waves into spectrum. Refraction.	21
11. Relation of refractive index to permeability and dielectric constant.	24
12. Spectrum.	25
13. Continuous spectrum. Line spectrum. Band spectrum. Combination spectra.	26
14. Reflection, absorption and transmission.	29
15. Conversion of absorbed radiation into heat and light.	30
16. Transmitted light.	31
17. Opaque colors and transparent colors.	32
18. Objective color and subjective color.	33
19. Effect of excess and of deficiency of certain wave length of the illuminant on the opaque and the transparent colors.	34

LECTURE III. PHYSIOLOGICAL EFFECTS OF RADIATION.

Visibility.

- | | |
|---|----|
| 20. The eye. | 37 |
| 21. Dependence of sensitivity of the eye on the color. Mechanical equivalent of light. Comparison of intensities of different colors. | 40 |
| 22. Sensitivity curves of eye for different intensities. | 43 |
| 23. Change of shape of sensitivity curve with intensity. | 45 |
| 24. Harmful effect of excessive radiation power. | 48 |
| 25. Protective action of eye. | 50 |
| 26. Specific high frequency effect beginning in blue. | 51 |
| 27. Perception of ultra-violet light. Harmful effects of ultra-violet. | 52 |
| 28. Arcs as producers of ultra-violet rays. | 55 |

Pathological and Therapeutic Effects of Radiation.

- | | |
|--|----|
| 29. Power effect and specific high frequency effect. | 57 |
| 30. Light as germicide and disinfectant. | 59 |

LECTURE IV. CHEMICAL AND PHYSICAL EFFECTS OF RADIATION.

Chemical Effects.

- | | |
|---|----|
| 31. Indirect chemical action by energy of radiation. Direct chemical action. | 63 |
| 32. Chemical action of red and yellow rays in supplying the energy of plant life. Destructive action of high frequency on plant life. | 64 |

Physical Effects.

- | | |
|---------------------------------------|----|
| 33. Fluorescence and phosphorescence. | 66 |
|---------------------------------------|----|

LECTURE V. TEMPERATURE RADIATION.

- | | |
|--|----|
| 34. Production of radiation by heat. | 70 |
| 35. Increase of intensity and frequency with temperature. | 73 |
| 36. Efficiency and temperature. | 76 |
| 37. Carbon incandescent lamp. | 78 |
| 38. Evaporation below boiling point. Allotropic modifications of carbon. | 81 |
| 39. Normal temperature radiation. | 84 |
| 40. Colored body radiation. | 85 |
| 41. Measurement of temperatures by radiation. | 89 |
| 42. Colored radiation and heat luminescence. | 90 |

LECTURE VI. LUMINESCENCE.

Fluorescence and Phosphorescence.

- | | |
|---|----|
| 43. Radioluminescence. Electroluminescence. Thermoluminescence. Physical phosphorescence. Chemical phosphorescence. Biological phosphorescence. | 94 |
| 44. Pyroluminescence. Chemical luminescence. | 96 |
| 45. Electroluminescence of gases and vapors. | 98 |

Disruptive Conduction.

- | | |
|--|-----|
| 46. Geissler tube and spark. Disruptive voltage. | 101 |
| 47. Change from spark to Geissler glow. | 105 |

Continuous Conduction.

- | | |
|---|-----|
| 48. Nature of continuous or arc conduction. | 106 |
| 49. Distinction between arc and spark discharge. | 111 |
| 50. Continuity at negative. | 113 |
| 51. Rectification of alternating voltages by arcs. | 117 |
| 52. Efficiency and color. | 122 |
| 53. Most efficient light producer. | 123 |
| 54. Electro-conduction from negative, long life, non-consuming positive, limitation in the available materials. | 125 |
| 55. Arc most efficient method of light production. | 126 |

LECTURE VII. FLAMES AS ILLUMINANTS.

- | | |
|---|-----|
| 56. Hydrocarbon flames. | 128 |
| 57. Effect of rapidity of combustion and of flame shape on smokiness. | 130 |
| 58. Effect of oxygen atom in the hydrocarbon molecule on luminosity. | 132 |
| 59. Mixture of hydrocarbon with air. | 133 |
| 60. Chemical luminescence. | 134 |
| 61. Flames with separate radiator. | 135 |

LECTURE VIII. ARC LAMPS AND ARC LIGHTING.

Volt-Ampere Characteristics of the Arc.

- | | |
|-----------------------------------|-----|
| 62. Arc length and voltage. | 137 |
| 63. General equations of the arc. | 140 |

Stability Curves of the Arc.

- | | |
|--------------------------------------|-----|
| 64. Instability on constant voltage. | 142 |
| 65. Equations of the vapor arc. | 145 |

Arc Length and Efficiency.

- | | |
|--|-----|
| 66. Maximum efficiency length of carbon arc. | 146 |
| 67. Maximum efficiency length of luminous arc. | 148 |

LECTURE VIII. ARC LAMPS AND ARC LIGHTING (*Continued*).*Arc Lamps.*

68. The elements of the arc lamp.	151
69. Differential arc lamp.	153
70. Series arc lamp.	157
71. Luminous arc lamp.	160

Arc Circuits.

72. Constant potential and constant current. The mercury arc rectifier system. The arc machine.	160
73. The constant current transformer. The constant current reactance.	163

LECTURE IX. MEASUREMENT OF LIGHT AND RADIATION.

74. Measurement of radiation as power.	166
75. Light a physiological quantity.	167
76. Physiological feature involved in all photometric methods.	169
77. Zero method photometers.	170
78. Comparison of lights.	172
79. Flicker photometer.	173
80. The luminometer.	175
81. Primary standards of light.	177
82. Proposed primary standards.	178
83. Illumination and total flux of light. Incandescent lamp photometry.	179
84. Arc lamp photometry.	182
85. Discussion. Mean spherical, horizontal, downwards, maximum, hemispherical candle power.	184

LECTURE X. LIGHT FLUX AND DISTRIBUTION.

86. Light flux, light flux density, light intensity.	180
87. Symmetrical and approximately symmetrical distribution.	187
88. Calculation of light flux from meridian curve of symmetrical radiator.	188

Distribution Curves of Radiation.

89. Calculation of distribution curves. Point or sphere of uniform brilliancy.	190
90. Straight line or cylindrical radiator.	195
91. Circular line or cylinder.	197
92. Single loop filament incandescent lamp as illustration.	200

LECTURE X. LIGHT FLUX AND DISTRIBUTION (*Continued*).

PAGE

Shadows.

93. Circular shade opposite and symmetrical to circular radiator. 202
94. Calculation of the meridian curves of a circular radiator, for different sizes of a symmetrical circular shade, and for different distances of it. 206
95. Circular shade concentric with end of linear radiator. 210

Reflection.

96. Irregular reflection. 212
97. Regular reflection. 215
98. Reflector with regular and irregular reflection. 218

Diffraction, Diffusion and Refraction.

99. Purpose of reducing the brilliancy of the illuminant. 221
100. Effect of the shape of the diffusing globe on the distribution curve. 223
101. Prismatic refraction and reflection. 224

LECTURE XI. LIGHT INTENSITY AND ILLUMINATION.

Intensity Curves for Uniform Illumination.

102. Calculation of intensity distribution of illuminant for uniform total, horizontal and vertical illumination. 226
103. Uniform illumination of limited area. 229

Street Illumination by Arcs.

104. Discussion of problem. 234
105. Combined effect of successive lamps. 238

Room Illumination by Incandescent Lamps.

106. Distribution curve of lamp. Calculation of resultant total intensity of direct light. 242
107. Reflection from walls and ceiling. 246
108. Total directed and diffused illumination. 251

Horizontal Table Illumination by Incandescent Lamps.

109. Location of lamps. 253

LECTURE XII. ILLUMINATION AND ILLUMINATING ENGINEERING.

110. Physical and physiological considerations.	256
111. Light flux density. Illumination. Brilliancy.	259
112. Physical problems. Ceilings and walls. Reflectors, diffusing globes, diffracting shades, etc.	260
113. Objective illumination. Subjective illumination. Contraction of pupil. Intrinsic brilliancy. Direct and indirect lighting.	261
114. Fatigue.	263
115. Differences in intensity and in color. Control of color differences. Shadows and their control. Directed and diffused light.	265
116. Direction of shadows.	267
117. Color sensitivity in relation to required intensity of illumination.	269
118. Domestic lighting.	270
119. The twofold problem of domestic lighting: daylight and artificial light.	271
120. Street lighting.	272
121. Defects of present street lighting.	273
122. Tower lighting.	274

LECTURE XIII. — PHYSIOLOGICAL PROBLEMS OF ILLUMINATING ENGINEERING.

123. Physical side of illuminating engineering. Physiological problems.	277
124. Physiological difference between diffused and directed light.	278
125. Indefiniteness of diffused light. Shadows cast by diffused daylight. Equivalent diffusion near light source of large extent.	279
126. Equivalent diffusion by using several light sources.	281
127. Unequal diffusion in different directions. Complex shadows.	282
128. Physiological light distribution.	283
129. Physiologically, light not a vector quantity.	284
130. Resultant effect of several light sources.	287

RADIATION, LIGHT, AND ILLUMINATION.

LECTURE I.

NATURE AND DIFFERENT FORMS OF RADIATION.

1. Radiation is a form of energy, and, as such, can be produced from other forms of energy and converted into other forms of energy.

The most convenient form of energy for the production of radiation is heat energy, and radiation when destroyed by being intercepted by an opaque body, usually is converted into heat. Thus in an incandescent lamp, the heat energy produced by the electric current in the resistance of the filament, is converted into radiation. If I hold my hand near the lamp, the radiation intercepted by the hand is destroyed, that is, converted into heat, and is felt as such. On the way from the lamp to the hand, however, the energy is not heat but radiation, and a body which is transparent to the radiation may be interposed between the lamp and the hand and remains perfectly cold. The terms "heat radiation" and "radiant heat," which are occasionally used, therefore are wrong: the so-called radiant heat is not heat but radiation energy, and becomes heat only when, intercepted by an opaque body, it ceases to be radiation; the same, however, applies to any radiation. If we do not feel the radiation of a mercury lamp or that of the moon as heat, while we feel that of a coal fire, it is merely because the total energy of the latter is very much greater; a sufficiently sensitive heat-measuring instrument, as a bolometer, shows the heat produced by the interception of the rays of the mercury lamp or the rays of the moon.

The most conspicuous form of radiation is *light*, and, therefore, it was in connection with this form that the laws of radiation were first studied.

2. The first calculations of the velocity of light were made by astronomers in the middle of the eighteenth century, from the observations of the eclipses of the moons of Jupiter. A number of moons revolve around the planet Jupiter, some of them so close that seen from the earth they pass behind Jupiter and so are eclipsed at every revolution. As the orbits of Jupiter's moons were calculated from their observations by the law of gravitation, the time at which the moon M should disappear from sight,

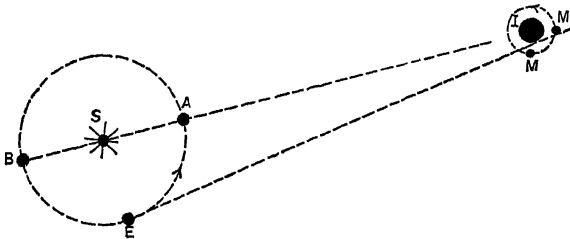

FIG. 1.

when seen from the earth E , by passing behind Jupiter, J (Fig. 1), could be exactly calculated. It was found, however, that sometimes the moon disappeared earlier, sometimes later than calculated, and the difference between earliest and latest disappearance amounts to about 17 min. It was also found that the disappearance of the moon behind Jupiter occurred earlier when the earth was at the same side of the sun as Jupiter, at A , while the latest disappearance occurred when the earth was on the opposite side of the sun from Jupiter, at B . Now, in the latter case, the earth is further distant from Jupiter by the diameter ASB of the orbit of the earth around the sun S , or by about 195,000,000 miles and the delay of $17\frac{1}{3}$ min. thus must be due to the time taken by the light to traverse the additional distance of 195,000,000 miles. Seventeen and one-third min. are 1040 sec. and 195,000,000 miles in 1040 sec. thus gives a velocity of light of $\frac{195,000,000}{1040}$, or 188,000 miles per sec.

Later, the velocity of light was measured directly in a number of different ways. For instance, let, in Fig. 2, D be a disk perforated with holes at its periphery. A lamp L sends its light through a hole H_0 in the disk to a mirror M located at a considerable distance, for instance 5 miles; there the light is reflected

and the mirror is adjusted so that the reflected beam of light passes through another hole H_1 of the disk into the telescope T . If the disk is turned half the pitch of the holes the light is blotted out as a tooth stands in front of both the lamp and the telescope. Again turning the disk half the pitch of the holes in the same

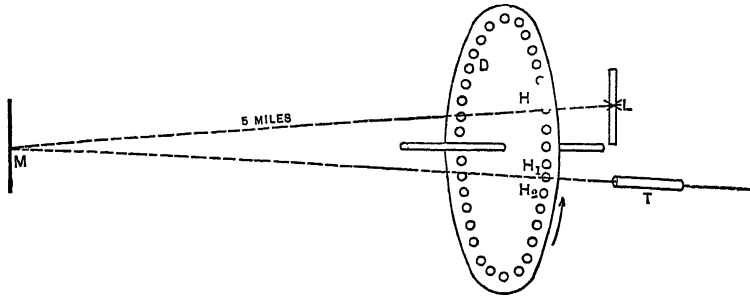

FIG. 2.

direction the light reappears. If the disk is slowly revolved, alternate light and darkness will be observed, but when the speed increases so that more than from 10 to 20 holes pass per second, the eye is no longer able to distinguish the individual flashes of light but sees a steady and uniform light; then increasing the speed still more the light grows fainter and finally entirely disappears. This means when a hole H_0 is in front of the lamp, a beam of light passes through the hole. During the time taken by the light to travel the 10 miles to the mirror and back, the disk has moved, and the hole H_1 , which was in front of the telescope when the light from the lamp passed through the hole H_0 , has moved away, and a tooth is now in front of the telescope and intercepts the light. Therefore, at the speed at which the light disappears, the time it takes the disk to move half the pitch of a hole is equal to the time it takes the light to travel 10 miles.

Increasing still further the velocity of the disk D , the light appears again, and increases in brilliancy, reaching a maximum at twice the speed at which it had disappeared. Then the light reflected from the mirror M again passes through the center of a hole into the telescope, but not through the same hole H_1 , through which it would have passed with the disk stationary, but through the next hole H_2 , that is, the disk has moved a distance equal to the pitch of one hole while the light traveled 10 miles. Assume, for instance, that the disk D has 200 holes and makes

94 rev. per sec. at the moment when the light has again reached full brilliancy. In this case, $200 \times 94 = 18,800$ holes pass the telescope per second, and the time of motion by the pitch of one hole is $\frac{1}{18,800}$ sec., and as this is the time required by the light

to travel 10 miles, this gives the velocity of light as $10 \div \frac{1}{18,800}$, or 188,000 miles per sec.

The velocity of light in air, or rather in empty space, thus is 188,000 miles or 3×10^{10} cm. per sec.

For electrical radiation, the velocity has been measured by Herz, and found to be the same as the velocity of light, and there is very good evidence that all radiations travel with the same velocity through space (except perhaps the rays of radioactive substances).

3. Regarding the nature of radiation, two theories have been proposed. Newton suggested that light rays consisted of extremely minute material particles thrown off by the light-giving bodies with enormous velocities, that is, a kind of bombardment. This theory has been revived in recent years to explain the radiations of radium, etc. Euler and others explained the light as a wave motion. Which of these explanations is correct can be experimentally decided in the following manner: Assuming light to be a bombardment of minute particles, if we combine two rays of light in the same path they must add to each other, that is, two equal beams of light together give a beam of twice the amplitude. If, however, we assume light is a wave motion, then two equal beams of light add to one of twice the amplitude only in case the waves are in phase, as A_1 and B_1 in Fig. 3 add to C_1 . If, however, the two beams A_2 and B_2 are not in phase, their resultant C_2 is less than their sum, and if the two beams A_3 and B_3 in Fig. 3 happen to be in opposition (180 degrees apart), that is, one-half wave length out of phase with each other, their resultant is zero, that is, they blot each other out.

Assuming now we take a plain glass plate A (Fig. 4) and a slightly curved plate B , touching each other at C , and illuminate them by a beam of uniform light — as the yellow light given by coloring the flame of a bunsen burner with some sodium salt — a part of the light b , is then reflected from the lower surface of

the curved glass plate *B*, a part *c*, passes out of it, and is reflected from the upper surface of the plain glass plate *A*. A beam of

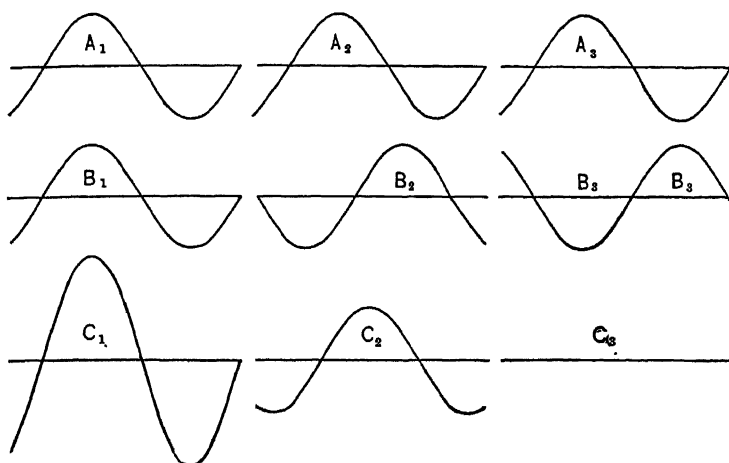

FIG. 3.

reflected light *a*, thus is a combination of a beam *b* and a beam *c*. The two beams of light which combine to a single one, *a*, differ from each other in phase by twice the distance between the two glass plates. At those points d_1, d_2 , etc. at which the distance

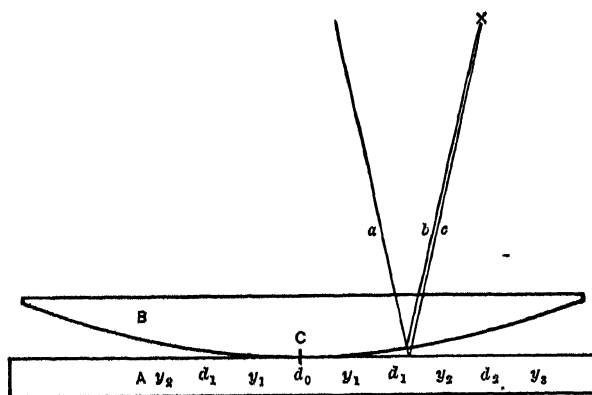

FIG. 4.

between the two glass plates is $\frac{1}{2}$ wave length, or $\frac{3}{4}, \frac{5}{4}$, etc., the two component beams of *a* would differ by $\frac{1}{2}, \frac{3}{2}, \frac{5}{2}$, etc. wave lengths, and thus would blot each other out, producing darkness,

while at those points where the distance between the glass plates is $\frac{1}{2}$, 1, $1\frac{1}{2}$, etc. wave lengths, and the two component beams α thus differ in phase by a full wave or a multiple thereof, they would add. If, therefore, light is a wave motion, such a structure would show the contact point C of the plates surrounded by alternate dark rings, d , and bright rings, y . This is actually the case, and therefore this phenomenon, called "interference" proves light to be a wave motion, and has led to the universal acceptance of the Eulerian theory.

Measuring the curvature of the plate B , and the diameter of the dark rings d , the distance between the plates B and A at the dark rings d , can be calculated and as this distance is one-quarter wave length, or an odd multiple thereof, the wave length can be determined therefrom.

The wave length of light can be measured with extremely high accuracy and has been proposed as the absolute standard of length, instead of the meter, which was intended to be 10^{-7} of the quadrant of the earth.

4. It is found, however, that the different colors of light have different wave lengths; red light has the greatest wave length, and then in the following order: red, orange, yellow, green, blue, indigo, violet, the wave length decreases, violet light having the shortest wave length.

If in experiment (Fig. 4) instead of uniform light (monochromatic light), ordinary white light is used, which is a mixture of all colors, the dark and bright rings of the different colors appear at different distances from each other, those of the violet nearest and those of the red the furthest apart, and so superimpose upon each other, and instead of alternately black and light rings, colored rings appear, so-called interference rings. Wherever a thin film of air or anything else of unequal thickness is interposed between two other materials, such interference colors thus appear. They show, for instance, between sheets of mica, etc. The colors of soap bubbles are thus produced.

The production of such colors by the interference of rays of light differing from each other by a fractional wave length is called *iridescence*.

Iridescent colors, for instance, are those of mother-of-pearl, of opal, of many butterflies, etc.

Light, therefore, is a wave motion.

The frequency of radiation follows from the velocity of light, and the wave length.

The average wave length of visible radiation, or light, is about $\lambda_w = 60$ microcentimeters,* that is, 60×10^{-6} cm. (or about $\frac{1}{16666}$ in.) and since the speed is $S = 3 \times 10^{10}$ cm. the frequency is $f = \frac{S}{\lambda_w} = 500 \times 10^{12}$, or 500 millions of millions of cycles per second, that is, inconceivably high compared with the frequencies with which we are familiar in alternating currents.

If, as proven, light is a wave motion, there must be some thing which is moving, a medium, and from the nature of the wave motion, its extremely high velocity, follow the properties of this medium: it has an extremely high elasticity and extremely low density, and it must penetrate all substances since no vacuum can be produced for this medium, because light passes through any vacuum. Hence it cannot be any known gas, but must be essentially different, and has been called the "ether."

Whether the ether is a form of matter or not depends upon the definition of matter. If matter is defined as the (hypothetical) carrier of energy (and all the information we have of matter is that it is the seat of energy), then the ether is matter, as it is a carrier of energy: the energy of radiation, during the time between the moment when the wave leaves the radiator and the moment when it strikes a body and is absorbed, resides in the ether.

5. If light is a wave motion or vibration, it may be a longitudinal vibration, or a transversal vibration. Either the particles of the medium which transmit the vibrations may move in the direction in which the wave travels, as is the case with sound waves in air. If in Fig. 5 sound waves travel from the bell *B* in the direction *BA*, the air molecules *m* vibrate in the same direction, *A* to *B*. Or the vibration may be transversal; that is, if the beam

* As measures of the wave length of light, a number of metric units have survived and are liable to lead to confusion:

The micron, denoted by μ , equal to one thousandth of a millimeter.

The $\mu\mu$, equal to one millionth of a millimeter.

The Angstrom unit, equal to one ten-millionth of a millimeter.

As seen, the basis of these units is the millimeter, which was temporarily used as a standard unit of length before the establishment of the present absolute system of units, the (C.G.S.), which is based on centimeter length, gram mass, and second time measure.

A radiation of the wave length of 60 microcentimeters thus can be expressed also as: 6000 Angstrom units, or 0.6μ , or $600 \mu\mu$.

of light moves in Fig. 6 perpendicularly to the plane of the paper, the vibrating particles move in any one of the directions oa , ob , etc. in the plane of the paper, and thus perpendicular to the ray

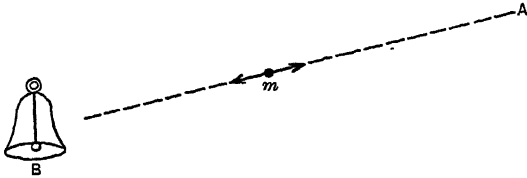

FIG. 5.

of light. In the former case (a longitudinal vibration, as sound) there obviously can be no difference between the directions at right angles to the motion of the wave. In a transversal vibration, however, the particles may move either irregularly in any of the infinite number of directions at right angles to the ray (Fig. 6) and thus no difference exists in the different directions perpendicular to the beam, or they may vibrate in one direction only, as the direction boa (Fig. 7). In the latter case, the wave is called "polarized" and has different characteristics in three directions at right angles to each other: one direction is the direction of propagation, or of wave travel; the second is the direction of vibration; and the third is the direction perpendicular to progression and to vibration. For instance, the electric field of a conductor carrying alternating current is a polarized wave: the direction parallel to the conductor is the direction of energy flow; the direction concentric to the conductor is the direction of the electromagnetic component, and the direction radial to the conductor is the direction of the electrostatic component of the electric field.

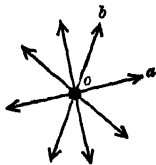

FIG. 6.

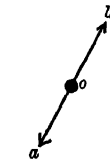

FIG. 7.

Therefore, if light rays can be polarized, that is, made to exhibit different properties in two directions at right angles to each other and to the direction of wave travel, this would prove the light wave to be a transversal vibration. This is actually the case. For instance, if a beam of light is reflected a number of times under a fairly sharp angle, as shown in Fig. 8, this beam becomes polarized; that is, for instance, the reflection from the mirror m_0 , set like the mirrors m_1 , m_2 . . . which produced the polarization,

is greater, and the absorption less than from a mirror set at right angles thereto, as m_0' .

Some crystals, as Iceland spar (calcium carbonate), show "double refraction," that is, dissolve a beam of light, a , entering them, into two separate beams, b and c (Fig. 9) which are polarized at right angles to each other.

In a second crystal, K_2 , beam b would then enter as a single beam, under the same angle as in the first crystal K_1 , if K_2 were in the same position as K_1 ; while if K_2 were turned at right angles to K_1 , beam b would enter K_2 under the same angle as beam c in crystal K_1 .

6. As seen, light and radiation in general are transversal wave

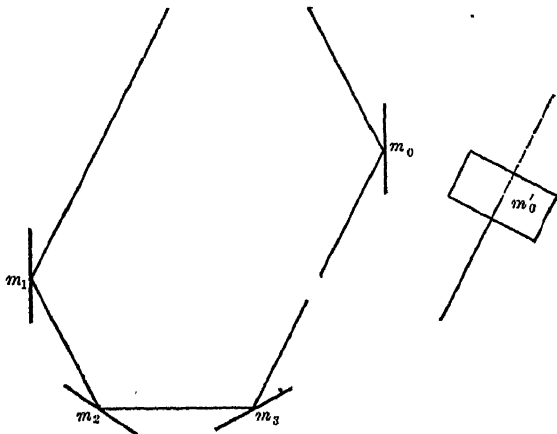

FIG. 8.

motions of very high speed, $S = 3 \times 10^{10}$ cm. per sec. in a hypothetical medium, ether, which must be assumed to fill all space and penetrate all substances.

Radiation is visible, as light, in a narrow range of frequencies only: between 400×10^{12} and 770×10^{12} cycles per sec. corresponding to wave lengths from 76×10^{-6} cm. to 39×10^{-6} cm.* All other radiations are invisible and thus have to be observed by other means.

I have here a pair of rods of cast silicon (10 in. long, 0.22 in. in diameter, having a resistance of about 10 ohms each), connected

* The visibility of radiation is greatest between the wave lengths 50×10^{-6} to 60×10^{-6} and good between the wave lengths 41×10^{-6} to 76×10^{-6} , but extends more or less indistinctly over the range of wave lengths from 33×10^{-6} to 77×10^{-6} and faintly even as far as 30×10^{-6} to 100×10^{-6} .

in series with each other and with a rheostat of about 40 ohms resistance in a 120-volt circuit. When I establish a current through the rods, electric energy is converted into heat by the resistance of the rods. This heat energy is converted into and sent out as radiation, with the exception of the part carried off by heat conduction and convection. Reducing the resistance, I increase the heat, and thereby the radiation from the silicon rods. Still nothing is visible even in the dark; these radiations are of too low frequency, or great wave length, to be visible. By holding my hand near the rods, I can feel the energy as heat, and show it to you by bringing the rods near to this Crookes' radiometer,

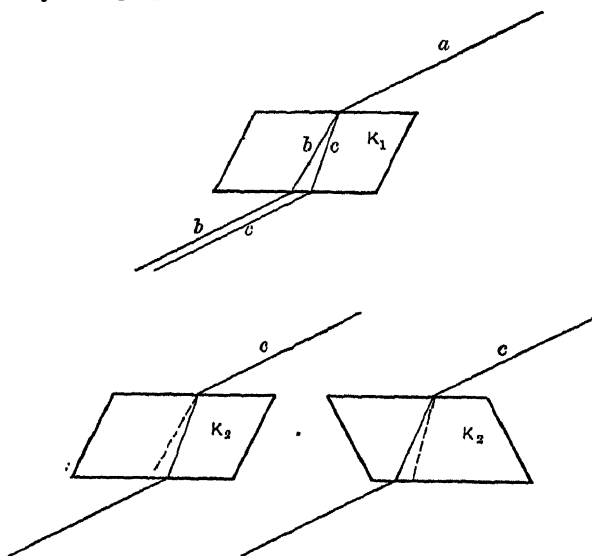

FIG. 9.

which is an instrument showing the energy of radiation. It consists (Fig. 10) of four aluminum vanes, mounted in a moderately high vacuum so that they can move very easily. One side of each vane is polished, the other blackened. The waves of radiation are reflected on the polished side of the vane; on the blackened side they are absorbed, produce heat, thus raise the temperature of the air near the vane; the air expands and pushes the vanes ahead, that is, rotates the wheel. As you see, when I bring the heated rods near the radiometer, the wheel spins around at a rapid rate by the radiation from the rods, which to the eye are invisible.

Increasing still further the energy input into the silicon rods, and thereby their temperature, the intensity of radiation increases, but at the same time radiations of higher and higher frequencies appear, and ultimately the rods become visible in the dark, giving a dark red light; that is, of all the radiations sent out by the rods, a small part is of sufficiently high frequency to be visible.

Still further increasing the temperature, the total radiation increases, but the waves of high frequency increase more rapidly than those of lower frequency; that is, the average frequency of radiation increases or the average wave length decreases and higher and higher frequencies appear,—orange rays, yellow, green, blue, violet, and the color of the light thus gradually changes to bright red, orange, yellow. Now I change over from the silicon rods—which are near the maximum temperature they can stand—to a tungsten lamp (a 40-watt 110-volt lamp, connected in series with a rheostat of 2000 ohms resistance in a 240-volt circuit). For comparison I also turn on an ordinary 16 c. p. carbon filament incandescent lamp, running at normal voltage and giving its usual yellow light. Gradually turning out the resistance, the light of the tungsten lamp changes from orange to yellow, yellowish white

and ultimately, with all the resistance cut out and the filament running at more than double voltage, is practically white; that is, gives a radiation containing all the frequencies of visible light in nearly the same proportion as exist in sunlight. If we should go still further and very greatly increase the temperature, because of the more rapid increase of the higher frequencies (violet, blue, green) than the lower frequencies of light (red, orange and yellow) with increase in temperature, the light

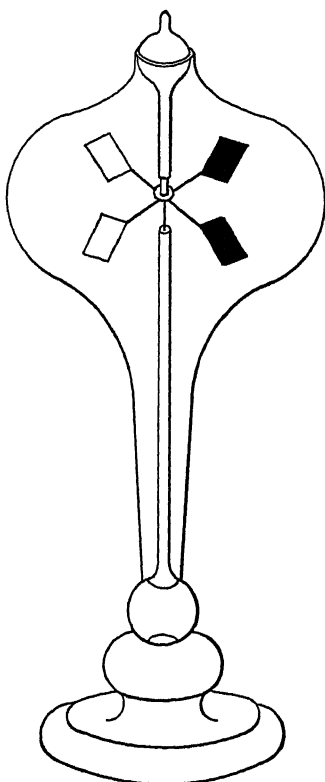

FIG. 10.

should become bluish. However, we are close to the limit of temperature which even tungsten can stand, and to show you light of high frequency or short wave length I use a different apparatus in which a more direct conversion of electric energy into radiation takes place,—the mercury arc lamp. Here the light is bluish green, containing only the highest frequencies of visible radiation, violet, blue and green, but practically none of the lower frequencies of visible radiation, red or orange.

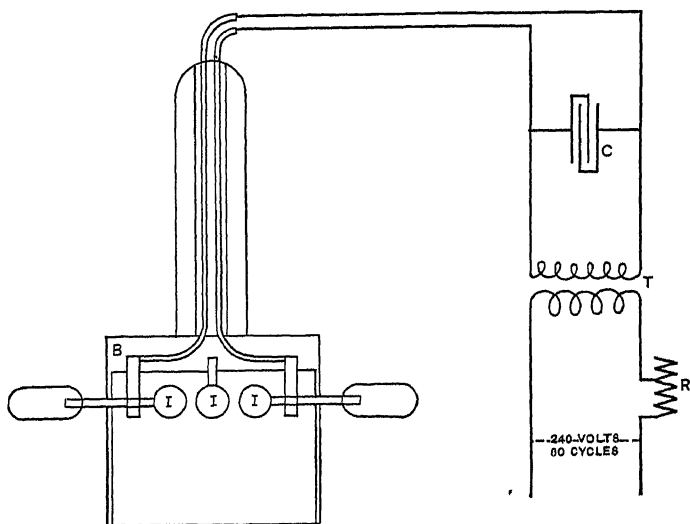

FIG. 11.

In the tungsten lamp at high brilliancy and more still in the mercury arc, radiations of higher frequencies appear, that is, shorter wave lengths than visible light, and these radiations are again invisible. As they are of frequencies beyond the violet rays of light, they are called "ultra-violet rays," while the radiations which we produced from the heated silicon rods at moderate temperatures were invisible because of too low frequency and are thus called "ultra-red rays," or "infra-red rays," as they are outside of and below the red end of the range of visible radiation.

To produce powerful ultra-violet rays, I use a condenser discharge between iron terminals, a so-called ultra-violet arc lamp. Three iron spheres, *I* in Fig. 11, of about $\frac{3}{8}$ in. diameter, are mounted on an insulator *B*. The middle sphere is fixed, the

outer ones adjustable and set for about $\frac{3}{16}$ in. gap. This lamp is connected across a high voltage 0.2-mf. mica condenser *C*, which is connected to the high voltage terminal of a small step-up transformer *T* giving about 15,000 volts (200 watts, $110 \div 13,200$ volts). The low tension side of the transformer is connected to the 240-volt 60-cycle circuit through a rheostat *R* to limit the current. The transformer charges the condenser, and when the voltage of the condenser has risen sufficiently high it discharges through the spark gaps *I* by an oscillation of high frequency (about 500,000 cycles), then charges again from the transformer, discharges through the gap, etc. As several such condenser discharges occur during each half wave of alternating supply voltage the light given by the discharge appears continuous.

You see, however, that this iron arc gives apparently very little light; most of the radiation is ultra-violet, that is, invisible to the eye. To make it visible, we use what may be called a frequency converter of radiation. I have here a lump of willemite (native zinc silicate), a dull greenish gray looking stone. I put it under the iron arc and it flashes up in a bright green glare by converting the higher frequency of ultra-violet rays into the lower frequency of green light. This green light is not given by the iron arc, as a piece of white paper held under the arc shows only the faint illumination given by the small amount of visible radiation. I now move a thin sheet of glass, or of mica, between the iron arc and the lump of willemite, and you see the green light disappear as far as the glass casts a shadow. Thus glass or mica, while transparent to visible light, is opaque for the ultra-violet light of the iron arc. A thick piece of crystallized gypsum (selenite) put in the path of the ultra-violet light does not stop it, hence is transparent, as the lump of willemite continues to show the green light, or a piece of cast glass its blue light.

I have here some pieces of willemite in a glass test tube. They appear dull and colorless in the ultra-violet light, as the glass is opaque for this light. I shift them over into a test tube of fused quartz, and you see them shine in the green glare. Quartz is transparent to ultra-violet light. When investigating ultra-violet light, quartz lenses and prisms must, therefore, be used.

Still higher frequencies of ultra-violet light than those given by a condenser discharge between iron terminals are produced by a low temperature mercury arc. Obviously this arc must not be

operated in a glass tube but in a quartz tube, as glass is opaque for these rays.

These ultra-violet radiations carry us up to frequencies of about 3000×10^{12} cycles per sec., or to wave lengths of about 10×10^{-6} cm. Then, however, follows a wide gap, between the highest frequencies of ultra-violet radiation and the frequencies of X-rays. In this gap, radiations of very interesting properties may sometimes be found.

At the extreme end of the scale we find the X-rays and the radiations of radio-active substances — if indeed these radiations are wave motions, which has been questioned. Since at these extremely high frequencies reflection and refraction cease, but irregular dispersion occurs, the usual methods of measuring wave lengths and frequencies fail. The X-rays apparently cover quite a range of frequency and by using the atoms of a crystal as diffraction grating, their average wave length has been measured as 0.1×10^{-6} cm., giving a frequency of 0.3×10^{18} cycles per sec.

In comparing vibrations of greatly differing frequencies, the most convenient measure is the *octave*, that is, the frequency scale of acoustics. One octave represents a doubling of the frequency; n octaves higher then means a frequency 2^n times as high, n octaves lower, a frequency $(\frac{1}{2})^n$ as high. By this scale all the intervals are of the same character; one octave means the same relative increase, which ever may be the absolute frequency or wave length.

As the perceptions of our senses vary in proportion to the percentual change of the physical quantity causing the perception (Fechner's law), in the acoustic or logarithmic scale the steps are thus proportional to the change of sensual perception caused by them.

The visible radiation covers somewhat less than one octave; ultra-violet radiations have been observed beyond this for about two more octaves. Nine octaves higher is the estimated frequency of X-rays.

On the other side of the visible range, towards lower frequencies or longer waves, ultra-red rays, observations have been extended over more than eight octaves up to wave lengths as great as 0.03 cm. length, or frequencies of only 10^{12} cycles per sec. The ultra-red rays given by the heated silicon rods of our experiment do not extend to such low frequencies, but such very low frequencies

have been observed in the radiations of bodies of very low temperature, as liquid air, or in the moon's rays.

7. Very much longer waves, however, are the electric waves. They are used in wireless telegraphy, etc. I here connect (Fig. 12)

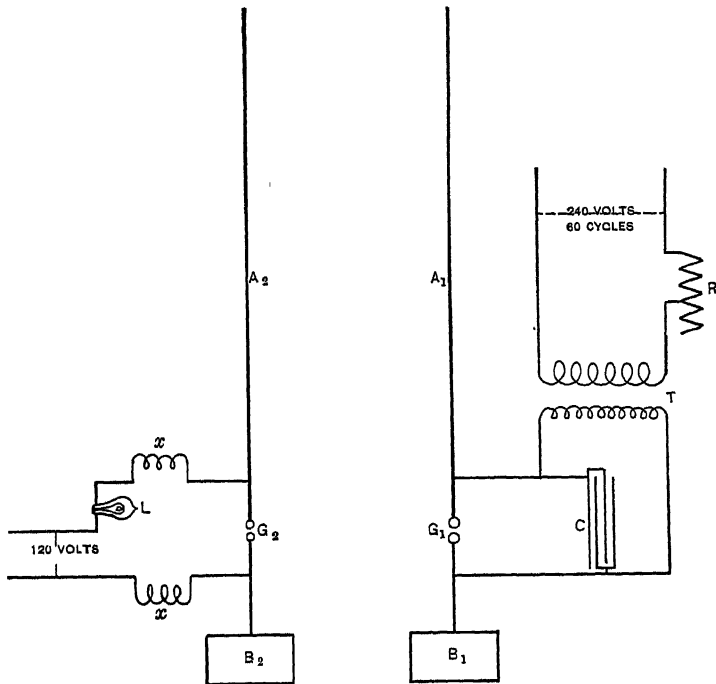

FIG. 12.

the condenser C of the apparatus which I used for operating the ultra-violet arc, to a spark gap G_1 , of which the one side is connected to ground B_1 , the other side to a vertical aluminum rod A_1 , about 8 feet long. The charge and discharge of the aluminum rod A_1 by the oscillating condenser current, send out an electric wave of about 50 feet length. This wave passes through you, and when striking the aluminum rod A_2 back of you, induces therein an electric charge. A_2 is separated from ground B_2 by a narrow spark gap G_2 , between graphite terminals, and the arrival of the electric wave at A_2 , causes a small spark to jump across the gap G_2 , which closes the circuit of the tungsten lamp L , thereby lighting it as long as the wave train continues.

The electric waves used in wireless telegraphy range in wave lengths from 100 feet or less to 10,000 feet or more, corresponding to 10^7 to 10^5 cycles per sec. or less.

Still very much longer waves are the fields of alternating current circuits: the magnetic and electrostatic field of an alternating current progresses as a wave of radiation from the conductor. But as the wave length is very great, due to the low frequency, — a 60-cycle alternating current gives a wave length of $\frac{3 \times 10^{10}}{60} = 500 \times 10^6$ cm. or 3100 miles — the distance to which the field of the circuit extends is an insignificant fraction only of the wave length, and the wave propagation of the field thus is usually not considered.

Electric waves of higher frequencies than used in wireless telegraphy are the Herzian waves, produced by electric oscillators, that is, a moderately long straight conductor cut in the middle by a gap and terminated by spherical condensers, as shown in Fig. 13. On these waves the velocity of propagation

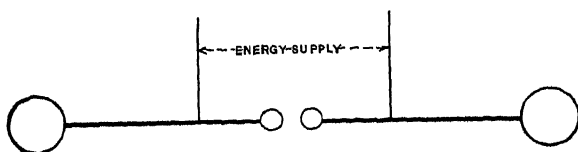

FIG. 13.

has been measured by Herz by producing standing waves by combination of main wave and reflected wave.

Still much higher frequencies are the oscillations between the cylinders of multi-gap lightning arresters, and the limit of frequency of electric waves would probably be given by the oscillating discharge of two small spheres against each other when separated by a narrow gap. It probably is at about 5×10^{10} cycles, or 0.6 cm. wave length.

The blank space between the shortest electric wave and the longest ultra-red light wave thus has become fairly narrow — from 0.6 to 0.03 cm., or only about four octaves.

8. In the following tables, the different known forms of radiation are arranged by their frequency and wave length, and are given also in octaves, choosing as zero point the middle *c* of the piano, or a frequency of 128 cycles per sec.

SPECTRUM OF RADIATION.

Zero point chosen at $c = 128$ cycles per second.
 Speed of radiation $S = 3 \times 10^{10}$ cm.

	Cycles.	Wave Length in Air (or Vacuum).	Octave:	No. of Octaves.
Alternating current field :	15	20,000 km. = 12,500 mi.	-3.09	} 3.15
	25	12,000 km. = 7,500 mi.	-2.36	
	60	5,000 km. = 3,100 mi.	-1.09	
	133	2,250 km. = 1,400 mi.	+0.06	
High frequency currents, surges and oscillations, arcing grounds, lightning phenomena, etc.			(9.57)	} 31.64
Wireless telegraph waves :	10^5	3 km. = 10,000 ft.	9.63	
	10^7	30 m. = 100 ft.	16.25	} 6.62
Herzian waves:	10^7	30 m. = 100 ft.	16.25	
	10^9	30 cm. = 1 ft.	22.90	} 12.3
Limit of electric waves:	5×10^{10}	0.6 cm. = 0.25 in.	28.55	
First gap :			[4.25]	
Ultra-red rays :	10^{12}	$30,000 \times 10^{-6} = 0.03$ cm.	32.80	} 8.68
	4×10^{14}	76×10^{-6} cm.	41.48	
Visible light rays :	4×10^{14}	76×10^{-6} cm.	41.48	} 0.97
	7.7×10^{14}	39×10^{-6} cm.	42.45	
Ultra-violet rays :	7.7×10^{14}	39×10^{-6} cm.	42.45	} 1.95
	30×10^{14}	10×10^{-6} cm.	44.40	
Second gap:			[7.0]	
X-rays (estimated) :	0.3×10^{18}	0.1×10^{-3} cm.	51.4	
Sound Waves :		Total :	57.7 octaves	
Lowest audible sound :	15	66 ft. in air	-3.1	
Highest audible sound :	16000	.75 in. in air	+7.0	
		Total :	10.1 octaves	

These radiations are plotted graphically in Fig. 14, with the octave as abscissæ.

As seen, the total range of frequencies of radiation is enormous, covering nearly 60 octaves, while the range of sound waves is only about nine octaves, from 15 to 8000 cycles.

There are two blank spaces in the range of radiation, one between electric and light waves, and a second and longer one between light and X-rays.

It is interesting to note that the range of electric waves is far greater than that of light waves.

Only a very narrow range of radiation, less than one octave out of a total of 60, is visible. It is shown shaded in Fig. 14. This

exhibits the great difficulty of the problem of efficient light production: it means producing as large a part of the total radiation as possible within this very narrow range of visibility.

Regarding the range of frequencies covered by it, the eye thus is much less sensitive than the ear, which hears over ten octaves as sound waves.

While the visible radiations are the most important ones, as light, the total range of radiation is of interest to the electrical engineer.

The ultra-red rays are those radiations which we try to avoid as far as possible when producing light, as they consume power

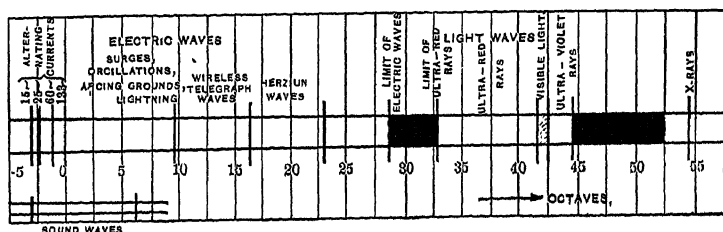

FIG. 14.

and so lower the efficiency; the ultra-violet rays are of importance in medicine as germ killers. They are more or less destructive to life, appear together with the visible radiation, and where they are of appreciable amount, as in the arc, protection against them becomes desirable. The X-rays have become of importance in medicine, etc., as they penetrate otherwise opaque bodies and thus allow seeing things inside of other bodies.

The total range of electric waves, between the frequencies of alternating currents and the limits of electric waves, has been of importance to the electrical engineer as harmful and destructive phenomena in electric circuits, which are to be guarded against, and only in recent years, with the development of wireless telegraphy, some such electric waves have found a useful commercial application. The main object of their study — which is the study of transient electric phenomena, is still, however, to guard against their appearance in electric circuits and discharge them harmlessly when they appear.

Considering the great difference which already exists between alternating currents of low frequency, 25 or 15 cycles, and of high

frequency, 133 cycles, and realizing that the total range of waves, which may appear in electric circuits, is many hundred times greater than the difference between high and low frequency alternating currents, it can be realized that the differences in the character of electric waves are enormous between the low frequency surges of near machine frequency and the high frequency oscillations of a multi-gap lightning arrester, near the upper limits of electric wave frequencies, and the problem of protecting circuits against them thus is vastly more difficult than appears at first sight and the conclusions drawn from experimental investigations of electric waves may be very misleading when applied to waves many octaves different from those used in the experiment. This explains the apparently contradictory evidence of many experimental investigations on the protection of electric circuits.

LECTURE II.

RELATION OF BODIES TO RADIATION.

9. For convenience, the total range of known radiations can be divided into two classes, the *electric waves* and the *light waves*, which are separated from each other by the blank space in the middle of the spectrum of radiation (Fig. 14). Under light waves we here include also the invisible ultra-red radiation and the ultra-violet radiation and the non-refrangible radiations, as X-rays, etc., separated from the latter by the second blank space of the radiation spectrum.

In the following, mainly the light waves, that is, the second or high frequency range of radiation, will be discussed. The electric waves are usually of importance only in their relation to the radiator or oscillator which produces them, or to the receiver on which they impinge, and thus are treated in connection with the radiator or receiver, that is, the electric conductor, in the theory of transient electric phenomena and oscillations.*

The radiation may be of a single frequency, that is, a single wave; or a mixture of different frequencies, that is, a mixture of different and frequently of an infinite number of waves.

Electric radiation usually is of a single frequency, that is, of the frequency or wave length determined by the constants of the electric circuit which produces the radiation, mainly the inductance L and the capacity C . They may, however, have different wave shapes, that is, comprise, in addition to the fundamental wave, higher harmonics or multiples thereof, just as the sound waves which represent the same tone with different musical instruments are of the same frequency but of different wave shapes, that is, contain different higher harmonics.

Light radiations usually are a mixture of a number of waves of different frequencies, and very commonly a mixture of an infinite number of frequencies, as is, for instance, the case with the

* "Theory and Calculation of Transient Electric Phenomena and Oscillations."

radiation of an incandescent body as a lamp filament, which contains all the frequencies from long ultra-red waves over visible light waves to ultra-violet waves.

In the action of vibrations on our senses there is a characteristic difference between the perception of sound waves by the ear and that of light waves by the eye: the ear is analytic, that is, can separate the individual waves in a mixture of different sound waves, as an accord on the piano, and distinguish the individual components of the mixed sound which reaches the ear. Thus we can hear and distinguish an individual voice amongst a mass of other noises. The eye, however, perceives only the resultant of all the visible radiations which reach it, but cannot separate their components, and very different mixtures of radiations thus make the same impression upon the eye: thus, for instance, numerous mixtures of blue and yellow light appear alike to the eye and the same as green light, that is, appear green, while physically, it is obvious that mixtures of blue and yellow light are essentially different from green light.

It is interesting to imagine how nature would look to us if the eye were analytic, that is, could separate the different component radiations, and if it could perceive waves over as great a range of frequency as the ear, about ten octaves instead of less than one octave as is now the case. The information given to us by the sense of sight would be infinitely increased, and we would see many differences and changes which now escape us.

10. However, while the eye cannot distinguish the different component radiations but sees only their resultant, the specific effects of the component radiations, as the physiologically harmful action of an ultra-violet component of light, still remain, even if the eye does not see the components, and in the study of radiation for the purpose of its engineering use for illumination it is therefore necessary to analyze the mixed radiation given by a source as a lamp, by resolving it into its component waves.

This is done by using some feature of the radiation which varies with the frequency. Such is the case with the velocity of propagation.

The velocity of light in empty space is 3×10^{10} cm. per sec. It is practically the same in air and other gases. In denser bodies, however, as water, glass, etc., the velocity of light is less and, as will be seen, is different for different frequencies.

Assume then, in Fig. 15, a beam of light B striking under an angle the boundary between two media, as air A and water W , the vibration of the ether particles in the beam of light is at right angles to the direction of propagation BC , and successively the waves thus reach $a_1 b_1, a_2 b_2 \dots$. As soon, however, as the back edge of the beam reaches the boundary at D its speed changes

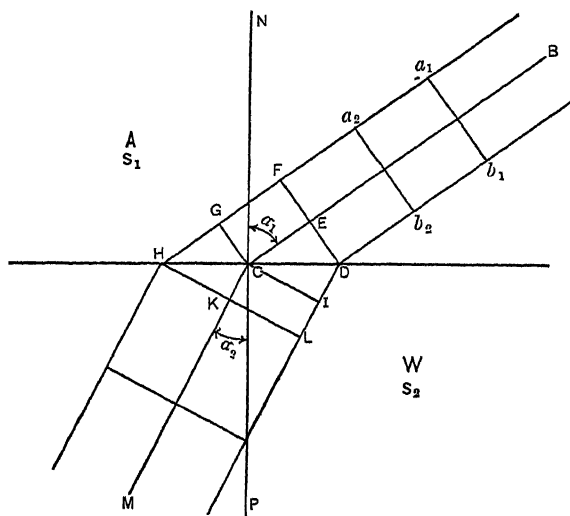

FIG. 15.

by entering the medium W — decreases in the present instance. Let then S_1 = speed of propagation in medium A , S_2 = speed of propagation in medium W . Then, while the center of the beam moves the distance EC , the back edge, in the denser medium, moves only the distance $DI = \frac{S_2}{S_1} EC$, and the wave front of the back half of the beam thus changes to CI while that of the front half of the beam, which is still in the medium A , remains GC . Then, while the front edge of the beam moves from G to H , the center and the whole back half of the beam moves in the denser medium W , only the distance $CK = \frac{S_2}{S_1} GH$, and the wave front of the beam, in the medium W , now is HL . That is, due to the difference in velocity in the two media A and W , the wave front of the beam, and thereby its direction of propagation, is changed

when traversing the boundary between the two media, and the beam BC continues its motion in the direction CM .

Let then $\alpha_1 =$ angle of incidence, that is, the angle between the incident beam BC and the perpendicular CN on the boundary, and $\alpha_2 =$ angle of refraction, that is, the angle between the outgoing or refracted beam CM and the perpendicular CP on the boundary. It is then:

$$FDH = \alpha_1 \text{ and } LHD = \alpha_2 ;$$

hence,

$$FH = DH \sin \alpha_1 \text{ and } DL = DH \sin \alpha_2. \quad (1)$$

The front edge of the beam moves the distance FH in medium A , while the back edge moves the distance DL in medium W ; that is,

$$FH \div DL = S_1 \div S_2; \quad (2)$$

hence, substituting (1) into (2), gives:

$$\frac{\sin \alpha_1}{\sin \alpha_2} = \frac{S_1}{S_2}; \quad (3)$$

That is, the ratio of the sines of the angle of incidence and the angle of refraction equals the ratio of the speed of propagation in the two media, hence the ratio of the sines of these two angles is constant. This is the *law of refraction*, and this ratio of sines is called the *refractive index* between the two media A and W . As the *refractive index of one medium W* , then, is understood its refractive index against empty space or against air:

$$\delta_1 = \frac{\sin \alpha}{\sin \alpha_1} = \frac{S}{S_1}, \quad (4)$$

where S is the velocity of light in empty space $= 3 \times 10^{10}$, and S_1 the velocity in the medium, of which δ_1 is called the refractive index.

From equation (4) it follows, that, if δ_{1-2} is the refractive index between medium 1 and medium 2, δ_{2-3} , the refractive index between medium 2 and medium 3, $\delta_{1-3} = \delta_{2-3} \div \delta_{1-2} =$ refractive index of medium 1 and medium 3; that is, the refractive index between any two media is derived as the ratio of their refractive indices against a third medium, as, for instance, against air.

11. Incidentally, it is interesting to consider the corresponding relations in electric waves.

In an electric circuit, the speed of propagation of an electric wave is, when neglecting the energy losses in and by the conductor:

$$S = \frac{1}{\sqrt{LC}}, \quad (5)$$

where L is the inductance, C the capacity of the conductor per unit length (the length measured in the same measure as the speed S).

The inductance L is proportional to the permeability μ , and the capacity C proportional to the dielectric constant, or specific capacity κ of the medium surrounding the conductor, that is, the medium through which the electric wave propagates; that is,

$$S = \frac{1}{A \sqrt{\mu\kappa}}, \quad (6)$$

where A is a proportionality constant.

The ratio of the speed of propagation of an electric wave in two media 1 and 2 thus is:

$$\frac{S_1}{S_2} = \sqrt{\frac{\mu_2 \kappa_2}{\mu_1 \kappa_1}}; \quad (7)$$

for empty space, $\mu = 1$ and $\kappa = 1$;

hence,

$$\frac{S}{S_1} = \sqrt{\mu_1 \kappa_1}, \quad (8)$$

where S_1 is the speed of propagation in the medium of constants μ_1 and κ_1 .

Comparing equation (8) with (4) it follows:

$$\mu_1 \kappa_1 = \delta_1^2; \quad (9)$$

that is, the square of the refractive index δ equals the product of permeability μ and dielectric constant κ .

Since for most media the permeability $\mu = 1$, for all except the magnetic materials

$$\kappa = \delta_1^2. \quad (10)$$

This relation between the constant of the electric circuit κ and the constant of optics δ was one of the first evidences of the identity of the medium in which the electric field exists with the medium which carries the light waves. It is, however, only approximately correct, as the refractive index δ varies with the frequency and is derived for the extremely high frequencies of light radiation, while κ refers to stationary conditions. A better agreement is thus reached when using as δ the refractive index extrapolated for infinite wave lengths.

12. It is found that the different component frequencies of a beam of radiation are deflected differently when passing from one medium into another, and the higher frequencies are deflected

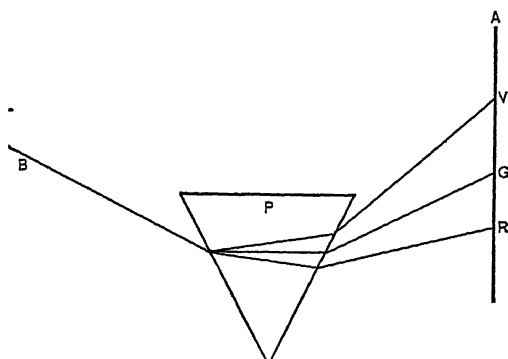

FIG. 16.

more than the lower frequencies, thus showing that the velocity of propagation decreases with an increase of frequency, that is, a decrease of wave length.

This gives a means of resolving a mixed radiation into its component waves, that is, into a *spectrum*, by refraction.

A narrow beam of light *B* (Fig. 16) is passed through a prism *P* of transparent material, and the component frequencies then appear on the screen *A* (or are seen by the eye) side by side, the red *R* below, the violet *V* above, in Fig. 16, and the green *G* in the middle.

It is obvious that the material of the prism must be transparent to the radiation; thus, when studying ultra-violet radiation, to which glass is opaque, glass prisms cannot be used, but some material transparent to ultra-violet light such as a quartz or fluorite prism must be used.

The beam of light also can be resolved into its components by a diffraction grating, in which case the lower frequencies are deflected more than the higher frequencies; that is, the red more than the violet.

These two forms, the refracting spectroscop and the diffracting spectroscop, now enable us to resolve a beam of mixed radiation into its components and thus study its spectrum.

13. I show you here a number of typical spectra:

(1). The spectra of an incandescent lamp and an alcohol lamp with Welsbach mantel. These are *continuous spectra*, that is, show all the radiations from red over orange, yellow, green, blue, indigo to violet, uniformly shading into each other.

(2a). The spectrum of the mercury lamp. This is a *line spectrum*, that is, shows only a finite number of bright lines on black background. It contains five bright lines; greenish yellow, bright green, indigo and two violet, one faint dark green line, and

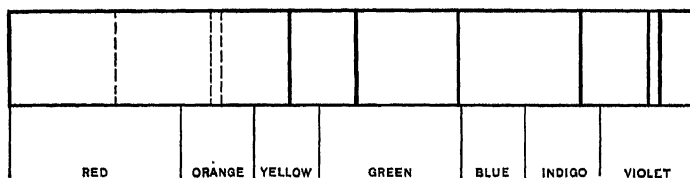

FIG. 17.

a number of very faint red and orange lines, of which three are indicated dotted in Fig. 17.

(2b). The spectrum of an arc between titanium carbide electrodes. This also is a line spectrum, but unlike the mercury spectrum, which has only six bright lines, the titanium spectrum contains many thousands of bright lines, so that with the low power of the spectroscop which you have, the lines blurr into each other and we see only the most prominent or brightest lines on a uniformly luminous background, which latter requires a more powerful spectroscop to resolve into lines.

(3). The *band spectrum*. This shows a number of bright bands, frequently gradually fading out at their edge and separated by dark spaces. It thus differs from the continuous spectrum (1) in being discontinuous, that is, missing certain ranges of frequency, and differs from the line spectrum (2) in that the band spectrum has a number or range of frequencies in each band, where the line

spectrum has only one single frequency in each line. Such band spectra are usually characteristic of luminescent compounds or of gases and vapors at high pressure, while elementary gases or vapors give line spectra. Absorption and fluorescence also give band spectra, and I thus show you a band spectrum by operating a mercury lamp in a tube of uranium glass, behind a transparent screen colored by rhodamine (an aniline dye which fluoresces red). As you see, the spectrum shows a broad red band, due to the reddish screen, and a greenish yellow band due to the uranium glass, while the normal mercury lines are decreased in intensity.

(4). If you now look with the spectroscope at the Welsbach mantel through the mercury arc stream, you see the continuous spectrum of the mantel and superimposed upon it the line spectrum of the mercury lamp. The light giving mercury vapor thus is transparent for the light of the Welsbach mantel back of it, and lets it pass through, with the exception of those particular frequencies which it gives itself; that is, a luminous gas absorbs those frequencies of radiation which it produces, but is transparent for all other frequencies. This is easily understood: an atom on which a vibration impinges will be set in motion by it and thus absorb the energy of the impinging vibration if it is able to vibrate with the frequency of the impinging vibration; that is, to resonate with it, but will not be affected by any other frequency to which it cannot respond, and thus is transparent to all frequencies of vibration, except to those to which it can respond; that is, which it produces when vibrating.

When looking at a continuous spectrum through a luminous gas or vapor, two cases thus may occur: either the spectrum lines of the gas are brighter than the continuous spectrum, as in the present case, and then appear as bright lines on a bright background, or the continuous spectrum is brighter than the lines of the gas spectrum in front of it and the lines of the gas spectrum appear less bright than the background, that is, appear as dark lines on a bright background. Such a spectrum is called a *reversed spectrum*, or *absorption spectrum*. It shows the lines of the gas or vapor spectrum, by contrast, dark on the brighter background of the continuous spectrum.

The sun and many fixed stars present such a reversed spectrum: the sun's spectrum shows the spectrum lines of all the elements

which are in the sun's atmosphere as dark lines on the continuous spectrum given by the inner core of the sun.

Whether the line spectrum of a gas or vapor is reversed by the continuous spectrum of a solid or liquid back of it or not depends upon the relative intensity, and thus, to some extent, on the relative temperature. Some fixed stars show bright lines on a less luminous background, due possibly to a higher temperature and greater thickness of their atmosphere, and sometimes bright lines and dark lines occur simultaneously, or dark lines may change to bright lines at such places at which, by some activity, as a temperature rise, their brilliancy is greatly increased.

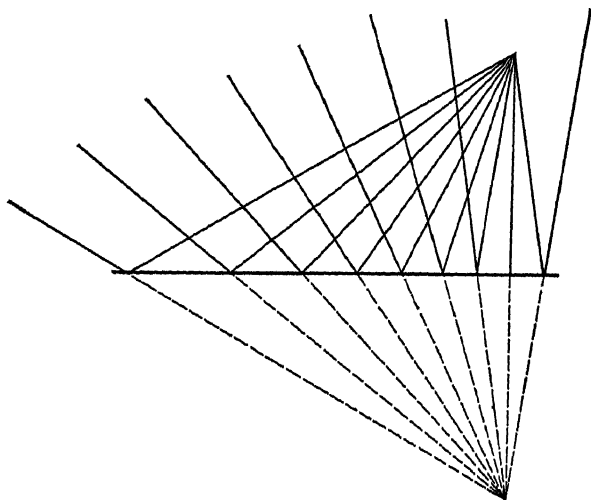

FIG. 18.

Combinations of the different types of spectra: continuous spectrum, line spectrum, band spectrum, reversed spectrum, frequently occur, as we have seen bands and lines together in the modified mercury spectrum, and in this case, by turning on an incandescent lamp, we can still add a continuous spectrum due to the light of the incandescent lamp reflected from the walls of the room. So also in the continuous spectrum of incandescent bodies, bright bands or dark bands occasionally appear, that is, regions in the spectrum of greater or lesser intensity, as will be discussed in the paragraphs on colored radiation and selective radiation.

14. When a beam of radiation impinges upon a body it is resolved into three parts: one part is reflected, that is, does not enter the body at all, but is thrown back. The second part is absorbed in the body, that is, converted into another form of energy (which other form of energy usually is heat, but may be chemical energy, some other frequency of radiation, etc.) and the third part is transmitted, that is, passes through the body, and out of it, if the body is not too thick. No body reflects, or absorbs, or transmits all the radiations, but even the most perfectly reflecting body absorbs and transmits some radiation, the most transparent body reflects and absorbs some radiation, etc.

Reflection may be either regular reflection, or irregular reflection. In the former case (Fig. 18) the beam of light is reflected under the same angle under which it impinges upon the body, and the body thus acts as a *mirror*, that is, gives a virtual image

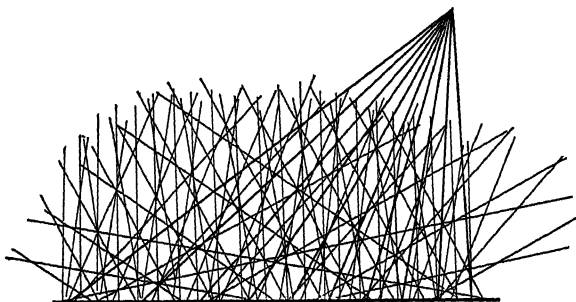

FIG. 19.

back of it as shown in dotted line in Fig. 18. In the latter case (Fig. 19) the light is reflected irregularly in all directions.

A body which reflects all the frequencies of radiation uniformly, that is, in which the percentage of the impinging radiation, which is reflected, is the same for all frequencies of radiation, is called a *colorless body*, and a body which reflects a higher percentage of the radiation of some frequency than of other frequencies, is called a *colored body*, and its *color* is the color of radiation, that is, the frequency or frequencies which it reflects more than other frequencies.

A colorless body which reflects all the radiation impinging upon it is called a *white body*. Most nearly white bodies are silver, magnesia, chalk, etc. A body which reflects none of the radiation impinging upon it, but absorbs all, is called a *black body*. The

most nearly black bodies are lampblack, charcoal, etc. A body which reflects a constant part of the impinging radiation, that is, the same part or percentage for all frequencies, is called a *grey body*, and the ratio of the reflected light to the total impinging light is called its whiteness or *albedo*. A perfectly white body thus has albedo 1, a perfectly black body albedo 0, and a body which reflects one-quarter and absorbs the other three-quarters of the radiation of any wave length impinging upon it, would be said to have albedo 0.25.

Black, white and grey thus are not considered as colors in physics.

As examples of colorless bodies I show you here:

Regular reflection: polished silver, white; polished iron, grey.

Irregular reflection: powdered magnesia, white; lampblack, black; powdered zinc, barium sulphide, grey.

As example of colored bodies I show you:

Regular reflection: polished copper, red; polished gold or brass, yellow.

Irregular reflection: mercury sulphide (cinnabar), red; potassium bichromate, orange; magnesium chromate, yellow; copper acetate-arsenite (paris green), green; copper oxide hydrate precipitated by ammonia, blue; ultra-marine, indigo; magnesium permanganate mixed with magnesia, violet.

15. Of the radiation which enters a body, that part which is absorbed is usually converted into heat. Thus a black body, when exposed to radiation, becomes hotter than a white body, which reflects, or a transparent body, which transmits, most of the radiation. Thus the globe of a colored incandescent lamp, which absorbs more of the radiation than a transparent globe, becomes hotter than a clear glass globe. When scattering dirt on the snow it can be made to melt down far more rapidly in the spring, under the rays of the sun, than when remaining clean, etc.

Some bodies convert the absorbed radiation into chemical energy, into other frequencies of radiation, etc.

Bodies which convert the absorbed radiation, or rather a part thereof, into radiation of different, as far as known always lower, frequencies, are called *fluorescent* bodies. Thus the solution of rhodamine in alcohol, which I show you here, fluoresces red. It transmits red light, but absorbs green, blue and violet light, and converts a part thereof into red light. This is best

illustrated by exhibiting it in a source of light which contains no red rays, as the mercury lamp. You see in the rays of the mercury lamp the rhodamine solution looks bright red, the red light seems to come from the inside of it, and especially through a red glass the solution looks like a red hot incandescent body. Here then, as no red light reaches the solution, the red light given by it must be produced by frequency conversion from other radiation. The spectroscope shows especially the bright green mercury line weakened.

The phenomena of conversion of absorbed light into other forms of energy will be more fully discussed in the following paragraphs.

16. By the transmitted light, that is, the radiation which passes through them, bodies are again divided into *colorless bodies*; that is, such bodies which transmit the same percentage of radiation for every wave length or frequency, and *colored bodies*; that is, bodies which transmit a larger percentage of radiation of some frequencies than of others, and as the *transparent color* of a body, then, is understood the color, that is, the frequency, of that radiation of which the greatest percentage is transmitted. Thus a red glass is one which transmits a higher percentage of red radiation than of any other radiation.

A body, then, is called *transparent*, if it transmits all the radiation, and *opaque*, if it transmits no radiation, but absorbs or reflects all. If only a part of the radiation is transmitted, but in such manner that it is the same part for all frequencies, the body is called *grey*; or *imperfectly transparent*, if the part which is not transmitted is absorbed in the body; and *translucent*, if the part which is not transmitted is irregularly reflected inside of the body.

The most perfectly transparent bodies, for visible light, are glass, water, quartz, etc.; the most opaque are the metals, and perfectly, or almost perfectly opaque are the magnetic metals, perhaps due to the very low speed of propagation in these metals, which would result from the high value of the permeability μ by equation (8) paragraph 11.

As example of colorless bodies I show you here a glass tube filled with water, transparent; a tube filled with nigrosine solution in alcohol, opaque and black; a very diluted solution of nigrosine with traces of other aniline dye for color correction, in

alcohol, as grey, and a tube filled with an emulsion of water with a solution of chloroform in white paraffin oil, which latter solution has the same specific gravity as water, translucent.

Samples of transparent colored bodies are: carmine solution, red; potassium bichromate solution, orange; potassium chromate solution, yellow; nickel sulphate solution, green; copper nitrate solution, blue; diluted potassium permanganate solution, or diluted solution of iodine in chloroform, violet.

As seen, the terms "colorless" and "colored" have two different meanings when applied to the reflected radiation and when applied to the transmitted radiation, and the color of a body in reflected light may be different, and frequently is different, from its color in transmitted light, and some bodies may be colorless in reflected light, but colored in transmitted light, and inversely. In materials of low absorption, the transmitted and the reflected colors must be approximately complementary; thus the transmitted color of the atmosphere is orange, the reflected color blue.

17. Colors are, therefore, distinguished into *opaque colors* and *transparent colors*. The *opaque colors* are those shown by the light reflected from the body, the *transparent colors* those shown by the light transmitted through the body. In reflected light, the transparent colors, therefore, show only when covering a white, that is reflecting, surface, and then, because the light reflected from the white background of the transparent coloring body traverses this body twice, before and after reflection, and, therefore, depend in their brilliancy on the background. The difference between opaque and transparent colors, the former reflecting from the surface, the latter reflecting from back of the colored substance, is seen by comparing the appearance of the two classes of colors shown in 14 and in 16.

In its general use, the terms colorless, white, black, transparent, opaque, refer only to the visible radiation, that is, to the frequencies within that octave which the eye perceives as light. More broadly, however, these terms may in physics be applied to the total range of radiation, and then many substances which are colorless for visible light, would be considered as strongly colored, that is, show for different frequencies great differences in the percentage of radiation which they reflect or transmit. Thus we have seen that glass, which is transparent for visible light, is

entirely opaque for some ultra-violet light and also opaque for ultra-red light of low frequency, so in this broader sense would have to be called *colored*; the color of clear glass, however, is that of the visible spectrum; or, for instance, iodine solution, which is opaque for visible light, is transparent for ultra-red light, that is, its color is ultra-red, etc.

In this broader sense, referring to the total range and not merely to the visible range, glass, water, mica, etc., are not colorless transparent but colored, and quartz is probably the most transparent and colorless body.

18. The color of the body, thus, is represented by that frequency or those frequencies of radiation of which a higher percentage are reflected or transmitted than of the other frequencies of radiation. This color, therefore, is a characteristic property of the body and independent of the character of the light and of its physiological effect on the eye, and can thus be called the *actual or objective color* of the body. If we consider diffused daylight as white, then the body appears to the eye in its objective or actual color when compared with a white body, that is, a body uniformly reflecting all radiation in the diffused daylight. Under other conditions, as, for instance, in artificial illumination, bodies do not always appear to the eye in their objective colors, but may show a very different color depending on the character of the source of light. For instance, I have here a plate of colored glass: looking through it at the mercury lamp you see the glass has an olive green color; but when I turn on an incandescent lamp you see that it is ordinary red glass. Its objective color is red, its subjective color in the mercury light is green. Looking through this glass in daylight it appears red as it transmits more red light than other colors of light, and the transmitted light thus contains a higher percentage of red rays than diffused daylight. The rays of the mercury lamp, however, contain very little red light and very much green light, and while by this red glass a much higher percentage of the red light from the mercury lamp is transmitted than of its green light, this higher percentage of transmitted red light is very much less than the lower percentage of the transmitted green light, and, therefore, in the transmitted light, green still preponderates more than in the diffused daylight, that is, the glass appears green. For instance, if in the

mercury lamp the ratio of red light to green light is only one hundredth of what it is in daylight, and the red glass transmits ten times as high a percentage of red as of green light, then in the light of the mercury lamp transmitted through this red glass the ratio of red light to green light is still only one-tenth of what it is in daylight, and the glass thus appears green.

We have to distinguish between the *actual* or *objective color* of a body, which is a constant of the body, and its *apparent* or *subjective color*, which depends upon the light in which we view the body, and therefore may be very different for different illuminants, and bodies which have the same colors in one illuminant may have entirely different colors in another illuminant and inversely. It is, however, the subjective color of the body corresponding to the particular illuminant used which we see, and which is, therefore, of importance in illuminating engineering, and the study of the subjective colors, therefore, is of foremost importance, and the success or failure of an illumination depends on the production of the desired subjective colors.

19. Broadly, an illuminant discriminates for the color in which it is deficient and the color in which it is rich. The color in which the illuminant is deficient — as red in the mercury lamp, blue and violet in the incandescent lamp — appears black; the color in which the illuminant is abnormally rich — as yellow in the incandescent lamp, green in the mercury lamp — appears as white; that is, both colors disappear, more or less; as colors, become colorless. Thus in the yellow incandescent lamp, opaque yellow appears the same as white, opaque blue and violet appear more or less as black; transparent yellow appears colorless, transparent blue and violet appear colorless and from light transparent grey to opaque black. In the green mercury lamp, opaque green and white appear the same, opaque red appears as black; transparent green appears colorless, and transparent red appears colorless, from clear transparent to grey, to opaque black, depending upon its intensity.

It is interesting to see the difference between opaque and transparent colors in this respect: as opaque colors the deficient color turns black, the excess color white; but as transparent colors both become colorless and more or less transparent. Thus, in the mercury lamp, red and green as transparent colors both vanish, or rather, very greatly decrease in their prominence.

As the eye perceives only the resultant of radiation, very different combinations of radiation may give the same impression to the eye, but when blotting out certain radiations, as red and green, in the mercury lamp, these different combinations of radiation may not give the same resultant any more, that is, become of different colors, and inversely, different colors, which differ only by such component radiations as are blotted out by an illuminant, become equal in this illuminant. For instance, a mixture of red and blue, as a diluted potassium permanganate solution, appears violet in daylight. In the mercury light it appears blue, as the red is blotted out, and in the light of the incandescent lamp it appears red, as the blue is blotted out.

I show you here, in the light of an incandescent lamp, two pieces of black velvet. I turn off the incandescent lamp and turn on the mercury lamp, and you see the one piece is blue, and the other black. Now I show you two pieces of brownish black cloth in the mercury light. Changing to the incandescent lamp you see that the one is a bright crimson, and the other still practically black. In both cases the color deficient in the illuminant appeared as black.

This tube of copper chloride crystals appears bright green in the incandescent lamp. In the mercury light it is a dirty white. The excess color, green, is blotted out.

These crystals of didymium nitrate, which are a light pink in daylight, are dark pink in the incandescent light. In the mercury light they are blue: the color is a mixture of red and blue, and the one is blotted out in the mercury light and the other in the incandescent light.

These two tubes, one containing a concentrated solution of manganese chloride, the other a solution of didymium nitrate, are both a dark pink in the incandescent light. In the mercury light the first becomes a faint pink, the second becomes grass green.

These tubes, one containing a solution of didymium nitrate, the other a diluted solution of nickel sulphate, appear both light green in the mercury light. In the incandescent lamp the former is dark pink, the latter dark green. [Didymium, which formerly was considered as an element, has been resolved into two elements, praseodymium, which gives green salts, and neodymium, which gives pink salts. It is interesting to see that this separa-

tion is carried out photometrically by the light: the mercury lamp showing only the green color of the praseodymium, the incandescent lamp the pink color of neodymium].

I have here a number of tubes, which seen in the light of the incandescent lamp contain red solutions of nearly the same shade. Changing to the mercury lamp you see that they exhibit almost any color. As the red disappeared in the mercury lamp the other component colors, which did not show in the incandescent lamp as they were very much less in intensity than the red, now predominate: potassium permanganate solution turns blue, carmine blue; potassium bichromate, greenish brown; coralline, (an aniline dye), olive green, etc., etc.

Again, a number of tubes, which in the mercury light appear of the same or nearly the same blue color, turn to very different colors when seen in the incandescent lamp, due to the appearance of red and green, which were not seen with the mercury light.

A solution of rhodamine, however, which looks a dull red in the light of the incandescent lamp, turns a glowing crimson in the mercury lamp, due to its red fluorescence. This diluted solution of rhodamine and methyl green (aniline dyes), which is grey in the light of the incandescent lamp, turns brownish red in the mercury lamp, the green is blotted out, while the rhodamine shows its red fluorescence. Thus, you see, the already very difficult problem of judging the subjective colors of bodies under different illuminants is still greatly increased by phenomena as fluorescence.

To conclude then: we have to distinguish between colorless and colored bodies, between opaque colors and transparent colors, between color, as referred to the visible range of radiation only, or to the total range, including ultra-red and ultra-violet, and especially we have to realize the distinction between objective or actual color, and between subjective or apparent color, when dealing with problems of illuminating engineering.

LECTURE III.

PHYSIOLOGICAL EFFECTS OF RADIATION.

Visibility.

20. The most important physiological effect is the visibility of the narrow range of radiation, of less than one octave, between wave length 76×10^{-6} and 39×10^{-6} .

The range of intensity of illumination, over which the eye can see with practically equal comfort, is enormous: the average intensity of illumination at noon of a sunny day is nearly one million times greater than the illumination given by the full moon, and still we can see fairly well in either case; that is, the human eye can adapt itself to enormous differences in the intensity of illumination, and that so perfectly that it is difficult to realize the differences in intensity without measuring them. The photographic camera realizes it. An exposure taken in $\frac{1}{100}$ second with $\frac{1}{8}$ opening of the diaphragm in full sunlight usually gives a better photograph than an exposure of 10 minutes at full opening, in the light of the full moon. The ratio of time of exposure in the two cases, however, is about 1 to 1,000,000, thus showing the difference in the intensity of illumination. Also, the disk of the moon, when seen in daylight, has about the same intensity as the sky — somewhat more than the cloudless sky, less than white reflecting clouds. As the surface of the moon's disk, of one-half degree diameter, is about $\frac{1}{100,000}$ the surface of the sky, it thus follows that the daylight reflected from the sky is about 100,000 times more intense than the light of the full moon.

The organ by which we perceive the radiation, the human eye (Fig. 20), contains all the elements of a modern photographic camera — an achromatic lense: the lense *L*, of high refractive power, enclosed between the two transparent liquids *A* and *B* which correct the color dispersion, that is, give the achromatic property; a diaphragm: the iris *I*, which allows the increase or decrease of the opening *P*, the pupil; a shutter: the eyelids and

the sensitive plate or retina *R*. The nerves of vision end at the back of the retina, and in the center of the retina is a spot *F*, the "sensitive spot" or "fova," at which the retina is very thin, and the nerve ends specially plentiful. At this spot we thus see sharpest and clearest, and it is this spot we use for seeing by turning the eye so as to fix on it the image of the subject we desire to see, while the image on the rest of the retina is used merely for orientation.

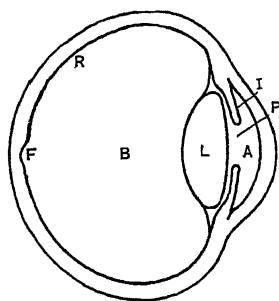

FIG. 20.

The adaptability to the enormous range of intensity of illumination, which

as seen we meet in nature, is secured:

(1). By changing the opening and thereby the amount of light admitted to the eye, by contracting or opening the pupil. This action is automatic. In low intensity of illumination the pupil thus is wide open and contracts at higher intensities. As this automatic action takes an appreciable, though short time, a flash light photograph shows the pupil of the eye fully open and thereby gives a staring impression to the faces which is avoided by keeping a photographically inactive light, as a candle, burning outside of the field of the camera when preparing for a flash light photograph.

(2). By the fatigue of the optic nerves, exposed to high intensity of illumination, the nerves becomes less sensitive, while at low intensity they rest and thus become more sensitive, and the differences of sensation are hereby made very much less than corresponds to the differences of intensity of radiation. Therefore, when entering a brightly illuminated room from the darkness we are blinded in the first moment, until the eye gets accustomed to the light, that is, the nerves become fatigued and so reduce the sensation of light. Inversely, when stepping from a bright room into the darkness we first see almost nothing until the eye gets accustomed to the darkness, that is, the nerves are rested and their sensitivity thus increased so as to perceive the much lower intensity of illumination.

(3). By the logarithmic law of sensation. The impression made on our senses, eye, ear, etc., that is, the sensation, is not proportional to the energy which produces the sensation, that is, the

intensity of the light, the sound, etc., but is approximately proportional to its logarithm and the sensation, therefore, changes very much less than the intensity of light, etc., which causes the sensation. Thus a change of intensity from 1 to 1000 is 1000 times as great a change of intensity as from 1 to 2, but the change of sensation in the first case, $\log 1000 = 3$, is only about 10 times as great as the change in the latter case, $\log 2 = 0.301$.

This logarithmic law of sensation (Fechner's Law), while usually not clearly formulated, is fully familiar to everybody, is continuously used in life, and has been used from practical experience since by-gone ages. It means that the same relative or percentage change in intensity of light, sound, etc., gives the same change of sensation, or in other words, doubling the intensity gives the same change in sensation, whether it is a change of intensity from one candle power to two candle power, or from 10 to 20, or from 1000 to 2000 candle power.

It is obvious that the change of sensation is not proportional to the change of intensity; a change of intensity of light by one candle power gives a very marked change of sensation, if it is a change from one to two candle power, but is unnoticeable, if it is a change from 100 to 101 candle power. The change of sensation thus is not proportional to the absolute change of intensity — one candle power in either case — but to the relative or percentage change of intensity, and as this is 100 per cent in the first, 1 per cent in the latter case, the change of sensation is marked in the first, unnoticeable in the latter case.

This law of sensation we continuously rely upon in practice. For instance, when designing an electrical distribution system for lighting, we consider that the variation of voltage by 1 per cent is permissible as it gives a change of candle power of about 5 per cent, and 5 per cent variation is not seriously noticeable to the eye. Now this 5 per cent change of candle power may be a change from 1 to 0.95, or by $\frac{1}{20}$ candle power, or it may be a change from 1000 to 950, or by 50 candle power, and both changes we assume, and are justified herein from practical experience, to give the same change of sensation, that is, to be near the limits of permissibility.

This law of sensation (Fechner's Law) means:

If i = intensity of illumination, as physical quantity, that is,

in meter-candles or in watts radiation of specified wave length, the physiological effect given thereby is:

$$L = A \log \frac{i}{i_0}$$

where A is a proportionality constant (depending on the physiological measure of L) and i_0 is the minimum perceptible value of illumination or the "threshold value," below which sensation ceases.

The minimum value of change of intensity i , which is still just perceptible to the average human eye, is about 1.6 per cent. This, then, is the sensitivity limit of the human eye for changes of illumination.

Obviously, when approaching the threshold value i_0 , the sensitivity of the eye for intensity changes decreases.

The result of this law of sensation is that the physiological effect is not proportional to the physical effect, as exerted, for instance, on the photographic plate. The range of intensities permissible on the same photographic plate, therefore, is far more restricted. A variation of illumination within the field of vision of 1 to 1000, as between the ground and the sky, would not be seriously felt by the eye, that is, not give a very great difference in the sensation. On the photographic plate, the brighter portions would show 1000 times more effect than the darker portions and thus give bad halation while the latter are still under exposed. A photographic plate, therefore, requires much smaller variations of intensity in the field of vision than permissible to the eye. In the same manner the variations of intensity of the voice, used in speaking, are far beyond the range of impression which the phonograph cylinder can record, and when speaking into the phonograph a more uniform intensity of the voice is required to produce the record, otherwise the lower portions of the speech are not recorded, while at the louder portions the recording point jumps and the voice breaks in the reproduction.

21. The sensitivity of the eye to radiation obviously changes with the frequency, as it is zero in the ultra-red, and in the ultra-violet—where the radiation is not visible—and thus gradually increases from zero at the red end of the spectrum to a maximum somewhere near the middle of the spectrum and then decreases again to zero at the violet end of the spectrum; that is, the physi-

ological effect produced by the same radiation power — as one watt of radiating power — is a maximum near the middle of the visible spectrum and decreases to zero at the two ends, about as illustrated by the curves in Fig. 21. Inversely, the mechanical equivalent of light, or the power required to produce the same physiological effect — as one candle power of light — is a minimum near the middle of the spectrum and increases from there to infinity at the end of the visible range, being infinite

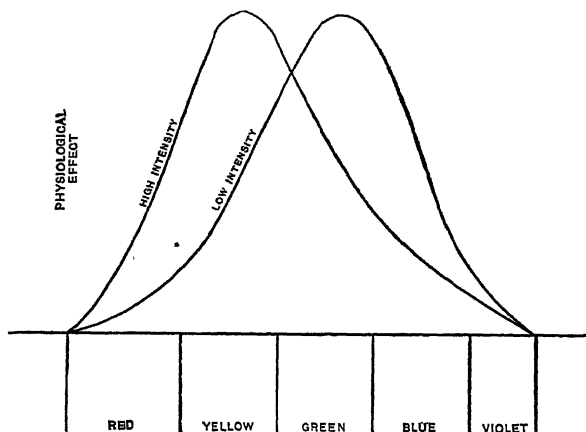

FIG. 21.

in the ultra-red and ultra-violet, where no power of radiation can produce visibility. It thus varies about as indicated in Fig. 22.

The mechanical power equivalent of light, thus, is not constant, as the mechanical energy equivalent of heat — which is 426 kgm. or 4.25 kilo-joule per calorie — but is a function of the frequency, that is, of the color of radiation, with a maximum, probably not very far from 0.02 watt per candle power in the middle of the spectrum.

When comparing, however, the physiological effects of different frequencies of radiation, that is, different colors of light, the difficulty arises that different colored lights cannot be compared photometrically, as all photometers are based on making the illumination produced by the two different sources of light equal, and when these sources of light are of different color they can never become equal. As long as the colors are not very different — two different shades of yellow or yellowish white and white — the eye can still approximately estimate the equality of intensity and

thus compare them, though not as accurately as when the two sources of light are of the same color. With very great color differences, as green light and orange light, this is no longer feasible. However, an accurate comparison can still be made on the basis of equal ease in distinguishing objects. As the pur-

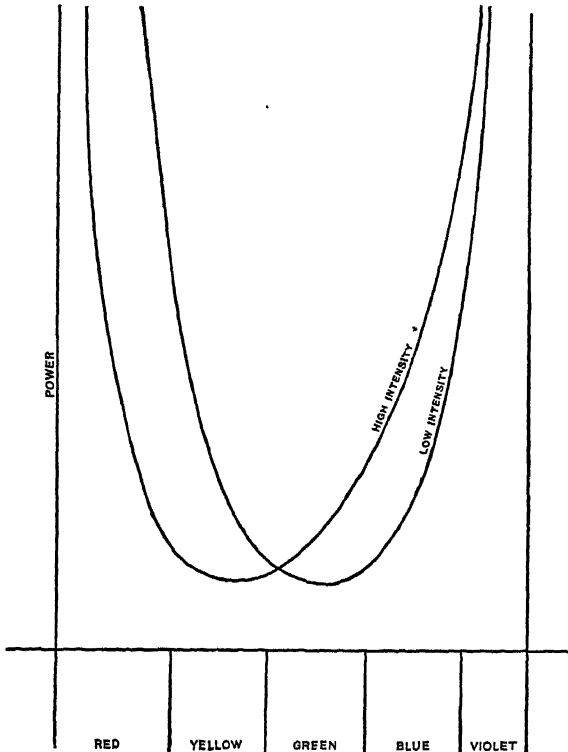

FIG. 22.

pose for which light is used is to distinguish objects, the correct comparison of lights obviously is on the basis of equal distinctness of objects illuminated by them; that is, two lights, regardless whether of the same or of different colors, give the same candle power, that is, the same physiological effect, if they enable us to distinguish objects with the same ease at the same distance. Experience has shown that the sharpest distinction, that is, the greatest accuracy in comparing different lights in this manner, is reached by determining the distance from the source of light at

which print of moderate size just ceases to be readable. For this purpose the print must be a mixture of letters which do not form intelligible words and the point which can be determined most accurately is where large letters, as capitals, are still readable, while small letters are already unreadable (see p. 174). Obviously, in comparing different colors of light the object must be colorless, that is, the print be black on white. This method of comparison of the physiological effect, by what has been called the "luminometer," is theoretically the most correct, as it is independent of the color of light. It is, however, not as accurate as the comparison by photometer, and thus the average of a number of observations must be used. The only error which this method leaves is that due to the difference in the sensitivity of different eyes, that is, due to the differences between the sensitivity curves (Fig. 21), and this in most cases seems to be very small.

22. It is found, however, that the sensitivity curve for different colors of radiation is a function of the intensity of radiation; that is, the maximum sensitivity point of the eye is not at a definite frequency or wave length, but varies with the intensity of illumination and shifts more towards the red end of the spectrum for high, towards the violet end of the spectrum for low intensity of illumination, and for illumination of very high intensity the maximum physiological effect takes place in the yellow light, while for very low intensity of illumination it occurs in the bluish green light; that is, at high intensity yellow light requires less power for the same physiological effect than any other color of light, while for low intensity, bluish green light requires less power for the same physiological effect than any other color of light. Thus, if an orange yellow light, as a flame carbon arc, and a bluish green light, as a mercury lamp, appear of the same intensity from the distance of 100 feet, by going nearer to the lamps the orange yellow appears to increase more rapidly in intensity than the bluish green, and from a very short distance the former appears glaring bright, while the latter is disappointing by not showing anywhere near the same apparent intensity. Inversely, when going further and further away from the two lamps the orange yellow light seems to fade out more rapidly than the bluish green, and has practically disappeared while the bluish green is still markedly visible. A mercury lamp, therefore, can be seen from distances from which a much brighter yellow flame arc is practi-

cally unnoticeable, but inversely, from a very short distance the yellow light appears dazzling, while a mercury lamp of higher candle power appears less bright.

Fig. 23 illustrates the change of sensitivity with intensity, by approximate curves of the variation of the relative sensitivity of the average human eye with the intensity i of illumination in

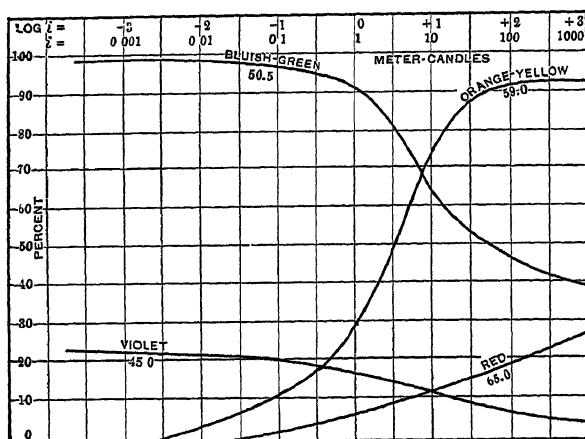

FIG. 23.

meter candles (or rather $\log i$) as abscissas, for red light, wave length 65.0; orange yellow light, wave length 59; bluish green light, wave length 50.5; and violet light, wave length 45.0.

As seen for red light as well as violet light — the two ends of the visible spectrum — the sensitivity is low, while for orange yellow as well as bluish green light — near the middle of the visible range — the sensitivity is high.

For bluish green light, however, the sensitivity is high at low and moderate intensities but falls off for high intensities, while for orange yellow light the sensitivity is high at high intensities and falls off at medium and low intensities and ultimately vanishes, that is, becomes invisible at intensities many times higher than those at which green light is still well visible.

Red light vanishes from visibility still earlier than orange yellow light, while violet light remains visible even at very low intensities.

The vanishing points of the different colors of light, that is,

the minimum intensities which can just be perceived are, approximately, at:

Color	red	orange	yellow	green	blue	violet
Wave length $l_w =$	67	60.5	57.5	50.5	47	43×10^{-6}
Meter-candles in- tensity... $i_o =$	0.06	0.0056	0.0029	0.00017	0.00012	0.00012
Relative radiation power... $p_o =$	10,000	1000	100	1	2	20

That is, the minimum visible amount of green light represents the least amount of power; the minimum visible amount of blue light requires twice as much power as green light; violet light 20 times as much, but yellow light 100 times and red light even 10,000 times as much power as green light at the threshold of visibility.

While the intensity of radiation varies inversely proportional to the square of the distance, it follows herefrom that the physiological effect of radiation does not vary exactly with the square of the distance, but varies somewhat faster, that is, with a higher power of the distance for orange yellow or the long-wave end of the spectrum, and somewhat slower, that is, with a lesser power of the distance than the square, for bluish green or the short-wave end of the spectrum.

This phenomenon is appreciable even when comparing the enclosed alternating carbon arc with the open direct current carbon arc: by photometer, where a fairly high intensity of illumination is used, the relative intensity of the two arcs is found somewhat different than by luminometer, that is, by reading distances nearer the lower limit of visibility. For low intensities, the alternating arc compares more favorably than for high intensities.

It follows, therefore, that in the photometric comparison of illuminants, where appreciable color differences exist, the intensity of illumination at which the comparison is made must be given, as it influences the result, or the candle power and the distance of observation stated.

23. Not only the sensitivity maximum is different for low and for high intensity of illumination, but the shape of the sensitivity curve also is altered, and for low intensity is more peaked, that is, the sensitivity decreases more rapidly from a maximum towards the ends of the spectrum than it does for high intensity

of illumination as indicated by the curves in Fig. 24 which shows approximate sensitivity curves of the average human eye: (a) for every low illumination near the threshold value of visibility or 0.001 meter-candles; (b) for medium illumination, 4.6 meter-candles; (c) for very high illumination, 600 meter-candles.

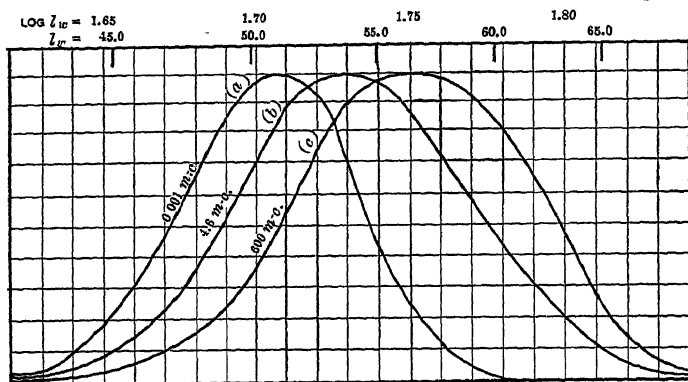

FIG. 24.

(1 meter-candle is the illumination produced by 1 candle power of light intensity at 1 meter distance; N meter-candles, thus, the illumination produced by a light source of N candle power at 1 meter distance or of 1 candle power at $\frac{1}{\sqrt{N}}$ meter distance, etc.).

As seen, curve (a) ends at wave length $\lambda_w = 61 \times 10^{-6}$; that is, for longer waves or orange and red light, 0.001 meter-candles is below the threshold value of visibility, hence is no longer visible.

The maximum visibility, that is the sensitivity maximum of the human eye, lies at wave length.

$\lambda_0 = 51.1$, bluish green for very low intensity, curve (a).

$\lambda_0 = 53.7$, yellowish green for medium intensity, curve (b).

$\lambda_0 = 56.5$, yellow for high intensity, curve (c).

The sensitivity maximum varies with the intensity about as shown in Fig. 25; that is, it is constant in the bluish green for low intensities, changes at medium intensities in the range between 0.5 and 50 meter-candles and again remains constant in the yellow for still higher intensities.

The sensitivity curves, as given in Fig. 24, have the general character of probability curves:

$$H = H_0 \varepsilon^{-k_s \left(\frac{l_w}{l_{w_0}} - 1 \right)^2},$$

where l_{w_0} is the wave length at maximum sensitivity and H_0 is the sensitivity at this wave length, that is, the maximum sensitivity and k_s is a constant which is approximately 120 for low,

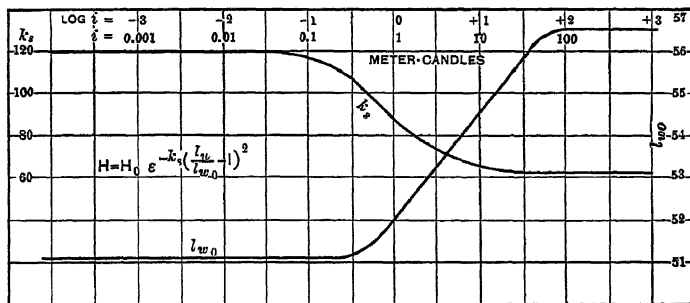

FIG. 25.

62 for high intensities and changes in approximately the same range of intensities in which l_{w_0} changes; k_s is also plotted in Fig. 25.

This effect of the intensity of illumination on the sensitivity of the eye is very important in illuminating engineering as it determines the color shades which are most effective for the particular purpose. For instance, in sending the light to great distances, for signalling, etc., the bluish green of the mercury lamp is best suited, carries farthest, and the yellow flame arc the poorest; the white carbon arc superior to the yellow flame arc, even where the latter is of greater intensity. Inversely, where a big glare of light is desired, as for decorative purposes, for advertising, etc., the yellow flame carbon arc is best suited, the bluish green mercury lamp disappointing.

Apparent exceptions may exist: for instance, the long waves of the orange yellow penetrate fog better than the short waves of bluish green, and for lighthouses, where the important problem is to reach the greatest possible distance in fog, yellow light, thus, may be superior. In general, however, the bluish green is superior

in invisibility to the orange yellow for long distances, and inversely, the orange yellow is superior for short distances.

At the limits of visibility the eye is very many times more sensitive to green light and, in general, high-frequency light, than to orange yellow and, in general, low-frequency light.

A necessary result of the higher sensitivity of the eye for green light is the preponderance of green in gas and vapor spectra. As no special reason exists why spectrum lines should appear more frequently at one wave length than at any other and as the radiation is most visible in the green, this explains, somewhat, the tendency of most highly efficient illuminants towards a greenish or yellow color (as, for instance, the Welsbach mantel, the Nernst lamp, etc.).

Pathological and Other Effects on the Eye.

24. Radiation is a form of energy, and thus, when intercepted and absorbed, disappears as radiation by conversion into another form of energy, usually heat. Thus the light which enters the eye is converted into heat, and if its power is considerable it may be harmful or even destructive, causing inflammation or burns. This harmful effect of excessive radiation is not incident to any particular frequency, but inherent in radiation as a form of energy. It is, therefore, greatest for the same physiological effect, that is, the same amount of visibility, for those frequencies of light which have the lowest visibility or highest power equivalent, that is, for the red and the violet and least for the green and the yellow, which for the same amount of visibility represent least power. Hence, green and greenish yellow light are the most harmless, the least irritating to the eye, as they represent the least power. We feel this effect and express it by speaking of the green light as "cold light" and of the red and orange light as "hot" or "warm." The harmful effect of working very much under artificial illumination is largely due to this energy effect, incident to the large amount of orange, red, and ultra-red in the radiation of the incandescent bodies used for illuminants and thus does not exist with "cold light," as the light of the mercury lamp.

Blue and violet light, however, are just as energetic, or "hot," as orange and red light, and the reason that they are usually not recognized as such is that we have no means to produce efficiently

powerful blue and violet light, and if we could produce it would not be able to use it for illumination, due to the specific effects of this light which will be described in the following.

In Fig. 26, let the curve *A* represent roughly the mechanical power equivalent of light for average intensity, that is, the power required to produce the same physiological effect or the same candle power. The distribution of power in an incandescent

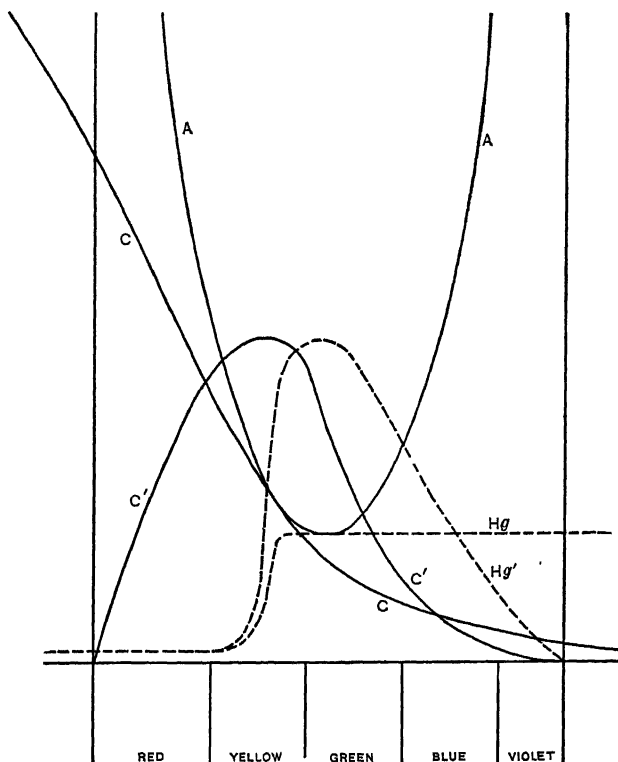

FIG. 26.

lamp carbon filament would be somewhat like *C*. Hence, the physiological effect falls off somewhat towards the green, as *C* drops more than *A*, and almost vanishes in the blue and violet, as *C* rapidly decreases, while *A*, the power required to give the same physiological effect, rapidly increases. From the yellow towards the red the physiological effect again decreases somewhat, but

the radiation still increases towards the ultra-red. Dividing C by A then gives the distribution of the physiological effect, curve C' , that is, of visibility, in the incandescent lamp spectrum, showing that the color of the light is yellow. Hg gives the distribution of power in the mercury spectrum. It is shown in dotted lines, as the distribution is not continuous, but the power massed at definite points, the spectrum lines of mercury. Hg' then gives the visibility curve by dividing Hg by A . As seen, the ratio of the area of Hg' to Hg , that is, the ratio of the physiological effect to the power, is much less than the ratio of the area of C' to C ; that is, the former produces for the same amount of visibility far less heat and thus is safer.

25. Excessive intensity, such as produced at a short-circuiting arc, is harmful to the eye. The human organism has by evolution, by natural selection, developed a protective mechanism against the entrance of radiation of excessive power into the eye: at high intensity of illumination the pupil of the eye contracts and thus reduces the amount of light admitted, and a sudden exposure to excessive radiation causes the eyelids to close. This protective mechanism is automatic; it is, however, responsive mainly to long waves of radiation, to the red and the yellow light, but not to the short waves of green, blue and violet light. The reason for this is apparently that all sources of excessive radiation which are found in nature, the sun and the fire, are rich in red and yellow rays, but frequently poor in rays of short wavelength, and, therefore, a response to short wavelengths alone would not be sufficient for protection as they might be absent in many intense radiations, while a response to long waves would be sufficient since these are always plentiful in the intense radiations found in nature.

It is only of late years that illuminants, as the mercury lamp, which are deficient in the long waves, have been produced, and for these the protective action of the eye, by contracting the pupil, fails. This absence or reduction of the contraction of the pupil of the eye in the light of the mercury lamp is noticed when passing from a room well illuminated by incandescent lamps, to one equally well illuminated by mercury lamps and inversely. When changing from the incandescent light to the mercury light, the illumination given by the latter at first appears dull and inferior as the pupil is still contracted, but gradually gains in intensity as the pupil

opens; and inversely, coming from the mercury light to the incandescent light, the latter first appears as a big glare of light, the pupil still being open, but gradually dulls down by the contraction of the pupil.

This absence of the automatic protective action of the eye against light deficient in long waves is very important, as it means that exposure to excessive intensity of illumination by mercury light may be harmful, due to the power of the light, against which the eye fails to protect, while the same or even greater power of radiation in yellow light would be harmless, as the eye will protect itself against it. The mercury lamp, therefore, is the safest illuminant, when of that moderate intensity required for good illumination, but becomes harmful when of excessive intensity, as when closely looking at the lamp for considerable time, when operating at excessive current. The possibility of a harmful effect is noticed by the light appearing as glaring. This phenomenon explains the contradictory statements occasionally made regarding the physiological effect of such illuminants.

26. Up to and including the green light, no specific effects, that is, effects besides those due to the power of radiation, seem yet to exist. They begin, however, at the wave length of blue light.

I show you here a fairly intense blue violet light, that is, light containing only blue and violet radiation. It is derived from a vertical mercury lamp, which is surrounded by two concentric glass cylinders welded together at the bottom. The space between the cylinders is filled with a fairly concentrated solution of potassium permanganate (strong copper nitrate solution or a cupric-ammon salt solution, though not quite so good, may also be used) which is opaque to all but the blue and violet radiations. As you see, the light has a very weird and uncanny effect, is extremely irritating: you can see by it as the intensity of illumination is fairly high, but you cannot distinguish everything, and especially the lamp is indefinite and hazy: you see it, but when you look at it it disappears, and thus your eye is constantly trying to look at it and still never succeeds, which produces an irritating restlessness. It can well be believed that long exposure to such illumination would result in insanity. The cause of this weird effect — which is difficult to describe — probably is that the sensitive spot on the retina, that is, the point on which we focus the image

of the object which we desire to see, or the fovea F in Fig. 19, is blue blind, that is, does not see the blue or violet light. Thus we see the lamp and other objects indistinctly on the outer range of the retina, but what we try to see distinctly disappears when focused on the blue blind spot F . This spot, therefore, is often called the "yellow spot," as we see yellow on it — due to the absence of the vision of blue at this particular place of the retina.

To produce this effect requires the mercury lamp; most other illuminants do not have sufficient blue and violet rays to give considerable illumination of this color and even if they do, no screen which passes blue and violet is sufficiently opaque to the long waves not to pass enough of them to spoil the effect, if the illuminant is rich in such long waves. The mercury lamp, however, is deficient in these, and thus it is necessary only to blind off the green and yellow rays in order to get the blue and violet light.

I show you here a mercury lamp enclosed by a screen consisting of a solution of naphthol green (an aniline dye) which transmits only the green light. As you see, in the green the above-described effect does not exist, but the vision is clear, distinct and restful.

27. Beyond the violet the radiation is no longer visible to the eye as light. There is, however, a faint perception of ultra-violet light in the eye, not as distinct light, but rather as an indistinct, uncomfortable feeling, some form of dull pain, possibly resulting from fluorescence effects caused by the ultra-violet radiation inside of the eye. With some practice the presence of ultra-violet radiation thus can be noticed by the eye and such light avoided. In the ultra-violet, and possibly to a very slight extent in the violet and even in the blue, a specific harmful effect appears, which possibly is of chemical nature, a destruction by chemical dissociation. This effect increases in severity the further we reach into the ultra-violet, and seems to become a maximum in the range from one to two octaves beyond the violet. These very short ultra-violet rays are extremely destructive to the eye: exposure even to a moderate intensity of them for very few minutes produces a severe and painful inflammation, the after effects of which last for years, and long exposures would probably result in blindness. The chronic effects of this inflammation are similar to the effect observed in blue light: inability or difficulty in fixing objects on the sensitive spot F , so that without impairment of the vision on the rest of the retina clear dis-

tion is impaired and reading becomes difficult or impossible, especially in artificial illumination. It appears as if the sensitive spot F , or the focusing mechanism of the eye, were over-irritated and when used, for instance in reading, becomes very rapidly fatigued and the vision begins to blur. If further irritation by ultra-violet light or by attempting to read, etc., is avoided, gradually the rapidity of fatigue decreases, the vision remains distinct for a longer and longer time before it begins to blur and ultimately becomes normal again.

The inflammation of the eye produced by ultra-violet light appears to be different from that caused by exposure to high-power radiation of no specific effect, as the light of a short circuit of a high-power electric system, or an explosion, etc.

The main differences are:

1. The effect of high-power radiation (power burn) appears immediately after exposure, while that of ultra-violet radiation (ultra-violet burn) appears from 6 to 18 hours after exposure.

2. The external symptoms of inflammation: redness of the eyes and the face, swelling, copious tears, etc., are pronounced in the power burn, but very moderate or even entirely absent in the ultra-violet burn.

3. Complete recovery from a power burn even in severe cases usually occurs within a few days, leaving no after effects, while recovery from an ultra-violet burn is extremely slow, taking months or years, and some after effects, as abnormal sensitivity to radiation of short wave lengths, may be practically permanent.

The general phenomena of a severe power burn are:

Temporary blindness immediately after exposure, severe pains in the eyes and the face, redness of eyes and face, swelling, copious tears, etc. These effects increase for a few hours and then decrease, yielding readily to proper treatment: application of ice, cold boric acid solution, etc., and complete recovery occurs within a few days.

In chronic cases, as excessive work under artificial illumination, the symptoms appear gradually, but recovery, if no structural changes in the eyes have occurred, is rapid and complete by proper treatment and discontinuance of work under artificial illumination.

Most artificial light is given by temperature radiation (incandescent lamp, gas and kerosene flame), and therefore its radiation

consists of a very small percentage only of visible light (usually less than 1 per cent), while most of its energy is in the ultra-red and invisible, and for the same amount of visible radiation or light the total radiated power thus is many times greater than with daylight. Regarding chronic "power burn," artificial light, therefore, is much more harmful than daylight, that is, much more energy enters the eye under incandescent illumination than under much more powerful daylight illumination.

In a severe ultra-violet burn no immediate symptoms are noticeable, except that the light may appear uncomfortable while looking at it. The onset of the symptoms is from 6 to 18 hours later, that is, usually during the night following the exposure, by severe deep-seated pains in the eyes; the external appearance of inflammation is moderate or absent, the vision is not impaired, but distinction made difficult by the inability to focus the eye on any object. The pains in the eyes and headache yield very slowly; for weeks and even months any attempt of the patient to use the eyes for reading, or otherwise sharply distinguishing objects, leads to blurring of the vision; the letters of the print seem to run around and the eye cannot hold on to them, and severe headache and deep-seated pains in the eyes follow such attempt. Gradually these effects become less; after some months reading for a moderate length of time during daylight is possible, but when continued too long, or in poor light, as in artificial illumination, leads to blurring of the vision and head or eye ache. Practically complete recovery occurs only after some years, and even then some care is necessary, as any very severe and extended strain on the eyes temporarily brings back the symptoms. Especially is this the case when looking at a light of short wave length, as the mercury arc; that is, there remains an abnormal sensitivity of the eye to light of short wave lengths, even such light which to the normal eye is perfectly harmless, as the mercury lamp.

In chronic cases of ultra-violet burn, which may occur when working on unprotected arcs, and especially spark discharges (as in wireless telegraphy), the first symptoms are: occasional headaches, located back of the eyes, that is, pains which may be characterized either as headache or as deep-seated eye ache. These recur with increasing frequency and severity. At the same time the blurring of the vision begins to be noticeable

and the patient finds it more and more difficult to keep the eye focused for any length of time on objects, as the print when reading. These symptoms increase in severity until the patient is obliged to give up the occupation which exposed him to ultra-violet light, and then gradual recovery occurs, as described above, if the damage has not progressed too far.

In mild cases recovery from power burns may occur in a few hours and complete recovery from mild ultra-violet burns in a few weeks.

Both types of burn may occasionally occur simultaneously and their symptoms then successively.

For instance, in a case of an exposure while working for about half an hour with a flame-carbon arc without enclosing glass globe (such an arc contains large amounts of high-power radiation, of yellow and orange color, but also a considerable amount of ultra-violet rays), the symptoms of the power burn increased in severity for a few hours, and then rapidly vanished by the application of cold water, and recovery was practically complete six hours after exposure; then some hours later, in the middle of the night, the patient was awakened by severe pains in the eyes, the symptoms of the ultra-violet burn, and had to seek medical attendance. Under proper treatment recovery occurred in a few days, but the blurring of the vision was appreciable for some days longer, and the sensitivity to high-frequency light for some weeks.

28. Arcs produce considerable amount of ultra-violet light,* and in former experiments we have used a high frequency iron arc for producing ultra-violet light and also have seen that even a very thin sheet of glass is opaque for these radiations. For very long ultra-violet rays, that is, the range close to the visible violet, glass is not quite opaque, but becomes perfectly opaque for about one-quarter to one-half octave beyond the violet, and in this first quarter of an octave the harmful effect of the ultra-violet radiation is still very small and becomes serious only when approaching a distance of about one octave from the visible end of the violet. Clear transparent glass thus offers a practically complete protection against the harmful effects of ultra-violet light, except when the latter is of excessive intensity, and thus arcs enclosed

* An arc between silicon terminals emits especially powerful ultra-violet radiation accompanied by little visible light.

by glass globes are harmless. It is, however, not safe to look into and work in the light of open metal arcs for too long a time.

The carbon arc gives the least ultra-violet rays, so little that even without enclosure by glass it is fairly safe; metal arcs give more and the mercury arc gives the greatest amount and reaches to the farthest distance beyond the visible, and these very destructive very short ultra-violet rays have so far only been observed in the radiation of a low temperature mercury arc in a quartz tube: quartz being transparent to these rays while glass is opaque. The high temperature mercury arc in a quartz tube, that is, arc operated near atmospheric pressure as it is used to some extent for illumination, especially abroad, seems to be much less dangerous than the low temperature or vacuum arc, but it also requires a protecting glass globe.

In general, no metal arc, spark discharge, or glow discharge should ever be used industrially or otherwise without being enclosed by a glass globe, preferably of lead glass, if located so that it may be looked at. Those experimenting with arcs or other electric discharges should always protect their eyes by the interposition of a glass plate.

Thus the sparks of wireless telegraph stations, the discharges of ozonizers, the arcs of nitric acid generators, electric furnaces, etc., may be dangerous without glass enclosure.

While artificial illuminants, and especially metal arcs, give an appreciable amount of ultra-violet light, these ultra-violet rays extend only to about one-quarter octave beyond the visible violet and if, as is always the case, the illuminant is enclosed by glass, the harmful effect of these long ultra-violet rays is negligible. The radiation of the sun also contains ultra-violet rays, and a larger percentage compared with the total radiation than any glass-enclosed artificial illuminant, and as the light of the sun, that is, daylight, is recognized as perfectly harmless, as far as this specific destructive action is concerned, the same applies to the artificial illuminants, as they contain less ultra-violet rays than the light of the sun.

This specific destructive action on the eye of short ultra-violet radiation extends beyond the blank space in the spectrum of radiation (Fig. 14) and still exists, though possibly to a lesser extent, in the X-rays.

Pathological and Therapeutic Effects of Radiation.

29. Radiation impinging on the tissue of the human body or other living organisms exerts an influence depending on intensity, power and frequency. The effect on the eye has been discussed in the preceding paragraphs. The specific chemical effect in supplying the energy of plant life will be more fully discussed in the following under chemical effects. As is to be expected, the effect of radiation on the living protoplasm of the cells is stimulating if of moderate intensity, destructive if of excessive intensity; that is, by the energy of the radiation the motions of the parts of the protoplasm-molecule are increased, and, if the intensity of radiation is too high, the molecule thus is torn asunder, that is, destroyed, the living cell killed and inflammation and necrosis (mortification) result. If the intensity is moderate, merely an increase of the rapidity of the chemical changes in the protoplasm, which we call life, results; that is, the radiation exerts a stimulating effect, increasing the intensity of life, causing an increased renewal of worn-out tissue and reconstruction, and thus is beneficial or curative, especially where the metabolism is sluggish.

Just as in the action on the eye, two different effects probably exist: a general effect due to the energy of the radiation — which with sunlight is a maximum beyond the visible close to the red end of the spectrum, and with most artificial illuminants (those based on incandescence) reaches a maximum still further in the ultra-red — and a specific effect depending on the frequency.

The power effect is general and probably fairly uniform throughout the exposed tissue, appears simultaneous with or immediately after the exposure, and thus practically no danger of harmful results from destruction of tissue exists, as excessive intensity makes itself felt immediately, before far-going destruction of tissue can occur, and, therefore, the only possible danger which could exist would be in the indirect effect of stimulation on other organs of the body, as the heart. Thus the use of incandescent light as stimulant appears fairly harmless.

Different is the specific action of high-frequency radiation. This occurs only some time after exposure, from a few hours to several weeks (with X-rays). As these higher frequencies are not felt by the body as such and exert a powerful action even at such

low intensities that their energy is not felt as heat, and, furthermore, the susceptibility of different people may be different, there is nothing to guard against excessive and thereby harmful exposure. Furthermore, the damage is far more severe and lasting than with the power effect, and fatal cases have occurred years after exposure. Possibly, as may be expected from selective action, only a few cells in the living tissue are killed by the radiation, and the disintegration products of these dead cells then gradually involve the surrounding living cells, causing their destruction or degeneration, so that the harm is far out of proportion with the immediate destructive effect of the radiation proper, especially with penetrating forms of radiation, as X-rays and radium rays, in which the lesions are correspondingly deep-seated.

High-frequency radiation (violet, ultra-violet, X-ray) should therefore be used only under the direction of experts fully familiar with their physiological action and danger.

The specific action of high-frequency radiation is still absent in the green, begins slightly in the blue and violet, increases into the ultra-violet and persists up to the highest frequencies of the X-rays. It is shared also by the radiation of the radio-active substances, as the alpha and beta rays of radium. While the maximum of this effect probably also lies in the ultra-violet, from one to two octaves beyond the visible spectrum, the effect is profoundly modified by the transparency or opacity of the tissue for different frequencies, and the character of the stimulating and pathological effects greatly depends on the depth to which the radiation penetrates the body.

The largest part of the organism is water. Water is transparent for visible light, becomes more and more opaque in the ultra-red as well as in the ultra-violet, and is again fairly transparent for X-rays. Blood is fairly transparent for the long visible rays of red and yellow, but nearly opaque for the shorter violet and ultra-violet rays. Hence next to the X-rays which can pass through the body, the longest visible rays of red and yellow penetrate relatively deepest into the body, though even they are practically absorbed within a short distance from the surface. Thus while the energy maximum of the sunlight is in the ultra-red, the maximum physiological effect probably is that of the red and yellow rays: the same which are the active

rays in plant life. The violet and ultra-violet rays are absorbed close to the surface of the body by the blood, which is opaque for them. They can thus be made to penetrate deeper — as is done in their therapeutic use — by freeing the tissue of the body from blood by compression or other means. Even then, however, probably only the longest ultra-violet rays penetrate, the very short ones being kept out by the opaque character of the water in the tissue.

The penetration of the radiation of the sunlight into the human body is very greatly reduced by acclimatization, which leads to the formation of a protective layer or pigment, more or less opaque to the light. Such acclimatization may be permanent or temporary. Permanent acclimatization has been evolved during ages by those races which developed in tropical regions, as the negroes. They are protected by a black pigment under the skin, and thereby can stand intensities of solar radiation which would be fatal to white men. A temporary acclimatization results from intermittent exposure to sunlight for gradually increasing periods: tanning, and enables the protected to stand without harmful effects exposure to sunlight which would produce severe sunburn in the unprotected. This acquired protection mostly wears off in a few weeks, but some traces remain even after years.

A slight protection by pigmentation also exists in white men, and its differences lead to the observed great differences in sensitivity to solar radiation: blondes, who usually have very light pigmentation, are more susceptible to sunburn and sunstroke than the more highly pigmented brunette people.

In sunburn we probably have two separate effects superimposed upon the other: that due to the energy of the solar radiation and the specific effect of the high frequencies, which to a small extent are contained in the sunlight. The two effects are probably somewhat different, and the high-frequency effect tends more to cause inflammation of the tissue, while the energy effect tends towards the production of pigmentation (tanning), and the symptoms of sunburn thus vary with the different proportions of energy radiation and of high-frequency radiation as depending on altitude, humidity of the air, the season, etc.

30. The action of radiation on living organisms is stimulating if of moderate intensity, destructive if of high intensity. Thus

it is analogous with that of any other powerful agent or drug, as alcohol, caffeine, etc. The intensity of light which is destructive to life largely depends on the amount of light to which the organism is accustomed. Those organisms which live in the dark may be killed by an amount of light which is necessary for the life of other organisms. Amongst the saprophytic bacilli, for instance (the germs of putrefaction), many species live in the light, and die, or at least do not multiply, if brought into the dark, while other putrefactive bacilli live in the dark and are killed by light. The latter also is the case with the pathogenic bacilli, that is, the disease germs, as the bacillus of tuberculosis, cholera, etc. As these live in the dark, the interior of the body, they are rapidly killed by light. Light, and radiation in general, therefore is one of the most powerful germicides and disinfectants. One of the most effective prophylactic measures, especially against the diseases of civilization, as tuberculosis, etc., thus is to flood our homes with light, especially direct sunlight, while our habit of keeping the light out of our houses by curtains, shades, etc., closing our residences almost light-tight, when leaving them for some time, converts them into breeding places of disease germs, and then we wonder about mortality.

Obviously excessive light intensity ultimately becomes harmful even to the human organism, and it is therefore advisable to protect ourselves against the light when it becomes annoying by its intensity. It has even been claimed that the impossibility of white men to become permanently acclimatized in the tropics and the change in the temperament of the population of our country within a few generations from their immigration: the increased nervousness, restlessness and "strenuousness," are the result of the greater intensity of the sunlight, especially its high-frequency radiation, compared with the more cloudy climate of our original European home. Whether this is the case remains to be further investigated. It is hard to believe, however, that such a profound effect should result from the exposure of a small part of the body, face and hands, to a more intense light, and the failure of acclimatization in the tropics could well be explained by the higher temperature and its damaging effect, while the change from Europe to America is not merely a change from a more cloudy to a more sunny climate, but from a maritime climate, that is, climate having fairly uniform

and slowly changing temperatures, to a continental climate, with its rapid changes of temperature and enormous temperature extremes, and the difference between continental and maritime climate may be suspected as the cause in the change of the temperament of the races.

As men have lived for ages in the light, the cells of the human body are far more resisting to the light than the disease germs, which for ages have lived in the dark; and light, and more particularly the high-frequency violet and ultra-violet radiation and the X-rays, thus have found a useful therapeutic application in killing disease germs in the human body. Thus, by exposing the diseased tissue to high-frequency radiation, the disease germs are killed, or so far damaged that the body can destroy them, while the cells of the body are still unharmed, but stimulated to greater activity in combating the disease germs. As seen, for this purpose the radiation must be of sufficient intensity and duration to kill or damage the bacilli, but not so intense as to harm the cells of the body. Surface infections, as tuberculosis of the skin (scrofulosis, lupus), thus are effectively and rapidly cured by high-frequency light. More difficult and less certain the effect is if the infection is deeper seated, as then the radiation must penetrate a greater thickness of tissue to reach the bacilli, and is thereby largely absorbed, and the danger thus exists that, before a sufficient intensity of radiation can be brought to the seat of the infection, the intensity at the surface of the tissue may become harmful to the cells of the body. In this case the more penetrating X-rays would be more applicable, as they can penetrate to any depth into the body. They are, however, so far distant in frequency from the light radiation, that the acclimatization of the body to the light radiation probably exists only to a lesser extent against the X-rays; that is, the difference in the destructive effect on the bacilli and on the cells of the body, on which the curative effect is based, probably is less with the X-rays than with the long ultra-violet waves.

Since Dr. Finsen introduced phototherapy and radiotherapy, some twenty years ago, it thus has found a very extended and useful field, within its limitation.

This greater destructive action of radiation on micro-organisms than on the cells of the human body, extends not merely to the pathogenic bacilli, but to all organisms living in the dark.

Thus the spermatozoa — which biologically are independent living organisms — seem to be killed by X-rays before any damage is done to the body, and permanent sterility then results. Amongst the cells of the body differences seem to exist in their resistivity. It is claimed, for instance, that the sensory nerves are first paralyzed by violet radiation and that intense violet light can thus be used to produce local anæsthesia, sufficient for minor operations.

Occasionally the effect of light may be harmful in the relation of the human body to invading bacilli. In some eruptive infections, as smallpox, ulceration of the skin (leading to marking) seems to be avoided if the patient is kept from the light, and the course of the disease mitigated. As red light, however, seems to have no effect, instead of perfect exclusion of light, which is not very feasible, the use of red light thus seems to offer an essential advantage.

LECTURE IV.

CHEMICAL AND PHYSICAL EFFECTS OF RADIATION.

Chemical Effects.

31. Where intense radiation is intercepted by a body chemical action may result by the heat energy into which the radiation is converted. This, however, is not a direct chemical effect of radiation but an indirect effect, resulting from the energy of the radiation. !

Direct chemical effects of radiation are frequent. It is such an effect on which photography is based: the dissociating action of radiation on silver salts, the chloride in ordinary photographic paper, the bromide and iodide in the negative plate and the quick printing papers. This chemical action is greatest in the violet and ultra-violet and decreases with increasing wave length, hence is less in the green, small in the yellow, and almost absent in the red and ultra-red, so that the short waves, blue, violet and ultra-violet, have sometimes been called "chemical rays." This, however, is a misnomer, just as the term "heat rays" sometimes applied to red and ultra-red rays. In so far as when intercepted they are converted into heat, all rays are heat rays, but neither the ultra-red nor any other radiation is heat, but it may become heat when it ceases to be radiation. Thus all radiations are chemical rays, that is, produce chemical action, if they strike a body which is responsive to them.

The chemical action of radiation is specific to its frequency and seems to be some kind of a resonance effect. We may picture to ourselves that the frequency of vibration of a silver atom is that of violet or ultra-violet light, and therefore, when struck by a wave of this frequency, is set in vibration by resonance, just as a tuning fork is set in vibration by a sound wave of the frequency with which it can vibrate, and if the vibration of the silver atom, in response to the frequency of radiation, becomes sufficiently intense, it breaks away from the atom with which it is chemically

combined in the compound, the silver bromide, etc., and this compound thus splits up, dissociates. The phenomenon, however, must be more complex, as a simple resonance vibration would be especially pronounced at one definite frequency, the frequency of complete resonance, and rapidly decrease for higher and for lower frequencies. The chemical action of radiation on silver compounds, however, does not show such a response to any definite frequency, but, while strongest in the ultra-violet, extends over the entire range from the frequency of green light beyond the ultra-violet and up to the highest frequencies of X-rays. That the chemical activity of radiation is some form of resonance, is, however, made very probable by the relation which exists between the active frequency range and the weight of the atom or molecule which responds to the radiation. Thus, while the fairly heavy silver atom (atomic weight 108) responds to rays near the violet end of the visible spectrum, the much lighter oxygen atom (atomic weight 16) responds only to much higher frequencies, to those of the physiologically most destructive rays, about one to two octaves beyond the visible spectrum. These very short radiations energetically produce ozone O_3 , from oxygen O_2 , probably by dissociating oxygen molecules O_2 , into free atoms, and these free atoms then join existing molecules: $O + O_2 = O_3$, thus forming ozone. Possibly their destructive physiological action is due to this ability to cause resonance with the oxygen atom and thereby destroy molecular structures.

32. Response to the long waves of red and ultra-red light thus may be expected from atoms or groups of atoms which are very much heavier than the silver atom, and this indeed seems to be the case in the action of radiation on the life of the plants. There the response is not by atoms, but by the much heavier groups of atoms, radicals of carbon compounds, which separate and recombine in response to radiations and thus produce in vegetable organisms the metabolism which we call life.

The action of radiation on plant life thus seems to be a chemical action, and this would be the most important chemical action, as on it depends the life of the vegetation and thereby also the existence of animal life and, thus, our own. This action by which the vegetation converts the energy of radiation into chemical energy is related to the presence of chlorophyl, a green body which exhibits a red fluorescence. I show you here a solution

thereof in alcohol. This use of the energy of radiation occurs only in those parts of the plant in which chlorophyl is present, usually shown by its green color, that is, in the leaves and young stems. In those plants in which the leaves have lost their chlorophyl in taking up other functions — as the function of protection against attack by conversion into spines in the cacti — the stems and trunks have acquired the function of energy supply from radiation, and show the green color of chlorophyl. When the leaves die in the fall their chlorophyl disappears and they change to yellow or red color. Those parts of the plants which contain chlorophyl, mainly the leaves, take carbon dioxide (CO_2) from the air through breathing openings (stomata), absorb the radiation, and convert its energy into chemical energy, and use this energy in splitting up or dissociating the CO_2 , exhausting the oxygen O_2 and using the carbon in producing the complex carbon compounds of their structure: fiber (cellulose), starch, protoplasm, etc. The energy of plant life thus is derived from radiation and their work is constructive or synthetic, that is, they produce complex chemical compounds from simple ones: the carbon dioxide of the air, the nitrates and phosphates of the soil, etc. Inversely, the animal organism is analytic, it converts the chemical energy of complex compounds into mechanical and heat energy by splitting them into simpler compounds, burning them in the lungs or gills. For the supply of mechanical energy which maintains the life, the animal organism thus depends upon the synthetic work of the vegetation by consuming as food the complex compounds constructed by the plants from the energy of radiation, either directly (vegetarians), or indirectly, by eating other animals, which in their turn live on the vegetation. Thus, while the plants take in from the air carbon dioxide CO_2 , exhaust the oxygen O_2 , and convert the C into complex compounds, the animal takes in oxygen O_2 , by it burns up the complex carbon compounds derived from the plants, and exhausts CO_2 as product of combustion, but in its ultimate result, all life on the earth depends for its energy on radiation, which is made available in the plants by conversion to chemical energy and used as such by the animals.

The radiations which supply the energy of plant life, probably are the long waves of yellow, red and ultra-red light, while the short waves of blue, violet and ultra-violet cannot be used by the

plant, but are harmful, kill the vegetation. This can easily be understood: to the long waves of red and yellow light the atoms do not respond, but only the much heavier groups of atoms or carbon radicals, and these thus separate and recombine and thereby constitute what we call life. To very short waves, that is, high frequencies, these heavy groups of atoms cannot respond, but single atoms would respond thereto and thus by their separation break up and destroy the atomic groups. That is, the resonant dissociation produced by low frequency of radiation extends only to the groups of atoms and thereby results in their separation and recombination to heavier molecules: life, while the resonant dissociation produced by high frequencies extends to the atom and thereby splits up and destroys the molecules of the living organism, that is, death. Therefore the short waves of radiation, green, blue, etc., which are more or less harmful to plants, are not used but are reflected by the chlorophyl; hence the green color. To some extent violet radiation is absorbed by chlorophyl, but it is questionable whether the energy of violet light directly contributes to the chemical action, and it is rather probable that the violet radiation is converted into red light by fluorescence — chlorophyl fluoresces red — and used as red light. Excessive violet radiation seems to be harmful.

Physical Effects.

33. Some of the most interesting physical effects of radiation are those by which it is converted into another form of radiation: fluorescence and phosphorescence.

Many substances have the property of converting some of the radiation which is absorbed by them into radiation of a different wave length, that is, act as frequency converter of radiation, *fluorescence*. Many bodies when exposed to radiation store some of the energy of radiation in such a manner as to give it out again afterwards and thus, after exposure to light, glow in the darkness with gradually decreasing intensity, *phosphorescence*. These phenomena probably belong to the least understood effects of radiation. They are very common, but phosphorescence usually lasts such a short time that it can be observed only by special apparatus, although a few bodies continue to phosphoresce for hours and even days. Fluorescence also is usually

so weak as to escape notice, although in a few bodies it is very strong.

The change of frequency in fluorescence always seems to be a lowering of the frequency, that is, an increase of wave length, and in phosphorescence also the light given out seems always to be of lower frequency than the light absorbed and indeed, fluorescence and phosphorescence seem to be essentially the same phenomenon, radiation is absorbed and its energy given out again as radiation of lower frequency and that part of the returned radiation which appears during the absorption we call fluorescence, that part which appears later, phosphorescence. There is, however, frequently a change of the color of the light between fluorescence and phosphorescence and also between phosphorescence immediately after exposure to light and some time afterwards. For instance, some calcite (calcium carbonate or limestone) fluoresces crimson, but phosphoresces dark red. The phosphorescence of calcium sulphide changes from blue in the beginning to nearly white some time after, etc.

Due to the change of frequency to longer waves the longest visible rays, red, orange and yellow, produce no fluorescence or very little thereof, as their fluorescent and phosphorescent radiation would usually be beyond the red, in the invisible ultra-red. Blue, violet and ultra-violet light produce the most intense effects, as a lowering in frequency of these radiations brings them well within the visible range.

Ultra-violet light is best suited for studying fluorescence as it is not visible, and thus only the fluorescent light is visible; white light, for instance, does not show the same marked effect, since the direct white light is superimposed upon the light of fluorescence. Most brilliant effects, however, are produced by using a source of light which is deficient in the frequencies given by fluorescence and then looking at the fluorescent body through a glass having the same color as that given by fluorescence. Thus the least traces of red fluorescence can be discovered by looking at the body through a red glass, in the illumination given by the mercury lamp. As the mercury lamp contains practically no red rays, seen through a red glass everything appears nearly black or invisible except red fluorescent bodies, which appear self-luminous, glowing in a light of their own, and appear like red hot bodies.

In the illumination given by the mercury lamp I here drop a few drops of a solution of rhodamine 6 G, rhodamine R and uranine (aniline dyes) into a large beaker of water. As you see, when sinking down and gradually spreading, they appear — especially against a dark background — as brilliant luminous clouds of orange, red and green, and seen through a red glass they appear like clouds of fire. I change to the illumination given by the incandescent lamp and all the brilliancy disappears, fluorescence ceases and we have a dull red colored solution. I show you here the sample card of a silk store of different colored silks. Looking at it through a red glass, in the mercury light all disappear except a few, which you can pick out by their luminosity: they are different colors, pinks, reds, heliotrope, etc., but all containing the same red fluorescent aniline dye, rhodamine. A glass plate coated with a thick layer of transparent varnish, colored by rhodamine, appears like a sheet of red hot iron in the mercury light, especially through a red glass, while in the light of the incandescent lamp it loses all its brilliancy.

This solution of rhodamine 6 G in alcohol, fluoresces a glaring orange in the mercury light, in the light of a carbon arc lamp (or in daylight) it fluoresces green and less brilliant. Thus you see that the color of the fluorescent light is not always the same, but depends to some extent on the frequency of radiation which causes the fluorescence.

Here I have a sheet of paper covered with calcium sulphide and a lump of willemite (zinc silicate) and some pieces of calcite. As you see, none of them show any appreciable fluorescence in the mercury light. But if I turn off the mercury light, the calcium sulphide phosphoresces brightly in a blue glow, the others do not. Now I show you all three under the ultra-violet rays of the condenser discharge between iron terminals, or ultra-violet lamp (Fig. 11) and you see all three fluoresce brilliantly, in blue, green and red. Turning off the light all three continue to glow with about the same color, that is, phosphoresce, but the red fluorescence of the calcite very rapidly decreases, the green glow of the willemite a little slower, but the blue glow of the calcium sulphide screen persists, decreasing very little. I now hold my hand back of it and close to it and you see the picture of the hand appear on the screen by an increase of the luminosity where by contact with the hand the temperature of the screen was slightly

raised, thus showing the effect of the temperature rise in increasing phosphorescence.

These substances which I show you, calcium sulphide, calcium carbonate (calcite), zinc silicate (willemite), are not fluorescent or phosphorescent themselves, but their luminescence is due to a small percentage of some impurities contained in them. Chemically pure substances and concentrated solutions of the aniline dyes, or these dyes in their solid form, do not show the luminescence, but only when in very diluted solutions; that is, luminescence as fluorescence and phosphorescence seems to be the property of very diluted solutions of some substances in others. Thus a sheet of paper or cardboard colored red by rhodamine does not fluoresce, but if a small quantity of rhodamine is added to some transparent varnish and the paper colored red by a heavy layer of this varnish it fluoresces brightly red.

To show you the fluorescent spectrum, I have here a mercury lamp surrounded by a very diluted solution of rhodamine 6 G, and some rhodamine R, contained between two concentric glass cylinders. As you see, through the spectroscope a broad band appears in the red and the green light has faded considerably. You also notice that the light of this lamp, while still different from white light, does not give anything like the ghastly effect of human faces, as the plain mercury lamp, but contains considerable red rays, though not yet enough. I also show you a mercury lamp surrounded by a screen of a very dilute solution of uranine: you see, its light is bright greenish yellow, but much less ghastly than the plain mercury light and the spectroscope shows the mercury lines on a fluorescent spectrum, which extends as a continuous luminous band from the green to and beyond the red. You also see that with this uranine screen the mercury lamp gives more light than without it: considerable of its ultra-violet and violet light is converted to yellow and thereby made visible or more effective.

LECTURE V.

TEMPERATURE RADIATION.

34. The most common method of producing radiation is by impressing heat energy upon a body and thereby raising its temperature. Up to a short time ago this was the only method available for the production of artificial light. The temperature is raised by heating a body by the transformation of chemical energy, that is, by combustion, and in later years by the transformation of electric energy, as in the arc and incandescent lamp.

With increasing temperature of a body the radiation from the body increases. Thus, also, the power which is required to maintain the body at constant temperature increases with increase of temperature. In a vacuum (as approximately in the incandescent lamp), where heat conduction and heat convection from the radiating body is excluded, all the power input into the body is radiated from it, and in this case the power input measures the power of the radiation.

The total power or rate at which energy is radiated by a heated black or grey body varies with the fourth power of its absolute temperature, that is,

If A = surface area, T_1 = absolute temperature of the radiator and T_2 = absolute temperature of the surrounding objects on which the radiation impinges: the total power radiated by the body is (Stefan's Law):

$$P_r = kA (T_1^4 - T_2^4), \quad (1)$$

where for a black body, as the carbon filament with P_r given in watts per square cm., k is probably between

$$5 \times 10^{-12} \quad \text{and} \quad 6 \times 10^{-12}; \quad (2)$$

T_2 is usually atmospheric temperature or about 300 degrees abs.

If T_1 does not differ much from T_2 , that is, when considering the radiation of a body raised slightly above the surround-

ing temperature, as an electric machine, equation (1) can be written:

$$P_r = kA (T_1 - T_2) (T_1^3 + T_1^2 T_2 + T_1 T_2^2 + T_2^3);$$

or, approximately,

$$P_r = 4 kAT^3 (T_1 - T), \quad (3)$$

where T is the room temperature ($T_1 - T$) the temperature rise of the radiator above room temperature; that is, for moderate temperature differences the radiation power is proportional to the temperature rise.

This equation (3) gives the law generally used for calculating temperature rise in electric machinery and other cases where the temperature rise is moderate. Obviously, in air the power given off by the heated body, P , is greater than the power radiated, P_r , due to heat convection by air currents, etc., but as heat conduction and convection also are approximately proportional to the temperature rise, as long as the latter is moderate, equation (3) can still be used, but with the numerical value of k increased to k_1 so as to include the heat conduction and convection: in stationary air k_1 reaches values as high as $k_1 = 25 \times 10^{-12}$ to 50×10^{-12} .

As soon, however, as the temperature rise ($T_1 - T$) becomes comparable with the absolute temperature T , the equation (3) can no longer be used, but the complete equation (1) must be used, and when the temperature of the radiator, T_1 , is very much greater than the surrounding temperature T_2 , T_2^4 becomes negligible compared with T_1^4 and equation (1) can, for high temperatures, thus be approximated by:

$$P_r = kAT_1^4; \quad (4)$$

That is, the radiation power, as function of the temperature, gradually changes from proportionality with the temperature rise, at low temperature rise, to proportionality with the fourth power of the temperature for high temperature rises.

Inversely then, with increasing power input into the radiator and thus increasing radiation power, its temperature first rises proportional to the power input and then slower and ultimately approaches proportionality with the fourth root of the power output:

$$T_1 = \sqrt[4]{\frac{P_r}{kA}}.$$

In Fig. 27 is shown the radiation curve, with the temperatures T as ordinates and the radiated power P_r as abscissas, the upper curve with 100 times the scale of abscissas.

Thus, to double the temperature rise, from 10 deg. cent. to 20 deg. cent., requires doubling the power input. To double, however, the temperature rise, from 1000 deg. cent. to 2000 deg. cent., requires an increase of the power input from 1273⁴ to 2273⁴, or more than ten fold. At high temperature the power input, therefore, increase enormously with the increase of temperature.

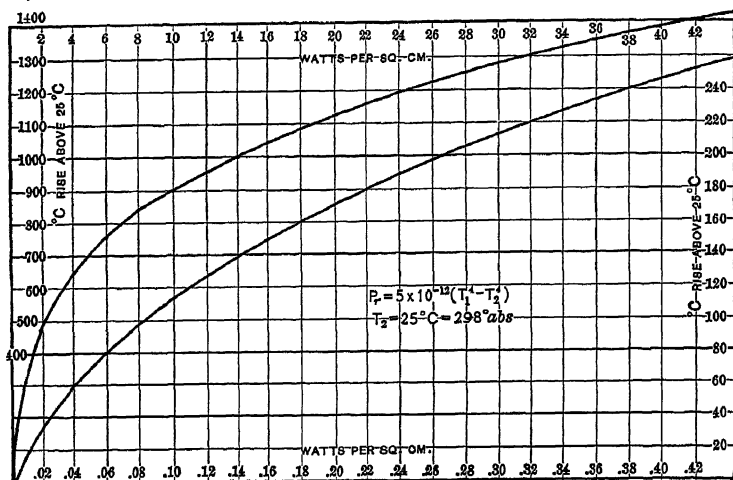

FIG. 27.

With bodies in a vacuum, the radiation power is the power input and this above law can be used to calculate the temperature of the radiator from the power input. In air, however, a large part of the energy is carried away by air currents, and this part of the power does not strictly follow the temperature law of radiation, equation (1). For radiators in stationary air (that is, not exposed to a forced blast, as the centrifugal blast of revolving machinery), the total power input for high temperature (as expended by radiation and heat convection) varies with a high power of the temperature, so that the radiation law equation (1) can still be used to get a rough approximation of the relative values of temperatures.

It, therefore, is not permissible to assume the temperature rise as proportional to the power input as soon as the temperature

rise is considerable and even in electrical apparatus of fire-proof construction as some rheostats, etc., where a higher temperature rise is permitted, the calculation of this temperature rise must be approximated by the general law (1) and not the law of proportionality (3), as the latter would give entirely wrong results. For instance, assuming a temperature rise of 50 deg. cent. per watt per sq. in. a cast silicon rod, which — at bright incandescence — can dissipate 200 watts per sq. in. would give by (3), a temperature rise of 10,000 deg. cent. This obviously is impossible, as silicon melts at about 1400 deg. cent.

35. With increasing temperature of the radiator, the intensity of the radiation increases, and at the same time the average frequency of radiation also increases, that is, the higher frequencies increase more rapidly than the lower frequencies and higher and higher frequencies appear, until ultimately frequencies are reached where the radiation becomes visible to the eye, as light. When with increasing temperature the radiation just begins to be visible, it appears as a faint colorless grey, "gespenster grau" exhibiting the same weird and indistinct appearance as are seen at higher intensities in the monochrome blue and violet radiations: that is, we see a faint grey light, but when we look at it, it has disappeared: the reason is that the sensitivity of the sensitive spot of the eye for very faint light is less than that of the surrounding retina and the first glimmer of light thus disappears as soon as we focus it on the sensitive spot. With increasing temperature, first the lowest of the visible frequencies appear and become visible as red light, and with still further increase of temperature gradually orange, yellow, green, blue, violet and ultra-violet rays appear and the color thus changes from red to orange, yellow, yellowish white and then white, the latter at that temperature where all the visible radiations are present in the same proportion as in daylight. With still further increase of temperature, the violet end of the spectrum would increase faster than the red end and the light thus shift to bluish white, blue and violet.

The invisibility of the radiation of low temperature is not due to low intensity. I have here an incandescent lamp at normal brilliancy. If I decrease the power input and thereby the radiated power to $\frac{1}{100}$ it becomes invisible, but if we move away from the lamp to 10 times the previous distance, we get only $\frac{1}{100}$ the radiation reaching our eyes and still the light is very plainly

visible. The invisibility in the former case, thus, is not due to low intensity, but to low frequency.

The fraction of the total radiation, which is visible to the eye as light, thus increases with the increasing temperature, from zero at low temperature — where the radiator does not give sufficiently high frequencies to be visible — and very low values when it just begins to be visible as red light, to a maximum at that temperature where the average frequency of the radiation is in the visible range, and it would decrease again for still higher temperature by the average frequency of radiation shifting beyond the visible into the ultra-violet. The efficiency of light production by incandescence thus rises with increasing temperature to a maximum, and then decreases again. If the total radiation varies with the fourth power of the temperature, it thus follows that the visible radiation first varies with a higher power of the temperature than the fourth, up to the maximum efficiency point, and beyond that increases with less than the fourth power of the temperature. The temperature at which the maximum efficiency of light production by incandescence occurs, that is, where the average frequency of temperature radiation is in the visible range, probably is between 5000 and 8000 deg. cent. and as the most refractory body, carbon, boils at 3750 deg. cent., this temperature thus is unattainable with any solid or liquid radiator.

Most bodies give approximately the same temperature radiation, that is, follow the temperature law (1), differing only by the numerical value of the constant k ; that is, with increase of temperature the radiation intensity increases and the average frequency of radiation increases in the same manner with most solid and liquid bodies, so that at the same temperature all the bodies of normal temperature radiation give the same radiation curve; that is, the same distribution of intensity as function of the frequency and thus the same fraction of visible to total radiation, that is, the same efficiency of light production.

If T is the absolute temperature in deg. cent. and l_w the wave length of radiation, the power radiated at wave length l_w and temperature T_1 by normal temperature radiation is:

$$P(l_w) = c_1 A l_w^{-a} \varepsilon^{-\frac{b}{l_w T}}, \quad (\text{Wien's law});$$

or,

$$P(l_w) = c_1 A l_w^{-a} \left\{ \varepsilon + \frac{b}{l_w T} - 1 \right\}^{-1} \quad (\text{Planck's law});$$

where $a = 5$ for normal temperature radiation or black body radiation: $b = 1.42$, and $A =$ surface area of the radiator.

Integrating the formula of Wien's law over l_w from 0 to ∞ , gives the total radiation:

$$P = \int_0^{\infty} P(l_w) dl_w = cAT^{a-1};$$

thus, for $a = 5$;

$$P = cAT^4;$$

or, Stefan's law, as discussed above.

The maximum energy rate at temperature T occurs at the wave length $l_w = l_m$ given by:

$$\frac{dP(l_w)}{dl_w} = 0,$$

which gives:

$$l_m T = \frac{c}{a} = 0.284;$$

or,

$$l_m = \frac{0.284}{T},$$

$$l_m = 50 \times 10^{-6} \quad \text{thus gives:}$$

$$T = \frac{0.284}{l_m} = 5680 \text{ deg. abs.}$$

With normal temperature radiation the efficiency of light production is thus merely a function of the temperature and does not depend upon the material of the radiating body, provided that the material is such as to withstand the temperature.

As the efficiency maximum of normal temperature radiation is far beyond the attainable, within the range of temperature available up to the boiling point of carbon, the efficiency of light production by incandescence continuously increases, but even then the octave of visible radiation is at the far upper end of the radiation curve, and thus the problem of efficient light production is to operate the radiator at the highest possible temperature.

The efficiency of light production is rather low even at the maximum efficiency point, that is, with the average frequency of radiation in the visible range, since this visible range is less than one octave; under these most favorable conditions the visible

energy probably does not much exceed 10 per cent of the total radiation, the rest falls below and above the visible frequencies.

36. At the highest attainable temperature, the boiling point of carbon, the efficiency is much lower, probably below 10 per cent and this would be the highest efficiency attainable by normal temperature radiation. It is utilized for light production in the carbon arc lamp. The carbon arc flame gives practically no light, but all the light comes from the incandescent tips of the carbon electrodes, mainly the positive, which are at the boiling point of carbon and thus give the most efficient temperature radiation.

Obviously, in the carbon arc lamp a very large part of the energy is wasted by heat conduction through the carbons, heat convection by air currents, etc., and the total efficiency of the carbon arc lamp, that is, the ratio of the power of the visible radiation to the total electric power input into the lamp, thus is much lower than the radiation efficiency, that is, the ratio of the power of the visible to the total radiation.

Thus the efficiency of the carbon arc is considerably increased by reducing the loss by heat conduction, by the use of smaller carbons — the life of the carbons, however, is greatly reduced thereby, due to their more rapid combustion.

The carbon arc lamp thus gives the most efficient incandescent light, as it operates at the highest temperature, the boiling point of carbon. But by doing so the radiator is continuously consumed and has to be fed into the arc. This requires an operating mechanism and becomes feasible only with large units of light.

To attain the highest possible efficiency of light production by temperature radiation with a permanent radiator, thus requires the use of extremely refractory bodies, since the efficiency increases with the increase of the temperature, and is still very low at the melting point of platinum.

To exclude all the losses of energy by heat conduction and heat convection, the radiator is enclosed in a vacuum, so that all the power input is converted into radiation. Even in this case the efficiency of light production is still relatively low.

The vacuum used in the incandescent lamp, thus, is not only for the purpose of protecting the filament from combustion. Filling the globe with some gas which does not attack the carbon would do this and yet it would very greatly lower the efficiency,

as can be seen by admitting air into the lamp bulb, when the filament drops down to dull red heat, before it burns through. However, the presence of an indifferent gas of low heat capacity may lower the evaporation of the filament and so permit operation at higher temperature, and the gain in efficiency more than makes up for the increased losses, as in the gas filled tungsten lamps.

A search, thus, has been made and is still being made, throughout the entire range of existing bodies, for very refractory materials. Such materials may be chemical elements or compounds. However, the combination of a refractory element with one of very much lower melting point lowers its melting point, and very refractory compounds, thus, may be expected only amongst the combinations of very refractory elements with each other.

The chemical elements, arranged in order of their atomic weight, exhibit a periodicity in their properties which permits

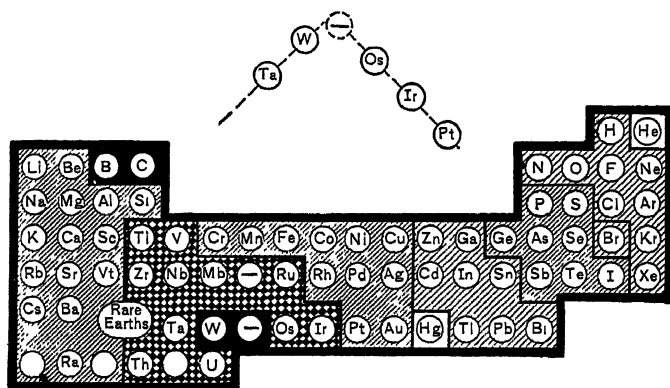

FIG. 28.

a systematic study of their properties. In diagram Fig. 28 the elements are arranged in order of their atomic weight in the "periodic system."

The height of their melting point is indicated by the darkness of the background. That is, the most refractory elements, wolfram and carbon, are shown on black background. The elements of somewhat lower melting point are shown on cross shaded background. Inversely, the elements of the lowest melting point, mercury under the metals and helium under metal-

loids, are shown on white background, and the easily fusible metals and gaseous metalloids on lightly shaded background.

As seen, there are two peaks of refractoriness, one amongst the metalloids, in carbon, and one under the metals in wolfram (or tungsten), and around these two peaks all the refractory elements are grouped. Inversely, there are also two depressions, or points of minimum melting point, in helium under the metalloids, around which all the gaseous elements are grouped, and in mercury under the metals, around which all the easily fusible metals are grouped.

It is interesting to note that the melting point rises towards wolfram from both sides, as diagrammatically illustrated at the top of Fig. 28, in such a manner that the maximum point should be expected in the space between wolfram and osmium and the unknown element, which belongs in this space of the periodic system, thus should be expected to have still a higher melting point than wolfram, and thus give a higher efficiency of light production.

As metal alloys almost always have lower melting points than their most refractory element, very refractory compounds thus may be expected only in the compounds between the very refractory elements, in which at least one is a metalloid, that is, amongst the carbides and borides and possibly silicides and titanides.

37. Some of the earliest work on incandescent lamps was carried out with metal filaments. Platinum and iridium, however, were not sufficiently refractory to give good efficiencies, and the very refractory metals were not yet available in sufficient purity. A small percentage of impurities, however, very greatly lowers the melting point, especially with metals of very high atomic weight. For instance, wolfram carbide contains only 3 per cent of carbon and 97 per cent of wolfram and even 0.1 per cent of carbon in wolfram metal thus means that over 3 per cent of the metal consists of the easily fusible carbide.

Very soon, therefore, metal filaments were abandoned and carbon used as lamp filament. While carbon is the most refractory body, remaining solid up to 3750 deg. cent., it was found that the carbon filament could not be operated much above 1800 deg. cent. without shortening the life of the lamp below economic limits by the evaporation of the carbon and the resulting blackening of the lamp globes. All bodies evaporate below their melting point.

Thus water evaporates considerably below the boiling point and even below the freezing point: ice and snow gradually disappear by evaporation even if the temperature never rises above the melting point. Considerable differences, however, exist between different bodies regarding their rate of evaporation. Thus water and benzine have practically the same boiling point, but at the same distance below the boiling point, benzine evaporates much faster than water; that is, has a much higher vapor tension. Carbon has a very high vapor tension, that is, shows a very rapid evaporation far below the boiling point, and since in the incandescent lamp the carbon vapor condenses and is deposited on the globe and carbon is black, it blackens the globe and obstructs the light. Also, the decrease of the filament section by evaporation increases its resistance and thereby decreases the power consumption and so still further lowers the efficiency. While, therefore, carbon remains solid up to 3750 deg. cent., at about 1800 deg. cent. its rate of evaporation is such as to lower the candle power of the lamp by 20 per cent in 500 hr. life, and at this temperature it gives only an output of one candle power for 3.1 watts input. Operating the carbon filament at higher temperature would increase the efficiency and thus reduce the cost of energy for the same amount of light, but would decrease the useful life of the lamp and, therefore, increase the cost of lamp renewals, and the most economical operation, as determined by balancing the cost of lamp renewals against the cost of energy, is reached by operating at such temperatures that the candle power of the lamp decreases by 20 per cent within 500 hr. life. The life of a lamp down to a decrease of candle power by 20 per cent, thus, is called the useful life, and when comparing the efficiencies of incandescent lamps it is essential to compare them on the basis of the same length of useful life: 500 hours with the carbon filament, since obviously by shortening the life higher efficiencies could be reached in any incandescent lamp. The operating temperature of the carbon filament lamp, thus, was limited by the vapor tension of carbon and not by its boiling point.

This limitation of carbon led to the revival of the metal filament lamps in recent years. First arrived the osmium lamp, with 1.5 watts per candle power. The melting point of osmium is very high, but still very much below that of carbon, but the vapor tension of osmium is very low even close to its melting point, so

that osmium could be operated at temperatures far closer to its melting point without appreciable evaporation; that is, without blackening and falling off of candle power, or, in other words, could be run at a temperature from which carbon was excluded by its too rapid evaporation. Osmium, however, is a very rare metal of the platinum group, and found only in very limited quantities in very few places and is one of those substances of which no search could very greatly increase the supply, and while one pound of osmium is sufficient for some 60,000 filaments, the total amount of osmium which has ever been found on earth would not be sufficient for one year's supply of incandescent lamps. Osmium, therefore, was excluded from general use by its limited supply.

The metal tantalum does not seem to have quite as high a melting point as osmium, as it can be operated only at 2 watts per candle power. Tantalum also is a very rare metal, but, unlike osmium, it is found in very many places, though in small quantities, but it is one of those substances, like the rare earth metals used in the Welsbach mantle, of which it seems that the supply could be indefinitely increased when required by the industries and the prices thus would go down with the demand, just as has been the case with the rare earths of the Welsbach mantle.

Last of all, however, was made available the most refractory of all metals, wolfram or tungsten, and permitted to lower the specific consumption to 1 to 1.25 watts and finally, in the gas filled lamp, to less than 0.5 watts per candle power. Wolfram melts far lower than carbon, probably at about 3200 deg. cent., but far above the temperature to which the carbon filament is limited by evaporation, and having practically no vapor tension below its melting point, it can be operated far above the temperature of the carbon filament, and thus gives a much higher efficiency. Tungsten (or rather wolfram, as the metal is called, tungsten is the name of its ore) is a fairly common metal, its salts are industrially used to a very large extent for fire-proofing fabrics and its supply practically unlimited.

These metal filaments thus differ from the carbon filament in that their temperature is limited by their melting point and not by evaporation, as is the case with the carbon filament, and thus their useful life is usually ended by the destruction of the filament by melting through at some weak spot, but not by blackening.

These filament lamps do not blacken the globe, except when the vacuum is defective or becomes defective, and by the residual gases in the lamp globe volatile compounds are formed, as tungsten oxides, which then deposit on the globe and terminate the life of the lamp. Even then their blackening is characteristically different from that of the carbon filament, in that it occurs very rapidly, and the lamp, after running possibly for hundreds or thousands of hours without blackening, suddenly blackens within a few days and thereby becomes inoperative, while with the carbon filament the blackening is gradual throughout the life.

38. By the use of these refractory metals the efficiency of light production by temperature radiation has been greatly increased, by permitting the use of higher temperatures in the radiator than were permissible with the carbon filament due to its evaporation. However, regarding the rate of evaporation, different modifications of carbon show very different characteristics. The carbon filaments first used in incandescent lamps were made by carbonizing vegetable fiber, as bamboo, or by squirting a solution of cellulose through a small hole into a hardening solution and carbonizing this structureless horn-like fiber. These filaments had a very high vapor tension, thus could not be run as hot as the modern carbon filament and so gave a lower efficiency. They are now used only as base filaments, that is, as core on which a more stable form of carbon is deposited. Such a form of carbon was found in carbon deposited on the filament by heating it in the vapor of gasolene or other hydrocarbons. This carbon deposit is of much lower electric resistance than the base on which it was deposited, its negative temperature coefficient of electric resistance is lower and its vapor tension so much lower as to make it possible to operate the lamp at a specific consumption of 3.1 watts per candle power. Of late years a still more stable form of carbon has been found in the so-called "metallic carbon," produced from the gasolene deposited carbon shell of the filament, by exposing it for several minutes to a temperature at the boiling point of carbon; that is, the highest attainable temperature in an electric carbon tube furnace. Hereby the gasolene deposited carbon of the filament shell — the inner base does not appreciably change its characteristics — acquires metallic characteristics: a low electric resistance, a positive tempera-

ture coefficient of electric resistance, metallic luster and elasticity and very low vapor tension, so that it can be run at higher temperature corresponding to a specific consumption of 2.5 to 2.6 watts per candle power, with very little blackening. These metalized carbon filament lamps exhibit characteristics similar to the metal filament lamps; their life is largely limited by breakage and not by blackening.

Whether hereby the possibilities of carbon are exhausted or still more stable forms of carbon will be found, which permit raising the filament temperature as near to the boiling point of carbon as the temperature of the wolfram filament is to its melting point* and thereby reach an efficiency superior to that of the tungsten lamp, remains to be seen, but does not appear entirely impossible. Carbon exists in a number of "allotropic" modifications of very different characteristics (similar to phosphorus in "yellow phosphorus," "red phosphorus" and "metallic phosphorus") to a greater extent than any other element, probably due to the tendency of the carbon atom to join with other carbon atoms into chains and rings, which tendency is the case of the infinite number of carbon compounds. These form two main groups: the chain carbon derivatives (methane-derivates) and the ring carbon derivatives (benzol derivatives). The latter are far more stable at high temperatures, since the breakage of the molecule by temperature vibration is less liable in a ring structure than a chain: a single break splits the molecule in a chain formation, while with a ring formation it still holds together until the break closes again. Chain hydrocarbons at higher temperatures usually convert to ring hydrocarbons. It is, therefore, reasonable to assume that the carbon skeleton left by the carbonization of the hydrocarbons also may exist in either of the two characteristic atomic groupings: as chain carbon and as ring carbon, and that the latter exhibits a much greater stability at high temperature than the former, that is, a lower vapor tension. Cellulose is a chain hydrocarbon, and as in carbonization it never passes through a fluid state, the molecular structure of its carbon atom probably remains essentially unchanged. Thus the base fila-

* As carbon boils, at atmospheric pressure, below its melting point, and the limiting temperature is that at which the filament ceases to be solid, with carbon the limit is the boiling point temperature, while with tungsten it is the melting point.

ment would be a chain carbon, and its low stability and high vapor tension, that is, the ease of breaking up of the molecules by evaporation, thus would be accounted for.

A carbon compound, however, which passes through the vapor state in carbonization, as the gasolene vapor in treating the carbon filament, would as vapor at high temperature largely convert into ring structures, that is, benzol derivates, and thus give a carbon deposit consisting largely of molecules in which the carbon atoms are grouped in rings. These molecules, therefore, are more stable at high temperatures, and thus exhibit the lower vapor tension shown by the gasolene deposited coating of the base filament. This deposited carbon, however, must be expected to have numerous side chains attached to the ring nuclei of the molecules, and the side chains are relatively easily split off at high temperatures, as is well known of the benzol derivates. As a result thereof, this form of carbon, which I may call "intermediate carbon," still shows a considerable vapor tension, due to the side chains of the ring structure. Exposure to extremely high temperatures splits off these side chains, which then rearrange into the only form of carbon stable at these very high temperatures; that is, ring structure and the "metallic" form of carbon produced from the gasolene deposited carbon by the electric furnace, thus would be largely ring structure of the carbon molecule, that is, the condensation of numerous rings, similar to that found in anthracene, etc. It, therefore, would have a very high stability at high temperature; that is, be difficult to split up and thus show the low vapor tension characteristic of the metallic carbon. In other words, the high vapor tension of most forms of carbon would be the result of the dissociation of complex carbon molecules of chain structures, or of side chains of ring structures, and a carbon atom of complete ring structure thus would only show the vapor tension corresponding to the molecular weight, which is very high, due to the large number of atoms in the molecule.

Thus two characteristic allotropic modifications of carbon may exist besides the transparent carbon or diamond:

(a). Chain carbon: high resistance, negative temperature coefficient of electric resistance, non-metallic character, high vapor tension at moderate temperature.

(b). Ring carbon: low resistance (within the range of

metallic resistivities), positive temperature coefficient of resistance, metallic character, low vapor tension at high temperatures. The latter one, obviously, is best suited as an incandescent radiator. It may be possible to introduce into the ring structure of the carbon molecule other atoms of very refractory nature, as boron, titanium, silicon, and by their chemical affinity still further increase the stability of the molecule, so that it does not appear outside of the possibility to find a form of carbon which as radiator would be superior to any metal filament. If carbon could be operated as near to its limit of solidness as tungsten, it would give about 0.15 watts per candle.

39. Most bodies show similar characteristic in their temperature radiation; that is, the total radiation varies in the same manner with the temperature as the fourth power of the absolute temperature. Thus the distribution of the frequencies in the radiation is the same for the same temperature, varies in the same manner with the temperature, so that the distribution of the radiation power between the different frequencies is a characteristic of the temperature, independent of the material of the body, and can be used for determining the temperature of the radiator.

Such bodies, therefore, are said to give normal temperature radiation.

Many bodies of normal temperature radiation give the same intensity, or power of radiation, at the same temperature, that is, have the same radiation constant k in equation (1); these bodies are called "black bodies," and their radiation "black body radiation." Their radiation is the maximum temperature radiation given by a body. Other bodies of normal radiation give a lower intensity or radiation, but so that their radiation is at any temperature and for any frequency the same fraction of the radiation of a black body. Their radiation, then, is called "grey body radiation," and they also would follow the radiation law equation (1), but with a constant k , which is a fraction of the constant k_0 of black body radiations:

$$k = bk_0.$$

For temperature radiation the following law applies:

"The temperature radiation of a body is at any temperature and at any frequency the same percentage of black body radiation

as the absorbed radiation of the body is of the total impinging radiation." (Kirchhoff's law.)

This law relates the behavior of a body towards radiation impinging upon it from other bodies, with its behavior as radiator.

A body which absorbs all the impinging radiation, that is, a black body, gives a maximum temperature radiation, and this radiation, thus, has been called the black body radiation. An opaque grey body of albedo a , that is, a body which reflects the same fraction a of the impinging radiation and thus absorbs the part $(1 - a)$ of the impinging radiation, thus gives as radiator the part $(1 - a)$ of black body radiation. That is, its radiation constant is

$$k = bk_0 = (1 - a) k_0,$$

and the radiation constant of any opaque body, thus, is the radiation constant of the black body multiplied by 1 minus its albedo a .

For a perfectly white or perfectly transparent body, the radiation constant, thus, would be zero; that is, this body would give no temperature radiation, would not become incandescent at high temperatures.

40. A colored body was defined as a body which reflects or transmits different fractions of the impinging radiation for different frequencies. Such a colored body usually absorbs different parts of the impinging radiation for different frequencies and as radiator, then, would for different frequencies give different fractions of black body radiation; that is, its radiation for some frequencies would be a greater part of black body radiation. The radiation of such a body is called "colored body radiation." In colored body radiation the distribution of intensities throughout the spectrum, that is, for different frequencies, thus differs from that of the black or grey body at the same temperature, that is, colored radiation is not normal radiation and thus also does not follow the temperature law equation (1).

For instance, if in Fig. 29, I is the curve of distribution of the intensity of radiation as function of the frequency, at a certain temperature, as the melting point of tungsten, for a black body; grey body radiation would be represented by curve II or III, in which the ordinates are a constant fraction of those of curve I. Curve II, for albedo $a = 0.3$, has the height $1 - a = 0.7$ times that of black body radiation I, that is, radiates 70 per cent as

much energy, at any temperature and of any frequency, as a black body. Curve III corresponds to albedo $a = 0.6$, or a radiation constant $1 - a = 0.4$ times that of the black body. Colored body radiation, then, would be represented by curves IV and V.

Representing the octave of visible radiation by L , the area of the curve within the limits of L to the total area of the radiation curve, gives the ratio of power visible to total radiation, or the "radiation efficiency." As seen, this radiation efficiency is the same for black and grey bodies, I, II, III, and the only difference between the black and the grey body is that with the grey body the amount of light per unit radiating surface is less, but the

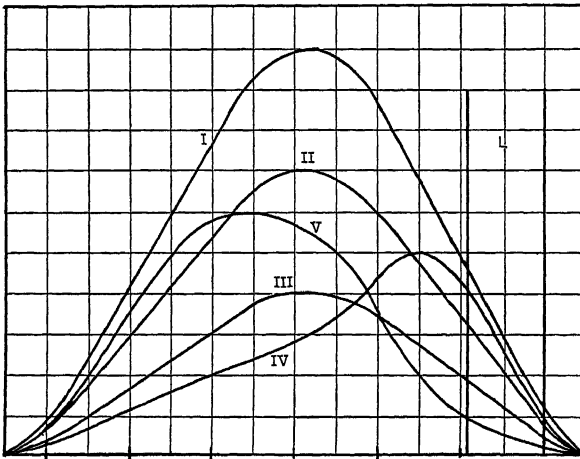

FIG. 29.

power required to maintain the temperature is correspondingly less, hence the efficiency is the same and merely a larger radiator surface required to produce the same amount of light; the larger the surface, the higher the albedo of the radiator. For colored radiators, however, the radiation efficiency may be different and frequently is. In the colored body IV, in which the radiation in the visible range is a greater part of the black body radiation I than in the invisible range, the radiation efficiency is greater than that of colorless or normal radiation at the same temperature; that is, such a colored body gives a higher efficiency of light production than corresponds to normal radiation at the same temperature. Such, for instance, is the case with the material of

the Welsbach mantle and to some extent probably also with the tungsten filament. Inversely, the colored body V, in which the radiation in the visible range is a lower percentage of black body radiation than in the invisible range, gives a lower efficiency of light production. Such, for instance, is the case with glass, which, therefore, would be an abnormally inefficient incandescent light producer.

To illustrate the difference in the radiation of black and grey bodies, I show you here a piece of graphite rod, around which a strip of platinum foil is wrapped in an open spiral and then it is enclosed in a transparent quartz tube. Heating it in the bunsen flame, you see the graphite becomes bright red, while the platinum foil surrounding it is far less luminous and the quartz tube is not luminous at all, though all three have practically the same temperature, or if anything, the outer quartz tube is the hottest, the interior graphite rod the coolest. Still, the graphite gives the greatest amount of light: graphite is a black body and thus gives maximum radiation; the platinum as a grey body gives less radiation at the same temperature and the quartz as a transparent body which absorbs almost no radiation, thus, also, gives out almost no radiation, that is, does not become luminous at a temperature at which the graphite is bright red.

I now drop a small platinum spiral into a mixture of the nitrates of thoria and ceria (the rare earths of the Welsbach mantle), and then immerse it in the bunsen flame. The nitrates convert to oxides, which fluff out into a very light and porous mass, which you see glow in a very intense, slightly greenish light, far brighter than the platinum wire immersed in the same flame. The distribution of intensity of this radiation differs from that corresponding to any temperature, and the percentage of visible radiation, especially from the center of the visible spectrum (greenish yellow), is abnormally large. This, therefore, is a colored radiator, giving a higher radiation efficiency than the normal temperature radiation.

A radiation which does not follow the temperature law of normal radiation as regard to the distribution of intensity with the frequency, is called "selective radiation." Colored body radiation, thus, is selective radiation.

In regard to their reaction on light impinging on them, in reflecting or transmitting it, most bodies are more or less colored and colorless bodies: black, grey, white, transparent, the exception.

Regarding the temperature radiation produced by the body as radiator, most bodies are more nearly colorless, black or grey bodies, that is, give normal radiation or nearly so, and colored or selective radiation of considerable intensity is the exception.

Obviously, no perfectly black, or even perfectly colorless radiator exists, but even carbon shows a slight selectivity, a slightly greater intensity of radiation at the red end of the spectrum than corresponds to the temperature.

Perfectly black body radiation, however, is the radiation at the inside of a hollow body of uniform temperature, and the laws of black body radiation, thus, are studied on the radiation in the interior of a closed shell with opaque walls of uniform temperature.

In the interior of such a hollow body of uniform temperature every surface element radiates to every other element and receives radiation from every other surface element, that is, the surface element A_1 receives as much radiation from element A_2 , as element A_2 receives from A_1 .

Of the radiation received by a surface element A_1 by the radiation law, that part which exists in the radiation produced by A_1 is absorbed, that part which does not exist in the temperature radiation of A_1 , is reflected, and the total radiation issuing from A_1 , the radiation produced by it plus that reflected by it, together, thus, make up complete black body radiation. If, then, the hollow radiator is a black body, it absorbs all the impinging radiation, reflects none, and the radiation issuing from it thus is the black body radiation produced by it. If the radiator is not a black body, but a grey or a colored body, of any frequency of radiation, for which it has the albedo a , only the part $(1 - a)$ is produced by it, but the part a of the impinging radiation of this frequency is reflected, and the total radiation of this frequency, thus, still is unity, that is, black body radiation.

Obviously, the body cannot be perfectly closed, but must contain an opening, through which the interior radiation is observed, but if this opening is sufficiently small it introduces no appreciable error.

The production of black body radiation from the interior of a hollow body obviously requires that the walls of the body be opaque; that is, that all the radiation produced inside of it is either absorbed or reflected, and also depends on the condition

that all the frequencies of black body radiation are present, since evidently, no frequency which is entirely absent in the radiation of the body could be produced by reflection. Furthermore, all the radiation must be temperature radiation, that is, no luminescence exist in the interior of the body. These requirements are easily fulfilled, except at extremely high temperatures.

41. The radiation laws offer a means of measuring temperature, and the only means for those very high temperatures where the gas thermometer (that is, the measurement of temperature by the expansion of a gas) and the thermo-electric couple or the resistance pyrometer cannot longer be used, as no material exists which remains solid at temperatures such as those of electric furnaces, etc.

As the total intensity of the radiation varies with the temperature, and the ratio of the intensity of radiation of any definite frequency to the total radiation, or the ratio of intensities at two different frequencies of radiation, is a function of the temperature, either can be used for measuring the temperature.

For instance, measuring the intensity of the total radiation — which in vacuum enclosed radiators as incandescent lamp filaments is done by measuring the power input — gives the temperature if the body is a black body and its radiating surface measured. If one temperature is known, as, for instance, by the melting point of some substance, by comparing the total radiation power with that at the known temperature, other temperatures can be measured.

.Determining the ratio of the power of the visible radiation, and that of the total radiation — that is, the radiation efficiency — thus gives the temperature for black bodies as well as grey body radiators, and thus is frequently called the “black body temperature.”

By comparing the intensity of any two radiations we get the temperature. This could be done by using two wave lengths of radiation in the visible range. For instance, the ratio of the intensity of the yellow and the blue radiation gives the temperature. Resolving, then, the radiation by a prism P in Fig. 30, into a spectrum, and by a shutter S_1 cutting out a definite width of yellow and of blue light, and combining these again by the mirror M_1 and M_2 , we get a resultant green color which is intermediate between yellow and blue, and the nearer to the blue, the higher the temperature. Arranging, then, the mov-

able shutter S_2 below S_1 with a single opening, we can by it cut out a single green color, and by moving the shutter S_2 bring this to coincidence in shade with the resultant color of shutter S_1 , and the position of the shutter S_2 then measures the temperature. The scale of such a direct vision pyrometer may either be calculated from the radiation laws, or it may be calibrated by some known temperatures, as the melting points of gold, platinum, boiling point of carbon, etc.

A number of types of such visual pyrometers have been developed, and are very convenient.

Their limitation, obviously, is that they apply only when the radiation is normal temperature radiation, but give wrong results where colored radiation or luminescence is present. Thus the

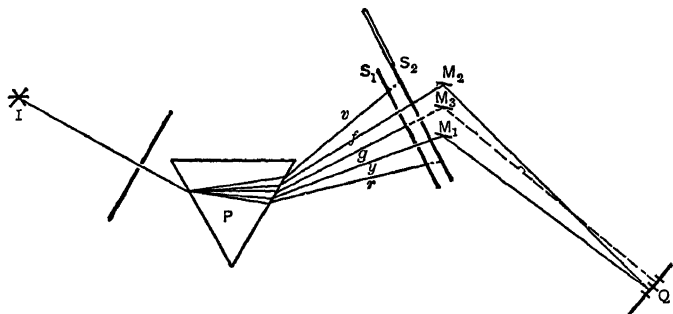

FIG. 30.

radiation given by the interior of a closed body of uniform temperature ceases to be black body radiation if the interior is filled with luminous vapors, as is frequently the case in the interior of electric furnaces. For instance, using such a visual pyrometer for the interior of the carbon tube furnace used for metallizing carbon filaments gives, frequently, quite impossible results, temperatures above those of the sun, due to the error caused by the luminescent silicon vapor filling the tube.

The errors of temperature measurements by radiation are the greater the nearer together the radiation frequencies are which are used for the measurement, hence are greatest with the visual pyrometers, least in the methods based on the total radiation power.

42. In the temperature radiation of a colored body the ratio of the intensity of the radiation to that of a black body of the

same temperature is different for different frequencies of radiation, and the average wave length of radiation and the total intensity of radiation of a colored body thus do not vary with the temperature in the same manner as is the case with the black and the grey body, that is, the normal radiation. The intensity of colored body radiation at any frequency cannot exceed the intensity of radiation of a black body at the same temperature and frequency, since the radiation of the black body is the maximum temperature radiation at any temperature and frequency.

A body which gives at some frequency a greater intensity of radiation than a black body of the same temperature is called *luminescent*, that is, said to possess "heat luminescence." Characteristic of heat luminescence, thus, is an excess of the intensity of radiation over that of a black body of the same temperature for some frequency or range of frequencies, and the color of luminescence is that of the radiation frequencies by which the luminescent body exceeds the black body.

It is not certain whether such heat luminescence exists.

The high efficiency of light production of the Welsbach mantel, of the lime light, the magnesium flame, the Nernst lamp, etc., are frequently attributed to heat luminescence.

The rare oxides of the Weisbach mantel, immersed in the bunsen flame, give an intensity of visible radiation higher than that of a black body, as a graphite rod, immersed in the same flame, and if we assume that these oxides are at the same temperature as the flame in which they are immersed, their light must be heat luminescence and not colored radiation, as the latter cannot exceed that of a black body. It is possible, however, that these oxides are at a higher temperature than the flame surrounding them, and as the radiation intensity of a black body rapidly rises with the temperature, the light radiation of the rare oxides, while greater than that of a black body of the flame temperature, may still be less than that of a black body of the same temperature which the oxides have, and their radiation, thus, colored temperature radiation and not luminescence. Very porous materials, as platinum sponge, absorb considerable quantities of gases, and by bringing them in close contact with each other in their interior cause chemical reaction between them, where such can occur, and thus heat and a temperature rise above surrounding space. Thus platinum sponge, or fine platinum wire, immersed

in a mixture of air and alcohol vapor at ordinary temperature, becomes incandescent by absorbing alcohol vapor and air and causing them to combine. The oxides of the Welsbach mantel, as produced by the deflagration of their nitrates, are in a very porous state, and thus it is quite likely that in the bunsen flame they absorb gas and air and cause them to combine at a far more rapid rate than in the flame, and thereby rise above the flame temperature. An argument in favor of this hypothesis is, that these oxides, when immersed in the bunsen flame in close contact with a good heat conductor, as platinum, and thereby kept from rising above the flame temperature, do not show this high luminosity. I have here a small, fairly closely wound platinum spiral filled with these oxides. Immersing it in the bunsen flame you see the oxides and the platinum wire surrounding them glow with the same yellow light, but see none of the greenish luminosity exhibited by the oxide when free in the flame, except at a few points at which the oxide projects beyond and is not cooled by the platinum spiral. The absence of a high selective luminosity of these oxides, when heated electrically in a vacuum or in an inactive gas, also points this way. The gradual decay of the luminosity shown by such radiators may be due to their becoming less porous, by sintering — this would account for the very rapid decay of the light of the lime cylinder in the hydro-oxygen flame, and the very small decay of the more refractory oxides in the Welsbach mantel — but it also may be the general characteristic of luminescence, as we have found in the discussion of fluorescence and phosphorescence.

In favor of heat luminescence as the cause of the very high efficiency of these radiators is, however, the similarity of the conditions under which it occurs, with those we find in fluorescence and phosphorescence. Just as neither calcium sulphide nor zinc silicate nor calcium carbonate are fluorescent or phosphorescent, when chemically pure, but the fluorescence and phosphorescence are due to the presence of a very small quantity of impurities, as manganese, so the pure oxides, thoria, erbia, ceria, do not give very high luminosity in the bunsen flame, but the high luminosity is shown by thoria when containing a very small percentage of other oxides.

While the existence of heat luminescence in these rare oxides is not certain, no theoretical reason exists against it, as at ordi-

nary temperature we have in phosphorescence the same phenomenon of the production of a radiation exceeding in intensity that of a black body of the same temperature: the black body radiation at ordinary temperature contains no visible rays, while that of a phosphorescent body does. Heat-luminescence, thus, may be considered as fluorescence at high temperature.

However, to some extent, the question of the existence of heat luminescence depends upon the definition of luminescence, and any colored radiation may be considered as heat luminescence of a grey body. For instance, the radiation represented by curves IV and V of Fig. 29, may be considered as colored temperature radiation, as they are below black body radiation, curve I. But as they exceed at some frequencies the curves of grey body radiation II and III, they may also be considered as heat luminescence of a grey body. If, then, we compare such curves of selective radiation, IV and V, with normal temperature radiation of the same total intensity — that is, with a grey body radiation of the same power at the same temperature — all such selective radiation can be considered as heat luminescence.

While the term "luminescence" is usually applied only to abnormally high radiation in the visible range, in its general physical meaning it applies to abnormal radiation of any frequency range, and curve V in Fig. 29, for instance, would be the curve of a grey body, which luminesces in the ultra-red, while curve IV would be that of a grey body, in which the heat luminescence is in the visible range.

In general, however, it is preferable to consider as luminescence only such radiation as exceeds the black body radiation of the same temperature, and this will be done in the following, while radiations which differ in their frequency distribution from the black body, without exceeding it in intensity, are considered as colored body radiations.

LECTURE VI.

LUMINESCENCE.

43. All methods of producing radiation, and more particularly light, other than the temperature radiation or incandescence, are generally comprised by the name *luminescence*. Some special cases of luminescence have already been discussed in the phenomena of fluorescence and phosphorescence, represented by the conversion of the radiation absorbed by a body into radiation of a different wave length.

Usually luminescence at ordinary temperature, or at moderate temperatures, that is, temperatures below incandescence, is called *fluorescence* or *phosphorescence*.

Fluorescence and Phosphorescence.

Fluorescence is the production of radiation from the energy supplied to and absorbed by the fluorescent body, while phosphorescence is the production of radiation from the energy stored in the phosphorescent body. This energy may be derived from internal changes in the body, as slow combustion, or may have been received by the body at some previous time — as by exposure to light a calcium sulphide screen absorbs the energy of incident radiation, stores it in some form, and afterwards radiates it.

Fluorescence and phosphorescence usually occur simultaneously: the energy supplied to such a luminescent body brings about certain changes in the body — as vibrations of the atoms, or whatever it may be — which cause the body to send out radiation. As long as this energy is supplied, the radiation of the body continues, that is, it fluoresces. The changes in the body which make it luminesce, represent energy storage — the kinetic energy of the luminescent vibration, etc. — and when the energy supply to the body ceases, the radiation issuing from the body does not instantly cease, but continues, with gradually decreasing intensity, until the stored energy is dissipated: the body phos-

phoresces. Inversely, fluorescent radiation probably does not appear instantly at full intensity, as energy has first to be stored. The persistence of the luminescence after the power supply has stopped, as phosphorescence, is very short, except with a few substances, where it lasts for days. Where the energy of phosphorescent radiation is supplied by the energy of chemical change in the body — as with yellow phosphorus — obviously the phosphorescence persists as long as these chemical changes can occur.

The different forms of luminescence may be distinguished by the character of the energy which is converted into radiation.

The conversion of radiation energy into radiation of different wave length, either immediately, or after storage in the body, thus may be called *radio-fluorescence* and *radio-phosphorescence*. It was discussed in Lecture II.

The same bodies, exposed to an electric discharge in a vacuum (Geissler tube or Crooke tube) show *electro-luminescence*, fluorescence as well as phosphorescence, and usually with the same color as in radio-luminescence.

Thermo-luminescence is exhibited by some materials, as the violet colored crystals of fluorite (CaFl_2), which, when slightly warmed, luminesce — it is this which gave the name “fluorescence” to the phenomenon.

Some solutions, when crystallizing, show light during the formation of crystals, and thus may be said to exhibit a *physical phosphorescence*.

Chemical phosphorescence is exhibited by yellow phosphorus and its solutions, which in the air glow by slow combustion, at ordinary atmospheric temperature. As the ignition point of phosphorus, that is, the temperature where it spontaneously ignites, is little above atmospheric temperature, the chemical phosphorescence of phosphorus occurs at temperatures a few degrees below ignition; it ceases, however, at very low temperature.

The chemical luminescence, as shown by phosphorus, is not an exceptional phenomenon, but many substances exhibit chemical phosphorescence at temperatures a few degrees below their ignition temperature, as the result of slow combustion. With those substances which have an ignition point above incandescence, this cannot be observed, but it is observed, for instance, in carbon bisulphide, CS_2 , which ignites spontaneously at about

180 deg. cent., and a few degrees below this temperature phosphoresces in air, by slow combustion.

A *biological phosphorescence* is shown by many forms of life: some bacilli of putrefaction phosphoresce, and are the cause of the faint glow occasionally observed in decaying food, especially fishes. Amongst insects and numerous sea animals of different classes, especially deep-sea animals, phosphorescence is frequently met, but its origin, that is, the mechanism of light production by the firefly, etc., is still unknown.

When splitting a sheet of mica, or shaking a well-exhausted tube containing mercury, flashes of light are seen in the darkness. This, however, is not real phosphorescence but due to electrostatic flashes of frictional electricity.

The light given by fluorescence and phosphorescence of solids or liquids, gives a continuous spectrum, that is, is a mixture of all frequencies, just as is the case with temperature radiation; it differs, however, from temperature radiation by the distribution of the energy in the spectrum, which is more or less characteristic of the luminescent body, and to some extent, also, of the method of exciting the luminescence. Thus crystalline calcium tungstate, WO_4Ca , fluoresces white in the X-ray, light blue with ultra-violet light; the aniline dye, rhodamine 6 G, in alcoholic solution fluoresces green in daylight, crimson in the light of the mercury lamp; willemite (calcium silicate) shows a maximum fluorescent radiation in the green, some chalcites in the red, etc.

So far, fluorescence and phosphorescence have not yet found any extended industrial application.

44. Some of the characteristic forms of luminescence at higher temperatures are *pyro-luminescence*, *chemical-luminescence*, and *electro-luminescence*.

As *pyro-luminescence* or *heat-luminescence*, must be considered all radiation, produced by heat, which exceeds at some wave length the intensity of the black body radiation at the same temperature.

Whether real pyro-luminescence exists, is uncertain, but by an extension of the definition any colored temperature radiation may be considered as heat luminescence of a grey body of an albedo which as normal temperature radiation would give the same total radiation at the same temperature as the colored radiator. Heat luminescence has been discussed already under colored radiation.

Chemical Luminescence.

Whenever intense chemical changes take place at higher temperature, luminescence frequently occurs. I have here an ordinary, non-luminous bunsen flame. I dip a platinum wire into a solution of lithium chloride, LiCl , and then hold it into the lower edge of the flame: the flame colors a bright red, and through the spectroscope you see a bright deep red line and a less bright orange line, the spectrum of Li . After a little while, the coloring disappears by the LiCl evaporating from the wire, and the flame again becomes non-luminous. I repeat the same experiment, but dip the platinum wire into sodium chloride, NaCl , solution, and you see the flame colored brightly yellow, and the spectroscope shows one yellow line, the sodium line D . Dipping the platinum wire into thallium chloride, TlCl , I color the flame a bright deep green, the characteristic Tl spectrum, which has one bright green line. As you see, the green coloring disappears more rapidly than the yellow did, and the flame turns yellow; the Tl salt is more volatile than the sodium salt, evaporates more rapidly, and as it contains some Na as impurity, the latter becomes visible as yellow flame coloring after the Tl has evaporated.

In the bunsen flame these salts are evaporated, split up into their elements by the flame gases, and recombine, and by these chemical changes the atoms of Li , Na or Tl are set in vibration, and as vapors, being free to vibrate without mutual interference, they vibrate with their characteristic frequency, that is, give a definite frequency and thus color of the light, independent of the temperature; if we introduce the same salts into the carbon arc we get the same color and the same spectrum lines, only much brighter, as at the much higher temperature of the arc flame the vibration is far more intense; but it is of the same frequency, and in this respect essentially differs from temperature radiation which varies in frequency with the temperature.

In the same manner by introducing Sr , Ba or Ca salts in the bunsen flame, the flame is colored with other characteristic colors; bright red, green, orange. The spectroscope shows in every case a spectrum having a number of definite lines which are brightest and most numerous in the red for Sr , in the green for Ba , and in the orange yellow for Ca . In general,

metal spectra show a number, frequently very many lines in the visible range.

As Sr, Ba, Ca, are much less volatile than Li, Na, Tl, to get good effects in the bunsen flame, instead of the chlorides, the nitrates, or preferably the chlorates or perchlorates are used, which are more unstable, and thus easier split up and carried into the flame. At the much higher temperature of the carbon arc, the chlorides, or even the still more refractory oxides are used.

Chemical luminescence is used industrially in fireworks and colored signal lights; salts of these metals with acids which contain a large amount of easily split off oxygen, as nitrates, or more commonly chlorates and perchlorates, are mixed with some combustible material, as charcoal, sugar, sulphur, antimony sulphide, etc. When ignited, the combustible burns with the oxygen given off by the nitrates or chlorates, and in the focus of this intense chemical action, intense luminescence of the metal is produced. Thus Sr gives a bright red, Ba a green, Ca an orange yellow, copper ammon a blue coloring.

Electro-luminescence of Gases and Vapors.

45. Industrially this is the most important form of luminescence. Solids and liquids can be made to luminesce only indirectly by exposure to electric discharges, as electrical fluorescence. Gases, however — and under gases here and in the following we include vapors as, for instance, the carbon vapor, which is the conductor in the carbon arc — become electro-luminescent by being used as conductors of the electric current. It is a characteristic of electric conduction of the gases that this conduction is accompanied by the production of radiation, and in the electric conduction of gases we thus find the means of a more direct conversion of electric energy into radiation, and thus into light. It is, therefore, in this direction that a radical advance in the efficiency of light production would be possible, and the subject of electric conduction of gases (including vapors) thus is of the highest importance.

Two forms of electric conduction in gases exist: *disruptive conduction*, as represented by the Geissler discharge or the electrostatic spark, and *continuous conduction*, as represented by the electric arc.

Disruptive Conduction.

In *disruptive conduction* the conductor is the gas which fills the space between the terminals, and in carrying the current is made luminous. The color of the light and its spectrum is that of the gas which fills the space, and the electrode material has no effect on the phenomenon, is immaterial (in the Geissler tube, or the spark gap, any material may be used as terminal, if it otherwise is suitable, that is, is not destroyed by whatever heat is produced at the terminals, or by the chemical action of the gas in the space, etc.) usually, however, the electrodes gradually disintegrate in disruptive conduction.

Disruptive conduction is discontinuous; that is, no current exists below a certain definite voltage, while above this voltage there is current. The voltage at which conduction begins is called the *disruptive voltage*. It is the minimum supply voltage at which current exists: if the supply voltage rises above this value there is current; if it drops below the disruptive voltage the current ceases, but begins again spontaneously as soon as the voltage rises above the disruptive value. Disruptive conduction thus occurs equally well with unidirectional, with alternating, or with oscillating currents. It is best studied with alternating or oscillating voltage supply, as with a steady unidirectional voltage, the disruptive conduction, that is, conduction by the gas filling the space between the electrodes, tends to change to continuous conduction, by vapors forming at the negative electrode and gradually bridging the space between the electrodes, and thereby replacing the gas which fills the space, by the electrode vapor as conductor. This is usually expressed by saying: the electrostatic spark between two terminals starts, or tends to start, an arc.

Disruptive conduction, thus, does not follow Ohm's law; it is zero below the disruptive voltage, while with a supply voltage exceeding the disruptive voltage of the gas between the terminals, current exists, but the terminal voltage is apparently independent of the current, that is, if the other conditions as temperature, gas pressure, etc., remain the same, the terminal voltage of the Geissler tube or the spark gap remains the same and independent of the current, and the current is determined by the impedance between the Geissler tube or spark gap and the source of

e.m.f., or by the available power of the supply source. A Geissler tube, thus, cannot be operated directly on a constant potential supply of unlimited power, but requires a current limiting impedance in series with it, or a source of limited power, that is, a source in which the voltage drops with increase of current, as a constant current transformer or an electrostatic machine, etc.

The disruptive voltage essentially depends on the gas pressure in the space between the electrodes, and also on the chemical nature, and on the temperature of the gas. It is over a wide range, directly proportional to the gas pressure. Thus, at n atmospheres pressure the voltage required to jump a spark between two terminals is n times as great as at one atmosphere. This law seems to hold from the highest pressures which have been investigated down to pressures of a few mm. mercury, that is, down to about $\frac{1}{100}$ atmosphere. When coming to still lower pressures, however, the disruptive voltage decreases less, ultimately reaches a minimum — usually somewhere between 1 mm. and 0.1 mm. mercury pressure — and then increases again and at extremely high vacua becomes much higher than at atmospheric pressure, so that it seems that it is infinite in a perfect vacuum, that is, no voltage can start conduction through a perfect vacuum. As the gas filling the space is the conductor in disruptive conduction, it is easily understood that in a perfectly empty space, or an absolute vacuum, no disruptive conduction would exist.

The visible phenomena of disruptive conduction very greatly change with the change of gas pressure; from the electrostatic spark at atmospheric pressures to the Geissler tube glow in the vacuum; but the change is gradual, thus showing the identity of the two phenomena. At atmospheric pressure, disruptive conduction occurs by a sharply defined, relatively thin and noisy spark of very high brilliancy, which traverses the space between the electrodes in an erratic zigzag path, not unlike in appearance to the mechanical fracture of a solid material; and, indeed, the spark is an electrostatic rupture of the gas. If the electrostatic field is fairly uniform, as between parallel plates, or between spheres of a diameter 1.5 or more times their distance, with gradual rising voltage, the spark occurs when the disruptive voltage is reached, without being preceded, at lower voltage, by

any other phenomenon. If, however, the electrostatic field is not uniform, as, for instance, between needle points or small spheres or wires, with increasing voltage the disruptive strength of the gas is exceeded at those places where the field intensity is highest, as at the needle points, before the disruptive voltage of the spark gap is reached, and then a partial break down occurs at the points of maximum field intensity, as at the needle points, or at the surface of high potential conductors, etc. A blue glow, then, appears at the needle points, followed by violet streamers (in air, the color being the nitrogen spectrum; in other gases other colors appear), and gradually increases in extent with increasing voltage, the so-called "brush discharge," or "corona." Between needle points the brush discharges increase in extent, and approach each other until they bridge nearly 60 per cent of the gap, and then the static spark occurs.

At higher gas pressures the spark increases in brilliancy, in noisiness, but gets thinner. If, however, we gradually decrease the gas pressure, the spark gets thicker, less brilliant, and less noisy, its edges are less sharply defined, that is, get more diffused, and ultimately it passes between the terminals as a moderately bright, thick and noiseless stream, gradually fading at its outside, and at still higher vacua it fills the entire space of the vacuum tube. At the same time the required voltage is decreased with decreasing gas pressure, as discussed above.

46. I show you here (Fig. 31) the gradual change from the static spark to the Geissler tube glow: in a closed glass tube *G*, I have two needle-shaped terminals, 5 cm. distant from each other, and supply them with energy from a small 33,000-volt transformer. You see the oscillating static spark at atmospheric pressure. By now exhausting the tube, while the voltage is maintained at the terminals, you can watch the gradual change from the static spark to the Geissler tube glow. In this experiment, a small condenser, a Leyden jar, is shunted across the high-potential terminals of the transformer, to guard against the disruptive conduction changing to continuous conduction, that is, to an arc, and a reactance inserted into the low-tension primary of the step-up transformer, to limit the discharge current, as shown diagrammatically in Fig. 31.

If the Geissler tube has a considerable diameter, 3 to 5 cm., the Geissler discharge with alternating current is striated; that

is, disk-shaped bright spots with diffused outlines alternate with less luminous spaces, about as shown in Fig. 32. The distance between the luminous disks increases with decrease of the gas pressure. Two sets of such disks exist, one issuing from the one, the other from the other terminal. They are stationary

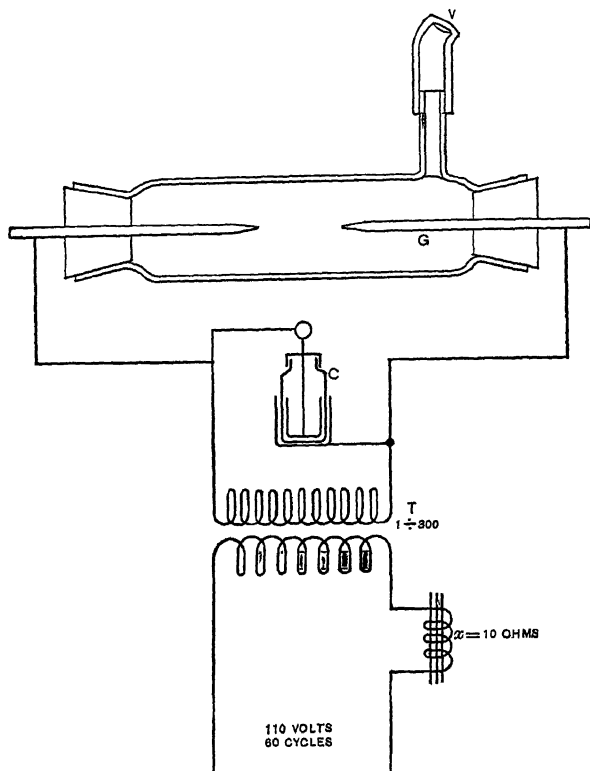

FIG. 31.

only if the gas pressure is perfectly constant, but separate and contract with the slightest change of pressure, hence are almost never at rest, but constantly moving through each other. The two sets of disks, by passing through each other during their motion, give rise to a number of different appearances. Some of the successive shapes are shown in Fig. 32.

The voltage distribution in the space between the terminals, in disruptive conduction, also changes with the pressure: at

atmospheric pressure, practically all the voltage is consumed in the space between the terminals, and between needle points for distances of 10 cm. and over very closely 4000 volts effective alternating per cm. (10,000 volts per inch) are required (corresponding to a breakdown gradient of 30,000 volts per cm. in a uniform field). With

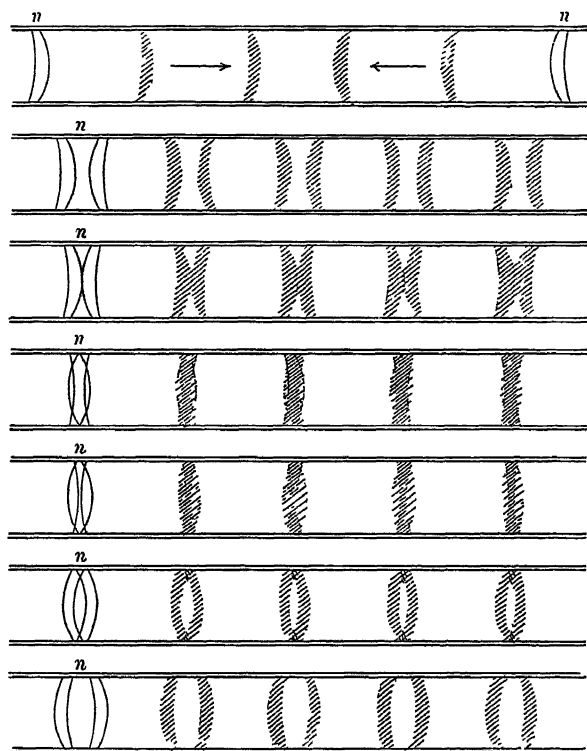

FIG. 32.

decreasing gas pressure the voltage consumed in the space between the terminals decreases, but the voltage consumed at the terminals increases, and in a good Geissler tube vacuum with nitrogen gas filling the space between the terminals, from 1000 to 3000 volts may be consumed at the terminals, while the voltage consumed in the space between the terminals may drop as low as 2 volts per cm. or less.

The voltage consumed at the terminals seems to decrease with increase of their size. The voltage consumed in the space be-

tween the terminals, that is, in the luminous stream of the Geissler tube, seems to be practically independent, not only of current, but also of the size of the tube, as should be expected with a disruptive discharge. It varies, however, with the temperature, and is different with different gases, that is, different gases have different disruptive strength.

The light given by the Geissler tube shows the spectrum of gas, and thus is very bright and fairly efficient with a gas as nitrogen, and especially neon, which gives a large number of spectral lines in the visible range, and less efficient with a gas as carbon dioxide or hydrogen, in which the lines in the visible range represent only a small part of the radiated energy.

The industrial use of the electro-luminescence of disruptive conduction, that is, Geissler tube lighting, is still limited (No tube). So far only nitrogen gives a fairly good efficiency; it reaches apparently values between the tungsten lamp and the tall lum lamp, or, a specific consumption of two watts per m spherical candle power. The color of the nitrogen spectrum is a reddish yellow. As the range of gas pressure in which the voltage is near the minimum is very narrow, and the gas pressure changes during operation, by absorption at the electrodes etc., means have to be provided to maintain constant gas pressure by automatically feeding gas into the tube whenever the pressure drops below the minimum voltage or maximum efficiency point. The greatest disadvantage of Geissler tube lighting however, is the high voltage required at the terminals. To obtain fair efficiency the tube must be so long that the voltage consumed in the stream — which represents the power converted into light — is much larger than the voltage consumed at the terminals — which represents wasted power. With a terminal drop of 2000 volts, and two volts per cm. in the conducting stream, to use half of the supply voltage for light production, it requires a tube length of $2000/2 = 1000$ cm. = 10 m. or 33 ft and to use 80 per cent of the supply voltage for light production that is, waste only 20 per cent of the supplied power in heating terminals, requires a tube length of $8000/2 = 40$ m. or 133 ft. Thus the Geissler tube as an illuminant is essentially a large source of light, requiring high voltage (which obviously may be produced by a transformer at the tube) and having a very great size. It gives, however, low intrinsic brilliancy and splendid diffusion

the light. Neon gives a still much higher efficiency, though a red light, and as a noble gas is only very slowly absorbed, but is a very rare gas.

Continuous Conduction.

47. In *continuous conduction*, or arc conduction, the conductor is a stream of electrode vapor, which bridges the gap between the electrodes or terminals.

While in the spark, or the Geissler discharge, the conductor is the gas which fills the space between the terminals, in the electric arc the current makes its own conductor, by evaporation of the electrode material, and maintains this conductor by maintaining a supply of conducting vapor. The color and the spectrum of the arc, thus, are those of the electrode material, and not of the gas which fills the space in which the arc is produced, and the nature of the gas in the space thus has no direct effect on the arc. Its pressure obviously has an effect, as the vapor pressure of the conducting arc stream is that of surrounding space, thus increases with increasing gas pressure, and the arc vapor then contracts, the arc gets thinner, while with decrease of the gas pressure in the space surrounding the arc the vapor pressure of the arc stream also decreases, thus the vapor expands, and the arc stream becomes larger in section and correspondingly less luminous.

As the arc conductor is a vapor stream of electrode material, this vapor stream must first be produced, that is, energy must first be expended before arc conduction can take place. An arc, that is, continuous conduction, therefore, does not start spontaneously between the arc terminals if sufficient voltage is supplied at the terminals to maintain the arc, but the arc has first to be started, that is, the conducting vapor bridge produced by the expenditure of energy.

If, therefore, in the arc the current ceases even momentarily, the conduction ceases by the disappearance of the vapor stream and does not start again spontaneously, but the arc has to be started by producing a vapor stream. With alternating voltage supply the arc, thus, would go out at the zero of current and have to be started again at every half wave. In general, the arc, thus, is a direct current phenomenon.

Some of the means of starting arc conduction are:

(1.) By bringing the terminals into contact with each other and thereby closing the circuit, that is, establishing the current, and then slowly separating them. In the moment of separation the contact point is heated, vapor produced at it, and during the separation of the terminals, a vapor stream is left behind as conducting bridge. Obviously, if the terminals are separated very rapidly, and the voltage is not much higher than required to maintain the arc, not enough vapor may be produced to conduct the current, and the arc does not start.

(2.) By raising the voltage between the terminals so high that a static spark passes between them, that is, disruptive conduction occurs. The energy of this static spark, if sufficiently large, that is, if the high voltage is maintained sufficiently long, then produces the vapor stream and starts the arc, that is, the arc follows the spark. If the duration of the high voltage is very short, the energy of the spark may not be sufficient to start the arc. Thus high frequency discharges between live terminals frequently are not followed by an arc, and the lower the voltage between the terminals is, the more powerful a static spark is required to start an arc.

(3.) By supplying the conducting vapor stream from another arc, that is, by an auxiliary arc. If the vapor stream of this auxiliary arc issues from the same terminal as the vapor stream of the main arc which is to be started, only the normal operating voltage is required in starting the latter arc, while a higher voltage is required, if the vapor is supplied by an entirely separate arc.

(4.) By raising the space between the terminals to a very high temperature, as by bridging the terminals by a carbon filament, and by the passage of current raising this filament to very high temperature.

48. The sharp distinction between the arc, in which the current makes its own conductor by a vapor stream issuing from the terminals, and the Geissler discharge, in which the current uses the gas which fills the space as conductor, is best illustrated by using in either case the same material, mercury, as conductor. I have here a vacuum tube, shown to scale in Fig. 33, about 2.5 cm. diameter, with three mercury terminals. The tube has four mercury terminals, of which, however, I use only three. The

gas which fills the space between the terminals is mercury vapor.* I now connect, as shown diagrammatically in Fig. 34, terminals 2 and 3 to the high potential coil of a step-up transformer — the low potential circuit contains a reactance to limit the current — and you see the striated Geissler discharge through mercury

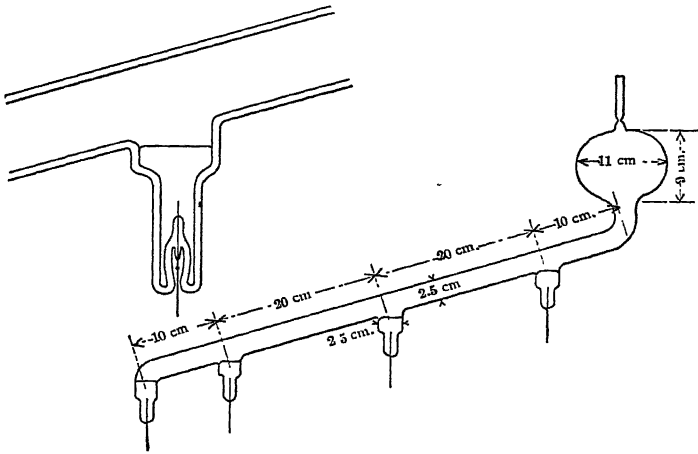

FIG. 33.

vapor appear between terminals 2 and 3, giving the green light of the mercury spectrum. The terminals are quiet, as they do not participate in the conduction. I now connect terminals 1 and 2 through a resistance, to a direct current supply, and tilt the tube momentarily to let some mercury run over from 2 to 1, and by thus momentarily connecting these terminals, establish the current and so start the arc, and you see the mercury arc pass between terminals 1 and 2, and see at one terminal — the negative one — a rapidly moving bright spot, which marks the point from which the vapor stream issues which carries the current. We have here in one and the same vacuum tube, and with the same material — thus, the same color and spectrum of light, both types of conduction — the continuous high current and low voltage conduction of the mercury arc, and the striated high voltage low current disruptive conduction of the Geissler discharge through mercury vapor.

The conducting vapor stream which carries the current in the arc, at least in all arcs which so far have been investigated, issues

* A trace of hydrogen is left in the tube, to lower the alternating voltage required for its operation.

from the negative terminal or cathode, and is in rapid motion from the negative towards the positive. The character of the arc, therefore, is determined by the material of the negative terminal, the temperature of the arc stream in general probably is the temperature of the boiling point of the negative terminal,

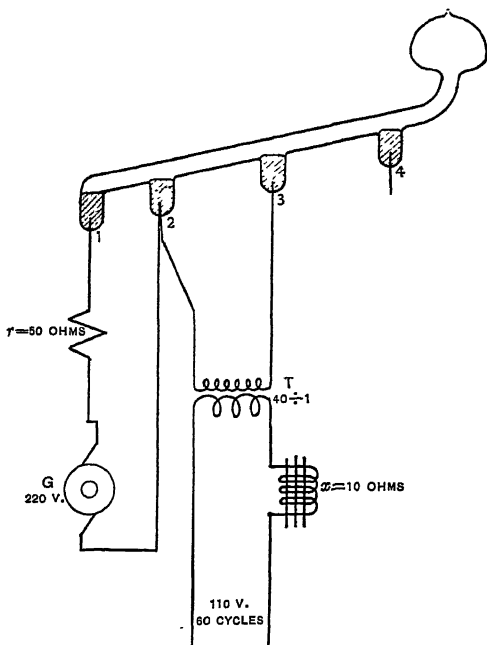

FIG. 34.

and the spectrum of the arc is the spectrum of the negative terminal. An exception herefrom, occurs only in those cases in which the positive terminal contains material which boils below the temperature of the arc stream (flame carbons) and the positive terminal is made so small that its tip is raised to the temperature of the arc stream, and at this temperature heat evaporation of the material of the positive occurs. These vapors enter the arc stream, and there become luminous, possibly by chemical luminescence, and add their spectrum to that of the arc conductor, that is, the negative material. In this case the arc spectrum shows the negative as well as the positive material, or at least the more volatile components of the positive material.

LUMINESCENCE.

With the exception of this case of heat evaporation from positive terminal, the material of the positive terminal does not participate in the phenomena occurring in the arc. The positive can be made of any conducting and refractory material and if made sufficiently large not to get too hot, does not consume; only the negative terminal of the arc consumes in feeding the arc flame, that is, supplying the vapor conductor, but the positive is inherently non-consuming, and may be made a permanent part of the arc-lamp mechanism. On the contrary, the negative terminal is made so large that its temperature remains very low, below the arc temperature, condensation of the arc vapor occurs at it, and it builds up, that is, increases in size. Consumption of the positive terminal is thus due merely to the heat produced at it by combustion or heat evaporation.

While the arc conductor issues from the negative terminal, in general more heat is produced at the positive terminal. With both terminals of the same size and material, as usual in the carbon arc, the positive gets hotter, and therefore in air burns off faster, which has led to the erroneous assumption that the positive feeds the arc.

While carbon was the material most commonly used as terminal, the carbon arc is not a typical arc, but is an exceptional one.

(1) Because carbon is one of the very few substances which change directly from the solid to the vapor state, that is, does not melt at atmospheric pressure, but boils below the melting point.

(2) Carbon is the most refractory substance and the temperature of the carbon arc higher than the boiling point of any other substance. Any material existing in the terminals of a carbon arc thus evaporates, and by entering the arc stream shows a continuous spectrum, so that luminescent material can be fed into the carbon arc from either terminal.

(3) At the temperature of the carbon arc all gases and vapors have become good conductors, and a carbon arc thus can operate equally well on alternating current as on direct current; though the voltage required to maintain the carbon arc is sufficient after the reversal of current, to restart it through the hot carbon vapor.

A typical arc is shown in Fig. 35 as the magnetite arc with a lower negative terminal *M* consisting of magnetite, and the non-consuming upper terminal *C* of copper, and of

size that it does not get so hot as to oxidize or evaporate, but sufficiently hot to avoid condensation of magnetite vapor on it.

The arc flame consists of an inner cylindrical core *A*, of bluish white color and high brilliancy, slightly tapering at both ends, which is surrounded by a less luminous shell *B*, of more yellowish color, narrowest at the negative end, and increasing in diameter towards the positive, surrounding the latter.

The inner core *A* is the arc conductor, or conducting vapor stream, while the outer shell *B* is non-conducting luminous vapor, possibly containing particles of solid material floating in it as incandescent bodies.

The arc conductor *A* issues from a depression *S* in a melted pool *P* formed on the surface of the terminal *M*. This depression *S* is in a rapid and erratic motion, and thereby causes a constant and rapid flickering of the arc. It is this flickering, inherent to all arcs in which the negative terminal is fusible (which therefore does not exist in the carbon arc), which has

retarded the industrial development of the more efficient metal arcs until late years. Its cause is the reaction exerted by the velocity of the vapor blast from the negative, which presses the surface of the liquid pool down at the point from which the current issues. The starting point of the current continuously climbs up the side of this depression, in shortening the arc, but, in doing so, depresses its new starting point, that is, the depression *S*, and thereby the negative end of the arc stream moves over the surface the faster the more fluid the surface is. In the mercury arc, this phenomenon of the running spot at the negative terminal thus is very marked, but not so objectionable, as the arc stream is so long that the flicker at the negative terminal has no effect on the total light. This flickering disappears in the magnetite arc if we destroy the fluidity of the melted magnetite by mixing with it some much more refractory material, as chromite. The chromite remains solid and holds the melted magnetite like a sponge. The reaction of the vapor blast, then, cannot depress its starting point, and no tendency exists of shifting the starting point, and the arc becomes



FIG. 35.

steady. In this manner such arcs have now been made steady and thereby suitable for industrial use.

49. Since the arc conductor issues as a rapidly moving vapor stream from the negative terminal or cathode, it must be continuous at the cathode; if interrupted even for a very short time at the cathode, a break exists in the continuity of the conductor and conduction ceases, that is, the arc extinguishes. At any other point of the arc stream, however, a break in the continuity of the stream may exist, provided that current continues from the negative, since such a break in the continuity of the conducting vapor stream is bridged again, and conduction re-established by the vapor stream coming from the negative. Thus the

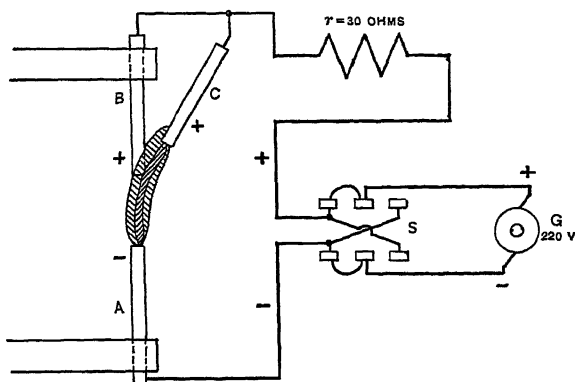

FIG. 36.

arc can be started by merely starting a conducting vapor stream from the negative, as by an auxiliary arc. As soon as this conducting vapor reaches the positive terminal, it closes the circuit and establishes conduction. An arc can be shifted or jumped from one positive terminal to another one, but cannot be shifted from negative to negative; the negative terminal, as the source of the conducting vapor stream, must be continuous.

To illustrate this, I have here (Fig. 36) in a hand lamp two copper rods *A* and *B* of about 5 mm. diameter, as arc terminals, separated by 2.5 cm., and connected into a 220-volt direct-current circuit, with sufficient resistances in series to limit the current to about 4 amperes. A third copper rod of the same size, *C*, is connected by a flexible lead to the upper terminal *B*. I close the reversing switch *S* so as to make *A* negative, and *B* and *C*

positive, and start an arc between A and C by touching C to A . I draw this arc to about 4 cm. length, and without touching C with B , as soon as the conducting vapor stream of the arc AC (the inner core A of Fig. 35) touches B , as shown in Fig. 36, the arc leaves C and goes to B , that is, by the arc AC I have started arc AB . If I had separate resistances in series with the terminals B and C , the arc AC would also continue to exist after it started arc AB ; otherwise, as two arcs cannot run in parallel, the longer arc, AC , goes out as soon as the shorter arc AB starts.

I now reverse the circuit by throwing switch S , and make A positive, and B and C negative, again start AC by contact, and draw it out until the arc flame wraps itself all around terminal

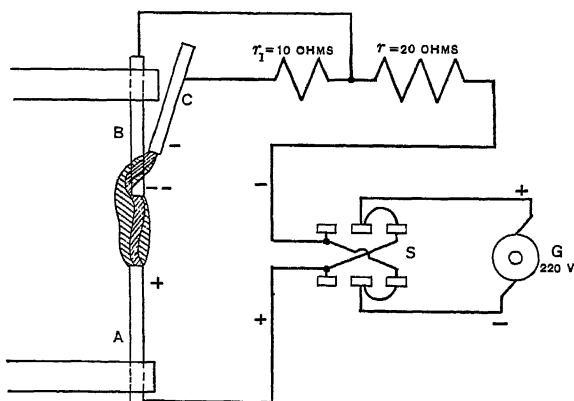

FIG. 37.

B , but the arc does not transfer. I even insert 10 ohms resistance r_1 in series with C (Fig. 37), so that the voltage AB is about 40 volts higher than AC , that is, B by 40 volts more negative than C , and still the arc does not transfer. I now touch C with B and separate it again; if during contact the negative spot during its motion happens to run over to terminal B , the arc continues between B and A ; if, however, the negative spot has remained on C , when separating again, the arc remains at C as negative, although B is more negative by 40 volts.

An arc therefore can be started at its normal starting voltage by an auxiliary arc having the same negative, but not by an auxiliary arc with the same positive, and an arc can be shifted from one positive to another, but not from one negative to

another. The cause is, as explained above, the necessity of the continuity at the negative terminal as the source of the conducting vapor stream.

Still more startling is the following demonstration: I shift the resistance r_1 from C to B , and start the arc from A to B , with B as negative, by bringing these terminals into contact with each other, and then separating them. The auxiliary terminal C (Fig. 38) now is by 40 volts more negative than the negative terminal B of the arc. I now cut slowly through the arc stream by moving C across it between A and B , as shown in Fig. 38: the arc AB remains, but no current goes to C , although more

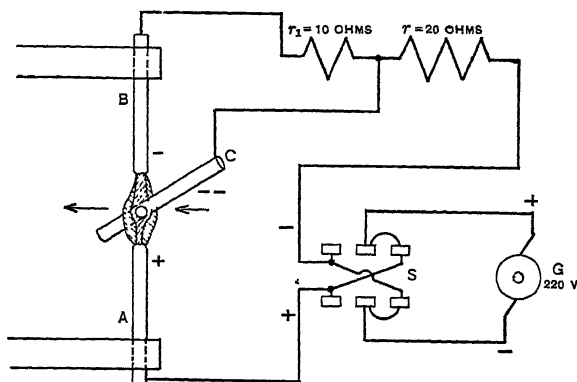

FIG. 38.

negative, that is, at a higher potential difference and a shorter distance against A than B is. I even hold C for some time in the conducting core of the arc AB , and still the current does not shift from the negative B to the still more negative terminal C . This experiment is interesting in demonstrating that a conductor immersed into the arc flame does not assume the potential of the arc flame, but may differ therefrom by considerable voltage, and that it therefore is not feasible to determine the potential distribution in an arc by means of exploring electrodes, as has frequently been attempted.

Obviously, if I now reverse the circuit, and make B and C positive, A negative, the current leaves B and goes to C as soon as C touches the conducting core of the arc AB .

50. The electric arc, therefore, is a *unidirectional conductor*, that is, the vapor stream is conducting between its negative

terminal *A* in Fig. 36, that is, the starting point of the arc stream, and any point reached by it which is positive to *A*, but is non-conducting for any point which is negative with respect to *A*.

If, now, in Fig. 38, with the terminal *C* immersed in the arc stream, I connect *A* and *C* to a source of alternating voltage, as shown in Fig. 39, while a direct-current arc flows from *A* to *B*, with *A* as negative, then during that half-wave of the alternating voltage, for which *C* is positive to *A*, there is current between *A* and *C*, while for the reverse half-wave, in which *C* is negative to *A*, there is no current. The arc thus rectifies the alternating voltage, and the rectification is complete, that is, there is

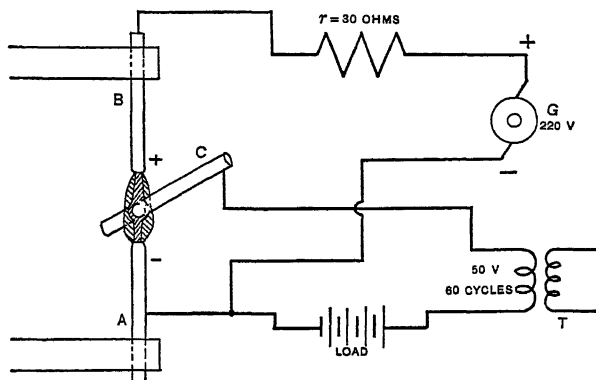

FIG. 39.

current during one half-wave only, but no current at all during the other. I show you this experimentally, using 110 volts alternating between *A* and *C*. With this arrangement, to maintain the rectification continuously, obviously the terminal *C* would have to be cooled.

Alternating voltage thus can be rectified by means of the unidirectional character of the arc: if a continuous vapor stream is maintained from one terminal, either by direct-current excitation or by overlapping several waves of alternating current, current is in that direction only in which this exciter terminal is negative, but not in the opposite direction.

Such arc rectifiers — of which the mercury arc rectifier is the most commonly used — have been developed and extensively introduced in the industry, of late years, for operating low-volt-

age constant direct potential and high-voltage constant direct-current circuits from a source of alternating voltage. Regarding the electrical phenomena occurring in arc rectification, see "Theory and Calculation of Transient Electric Phenomena and Oscillations," Section II, Chapter IV.

The inability of an alternating voltage to maintain an arc, I show you here on the same apparatus by connecting the two terminals (Fig. 40) *A* and *B* to the 1000-volt terminals of a transformer — with sufficient resistance in series to limit the current.

While 220 volts direct current easily maintained a steady 2-cm. arc between these terminals, with 1000 volts alternating between the terminals, if I try to produce an alternating arc by gradually separating the terminals, the circuit opens before the terminals have separated 1 mm.; that is, 1000 volts alternating cannot maintain an arc of 1 mm. between these copper

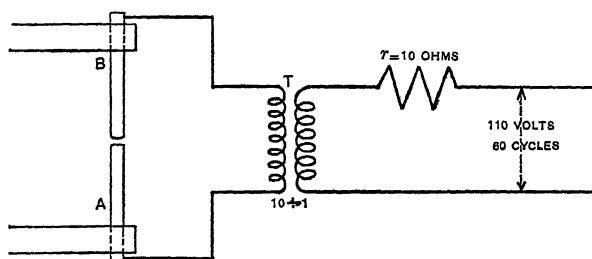

FIG. 40.

terminals. The cause is obvious: to maintain an alternating arc between two terminals, a voltage is required sufficiently high to restart the arc at every half-wave by jumping an electrostatic spark between the terminals through the hot residual vapor of the preceding half-wave. The voltage required by an electrostatic spark, that is, by disruptive conduction, decreases with increase of temperature: for a 13-mm. (0.5-in.) gap, it is about 10,000 volts at atmospheric temperature, 7000 volts at the boiling point of mercury (360 deg. cent.), 2500 volts at the boiling point of zinc (1000 deg. cent.), 500 volts at the boiling point of magnetite (2000 deg. cent.), 100 volts at the boiling point of titanium carbide (3000 deg. cent.), 40 volts at the boiling point of carbon (3700 deg. cent.). The voltage required to maintain a 13-mm. alternating arc must therefore be

at least as high as given by a curve somewhat like curve I in Fig. 41 * (to bring the values of voltage within the scale of the figure, the logarithm of voltage, as ordinate, is plotted against the temperature as abscissa).

The voltage required to maintain an arc, that is, the direct-current arc voltage, increases with increasing arc temperature, and thereby increasing radiation, etc. For a 13-mm. (0.5-in.)

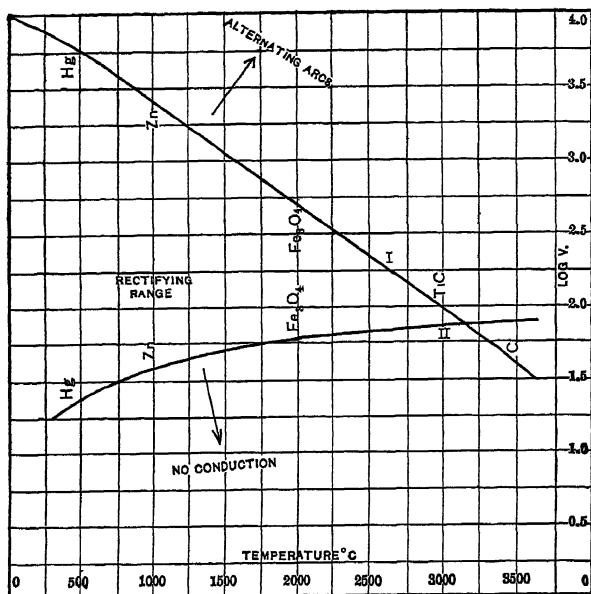

FIG. 41.

arc it is approximately shown as Curve II in Fig. 41: 20 volts for the mercury arc, 40 volts for the zinc arc, 60 volts for the

* As the disruptive voltage also depends on the chemical nature of the vapor, that is, some gases and vapors have a higher disruptive strength than others, as discussed above, the arrangement of the different materials regarding their alternating arc voltages is not entirely determined by their boiling points, but modified by individual characteristics. It further depends on the current: at higher currents and thus larger amounts of residual vapor, the voltage is lower. It further depends on the frequency: the lower the frequency and the greater, therefore, the cooling effect during the reversal of current the higher is the required voltage.

magnetite arc, 75 volts for the titanium carbide arc, 80 volts for the carbon arc.*

As seen from Fig. 41, the curves I and II intersect at some very high temperature, near the boiling point of carbon, and materials which have a boiling point above the temperature of intersection of these curves require a lower voltage for restarting the arc than for maintaining it, and a voltage sufficient to maintain the arc restarts it at every half-wave of alternating current, that is, such materials can maintain a steady alternating arc at the same voltage as a direct-current arc. Even materials like titanium carbide, in which the starting voltage is not much above the running voltage, maintain a steady alternating arc, as in starting, the voltage consumed during running in the steadying resistance or reactance is available.

Alternating arcs thus can be maintained at moderate voltages only by a few materials of extremely high boiling points, as carbon and carbides, but by far the largest number of materials cannot be used as terminals of an alternating-current arc.

In Fig. 41 the range between the curves I and II is the "rectifying range," as in this range unidirectional current is produced from an alternating source of voltage through the arc, if the arc conductor is maintained by excitation of its negative terminal. The voltage range of rectification thus is highest in the mercury arc, which has the lowest temperature, and vanishes in very high-temperature arcs. The carbon arc thus cannot give complete rectification, while the mercury arc, or zinc arc, etc., can do so. The mercury arc, having the greatest rectification range, thus is practically always used for this purpose.

Below curve II of Fig. 41 no conduction occurs, between curves I and II, unidirectional conduction takes place, and above curve I disruptive conduction by alternating current can exist.

51. The light, and in general the radiation given by the arc proper, that is, by the vapor conductor which carries the current between the terminals, is due to luminescence, that is, to a more or less direct transformation of electric energy into

* This voltage also is not merely a function of the arc temperature, but modified somewhat by the chemical individuality of the material. It is a function of the current and decreases with increase of current, so that above values are approximate only, corresponding to about 4 amperes.

radiation, without heat as intermediary form of energy. The quality or color of the light, or its spectrum, that is, the frequency or frequencies of radiation given by the arc stream, thus are not a function of the temperature, as in the radiation produced by heat energy, but the frequencies are those at which the luminescent body is capable of vibrating, that is, are determined by the chemical nature of the luminescent body or vapor conductor. The efficiency of light production thus does not directly depend upon the temperature, does not increase with increase of temperature, as in temperature radiation, but to some extent rather the reverse. We have the same relation as in other energy transformations: when converting heat into other forms of energy, the more intense the heat, that is, the higher the temperature, the higher efficiency we may expect. When transforming, however, some form of energy differing from heat, into another form of energy, as mechanical into electrical energy, the heat produced represents a waste of energy, and the lower the temperature, the higher in general, other things being equal, would be the efficiency. The efficiency of light production by the arc thus is not a function of the temperature, but the lowest temperature arc, the mercury arc, is one of the most efficient.

The light given by the arc contains only a finite number of definite wave lengths, that is, gives a line spectrum: very few lines in the ordinary mercury arc, many thousands in the titanium arc. The color of the light is essentially characteristic of the nature of the luminescent body. For instance, it is white in the titanium arc, as the lines of the titanium spectrum are fairly uniformly distributed over the entire visible range. The light of the calcium arc is orange yellow, as the spectrum lines of calcium are more frequent and more intense in the orange-yellow range of radiation, etc.

Frequently a change of the color of the luminescent light of the arc occurs with the temperature, but it does not follow a definite law, as in temperature radiation, but is a characteristic peculiarity of the luminescent body: some of the spectrum lines increase more rapidly in intensity, with increasing temperature, than others, and the resultant color of the light changes thereby. For instance, the ordinary iron arc, as produced by 4 amperes direct current across a gap of 2 cm.

between iron or magnetite terminals, and requiring about 75 volts, is white and very brilliant, that is, has a spectrum with many lines about uniformly distributed over the visible range. We can greatly increase the temperature of the arc by using a high-frequency condenser discharge: in this case very large currents of very short duration exist as oscillations between the terminals, with periods of rest between the oscillations, very long compared with the duration of the current. In this case the duration of the current is too short to feed a large volume of electrode vapor into the arc stream, and as the current is very large during the short moment of the discharge, the vapor between the terminals is very greatly overheated. Oscillating condenser discharges thus offer a means of increasing the temperature of the arc stream very greatly beyond the boiling point of the material. When using a condenser discharge between iron terminals, we thus get an iron arc of very much higher temperature, and this arc gives very little visible light, but a very large amount of ultra-violet radiation. It is this arrangement which we have used in the preceding to produce ultra-violet light by the so-called "ultra-violet iron arc." In the iron arc the average wave length of the radiation thus shifts with increasing temperature to shorter wave lengths, or higher frequencies, similar as in temperature radiation.

The reverse is the case with the mercury arc: the ordinary mercury arc in an evacuated glass tube, with ample condensing chamber, gives practically no red light; only a very powerful spectroscopist can discover some very faint red lines. If now the condensation of the mercury vapor is made insufficient, by obstructing ventilation, or greatly raising the current, or omitting the condensing chamber in the construction of the lamp, and the mercury vapor pressure and thereby the temperature increased, at least three red lines located about as shown in Fig. 42 become visible in the mercury spectrum even in a low-power spectroscopist, and increase in intensity with increasing vapor pressure. To

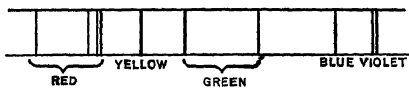

Fig. 42.

show you this I use a U-shaped mercury lamp constructed as shown half size in Fig. 43. I connect the lamp into a 220-volt direct-current circuit, with an inductive resistance in series thereto, to limit the current, and

start the arc by pouring some mercury over from one side to the other. Immediately after starting the lamp you see no red lines in the low-power spectroscope which I have here. As with the large current which I use — 3 amperes — the mercury vapor cannot freely condense, the mercury vapor pressure rises and

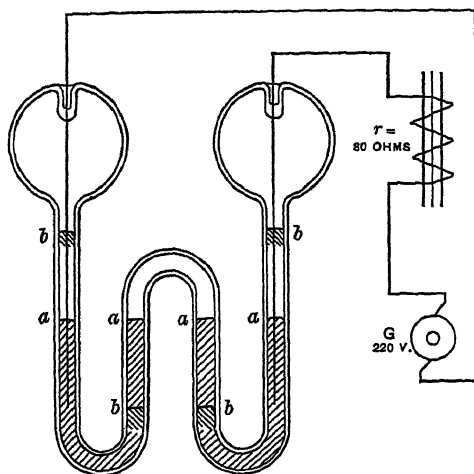

FIG. 43.

presses the mercury level down in the center tubes, up in the outside tubes, as indicated at *b* in Fig. 43, and thereby enables us to measure the mercury pressure. Gradually you see the three red lines appear, and increase in intensity, and when the vapor pressure has risen to about 5 cm., the three red lines are fairly bright, and numerous other red and orange mercury lines have appeared. At this pressure we are so close to the softening point of the glass that we cannot go further, but by operating the mercury arc in a quartz tube, vapor pressures of several atmospheres can be produced, and then the red lines are very much more intense, many more lines have become visible in the mercury spectrum, and the light is far less greenish than the low-temperature mercury arc, more nearly white.

Still much higher temperatures can be reached in the mercury arc in an ordinary glass tube by using the condenser discharge.

I. have here, in Fig. 44, a mercury-arc tube with four

terminals — the same which I used in Fig. 34 for showing simultaneously the mercury arc and the Geissler discharge. I connect terminals 3 and 4 to the high potential terminals of a step-up transformer, but shunt a small condenser *C* across 3 and 4; you see, in the moment where I connect the condenser, the previously existing green and striated Geissler discharge changes

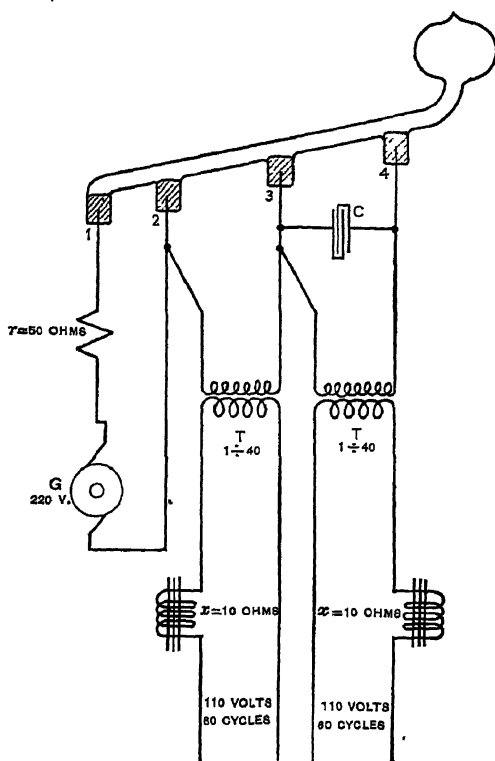

FIG. 44.

to a bright pinkish-red arc, and the spectroscopie shows that the spectrum lines in the red and orange have greatly increased in number, and have increased in intensity beyond that of the lines in the green and blue, and the color of the light therefore has changed from green to pinkish red.

We have here in the same mercury tube shown diagrammatically in Fig. 44 all three forms of luminescence of mercury vapor: the high-current low-voltage, low-temperature arc of

uniform green color, from 1 to 2; the green high-voltage low-current striated Geissler discharge, from 2 to 3, and the red high-voltage mercury arc, from 3 to 4.

In the mercury arc, as result of the more rapid increase of intensity of the red lines, the color of the light thus changes with increase of temperature from bluish green at low temperature to white to red at very high temperature, that is, the average frequency decreases with increase of temperature, just the reverse from what is the case with temperature radiation.

The change in the distribution of the power of radiation between the different spectrum lines, with change of temperature, may increase the efficiency of light production — if the lines in the visible range increase faster than in the ultra-red and ultra-violet — or may decrease — if the visible lines increase slower — or may increase in some temperature range, decrease in some other temperature range, but all these changes are characteristic of the luminescent material, and do not obey a general law. Thus in the mercury arc the efficiency of light production, with increase of temperature, rises to a maximum at about 150 deg. cent., then decreases to a minimum, and at still higher temperature increases to a second maximum, higher than the first one, possibly between 600 and 800 deg. cent., and then decreases again.

52. Essentially, however, the efficiency of light production by the arc is a characteristic of the material of the arc stream, and thus substances which give a large part of their radiation as spectrum lines in the visible range — as calcium — give a very efficient arc, while those substances which radiate most of their energy as lines in the invisible, ultra-violet or ultra-red — as carbon — give a very inefficient arc. The problem of efficient light production by the arc therefore consists in selecting such materials which give most of their radiation in the visible range.

Carbon, which was most generally used for arc terminals, is one of the most inefficient materials: the carbon arc gives very little light, and that of a disagreeable violet color; it is practically non-luminous, and the light given by the carbon arc lamp is essentially incandescent light, temperature radiation of the incandescent tip of the positive carbon. The fairly high efficiency of the carbon arc lamp is due to the very high temperature of the black body radiator, which gives the light.

The materials which give the highest efficiencies of light production by their spectrum in the arc stream are mercury, calcium and titanium.

As mercury vapor is very poisonous, the mercury arc has to be enclosed air-tight, and has been developed as a vacuum arc, enclosed by a glass or quartz tube. Its color is bluish green.

Calcium gives an orange-yellow light of very high efficiency, and is used in most of the so-called "flame-carbon arcs," or "flame arcs."

Titanium gives a white light of extremely high efficiency. It is used in the so-called "luminous arc," as the magnetite arc in direct-current circuits, the titanium-carbide arc in alternating-current circuits.

53. Two methods exist of feeding the light-giving material into the arc stream:

(1) By *electro-conduction*, that is, using the material as the vapor conductor which carries the current. In this case, it must be used as negative, as the vapor conductor is supplied from the negative; such arcs are called "luminous arcs."

(2) By *heat evaporation*; in this case, a very hot arc must be used, and thus usually a carbon arc is employed. As the positive terminal is the hottest, the material is mixed with the carbon of the positive terminal, and as negative terminal either a plain carbon, or also an impregnated carbon used; such arcs are called "flame arcs."

The method of heat evaporation is always used with calcium, since no stable conducting calcium compound is known which may be used as negative arc terminal. With titanium, usually electro-conduction is employed, that is, a titanium oxide-magnetite mixture, or titanium metal, used as negative terminal, and any other terminal, as copper or carbon, as positive terminal. Titanium can also be introduced by heat evaporation by using a titanium-carbon mixture as positive terminal or as both terminals of the flame-carbon arc.

Both methods of feeding — electro-conduction and heat evaporation — have advantages and disadvantages.

Electro-conduction has the great advantage that the temperature of the terminals is immaterial, as heat plays no part in feeding the luminescent material into the arc flame. The positive terminal of the arc can be made sufficiently large and of

such material as not to consume at all, and the trimming of the lamp thus reduced to the replacing of one electrode only — the negative. The negative electrode also can be made so large as to remain fairly cold, and therefore consumes only at the very slow rate required to supply the arc vapor, but does not consume by combustion or heat evaporation. Thus its rate of consumption can be reduced to 1 mm. or less per hour (while the open carbon arc of old consumes about 5 cm. of electrodes per hour), and thereby even with a moderate size of electrode a life of electrodes of 100 to 300 hr. or even much more secured. This method of feeding thus lends itself very well to long-burning arcs, as they are almost exclusively used for American street lighting.

By electro-conduction higher efficiencies can be reached than by heat evaporation, as the arc vapor stream when produced by electro-conduction can be made to consist entirely of the vapor of the luminescent material, as when using metallic titanium as negative terminal.

A disadvantage of the method of feeding the arc by electro-conduction is the much greater limitation in the choice of materials: the material must be an electric conductor, which is stable in the air, and reasonably incombustible. In the method of feeding by heat evaporation any material can be used, as it is mixed with carbon, and the conductivity is given by the carbon. Thus, in the titanium arc, either metallic titanium or titanium carbide or sub oxide must be used, but the most common titanium compound, TiO_2 , or rutile, is not directly suitable, since it is a non-conductor. In the direct-current titanium arc, the so-called magnetite arc, a solution of TiO_2 , or rutile, in magnetite, Fe_3O_4 , which is conducting, is used, that is, a mixture of rutile with a considerable weight of magnetite. While magnetite also gives a luminous arc, — the white iron spectrum, — the efficiency of the iron arc is lower than that of the titanium arc, and the efficiency of the magnetite arc thus lower than that of the pure titanium arc, though much higher than that of the carbon arc.

Calcium cannot be used at all by electro-conduction: the only more common conducting calcium compound is calcium carbide. As negative terminal calcium carbide gives an arc of an efficiency far superior to that of the flame-carbon arc, but, as calcium carbide disintegrates in the air, it cannot be used.

Still greater is the limitation for alternating current; in this case the material, in addition to its other qualifications, must have such a high boiling point as to maintain a steady alternating arc, as discussed above. Of the titanium compounds only titanium carbide seems to fulfill this requirement; of the iron compounds, apparently none.

54. The most serious disadvantage of the use of electro-conduction for feeding the arc, however, has been the inherently greater unsteadiness of metal arcs compared with the carbon arc. It is this feature which has retarded the development of true luminous arcs until recent years, that is, until means were found to produce steadiness by eliminating the flickering of the negative spot by the admixture of a more refractory material, — chromite in the magnetite arc, — and eliminating the unsteadiness due to the occasional momentary fading out of the luminous inner core of the arc by the admixture of a very small amount of some more volatile material.

The great advantage of the method of feeding the luminescent material into the arc flame by *heat evaporation*, mainly from the positive, is the possibility of using carbon as arc conductor, which gives the inherent steadiness of the carbon arc, and thus has led to the development of this type of high efficiency arc, the flame arc, before the development of true luminous arcs.

A further advantage is the possibility of using alternating current equally well and with the same electrodes as used with direct current, as the arc is a carbon arc and thus operative on alternating current.

Another advantage is the great choice of materials available, since practically any stable compound, whether conducting or not, can be used in the flame carbon. Thus in the yellow-flame arc, calcium fluoride, oxide and borates are used; in the titanium arc, the oxide (rutile) or the carbide may be used.

The most serious disadvantage of the method of feeding by heat evaporation, which has so far excluded the flame arc from general use for American street illumination, is the rapid consumption of the electrodes and their consequent short life. Since the luminescent material is fed into the arc by heat evaporation, the electrodes must be so small that their ends are raised to arc temperature, and thus rapidly consumed by the combustion of the carbon. The combustion cannot be reduced by

excluding the air by enclosing the arc with an almost air-tight globe, as in the enclosed carbon arc, since the luminescent material leaves the arc as smoke, and by depositing on the globe rapidly obstructs the light. The rate of consumption of the electrodes thus is the same as in the open carbon arc, 3 to 5 cm. (1 to 2 in.) per hour, and the flame-carbon arc even with very great length of carbon thus lasts only one night, that is, requires daily trimming. To some extent this difficulty may be reduced by using the same air again, after passing it through a smoke-depositing chamber in a so-called "circulating" or "regenerative" flame lamp, but the efficiency is lowered, and the lamp made more complicated.

The mercury arc, being enclosed in a glass tube, necessarily must always be fed by electro-conduction from the negative. The calcium arc is always fed by heat evaporation from the carbon positive, with a carbon negative, or from positive and negative, by using flame carbons for both electrodes. The titanium arc is usually fed by electro-conduction from the negative, but also by heat evaporation from the positive by using a titanium-flame carbon.

55. As, by electro-luminescence, electric energy is converted more directly into radiation, without heat as intermediary form of energy, no theoretical limit can be seen to the possible efficiency of light production by the arc, and in the mercury, calcium and titanium arcs, efficiencies have been reached far beyond those possible with temperature radiation. Thus, specific consumptions of 0.25 watt per mean spherical candle power are quite common with powerful titanium, calcium or mercury arcs, and even much better values have been observed. It is therefore in this direction that a radical advance in the efficiency of light production appears most probable. At present, the main disadvantage of light production by the arc is the necessity of an operating mechanism, an arc lamp, which requires some attention, and thereby makes the arc a less convenient illuminant than, for instance, the incandescent lamp, and especially the limitation in the unit of light: the efficiency of the arc decreases with decrease of power consumption, and, while the arc is very efficient in units of hundreds or thousands of candle power, its efficiency is much lower in smaller units, and very small units cannot be produced at all. Thus, for instance, while a 500-watt flame arc may give 10 times as much light as a 500-watt

carbon arc, to produce by a flame arc the same amount of light as given by a 500-watt carbon arc requires very much more than one-tenth the power. So far no way can be seen of maintaining the efficiency of the arc down to such small units of light as represented by the 16- or 20-candle power incandescent lamp.

LECTURE VII.

FLAMES AS ILLUMINANTS.

56. Two main classes of illuminants exist: those producing radiation by the conversion of the chemical energy of combustion—the flames—and those deriving the energy of radiation from electric energy—the incandescent lamp and the arc lamp, and other less frequently used electric illuminants.

Flames.

To produce light from the chemical energy of combustion, almost exclusively *hydrocarbon flames* are used, as the gas flame, the candle, the oil lamp, the gasolene and kerosene lamp, etc.; that is, compounds of hydrogen and carbon or of hydrogen, carbon and some oxygen are burned. The hydrogen, H, combines with the oxygen, O, of the air to water vapor, H_2O , and the carbon, C, with the oxygen of the air, to carbon dioxide, CO_2 ; or, if the air supply is insufficient, to carbon monoxide, CO, a very poisonous, combustible, odorless gas (coal gas), which thus appears in all incomplete combustions and is present, also, as intermediary stage, in complete combustion.

The mechanism of the light production by the hydrocarbon flame I illustrate here on the luminous gas flame: where the gas issues from the burner into the air, it burns at the surface of the gas jet. By the heat of combustion the gas is raised to a high temperature. Most hydrocarbons, however, cannot stand high temperatures, but split up, dissociate into simpler hydrocarbons very rich in hydrogen: methane, CH_4 , and in free carbon. The carbon particles formed by this dissociation of hydrocarbon gas float in the burning gases, that is, in the flame, and are raised to a high temperature by the heat of combustion of the gases, thereby made incandescent, and radiate light by temperature radiation; until ultimately, at the outer edge of the flame, they are burned by the oxygen of the air, and thus destroyed. We can see these carbon particles, which, floating

in the flame in an incandescent state, give the light, if by passing a cold porcelain or glass plate through the luminous flame, we suddenly chill it and thereby preserve the carbon particles from combustion; they appear then on the plate as a carbon deposit, soot or lampblack. The light given by the luminous hydrocarbon flame thus is due to black-body radiation, and the flame makes its own radiator, and afterwards destroys it by combustion.

To give a luminous flame, the hydrocarbon must be sufficiently rich in carbon to split off carbon at high temperatures. Thus methane, CH_4 , does not give a luminous flame, since it contains the smallest amount of carbon which can combine with hydrogen, and therefore does not deposit carbon at high temperatures. Ethylene, however, C_2H_4 , which is the foremost light giving constituent of illuminating gas, dissociates in the flame into CH_4 and C, and thus gives a luminous flame, as half of its carbon is set free and gives the incandescent radiator.

If, however, the hydrocarbon is very rich in carbon, the amount of deposited carbon becomes so large that the energy of combustion of the remaining hydrocarbon is not sufficient to raise the carbon to very high temperatures, the luminosity therefore again decreases, the flame becomes reddish yellow, and a large amount of carbon escapes from the flame unconsumed, as smoke or soot, that is, the flame becomes smoky.

To show you this, I pour some gasolene and some benzol in small glass dishes. The gasolene, having $2\frac{1}{2}$ hydrogen atoms per carbon atom, burns with a luminous flame and very little smoke. The benzol, having only one hydrogen atom per carbon atom, burns with a reddish-yellow flame, pouring out masses of black smoke.

The proportion between the hydrogen and carbon required to give a luminous non-smoky flame, therefore can be varied only within narrow limits: too little carbon gives a less luminous or non-luminous flame, too much carbon a smoky reddish flame.

Hydrocarbons exist having almost any proportion between hydrogen and carbon, from a maximum of four hydrogen atoms to one carbon in methane, CH_4 , to practically pure carbon in anthracite coal. Some of them are shown in the following table, with the number of hydrogen atoms per carbon atom

added in column *a*, and the percentage of carbon which is deposited by dissociation, in column *b*;* *b* thus may be called the luminosity index of the hydrocarbon.

HYDROCARBONS.

Name.	State.	Formula.	Hydrogen Index (a)	Luminosity Index (b).
Paraffines:				
Methane.....	Gas.	CH_4	4 0	0
Ethane.....	do.....	C_2H_6	3.0	0.25
Propane.....	do.....	C_3H_8	2.67	0.333
Butane.....	do.....	C_4H_{10}	2.5	0.375
Pentane.....	Liquid.	C_5H_{12}	2.4	0.40
Gasolene.....	do.....	C_6H_{14}	2.33	0.417
Kerosene.....	do.....	$\text{C}_{10}\text{H}_{22}$	2.2	0.45
Mineral oil.....	do.....	$\text{C}_{14}\text{H}_{30}$	2.14	0.464
Vaseline.....	Solid.	$\text{C}_{20}\text{H}_{42}$	2.1	0.475
Paraffine.....	do.....	$\text{C}_{24}\text{H}_{50}$	2.08	0.479
Olefines:				
Ethylene.....	Gas.	C_2H_4	2	0.50
Acetylenes:				
Acetylene.....	Gas.	C_2H_2	1	0.75
Benzols:				
Benzol.....	Liquid.	C_6H_6	1	0.75
Naphthalene.....	Solid.	C_{10}H_8	0.8	0.80
Anthracene.....	do.....	$\text{C}_{14}\text{H}_{10}$	0.71	0.821

57. The proportion between carbon and hydrogen required to give a luminous non-smoky flame somewhat depends on the size of the flame, and, with a larger size, a higher proportion of hydrogen is required to avoid smoke than with a smaller flame, as in the latter, due to the larger surface compared with the volume, the combustion is more rapid. I show you this on the gas flame: admitting a little gas, I get a small flame, which does not smoke, but if I open the stop-cock wide I get a large and smoky flame.

With a moderate-sized flame without artificial ventilation, from 30 to 40 per cent of the carbon must be deposited to give good luminosity without smoke. This corresponds to a value *a*

* Every four hydrogen atoms retain one carbon atom, while the rest of the carbon is set free.

between 2.4 and somewhat less than three hydrogen atoms per carbon atom. Ethane, C_2H_6 , with $a = 3$, still gives a luminous flame, but of somewhat lower luminosity, and, on the other side, the gasolene flame, $a = 2.33$, is slightly smoky. However, in very small flames in which the surface is larger compared with the volume, and the combustion thus very rapid, higher percentages of carbon can be used without smoke. Thus the flame of the paraffine candle $a = 2.08$ is still smokeless but begins to smoke if it gets large, and in extremely small flames, $\frac{1}{8}$ in. or less diameter, even acetylene, $a = 1$, gives smokeless combustion.

Increase of the rapidity of combustion by increasing the surface of the flame by using a flat or hollow cylindrical burner, and increasing the air supply by artificial draft, as by a chimney, gives smokeless flames even up to $b = 0.50$, or one carbon atom to two hydrocarbon atoms, $a = 2$.

Thus kerosene, which, due to its high carbon content $a = 2.14$, smokes badly, except in very small flames, is burned smokelessly in lamps with chimneys and flat or hollow round burners, and then gives a high light intensity: with the rapid air supply and the large surface of the thin flame, the combustion is very rapid, a part of the free carbon is immediately consumed, the temperature is high, and thus the free carbon heated sufficiently to give considerable light, and to consume completely when leaving the flame. With a hydrocarbon still richer in carbon, as acetylene or benzol $a = 1$, artificial draft and large flame surface are no longer sufficient to give smokelessness, and the total range of hydrocarbons which can be burned with luminous flames and without smoke thus is between from three to two hydrogen atoms per carbon atom.

Hydrocarbons which are too rich in carbon to be burned smokelessly, as acetylene or benzol, obviously can be burned with a smokeless luminous flame by mixing them in the proper proportions with hydrocarbons deficient in carbon, which latter by themselves would give a non-luminous or nearly non-luminous flame. Thus a mixture of one volume of acetylene, C_2H_2 , with three volumes of methane, $3 CH_4$, (the number of molecules of gases are proportional to their volumes), gives a non-smoky luminous flame: 5 C to 14 H, or $a = 2.8$.

Such hydrocarbons as acetylene, benzol, etc., which are rich

in carbon, are used for enriching poor gas, that is, making it more luminous: gas which gives little free carbon, as water-gas (which is rich in H and CO — both giving non-luminous flames), and which therefore would give a non-luminous or only slightly luminous flame, thus is improved in its light-giving quality by admixture of acetylene, etc.

58. If the hydrocarbon contains oxygen, as alcohol, C_2H_6O , etc., the presence of oxygen atoms reduces the luminosity or the tendency to smoke, by taking care of a corresponding number of carbon atoms: the most stable compound is CO, and water vapor, H_2O , as well as carbon dioxide, CO_2 , are reduced by carbon at high temperature with the formation of carbon monoxide, CO. During the dissociation of the hydrocarbon in the flame, each oxygen atom takes up one carbon atom, forming CO, which burns with a non-luminous flame. In approximately estimating the luminosity or the tendency to smoke of a hydrocarbon containing oxygen, for each oxygen atom one carbon atom is to be subtracted. To illustrate this I pour some aldehyde, C_2H_4O , and some amyl acetate, $C_7H_{14}O_2$, in small glass dishes and ignite them. In both the ratio of hydrogen to carbon atom is $a = 2$, corresponding to a luminous but smoky flame. You see, however, that the aldehyde burns with a perfectly non-luminous flame: we have to put out the light to see it; while the amyl acetate burns with a luminous, non-smoky flame. Applying above reasoning, the oxygen accounts for one carbon atom in the aldehyde: $C_2H_4O = CO + CH_4$, and in CH_4 : $a = 4$, corresponding to a non-luminous flame, as observed. In amyl acetate, the two oxygen atoms take up two carbon atoms: $C_7H_{14}O_2 = 2 CO + C_5H_{14}$, and the ratio of hydrogen to carbon atoms is $a = 2.8$, or $b = 30$, corresponding to a luminous non-smoky flame, as observed.

The same effect as given by oxygen contained in the hydrocarbon molecule obviously is obtained by mixing oxygen or air with the hydrocarbon. I illustrate this on the bunsen flame: closing the air supply, I have an ordinary luminous and somewhat smoky gas flame. I now gradually admit air, and you see first the smoke disappear, and then the luminosity decreases, and first the lower part, and then the entire flame, becomes non-luminous. When the luminosity has just disappeared, the amount of air mixed with the gas is just sufficient to take up

all the carbon as CO, which would deposit otherwise and give the incandescent radiator, but it is far below the amount required for complete combustion, and, by still further increasing the air supply, you see the rapidity of combustion still further increase, as shown by the decreasing size of the flame. With increasing air supply, the size of the flame very greatly decreases, and, as the same total heat is produced by the combustion, this means that the heat is concentrated in a smaller volume, that is, the temperature of the flame is increased, in other words, the non-luminous bunsen flame is of higher temperature than the luminous gas flame.

Hydrocarbons which are too rich in carbon to burn without smoke, as acetylene, can be burned with a smokeless flame by mixing them with oxygen or with air. Acetylene is always burned in this manner, and all acetylene-gas burners are constructed so as to take in air with the acetylene gas before combustion, that is, are small bunsen burners or similar thereto. Since the temperature of the bunsen flame, due to the more rapid combustion resulting from the mixture with air, is higher than that of the ordinary gas flame, and in the acetylene flame in the acetylene air mixture a large part of the carbon is also immediately burned, the temperature of the acetylene flame is very high, and the deposited carbon therefore raised to a very high temperature, much higher than in the ordinary gas flame, and, as the result of the higher temperature, the black-body radiation of the free carbon in the acetylene flame is far more efficient, and of much whiter color than in the ordinary gas flame.

Thus the hydrocarbons which are very rich in carbon, as acetylene, benzol, naphthalene, etc., if burned smokelessly by mixture with air, give whiter and more efficient flames, due to their higher temperature. Especially is this the case with acetylene, as the energy of combustion of acetylene is higher than that of other hydrocarbons of the same relative proportions of hydrogen and carbon: acetylene being endothermic, that is, requiring energy for its formation from the elements.

59. Since, as discussed in Lecture VI, chemical luminescence usually occurs where intense chemical reactions take place at high temperatures, — and this is the case in the flame, — chemical luminescence of the flame gases must be expected in the hydrocarbon flame. It does occur, but does not contribute anything

to the light production, since the spectra of hydrogen and carbon (or CO and CH₄) are practically non-luminous. The luminescence of the hydrocarbon flame therefore can be observed only with those hydrocarbons which are sufficiently poor in carbon as not to deposit free carbon, as methane, alcohol, etc., or in which, by the admixture of air, the deposition of free carbon and thereby the formation of an incandescent radiator, is avoided, as in the bunsen flame. In this case, the blue color of the chemical luminescence of carbon-flame gases is seen: all non-luminous hydrocarbon flames are blue.

60. While light, and radiation in general, can also be produced by the combustion of other materials besides hydrocarbons, industrially other materials are very little used.

Burning magnesium gives a luminous flame of extremely high brilliancy and whiteness. Its light is largely due to temperature radiation, and the flame makes its own incandescent radiator; but unlike the hydrocarbon flame, in which the radiator is again destroyed by combustion, the incandescent radiator of the magnesium flame is the product of combustion, magnesia, MgO, and escapes from the flame as white smoke. While, however, in the hydrocarbon flame the incandescent radiator is a black body,—carbon,—giving the normal temperature radiation, the radiator of the magnesium flame, magnesia, is a colored radiator, and its radiation is deficient in intensity in the ultra-red, and very high in the visible range, and thereby of a much higher efficiency than given by black-body radiation. The magnesium flame therefore is far more efficient than the hydrocarbon flame, and its light whiter.

So also burning aluminum, zinc, phosphorus, etc., give luminous flames containing incandescent radiators produced by the combustion: alumina, zinc oxide, etc.

Superimposed upon the temperature radiation of the incandescent radiator of those flames is the radiation of chemical luminescence. Since, however, magnesium, zinc, aluminum, give fairly luminous spectra, in these flames the chemical luminescence contributes a considerable part of the light, and where the luminescent light, that is, the metal spectrum, is of a marked color—as green with zinc—the flame of the burning metal also is colored. Hence burning zinc gives a greenish-yellow flame, burning calcium an orange-yellow flame, etc.

Obviously, where during the combustion no solid body is formed, the light given by the flame is entirely chemical luminescence. Thus burning sulphur gives a blue flame, and, if the temperature of combustion is increased by burning the sulphur in oxygen, it gives a fairly intense light, of violet color, and a radiation which is very intense in the ultra-violet. Thus before development of the ultra-violet electric arcs, as the iron arc, for the production of ultra-violet radiation lamps were used, burning carbon bisulphide, CS_2 , in oxygen. Carbon bisulphide, has the advantage over sulphur that, as liquid, it can easier be handled in a lamp, and especially the combustion of carbon (without adding much to the light, due to the non-luminous character of the carbon spectrum) greatly increases the flame temperature, and thereby the intensity of the radiation.

Flames with Separate Radiator.

61. The hydrocarbons are the only sources of chemical energy which by their cheapness are available for general use in light production. Carbon, however, is a black-body radiator, and its efficiency of light production therefore very low, especially at the relatively low temperature of the luminous hydrocarbon flame, and such flames are, therefore, low in efficiency of light production, with the exception of the acetylene flame and other similar flames.

Separating the conversion into light from the heat production; that is, using the hydrocarbon flame merely for producing heat, and using a separate radiator for converting the heat into light, offers the great advantage

(1) That a colored body can be used as radiator, and thereby a higher efficiency of light production, at the same temperature, secured, by selecting a body deficient in invisible and thereby useless radiation.

(2) That the rapidity of combustion can be greatly increased by mixing the hydrocarbon with air in a bunsen burner, and thereby the temperature of the flame increased, which results in a further increase of the efficiency of light production.

Thus, by the use of suitable external radiators, in a non-luminous hydrocarbon flame, far higher efficiencies of light production are reached than by the use of the luminous hydrocarbon flame.

The first use of external radiators probably was the use of a lime cylinder in a hydro-oxygen flame, in the so-called "lime light," for producing very large units of light in the days before the electric arc was generally available.

In the last quarter of a century the external radiator has come into extended use in the Welsbach mantle; the hydrocarbon is burned in a bunsen burner, that is, mixed with air, so as to get a non-luminous flame of the highest temperature, and in this flame is immersed a cone-shaped web of a highly efficient colored radiator: thoria with a small percentage of ceria, etc., the so-called "mantle." The higher temperature, combined with the deficiency of radiation in the invisible range, exhibited by this colored radiator, results in an efficiency of light production several times as high as that of the luminous gas flame. The distribution of intensity in the spectrum of the Welsbach mantle obviously is not that of black-body radiation, but differs therefrom slightly, and the radiation is somewhat more intense in the greenish yellow, that is, the light has a slightly greenish-yellow hue.

The Welsbach mantle is very interesting as representing the only very extensive industrial application of colored radiation.

LECTURE VIII.

ARC LAMPS AND ARC LIGHTING.

Volt-Ampere Characteristics of the Arc.

62. The voltage consumed by an arc, at constant current, increases with increase of arc length, and very closely proportional thereto. Plotting the arc voltage, e , as function of the

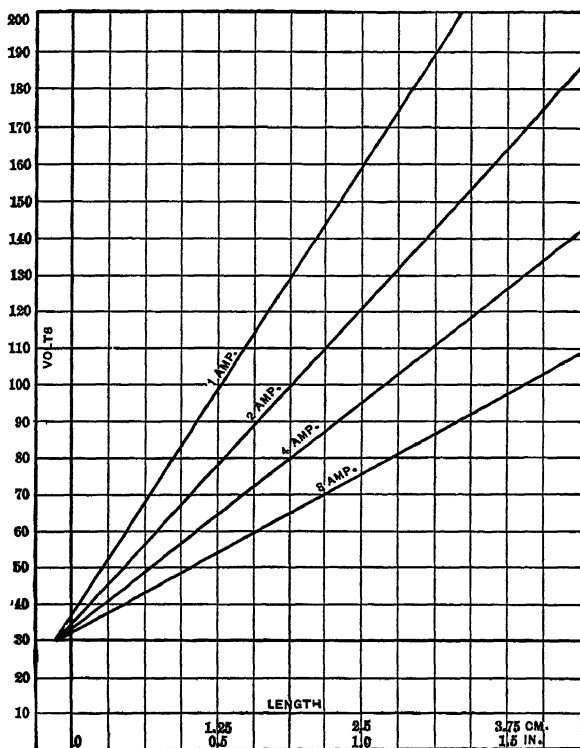

FIG. 45.

arc length, l , we get for every value of current, i , a practically straight line, as shown for the magnetite arc in Fig. 45, for values of current of 1, 2, 4 and 8 amperes. These lines are steeper

for smaller currents, that is, low-current arcs consume a higher voltage for the same length than high-current arcs, the increase being greater the longer the arc. These lines in Fig. 45 intersect in a point which lies at $l = -0.125$ cm. = -0.05 in. and $e = 30$ volts; that is, the voltage consumed by the arc consists of a part, $e_0 = 30$ (for the magnetite arc), which is con-

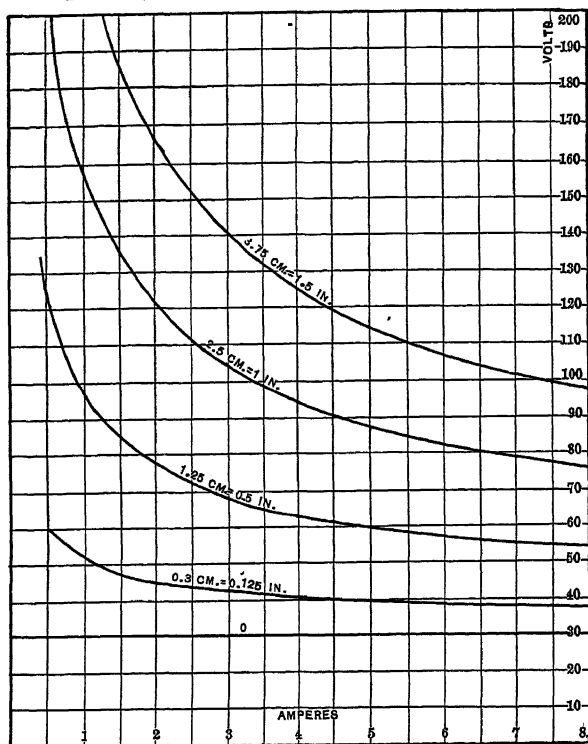

FIG. 46.

stant, that is, independent of the arc length and of the current in the arc, but different for different materials, and a part, e_1 , which is proportional to the arc length, l , or rather to the arc length plus a small quantity, $l_1 = 0.125$ (for the magnetite arc): $e_1 = k_1(l + 0.125)$, and depends upon the current, being the larger the smaller the current.

Plotting the arc voltage, e , as function of the current, i , we get curves which increase with decrease of current, the increase being greater the longer the arc, as shown in Fig. 46, for the

magnetite arc, for $l = 0.3, 1.25, 2.5, 3.75$ cm. = 0.125, 0.5, 1 and 1.5 in. Subtracting from the voltage, e , in Fig. 46, the constant part, $e_0 = 30$ volts, which apparently represents the terminal drop of voltage, that is, the voltage which supplies the energy used in producing the conducting vapor stream at the negative, and the heat at the positive terminal, leaves the voltage, $e_1 = e - e_0$, as the voltage consumed in the arc stream.

The curves of arc-stream voltage, e_1 , as function of the current, i , in Fig. 46, can with good approximation be expressed by cubic hyperbolas: $e_1^2 i = k_2^2$; or, $e_1 = \frac{k_2}{\sqrt{i}}$; and since we find for constant value of current: $e_1 = k_1 (l + 0.12)$, as function of arc length and current, i , the voltage of the arc stream is expressed by:

$$e_1 = \frac{k (l + l_1)}{\sqrt{i}}, \quad (1)$$

and the total arc voltage by:

$$e = e_0 + \frac{k (l + l_1)}{\sqrt{i}}, \quad (2)$$

where e_0 , k and l_1 are constants of the terminal material (k , however, varies with the gas pressure in the space in which the arc exists).

This equation (2) represents the arc characteristics with good approximation, except for long low-current arcs, which usually require a higher voltage than calculated, as might be expected from the unsteady nature of such long thin arcs.

The equation (2) can be derived from theoretical reasoning as follows: Assuming the amount of arc vapor, that is, the volume of the conducting vapor stream, as proportional to the current, and the heat produced at the positive terminal also as proportional to the current, the power p_0 required to produce the vapor stream and the heating of the positive terminal is proportional to the current, i ; and, as the power is $p_0 = e_0 i$, it follows that the voltage, e_0 , consumed at the arc terminals is constant.

The power consumed in the arc stream: $p_1 = e_1 i$, is given off, by heat conduction, convection, and by radiation, from the sur-

face of the arc stream, and thus, as the temperature of the arc stream is constant, and is that of the boiling point of the arc vapor, the power p_1 consumed in the arc stream is proportional to its surface, that is, to the product of arc diameter l_d and arc length l , or rather the arc length l increased by a small quantity l_1 , which allows for the heat carried away to the electrodes. As the diameter l_d is proportional to the square root of the section of the arc stream, and the section of the arc stream, or the volume of the arc vapor, was assumed as proportional to the current, i , the arc diameter is proportional to the square root of the current, and the power p_1 consumed in the arc stream thus is proportional to the square root of the current, i , and to $(l + l_1)$; that is,

$$p_1 = k \sqrt{i} (l + l_1);$$

and since

$$p_1 = e_1 i,$$

$$e_1 = \frac{k (l + l_1)}{\sqrt{i}},$$

which is equation (1), and herefrom, since $e = e_0 + e_1$, follows equation (2).

63. Since e_0 represents the power consumed in producing the vapor stream and the heating of the positive terminal, and k the power dissipated from the arc stream, e_0 and k are different for different materials, and in general higher for materials of higher boiling point and thus higher arc temperatures. It is, approximately,

$$\begin{aligned} e_0 &= 13 \text{ volts for mercury,} \\ &= 16 \text{ volts for zinc and cadmium,} \\ &= 30 \text{ volts for magnetite,} \\ &= 36 \text{ volts for carbon,} \\ k &= 48.5 \text{ for magnetite (123 in inch measure)} \\ &= 51 \text{ for carbon (130 in inch measure).} \end{aligned}$$

The magnetite arc, of which the characteristics are shown in Figs. 45 and 46, thus can be represented by

$$e = 30 + \frac{48.5 (l + 0.125)}{\sqrt{i}}. \quad (3)$$

The least agreement with the theoretical curve (2) is shown by the carbon arc. This may be expected from the exceptional character of the carbon arc, as discussed in Lecture VI. Plot-

ting, in Fig. 47, the voltage, e , consumed by a carbon arc, at constant values of current i , as function of the arc length l , — as done for the magnetite arc in Fig. 45, — when using only the observations for arc length of 0.25 in. and over, we get fairly satisfactory straight lines, which intersect at the point, giving $e_0 = 36$ volts, but $l_1 = -0.8$ cm. = -0.33 in.; that is, a value much greater than for any other arc. For short arc

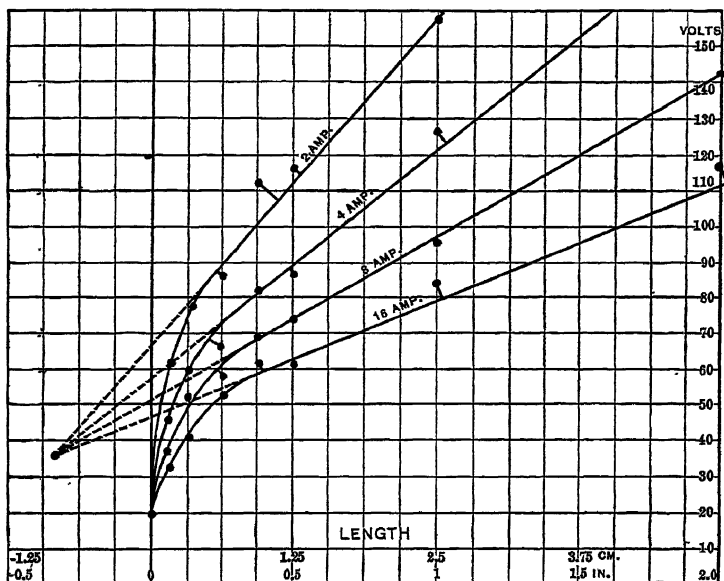

FIG. 47.

lengths, however, the observed values of voltage drop below the straight line, as shown in Fig. 47, and converge towards a point, at zero arc length, or $e_0' = 28$ volts. This looks as if, of the potential drop of $e_0 = 36$ volts of the carbon arc, only a part, $e_0' = 28$ volts, occurs at the surface of the terminals, and the remaining part, $e_0'' = 8$ volts, occurs in the space within a short distance from the terminal surface. If then the arc length is decreased to less than the distance within which the terminal drop e_0'' occurs, the arc meets only a part of this terminal drop e_0'' , and, for very short arc length, only the terminal drop e_0' occurs. Possibly the voltage $e_0' = 28$ is consumed at the negative terminal in producing the conducting vapor stream,

while the voltage $e_0'' = 8$ is consumed by the moving vapor stream in penetrating a layer of dead carbon vapor formed by heat evaporation from the positive terminal, and surrounding this terminal.

Stability Curves of the Arc.

64. From the volt-ampere characteristic of the arc, as represented by equation (2) and reproduced in Fig. 48 as Curve I, for a magnetite arc of 1.8 cm. (about 0.75 in.) length, it follows that the arc is unstable on constant potential supply, as the voltage consumed by the arc decreases with increase of current and, inversely, a momentary increase of current decreases the consumed voltage, and, on constant voltage supply, thereby increases the current, still further decreases the arc voltage and increases the current, and the arc thus short circuits; or a momentary decrease of current increases the required voltage and, at constant supply voltage, continues to decrease the current and thus increase still further the required voltage, that is, the arc goes out.

On constant voltage supply only such apparatus can operate under stable conditions in which an increase of current requires an increase, and a decrease of current a decrease of voltage, and thus checks itself.

Inserting in series with the arc, curve I, in Fig. 48, a constant resistance of 10 ohms, the voltage consumed by this resistance, $e' = ir$, is proportional to the current, and given by the straight line II. Adding this voltage to the arc voltage curve I, gives the total voltage consumed by the arc and its series resistance, as curve III. In curve III, the voltage decreases with increase of current, for values of current below $i_0 = 2.9$ amperes, and the arc thus is unstable for these low currents, while for values of current larger than $i_0 = 2.9$ amperes, the voltage increases with increase of current. The point $i_0 = 2.9$ amperes thus separates the unstable lower part of the curve III from the stable upper part. With a series resistance of $r = 10$ ohms, a 1.8-cm. magnetite arc thus requires at least $e = 117$ volts supply voltage, and $i_0 = 2.9$ amperes for steady operation. With a larger series resistance, as $r = 20$ ohms, represented by curve II' and III', a larger supply voltage is required, but smaller currents can be operated; with a lower series resistance, $r = 5$ ohms, curves

II'' and III'', larger currents are required for stable operation, but a lower supply voltage is sufficient.

When attempting to operate an arc close to the stability limit, i_0 , where a small variation of voltage causes a large variation of current, the operation of the arc is unsatisfactory, that is, the

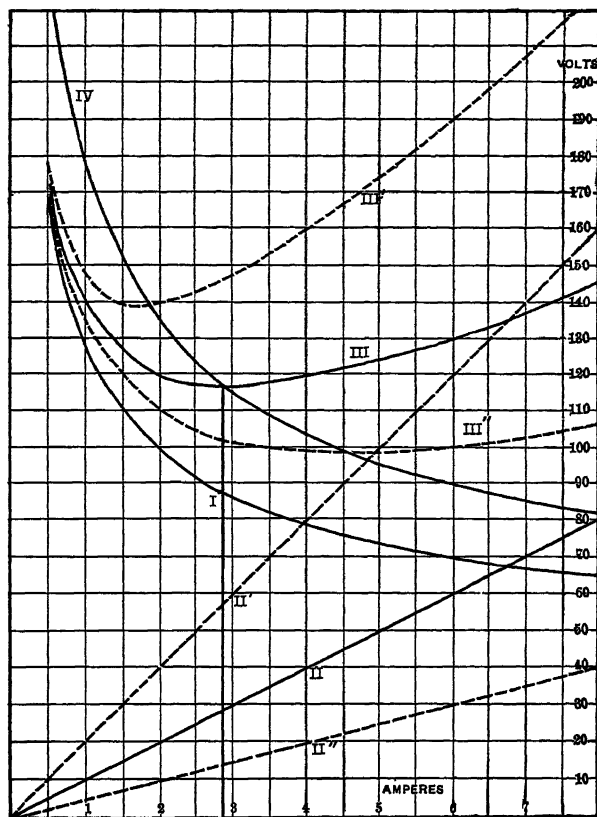

FIG. 48.

current drifts; small variations of the resistance of the arc stream, and thereby of the voltage consumed by the arc, cause excessive fluctuations of the current. These pulsations of current can be essentially reduced by using a large inductance in series with the arc, and an arc can be operated very much closer to its stability limit if its series resistance is constructed highly inductive, that is, wound on an iron core. Obviously,

no series inductance can extend stable operation beyond the stability point i_0 .

At the stability limit i_0 , the resultant characteristic III in Fig. 48 is horizontal, that is, the slope of the resistance curve II, $r = \frac{e'}{i}$, is equal but opposite to the slope of the arc characteristic I, $\frac{de}{di}$; that is, at the stability limit,

$$\frac{de}{di} + r = 0; \quad (4)$$

and, substituting equation (2) in (4), gives

$$-\frac{k(l+l_1)}{2i\sqrt{i}} + r = 0;$$

or,

$$r = \frac{k(l+l_1)}{2i\sqrt{i}};$$

and the total voltage consumed by the arc of current i and length l and such a series resistance r as just to reach stability is

$$\begin{aligned} E &= e + ir, \\ &= e_0 + \frac{k(l+l_1)}{\sqrt{i}} + \frac{k(l+l_1)}{2\sqrt{i}}; \end{aligned}$$

that is,

$$E = e_0 + 1.5 \frac{k(l+l_1)}{\sqrt{i}}; \quad (5)$$

or,

$$E = e + \frac{e_1}{2}. \quad (6)$$

This curve is called the stability curve of the arc. It is shown as IV in Fig. 48. It is of the same form as the arc characteristic I, and derived therefrom by adding 50 per cent of the voltage consumed in the arc *stream*.

Thus, in an arc requiring 80 volts, of which $e_0 = 30$ volts are consumed at the terminals, $e_1 = 50$ volts in the arc stream, for stable operation, a supply voltage of more than $E = e + \frac{e_1}{2} = 80 + 25 = 105$ volts is required.

The stability limit, on constant potential, thus lies at an excess of the supply voltage over the arc voltage by 50 per cent of the voltage, e_1 , consumed in the arc stream. In general, to get reasonable steadiness of the current, and absence of drifting, a supply voltage is used which exceeds the arc voltage by from 75 per cent to 100 per cent or more of the voltage, e_1 , of the arc stream.

65. The preceding consideration applies only to those arcs in which the gas pressure in the space surrounding the arc, and thereby the arc vapor pressure and temperature, are constant and independent of the current, as is the case with arcs in air (even "enclosed" arcs, as the enclosure cannot be absolutely airtight), as it is based on the assumption that the section of the vapor stream is proportional to the current. With arcs in which the vapor pressure and temperature vary with the current, as with vacuum arcs, as the mercury arc, the reasoning has to be correspondingly modified. Thus in the mercury arc in a glass tube, if the current is sufficiently large to fill the entire tube, and not so large that condensation of the mercury vapor cannot freely occur in the condensing chamber, the power p_1 dissipated by radiation, etc., may be assumed as proportional to the length l of the tube, and to the current i :

$$p_1 = e_1 i = k l i, \quad (7)$$

this gives $e_1 = k l$, or independent of the current; and

$$\begin{aligned} e &= e_0 + e_1 \\ &= e_0 + k l; \end{aligned} \quad (8)$$

that is, the voltage consumed by a mercury arc, within a certain range of current, is constant and independent of the current, and consists of a constant part, the terminal drop e_0 , and a part which is proportional to the length and to the diameter of the tube.

Approximately it is for the mercury arc in a vacuum:

$$e_0 = 13 \text{ volts}; \quad k = \frac{1.4}{l_d}$$

hence,

$$e = 13 + \frac{1.4 l}{l_d}.$$

Calculating approximately the increase of vapor pressure and thereby of arc-stream resistance at high currents, and the

increase of resistance at low current, due to the arc stream not completely filling the vapor tube, gives for the vacuum arc the approximate equation:

$$e = e_0 + \frac{l}{al_d - bi - \frac{cl_d^2}{i}};$$

where

l_d = diameter of arc tube, cm.,

l = length of arc, cm.,

i = current.

For the mercury arc, it is:

$e_0 = 13$ volts,

$a = 1.68$,

$b = 0.29$ for mercury anode,
 $= 0.167$ for graphite or metal anode,

$c = 0.52$.

Arc Length and Efficiency.

66. The arc most frequently employed for illumination is the plain carbon arc. In this the arc flame or the vapor stream gives no useful light, but the light is given by the black-body radiation of the incandescent carbon terminal, mainly the positive terminal, which is hottest, and is given at high efficiency due to the very high temperature of the radiator. The light of the carbon arc thus is incandescent light, and not luminescence. In the alternating carbon arc, alternately, the two terminals are positive and negative, and, as relatively little heat is produced at the negative terminal, the average temperature of the carbon terminals of an alternating arc is lower, and the efficiency of light production therefore less. Thus, while direct-current carbon arcs reach efficiencies corresponding to specific consumptions of from 1 to 1.5 watts per mean spherical candle power, alternating carbon arcs show only from 2.5 to 3 watts per candle power, or even still higher specific consumption. Thus, the only excuse for the use of the alternating carbon arc is the much greater simplicity and convenience of the electric generating apparatus, the stationary transformer, compared to the arc machine with the direct-current arc, and with the development of the constant-current mercury-arc rectifier; this

difference in the simplicity of generation of the arc current has largely disappeared.

In the direct-current carbon arc, the light comes mainly from the positive terminal; in the alternating carbon arc equally from both terminals, and the distribution curve of the light thus is different.

Since in the carbon arc no useful light comes from the arc flame, the voltage and therefore the power consumed in the arc flame is wasted, and in general, therefore, the efficiency of light production of the carbon arc is the higher the shorter the arc. Thus comparing in Fig. 49 a 1-in. carbon arc *A* with a

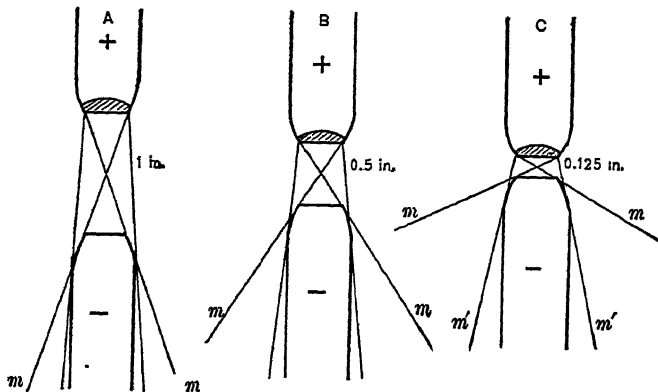

FIG. 49.

0.5-in. carbon arc *B*, the former requires, at 5 amperes, 112 volts and 560 watts, the latter only 84 volts and 420 watts, but radiates the same amount of light from the incandescent tip of the positive carbon. As the 1-in. arc requires 33 per cent more power, and only produces the same amount of light, it is less efficient than the latter. Thus, the shorter we make the arc and the less power we therefore consume in it the more efficient seems the light production, as we produce the same amount of light radiation from the positive terminal in either case. When we come to short arc lengths, however, while the same amount of light is produced at the positive terminal, we do not get the same amount of light from the lamp, as an increasing part of the light is intercepted by the negative terminal. Thus with the 1-in. arc, *A*, in Fig. 49, the light escapes

freely from the incandescent positive only in the space above the lines m , while at m the shadow of the negative terminal begins to obstruct the light more and more, and does so completely vertically below the arc. In the 0.5-in. arc B the area covered by the shadow of the negative terminals is somewhat increased, but in both arcs A and B the obstruction of the light by the shadow of the negative is still so small that the saving in power far more than makes up for it. In the 0.125-in. arc, however, C in Fig. 49, the shadow of the negative terminal m has crept up greatly, and thus, when decreasing the arc length, a point is reached where the increasing shadow of the negative terminal reduces the light more than the decreasing arc length reduces the power supply. Maximum efficiency of light production thus is reached in the carbon arc at a certain definite arc length (which depends on the size of the electrodes and on the current), at which the change of power consumption just balances the change of radiated light, which results from a change of arc length and thereby of shadow of negative terminal.

With the high-current (9 to 10 amperes) open arcs, the maximum efficiency point is at about $\frac{1}{4}$ -in. arc length, giving a voltage consumption of about 45 to 50 volts. Such arcs require daily trimming, and therefore are no longer used in American cities, except in a few places.

The open or short-burning arc has been practically entirely superseded by the enclosed or long-burning arc lamp, in which the arc is enclosed by an almost air-tight globe, the combustion of carbon is greatly decreased, and the life of the carbons thus increased about tenfold.

In the open arc of large current, the carbon terminals burn off into a rounded shape, but in the enclosed arc, the current being less and combustion greatly reduced, the carbon terminals burn off to more flat shape, and thus obstruct the light more; and, furthermore, since at the lower current the size of the incandescent spot of the positive terminal is less, the maximum efficiency of light production in the enclosed arc lamp is reached at a much greater arc length, about $\frac{3}{8}$ in. As the result thereof, the enclosed arc lamp, with 5, 6.5 or 7.5 amperes in the arc, consumes from 70 to 75 volts.

67. Entirely different are the conditions in the luminous

arc, as the magnetite arc. In this, the light is given by the vapor stream, and not by the terminals, and the voltage e_0 and power consumed by the terminal drop thus is wasted, and the voltage e_1 and power p_1 consumed by the arc stream is useful for light production. The greater, therefore, the voltage e_1 of the arc stream is, compared with the terminal drop e_0 , or in other words the longer the arc, the higher is the efficiency of light production. Thus a 4-amp. magnetite arc of 0.125-in. length requires 41 volts, while a 0.5-in. 4-amp. arc requires 64 volts; that is, only 56 per cent more voltage and thus power, but gives about four times the light. A 1-in. arc requires 95 volts or 48 per cent more power than the 0.5-in. arc, and gives twice the light. The greater, thus, the arc length of the luminous arc, with the same current, the higher is the efficiency. However, at the same current, the longer the arc, the greater is the power consumption. In the design of the arc lamp the power consumption is given, and the problem is to select the most efficient arc length for a given and constant power consumption. As an increase of arc length increases the arc voltage for the same power consumption, the current has to be decreased, and the efficiency of the arc conductor decreases with decrease of current. Thus, with increasing arc length at constant power consumption in the luminous arc, a point is reached where the decrease of current required by the increase of arc length and thus arc voltage decreases the efficiency more than the increase of arc length increases it. Thus with the luminous arc, for a given power consumption, a definite arc length exists, which gives maximum efficiency.

Assuming the light given by the arc to be proportional to the arc length and the current in the arc,

$$L = k'li, \quad (9)$$

if the power p shall be consumed in the arc, it is

$$ei = p; \quad (10)$$

however, by (2),

$$e = e_0 + \frac{kl}{\sqrt{i}} \quad (11)$$

(neglecting the small quantity l_1 , as the calculation can obviously be approximate only).

From (10) and (11) follows:

$$l = \frac{1}{k} \left(\frac{p}{\sqrt{i}} - e_0 \sqrt{i} \right); \quad (12)$$

and, substituting this in (9), gives:

$$L = \frac{k'}{k} (p\sqrt{i} - e_0 i \sqrt{i}), \quad (13)$$

and the maximum amount of light produced by power p is given by:

$$\frac{dL}{di} = 0.$$

This gives

$$i = \frac{p}{3e_0}; \quad (14)$$

hence, by (13):

$$L = \frac{2k'}{k} \sqrt{\frac{p^3}{2e_0}}; \quad (15)$$

and herefrom, by (12) and (11), the values of the arc length l and the arc voltage e .

Assuming $p = 300$ watts, and the constants of the magnetite arc: $e_0 = 30$, $k = 48.5$, gives:

$$i = 3.33 \text{ amperes,}$$

$$e = 90 \text{ volts,}$$

$$l = 2.21 \text{ cm.} = 0.885 \text{ in.}$$

Near the maximum efficiency, where the efficiency curve is horizontal, the efficiency does not vary much for moderate changes of current and of arc length. Thus, in above instance, practically the same efficiency is reached for currents from 3 amperes to 4 amperes.

Larger currents and shorter arc lengths, however, are preferable in an arc lamp.

(1) Because the shorter and thicker arc is less affected by minor air currents, etc., than the thin long arc, hence, is steadier.

(2) The shorter arc gives lower voltage, and this, in constant-current arc lighting, permits with the same total circuit voltage the use of more arc lamps in series.

Thus in the magnetite arc lamp a current of 4 amp. has been chosen.

$i = 4$: $e = 75$ volts, and $l + l_1 = 0.73$ in., or about $\frac{3}{4}$ -in. arc length.

In general, obviously the maximum efficiency points of luminous arcs occur at much greater arc lengths than in the plain carbon arc.

Since the lower efficiency of the alternating carbon arc is due to the lower temperature of the terminals, which are heated during one half-wave only, and in the luminous arc the temperature of the terminals does not determine the light production, but the light is produced by the vapor stream, no essential difference exists in the efficiency of a luminous arc, and practically no difference in the efficiency of the flame-carbon arc, whether operated on alternating or on direct current; that is, the alternating luminous or flame-carbon arc, with the same luminescent material, has the same efficiency as the direct-current luminous or flame-carbon arc, but the alternating plain carbon arc is much less efficient than the direct-current carbon arc.

Arc Lamps.

68. The apparatus designed for the industrial production of light by arc conduction, or the arc lamp, in general comprises four elements:

- (1) The current-limiting or steadying device.
- (2) The starting device.
- (3) The feeding device.
- (4) The shunt protective device.

(1) From the volt-ampere characteristic of the arc as given by equation (2) and curves, Fig. 46, it follows that an arc cannot be operated directly on constant voltage supply, but in series thereto a steadying device must be inserted; that is, a device in which the voltage increases with the current so that the total voltage consumed by the arc and the steadying device increases with increase of current, and pulsations of current thus limit themselves.

All arc lamps for use on constant voltage supply thus contain a sufficiently high steadying resistance, or, in alternating-current circuits, a steadying reactance.

Arc lamps for use on constant-current circuits, that is, circuits in which the current is kept constant by the source of power supply, as the constant-current transformer or the arc machine, require no steadying resistance or reactance.

Where several lamps are operated in series on constant potential mains, as two flame-carbon arcs in series in a 110-volt circuit, or five enclosed arc lamps in a 550-volt railway circuit, either each lamp may have its own steadying resistance, or a single steadying resistance or reactance of sufficient size may be used for all lamps which are in series on the constant potential mains.

(2) Since the arc does not start itself, but has to be started by forming the conducting vapor bridge between the terminals, all arc lamps must have a starting device. This consists of a mechanism which brings the terminals into contact with each other and then separates them, and hereby forms the vapor conductor, that is, starts the arc.

(3) As the arc terminals consume very rapidly in some arcs, as the open carbon arc, and very slowly in others, as the enclosed carbon arcs or the luminous arcs, some mechanism must be provided which moves the terminals towards each other at the rate at which they are consumed, and thereby maintains constant arc length and thus constant voltage and power consumption.

With arcs in which the electrodes consume very slowly, as the magnetite arc, the feeding may occur only at long intervals, every quarter or half hour, or even less frequently, while in arcs with rapidly consuming electrodes, as the flame arcs, practically continuous feeding is required.

(4) The circuit between the arc electrodes may accidentally open, as by a breakage of one electrode, or by the consumption of the electrodes if the lamp-trimmer has forgotten to replace them, or one of the electrodes may stick and fail to feed, and the arc thus indefinitely lengthen. In such cases, either the entire circuit would open, and thus all the lamps in series in this circuit go out, or, if the circuit voltage is sufficiently high, as in a constant-current series system, the arc lamp would be consumed and the circuit damaged by a destructive arc. Thus a device is necessary which closes a shunt circuit between the lamp terminals in case the lamp voltage becomes excessive by a failure of proper operation of the lamp.

Where only one lamp is operated on constant potential low-voltage supply, no such protective device is needed. If with two or more lamps in series on constant potential supply, no

objection exists, in case of the failure of one lamp, to have the others go out also, the shunt protective device may also be omitted, except if the circuit voltage is so high that it may damage the inoperative lamp, as is the case with 550 volts.

When operating a number of lamps in series on constant potential supply, as two flame lamps on 110 volts, the shunt circuit, which is closed in case of the failure of one lamp to operate, must have such a resistance, or reactance with alternating currents, that the remaining lamp still receives its proper voltage, even if the other lamp fails and its shunt circuit closes. With alternating-current lamps, this does not require a reactance of such size that the potential difference across the reactance equals that across the lamp, which it replaces, but the reactance must be larger; that is, give a higher potential difference at its terminals, than the lamp which it replaces, to leave the normal operating voltage for the remaining lamp, since the voltage consumed by the reactance is out of phase with the voltage consumed by the lamp.

69. For illustration, the operating mechanism of a constant direct-current arc lamp is shown diagrammatically in Fig. 50:

The lower electrode *A* is held in fixed position. The upper electrode *B* slides loose in a holder *C*, and thus, if there is no current through the lamp, drops down into contact with the lower carbon, as shown in Fig. 50. When there is a current through the arc circuit, its path is from terminal 1 through electromagnet *S*, holder *C*, upper electrode *B*, lower electrode *A* to terminal 2. The electromagnet *S* is designed so as to give a long stroke. When energized by the current, it pulls up its armature, the lever *DD'*, which is pivoted at *E*. Through the rod *F*, the lever *D* pulls up the clutch *G*. This clutch and its operation are shown in larger scale in Fig. 51, *a* and *b*; it consists of a metal piece *G*, which has a hole somewhat larger than the upper electrode *B*. This electrode slides freely through the hole, if the clutch *G* is in horizontal position, as shown in Fig. 51*a*. When the rod *F* pulls the clutch *G* up, and thereby inclines the piece *G*, as shown in Fig. 51*b*, the edges *p* and *q* of the hole in the piece *G* catch the electrode *B*, and, in the further upward motion of *D* and *F*, raise the other electrode, *B*, from contact with the lower carbon, *A*, and thereby start the arc. An electromagnet of many turns of fine wire, and of high resistance, *P*,

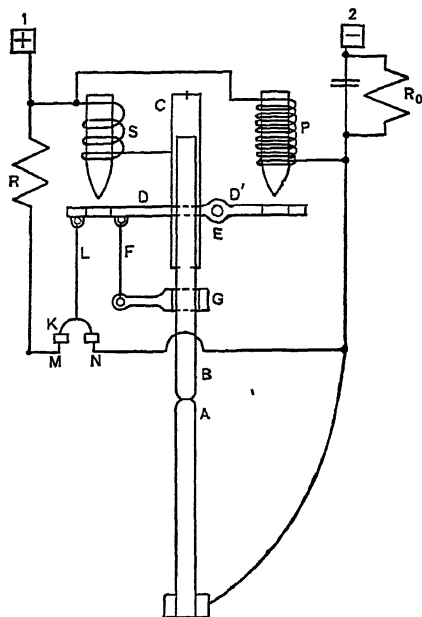

FIG. 50.

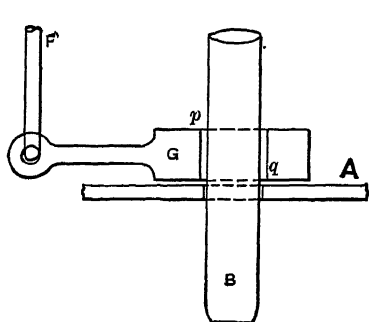

FIG. 51a.

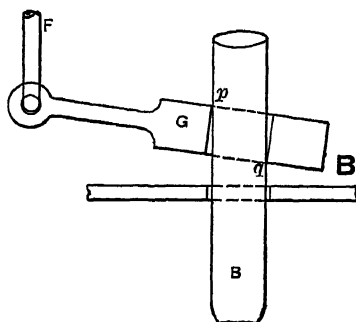

FIG. 51b.

connected in shunt between the lamp terminals 1 and 2, acts upon the side D' of the lever DD' , opposite from the side D , on which the series magnet S acts. With the carbons in contact with each other, and practically no voltage between the lamp terminals 1 and 2, the coil P receives no current, and exerts no pull. When by the action of the series magnet S the lever D pulls up, and the arc starts and lengthens, its voltage increases,

a branch current is established through the shunt magnet *P*, and this shunt magnet thus opposes the series magnet *S*. With increasing arc length and thus arc voltage, a point is reached, where the shunt magnet *P* counterbalances the pull of the series magnet *S*, and the lever *D* and thereby the electrode *B* come to rest; the arc has reached its full length, that is, the starting operation is over. As soon as, by the combustion of the electrodes, the arc length and thereby the arc voltage begins to rise, the current in the shunt magnet *P*, and thus its pull, increases, while that of the series magnet *S*, being energized by the constant main current, remains constant; the lever *D'* thus pulls up, and lowers *D*, and thereby, through rod *F* and clutch *G*, the upper electrode *B*, and thus maintains constant arc length. During the combustion of the electrodes, by the operation of the shunt magnet *P*, the clutch *G* and thereby the upper electrode *B* are gradually lowered, and the arc length thus maintained constant. Ultimately, however, the clutch *G* hereby approaches the horizontal position, shown in Fig. 51*a*, so far, that the edges of the hole, *p* and *q*, cease to engage, and the electrode *B* is free and drops down on the lower carbon *A*. While dropping, however, the arc shortens, the arc voltage, and thereby the current in the shunt magnet *P*, decreases, the pull of this magnet decreases correspondingly, and the series magnet *S* pulls the clutch *G* up again, thereby catches the electrode *B* — usually before it has dropped quite down into contact with the lower carbon *A* — and again increases the arc to its proper length, and the same cycle of operation repeats: a gradual feeding down of the upper electrode *B* by the shunt magnet until it slips, and is pulled up again by the series magnet *S*.

From the same lever *D* is supported, by rod *L*, a contact-maker *K*. If then the upper electrode *B* should stick, and thus does not slip, when by the shunt magnet *P* the clutch *G* has been brought into horizontal position, or, if *B* has been entirely consumed, etc., the arc continues to lengthen and the pull of the shunt magnet *P* to rise, and *D* thereby goes still further down until contact-maker *K* closes the contacts *MN*, and thereby closes a shunt circuit from terminal 1 over resistance *R*, contacts *MKN* to terminal 2. In the same manner, if, by the breaking of one electrode or any other cause, the arc should be interrupted, for a moment the full current passes through shunt

magnet P , it pulls up its armature D' to its full extent, and thereby closes the shunt circuit around the lamp.

When the current is taken off the circuit, armature D drops down, and thereby K closes the shunt circuit, and clutch G releases the electrode B , and it drops down into contact with carbon A . In starting the lamp, two paths thus are available: over series magnet S , and electrodes B and A , or over resistance R and contacts MN . While the resistance of the former path is very low, it is not entirely negligible. Therefore a sufficient resistance R must be inserted in the by-path MN , so that in starting practically all the current passes over S and the electrodes, as otherwise the lamp would not start. During the pulling up of the armature D by the series magnet S , in starting, the contact K opens, before the clutch G has caught the electrode B ; that is, while the electrodes are still in contact with each other, and the opening of contact K therefore breaks no appreciable voltage or current, hence is sparkless.

In this lamp, no steadying resistance is used, as it is intended for operation on a constant-current circuit. If used on constant-potential circuit, as, for instance, a number in series on 550 volts, a steadying resistance R_0 would be inserted, as indicated at R_0 in Fig. 50.

The starting of the arc is accomplished by series magnet S and clutch G ; the feeding by shunt magnet P ; the protective device is the contact MKN .

Such an arc lamp is called a *differential lamp*, as it is controlled by the differential action of a shunt and a series magnet.

It contains a *floating system of control*; that is, the upper electrode is suspended by the balance of two forces, exerted by the series and the shunt magnet; that is, by the current and the voltage; the upper carbon therefore is almost continuously moving slightly in following the pulsation of the arc resistance which occurs during operation. Since, with the plain carbon arc, the arc flame gives no light, this pulsation of the arc length is not objectionable; and, since the lamp regulates very closely and rapidly for constant terminal voltage, it is very easy on the circuit, that is, does not tend to produce surging of current and voltage in the circuit. The floating system of control is, therefore, used in all carbon arc lamps.

Where a single lamp is operated on a constant-potential circuit, the mechanism can be simplified by omitting the protective shunt circuit RMN , and omitting the shunt magnet P , as, with a change of arc length, the main current and thereby the pull of the series magnet S varies, and the control thus can be done by the series magnet. Such a lamp then is called a *series lamp*. An alternating-current series lamp is shown diagrammatically in Fig. 52.

In starting, the series magnet S pulls up the electrode B by the clutch G , in the same manner as in Fig. 50. With increasing arc length and thus increasing voltage consumed by the arc, the current in the arc and thus in the series magnet S decreases, and thereby the pull of this magnet, until it just counterbalances the weight of the armature, and the motion stop. With the consumption of the carbons, the armature D , clutch G and electrode B gradually move down, until the clutch lets the carbon slip, the arc shortens, the current rises, and the magnet S pulls up again, the same as in Fig. 50. A reactance x in series with the lamp, as steadying device, limits the current. This reactance

usually is arranged with different terminals, so that more or less reactance can be connected into circuit, and the lamp thereby operated, with the same arc voltage, on supply circuits of different voltage, usually from 110 to 125 volts.

Obviously, such a series lamp can be used only as single lamp on constant potential supply, as it regulates by the variation of current, and, with several lamps in series, the current would vary in the same manner in all lamps. One lamp would then take all the voltage, draw an arc of destructive length, while the other lamps would drop their electrodes together and go out.

70. With the luminous arc, in which the light is proportional

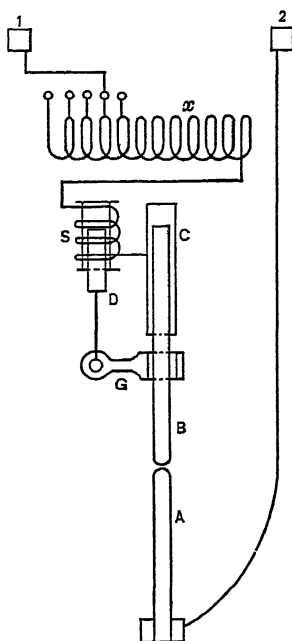

FIG. 52.

to the arc length, pulsations of the arc length, if appreciable, give pulsations of the light, and the floating system of control, which maintains constant voltage by varying the arc length in correspondence with the pulsation of arc resistance, thus is undesirable, and a mechanism maintaining fixed arc length is required. Such a mechanism, that of the magnetite arc lamp, is diagrammatically illustrated in Fig. 53.

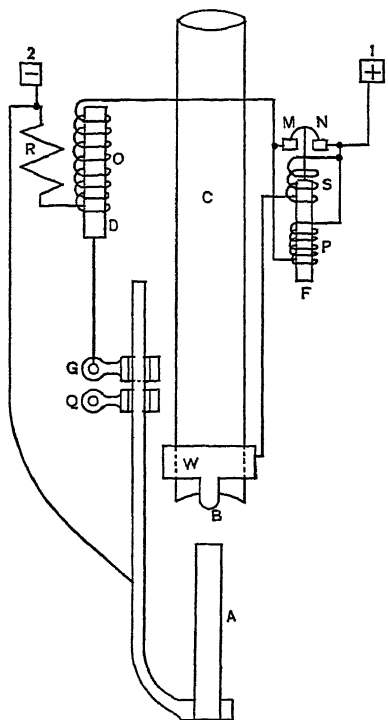

FIG. 53.

When starting the circuit, beginning at terminal 1, passes contacts *MN*, through a powerful electromagnet or solenoid *O* and resistance *R*, to terminal 2. The solenoid *O* pulls up its core *D*, and by the clutch *G* raises the lower electrode *A* into contact with the upper electrode, *B*, and thereby closes the circuit from 1 over series coil *S*, electrodes *B* and *A*, to terminal 2. The series coil *S* pulls up the core, and thereby opens the contact *MN*, thus cuts out the shunt circuit *OR*. The solenoid *O* thus loses its excitation, and drops the clutch *G*, and the lower terminal *A* drops away from the upper terminal *B* by a

As, during operation, a melted pool forms on the surface of the electrode, the electrodes are left separated from each other when taking the power off the circuit, since when letting them drop together when taking off the power—as in the carbon arc—they may weld together and the lamp thus fail to start again.

A represents the lower or negative magnetite terminal which is movable, *B*, the non-consuming upper positive electrode, consisting of a piece of copper, with heat-radiating wings, *W*, which is a stationary and fixed part of the lamp. *C* is the chimney required to carry off the smoke.

distance which is fixed by an adjustable clutch, Q , and thus starts an arc of definite length.

When during the consumption of this electrode A the arc length and thereby the arc voltage rises, the shunt magnet P increases in strength, and ultimately pulls the core F away from the series magnet S , closes the contact MN of the shunt circuit OR , and thereby energizes the solenoid O . This again raises, by the clutch G , the lower electrode A into contact with the upper electrode B , and so repeats the cycle of operation.

If the arc between A and B opens, the solenoid S loses its excitation, the coil F drops and closes the contact MN of the shunt circuit OR .

If the arc resistance were perfectly constant, such a mechanism would not operate satisfactorily, as the arc would have to lengthen considerably to have the shunt coil P overpower the series coil S sufficiently to pull the core F down, close the contact MN , and thereby feed.

The resistance of an arc, and thereby, at constant length, its voltage, pulsates, however, continuously, about as shown diagrammatically in Fig. 54, that is, peaks of voltage of vari-

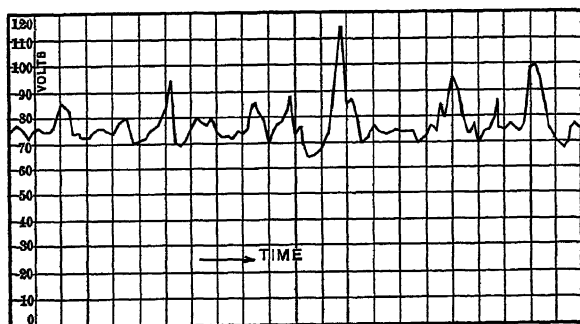

FIG. 54.

ous height follow each other. Thus with an average arc voltage of 75, momentary peaks of 85 volts will probably be reached every few seconds, peaks of 100 volts every few minutes, of 110 volts every half hour. Adjusting the shunt magnet P so as to operate at 105 volts, a voltage peak above 105, which causes the lamp to feed, would be reached about every 20 minutes. During 20 minutes, however, the arc length does not appre-

ciably increase by the consumption of the electrode. Due to the character of the arc as a pulsating resistance, such a controlling mechanism thus maintains constant arc length by a potential magnet set for a voltage considerably above the average arc voltage.

Such a mechanism, controlling for constant arc length, does not operate for constant voltage at the lamp terminals, but allows the pulsation of the arc resistance to appear as pulsation of the terminal voltage. In a constant-current circuit, with many lamps in series, these voltage pulsations of the individual arcs overlap and have no effect on the circuit. When operating, however, a lamp of such a mechanism on a low-voltage constant potential circuit, a highly inductive steadying resistance is desirable, to take care of the pulsations of arc voltage.

71. The open or short-burning carbon arcs of former times — which have survived only in a few cities — were operated on constant direct-current circuits of 9.6 and 6.6 amp. with 40 to 45 volts per lamp.

The present enclosed or long-burning carbon arcs are operated on constant-current circuits of 5 amp. and 6.6 amp. direct current, or of 6.5 and 7.5 amp. alternating current, with about 72 volts at the lamp terminals. They are operated as single lamps, of 5 to 9 amp. on direct- or alternating-current constant potential circuits of 110 to 125 volts, or two lamps in series on circuits of 220 to 250 volts.

The flame-carbon arcs, as short-burning open arcs, are usually operated two in series on constant-potential circuits of 110 to 125 volts, or four in series on circuits of 220 to 250 volts, with 10 to 15 amp. in the arc.

The luminous arcs are operated on 4- and 6.6-amp. constant direct-current circuits (magnetite lamp), with 75 volts per lamp, and on 3- and 4.5-amp. constant alternating-current circuits (titanium-carbide arc), with 80 volts per lamp.

Arc Circuits.

72. Arc lamps are built for, and operated on, constant-potential supply, and on constant-current supply. In general, the constant-potential arc lamp is less efficient, as voltage and thereby power is consumed in the steadying resistance which is required to limit the current, that is, to give an approximate

constant-current effect, as discussed above. In alternating-current circuits, reactance may, and usually is, employed instead of the steadying resistance, and the waste of power thereby greatly decreased. Voltage, however, is still consumed and the power factor lowered.

An additional waste of energy generally occurs in constant-potential arc-lamp circuits, due to the standard distribution voltages of low-potential circuits being higher than necessary for the operation of a single lamp, but too low for the operation of two lamps in series. Thus with an enclosed 5-amp. carbon arc lamp, with about 70 volts at the arc, a supply voltage of 95 to 100 volts would be sufficiently high above the stability curve of the arc (Fig. 46) to give steady operation. Distribution voltages, however, vary between 110 to 130 volts, and the difference thus must be consumed in resistance, giving an additional waste. (Except in those rare cases, where as steady-ing resistance some useful devices, as incandescent lamps, can be employed.) With an enclosed arc lamp on a 125-volt circuit, only 36 volts, or 29 per cent, are usefully employed in heating the carbon terminals and thereby producing the light, while the remaining 71 per cent is wasted in the resistance and in the non-luminous arc flame. Somewhat better are the conditions when operating two high-current open arcs, as two flame lamps, in series on such a circuit. However, at the lower distribution voltage, as 110 volts, the supply voltage may be already so close to the stability limit of the arc that the arcs are not as steady as desirable.

The low-current, long luminous arcs of electro-conduction, as the magnetite arc, can in general be operated only with difficulty on circuits of 110 to 125 volts, and therefore are, for constant-potential service, frequently designed for operation as single lamps on 220 to 250 volts supply, with extra great arc length.

For indoor illumination, constant-potential arc lamps must obviously be used, as safety does not permit the introduction of the high-voltage series arc circuits into houses. For outdoor illumination, as street lighting, in the United States the constant-current arc lamp is, with the exception of the interior of a few very large cities, as New York, used exclusively, due to its greater efficiency, and the greater distance to which the cur-

rent can be sent at the high voltage of the constant-current circuit. In American towns and cities, where arc lamps are used for street lighting, practically always the entire city up to the farthest suburbs is lighted by arc lamps, and frequently arc lamps installed even beyond the reach of the high-potential primary alternating-current supply. To reach such distances with low-voltage constant-potential supply, is impossible, and thus the constant-current series system becomes necessary. In European cities, where a prejudice exists against high-voltage constant-current circuits, and people are satisfied to have arc lamps only in the interior of the city, and leave the lighting of the suburbs to gas lamps, constant-potential street lighting is generally employed, and is eminently satisfactory within the limitations with which European cities are satisfied, but would be impossible in the average American city.

Where plain carbon arcs are used in American cities the enclosed arc lamp is exclusively installed, and open arc lamps have survived only in a few exceptional cases, mainly where political reasons have not yet permitted their replacement by modern lamps. The lesser attention required by the enclosed arc lamp — weekly trimming instead of daily with the open arc lamp — has been found to make it more economical than the open arc lamp of old. In Europe, where labor is cheaper, and the daily attention not considered objectionable, the open or short-burning arc lamp has maintained its hold, and the enclosed arc lamp has never been used to any great extent. With the development of the flame carbon, the flame arc, therefore, has found a rapid introduction in Europe, while in the United States it was excluded from use in street lighting, due to its short-burning feature, which requires daily trimming, and is used only for decorative purposes, for advertising, etc., until an enclosed or long burning flame arc lamp had been developed.

In spite of the lower efficiency of the alternating carbon arc, the constant-current circuits used for arc lighting are generally alternating, due to the greater convenience of generation of alternating current, and constant direct-current arc circuits used only where the city or the electric light company lays stress on the efficiency of light production.

While the development of the constant-current mercury arc rectifier has made the generation of constant direct current

almost as simple and convenient as that of alternating current, this has very little increased the use of the direct-current enclosed arc lamp, but when changing to direct current supply, usually the arc lamp is also changed to the luminous arc, the magnetite lamp, which gives more light and consumes less power.

In constant-current arc circuits, usually from 50 to 100 lamps are operated in series on one circuit, with circuit voltages of 4000 to 8000 volts. Seventy-five-lamp circuits, of 6000 volts, probably are the most common.

73. Constant direct current was produced by so-called "arc machines" or "constant-current generators." Of these only the *Brush machine* has survived, and is now also beginning to disappear before the mercury arc rectifier, which changes the alternating current of the constant-current transformer to direct current without requiring moving machinery.

The Brush machine in its principle essentially is a quarter-phase constant-current alternator with rectifying commutator. An alternator of low armature reaction and strong magnetic field regulates for constant potential: the change of armature reaction, resulting from a change of load, has little effect on the field and thereby on the terminal voltage, if the armature reaction is low. An alternator of very high armature reaction and weak field, however, regulates for constant current: if the m.m.f., that is, the ampere-turns required in the field coil to produce the magnetic flux, are small compared with the field ampere-turns required to take care of the armature reaction, and the resultant or magnetism-producing field ampere-turns thus the small difference between total field excitation and armature reaction, a moderate increase of armature current and thereby of armature reaction makes it equal to the field excitation, and leaves no ampere-turns for producing the magnetism; that is, the magnetic flux and thereby the machine voltage disappear. Thus, in such a machine, the current output at constant field excitation rises very little, from full voltage down to short circuit, or, in other words, the machine regulates for approximately constant current. Perfect constant-current regulation is produced by a resistance shunted across the field, which is varied by an electromagnet in the machine circuit, and lowered — that is, more current shunted through it, and

thereby the field excitation decreased — if the machine current tends to rise by a decrease of the required circuit voltage, and inversely.

The constant-current regulation of the arc machine thus is not produced by its so-called “regulator,” but approximate constant-current regulation is inherent in the machine design, and the regulator merely makes the regulation perfect.

A more explicit discussion of the phenomena in the arc machine, and especially its rectification, is given in Chapter III of Section II of “Theory and Calculation of Transient Electric Phenomena and Oscillations.”

In alternating-current circuits, approximate constant-current regulation is produced by a large reactance, that is, by self-induction, in the circuit. In transformers, the self-induction is the stray field, or the leakage flux between primary coil and secondary coil. In the constant-current transformer, which is most generally used for constant alternating-current supply from constant alternating voltage, the primary turns and the secondary turns are massed together so as to give a high magnetic stray flux between the coils. Such a transformer of high internal self-induction, or high stray flux, regulates approximately for constant current. Perfect constant-current regulation is produced by arranging the secondary and the primary coils movable with regard to each other, so that, when low circuit voltage is required, the coils move apart, and the stray flux, that is, the reactance, increases, and inversely. The motion of the coils is made automatic by balancing the magnetic repulsion between the coils by a counter-weight. A discussion of the constant-current transformer and its mode of operation is given in “Theory and Calculation of Electric Circuits,” Chap. XIV.

In the so-called “constant-current reactance,” the two coils of the constant-current transformer are wound for the same current, and connected in opposition with each other, and in series to the arc circuit into the constant-potential mains. With the coils close to each other, the reactance is a minimum, and it is a maximum with the coils their maximum distance apart.

The constant-current reactance has the advantage of greater cheapness, but also has the serious disadvantage that it connects

all the arc circuits electrically with the constant-potential alternating-current system, and any ground in an arc circuit is a ground on the constant-potential supply system. As grounds are more liable to occur in arc circuits, the constant-current reactance is therefore very little used, and generally the constant-current transformer preferred, as safer.

In the constant direct-current mercury-arc rectifier system, the constant-potential alternating-current supply is changed to constant alternating current by a constant-current transformer, and the constant alternating current then changed to constant direct current by the mercury-arc rectifier. An explicit discussion of the phenomena of the constant-current mercury arc rectifier is given in Chapter IV of Section II of "Theory and Calculation of Transient Electric Phenomena and Oscillations."

If the constant-current arc circuit accidentally opens, with a Brush machine as source of supply, the voltage practically vanishes, as the machine has series field excitation, and thus loses its field on open circuit. The constant-current transformer, however, maintains its voltage, and gives maximum voltage on open circuit. The mercury arc rectifier, when separately excited by a small exciting transformer, also maintains its voltage on open circuit. If, however, after starting, the excitation is taken off, that is, the exciting circuit opened, as is permissible in a steady arc circuit, the voltage in the arc circuit disappears if the arc circuit is opened. Inversely, when connecting an arc circuit to a Brush arc machine, an appreciable time elapses while the voltage of the machine builds up, while with the constant-current transformer and thus also with the constant-current mercury arc rectifier system, full voltage exists even before the circuit is closed.

LECTURE IX.

MEASUREMENT OF LIGHT AND RADIATION.

74. Since radiation is energy, it can be measured as such by converting the energy of radiation into some other form of energy, as, for instance, into heat, and measuring the latter.

Thus a beam of radiation may be measured by having it impinge on one contact of a thermo-couple, of which the other contact is maintained at constant temperature. A galvanometer in the circuit of this thermo-couple thus measures the voltage produced by the difference of temperature of the two contacts of the thermo-couple, and in this manner the temperature rise produced by the energy of the incident beam of radiation is observed.

Probably the most sensitive method of measuring even very small amounts of radiation is the bolometer. The beam of the radiation (or after dissolving the beam into a spectrum, the wave length of which the power is to be measured) impinges upon a narrow and thin strip of metal, as platinum, and thereby raises its temperature by conversion of the radiation energy into heat. A rise of temperature, however, produces a rise of electric resistance, and the latter is measured by enclosing the platinum strip in a sensitive Wheatstone bridge. The rise of temperature of the platinum strip by the small power of radiation obviously is so small that it could not be observed by any thermometer. Electric resistance measurements, however, can be made with extreme accuracy, and especially extremely small changes of resistance can be measured. Thus a change of resistance of 1 in a million and, with very sensitive measurements, even many times smaller changes can be observed. As 1 deg. cent. produces a resistance change of about 0.4 per cent, a change of one millionth corresponds to a temperature rise of $\frac{1}{2500}$ deg. cent. Thus, by the bolometer, extremely small amounts of radiation can be measured, as, for instance, the power of the moon's radiation, etc.

The total radiation energy of a body for a given time can be measured by absorbing it and measuring the heat produced by it, as, for instance, the amount of ice melted in a calorimeter. Any particular range of the total radiation, as, for instance, the total visible radiation, can be measured in the same manner by passing the radiation first through a body which absorbs that part which is not desired, for instance, a body transparent to visible, but opaque to invisible radiation. As no body is perfectly transparent to one, perfectly opaque to another radiation, the separation of the radiation by absorption is necessarily incomplete, and correction must therefore be made in the result. This makes this method rather inconvenient and inaccurate. Even when measuring the total radiation by absorption in a calorimeter, it is practically impossible to collect the total radiation without either losing some, or including energy, which is not radiation, but heat conduction or convection. Obviously, by enclosing the radiator in the calorimeter, the latter would measure not only the radiation, but also the power lost by heat conduction, convection, etc.

Sometimes the power of radiation can be measured by measuring input and losses. Thus, in an incandescent lamp, the electric-power input is measured, and the power lost by heat conduction and convection estimated if not entirely negligible. In those cases in which all or most of the energy supplied is converted into radiation, as in an incandescent lamp, this method is the most exact. However, it can directly measure only the total radiation power. To measure the different parts of the radiation so as to determine separately the power in the visible, the ultra-red, and the ultra-violet range, the method of input and losses can be used to give the total radiation power, and, by bolometer or other means, the relative powers of the component radiations measured in a beam of light. From the total radiation and the ratio of its components, then, follows the values of radiation power of the components.

75. *Light*, however, cannot be measured by any of the preceding methods, since light, in the sense in which it is considered photometrically, is not power, but is the physiological effect of certain wave lengths of radiation, and therefore cannot be measured, physically, as power, but only physiologically,

by comparison with other physiological effects of the same nature.

The power of visible radiation obviously can be measured, and thus we can express the power of the visible radiation of a mercury lamp or an incandescent lamp in watts. But the power of visible radiation is not proportional to the physiological effect, and thus not a measure thereof. One watt of green radiation gives many times as great a physiological effect, that is, more light, as does one watt of red or violet radiation, and, besides, gives a different kind of physiological effect: a different color.

The unit in which illuminating value of light, or its intensity, is expressed as the "candle-power," is, therefore, a physiological and not a physical quantity, and hence it has no direct or constant relation to the unit of power, or the watt. The unit of light intensity has been chosen by convention: as the physiological effect exerted on the human eye by 5 sq. mm. of melting platinum, or by a flame burning a definite chemical compound — as amyl acetate or pentane — at a definite rate and under definite conditions, etc.

Broadly, therefore, the conception of a chemical equivalent of light, that is, a relation between candle power and watt, is irrational, just as, broadly, a relation between time and distance is irrational; that is, just as distance cannot be expressed by the unit of time, so candle power cannot be expressed by a unit of power, as the watt. A relation between two such inherently different quantities can be established only by an additional conventional assumption, and varies with a change of this extraneous assumption. Thus stellar distances are measured in "light years," that is, by the distance traveled by the light in one year, as unit. So also the physiological effect of one definite color of light, as that of the green mercury line, or the yellow sodium line, or the red lithium line, can be related to the unit of power, or the watt, and we may speak of a mechanical equivalent of green light, or of yellow light, or of red light. When doing so, however, we give to the term "mechanical equivalent" a different meaning from what it has in physics, for instance, as "mechanical equivalent of heat." The latter is the constant relation between two different forms of the same physical quantity, while, for instance, the "mechanical

equivalent of green light" is the relation between a physiological effect and the physical quantity required to produce the effect, and thus is not necessarily constant, but may, and does, vary with the intensity of the effect, the individuality of the observer, etc. It appears, however, that at higher intensities the relation is very nearly constant and the same with different observers, so that it is possible to express the physiological effect of a definite wave length of radiation, within the accuracy of physiological measurements, by the power consumed in producing this wave length of radiation; but it becomes entirely impossible to compare physiological effects of widely different wave lengths by comparing the power required to produce them.

When speaking of mechanical equivalent of light, it thus must be understood in the extended meaning of the word, as discussed above.

76. In photometry, and in general in illuminating engineering, it is of essential importance to keep in mind this difference in the character of light as physiological effect, and radiation as physical quantity of power. This is the reason why all attempts to reduce photometry to a strictly physical measurement, and thereby bring photometric determinations up to the high grade of exactness feasible in physical observations, have failed and must necessarily fail; we cannot physically compare an effect as light, which is not a physical quantity, but somewhere in all photometric methods the physiological feature, that is, the judgment of the human eye, must always enter.

Photometric tests therefore can never have the accuracy of strictly physical determinations. All attempts to eliminate the judgment of the human eye from photometry, by replacing it by the selenium cell, or the photographic plate, or Crookes' radiometer, etc., necessarily are wrong in principle and in results: some of those instruments, as the bolometer, the radiometer, etc., compare the power of the radiation, others, as the selenium cell or the photographic plate, the power of certain changes of radiation, but their results are comparisons of power, and not of physiological effects, and thus they cannot be of value in measurement of illuminating power.

Measurements of light thus are made by comparison with an arbitrarily chosen conventional unit, a primary standard

of light, as "standard candle," or a duplicate or multiply thereof. Obviously, in measurements of light, usually not the primary standard of light is used, but a more conveniently arranged secondary standard of light, that is, a standard which has been calibrated by comparison, directly or indirectly, with a primary standard.

77. The most accurate method of comparing lights is the zero method, as represented by the different types of photometers. The illumination produced by the two different sources of light — the one to be tested and the standard — are made equal by changing the relative distances of the sources. At equal illumination their intensities are proportional to the square of their distances. Thus, for instance, in the bunsen type of photometer, as shown diagrammatically in its simplest form in Fig. 55, the

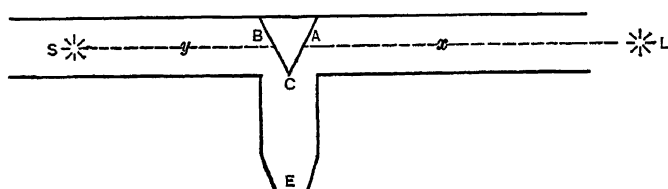

FIG. 55.

two white screens *A* and *B* are illuminated, the one, *A*, by the light, *L*, which is to be tested, the other, *B*, by the standard *S*, as a calibrated or standardized 16-cp. incandescent lamp, and then either *L* or *S* or both are moved until, seen from *C*, the two sides *A* and *B* of the screen become equal, that is, the dividing line *C* between them disappears. When this is the case, $L \div S = x^2 \div y^2$, where *x* and *y* are the two distances of the sources from the screen.

Different modifications of the bunsen photometer are most commonly used.

As the sensitivity of the eye to differences of illumination is not very great, usually a number of readings are taken on the photometer, and then averaged.

For testing incandescent lamps, *L*, as standard *S*, a calibrated incandescent lamp is used, operated on the same voltage supply, so that fluctuations of light caused by minor fluctuations of supply voltage eliminate by appearing in both sources *L* and *S*.

For similar reasons, when testing gas lamps or other flames, L , as S , a flame standard, as the pentane lamp, is used, so that the effect of barometric pressure, humidity of the air, etc., appears in both lamps and thereby does not appreciably affect the comparison of their light.

A quick and approximate method of comparison of sources of light is given by the shadow photometer by moving an object between the two lamps until the two shadows of the object give the same darkness. When this is the case, the illumination at the object is the same, and the intensities of the two sources are then proportional to the square of their distances from the object. Street lamps can, in this manner, be rapidly compared, with fair accuracy, by pacing the distance from the one to the other, and noting when the two shadows of the observer are equal in darkness. If then at x steps from the one lamp, L_1 , the shadows are equal, and y further steps are required to reach the second lamp, L_2 , it is:

$$L_1 \div L_2 = x^2 \div y^2.$$

A very convenient form of photometer, which gives good results even where the two lights are of somewhat different color, is the paraffine photometer. A

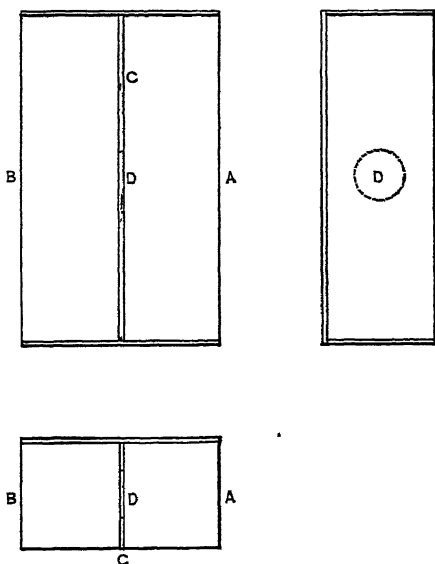

FIG. 56.

A block of paraffine is cast, as shown in Fig. 56, divided by a sheet of tinfoil in the center C , and covered with tinfoil except at the top and on the sides A and B . It is advantageous to have the center sheet of tinfoil C perforated by a hole D .

The block of paraffine then is held so that the side A is illuminated by the one lamp, L , the side B by the other lamp, S , as shown in Fig. 57. As paraffine is translucent, the entire block then appears luminous, and a beam of light is seen traversing

the block from the hole *D*, on the side which receives less light. By moving the paraffine block between the lamps *L* and *S*, until both sides of it are of the same luminosity, that is, the dividing line *C* and the beam cast by hole *D* disappear, equality of the two illuminations can be located rapidly and with great accuracy.

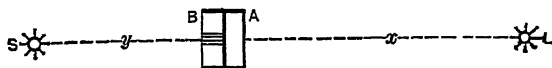

FIG. 57.

78. When comparing lamps giving light of the same color, as incandescent lamps of the same filament temperature, that is, the same efficiency, exact comparisons can be made — within the limits of sensitivity of the eye for intensity differences — by the photometer by making the two sides *A* and *B* of the Bunsen photometer screen, or the two halves of the paraffine block, identical, that is, making the dividing line *C* disappear. If, however, the color of the two lights is not the same, as, for instance, when comparing a tungsten lamp and an ordinary incandescent lamp, no position of the photometer can be found where the dividing line *C* between *A* and *B* (Figs. 55, 57) disappears, but a color difference always remains. To make a comparison, it is therefore necessary for the eye to judge when the two sides *A* and *B* are of the same intensity while of different colors. If the color difference is small, as between two different types of incandescent lamps, this can be done with fair accuracy, though obviously not as accurately as the comparison of lights of identical colors. If, however, the color difference is great, as between the mercury arc and the orange-yellow carbon filament lamp, the uncertainty of equality of the intensity of illumination becomes very great, and constant errors appear, due to the difference of the physiological effect of different colors, and differences also appear between different observers, so that the photometric comparison of light sources of greatly different colors is quite unreliable, and that not merely by inaccuracy, but by unknown and individual constant errors.

In such cases, frequently lights of intermediary color are used to reduce the differences in each observation. Thus the carbon filament lamp is compared with the tungsten lamp, the

tungsten lamp with the carbon arc lamp, and the latter with the mercury arc lamp. Hereby the uncertainty of each observation is reduced by the reduced color difference. In the final result, however, the comparison of the carbon incandescent-lamp standard and the mercury arc lamp no advantage is gained, because the errors of the successive measurements add. Especially is this the case with the constant errors, that is, errors due to the specific color effect, and in consequence thereof the inaccuracy of the final result is not much better than it would be by single and direct comparison.

A photometer which is sometimes used for comparing lights of different color, and is based on a different principle from either of the above discussed instruments, is the *flicker photometer*. In its simplest form it consists of a stationary disk, illuminated by the one lamp, and a rotating half disk or sector in front of it, which is illuminated by the other lamp. At slow rotation a flicker shows, which disappears if the speed becomes sufficiently high. It is obvious that the more nearly equal the effect on the eye of the two illuminations — that of the stationary disk and that of the revolving sector — the lower is the speed at which the flicker disappears, and, by adjusting the distances of the two lamps so as to cause the flicker to disappear at the minimum speed, the instrument indicates equality of the effect of the two successive illuminations on the eye. This is frequently considered as representing equality of the illumination, and the instrument in this manner used to compare illuminations. There is, however, no reason why this should be the case, but, on the contrary, it is improbable. As the persistence of vision, and in general the physiological effects of different colors, are different, the flicker photometer must be expected to have a constant error which increases with color difference; that is, it does not compare lights of different color by their illuminating values, but by some other feature not directly related thereto.

79. The photometer thus cannot satisfactorily compare lights of different colors. After all, this is obvious: the photometer compares by identity, but lights of different colors cannot be identical, and thus two such lights cannot be more broadly compared than any other two quantities of different character; that is, a green light can no more be equal to a red

light than a piece of stone can be equal to a piece of ice. A comparison of quantities of different nature is possible only regarding particular features of the quantities which they have in common. Thus a piece of stone and a piece of ice can be compared regarding their weight, or their density, etc. In the same manner, two different colors of light, or in general two different frequencies of radiation, can be compared by any feature which they have in common. Thus, for instance, the photographic plate compares them in their chemical activity, the bolometer by their physical energy.

Light is used for seeing things by, that is, distinguishing objects and differences between objects. Regarding this feature, the distinction of objects given by them, different colored lights can be compared, and a green light can be made equal to a red light in illuminating value.

It thus means that any two lights, regardless of their color, have the same intensity if, at the same distance from them, objects can be seen with the same distinctiveness, as, for instance, print read with equal ease. The only method, therefore, which permits comparing and measuring lights of widely different color is the method of "reading distances," as used in the so-called *luminometer*. It after all is the theoretically correct method of comparison, as it compares the lights by that property for which they are used. Curiously enough, the luminometer, although it has the reputation of being crude and unscientific, thus is the only correct light-measuring instrument, and the photometer correct only in so far as it agrees with the luminometer, but, where luminometer and photometer disagree, the photometer is wrong, as it gives a comparison which is different from the one shown by the lights in actual use for illumination.

The relation between luminometer and photometer for measuring light intensity, therefore, is in a way similar to the relation between spark gap and voltmeter when testing the disruptive strength of electrical apparatus: while the voltmeter is frequently used, the exact measure of the disruptive strength is the spark gap and not the voltmeter, and, where the spark gap and voltmeter disagree, the voltmeter must be corrected by the spark gap. In the same manner the luminometer measures the quality desired — the illuminating value of the light — but

the photometer may be used as far as it agrees with the luminometer.

80. The luminometer can hardly be called an instrument, but it is merely a black box, as shown in Fig. 58, to screen off all extraneous light, and allow only the light of the source which is to be observed, to fall on the print. The print obviously must be black on white, that is, complete absorption and complete reflection, so as not to discriminate in favor of particular colors. No great accuracy could be reached by merely comparing the ease of reading

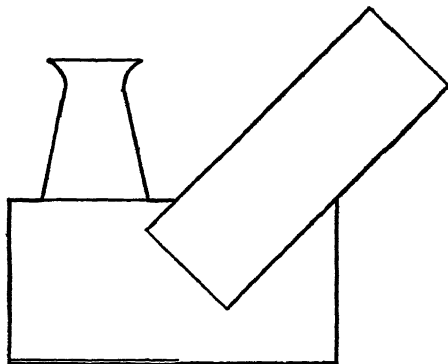

FIG. 58.

the same kind of print with different sources of light. A high accuracy, however, is reached by using a print which does not give definite words—in which letters which are not clearly seen cannot be guessed from the sense of the word or sentence—but a jumble of letters, capitals and small letters, arranged in meaningless words.

Such a luminometer chart is given below:

Amhof dirito amritu, Lisno Iadse pemrane odo Ulay
 Foresca 1598720 woleb noitaidar. Ybod ergy may
 Pewos ex Idetnera, bsor poge Morf Tenscerophop War-
 dog; Omsk whykow efforau tespo ygnew col Brispo
 Monas albo darmosphor? Cottet vol Demno myo
 36802 Erbtomy, quot Hiaworu pio Nio cuguab Qaphla-
 qua H 530 K b n q; 267 Lloysir baraka nunc, cinc
 Viamara W x 4 zoliaq kama nambosi erianosecum.
 Zaraz didym fore ik yiquia Fumne.

With such a printed chart in the luminometer, the observer moves towards the light or away from it—or the light is moved, with the observer stationary—until a point is found at which the large letters, as the capitals, can be clearly distinguished, but the small letters are indistinguishable. This point can be found with great sharpness, and the accuracy of

observation by the luminometer when used in this manner is nearly as great as that of the ordinary photometer, but, unlike the photometer, the luminometer gives consistent and reliable readings even with widely different colors of light.

The comparisons made by the luminometer of widely different colored lights by different observers agree remarkably well, showing that the distribution of color sensitivity is practically the same in different human eyes. Only occasionally a person is found with abnormally low sensitivity for some particular color — this obviously is not a fault of the instrument, but in the nature of the measured object, which is a physiological effect, and as such may be different in different persons.

The luminometer can be still further improved by illuminating one half of the printed chart from the one, the other half from the other, source of light, and then moving the two sources to such distances that the small letters on both sides of the chart become indistinguishable, while the capitals are distinguishable.

As well known, the luminometer is largely used for measuring street illumination, as it is very simple and requires no special technical training. Such observations, where the distances are measured by pacing, are crude, and, to get exact results by the luminometer, the same care is required as when using the photometer.

The limitation of the luminometer, as generally used, is that it compares lights at constant and relatively low intensity of illumination. The relative intensity of light sources of different colors changes however over a wide range with the intensity of illumination at which they are compared, as discussed in Lecture III. A complete comparison of different colored lights therefore requires measurements at different intensities of illumination.

With a photometer, the intensity of illumination can usually be varied over a wide range by bringing the light sources nearer to the screen or removing them farther. In the luminometer, only a moderate change of the intensity of illumination, at which the comparison is made, can be produced by using different sizes of print, and the interpretation of such tests is difficult.

A wide and definite range of intensities of illumination, at which comparison of the light sources is made by the lumi-

nometer, can be secured by using gray print on white background, and lights of different colors thereby compared over a wide range of illuminations.

With a luminometer chart of gray letters, of albedo a , on white background, the illumination or light flux density, at which the luminometer readings are made as described above, is:

$$i = \frac{i_0}{1 - a},$$

where i_0 is the illumination or light flux density when using black print on white background.

81. Since light is a physiological effect, the measurement of this effect requires a physiological unit, which is more or less arbitrarily chosen. Such a unit may be a unit of light, that is, of light intensity or light flux, as a flame, or it may be a unit of light-flux density or illumination, that is, of light flux per unit area.

Thus, a fairly rational unit of light-flux density or illumination would be the illumination required at the limits of distinguishability of black print of a specified type, on white background, that is, the light flux per unit area by which, with such black print on white background, the capitals and large letters can still be distinguished, while the small letters are indistinguishable.

Usually so-called "primary standards" have been chosen as units of light intensity. Violle recommended as standard the light at right angles from 1 sq. cm. of melting platinum. (Approximately 20 cp.) This unit has never been introduced, partly due to the difficulty of producing it, partly due to the unsuitability of platinum for this purpose: platinum gives gray-body radiation, therefore any impurity, as a trace of carbonized dust, may increase the light.

Candles have been largely used for standards, as the name of the unit implies, made and burned under definite specifications. As individual candles vary widely in their light, the use of the candle as standard necessarily is very crude and inaccurate, and thus unsatisfactory.

The only primary standard which has found extensive and international use is the amyl-acetate lamp of Hefner. This is a lamp burning amyl acetate at a definite rate, with a definite

height of flame and definite conditions regarding air pressure and humidity. This Hefner lamp, or *German candle*, equals about 90 per cent of the British candle and equals 90 per cent of the *international candle*. Amyl acetate has been chosen, as it can easily be produced in chemical purity, and gives a good luminous flame. The flame, however, is somewhat reddish, thus markedly different from the color of the carbon incandescent lamp, and departs still much more from that of the tungsten lamp. Instead of amyl acetate, pentane has been used and is still used. It gives a somewhat whiter flame, but the pentane lamp is not as constant.

However, the Hefner lamp, while universally used as primary standard, is altogether too inconvenient for general photometric use, and, for this purpose, usually incandescent lamps are employed which have been compared with, and standardized by, the Hefner lamp. In reality, from these standard incandescent lamps, by comparison, other incandescent lamps have been standardized, and so on, until of late years the Hefner lamp has been finally abandoned as primary standard of light, and we have no primary standard; but the standard of light is maintained by comparison with incandescent lamps kept for this purpose; that is, it is maintained by duplication of samples, and by international agreement an incandescent lamp unit has been adopted as the standard or "international candle."

82. A number of primary standards have lately been proposed, but none has yet been much developed.

Some work was done on the acetylene flame, burning in oxygen. It has a very suitable white color, but its intensity is very sensitive to slight impurities of the acetylene, and such impurities, as hydrogen, are difficult to avoid.

A suitable unit appears to be the normal temperature radiation at specified temperature, and the temperature could be defined by the ratio of the radiation power of definite wave lengths. Thus, such a unit would be an incandescent lamp, radiating x watts at such temperature that the power radiated between wave lengths 45 and 55 bears to the power radiated between wave lengths 60 to 70 the ratio y . The radiated power x could probably be determined from electric power input and losses. Such a unit would probably be replaceable with considerable exactness, but would still be arbitrary.

A further possible unit would be the light given by one watt visible radiation, by normal temperature radiation at a definite temperature — the latter specified and measured by the ratio of radiation power of two different ranges of wave length. Such definition would base the physiological effect, under specified conditions of temperature, on the unit of power, or the watt, as unit of light. Its disadvantage is the difficulty of measuring the power of the total visible radiation, since at the ends of the visible spectrum the power is high and the physiological effect low, and a small error in the limits of the spectrum would make a considerable error in the result.

More satisfactory, therefore, appears the derivation of a primary standard of light by combining three primary colors of light in definite power proportions. Thus, choosing three lines of the mercury spectrum — in the mercury arc in a vacuum, perfect steadiness and high intensity can easily be produced — in the red, green and blue, about equidistant from each other, these three radiations would be combined in definite proportions — chosen so as to give the desired color of the light, probably a yellowish white — and in such quantities as to give one watt total radiation, or, if as unit the illumination is used, to give one microwatt per sq. cm.; that is, the standard of illumination would be the illumination produced by one microwatt of radiation power, composed of the three wave lengths of the three chosen mercury lines, in definite proportions.

Such a standard, derived by combination of definite wave lengths, which are easily reproducible, appears the most satisfactory in regard to permanence. It would incidentally give a numerical expression to color values, as any color then would be represented by the numerical ratio of the power of the three standard spectrum radiations, which, mixed together, give the color.*

83. Light is produced for the purpose of illumination. The raw material used in illumination is the flux of light issuing from the illuminant. The important characteristic of the illuminant, by which it is judged, thus is the total flux of light issuing from it, and its measurement one of the main objects of photometry.

* Proc. A. I. E. E., (1908).

The photometer or luminometer, however, gives the light intensity in one direction only. Thus, to measure the total flux of light, the light intensity in all directions in space must be determined, and added, or averaged, to get the average intensity of light, usually called the "mean spherical intensity."

If the light intensity were the same in all directions, one single photometric observation would give it, and therefrom, by multiplying with 4π , the total flux of light would be obtained. This, probably, is never the case.

Many illuminants, however, give a symmetrical distribution of light around an axis, so that the distribution curve is the same in all meridians. This is practically the case with the ordinary incandescent lamp with oval filament, and also with the tantalum and the tungsten lamp. Thus if the curve, shown in Fig. 59, is the distribution curve in one meridian, it is the same

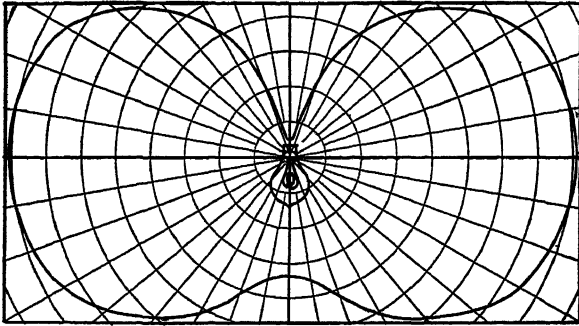

FIG. 59.

in every other meridian, and for photometric test of the illuminant it is sufficient to measure the light intensities in one meridian only, for instance, from 10 to 10 degrees. To get herefrom the mean or average intensity, it would obviously be wrong to merely average all the intensities under equal angles, since the equatorial intensity covers a far greater area — a zone of 10 degrees width and 2π circumference — than the intensity of latitude ϕ , that is, under angle ϕ from the horizontal: the latter covers a zone of 10 degrees width and $2\pi \cos \phi$ circumference, and the polar intensity covers only a point.

To get the total flux of light, the intensity under each angle ϕ

thus is to be multiplied with the area of the zone which it covers, $2 \pi \delta \cos \phi$, where δ is the angular width of the zone (10 deg., for instance), and then added. The average or mean spherical intensity then is derived herefrom by dividing with the surface of the sphere, or by 4π .

Thus, to get the mean spherical intensity from the distribution curve, the instantaneous values of intensity, taken under equal angles δ , are multiplied each by $\cos \phi$, then added, and the sum multiplied by $\frac{\delta}{2}$, where δ , the angular distance under which observations are taken, is given in radians, that is, 10 deg. gives $\delta = \frac{10}{180} \pi$. This usually is done graphically.

Occasionally, as in incandescent lamps with single-loop filament, the light intensity is not the same in all meridians, but a maximum in two opposite meridians: at right angles to the plane of the filament; and a minimum in the two meridians at right angles to the former, giving a horizontal or equatorial distribution

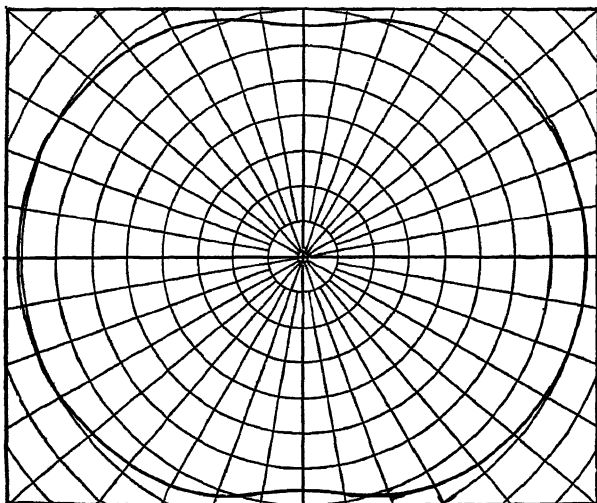

FIG. 60.

of light intensity about as shown in Fig. 60. In this case the horizontal distribution curve may also be determined photometrically, averaged so as to give the mean horizontal intensity

and the ratio of the mean horizontal intensity to the maximum horizontal intensity (or any other definite horizontal intensity); and the mean spherical intensity, as derived from the meridian of maximum horizontal intensity (or any other definite horizontal intensity), is multiplied with this ratio to get the real mean spherical intensity. Usually in this case measurements are taken only in one meridian, but during the test the lamp rotated around its vertical axis with sufficient speed, so that each observation in the meridian, under angle ϕ , in reality is the mean intensity in the direction ϕ . Thus, in incandescent lamp tests, usually the lamp is revolved, so as to average between the different meridians.

As the distribution of intensity in the meridian is the same, within the error of photometric test, for all incandescent lamps of the same type of filament, usually the distribution curve of one meridian is measured once for all, therefrom the ratio of horizontal to mean spherical candle power, the so-called *spherical reduction factor*, determined, and then in further photometric tests of lamps of this type only the horizontal intensity measured, and from this, dividing by the spherical reduction factor, the mean spherical intensity is derived. Thus, while with the incandescent lamp the intensity varies in each meridian, and is different in the different meridians, the mean spherical intensity nevertheless is derived by a single photometric observation of the horizontal intensity with rotating lamp: the rotation averages between the different meridians, and the spherical reduction factor translates from horizontal to mean spherical intensity. Reduction factors of incandescent lamps usually are between 0.75 and 0.80, reaching practically 1.00 in the modern tungsten lamp.

84. Far more difficult is the matter with arc lamps: in the ordinary carbon arc lamp, the intensity also varies in the meridian, and is different in the different meridians, but not with the same regularity as in the incandescent lamp, and, furthermore, the intensity distribution between the different meridians, as well as, to a lesser extent, the total light flux of the lamp, varies with the time. The arc is not steady and constant in position, as the incandescent filament, but wanders, and the light intensities on the side of the lamp, where the arc happens to be, thus are greater than on the side away from the arc. The meridians of maximum and of minimum intensity,

however, do not remain constant in position, but continuously change with the wandering of the arc. Therefore, by measurements in a single meridian, the distribution curve of maximum and that of minimum intensity can be determined by waiting during the observation for the arc to come around to the side of the observer—maximum—and go to the opposite side—minimum—intensity. Such curves are shown in Fig. 61.

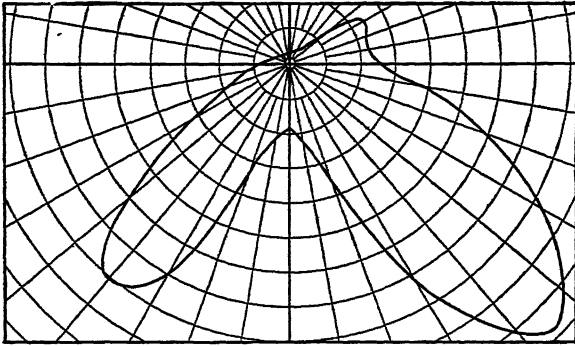

FIG. 61.

This, however, carried out for every angle in the meridian, makes arc-light photometry rather laborious, especially as the total intensity pulsates with the time, and therefore a considerable number of readings have to be taken in every position.

Therefore, for arc light photometry, integrating photometers are especially desirable, that is, photometers which, by a single observation, determine—more or less accurately—the mean spherical intensity; that is, the average intensity, in all directions. With such an integrating photometer, by taking a number of successive readings and averaging, so as to eliminate the variation of total intensity with the time, the mean spherical intensity, and thus the total flux of light, can be derived more rapidly.

Such an integrating photometer is the Matthews photometer. It consists of a circle of inclined mirrors, which surround the lamp and reflect the light in all—or, rather, a certain number of—different angles into the photometer, and there the different reflected beams are by absorption reduced in the proportion

of $\cos \phi$ and combined on the photometer screen. Obviously, the Matthews photometer does not average the intensity in all directions, but only in two meridians opposite to each other; however, by averaging a number of successive readings, very accurate results can be derived.

A method of averaging in all directions is based on a similar principle as that by which the radiation from the interior of a closed sphere of constant temperature was found to be black-body radiation: if the lamp is located in the center of a closed sphere (perforated only at the place where the photometer enters) of perfectly white reflecting surface, then the light intensity throughout the entire inner surface of the sphere is uniform, and is the mean spherical intensity of illumination at the distance of the radius of the sphere. The reason is: every element of the interior of the sphere receives light directly from the lamp, and also light reflected from all the other elements of the sphere, so that the total light received at every element of the sphere is the same, hence is the average illumination. By enclosing the test lamp in the center of such a photometric sphere of sufficient size, its mean spherical intensity thus can be determined by a single reading. Such an arrangement has the further advantage that it allows a direct measurement of mean spherical intensity — or light flux — of such illuminants as the mercury lamp, in which the radiator is of such extent that it cannot be considered as a point without going to excessive distances.

85. Photometrically, and in illuminating engineering, only the mean spherical intensity — which represents the total flux of light — and the distribution curve — which represents the distribution of this light in space — are of importance. The “horizontal intensity” has been used as a conventional rating of incandescent lamps, but is merely fictitious, as it does not mean an actual average horizontal intensity, but the horizontal intensity which the light flux of the lamp would give with the standard mean spherical reduction factor, if the filament had the standard shape.

Downward candle power and maximum candle power obviously have no meaning regarding the light flux of the lamp, but merely represent a particular feature of the distribution curve.

Hemispherical candle power is used to some extent, especially abroad. It is a mixture between light flux and distribution curve, and as it gives no information on the total light flux, nor on the actual distribution curve, and may mislead to attribute to the lamp a greater light flux than it possesses — by mistaking it with mean spherical candle power — it has no excuse for existence, and should not be used.

LECTURE X.

LIGHT FLUX AND DISTRIBUTION.

86. The light flux of an illuminant is its total radiation power, in physiological measure. It therefore is the useful output of the illuminant, and the efficiency of an illuminant thus is the ratio of the total light flux divided by the power input.

In general, the distribution of the light flux throughout space is not uniform, but the light-flux density is different in different directions from an illuminant.

Unit light-flux density is the light-flux density which gives the physiological effect of one candle at unit distance. The unit of light flux, or the *lumen*, is the light flux passing through unit surface at unit light-flux density. The unit of light intensity, or one candle, thus gives, if the light-flux distribution is uniform in all directions, unit flux density at unit distance from the radiator, and thus gives a total flux of light of 4π units, or 4π lumens (since the area at unit distance from a point is the surface of a sphere, or 4π).

The unit of light intensity, or one candle power, thus gives, with a radiator of uniform light-flux distribution, 4π lumens of light flux, and inversely, a radiator which gives 4π lumens of light flux, gives an intensity of one candle, if the intensity is uniform in all directions, and, if the distribution of the intensity is not uniform, the average or mean spherical intensity of the radiator is one candle. Thus one mean spherical candle represents 4π lumens of light flux, and very frequently the mean spherical candle is used as representing the light flux: the light flux is 4π times the mean spherical intensity, and the mean spherical intensity is the total light flux divided by 4π , regardless whether the light flux is uniformly distributed or not.

The total light flux of an illuminant is derived by the summation or integration of the intensities, that is, the flux densities at unit distance, in all directions from the radiator.

The distribution of light flux or of intensity is never uniform, and the investigation of intensity distribution of the light flux thus necessary.

The distribution of the light intensity of an illuminant depends upon the shape of the radiator and upon the objects surrounding it; that is, the distribution of the light flux issuing from the radiator depends on the shape of the radiator, but is more or less modified by shadows cast by surrounding objects, by refraction, diffraction, diffusion in surrounding objects, etc.

The most common forms of radiators are the circular plane, the straight line, that is, the cylinder, the circular line or circular cylinder and combinations thereof.

87. Very frequently the intensity distribution of an illuminant is symmetrical, or approximately symmetrical, around an axis. This, for instance, is the case with the arc lamp, the incandescent lamp, most flames, etc. If the distribution is perfectly symmetrical around an axis, the distribution in space is characterized by that in one meridian, that is, one plane passing through the axis. If the distribution is not symmetrical around the axis, usually the space distribution is characterized by the distribution curves in two meridians at right angles to each other, the meridian of maximum and that of minimum intensity, and the distribution in the equatorial plane, that is, the plane at right angles to the axis.

Distribution curves are best represented in polar coordinates, and the angle ϕ counted from the axis towards the equator (that is, complementary to the "latitude" in geography).

As most illuminants are used with their symmetry axis in vertical direction, and the downward light is usually of greater importance, it is convenient in plotting distribution curves to choose the symmetry axis as vertical, and count the angle ϕ from the downward vertical towards the horizontal; that is, the downward beam would be given by $\phi = 0$, the horizontal beam by $\phi = 90$ deg., and the upward beam by $\phi = 180$ deg.

The usual representation of the light-flux distribution in polar coordinates does not give a fair representation of the total light flux, or the mean spherical intensity of the light source, but on the contrary frequently is very misleading. When comparing different polar curves of intensity distribution, it is

impossible to avoid the impression of the area of the curve as representative of the light flux. The area of the polar curve, however, has no direct relation whatever to the total light flux, that is, to the output of the illuminant, since the area depends upon the square of the radii, and the light flux directly upon the radii of the curve. Thus an illuminant of twice the intensity, but the same flux distribution, gives a polar curve of four times the area, and the latter gives the impression of a source of light far more than twice as great as the former.

The meridian curves of intensity distribution are still more misleading: the different angles of the curve correspond to very different amounts of light flux: the horizontal intensity ($\phi = 90$ deg.) covers a zone of $2r\pi$ circumference, while the intensity in any other direction ϕ covers a zone of $2r\pi \sin \phi$ circumference; that is, an area which is the smaller, the nearer ϕ is to 0 or 180 deg.; the terminal intensity, upward or downward, finally covers a point only, that is, gives no light flux. As the result hereof, an illuminant giving maximum intensity in the downward direction, and low intensity in the horizontal, gives a much larger area of the polar curve than an illuminant of the same or even a greater total light flux which has its maximum intensity in the horizontal. Comparing, therefore, illuminants of different distribution curves, it is practically impossible not to be misled by the area of the polar curve, and thus to overestimate the illuminant having maximum downward intensity, and underestimate the illuminant having maximum horizontal intensity.

The misleading nature of the polar curves of intensity distribution in the meridian is illustrated by the curves in Figs. 64 and 99: the three curves of Fig. 64 give the same total light flux; that is, the same useful output; but 2 looks vastly greater than 1 or 3, and 3 especially looks very small. Curves I, II, III, IV in Fig. 99 give the same total light flux, and curve 0 gives only one tenth the light flux. To the eye, however, the curve I gives the impression of a far more powerful illuminant than the curve IV, and curve 0 appears practically equal to, if not larger than IV, while in reality it represents only one tenth the light output of IV.

88. In an illuminant in which the distribution of intensity is symmetrical around an axis, and thus can be represented

by one meridian curve, the total light flux is calculated thus:

Let $I =$ intensity at angle ϕ

(counting the angle ϕ from one pole over the equator to the other pole).

This intensity covers a zone of the sphere of unit radius of width $d\phi$ and angle ϕ , that is, a zone of radius (Fig. 62) $r = \sin \phi$; thus surface

$$dA = 2\pi \sin \phi d\phi,$$

and the light flux in this zone therefore is:

$$\begin{aligned} d\Phi &= IdA \\ &= 2\pi I \sin \phi d\phi; \end{aligned} \tag{1}$$

hence, the total light flux:

$$\Phi = 2\pi \int_0^\pi I \sin \phi d\phi. \tag{2}$$

The light flux in the space from the downward direction $\phi = 0$ to the angle $\phi = \phi_1$ against the vertical or symmetry axis, then is

$$\Phi_0^{\phi_1} = 2\pi \int_0^{\phi_1} I \sin \phi d\phi, \tag{3}$$

and the light flux in a zone between the angles ϕ_1 and ϕ_2 is

$$\Phi_{\phi_1}^{\phi_2} = 2\pi \int_{\phi_1}^{\phi_2} I \sin \phi d\phi. \tag{4}$$

I. DISTRIBUTION CURVES OF RADIATION.

(1) *Point, or Sphere, of Uniform Brilliancy.*

In this case, the intensity distribution is uniform, and thus, if

$$\begin{aligned} I &= \text{intensity of light, in candles,} \\ \Phi &= 4\pi I = \text{light flux, in lumens;} \end{aligned} \tag{5}$$

or, inversely:

$$I = \frac{\Phi}{4\pi}. \tag{6}$$

The brilliancy of a radiator is the light-flux density at its surface. Thus, with a luminous point of intensity I , the brilliancy

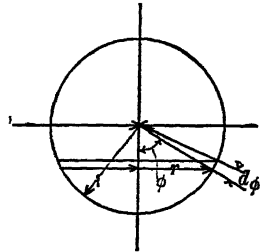

FIG. 62.

would be infinite; with a luminous sphere of uniform intensity distribution, and of radius r , the brilliancy is

$$B = \frac{\Phi}{4 \pi r^2} = \frac{I}{r^2}; \tag{7}$$

hence, inversely proportional to the square of the radius of the spherical radiator.

(2) *Circular Plane of Uniform Brilliancy.*

89. Such radiators are, approximately, the incandescent tip of the carbons in the (non-luminous) electric carbon arc, or the luminous spot in the lime cylinder of the lime light (hydro-oxygen flame), etc.

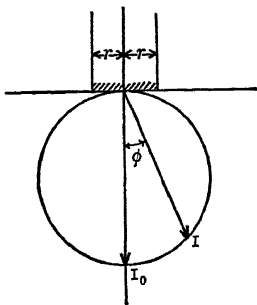

FIG. 63.

Choosing the circular luminous plane as horizontal direction, the intensity distribution is symmetrical around the vertical, the vertical direction thus can be chosen as axis, and the angle ϕ counted from the vertical upward.

The intensity is a maximum I_0 , vertically downward, for $\phi = 0$.

In any other direction, under angle ϕ against the vertical (Fig. 63), the intensity is

$$I = I_0 \cos \phi, \tag{8}$$

and is zero for

$$\phi \geq 90 \text{ deg.}$$

The light flux issuing from the radiator below angle ϕ is, by (3):

$$\Phi_0^\phi = 2 \pi \int_0^\phi I \sin \phi d\phi;$$

hence, by (8):

$$\begin{aligned} \Phi_0^\phi &= 2 \pi I_0 \int_0^\phi \sin \phi \cos \phi d\phi \\ &= \frac{\pi}{2} I_0 \left/ \cos 2 \phi \right/_\phi \\ &= \frac{\pi}{2} I_0 \{1 - \cos 2 \phi\}, \end{aligned} \tag{9}$$

and the total light flux, from $\phi = 0$ to $\phi = 90$ deg. $= \frac{\pi}{2}$, thus is:

$$\Phi = \pi I_0; \quad (10)$$

or,

$$I_0 = \frac{\Phi}{\pi}. \quad (11)$$

The brilliancy of the source of light is the total light flux divided by the luminous area; or,

$$B = \frac{\Phi}{A};$$

and, if r = radius of the luminous circle,

$$A = \pi r^2,$$

and

$$\begin{aligned} B &= \frac{\Phi}{\pi r^2} = \frac{\pi I_0}{\pi r^2} \\ &= \frac{I_0}{r^2}; \end{aligned} \quad (12)$$

or,

$$I_0 = r^2 B; \quad (13)$$

that is, the same as in class (1).

Comparing (10) with (5), it thus follows that the total light flux of such a radiator, for the same maximum intensity, is only one quarter that of a radiator giving uniform intensity distribution throughout space, or inversely, with such a downward distribution of light, the maximum intensity is four times as great as it would be with the same total light flux uniformly distributed through space.

The flux distribution is a circle having its diameter from the source of light downward. It is shown as 2 in Fig. 64, and the concentric circle giving uniform intensity distribution of the same total light flux is shown as 1.

(3) *Hollow Circular Surface.*

Such a radiator, for instance, is approximately the crater of the positive carbon of the arc lamp.

As with such a radiator, as shown in section in Fig. 65, the projection of the luminous area in any direction ϕ is the same

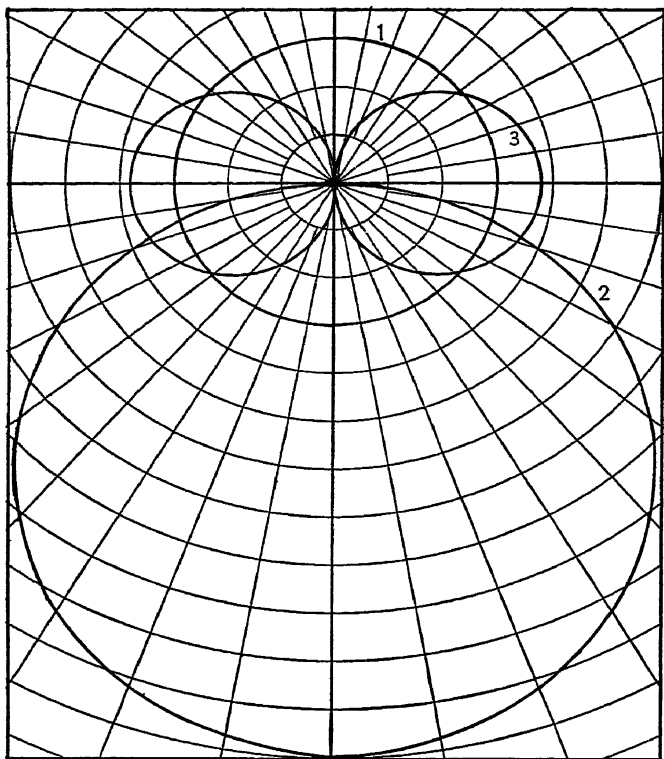

FIG. 64.

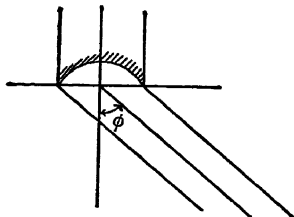

FIG. 65.

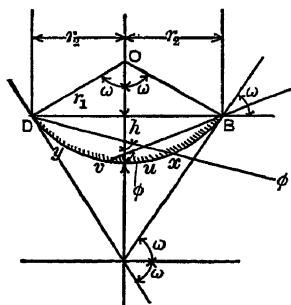

FIG. 66.

as with the plane circular radiator (2), the same equations apply.

(4) *Rounded Circular Surface.*

Such, for instance, is approximately the incandescent carbon tip of the arc-lamp electrodes, when using carbons of sufficiently small size, so that the entire tip becomes heated.

Assuming, in Fig. 66, the radiator as a segment of a sphere, and let $2\omega =$ the angle subtending this segment, r_1 the radius of this sphere.

For all directions ϕ , up to the angle ω below the horizontal:

$$0 < \phi < \frac{\pi}{2} - \omega ;$$

the projection of the spherical segment in Fig. 66 is the same as that of a plane circle, and thus the intensity is given in class (1), as:

$$i = I_0 \cos \phi.$$

In the direction, $\frac{\pi}{2} - \omega < \phi < \frac{\pi}{2}$, however, the intensity is greater, by the amount of light radiated by the projection Dyx , and, in the horizontal direction, the intensity does not vanish, but corresponds to the horizontal projection of the luminous segment.

Above the horizontal, light still issues in the direction,

$$\frac{\pi}{2} < \phi < \frac{\pi}{2} + \omega,$$

from the segment Buv , and only for $\frac{\pi}{2} + \omega < \phi$ does the light cease.

If $r_2 =$ radius of carbon, the radius of the luminous segment is

$$r_1 = \frac{r_2}{\sin \omega} ;$$

the height of the segment is

$$\begin{aligned} h &= r_1 (1 - \cos \omega) \\ &= \frac{r_2 (1 - \cos \omega)}{\sin \omega} ; \end{aligned}$$

hence the surface of the segment, or the luminous area, is

$$\begin{aligned}
 A_2 &= 2 r_1 h \pi \\
 &= \frac{2 r_2^2 \pi (1 - \cos \omega)}{\sin^2 \omega} \\
 &= \frac{2 r_2^2 \pi \times 2 \sin^2 \frac{\omega}{2}}{4 \sin^2 \frac{\omega}{2} \cos^2 \frac{\omega}{2}} \\
 &= \frac{r_2^2 \pi}{\cos^2 \frac{\omega}{2}}.
 \end{aligned} \tag{14}$$

Thus, if the luminous area is the same as in the plane circle class (2), it must be:

$$\frac{r_2^2 \pi}{\cos^2 \frac{\omega}{2}} = r^2 \pi;$$

or,

$$r_2 = r \cos \frac{\omega}{2}; \tag{15}$$

and, if the brilliancy B is the same, the maximum intensity for $\phi = 0$ is

$$\begin{aligned}
 I_0 &= r_2^2 B \\
 &= r^2 B \cos^2 \frac{\omega}{2};
 \end{aligned} \tag{16}$$

that is, the rounding off of the circular radiator, at constant brilliancy and constant luminous surface, decreases the maximum intensity I_0 by the factor $\cos^2 \frac{\omega}{2}$, but increases the intensity within the angle from ω below to ω above the horizontal direction.

In Fig. 67 are plotted the distribution curves, for the same brilliancy and the same area of the radiator, for a plane circular radiator, as 1; a rounded circular radiator of angle $\omega = 30$ deg. as 2, and a rounded circular radiator of angle $\omega = 60$ deg.,

as 3. As seen, with increasing rounding, gradually more and more light flux is shifted from the vertical into the horizontal direction.

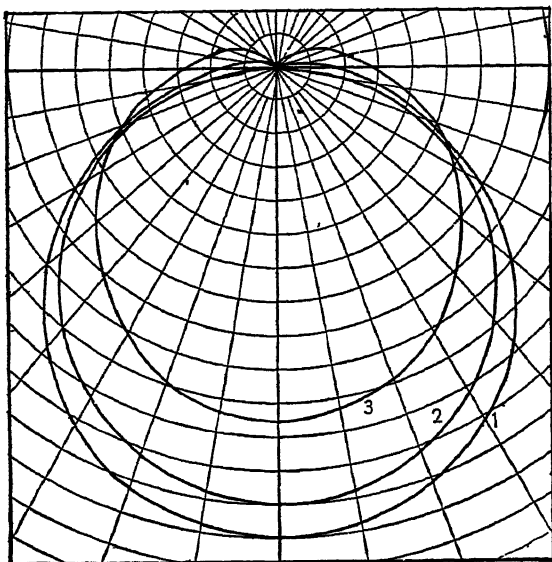

FIG. 67.

Straight Line or Cylindrical Radiator.

90. Such radiators are represented approximately by the luminous arcs with vertical electrodes, by the mercury-arc tube, by straight sections of incandescent-lamp filaments, etc.

The intensity distribution is symmetrical with the radiator as axis.

The intensity is a maximum I_0 at right angles to the radiator, or in horizontal direction, $\phi = 90$ deg., when choosing the radiator as vertical axis. At angle ϕ , the intensity is, Fig. 68,

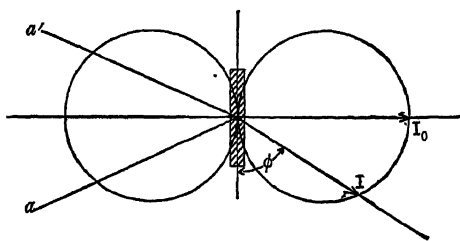

FIG. 68.

$$I = I_0 \sin \phi, \tag{17}$$

and is zero for $\phi = 0$ and $\phi = 180$ deg., or in the vertical.

The light flux within angle ϕ from the vertical is, by (4),

$$\begin{aligned}\Phi_0^\phi &= 2\pi \int_0^\phi I \sin \phi d\phi \\ &= 2\pi I_0 \int_0^\phi \sin^2 \phi d\phi \\ &= \pi I_0 \int_0^\phi (1 - \cos^2 \phi) d\phi;\end{aligned}$$

hence,

$$\Phi_0^\phi = \pi I_0 \left/ \phi - \frac{\sin 2\phi}{2} \right/ , \quad (18)$$

and the total light flux for $\phi = \pi$ is

$$\Phi = \pi^2 I_0; \quad (19)$$

or, inversely:

$$I_0 = \frac{\Phi}{\pi^2}, \quad (20)$$

and the radiating surface is

$$A = \pi w l, \quad (21)$$

where l is the length; w the diameter of radiator. The brilliancy, therefore, is

$$\begin{aligned}B &= \frac{\Phi}{A} \\ &= \frac{\pi I_0}{w l};\end{aligned} \quad (22)$$

or,

$$I_0 = \frac{w l B}{\pi}; \quad (23)$$

$$I'_0 = \frac{w B}{\pi}, \quad (24)$$

may be called the *linear maximum intensity*, or, *maximum intensity per unit length*.

Most of the light of a linear vertical radiator issues near the horizontal, very little in downward and upward direction. Putting $\Phi_0^\phi = \frac{1}{4} \Phi$, gives the angle ϕ , which bisects the light flux:

$$\phi - \frac{\sin 2\phi}{2} = \frac{\pi}{4},$$

and herefrom, by approximation, $\phi = 66$ deg.; that is, half the light flux issues within the narrow zone from 24 deg. below to

24 deg. above the horizontal, or in the space between a and a' in Fig. 68.

It is interesting to compare the three radiators, (1), (2), and (5), on the basis of equal maximum intensity, and on the basis of equal light flux, thus:

	Uniform.	Circle.	Cylinder.
Light flux Φ , at equal maximum intensity I_0	$4 \pi I_0$	πI_0	$\pi^2 I_0$
	4	1	$\pi = 3.14$
Maximum intensity I_0 , at equal light flux Φ	$\frac{\Phi}{4 \pi}$	$\frac{\Phi}{\pi}$	$\frac{\Phi}{\pi^2}$
	1	4	$\frac{4}{\pi} = 1.27$

As seen, at the same maximum intensity, the cylinder gives nearly as much light flux as given by uniform distribution, that is, its deficiency in intensity in the polar regions represents very little light flux. The circular plane, however, gives only one quarter as much light flux as uniform distribution.

With the same horizontal intensity of a cylindrical radiator, as the vertical intensity of a circular plane, the former gives $\pi = 3.14$ times the flux of light.

In Fig. 64 the three distribution curves are shown for the same total flux of light: curve 1 for uniform intensity, 2 for a plane circle, and 3 for a straight cylinder as radiator.

(6) *Circular Line or Cylinder.*

In the spirals, loops or ovals of incandescent-lamp filaments, circular radiators, or sections thereof, are met.

Let r = radius of the circular radiator, w = diameter of the radiator cylinder, shown in section in Fig. 69.

The intensity is a maximum in the direction at right angle to the plane of the circle.

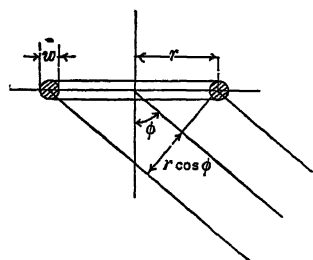

FIG. 69.

The projection of the radiator in this direction of maximum intensity, $\phi = 0$, has the length: $2 \pi r$; and if, by (24):

$$I_0' = \frac{wB}{\pi}$$

= maximum linear intensity,

where $B =$ brilliancy,
 it is, $I_0 = 2 \pi r I_0' = 2 r w B.$ (25)

This is in the direction in which the projection of the radiator is a circle of radius r , and thus circumference $2 \pi r$.

In any other direction ϕ , the projection of the radiator is an ellipse, with r and $r \cos \phi$ as half axes, as seen from Fig. 69.

If $l =$ the circumference of this ellipse, the intensity in the direction ϕ bears to the maximum intensity I_0 the same ratio as the circumference of the ellipse to that of the circle; that is,

$$I = I_0 \frac{l}{2 \pi r} = I_0' l. \quad (26)$$

The circumference of an ellipse with the half axes a and c is

$$l = (a + c) \pi (1 + q),$$

where

$$q = \frac{1}{4} \left(\frac{a - c}{a + c} \right)^2 + \frac{1}{64} \left(\frac{a - c}{a + c} \right)^4 + \frac{1}{256} \left(\frac{a - c}{a + c} \right)^6 + \dots \quad (27)$$

The ratio of the circumference of the ellipse to its maximum diameter, $y = \frac{l}{2r}$, is given in Table I, and plotted in Fig. 70, with the ratio of the half axes, that is, $\cos \phi$, as abscissas, and, in Fig. 71, with angle ϕ as abscissas.

TABLE I. — CIRCUMFERENCE OF ELLIPSE.

$\frac{c}{a} = \cos \phi.$	$y = \frac{l}{2r}.$	$\phi.$	$y = \frac{l}{2r}.$
1.0	$1.571 = \frac{\pi}{2}$	0	$1.571 = \frac{\pi}{2}$
0.9	1.495	10	1.560
0.8	1.418	20	1.525
0.7	1.345	30	1.470
0.6	1.278	40	1.390
0.5	1.210	45	1.350
0.4	1.150	50	1.305
0.3	1.110	60	1.220
0.2	1.055	70	1.120
0.1	1.025	80	1.045
0	1.000	90	1.000

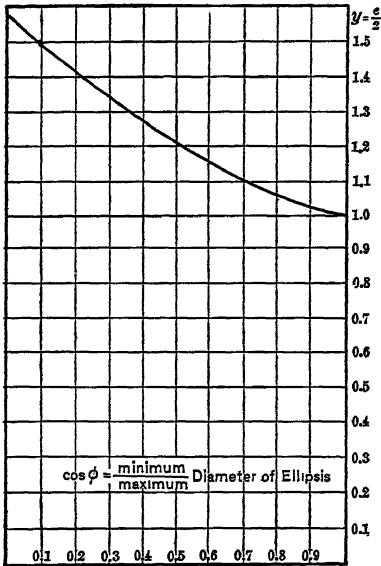

FIG. 70.

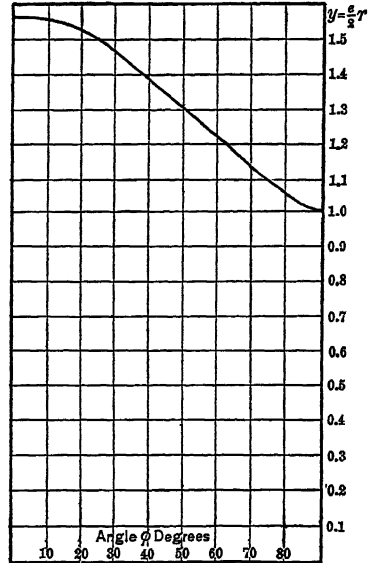

FIG. 71.

In Fig. 72 is plotted the intensity distribution in the meridian of such a circular radiator. This shows a maximum I_0 in the vertical, and a minimum $I_1 = \frac{2}{\pi} I_0$ in the horizontal.

Theoretically, exactly in the horizontal, $\phi = 90$ deg., the intensity should be $\frac{I_1}{2}$, as one half of the circle shades the other half. In most cases of such circular radiators, sections of incandescent-lamp filaments, w is so small compared with r , that it is practically impossible to have the radiator perfectly in one plane, as would be required for one half to shade the other half.

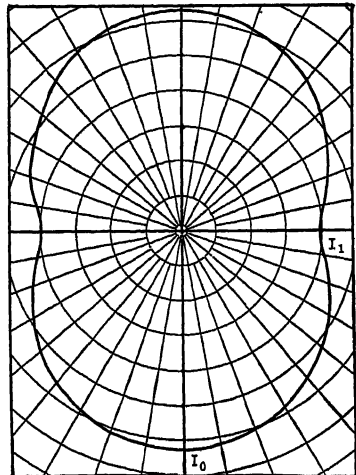

FIG. 72.

(7) Single-Loop Filament.

92. As an illustration of the use of the distribution curves of different typical forms of radiators, the distribution curves of a single-loop incandescent-lamp filament may be calculated.

Such a filament consists of two straight sides, joined by a half circle, as shown in Fig. 73.

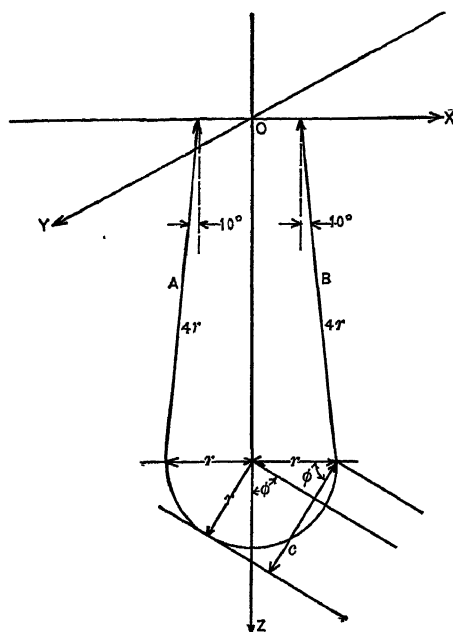

FIG. 73.

The distribution of intensity is not symmetrical around any axis, but approximately so around the axis Z in Fig. 73.

The meridian of maximum intensity is the plane YZ , at right angles to the plane of the filament; the meridian of minimum intensity is the plane of the filament, XZ , and the least variation of intensity occurs in the equatorial plane XY . The distribution curves in all three of these planes are required.

Assuming the straight sides as of a length equal to twice the diameter of the loop, or of length $4r$,

where r = radius of the half circle.

As it is impossible to produce and maintain such a filament perfectly in one plane, we assume, as an average deviation of the two straight sides A and B of Fig. 73 from the vertical, an angle of 10 deg.

The intensity distribution of the straight sides A and B in any meridian plane thus is that of a straight radiator, (5), at an angle of 10 deg. against the vertical.

Let I_0' = maximum intensity per unit length. Then the meridional distribution of the sides $A + B$ is:

$$I_1 = 4rI_0' \{ \sin(\phi + 10^\circ) + \sin(\phi - 10^\circ) \} \quad (28)$$

Hereto in the meridian of maximum intensity is added the light

intensity produced by a half circle of radius r , (6); that is,

$$I_2 = \frac{lI_0'}{2}, \quad (29)$$

where l is the circumference of the ellipse which projects the circle of radius r , under angle ϕ , and is given by Table I and Figs. 70 and 71.

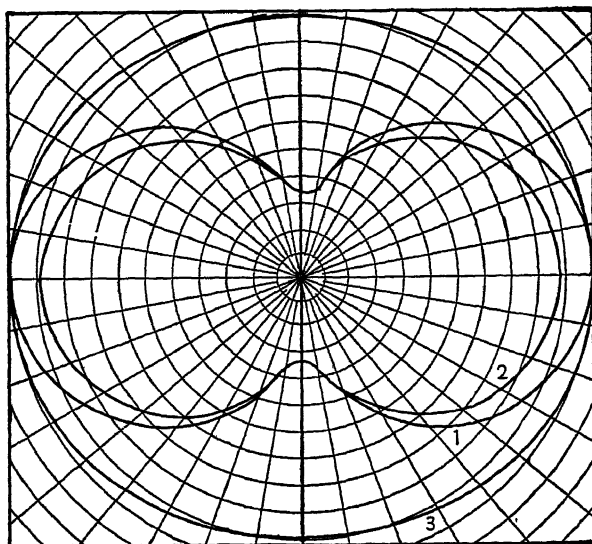

FIG. 74.

In the meridian of minimum intensity, the light intensity I_2 produced by the projection of the half circle in its own plane, under angle ϕ , is added to the intensity I_1 . This projection is, by Fig. 73,

$$c = r(1 + \cos \phi), \quad (30)$$

and thus

$$\begin{aligned} I_3 &= cI_0' \\ &= rI_0'(1 + \cos \phi). \end{aligned} \quad (31)$$

In the equatorial plane, the intensity, due to the straight sides $A + B$, is constant, and is that of a straight radiator under angle 10 deg. from the direction of maximum intensity; hence is

$$I_0 = 8rI_0' \cos 10^\circ. \quad (32)$$

To this is added the intensity produced by the half circle of radius r , that is, I_2 ; hence, in the meridian of maximum intensity, $I = I_1 + I_2$, Curve 1 of Fig. 74; in the meridian of minimum

intensity, $I = I_1 + I_2$, Curve 2 of Fig. 74; and in the equator, $I = I_0 + I_2$, Curve 3 of Fig. 74.

(8) In Table II are recorded the intensity distribution of the different radiators discussed in the preceding paragraphs.

TABLE II.

ϕ .	Circular surface.			Circular line.	Single-loop filament.		
	Plane.	Rounded by			Meridian of		Equator.
		30 deg.	60 deg.		Max. intensity.	Min. intensity.	
0	7.00	6.50	5.25	3.14	1.70	1.70	5.51
10	6.88	6.40	5.18	3.12	1.73	1.68	5.50
20	6.57	6.12	4.94	3.05	2.47	2.35	5.46
30	6.05	5.63	4.56	2.94	3.19	2.97	5.41
40	5.35	4.98	4.07	2.78	3.84	3.53	5.33
50	4.50	4.19	3.55	2.61	4.41	4.02	5.24
60	3.50	3.25	3.01	2.44	4.88	4.41	5.16
70	2.39	2.31	2.44	2.24	5.23	4.70	5.06
80	1.21	1.47	1.90	2.09	5.44	4.88	4.98
90	0	0.75	1.37	2.00	5.51	4.94	4.94
100	0.39	1.00
110	0.09	0.07
120	0	0.04
130	0.02
140	0.005
150	0

II. SHADOWS.

93. The radiator of an illuminant can rarely be arranged so that no opaque bodies exist in its field of light flux and obstruct some light, that is, cast shadows. As the result of shadows, the distribution of intensity of the illuminant differs more or less from that of its radiator, and the total light flux is less.

The most common form of shadow is the round shadow symmetrical with the axis of the radiator, that is, the shadow of a circular plane concentric with and at right angles to the symmetry axis of the illuminant. Such for instance are, approximately, the shadows cast by the base of the incandescent lamp, by the top of the arc lamp, etc. Such also are the shadows of

the electrodes in the arc lamp in that most common case where the electrodes are in line with each other.

As an example may be considered the effect of a symmetrical circular shadow on the light flux and its distribution with a circular plane and with a straight line as radiator.

(1) *Circular Plane Opposite to Circular Plane of Radiator.*

Shadow of negative carbon in front of the positive carbon of the carbon arc.

In Fig. 75, let $2r$ be the diameter of a circular plane radiator (positive carbon); $2r_1$ the diameter of the plane, which casts a shadow (negative carbon of the arc lamp); and l the distance between the two.

Assume I_0 as the maximum intensity of the light flux issuing from the radiator AOB (which is in downward direction, hence completely or partly intercepted by the circle $A_1O_1B_1$). Then, the intensity of the light flux from the radiator, in any direction ϕ , is, according to reasoning under heading I, class (2),

$$I = I_0 \cos \phi. \quad (1)$$

In this direction ϕ , the circle A_1B_1 projects on the plane AB as a circle A_2B_2 , with radius r_1 , and the center O_2 of this circle has from the center O of the radiator the distance

$$a = \overline{OO_2} = l \tan \phi. \quad (2)$$

If now the projected circle O_2 overlaps with the radiator circle O_1 , the area S of overlap, shown shaded in Fig. 76, is cut out from the radiator by the shadow, and the light flux in the direction ϕ thus reduced from that of the complete radiator surface, πr^2 , to that of the radiator surface minus the shaded part S , that is, $\pi r^2 - S$, or in the proportion

$$q = \frac{r^2\pi - S}{r^2\pi} = 1 - \frac{S}{r^2\pi}, \quad (3)$$

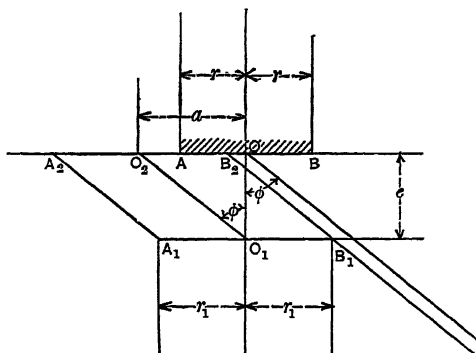

FIG. 75.

and the intensity of the remaining light flux, in the direction ϕ , thus is

$$I = I_0 q \cos \phi. \quad (4)$$

If the distance, a , between the circles O and O_2 is greater than the sum of radii, $l \tan \phi > r + r_1$, the circles O and O_2 do not overlap, and in that direction no shadow is cast.

The light intensity thus is reduced by the shadow of the lower carbon only for those angles ϕ which are smaller than the angle ϕ_1 given by

$$\tan \phi_1 = \frac{r + r_1}{l}. \quad (5)$$

In the direction in which ϕ is smaller than the angle,

$$\tan \phi_2 = \frac{r_1 - r}{l}, \quad (6)$$

and the shadow O_2 thus covers the entire radiator O , no light issues, but the radiator is completely shaded. This can occur only if $r_1 > r$, and if this is the case, a circular area below the radiator receives no light.

If $r_1 = r$, the intensity becomes zero only in the direction $\phi = 0$; and if $r_1 < r$, the light in the downward direction is merely reduced, but nowhere completely extinguished.

The shaded area of the radiator consists of two segments, of the respective radii r and r_1 : $S = D + D_1$.

Let $2\omega = \text{angle subtending segment } D$ and $2\omega_1 = \text{angle subtending segment } D_1$, and denoting the width of the segments thus

$$w = \overline{AC},$$

$$w_1 = \overline{B_2C},$$

and the total width of the shaded area is

$$p = AB_2 = w + w_1. \quad (7)$$

From Fig. 76,

$$\begin{aligned} a = \overline{OO_2} &= \overline{OA} + \overline{B_2O_2} - \overline{AB_2} \\ &= r + r_1 - p; \end{aligned}$$

or,

$$p = r + r_1 - a;$$

hence, by (2),

$$p = r + r_1 - \tan \phi. \quad (8)$$

In $\triangle O_2EO$,

$$\frac{\sin \omega_1}{\sin \omega} = \frac{r}{r_1},$$

$$\sin \omega_1 = \frac{r}{r_1} \sin \omega, \tag{9}$$

and

$$\cos \omega = 1 - \frac{w}{r}, \tag{10}$$

$$w_1 = r (1 - \cos \omega_1); \tag{11}$$

hence,

$$p = w + w_1. \tag{12}$$

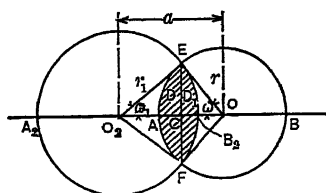

FIG. 76.

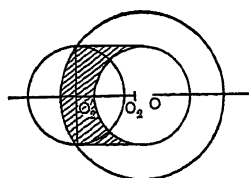

FIG. 77.

Furthermore,

$$\begin{aligned} D &= \text{Sector } OEAF - \triangle EOF. \\ &= r^2 \omega - r^2 \frac{\sin 2 \omega}{2} \\ &= r^2 \left(\omega - \frac{\sin 2 \omega}{2} \right), \end{aligned} \tag{13}$$

$$D_1 = r_1^2 \left(\omega_1 - \frac{\sin 2 \omega_1}{2} \right), \tag{14}$$

$$S = D + D_1, \tag{15}$$

and, by (3),

$$q = 1 - \frac{S}{\pi r^2}. \tag{16}$$

For different values of w the

values of ω w_1 p D D_1 S q are calculated from equations (10) (11) (12) (13) (14) (15) (16) and then q plotted as function of p in Fig. 78.

From equation (8) then follows, for every value of ϕ , the corresponding value of p , herefrom the value of q and by (4) the value of I .

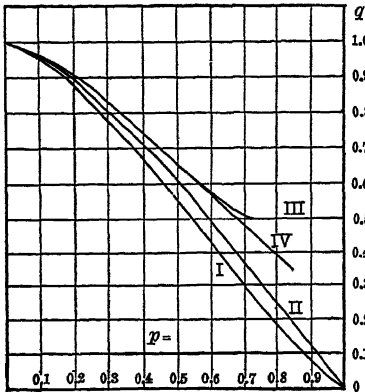

FIG. 78.

94. In Table III are given the values of p and q for the ratio of radii:

$$\frac{r_1}{r} = 2.0; 1.0; 0.7,$$

corresponding to a shadow section equal to 4 times, 1 times, and 0.5 times the section of the radiator.

These are plotted as curves I, II, III, in Fig. 78.

TABLE III.

p .	$\frac{r_1}{r} = 2.$	$\frac{r_1}{r} = 1.$	$\frac{r_1}{r} = 0.7.$	
	I.	II.	III.	IV.
0	1.000	1.000	1.000
0.1	0.962	0.964	0.968
0.2	0.885	0.895	0.910
0.3	0.785	0.810	0.835
0.4	0.675	0.715	0.748
0.5	0.560	0.615	0.660	0.660
0.6	0.435	0.500	0.575	0.569
0.65	0.532	0.520
0.7	0.308	0.380	0.502	0.477
0.71	0.500
0.8	0.183	0.255	0.500	0.386
0.85	0.340
0.9	0.070	0.127	0.500
0.95	0.028	0.063
1.0	0	0	0.500

If $\frac{r_1}{r} < 1$, the curve III represents the effective light-giving area only up to the values of p , where $w_1 = r_1$, but beyond this value, at least in the application to the shadow cast by the

negative carbon of the arc lamp, the shaded area is not merely the circle O_2' , but also the area shown shaded in Fig. 77, which is shaded by the shadow cast by the sides of the lower electrode.

From the value p' , which corresponds to $w_1 = r_1$, the area S then increases by $2 r_1 (p - p')$; hence, if S' = shaded area for $p = p'$, for any value of $p > p_1$,

$$S = S' + 2 r_1 (p - p'),$$

and

$$q = 1 - \frac{S'}{\pi r^2} - \frac{2 r (p - p')}{\pi r^2}. \quad (17)$$

This is shown in Table III and in Fig. 78 as curve IV.

Such curves of intensity of a plane circular radiator of radius r , shaded by a concentric circular shade of radius r_1 at distance l [corresponding to a diameter of positive carbon $2 r$, of negative carbon $2 r_1$, and an arc length l], are given in Figs. 79 to 82, and the numerical values given in Table IV.

Fig. 79 gives the curves for $\frac{r_1}{r} = 2$, and the arc lengths, $\frac{l}{2 r} = 0.25; 0.5; 1.0; 2.0$, as curves I, II, III, IV. Fig. 80 gives the curves for $\frac{r_1}{r} = 1$, and the arc lengths, $\frac{l}{2 r} = 0.25; 0.5; 1.0; 2.0$, as curves I, II, III, IV. Fig. 81 gives the curves for $\frac{r_1}{r} = 0.7$, and the arc lengths, $\frac{l}{2 r} = 0.25; 0.5; 1.0; 2.0$, as curves I, II, III, IV. In Fig. 82 are shown, for comparison, the intensity curves for

$$\frac{r_1}{r} = 2; \quad \frac{l}{2 r} = 2, \text{ as I.}$$

$$\frac{r_1}{r} = 1; \quad \frac{l}{2 r} = 1, \text{ as II.}$$

$$\frac{r_1}{r} = 0.7; \quad \frac{l}{2 r} = 0.5, \text{ as III.}$$

As seen from Fig. 82, a larger shade at greater distance, l , gives approximately the same light flux and a similar distribution, but gives a much sharper edge of the shadow, while a smaller

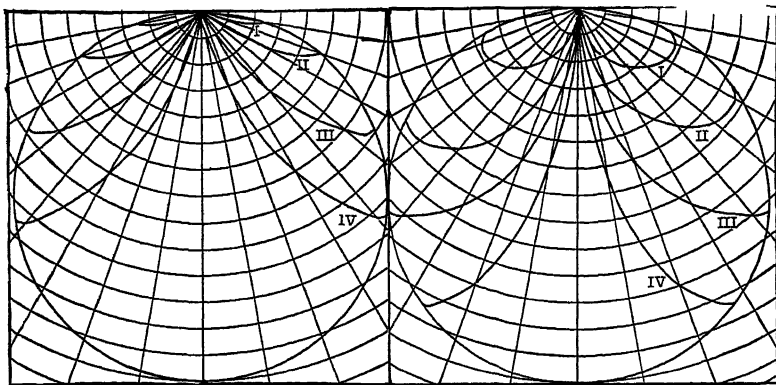
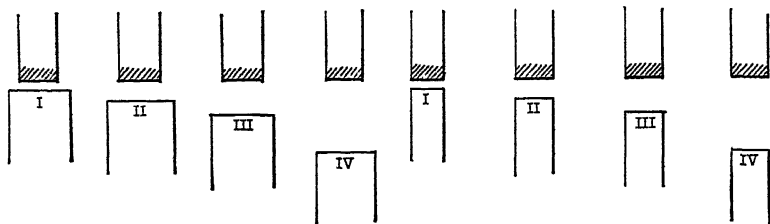

FIG. 79.

FIG. 80.

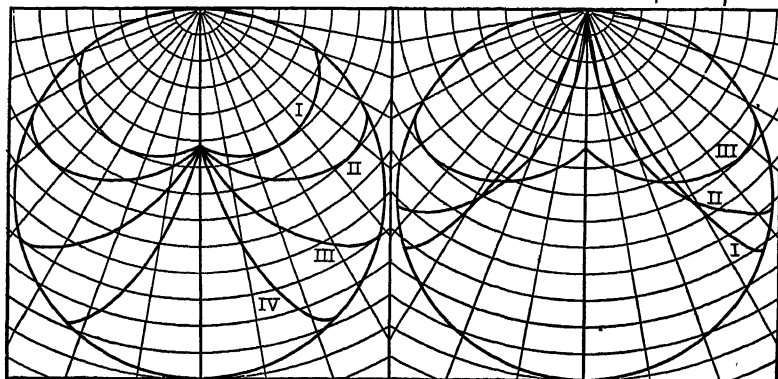
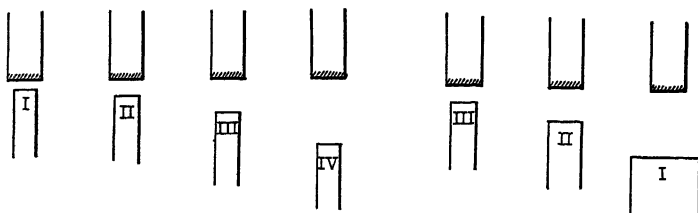

FIG. 81.

FIG. 82.

TABLE IV.

Degrees.	Circular plane as radiator (carbon arc).												Straight-line radiator (luminous arc).			
	$\frac{r_1}{r} = 2.$				$\frac{r_1}{r} = 1.$				$\frac{r_1}{r} = 0.7.$				$\frac{l}{2r} =$			
	0.25	0.5	1.0	2.0	0.25	0.5	1.0	2.0	0.25	0.5	1.0	2.0	0.25	0.5	1.0	2.0
0	0	0	0	0	0	0	0	3.7	3.7	3.7	3.7	0	0	0	0	0
5	0.25	0.52	1.06	3.9	4.1	4.4	5.0
10	0	0.51	1.08	2.19	4.33	4.4	4.4	6.5	0
15	0.2	0.77	1.64	3.28	6.34	4.6	4.6	7.9	0.17
20	2.1	1.05	2.16	4.27	7.80	4.2	4.9	8.9	1.07
25	0	4.4	1.33	2.68	5.25	8.86	4.3	5.1	(9.1)	0	2.00
30	0.5	6.3	1.56	3.17	6.03	(8.66)	4.3	5.3	8.7	0.67	2.67
35	1.5	7.9	1.80	3.60	5.65	8.19	4.2	5.4	8.2	1.64	3.70
40	2.8	(7.7)	2.03	4.10	7.20	7.66	4.1	5.5	7.7	2.60	4.53
45	0	4.0	7.1	2.27	4.40	(7.07)	7.07	4.1	5.7	7.1	3.53	5.30
50	0.4	4.9	6.4	2.43	4.60	6.43	6.43	4.0	5.6	6.4	4.45	6.05
55	1.1	5.6	5.7	2.57	4.72	5.74	5.74	3.9	5.5	5.7	5.30	6.75
60	0	2.0	(5.0)	5.0	2.72	4.75	5.00	5.00	3.6	(5.0)	5.0	0	3.66	7.40
65	0.1	2.7	4.2	4.2	2.77	(4.23)	4.23	4.23	3.5	4.2	4.2	0.62	4.85	8.03
70	0.6	3.3	3.4	3.4	2.72	3.42	3.42	3.42	3.3	3.4	3.2	2.56	7.70	8.55
75	1.3	(2.6)	2.6	2.6	2.55	2.59	2.59	2.59	(2.6)	2.6	2.6	4.48	8.36	9.00
80	(1.7)	1.7	1.7	1.7	(1.74)	1.74	1.74	1.74	1.7	1.7	1.7	6.38	9.00	9.40
85	0.9	0.9	0.9	0.9	0.87	0.87	0.87	0.87	0.9	0.9	0.9	8.23	9.55	9.75
90	0)	0)	0)	0)	0)	0)	0)	0)	0)	0)	0)	10.00	10.00	10.00

shade at shorter distance, III, gives a far broader half shadow, which extends even to the vertical direction.

This is illustrated by the distribution of the open arc and the enclosed arc in clear globes — that is, without means of diffraction or diffusion. In the enclosed arc the distance between the electrodes, l , is made larger, since the ratio of radii $\frac{r_1}{r}$ is greater, as due to the smaller current the diameter of the radiator, $2r$, is smaller than in the open arc. The enclosed arc has a much sharper edge of the shadow, that is, narrower half shadow, than the open arc, thus requiring means of diffusion of the light even more than the open arc.

Where the shade which casts the shadow is rounded, the distribution curve is somewhat modified by similar considerations, as have been discussed under headings I, class (4). This is frequently the case where the shadow is cast by the electrodes of an arc, and especially so in the carbon arc, in which the negative electrode — which casts the shadow — is more or less rounded by combustion.

(2) *Circular Plane Concentric with the End of Linear Radiator.*

95. This condition is approximately realized by the shadows of the electrodes of a luminous arc with vertical electrodes.

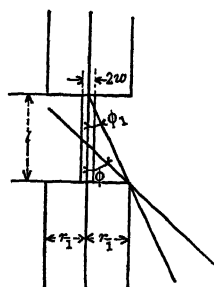

FIG. 83.

Let, in Fig. 83, $2r_1$ = diameter of the lower electrode, l = length of the linear radiator, and $2w$ the diameter of the radiator. Neglecting first the diameter $2w$ of the radiator, the part of the radiator which, in the direction ϕ , is shaded, is

$$s = r_1 \cot \phi, \quad (18)$$

and the reduction factor of the light, or the ratio, by which the intensity of light flux of the radiator proper (heading I, class (5)),

$I = I_0 \sin \phi$, has to be multiplied, is

$$\begin{aligned} q &= 1 - \frac{s}{l} \\ &= 1 - \frac{r_1}{l} \cot \phi, \end{aligned} \quad (2)$$

and the light intensity in the direction ϕ thus is

$$\begin{aligned} I &= qI_0 \sin \phi \\ &= I_0 \left(1 - \frac{r_1}{l} \cot \phi\right) \sin \phi \\ &= I_0 \left(\sin \phi - \frac{r_1}{l} \cos \phi\right). \end{aligned} \tag{21}$$

For values of ϕ less than ϕ_1 , where.

$$\tan \phi_1 = \frac{r_1}{l}, \tag{22}$$

the light flux is zero, that is, complete shadow would exist if there were no diffusion, etc.

If we now consider the diameter, $2w$, of the radiator, we get the same distribution of intensity, except in the angle

$$\phi_1' < \phi < \phi_1'',$$

where ϕ_1' and ϕ_1'' is given by

$$\tan \phi_1' = \frac{r_1 - w}{l} \quad \text{and} \quad \tan \phi_1'' = \frac{r_1 + w}{l}.$$

In this narrow angle the light flux fades from the value which it has at ϕ_1'' — and which is the same as given by equation (21) — to 0 at ϕ_1' , while, when neglecting $2w$, the intensity would become zero at ϕ_1 by equations (22) and (21).

As illustrations are plotted in Fig. 84 and recorded in Table IV,

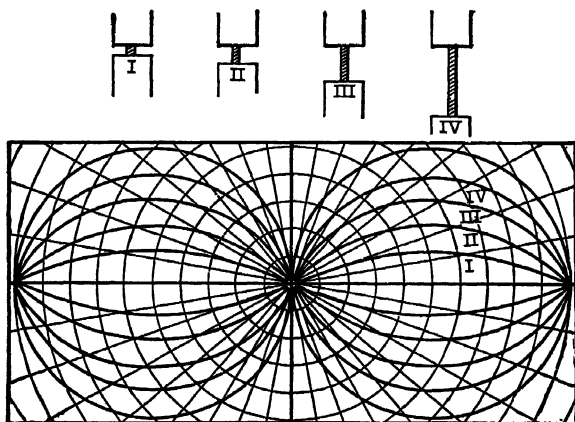

FIG. 84.

the distribution of light flux for $\frac{l}{2r_1} = 0.25; 0.5; 1; 2$, as curves I, II, III, IV, corresponding to an arc length equal to $\frac{1}{4}$, $\frac{1}{2}$, 1 and 2 times the electrode diameter.

III. REFLECTION.

96. As rarely the distribution of intensity and the brilliancy of the radiator are such as desired, reflection, diffraction, and diffusion are used to a considerable extent to modify the distribution curve and the brilliancy of the radiator.

Reflection may be irregular or regular reflection. In irregular reflection, the light impinging on the reflector is thrown back irregularly in all directions, while in regular reflection the light is reflected under the same angle under which it impinges on the reflector. The former is illustrated by a piece of chalk or other dull white body, the latter by the mirror.

A. Irregular Reflection.

Irregular reflection is used in indirect lighting to secure diffusion and low intrinsic brilliancy of the light source by throwing the direct light against the ceiling and illuminating by the light reflected from white or light colored ceilings. In some luminous arcs, the so-called flame carbon arc lamps, irregular reflection is used to direct most of the light downward by using a small circular reflector — usually hollow — immediately above the arc, the so-called “economizer.” In this case the smoke produced by the arc largely deposits on the reflector and thereby maintains it of dull white color, the deposit of most flame carbons being calcium fluoride and oxide and thus white.

In irregular reflection, the reflector is a secondary radiator; that is, if Φ_1 = that part of the flux of light of the main radiator which is intercepted by the reflector, and a = albedo of the

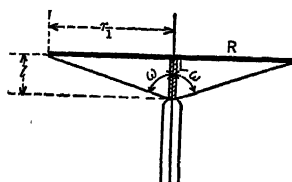

FIG. 85.

reflector (that is, the ratio of reflected light to impinging light, or the “efficiency of the reflector”), the radiator is a generator of the light flux $a\Phi_1$.

As an example may be discussed the intensity distribution of a vertical luminous arc L having a circular (irregular) reflector R immediately above the arc, as shown in Fig. 85. Let 2ω = angle subtended by the reflector R from

the base of the arc, l the (vertical) length of the arc. The radius of the reflector then is $r_1 = l \tan \omega$, and the light flux intercepted by the reflector is calculated in the manner as discussed under heading II, Class (2); that is, if I_0 is the maximum or horizontal intensity of the arc L , the intensity in the direction $(180 \text{ deg.} - \phi)$ will be

$$I = I_0 \sin \phi. \quad (1)$$

The reflector then intercepts the entire light flux issuing from the radiator L between 180 deg. and $180 - \omega$, and the part q of the light flux issuing between $180 - \omega$ and 90 deg. , which is given by

$$q = \frac{r_1 \cot (180 - \phi)}{l} = \tan \omega \cot \phi; \quad (2)$$

hence, the light flux intensity which is intercepted by the reflector is

$$\begin{aligned} I_1 &= qI_0 \sin \phi \\ &= I_0 \tan \omega \cos \phi, \end{aligned} \quad (3)$$

and the light intensity issuing into space from the main radiator

in this angle, $\frac{\pi}{2} < \phi < (180 - \omega)$, is

$$\begin{aligned} I_0 &= (1 - q) i_0 \sin \phi \\ &= I_0 (\sin \phi - \tan \omega \cos \phi). \end{aligned} \quad (4)$$

Therefore the light flux intercepted by the reflector within the angle $\phi = 0$ to $\phi = \omega$ (or rather, $\phi = 180 \text{ deg.}$ to $\phi = 180 - \omega$) is

$$\Phi_1' = 2 \pi I_0 \int_0^\omega \sin^2 \phi \, d\phi = \pi I_0 \left(\omega - \frac{\sin 2 \omega}{2} \right);$$

within the angle $\phi = \omega$ to $\phi = \frac{\pi}{2}$ is

$$\begin{aligned} \Phi_1'' &= 2 \pi I_0 \int_\omega^{\frac{\pi}{2}} q \sin^2 \phi \, d\phi = 2 \pi I_0 \tan \omega \int_\omega^{\frac{\pi}{2}} \cos \phi \sin \phi \, d\phi \\ &= \pi I_0 \tan \omega \left(\frac{1 + \cos 2 \omega}{2} \right) \\ &= \pi \frac{I_0 \sin 2 \omega}{2}, \end{aligned} \quad (5)$$

and therefore the total light flux intercepted by the reflector

$$\Phi_1 = \Phi_1' + \Phi_1'' = \pi I_0 \omega,$$

and the reflected light flux, or light flux issuing from the reflector as secondary radiator, is

$$\Phi_2 = a\Phi_1 = \pi I_0 a \omega, \tag{6}$$

where a = albedo.

As the reflector is a plane circular radiator, its maximum intensity is in the downward direction, and is given under heading I, class (2), as

$$I_0'' = \frac{\Phi_2}{\pi} = I_0 a \omega, \tag{7}$$

and herefrom follows the intensity of radiation of the secondary radiator in any direction ϕ ,

$$\begin{aligned} I'' &= I_0'' \cos \phi \\ &= I_0 a \omega \cos \phi. \end{aligned} \tag{8}$$

The total intensity of radiation of main radiator and reflector or secondary radiator combined, in the lower hemisphere, or

for $0 < \phi < \frac{\pi}{2}$, is

$$I = I' + I'' = I_0 (\sin \phi + a \omega \cos \phi); \tag{9}$$

and in the upper hemisphere light flux issues only under the angle $\frac{\pi}{2} < \phi < \pi - \omega$, and is

$$I = I' = I_0 (\sin \phi - \tan \omega \cos \phi). \tag{10}$$

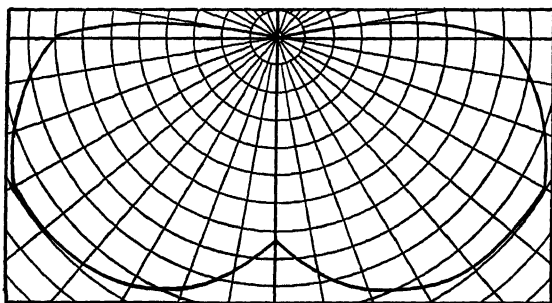

FIG. 86.

For $\omega = 75 \text{ deg.} = \frac{5\pi}{12}$ and $a = 0.7$, the intensity distribution is plotted in Fig. 86 and given in Table V. The distribution

curve is of the type characteristic of most flame carbon arc lamps.

Substituting the numerical values in

$$(9) \text{ gives } I = I_0 (\sin \phi + 0.92 \cos \phi),$$

$$\text{and in (10) gives } I = I_0 (\sin \phi - 3.73 \cos \phi).$$

TABLE V.

ϕ .	Irregular reflection. $a = 0.7$. $\omega = 75$ deg.	Regular reflection. $a = 0.7$. $\omega_1 = 60$ deg. $\omega_2 = 85$ deg.	Regular: $a = 0.6$. Irregular: $a' = 0.1$. $\omega_1 = 60$ deg. $\omega_2 = 85$ deg. $\frac{2r_1}{l} = 1$.
0	3.68	0	0.18
10	4.32	0.70	0.17
20	4.83	1.47	0.16
27	0.16
30	5.19	2.00	0.42
35	0.80
40	5.39	2.57	1.19
45	1.54
50	5.44	3.06	1.89
55	2.23
60	5.46	3.46	2.55
65	4.11	3.27
70	5.02	4.74	3.97
75	4.82	5.32	4.62
80	4.58	5.86	5.26
85	4.30	6.34	5.86
87.5	5.18	4.93
90	4.00	4.00	4.00
92.5	2.00	2.00
95	2.68	0	0
100	1.34
105	0

B. Regular Reflection.

97. With regular reflection by a polished reflector or mirror as used, for instance, in some forms of luminous arcs, the reflector is represented by a second radiator, which has the same shape as the main radiator and is its image with regard to the plane of the reflector. If a is the albedo of the radiator and I_0 the maximum

intensity of the main radiator, the maximum intensity of the virtual or secondary radiator is aI_0 .

The reflector then cuts out of the light flux of the radiator that part intercepted by it, and adds to the light flux that part of the (virtual) light flux of the secondary radiator which passes through the plane of the reflector.

As example may be considered the intensity distribution of a vertical luminous arc of length l , supplied with a circular ring-shaped mirror reflector concentric with and in the plane of the top of the arc. Let ω_1 be the angle subtended by the inner, ω_2 the angle subtended by the outer edge of the reflector, from

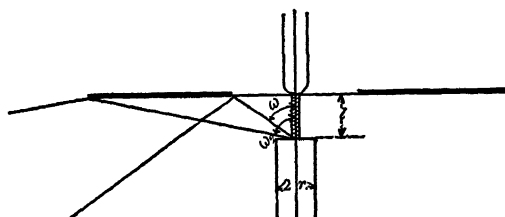

FIG. 87.

the base of the arc, as diagrammatically illustrated in Fig. 87; then the intensity of the light flux of the main radiator

$$\text{for} \quad 0 < \phi < \frac{\pi}{2}$$

$$\text{is} \quad I = I_0 \sin \phi,$$

$$\text{and for} \quad \frac{\pi}{2} < \phi < \pi - \omega_2 \quad (11)$$

$$\text{is} \quad I' = (1 - q_2) I_0 \sin \phi, \quad (12)$$

where, by (2),

$$q_2 = \tan \omega_2 \cot \phi, \quad (13)$$

hence,

$$I'_1 = I_0 (\sin \phi - \tan \omega_2 \cos \phi), \quad (14)$$

and is zero for

$$\phi > \pi - \omega_2.$$

All the light flux issuing from the main radiator between the upper vertical and the angle ω_1 ($0 < \phi < \omega_1$)

$$I' = I_0 \sin \phi \quad (15)$$

is wasted by passing through the central hole in the reflector.

Of the light flux issuing between angle ω_1 and $\frac{\pi}{2}$ from the upper vertical, the part $(\omega_1 < \phi < \frac{\pi}{2})$

$$I_1 = q_1 I_0 \sin \phi \tag{16}$$

is wasted by passing through the hole in the reflector.

Since, by (13),

$$q_1 = \tan \omega_1 \cot \phi, \tag{17}$$

it is:

$$I_1 = I_0 \tan \omega_1 \cos \phi, \tag{18}$$

for

$$\omega_1 < \phi < \frac{\pi}{2}.$$

All the light flux issuing between the upper vertical and the angle ω_2 ,

$$I' = I_0 \sin \phi, \tag{19}$$

is received by the reflector, with the exception of that part which passes through the hole in the reflector.

Of the light flux issuing between angle ω_2 and $\frac{\pi}{2}$ from the upper vertical, the part

$$\begin{aligned} I_2 &= q_2 I_0 \sin \phi \\ &= I_0 \tan \omega_2 \cos \phi, \\ \text{for } \omega_2 &< \phi < \frac{\pi}{2}, \end{aligned} \tag{20}$$

is received by the reflector, with the exception of that part which passes through the hole in the reflector.

The total light flux intensity reflected by the reflector, or the useful light flux of the virtual or secondary radiator, thus is, if a = albedo of the reflector,

Within the angle $\frac{\pi}{2} > \phi > \omega_2$ from the upper vertical,

$$I'' = a (I_2 - I_1) = a I_0 (\tan \omega_2 - \tan \omega_1) \cos \phi; \tag{21}$$

within the angle $\omega_2 > \phi > \omega_1$ from the upper vertical,

$$I''' = a (I' - I_1) = a I_0 (\sin \phi - \tan \omega_1 \cos \phi); \tag{22}$$

and for $\omega_1 > \phi > 0$,

$$I'''' = a (I' - I') = 0; \tag{23}$$

hence, the light intensity of the illuminant, consisting of vertical radiator and ring-shaped mirror reflector, for

$$\begin{aligned} 0 < \phi < \omega_1 \text{ is} \\ I &= I_0 \sin \phi; \end{aligned} \quad (24)$$

for $\omega_1 < \phi < \omega_2$ is

$$I = I' + I''' = I_0 \{ (1 + a) \sin \phi - a \tan \omega_1 \cos \phi \}; \quad (25)$$

for $\omega_2 < \phi < \frac{\pi}{2}$ is

$$I = I' + I'' = I_0 \{ \sin \phi + a (\tan \omega_2 - \tan \omega_1) \cos \phi \}; \quad (26)$$

for $\frac{\pi}{2} < \phi < \pi - \omega_2$ is

$$I = I_1' = I_0 (\sin \phi - \tan \omega_2 \cos \phi), \quad (27)$$

and for $\phi > \pi - \omega_2$ is

$$I = 0.$$

For $\omega_1 = 60^\circ = \frac{\pi}{3}$, $\omega_2 = 85^\circ = \frac{17\pi}{36}$, and albedo $a = 0.7$, the intensity distribution is plotted in Fig. 88 and recorded in Table V.

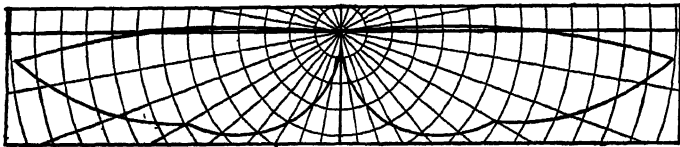

FIG. 88.

Substituting the numerical values in the foregoing, we have:

$$\begin{aligned} (24) \quad I &= I_0 \sin \phi, \\ (25) \quad I &= I_0 (1.7 \sin \phi - 1.21 \cos \phi), \\ (26) \quad I &= I_0 (\sin \phi + 6.79 \cos \phi), \\ (27) \quad I &= I_0 (\sin \phi - 11.43 \cos \phi). \end{aligned}$$

98. As it is difficult to produce and maintain completely regular reflection, usually some irregular reflection is superimposed upon the regular reflection.

For the irregular reflection, the reflector is a horizontal plane radiator.

The light flux reflected by a plane circular reflector subtending angles ω_1 to ω_2 , by (6), is

$$\Phi_2 = \pi I_0 a' (\omega_2 - \omega_1), \quad (28)$$

where a' is the albedo of irregular reflection.

This light flux gives in the lower hemisphere the maximum intensity for $\phi = 0$ as

$$I_0'' = I_0 a' (\omega_2 - \omega_1), \quad (29)$$

and thus the intensity of the irregularly reflected light in the direction ϕ is

$$\begin{aligned} I_2 &= I_0'' \cos \phi \\ &= I_0 a' (\omega_2 - \omega_1) \cos \phi, \end{aligned} \quad (30)$$

and this intensity thus adds to that given by equations (24) to (27) in the preceding.

If some light is obstructed by the shadow of the lower electrode, then the light intensity of the main radiator, I' , in the lower hemisphere within the angle $\phi_1 < \phi < \frac{\pi}{2}$, is reduced to

$$I' = I_0 \left(\sin \phi - \frac{r_1}{l} \cos \phi \right), \quad (31)$$

and becomes zero for $\phi < \phi_1$, where $\tan \phi_1 = \frac{r_1}{l}$ as discussed under heading II, class (2), equations (21), (22), where r_1 is the radius of the lower electrode.

Thus, with a linear radiator of length l , a diameter of the lower electrode of $2 r_1$, a ring-shaped mirror reflector subtending, from the base of the arc, the angles ω_1 and ω_2 , and of the albedo of regular reflection a and the albedo of irregular reflection a' , the light intensity distribution within the angle $0 < \phi < \phi_1$ is

$$I = I_0 a' (\omega_2 - \omega_1) \cos \phi; \quad (32)$$

within

$$\phi_1 < \phi < \omega_1 \text{ is}$$

$$I = I_0 \left(\sin \phi + \left[a' (\omega_2 - \omega_1) - \frac{r_1}{l} \right] \cos \phi \right); \quad (33)$$

within

$$\omega_1 < \phi < \omega_2 \text{ is}$$

$$I = I_0 \left\{ (1 + a) \sin \phi + \left[a' (\omega_2 - \omega_1) - a \tan \omega_1 - \frac{r_1}{l} \right] \cos \phi \right\}; \quad (34)$$

within $\omega_2 < \phi < \frac{\pi}{2}$ is

$$I = I_0 \left\{ \sin \phi + \left[a (\tan \omega_2 - \tan \omega_1) + a' (\omega_2 - \omega_1) - \frac{r_1}{l} \right] \cos \phi \right\}; \quad (35)$$

within $\frac{\pi}{2} < \phi < \pi - \omega_2$ is

$$I = I_0 (\sin \phi - \tan \omega_2 \cos \phi), \quad (36)$$

and within $\pi - \omega_2 < \phi < \pi$ is

$$I = 0.$$

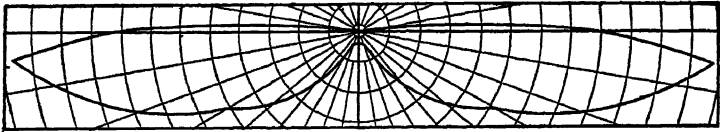

FIG. 89.

The distribution curve of such an illuminant is plotted in Fig. 89 and recorded in Table V for the values

$$\omega_1 = 60 \text{ deg.} = \frac{\pi}{3}; \quad \omega_2 = 85 \text{ deg.} = \frac{17\pi}{36};$$

$$a = 0.60; \quad a' = 0.10, \quad \text{and} \quad \frac{2r_1}{l} = 1.$$

Substituting the numerical values in the foregoing equations this gives

$$\phi_1 = 27 \text{ deg.}$$

$$(32) \quad I = 0.044 I_0 \cos \phi,$$

$$(33) \quad I = I_0 (\sin \phi - 0.456 \cos \phi),$$

$$(34) \quad I = I_0 (1.6 \sin \phi - 1.495 \cos \phi),$$

$$(35) \quad I = I_0 (\sin \phi + 5.364 \cos \phi),$$

$$(36) \quad I = I_0 (\sin \phi - 11.43 \cos \phi).$$

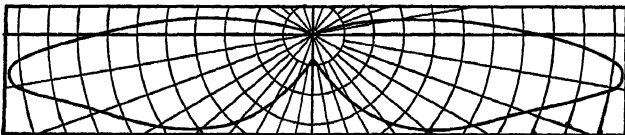

FIG. 90.

As comparison is given in Fig. 90 the distribution curve of the magnetite arc, which is designed of the type of Fig. 89 for the purpose of giving more nearly uniform illumination in street lighting.

IV. DIFFRACTION, DIFFUSION, AND REFRACTION.

99. Many radiators are of too high a brilliancy to permit their use directly in the field of vision when reasonably good illumination is desired. A reduction of the brilliancy of the illuminant by increasing the size of the virtual radiator thus becomes necessary. This is accomplished by surrounding the radiator by a diffracting, diffusing, or prismatically refracting envelope.

Diffraction is given by a frosted glass envelope, as a sand blasted or etched globe; diffusion by an opal or milk-glass globe. The nature of both phenomena is different to a considerable extent, and a frosted globe and an opal globe thus are not equivalent in their action on the distribution of the light flux. This may be illustrated by Fig. 91.

Let, in Fig. 91, 1 A, R represent the light-giving radiator, for simplicity assumed as a point, and G represent a diffracting sheet, as a plate of ground glass. A beam of light, C , issuing from the radiator R is, in traversing the diffracting sheet G , scattered over an angle, that is, issues as a bundle of beams D , of approximately equal intensity in the middle and fading at the edges. The direction of the scattered beam of light D , that is, its center line, is the same as the direction of the impinging beam C , irrespective of the angle made by the diffracting sheet with the direction of the beam.

Different is the effect of diffusion, as by a sheet of opal glass, shown as G in Fig. 91, 1 B. Here the main beam of light C passes through, as C' , without scattering or change of direction, but with very greatly reduced intensity; usually also with a change of color to dull red, due to the greater transparency of opal glass for long waves. Most of the light, however, is irregularly reflected in the opal glass, and the point or area at which the beam C strikes the sheet G becomes a secondary radiator and radiates the light with a distribution curve corresponding to the shape of G , that is, with a maximum intensity at right angles to the plane of G , as illustrated in Fig. 91, 1 B.

A point P thus receives from a radiator R , enclosed by a diffracting globe G , a pencil of light, as shown in Fig. 91, 2 A, and from the point P the radiator appears as a ball of light, shown densely shaded in 3 A, surrounded by a narrow zone of half light,

shown lightly shaded, and in the interior of a non-luminous or faintly luminous envelope.

If the radiator R is enclosed by a diffusing globe, Fig. 91, B2, the point P receives light from all points of the envelope G as

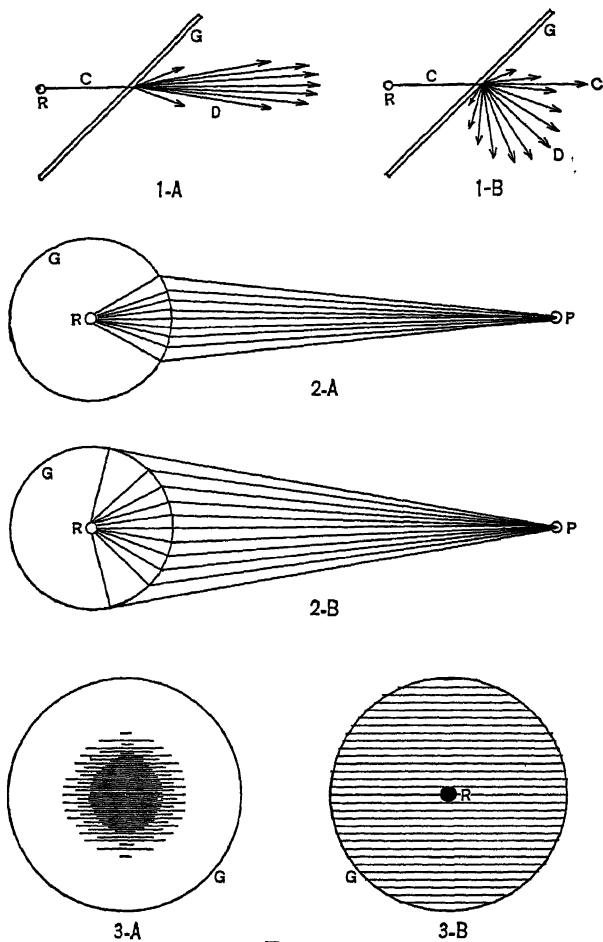

FIG. 91.

secondary radiator, and a ray of direct light from the radiator R . From the point P the entire globe G thus appears luminous, and through it shows faintly the radiating point R , as sketched in 3 B.

An incandescent-lamp filament in an opal globe thus is clearly

but faintly visible, surrounded by a brightly luminous globe, while an incandescent filament in a frosted globe appears as a ball of light surrounded by a non-luminous or faintly luminous globe, but the outline of the filament is not visible.*

100. The distribution of light flux thus essentially depends on the shape of the diffusing envelope, but does not much depend on the shape of the diffracting envelope; that is, a diffracting envelope leaves the distribution curve of the radiator essentially unchanged, and merely smooths it out by averaging the light flux over a narrow range of angles, while a diffusing envelope entirely changes the distribution curve by substituting the diffusing globe as secondary radiator, and leaves only for a small part of the light — that of the direct beam C' — the intensity distribution of the primary radiator unchanged.

Thus, for a straight vertical cylindrical envelope surrounding a radiator giving the distribution curve shown in Fig. 92, curve I,

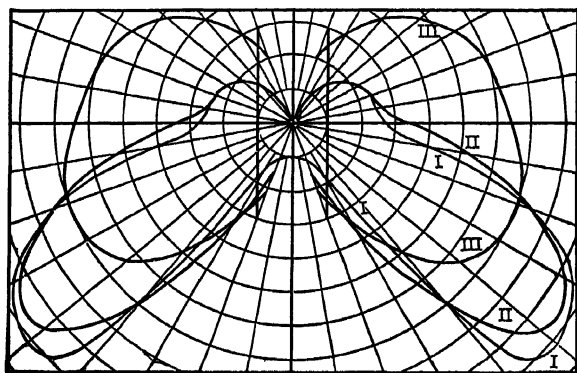

FIG. 92.

the distribution curve is changed by diffraction (frosted envelope), to that shown in Fig. 92, curve II, but changed to that shown by Fig. 92, curve III, by diffusion (opal envelope). The latter consists of a curve due to the transmitted light and of the same shape as I, and a curve due to the diffused light, or light coming from the envelope as secondary radiator. The latter is the distribution curve of a vertical cylindrical radiator, as discussed under heading I, class (5).

The shape of a diffusing envelope thus is of essential importance

for the distribution of the light intensity, while the shape of the diffracting envelope is of less importance.

TABLE VI.

ϕ .	I_0 . Clear globe.	I_0 . Frosted globe.	I_0 . Opal globe.
0	5
10	5
20	6	8	11
25	7	12
30	9	18	17
35	15	26
40	34	35	25
45	49.6	43
50	50.6	47.5	32
55	49.6	48
60	47.5	46	34.5
67	43	42
70	37	37	35
75	29	32
80	20	26	34
85	15	21
90	13.5	17	32
95	13	14
100	12.5	13	30.5
110	12	12	29.5
120	11	11	27
130	9	9	24
140	6	7	20
150	0	2	15
160	0	0	10

It is obvious that frosted glass does not perfectly represent diffraction, but some diffusion occurs, especially if the frosting is due to etching, less if due to sand-blasting. Opal glass also does not give perfect diffusion, but, in the secondary radiation issuing from it, the direction of the horizontal or impinging beam slightly preponderates.

101. Regular or prismatic refraction also affords a means of decreasing the brilliancy by increasing the size of the virtual illuminant, and at the same time permits the control of the

intensity distribution. It probably is the most efficient way, as involving the least percentage of loss of light flux by absorption.

For instance, by surrounding the radiator *R* by a cylindrical lens, as shown diagrammatically in Fig. 93, the rays of light may

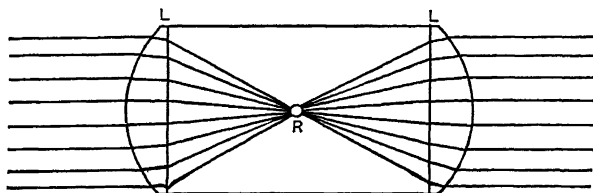

FIG. 93.

be directed into the horizontal (or any other desired) direction, and the entire lens then appears luminous, as virtual radiator.

Usually in this case, instead of a complete lens, individual sections thereof are used, as prisms, as shown in Fig. 94, and this

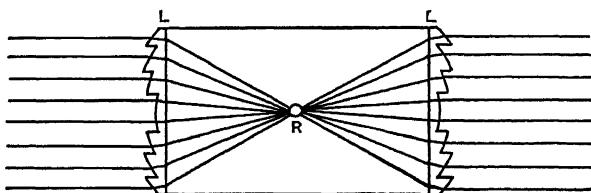

FIG. 94.

method of light control thus called "prismatic refraction," or, where the light does not pass through, but is reflected and turned back from the back of the prism, "prismatic reflection."

Such prismatically reflecting or refracting envelopes and shades have found an extensive use.

LECTURE XI.

LIGHT INTENSITY AND ILLUMINATION.

A. INTENSITY CURVES FOR UNIFORM ILLUMINATION.

102. The distribution of the light flux in space, and thus the illumination, depends on the location of the light sources, and on their distribution curves. The character of the required illumination depends on the purpose for which it is used: a general illumination of low and approximately uniform intensity for street lighting; a general illumination of uniform high intensity in meeting-rooms, etc.; a local illumination of fairly high intensity at the reading-table, work bench, etc.; or combinations thereof, as, in domestic lighting, a general illumination of moderate intensity, combined with a local illumination of high intensity. Even the local illumination, however, within the illuminated area usually should be as uniform as possible, and the study of the requirements for producing uniformity of illumination either throughout or over a limited area thus is one of the main problems of illuminating engineering.

The total intensity of illumination, i , at any point in space is proportional to the light intensity, I , of the beam reaching this point, and inversely proportional to the square of the distance l of the point from the effective center of the light source:

$$i = \frac{I}{l^2}. \quad (1)$$

If the beam of light makes the angle ϕ with the vertical direction, the illumination, i , is thus in the direction ϕ , the horizontal illumination, that is, the illumination of a horizontal plane (as the surface of a table), is

$$i_h = i \cos \phi = \frac{I \cos \phi}{l^2}, \quad (2)$$

and the vertical illumination, that is, the illumination of a vertical plane (as the sides of a room), is

$$i_v = i \sin \phi = \frac{I \sin \phi}{l^2}. \quad (3)$$

If, then, in Fig. 95, L is a light source at a distance l_v above a horizontal plane P , then, for a point A at the *horizontal* dis-

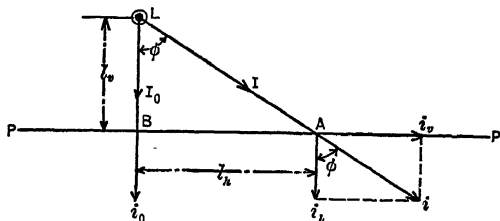

FIG. 95.

tance l_h from the lamp, L (that is, the distance l_h from the point B of the plane P , vertically below the lamp L), we have:

$$\tan \phi = \frac{l_h}{l_v}, \quad (4)$$

and the distance of the point A from the light is

$$\overline{AL} = \frac{l_v}{\cos \phi}; \quad (5)$$

hence, the total illumination at point A is

$$i = \frac{I \cos^2 \phi}{l_v^2}; \quad (6)$$

the horizontal illumination is

$$i_h = \frac{I \cos^3 \phi}{l_v^2}, \quad (7)$$

and the vertical illumination is

$$i_v = \frac{I \cos^2 \phi \sin \phi}{l_v^2}, \quad (8)$$

where I is the intensity of the light source in the direction ϕ .

Inversely, to produce a uniform total illumination, i_0 , on the

horizontal plane P , the intensity of the light source must vary with the angle ϕ according to the equation (6):

$$I = \frac{i_0 l_v^2}{\cos^2 \phi}; \quad (9)$$

or, if we denote by I_0 the vertical, or downward, intensity of the light source,

$$I_0 = i_0 l_v^2; \quad (10)$$

hence,

$$I = \frac{I_0}{\cos^2 \phi} \quad (11)$$

gives the intensity distribution of the light source required to produce uniform total illumination i_0 on a horizontal plane beneath the light.

In the same manner follows from (7) and (8):

To produce uniform horizontal illumination i_h on a plane P beneath the light source L , the intensity curve of the light source is given by

$$I = \frac{I_0}{\cos^2 \phi}, \quad (12)$$

and, to produce uniform vertical illumination i_v of objects in the plane P beneath the light source L ,

$$I = \frac{I_0}{\cos^2 \phi \sin \phi}. \quad (13)$$

Where the objects in the plane P which are to be illuminated may have different shapes—as on a dining-table, work bench, etc., uniformity of the total illumination, i , is desirable; where all the objects which shall be illuminated are horizontal—as the surface of a drafting-board—constancy of the horizontal illumination i_h is desirable, while where vertical objects are to be illuminated—as, for instance, to read labels on bottles—constancy of the vertical illumination i_v is desirable.

By “horizontal illumination” i_h is here understood the illumination of a horizontal plane, which is due to the vertical component of the total light flux, while the “vertical illumination” i_v is the illumination of a vertical plane, due to the horizontal component of the light flux.

In Fig. 96, the intensity curves of the light source required to give uniform total illumination i_0 (11) in a horizontal plane are plotted as curves I, II and III; the intensity distribution for uniform horizontal illumination i_{h_0} (12) is plotted as curve IV, and the intensity distribution for uniform vertical illumination i_{v_0} (13) in the horizontal plane beneath the light source is plotted as curve V. For convenience, curves IV and V are shown in the upper half of the diagram. The numerical values for $l_w = 1$ are recorded in Table I. With increasing angle ϕ , the required intensity increases very rapidly, and, as is obvious, becomes infinite for $\phi = 90$ deg.

TABLE I. — (Figs. 95 and 96.)
UNIFORM DISTRIBUTION ILLUMINATION CURVES.

ϕ . degrees.	$\cos \phi$.	Total. $\frac{1}{\cos^2 \phi}$.	Horizontal. $\frac{1}{\cos^2 \phi}$.	Vertical. $\frac{1}{\sin \phi \cos^2 \phi}$.
0	1	1	1	∞
5	996	1.01	1.015	11.60
10	985	1.03	1.045	5.90
15	966	1.07	1.11	4.30
20	940	1.13	1.20	3.30
25	906	1.22	1.35	2.88
30	866	1.33	1.54	2.66
35	819	1.49	1.82	2.59
40	766	1.70	2.22	2.64
45	707	2.00	2.83	2.83
50	643	2.43	3.73	3.17
55	574	3.03	5.27	3.70
60	500	4.00	8.00	4.60
65	423	5.59	13.20	6.16
70	342	8.35	24.4	8.90
75	259	15.10	58.3	15.60
80	174	33.00	190.0	32.50
85	087	132.00	152.0	133.00
90	0	∞	∞	∞

103. Therefore, in the problem, as it is usually met, of producing uniform intensity i_0 over a limited area, subtending angle 2ω beneath the light source, the intensity of the light source

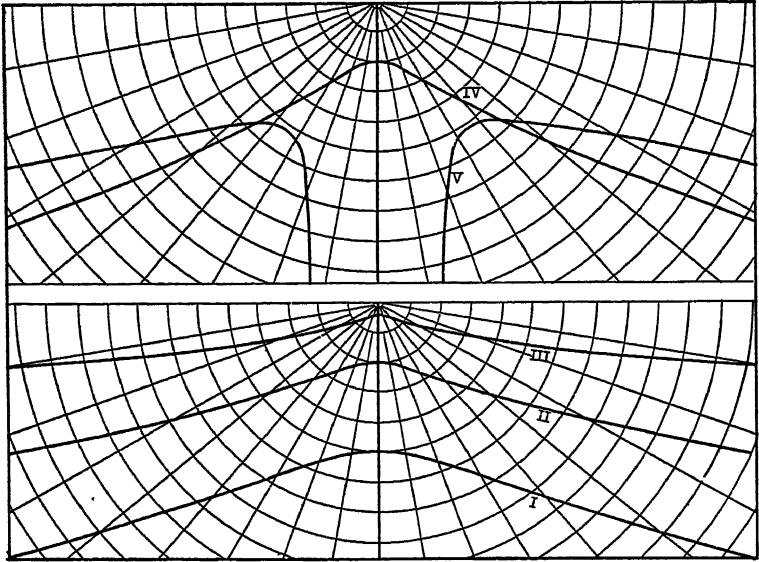

FIG. 96.

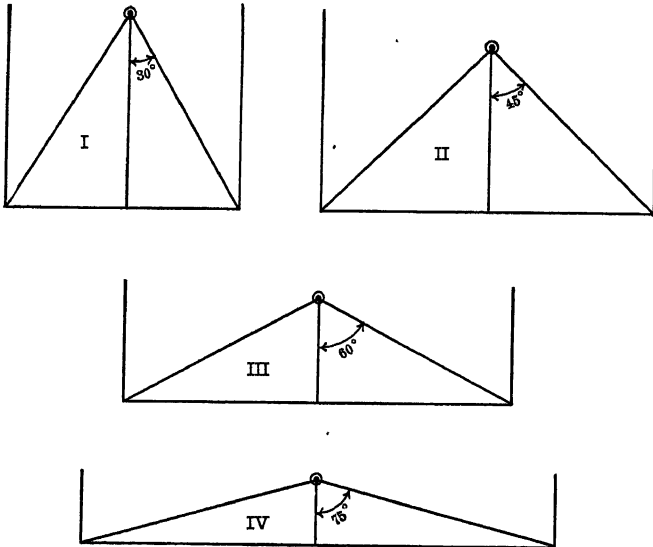

FIG. 97.

should follow (11) for $0 < \phi < \omega$. Beyond $\phi = \omega$, the intensity may rapidly decrease to zero — as would be most economical, if no light is required beyond the area subtended by angle 2ω . This, for instance, is the case with the concentrated lighting of a table, etc. However, the intensity beyond $\phi = \omega$ may follow a different curve, to satisfy some other requirements, for instance, to produce uniform illumination in a vertical plane. Thus in domestic lighting, for the general uniform illumination of a room by a single illuminant, the intensity curve would follow equation (11) up to the angle ω — if 2ω is the angle subtended by the floor of the room from the light source — and for $\phi > \omega$ the intensity curve would follow the equation,

$$I = \frac{i_0}{\sin^2 \phi}, \quad (14)$$

which gives uniform illumination in the vertical plane, that is, of the walls of the room.

In Fig. 98 are shown intensity curves of a light source giving uniform illumination in the horizontal plane beneath the lamp, from 0 to ω , and the same uniform illumination in the vertical plane from $\phi = \omega$ to $\phi = 90$ deg., as diagrammatically shown in Fig. 97; that is, uniform illumination of the floor of a room and (approximately) its walls, by a lamp located in the center of the ceiling, where ω is the (average) angle between the vertical and the direction from the lamp to the edge of the floor:

I for $\omega = 30$ deg.; or diameter of floor \div height of walls =

$$2 \tan 30 \text{ deg.} = \frac{2}{\sqrt{3}} = 1.15.$$

II for $\omega = 45$ deg.; or diameter of floor \div height of walls =

$$2 \tan 45 \text{ deg.} = 2.$$

III for $\omega = 60$ deg.; or diameter of floor \div height of walls =

$$2 \tan 60 \text{ deg.} = 2\sqrt{3} = 3.46.$$

IV for $\omega = 75$ deg.; or diameter of floor \div height of walls =

$$2 \tan 75 \text{ deg.} = 7.46.$$

These curves are drawn for the same total flux of light in the lower hemisphere, namely, 250 mean hemispherical candle power;

or, 1570 lumens. The vertical or downward intensities I_0 are in this case:

- I: $\omega = 30$ deg.; $I_0 = 428$ cp.
- II: $\omega = 45$ deg.; $I_0 = 195$ cp.
- III: $\omega = 60$ deg.; $I_0 = 95$ cp.
- IV: $\omega = 75$ deg.; $I_0 = 41.5$ cp.

The values are recorded in Table II, in column I, for equal downward candle power I_0 , and in column *a*, for equal light flux, corresponding to 1 mean hemispherical candle power.

TABLE II. — (Figs. 97 to 99.) INTENSITY CURVES.

Uniform illumination from vertical $\phi = 0$ to $\phi = \omega$ degrees from vertical, and

(a) Uniform illumination (on vertical plane) from $\phi = \omega$ to horizontal $\phi = 90$ deg.

(b) No illumination beyond $\phi = \omega$.

I_0 for unity illumination at $\phi = 0$.

a and *b* for mean hemispherical candle power 1, or 2π lumens.

ϕ .	$\omega = 30$ deg.			$\omega = 45$ deg.			$\omega = 60$ deg.			$\omega = 75$ deg.		
	I_0 .	<i>a</i> .	<i>b</i> .	I_0 .	<i>a</i> .	<i>b</i> .	I_0 .	<i>a</i> .	<i>b</i> .	I_0 .	<i>a</i> .	<i>b</i> .
0	1.00	1.71	3.73	1.00	0.78	1.57	1.00	0.38	0.67	1.00	0.166	0.222
5	1.01	1.72	3.76	1.01	0.79	1.58	1.01	0.385	0.67	1.01	0.168	0.224
10	1.03	1.76	3.83	1.03	0.80	1.62	1.03	0.39	0.685	1.03	0.172	0.229
15	1.07	1.83	3.98	1.07	0.83	1.68	1.07	0.41	0.71	1.07	0.178	0.237
20	1.13	1.93	4.20	1.13	0.88	1.77	1.13	0.43	0.75	1.13	0.188	0.251
25	1.17	2.00	4.35	1.22	0.95	1.99	1.22	0.465	0.81	1.22	0.203	0.271
30	1.20	2.05	4.47	1.33	1.03	2.08	1.33	0.51	0.89	1.33	0.221	0.295
35	1.01	1.73	3.57	1.49	1.16	2.33	1.49	0.57	0.99	1.49	0.248	0.331
40	0.81	1.38	2.24	1.70	1.32	2.66	1.70	0.65	1.13	1.70	0.283	0.377
45	0.67	1.14	0.57	1.80	1.40	2.85	2.00	0.76	1.34	2.00	0.333	0.445
50	0.57	0.98	0	1.70	1.32	2.50	2.43	0.93	1.62	2.43	0.405	0.540
55	0.50	0.85	1.49	1.16	1.10	3.03	1.16	2.02	3.03	0.504	0.672
60	0.44	0.75	1.33	1.03	0.31	3.60	1.37	2.40	4.00	0.665	0.887
65	0.41	0.70	1.22	0.95	0	3.51	1.34	2.00	5.59	0.930	1.24
70	0.38	0.65	1.13	0.88	3.39	1.29	0.80	8.35	1.39	1.86
75	0.36	0.61	1.07	0.83	3.21	1.22	0.20	12.80	2.13	2.85
80	0.34	0.58	1.03	0.80	3.09	1.18	0	12.40	2.07	2.11
85	0.34	0.58	1.01	0.79	3.03	1.16	12.10	2.02	0.67
90	0.33	0.57	.	1.00	0.78	3.00	1.14	12.00	2.00	0.11

These curves in Fig. 98 consist of a middle branch, giving uniform floor illumination, and two side branches, giving uniform side illumination, and are rounded off where the branches join.

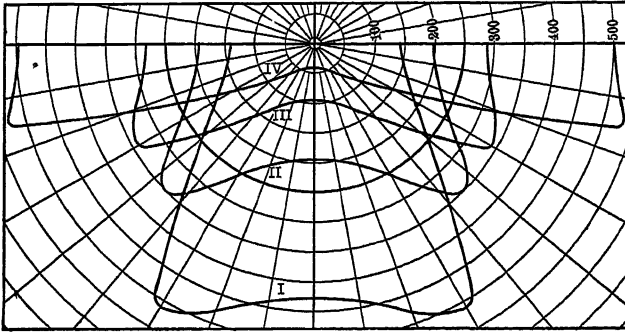

FIG. 98.

Fig. 99 gives the intensity curves for the same angles, $\omega = 30, 5, 60,$ and 75 deg., for uniform illumination only in the hori-

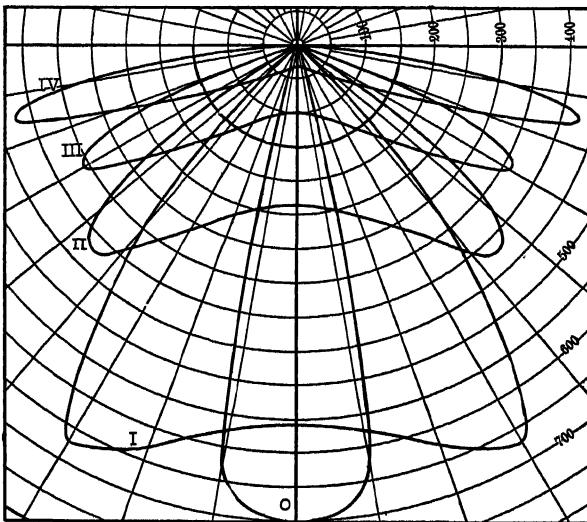

FIG. 99.

zontal plane beneath the lamp, but no illumination beyond this; for $\phi > \omega$, the light flux rapidly decreases.

The curves in Fig. 99 are also plotted for equal total light flux, of 150 mean hemispherical candle power, or 940 lumens. The

curve, O , giving (approximately) uniform illumination within an angle of 20 deg., or for $\omega = 10$ deg., is added to the set; this curve, however, is plotted for one-tenth the light flux of the other curves, 94 lumens, or 15 mean hemispherical candle power.

The vertical or downward intensities I_0 are in this case, for equal light flux of 940 lumens:

- I: $\omega = 30$ deg.; $I_0 = 500$ cp.
 II: $\omega = 45$ deg.; $I_0 = 235$ cp.
 III: $\omega = 60$ deg.; $I_0 = 100$ cp.
 IV: $\omega = 75$ deg.; $I_0 = 25$ cp.
 O: $\omega = 10$ deg.; $I_0 = 7000$ cp.

Fig. 99 best illustrates the misleading nature of the polar diagram of light intensities. It is hard to realize from the appearance of Fig. 99 that curves I, II, III and IV represent the same light flux, and curve O one-tenth the light flux, that is, little more than half the light flux of a 16-cp. lamp.

Curve O , however, illustrates that enormous light intensities can be produced with very little light flux, if the light flux is concentrated into a sufficiently narrow beam. This explains the enormous light intensities given by search-light beams: for $\omega = 1$ deg., or a concentration of the light flux into an angle of 2 deg. — which is about the angle of divergency of the beam of a good search light — we would get $I = 700,000$ cp. in the beam, with 15 mean hemispherical, or 7.5 mean spherical, candle power light source; and a light source of 9000 mean spherical candle power — a 160-ampere 60-volt arc — would thus, when concentrated into a search-light beam of 2 deg., have an intensity in the beam of $I_0 = 210$ million candle power, when allowing 75 per cent loss of light flux, that is, assuming that only 25 per cent of the light flux is concentrated in the beam.

The numerical values of Fig. 99 are given as b in Table II, for equal light flux corresponding to 1 mean spherical candle power.

B. STREET ILLUMINATION BY ARCS.

104. To produce uniform illumination in a plane beneath the illuminant, a certain intensity distribution curve is required, as discussed in *A*; for other problems of illumination, correspondingly different intensity curves would be needed to give the desired illumination.

It is not feasible to produce economically any desired distribution curve of a given illuminant. Therefore, the problem of illuminating engineering is to determine, from the purpose for which the illumination is used, the required distribution of illumination, and herefrom derive the intensity curve of the illuminant which would give this illumination. Then from the existing industrial illuminants, or rather from those which are available for the particular purpose, that is selected whose intensity distribution curve approaches nearest to the requirements, and from the actual intensity curve of this illuminant the illumination which it would give is calculated, so as to determine how near it fulfils the requirements.

The intensity curve of the illuminant, required to give the desired illumination, depends on the location of the illuminant and the number of illuminants used. Thus if, with a chosen location and number of light sources, no industrial illuminant can be found which approaches the desired intensity curve sufficiently to give a fair approach to the desired illumination, a different location, or different number of light sources would have to be tried. Here, as in all engineering designs which involve a large number of independent variables, judgment based on experience must guide the selection. If so, practically always some industrially available illuminant can be found which sufficiently approaches the intensity curve required by the desired illumination.

As example may be discussed the problem of street lighting.

This problem is: with a minimum expenditure of light flux—that is, at minimum cost—to produce over the entire street a sufficient illumination. This illumination may be fairly low, and must be low, for economic reasons, where many miles of streets in sparsely settled districts have to be illuminated. This requires as nearly uniform illumination as possible, since the minimum illumination must be sufficient to see by, and any excess above this represents not only a waste of light flux, but, if the excess is great, it reduces the effectiveness of the illumination at the places, where the intensity is lower, by the glare of the spots of high illumination.

Uniformity of street illumination thus is of special importance where the illumination must for economic reasons be low; while in the centers of large cities, or in densely populated districts,

as European cities, the relatively small mileage of streets per thousand inhabitants economically permits the use of far greater light fluxes, and then uniformity, while still desirable, becomes less essential.

TABLE III — (Figs 100 and 101.)

Angle. ϕ .	Intensity: 100 m. sph. cp.			Illumination: 200 m. sph. cp.; $l_v = 20$.			
	a.	b.	c.	Distance. $x = \frac{l_h}{l_v}$	a.	b.	c.
	D. C. enclosed carbon arc. Clear inner globe.	D. C. enclosed carbon arc. Opal inner globe.	Magnetite arc. Clear globe.		D. C. enclosed carbon arc. Clear inner globe.	D. C. enclosed carbon arc. Opal inner globe.	Magnetite arc. Clear globe.
	I.	I.	I.		i.	i.	i.
0	30	45	59	0	15	22.5	29.5×10^{-2}
10	42	50	63	0.2	22	24.5	30.5
20	92	70	69	0.4	46	33.0	31.0
30	182	107	79	0.6	73	42.5	31.0
40	247	150	102	0.8	73	44.5	30.5
45	270	1.0	67	40.5	29.5
50	257	171	136	1.2	53	35.5	28.0
60	210	181	177	1.4	39	30.5	26.0
70	147	182	226	1.6	30.5	25.5	23.5
75	122	181	243	1.8	24.5	21.5	21.5
80	97	160	250	2.0	19.0	18.0	19.0
85	75	118	249	2.5	11.5	13.0	15.0
90	65	89	197	3.0	7.0	9.5	12.0
100	57	82	47	3.5	5.0	7.0	9.5
110	57	77	16	4.0	3.5	5.5	7.5
120	60	68	5.0	2.0	3.2	4.8
130	35	62	6.0	1.2	2.0	3.4
140	3	56	7.0	1.0	1.4	2.5
150	17	8.0	0.8	1.0	2.0
.....	9.0	0.5	0.8	1.7
.....	10.0	0.4	0.6	1.1
.....	15.0	0.2	0.3	0.5
.....	20.0	0.1	0.1	0.3
.....	25.0	0.1	0.1	0.2

The arc, as the most economical illuminant, is mostly used for street lighting. Fig. 100 gives the average intensity curves

of three typical arcs for equal light flux of 200 mean spherical candle power:

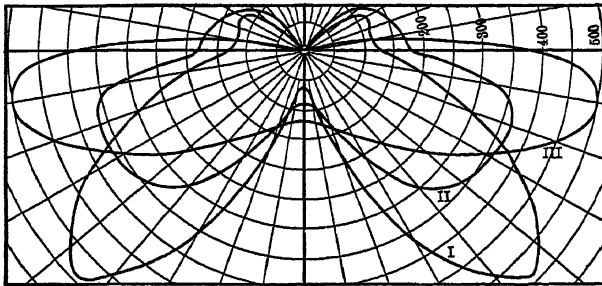

FIG. 100.

I. The direct-current enclosed carbon arc, with clear inner globe: a curve of the character discussed in Fig. 82. II. The direct-current enclosed carbon arc, with opal inner globe: a

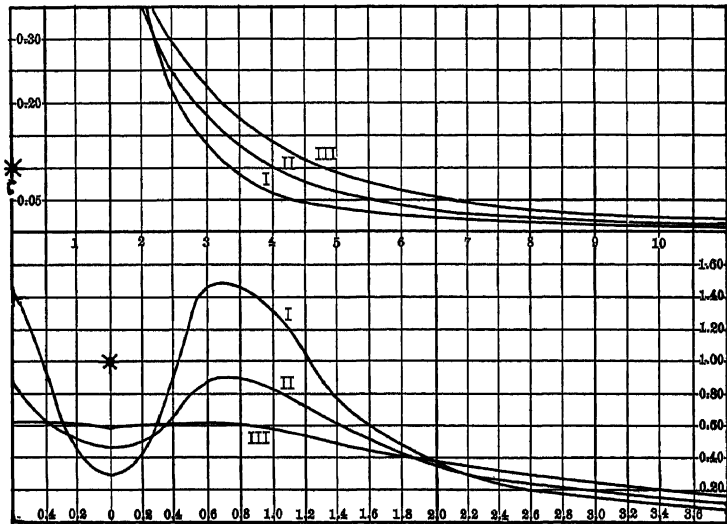

FIG. 101.

curve of the character discussed in Fig. 92. III. The magnetite arc or luminous arc, with clear globe: a curve of the character discussed in Fig. 89. The numerical values are recorded in Table III, per 100 mean spherical candle power.

Herefrom then follows, by equations (6) and (4), the (total) intensity, i , in a horizontal plane beneath the lamp, at the horizontal distance l_h from the lamp, where l_v is the height of the lamp above this plane (the street).

These values of illumination, i , are plotted, with $x = \frac{l_h}{l_v}$ as abscissas, in Fig. 101 and recorded in Table III for $l_v = 20$, and lamps of 200 mean spherical candle power.

105. With lamps placed at equal distances l_{h_0} , and equal

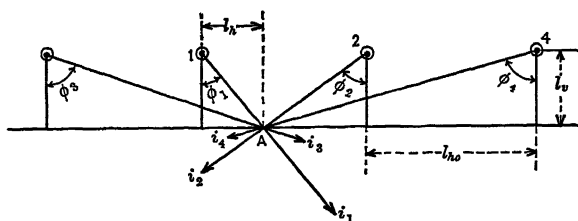

FIG. 102.

heights l_v , as shown diagrammatically in Fig. 102, the illumination of any point A of the street surface is due to the light flux of a number of lamps, and not only to the two lamps 1 and 2, between which the point A is situated. As, however, the illumination rapidly decreases with the distance from the lamp, it is sufficient to consider only the four lamps nearest to the point A .

The illumination of a point A of the street surface, at a horizontal distance l_h from a lamp, 1, then is:

$$i = i_1 + i_2 + i_3 + i_4, \quad (15)$$

where i_1, i_2, i_3, i_4 are the illumination due to the lamps 1, 2, 3, 4, respectively.

Let $\frac{l_{h_0}}{l_v} = p$ and $\frac{l_h}{l_v} = x;$ (16)

then the directions under which point A receives light are given by:

$$\left. \begin{aligned} \tan \phi_1 &= x, \\ \tan \phi_2 &= p - x, \\ \tan \phi_3 &= p + x, \\ \tan \phi_4 &= 2p - x, \end{aligned} \right\} \quad (17)$$

and

$$\left. \begin{aligned} i_1 &= \frac{I_1}{l_v^2 \cos^2 \phi_1}, \\ i_2 &= \frac{I_2}{l_v^2 \cos^2 \phi_2}, \\ i_3 &= \frac{I_3}{l_v^2 \cos^2 \phi_3}, \\ i_4 &= \frac{I_4}{l_v^2 \cos^2 \phi_4} \end{aligned} \right\} \quad (18)$$

where I_1, I_2, I_3, I_4 are the intensities of the light source in the respective directions $\phi_1, \phi_2, \phi_3, \phi_4$.

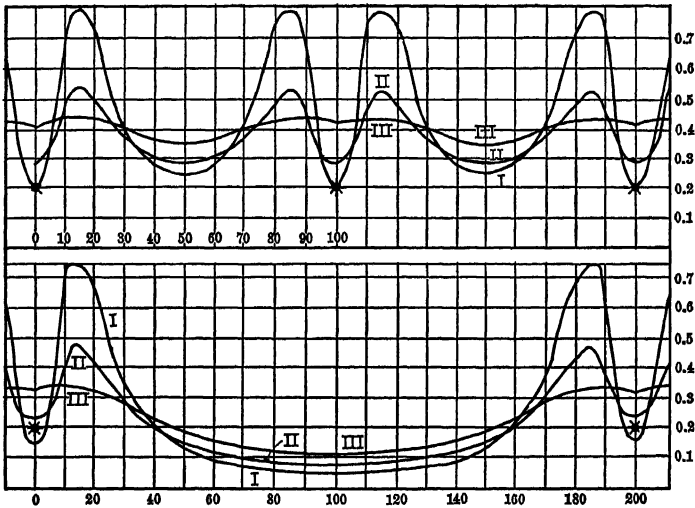

Figs. 103, 104.

Herefrom are calculated the illumination, i , plotted in Figs. 103 and 104 and recorded in Table IV for $l_v = 20$ ft.; $p = 5$, hence $l_{h_0} = 100$ ft., Fig. 103, and $p = 10$, hence $l_{h_0} = 200$ ft., Fig. 104, for equal light flux of 200 mean spherical candle power per lamp.

As seen, with the same light flux per lamp, the distribution curve III of Fig. 100 gives the highest and the curve I the lowest intensity at the minimum point midway between the lamps, while inversely I gives the highest and III the lowest intensity near the lamp; that is, I, the carbon arc with clear inner globe, gives the least uniform, and III, the luminous arc, the most uni-

form, illumination, while the carbon arc with opal inner globe, II, stands intermediate.

TABLE IV. — (Figs. 101 to 106.) STREET ILLUMINATION.

$$i = i_1 + i_2 + i_3 + i_4.$$

$$\tan \phi_1 = x \quad \tan \phi_2 = p - x \quad x = \frac{lh}{lv} \quad \tan \phi_3 = p + x \quad \tan \phi_4 = 2p - x \quad p = \frac{lh_0}{lv}.$$

x .	Equal light flux per lamp.						Equal illumination at minimum.					
	$p = 10.$			$p = 5.$			$p = 10.$			$p = 5.$		
	$a.$	$b.$	$c.$	$a.$	$b.$	$c.$	$a.$	$b.$	$c.$	$a.$	$b.$	$c.$
0	15.8	23.7	31.7	20	29	41.5	38	35	31	8	10	12.1 ⁻²
0.2	22.8	25.7	32.7	27	31	42.5	54	38	32	11	11	12.3
0.4	46.8	34.7	33.5	51	40	43	111	52	32.7	20	14	12.5
0.6	74	44	33.5	78	50	43	176	66	32.7	31	17	12.5
0.8	74	46	33	78	52	43	176	69	32.3	31	18	12.5
1.0	68	42	32	72.5	48	42.5	162	63	31.4	29	17	12.3
1.2	54	37	30.5	59	43	41.5	128	55	30	24	15	12.1
1.4	40	32	29	45	38.5	40.5	95	48	28.4	18	13	11.8
1.6	32	27	26.5	37	35	39	76	40	26	15	12	11.3
1.8	26	23	24.5	32	32.5	37.5	62	34	24	13	11	11
2.0	20	19.5	22	29	30	36	48	29	22	11.6	10.4	10.5
2.5	12.7	14.6	18	25	29	34.5	30	22	18	10	10	10
3.0	8.2	11.3	15	20	17	15
3.5	6.3	9	13	15	13.5	13
4.0	4.9	8	11.5	12	12	11
5.0	4.2	6.7	10.2	10	10	10
Ratio of minimum intensities.						Ratio of total light fluxes.						
	1	1.60	2.43	1	1.16	1.38	5.95	3.75	2.45	4.00	3.45	2.90
							2.43	1.53	1.00	1.38	1.19	1.00
						Ratio of maximum to min. illum.						
							17.6	6.9	3.3	3.1	1.8	1.25

The ratio of maximum to minimum illumination is:

	$p = 10$	$p = 5$
I. Carbon arc with clear globe:	17.6	3.1
II. Carbon arc with opal globe:	6.9	1.8
III. Luminous, or magnetite, arc:	3.3	1.25

As seen, lower values of p , that is, either shorter distances between the lamps, or greater elevation of the lamps above the street surface, give a more uniform illumination, so that, for $p = 5$, III gives only 25 per cent intensity variation, while, for $p = 10$, I gives a very unsatisfactory illumination, alternating darkness and blinding glare.

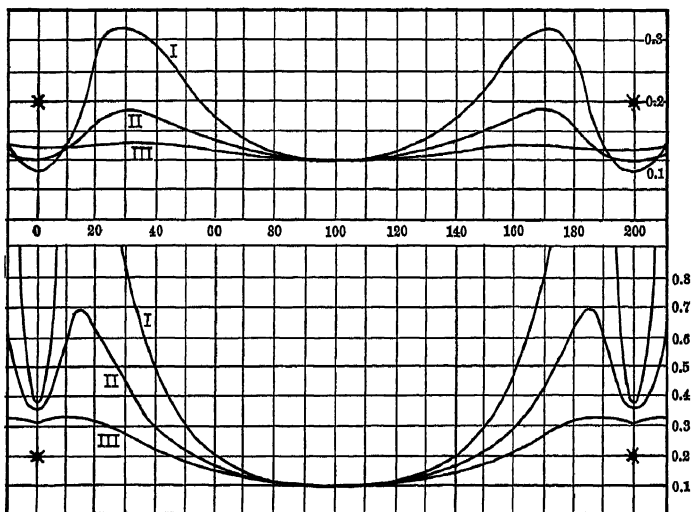

Figs. 105, 106.

In Figs. 105 and 106 are plotted, and recorded in Table III, the illuminations for equal minimum intensity midway between the lamps, and for equal distances $l_{h_0} = 200$ ft., between the lamps, for

- $p = 5$, or $l_v = 40$ ft. height above the street level, Fig. 105.
- $p = 10$, or $l_v = 20$ ft. height above the street level, Fig. 106.

To produce this minimum intensity of 0.1 candle feet, with 200 feet distance between the lamps, would require the following mean spherical candle powers:

$$p = 10, \text{ or } l_v = 20 \text{ ft.}; \quad p = 5, \text{ or } l_v = 40 \text{ ft.}$$

I. Carbon arc with clear globe:	1190	800
II. Carbon arc with opal globe:	750	690
III. Magnetite arc:	490	580

It is interesting to note the great difference in the light flux, required to produce the same minimum illumination, for the three distribution curves.

The carbon arc gains in efficiency and in uniformity of illumination by increasing the elevation from 20 to 40 ft., while the magnetite arc loses in efficiency — due to the greater distance from the illuminated surfaces — but makes up for this by the gain in uniformity of illumination.

C. ROOM ILLUMINATION BY INCANDESCENT LAMPS.

106. Let Fig. 107 represent the intensity distribution of an incandescent lamp with reflector, suitably designed for approximately uniform illumination in a horizontal plane below the lamp. Such a distribution curve can, for instance, be produced

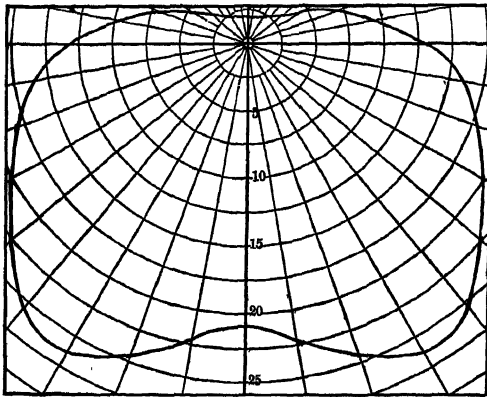

FIG. 107.

by a spiral filament F (Fig. 108) located eccentric in a spherical globe G , of which the upper part is clear glass and covered by a closely attached mirror reflector R , while the lower part is frosted, as shown diagrammatically in Fig. 108.

With this arrangement, half of the light flux issues directly, with approximately uniform intensity in the lower hemisphere, from $\phi = 0$ to $\phi = \phi_1$, and with gradually decreasing intensity from $\phi = \phi_1$ to 0 at $\phi = \phi_2$. The other half of the light flux is

reflected from the mirror, and, due to the eccentric location of the filament, the reflected rays are collected into an angle of about 45 deg. from the vertical, and cross each other, thereby producing the intensity maximum at $\phi = 30$ deg. The intrinsic brilliancy is sufficiently reduced, and the distribution curve smoothed out, by the frosting of the globe as far as not covered by the reflector. The light in the upper hemisphere beyond $\phi = \phi_2$ then is only that reflected by the frosting.

The numerical values of intensity of Fig. 107 are recorded in Table V.

The mean spherical candle power of the lamp is 12.93, or 163 lumens; the mean candle power in the lower hemisphere is 20.20, or 127 lumens, and the mean candle power in the upper hemisphere is 5.66, or 36 lumens.

Table V gives the distribution of illumination i in a horizontal plane beneath and above the lamp, for different horizontal distances l_h and the vertical distance $l_v = 1$, by equation (6), and the horizontal illumination i_h , by equation (7), as discussed in A. These are plotted in Fig. 109, for the lower hemisphere in the lower, for the upper hemisphere in the upper, curve.

Assuming now that a room of 24 ft. by 24 ft. and 10 ft. high is to be illuminated by four such lamps, located 6 inches below the ceiling in such a manner as to give as nearly as possible uniform illumination in a plane 2.5 ft. above the floor (the height of table, etc.).

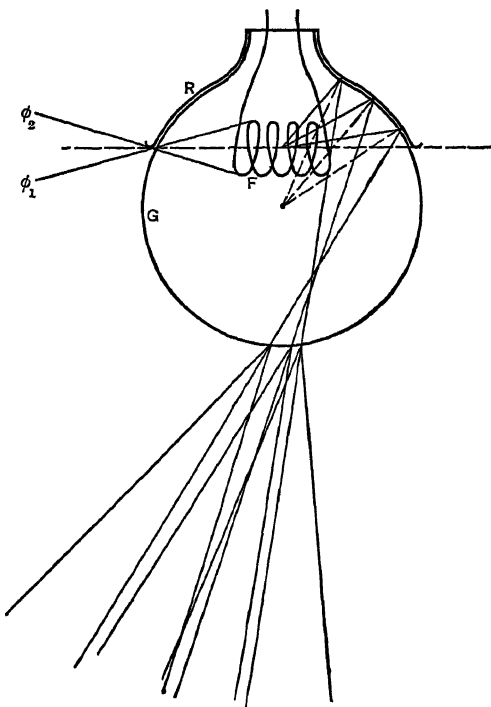

FIG. 108.

TABLE V. — (Figs. 107 to 109.)

ϕ .	I .	$\frac{l_h}{l_v} = \tan \phi$.	$\frac{i = I}{\cos^2 \phi}$.	$\frac{i_h = I}{\cos^3 \phi}$.	$x = \frac{l_h}{l_v}$.	$\frac{i = I}{\cos^2 \phi}$.	$\frac{i_h = I}{\cos^3 \phi}$.	(Upper hemisphere).	
								i' .	i'_h .
0	21.0	0	21.0	21.0	0	21.0	21.0	2.0	2.0
10	22.2	0.176	21.5	21.3	0.1	21.25	21.1
20	24.5	0.364	21.7	20.4	0.2	21.55	21.3
30	26.3	0.577	19.8	17.0	0.3	21.8	21.0
40	25.5	0.839	15.0	11.5	0.4	21.6	20.0
50	22.5	1.192	9.3	6.0	0.5	20.8	18.5	1.6	1.5
60	20.0	1.732	5.0	2.5	0.6	19.4	16.5
65	19.0	2.144	3.4	1.44	0.7	17.7	14.3
70	18.0	2.745	2.15	0.74	0.8	15.8	12.3
75	17.0	3.732	1.13	0.29	0.9	13.9	10.4
80	16.0	5.671	0.49	0.08	1.0	12.2	8.6	1.35	1.0
85	15.0	11.43	0.11	0.01	1.1	10.6	7.2
90	13.0	∞	0	0	1.2	9.2	6.0
95	11.0	11.43	0.08	0.01	1.3	5.1	5.1
100	9.5	5.671	0.29	0.08	1.4	7.2	4.2
105	8.0	3.732	0.53	0.14	1.5	6.45	3.55	1.2	0.68
110	7.0	2.745	0.84	0.29	1.6	5.8	3.1
115	5.5	2.144	1.00	0.42	1.7	5.2	2.65
120	4.5	1.732	1.12	0.56	1.8	4.7	2.25
130	3.0	1.192	1.23	0.80	1.9	4.2	1.95
140	2.5	0.839	1.47	1.13	2.0	3.9	1.7	1.08	0.48
150	2.2	0.577	1.66	1.43	2.5	2.55	1.0	0.9	0.35
160	2.0	0.364	1.77	1.66	3.0	1.8	0.6	0.77	0.27
170	2.0	0.176	1.94	1.91	3.5	1.33	0.37	0.63	0.20
180	2.0	0	2.0	2.0	4.0	1.0	0.25	0.5	0.13
.....	4.5	0.8	0.18	0.43	0.10
.....	5.0	0.67	0.13	0.38	0.08
.....	6.0	0.45	0.10	0.28	0.06
.....	7.0	0.33	0.08	0.20
.....	8.0	0.25	0.05	0.17
.....	9.0	0.20	0.14
.....	10.0	0.17	0.12

As the illumination in the space between the lamps is due to several lamps and thus is higher than that at the same horizontal distance outside of a lamp, for approximate uniformity of illumination, the distance between the lamps must be considerably greater than twice their distance from the side walls

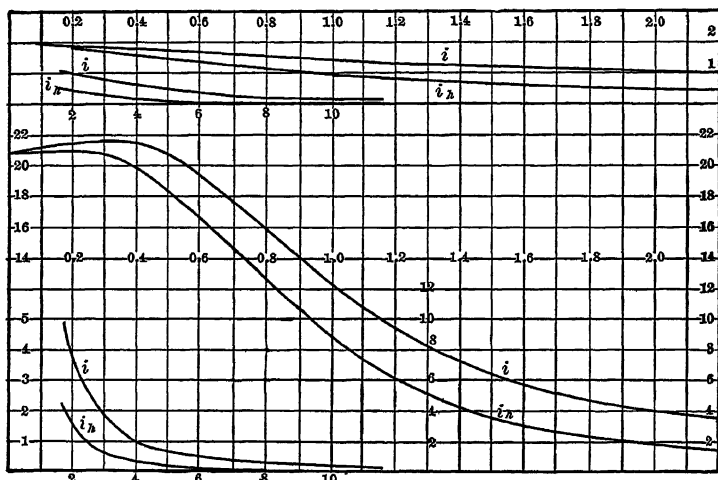

FIG. 109

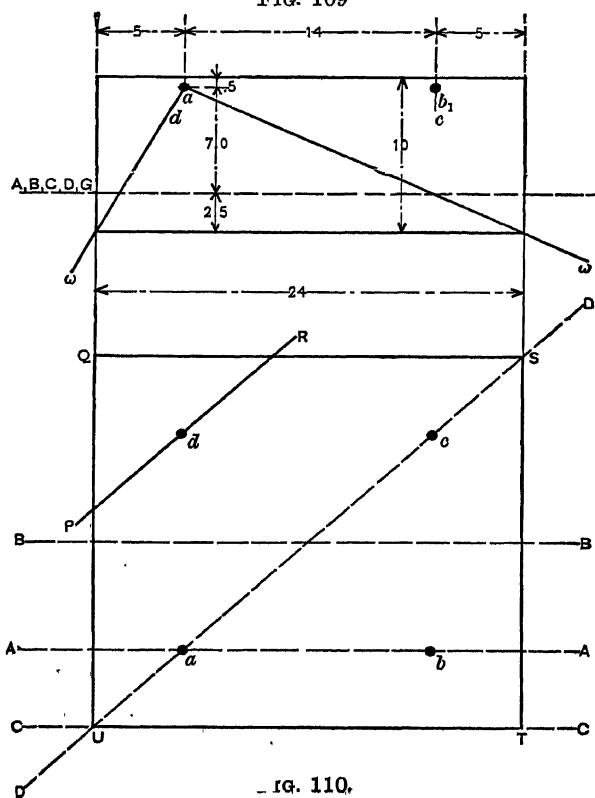

FIG. 110.

of the room. Locating thus the lamps, as shown diagrammatically in Fig. 110, at 5 ft. from the side walls and 14 ft. from each other, the (total) illumination in the lines *A*, *B*, *C*, *D* in the test plane 2.5 ft. above the floor is calculated. As this plane is 7 ft. beneath the lamps, first the illumination curve in a plane 7 ft. beneath the lamp is derived from that in Fig. 109, by dividing the ordinates by $7^2 = 49$, and multiplying the abscissas by 7. It is given in Fig. 111.

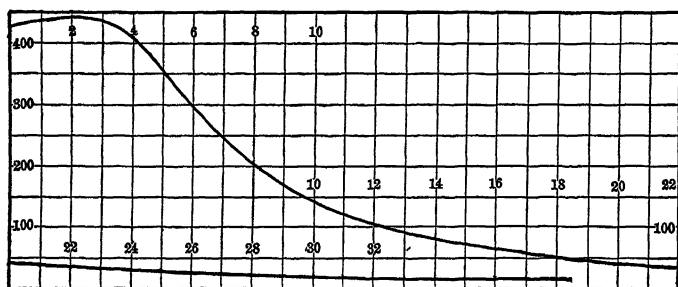

FIG. 111.

The illumination, i , at any point, P , then is derived by adding the illumination i_a, i_b, i_c, i_d of the four lamps a, b, c, d , taken from curve in Fig. 111 for the horizontal distances of point P from the lamps: $l_{ha}, l_{hb}, l_{hc}, l_{hd}$. These component illuminations are plotted in Figs. 112 to 115; as A_a, A_b, A_c, A_d in Fig. 112; as B_a, B_b in Fig. 113, etc., and their numerical values, in thousandths of candle feet, recorded in Table VI. In Fig. 116 are shown the four curves of the resultant direct illumination, superimposed upon each other.

107. To this direct illumination is to be added the diffused illumination G resulting from reflection by ceiling and walls.

$$\text{Let:} \quad \left. \begin{array}{l} a_1 = 0.75 = \text{albedo of ceiling;} \\ a_2 = 0.4 = \text{albedo of walls;} \end{array} \right\} \quad (19)$$

while the floor may be assumed as giving no appreciable reflection: $a = 0$. The diffused light, then, may be approximated as follows:

The ceiling receives as direct light the light issuing in the upper hemisphere, or 36 lumens per lamp, thus a total of

$$L_1 = 4 \times 36 = 144 \text{ lumens,} \quad (20)$$

TABLE VI. — (Figs. 110 to 116)

<i>x.</i>	<i>A_a.</i>	<i>A_b.</i>	<i>A.</i>	<i>B_a</i> and <i>B_d.</i>	<i>B.</i>	<i>C_a.</i>	<i>C_b.</i>	<i>C.</i>	<i>D_a.</i>	<i>D_b</i> and <i>D_c.</i>	<i>D</i>
0	353	71	746	180	690	244	43	600	245	43	600
1	406	74	813	200	738	276	44	645	317	49	691
2	438	76	852	218	782	306	44	681	395	55	785
3	442	78	866	234	822	332	45	714	441	62	845
4	438	80	875	244	852	348	45	737	440	70	866
5	429	80	880	247	870	353	45	746	429	79	880
6	438	80	903	244	882	348	45	754	440	90	919
7	442	78	922	234	880	332	45	750	441	101	949
8	438	76	936	218	866	306	44	737	395	114	939
9	406	74	927	200	850	276	44	723	317	125	896
10	353	71	898	180	838	244	43	710	245	135	859
11	298	67	875	162	830	209	42	696	184	143	835
12	247	63	870	144	825	180	41	690	144	144	825
13	200	60	129	156	39	115	143
14	167	57	114	136	37	94	135
15	143	54	102	118	35	79	125
16	121	51	90	103	33	66	114
17	104	48	81	90	31	56	101
18	90	45	72	80	30	49	90
19	80	41	63	72	30	42	79
20	70	38	57	64	30	36	70
21	61	35	52	58	29	33	62
22	55	33	48	52	29	30	55
23	52	31	44	47	28	26	49
24	45	29	40	43	28	23	43

and also receives some reflected light from the walls. Thus, if Φ_1 = total light flux received by the ceiling, and Φ_2 = total light flux received by the walls, the light flux received by the ceiling is

$$\Phi_1 = L_1 + b_2 a_2 \Phi_2, \tag{21}$$

where b_2 is that fraction of the light flux issuing from the walls, which is received by the ceiling.

And the light reflected from the ceiling thus is:

$$\Phi_1' = a_1 \Phi_1 = a_1 (L_1 + b_2 a_2 \Phi_2). \tag{22}$$

The walls receive as direct light the light issuing from the lamps in the lower hemisphere, between the horizontal, $\phi = 90$

deg., and the direction, $\phi = \omega$ (Fig. 110), from the lamp to the lower edge of the walls. This angle ω varies, and averages 30 deg. for that half of the circumference, PQR (Fig. 110), at which the walls are nearest, and 60 deg. for that half, $RSTUP$, for which the walls are farthest, from the lamp. Hence the

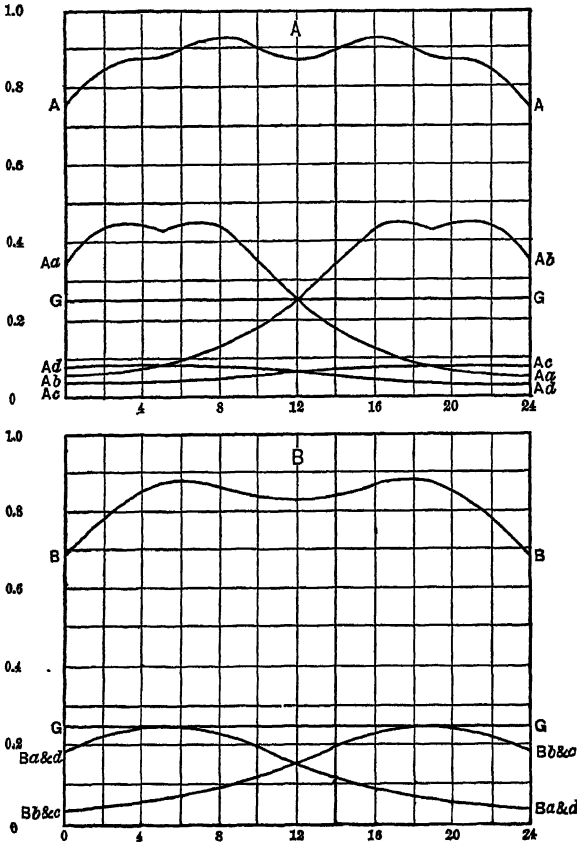

FIGS. 112, 113.

light flux received by the walls as directed light, from each lamp, is

$$\frac{1}{2} \int_{30^\circ}^{90^\circ} I \sin \Phi \, d\Phi + \frac{1}{2} \int_{60^\circ}^{90^\circ} I \sin \Phi \, d\Phi = 83 \text{ lumens}; \quad (23)$$

or, a total of $L_2 = 4 \times 83 = 332$ lumens. (24)

In addition hereto, the walls receive some of the light flux reflected by the ceiling. The total light received by the walls thus is:

$$\Phi_2 = L_2 + b_1 a_1 \Phi_1, \tag{25}$$

here b_1 is that fraction of the light flux issuing from the ceiling, which is received by the walls.

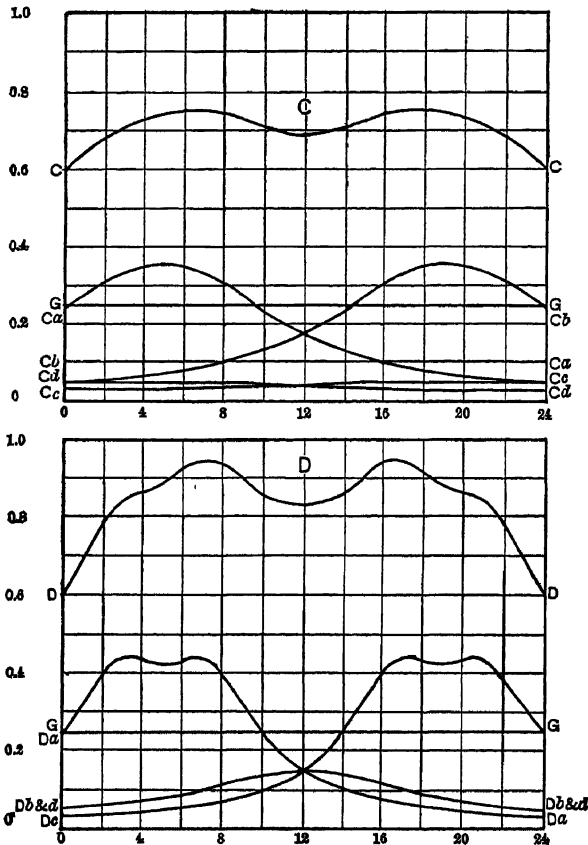

FIGS. 114, 115.

And the light reflected from the walls thus is:

$$\Phi_2' = a_2 \Phi_2 = a_2 (L_2 + b_1 a_1 \Phi_1). \tag{26}$$

It thus remains to calculate the numerical values of b_1 and b_2 . Of the light reflected by the ceiling as secondary generator, Φ_2' , a part is obstructed by the floor, a part received by the walls.

The floor is a square plane, of the same size, 24 by 24 ft., as the radiator, that is, the ceiling, and at the distance 10. The light intercepted by the floor can thus approximately be calculated as discussed in Lecture X, II, 1, Fig. 75, for circular radiator and circular shades, by replacing the quadratric shade and radiator by circular shades of the same area, $r^2\pi = 24^2$, and $r = 13.5$, at the same distance $l = 10$, hence of the ratio: $\frac{l}{r} = 0.74$.

Calculated as discussed in Lecture X, II, 1, the floor receives 55 per cent and the walls 45 per cent of the light reflected by the ceiling.

Assuming, approximately, that the walls receive the same percentage of the light reflected from the ceiling, as the ceiling receives of the light reflected from the walls, or

$$b_2 = b_1, \quad (27)$$

equations (21) and (25) become:

$$\Phi_1 = L_1 + b_1 a_2 \Phi_2, \quad (28)$$

$$\Phi_2 = L_2 + b_1 a_1 \Phi_1; \quad (29)$$

hence,

$$\left. \begin{aligned} \Phi_1 &= \frac{L_1 + b_1 a_2 L_2}{1 + b_1^2 a_1 a_2} \\ \Phi_2 &= \frac{L_2 + b_1 a_1 L_1}{1 + b_1^2 a_1 a_2} \end{aligned} \right\} \quad (30)$$

and the light reflected from the ceiling is

$$\Phi_1' = a_1 \Phi_1 = a_1 \frac{L_1 + b_1 a_2 L_2}{1 + b_1^2 a_1 a_2};$$

the light reflected from the walls is

$$\Phi_2' = a_2 \Phi_2 = a_2 \frac{L_2 + b_1 a_1 L_1}{1 + b_1^2 a_1 a_2};$$

hence, substituting the numerical values:

$$\Phi_1' = 146 \text{ lumens and } \Phi_2' = 144 \text{ lumens}$$

are the values of light reflected from the ceiling and from the walls respectively.

Of that from the ceiling, the floor receives $(1 - b_1) = 0.55$, and of that from the walls, the floor receives $b_1 = 0.45$; hence,

the diffused light on the floor plane, and thus also, sufficiently approximate, on the test plane 2.5 ft. above the floor, is

$$\begin{aligned}\Phi_0 &= (1 - b_1) \Phi_1' + b_1 \Phi_2' \\ &= 145 \text{ lumens,}\end{aligned}$$

and as this plane contains $A_1 = 576$ sq. ft., the flux of diffused light per square foot in the test plane, or the *diffuse illumination*,

is
$$i_0 = \frac{\Phi_0}{A_1} = 0.250 \text{ foot-candle.}$$

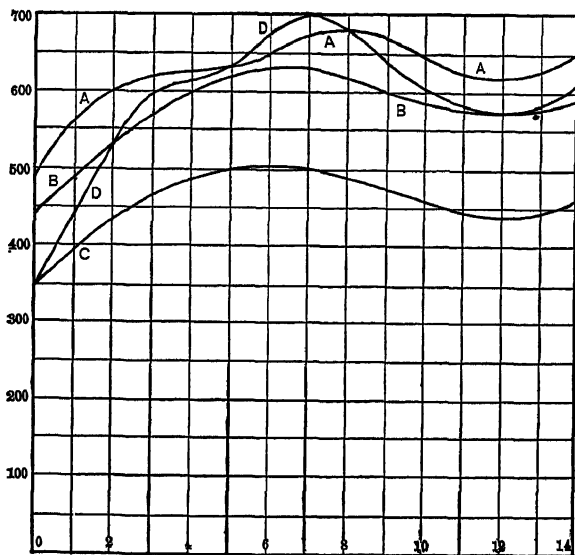

FIG. 116.

108. Adding this diffuse illumination, shown as G , to the directed illumination, gives the total illumination, i , shown as A, B, C, D in Figs. 112 to 115, and recorded in Table VI.

From these curves are taken the values of the distance, Table VII, at which the total illumination passes 0.600; 0.650; 0.700, etc., foot-candle, and plotted in Fig. 117. The points of equal illumination, then, are connected by curves, and thus give what may be called equi-luminous curves, or equi-potential curves of illumination.

These equi-luminous curves are plotted for every 0.05 foot-candle, except that the curves 0.875 and 0.925 are added in

dotted lines. As seen, the illumination is a minimum of 0.600 in the corners of the room and a maximum of 0.950 at a point between the lamps and the center of the room, and is between 0.800 and 0.950 everywhere except close to the edges of the room.

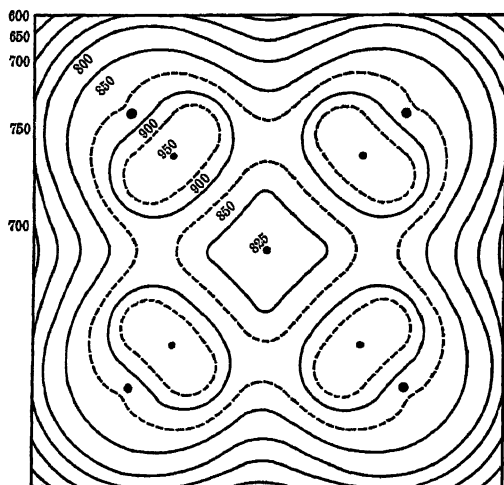

FIG. 117

TABLE VII — (Fig. 117.) EQUI-POTENTIAL CURVES.

<i>i.</i>	<i>A.</i>	<i>B.</i>	<i>C.</i>	<i>D.</i>
600	0	0
62555	.28
650	1.15	.56
675	1.80 [(440)]	.82
70020	2.57 10 70	1 09
72570	3.45 8.85	1.37
750	.05	1.24	5.50 7.00	1.61
775	.37	1.88	6.30	1.88
800	.77	2.45 [(576)]	(505)	2.18 [(576)]
825	1.21 [(620)]	3.08 [(12.00)]	2.50 [(12.00)]
850	1.90 [(12.00)]	3.88 9 00	3.10 10.35
875	4.00 11.00	5.30 7.47	4.70 9.50
900	5.90 9.90	6.40	5.53 8.90
925	7.15 9.10	(634)	6.13 8.32
950	8.20	7.20
.....	(686)	(700)

The direct light, which reaches the test plane, 2.5 ft. above the floor, as directed light from the lamps, issues within the angle from the vertical, $\phi = 0$, up to from $\phi = 40$ deg. to $\phi = 70$ deg., and is 75 lumens per lamp; or, a total of directed light in the test plane of $4 \times 75 = 300$ lumens. The diffused light in the test plane is $576 \times 0.25 = 144$ lumens, and the total light in the test plane thus is 444 lumens; while the total light issuing from the four lamps is $4 \times 163 = 652$ lumens, giving an efficiency of illumination of $\frac{444}{652} = 0.68$; or, 68 per cent: the

average horizontal illumination in the test plane is $i_{hm} = \frac{444}{576} = 770$; while the average total illumination, from Fig. 117, is about $i_m = 870$. The difference is due to the varying direction in which the directed light traverses the test plane.

Measurement of the illumination of a room by illuminometer, to give correct values, thus must take in consideration the different directions in which the light traverses every point; by measuring the light flux intercepted by a horizontal surface, the result represents only the horizontal illumination, and not the total illumination at the point measured, and therefore frequently does not represent the illuminating value of the light.

D. HORIZONTAL TABLE ILLUMINATION BY INCANDESCENT LAMPS.

109. Assuming a table, of 5 ft. by 13 ft., to be illuminated so as to give as nearly as possible uniform horizontal illumination i_h . With a light source of the distribution curve, Fig. 107, but of four times the intensity, and using two such lamps, they would be located vertically above the table, at a distance from each other which would be chosen so that, midway between the lamps, the illumination is approximately the same as vertically beneath the lamps.

In the same manner as discussed in C, the illumination is calculated in characteristic lines, indicated as A, B, C in Fig. 118, using, however, the curve i_h of Fig. 109.

About the most uniform horizontal illumination then is given by locating the lamps 5 ft. above the table, 8 ft. from each

other and 2.5 ft. from the edge of the table, as shown in Fig. 118. The illuminations in the lines *A*, *B*, and *C*, and their components are plotted in Figs. 119, 120, 121, and recorded in Table VII.

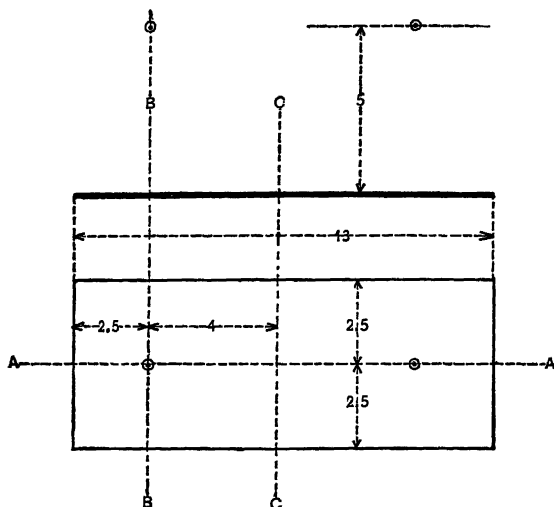

FIG. 118.

TABLE VIII. — (Figs. 118 to 121.) HORIZONTAL ILLUMINATION OF TABLE.

<i>x</i> .	<i>A_a</i> .	<i>A_b</i> .	<i>A</i> .	<i>B_a</i> .	<i>B_b</i> .	<i>B</i> .	<i>C_{a'b}</i> .	<i>C</i> .
—2.5	2.96	0.24	3.20	2.96	0.38	3.34	1.55	3.10
—2.0	3.20	0.27	3.47	3.20	0.46	3.66	1.66	3.32
—1.5	3.36	0.32	3.68	3.36	0.48	3.84	1.79	3.58
—1.0	3.41	0.37	3.78	3.41	0.48	3.89	1.89	3.78
—0.5	3.37	0.43	3.80	3.37	0.50	3.87	1.96	3.92
0	3.36	0.50	3.86	3.36	0.50	3.86	1.97	3.94
+0.5	3.37	0.57	3.94	3.37	0.50	3.87	1.96	3.92
1.0	3.41	0.67	4.08	3.41	0.48	3.89	1.89	3.78
1.5	3.36	0.81	4.17	3.36	0.48	3.84	1.79	3.58
2.0	3.2	0.96	4.16	3.20	0.46	3.66	1.66	3.32
2.5	2.96	1.15	4.11	2.96	0.38	3.34	1.55	3.10
3.0	2.63	1.37	4.00
3.5	2.28	1.66	3.94
+4.0	1.96	1.96	3.92

From the curves as given in Figs. 119 to 121 may then be plotted the equi-luminous curves at the table surface, as done in Fig. 117 of the preceding paragraph. In this case, which represents concentrated illumination, diffusion is not considered, but the light is all directed light.

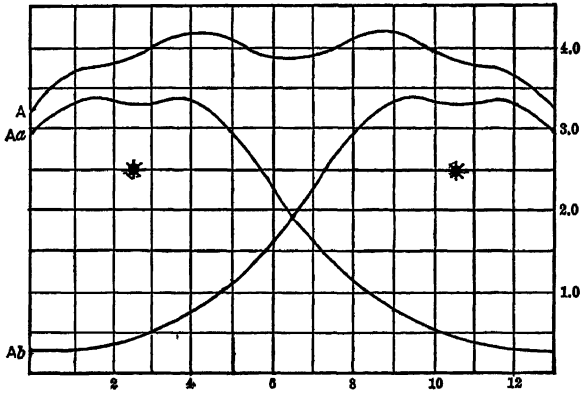

FIG. 119.

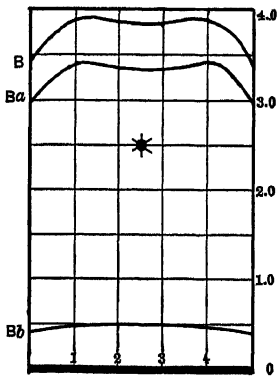

FIG. 120.

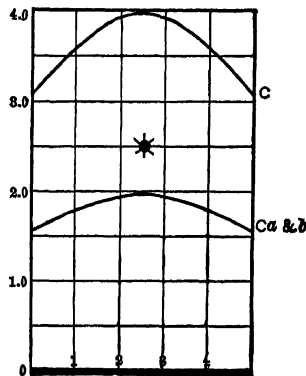

FIG. 121.

LECTURE XII.

ILLUMINATION AND ILLUMINATING ENGINEERING.

110. Artificial light is used for the purpose of seeing and distinguishing objects clearly and comfortably when the daylight fails. The problem of artificial lighting thus comprises consideration of the source of light or the illuminant; the flux of light issuing from it; the distribution of the light flux in space, that is, the light flux density in space and more particularly at the illuminated objects; the illumination, that is, the light flux density reflected from the illuminated objects, and the effect produced thereby on the human eye. In the latter, we have left the field of physics and entered the realm of physiology, which is not as amenable to exact experimental determination, and where our knowledge thus is far more limited than in physical science. This then constitutes one of the main difficulties of the art of illuminating engineering: that it embraces the field of two different sciences — physics and physiology.

The light flux entering the eye is varied in its physical quantity by the reaction of the eye on light flux density in contracting or expanding the pupil. The effect of the light flux which enters the eye is varied by the fatigue, which depends on intensity and also on color. Distinction is due to differences in the light flux density from the illuminated objects, that is, differences of illumination, which may be differences in quality, that is, in color, or differences in intensity, that is, in brightness, and as such includes the effect of shadows as causing differences in intensity at the edge of objects.

The physical quantities with which we have to deal in illuminating engineering thus are:

The *intensity of the light source* or the illuminant, and its *brilliance*, that is, the flux density at the surface of the illuminant;

The *flux of light*, that is, the total visible radiation issuing from the illuminant;

The *light flux density*, that is, the distribution of the light flux in space, and

The *illumination*, that is, the light flux density issuing from the illuminated objects.

The *intensity of a light source* is measured in *candles*. The unit of light intensity, or the candle, is a quantity not directly related to the absolute system of units, but reproduced from specifications or by comparison with maintained standards, and for white light is probably between 0.04 and 0.02 watt. Intensity has a meaning only for a point source of light; that is, an illuminant in which the flux of light issues from a point or such a small area that, at the distance considered, it can be considered as a point. "Intensity of light" thus is a physical quantity of the same nature as "intensity of magnet pole," which latter also presupposes that the total magnetic flux issues from a point, and thus is applicable only when dealing with such distances from the source of the light flux or magnetic flux, that the flux can be assumed as issuing from a point. Frequently the intensity of a light source is different in different directions, and then either the *distribution curve of the light intensity* is required for characterizing the illuminant, or the average of the intensities in all directions in space is used, and is called the "*mean spherical intensity*."

The unit of light intensity, or the candle, is the intensity which produces unit flux density at unit distance from the light source, and thus produces a total flux of light equal to 4π units (the surface of the sphere at unit distance from the light source). The unit of light flux is called the lumen, and one candle of light intensity thus produces 4π lumens of light flux (just as a magnet pole of unit intensity produces 4π lines of magnetic force).

The *light flux* is the essential quantity which characterizes the usefulness of an illuminant, and it is the raw material from which all illuminating engineering starts. Any source of light can be measured in units of light flux or lumens — the diffused daylight entering the windows of a room, or the visible radiation of the mercury lamp or a Moore tube as well as that of a point source — by adding all the flux densities intercepted by any surface enclosing the source of light.

In a point source of light, the intensity, in candles, is the total

flux of light, in lumens, divided by 4π . In any illuminant which is not a point source, we cannot speak of an intensity, except at such distances at which the source of light can be assumed as a point; and in interior illumination this is rarely the case. Since, however, the candle power, as measure of the intensity of light, has become the most familiar quantity in characterizing illuminants, very commonly even sources of light which are not point sources — as a Moore tube or the diffused daylight — are expressed in “*equivalent candle power*,” and when thus speaking of the candle power of a mercury lamp, or of the diffused daylight from the windows, we mean the candle power of a point source of light, which would give the same total flux of light as the mercury lamp, or the daylight from the windows, etc. The “*equivalent candle power*,” or frequently merely called “*mean spherical candle power*,” thus is the total light flux divided by 4π , hence in reality is not a unit of intensity, but a unit of light flux.

This explains the apparent contradiction between the claims that sources of light, as the mercury lamp or the Moore tube, cannot be expressed in candle powers, while at the same time their specific consumptions are given in candle power per watt: meaning equivalent candle power, which refers to the total flux of light, and thus is a definite and measurable physical quantity.

While it is not probable that the custom of rating illuminants in candles, regardless of their shape, will quickly disappear, and no objection exists against it, provided that it is understood to mean the equivalent candle power, it is preferable to use the correct unit of light flux, and express the output of a source of light in lumens, adding where necessary the equivalent candle power in parenthesis. Obviously, the use of the candle power in any particular direction — horizontal, or terminal, or maximum candle power — has a meaning only in characterizing the distribution of the light flux, as applicable for a particular purpose, as street lighting, but, when used for rating the illuminant by its light flux output, is an intentional or unintentional deception. Incandescent lamps have been rated, and to some extent still are, in horizontal candle power, but in this case the horizontal candle power has ceased to mean the actual horizontal candle power, but is the horizontal candle power which with a certain standard distribution of light flux would correspond to the light flux of the

lamp, and thus also is merely a practical measure of the light flux, retained by convenience: one horizontal candle power represents 0.78 mean spherical or equivalent candle power of the standard distribution curve, and thus $4\pi \times 0.78$ lumen.

In general, intensity, or candle power, thus is an *angular measure*, useful in characterizing the distribution of the light flux, but not the total light flux.

111. *Light-flux density* is the light flux per unit area traversed by it, thus is measured in lumens per square meter (or square foot), just as the magnetic density is measured in lines of magnetic force per square centimeter. In illumination, as unit of length, usually the meter is employed, and not the centimeter, as in the absolute system of units, and 10^2 thus is the reduction factor to absolute units. Frequently also the foot is used as practical unit of length.

For a point source of light the light flux density is the intensity of the light source, in candles (in the direction towards the point of observation, if the distribution is not uniform in all directions), divided by the square of the distance, in meters, or feet, and the light flux density thus is frequently expressed in meter-candles, or foot-candles. Thus at 10 feet distance from a 16 candle power lamp, the light flux density is 0.16 foot-candle, or 0.16 lumen per square foot. Very commonly, therefore, the light flux density produced by sources of light which are not points, is also expressed in meter-candles or foot-candles—which numerically is the same value, that is, the same quantity, as lumens per square meter or square foot, but physically would refer to the equivalent candle power of the light source.

Illumination is the light flux density reflected from the illuminated object, and as flux density thus is measured also in lumens per square meter or square foot, or in meter-candles or foot-candles.

Brilliancy is the light flux density at the surface of the illuminant, and as flux density thus could also be measured in lumens per square meter or square foot, but, as this would usually give enormous values, brilliancy of the light source generally is measured in lumens per square centimeter, or per square millimeter. It is a quantity which is of high importance mainly in its physiological effect.

Light intensity, brilliancy and light flux thus are character-

istics of the illuminant, while flux density is a function of the space traversed by the light flux, but not of the source of light: with the same source of light, in the space from the surface of the illuminant to infinite distance, all light flux densities exist between the maximum at the surface of the illuminant (its brilliancy) and zero. Brilliancy thus is the maximum of the light-flux density. While intensity and brilliancy depend upon the shape of the illuminant, light flux is independent thereof. Illumination is a quantity which depends not only on the source of light, that is, light flux and flux density, but also on the illuminated objects and their nature, and thus is the light flux density as modified by the illuminated objects. Very commonly, however, the term "illumination" is used to denote "light flux density," irrespective of the illuminated objects.

112. The light flux thus is the raw material with which illuminating engineering starts, and the first problem then is to distribute the light flux through space so as to give at all points the light flux density required for satisfactory illumination.

Some problems, as the lighting of a meeting place, school-room, etc., require a uniform or general, and fairly high intensity of illumination, while in street lighting a uniform but fairly low intensity of illumination is desirable. In other cases, mainly a local or concentrated illumination is needed. Usually, however, a combination of a local or concentrated illumination, of fairly high intensity, with a general illumination of lower intensity, is required: the former at those places where we desire to distinguish details, as where work is being done, at the reading-table, work bench, dining-table etc., while the general illumination is merely for orientation in the space, and thus may be of lower intensity, and for reasons of economy, and also physiological reasons, should be of lower intensity.

We thus have to distinguish between *local* or *concentrated*, and *general* or *uniform*, illumination, and a combination of both, and have to distribute the light flux in accordance therewith, that is, produce a high flux density at the points or areas requiring high concentrated illumination, a low and uniform flux density throughout the remaining space.

This can be done by choosing a light source of the proper distribution curve, as, for instance, in street illumination a lamp

giving most of the light flux between the horizontal and 20 deg. below the horizontal; in many cases of indoor illumination a light source giving most of the light between the vertical and an angle of from 30 to 60 deg. from the vertical—depending on the diameter of the area of concentrated illumination and the height of the illuminant above it. It can also be done by modifying or directing the light flux of the illuminant by reflection or diffraction and diffusion, either from walls and ceilings of the illuminated area, or by attachments to the illuminant, as reflectors, diffusing globes, diffracting shades, etc. Furthermore, the required flux distribution can be secured by the use of a number of illuminants, and with a larger area this usually is necessary. Frequently the desired flux distribution is produced by using an illuminant giving more light flux than necessary, and destroying the excess of flux in those directions where it is not wanted, by absorption. Obviously this arrangement is uneconomical and thus bad illuminating engineering; the desired flux distribution should be secured economically, that is, without unnecessary waste of light flux by absorption, and this usually can be done by a combination of a number of light sources of suitable distribution curves. The most economical method of securing the desired distribution curve obviously is to choose a light source coming as near to it as possible, and then modifying it by reflection or diffraction.

113. Thus far, the problem is one of physics, and the result, that is, the *objective illumination*, can be measured by photometer or luminometer, and thus checked. The duty of the illuminating engineer, however, does not end here, but with the same objective illumination, that is, the same distribution of light flux throughout the entire illuminated area, as measured by photometer, the illumination may be very satisfactory, or it may be entirely unsatisfactory, depending on whether the physiological requirements are satisfied or are violated; and very often we find illuminations which seem entirely unsatisfactory, tiring, or uncomfortable, but when judged by the density and the distribution of the light flux, should be satisfactory. Even numerous commercial illuminants, designed to give suitable distribution curves, fail to do justice to their light flux and its distribution, by violating fundamental physiological requirements.

The physiological problems of illumination, that is, the effects entering between the objective distribution of light flux in space, and the subjective effects produced on the human eye, thus are the most important with which the illuminating engineer has to deal, and the first feature which must be recognized is that the objective illumination, as measured by the photometer, is no criterion of the *subjective illumination*, that is, the physiological effect produced by it, as regard to clearness, comfort and satisfaction, and it is the subjective illumination by which the success of an illuminating engineering problem is judged.

The most important physiological effects are:

(a) *The contraction of the pupil.* The pupil of the eye automatically reacts, by contraction, on high brilliancy at or near the sensitive spot, that is, the point of the retina, on which we focus the image of the object at which we look, and to a somewhat lesser extent on high brilliancy anywhere else in the field of vision. If, therefore, points or areas of high brilliancy are in the field of vision, especially if near to objects at which we look, the pupil contracts the more the higher the brilliancy, and thereby reduces the amount of light flux which enters the eye, that is, produces the same result as if the objective illumination had been correspondingly reduced, intensified by the uncomfortable effect of seeing high brilliancy. The existence of points of high brilliancy in the field of vision thus results in a great waste of light flux, and additional discomfort, and, for satisfactory illumination, points of high brilliancy thus must be kept out of the field of vision. Light sources of high brilliancy must be arranged so that they cannot directly be seen, but the illumination accomplished by the light reflected from ceilings, etc., or from reflectors attached to the illuminant: *indirect lighting*; or at least the light sources should be located where we are rarely liable to look at them, that is, with moderate-sized rooms, at or near the ceilings. Or light sources of moderate intrinsic brilliancy should be used, as the Moore tube, the mercury lamp, the Welsbach mantel. Or, with illuminants of high brilliancy, as the electric arc, the incandescent lamp (especially the tungsten filament), etc., the brilliancy of the illuminant must be reduced by enclosing it with a diffusing or diffracting globe or shade, as an opal or frosted or holophane globe, etc.

No illumination, however, can be satisfactory in which the eye at any time can be exposed to the direct rays from a tungsten filament or an arc. While the methods of removing the high brilliancy of the illuminant usually involve a considerable loss of light flux, by absorption at the refracting surface, in the frosted or opal globe, etc., and the objective illumination thus is decreased, if the methods of reducing the brilliancy are anywhere reasonably arranged, the light flux entering the eye, and thus the subjective illumination, is increased, and often very greatly. Thus while frosting an incandescent lamp decreases its light flux by about 15 per cent, in spite thereof usually more light flux enters the eye from the frosted lamp than from a clear glass lamp at the same distance.

It is, therefore, inefficient to use illuminants of high brilliancy in the field of vision, and in addition makes the illumination uncomfortable and thereby unsatisfactory. Physiologically the brilliancy of the light source thus is one of the most important quantities.

114. (b) *Fatigue*. When exposed to fairly high light flux density, that is, high illumination, the nerves of the eye decrease in sensitivity, by fatigue, and inversely, in lower illumination or in darkness, increase in sensitivity. This reaction, or adjustment of the sensitivity of the nerves of vision to different intensities of illumination, enables us to see equally well in illuminations varying in intensity by more than 10,000 to 1 (as daylight and artificial light). Thus, when entering a well-illuminated room from the darkness, it first appears glaring, until gradually the impression fades down to normal. Inversely, coming from a well-lighted room into a space of much lower illumination, it first appears practically dark, until gradually the eye adjusts itself, that is, the nerves of vision increase in sensitivity by their rest, and then we again see fairly well.

Fatigue and contraction of the pupil thus are similar in their action, in that they reduce the physiological effect for high intensities. The contraction of the pupil, however, is almost instantaneous, and is a protective action against excessive brilliancies in the field of vision, while the fatigue is a gradual adjustment to the average intensity of illumination, within the operating range of the human eye.

By exposure for a considerable period to the fairly high illumi-

nation required when working by artificial light, the sensitivity of the eye decreases, the illumination appears less bright, and thus a higher illumination is required than would be sufficient in the absence of fatigue, and the continuous use and absence of rest cause the sensation of strain, that is, irritation or an uncomfortable feeling, as especially noticeable when working or reading for a considerable length of time in rooms having a high uniform intensity of illumination, as meeting-rooms, some libraries, etc. If, however, the eye can rest even momentarily, by a change to lower intensity of illumination, fatigue is decreased, never becomes as complete and uncomfortable, and the concentrated illumination of the working-table appears brighter than it would without the possibility of rest.

A room having a uniform intensity of illumination thus appears glaring and uncomfortable, and for satisfactory illumination it is necessary not only to provide a sufficiently high intensity at the place where needed, but it is just as necessary to keep the intensity of illumination as low as permissible, wherever it is not needed, so as to afford to the eye rest from the fatigue. In some cases, as meeting-halls, schoolrooms, this may not be possible, but a uniform high intensity required, to be able to work or read anywhere in the room. Where, however, it is not necessary, it is not merely uneconomical to provide a uniform high intensity of illumination, but it is an illuminating engineering defect, and a high intensity should be provided, as concentrated illumination, only at those places where required, as at the reading-tables of the library, but the general illumination should be of lower intensity. While we rarely realize the cause, we feel the superiority of the combination of high concentrated and lower general illumination, by speaking of such illumination as home-like, restful, etc. Especially in places where considerable work has to be done by artificial illumination, as in libraries, factories, etc., to get satisfactory results, it is important to consider this effect of fatigue, and to properly combine a moderately low general illumination with a local higher intensity of illumination at the places of work. The latter can usually be given by a light source having a downward distribution, located sufficiently high above the place of work. The average standing or reading lamp, however, generally is not sufficiently high to accomplish the result. Obviously, in such local illumination,

the brilliancy of the illumination must be kept low, as discussed above.

Of considerable importance regarding fatigue is the quality, that is, the color, of the light: fatigue at high intensities occurs far more with yellow and orange rays than with white light, and very little with green and bluish-green light. Thus, in artificial illumination, in which practically always the yellow and orange rays greatly preponderate, the question of fatigue is far more important than with the bluish-white diffused daylight, and the irritating effects of fatigue thus are mostly felt with artificial illumination.

115. (c) *Differences.* Objects are seen and distinguished by differences in quality, that is, color, and in intensity, that is, brightness, of the light reflected by them. If there were no differences in color or in intensity throughout the field of vision, we would see light but would not distinguish objects. Therefore, in good illumination, the differences in color and in intensity should be sufficiently high to see clearly by them, but still limited so as not to preponderate to such extent as to distract the attention from smaller differences. The differences in intensity, to give distinction, should be high, but at the same time are limited by the phenomena of fatigue and of the contraction of the pupil: the minimum intensity must still be sufficiently high to see clearly, and the maximum intensity not so high as to cause fatigue and contraction of the pupil, much beyond that corresponding to the average intensity, otherwise the vision becomes indistinct and unsatisfactory, and uncomfortable by too much contrast; that is, the intensity differences must give a sufficient, but not an excessive, contrast, if the illumination is to be satisfactory.

Differences in quality, that is, in color, are to a limited extent only under the control of the illuminating engineer. In some cases the illuminating engineer can control or advise regarding the color of objects, as the walls, ceilings, etc. In most cases, however, the *absolute color* of the illuminated objects is not within the control of the illuminating engineer: for instance, in street lighting, the color of the street surface, its surroundings, as vegetation, houses, etc., are fixed and cannot be changed for effects of illumination. So also in most cases of indoor illumination. To some extent, however, the *subjective color* can be con-

trolled by the choice of the proper shade of light, and thereby slight color differences increased and made more distinct, or decreased and thus obliterated. For instance, the color resulting from age and dirt is usually the color of carbon and of iron, yellowish brown or reddish brown, that is, colors at the long wave end of the spectrum. Spots and blemishes due to dirt or age, thus are made more distinct by using an illuminant deficient in the long waves of light, as the mercury lamp, while inversely they are decreased by using a reddish-yellow illuminant, as the incandescent lamp or the candle. Thus the white arc lamp and still more so the bluish-green mercury lamp shows blemishes and slight color differences of age and dirt harsh and exaggerated, while the yellow light softens them and makes them disappear; and while, for a ballroom, the yellow light is thus preferred, and the mercury arc or even the ordinary white carbon arc would give a harsh and disagreeable effect, inversely the yellow light would be unsuitable where such slight differences should be distinguished. It is therefore essential for the illuminating engineer to choose as far as it is feasible the proper color of light, and an otherwise good illumination may be spoiled by using too white or too yellow a light.

The main distinction of objects, however, is due to differences in intensity or brightness, and, for producing these, the shadows are of foremost assistance, and indeed the differences of intensity, by which we see objects, are to a large extent those due shadows. The study of the shadow thus is one of the most important subjects of illuminating engineering. If we have no shadows, but a perfectly diffused illumination, even if the intensity of illumination is sufficient, the illumination is unsatisfactory, as we lose the assistance of the shadows in distinguishing objects, and therefore find seeing more difficult, the illumination restless and uncomfortable.

The use of shadows for illumination requires that we must have directed light, that is, light coming from one or a number of sources, and thus causing shadows, and not merely diffused illumination, that is, light coming from all directions and thus causing no shadows. While, however, in general perfectly diffused illumination is unsatisfactory, an illumination having only directed light is also unsatisfactory. If the light is all directed, as from a single arc, the shadows are absolutely black, we can-

not see anything in them, and, in attempting to see the objects in the shadows, the illumination becomes tiring to the eyes, irritating and restless.

For satisfactory illumination, it therefore is necessary to have sufficient directed light to mark the edge of the objects by their shadow, and thereby improve distinction, but at the same time sufficient diffused light to see clearly in the shadows; that is, a proper proportion of *directed* and *diffused* light is necessary.

In cases in which all the objects assume practically the same color, as in flour mills or foundries, a diffused illumination without shadows would make the illumination so bad as to be practically useless. In other cases, as a drafting-room, where all the objects requiring distinction are in one plane, as the drafting board, and the distinction is exclusively by differences of color and intensity, but not by shadows, a perfectly diffused illumination is required, and shadows would be objectionable and misleading, and this is one of the cases where directed light is objectionable.

While with a single light source all the light issuing from it is directed light, by using a number of illuminants, the overlap of their light fluxes causes more or less light to reach objects from all directions, and thereby gives the effect of diffused light, except at those places where the shadows cast by the different light sources coincide, and by proper positions of sufficient numbers of light sources this can be avoided. The use of a number of light sources thus offers a means of increasing the proportion of diffused to directed light.

116. It is not sufficient, however, to have merely a combination of diffused and directed light in the proper proportion, but the direction of the latter also is of importance. In some simple cases this is obvious, as, in writing, the directed light should be from in front on the left side above the table, so as not to cast the shadow on the work. The purpose of the shadow in illumination is to mark the edge of the object, and its height by the length of the shadow. The shadow, therefore, should not extend too far from the object to which it is related, otherwise it loses its close relation to it and becomes misleading and thereby interferes with good illumination. Thus the directed light should come from above, that is, in a direction making a considerable angle with the horizontal, so as to limit the length

of the shadow without, however, being vertical, as the latter would largely obliterate shadows. Perhaps an angle of 45 to 60 degrees with the horizontal would be most satisfactory. The practically horizontal shadows cast in the usual form of street lighting therefore are not satisfactory for best illumination.

The number of shadows is of less importance. While in nature objects have one shadow only, cast by the sun, indoors we are familiar with seeing several shadows due to the diffused daylight from several windows. Of high importance, however, is the shape of the illuminant, in so far as it determines the outer edge of the shadow. The purpose of the shadow is to give an intensity difference at the edge of the object, and thereby make it easier to see the object. The shadow, however, has another edge, its outer end, and that we should not see, as no object ends there, or at least it must be such that it cannot be mistaken for the edge of an object. The problem thus is not merely to provide sufficient directed light to cast a shadow, but the shadow should be such that only one side, at the edge of the object, is sharply defined, while the other edge of the shadow, which terminates on the flat surrounding surface, should gradually fade or blur. If we have to look closely to determine that the outer edge of the shadow is not the edge of another object, the strain of distinguishing between the edge of an object and the edge of a shadow makes the illumination uncomfortable and thus unsatisfactory. In the shadows cast by a single arc in a clear glass globe, this difficulty of distinguishing between the edge of a shadow and the edge of an object is especially marked, and, combined with the invisibility of objects in the shadow, makes such shadows appear on first sight like ditches or obstructions.

In the use of shadows in illuminating engineering it thus is necessary to have the outer edge of the shadows blur or gradually fade, and this requires that the source of directed light be not a point, but a sufficiently large area to scatter the light at the outer edge of the shadow, preferably even more than is the case with the shadows cast by the sun. This requires enclosing the illuminant by a fairly large opal globe or other similar device; that is, have the light issue from a fairly large luminous area.

It must be recognized that the proper treatment of the shadows

is one of the most important problems determining the success or failure of an illumination.

117. *Color sensitivity.* The maximum of sensitivity of the eye shifts with decreasing illumination from yellow to bluish green, and where a low intensity of illumination is used, as in street lighting, a source of light which is rich in the shorter waves, that is, a white light, is superior in its physiological illuminating value to a yellow light of the same or even higher light flux, while inversely at high values of illumination, as for decorative purposes, the yellow light is more effective.

Therefore it is a mistake to choose a yellow light source for illumination of very low intensity, or a white or bluish-green light for illumination attempting high intensity effects. Thus, for the average street lighting of American cities, the white arc is superior to the yellow flame arc, but, to produce a glare of light, the latter would be superior.

While there are further physiological effects which are of importance in illuminating engineering, the above four may illustrate the long step which exists between the distribution of the light flux as measurable by the photometer, and the success or failure of the illumination represented by it.

The requirements of satisfactory illumination can thus be grouped in two main classes, referring respectively to economy and to comfort, and the characteristics are:

(1) General or uniform, and local or concentrated illumination, and combination of both. This is of importance for economy: to avoid the production of unnecessary light flux; and comfort: to reduce the effect of fatigue.

(2) Diffused and directed illumination, and combinations of both, and the theory of the shadow. This is of importance for the comfort of illumination, in securing clearest distinction.

(3) Quality or color of light, of importance in economy, to suit the color to the intensity of illumination, and to comfort, in increasing or softening differences in color shades.

(4) Massed and distributed illumination, as controlling the distribution of the light flux, and thereby the economy and also the diffusion.

(5) Direct illumination and indirect illumination, shaded, diffracted, diffused, or reflected light, in its relation to the bril-

liancy of the light source, and thereby the effect of the contraction of the pupil, on economy and comfort.

Some of the common mistakes made in illumination are:

(1) Unsatisfactory proportion of general and of concentrated light.

(2) Exposure of high brilliancies in the field of vision, as naked filaments.

(3) Unsuitable proportion of diffused and directed light.

(4) Improper direction of directed light and thereby improper length of shadows.

(5) Sharp edges of shadows.

In order to illustrate the preceding principles, some typical cases may be considered:

(a) *Domestic lighting.*

118. Domestic lighting usually requires a combination of a concentrated illumination of fairly high intensity locally at the work-table, dining-table, etc., and a general illumination of low intensity, to secure comfort and economy. Occasionally, as in halls, etc., the local lighting is absent and only general illumination required, while for instance in a sick room the general illumination is absent and only local illumination required.

In this illumination the proportion between directed and diffused light should be such as to give the proper effect of shadows. The problem of domestic illumination thus is to produce a definite distribution of light flux density, with a definite proportion between diffused and directed light. If we deviate from the proper proportion on one side, the room appears cold and uncomfortable; if we deviate in the other direction, it appears dark and gloomy.

The light issuing directly from a single illuminant is directed light; the light issuing from a number of illuminants is diffused in proportion to the number of sources by the overlap of the light fluxes of the illuminants. The light reflected from walls and ceilings is diffused light. The proportion between the light reflected from walls and ceilings, or the indirect light, and the direct light from the illuminants, varies with the reflecting power of walls and ceilings, that is, their brightness or darkness. The proportion between directed and diffused light thus can be changed, and the diffused light increased by increasing the number of illuminants, and also by increasing the brightness of walls

and ceilings. With a given brightness of walls and ceilings, the desired distribution of the light flux—a local high and general low intensity—can be produced by a single illuminant having the proper distribution curve of light flux. In this case, however, usually we get too much directed, and not enough diffused, light. The same distribution of light flux can be produced by a number of illuminants properly located: nearer together for the local than for the general illumination. In the latter case we get more diffused and less directed light, and thus by choosing the number of light sources it is possible, with any given brightness of walls and ceilings, to get the desired distribution of light flux and at the same time the proper proportion of directed and diffused light. With a different brightness of walls and ceilings, the distribution curve of a single light source, required to give the desired light flux distribution, is correspondingly changed, and, the lighter the walls and ceilings, the more light is reflected, giving a diffused general illumination, and thus less direct light from the illuminant is required for the general illumination. With increasing reflecting power of walls and ceilings, the proportion of diffused light increases, and the number of light sources which are required to give the proper proportion between directed and diffused light is decreased, and inversely it is increased with increasing darkness of walls and ceiling. Therefore, in a room with light walls, a smaller number of light sources is required for good illumination than in a room with dark walls, assuming the same intensity of local and of general illumination.

119. The problem of domestic illumination: to get a certain distribution of illumination, with a definite proportion between directed and diffused light, thus leaves one independent variable—the brightness of walls and ceilings. This is necessary, as the problem of domestic illumination is twofold: to get the proper illumination by means of the daylight, and also to get it for artificial illumination. During daytime, the windows are the source of light, the directed light issues from the windows, the diffused light from the walls and ceilings and by the overlap of the light from several windows. The proper distribution between local and general illumination during daytime, and at the same time the proportion of directed and diffused light, thus determines the number of windows and the brightness of walls and ceilings, in the manner as discussed before.

As the reflecting power of walls and ceilings is fixed by daylight considerations, it cannot be chosen, or at least only to a limited extent, by considerations of artificial illumination, but, as found above, this is not necessary, since by a combination of a suitable number of light sources of proper distribution curves the problem of artificial illumination may be solved. To some extent, due to the quality of artificial light and daylight, the walls can give a different reflecting power for the one than for the other. As artificial light is deficient in blue and green, a bluish or greenish shade of walls and ceilings gives them a greater reflecting power for daylight than for artificial light — which usually is desirable — and inversely with a reddish-yellow shade.

(b) *Street Lighting.*

120. The problem of street illumination is to produce a uniform low intensity. For reasons of economy, the intensity must be low, at least in American cities, in which the mileage of streets, for the same population, usually is many times greater than in European cities, and, at the same time, the same type of illuminant is usually required for the entire area of the city. The low intensity of illumination requires the quality of light which has the highest physiological effect at low densities, that is, white light, and excludes the yellow light as physiologically inefficient for low intensities. Still better would be the bluish green of the mercury lamp, but is not much liked, due to its color. Quite satisfactory also is the greenish yellow of the Welsbach mantle for these low intensities. The American practice of preferring the white light of the carbon or magnetite arc thus is correct and in agreement with the principles of illumination, and the yellow-flame arc can come into consideration — even if it were not handicapped by the necessity of frequent trimming — only in those specific cases where a high intensity of illumination is used, as would be only in the centers of some large cities.

Uniformity of illumination is specially important in street lighting, where the observer moves along the street, and, due to the low intensity, the decrease of subjective illumination by fatigue is especially objectionable. For a street illuminant, a distribution curve is required which gives a maximum intensity somewhat below the horizontal, no light in the upper hemisphere, and very little downward light. Street lamps therefore should be judged and compared by the illumination given midway be-

tween adjacent lamps, or at the point of minimum intensity, or, in other words, by the intensity in a direction approximately 10 deg. below the horizontal. This also is in agreement with American practice. However, it is very important that the downward intensity be very low, and in this respect it is not always realized that the light thrown downward is not merely a waste of light flux, but is harmful in producing a glaring spot at or near the lamp and, by the fatigue caused by it, reducing the effective illumination at the minimum point between the lamps. Most objectionable in this respect is the open direct current carbon arc and those types of lamps giving a downward distribution, but even with the enclosed arc lamp the distribution of light on the street surface is still far from uniform, and the intensity too high near the lamp, and in this respect improvements are desirable.

121. The greatest defects of the present street illumination, which frequently makes it inferior in subjective illumination even to the far lower illumination given by the full moon, are the absence of diffused light, and especially the improper direction and termination of the shadows, and also the high brilliancy of the illuminant. The light of the usual street lamp is practically all directed light, issuing in a nearly horizontal direction from a point source. Thus the shadows are far longer than permissible, and terminate sharply and without blur; objects in the shadows are practically invisible, and the end of the shadow looks like the edge of an object, thus producing a misleading effect, which results in unsatisfactory illumination. To give a somewhat better direction to the light requires considerable increase of the height of the lamp above the street surface. This also would essentially decrease the intensity of illumination below and near the lamp, without appreciably affecting the intensity at the minimum point, and thus would give a more uniform and thereby better illumination. No valid reason usually exists against greatly increasing the height of the lamps, except that of the greater cheapness of short lamp posts, which is hardly justifiable. It is, however, more difficult to give a proper blur to the ends of shadows, so as to distinguish them from edges of objects. This would require an increase of the surface of the illuminant, by opal or frosted globe, etc. Enclosing the arc by an opal globe, however, scatters the light more uniformly in all directions, and

thereby spoils the distribution curve, and interferes with the required uniformity of illumination: with an opal globe, the intensity in the downward direction does not differ very much from that in the horizontal, while with lamps 20 feet above the street level, and at distances of 200 feet from each other, the downward intensity for uniform illumination should be not much more than one-twenty-fifth of that under an angle of $\sin \phi = \frac{20}{100} = 0.2$; or 12 deg. below the horizontal. Very much better is the effect of a frosted or sand-blasted globe. The best way of maintaining a proper distribution curve and at the same time diffusing the light, so as to reduce its brilliancy and blur the shadows, appears the use of prismatic diffraction, on the principle of the Fresnel lenses of lighthouses (holophane). Obviously, where the lamps are close together, as in the center of large cities, their light fluxes overlap and thereby give a better diffusion, and, at the same time, the midway point between lamps is under a greater angle against the horizontal; thus a more downward distribution of the light flux permissible. For the largest part of American street lighting, however, this does not apply.

122. In the early days of using arc lamps for American city lighting, lighting towers were frequently used, and such tower lighting has still survived in some cities. One or a number of arc lamps are installed on a high tower and were supposed from there, like artificial suns, to spread their light over an entire city district.

This method of city lighting was found unsatisfactory, as it did not give enough light. It is unsatisfactory, however, not in principle, but because it was too ambitious a scheme. If, in street illumination, we double the distance between the lamps, each unit must have four times the light flux to get the same minimum flux density, as the distance is doubled, and the flux density decreases with the square of the distance. At twice the distance between the lamps, each lamp thus must have four times the light flux, and each mile of street thus requires twice the power. Reducing the distance between lamps to one-half reduces the power to one-half with the same minimum illumination. In street lighting it is therefore of advantage to use as many units of illuminants as possible, and bring them together as close as possible, and correspondingly lower their

intensity, up to the point where the increasing cost of taking care of the larger number of units and increasing cost of poles and connections compensates for the decreasing cost of energy. There is a minimum which probably is fairly near our present practice.

When, however, you come to square and exposition lighting, you find that the distance between the illuminants has no effect on the efficiency. Let us assume that we double the distances between the lamps which light up a large area. Then each lamp requires four times the light flux to get the same minimum flux density between the lamps, but at twice the distance between the lamps each lamp illuminates four times the area, and the total power per square mile of lighting a large area, like an exposition, thus is independent of the number of lamps used, and, whether you place them close together or far apart, you require the same total flux of light, and if you keep the same proportions of height from the ground and distance between lamps, you also get the same variation between maximum and minimum intensity. But, supposing the lamps to be placed further apart, the maximum or minimum points also are further apart, and you get a more satisfactory illumination by having a less rapid intensity variation. That points to the conclusion that, for exposition lighting, the most efficient way would be to use a relatively moderate number of high-power sources of light on high towers at distances from each other of the same magnitude as the height of the towers. We would get a greater uniformity and better physiological effect by having the illuminants further apart, and they would require the same total light flux, and therefore the same power, as if you bring the lamps close to the ground, and place them very close to each other. The tower lighting therefore is the ideal form for lighting a large area. When the arc was first introduced, it was so much superior to any other illuminant known before, that people vastly over-rated it. They thought that they could light the whole city by it, and in trying to do so these towers would have been the proper way, but very soon it was found that even with the efficiency of the arc, to light not only the streets, but the whole area of the city, would require an entirely impracticable amount of light flux. It thus was too ambitious a scheme for city lighting, but it should be done in exposition work. City illumi-

nation thus has come down from this first ambition to light the whole city to an attempt to light only the streets. For the latter purpose, however, lighting towers are inefficient, since much of the light flux is wasted on those places which we no longer attempt to light. In exposition lighting, however, the most effective general illumination would be given by white arcs on high towers, leaving the concentrated or decorative illumination to the incandescent lamp and flame arc, of yellow color.

LECTURE XIII.

PHYSIOLOGICAL PROBLEMS OF ILLUMINATING ENGINEERING.

123. The design of an illumination requires the solution of physiological as well as physical problems. Physical considerations, for instance, are the distribution of light-flux intensity throughout the illuminated space, as related to size, location and number of light sources, while the relation, to the satisfactory character of the illumination, of the direction of the light, its subdivision and diffusion, etc., are physiological questions. Very little, however, is known on the latter, and the entire field of the physiological effects of the physical methods of illumination is still largely unexplored. As result thereof, illuminating engineering is not yet an exact science, as is, for instance, apparatus design, but much further physiological investigation is needed to determine the requirements and conditions of satisfactory illumination.

The physical side of illuminating engineering:—to produce a definite light flux density throughout the illuminated space,—is an engineering problem, which can be solved with any desired degree of exactness, usually in a number of different ways.

The solution of the physical problem of light distribution, however, does not yet complete the problem of illuminating engineering, does not yet assure a satisfactory illumination, but with the same distribution of light flux density throughout the illuminated surface, the illumination may be anything between entirely unsatisfactory and highly successful, depending on the fulfillment or failure to fulfill numerous physiological requirements. Some of these are well understood and such that they can be taken into consideration in the physical design of the illumination, and thus no excuse exists to fail in their fulfillment, though it is frequently done. Such, for instance, is the requirement of low intrinsic brilliancy in the field of vision, of the color of the light, etc. Other physiological requirements are still very little

understood or entirely unknown, while on others not sufficient quantitative data are available for exact engineering calculation.

Thus, for instance, the usual suburban street illumination with arcs spaced at considerable distances from each other and located on fairly low posts, is very much inferior to the illumination given by moonlight, even when allowing for the difference in intensity. Here the reason of the unsatisfactory character of the former illumination is mainly the almost horizontal direction of the light flux. A perfectly vertical direction of the light flux again is unsatisfactory in many cases, and the most satisfactory results are given by a direction of the light flux which makes a considerable angle with the horizontal as well as the vertical direction. Thus, when dealing with directed light, the direction angle is of essential physiological importance. We have very little exact knowledge to guide in the determination of the proper angle in which to direct the light flux; it is known that in general approximately horizontal and approximately vertical direction of the light flux are objectionable, and an intermediary angle gives best results. However, the horizontal direction usually is objectionable by excessive contrasts, the vertical direction by flatness in the appearance of the illuminated objects, and, depending on the nature of the objects, sometimes the one, sometimes the other feature may be more objectionable. Hence, the best angle of incidence of the light depends on the nature, that is, the shape and location, of the illuminated objects on the purpose of the illumination, etc., and thus is not constant, but is a function of the problem, which is still largely unknown.

124. Not represented by the physical distribution curve of illumination, but very marked in their physiological effect is the difference between directed light and diffused light. In most problems of illumination, either entirely directed light or entirely diffused light is unsatisfactory, and a combination of directed light and diffused light is required, as discussed in the preceding pages. No exact knowledge, however, exists on the proportion in which directed light and diffused light should be combined for satisfactory illumination, nor how this proportion varies with the nature, color, etc., of surrounding objects, with the purpose of the illumination, etc. That it varies is well known, as for some purposes, as a draughting room, entirely diffused light

seems best suited, while for other purposes mainly directed light seems more satisfactory.

Furthermore, the relations between directed and diffused light have in the illuminating engineering practice been obscured to some extent by the relation between high and low intrinsic brilliancy and between direct and indirect lighting. Thus, to eliminate the objectionable feature of high intrinsic brilliancy of the illuminant, direct lighting by light sources of high brilliancy, which was largely directed lighting, has been replaced by indirect lighting, by reflection from ceilings, etc., which is diffused lighting. Where such change has resulted in a great improvement of the illumination, it frequently has been attributed to the change from directed to diffused lighting, while in reality the improvement may have been due to the elimination of high brilliancy light sources from the field of vision, and engineers thereby led to the mistaken conclusion that perfectly diffused lighting is the preferable form. Again, in other instances such a change from direct to indirect lighting has not resulted in the expected improvement, but the indirect lighting been found physiologically unsatisfactory, and the conclusion drawn that the elimination of high brilliancy from the field of vision has not been beneficial, while in reality the dissatisfaction with the indirect light was due to the excess of diffused light and absence of directed light, and this improper proportion between directed and diffused light more than lost the advantage gained by eliminating the light sources of high brilliancy from the field of vision. In this case the proper arrangement would have been to reduce the brilliancy of the light sources, by diffusing or diffracting globes, to a sufficiently low value, but leave them in such position as to give the necessary directed light.

Thus, in illuminating engineering, as in other sciences, it is very easy to draw erroneous conclusions from experience by attributing the results to a wrong cause. Any change in the arrangement usually involves other changes: as in the above instance, the change from high to low brilliancy commonly causes a change from directed to diffused light; by attributing the results to a wrong cause, serious mistakes thus may be made in basing further work on the results.

125. In discussing diffused light, we must realize that the meaning of "diffused light" is to some extent indefinite. To

define diffused light as light which traverses the space in all directions and thus casts no shadow, is not correct, since even diffused daylight casts shadows. For instance, if in Fig. 122 P is the sur-

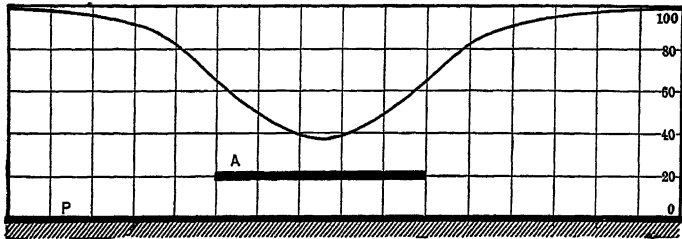

FIG. 122.

face of the ground and A a flat circular shade at distance l above the ground, the intensity distribution of the light in plane P is as shown in Fig. 122 for $l = 0.2 A$, thus showing a fairly dark shadow beneath the center of A , but a shadow which blurs so very gradually that with most objects it is not marked.

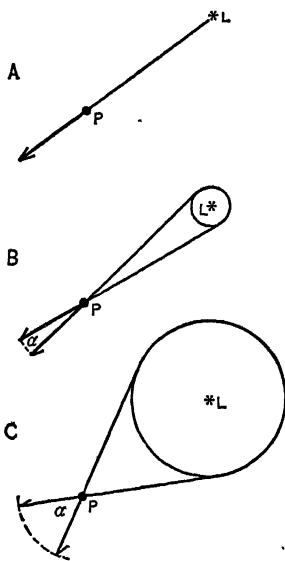

FIG. 123.

The light from a single point source is perfectly directed light; it traverses every point of space in one single direction only, as shown as A in Fig. 123. If we now enclose the point source in an opal globe, which then becomes the radiator, as discussed before, as diagrammatically shown as B in Fig. 123, the light flux traverses each point not in a single direction but in all directions within a narrow angle α , which is the angle subtended by the radiator L from the point P . With increasing size of the illuminant, and thus increasing angle α , C , Fig. 123, the pencil of rays, which traverses point P , gradually spreads, until, when α becomes 180 deg., we get perfectly diffused light, similar to daylight.

Hence, with a gradual change of the diameter of the illuminant, from $\alpha = 0$ to $\alpha = 180$ deg., the light gradually changes from directed to diffused light. Thus, no sharp dividing line

can be drawn between directed light, and diffused light, but the directed light from a light source of considerable diameter (that is, a diameter which is not negligible compared with the distance of the illuminated objects from the light) already has to some extent the character of diffused light.

Diffused light thus may be defined as light given by a radiator which subtends a spherical angle equal to a considerable part of the sphere. This makes the term "diffused light" a relative term. Near to a radiator of considerable size, the light given by this radiator thus is largely diffused light, while at considerable distance it is practically directed light, or, in other words, the light given by light sources of considerable size is directed light only at such distances from the radiator at which the law of inverse squares holds; but approaching the radiator so far that this law of inverse squares (flux density inverse proportional to the square of the distance) does not hold, the light approaches somewhat the character of diffused light.

The physiological effects, however, during a gradual change from $\alpha = 0$, or directed light, to $\alpha = 180$ deg., or diffused light, apparently do not change uniformly, but new effects appear and others disappear.

126. The main objection to directed light from a single source results from the absence of light in the shadows. Using, however, two or more illuminants, that is, combining directed light of several widely different directions, the shadow cast by one illuminant is illuminated by the other illuminants, and thus an effect produced very similar to diffusion. Thus with two light sources, at a point at which both light sources give the same illumination, the intensity in the shadow cast by one illuminant is still 50 per cent, that is, the illumination the same as if equal volumes of directed and of diffused light were combined, and to a considerable extent the physiological effect is the same. It is not completely so, however. In the illumination by equal volumes of diffused light and directed light from a single source, each object casts a single shadow, in which the illumination is reduced to half. When producing an equivalent diffusion by two light sources, an object casts two shadows, in which the illumination is reduced to half (if the two light sources give equal illumination), but, where the shadows overlap, a perfectly black and lightless shadow is produced. The more the two

half shadows overlap to a complete shadow, the less the combination of the two light sources is equivalent to diffusion. At the same time, occasionally the existence of two or more half shadows and of their compound shadows may assist distinction, and thereby be advantageous. In short, there is a vast and largely unexplored field in the physiology of illumination, which the illuminating engineer will have to study and investigate.

While one point source of light gives directed light, two sources at distances from each other give an effect equivalent to diffusion, and three or more sources still more so, until in the theoretical case of an infinite number of point sources distributed through space — or, practically, a very large number of distributed illuminants — we get perfect diffusion. With a change from a single to a very large number of illuminants, the illumination thus changes from directed to diffused, and thus, for a moderate number of illuminants, is intermediate between directed and diffused, but nevertheless this intermediate state is physiologically of entirely different character from that given by a single illuminant of very large diameter, that is large angle α , as discussed above.

127. We thus have true diffused light, as daylight, the equivalent diffusion given by the combination of several light sources, which depends on their relative location, and the equivalent diffusion given by a large relative diameter of the light source. The latter again varies with the shape of the light source, and in extreme cases, as a linear straight radiator, as a Geissler tube (Moore tube), we may get an illumination which, at any point of space, is practically diffused in one direction, and practically directed in a direction at right angle to the former. In such cases we again get different physiological phenomena. For instance, a straight rod, held parallel to the radiator, casts a sharp black shadow — directed light — while, when held at right angles to the radiator, it casts no shadow — diffused light. With objects of more irregular shape, it can be seen that the shape and appearance of the shadows give a rather interesting problem, and the physiological impression made by such illumination thus is different again, from that of ordinary directed or diffused light or their combination.

In general, wherever two or more illuminants are used, the

physiological effect depends on the relative position of the light sources to the illuminated objects, irrespective of the intensity of illumination. Thus, for instance, in the illumination shown in Fig. 117, on the same curve of equal illumination, the physiological effect is not constant, but varies from point to point. On the curve of 850 near the center of the room, an object casts four shadows of approximately equal intensity, in different directions. The shadows are sufficiently marked to assist in seeing, and the illumination in the shadow is quite high; thus the illumination is very satisfactory. On the same curve 850, near the edge of the room, the four shadows fall in nearly the same direction, only one is marked, and by the overlap of the shadows a large compound shadow is formed, in which the illumination is very low, distinction difficult, and the illumination thus unsatisfactory. Thus with the same physical value of illumination, on the same curve 850, the physiological effect in this case changes from a very satisfactory illumination at one place, to a quite unsatisfactory illumination at another place. Thus, in this instance, while the solution of the illuminating problem, given in Fig. 117, is physically perfect, that is, the illumination very uniform throughout the entire room, and the efficiency high, physiologically the illumination is satisfactory only in the middle of the room, but becomes more and more unsatisfactory the further we go outside of the square formed by the four light sources. Physiologically the illumination would probably be improved by locating the light sources in the four corners of the ceiling, or in the centers of the four sides of the ceiling. Physically, this arrangement of lamps in the corners of the room would greatly reduce the efficiency, thus require either more power, or lower the average illumination; the arrangement of the lamps at the sides would decrease the efficiency less, but would considerably impair the uniformity of illumination, giving a lower illumination near the corners of the room.

Furthermore, in illuminating engineering, enters as an important and largely unknown factor, the effect on the physical and physiological illumination, of the objects in the illuminated space, and of the *observer*; that is, the light flux distribution and its physiological effect, as depending on the location of light sources and distribution of their light flux through the illuminated space, is not sufficient to solve the problem of

illumination, but consideration must be given to the changes resulting from the use of the illumination. For instance, in the illumination shown in Fig. 117, and discussed above, the diffused light, 0.250, resulting from reflection from walls and ceiling, is quite considerable, and would be nearly sufficient for giving distinction in the compound shadow of all four illuminants, as it exists in a pronounced degree near the walls. Thus even there the illumination would be moderately fair. However, when relying on this diffused illumination to see in the shadow of objects close to the walls, it may not be present, or largely reduced by the shadow of the observer, since, as seen above, diffused light also casts shadows, though the blur at the edges of these shadows is such as to make them very little noticeable. Thus, when approaching close to the walls to look at an object, we may find it shaded from the direct light and from most of the diffused light, thus giving unsatisfactory illumination. Locating the light sources in the corners or the centers of the sides of the room, we get pronounced shadows of the objects located against the walls of the room, and thereby again unsatisfactory illumination, although in this case, physiologically, considering merely the room without the objects which may be located in it, the illumination would be satisfactory. Thus we may have to sacrifice uniformity of illumination still further, by arranging five light sources, four in the corners or centers of the sides of the room, and one, of larger light flux, in the center of the ceiling.

Thus, occasionally, illuminations designed for uniform flux density are not satisfactory, even though the proportion of directed and of diffused light, and the direction of the directed light, is physiologically correct, because the changes resulting from the objects in the room, and the person of the user of the illumination, are not sufficiently considered.

129. The cause of most of these difficulties in dealing with illuminating problems is that, physiologically, light is not a vector quantity; that is, light flux densities cannot be combined by the parallelogram law.

Two magnetomotive forces A and B , Fig. 124, acting on the same point P , combine by the parallelogram law to a resultant C ; that is, the combined action of A and B is identical with the action of a single m.m.f. C . Thus the m.m.f. existing at any

point P of space is perfectly characterized by two quantities only — the resultant intensity, C , and its direction.

If, however, in Fig. 125, A and B represent the two light flux densities produced at point P by two light sources L_1 and L_2 , their physiological and also their physical action may be entirely different from that of one light flux C derived by combining A and B by the parallelogram law.

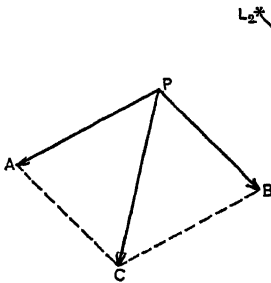

FIG. 124.

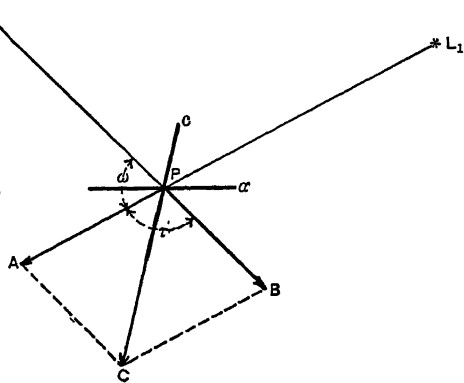

FIG. 125.

In some respects the action of the two separate flux densities A and B is the same, or nearly the same, as that of a resultant flux density C ; the illumination of an opaque plane α , located so that both light sources L_1 and L_2 are on the same side of the plane, is the same. If, however, the illuminated plane is transparent or translucent, and also in regard to the effects of polarization, reflection etc., the effect of the two separate flux densities A and B differs from that of a single resultant C . Entirely different is the effect if the light sources L_1 and L_2 are on different sides of the plane. Thus, with a plane c located in the direction C , the resultant flux density C would give no illumination, while in reality by A and B both sides of the plane are fairly well illuminated. Thus, with the plane in any direction within the angle ω between PL_2 and PA , it receives the same amount of light from A and B as it would receive from C ; but in any direction within the angle $\tau = \pi - \omega$, between PA and PB , it receives more light from A and B than it would receive

from the resultant C , and receives infinitely more light in the direction c (that is, in this direction it receives no light from C). Within this angle τ , both sides of the plane are illuminated by A and B , which obviously is never possible by a resultant vector C .

In the illumination of a plane, the differences between the actual illumination by A and B and the illumination which would result, if light were a vector quantity, by C , are only those of intensity of illumination. With an object of different shape, however, the phenomenon becomes far more complex. Thus the illumination of a sphere S by the resultant C would be as shown in Fig. 126, — half the sphere dark, the other half light, and with a maximum intensity at c , shading off towards zero at the terminator mn . The actual illumination as shown in Fig. 127 gives a

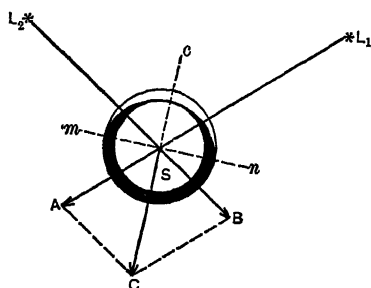

FIG. 126.

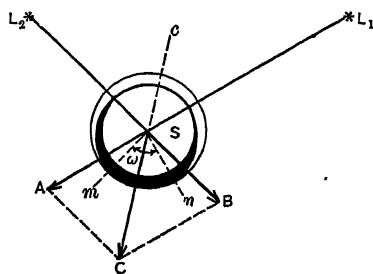

FIG. 127.

black segment of angle ω , while more than half the circumference of the sphere is illuminated. The maximum intensity is at the same place c , and of the same intensity as in Fig. 126 but the total light flux received by the sphere is far greater than would be received from the resultant C , and is the sum of the light fluxes received from the two light sources. Thus:

In the illumination of a sphere the light flux densities are added, irrespective of their direction, and not vectorially combined.

In the illumination of a plane, by light sources which all lie on the same side of the plane, the light flux densities are vectorially combined.

With other shapes of objects, the total received light flux may even be more than corresponds to the sum of the component flux densities.

As in general illumination for distinguishing objects we have to deal with all possible shapes, it thus follows that for the general problem of illumination the resultant effect is most nearly related to the "total flux density" or "total illumination" as derived by adding, irrespective of their direction, all the light flux densities, as was done in the preceding lectures when dealing with light flux distribution. Only in special cases, as the illumination of a draughting table, the flux density in one particular direction is of importance, and was used as the "horizontal illumination" in the instance represented by Figs. 119 to 121.

130. While the resultant effect, or the total illumination, is derived by adding the flux densities irrespective of their direction, in the physiological effect, that is, the appearance, the direction plays an essential part. Thus a sphere located as in Fig. 127 looks different than it looks in Fig. 126, even if it receives the same total light flux. Still more marked is this difference with more complex shapes of the illuminated objects. Thus a landscape looks different with every different position of the sun in the sky, and different again in the diffused light of a cloudy day, irrespective of the intensity of the illumination. Under some conditions sharp contrasts appear, where under other illuminations the appearance is flat, and with the change of illumination contrasts disappear in some places, appear in others, etc.; that is, the appearance of a complex body very greatly varies with the character of the illumination, entirely independent of its intensity.

With artificial illumination it then is the problem of the illuminating engineer to design the illumination so as to bring out contrasts where required by the purpose of the illumination, reduce them where too great or unnecessary, etc. If we consider the possible personal equations of the user of the illumination as depending on his physical nature, occupation or state, furthermore the effect of the color of light and the marked physiological effect which even slight variations in the color shade produce, it can be seen that the success of illuminating engineering problems still largely depends on the judgment of the designer, and this judgment is not yet guided by any extended exact experi-

ence, thus rather uncertain. An enormous amount of work is still to be done mainly in the field of "engineering physiology," before the design of a system of illumination can approach the same exactness as for instance the design of long-distance transmission or other engineering work.

INDEX.

	PAGE
Absolute color in illumination.....	265
Absorption of excess of light flux.....	261
of light by body.....	28
spectrum.....	27
Acclimatization to radiation.....	59
Acetylene flame.....	130
standard.....	178
Acoustic scale of frequency.....	14
Actual or objective color.....	33
Adaptability range of eye.....	38
Albedo of ceiling.....	246
radiator.....	85
reflector.....	212, 215
walls.....	246
whiteness.....	30
Allotropic modifications of carbon.....	81
Alternating arc.....	114, 116, 125
Alternating current field, frequency and wave length.....	17
as polarized wave.....	8
Amyl acetate lamp.....	177
Analytic action of animal organism.....	65
Angle of directed light.....	278
Angstrom unit.....	7
Animal organism, analytic action.....	65
Apparent or subjective color.....	34
Arc characteristics.....	138
conduction.....	105
conductor.....	105, 110
electric.....	98
efficiency of light production.....	122
flame.....	110
Arcing ground, frequency and wave length.....	17
Arc lamps.....	151
photometry.....	182
rectifier.....	114
spectrum.....	105
stability curve.....	144
stream.....	105
street illumination.....	234
as unidirectional conductor.....	113

	PAGE
Arc voltage curve	139
Area lighting	275
Armature reaction of arc machine	163
Artificial illumination, domestic lighting	271
more harmful than daylight	54
Auxiliary arc starting main arc	112
Band spectrum	26
Base filament	81
Beam of searchlight, intensity	234
Biological phosphorescence	96
Black	32
body	29
radiation	84, 88
of hydrocarbon flame	134
Blood, opaque for ultra-violet light	58
transparent for long light waves	58
Blue light, specific effect	51
Blurring of the shadow in illumination	268
vision	54
Borides as refractory bodies	78
Bolometer measuring radiation power	166
Brightness of walls and ceiling in domestic lighting	270
Brilliancy and contraction of pupil	262
of light sources	256, 259
objectionable effect	263
of radiator	189, 221
Brush arc machine	163
Brush discharge	101
Bunsen photometer	170
Burns by radiation	48
Calcium arc, orange yellow	123
carbide arc	124
Calculation of room illumination	247
street illumination	238
Candle	128
power	186
equivalent	258
standard of light	177
unit of light intensity	257
Carbides as refractory bodies	78
Carbon, allotropic modifications	81
arc	140
distribution	203
efficiency	122
electrode as radiator	190, 193

	PAGE
Carbon. arc, incomplete rectification.....	117
lamp as incandescent radiator.....	76
not a typical arc.....	109
in street illumination.....	236, 240
bisulphide lamp.....	135
filament as radiator.....	195
as refractory element.....	77
vapor tension.....	79
Cathode of arc.....	108
Ceiling, albedo.....	246
Change carbons.....	82
Characteristics of the arc.....	137
Chemical action of light.....	63
on plants.....	64
luminescence.....	97
of flame.....	133
phosphorescence.....	95
rays.....	63
Chimney of luminous arc lamp.....	158
Chlorophyl.....	64
Circular cylinder as radiator.....	197
line as radiator.....	197
plane as radiator.....	190
shading circular radiator.....	203
shading linear radiator.....	210
radiator shaded by circular plane.....	203
Circulating flame lamp.....	126
Clutch of arc lamp.....	153
Cold light.....	48
Color change of light of arc.....	118
differences in illumination.....	265
photometry.....	172
Colored.....	33
body.....	29, 31, 36
lights, comparison.....	42
radiation.....	85
radiator of magnesium flame.....	134
Color effect in illuminating engineering.....	269
street lighting.....	272
Colorless.....	32
body.....	29, 31, 36
Color of light and economy.....	269
fatigue.....	265
Combination of light fluxes by addition.....	285
Comfort and economy in domestic lighting.....	270
Comparison of arcs for street lighting.....	236
colored light.....	42

	PAGE
Comparison of globes regarding light flux distribution	224
illumination curves	232
radiators	202
and shadows	209
reflectors	215
Concentrated illumination	260
or local illumination	269
Conduction, continuous	98, 105
disruptive	98
Constant current system of arc lighting	162
Constructive action of plant	65
Continuous conduction	98, 105
spectrum	26
Continuity of the arc at the cathode	111
Contraction of pupil	38, 262
Control of subjective color in illumination	265
Core of arc flame	110
Corona	101
Crater of the arc as radiator	191
Crookes' radiometer	10
Cylindrical radiator	195
Daylight illumination, domestic lighting	271
Defects of street lighting	273
Density of light flux	256, 259
Destructive effect of radiation	48, 57, 59
short ultra-violet light	52
Dielectric constant and refractive index	24
Differences of color in illumination	265
intensity in illumination	265
Differential arc lamp	156
Diffracting globe and light flux distribution	223
Diffraction grating	26
and light distribution	221
spectroscope	26
Diffused and directed light	267, 269
illumination	251, 266
in indoor lighting	246
light, definition	279
and directed light, proportions	278
shadow	280
Diffusing globe and light flux distribution	223
Diffusion, equivalent	281
and light distribution	221
by number of radiators	281
by size of radiator	280
Directed and diffused light	267, 269

	PAGE
Directed light	266
angle of direction	278
Direct and indirect illumination ..	269
Discontinuity of the arc at the anode	112
Disease germs, action of light	61
Disinfecting action of light.	60
Disruptive conduction..	98
voltage.....	99
and gas pressure...	100
Distinction between arc and Geissler discharge..	106
of objects by shadow.	267
Distributed and massed illumination.....	269
Distribution curve and design of incandescent lamp	243
of frosted globe.....	221
of light	180, 187, 256
of opal globe.....	221
in street lighting.....	272
Domestic lighting.....	226, 270
Double refraction.....	9
Downward candle power	184
Ear as analytic organ.....	21
Economies of flame arc lamp.....	212
Efficiency and arc length.	146
of illuminant.....	186
light production by arc	118, 122
light production by incandescence.....	74, 81
room illumination	253
Electric waves, engineering importance.....	18
frequency	15
Electro-conduction feeding arc	123
Electro-luminescence, efficiency...	126
of gases and vapors	98
solids	95
Ellipse, circumference	198
Emulsions as translucent bodies.....	32
Enclosed arc efficiency	148
carbon arc	160
in street lighting.....	236
Energy of plant life derived from radiation.....	65
Engineering physiology	288
Equatorial distribution of light.....	181
Equiluminous curves.....	251
Equivalent candle power.....	258
diffusion.....	281
Etched glass globe, diffraction.....	221
Ether.....	7

	PAGE
Ether as carrier of energy.....	7
form of matter.....	7
Euler's theory of radiation.....	4
Evaporation of carbon.....	79
Exposition lighting.....	275
Eye perceiving only the resultant.....	21
structure of.....	37
Fatigue and color of light.....	265
of the eye.....	263
optic nerve.....	38
Fechner's law.....	39
Feeding device of arc lamp.....	151
Filament, single loop, distribution curve.....	199
Fire-fly, light of.....	96
Fireworks.....	98
Fixed arc length of luminous arc.....	158
Flame arc distribution.....	212
Flame carbon arc.....	123, 160
distribution.....	212
Flames as illuminants.....	128
Flicker photometer.....	173
Flickering of the arc.....	110
Floating system of arc control.....	156
Fluorescence.....	66, 94
spectrum.....	27, 69
Fluorescent bodies.....	30
Flux of light.....	256, 259
Frequency converter of radiation.....	13, 31
of radiation.....	7
and temperature.....	73
scale of acoustic.....	14
of ultra-violet radiation.....	14
Frosted globe.....	262
diffraction.....	221
Gas flame.....	128
pressure and disruptive voltage.....	100
Gasolene deposited carbon.....	81
flame.....	128
Geissler discharge.....	98
tube efficiency.....	104
glow.....	100
lighting.....	104
General illumination.....	260
or uniform illumination.....	269
German candle.....	178

	PAGE
Germicidal action of light.....	60
Glass, opaque for ultra-violet light.	13
as protection against ultra-violet light.	55
Globes, comparison of light distribution	224
Glow of Geissler tube.....	100
Grey body.....	30
radiation..	84, 93
Gypsum, transparent for ultra-violet light	13
Harmful effect of light on vegetation	56
radiation	48
violet and ultra-violet.....	52
Harmless radiation	48
Harmlessness of artificial illuminants	56
Harmonics of radiation.	20
Heat evaporation feeding arc	123
Heat evaporation from positive terminal of arc.	109
luminescence...	91, 93, 96
at positive terminal of arc.....	109
radiation.....	1
rays.....	63
Hefner lamp	178
Helium...	78
Hemispherical candle power.....	185
Hertzian waves, frequency and wave length	16, 17
High frequency currents, frequency and wave length.....	17
light, therapeutic action	61
Hollow circular surface as radiator.....	191
Holophane globe	262
Horizontal candle power of incandescent lamp.....	258
illumination.....	226, 287
of room	253
intensity..	184
of light	182
table illumination.....	253
Hydrocarbon flames	128
Hydro-oxygen flame.....	136
Iceland spar.....	9
Illuminant.....	256
Illuminating engineering.....	256
Illumination.....	177, 179, 256, 259
Illumination curves	226, 229
of arcs for street lighting	236
comparison	232
of incandescent lamp	244
of table by incandescent lamps.....	254

	PAGE
Illumination, horizontal.....	226
objective.....	261
problems.....	260
of streets by arcs.....	234
subjective.....	262
of table by incandescent lamp.....	253
total.....	226
uniform.....	226
vertical.....	227
Illuminometer in indoor illumination.....	253
Imperfectly transparent bodies.....	31
Incandescent lamp.....	76
design and distribution curve.....	243
illumination.....	242
photometry.....	182
Indirect and direct illumination.....	269
lighting.....	262
Indoor illumination, calculation.....	247
by incandescent lamps.....	242
Inflammation of the eye by ultra-violet light.....	53
radiation.....	48
Infra-red rays.....	12
Integrating photometry.....	183
sphere and photometry.....	184
Intensity curves of arcs for street lighting.....	256
comparison.....	232
comparison of radiators.....	197
differences in illumination.....	265
of light.....	257
of light source.....	256, 259
Interference.....	6
rings.....	6
Intermediary color in photometry.....	172
Intermediate carbon.....	83
International candle.....	178
Intrinsic brilliancy, <i>see</i> Brilliancy.	
Iridescence.....	6
Iron arc.....	119
giving ultra-violet light.....	13
Irregular reflection.....	28
and light distribution.....	212
Irritation by uniform intensity of illumination.....	264
Kerosene lamp.....	128
Kirchhoff's law of radiation.....	85
Lamps, arc.....	151
Light flux.....	177, 186, 256, 259

	PAGE
Light flux, combination by addition.....	285
comparison of radiators.....	197
density.....	177, 256, 259
distribution by frosted globe.....	223
distribution by opal globe.....	223
as germicide.....	60
intensity.....	177, 186
measurement.....	166
Lightning phenomena frequency and wave length.....	17
Light not a vector quantity.....	284
as physiological effect.....	168
production by incandescence.....	74
<i>also see</i> Radiation.	
sources, comparison.....	202, 209, 215
and enclosing globe, comparison.....	224
intensity.....	256, 259
as transversal vibration.....	8
Lighting, tower.....	274
Light unit.....	177
as wave motion.....	6
Lime light.....	136
Limits of electrical waves, frequency and wave length.....	17
frequency of electric waves.....	16
Linear radiator shaded by circular flame.....	210
Line spectrum.....	26
of arc.....	118
Local or concentrated illumination.....	269
illumination.....	226, 260
and uniform illumination.....	264
Logarithmic scale of frequency.....	14
law of sensation.....	38
Long burning carbon arc.....	160
Longitudinal vibration.....	7
Lumen.....	186
as unit of light flux.....	257
Luminescence.....	94
of arc.....	117
chemical.....	97
of flame.....	133
by heat.....	91
Luminometer.....	43, 174
chart.....	175
Luminous arc.....	123, 160
distribution.....	210, 215, 220
efficiency.....	149
lamp.....	157
radiator.....	195

	PAGE
Luminous arc in street illumination	240
flame	129
Magnesium flame	134
Magnetite arc	123
constants	140
distribution	220
in street lighting	236, 240
Magnetite arc as typical arc	109
Massed and distributed illumination	269
Maximum candle power	184
visibility	46
Mean spherical intensity	180, 184, 257
Measurement of light and radiation	166
Mechanical equivalent of light	42
Mechanism of arc lamp	152
Melting points of elements	77
Mercury arc, constants	140, 145
greenish blue	123
higher frequency of ultra-violet light	13
rectification	117
rectifier	114
rectifier system	165
tube as radiator	195
Meridian curve of light	180, 188
Metal arcs and ultra-violet light	56
unsteadiness	125
Metallic carbon	81
Metals as most opaque bodies	31
Methane	128
Mica opaque for ultra-violet light	13
Micron	7
Micro-organisms, effect of light	61
Milk glass globe diffusion	221
Minimum visible amount of light	45
Mirror	28
reflector and light distribution	215
Misleading character of meridian curves of light	188
polar curves of light	187
Modifications of carbons	81
Negative carbon electrode shadow	203
spot of arc	107, 110, 125
terminal, <i>also see</i> Cathode. determining character of arc	108
Newton's theory of radiation	4
Normal temperature radiation	75, 84

	PAGE
Objects, effect on light distribution	283
Objective or actual color	33
color in illumination	265
illumination	261
Observer, effect on light distribution	283
Octave as frequency scale	14
Oil lamp	128
Opal globe	262
diffusion	221
and nature of shadow	268
Opaque	32
body	31
colors	32, 36
Open arcs, efficiency	148
Open carbon arc	160
Oscillations, electrical, frequency and wave length	17
Osmium lamp	79
Overlap of light fluxes in illumination	267
Oxygen in flame	132
Ozone production by ultra-violet light	64
Paraffine candle	131
photometer	171
Parallelogram law and light flux	284
Pathogenic bacilli, effect of light	61
Pathological effects of radiation	57
Pentane lamp	178
Periodic system of elements and radiation efficiency	77
Permeability and refractive index	24
Personal equation of user in illuminating engineering	287
Physical phosphorescence	95
Physiological effect of sensation	40
in light measurement	167
measure of light	168, 186
problems of illumination	262
illuminating engineering	277
unit of light	177
Phosphorescence	66, 94
Photography	63
Photometry	169
Phototherapy	61
Pigment in acclimatization	59
Plane illumination	286
as radiator	190
Plants, action of light	64
Point as radiator	189
Polar curves of light distribution	187

	PAGE
Polarized wave.....	8
Positive terminal of arc.....	109
<i>also see</i> Anode.	
Power burn.....	53
effect of radiation.....	57
Primary standard color.....	179
standards of light.....	177
Prismatic reflection and refraction.....	221, 224
Problems of illumination.....	260
Protection against ultra-violet light.....	55
Protective device of arc lamp.....	151
mechanism of the eye against radiation.....	50
Protoplasm, effect of radiation.....	57
Pulsations of arc voltage.....	159
Pupil contraction.....	262
Putrefactive bacilli, effect of light.....	60
Pyro-luminescence.....	96
Pyrometers, visual.....	90
Quality or color of light.....	269
Quartz as most transparent body.....	31
transparent for ultra-violet light.....	13
Radiant heat.....	1
Radiation efficiency.....	86
as a form of energy.....	1
measurement.....	166
measured as power.....	166
power.....	72
<i>also see</i> Light.	
Radiators, comparison.....	202, 209
of light.....	187
separate from flame.....	135
Radio-active substances.....	14
Radio-fluorescence.....	95
Radio-luminescence.....	95
Radio-phosphorescence.....	95
Radio-therapy.....	61
Radium rays, harmful effects of.....	58
Range of frequencies of radiation.....	17
Reading distances measuring light.....	174
Rectification by arcs.....	114
Rectifying range of arc voltage.....	116
Red fluorescence.....	67
light, chemical action of.....	64
therapeutic effect.....	62
lines of mercury arc spectrum.....	120

	PAGE
Red mercury arc	121
Reduction factor of incandescent lamp	182
Reflected light from walls and ceiling, calculation	250
Reflection affecting light distribution	212
of light by body	28
regular, and light distribution	215
and shadow with radiator	219
Reflectors, comparison	215
as secondary radiators	212
as virtual radiators	215
Refraction law	23
and light distribution	221
spectroscope	25
Refractive index	23
and dielectric constant	24
and permeability	24
Regenerative flame lamp	126
Regular reflection	28, 215
and refraction	224
Regulator of arc machine	164
Reversed spectrum	27
Ring carbon	82
Room illumination, calculation	247
by incandescent lamp	242
Rounded circular surface as radiator	193
Sand blasted globe, diffraction	221
Saprophytic bacilli, effect of light	60
Searchlight beam, intensity	234
Secondary radiator and reflector	212, 216
Selective radiation	87
Sensitivity curve of the eye	43, 47
Sensitivity of the eye	263
and frequency	40
to ultra-violet light	54
maximum, of the eye	46
Separate radiator of flame	135
Series arc lamp	157
system of arc lighting	162
Shadow	202
blurring of, in illumination	268
of diffused light	280
in illuminating engineering	266
of negative carbon	203
of negative terminal of arc	148
number of	268
proper intensity in illumination	266

	PAGE
Shadow photometer	171
in street lighting, defective	273
theory of	269
Shell of arc flame	110
Short burning carbon arc	160
Short ultra-violet light, destructive effect	52
Spherical intensity	257
Signal lights, color	98
Silicides as refractory bodies	78
Single loop filament, distribution curve	199
Smokiness of flame	130
Smoky flame	129
Sound as longitudinal vibration	8
waves, frequency and wave length	17
Spark voltage	100
Specific effects of high frequency radiation	51
Spectrum of arc	118
and negative terminal	108
by diffraction	26
of flames	134
of luminescence	96
of radiation	17
by refraction	25
Sphere, illumination	287
as radiator	189
Spherical intensity	180
reduction factor of incandescent lamp	182
Stability curve of the arc	142, 144
limit of arc	143
Stable branch of arc characteristic	142
Standard candle	170
Starting of arc	106
by auxiliary arc	112
device of arc lamp	151
Steadying device of arc lamp	151
reactance or resistance of arc lamp	151
Stephan's law	70, 75
Stimulating effect of radiation	57, 59
Straight line as radiator	195
Street illumination by arcs	234
comparison of arc lamps	240
Street lighting	226, 272
calculation	238
comparison of illuminants	236
defects	273
Striated Geissler discharge	101
Subjective or apparent color	34

	PAGE
Subjective color, control in illumination	265
illumination	262
Sulphur flame	135
Sunburn	59
Sun spectrum	27
Surges, electrical, frequency and wave length	17
Symptoms of ultra-violet burns	54
Synthetic action of plants	65
Table illumination	253
Tanning	59
Tantalum lamp	80
Temperature of arc stream	108
of carbon filament	79
and frequency of radiation	73
of maximum efficiency of light production	74
measurement by radiation law	89
radiation	70
of flame	128
law of	84
standard	178
Therapeutic use of light	61
effects of radiation	57
Thermo-couple measuring radiation power	166
Thermo-luminescence	95
Threshold value of visibility	45
Titanides as refractory bodies	78
Titanium arc, white	123
carbide arcs	117, 123
Total illumination	226, 287
of room	253
Tower lighting	274
Transfer of arc between anodes	112
Transient electric phenomena	18
Translucent body	31
Transmission of light by body	28
Transparent	32
body	31
color	31, 32, 36
Transversal vibration	7
Tungsten lamp	80
as refractory element	78
<i>Also see</i> Wolfram.	
Typical arc	109
Ultra-red rays	12
frequency and wave length	14, 17

	PAGE
Ultra-violet arc lamp	12
burn	53
burn in wireless telegraphy	54
iron arc	119
lamp	135
light of arc	55
light and fluorescence	67
light harmful effect	62
therapeutic action	61
radiation, frequency	14
rays	12
frequency and wave length	17
Unidirectional conduction of electric arc	113
Uniform distribution illumination curve	229
or general illumination	269
illumination	226, 260
in street lighting	235
Uniformity in street lighting	272
Uniform and local illumination	264
total illumination	228
Unit of light	177
Unstable branch of arc characteristic	142
Unsteadiness of metal arcs	125
Vacuum arc	145
Vapor pressure of the arc	105
stream of the arc	105
tension of carbon	79
Vector quantities and light	284
Velocity of electrical radiation	4
light	2
in a medium	23
Vertical illumination	227
Violet light, harmful effect	52
specific effect	52
Violle standard of light	177
Virtual radiator	221
and reflector	216
Visible light, frequency and wave length	17
radiation	10
power measurement	168
range	14
and temperature	74
Visibility range of radiation	37
Visual pyrometers	90
Walls, albedo	246
Warm light	48

	PAGE
Waste of light flux by absorption.....	261
Water as transparent body.....	31
Wave length determination.....	6
of visible radiation.....	10
Welsbach mantle.....	92, 136
White.....	32
body.....	29
iron arc.....	119
Whiteness or albedo.....	30
Willemite fluorescence.....	13
Wireless telegraph waves, frequency and wave length.....	15, 17
ultra-violet burn.....	54
Wolfram as refractory element.....	77
<i>also see</i> Tungsten.	
X-ray frequency and wave length.....	14, 17
harmful effects of.....	58
specific action.....	56
Zinc arc, constants.....	140
rectification.....	117

UNIVERSAL
LIBRARY



136 216

UNIVERSAL
LIBRARY