



This electronic version (PDF) was scanned by the International Telecommunication Union (ITU) Library & Archives Service from an original paper document in the ITU Library & Archives collections.

La présente version électronique (PDF) a été numérisée par le Service de la bibliothèque et des archives de l'Union internationale des télécommunications (UIT) à partir d'un document papier original des collections de ce service.

Esta versión electrónica (PDF) ha sido escaneada por el Servicio de Biblioteca y Archivos de la Unión Internacional de Telecomunicaciones (UIT) a partir de un documento impreso original de las colecciones del Servicio de Biblioteca y Archivos de la UIT.

(ITU) للاتصالات الدولي الاتحاد في والمحفوظات المكتبة قسم أجراه الضوئي بالمسح تصوير نتاج (PDF) الإلكترونية النسخة هذه والمحفوظات المكتبة قسم في المتوفرة الوثائق ضمن أصلية ورقية وثيقة من نقلًا.

此电子版（PDF版本）由国际电信联盟（ITU）图书馆和档案室利用存于该处的纸质文件扫描提供。

Настоящий электронный вариант (PDF) был подготовлен в библиотечно-архивной службе Международного союза электросвязи путем сканирования исходного документа в бумажной форме из библиотечно-архивной службы МСЭ.



XVIIth PLENARY ASSEMBLY
DÜSSELDORF, 1990



INTERNATIONAL TELECOMMUNICATION UNION

REPORTS OF THE CCIR, 1990

(ALSO DECISIONS)

ANNEX TO VOLUME IV – PART 1

FIXED-SATELLITE SERVICE

CCIR INTERNATIONAL RADIO CONSULTATIVE COMMITTEE

Geneva, 1990





XVIIth PLENARY ASSEMBLY
DÜSSELDORF, 1990



INTERNATIONAL TELECOMMUNICATION UNION

REPORTS OF THE CCIR, 1990

(ALSO DECISIONS)

ANNEX TO VOLUME IV – PART 1

FIXED-SATELLITE SERVICE

CCIR INTERNATIONAL RADIO CONSULTATIVE COMMITTEE

92-61-04191-4



Geneva, 1990

ANNEX TO VOLUME IV
 FIXED-SATELLITE SERVICE
 (Study Group 4)

TABLE OF CONTENTS

	Page
Plan of Volumes I to XV, XVIIth Plenary Assembly of the CCIR (See Volume IV - Recommendations)	
Distribution of texts of the XVIIth Plenary Assembly of the CCIR in Volumes I to XV (See Volume IV- Recommendations)	
Table of contents	I
Numerical index of texts	VII
Index of texts deleted	IX
 <u>Section 4A - Definitions</u>	1
There are no Reports in this Section.	
 <u>Section 4B - Systems aspects - Performance and availability - Susceptibility to interference</u>	
<u>4B1 - Systems aspects</u>	
Report 552-4 Use of frequency bands above 10 GHz in the fixed-satellite service.....	3
Report 1139 General system and performance aspects of digital transmission in the fixed-satellite service.....	37
Report 1134 Digital satellite dedicated networks.....	56
Report 451-3 Factors affecting the system design and the selection of frequencies for inter-satellite links of the fixed-satellite service.....	76
Report 1237 Satellite news gathering (See Annex to Vol. XII).....	89
 <u>Section 4B2 - Performance and availability</u>	
Report 208-7 Form of the hypothetical reference circuit and allowable noise standards for frequency-division multiplex telephony and television in the fixed-satellite service.....	91



	Page
Report 997-1 Characteristics of a fixed-satellite service hypothetical reference digital path forming part of an integrated services digital network.....	97
Report 706-2 Availability of circuits in the fixed-satellite service.....	130
Report 214-4 The effects of Doppler frequency-shifts and switching discontinuities in the fixed-satellite service.....	135
 <u>Section 4C - Earth station and baseband characteristics - Earth station antennas - Maintenance of earth stations</u>	
Report 391-6 Radiation diagrams of antennas for earth stations in the fixed-satellite service for use in interference studies and for the determination of a design objective.....	143
Report 390-6 Earth-station antennas for the fixed-satellite service.....	159
Report 998-1 Performance of small earth-station antennas for the fixed-satellite service.....	182
Report 868-1 Contributions to the noise temperature of an earth-station receiving antenna.....	202
Report 875-1 A survey of interference cancellers for application in the fixed-satellite service.....	206
Report 212-3 Use of pre-emphasis in frequency-modulation systems for frequency division multiplex telephony and television in the fixed-satellite service.....	216
Report 384-6 Energy dispersal in the fixed-satellite service.....	220
Report 553-3 Operation and maintenance of earth stations in the fixed-satellite service.....	248
Report 554-4 The use of small earth stations for relief operation in the event of natural disasters and similar emergencies.....	255
Report 869-2 Low capacity earth stations and associated satellite systems in the fixed-satellite service.....	264

Section 4D - Frequency sharing between networks of the fixed-satellite service - Efficient use of the spectrum and geostationary-satellite orbit

4D1 - Permissible levels of interference

Report 455-5	Frequency sharing between networks of the fixed-satellite service.....	279
Report 710-3	Interference allocations in systems operating at frequencies greater than 10 GHz in the fixed-satellite service.....	322
Report 867-2	Maximum permissible interference in single-channel-carrier and intermediate rate digital transmissions in networks of the fixed-satellite service.....	333
Report 1001-1	Off-axis e.i.r.p. density limits for fixed-satellite service earth-stations.....	356
Report 555-4	Discriminations by means of orthogonal circular and linear polarizations.....	367
Report 1141	Polarization discrimination in interference calculation.....	398

Section 4D2 - Coordination methods

Report 453-5	Technical factors influencing the efficiency of use of the geostationary-satellite orbit by radiocommunication satellites sharing the same frequency bands. <u>General summary</u>	419
Report 454-5	Method of calculation for determining if coordination is required between geostationary-satellite networks sharing the same frequency bands.....	455
Report 870-2	Technical coordination methods for communication-satellite systems.....	494
Report 1000-1	Spectrum utilization methodologies.....	507
Report 1135	Optimization methods to identify satellite orbital positions.....	515
Report 1003	Methods for multilateral coordination among satellite networks.....	532
Report 1137	Stochastic approach in the evaluation of interference between satellite networks.....	537
Report 557-2	The use of frequency bands allocated to the fixed-satellite service for both the up link and down link of geostationary-satellite systems.....	567
Report 999	Determination of the bidirectional coordination area...	575

	Page
Report 1140	Satellite networks for more than one service in one or more frequency bands..... 589
Report 1138	Intra-service implications of using slightly inclined geostationary orbits for fixed satellite service networks. <u>Operational, sharing and coordination considerations</u> 596
Report 1004-1	Physical interference in the geostationary-satellite orbit..... 617
<u>Section 4D3 - Spacecraft station keeping - Satellite antenna radiation pattern - Pointing accuracy</u>	
Report 556-4	Factors affecting station-keeping of geostationary satellites of the fixed-satellite service..... 623
Report 1002-1	Flexibility in the positioning of satellites..... 627
Report 558-4	Satellite antenna patterns in the fixed-satellite service..... 640
Report 1136	Geostationary satellite antenna pointing accuracy..... 697
<u>Section 4E - Frequency sharing between networks of the fixed-satellite service and those of other space radiocommunications systems</u>	
Report 560-2	Sharing criteria for the protection of space stations in the fixed-satellite service receiving in the band 14 to 14.4 GHz..... 711
Report 872	Sharing criteria between inter-satellite links connecting geostationary satellites in the fixed-satellite service and the radionavigation service at 33 GHz..... 713
Report 561-4	Feeder links to space stations in the broadcasting-satellite service..... 717
Report 712-1	Factors concerning the protection of fixed-satellite earth stations operating in adjacent frequency band allocations against unwanted emissions from broadcasting satellites operating in frequency bands around 12 GHz..... 729
Report 873-2	An analysis of the interference from the broadcasting-satellite service of one region into the fixed-satellite service of another region around 12 GHz..... 740

	Page
Report 713-1 Spurious emissions from earth stations and space stations of the fixed-satellite service.....	746
Report 874 Frequency sharing between the inter-satellite service when used by the fixed-satellite service and other space services.....	754
 <u>Decisions</u>	
Decision 2-7 Frequency sharing between radiocommunication satellites. <u>Technical considerations affecting the efficient use of the geostationary-satellite orbit</u>	757
Decision 64-1 Updating of the handbook on satellite communications (<u>Fixed-Satellite Service</u>).....	761
Decision 70-1 Implementation of digital satellite systems.....	762
Decision 76-1 Satellite news gathering (SNG).....	763
Decision 87 Determination of the coordination area. <u>Appendix 28 of the Radio Regulations</u> . (See Annex to Vols. IV/ix-2)..	766

PAGE INTENTIONALLY LEFT BLANK

PAGE LAISSEE EN BLANC INTENTIONNELLEMENT

NUMERICAL INDEX OF TEXTS

ANNEX TO VOLUME IV

	Page
SECTION 4A: Definitions (There are no Reports in this Section)...	1
SECTION 4B: Systems aspects - Performance and availability susceptibility to interference.....	3
4B1: Systems aspects.....	3
SECTION 4B2: Performance and availability.....	91
SECTION 4C: Earth station and baseband characteristics - Earth station antennas - Maintenance of earth stations.....	143
SECTION 4D: Frequency sharing between networks of the fixed- satellite service - Efficient use of the spectrum and the geostationary satellite orbit	
4D1: Permissible levels of interference.....	279
SECTION 4D2: Coordination methods.....	419
SECTION 4D3: Spacecraft station keeping - Satellite antenna radiation pattern - Pointing accuracy.....	623
SECTION 4E: Frequency sharing between networks of the fixed- satellite service and those of other space radiocommunications systems.....	711

REPORTS	Section	Page	REPORTS	Section	Page
208-7	4B2	91	868-1	4C	202
212-3	4C	216	869-2	4C	264
214-4	4B2	135	870-2	4D2	494
384-6	4C	220	872	4E	713
390-6	4C	159	873-2	4E	740
391-6	4C	143	874	4E	754
451-3	4B1	76	875-1	4C	206
453-5	4D2	419	997-1	4B2	97
454-5	4D2	455	998-1	4C	182
455-5	4D1	279	999	4D2	575
552-4	4B1	3	1000-1	4D2	507
553-3	4C	248	1001-1	4D1	356
554-4	4C	255	1002-1	4D3	627
555-4	4D1	367	1003	4D2	532
556-4	4D3	623	1004-1	4D2	617
557-2	4D2	567	1134	4B1	56
558-4	4D3	640	1135	4D2	515
560-2	4E	711	1136	4D3	697
561-4	4E	717	1137	4D2	537
706-2	4B2	130	1138	4D2	596
710-3	4D1	322	1139	4B1	37
712-1	4E	729	1140	4D2	589
713-1	4E	746	1141	4D1	398
867-2	4D1	333	1237	4B1	89

Note. - Decisions which already appear in numerical order in the table of contents, are not reproduced in this index.

PAGE INTENTIONALLY LEFT BLANK

PAGE LAISSEE EN BLANC INTENTIONNELLEMENT

**INDEX OF TEXTS WHICH HAVE BEEN DELETED
AT THE END OF THE STUDY PERIOD 1986-1990**

(In order to facilitate the retrieval of a given text, the page number of Volume IV of the XVIth Plenary Assembly, Dubrovnik 1986, is indicated.)

ANNEX TO VOLUME IV

Text	Title	Page No. Vol. IV Dubrovnik, 1986
Report 204-6	Terms and definitions relating to space radiocommunications	1
Report 205-4	Factors affecting the selection of frequencies for telecommunications with space stations in the fixed-satellite service	5
Report 383-4	The effects of transmission delay in the fixed-satellite service	15
Report 385-1	Feasibility of frequency sharing between systems in the fixed-satellite service and terrestrial radio services. <u>Criteria for the selection of sites for earth stations in the fixed-satellite service</u>	208
Report 559	The effect of modulation characteristics on the efficiency of use of the geostationary-satellite orbit in the fixed-satellite service	440
Report 707-1	Digital interface characteristics between satellite and terrestrial networks	122
Report 711-1	Criteria of efficiency of use of the geostationary-satellite orbit	448
Report 871-1	Calculation of the equivalent satellite link noise temperature and the transmission gain	335

SECTION 4A: DEFINITIONS

There are no Reports in this Section.



PAGE INTENTIONALLY LEFT BLANK

PAGE LAISSEE EN BLANC INTENTIONNELLEMENT

SECTION 4B: SYSTEMS ASPECTS - PERFORMANCE AND AVAILABILITY
 - SUSCEPTIBILITY TO INTERFERENCE

4B1: SYSTEMS ASPECTS

REPORT 552-4

USE OF FREQUENCY BANDS ABOVE 10 GHz IN THE
 FIXED-SATELLITE SERVICE

(Study Programme 27C/4)

(1974-1978-1982-1986-1990)

1. Introduction

This Report makes a preliminary examination of some of the technical factors which should be considered in the design of systems of the fixed-satellite service which are intended for use in frequency bands above about 10 GHz. Since the allocated bandwidth is generally wider at frequencies above about 10 GHz, the use of these frequencies would facilitate the design of high-capacity systems. The use of the 30/20 GHz bands, would facilitate the design of very high capacity systems employing spot beam antennas.

The factors considered in this Report are:

- analogue system performance,
- system configuration strategies,
- frequency sharing with terrestrial systems,
- design considerations for systems in the fixed-satellite service.

2. Analogue system performance

CCITT Recommendation G.222 (see sections 1.2.1, 1.2.2 and 1.2.3) states the required design objective for an analogue telephony HRC of 2,500 km as:

- 10,000 pW0p for 20% of any month
- 50,000 pW0p for 0.1% of any month
- 1×10^6 pW0 for 0.01% of any month.

Reference to satellite systems is made by citation of Recommendation 353 of the CCIR which is:

" that the noise power, at a point of zero relative level in any telephone channel in the hypothetical reference circuit as defined in Recommendation 352 should not exceed the provisional values given below:

- 1.1 10 000 pW0p psophometrically-weighted one-minute mean power for more than 20% of any month;
- 1.2 50 000 pW0p psophometrically-weighted one-minute mean power for more than 0.3% of any month;
- 1.3 1 000 000 pW0 unweighted (with an integrating time of 5 ms), for more than 0.01% of any year; "

CCIR Recommendation 353 has been developed to be in compliance with the requirements of the CCITT, although there are some small differences. However, the concept of availability is not contained in the current version of the Recommendation and the following analysis shows the impact of its inclusion. The analysis is limited to 14/11 GHz systems since the performance of 6/4 GHz systems is not generally affected by propagation fades.

Performance of 14/11 GHz systems compliant with Recommendation G.222

The 10,000 pWOp requirement for 20% of any month is interpreted as applying to the worst month*, i.e., for the poorest propagation month. The same interpretation is applied to the 50,000 pWOp clause.

A standard link concept is used for the analysis to correspond to the current practice of other terrestrial systems of allowing 1 pWOp/km for design, or a link of 10,000 km. The operational locations for such links are typically at 40 degrees latitude and 25 degrees elevation angle. The climates for these latitudes exhibit rain rates, for 0.01% of the time, between 30 and 60 mm/hour. A value of 50 mm is chosen for the analysis. Calculations of the rain attenuation are then made in accordance with the methods of Study Group 5.

Propagation availability factor (as defined in Report 997) is taken as 10% of the duration of fade which results in reaching the system threshold. Two cases are shown in Figure 1, one at 50,000 pWOp and one at 100,000 pWOp. The margin in the first case is 7 dB and is 10 dB for the second.

The performance for the path expressed in terms of the available time will meet all of the G.222 performance objectives for the climate and latitudes assumed in this study. For low antenna elevation angles and higher rain rates, it may be more difficult to meet G.222. Further studies are required for such cases.

* The definition of the worst month is provided in Recommendation 581.

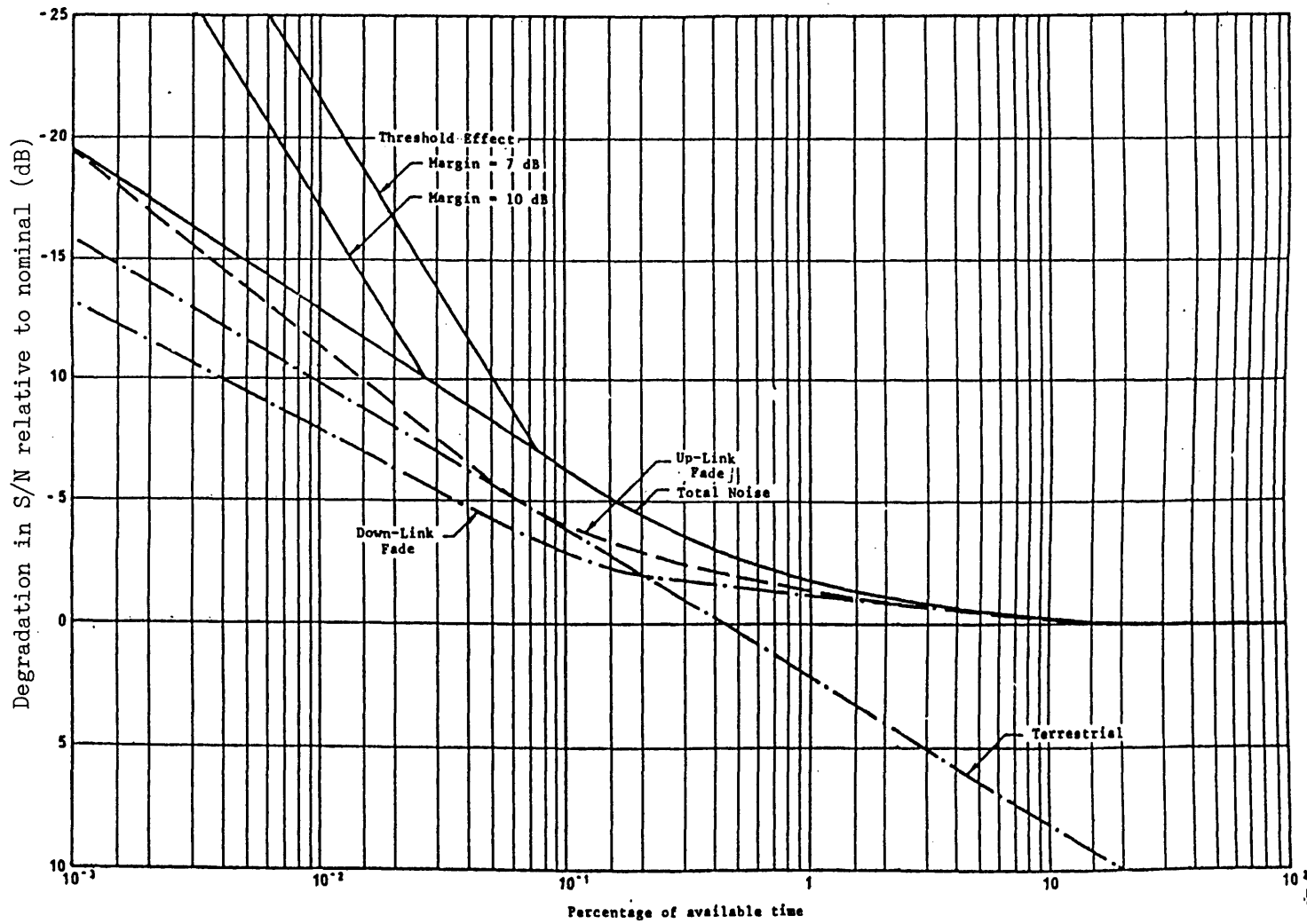

FIGURE 1

14/11 GHz noise performance as a function of available time

3. System configuration strategies

Scatter and absorption by cloud and precipitation increase rapidly at frequencies above about 10 GHz, and this adds considerably to the problems of designing such systems. Without the use of special techniques it may be quite impracticable to provide the large rain margins necessary to meet the required standards of performance.

Four possible ways in which the severe effects of precipitation at the higher frequencies can be overcome are:

- (a) the use of site diversity;
- (b) the use of a lower alternative frequency band to that normally used, and which is much less affected by precipitation;
- (c) the use of adaptive systems which alter the transmission parameters during changing propagation conditions;
- (d) the use of multiple narrow beam on-board antennas with possible extension to the single station per beam (SSPB) concept.

In the first approach referred to in (a) above advantage can be taken from the fact that for earth stations spaced a suitable distance apart (i.e. 10 to 30 km) the correlation of precipitation between them is almost negligible and the probability that both stations will be affected simultaneously by heavy rain is likely to be very small. The technique is to connect the two earth stations providing the diversity, by a transmission line free from the effects of precipitation, and select for operational use the earth station which is least affected. Diversity operation is discussed in detail in Annex I.

In the second approach referred to in (b) above, the assumption is that a number of earth stations within a system normally operate at frequencies which can be severely affected by precipitation, i.e. above about 10 GHz. However, since the probability of more than one station at a time being affected is likely to be small, the technique of switching into use a lower frequency band at the earth station badly affected by precipitation, can be employed [Mori *et al.*, 1978]. To make a better utilization of the normally unused lower alternative frequency band, it may be possible to normally carry the traffic in the lower frequency band and interchange the operating frequency bands between stations operating in the lower frequency and those operating in the higher frequencies under adverse weather conditions [Kosaka, 1978]. Based on this concept, an experimental system using 30/20 GHz and 6/4 GHz bands was constructed [Kosaka *et al.*, 1982].

In the third approach, referred to in (c) above, system performance of digital systems may be improved by reducing the information rate transmitted or increasing the transmitted power (up-link power control) during poor propagation conditions. Examples of this approach are given in Annexes II, III and IV.

Adaptive fade countermeasure (FCM) techniques give selective enhancement to carriers undergoing fading. Some FCM methods require that the user is prepared to accept a lower data rate during fading, as in Annex II, but other methods allocate part of a shared resource overhead (eg. power, frequency, time) to any fading carriers within the network, and thus maintain the user rate (see Annex III and IV). Adaptive methods use the shared resource efficiently by apportioning resource to carriers according to the depth of fading.

In the 30/20 GHz frequency range, even in temperate zones, fade depths for significant portions of time are too great for simple fixed fade margins to be a practical solution, so some FCM is essential if the bands are to be exploited. For applications requiring high availability in the wetter climatic zones, stations will suffer even more frequent and severe fading, and there is a practical limit to the fade depth which can be countered by an adaptive system, the deeper fades requiring unacceptable high levels of shared resource. Although further propagation studies are required, indications are that it is practical to operate a shared resource adaptive scheme for an availability corresponding to Recommendation 522 in climatic zone E, but for greater availability in the wetter regions, the diversity methods, which are not adaptive and may be expensive in the earth sector, seem the only suitable option for trunk satellite services.

In the fourth approach referred to in (d) above, the objective is to avoid complications of design and operation of earth stations, even at the expense of making the satellite more complicated due to the use of complex multiple beam on-board antennas with several narrow beams which however provide for both high satellite e.i.r.p. and high satellite G/T to compensate for the propagation effects.

Examples of various existing and planned system implementations in the 30/20 GHz frequency bands are given in Annex V.

4. Frequency sharing with terrestrial systems

At frequencies above about 10 GHz variations in the level of the wanted and unwanted signals due to precipitation, and the effects of scatter, have a greater influence on the minimum separation distance obtainable between earth stations of the fixed-satellite service, and terrestrial stations of the fixed service.

The effect of scatter can be overcome by careful site selection to avoid beam intersection of the two systems, and by using cross-polarization in the case of linearly polarized waves and, since the basic transmission loss over a given path increases with frequency, the separation distance between stations of the two systems can be less at the higher frequencies. By arranging that the separation angle between an earth station and terrestrial stations is more than about 20 to 30 degrees, the minimum separation distance can be reduced to a few kilometres and the effect of the fluctuation of the wanted and unwanted signals caused by differential rain attenuation of the two systems can be avoided to some extent.

5. Design aspects of systems in the fixed-satellite service at frequencies above 10 GHz

For systems in the fixed-satellite service which use frequency bands above 10 GHz, the effects of hydrometeors, especially rainfall, are particularly important and must be taken into account when the systems are designed. The most reliable calculation of the effects of hydrometeors may be made on the basis of experimental distributions of attenuation due to hydrometeors against time. This distribution varies with the frequency and the time of the year and depends on climatic conditions at the site of the earth station and the angle at which the satellite is visible.

It should also be borne in mind that the correlation between attenuations on the paths of the satellite link declines with the distance between earth stations and increased intensiveness of precipitations. A further de-correlating factor is the frequency difference between the up-link and the down-link.

The relevant data on propagation can be found in Reports 564 and 565. In addition to that, since 1969, continuous rain attenuation experiments on earth-satellite paths have been carried out at various locations in the United States of America. The measurement frequencies include 11.7, 13.6, 15.5, 17.8, 19 and 28.5 GHz. Interim results of the 10 year (1969-1978) experiments have been published in various technical journals and conference proceedings. [Lin, *et al.*, 1980] summarizes new results and the previously published results and discusses radio communication systems. The summary includes the geographic dependence, the frequency dependence, the diurnal, monthly, and yearly variations of rain attenuation statistics, the diversity improvement factors, the fade duration distributions, the dynamic rain attenuation behaviour, the long-term (20 years) rain rate distribution for United State of America locations and a simple empirical model for rain attenuation.

The data indicate that the 28.5 GHz earth-satellite radio link, assuming 20 dB fade margin, will require site-diversity protection for most United States of America locations to meet the conventional long-haul reliability objective. Operation in this or higher frequency bands would, therefore, probably require new network operation procedures.

On the other hand, the site-diversity protection may be avoidable for frequencies at or below 14 GHz where the antenna elevation angle is relatively high.

The earth-station satellite link at 19 GHz may or may not require site-diversity protection, depending on earth-station location and satellite orbital position. Other major findings are:

- Rain-induced outages on earth-satellite radio links have higher service impact than multipath-fading-induced outages on terrestrial (6/4 GHz) radio relays even if the two systems are engineered for equal total outage time. This is because multipath fading occurs mostly during the early morning hours of low telephone activity. Furthermore, multipath fading is frequency selective and interrupts only a fraction of the frequency band at a time. By contrast, about 35% of rain outages will occur during telephone busy hours, and the outage will interrupt all traffic on an earth-satellite radio link at the same time.
- Site-diversity protection can reduce the rain outage time by at least one order of magnitude if site separation exceeds 20 km. Orbital diversity protection, although effective against sun-transit outages, reduces rain outage time by less than 20%.

However, at present, there exists little measured propagation data in most parts of the world. In many places data from radiometer measurements is also available, but since satellite beacons at 20 and 30 GHz have not been generally available there are few results which are reliable enough for system design purposes.

Examples of the magnitude of this problem are shown in Figure 2. The attenuation axis is indicative of the rain margins which would be necessary to limit service unavailability to percentages of time corresponding to the probability axis.

In deriving link power budgets account shall be made of up-link and down-link noise, external interference and internal impairments, such as intermodulation, co-channel and adjacent channel interference, in the same way as for systems working below 10 GHz. However the relative importance of these contributions may be different and will usually vary significantly with the propagation conditions. The parameters of systems intended for international transmission should be defined according to CCIR Recommendations 353 and 522. These Recommendations specify transmission performance for three percentages of time. Link budgets should be calculated for these three percentages of time. For each earth station in the network the resulting parameters should be such as to satisfy the most stringent condition. Whereas at frequencies below 10 GHz the longer term condition is usually the governing one, at frequency above 10 GHz any of the three may be the most stringent depending on system requirements and on local climatic conditions. For this reason some of the earth station parameters usually have more than one specification to take into account the propagation phenomena. In this respect Annex VI gives a method of deriving an earth station antenna diameter from a G/T specification.

It should be noted however, that the choice of antenna diameter utilized in practice can depend on many factors, including up-link e.i.r.p. requirements, desired fade margins, cost, etc. It is possible in the design of a satellite system to minimize the cost of the earth station by optimization of the combined costs of the antenna, HPA, LNA, etc.

6. 30/20 GHz Band Technologies

The 30/20 GHz bands have yet to be exploited widely in the FSS even though they represent 3.5 GHz of available bandwidth for satellite communication applications. The principal technical problems are associated with severe rain attenuation of RF transmissions in this band. Table I summarizes some advantages and disadvantages of 30/20 GHz systems based on current technology.

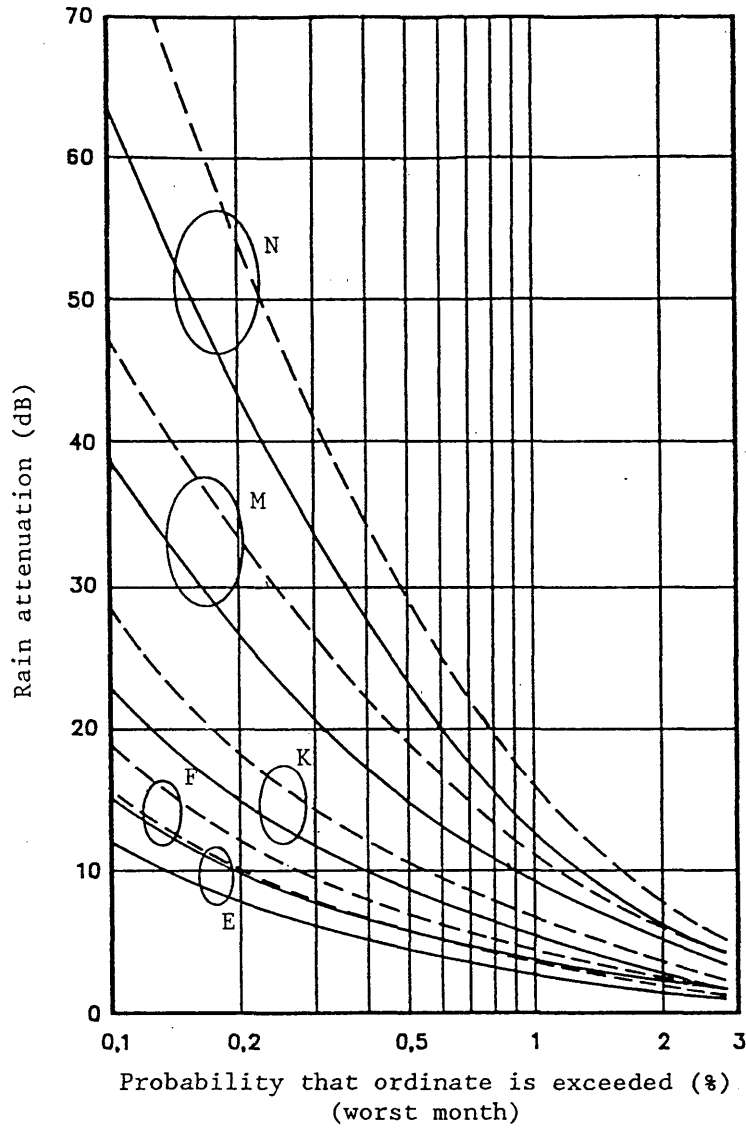

FIGURE 2

Rain attenuation versus probability that ordinate is exceeded*

- N : rain climatic zone N
- M : rain climatic zone M
- K : rain climatic zone K
- F : rain climatic zone F
- E : rain climatic zone E

Frequency : 30 GHz

- elevation angle of 30 deg.
(latitude 52.57 deg.)
- elevation angle of 60 deg.
(latitude 25.66 deg.)

The longitude of the earth station is assumed the same as that of a geostationary satellite.

* Calculation based on Table I of Report 563, equations (8), (9) and (21) of Report 564, and Table I and equations (1), (2) and (3) of Report 721 in CCIR Volume V, 1986.

TABLE I

Merits and Demerits of the 30/20 GHz
Band Satellite Communication Systems
compared with lower frequency bands

MERITS	DEMERITS
1. Wide bandwidth, high transmission capacities	1. Higher rain attenuations compared to lower frequency bands, i.e., large rain margins to guarantee the available time. Need for fade counter measures.
2. Narrow beamwidth and large antenna gain.	2. Relatively complex hardware characteristics (e.g. high output power and low noise figure).
3. Narrow required satellite orbital spacing between satellite antenna beamwidth (Large number of satellites on the GSO), easy coordination between satellites.	3. Relatively high cost of equipment at this early state of equipment development.
4. Parts of the spectrum are exclusive to satellite services.	4. Relatively limited experience of frequency reuse.
5. Easy introduction of multiple beam systems which increase system availability performance.	

Hardware technologies such as antennas, high power amplifiers (HPA), low noise amplifiers (LNA), and other on-board sub-systems have substantial effects on system design. Some key elements are summarized below.

Antennas at 30/20 GHz can achieve high gains in small physical sizes, compared with lower frequencies. However, surface roughness is more serious, perhaps resulting in some degradation in gain or sidelobe characteristics.

High power amplifiers at 30/20 GHz will continue to improve over the next few years. The output power from solid-state (FET) amplifiers, and the efficiency and size of travelling-wave-tube (TWT) amplifiers, will continue to improve.

Low noise amplifiers are also continuing to improve. The noise temperatures of both FET (field effect transistor) and HEMT (high electron mobility transistor) amplifiers should continue to improve significantly over the next five to seven years.

Other space-segment sub-systems requiring improvement include satellite switching, and very small and light weight transponders. An on-board switch, if implemented, is necessary to connect signals from different beams in a multibeam system. On-board switching can be performed both at baseband and microwave level. In case of baseband processing, on-board regeneration also needs to be implemented, which in turn improves the link budget performance. MICs and monolithic MICs will be used in transmitters and receivers to reduce size and weight. On-board switch control equipment will be realized by adopting very large scale integration (VLSI). These technologies are now under development, and some experimental systems will use these technologies in the 30/20 GHz bands.

By utilizing an optimum satellite arrangement to match the geographical distribution of service areas, introducing multiple beam satellite antennas, using improved sidelobe small earth station antennas and up-link power control techniques, a large number of satellites with high communication capacities can be realized at 30/20 GHz. If it is practicable for new services, a moderate availability value should be selected for system design, owing to the strong dependence of system capacity on its value at these frequencies.

7. Frequency reuse in the 30/20 GHz frequency bands

In the context of the exploitation of frequency bands above 10 GHz, particular attention must be paid when considering the practical use of the 30/20 GHz frequency bands especially if compared to the case of 14/12/11 GHz frequency bands. In fact, because the propagation losses in heavy rainfall conditions are considerably greater (even of the order of 5-6 times in decibels) at 30/20 GHz than at 14/12/11 GHz, they may become the ultimate limiting factor for the efficient exploitation, in a cost effective way, of the 30/20 GHz frequency bands, in many geographical regions.

Primarily important in this respect is the extent to which extensive frequency reuse of the 3.5 GHz available bandwidth can be feasible at such frequency bands, for the provision of high capacity regional and domestic satellite systems.

Preliminary indications, deriving from initial system analysis [CCIR, 1986-90] carried out using typical up-link attenuation values for the "K" climatic zone are as follows:

- a) satellite antennas with a single coverage beam operating with frequency reuse by orthogonal polarizations and earth stations transmitting both cross-polarized signals, can provide satisfactory performance with state of the art values of polarization discrimination of on-board and earth station antennas, with and without up path power control (UPC) (see Report 710);
- b) frequency reuse by orthogonal polarization in the same single coverage beam from the satellite and different earth stations transmitting cross-polarized signals, assuming no rain correlation between sites, is marginally feasible depending on the system configuration. In particular, it seems that frequency reuse is possible when UPC is used at all earth stations. If UPC is not applied, the possibility of frequency reuse is strictly dependent on specific climatic conditions and earth station operational elevation angles;
- c) frequency reuse by orthogonally polarized signals from the same earth stations operating with a multi-beam satellite antenna is possible in adjacent beams if:
 - spatial satellite antenna discrimination equal to or greater than 30 dB is used which in turn is achievable with an inter-beam distance of about 3 times the 3 dB beamwidth from beam centre to beam centre;
 - by using UPC such inter-beam distance may be reduced to about 2 beamwidths;
- d) frequency reuse by orthogonally polarized signals from different earth stations operating with a multi-beam satellite antenna is possible in adjacent beams only if:
 - UPC is used. If full UPC is used, less than 20 dB of spatial satellite antenna discrimination may be provided, but in any case an inter-beam distance of about 2 beamwidths will be necessary.

However, other possible configurations can be foreseen in the practical exploitation of the 30/20 GHz frequency bands which could be of interest in the context of frequency reuse under severe rain attenuation conditions and further studies would then be required.

8. Conclusions

At frequencies above about 10 GHz, scatter and absorption caused by cloud and precipitation have much greater significance. Moreover, there may be an appreciable difference between the up-link and down-link frequencies and careful design is needed to ensure that the necessary performance objectives are met in a balanced way.

Certain techniques, such as site diversity, the use of an alternative frequency band or the use of adaptive systems, could overcome the problems met due to large attenuation from precipitation for small percentages of time. At the 30/20 GHz frequency range a 99.95% availability may be achievable in the drier climatic regions by using one of the adaptive techniques; a composite adaptive system could also be considered. However, for greater availability in the wetter climatic zones, the only practical option for trunk satellite services at 30/20 GHz would seem to be one of the diversity schemes. Plans exist to test fade mitigation techniques using both the Olympus and ACTS satellites.

The use of frequency bands around 30 and 20 GHz, where 3.5 GHz of bandwidth is available, would make possible the provision of very high capacity regional and domestic systems using spot beam antennas, and should make it possible for the earth stations of such systems to be located very close to traffic centres.

In the 14/11 GHz frequency range several satellite communication systems have already been in service for some time. They have demonstrated that reliable operation can readily be achieved at these frequencies.

Concerning the 30/20 GHz frequency range substantial results have been obtained through the communication experiments with Japan's communications satellite (the medium capacity communications satellite for experimental purposes). As a result of these experiments, the design techniques of the 30/20 GHz band satellite and earth station hardware have been established. The prospects for practical use of a 30/20 GHz satellite communication system may be extremely good, provided that the minimum elevation angle is adequate according to the local climatic conditions [Hatsuda, *et al.*, 1980]. In February and August, 1983, Japan's operational communication satellites of CS-2a and CS-2b using the 6/4 GHz and 30/20 GHz bands were launched successfully. These satellites put the new 30/20 GHz frequency band into practical use for the first time in the world [Hayashizaki, 1983].

In the design and planning of systems in the fixed-satellite service using frequencies above about 10 GHz, there are a number of areas which require further study. These are, for example, the determination of earth station G/T , and the allowance to be made for propagation, including the effect on cross-polarization discrimination.

REFERENCES

- HATSUDA, T., MORIHIRO, Y. and NAKAJIMA, S. [July-August, 1980] Link calculation method for 30/20 GHz band satellite communication system. *Rev. Elec. Comm. Lab., NTT*, Vol. 28, 7/8, 604-619.
- HAYASHIZAKI, H. [1983] Domestic satellite communications system - satellite communication using 30/20 GHz band. *Japan Telecomm. Rev.*, R-129, 57-65.
- KOSAKA, K. [1978] Frequency switching TDMA system for countermeasure against rainfall attenuation. *J. Radio Res. Labs.*, (Japan), Vol. 25, 117/118.
- KOSAKA, K., HAMAMOTO, N., SUZUKI, R., UMEDA, Y. and ITO, H. [1982] Experimental frequency switching TDMA equipment for countermeasure against rainfall attenuation. IEEE Global Telecommunications Conference, (GLOBECOM '82), Miami, Fla., USA.
- LIN, S. H., BERGMANN, H. J. and PURSLEY, M. V. [February, 1980] Rain attenuation on Earth-satellite paths - summary of 10-year experiments and studies. *BSTJ*, Vol. 59, 2, 183-228.
- MORI, Y., HIGUTI, I. and MORITA, K. [1978] Estimation for frequency band diversity effect on Earth-satellite links in microwave and millimeter wave bands. *Trans. Inst. Electron. Comm. Engrs. Japan*, Vol. J61-B, 10.

BIBLIOGRAPHY

- DALGLEISH, D. J. and REED, A. C. [25-27 November, 1969] Some comparisons of the traffic-carrying capacity of communication-satellites using digital techniques with the capacity of satellites using frequency modulation. Proc. INTELSAT/IEE Conference on Digital Satellite Communications, London, 226-240.
- HATSUDA, T., FUKETA, H. and IZUMI, K. [February, 1974] System design of millimetre-wave satellite communication systems. Tech. Group on communication system, Inst. Electronics and Communications Engineers of Japan, Paper CS 73-147.
- IPPOLITO, L. J. [February, 1971] Effects of precipitation on 15.3 and 31.65 GHz earth-space transmissions with ATS-V Satellite. Proc. IEEE International Conference on Communications (ICC '71), Montreal, Canada, Conf. Rec. Vol. 59, 2, 189-205.
- IPPOLITO, L. J. [19-21 June, 1972] The 20 and 30 GHz communications system for the ATS-F millimetre wave experiment. IEEE International Conference on Communications (ICC '72), Philadelphia, Pa., USA, Conf. Rec., Session 26 Aerospace and electronic systems, 26-2 - 26-7.
- KAPLUNOV, B. B. [1971] Rasprostraneniye millimetrovyykh voln v atmosfere i sputnikovaya svyaz (Atmospheric propagation of HEHF waves in satellite communications). *Obzornaya informatsiya o zarubezhnoi tekhnike svyazi* (Review of foreign telecommunication technology). Ministry of Telecommunications of the U.S.S.R., 5, 24-55.

CCIR Documents

[1986-90]: 4/36 (Italy).

ANNEX I

SITE DIVERSITY OPERATION

1. General design considerations

The performance required for the diversity earth stations is decided not only by the rain climate but also by the diversity configuration. The first kind of configuration is balanced diversity (diversity by two earth stations with equal performance). The other configuration is unbalanced diversity. In this configuration, the performance of one earth station (main station) is made sufficiently high, so that the performance requirements of the other station (sub-station) may be considerably alleviated. Such an unbalanced diversity configuration is expected when the main station antenna is equipped with a multiple-frequency band feed such as 6/4 GHz and 14/11 GHz, and/or when the sub-station has to be simplified for technical and operational reasons.

Table II summarizes the results of sample calculations of the antenna diameter and the maximum transmit power required for the balanced diversity links with low elevation angles. Estimates are given for two assumed diversity links. (A) Yamaguchi-Hofu (diversity distance = 20 km) and (B) Yamaguchi-Hamada (100 km); both in Japan.

It is seen from this Table that the antenna diameters required for the 14/11 GHz FM link (14 GHz for up-link and 11 GHz for down-link) are about 28 m and 19 m for cases (A) and (B), respectively. When the diameter of the main station can be made larger than those values, the required diameter for the sub-station becomes smaller. Values shown in this Table are derived using many of the link parameters established for Intelsat-V satellites, so that they are subject to change when the link parameters are different from those used here.

The calculation methods of the required performances (antenna diameter and e.i.r.p.) for the diversity earth stations are different depending on the diversity configurations. In the design of the balanced diversity link, calculations have to be based upon the joint probability distribution of the rain attenuation at both locations, while in the case of the unbalanced diversity configuration, the cumulative time distribution of the rain attenuation and the conditional probability of the attenuation are required.

The conditional probability $P(L''/L')$ is the probability with which the rain attenuation at the site of the sub-station exceeds L'' under the condition that the rain attenuation at the main site exceeds L' [CCIR, 1978-82].

In order to perform reliable estimates of the earth station requirements, reliable statistics on the basis of the long-term propagation measurements are needed.

2. Site diversity switch-over operation

To implement diversity earth stations, care should be exercised on the switch-over operation, because, in the event of switch-over, short duration of signal loss or overlap may occur due to the difference in path length of diversity routes or carrier phase discontinuity.

TABLE II- Sample calculations of the required performances for balanced diversity links with low elevation angles (14/11 GHz)

Location	(A) Yamaguchi - Hofu	(B) Yamaguchi - Hamada
Elevation angle (degrees)	9.1 9.1	9.1 8.4
Diversity distance (km)	20	100
<i>FM</i>		
Required antenna diameter (m)	28 / 32	19 / 22
Required transmit power(1) (W) (maximum value)	730	510
<i>TDMA</i> (2)		
Required antenna diameter (m)	17 / 19	11 / 12
Required transmit power (W) (maximum value)	530	400

(1) Values for 792 channel FDM-FM carrier (25 MHz).

(2) Values for 4-phase CPSK at 120 Mbit/s with forward error-correction.

Assumptions:

Frequency: 14.5 (uplink)/11.7 (downlink) GHz

Orbital position of satellite: 63° E, 0° N

Satellite e.i.r.p.: 41.1 dBW

Antenna diameters are estimated for two cases, namely:

$$T_s = 50 \text{ K and } T_s = 150 \text{ K}$$

T_s : System noise temperature of earth-station antenna

Efficiency of the earth-station antenna: 65%

Estimates are based on the rain-rate statistics obtained for those locations.

In analogue transmissions such as FM-FDMA, switch-over in transmitting will necessarily cause discontinuity of carrier phase which will result in signal hit at the demodulator output in the receiving earth stations. Signal hit due to switch-over at the receive earth station may be avoided by carefully adjusting the electrical path length of each diversity link measured from the switch-over equipment to the satellite.

In digital transmissions it is possible to avoid signal hit even in the event of switch-over at the transmit earth station by providing dummy intervals in the transmitting signal sequence and making the switch-over during the dummy interval. In the receiving earth stations the dummy intervals should be discarded no matter whether or not switch-over took place.

The hitless switch-over both in the transmitting and receiving of the diversity system may most conveniently be achieved in TDMA transmission [Watanabe, *et al.*, 1978]. The dummy intervals are built-in because TDMA transmission occupies only a part of the TDMA frame. Furthermore, TDMA demodulators are capable of receiving burst mode carriers of incoherent phase. Therefore, phase incoherency of TDMA carriers does not cause any difficulty. The only possible problem of site diversity operation of TDMA transmission would be the necessity of very precise transmit timing control even for the initial transmission from the stand-by station. This may be solved either by continuously transmitting a dummy burst from the stand-by station or by obtaining sufficiently accurate ranging data of the satellite which is possible when the TDMA system employs open loop synchronization. In TDMA transmission, the path lengths of diversity routes can be equalized using the reception timing of frame synchronization signals. The reception timing of signals from both diversity routes can be automatically equalized by controlling the variable delay line inserted in one of the diversity routes. An experimental system and the results of experiments using the dummy burst technique are described in [Fugono *et al.*, 1979; Suzuki *et al.*, 1983].

For route selection in diversity operation, it is necessary to measure the transmission quality of diversity routes. Because the diversity effect may degrade depending on the choice of the measuring method of link quality, care should be taken on selecting the measuring time duration and achievable accuracy [Suzuki *et al.*, 1983].

3. Diversity interconnect link

A factor which must be considered is that the CCIR hypothetical reference circuit contained in Recommendation 352 and the CCIR hypothetical reference digital path contained in Recommendation 521 include the Diversity Interconnection Links (DIL) to the diversity switching point and any additional modulation/demodulation equipment required. This would mean that system noise budgets must include all the effects of the DIL.

3.1 Basic configuration

3.1.1 Physical aspects

There are a number of different specific configurations which can be considered and there could be reasons for preferring one of these. Two of these are identified and described in this Annex as (see Fig. 3):

- a main site which contains the diversity switch and the terrestrial interface. The diversity site is connected by a two-hop microwave DIL using either an active, or passive, repeater. (A repeater site is assumed, since the likelihood of mutual visibility of the diversity sites is small.)
- dual diversity sites and a separate control site with the interface and diversity switch; single microwave hops for each site to the control site.

It may also be possible to employ cable or waveguide links for the DIL. When both FDM-FM and TDM (FDMA or TDMA) are used at an earth station, two parallel links would usually be required.

3.1.2 Modulation requirements

When FDM-FM is used, because the satellite link modulation and baseband configurations are usually different from those conventionally used for terrestrial systems, remodulation will be required. The main difference is associated with the channel packaging. The terrestrial system will usually combine the channels in one or more basebands in each direction and will use a relatively low modulation index. The earth-station will break these basebands down into multiple, multi-destination, transmit basebands; different from those on the terrestrial system and using a different modulation index. The receive basebands are even more numerous and may only consist of a few channels and these must be re-combined into the terrestrial basebands. This process requires modulation/demodulation equipment at the main earth station site and at the diversity site where conventional design of the DIL is used. All configurations can be implemented using the remodulation technique at the expense of providing duplicate equipment at the diversity site.

An alternative technique is to use the same modulation arrangements on the terrestrial system as used on the satellite system. Such a technique would appear to be technically feasible although not conventional. The incentive is to save the cost of remodulation equipment at perhaps some added cost to the terrestrial system, although savings may also result for this element as well. The use of such a technique is only applicable to the second configuration of Fig. 3. When TDM is used (FDMA or TDMA), either technique could be employed. In the case of TDMA, diversity switching is performed between bursts (see Annex I, § 2). The same modulation could be used on the DIL as used on the satellite system although the data rates would not normally be those of a conventional terrestrial digital radio system.

3.2 Technical factors

3.2.1 Frequency selection

Frequency selection for a microwave DIL requires careful study to ensure that the required overall performance is obtained. Information on terrestrial microwave propagation is shown in CCIR Reports 338 and 720.

3.2.2 Bandwidth requirements

The bandwidth required to implement the DIL can be related to the earth station bandwidth by a factor which may be unity or less, depending upon whether re-modulation is used or not. If only frequency translation is used then bandwidth requirements must be MHz for MHz. By re-modulating, a greater channel density can be achieved by using smaller FM modulation indices at the expense of a substantial multiplex interface.

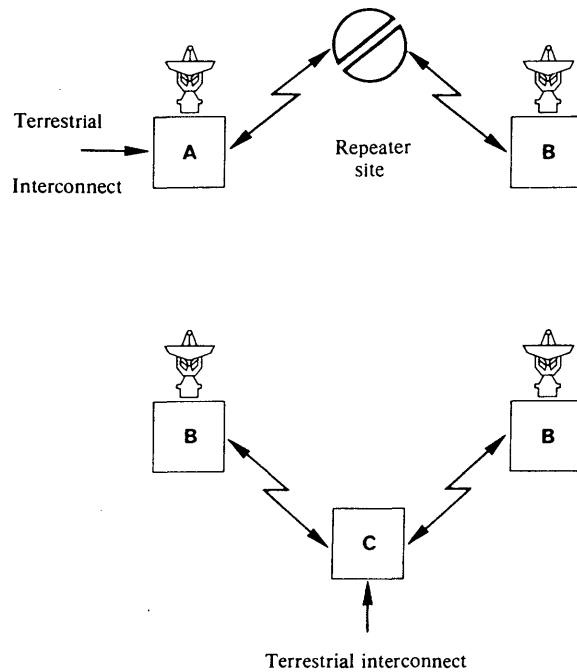

FIGURE 3 -- Diversity configurations

A: Main site
 B: Diversity sites
 C: Control site

3.2.3 Rain attenuation

A further factor is related to rain attenuation and site diversity characteristics as related to rainfall phenomenon. A dry climate is preferred. Diversity action is a function of the site spacing. It is expected that about 16 km spacing is the nominal required. The best orientation of a line connecting the sites may be assumed to be perpendicular to the direction of predominant weather patterns since the most severe attenuation condition would not be expected to affect both sites simultaneously and maximum diversity action would be obtained, [Gray, 1973; Hall and Allnut, 1975; Davis and Croom, 1974]. The weather effects on the microwave DIL must be accounted for if the higher frequencies are used for these links, although this should be a secondary consideration.

3.2.4 Variations in transmission delay due to diversity switching

Another element of importance is associated with the differential transmission delay between the diversity signals as they arrive at the switching point. Variations in transmission delay due to diversity switching are considered in Report 383.

3.3 General considerations

Two particular aspects of the DIL are important:

- the contribution to the overall system noise budgets, and
- the contribution to system outage.

These subjects are studied here to develop the effects of the important parameters and the interrelationship with the satellite link parts of the system.

The diversity link design can be made on two bases. If a re-modulation system is selected, then conventional radio-relay designs can be used. If a translation system is selected, then the design can follow a different pattern and will be very similar to the satellite system transmission design. Fading margins and noise contributions must be accounted for in overall performance. In the special case where the same frequencies are used for the DIL as for the satellite system, then interference noise allowances must also be made.

3.3.1 Noise budgets for FDM-FM

The contributions of the DIL to the overall noise of the hypothetical reference circuit have to be made reasonably small in order to maintain the system performance in accordance with Recommendation 353 of the CCIR.

It seems reasonable to assume that the DIL noise contribution would be considered as part of the earth station budget (usually 1500 pW0p), as the DIL actually provides part of the normal earth station function. It only needs to be determined that such a contribution can be kept sufficiently small so that the total of 1500 pW0p is not exceeded. The fading of the DIL will contribute to the overall short-term noise budget of the link.

The noise contribution from the DIL would have a number of components depending upon the implementation configuration and the frequency bands used. The components are:

(a) Thermal noise

Conventional CCIR designs for radio-relay are 1 to 3 pW0p per km or less, and can be held to 10 pW0p or less, for a single hop. Special designs also achieve small contributions. The time varying components due to multipath fading and rain attenuation are relatively large, but for short hops can be controlled to reasonable values. The thermal noise is dB for dB related to the fading from either mechanism.

(b) Basic intrinsic noise

This is baseband noise and is applicable only to re-modulating configurations. Noise levels of 50 to 100 pW0p are usual for back-to-back basebands. The normal earth station noise budget provides for one such contribution while a re-modulation configuration would add a second contribution.

(c) Interference

A very small interference contribution would be present from other microwave systems operating in the same frequency bands in some cases. This contribution can be considered to be negligible. For the special case of using the same frequency re-use design, up-link and down-link contributions of interference at the earth station can be expected. Values of the order of 10 to 100 pW0p are estimated for normal operation. In addition, certain fading situations may be accompanied by increases in this noise for very short time periods along with the thermal noise. This configuration does not require re-modulation, so all extra noise associated with item (b) is eliminated.

(d) Intermodulation

A re-modulating design will have an extra mod-demod pair plus IF amplifiers, while the translation design is all conventional earth station equipment and therefore contributes very little IM noise.

The following table illustrates a possible noise budget:

TABLE III

Sample budgets – Free space conditions				
	Re-modulation (2 hops)		Frequency translation (1 hop)	
	Low (pW0p)	High (pW0p)	Low (pW0p)	High (pW0p)
Thermal	2	20	1	10
Baseband intermodulation	50	100	–	–
Interference	–	–	10	100
Intermodulation (RF)	100	200	20	50
Total (pW0p)	152	320	31	160

3.3.2 Error budget for TDMA

The contributions of the DIL to the overall error rate of the hypothetical digital reference path have to be made reasonably small in order to maintain the system performance in accordance with Recommendation 522.

It should be noted that in the case of the re-modulating DIL the errors will be additive whereas in the case of frequency translation the noise effects will be additive.

3.3.3 Frequency considerations

The fading characteristics as a function of frequency, climate and path length for rainfall can be derived from conventional microwave designs. Rain attenuation and multipath fading are independent events – in fact they are almost mutually exclusive.

Since the expected spacing of a diversity pair of earth stations is of the order of 16 to 24 km and since it is also expected that either a repeater or a common site will be needed, the individual path lengths of the DIL will probably not exceed 16 km. The margins for such a path length can normally be made sufficiently high to accommodate short-term outages as low as 0.001% of the time.

REFERENCES

- DAVIS, P. G. and CROOM, D. L. [November, 1974] Diversity measurements of attenuation at 37 GHz with solar tracking radiometers. *Electron. and Lett.*, Vol. 10, 482-3.
- FUGONO, N., YOSHIMURA, K. and HAYASHI, I. [October, 1979] Japan's millimeter wave satellite communication program. *IEEE Trans. Comm.*, Vol. COM-27, 10, 1381-1391.
- GRAY, D. A. [22-24 August, 1973] Earth to space path diversity; dependence of baseline orientation. IEEE GAP International Symposium.
- HALL, J. E. and ALLNUT, J. E. [7-10 April, 1975] Results of site diversity tests applicable to 12 GHz satellite communications. IEE Conference Publication 126.
- SUZUKI, Y., SHIMADA, M., MINENO, H., SHINOZUKA, T., KUROIWA, H. and INOMATA, H. [September, 1983] TDMA site diversity switching experiments with Japanese CS. *IEEE J. Selec. Areas Comm.*, Vol. SAC-1, 4, 674-680.
- WATANABE, T., SAITOH, H., OGAWA, A., and DEAL, J. H. [October, 1978] Space diversity system for TDMA satellite link. 4th International Conference on Digital Satellite Communication, Session IX, Montreal, Canada.

CCIR Documents

[1978-82]: 4/26 (Japan).

ANNEX II

VARIABLE INFORMATION TRANSMISSION RATE SYSTEMS

1. Introduction

System performance of digital satellite communication systems can be improved by reducing adaptively the information transmission rate during poor propagation conditions. Variable parameters (clock rate and number of phase states) of PSK modulation and the variable coding rate of FEC (forward error correction) can be used for variable information transmission rate. A synchronization sum method for a demodulated PSK signal has also been applied to a variable transmission rate TDMA system.

It should be noted that public services may not be able to be subjected to reduction in information rate, and that other fade countermeasures may be necessary in these cases.

2. Variable parameter system of PSK modulation

Various kinds of general purposes PSK modems have been developed using LSI type digital signal processors. These modems have two modes of operation, BPSK and QPSK, and their transmission clock rates are continuously variable. They are suitable for a variable transmission rate system although high transmission rates are not achievable because of the limitation on operational speed of the digital signal processor. For example, a modem with a maximum transmission rate of 400 kbauds has been developed [Suzuki et al., 1987]. This modem can be applied to a burst mode signal. In another example, a modem with a maximum transmission rate of 6 Mbauds has been developed [Iwasaki et al., 1988]. This transmission rate is variable, but it takes a significant amount of time to reach a stable state after resetting the parameters.

When the reduction ratio of the transmission rate is γ , improvement of C/N is given by:

$$\Delta(C/N) = -10 \log \gamma \quad \text{dB.}$$

3. Variable coding rate system

Convolutional encoders and Viterbi decoders are suitable for a variable coding rate system because these codecs are expected to be constructed economically in the form of LSI and their coding gains are high. For example, LSI type codecs of constraint length = 4 or 7, coding rate = 1/2 or 2/3 or 3/4 or 7/8, and maximum transmission rates = 20 to 25 MHz have been developed [Suzuki et al., 1988], [Kubota et al., 1987]. One of these is a general purpose codec with a selectable coding rate.

C/N improvement, when a codec is applied to the variable information transmission rate system, is given as:

$$\Delta(C/N) = 10 \log R_o/R_a + G_a - G_o \quad \text{dB,}$$

where R_o : coding rate;

G_o : coding gain at operation in clear sky conditions;

R_a, G_a : same as above for operation in rain conditions.

4. Variable transmission rate system using spread spectrum and synchronization sum techniques

There is another method in the variable information transmission rate system [Yamamoto et al., 1986]. A baseband data bit stream (information bit or error corrected bit) is scrambled by a constant clock rate PN code and then PSK modulated. The transmission rate can be varied by changing the ratio of the data bit rate and the clock of the PN code. The selected ratio must be $1/n$ where n is a positive integer. In a receiver, the scrambled signal is PSK demodulated at the clock of the PN code and descrambled by the PN code. The data bit is detected after synchronizing the sum over the length of the data bit at the rate of the PN code clock.

This technique has been applied to a variable transmission rate TDMA system in which the transmission rate is adaptively variable at each TDMA burst. It has been confirmed by experiments that the degradation of bit error rate performance, compared with theoretical performance in a gaussian channel, is less than 2 dB when the TDMA system operates at a rate of $8/n$ Mbit/s ($n = 1, 2, 4, 8, 16, 32$).

This technique may be considered as modulation and demodulation capable of varying transmission rates using a constant clock or a variable coding rate with a coding gain of 0 dB.

5. Conclusion

Three kinds of variable information transmission rate techniques are discussed as methods of maintaining the signal quality of a digital satellite communication system during poor propagation conditions.

The variable coding rate technique using a convolutional encoder and a Viterbi decoder is suitable for a simple communication system with relatively economic and/or simple earth station equipment.

The other techniques are to be used in combination with a forward error correction technique. In the variable parameter system, however, an adaptively variable transmission rate modem with a maximum rate of more than 400 kbauds has not been developed. The variable transmission rate technique using the synchronizing sum fits a TDMA system rather than an SCPC system.

References

- SUZUKI H. et al. (1987)
 MODEM and FEC LSIs for COMPACT EARTH STATION.
 GLOBECOM 1987, 8.3.
- IWASAKI M. et al (1988)
 Development of Variable Rate Digital Modem for Satellite Communications, in Japanese.
 1988 AUTUMN NATINAL CONVENTION RECORD, EIC, SB-2-1, JAPAN.
- SUZUKI H. et al. (1987)
 On LSI-Implementation of Error Correcting Techniques, in Japanese.
 1987 JOINT CONVENTION RECORD OF INSTITUTES OF ELECTRICAL AND INFORMATION ENGINEERS, 26-6, JAPAN.
- KUBOTA S. et al. (1987).
 A proposal of universal-coding-rate Viterbi decoder.
 ICC 1987, 24.3.1-24.3.6.
- YAMAMOTO M. et al. (1986).
 Variable Transmission Rate TDMA Communication System for Small Earth Stations Network, in Japanese.
 NATIONAL CONVENTION RECORD, 1986, IEICE, JAPAN, S25-1.

ANNEX III

UP-LINK TRANSMITTING POWER CONTROL

1. Introduction

Up-link power control (UPC) can be used as a means of reducing the effect of up-link attenuation in the higher frequency bands (for example 14/11 and 30/20 GHz bands) satellite communication systems. This technique could be used to achieve efficient operation of a satellite communication system and to decrease interference to other satellite and terrestrial links by reducing clear-sky e.i.r.p.

2. Implementation of UPC

There are various methods of achieving UPC. The most commonly used methods are as follows.

2.1 Open-loop UPC method

Open-loop UPC is a method whereby a beacon signal from the satellite is used to measure the down-link rain attenuation. Owing to the correlation between the up-link and down-link rain attenuation, this measurement is used to estimate the up-link rain attenuation level and hence the UPC control values. Most predicted attenuation values coincide with actual values; however, some values differ because of such environmental conditions as wind velocity or rain drop-size distribution. Table IV shows an example of potential errors in estimating up-link (14 GHz) attenuation from a down-link (11 GHz) measurement.

TABLE IV – Example of potential errors in estimating up-link (14 GHz) attenuation from a down-link (11 GHz) measurement is tabulated below

a) Up-link attenuation of less than 1.0 dB			
Elevation angle:	5°	15°	25°
Equipment error(1)	0.725	0.725	0.725
Ice attenuation	0.05	0.05	0.05
Water vapour/diffusive	0.20	0.10	0.05
Clear-sky level	<u>0.10</u>	<u>0.10</u>	<u>0.10</u>
Maximum up-link error (dB)	± 1.075	± 0.975	± 0.925
b) Up-link attenuation of between 1 and 6 dB			
Elevation angle:	5°	15°	25°
Equipment error(1)	0.725	0.725	0.725
Ice attenuation	0.05	0.05	0.05
Raindrop-size distribution	0.10	0.075	0.05
Water vapour/diffusive	0.20	0.10	0.05
Clear-sky level	0.10	0.10	0.10
Polarization error	0.10	0.075	0.05
Path length error	0.20	0.10	0.05
Melting layer	<u>0.05</u>	<u>0.05</u>	<u>0.05</u>
Maximum up-link error (dB)	± 1.525	± 1.275	± 1.125
c) Up-link attenuation in excess of 6 dB			
Elevation angle:	5°	15°	25°
Equipment error(1)	0.725	0.725	0.725
Ice attenuation	0.05	0.05	0.05
Raindrop-size distribution	0.20	0.15	0.10
Water vapour/diffusive	0.10	0.075	0.05
Clear-sky level	0.10	0.10	0.10
Polarization error	0.20	0.15	0.10
Path length error	0.40	0.25	0.15
Melting layer	<u>0.05</u>	<u>0.05</u>	<u>0.05</u>
Maximum up-link error (dB)	± 1.825	± 1.550	± 1.325

(1) The equipment error of ±0.725 dB assumed above is estimated on the basis of a ±0.5 dB error being encountered at 11.7 GHz (on the down-link) and assuming a 1.45 scaling factor between 11.7 GHz and 14 GHz. The ±0.5 dB error was obtained using available data and needs further verification by additional measurements.

Some potential error sources have been excluded as being too small to estimate (e.g., antenna tracking error, satellite antenna pointing error, pre-emphasis error, antenna gain degradation, refractive effect at low elevation angles, rapid rainfall rate fluctuation). Also excluded are error sources of a very rare type (e.g., large accumulations of wet snow on the antenna, failure in the control or measurement circuits). Various combinations of these additional error sources could, potentially, make the cumulative up-link power level error larger.

2.2 Closed-loop UPC method

Closed-loop UPC is a method whereby the beacon signal from the satellite is compared with the loop-back C/N or S/N of a pilot signal or special channel signal. In this way the up-link rain attenuation and the UPC control value can be determined with high accuracy. A disadvantage of the approach, however, is that separate control channels in addition to the communication channel are necessary.

3. Up-link power control (UPC) experiment

An open-loop UPC experiment was conducted using the 30/20 GHz band [Isobe *et al.*, 1982], with the result shown in Fig. 4. In this experiment, the UPC values were determined from the values of down-link attenuation. Figure 4_a shows the beacon level, Fig. 4_b the HPA transmitting power level, and Fig. 4_c the satellite receiving level. As shown, the variation in total C/N values can be kept within 1 dB (peak-to-peak) except in the period in which the required transmitting power exceeds the maximum transmitting power.

A closed-loop UPC experiment was also conducted using the 30/20 GHz band with the result shown in Fig. 5. The control error was kept within 0.3 dB (peak-to-peak).

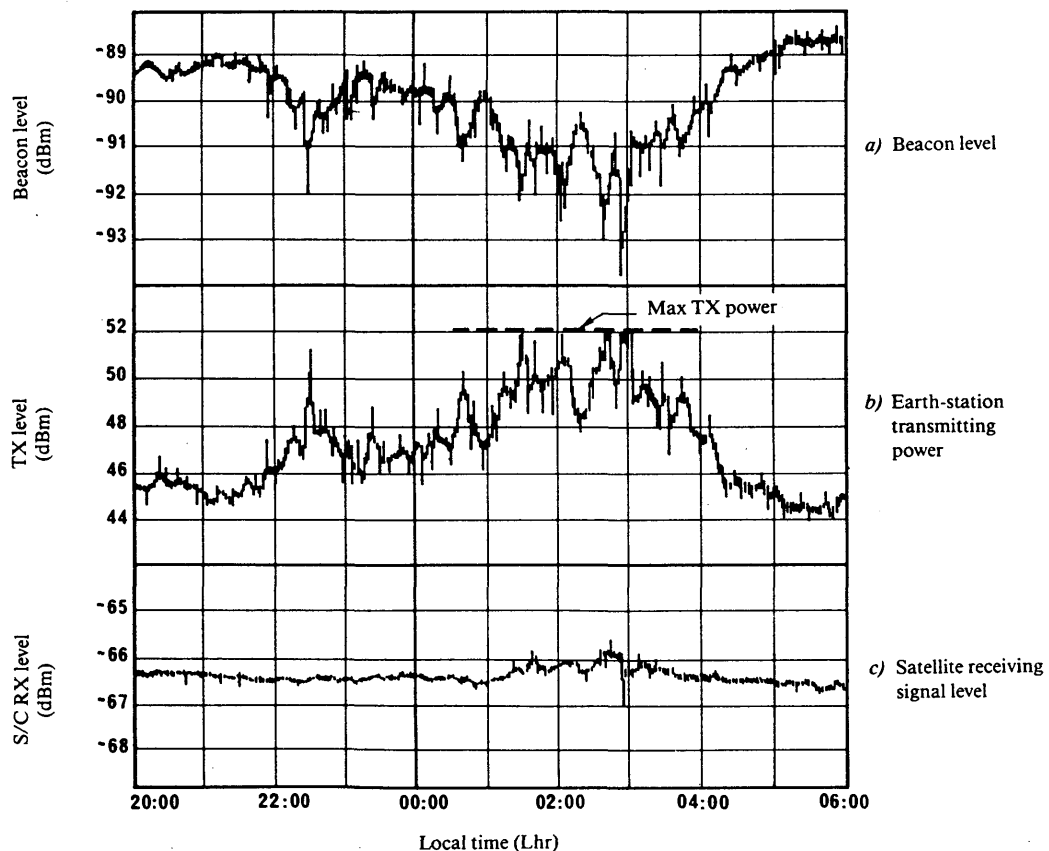

FIGURE 4— Experimental results of open-loop UPC

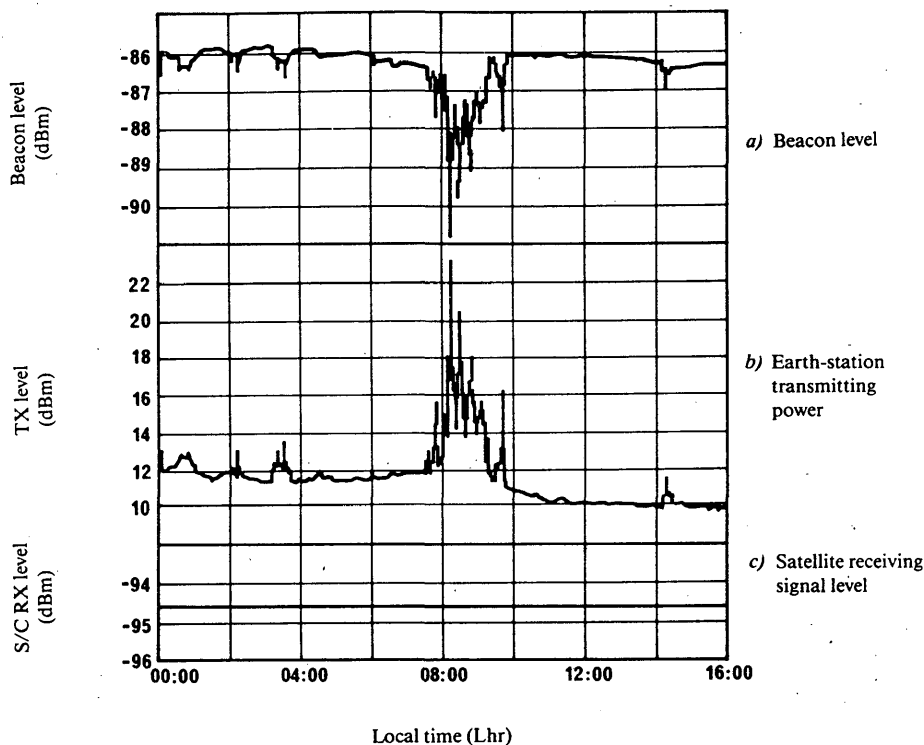

FIGURE 5- Experimental result of closed-loop UPC

4. Open-loop UPC using a radiometer

Uplink power control can be achieved by using a radiometer to measure the energy emitted by rain along the propagation path to the satellite. No beacon or pilot signal is required. Errors introduced by beacon receivers, such as the variation of gain with LNA temperature, etc., are eliminated.

The relationship between slant-path precipitation attenuation and antenna temperature has been examined by several investigators [Strickland, 1974]. Path attenuations calculated from measurements of the antenna temperature are generally accurate to better than 0.5 dB for attenuations less than 6 dB (at 12 GHz, in Canada). In a practical system, the uplink power will not likely be increased appreciably more than 6 dB. Thus, the radiometer can be used to compute path attenuations over the entire range of practical interest.

Sun transits will occur for a few days near the equinoxes when the declination of the sun is approximately that of the satellite. To distinguish between these increases in antenna temperature and those due to rain attenuation at other times, the satellite and solar look angles are calculated frequently. When the angular separation between the radiometer antenna axis and the sun is less than a chosen angle, the increase in antenna temperature is assumed to be due to the sun and uplink power control is inhibited.

An uplink power control system has been developed for the 14/12 GHz band in which a radiometer measures the antenna temperature in a band of frequencies below the uplink band, calculates the path attenuation at the desired uplink frequency and controls the signal strength applied at IF to the

up-converter. The antenna temperature is measured by a new type of radiometer. The principle of operation differs fundamentally from that of the conventional Dicke radiometer and results in a very stable measurement of antenna temperature. The entire radiometer is contained within a cylinder mounted at the prime focus of a parabolic reflector. The radiometer frequency must differ from the uplink frequency so that transmitted energy which is backscattered from rain along the path is not detected by the radiometer, a radiometer frequency of 13.3 GHz is used.

In an experiment using the system described above, the loopback signal strength was compared with the received signal strength of the satellite beacon. The signal strengths were well correlated, indicating that the uplink signal strength as received at the satellite was almost constant, independent of rain attenuation. Additional operational experience will be gained with the two uplink power control systems currently being installed in Canada.

5. Conclusion

UPC is one of the most important techniques for establishing higher frequency band satellite communications systems. By using UPC for the higher frequency bands, interference between neighbouring satellite systems and terrestrial networks can be reduced. As a result, efficient utilization of the geostationary-satellite orbit and efficient system operations can be achieved.

Detailed studies will be necessary for more accurate UPC methods.

REFERENCES

- ISOBE, S., SASAOKA, H., KOSAKA, K. and OTSU, Y. [1982] Small traffic domestic satellite communications system with a K-band transponder. IEEE Global Telecommunications Conference (GLOBECOM, '82), Miami, Fla., USA.
- STRICKLAND, J.I. [1974] - The measurement of slant path attenuation using radar radiometers and a satellite beacon. Journal de Recherches Atmospheriques, 8, Nos. 1-2.

ANNEX IV

FADE COUNTERMEASURES USING TIME-DIVISION-MULTIPLE-ACCESS TECHNIQUES (FCM-TDMA)

1. Introduction

FCM-TDMA is a method of countering the severe effects of precipitation at the higher frequencies; it is an adaptive system which allocates an additional time resource to fading carriers in a TDMA network to thus provide an acceptable error rate in the degraded C/N environment which occurs during fading.

A FCM-TDMA system has a portion of the frame designated as a shared resource, which is made available to fading carriers. This means that the frame efficiency, and therefore capacity, of a FCM-TDMA system is less than that of an

equivalent conventional TDMA system under clear-sky conditions. The frame period is not normally a variable but any bursts suffering fading are expanded in time within the frame. This means that a burst retains the same number of information (user) bits when expanded, therefore the information rate is not changed. The technique is therefore particularly suited to public switched services/networks, where variable information rate techniques (see Annex II) may not be appropriate.

Each burst need only be expanded to the degree necessary to counter the fading experienced on a particular routing, be it on the up-link or down-link, or both to maximize the efficiency of the system.

2. Methods of using an expanded burst to provide a level of noise immunity

There are several ways of using the additional time provided by an extended time slot to give a greater degree of noise immunity, the following are examples:

a) FEC

Differing rates of FEC overhead can be introduced in stages with increase in fade depth, the time slot being extended as necessary.

b) Reduction in transmitted data rate

The transmitted data rate can be reduced and the same information rate conveyed by increasing the burst length. If the transmitted data rate is reduced, the noise bandwidth at the receiver can also be reduced, giving increased noise immunity.

c) Replication of the user data within the burst

A burst suffering fading can be repeated (replicated) a number of times, and a sophisticated demodulator employed to interpret the received signal by taking a mean value for each symbol.

The above techniques all have implications on the modem design and care must be taken to ensure clock and carrier synchronization is retained during a fade. Furthermore, if the symbol rate is changed (resulting in a variation of spectra and power flux-density between bursts), there may also be interference implications.

The depth of fade which can be countered varies according to the method employed and the degree of sophistication which can be built into the modem. In practice, a composite FCM-TDMA system may be preferable; for example, adaptive FEC could be used together with any of the other methods outlined, and there is a case for using permanent FEC with method (c).

3. System control

FCM-TDMA systems will need robust protocols and control mechanisms to identify the onset and level of fading on any routing, to determine which bursts need to be expanded and by how much, and to implement such expansions together with any time-plan revision.

4. Conclusions

An FCM-TDMA system must be tailored to need. There are many system parameters which must be determined, for example, the maximum expansion which is to be given to any particular burst, the expansion step size, the implementation or reaction time to onset of fading, the percentage of the frame to be allocated as the shared resource, etc. The sizing of these parameters will depend on the nature of the network, the climatic region, the maximum depth of fade to be countered, and on the number and data rate mix of carriers.

It may also be possible to combine FCM-TDMA with other fade countermeasures systems; for example, the FCM-TDMA protocols could be developed to incorporate up link power control, or FCM-TDMA could be combined with a frequency diversity system whereby bursts subject to severe fading are transmitted in an alternative TDMA frame at a lower frequency.

ANNEX V

SYSTEM EXAMPLES AT 30/20 GHz

1. Introduction

In the following, a brief description of existing and on-going development of 30/20 GHz systems is presented.

2. Japanese communication satellite (CS)

The medium capacity communication satellite for experimental purposes (CS) was launched in 1977. Through the CS experiment, valuable data were obtained.

Two communication satellites (CS-2a and 2b) were launched in 1983 for commercial use. The CS-2 satellite communication system was introduced mainly for maintaining important communication links in case of disasters, providing communication links for remote islands and setting up temporary links.

Two communication satellites (CS-3a and 3b) were launched in February and September, 1988, respectively from Tanegashima using a Japanese H-I rocket, as successors to CS-2a and 2b. Public organizations and private companies, a total number of 14, use CS-3a and 3b. They are employed for satellite communication systems to provide telephone network services, dedicated/user oriented communication services, and private communication circuits. 113 earth stations were in operation at the end of 1988 for commercial services. For the telephone network, dynamic channel assigning and routing satellite aided digital networks (DYANET) have been newly introduced that combine satellite and terrestrial circuits to reduce network cost and enhance network reliability.

Four major types of systems were brought into commercial service:

- trunk transmission system utilizing earth stations with 11.5 m diameter antennas and PA-TDMA equipment and those with 4.2 m diameter dual-beam antennas and DA-TDMA equipment;
- back-up communication system for local telephone links utilizing small earth stations with 4.2 m diameter antenna and 20 Mbit/s TDMA equipment;
- temporary transmission system for TV and telephone utilizing transportable earth stations with 2.7 m diameter antenna and FM modulation equipment;
- dedicated/user oriented communication system utilizing small earth stations with 4.2 m diameter antenna and 20 Mbps TDMA equipment.

3. Olympus

The Olympus-1 satellite, which was launched on 11 July, 1989 to its orbital location at 19°W, is a three-axis stabilized satellite capable of carrying a variety of payloads. It has a rectangular 2.1 x 1.75 x 5.3 metre body with a flexible solar array which can provide up to 3.5 kW of electrical power at the end of life with an expansion capability up to 7.0 kW for future satellites. The launch mass of Olympus-1 is 2,600 kg; however, the structure has been designed to handle a lift-off mass of up to 3,500 kg.

The Olympus-1 payload consists of the following four packages:

- a two-channel high power (63 dBW) TV broadcast payload operating in the 11.7-12.5 GHz band for direct-to-home transmission in Europe;
- a four-channel 12/14 GHz SS/TDMA payload for specialized or business services in Europe;
- a 30/20 GHz communications payload; and
- a propagation beacon payload operating at 12.5, 20 and 30 GHz.

The 30/20 GHz payload consists of a transponder which provides two 40 MHz narrow band channels and one 700 MHz wide band channel via two independently steerable linearly polarized transmit/receive spot beam antennas with a 0.6° nominal coverage. The propagation payload consists of three unmodulated CW beacons which transmit via individual horn antennas at 12.5, 20 and 30 GHz.

The experimental program to be carried out through the 30/20 GHz payload consists mainly of data transmission tests for typical business, tele-education and tele-medicine applications performed using earth stations with antennas of 2 - 3 m diameter. The beacons will be used to collect comprehensive statistics on attenuation and depolarization from rain at 12.5, 20 and 30 GHz from numerous locations throughout Europe and eastern North America.

4. ITALSAT

In 1990, the launch of the ITALSAT pre-operational geostationary satellite is planned.

This system is a forerunner of the future telecommunication domestic satellite, foreseen to be operative within the end of the century in the context of the Italian terrestrial ISDN.

The satellite system incorporates both real-time demand assignment to achieve increased efficiency and traffic rearrangement (non real-time) for reallocating the satellite capacity between traffic stations to match diurnal, weekly, seasonal and unforeseeable variations in traffic demand.

The ITALSAT satellite will carry three different payloads:

- a 30/20 GHz multibeam regenerative payload with on-board baseband switching for the provision of digital telephony and data circuits;
- a 30/20 GHz domestic coverage transparent payload for digital business services;
- a 40 and 50 GHz package for propagation experiments.

The multi-beam payload will adopt a 147.5 Mbit/s "SS-TDMA" access technique with DSI to increase the satellite capacity. The domestic coverage payload will provide business services, by using a 25 Mbit/s TDMA system.

The ground segment will consist of 3.5 m circular antennas and 3.5 x 7 m elliptical antennas depending on the climatic zones. The selected antenna configuration is a multireflector off-set type with shaped subreflectors and with provision of frequency selective surface.

5. Kopernikus (DFS)

In December 1983, the Deutsche Bundespost awarded a contract for the establishment of a national communication satellite network to a consortium of German firms. The project is called "Deutscher Fernmeldesatellit Kopernikus (DFS)". The DFS Kopernikus was launched on 6 June 1989 to its orbital location at 23.5°E.

The principal mission in 30/20 GHz band will be experimental and subsequent commercial use of the 30/20 GHz range for TV broadcasting with the aid of large and small mobile earth stations.

In the process, 19.73 - 19.83 GHz signals, with horizontal polarization, will be received and 29.53 - 29.63 GHz signals, with vertical polarization, transmitted.

Two large earth stations with 11 m antennas at Usingen and in Berlin (West) are ready for operation.

Additionally, it is intended to put into operation transportable stations with antennas 2.5 m in diameter.

After a two-year pre-operational trial phase, the 30/20 GHz system will go into commercial service.

6. Advanced Communication Technology Satellite (ACTS)

ACTS is an experimental 30/20 GHz satellite communications system under development by the National Aeronautics and Space Administration (NASA) of the United States. This system, which is expected to be launched in 1992, will include the following features:

- (a) **STEERABLE ANTENNA** - A mechanically steerable antenna with a 1 degree half-power beamwidth and 1 degree per minute slew rate.
- (b) **MULTIBEAM ANTENNA (MBA)** - Rapidly reconfigurable pattern of hopping beams and fixed spot beams with 0.3 degrees half-power beamwidth.
- (c) **ON-BOARD STORED BASEBAND SWITCHED TDMA (OSBS/TDMA)** - A high speed digital base-band processor (BBP) on board the satellite which stores, regenerates and routes individual, circuit-switched, messages.
- (d) **SATELLITE SWITCHED TDMA (SS/TDMA)** - A dynamic reconfigurable intermediate frequency microwave switch matrix (MSM) which routes high volume point-to-point traffic and point-to-multipoint traffic.
- (e) **RF COMPONENTS** - Flight and ground segment hardware at 20 and 30 GHz.
- (f) **NETWORK CONTROL** - Advanced algorithms to provide flexible, efficient Demand Assignment Multiple Access communications.
- (g) **ADAPTIVE COMPENSATION FOR SIGNAL LEVEL CHANGES DUE TO RAIN** - Techniques such as Forward Error Correction and uplink power control (increased power, reduced burst rate) to automatically adjust for fades.

The space segment of the ACTIS system makes use of two systems, a remodulating on-board processor that provides demand assigned time division multiple access (TDMA) communications, and a microwave switch matrix (MSM) that enables high burst rate satellite switched TDMA communications. Both of these systems make use of spot antenna beams, hopping spot beams for the demand assigned TDMA system and fixed spot beams for the satellite switched TDMA system. The ground segment of the ACTIS system is made up of the master control station/RF terminal, located near Cleveland, Ohio and various experimental terminals, located throughout the United States.

In the baseband processing (BBP) mode, ground terminals can use 2.4-meter, 3-meter or 5-meter dish antennas and must use Serial Minimum Shift Keying (SMSK) modulation. Data are uplinked at burst rates of 27.5 mega symbol per second (M symbol/s) or 110 M symbol/s depending on terminal capacity requirements, and are downlinked at 110 M symbol/s. The BBP mode network is designed to accommodate 15 dB or uplink fade and 6 dB of downlink fade and still achieve end-to-end bit error rate (BER) of 1×10^{-6} . Fade compensation is implemented automatically by reducing the symbol rate by a factor of 2 and using a rate 1/2 convolutional FEC code to produce a 10 dB gain in performance.

In the MSM network, the NASA Link Evaluation Terminal (LET) uses a 4.72 meter dish antenna and SMSK modulation though other modulation schemes may be used in the MSM mode of operation. Data are uplinked and downlinked at 110 or 220 M symbol/s. The MSM network is designed to accommodate 12 dB of uplink fade to maintain a BER of 1×10^{-6} . Fade compensation is implemented automatically by increasing the uplink power by 8 dB. Fades are sensed by monitoring beacon signals transmitted from the spacecraft, one in the up-link band and two in the down-link band.

Figure 6 shows a diagram of the principal components and functions of the ACTIS space station, earth stations and ground facilities.

The technical features of the ACTIS system support unique network architectures with the following advantages:

- a. **Efficient use of satellite capacity** - Adaptive control of hopping beam dwell time in any one geographical location, allows the capacity of the satellite to be efficiently matched to the instantaneous demand for traffic;

b. Individual voice circuit switching - Store-and-forward in combination with baseband processing allows both time and space switching. This capability allows switching at individual voice circuits on-board the satellite, thus avoiding double hops and the attendant delay. This is particularly advantageous when ground stations with low to medium traffic are employed, as in the case of networks employing customer premises terminals;

c. Efficient use of spectrum, and smaller ground terminals - Satellites that produce multiple narrow spot beams with relatively low side lobes levels allows frequency band reuse among the beams over a relatively small geographical area, and the use of smaller, lower-cost ground terminals.

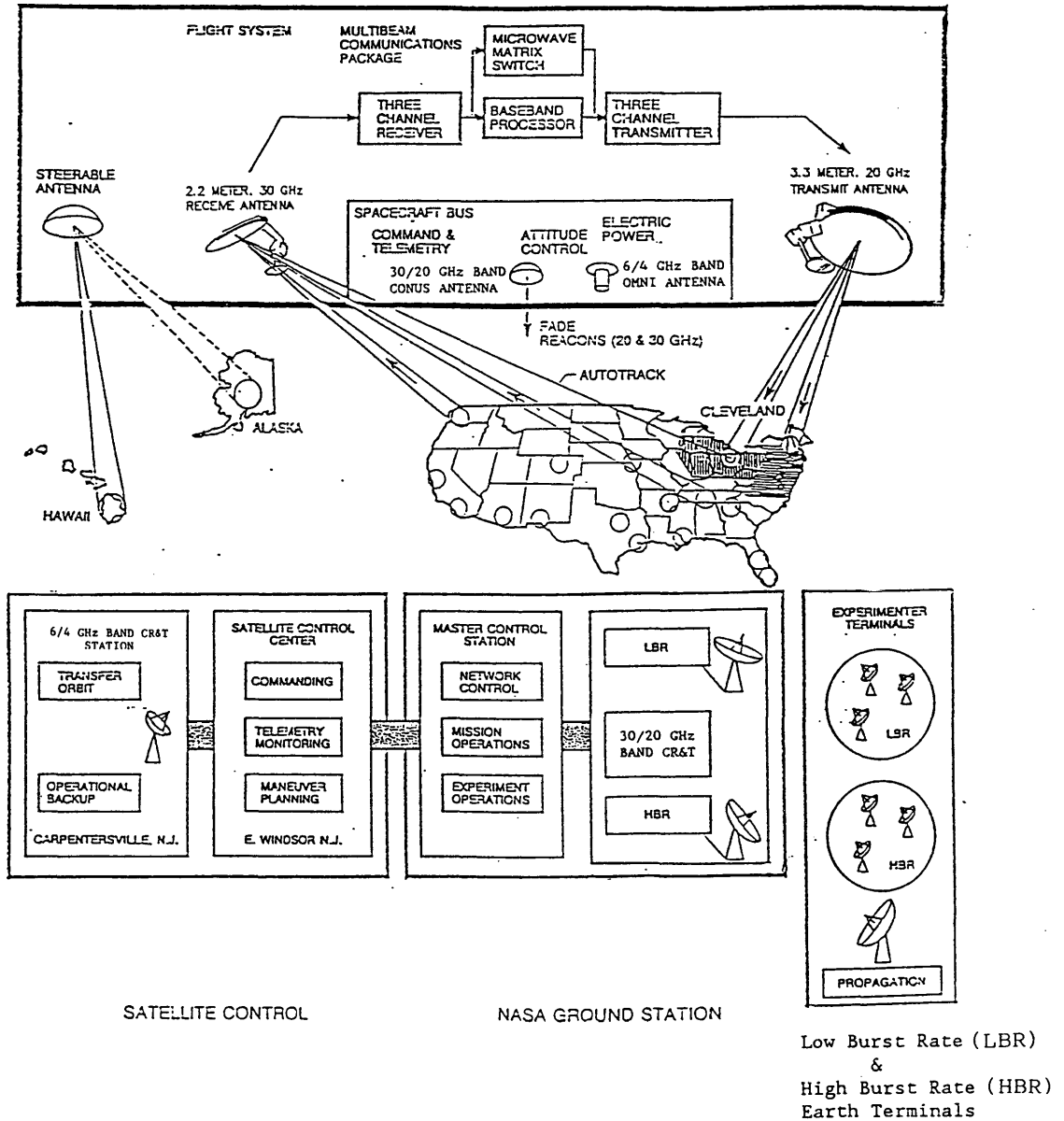

Figure 6 - ACTS functional overview block diagram

BIBLIOGRAPHY

1. MORIHIRO, Y., OKASAKA, S., NAKASHIMA, H. and OHNUKI, M. [1987] - A dynamic channel assigning and routing satellite aided digital networks. GLOBECOM'87.
2. KATO, S., INOUE, T. and HORI, T. [1987] - 30/20 GHz band compact earth station for LSI implemented TDMA terminal, transponder hopping HPA and dual-beam antenna. GLOBECOM'87.
3. ISHIDA, N. [1988] - Effective application of satellite communication for public telecommunication network (DYANET), JTR, April.
4. SHERTLER, R.J. [1986] - ACTS experimental program, IEEE Global Telecommunication Conference (GLOBECOM'86) Houston, United States.

ANNEX VI

METHOD OF DETERMINING EARTH STATION ANTENNA CHARACTERISTICS
AT FREQUENCIES ABOVE 10 GHz

1. Introduction

In communication-satellite systems operating at frequencies above 10 GHz, the specifications of the earth stations, in particular the figure of merit must take account of G/T losses due to atmospheric effects and precipitation. These losses are generally specified for a percentage of time determined by the desired quality of the system.

The specification of the G/T must take account of losses:

- in the first place directly, since they lead to an increase in the required G/T ;
- in the second place indirectly, since they entail an increase in the noise temperature T .

The formulae given below are designed to standardize the methods used in determining the antenna characteristics from the standpoint of losses. Information on the general characteristics of earth station antennas is given in Reports 390 and 868.

2. Specification of the figure of merit

The general formula used to specify the G/T of earth station antennas at frequencies above 10 GHz is usually written as follows:

$$\frac{G}{T_i} - L_i \geq \left(K_i + 20 \log \frac{F}{F_0} \right) \quad \text{dB(K}^{-1}) \quad (1)$$

in the receiving band of the frequencies F for at least $(100 - P_i)\%$ of the time.

L_i , expressed in dB, is the additional loss on the down-link caused by the climatic conditions specific to the site of the earth station concerned referred to nominal clear sky conditions.

The following examples may be cited:

(a) The following dual specification for earth stations belonging to the European network ECS:

$$\frac{G}{T_1} - L_1 \geq \left(39 + 20 \log \frac{F}{11.2} \right) \quad \text{dB(K}^{-1}) \quad \text{for at least 90\% of the worst month.}$$

$$\frac{G}{T_2} - L_2 \geq \left(31 + 20 \log \frac{F}{11.2} \right) \quad \text{dB(K}^{-1}) \quad \text{for at least 99.99\% of the year.}$$

(b) The following dual specification for INTELSAT standard C earth stations:

$$\frac{G}{T_1} - L_1 \geq \left(39 + 20 \log \frac{F}{11.2} \right) \quad \text{dB(K}^{-1}) \quad \text{to be met by all earth stations for at least 90\% of the year.}$$

$$\frac{G}{T_2} - L_2 \geq \left(32.5 + 20 \log \frac{F}{11.2} \right) \quad \text{dB(K}^{-1}) \quad \text{to be met by earth stations in Europe for at least 99.983\% of the year.}$$

$$\frac{G}{T_2} - L_2 \geq \left(29.5 + 20 \log \frac{F}{11.2} \right) \quad \text{dB(K}^{-1}) \quad \text{to be met by earth stations in North America for at least 99.983\% of the year.}$$

Note. – The different values for each region for the small percentage of time recognizes the different propagation conditions which exist in the two areas, while at the same time allowing the use of reasonably similar antenna design. Values for other regions are still under study.

3. Calculation model

It is proposed to establish a relation $D = f(L_i, K_i, T_R)$ which may be used to determine the circular aperture diameter D for the antenna of an earth station with a $\frac{G}{T_i}$ specified according to formula (1) and taking account of the receiving equipment noise temperature T_R .

Taking into account the expression for antenna gain G :

$$G = 10 \log \left[\eta \left(\frac{\pi D F}{c} \right)^2 \right]$$

formula (1) may be expressed as follows:

$$20 \log D \geq (L_i + K_i) \text{ dB} + 10 \log T_i - 10 \log \eta + 20 \log \frac{c}{\pi F_0} \quad (2)$$

where:

- D : antenna diameter (m),
- c : speed of light: 3×10^8 m/s,
- F_0 : frequency (GHz),
- η : antenna efficiency at receiving port at frequency F_0 ,
- L_i : atmospheric attenuation factor (referred to clear sky conditions) expressed in dB,
- K_i : value specified for clear sky figure of merit at frequency F_0 , expressed in dB(K⁻¹),
- T_i : noise temperature of the earth station, referred to the receiving port, expressed in kelvins.

The earth station noise temperature T_i is fairly accurately represented by the formula:

$$T_i = \frac{L'_i - 1}{\alpha L'_i} (T_{atm} - T_c) + \frac{1}{\alpha} \left[T_c + T_s + (\alpha - 1) T_{phys} \right] + T_R \quad \text{K} \quad (3)$$

where:

- T_c : antenna noise temperature due to clear sky,
- T_s : antenna noise temperature due to ground,
- T_{atm} : physical temperature of atmosphere and precipitations,
- T_{phys} : physical temperature of the non-radiating elements of the antenna feed,
- T_R : receiving equipment noise temperature,
- $\alpha \geq 1$: resistive losses due to non-radiating elements of the antenna feed,
- $L'_i \geq 1$: losses due to atmospheric effects and precipitation ratio.
- $L'_i = 10^{\frac{L_i}{10}}$ where L_i is expressed in dB.

Formula (3) may conveniently be expressed as follows:

$$T_i = T_A + (\Delta T_A) + T_R \quad (4)$$

where:

- T_A : antenna noise temperature in clear sky conditions ($L_i = 0$ dB)

$$T_A = \frac{T_c + T_s}{\alpha} + \frac{\alpha - 1}{\alpha} T_{phys} \quad (5)$$

$(\Delta T_A) =$ additional antenna noise temperature caused by atmospheric and precipitation losses.

$$(\Delta T_A) = \frac{L'_i - 1}{\alpha L'_i} (T_{atm} - T_c) \quad (6)$$

Inserting relation (3) or relation (4) into relation (2), we can solve

$$D = f(L_i, K_i, T_R)$$

using additional data relating to the typical characteristics of earth station antennas operating in the frequency band considered [ESA, 1976; Hansson, 1981].

4. Sample calculation

In the following example the diameter D of an INTELSAT standard C station antenna meeting the dual specification of paragraph 2(b) is calculated.

4.1 Assumptions

- the calculations are made at $F_0 = 11.2$ GHz for an elevation angle of about 30° above the horizon
- the antenna performances at receiving port at the frequency F_0 are:

$$\begin{aligned} \eta &= 0.67 \\ \left. \begin{aligned} T_c &= 15 \text{ K} \\ T_s &= 10 \text{ K} \end{aligned} \right\} && \text{(typical values of contribution to antenna noise temperature at an elevation angle of } 30^\circ) \\ &&& \text{at } F_0 = 11.2 \text{ GHz} \\ T_{aim} &= 270 \text{ K} \\ T_{phys} &= 290 \text{ K} \\ \alpha &= 1.122 \text{ (resistive losses = 0.5 dB)} \end{aligned}$$

- the specifications are:

$$\begin{aligned} K_1 &= 39 \text{ dB} \\ K_2 &= 32.5 \text{ dB} \end{aligned}$$

4.2 Calculation results

Figure 7 shows two series of curves

$$D = f(L_i)$$

parametered according to the dual specification for the clear sky figure of merit (K_i) and according to three receiving equipment noise temperature values T_R (130 K - 160 K - 190 K).

In the case of the example given above, if $T_R = 160$ K and if we wish to install a station at a site where the propagation data are such that:

$$\begin{aligned} L_1 &\leq 1 \text{ dB for 90\% of the year,} \\ L_2 &\leq 6 \text{ dB for 99.983\% of the year,} \end{aligned}$$

we obtain the following two values for the antenna diameter:

$$\begin{aligned} D_1 &= 16.80 \text{ m,} \\ D_2 &= 17.20 \text{ m,} \end{aligned}$$

so that we must select $D \geq 17.20$ m.

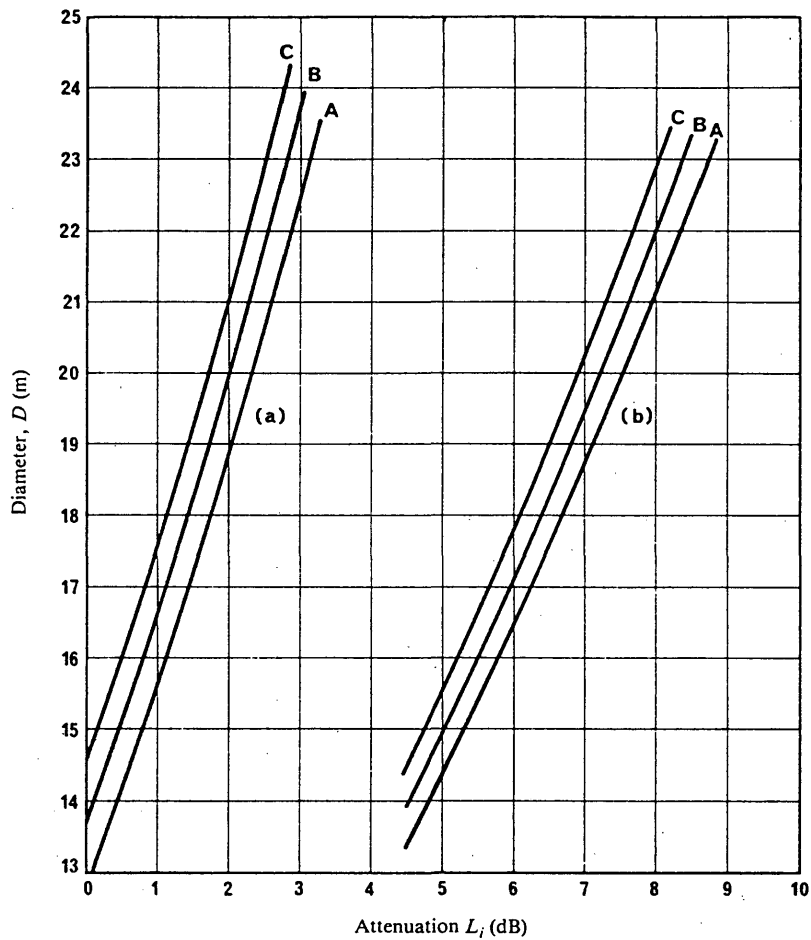

FIGURE 7— Variation in antenna diameter D as a function of attenuation L_i

For two figures of merit at 11.2 GHz:

(a): $G/T_1 = 39 \text{ dB(K}^{-1}\text{)}$

(b): $G/T_2 = 32.5 \text{ dB(K}^{-1}\text{)}$

and for three receiving equipment noise temperature values T_R :

A : $T_R = 130 \text{ K}$

B : $T_R = 160 \text{ K}$

C : $T_R = 190 \text{ K}$

REFERENCES

ESA [January, 1976] Atmospheric attenuation and noise in satellite systems at 11-14 GHz. Doc. TEC/9039/SED/SA, Rev. 2.

HANSSON, L. [8-10 April, 1981] Correlating OTS beacon measurements with radiometer and rainfall data. IEE International Conference on Results of Tests and Experiments with the European OTS Satellite, London, UK.

REPORT 1139

GENERAL SYSTEM AND PERFORMANCE ASPECTS OF DIGITAL
TRANSMISSION IN THE FIXED-SATELLITE SERVICE
(Question 29/4 and Study Programme 29A/4)

(1990)

1. Introduction

As the world-wide evolution of digital telecommunications systems continues, an increasing amount of different types of digital services are being carried by satellites as part of the evolving digital network. An example of this trend is the integrated services digital network or ISDN. This report presents material on system and performance aspects of other digital transmission systems in the FSS, in general, and, in addition, for systems carrying ISDN traffic but operating at rates greater than 64 kbit/s. Performance factors affecting ISDN transmission, that is connections operating at 64 kbit/s and designed to meet CCITT Recommendation G.821 are treated in Report 997.

2. Performance considerations

This section presents the effects of coding on the performance of a digital satellite link describing, as an example, the effects of burst errors on performance of a 64 kbit/s channel.

All of the aspects of a satellite digital transmission system can have an effect on the performance realized by the customer or end user. The performance of satellite digital transmission systems has traditionally been characterized by bit error ratio or bit error probability. Average bit error ratio represents a good measure of system performance but the system designer must be aware of the effects of other system aspects, such as "burst errors", on the performance as realized by the end user. Note that a "burst error" does not necessarily denote a group of consecutive errors, but more generally refers to an error event where the errors occur in a cluster.

2.1 Error performance at transmission rates greater than 64 kbit/s

The error performance objectives currently specified by CCITT and CCIR relate to the 64 kbit/s channel level and it is necessary to consider how these objectives can be applied to higher transmission rates. When considering this question it is important to distinguish between systems carrying separately identifiable 64 kbit/s channels and those carrying wideband services (e.g. at 2.048 or 1.544 Mbit/s). The sensitivity of particular coding schemes and frame structures must also be taken into account.

In this section, we report a generalization of performance objectives of other bit rates.

The methods described in section 2 of Report 997 for the 64 kbit/s rate can be easily generalized to accommodate other bit rates. We show below how the probability $P (\leq E)$ of obtaining E errors or less during a time T , when transmitting at a rate R is given by:

$$P (\leq E) = 1 - \underline{P} (2RT \times \text{BEP}, 2E + 2) \quad (1)$$

where BEP is the Bit Error Probability of the system and the number of errors is simply given by $E = RT \times \text{BER}$. $\underline{P} (X^2, v)$ is known as the cumulative chi-squared (X^2) distribution function with v degrees of freedom. In this formalism the calculation of BEP can easily be achieved by looking at tables of percentage points of the X^2 distribution which are readily available in the literature.

This approach shows that the relevant parameter is neither the transmission rate, R , nor the time interval considered, T , but rather the product of the two. RT refers to the total number of bits transmitted in the interval considered, and this block of data is the effective parameter when taking measurements. It is therefore natural to consider a constant block size when defining a recommendation, so that such a recommendation will be independent of the transmission rate and of the time interval considered. Thus, Recommendation 614 dealing with EFS at 64 kbit/s can be generalized to read:

- i) $P_1\%$ of the transmitted blocks (RT bits) must be error free.

and the recommendation on BER is generalized to:

- ii) $P_2\%$ of the transmitted blocks (RT' bits) should have a $\text{BER} \leq B$.

with the parameters in both recommendations being related by the value of BEP.

The 64 kbit/s EFS recommendation is simply a particular case of i) with $R = 64000$ and $T = 1$ second. The degraded minutes recommendation is a particular case of ii) with $T' = 60$ seconds and $B = 10^{-6}$, while the SES recommendation refers to ii) with $T' = 1$ second and $B = 10^{-3}$.

The error free interval defined on equal size blocks of data provides a universal measure of performance which can be applied to any transmission rate. In general it will be natural to select as the blocks of data those commensurate with the protocol used by the system of interest. This will undoubtedly avoid the problems associated with locking error performance recommendations to a particular rate or time interval. However, given the present predilection for, and the widespread use of, EFS as a determinant of the quality of a digital transmission system, the level of performance must be selected to conform to expectations for the particular block that corresponds to one second for the transmission rate of the system.

One immediate application of these results is the performance recommendation at the Primary Rates (1.544 Mbit/s and 2.048 Mbit/s). The error free block performance corresponding to an acceptable EFS level of the Primary Rates may be different from that selected for 64 kbit/s. The specific EFS level for the Primary Rates must be based on specific ISDN applications and customer needs, as well as on practical technical limitations and costs of satellite systems. Other parameters can then be derived using the appropriate statistical and propagation models. Again the specific additional parameters must be selected based on Primary Rate applications. For example, customers transmitting video teleconferencing signals may desire 10 minute interval specifications.

An immediate consequence of the approach stated above is that the knowledge of the BEP of the system allows the calculation of the probability of obtaining any given number of errors in any given time interval at any given transmission rate. BEP is the parameter that determines the performance of the system. This, in turn, provides for a simple way to relate recommendations between two different rates. All we need to do is to calculate the value of the BEP by using equation (1) with the known values of the parameter at one rate, and recalculate the performance objectives at the new rate by means of the same equation and the same BEP, with the low rate parameters.

The Poisson statistical distribution, as a limiting case, has provided illuminating results. However, it is necessary to reexamine this assumption by looking at more bursty distributions of errors and study how the results change from the ones quoted above. See Annex IV of Report 997 for a treatment of the effects of bursty errors on 64 kbit/s ISDN connections.

In Annex I of Report 997 a Poisson distribution formula is presented that is used to generate the graphs that apply to the specific case of the 64 kbit/s rate. The formulae given below are generalized to accommodate any transmission rate.

If we denote, by R the transmission rate of the system and by T the time interval under consideration, the total number of transmitted bits is given by $N=RT$. The probability of having E errors or less, when transmitting these N bits is given by:

$$P(\leq E) = \sum_{n=0}^E \frac{(RT \times \text{BEP})^n}{n!} e^{-RT \times \text{BEP}} \quad (2)$$

where BEP is the Bit Error Probability of the system and the number of errors $E=N \times \text{BER}$.

Equation (2) can be transformed into a form more amenable to analytical inversion. Calculating the derivative of the sum with respect to BEP, and expressing it in terms of the original sum, one can find a differential equation that can be easily integrated to obtain:

$$P(\leq E) = 1 - P(2RT \times \text{BEP}, 2E+2) \quad (3)$$

where $P(\chi^2, \nu)$ is the cumulative chi-squared (χ^2) distribution function with ν degrees of freedom, and it is defined in terms of the integral:

$$P(\chi^2, \nu) = \frac{1}{(\frac{\nu}{2} - 1)!} \int_0^{\chi^2} x^{\frac{\nu}{2}-1} t^{\frac{\nu}{2}-1} \cdot e^{-t} dt \quad (4)$$

Since what is needed is the variable BEP as a function of R for a fixed value of the cumulative function, one only needs to look at tabulations of the percentage points of the χ^2 distribution, which are widely available. Notice that the transmission rate also appears in the variable E; for a given value of R, one can easily obtain $\nu(2E + 2)$ and read the χ^2 value from the statistical tables without the need for further extrapolation. That is, from the value of χ^2 the Bit Error Probability is readily obtained.

$$\text{BEP} = \chi^2 / (2 R T) \quad (5)$$

This method avoids the need for inverse extrapolation techniques and for numerically calculating the probability function. It can be used more effectively and permits simple generalization to any transmission rate.

For the purpose of evaluating error performance objectives normalized to 64 kbit/s on the basis of measurement results obtained at the bit rate of a primary digital system or higher order systems, the following method may be used:

- an error substream corresponding to the 64 kbit/s channel is formed by selective demultiplexing from the error stream extracted from the signal transmitted over the system;
- the 64 kbit/s channel error signal thus obtained is processed in accordance with the algorithm given in Annex B to CCITT Recommendation G.821.

The error stream selective demultiplexing method can also be used to evaluate the performance objectives of various services with bit rates exceeding 64 kbit/s (e.g. sound broadcasting or television) which are component parts of a high bit rate signal.

Error characteristic measurements are also considered in Report 613.

2.2 Burst error events

As mentioned previously, average bit error ratio or probability gives a good measure of the long term performance of a digital transmission system and forms the basis for system design. The performance as realized by the end user can be greatly affected by the distribution of the errors. Systems using multiplexed 64 kbit/s channels experiencing "burst errors" may demonstrate degraded performance on some channels and acceptable performance on others when using octet interleaved multiplexing. Systems using bit interleaved multiplexing, will experience equal degradation of all channels. Channels with bursty error statistics may also cause problems in end to end signalling.

The systems that are connected to the transmission system may also be affected by the statistics of the bit errors. Digital television coder/decoders (codecs) that use bandwidth compression techniques to improve the efficiency of digital television transmission can exhibit picture degradation and loss of codec synchronization due to "bursty" errors. Digital circuit multiplication equipment (DCME) can also experience the loss of system synchronization due to "bursty" errors. The degree of degradation is of course dependent upon the specific equipment architecture which is connected to the transmission system. Source coding used at the terminal equipment may improve or degrade the sensitivity to "bursty" errors.

2.3 Loss of frame-synchronization

Loss of synchronization (for example loss of multiplex frame alignment) can happen when a long error burst is encountered. The garbled output during the re-framing time may not be detected upstream, and performance monitoring at the higher bit rate may then not represent the performance at the end-user bit rate. System designers should ensure that the frame synchronization structure be sufficiently robust to minimize this problem. Any increase in margin in the performance recommendation to cover de-synchronization will require further study.

3. Synchronous Digital Hierarchy

CCITT Recommendations G. 707, 708, and 709 relate to the Synchronous Digital Hierarchy (SDH).

One of the major features of this hierarchy is the new bit rates which transmission media will have to accommodate. Specifically, the lowest transport rate is 155 Mbit/s and so the implications of this on the design of satellite networks need to be considered.

If a satellite transmission network has to support the full 155 Mbit/s signal, new transmission equipment will have to be developed and it may also be necessary to increase the bandwidth above the typical 72 MHz currently in use.

Alternatives could be developed to interface between the SDH and existing transmission rates, as well as a sub 155 Mbit/s rate of approximately 50 or 40 Mbit/s. In this case some of the features of the SDH, particularly those relating to network monitoring and control, would be lost/reduced.

4. Broadband Integrated Service Digital Network (B-ISDN)

The Broadband Integrated Service Digital Network (B-ISDN) is a network concept that is developing from the Narrowband (64 kbit/s) ISDN (N-ISDN) and will be a network that will provide broadband services such as large data base enquiries, broadcast TV distribution, High definition TV, and video telephone, as well as those services currently being provided by the N-ISDN standard. These are expected to be implemented in the 1990's and it can be expected that connections in the B-ISDN will involve satellite radio connections particularly for intercontinental connection.

Transmission bit rate is a primary factor in determining how efficiently service such as B-ISDN can be transmitted via satellite.

This section examines existing and planned satellite systems that are scheduled for installation in the 1990's, and based on this examination, system bit rates that would allow efficient satellite transmission are identified.

4.1 B-ISDN Transmission Rates

CCITT Broadband Task Group (BBTG), at its January 1989 meeting, established the Asynchronous Transfer Mode (ATM) as its target mode for Broadband ISDN. The broadband channel rates which must be supported, per CCITT Recommendation I. 121, are: H21 (32.768 Mbit/s), H22 (43 - 45 Mbit/s), H4 (132 - 138.240 Mbit/s). The user-network interface would be at 150 Mbit/s, and possibly 600 Mbit/s. ATM can be supported by the Synchronous Digital Hierarchy (SDH) described in section 3.

4.1.1 Digital Transmission of Television Signals

Broadband Integrated Services Digital Networks (B-ISDN) are currently being defined by the CCITT. One application of B-ISDN will certainly be the distribution of television signal. Due to the point-to-multipoint nature of communications satellite systems, and the need to distribute television signal over wide areas, satellites are uniquely suited to the distribution of digital television signal. By careful application of image coding and channel coding techniques, where necessary, digital television transmission rate requirements can be made compatible with communications satellite transmission capabilities.

4.1.2 Satellite Transmission Rates

As described above, a variety of channel rates have been specified in B-ISDN Recommendation I.121. These rates will however be supported by both the existing and new digital hierarchies.

For the existing hierarchy, a common standard exists at 139.264 Mbit/s and is in use on a wide variety of transmission systems (eg TAT 8). Multiplexing schemes are specified so that the various rates of both the North American and European hierarchies can be accommodated.

For the SDH, the comparable rate is 155.52 Mbit/s.

It seems logical that from the discussion above the transmission rate used for B-ISDN would be between 140 to 160 Mbit/s. A rate within this range would be compatible with both existing and currently planned communication satellites. Satellite transmission at 140 Mbit/s through a 72 MHz transponder has already been demonstrated. In order to accommodate transmission rates of up to 160 Mbit/s, a coding rate of 8/9, as opposed to the presently tested coding rate of 7/9, could be used. This increase in coding rate implies a decrease in coding gain and hence the necessity to make up this loss somewhere in the satellite transmission path.

4.2 Satellite Capabilities

4.2.1 Satellite Transponders

The transmission capacity of satellite transponders is basically characterized by the available output power and the usable bandwidth. The Table I shows the transponder bandwidths and powers to the INTELSAT satellites that are already in service or are planned for service in the 1990's. The earth coverage regions of these transponders are also shown.

Carriers bearing B-ISDN traffic would most likely require full transponder bandwidth and, for reasons of efficiency, these carriers would operate close to the saturated transponder EIRP. As an example of current transmission systems, the INTELSAT TDMA system operates at a transmission rate of 120 Mbit/s in a 72 MHz bandwidth transponder at an EIRP of 27 dBW. Tests have demonstrated satisfactory performance of a Coded Octal Phase Shift Keyed (COPSK) system operating at an information rate of 140 Mbit/s and channel rate of 180 Mbit/s in a 72 MHz bandwidth transponder at an EIRP of 28.5 dBW.

4.2.2 Use of Spot Beam Antennas

The use of spot beams owing to its high satellite antenna gain will enable satellite to handle higher bit rate digital signals in proportion to the number of beams to cover a certain service area. In Japan, an experimental multibeam communication satellite, ETS-VI, will be launched in 1993 which covers the Japanese main islands by 13 spot beams. At the present, a single beam system carries 20 Mbit/s digital signal by using a 4.2m diameter earth station antenna, it is possible to transmit as high as 250 Mbit/s digital signal by using the same RF facility. Experimental applications of satellite communication to the B-ISDN are planned to be carried out using the ETS-VI.

As the rates that seem probable for B-ISDN have been indicated and it has been shown that both existing and currently planned telecommunications satellites are capable of accommodating these transmission rates, satellites will be able to form integral parts of B-ISDN connections.

4.3 Asynchronous Transfer Mode

A B-ISDN is a network that can support a wide range of audio, video and data applications, such as video telephony, video surveillance, television (standard, enhanced and high definition), file transfer, high speed data, etc, in addition to the traditional ISDN services. In order to be able to handle such a wide variety of signals represented by various bit rates, the CCITT has established the Asynchronous Transfer Mode (ATM) as the target transfer mode solution for implementing B-ISDN.

ATM is a packet-oriented switched network in which multiplexed information is organized in fixed-size blocks called cells. A cell consists of a user information field and a header. The primary role of the header is to identify cells belonging to the same virtual channel - i.e. the same connection. At its June 1989 meeting, CCITT Study Group XVIII established a cell size of 53 8-bit bytes (or octets), consisting of an information field of 48 octets and a header field of 5 octets.

The header contains only the information required to transfer the information field through the ATM. The following are some of the functions of the header:

- Virtual channel identification (VCI), to identify the cells belonging to the same virtual channel
- Virtual path identification (VPI)
- Access Control Field (ACF)
- Priority and congestion control (PR)
- Header error control (HEC)
- Payload identification (PI), which indicates whether the information field contains network or customer data.

The HEC can correct single errors in the header field and can detect multiple (2 or 3) errors. There is no check of the information bits. As a result, the primary types of errors are:

- detected but corrected errors
- detected but uncorrected errors, which could result in erroneous addresses and thus loss,
- undetected errors, resulting in delivery to the wrong address.

Information is needed on the acceptability of the various kinds of errors, and also of errors in the information fields. Till now most of the activity has concentrated upon the structure of the ATM. It is necessary to address the question of ATM performance specification, i.e. signal impairment levels which correspond to acceptable quality of services. These specifications may then be related to the contributions, if any, expected from the satellite portion of any connection.

For example, in the cases of video services, user-perceived criteria could be:

- events affecting 1 or 2 TV lines
- events affecting 2 fields,
- events affecting multiple fields

These could be affected by individual and burst errors, short interruptions, information losses and delay, resulting in cell losses, cell transfer delay and information errors.

Cell losses may be due to header error as discussed above and to buffer over-flows;

Cell delay may be due to queueing delays in ATM and to propagation;

Information errors may be due to a variety of causes.

The need for standards on these should be further studied in the CCIR as paced by decisions in the CCITT.

TABLE I - Equivalent isotropically radiated power and usable bandwidth of existing or planned international communications satellites

Satellite Designation	Usable Transponder Bandwidth	Minimum Transponder EIRP*	Antenna Beam Earth Coverage
INTELSAT V (currently in-service)	36 MHz 41 MHz 72 MHz 77 MHz 241 MHz	23.5 dBW 23.5 dBW 29.0, 29.0, 41.1 dBW 29.0, 29.0, 41.1 dBW 41.1 dBW	Global Global Hemi, Zone, Spot Hemi, Zone, Spot Spot
INTELSAT VI (initial launch 1989)	36 MHz 41 MHz 72 MHz 77 MHz 150 MHz	26.5, 28.0 dBW 26.5 dBW 31.0, 31.0, 41.7 dBW 41.7 dBW 44.7 dBW	Gobal, Zone Global Hemi, Zone, Spot Spot Spot
INTELSAT VII (planned launched 1993)	36 MHz 41 MHz 72 MHz 77 MHz 112 MHz	26.5, 33.0, 33.0 dBW 29.0 dBW 33.0, 33.0, 42.0 dBW 33.0, 33.0, 42.0 dBW 42.0 dBW	Global, Hemi, Zone Global Hemi, Zone, Spot Hemi, Zone, Spot Spot

* Saturated EIRP

5. Interference and sharing constraints

In designing a digital satellite circuit to meet the ISDN performance objectives in CCITT recommendation G.821, the system designer must include in his link budget some allowance for interference. One possible method of determining the permissible level of interference received from fixed-satellite services and terrestrial services would be to assume the interfering system will be accommodated on the basis of Recommendations 523 and 558. However, because of the improved performance (relative to recommendation 522) and the unique requirements of ISDN digital connections interference should be considered on a different basis, especially, systems operating in the 14/11-12 GHz bands.

Studies have shown that 14/11-12 GHz ISDN satellite connections, operating in moderate rain climatic regions (e.g. CCIR rain climatic zone 'K') will be generally limited by the short term performance objective, (BER < 1×10^{-3} for 0.03% of any month). In such cases the clear sky operating point may be much better than 1×10^{-7} BER long term requirement as stated in Recommendation 614. Therefore an interference budget similar to Recommendation 523, based on the 10^{-7} performance objective would not be related to the clear sky or the degraded operating conditions, nor the availability objectives.

Another consideration in developing an interference criteria for ISDN connections is the effect of interference on systems utilizing FEC. Most digital systems are utilizing some forms of FEC coding as a means of lowering the required C/N to achieve a given performance objective. However, by utilizing FEC a system becomes more sensitive to changes in the C/N. In one example it was found a 25% increase in system noise due to interference could degrade a systems BER with FEC about 6 times more than a system without FEC.

Figure 1 gives an example of the INTELSAT 2.048 Mbit/s service operating at 14/12 GHz in a fading environment. It is assumed that the up link is fading in this example and more information can be found in section 4 of CCIR Report 710 on the assumptions that are made.

The network is designed with a C/I of 16.7 dB, to meet the CCIR proposed allocation of interference noise for 10% of any month. With fading, this C/I will be reduced to 10.3 dB which is only 3.6 dB above the C/N required to meet CCIR Recommendation 614 for a BER of 10^{-3} at 0.2% of the worst month. In other words, the effect of this interference has become a significant factor, in terms of C/I, at the operating point of 10^{-3} BER.

Figure 1 also shows that the system performance is controlled by the short term performance requirement at 0.2% of the month. The carrier level was chosen just to meet this short-term performance, i.e. the unfaded carrier level had to be increased to take account of fading due to rain in order to meet the 0.2% point.

The effect of increasing the carrier level could have an impact on orbit efficiency. However, if some form of fade compensation, such as up link power control, is used the carrier during clear weather can be reduced back to its nominal level and thereby not affect the utilization of the orbit. Up link power control can also be used to improve the short performance in order to reduce the total noise as well as the interference noise at the 0.2% of the month point. Figure 1 shows how using 4 dB up link power control can improve the performance at 10^{-3} BER.

Table II summarizes the amount of up link power control that may be needed for a moderate climate. It also shows the difference between a system with and without FEC. The system without FEC is not used by INTELSAT and is only

shown for a comparison. It also shows the sharp roll-off for the FEC performance between a BER of 10^{-7} and 10^{-3} . A more complicated case, that of two mutually interfering systems, both using UPC, requires further study.

These considerations show that existing systems interference criteria, when applied to ISDN connections, do not reflect the unique requirements of ISDN connections and other approaches may be needed. One approach would be to base the interference on a percentage of the system noise, thereby eliminating the referencing of interference to any specific BER performance objective or to the use or non-use of FEC. Another approach would be to base the interference on the additional percentage of time the system can be degraded.

A similar consideration of the interference from terrestrial systems is also required.

It is considered that urgent and intensive study is required to develop an appropriate interference recommendation for an ISDN Satellite connection. This study might also have to take into account the need to maintain existing orbital efficiencies while still making ISDN connections cost effective. Annex I is a possible form of such a Recommendation.

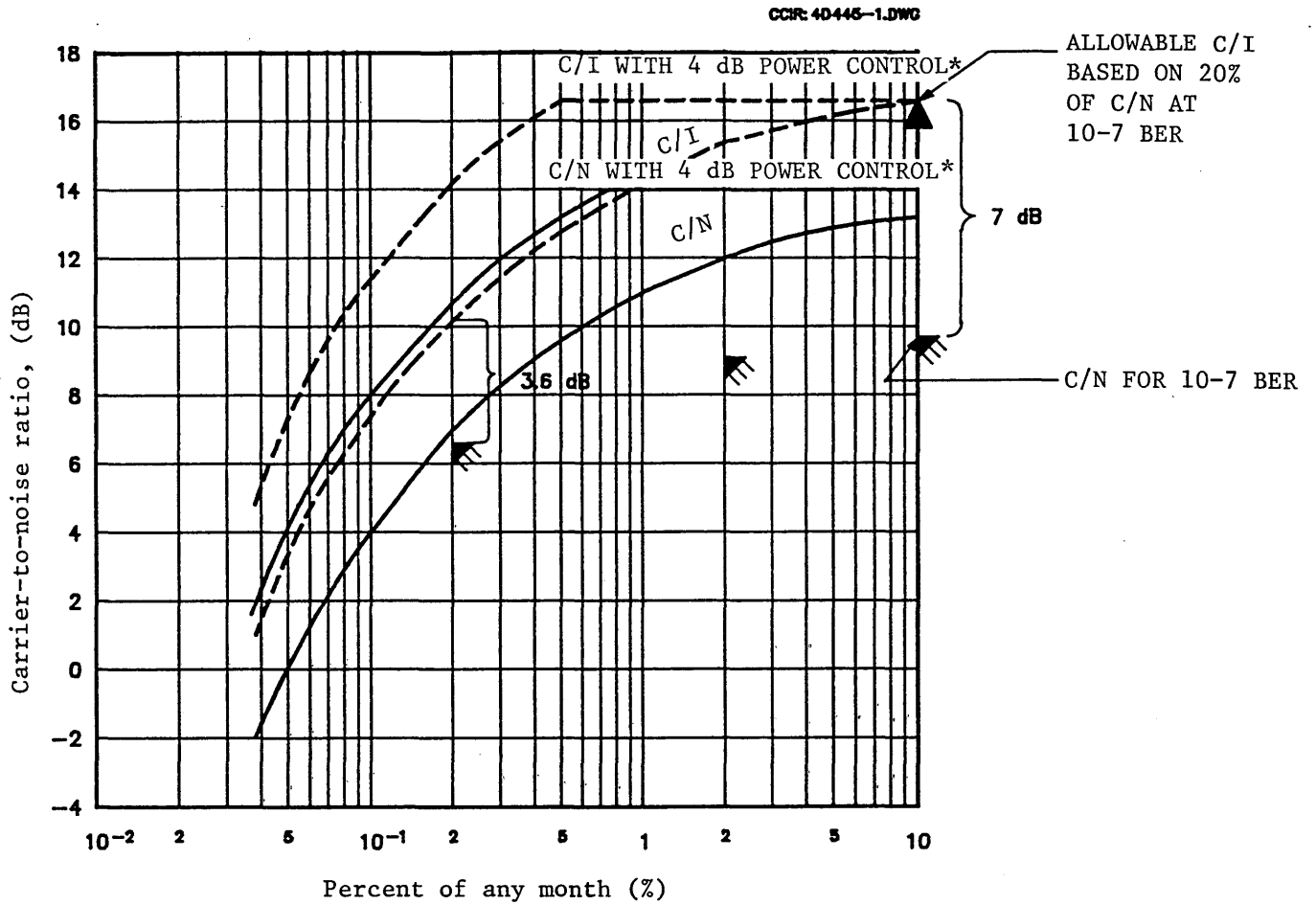

FIGURE 1 - 2.048 Mbit/s C/N with fading, region K with FEC at 14/12 GHz

- ▲ CCIR INTERFERENCE ALLOWABLE, (C/I) Rec. 523
- ▣ HDRP PERFORMANCE, (C/N) Rec. 614

* NOTE: EQUIVALENT C/I AND C/N IMPROVEMENT CAN BE ACHIEVED BY INCREASING THE UNFADED UPLINK POWER BY 4 dB OR OTHER MEANS

TABLE II INTELSAT 2.048 Mbit/s SERVICE AT 14/12 GHz, K-CLIMATE

	With FEC	Without FEC
Fading Depth at 0.2% of the month with respect to 10% of the month	6.4 dB	6.4 dB
Difference in C/N between BER 10^{-7} & 10^{-3} in Demodulator*	-3.0 dB	-4.6 dB
Advantage due to operating in the non-linear region of power amplifier at saturation	-0.0 dB	-0.0 dB
Amount of Fade Compensation Required**	3.4 dB	1.8 dB

* As measured over the entire system

** Required in order to not impinge on the satellite spacing set by the long term interference allowance, at 10% of the month

6. Other Applications of Satellite Links in the ISDN

There are various ways to apply satellite links within the ISDN which can lead to different system performance objectives. This section gives some considerations on the applications of satellite links within the ISDN.

Such applications of satellite links as a part of the ISDN can be classified into two basic forms as follows:

- (1) applied to one or more sections of the digital path in place of terrestrial systems;
- (2) applied to one or more sections of the digital path in parallel with terrestrial systems.

Figure 2 shows an example of the first form while Fig. 3 shows an example of the second form.

6.1 Performance Objectives

6.1.1 Error Performance

When a satellite link is applied to one or more sections of the digital path in place of terrestrial systems, overall end-to-end error performance requirements can be met if the performance objective of the satellite link equals the sum of the error performance objectives allocated to the corresponding section of HRX as given in Report 997. Figure 4 shows several examples of error performance objective allotments for a satellite link used in this way.

6.1.2 Availability

The unavailability objectives of a satellite HRDP due to equipment and propagation are given in Recommendation 579 and would be applicable to satellite links used in any of the above situations.

In satellite communication systems using frequency bands above 10 GHz, site diversity technology is an effective countermeasure against severe rain attenuation. In satellite links which are applied in parallel with terrestrial systems, earth stations are not required to process the site diversity function because of its dynamic routing capability. If the terminating earth station nearest to the destination subscriber encounters heavy rain attenuation, a satellite channel is assigned to the unaffected earth station second nearest to the destination subscriber.

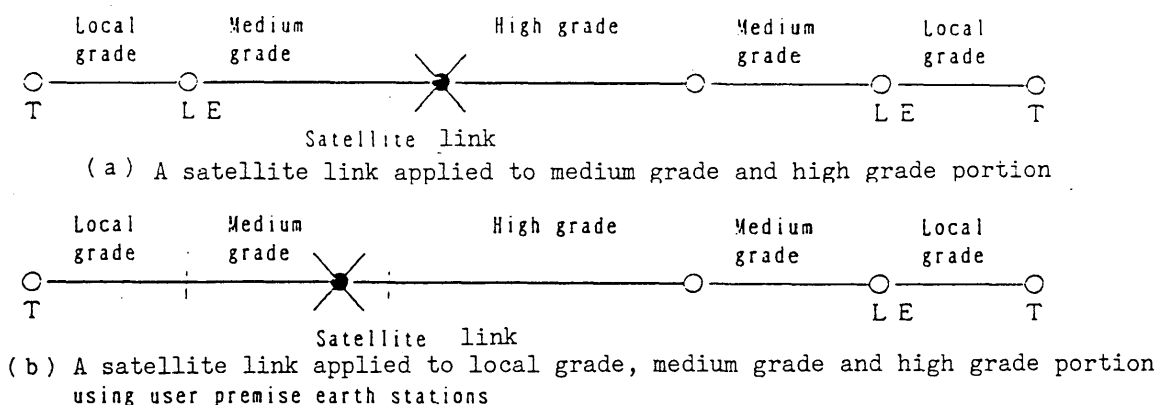

FIGURE 2 - Configuration examples of satellite links applied to one or several sections of the digital path as substitution for terrestrial systems

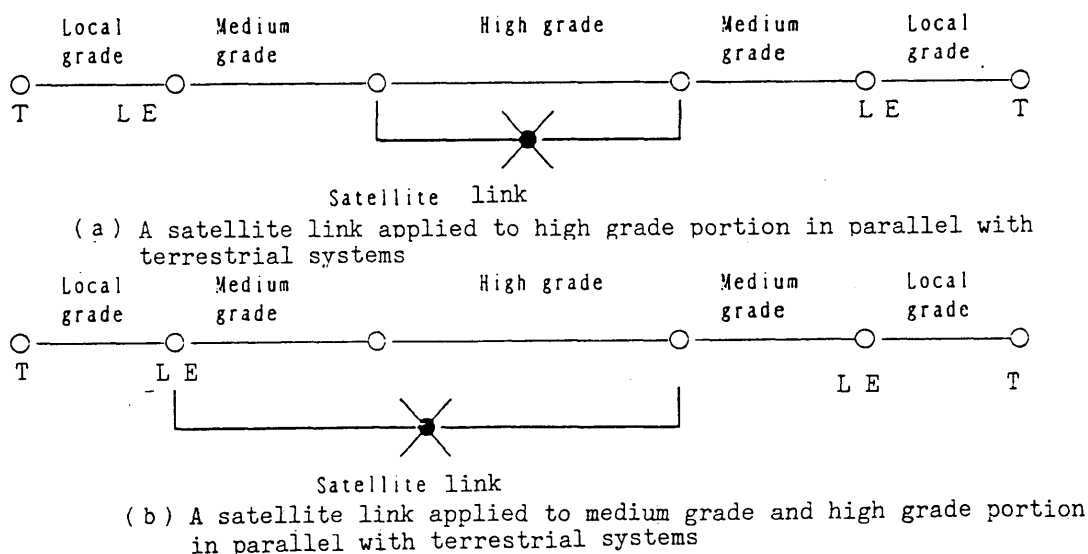

FIGURE 3 - Configuration examples of satellite links applied to one or several sections of the digital path in parallel with terrestrial systems

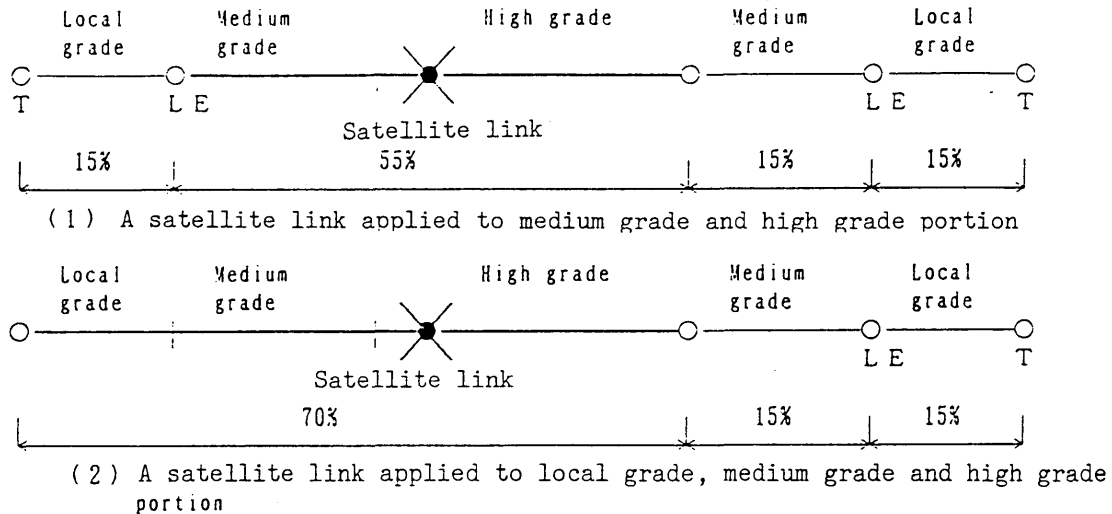

FIGURE 4 - Examples of error performance objective allotments for the HRDP using satellite links

6.2 An example of satellite communication systems applied to parts of the ISDN with terrestrial systems

In Japan, a satellite transit network with dynamic channel assignment and routing capability has been introduced to the public switched telephone network since October 1988. This system combines terrestrial-based circuits and satellite circuits.

Figure 5 shows the system configuration and Table III shows major parameters of this system. It uses the Japanese domestic communication satellite CS-3. The frequency band used in this system is 30/20 GHz band. This system consists of a number of traffic earth stations and one control earth station. The control earth station transmits and receives call control signals to/from terrestrial switches, and selects the destination traffic earth station and switch.

In this system, the satellite circuit group can be used commonly in units of 64 kbit/s circuit when the terrestrial circuit group is fully occupied. This can be realized by demand assigned TDMA techniques.

The earth station has a 4.2 m diameter dual-beam offset type antenna with torus-type reflector, and can access two satellites; CS-3a and 3b, simultaneously. As multiple transponders are used for many small traffic earth stations in this system, it is necessary for each station to access multiple transponders to connect with each other. Therefore, transponder hopping technology, one of the schemes available to them with a single set of TDMA equipment, transmitter and receiver, is effectively applied to the system in order to economize on earth station cost.

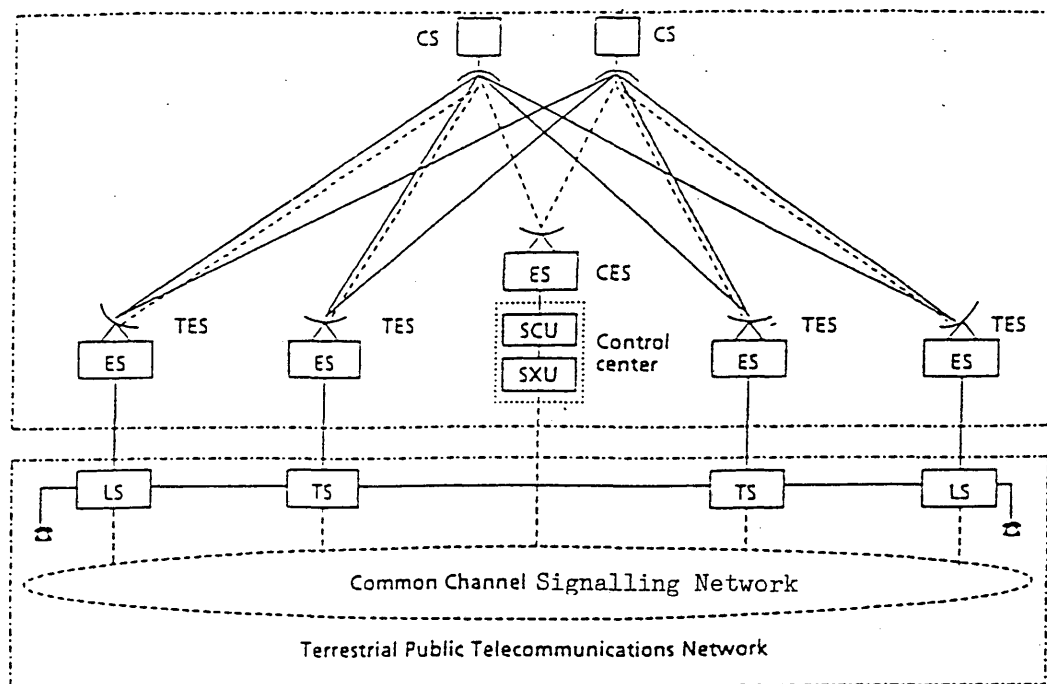

CS : Communication Satellite
 ES : Earth Station Equipment
 TES: Traffic Earth Station
 CES: Centralized Control Earth Station
 SCU: Satellite channel Control Unit
 SXU: Satellite communication transit Exchange Unit
 LS : Local Switch
 TS : Toll Switch
 ——— : Traffic channel
 - - - - : Control channel

FIGURE 5 - System configuration of trunk transmission system combined satellite systems and terrestrial systems

TABLE III - Major parameters of satellite trunk transmission system

Item	Content
Frequency	30/20 GHz bands
Multiple access	TDMA
Earth stations	Reference stations; 2 Traffic terminals ;30/transponder
Modem	QPSK-Coherent demodulation
FEC	Rate 1/2 convolutional encoding Viterbi decoding (constraint length: 4)
Clock rate	25.024 MHz
Transmission capacity	160ch/transponder (in 64 kbit/s channels)
TDMA-Terrestrial network interface	8.192 Mbit/s
Channel assignment	Demand assignment



7. Conclusions

This report has presented the general system and performance aspects of satellite digital transmission, and specifically, for systems carrying ISDN traffic operating at rates greater than 64 kbit/s.

Performance considerations have been discussed, noting that bit error ratio is still the preferred method of specifying digital system performance in the fixed-satellite service. System designers are cautioned to be aware of the effects on the performance of an end-to-end connection and end user equipment that can be caused by statistically non-random error distributions.

The application of satellites in the developing framework of digital transmission by the synchronous digital hierarchy (SDH) and in the broadband ISDN (B-ISDN) have also been considered.

Specific attention has been given to the effects of interference on ISDN performance, primarily for narrow-band ISDN (N-ISDN). It is anticipated that this information will be developed into a Recommendation providing guidelines on interference into satellite portions ISDN connections.

Finally, the applications of satellite links, other than those specifically covered by the hypothetical reference digital path (HRDP) given in CCITT Recommendation G.821, in the ISDN have been considered. It was shown that, when satellites are applied to digital sections normally carried by terrestrial means, more of the error performance allotment can be apportioned to the satellite part of the connection.

It is hoped that this report will serve as the basis for the development of new or improved Recommendations on digital transmission in the fixed-satellite service.

Some areas that require further study are:

- effects of bursty errors on equipment and systems that use bandwidth compression techniques;
- effects of interference on systems that use UPC;
- performance studies on packet-oriented switched networks.

BIBLIOGRAPHY

1. CCITT, COM XVIII N° D.164/WP6, June 1989.
2. MINKIN, V.M. and ITKIS, G.E. [1989] - Eksperimentalnoe issledovanie oshibok v tsifrovyykh lineinykh traktakh (Experimental study of errors in digital systems), Trudy NIIR, No. 1.

ANNEX I

Elements for the preparation of a possible New Recommendation
for consideration during the next Study Period

MAXIMUM PERMISSIBLE LEVELS OF INTERFERENCE IN A
GEOSTATIONARY-SATELLITE NETWORK FOR A HYPOTHETICAL REFERENCE
DIGITAL PATH WHEN FORMING PART OF THE INTEGRATED SERVICES
DIGITAL NETWORK IN THE FIXED-SATELLITE SERVICE CAUSED BY
OTHER NETWORKS OF THIS SERVICE BELOW 15 GHz

(Study Programme 28C-1/4)

The CCIR,

CONSIDERING

- (a) that geostationary-satellite networks in the fixed-satellite service operate in the same frequency bands;
- (b) that interference between networks in the fixed-satellite service degrades the error performance relative to its value in the absence of frequency sharing;
- (c) that it is desirable that the interference in networks in the fixed-satellite service caused by transmitters of different networks in that service should be such, as to give a reasonable orbit utilization efficiency;
- (d) that the overall performance of a network should essentially be under the control of the system designer;
- (e) that it is necessary to protect a network in the fixed-satellite service from interference by other such networks;
- (f) that it is necessary to determine the maximum permissible interfering radio frequency power in a satellite system to establish space station and earth station characteristics such as required protection ratios and minimum orbital spacing;
- (g) that networks in the fixed-satellite service may receive interference both into the space station receiver and into the earth station receiver;
- (h) that it is desirable that the increase in _____ interference from other satellite networks should be a controlled fraction of the total noise that would give rise to a bit error ratio, as set out in Recommendation 614;
- j) that the levels of interference between geostationary-satellite networks in the fixed-satellite service below 10 GHz are not expected to exhibit a large variation with time, and under these conditions it is preferable to define the permissible interference limit as a fraction of the pre-demodulator noise power, as this allows multiple interference entries to be superimposed on each other on the basis of RF power addition;
- k) that in frequency bands between 10 and 15 GHz where very high propagation attenuation may occur for short periods of time, it would generally be desirable for systems to make use of _____ some form of fade compensation _____ to counteract signal fading and that under these circumstances the levels of interference from other satellite systems would also not undergo a large variation with time,

RECOMMENDS

1. that networks in the fixed-satellite service operating in the same frequency bands below 15 GHz, and using geostationary satellites be designed and operated in such a manner that the total interference to a 64 kbit/s ISDN connection in the fixed-satellite service caused by the earth station and space station transmitters of all other networks, should conform provisionally to the following limits:

1.1 in frequency bands in which the network does not practise frequency re-use, the interference power level, should not exceed, for more than 10% of any month as referred to RECOMMENDS 1.1 of Recommendation 614, 25% of the total noise power level at the input to the demodulator which would give rise to a bit error ratio of 1 in 10^7 ;

1.2 in frequency bands in which the network practises frequency re-use, the interference power level, should not exceed, for more than 10% of any month as referred to RECOMMENDS 1.1 of Recommendation 614, 20% of the total noise power level at the input to the demodulator which would give rise to a bit error ratio of 1 in 10^7 ;

2. that the maximum level of interference power in any 64 kbit/s ISDN connection caused by the transmitters of another fixed-satellite network, should not exceed, for more than 10% of any month as referred to RECOMMENDS 1.1 of Recommendation 614, 6% on a provisional basis of the total noise power level at the input to the demodulator which would give rise to a bit error ratio of 1 in 10^7 ;

3. that the maximum level of interference noise power caused to that network should be calculated on the basis of the following values for the receiving earth station antenna gain, in a direction at an angle φ (in degrees) referred to the main beam direction:

$$G = 32 - 25 \log \varphi \text{ dBi for } 1^\circ \leq \varphi < 48^\circ$$

$$G = -10 \text{ dBi for } 48^\circ \leq \varphi \leq 180^\circ$$

except when the actual gain is known and is less than the above value, in which case the actual value should be used;

4. that the following notes should be regarded as part of this Recommendation:

Note 1. — For the calculation of the limits quoted in §§ 1.1, 1.2 and 2 it should be assumed that the total noise power at the input to the demodulator is of thermal nature.

Note 2. — It is assumed in this Recommendation that the interference from other satellite networks is of a continuous nature at frequencies below 10 GHz: further study is required with respect to cases where interference is not of a continuous nature above 10 GHz.

Note 3: For existing networks using 8-bit PCM encoded telephony; see Note 3 of Rec. 523.

Note 4. — In some cases it may be necessary to limit the single entry interference value to less than the value quoted in § 2 above in order that the total value recommended in § 1 may not be exceeded. In other cases, particularly in congested arcs of the geostationary-satellite orbit, administrations may agree bilaterally to use higher single entry interference values than those quoted in § 2 above, but any interference noise power in excess of the value recommended in § 2 should be disregarded in calculating whether the total value recommended in § 1 is exceeded.

Note 5. — The provisional single-entry value of 6% in § 2 has been provisionally taken pending the results of studies to determine the most appropriate value, taking into account the increase in the effective number of interferences contributing to the aggregate interferences because of the increasing use of spot beam antennas at space stations. Study of the relationship between the single-entry interference value quoted in § 2 above and the aggregate interference values quoted in § 1 is required as a matter of urgency.

Note 6. — There is an urgent need for study of the acceptability of an increase in the maximum total interference noise values recommended in § 1 and more particularly those given in § 1.2 for satellite networks in which frequency re-use is practised.

Note 7. — In segments of the geostationary-satellite orbit not likely to be crowded, interference allowances less than those recommended in § 1 above, may be utilized, allowing a corresponding increase in other noise contributions within total acceptable noise limits. However, § 1.1 and 1.2 above should normally be evaluated with the assumption that the total power noise level present is that which produces the specified bit error ratio under unfaded conditions of the received signal.

Note 8. — Although this Recommendation has _____ an upper frequency limit of 15 GHz, in the frequency range from 10 to 15 GHz short term propagation data are not available uniformly throughout the world and there is a continuing need to examine such data to confirm the appropriateness of the interference noise allowances.

Note 9. — There is a need for urgent study to be given to the interference noise allowances appropriate to systems operating at frequencies above 15 GHz.

Note 10. — The interference power levels indicated in § 1 and 2 above apply only to the transmission of digital services (see CCIR Recommendation 614 and CCITT Recommendation G.821). Further study by CCIR Study Group 4 is required regarding the performance objectives appropriate to the transmission of digital services other than 64 kb/s digital transmission forming part of a ISDN connection, as information on the performance requirements of such services becomes available to the CCIR.

Note 11 - The principles of this Recommendation may also be applied to satellite networks providing long-term performance objectives different from those in Recommendation 614. This is a subject of further study.

REPORT 1134

DIGITAL SATELLITE DEDICATED NETWORKS

(Study Programme 29C/4)

(1990)

1. Introduction

Satellite communication systems are characterized by their flexibility to provide various network configurations such as, distribution and multi-access, as well as direct network access using relatively small earth stations. Based on these features, Digital Satellite Dedicated Networks (DSDN) are established to offer a class of digital services to dedicated user points, by allocating a specific portion of the satellite capacity.

Often the term "business" is associated with the definition of these networks because most applications are for business purpose. Nevertheless Dedicated Networks may be established either in a standardized manner which may or may not be compatible with the public switched network and the ISDN, or in a non standardized manner which is usually not interconnected with the public switched network and is designed to meet specific customer requirements.

2. User requirements

For networks not interconnected with the public switched network, user requirements may vary widely in speed, message length, traffic variation, delay tolerance, etc. These requirements are restricted by cost and network hardware/software constraints.

3. Network topology

Basic network topology is categorized into the following:

- point-to-point
- point-to-multipoint
- multipoint-to-point
- multipoint-to-multipoint

The implementation of these topologies can be achieved by various network architectures (e.g. direct link, star network, mesh network).

4. Link and network management schemes

Link control schemes closely relate to multiple access schemes. Multiple access schemes are primarily categorized into pre-assignment, demand assignment, random access and so on.

Network management schemes must be determined based on the throughput and delay characteristics of the multiple access schemes and the constraints imposed by the services offered.

5. User/network interface

For the non standardized networks, user/network interfaces for digital satellite communication systems for establishing dedicated networks, and direct-to-user's circuits, must be determined from the economical and technical standpoint based on the following factors:

- adaptability to satellite link characteristics such as delay, quality and availability
- compatibility with general use terminals
- efficient utilization of satellite resources, such as spectrum and orbit, allocated to the fixed-satellite service.

6. System performance objectives

There may be different quality performance requirements in dedicated satellite networks depending on the application.

6.1 Error performance objectives

The types of Digital Satellite Dedicated Networks cover a wide variety of applications which are characterized by different error performance requirements and design objectives often related to the type of services carried in these Networks.

Annex I gives examples of existing systems and illustrates how broad the range of applications can be. This can be observed by comparing the following three categories of networks which can all be defined as DSDN:

- Standardized SCPC connections via INTELSAT IBS or EUTELSAT SMS.
- Independent TDMA networks, as the Japanese SDCS system or the French TELECOM 1, which offer well structured forms of digital access for business users.
- Non-standardized connections on INTELSAT IBS or EUTELSAT SMS, such as VSAT based networks, designed to meet specific service requirements or users' requests.

Reference error performance objectives are specified in some cases, such as the "open network" applications in the INTELSAT IBS or the EUTELSAT SMS systems (see sections 3.2 and 4.0 of Annex I) which offer two well defined "grades of service", but often the error

performance objectives are fixed by the end user on a case by case basis. It can be observed from the examples in Annex I that "closed network" applications for unidirectional transmission of press or financial data (e.g. distribution of news photographs, texts, stock exchange data) usually require a much higher error performance quality than the standard quality of the "open network", and that closed network applications for bidirectional services in VSAT based networks (using TDM outbound from hub to VSATs, and TDMA inbound from VSATs to hub) are often designed to objectives slightly more stringent than those of open network applications.

It is therefore rather difficult to provide forms of unified description or guidelines for the error performance requirements of digital satellite networks in dedicated applications.

There are however two cases of possible utilization of these networks which may be better characterized from the error performance viewpoint if further studies are performed.

These are given in the following subsections.

6.1.1 Interconnection of satellite dedicated networks with the ISDN

Digital Satellite Dedicated Networks can provide interconnection between points external to the ISDN and the point of access to the ISDN. In this case, the satellite path forms part of the subscriber terminations which are external to the ISDN HRX according to the definition given in CCITT Recommendation G.821. The quality of service experienced by the end users may be affected by the error performance and availability objectives of these links, thus end user requirements should be given due consideration in link design.

6.1.2 Digital satellite dedicated networks providing ISDN equivalent performance

There could be a requirement for the establishment of Dedicated Networks offering end-to-end performance equivalent to the ISDN, namely the overall G.821 error performance objectives.

Such networks, fully external and independent from the ISDN, could interconnect terminals designed for the ISDN and provide services of ISDN type to a closed group of users before the switched network is ready.

The overall link between the terminal equipments would be represented by a Hypothetical Connection (See Fig. 1) comprising one satellite portion and terrestrial tails at both ends.

In this case the apportionment of the overall objectives to the satellite path would depend on the length and the performance of the terrestrial tails. As an example, Figure 2 presents three ways of making the apportionment.

Figure 2c represents the worst case condition for the satellite portion in an ISDN-based business system. Nevertheless, this apportionment is a relaxation of the objectives set for a satellite link in the public ISDN.

Figure 3 illustrates this relaxation by comparing BEP model b from Report 997 with two BEP models (1 and 2) which are examples based on the apportionment of Figure 2c [CCIR, 1986-90]. Using the method described in Report 997, these BEP models can be translated to the corresponding G.821 parameters - see Table I. It is worth noting that, although these calculations are based on a Poisson distribution of errors, the SES (Severely Errored Seconds) calculation results in a significant margin when compared with the G.821 based objective and this margin offers protection against the effects of error bursts.

Table I: Calculated G.821 parameters for models 1 and 2

	EFS (%)	DM (%)	SES (%)
Model 1	97,70	4,53	0,03
Model 2	96,78	4,88	0,005
possible allowance (G.821)	> 96	< 5	< 0.06

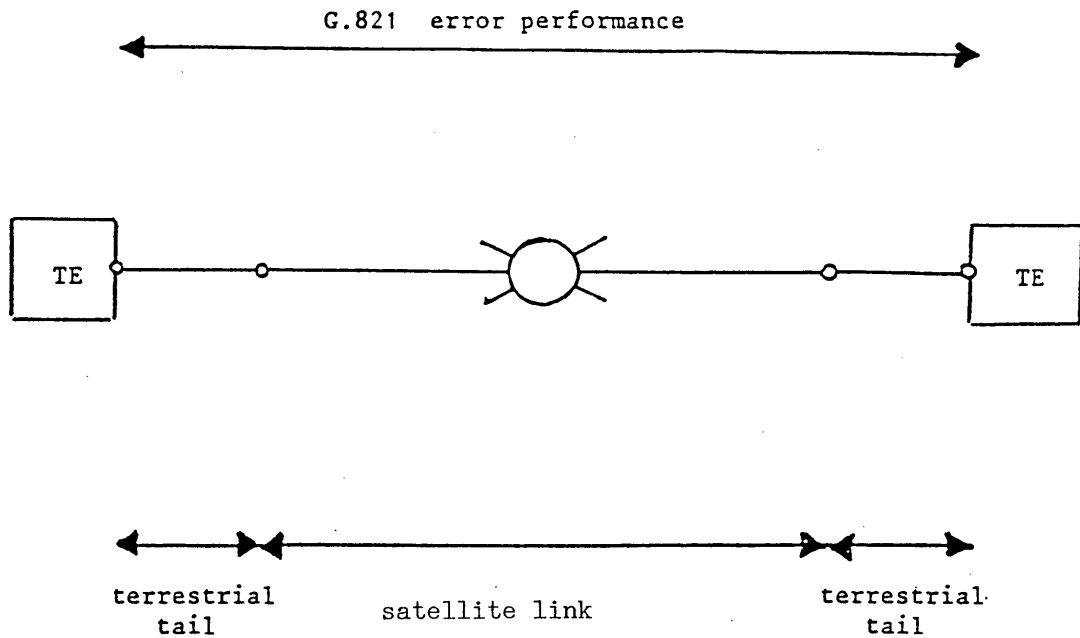

TE : Terminal Equipment

FIGURE 1 - Hypothetical connection including a satellite link which offers ISDN equivalent quality (e.g. end-to-end error performance objectives of Rec. G.821)

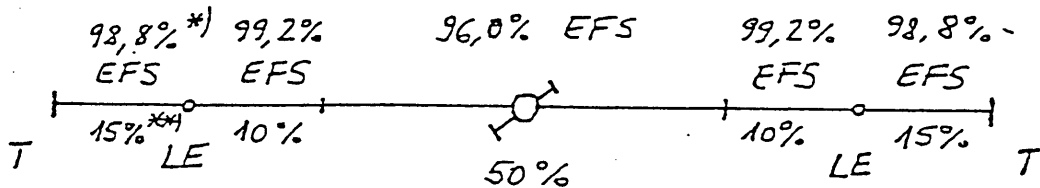
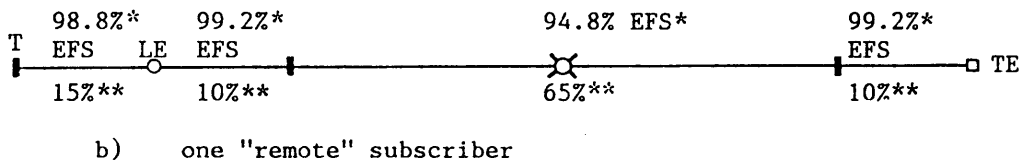
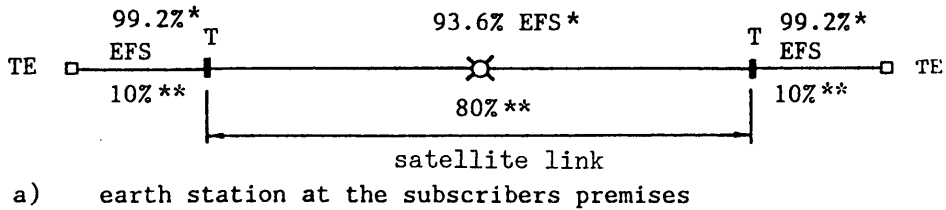

T : reference point
 TE: terminal equipment
 LE: local exchange

* Percentage of time
 ** Percentage of End-to-End (Recommendation G.821) HRX performance

FIGURE 2 - Examples of apportionment of the Rec. G.821 error performance objectives in a point-to-point connection including a satellite business system"

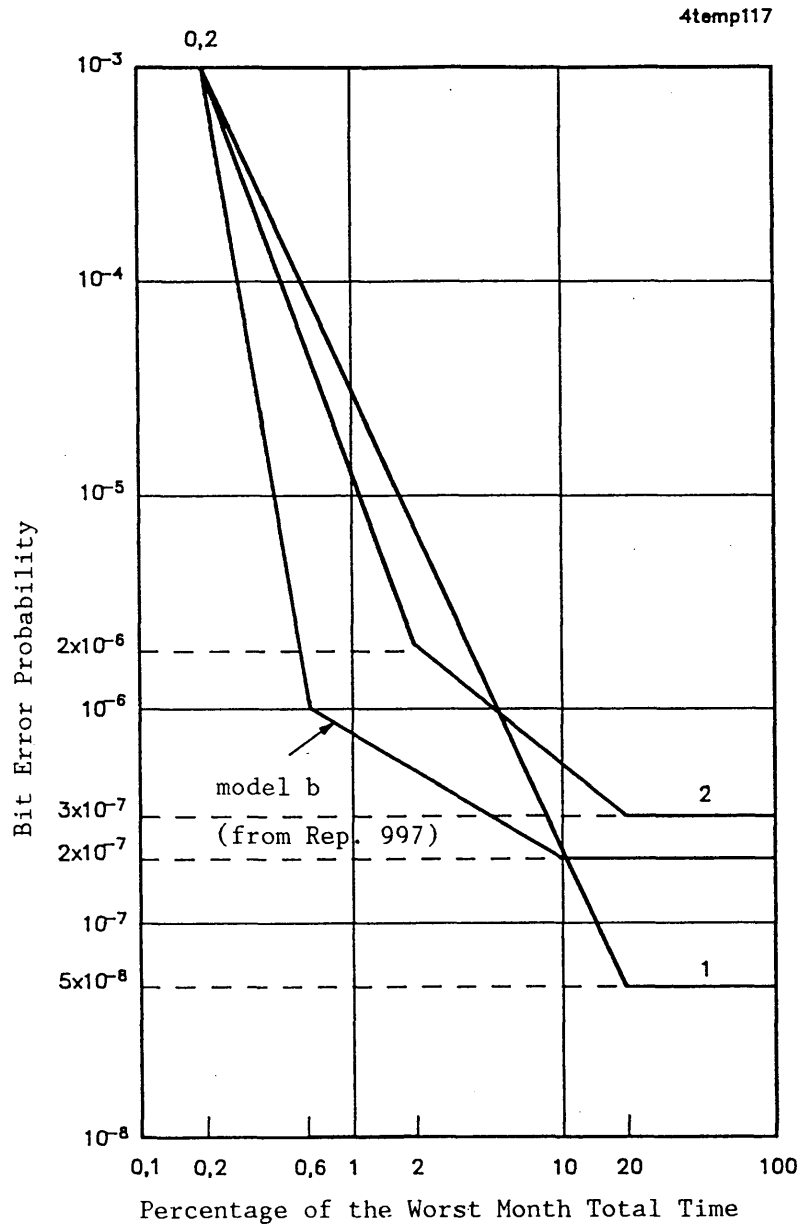

FIGURE 3

BEP performance models for DSDN which meet
CCITT Recommendation G.821

6.2 Availability

A business satellite network is a communications system where one customer's premises is directly connected to another customer's premises with dedicated facilities. These networks are alternatives to using the switched network and are generally constructed, or entered into, for economic reasons i.e. communication via a business satellite network is less expensive than communications via the switched network. Since these systems are being utilized by businesses, the period of heaviest use is during the business day and 24 hour a day availability may not be absolutely necessary.

From a practical viewpoint, most business satellite networks are being implemented at 14/11 GHz Band rather than 6/4 GHz Band with relatively small and therefore inexpensive antennas. Propagation conditions at these higher frequencies are generally more difficult than they are at 6/4 GHz Band. In the light of these facts, it is logical to expect that the availability of a business satellite network may be less than that of a switched network connection and thus a relaxed availability objective may be appropriate for business satellite networks.

The service is considered available if a given BER is not exceeded. The customer fixes a percentage of time for availability and does not care what happens during the remainder of the time.

The way business customers put requests to service providers is often different from what CCIR definitions and methods would suggest. For instance in certain cases only interruptions exceeding given durations (e.g. 2 hours, or 10 min) are considered unacceptable. These aspects are strictly related to the nature of each service and require further investigation.

It should be noted that some customers lease capacity on business satellite networks in order to overcome service availability problems associated with the public switched network (especially during "busy hour" periods). These customers are not generally prepared to relax their requirements and indeed may require a higher level of service availability than that which applies to links in the public network.

7. Earth stations

Implementation of economical earth stations is essential to expand the satellite communication applications. Optimization for earth station parameters, frequency bands and applied technologies such as modulation, coding and multiple access protocols must be achieved under the interference constraints to other satellite and terrestrial systems. The likely use of very small aperture terminals in the earth segment with poor side-lobe gain, may require careful analysis of the interference environment and appropriate provisions for coordination purposes.

References

CCIR Documents

[1986-90]: 4/362 (Federal Republic of Germany)

ANNEX I

Examples of existing systems used in dedicated network applications1. The Japanese SDCS system

The Satellite Digital Communication Service (SDCS), one of the new application services designed expressly for high-speed digital transmission, has been brought into commercial service using CS-2 and CS-3, Japan's communications satellites, in early 1985. The SDCS system is referred to as an example of digital satellite communication systems.

The SDCS system configuration is shown in Figure 4 and the major system parameters in Table II. A SDCS satellite channel is connected with digital terrestrial circuits which form access circuits. Data bit rates offered to subscribers range from 64 to 6144 kbit/s. Signals from each subscriber are conveyed to the SLT (Subscriber Line Terminal) by radio-subscriber lines or by metallic or optical fibre cables at speeds of 1544 or 6312 kbit/s. These signals are then multiplexed into 2048 or 8192 kbit/s signals and sent to the TDMA equipment.

Figure 5 shows the SDCS channel assignment scheme called the Multi-Access Closed Network (MAC-Net). The MAC-Net has three principal features:

- 1) The satellite channel is allocated to each user group using pre-assignment mode.
- 2) The "S" bit in service information channel controls signal transmission, differing from the conventional pre-assignment channel allocation scheme. No satellite channel signals (bursts) are transmitted if the "S" bit is OFF. That is the TDMA equipment transmits subscriber signals only when the "S" bit is ON.
- 3) No burst collision control for bursts in the pre-assigned channel is provided by the network.

The frame at the user/network interface consists of four components: information channel, signalling channel D, frame alignment signal F and service information channel with four indicators of DNR, UNR, S and SEND. The indicators of DNR, UNR, S and SEND indicate: circuit failures, unassigned satellite circuit, transmit demand and failures at DTE, or DSU to DTE, respectively.

It is easy to communicate in the following three ways using the MAC-Net:

- a) point-to-point,
- b) multipoint-to-point, and
- c) half-duplex, in which transmitting points change alternately.

Regarding the application, there are circuit switched services and multi-point TV conference as well as pre-assignment (PA) services in which users directly control the "S" bit.

BIBLIOGRAPHY

MORIHIRO, Y. [1984] - "Satellite Digital Communication System for New Business Use", JTR, Vol. 26, No. 4, pp. 270-277.

NAKASHIMA, H. et al. [1986] - "Satellite Digital Communication Service (SDCS) Using CS-2 in Japan" AIAA Proc., 86-0626, pp. 138-143.

TABLE II

Major system parameters

Frequency band	30/20 GHz
Multiple access	TDMA
Modem	QPSK coherent demodulation
FEC	R-1/2 Convolutional encoding Viterbi decoder
Clock	24.556 MHz
Transmission capacity	320 ch/transponder
No. of stations per transponder	Reference stations - 2 Traffic stations - 50
Bearer rate	64, 192, 384, 768, 1536, 6144 kbit/s

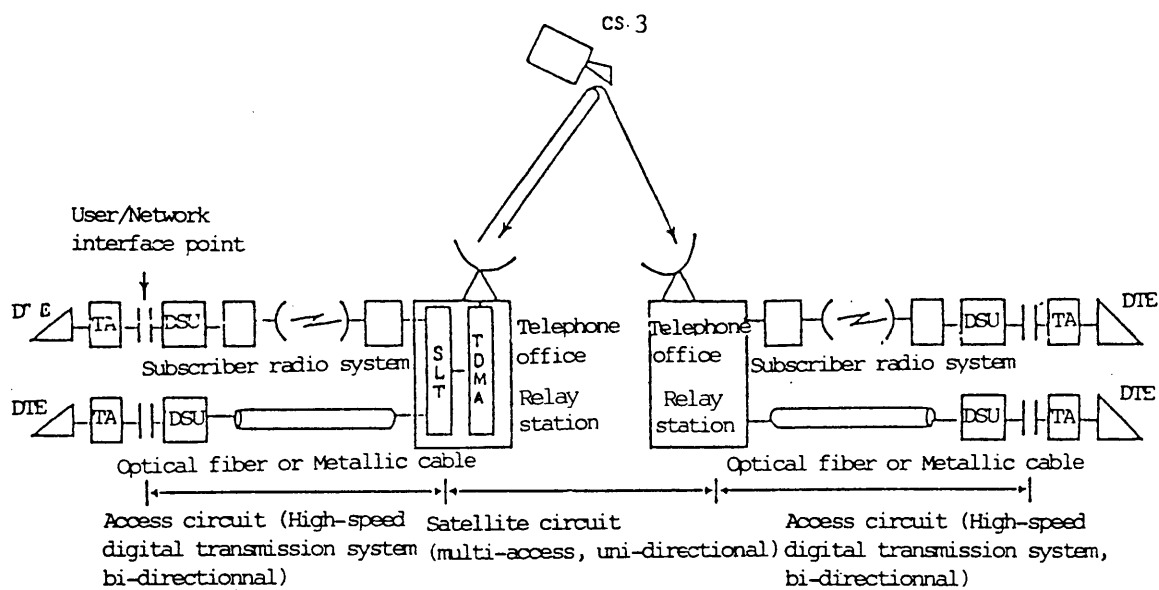

FIGURE 4

SDCS circuit configuration

DSU: Digital Subscriber Unit
 TA: Terminal Adaptor
 DTE: Digital terminal Equipment
 SLT: Subscriber Line Terminal

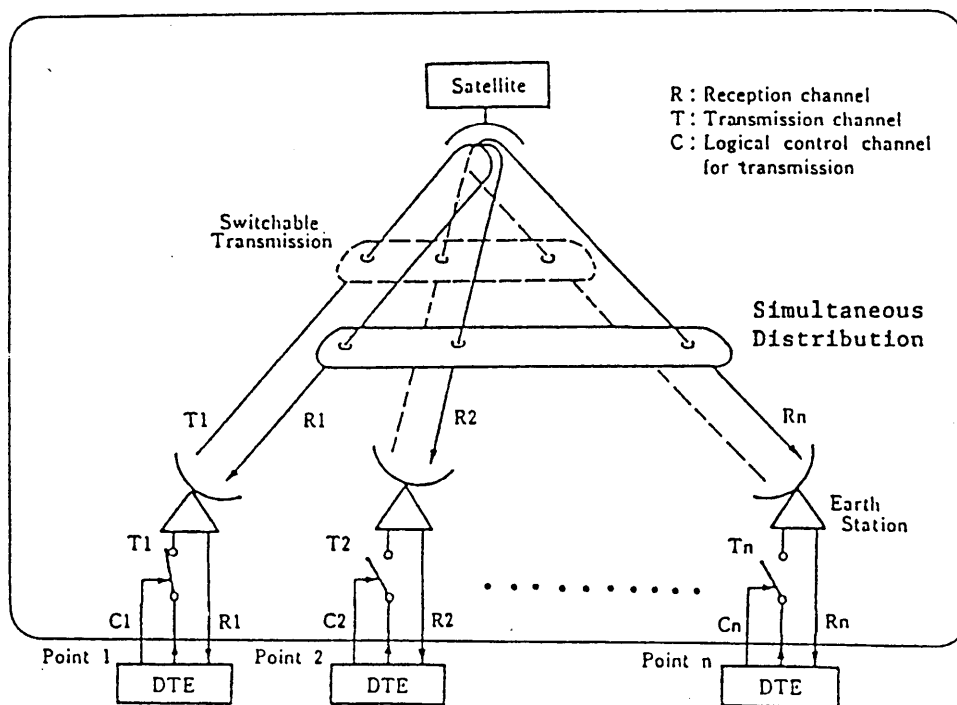

FIGURE 5

Multi-Access Closed Network (MAC-Net) configuration

2. The French business system TELECOM 1

A fully digital system using the French TELECOM 1 satellites and specially designed for multi-service corporate communications is in operation in France and Europe.

This system enables business, industrial, governmental, etc. organizations or companies to establish direct multi-purpose data links between their various premises. All types of data link, either bidirectional (symmetrical or unsymmetrical duplex) or unidirectional (with multi-user broadcast capability) are possible, ranging from low or medium bit rate (2.4 kbit/s to 64 kbit/s) to high bit rate (up to 2 Mbit/s) data transmission.

The system is entirely based on TDMA/DA transmission at 25 Mbit/s between a number of traffic stations forming the nodes of a mesh network. Synchronization and dynamic demand assignment (DA) management are carried out by a central station.

The Earth segment comprises of the central station located at Mulhouse (eastern France) and the traffic stations. In 1987, about 60 traffic stations were in operation, mainly in France but also in Denmark, Germany (FRG), the Netherlands, the United Kingdom and Ireland.

The unattended traffic stations are composed of:

- an outdoor radio, sub-system comprising a 3.5 m non-tracking antenna (including the LNA) and shelter-contained telecommunication equipment.
- an indoor TDMA terminal comprising the modem, the common logical units and the interface modules.

The main system characteristics are summarized in Table III.

The TDMA terminal interfaces are provided at 2 Mbit/s, through the TDMA interface modules (TIM).

They are three types of TIM:

- 2 Mbit/s unstructured TIM used to transmit a data stream transparently at 2 Mbit/s.
- 2 Mbit/s framed or superframed TIM used to transmit voice channels, or data channels, at 64 kbit/s or 32 kbit/s (or combinations thereof) on a reserved basis (with subscriber line signalling transparency) or, on a call-to-call basis.
- TIM-X 50: this type of TIM is used to transmit data from 2400, 4800, 9600 bit/s terminals in the TDMA frame.

Furthermore, a TIM/T1 at 1.5 Mbit/s is also available.

For more detailed system information, see CCIR Handbook on Satellite Communications - FSS (Second Edition, Geneva, 1988) § 5.6.3.3, "A typical example of a medium bit rate terminal: Telecom 1."

TABLE III

Main characteristics of the French business system (TELECOM 1)

Frequency bands	down-link: 12.5 - 12.75 GHz up-link: 14 - 14.25 GHz
Multiple access	TDMA
Frame duration	20 ms
Modem	Phase modulation (2/4 PSK) with differential demodulation and differential encoding
Bit rate	24.576 Mbit/s
Number of transponders	6 transponders accessible through frequency hopping at receive side
User data bit rate	2.4, 4.8, 9.6 kbit/s 32, 64 kbit/s n x 64 kbit/s 2 Mbit/s 91.5 Mbit/s optional)

3. INTELSAT Business Services (IBS) Network

INTELSAT Business Services (IBS) digital carriers utilize a Quadrature Phase-Shift-Keying (QPSK) modulation with Frequency Division Multiple Access (FDMA) technique. The service is designed for communication between INTELSAT Standard A, B, C, E and F earth stations and facilitates the use of national gateway, urban gateway, and customer-premise types of earth stations, but is not intended to be used for public switched telephony.

3.1 Grades of services (Basic and Super)

Two grades of service are offered: Basic and Super. Basic IBS is designed to maximize channel capacity in both 6/4 GHz and 14/11 GHz Band transponders. As an option, Super IBS is offered to provide an availability at 14/11 GHz Band equivalent to 6/4 GHz Band through an increase in uplink e.i.r.p. Super IBS has been designed to meet the requirements of CCIR Recommendation 614 and therefore offer ISDN equivalent quality. AQ comparison of Basic and Super IBS is shown below.

Comparison of Basic and Super IBS

Performance Objective	6/4 GHz Band Uplinks (6/4 & 6/11-12 GHz)	14/11 GHz Band Uplinks (14/11-12 & 14/4 GHz)		Units
Service	Basic	Basic	Super*	
Unavailability	0.04	1.0	0.04*	% per year
Minimum Clear Sky BER	10^{-8}	10^{-8}	10^{-8}	
Threshold BER	10^{-3}	10^{-6}	10^{-3}	
System Margin	3.0	2.5	7.0	dB

3.2 Categories of system usage (closed and open networks)

There are two general categories of system usage for IBS: a closed network and an open network. Regardless of the category of IBS usage, the earth station antenna and RF characteristics are the same.

- a) The closed network is intended to provide freedom to the user in selecting the digital system required for his particular needs. The performance characteristics for this type of service do not require specifications related to interconnection with other users and can be defined in terms of RF transmission characteristics. In general, the only mandatory requirements are those needed to ensure that one user's emissions will not interfere with others.
- b) An open network requires a certain degree of common terminal features to be defined in order for one user's network to interface with another. Carrier parameters, e.i.r.p.'s and other requirements which are necessary to ensure the compatibility of equipment are thus mandatory.

* Basic IBS provides a BER of 10^{-6} for 99% of the time; at 14/11 GHz Band Super IBS provides a BER of 10^{-6} for significantly greater than 99% of the time.

3.2.1 Closed network characteristics

Example transmission parameters for Rate 3/4 FEC are shown for closed network operation in Table IV. Although these types of FEC are common in the closed network, their use is not mandatory, no coding may be used in some circumstances. A wide range of bit rates is possible in addition to the examples shown.

3.2.2 Open network characteristics

Example Transmission Parameters

Example transmission parameters for open network operation are shown in Table V. A wide range of other bit rates are also possible.

Bit Error Rate Performance

In IF back-to-back mode, with FEC and data scrambling, the channel unit is required to meet the performance requirements given below. The effects of any carrier slips must be included.

BER better than	E_b/N_o (dB)
10^{-3}	4.2
10^{-4}	4.7
10^{-6}	6.1
10^{-8}	7.2

The E_b/N_o is referred to the modulated carrier power. The data rate equals the information rate plus overhead.

Forward Error Correction

Rate 1/2 convolutional encoding with Viterbi decoding is used by all carriers in the IBS Open Network. The constraint length of the coding is seven. The soft decision Viterbi (maximum likelihood) decoder must use adequate quantization to achieve the required BER performance.

Because of the fairly common use of Rate 3/4 FEC in the Closed Network, a particular coding process is recommended by INTELSAT which permits easy switching between Rates 1/2 and 3/4, if desired.

Scrambler

A 15-stage synchronous data scrambler of generator polynomial $1 + X^{-14} + X^{-15}$ is employed to ensure adequate energy dispersal in accordance with Recommendation 358.

Satellite Link Encryption

The use of satellite link encryption is optional, and the encryption method and algorithm are subject to bilateral agreement.

TABLE IV - Example IBS reference transmission parameters for rate 3/4 FEC*
(Closed network, 10% overhead)

Information Rate (bit/s)	Transmission Rate (bit/s)	Occupied Bandwidth Unit (Hertz)	Allocated Bandwidth Unit (Hertz)	C/T (dB(W/K))	C/N ₀ (dB(W/Hz))
				10 ⁻⁸	10 ⁻⁸
64 k	94 k	56 k	67.5 k	-171.0	57.6
1.544 M	2.3 M	1.38 M	1.643 M	-157.1	71.5
2.048 M	3.0 M	1.80 M	2.138 M	-155.9	72.7
8.448 M	12.4 M	7.44 M	8.708 M	-149.8	78.8

* Depending upon the actual transponder and link conditions, INTELSAT may establish the clear sky setting of the link at a C/N better than or equal to 10.1 dB in order to ensure adequate margins. The C/T and C/N₀ values for 10⁻³ and 10⁻⁶ are 3.5 dB and 1.1 dB less than those shown for 10⁻⁸ respectively.

Reference Unit = An integer multiple of the smallest carrier size (94 kbit/s x n) where n = 1 to 132. Example reference units are shown in this Table. In the case of 1.544 Mbit/s and 6.312 Mbit/s, which are not integer multiples, allocated bandwidth based on n = 25 and 99 respectively will be assigned.

TABLE V - IBS open network transmission parameters*
 (Open network, 1/15 (about 6.7%) overhead)

Information Rate (kbit/s)	Data Rate Including Overhead (kbit/s)	Transmission Rate (kbit/s)	Occupied Bandwidth Unit (Hertz)	Allocated Bandwidth Unit (Hertz)	No. of 22.5 kHz Slots for Allocated Bandwidth	C/T (dB(W/K))	C/N ₀ (dB(W/Hz))
						10 ⁻⁸	10 ⁻⁸
64	68.3	137	82 k	112.5 k	5	-172.5	56.1
1544	1638.4	3277	1.97 M	2.318 M	103	-158.7	69.9
2048	2184.5	4369	2.62 M	3.082 M	137	-157.5	71.2

* Depending upon the actual transponder and link conditions, INTELSAT may establish the clear sky setting of the link at a C/N better than or equal to 6.8 dB in order to ensure adequate margins. The C/T and C/N₀ values for 10⁻³ and 10⁻⁶ are 3.0 dB and 1.1 dB less than those shown for 10⁻⁸.

NOTES :

1. The assumed data rate (including overhead) E_b/N₀ is 7.6 dB for a BER of 10⁻⁸.
2. Transmission Rate = (Information Rate plus 1/15 overhead) x 2.
3. The bandwidth allocated to the carrier in the satellite transponder is a multiple of 22.5 kHz.

4. EUTELSAT Satellite Multiservice System (SMS)

The EUTELSAT Single Channel Per Carrier (SCPC) Satellite Multiservice System (SMS) offer fully digital service for business and other applications using capacity on the EUTELSAT I satellites. The "open network" configuration offers standardized forms of access and error performance levels.

The customer bit rates can range from 2.4 kbit/s to 2048 kbit/s, while carrier information rates are of 64 kbit/s and multiples thereof up to 2048 kbit/s.

Two grades of service are offered: standard grade with a BER lower than 10^{-6} for 99% of the time and high grade giving Recommendation 614 quality.

Three types of earth stations are standardized with antenna diameters of 5.0 to 5.4 m, 3.7 and 2.4 m respectively. The main parameters and characteristics of the EUTELSAT SMS earth stations are provided in Table 5.XXX of Appendix 5-I, Chapter 5 of the CCIR Handbook on Satellite Communications FSS (Geneva 1988, Second Edition).

The SMS transponder can also be used for other network architectures tailored to customer requirements referred to as "closed networks". Table VI gives a list of existing SMS closed network applications, with the relevant BER and percentages of time used as design criteria. Figure 6 gives the representative points of all the various performance objectives on logarithmic coordinates of BER versus percentage of time. All percentages of the time have been expressed in terms of the worst month, by using the conversion formula from annual to worst month statistic given in Report 564.

For illustrative purpose the representative points are grouped into four classes which correspond to different service requirements. In particular class A comprises closed network applications for data distribution (news photographs, texts, stock exchange data etc.) and for computer to computer interconnection, while class B comprises closed network applications for bi-directional services in VSAT based networks, e.g. using TDM outbound (from hub to VSATs) and TDMA inbound (from VSATs to hub), as well as data collection and some data distribution applications.

TABLE VI - Design objectives for non standard applications
(closed networks) in the EUTELSAT SMS system.
BER not to be exceeded for more than a given
percentage of time

Type of network	Bit rate (kbit/s)	BER	% of time y = year wm = worst month
Distribution, star point to multipoint, uni-directional (financial data)	128 BPSK	10^{-9}	90 y
Unidirectional, star (distribution of news text + photo)	19.2 BPSK	10^{-7}	99.9 y
Unidirection, point to multipoint (stock exchange data distribution)	64 BPSK	10^{-7}	99.9 y
Unidirectional, point to multipoint (stock exchange data distribution)	19.2 BPSK	10^{-7}	99.9 y
Point-to-point bi-directional (computer inter-connection)	64 QPSK	10^{-6}	99.0 wm
Bidirectional, star (Registration and delivery of documents)	9.6 BPSK	10^{-6}	99 y
	64 QPSK	10^{-6}	99.3 y
Interactive TDM (outbound) TDMA (inbound)	512 BPSK, TDM 64 BPSK, TDMA	10^{-6}	99 y
Bidirectional star (computer to terminals)	64 QPSK	10^{-6}	99 y
Unidirectional star point to multipoint (distribution of documents)	64 QPSK	10^{-6}	99 y
Interactive partly meshed (civil air traffic control)	9.6 BPSK	10^{-6}	99.5 y

TABLE VI (cont'd)

Type of network	Bit rate (kbit/s)	BER	% of time y = year wm = worst month
Interactive TDM/TDMA star - collection of environmental data - emergency communications	2048 QPSK-SCPC 512 TDM-64 TDMA BPSK	10^{-6}	99.5 y
Interactive star TDM/ TDMA (Terminal to central computer connection)	256 TDM-BPSK 56 TDMA-BPSK	10^{-6}	99 y
Fully meshed TDMA (voice, data, video- conference)	1544 QPSK	10^{-6}	99.5 y
Interactive star TDM/ TDMA (on trial)	512 BPSK-TDM 128 BPSK-TDMA	10^{-7}	99 y
Unidirectional point to multipoint spread spec- trum (Data distribution)	19.2 (2.4576 Mchip/s) BPSK SP. SP.	10^{-7}	99 y
Unidirectional Point to multipoint -(distribution of news) -(stock exch. data, reduced quality)	19.2 (2.4576 Mchip/s) BPSK SP. SP.	10^{-7} 10^{-7}	99.9 y 99 y
Unidirectional point to multipoint (experimental)	19.2 (2.4576 Mchip/s) BPSK SP. SP.	10^{-7}	99 y
Interactive star TDM/ TDMA	256 BPSK-TDM 64 BPSK-TDMA	10^{-7} 10^{-7}	99 y 99.9 y
Unidirectional point to multipoint broadcast star (radio sound distribution)	1920 QPSK	10^{-6}	99 y

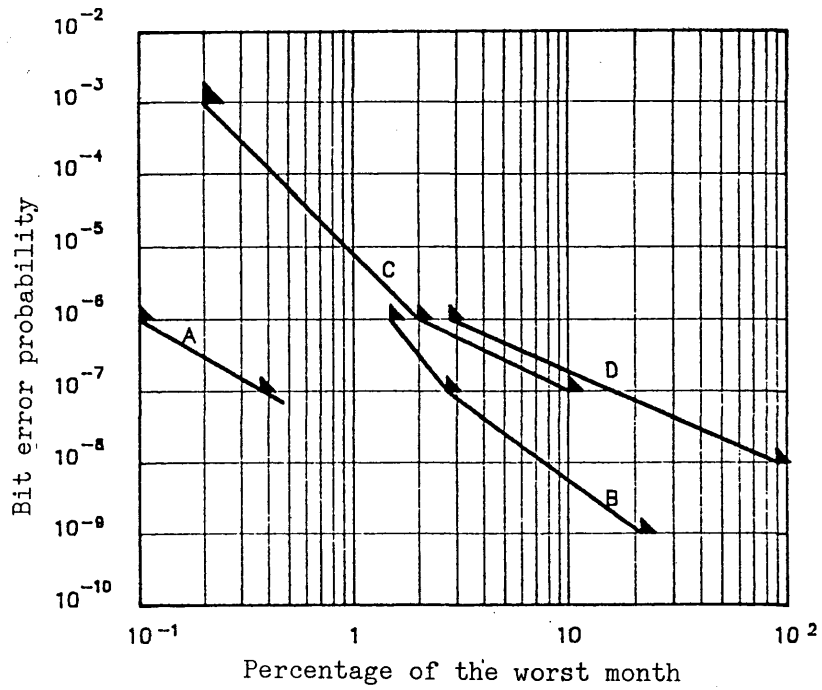

FIGURE 6 - Error performance objectives for digital satellite dedicated networks in the EUTELSAT SMS system. The points given in the figure are used as design objectives for different applications

- A: Very high quality closed network
- B: High quality closed network
- C: High grade open network
- D: Standard grade open network

REPORT 451-3

**FACTORS AFFECTING THE SYSTEM DESIGN AND THE SELECTION
OF FREQUENCIES FOR INTER-SATELLITE LINKS
OF THE FIXED-SATELLITE SERVICE**

(Question 31/4)

(1970-1974-1978-1982)

1. General

The use of radiocommunication links between space stations in the fixed-satellite service is a means of interconnecting space networks. It is an alternative to employing multiple earth station antenna systems or multiple-hop circuits. Several experiments using this technique have been successfully conducted.

In recognition of the potential usefulness of inter-satellite links, the 1971 WARC-ST defined the inter-satellite service. The WARC-79 allocated to this service frequencies above 22 GHz.

This Report considers, in broad terms, some of the concepts involved in the development of inter-satellite links and the technical requirements of inter-satellite link operation.

Although the use of laser beams between spacecraft may be possible, their extremely narrow beamwidths and other limitations tend thus far to favour the use of millimetre wave or other radio links, and only the frequency range of 3 GHz to 300 GHz is considered in this Report.

2. Advantages and disadvantages of inter-satellite links

There are at least four broad benefits provided by inter-satellite connections, viz:

- a reduction in the number of earth stations and/or associated antennas needed;
- better circuit utilization of available capacity on paths between Earth and space may be obtained;
- the provision of extensive (global) connectivity for earth stations accessing satellites through spot beams;
- increased flexibility of network arrangements.

In order to illustrate these points consider the extreme hypothetical example of a system containing, for every earth station, a satellite fully dedicated to connecting with only one earth station (a "tethered" satellite). Circuit connections between earth stations in the system would be made through inter-satellite communication links in the orbital arc. In effect each satellite would be a very long extension of its associated earth station.

In this extreme example of tethered satellites, any inefficiencies in actual capacity utilization of available power and bandwidth due to:

- circuit grouping,
- connection constraints,
- switching,
- multiplex, etc.,

are removed from the earth-space links to the geostationary arc. Within the geostationary arc and removed from the terrestrial links, the greatly increased available spectrum at submillimetre or optical wavelengths would be more tolerant of inefficiencies in utilization generated by real system circuit connection constraints.

Furthermore, since there would be only one earth station for each satellite, the satellite antenna coverage requirement would be minimized. Conceptually, this allows using a very narrow beam earth oriented satellite antenna providing good off-axis rejection of received up-link interference signals from other earth stations, and minimizes generation of down-link interference to other earth stations. With a reduced level of interference flux density generated by low antenna sidelobes, closer inter-satellite spacings could be allowed. Also, with only one bothway connection to an earth station, additional capacity increases beyond that provided by narrow antenna beams would be obtained from the single carrier per transponder mode of operation (i.e., reduced intermodulation and little or no transponder back-off).

Such a system conceptually would allow maximization of the space to earth spectrum efficiency. With the greater spectrum availability at the higher frequencies for the inter-satellite links, it is reasonable to expect that orbital capacity would still be dominated by the capacity achieved on the earth space links even in their most advantageous configuration. Consequently, the idealized model described, would appear to offer an upper limit to achievable geostationary orbital capacity. Less advanced systems using inter-satellite links to connect satellites, each of which serves several earth stations, would give the benefits listed above to a lesser degree.

However, CCITT Recommendation G.114 specifies a limit of 400 ms as an acceptable telephone channel signal propagation time. The signal delay in a link using a single geostationary satellite and including an allowance for the delay in the terrestrial end connections is generally about 290 ms. Hence the permissible signal delay in a telephone channel on an intersatellite link should not exceed a figure of the order of 110 ms. The separation angle between the two geostationary satellites is defined by the formula:

$$\theta \leq 2 \arcsin \frac{t \cdot C}{2(R_E + H)}$$

where

- t : permissible signal delay in a telephone channel on the satellite-to-satellite section,
- C : speed of radiowave propagation,
- R_E : Earth's radius,
- H : height of satellite above Earth's surface.

To meet CCITT Recommendation G.114, the separation angle between two geostationary satellites in an inter-satellite link for telephony should not exceed a figure of the order of 50°.

In the near term, with the object of economically augmenting existing capacity with minimum impact on existing systems, consideration must be given to more limited concepts of inter-satellite link facilities. Typically, such links might provide only limited inter-satellite circuit capacity. Then near-term systems would probably have the following characteristics:

- relatively short inter-satellite spacing,
- limited capacity,
- few systems in service,
- minimum impact on existing spacecraft technology: structure, pointing/orientation, and RF components.

3. Inter-satellite link design considerations

The elements which must be taken into account in the design of an inter-satellite link are the following:

- geocentric satellite spacing ϕ (degrees);
- frequency f (MHz);
- antenna diameter D (metres) of equivalent circular aperture of about 55% efficiency;
- receiving system noise temperature T (K);
- available RF power p (watts);
- required bandwidth b (Hz).

Based on these parameters, the performance of an inter-satellite link may be expressed in terms of its predetection carrier/noise ratio which can be approximated by the equation:

$$C/N = 3.72 \frac{pD^4 f^2}{\varphi^2 kTb} 10^{-18} \tag{1}$$

where $k = 1.38 \times 10^{-23}$ J/K is Boltzmann's constant. This equation holds for small orbital separations. For $\varphi > 10^\circ$, the term φ^2 should be replaced by the term $1.31 \times 10^4 \times \sin^2(\varphi/2)$.

In equation (1), the receiving system noise temperature is a function of frequency. Noise temperatures of about 1000 K are typical for frequencies around 6 GHz, and the following frequency dependence is postulated:

$$T(f) \approx 31.6 (f/6)^{1/2} \text{ K} \tag{2}$$

In a real system design the parameters C/N and φ are usually system constraints; the former determined by the required system performance, the latter by inter-satellite interference considerations. It is of interest to establish the relationship between power requirements and antenna size in inter-satellite links.

Figure 1 shows relative available power per unit bandwidth (p/b) as a function of frequency with antenna diameter as a parameter, in dB against an arbitrary reference and for fixed values of φ and C/N . Also shown in Fig. 1 are the beamwidths of inter-satellite link antennas for the various combinations of D and f . Increasing the antenna diameter on inter-satellite links reduces power requirements in an inverse 4th power relationship. As antenna size increases, beamwidth decreases and mutual pointing requirements between the two satellites become increasingly more stringent.

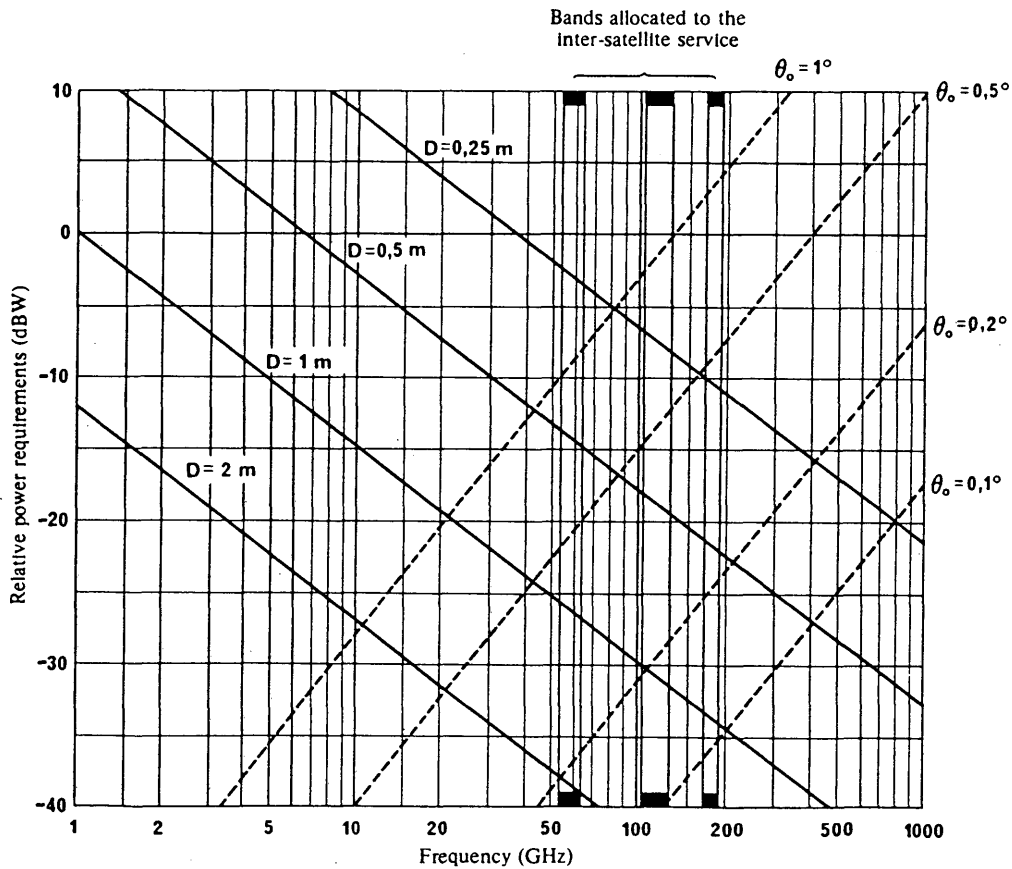

FIGURE 1 — Relative power per unit bandwidth required for an inter-satellite link as a function of frequency for various antenna diameters: no pointing or tracking losses

D : Antenna Diameter
 θ_0 : Half-Power Beamwidth

For example, with 20 watts of available power, at a satellite spacing of 3 degrees, a 100 MHz wide inter-satellite link at 54 GHz with a postulated carrier/noise ratio of 30 dB would require antennas of 0.68 metre diameter. The beamwidth of such antennas is about 0.56° , and pointing accuracies of about 1/10 of that, or about 0.06° , would be required to utilize the full antenna gain. The carrier/noise ratio of 30 dB has been assumed on the basis that the inter-satellite link noise should not significantly affect total performance.

Hence, the use of reasonably sized antennas to minimize power at 54 GHz or beyond is likely to require mutual tracking between satellites with the present state of the art in spacecraft attitude stabilization and orbital element matching. Tracking and beam steering technology is well developed up to optical frequencies.

Nevertheless, to minimize spacecraft complexity and improve reliability it is attractive to consider, e.g., for INTELSAT applications, inter-satellite links which can be maintained without mutual tracking.

4. Non-tracking inter-satellite links

When considering inter-satellite links the antennas of which do not track each other, two additional system constraints need to be taken into consideration:

- allowable signal level variation on the inter-satellite link, ΔC (dB);
- antenna pointing error due to relative attitude tolerances of the spacecraft, δ (degrees).

Typical in-plane and plane-normal pointing error budgets for nominally geostationary spacecraft are derived in Annex I. Within the state of the art net error angles between 0.5° and 1° can be realized.

The main lobe gain degradation due to pointing offset, $g(\theta)/g_0$, for a simple feed antenna may be approximated by:

$$g(\theta)/g_0 \approx 10^{-1.2 (\theta/\theta_0)^2} \quad (3)$$

where θ is the angle off boresight (in degrees) and θ_0 the half-power beamwidth (in degrees) which, in turn, is related to the aperture diameter D by:

$$\theta_0 = \frac{2.14}{fD} \cdot 10^4 \quad \text{degrees} \quad (4)$$

where,

$$f = \text{MHz}$$

$$D = \text{metres.}$$

Considering that the pointing uncertainty involves a boresight error of $\theta = \delta$ and that two antennas are involved, each of which may go through gain variations between g_0 and $g(\theta)$, one may combine equations (3) and (4) to obtain:

$$20 \log (g/g_0) = \Delta C \approx 5.24 (\delta f D)^2 10^{-8} \quad \text{dB} \quad (5)$$

Combining equations (1) and (2), solving the new expression for minimum required power spectral density p/b , and inserting equation (5) as an additional attenuation due to pointing errors, one obtains, in dB notation:

$$10 \log (p/b) = P_0 = C/N + 20 \log \phi - 15 \log f - 40 \log D +$$

$$+ 5.24 (\delta f D)^2 10^{-8} - 43.2 \quad \text{dB(W/Hz)} \quad (6)$$

Plots of P_0 versus f for $\delta = 0.5^\circ$ and $\delta = 1^\circ$ and antenna diameters of 0.25, 0.5, 1 and 2 metres (Fig. 2) show that minimum power requirements may be realized at frequencies below 54 GHz, the lowest frequency presently allocated to the inter-satellite service. Figure 2 uses an arbitrary reference for P_0 and considers C/N and ϕ to be system constants. How close to the optimum (i.e., minimum P_0) frequency an inter-satellite link can be

operated depends on the signal level tolerance ΔC one is willing to accept. Limits for $\Delta C = 1$ dB and 2 dB are shown in Fig. 2. The effective optimum frequency is that at which the P_0 and ΔC curves intersect. Absolute minimum power requirements are realized for ΔC of about 3.4 dB; hence, there is no advantage to be gained by allowing a greater level variation than about 3 dB.

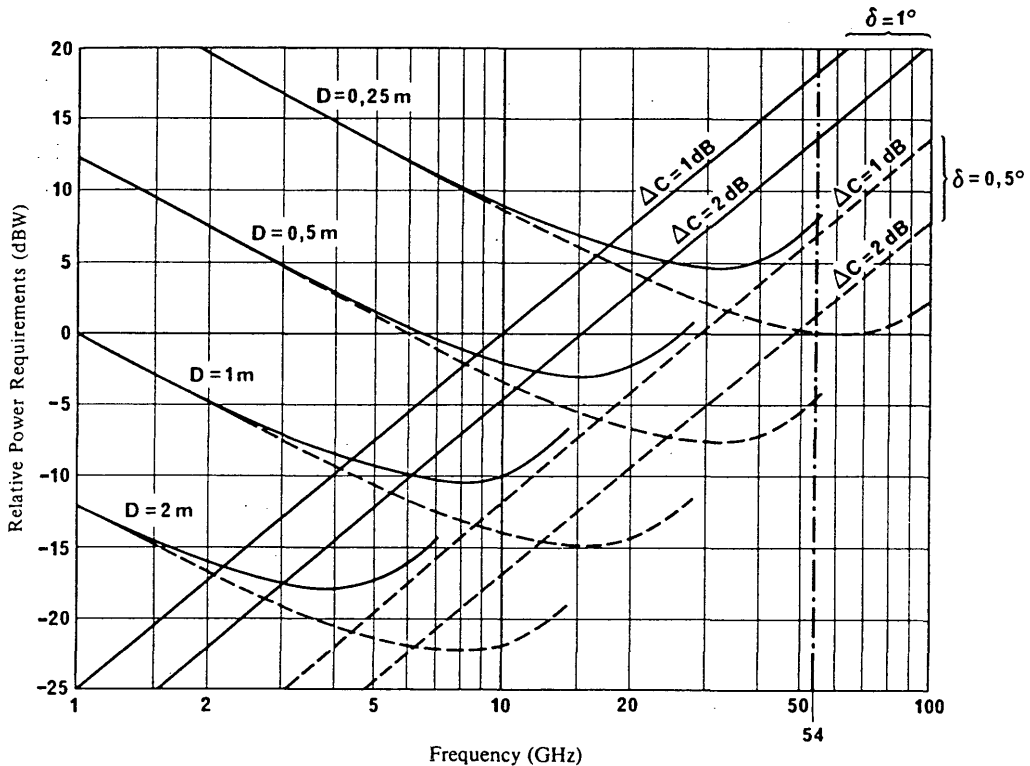

FIGURE 2 — Relative power requirements in a non-tracking inter-satellite link as a function of frequency with antenna diameter (D), net pointing error (δ) and allowable level variation (ΔC) as parameters

— $\delta = 1^\circ$
 - - - $\delta = 0.5^\circ$

These considerations indicate that for antenna sizes greater than 0.25 metres the optimum frequencies for non-tracking inter-satellite links between closely spaced satellites may lie below 54 GHz, the larger antenna sizes favouring the lower frequencies.

5. Frequency re-use among inter-satellite links with tracking antennas

Annex II to this Report presents the results and conclusions of an analysis, based on certain assumptions, of the degree to which inter-satellite links between geostationary satellites can re-use the same frequencies.

6. Choice of frequencies for inter-satellite links

Two distinct categories of use can be envisaged for inter-satellite links operating between geostationary communication satellites:

- (a) Links between satellites separated quite widely in the geostationary satellite orbit (e.g. 60°) to extend the geographical coverage of a system without relaying at an earth station.
- (b) Links between satellites relatively close together (e.g. 3° to 5° orbit spacing) and having virtually the same coverage area, but serving different communities of earth stations.

The optimum technical parameters for these two types of link, which would normally be quite different, are considered below.

6.1 *Long inter-satellite links*

In category (a) links, a high path loss will exist between the satellites, comparable with the path loss from a geostationary satellite to the Earth, and to keep the link transmitter power to a practicable value it would be necessary to use high gain transmitting and receiving antennas. For a maximum antenna diameter of, say, 1.2 m governed by satellite launch vehicle shroud dimensions, this high gain would call for operation at as high a frequency as possible, typically in excess of 20 GHz, and preferably in the inter-satellite band already allocated at 54.25 to 58.2 GHz. If station-keeping errors and orbital inclination are kept to small, but currently achievable values, variations in the direction from one satellite to the other will be quite small at the wide separation distances involved in these systems, allowing the use of narrow beam antennas even in the absence of antenna tracking facilities.

6.2 *Short inter-satellite links*

For the short-hop type of link described in category (b) the relative proximity of the satellites results in large angular variations in the link path for quite small values of orbital inclination. For example, the maximum angular variation in a link between satellites spaced 4° apart and each having orbit inclination tolerances of $\pm 0.1^\circ$ will be:

$$2 \text{ arc tan } \frac{0.2}{4} = 5.7^\circ$$

This assumes a "worst-case" situation where the latitudinal excursions of the two satellites are in complete antiphase. This condition would normally be avoided by suitable choice of orbital parameters and, as shown in Annex I, it should be possible to reduce the angular variation to $\pm 1^\circ$. If antenna tracking were available, high gain antennas could be used for short-hop inter-satellite links. However, antenna tracking would involve rather sophisticated satellite devices, probably not currently achievable in a reliable, low-mass form. It is therefore necessary to use antennas with beamwidths equal, in the example quoted above, to 2.0° plus an allowance of perhaps 0.15° for satellite attitude errors.

These results and Fig. 2, indicate that non-tracking antennas one metre in diameter would be best served by frequencies of the order of 10 GHz. If the angular variation could be reduced to a fraction of one degree by an antenna tracking system, the optimum would be raised to somewhere in the region of 20 to 30 GHz. The tracking problem could be relieved to some degree by the use of smaller antennas, but the transmitter power requirement would be substantially increased.

Because of interference considerations it would not be possible to use fixed-satellite space-to-Earth or Earth-to-space bands for space-to-space links. However since link transmission paths will be directed well away from the Earth, there may be no problem in sharing with terrestrial services, and this point is examined in Report 387.

6.3 *Device technology*

Today the 11/14 and 20/30 GHz technology is well-developed for space stations. It would be very desirable for this space-proved hardware or similar equipment to be made usable for inter-satellite links. Frequencies above 50 GHz may be too high for early implementation.

6.4 *Interference and co-ordination problems*

The following substantial problems have been identified:

- The inter-satellite service will need full duplex capability. Pairs of bands of equal width separated by a gap in frequency, will therefore be necessary.
- The inter-satellite bands should be separated in frequency from the up and the down link bands. It is advisable to have gaps between any two of these bands to minimize the interference problems. An inter-satellite frequency is used on one satellite for transmission and on another for reception. With up or down path frequencies very close to an inter-satellite frequency it would be possible to get very large level differences between a transmitter and a receiver adjacent in frequency. This leads to very severe isolation requirements on board the satellite, so severe, in fact, that it would be necessary to leave part of the bands unused to create a gap between the transmitting and the receiving frequencies.
- In general the inter-satellite frequency bands should not be shared with other bands used by satellites. However, they can be shared with bands used for some terrestrial services. See Report 791.

- The beams of all inter-satellite links would be aimed in the plane of the geostationary satellite orbit and the angular separation between the beams of inter-satellite links belonging to different systems may be no greater than the angular spacing between adjacent satellites. In order to achieve frequency re-use of the spectrum allocated for inter-satellite links it will be necessary to design for very narrow beamwidths, low side-lobe levels and highly accurate antenna pointing capability in respect of inter-satellite link applications. It is also clear that there is a need to devise techniques and criteria for the co-ordination of frequencies assigned to inter-satellite links.

7. Conclusion

From the preceding discussion, it is reasonable to expect increasing interest in inter-satellite links. Some of the major technical issues identified as requiring further study are:

- design and specification of inter-satellite link transmission parameters, technology and design;
- inter-orbital trunking arrangements and switching concepts/technology;
- impact on spacecraft mechanical design requirements.

A possible demand can be foreseen for "short-hop" inter-satellite links to provide interconnection facilities between communication-satellite networks, and the optimum frequency of operation is found to be substantially below the lowest frequency allocated for the inter-satellite service, and preferably between 15 and 35 GHz.

BIBLIOGRAPHY

KURAKOV, P. S. [1980] Vyor parametrov mezhsputnikovoi linii svyazi (Choice of inter-satellite link parameters) *Elektrosviaz*, 2, 11-14.

ANNEX I

GEOMETRY AND POINTING ERRORS FOR NON-TRACKING ANTENNAS IN AN INTER-SATELLITE LINK

The inter-satellite link antennas on each space station are assumed to be fixed to a de-spun platform and are initially aligned so that each space station is in the centre of the other space station antenna's beam pattern under nominal synchronous orbit conditions. The pointing errors caused by deviations from nominal conditions are separated into their in-plane and out-of-plane components in Tables I and II. The total error is the root of the sum of squares (RSS) of the two component classes and affects each satellite independently.

TABLE I — *In-plane pointing errors*

Error source	Error magnitude
1. <i>Long-term variation</i>	
Antenna thermal distortion	± 0.02°
In-track position error	± 0.05°
Cross-track position error :	
Nominal longitude separation :	
2°	± 0.47°
3°	± 0.31°
4°	± 0.23°
5°	± 0.19°
2. <i>Bias</i>	± 0.20°
3. <i>Short-term variation</i>	
Despun platform pointing	± 0.25°

TABLE II — *Out-of-plane pointing errors*

Error source	Error magnitude
<i>1. Long-term variation</i>	
Antenna thermal distortion	$\pm 0.04^\circ$
Attitude uncertainty	$\pm 0.01^\circ$
Attitude precession with respect to orbit normal	$\leq 0.10^\circ$
Out-of-plane position error:	
Nominal longitude separation:	
2°	$\pm 0.31^\circ$
3°	$\pm 0.21^\circ$
4°	$\pm 0.15^\circ$
5°	$\pm 0.12^\circ$
<i>2. Bias</i>	
Mechanical alignment	$\pm 0.20^\circ$
<i>3. Short-term variation</i>	
Spin wobble and nutation	$\pm 0.06^\circ$

The angular pointing errors contributed by orbital motion are a function of the nominal longitude separation between satellites. The in-plane position error comprises an in-track error, caused by departures from nominal longitude separation, and a cross-track error caused by one or both satellites not being at their nominal altitude. The out-of-plane error arises from motion not taking place in the same plane. These errors are assumed to exist due to tolerances allowed in the orbital elements and not from statistical uncertainty in the individual satellite positions.

The in-track position error makes a relatively small contribution to the angular pointing error since it is equal to half the allowable error in satellite separation. A tolerance of $\pm 0.1^\circ$ in the satellite separation can be maintained at a small additional expenditure of propellant beyond that required for normal east-west station-keeping, if great care is taken. The tolerance is also large enough to allow flexible scheduling of individual manoeuvres.

The cross-track error arises because neither satellite can be maintained in a perfectly circular orbit without daily velocity corrections. Thus the altitude of each satellite will undergo a 24-hour variation about a mean value. The mean altitude of each satellite will be nearly the same as a consequence of the east-west motion being nearly in phase, but the individual variations will, in general, have different amplitudes and phase.

The capability exists to control the amplitudes of the individual altitude variations, or alternatively, to control their phase, such that the cross-track position error never exceeds several kilometres. To do so, however, would require additional velocity corrections in the presence of in-plane velocity coupling from north-south manoeuvres, and would require close co-ordination of the normal east-west manoeuvres performed on the two satellites. Without introducing these additional complexities, it is estimated that the position error can be maintained within 12 km.

The out-of-plane pointing error arises if the two satellites do not move in exactly the same plane. It is estimated that the position error can be maintained within 8 km, which corresponds to an angle of approximately 0.01° between the individual orbit planes. This error reflects the expected uncertainty in the velocity corrections obtained during the individual north-south station-keeping manoeuvres performed on each satellite.

Each north-south station-keeping manoeuvre will alter the inertial orientation of each orbit plane by 0.2° . In order to keep the relative orientation nearly the same, the individual manoeuvres must be closely co-ordinated. For a longitude separation of 3° between satellites, the manoeuvres must be performed within 12 minutes of each other (equal to 4 minutes for each degree of longitude separation).

Pointing error

The various elements in the pointing error budget have been reduced to a single effective value by the following rule:

- All in-plane, long-term contributions are summed algebraically to give a single value. Likewise all cross-plane, long-term contributions.
- The in-plane and cross-plane long-term errors are added on an RSS basis to give a single long-term error value. Since the two contributors are equal and assumed to be uncorrelated, the long-term RSS error is circular.
- The in-plane, short-term contributions are summed algebraically. Likewise the cross-plane, short-term contributions.
- The in-plane and cross-plane contributions and the RSS long-term error are summed on an RSS basis to give the total pointing error.
- Since each term of the total sum is individually a low probability, nominally 3σ , value, the total pointing error is likewise a low probability, nominally 3σ , value.

When the above rule is applied to the error budgets given above, the total error at various satellite-to-satellite spacings is found to be as given in Table III. These are the pointing errors that have been used to estimate transmission performance of the link.

TABLE III — *Pointing error versus satellite spacing*

Spacing	Effective pointing error
2°	1.01°
3°	0.833°
4°	0.739°
5°	0.693°

The total effective error is assumed to be circular, although this is not precisely true. The computational convenience of making the assumption outweighs the small error involved.

ANNEX II

FREQUENCY RE-USE AMONG GEOSTATIONARY INTER-SATELLITE LINKS USING TRACKING ANTENNAS

1. Introduction

The major eventual development of the inter-satellite service will require the use of mutually tracking communications antennas on board different linked space stations.

Stipulating widespread use of inter-satellite links between geostationary satellites, the questions arise as to how many such links could share the same frequencies and what factors affect the frequency re-use potential in the inter-satellite service.

2. Link definition

A geostationary inter-satellite link is characterized by two geostationary space stations at geocentric angular spacing θ , with each space station having a high gain transmit and receive antenna (which may be the same antenna) point their main beams at the other space station. Pointing is maintained through tracking with negligible tracking error. East-west and west-east transmit frequency bands are assumed to be different but sufficiently close to each other so that antenna gains and path losses may be assumed to be the same for both, ($|f_1 - f_2| \ll f_1$). The performance requirement (C/N) in both directions is assumed to be the same, as is the required protection ratio (wanted-to-unwanted carrier ratio (C/I)) against interference from emissions of other inter-satellite links.

The antenna patterns for both transmit and receive antennas are assumed to be identical and are characterized by the pattern equation:

$$g(\xi) = 6750 \varphi_0^{-2} \left[1 + \left(\frac{\xi}{\varphi_0} \right)^{2.5} \right]^{-1}$$

$$g(\xi) = 0.1$$

} whichever is the greater (7)

where $2\varphi_0$ is the half-power beamwidth of the transmit and receive antenna and ξ is the angle off the main beam axis (discrimination angle).

3. Interference between identical short inter-satellite links

We consider first the simple case of identical (homogeneous) short inter-satellite links. Two such links can be arranged in four different ways as shown in Fig. 3 which also identifies the various possible interference paths.

3.1 Counter-directional frequency assignments

When considering two inter-satellite links, their frequencies may be assigned to be pair-wise counter-directional (Figs. 3 a) and b)). For such configurations it can be shown by detailed analysis that their spacing in terms of the geocentric angle θ' between the two "left" satellites of either link may be quite small; for appropriate assumptions regarding orbit eccentricity, and isolation of the order of 30 dB, it is generally less than 1° of arc. It can also be shown that, under the assumptions, a space station may originate an eastward and a westward link on the same frequencies.

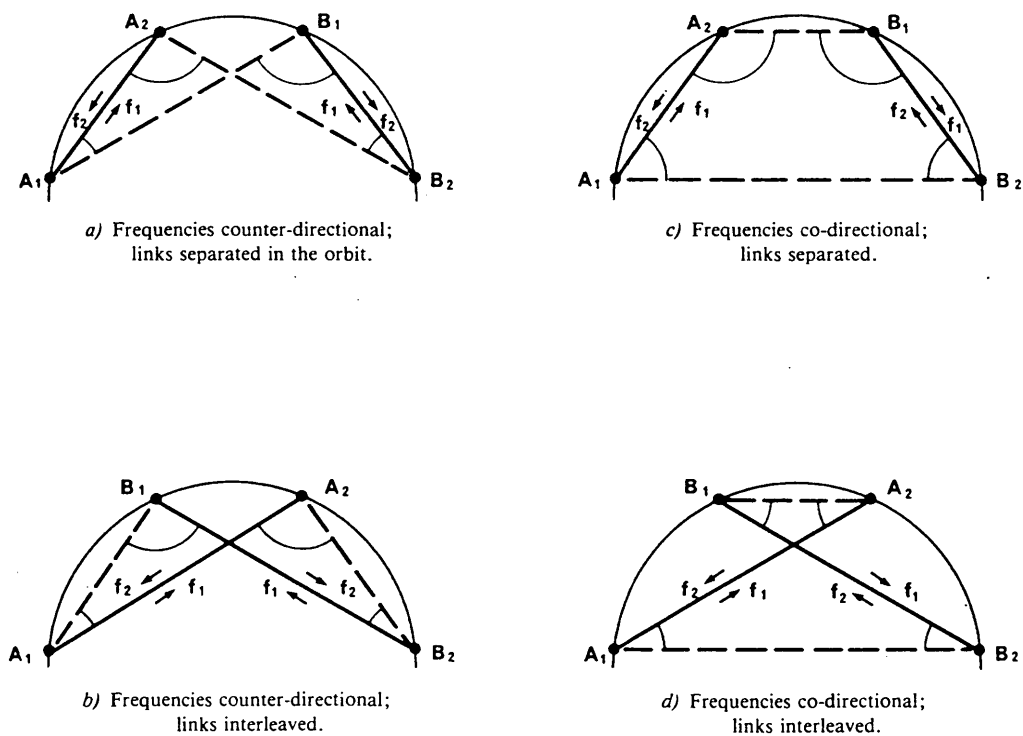

FIGURE 3 — Interference geometries between inter-satellite links
 (Angles marked are antenna discrimination angles.
 Interference paths are shown in broken lines.)

When arranging more than two inter-satellite links with counter-directional frequency assignments along the orbit, every other link will, necessarily, have co-directional frequency assignments.

3.2 Co-directional frequency assignments

These correspond to the arrangement illustrated in Figs. 3 c) and d). When more than two links are so arranged it can be shown that the link separation angle θ' is a function of the link "length" θ , of the inter-satellite link antenna beamwidth $2\varphi_0$, of the necessary isolation C/I , and of the maximum radial deviation Δh of the space stations from the normal orbit altitude (a function of orbit eccentricity and the maximum east-west drift rate between station-keeping manœuvres). Representative currently achievable values for Δh vary between 15 and 100 km.

Detailed analysis shows that there is minimum link "length" θ which allows such links to be "interleaved": see Fig. 3d). Further, the greater link length θ , the more identical inter-satellite links may originate within any given link's occupied arc. Figure 4 shows the interleaving "cut-off" link length, and the number of interleaved links n which may originate within a link arc.

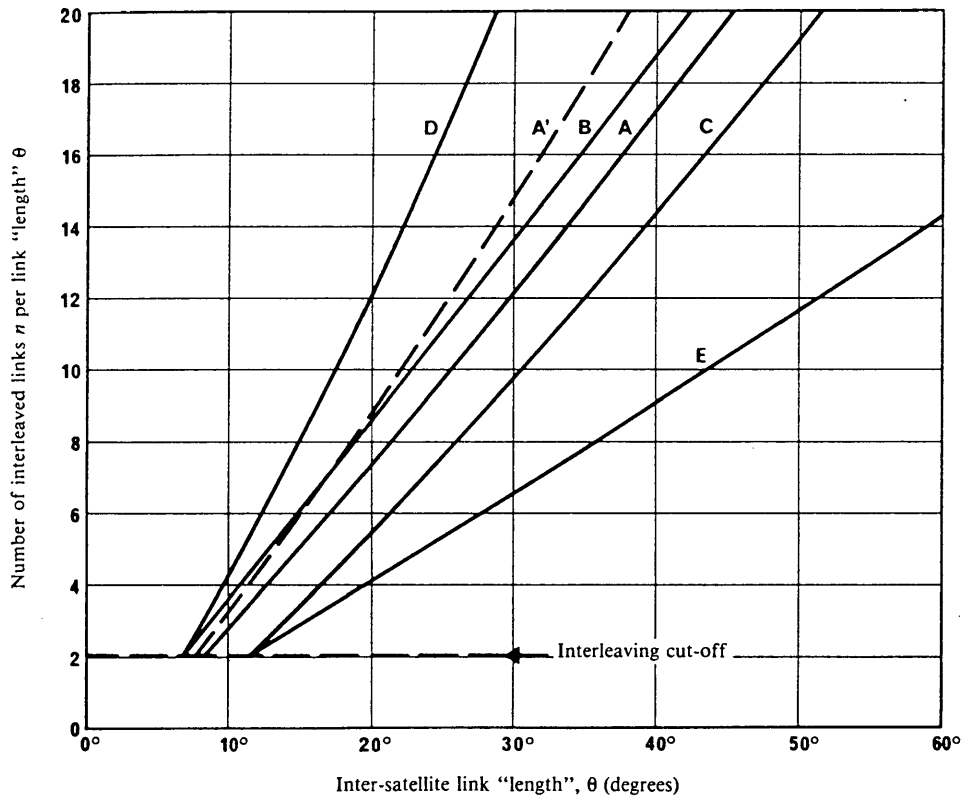

FIGURE 4 — Number of interleaved links n per link "length" θ as a function of link "length", for various combinations of φ_0 , Δh and C/I

- A: $\varphi_0 = 0.25^\circ$; $\Delta h = 40$ km
- B: $\varphi_0 = 0.25^\circ$; $\Delta h = 15$ km
- C: $\varphi_0 = 0.25^\circ$; $\Delta h = 100$ km
- D: $\varphi_0 = 0.125^\circ$; $\Delta h = 40$ km
- E: $\varphi_0 = 0.5^\circ$; $\Delta h = 40$ km
- A': as A, but with $C/I = 25$ dB

Non-interleaved co-directional links can be established end-to-end but require some non-zero spacing between adjacent satellites except for very small link lengths for which, with decreasing link length, this spacing must be increased.

4. Orbit utilization by short identical links

Figure 5 shows the relationship between the number of links which can be accommodated along the entire geostationary orbit (right-hand ordinate) and link length, for various parameter assumptions. The left-hand ordinate shows relative frequency re-use density (orbit utilization) against an arbitrary reference. The curve sections to the left of the major vertical "steps" reflect non-interleaved links, those to the right increasingly greater link interleaving. The actual curves would be in the form of steps indicating the link-by-link addition, as shown for one example; for all other cases only the step envelopes are shown.

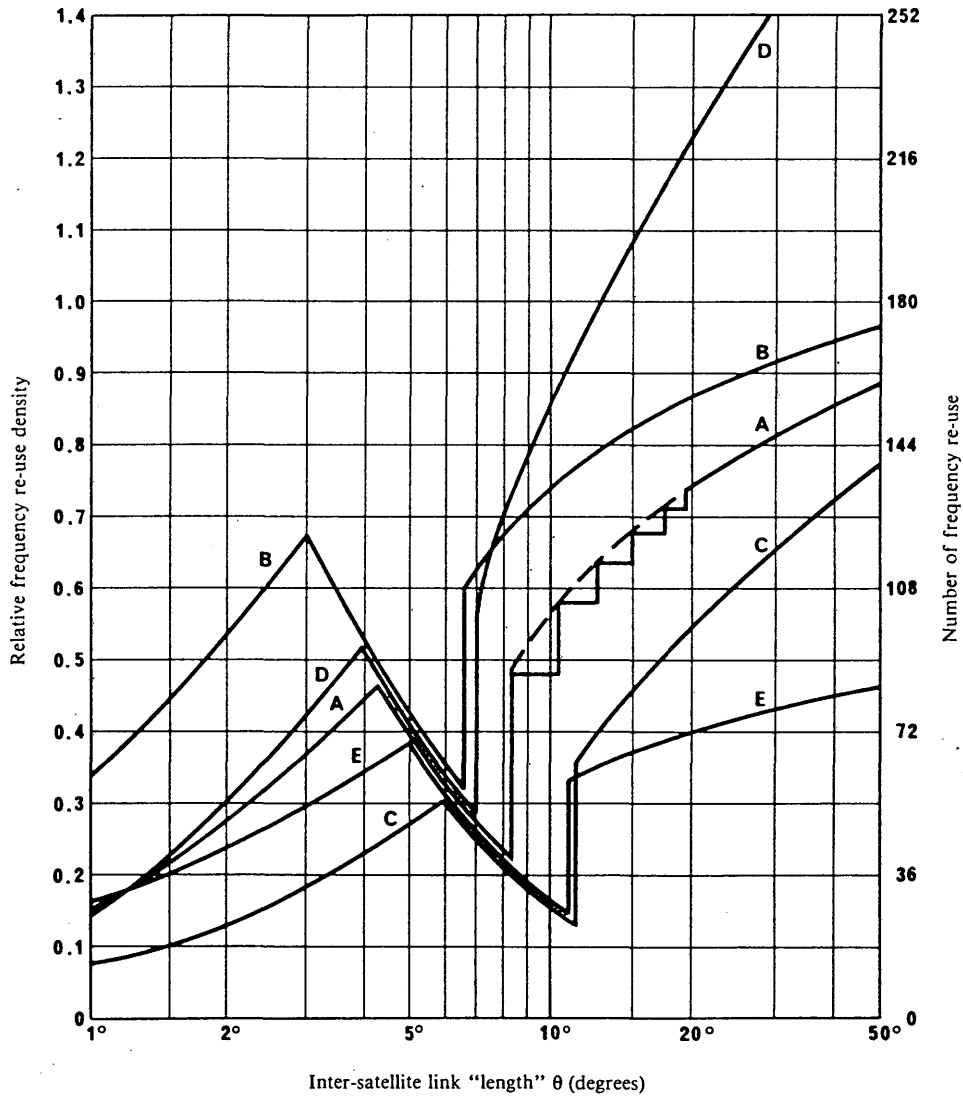

FIGURE 5 — Maximum relative frequency re-use density (orbit utilization) for identical inter-satellite links as a function of link "length" θ , for various combinations of φ_0 and Δh

- A: $\varphi_0 = 0.25^\circ$; $\Delta h = 40$ km
- B: $\varphi_0 = 0.25^\circ$; $\Delta h = 15$ km
- C: $\varphi_0 = 0.25^\circ$; $\Delta h = 100$ km
- D: $\varphi_0 = 0.125^\circ$; $\Delta h = 40$ km
- E: $\varphi_0 = 0.5^\circ$; $\Delta h = 40$ km

5. Non-identical inter-satellite links

It can be shown that, to an existing array of short links, additional sets of links can be added as shown in Fig. 6. This is achieved by making the links of the additional sets long enough to realize the necessary isolation against those of the original link set. Each additional link set will increase orbit utilization by that of the original "short" link set, until link lengths are reached which would start to intercept the Earth (around 160° of arc).

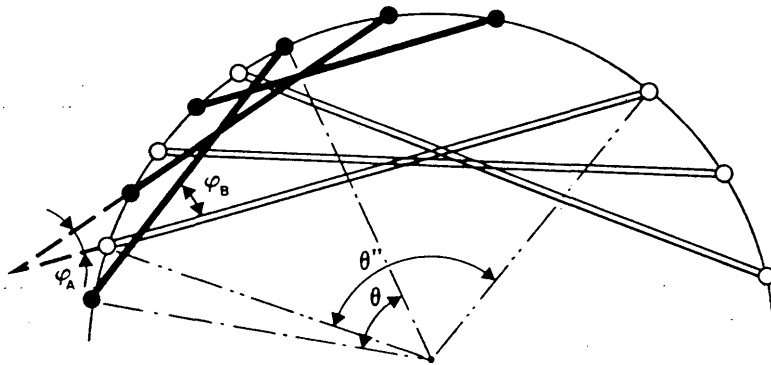

FIGURE 6 — Geometry for the interleaving of two link sets with link "lengths" θ and θ''

6. Conclusions

A preliminary investigation of the geostationary frequency re-use potential of the inter-satellite service leads to the following tentative conclusions:

- The frequency re-use potential for geostationary inter-satellite links is high and may allow on the order of several hundred inter-satellite links to be accommodated within acceptable interference bounds.
- Major factors which affect the frequency re-use potential are the antenna side-lobe discrimination and the orbit ellipticity. It is found that high side-lobe discrimination (narrow antenna beams and/or steep side-lobe decay exponents) improve the re-use potential and that low orbit ellipticities (highly circular orbits), also improve the re-use potential.
- Specifically it was found that very short inter-satellite links with co-directional frequency assignments such as might be of particular interest to early users of the inter-satellite service cannot overlap. The smallest length of similar inter-satellite links for which overlapping is possible, depends on antenna discrimination and on orbit ellipticity; the higher the former and the lower the latter, the smaller is the link length for which overlapping is possible.
- The use of several inter-satellite link sets of sufficiently different link length allows frequency re-use to be increased to a multiple of that achievable with a single set of short identical links.

No consideration was given to the problem of frequency re-use of inter-satellite links connecting space stations in a "cluster" (i.e., contained within an earth station's main beam). Frequency re-use within and between cluster links remains the subject of further study.

BIBLIOGRAPHY

CCIR Documents

[1978-82]: Doc. 4/55 (USA).

REPORT 1237

SATELLITE NEWS GATHERING

(Study Programme 13H/CMTT)

(1990)

The text of this Report is published in the Annex to Volume XII.

PAGE INTENTIONALLY LEFT BLANK

PAGE LAISSEE EN BLANC INTENTIONNELLEMENT

SECTION 4B2: PERFORMANCE AND AVAILABILITY

REPORT 208-7

FORM OF THE HYPOTHETICAL REFERENCE CIRCUIT AND ALLOWABLE
NOISE STANDARDS FOR FREQUENCY-DIVISION MULTIPLEX TELEPHONY
AND TELEVISION IN THE FIXED-SATELLITE SERVICE

(Question 27/4)

(1963-1966-1970-1974-1978-1982-1986-1990)

1. Form of the hypothetical reference circuit

The concept of the hypothetical reference circuit (HRC) has been used by the CCITT in developing the requirements for making international connections for telephony and television and has been typically associated with terrestrial systems. This topic is discussed in Recommendation G.222 of the CCITT along with the associated standards of noise performance. The HRC applicable to the fixed-satellite service (FSS) is given in Recommendation 352 which includes provisions for the possibility of the use of diversity at the higher frequency bands where rain attenuation is a factor in the performance.

The HRC is applicable to all types of analogue transmissions and generally comprises a single, geostationary orbit satellite link although a satellite-to-satellite link can be used.

With respect to television, the definition and characteristics of reference chains comprising one or more hypothetical reference circuits and corresponding to different services, have been studied by the CMTT and are reflected in Recommendations 354 and 567.

2. Allowable noise standards2.1 General considerations

Allowable noise standards in the HRC for the FSS should be commensurate with those adopted for other long haul systems; the principles established by the Joint CCITT/CCIR Special Study Group CMBD on circuit noise for telephony, and by the CMTT for long distance television transmission are relevant.

The noise standards for international connections for analogue telephony services are established by the CCITT taking into account the need to provide a minimum quality for the longest connections considered reasonable and, from this minimum quality for the end-to-end connection, an allowance for each portion of the circuit can be determined.

The current status of this work is the specifications that exist for the basic HRC which applies to terrestrial systems, the length being 2500 km and the total noise allowance being 10,000 pWOp including the multiplex. This specification was made in 1963 and it seemed appropriate at the time to consider the satellite link as the equivalent of a single HRC with a proviso that multiplex noise was excluded. This latter provision accounts for the fact that only a single multiplexing operation is a normal part of a satellite link.

Four such international connections were deemed to make up the longest connections, hence it was implicit that this part of a connection could have a total noise of 40,000 pWOp. Additionally, the local part of the circuit could be considered to add another 10,000 pWOp for an end-to-end total of 50,000 pWOp or -43 dBmOp. This level of noise has generally been accepted as the level where user difficulties begin to be of concern even though noise of twice this level is found to be acceptable by as many as half the users [Bell Telephone Laboratories, 1971]

The specifications of 1963 were made in consideration of the possibility of the use of low altitude satellite systems with the particular characteristics of that type of system and also took into account the fact that there were many unknowns associated with the new technology. The current state of development of international telephony practice and the role which satellite systems using the geostationary-satellite orbit play in providing telephony services, leads to the conclusion that the concept of the satellite HRC and the noise allocations need to be up-dated.

It is also necessary to take account of the existence of the new recommendations on circuit availability which did not exist in 1963. This too will serve to up-date recommendations on analogue systems.

2.2 Allowable noise in the HRC: frequency-division multiplex telephony

2.2.1 Factors influencing the allowable noise

The total noise of a typical HRC of 10,000 pWOp for terrestrial links is translated into a distance dependent factor of 3 pWOp/km, after making an allowance of 2500 pWOp for the multiplex and the specified length of 2500 km. The total of 4 such HRC's providing an international connection of 10,000 km was probably reasonable in 1963, however, such a length is not consistent with present practice. For example, the ISDN hypothetical reference connection is 27,500 km and ISDN performance is based on that concept. At the same time, the practice of system designers of terrestrial systems has long been to use an objective of 1 pWOp/km instead of 3 pWOp/km. This objective allows for twice as many HRCs in a connection without exceeding the 40,000 pWOp limit for the long haul portion of the connection. This assumes that the multiplex contribution is maintained at 2500 pWOp for each HRC. The effect is to increase the length of a connection which meets the overall requirement to be over 20,000 km which is more representative of modern communications.

The use of satellites, with their distance independent performance, and their ability to provide connections of as much as 17,000 km with a single link makes it clear that such links having the noise level corresponding to a single HRC will provide for improved end-to-end performance in many cases.

During the time when satellite systems were severely power limited, a relaxation of the noise levels could have been translated into economic terms and great savings could have been made. However, this situation no longer exists, although power is still a factor, the overall benefit is much smaller than it would have been. Also, the satellite HRC has a short term noise limit that would also have to be adjusted so that margins would be still reasonable. This is quite feasible to do for the 6/4 GHz bands where the actual margin requirements are small (of the order of 3 dB or less). For this case then, the current short term allowance of 50,000 pWOp for 0.3% of the month is easily met as would be the 0.1% of the month specified in Recommendation G.222.

For the 14/11 GHz bands this is not the case and the short term value will be affected depending upon the margin used. For example, on a link designed to a long term value of 10,000 pWOp with 10 dB of margin, the short term noise could reach a level of 100,000 pWOp, which while still a usable circuit for many users, exceeds the current limits. The CCITT itself preferred this value for the short term allowance in 1963 but thought it would be too difficult to measure, and therefore adopted the 50,000 pWOp number.

The subject of increased noise is also discussed in Annex I from a slightly different point of view, however, the same general conclusions are reached.

2.2.2 The concept of satellite equivalent distance

For the purposes of ISDN, the distance independence of satellite links was recognized by the use of a satellite equivalent distance to permit the use of the same performance degradation/km applied to other transmission systems. In the long distance, high quality portion of the HRX for ISDN, half of the noise allocation was assigned to satellite HRDP's which can be translated to an equivalent distance of 12,500 km. Although application of this concept to the analogue case could result in an increased allocation of noise for a satellite HRC without violating the overall end-to-end performance of connections made using a satellite link, there are many situations using a satellite link where better performance is desirable.

2.2.3 Propagation availability

Recommendation 579 covers the subject of availability of the HRC and includes all outages which persist for longer than 10 seconds. In particular, propagation fades which are the major source of degradation to satellite circuits, have been studied to establish a relationship between fading level and the duration. For the fade levels which are typical for satellite system designs, a value of 0.1 has been determined to be appropriate for the ratio of available to unavailable time for propagation fades. This factor has more impact at the higher frequencies and Report 552 contains the results of analysis which includes this concept.

2.2.4 Use of syllabic compandors

The use of syllabic compandors has been largely confined to up-grading poor quality circuits on older cable systems where the economics rule out replacement of the system. Such compandors give a subjective improvement in a voice channel which can be as much as 18 dB, but suffer from various stability problems which ruled against their widespread use. The latter have been solved by digital implementation and in recent years they have been increasingly used on satellite circuits where the economics would not permit circuits without them.

The use of syllabic compandors on satellite circuits can improve the utilization of either or both, power and bandwidth. They have been shown to provide 10-12 dB of improvement in voice channel quality for speech-like signals [G.G. Szarvas & H.G. Suyderhoud, 1981]. However, the use of syllabic compandors on circuits where the signals are constant, such as data circuits, will not realize any improvement and care must be taken to ensure that the available satellite link signal-to-noise ratio is adequate for the data signals.

There has been increased usage in recent years with none of the problems of the early days and for many cases, syllabic compandors are a valid solution to providing circuits which meet the requirements of Recommendation G.222 of the CCITT.

2.3 *Allowable noise in the hypothetical reference circuit: television*

The majority of international television connections are likely to contain only one satellite link, although two such links will be needed for the longest world-wide connections. Under these conditions, an entirely adequate performance for the continuous random noise at the end of the hypothetical reference circuit would be one which provisionally equals that for the terrestrial 2500 km hypothetical reference circuit — the precise values depending on the television standards involved (see Recommendation 567).

3. **Video bandwidth in the hypothetical reference circuit**

The following points have been taken into account in preparing Recommendation 354 on the nominal upper limit of the video-frequency band in a fixed-satellite system for television:

- the video bandwidth should be adequate for acceptable transmission of television signals up to and including 625-line standards;
- the need, for economic reasons, to provide a video bandwidth no wider than is strictly necessary;
- the desirability that the width of the baseband for television should be compatible with that for high-capacity frequency-division multiplex telephony.

Taking these factors into account, it is recommended that the video bandwidth in the hypothetical reference circuit for television should be compatible with the necessary band for the television system or systems in question.

4. **Simultaneous transmission of a sound channel and a television picture**

To avoid excessive differences in transmission delay between a television picture signal and the corresponding sound signal, there are advantages in transmitting both over the same satellite link. In this event, a wider baseband may be needed to accommodate the sound signal (e.g., on a separate sub-carrier in the baseband). Alternatively, the sound signal might be transmitted by time-division multiplex with the video signal, e.g., using the synchronizing pulses or the blanking intervals, without the need for a wider baseband. Also, the sound may be transmitted by radio channel on the same satellite.

5. Transmission of television signals different from conventional signals

There are various systems, different from conventional television signals such as NTSC, PAL or SECAM, for satellite television broadcasting, e.g. B-MAC, C-MAC, D2-MAC, D-MAC that are described in Report 1073, and for high definition television satellite broadcasting and transmission. (see Report 1075).

Transmission tests have been carried out in Europe for the HD-MAC/packet system and in Japan for the MUSE system. It was demonstrated that there were no difficulties in transmitting these two systems on a conventional telecommunication satellite circuit with minor modification to the modulator/demodulator.

6. Summary

The consideration of the factors which bear on the allowances made for the noise in the HRC for the FSS lead to the conclusions that, except for up-dating the provisions of Recommendation 353 to take account of the concept of propagation availability, use of syllabic companders and the need to account for rain attenuation at the higher frequencies, the current provisions are reasonable.

REFERENCES

Bell Telephone Laboratories [1971], "Transmission systems for communications", revised fourth edition, pp. 50-52.

G. G. Szarvas & H. G. Suyderhoud, "Enhancement of FDM-FM Satellite Capacity by Use of Compandors", COMSAT Technical Review, Vol. 11, No. 1, pp. 1-58, Spring 1981.

ANNEX 1

NOISE PERFORMANCE OBJECTIVES FOR SATELLITE
TELEPHONE CIRCUITS - RELATED TO USER PREFERENCES**1. Introduction**

In terrestrial telephone circuits and channels, noise is substantially dependent on the circuit length, and this has led to an approach of specifying noise in terrestrial circuits as a function of the distance spanned by the circuit plus a constant noise contribution that is independent of distance due to those equipment and interference characteristics that are not distance-dependent.

However, if one examines the philosophy underlying the method of arriving at terrestrial circuit noise standards the most important feature is the quality of service given to telephone users under average and extreme conditions within the network.

Whilst distances impose a major constraint on transmission performance in terrestrial circuits, satellite circuit noise and attenuation (or loss) are largely independent of distance. Therefore it would seem more appropriate to determine a value, or range of values, that will provide satisfactory connections irrespective of the distances spanned by the satellite circuits. In the light of these considerations it may be desirable to examine the feasibility of departing from the noise levels allowed by Recommendation 353, and the effects of such a departure on the quality of telephone connections via satellite networks for a national service.

2. Possible practical solutions in providing satellite circuits

An analysis and discussion submitted by Australia during the period 1974-1978 demonstrates that for certain classes of circuits used in a national traffic situation, the standards applied generally to international telephone circuits via satellite can be modified to gain economic advantage yet provide an adequate service within a country. It will not be possible to take advantage of this for all connections and some special arrangements may be necessary to ensure conformity with international requirements when these "national standard" satellite circuits are to be connected to an international circuit. There are, of course, national traffic situations where standards exceeding those in Recommendation 353 may have to be applied.

The analysis considered three types of link:

- (a) conforming with Recommendation 353 (10 000 pW0p circuits),
- (b) relaxation of 3 dB (20 000 pW0p circuits),
- (c) relaxation of 6 dB (40 000 pW0p circuits).

It would be feasible to provide separate transponders for separate types or a mixed arrangement within one transponder. The possible changes in system capacities by departing from the 10 000 pW0p value depends on the system configuration considered, but can offer as much as 100% increase in the total number of channels per transponder in return for 6 dB relaxation from Recommendation 353 [Feder, 1976].

It may also be desirable to provide some links with a very low noise contribution to enable very long terrestrial extensions to be permanently associated with them. Such links could perhaps conform to the Recommendation 353 standard. These could then be extended with about 6500 km of terrestrial transit circuits.

Another possible arrangement is when all traffic to or from international sources is restricted to terrestrial trunks where possible, thus allowing the provision of only type (c) circuits with very few of the other types being necessary. This arrangement would have the advantage of simplifying the special international switching arrangements that would be necessary to avoid excessive tandem satellite connections.

Finally, if it is acceptable to use, say, 40 000 pW0p or 20 000 pW0p circuits, rather than the 10 000 pW0p circuit standard, then it will be desirable to re-examine both the total allowance of non-thermal noise (assumed to be constant at 6000 pW0p) and also, the interference component of this non-thermal noise (assumed at 2000 pW0p). Clearly, if the interference and hence the non-thermal noise contribution could be increased at the expense of thermal noise, some economic benefits might occur in terms of relaxed co-ordination requirements of the satellite system.

3. Conclusion

Noise objectives in the terrestrial network must recognize the worst and average conditions that may be encountered and which generally are due to the distance factor. Within the constraints of the overall noise standards currently recommended by the CCITT, standards for satellite circuits can be chosen that should provide equivalent or somewhat better performance than comparable long distance terrestrial connections. Essentially it is envisaged that the noise allowance for a satellite circuit should correspond to the noise allowance of the terrestrial systems it notionally replaces. Where special conditions require better circuits a special arrangement could be made to meet the requirements. It has been shown that this method of establishing the satellite circuit objectives rather than the simple application of the Recommendation 353 standard, leads to a possible increase in a given system's capacity, leading to a reduction in cost per channel for a given system, or reduction in system costs for a given channel requirement.

REFERENCES

- FEDER, A. [1976] Transmission performance objectives for national satellite telephone circuits. *Austral. Telecomm. Res.*, Vol. 10, 2, 59-74.
-

REPORT 997-1

**CHARACTERISTICS OF A FIXED-SATELLITE SERVICE
HYPOTHETICAL REFERENCE DIGITAL PATH FORMING PART OF
AN INTEGRATED SERVICES DIGITAL NETWORK**

(Study Programme 29A/4)

(1986-1990)

1. Introduction

The traditional role of the fixed-satellite service (FSS) in the international telecommunications network has been to provide a high quality and reliable international transmission facility between administrations. It is envisaged that the international FSS hypothetical reference digital path (HRDP) will fulfil a similar role within the integrated services digital network (ISDN).

This Report discusses the performance objectives that an FSS HRDP will need to achieve when it forms part of a hypothetical reference connection (HRX) in an ISDN. The ISDN HRX for a 64 kbit/s circuit switched connection is defined in CCITT Recommendation G.821 (CCITT Red Book 1984, Volume III.3) which uses three circuit classifications for performance quality definition: local, medium and high grade. International satellite circuits are considered part of the high grade performance section.

The apportionment of the overall ISDN HRX performance objectives to the FSS and the impact of this apportionment on the design of FSS systems are presented in the following sections of this Report.

System and performance aspects for connections operating at greater than 64 kbit/s are treated in the Report 1139.

2. 64 kbit/s Satellite Channels Forming Part of the ISDN HRX**2.1 Performance requirements of the FSS HRDP****2.1.1 *Satellite system error performance objectives***

The performance of satellite systems is generally given in terms of bit error probability while CCITT Recommendation G.821 identifies time intervals that must have a specified error ratio for certain time percentages. These percentages are taken over a longer period, i.e. of the order of one month. This section presents the method that has been used for converting from the CCITT specification to the form of performance objective used for satellite systems, and gives the satellite HRDP performance requirements that result from applying this method to the values quoted in Recommendation G.821.

A careful distinction between bit error probability (BEP) and bit error ratio (BER) has been made in this Report. Bit error probability, which is used extensively in the following sections, is an abstract quantity used to express the theoretical performance of data communications equipment. Bit error ratio is a quantity that is readily measurable (i.e. bit errors per bits transmitted). By making a sufficient number of measurements each lasting a sufficient time, the bit error probability can be estimated to within any desired accuracy.

The approach adopted in this report is to assume that (at 64 kbit/s) the satellite system link performance is limited by mechanisms that are essentially random in nature and can be analyzed by using a Poisson or Binomial approach to calculate the probability of experiencing a given number of errors in a given time interval, with a given bit error probability. In practice, system designers must also be aware of bursts of errors which would not be picked up by this approach (some of the mechanisms which could give rise to such bursts are described in para 2.2) and allow sufficient margins to cover these effects.

The bursty errors due to error correction techniques are treated in Annex IV.

2.1.2 CCITT Recommendation G.821 requirements

Table I summarizes the end-to-end performance objectives given in Recommendation G.821 and the satellite HRDP objectives. For each performance classification the overall end-to-end requirement is given, along with the requirement on a satellite HRDP assuming a satellite allocation of 20% (performance classifications (a) and (c)) or 15% (performance classification (b)) of permitted overall degradation.

It should be noted that Recommendation G.821 also contains a way by which the performance is to be measured. Input documents relating to this have been received [CCIR, 1986-90a,b] and the potential impact, if any, of this is left for further study.

TABLE I – Overall end-to-end and satellite HRDP error performance objectives for international ISDN connections

Performance classification	Overall end-to-end objective (Note 4)	Satellite HRDP objectives (Note 4)
(a) (Degraded minutes) (Notes 1, 2)	Fewer than 10% of 1 min intervals to have a bit error ratio worse than 1×10^{-6} (Note 3)	Fewer than 2% of 1 min intervals to have a bit error ratio worse than 1×10^{-6} (Note 4)
(b) (Severely errored seconds) (Note 1)	Fewer than 0.2% of 1 s intervals to have a bit error ratio worse than 1×10^{-3}	Fewer than 0.03% of 1 s intervals to have a bit error ratio worse than 1×10^{-3}
(c) (Errored seconds) (Note 1)	Fewer than 8% of 1 s intervals to have any errors (equivalent to 92% error-free seconds)	Fewer than 1.6% of 1 s intervals to have any errors (equivalent to 98.4% error-free seconds)

Note 1. – The terms “degraded minutes”, “severely errored seconds” and “errored seconds” are used as a convenient and concise performance objective “identifier”. Their usage is not intended to imply the acceptability, or otherwise, of this level of performance.

Note 2. – The 1 min intervals mentioned above are derived by removing unavailable time and severely errored seconds from the total time and then consecutively grouping the remaining seconds into blocks of 60.

Note 3. – For practical reasons, at 64 kbit/s, a minute containing four errors (equivalent to an error ratio of 1.04×10^{-6}) is not considered degraded. However, this does not imply relaxation of the error ratio objective of 1×10^{-6} .

Note 4. – Overall end-to-end and satellite HRDP performance objectives are expressed in terms of available time (see § 2.1.5).

2.1.3 Bit error probability models required to meet CCITT Recommendation G.821

Annex I outlines the method by which a given bit error probability versus percentage-of-time distribution can be analyzed in terms of the parameters given in Table I. Using this procedure, it has been possible to derive a number of distributions, or models, based on the general characteristics of satellite systems, which meet or exceed the objectives given in Recommendation G.821.

Of the models studied in Annex I, one is summarized here. This model strikes a compromise between the requirements of propagation limited systems and those of interference limited systems, and can be met by high-capacity, state-of-the-art satellite systems.

The bit error probability requirements of this model as indicated by the breaking points of Figure 4 of Annex I are as follows:

- BEP = 1×10^{-7} for 90% of the worst month;
- BEP = 1×10^{-6} for 98% of the worst month.

This model is identified in Annex I as model d).

The performance of the model is summarized in Table II in terms of degraded minutes, errored seconds and severely errored seconds. The performance is listed in terms of both total time and available time in order to show the relationship between system design calculations and the objectives of Recommendation G.821.

The short-term* breakpoint (i.e. BEP = 10^{-3}) used in these models was 0.2% of the month (total time) with a propagation availability factor of 10% (see Annex I and §2.1.5).

TABLE II

Objectives	Performance	
	Total time (%)	Available time (%)
Degraded minutes	2.05	1.87
Errored seconds	1.74	1.56
Severely errored seconds	0.204	0.024

2.1.4 Satellite transmission considerations

The performance of a satellite digital transmission link is a function of various factors. One highly significant factor is the effect of propagation disturbances on transmission. Using methods developed by Study Group 5, the effects of propagation disturbances on digital transmission performance can be predicted.

Annex II gives the results of calculations comparing the performance of three different international digital satellite systems. These calculations are included to provide insight into the effects of propagation on the short-term bit error probability, as a function of time for practical systems. A comparison of the performance of the three example systems with the suggested bit error ratio models can be made by examining Figs. 5 and 4.

It should be noted that the performance of a satellite digital transmission channel can be designed to meet virtually any performance specification. However, the use of forward error correction, power control and site diversity which can significantly improve system performance has penalties of decreased capacity and/or increased cost. The use of such techniques therefore requires suitable justification.

Study Group 4 feels that further study is required on the effects of propagation disturbances on satellite digital channel performance and welcomes further information on this topic.

* In this Report the phrase "short term" refers to the period of time when the satellite portion of the connection is experiencing extremely degraded performance (i.e. error performance $> 1 \times 10^{-3}$). The words "long term" refer to the period of time when the satellite portion of the connection is not experiencing degraded performance (i.e. error performance $\leq 1.0 \times 10^{-6}$).

2.1.5 Availability and severely errored seconds performance

In the derivation of the performance models to meet CCITT Recommendation G.821 described in Annex II, it was necessary to consider the proportion of time for which the link is declared available. The generally accepted definition for the unavailable time is:

A period of unavailable time begins when the BER in each second is worse than 1×10^{-3} for a period of 10 consecutive seconds. These 10 s are considered to be unavailable time. The period of unavailable time terminates when the BER in each second is better than 1×10^{-3} for a period of 10 consecutive seconds. These 10 s are considered to be available time and would contribute to the severely errored second performance objective. Excessive BER is only one of the factors contributing towards the total unavailable time. Definitions concerning availability can be found in CCITT Recommendation G.106.

The concept of availability must be taken into account in the design of satellite transmission links which experience occasional periods of attenuation during precipitation which exceed the margins of the system. This is particularly true at frequencies above 10 GHz and the propagation studies in CCIR Report 706 illustrate this fact.

Most attenuation statistics include significant portions of unavailable time and therefore are not appropriate for use in the determination of margin requirements to meet the severely errored seconds specification of Recommendation G.821. More appropriate statistics would be those corresponding to propagation attenuation which does not result in unavailable time.

A summary of propagation measurements showing propagation attenuation events which do not result in unavailable time is given in Report 706. The conclusion of the Report indicates that of the total time when attenuation levels likely to cause a BER worse than 10^{-3} are experienced, only some 10% is made up of periods that would be defined as "available time" by the CCITT criteria. The remainder would be unavailable time.

An availability factor of 10% leads to a short-term break point for the performance models of approximately 0.2% of the month (total time). For the model concerned a much lower value of propagation availability factor, i.e. 1-2%, would only result in a marginal increase in the short-term break point. Higher percentage availability factors can be experienced (typically for 2-3 dB attenuation). However, in this case, the number of events (and thus unavailable time) is generally small.

The unavailability objectives of a satellite HRDP due to equipment and propagation are given in CCIR Recommendation 579. A provisional value of 0.2% of a year is assigned to the equipment unavailability objective, whilst a suggested value of 0.2% of the worst month is proposed for the propagation unavailability performance for an HRDP.

Report 706 provides measurement data on propagation availability performance which indicates that for low "availability factors" and various locations and climates, the percentage of unavailable time can exceed 0.2% of the month, for attenuation levels of interest. In any event, the total unavailable time allowance for propagation should not be less than the model short-term objective required to meet CCITT Recommendation G.821, i.e. 0.2% of the month. Consequently, it was recommended that this value be adopted in Recommendation 579 for frequencies less than 15 GHz.

Further propagation study is required, however, to confirm a representative percentage value for different frequency bands, elevation angles and climatic zones.

Finally, regarding the availability of a transmission system (employing techniques such as TDMA), it should be noted that system availability can differ from propagation availability owing to the possible loss of synchronization when the carrier drops below some synchronization threshold (typically 10^{-3}) for several seconds. Since it usually takes several round trip times for acquisition in the TDMA system, synchronization cannot always follow momentary recoveries of the carrier level. As a consequence, there may be periods when the carrier will rise to a level corresponding to a BER better than 10^{-3} , but due to synchronization delay the circuit may have a measured BER worse than 10^{-3} . These periods may contribute to unavailable time as opposed to available time.

In some Operational TDMA systems the terminals make BER measurements on the unique word of each received traffic burst over successive periods of less than 10 sec. This period has a duration of 4 sec (128 multi-frames) in the case of the EUTELSAT TDMA system. When a BER threshold of 10^{-3} is exceeded during one measurement period a set of high BER maintenance alarms are exchanged between the transmit and receive TDMA terminals.

This causes the sending of particular signalling sequences (a and b bits set to 1 for all circuits concerned or alarm indication signal (AIS)) towards the ISC from each of the two terminals. These sequences may be interpreted as call release messages and may cause the interruption of the calls concerned.

Further study is required to determine the effect on the network availability as a result of high BER alarms.

2.2 Other error-causing mechanisms

Although the major error contributions in digital satellite systems will be due to propagation and interference effects, other error mechanisms do occur. This section provides some information relating to the frequency and duration of such errors specifically with the objective of identifying them to the satellite system designer. In fact, during the design of a digital link a percentage allocation of the overall performance objectives may be assigned to these mechanisms. However, it is assumed that these errors will not cause the satellite link to be considered unavailable, i.e. those of 10 s duration or less. Further information on mechanisms causing unavailability is given in Report 706.

The following corresponding mechanisms have been identified as producing bursts of errors:

- signal path switching in earth-station IF and RF equipment;
- signal path switching in earth-station baseband equipment;
- power supply transients at earth stations;
- signal path switching in the satellite.

Estimates for the frequency and duration of error bursts due to the above mechanisms are contained in Annex III. Typical results are summarized in Table III.

TABLE III - Typical examples of burst error mechanisms

Effect	Frequency	Duration
IF/RF switching	1.0/month	150 ms
Spurious switching	2.0/month	150 ms
Baseband switching	1.2/month	2-128 bits

From Table III the following deductions can be made:

- considering the effect on 64 kbit/s connection over a 1 min. integration period, it can be concluded that all the effects in Table III cause a 1×10^{-6} per minute objective to be broken, meaning that some of the time for which 10^{-6} is permitted to be exceeded must be allocated to these effects;
- the total number of events in Table III is 4.2 per month, hence on average 0.0097% of 1 min. periods will be degraded;
- each of the events in Table III lasts less than 1 s and so on average only 4.2 s/month, i.e. 0.0002%, will contain errors as a result of these effects.

The 4.2 occurrences per month represent only 0.01% in degraded minutes and 0.00016% in SES, whereas CCIR Rec. 614 has a safety margin of 0.13% and 0.006% respectively. Therefore the mask of the present recommendation does not require modification to cater for the possible existence of burst errors on a particular satellite system. If further study reveals the existence of other burst producing mechanisms, modification of the present BER requirements may be necessary.

3. Conclusions

This report provides some insight into the ISDN HRX requirements as specified in CCITT Recommendation G.821, and presents to the satellite system designer the necessary background information. Further studies should be conducted to confirm the effects of propagation on the short-term performance and availability assumptions used in this report, especially as it would relate to higher frequency bands (above 15 GHz) and for various elevation angles and climatic zones.

REFERENCES

CCIR Documents

[1986-90]: a. 4/125 (Japan); b. 4/4 Att. 10 (Sweden).



ANNEX I

ERROR-PERFORMANCE CALCULATIONS AND MODELS

1. Introduction

This Annex describes the method by which the performance of a link, expressed in terms of a BEP versus percentage of time distribution, can be assessed in terms of the parameters given in Table I, § 2.1.2 of this Report. The procedure for determining the performance is outlined in § 2 below, whilst § 3 develops a number of BEP versus percentage of time models which meet Recommendation G.821 based on the general characteristics of "real" systems.

2. Method of calculation

An important first assumption is that satellite system link performance is limited by mechanisms that are essentially random in nature. This enables a Poisson or binomial approach to be used to calculate the probability of experiencing a given number of errors in a given time interval with a given bit error probability (within the numerical range of the parameters of interest, the binomial distribution converges to the Poisson distribution).

An example of the validity of this assumption is given in Figure 1 which shows the results of field measurements which compare the distribution of Error Free Intervals (EFI, Error Free Seconds and Error Free Deciseconds) to a Poisson bit error distribution. The agreement between the measured data and the theoretical distribution is obvious. This data also shows that the agreement holds for systems corrupted by thermal noise and thermal noise plus interference. These measurements were conducted over a 120 Mbit/s looped satellite TDMA link, and were made on a 64 kbit/s sub-channel. The system was operated under various conditions of co-channel interference from a similar continuous 120 Mbit/s carrier.

Probability curves that result from applying a Poisson analysis are shown in Figures 2 and 3. (When certain types of FECs are used the distribution of errors may depart from the Poisson or binomial law. This is treated in Annex IV.)

The curves of Figures 2 and 3 can be applied to a satellite link assuming a constant BEP. However, in reality, such a link will generally exhibit a time varying BEP performance, as a result mainly of varying propagation conditions (see Annex II).

In order to assess the performance of the link it is necessary first to establish a model of the link in terms of the BEP versus percentage time distribution. Recommendation G.821 suggests that a time period of any one month is appropriate. The method of calculation then involves determining for each small element of percentage time in the month (assuming a constant BEP for the element) the probability of achieving the performance parameter under consideration. Studies have shown that the curves in Figures 2 and 3 which define the probability of achieving the performance parameter under consideration are almost identical to probability curves expressed in terms of the percentage time in a month (with a confidence of 99.9%). The former curves have therefore been used in subsequent calculations.

To illustrate the method of calculation, the percentage of errored seconds (ES), severely errored seconds (SES), and degraded minutes (DM) are determined as follows:

- (a) divide the percentage of time axis of the model under consideration into many sections such that the curve may be represented by a ladder approximation. Each stepped interval then possesses a constant BEP;
- (b) for the BEP value of each stepped section, determine from Figs 2 or 3 the probability of ES, SES, or DM as appropriate;
- (c) this probability multiplied by the elemented percentage of time in the interval, gives the ES, SES, or DM contributed by this interval;
- (d) the sum of all contributions gives the total percentage of ES, SES, or DM.

Steps (a) to (d) can be summarized mathematically as follows:

$$\text{Total of all contributions} = \Sigma [(1 - P(E, N, BEP)) \Delta T]$$

where ΔT is the time interval of the stepped section and $P(E, N, BEP)$ is the probability of the particular objective where E is the error threshold, N is the number of bits in the time interval of the performance parameter under consideration and BEP is the bit error probability.

- (e) An additional term must be added to the total for severely errored seconds to include those contributed from the periods that have a BEP in excess of 10^{-3} and which are also available (see § 2.1.5);
- (f) finally the results may be expressed in terms of the percentage of available time. The results are then in the form of the performance objectives of Recommendation G.821 and may be compared with them.

3. Performance of models

By application of the conversion process outlined above, it is possible to identify a number of different satellite system performance models that will meet or exceed the objectives of Recommendation G.821. Four such models are shown in Fig. 4.

The long-term break points of these models (expressed in terms of the total time of the worst month) are as follows:

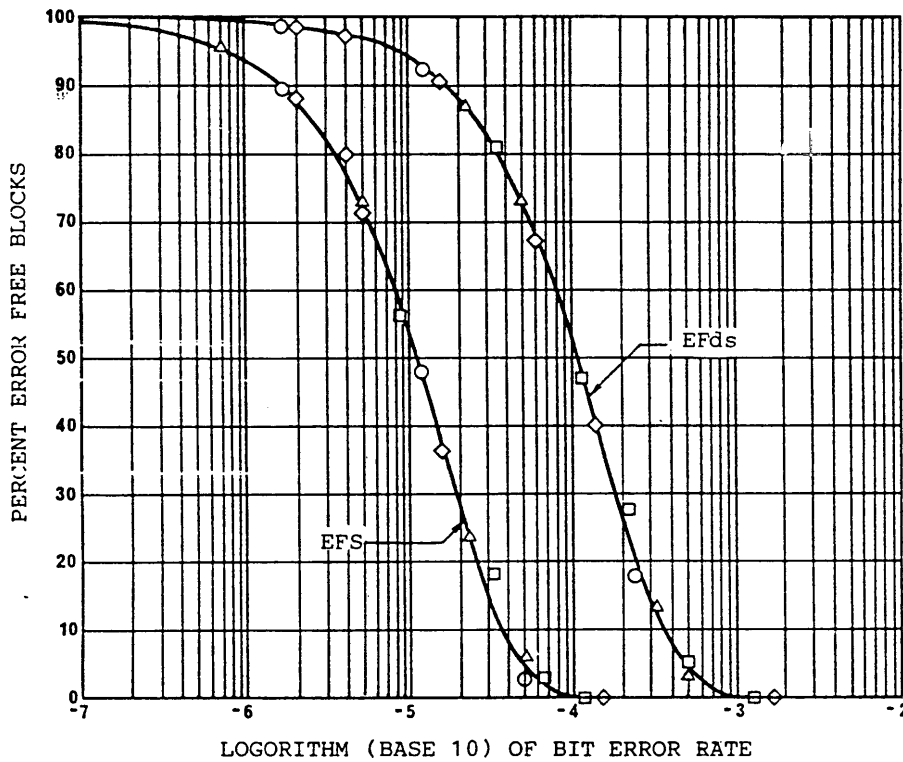

FIGURE 1
DISTRIBUTION OF ERROR-FREE BLOCKS: 64 kbit/s, NO FEC CODING

- No Interference
- ◇ 21 dB carrier-to-Interference ratio
- △ 18 dB carrier-to-Interference ratio
- 15 dB carrier-to-Interference ratio

- model a) : BEP = 10^{-7} for 95% of the worst month;
- model b) : BEP = 2×10^{-7} for 90% of the worst month,
BEP = 10^{-6} for 99.4% of the worst month;
- model c) : BEP = 10^{-8} for 89% of the worst month;
- model d) : BEP = 1×10^{-7} for 90% of the worst month,
BEP = 1×10^{-6} for 98% of the worst month.

In deriving model c) of Fig. 4 the aim was to produce a model in which performance was held at a low BEP (10^{-8}) for as short a time as possible (89% of the worst month). Such a model would be appropriate where performance is limited almost entirely by rain attenuation (i.e. above 10 GHz). The large fade margin required in this situation ensures that a good BEP is achieved for much of the time. In curve A (model a)) the aim was to assess the impact on the long-term BEP break point of adopting a BEP of 10^{-7} . In this case a two break point mask was again adopted.

Model b) is intended to allow the highest possible long-term BEP. In this case an additional break point has been included at a BEP of 10^{-6} for 99.5% of the month to more closely model system performance at around these time percentages. This model will probably be appropriate in situations where there is little rain attenuation or where the system is inter- and intra-system interference-limited.

Model d) strikes a compromise between the requirements of propagation limited systems and those of interference limited systems. It is considered possible to meet this model in high capacity, state-of-the-art satellite systems without undue cost or capacity penalties.

A common feature of the four models is the (0.2%, 10^{-3}) point and it is important to identify how this point enables the models to comply with the severely errored second objective b) of Recommendation G.821. This objective is 10^{-3} for 99.97% of available time in the worst month. In accordance with the definition in Recommendation G.821, a period of ten or more consecutive severely errored seconds (those with a BER worse than 10^{-3}) is considered as unavailable time. Periods of nine or less consecutive seconds are included in available time. An indication of the proportion of time which is unavailable can be deduced from Report 706.

The performance of these four models, in Recommendation G.821 parameters, is given in Table IV. This table gives, for each parameter, percentages of the time interval in the available time in a month. Unavailable time has been subtracted from total time to obtain the results given in the table. Since Recommendation G.821 refers to percentages of available time, the form of this table is appropriate for comparing performance with G.821 requirements.

The values shown in Table IV have been computed on the basis of a short-term break point (i.e. BER = 1×10^{-3}) of 0.2% total time and a propagation availability factor of 10%.

TABLE IV

Objective	Performance (% of available time)				
	Rec. G.821	Model a)	Model b)	Model c)	Model d)
Degraded minutes	2.0	1.97	0.75	1.97	1.87
Errored seconds	1.6	1.59	1.60	1.06	1.56
Severely errored seconds	0.03	0.024 ⁽¹⁾	0.022 ⁽¹⁾	0.024 ⁽¹⁾	0.024 ⁽¹⁾

⁽¹⁾ Three decimal places have been given for these values to indicate the contribution to severely errored seconds from the integral of time with BER $\leq 1 \times 10^{-3}$.

Note 1 - The values in the table are given for the purpose of demonstrating, for the particular models studied, compatibility with Recommendation G.821. Different values will be achieved using different models.

Note 2 - It should be noted that if a satellite system designer were to base system calculation directly on one of the models of the type shown, the performance of that system would exceed that obtained from the above calculations. This is because the practical system BEP/% time characteristic must inevitably exceed the model in most places.

A significant difference between model b) and the other models can be seen from Table IV in that models a), c) and d) result in nearly all the parameters equally meeting the objectives of Recommendation G.821, whereas with model b) performance is dictated quite clearly by the errored second requirement.

It is clear that any satellite system design objectives could be written in terms of total time (as has been adopted in the past) or of available time. The principal advantage of adopting the latter approach is that it is more immediately apparent that the objectives are consistent with Recommendation G.821 since no assumptions about percentage unavailable time have to be made. In the event that a designer does require total time percentages, he can employ a conversion factor appropriate to the frequency band and climatic region being considered. This could well lead, in many cases, to objectives that are not quite so severe as those in a "total time" objective since these have a "percentage unavailable time" assumption incorporated in them.

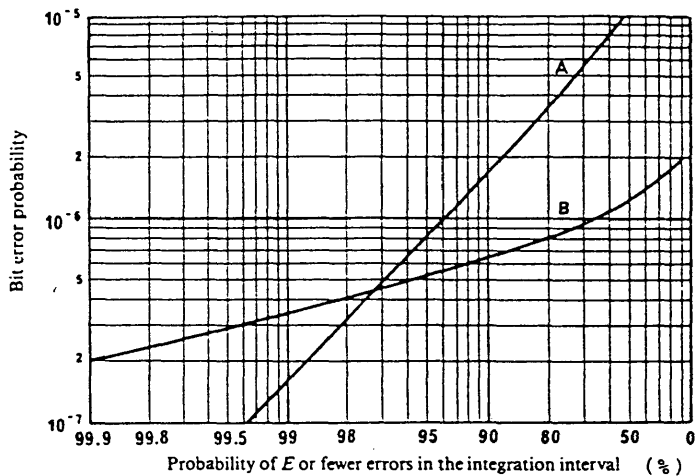

FIGURE 2

Curves A: probability of error-free seconds, i.e. (1 - probability of errored seconds)
 B: probability of 4 errors or less in a minute, i.e. (1 - probability of degraded minutes)

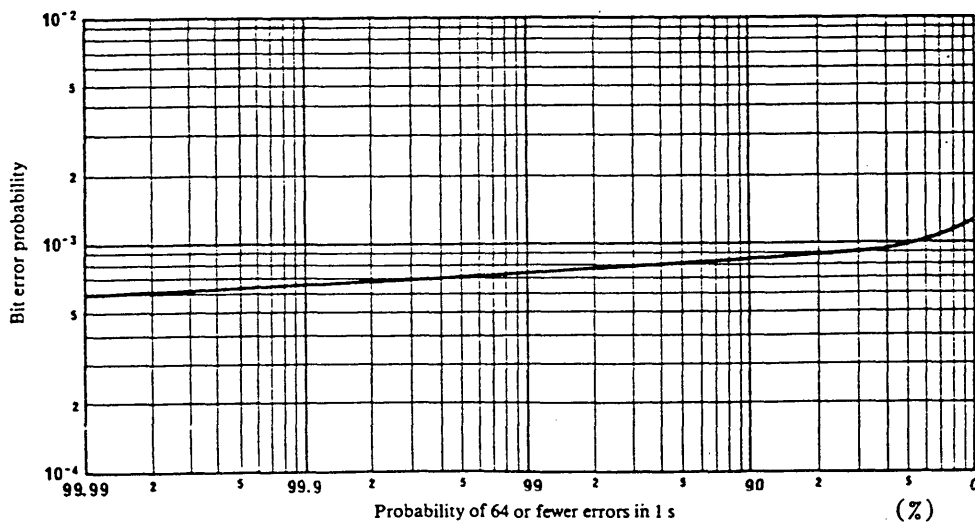

FIGURE 3 Probability that the number of errors is less or equal to 64 in 1 s

Note. - Probability of 64 or fewer errors per second is equivalent to (1 - probability of severely errored seconds).

The curves of Figures 1 and 2 have been calculated using the following Poisson distribution formula:

$$P(E \text{ or fewer errors}) = \sum_{K=0}^E \frac{(N \cdot BEP)^K \cdot (e^{-N \cdot BEP})}{K!}$$

where:

- N*: number of bits in the desired integrating time interval, e.g. 64 000 × 60 for a 1 min interval;
- E*: error threshold; and
- BEP*: bit error probability.

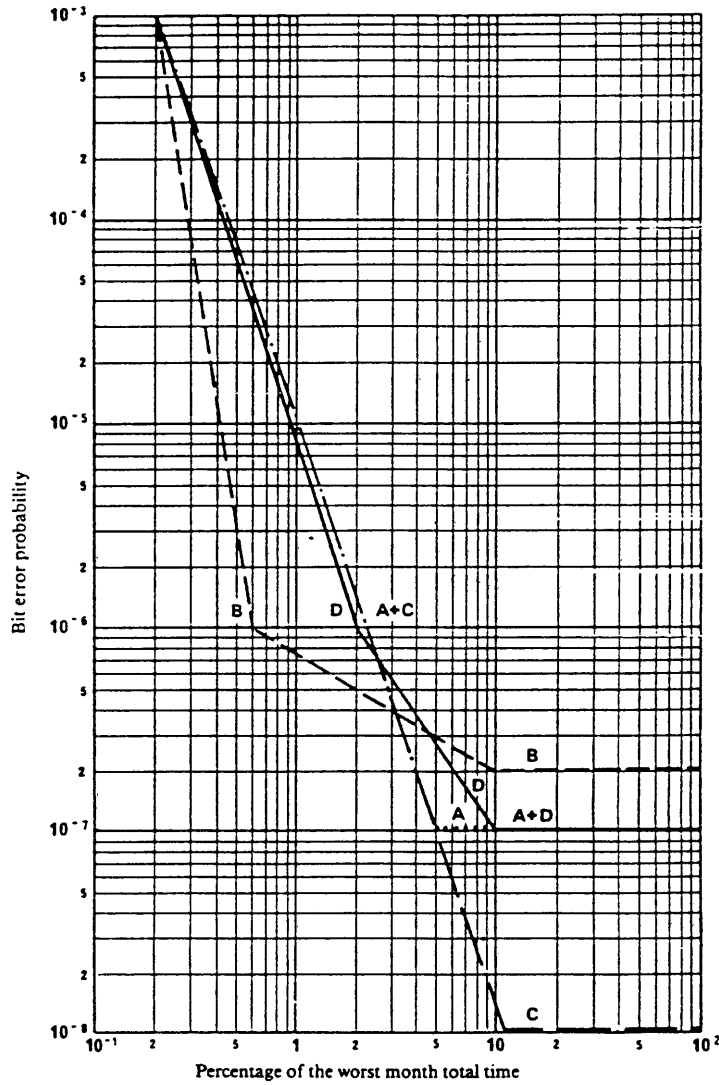

FIGURE 4 BEP performance models which meet CCITT Recommendation G.821

- A: model a)
- B: model b)
- C: model c)
- D: model d)

ANNEX II

EXAMPLES OF TYPICAL SATELLITE LINK PERFORMANCE

This Annex provides results of calculations of digital performance for three different satellite digital transmission systems:

- 6/4 GHz INTELSAT-V 120 Mbit/s TDMA;
- 14/11 GHz EUTELSAT 120 Mbit/s TDMA;
- 14/11 GHz INTELSAT-V 120 Mbit/s TDMA (with up-link power control and site diversity).

The choice of these systems was made on the basis that they include existing, or soon to be operational, satellite systems in both 6/4 GHz and 14/11 GHz bands. These systems could be used as guidelines for the design of satellite portions of future ISDN connections. Different performance characteristics may occur depending upon factors such as elevation angle, rain climate and interference situations. The system designer is cautioned to give full consideration to factors of this type when carrying out the design of a satellite ISDN HRDP.

The results of the link budget calculations are curves of bit error probability as a function of percentage of total time in the worst month. Using these curves, insight can be gained into the implications of the ISDN performance objectives on the design of satellite systems.

This annex also contains (section 3) the results of measurements made between Bercey en Othe (France) and Trou Biran (French Guyana) over a 64 kbit/s service channel link. The measurements were conducted over more than one year with a monthly average of 445 hours' recording.

1. Attenuation model

The attenuation model used in this exercise for the INTELSAT-V system calculations is an application of the method provided by Study Group 5 in their Report 564 [CCIR, 1982-86]. Using this method, percentage of the year statistics of slant path rain attenuation at earth-station locations can be calculated. The statistics are derived using several parameters. These are:

- rain climate - specifically, the point rainfall rate for 0.01% of an average year;
- earth-station height above mean sea level;
- earth-station elevation angle to the satellite;
- earth-station latitude.

With these parameters, the attenuation due to rain that will be exceeded for 0.01% of a year is calculated. Attenuation values for other percentages of a year are determined using the following formula:

$$A_p = b A_{0.01} P^{-a}$$

where:

- A_p : attenuation for the desired percentage of the year,
- $A_{0.01}$: attenuation for 0.01% of the year,
- P : desired percentage of the year,
- a and b : constants.

These yearly attenuation figures can be related to attenuation during a "worst month" by using the following relationship:

$$P_y = 0.29 P_w^{1.15}$$

where:

- P_y : yearly percentage,
- P_w : worst month percentage.

This method was used to arrive at the INTELSAT-V performance curves shown in Fig. 5. The INTELSAT-V 6/4 GHz performance assumed transmission from the United States of America to Italy where both stations were located in rain climate "K" and the United States earth station had an elevation angle of 25° and the Italian station had an elevation angle of 21°. In the 14/11 GHz INTELSAT case, the transmitting earth station was located in the United Kingdom, with an elevation angle of 29° and the receiving earth station was again located in the United States with the same elevation angle. The United Kingdom earth station is located in rain climate "G" and the United States earth station is again located in rain climate "K".

The INTELSAT-V, 6/4 GHz link budgets took into account interference contributions due to terrestrial, other system, adjacent channel and co-channel interferers. Four-fold frequency re-use with polarization discrimination and spatial isolation was assumed. Transponder output power variations due to operating point changes caused by up-link fading were included by making use of a non-linear transponder transfer characteristic.

For the INTELSAT 14/11 GHz system it was assumed for the purposes of this study that 10 dB of up-link power control is applied in a continuous manner. It was further assumed that site diversity with a site separation of 20 km was used at the receiving stations. Again transponder output power variations due to operating point changes caused by up-link fading were included. Neither of the INTELSAT system curves assume the use of any error correction coding. It should be noted that all INTELSAT TDMA terminals are equipped for the use of an optional forward error correction system using a rate 7/8 BCH (128 : 112) block code which realizes a coding gain of at least 3 dB for an input bit error ratio of 1×10^{-4} .

The performance for the EUTELSAT system was derived using a similar method. The attenuation statistics used correspond to a typical European mainland climate and are based on measurements made with OTS. These statistics are similar to, but slightly more optimistic than, those labelled climate "H" in Report 723.

2. Propagation considerations relating to short-term objectives

In CCIR performance Recommendations certain short-term objectives are given in percentages of the year. By contrast the long-term objectives are quoted in terms of percentages of worst month. The objectives of CCITT Recommendation G.821 are also quoted as percentages of a period of time of the order of one month. These facts lead to the conclusion that in any future ISDN performance Recommendations for satellites, there may be a need to use monthly attenuation statistics.

The information for performing such a conversion is contained in Report 723. From this Report, it can be seen that the conversion factor varies with climate and time percentage. For 0.01% of the year, a factor of between 4.5 and 6.5 is given, depending on climate.

With respect to the transmission impact of the attenuation expected at various frequencies, some general observations can be made.

These are:

- for frequencies below 10 GHz, the long-term BEP becomes the controlling factor in the one 6/4 GHz frequency re-use case which was examined;
- for frequencies from 10-15 GHz, the short-term (10^{-3}) BEP is the controlling factor if diversity is not used. Both diversity and non-diversity cases were analyzed;
- for frequencies > 15 GHz, particularly at 30/20 GHz, the short-term (10^{-3}) BEP is also likely to be the controlling factor. However, no analysis was carried out.

3. Results of measurements on the TELECOM 1 satellite

The link characteristics, similar to model a) in Figure 4 of Annex I, were as follows:

- link budget calculated to give for 99.9% of the time an error rate better than 10^{-4} , i.e., a clear-sky error rate of about 10^{-7} ;
- $E/N_0 = 14.000$ dB;
- transmitted bit rate = 8.768 Mbit/s without direct error correction;
- transmission in the 6/4 GHz band.

The test results are shown in figures 6 and 7 for DM and ES, respectively. The SES recorded were between 0.01% and 0.02%.

These results do not show the unavailability due to scintillation phenomena encountered in the equatorial zone where the Trou-Biran earth station is located.

During the measurements it was observed that solar interference caused an increase of unavailable time and an increase of the SES. (Recommendation 579 provides for 0.2% unavailability in any month for any phenomenon related to propagation conditions.)

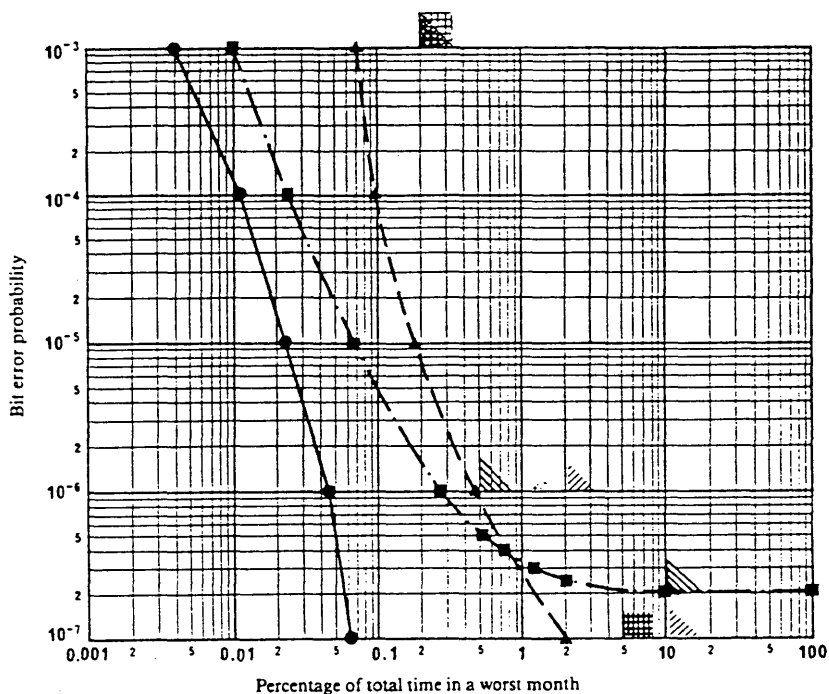

FIGURE 5 - Bit error probability versus percentage of total time in a worst month

- — — ■ INTELSAT-V, 6/4 GHz (without FEC)
- ▲ — — ▲ EUTELSAT, 14/11 GHz
- — — ● INTELSAT-V, 14/11 GHz with up-link power control and receive site diversity (without FEC)

- ▣ Model a) (Annex I)
- ▤ Model b) (Annex I)
- ▥ Model d) (Annex I)

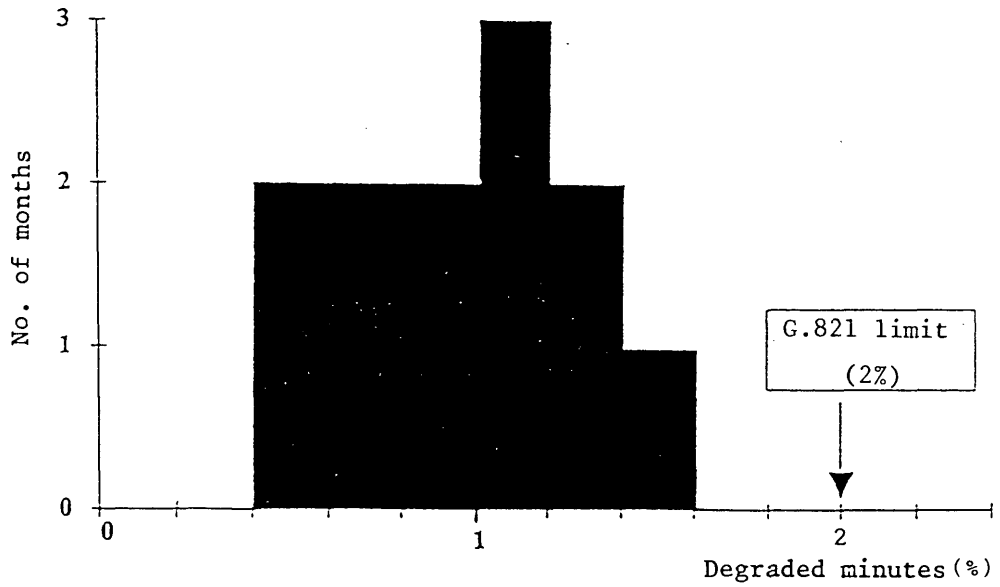

Figure 6: Distribution of Degraded Minutes (DM) on a monthly basis.

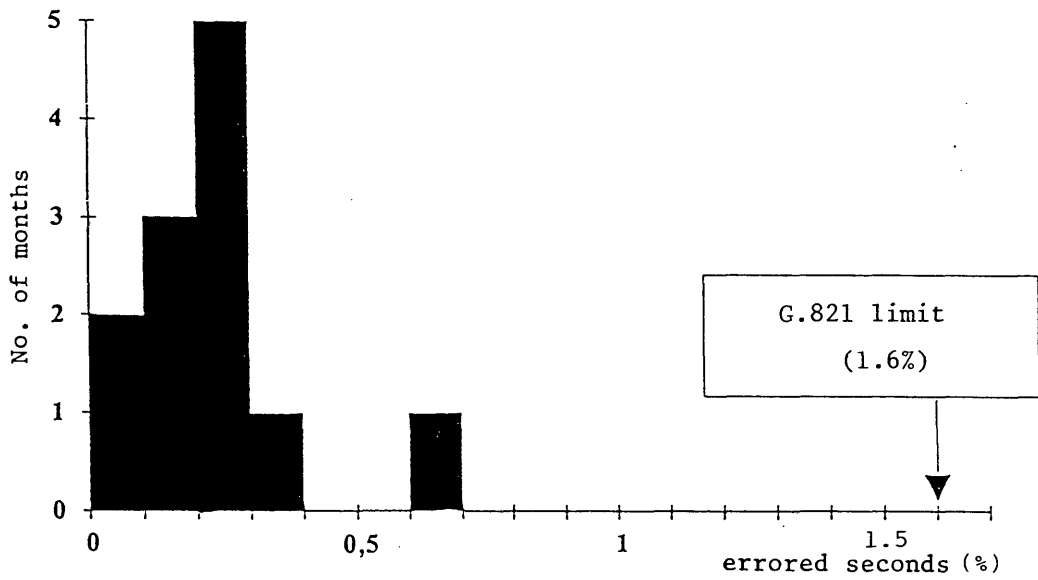

Figure 7: Distribution of Errored Seconds (ES) on a monthly basis.

ANNEX III
OTHER ERROR MECHANISMS

This Annex discusses briefly mechanisms other than noise and interference which will cause errors. Such errors will probably be "bursty" in nature.

1. Switching at IF and RF

Errors are caused as a result of IF and RF switching to bring stand-by equipment into use because of failures or routine maintenance requirements.

To determine the frequency of switching events, it is necessary to look at the mean time between failures (MTBF) for various components. From this, the number of switch-overs per month can be deduced. An example of some typical MTBFs is given in Table V along with the resulting average switch-over frequency.

TABLE V - Typical earth-station equipment failure rates

Device	MTBF (h)	Average switch-over frequency (per month)
HPA	2 000	0.36
Up converter	4 000	0.18
Modem	> 4 000	< 0.18
LNA	8 000	0.09
Post LNA cabinet	50 000	0.01
Down converter	4 000	0.18
Total		1.0

The "total" figure given in Table V relates to a one-way link incorporating one transmit and one receive earth station. It does not, of course, make any allowance for the fact that statistically some months will be worse than this average. The possible need to allow for this requires further study.

The duration of each switch-over will be typically 150 ms including control circuit reaction time.

2. Switching at baseband

Because of the limited application of digital baseband equipment to date, there is very little experience from which to derive failure rates. The only information available relates to TDMA equipment which is expected to return overall MTBFs of 3000 h for central terminal equipment and 2000 h for interface modules. Taken together these will result in 0.6 failures per month, or 1.2 per month total on a complete link. This is a figure which can be closely controlled by use of good design practices.

The switch-over time when failures do occur is very short but the effect on traffic can last rather longer. The result can be anything from 2 or 3 bit errors up to loss of a multi-frame, i.e. 128 bits on any one 64 kbit/s channel.

3. Power supply transients

This effect is very difficult to quantify. The best evidence available is that within the IF/RF equipment, twice as many switch-overs are, on average, the result of these spurious effects as are caused by actual equipment failures. Based on the IF/RF information given above, a figure of two switch-overs per month can therefore be attributed to this effect.

4. Signal path switching in the satellite

Although no data is currently to hand on this effect, it is considered unlikely to be as frequent as earth-station path switching. However, this may change as more complex satellites are put into service, especially if on-board switching or processing is employed, and the subject therefore requires further study.

5. Effects of Equipment Switch-overs on G.821 Parameters

During tests conducted on TELECOM-1 between Bercenay-en-Othe and Trou-Biran, it was observed that earth station equipment switch-overs produced the following effects on G.821 parameters;

	SES	ES	DM
Parametric Amplifier	2	2	0
Modem	2	2	0

Further information is needed on this topic, particularly in regard to the effects caused by other IF/RF equipment.

ANNEX IV

IMPACT OF BURST ERRORS DUE TO FEC CODING ON THE SATELLITE LINK

1. Introduction

It has been shown that the major error contributions on digital satellite links are due to propagation and interference effects which can be described by the Poisson distribution. However, when forward error correction (FEC) (used in many digital satellite systems to improve performance) is applied to the digital channel, the errors arriving at the output of the decoder tend to occur in groups, and therefore are likely to depart from the Poisson law. This clustering effect is illustrated by the measurement of error free intervals given in Figure 8. The degree of departure from the Poisson law will depend on the specific coding and multiplexing schemes used.

This annex provides examples of typical coding schemes, gives the results of measurements showing the impact of specific FEC schemes on the digital satellite link and introduces preliminary mathematical models that can be used to describe burstiness.

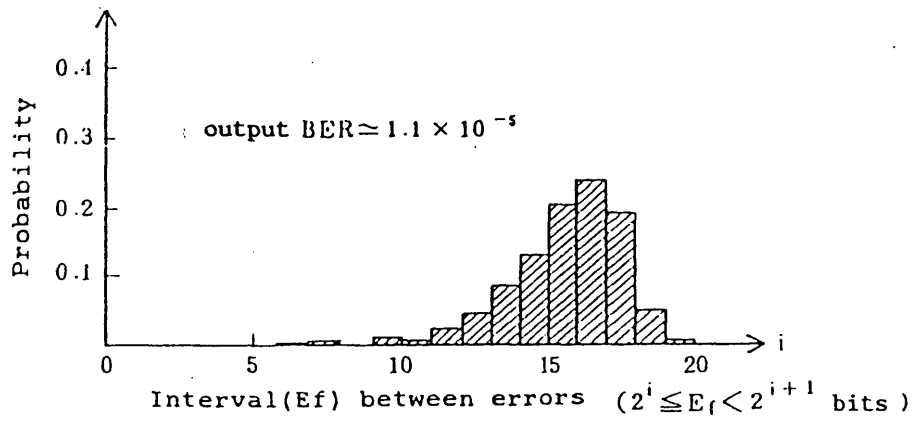

(a) without FEC (random error)

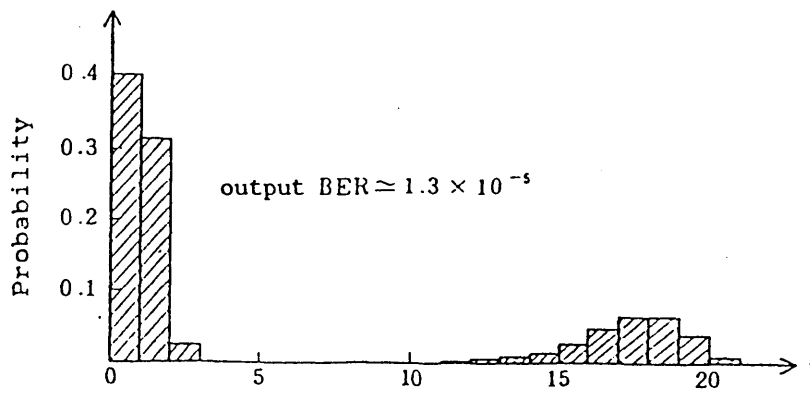

(b) with FEC

(Rate 1/2 Convolutional encoding of K=7 and Viterbi decoding)

FIGURE 8 Distribution of Errors with and without FEC

2. Characteristics of typical FEC coding schemes

2.1 Rate 7/8 BCH coding

Rate 7/8 Bose-Chaudhuri-Hocquenghen (BCH) FEC coding is currently used on digital satellite systems, e.g. INTELSAT 120 Mbit/s TDMA systems. This block code corrects up to two errors in a block of 127 bits and can detect three errors, but in the latter case the decoder takes no action. Hence, the most probable number of errors contained in a BCH block is three at the decoder output. In this scheme, the bit stream, comprised of 128 bit blocks, is restructured into blocks of 112 information bits to which 15 redundant coding bits and 1 dummy bit are appended, thus retaining the overall 128 bit block length. Consequently, during the coding process, the 128 contiguous bits of a specific 64 kbit/s channel originally appearing in a sub-burst will be split up in one of seven ways:

- | | | | |
|-----------|----------|-----------|----------|
| a) 112:16 | b) 96:32 | c) 80:48 | d) 64:64 |
| e) 48:80 | f) 32:96 | g) 16:112 | |

As a result, individual channels can exhibit four different degrees of burstiness with a) and g) being the most bursty and d) being the least.

2.2 Convolutional encoding-Viterbi decoding

The combination of convolutional coding and Viterbi decoding techniques is also a typical FEC scheme and being introduced into many satellite systems.

This method involves storing sequences of digits in memory and then comparing those sequences with the received digital stream to determine which one is most likely to be correct. Error events at the output of the decoder are caused by the selection of an incorrect data sequence or path. This incorrect selection gives rise to errors at the output of the decoder, but these errors do not necessarily occur consecutively. The length of the error event is a function of the codec configuration, in particular the length of the path memory. In the case of Viterbi decoding, a rate 1/2, 64 state code with a constraint length of 7, typically has a path memory length of about 37 bits. This path memory length is larger than any error event that occurs with significant probability.

Figure 8 shows typical experimental results on the error distribution without and with FEC decoding in terms of error free intervals.

There are great differences; the former has a peak which is typical of a random distribution, while the latter has two peaks. One peak (right-hand side) shows the distribution of the intervals between burst errors and implies their random occurrences. The other peak (left-hand side) shows the bit error distribution within a burst error.

Figure 9 presents experimental results on the distribution of the burst error length for both rates 1/2 and 3/4 at two values of BERs. The length of an error burst event is defined as the number of bits between the first error occurring in the burst and the last error occurring in the burst. Figure 10 shows the relation between the average burst error length and bit error rate after decoding.

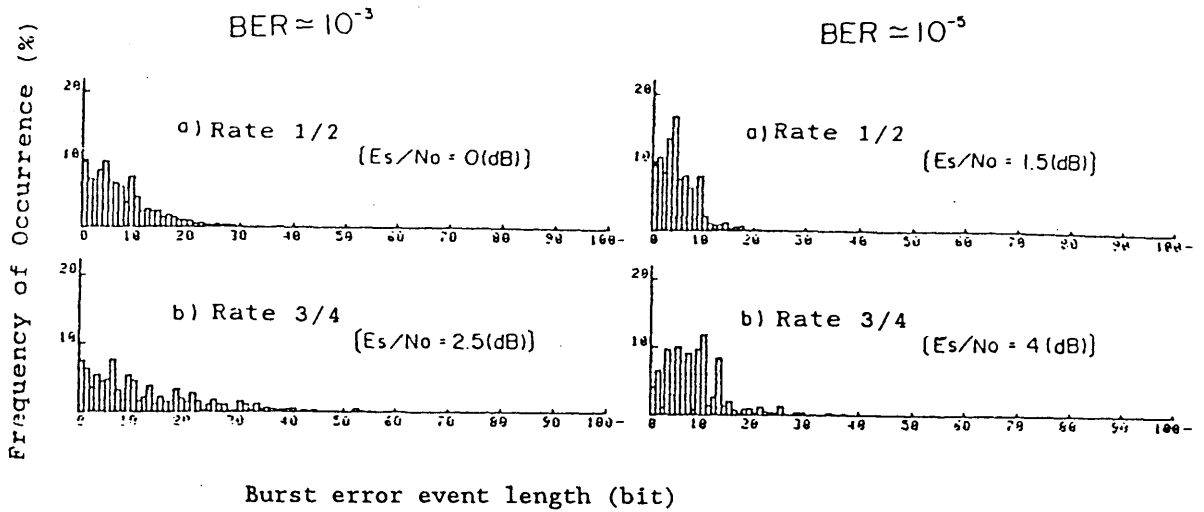

(Convolutional encoding and Viterbi decoding)

FIGURE 9

Distribution of burst error event length

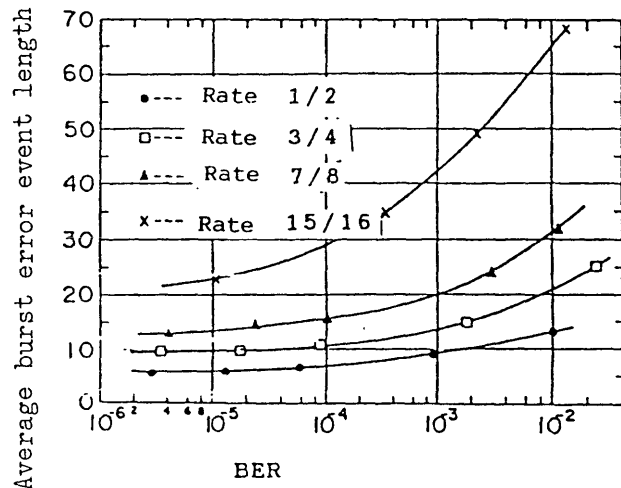

(Convolutional encoding and Viterbi decoding)

FIGURE 10

Relation between average burst error event length and BER

It can be observed from these figures that, as the code rate and bit error ratio become larger, the duration of the error burst event grows longer. Generally speaking, the average length of error burst events is about five and ten bits for rate 1/2 and rate 3/4 codes, respectively. A few burst error events exceed 20 bits in length. It is important to note that not all of the bits in an error burst event are errors. The error ratio within an error burst event can be regarded as approximately 1/2, that is, the average number of errors included in a burst error event is two or three for rate 1/2 codes and about five for rate 3/4 codes. The above experiments were carried out with an INTELSAT standard E1 earth station in a satellite loop-back mode using a 64 kbit/s IBS carrier.

As the result of the above discussions, the BER after decoding is given by:

$$P_e \text{ (BER after decoding)} = \frac{L_b/2}{L_b + E_{fb}}$$

where the average interval between burst errors E_{fb} can be derived as:

$$E_{fb} = (1/(2 P_e) - 1)L_b \approx L_b/(2P_e)$$

and L_b is the average length of burst error.

Another effect which requires consideration is the dependence of the burst error structure on the multiplexing of 64 kbit/s channels to primary rates (2048 kbit/s) or higher; this is shown in Figure 11(a) and (b) for a BER of 10^{-6} . In Fig. 11(a) a histogram of the number of errors per burst is shown for a composite 1920 kbit/s (30 time slots) signal in a 2048 bit stream multiplexed in accord with Recommendation G.704. However, within an individual 64 kbit/s channel, the number of errors per burst tends to be smaller as seen in Figure 11(b).

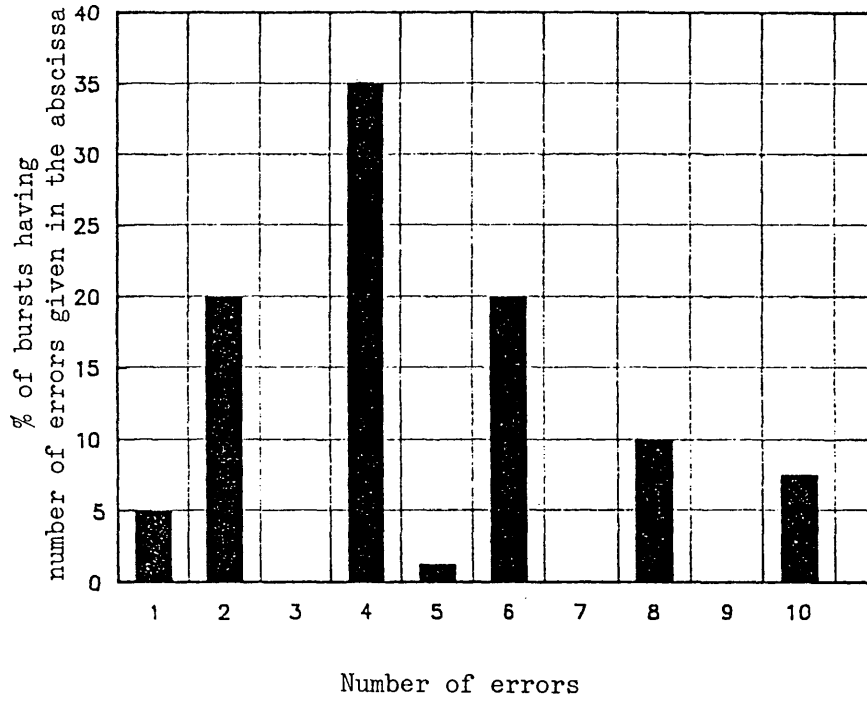

FIGURE 11a) - Histogram of number of errors per burst

BER = 10^{-6}

FEC (Rate 1/2) applied at bit rate of 2048 kbit/s

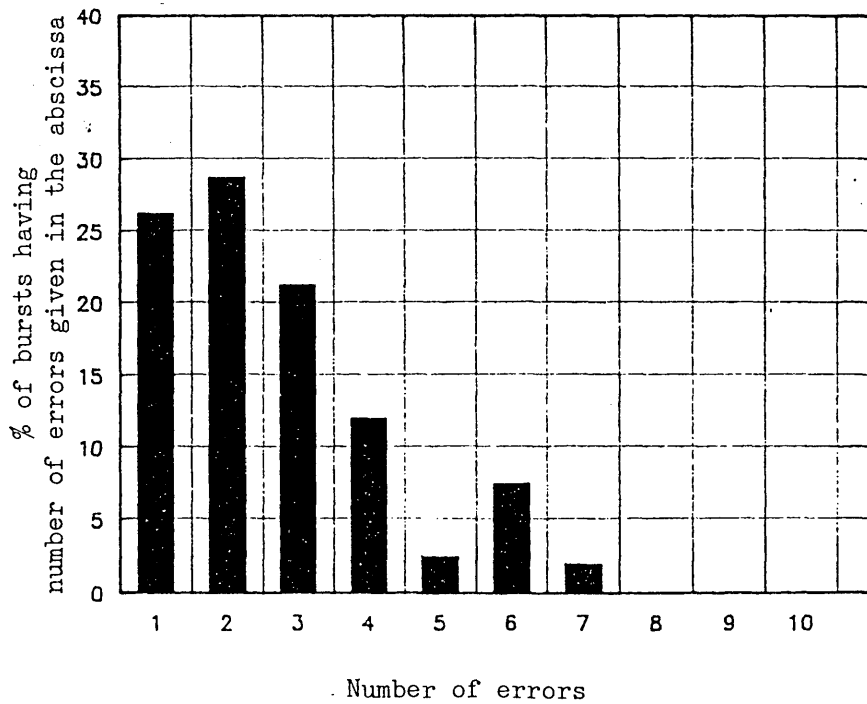

FIGURE 11b) - Histogram of number of errors per burst in one 64 kbit/s channel within a multiplex at primary rate of 2048 kbit/s (Rec. G.704).

BER = 10^{-6}

FEC (Rate 1/2) applied at primary rate

3. Effects on DM, SES and ES

3.1 Qualitative discussion

Effects of burst errors caused by convolutional encoding FEC are as follows:

Degraded minutes (DM)

One DM includes five errors or more. In the case of the rate 3/4 Viterbi decoding which often causes burst errors with five errors or more, the probability of DM may increase compared with random errors even under the same average error rate. In the case of rate 1/2 Viterbi decoding, this increase might be smaller.

Severely errored seconds (SES)

One SES includes sixty-five errors or more. Since the number of errors in one burst error event induced by the said FEC is far less than sixty-five, one SES will include several tens of burst errors. This may result in no significant difference in the probability of SES between burst and random errors.

Errored seconds (ES)

When error bunching occurs, as is the case for a channel with FEC, the probability of ES will decrease compared with random errors for the same average error rate.

The influence of burst errors will be less because of the fact that most satellite links multiplex many channels and that burst errors are dispersed over these multiplex channels.

3.2 Measurements

3.2.1 BCH Coding

Measurements have been conducted on a EUTELSAT 120 Mbit/s TDMA traffic terminal operated in burst mode and looped at IF where noise was added. A 64 kbit/s pseudo-random sequence was generated by a BER analyzer and percentage errored seconds, degraded minutes and severely errored seconds were measured in accordance with Recommendation G.821.

Measurements were carried out for the two time slots associated with cases a) and d) and it was found that a clear departure from the Poisson law could be observed for errored seconds and degraded minutes statistics (Fig. 12).

As concerns the severely errored seconds, a marginal shift could be observed for the small percentages of time on the distribution when FEC is used (Fig. 13). This shift is nevertheless quite small and not very significant when considering the flatness of the distribution, even if the computed confidence intervals prove that an actual shift has occurred.

These measurements were found to agree well with the theoretical prediction explained in section 4.2.

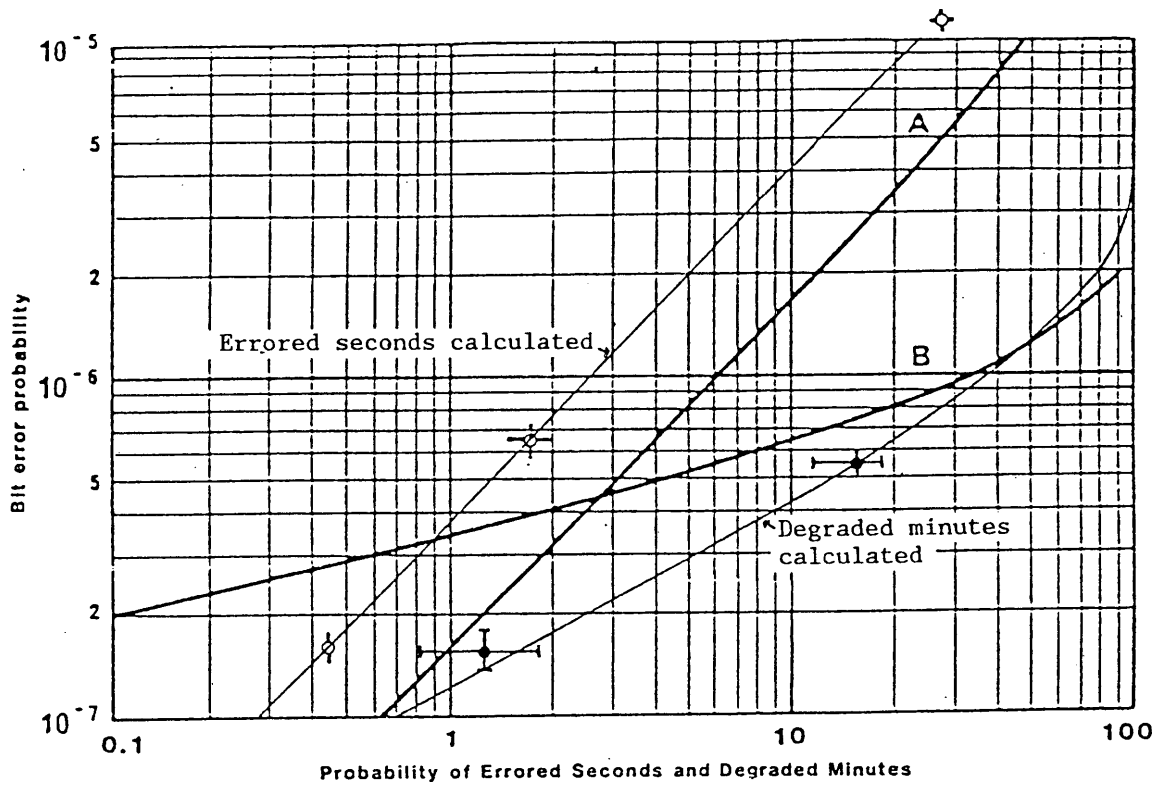

 Measured Errored Seconds (Rate 7/8 BCH) and confidence intervals } time slot (a)



 Measured Degraded Minutes (Rate 7/8 BCH) and confidence intervals }
 Curve A : Errored Seconds, POISSON Law
 Curve B : Degraded Minutes, POISSON Law

FIGURE 12 - ERRORED SECONDS AND DEGRADED MINUTES STATISTICS AT 64 kbit/s

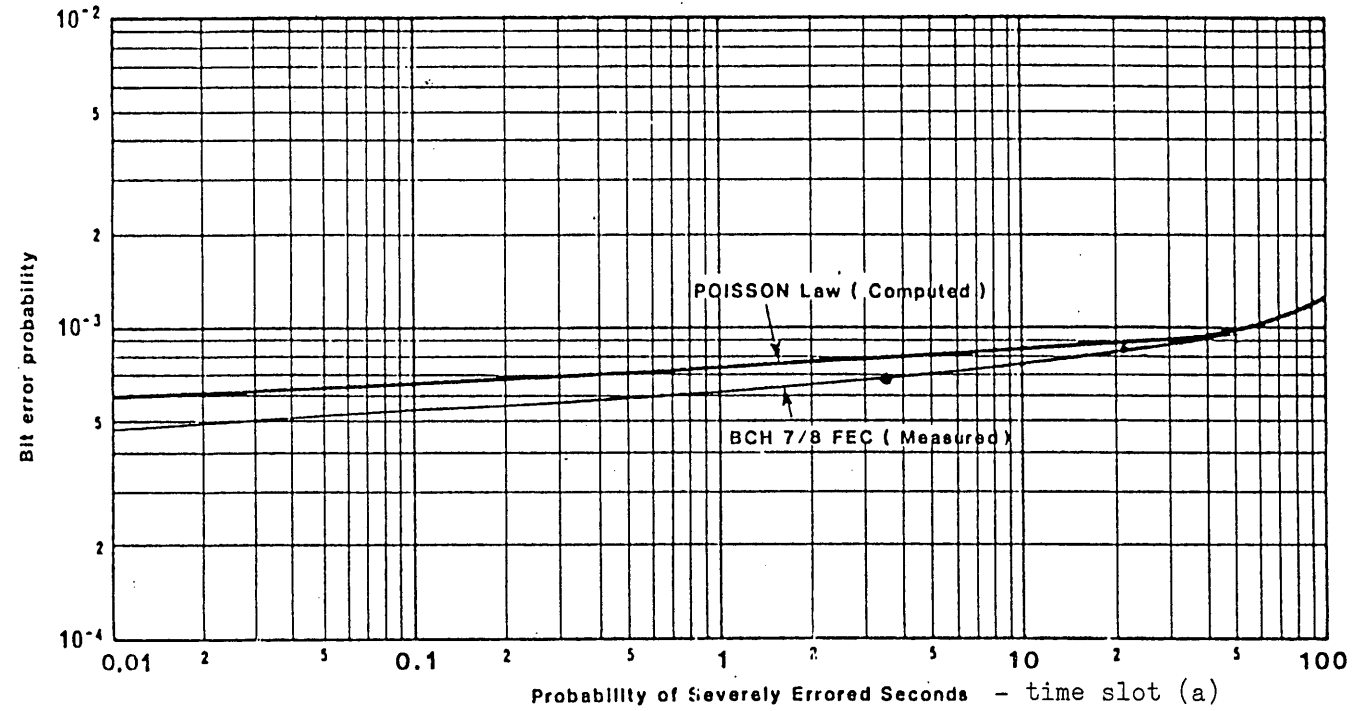

FIGURE 13 - PROBABILITY OF SEVERELY ERRORED SECONDS

3.2.2 Convolutional Coding - Viterbi Decoding

For convolutional coding - Viterbi decoding, similar measurements have been made and are shown in Figs. 14 to 17. As is seen, results have been obtained for both rates 1/2 and 3/4 at 64 kbit/s and rate 3/4 for one 64 kbit/s channel in a 2048 kbit/s composite stream.

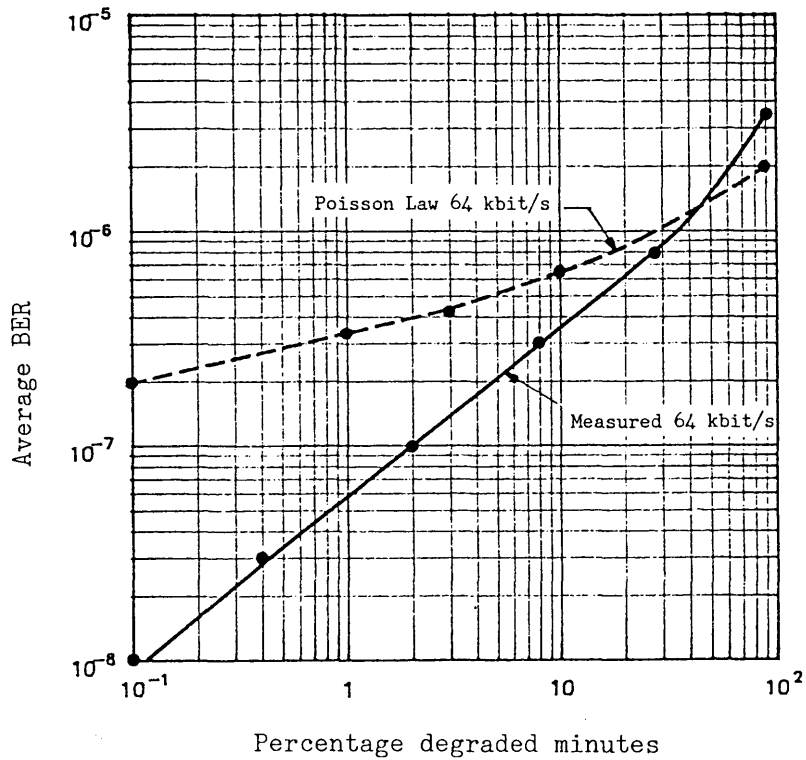

FIGURE 14 - Percentage degraded minutes for a 64 kbit/s channel multiplexed (Rec. G.704) in a 2048 kbit/s bit stream (rate 3/4 FEC, self-synchronizing scrambler in accord with INTELSAT IDR specification)

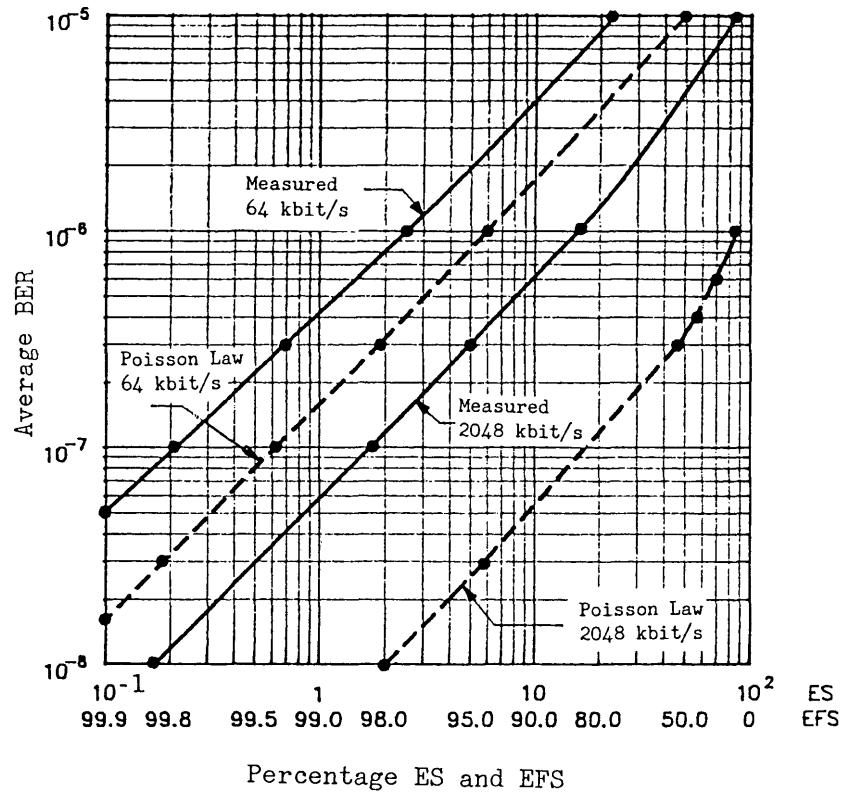

FIGURE 15 - Percentage Errored and Error-Free Seconds for a 64 kbit/s channel multiplexed (Rec. G.704) in a 2048 kbit/s stream and for the composite 2048 kbit/s stream (rate 3/4 FEC, self-synchronizing scrambler in accord with INTELSAT IDR specification)

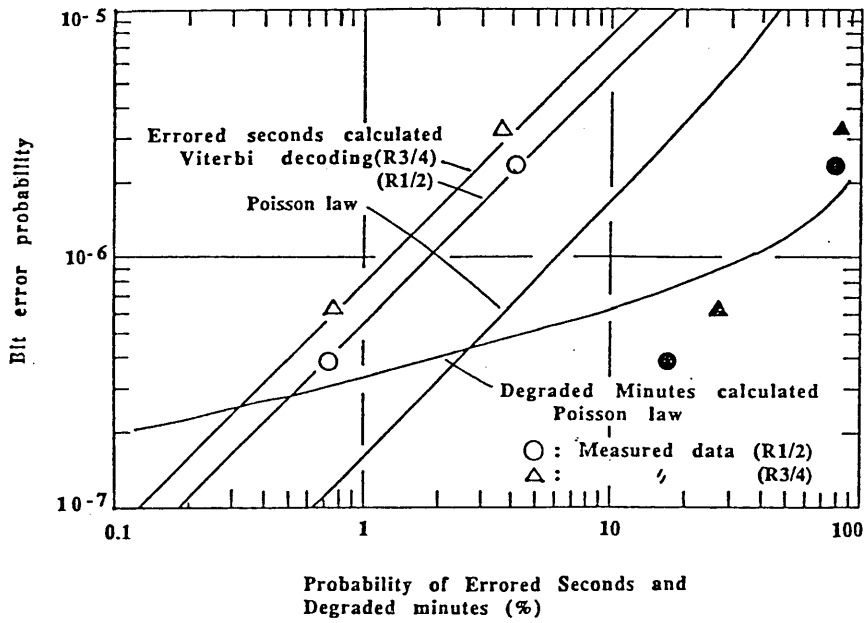

FIGURE 16 - Errored seconds and degraded minutes statistics for a 64 kbit/s bit stream. (No data scrambling or differential encoding.)

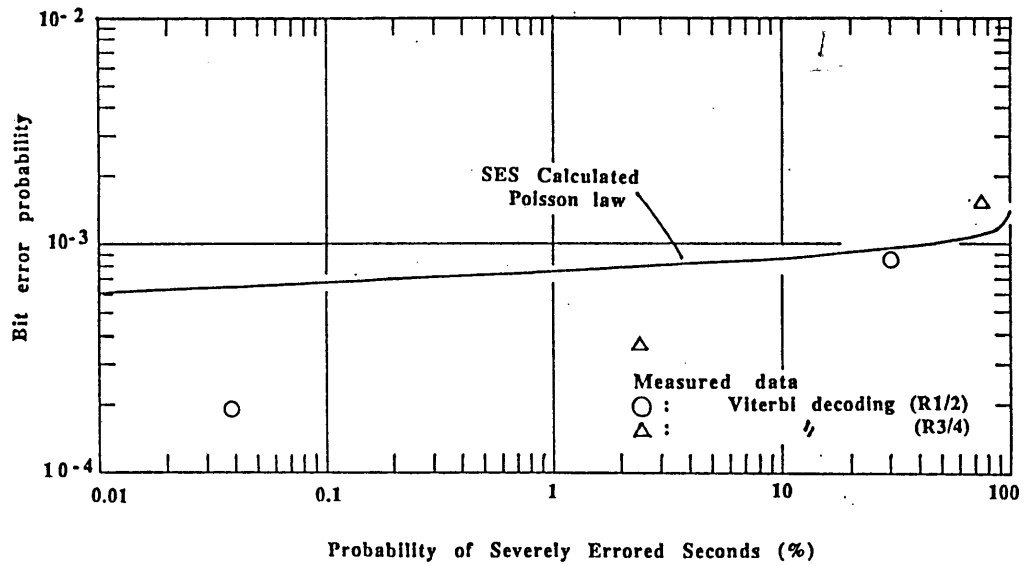

FIGURE 17 - Probability of severely errored seconds for a 64 kbit/s bit stream

3.3 Quantitative analysis

Figure 18 shows the probability of degraded minutes versus the BEP for three different cases of error distribution, named α , β_m and β_w . Case α is the random case considered in report 997. Cases β_m and β_w assume that the errors are clustered but the bursts themselves occur at random. Case β_m (m for moderate) assumes that there are systematically 3 errors per burst. Case β_w (w for worst) assumes that there are systematically 5 errors per bursts. The formulas used to compute the curves are given in the Figure. They are in fact Poisson formulas applied to bursts.

The degraded minutes increase with burstiness in the low BEP region. Moreover, if the bursts have systematically more than 5 errors each, then any minute that receives a burst is counted as degraded the same way as if there were only 5 errors. But if there are more errors per burst then the bursts will be further separated, and more minutes will be burst-free. Thus β_w is the worst case distribution as concerning this parameter [Pham, 1989].

If the error distributions of Figures 9a and 9b (at BER = 10^{-5}) are approximated as uniform and the error burst occurrences are considered as independent events, it is possible to calculate the degraded minutes and error-free seconds performance.

Table VI summarizes the calculation results. The case with double errors, typical for systems with differential coding is also included in the Table. The calculations have been performed under the assumption that from the BER point of view, circuit performances comply with model d) of Report 997, Figure 4. The values in Table VI show that error bursts can significantly affect the performances of a digital circuit in terms of requirements given in Recommendation G. 821. This analysis does not however, consider the effect of multiplex structure. Further study is needed in this area. Pending the results of such studies care should be exercised in the design of systems utilizing FEC in meeting DM objectives.

TABLE VI

Objective	Performance (% of available time)				
	Rec. G.812	single errors	double errors	error bursts (1/2 code)	error bursts (3/4 code)
Degraded minutes	2.0	1.87	2.67	6.2	6.7
Errored seconds	1.6	1.56	1.4	1.2	1.16

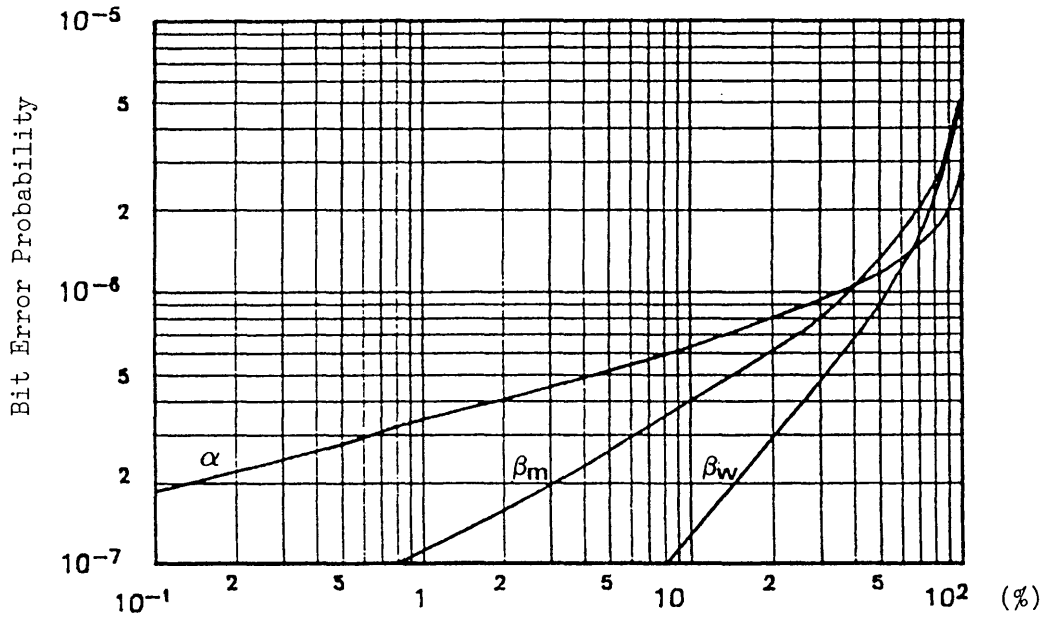

Probability of 5 errors or more in 384×10^4 Bits
 (i.e. Probability of degraded minutes for 64 kbit/s)

FIGURE 18 - Probability of degraded minutes assuming constant bit error probability

Case α : Random Error Channel

$$DM(p) = 1 - \left(1 + \frac{x^2}{2!} + \frac{x^3}{3!} + \frac{x^4}{4!} \right) e^{-x} \quad x = 384 \cdot 10^4 p$$

Case β_m : Moderately Bursty Channel (3 errors per burst)

$$DM(p) = 1 - (1+x)e^{-x} \quad x = 384 \cdot 10^4 p/3$$

Case β_w : Worst - Case Bursty Channel (5 errors per burst)

$$DM(p) = 1 - e^{-x} \quad x = 384 \cdot 10^4 p/5$$

p = Bit Error probability
 DM(p) = probability of degraded minutes

4. Mathematical modelling

In order to demonstrate that a particular system meets Recommendation G.821 requirements, it is necessary to know:

- i) BEP statistics with time percentage;
- ii) mathematical model, through which ES, DM and SES are calculated, to describe the error distribution at the 64 kbit/s stage, taking into account the type of FEC applied and method of multiplexing used.

The following two models have been studied.

4.1 The Neyman-A contagious distribution

One statistical model which can be used to describe the clustering of probabilistic events is the Neyman-A contagious distribution. In particular, this distribution can describe the burstiness of error arrivals due to propagation and interference effects on digital satellite systems. Applying this model assures that error bursts are independent, i.e., arrive at random and that the duration of the bursts are random (though errors in some FEC schemes typically arrive in bursts of three or four at the decoder output, the actual average number of errors on a given demultiplexed channel needs to be evaluated from the knowledge of the system).

The Neyman-A contagious model is given by:

$$P(n) = \frac{(BEP/A)^n}{n!} e^{-NA} \sum_{k=0}^{\infty} \frac{k^n}{k!} (NA)^k e^{-kBEP/A}$$

where

$P(n)$ is the probability that n errors occur in N transmitted bits, NA is the average number of bursts and BEP/A is the mean value of errors per burst. Then the probability of error free seconds and degraded minutes can be determined, respectively by:

$$P(0) = e^{-AN} \sum_{k=0}^{\infty} \frac{(NA)^k}{k!} e^{-kBEP/A}, \text{ with } N = 64000 \text{ bits}$$

$$P(DM) = 1 - \sum_{n=0}^4 P(n), \text{ with } N = 3.84 \text{ Mbits}$$

4.2 Analytical representation for a BCH code

When the transmission system is known (type of FEC used, multiplexing scheme, etc.), analytical formulae can be derived in place of measurements in order to predict the statistics of ES, DM and SES parameters with BEPs.

It has been shown [CCIR, 1986-90] that analytical expressions can be derived and that predictions could be obtained in the case of the BCH 7/8 FEC as used in the INTELSAT and EUTELSAT 120 Mbit/s TDMA systems (see TABLE VII).

TABLE VII

Summary of formulae to compute the percentage errored seconds,
degraded minutes and severely errored seconds

7/8 BCH

% ES	$P = 100 \times \{1 - \text{Exp}(-L)\} \times u$ $L = \text{BEP} \times 42333.3$ $u = 0.667 \quad \text{For case (a)}$ $u = 0.881 \quad \text{For case (d)}$
% DM	$P = 100 \times \{1 - (1 + L + L^2/2! \times (1 - u_2) + L^3/3! \times (1 - u_3) + L^4/4! \times (1 - u_4)) \times \text{Exp}(-L)\}$ $L = \text{BEP} \times 2.54\text{E}+6$ $u_2 = 0.227 \quad u_3 = 0.506 \quad u_4 = 0.702 \quad \text{For case (a)}$ $u_2 = 0.111 \quad u_3 = 0.510 \quad u_4 = 0.713 \quad \text{For case (d)}$
% SES	$P = 100 \times \{1 - (1 + L + L^2/2! + \dots + L^{38}/38!) \times \text{Exp}(-L)\}$ $L = \text{BEP} \times 42333.3$

5. Impact on system design in the 14/11 GHz band

For 14/11 GHz systems operating in European climatic zones, the constraining criterion of the mask specified in Recommendation 614 in the case of a non-coded satellite link is the "long term" BEP. This is because the difference in C/N required at the input of the earth station demodulator to achieve BEPs of 10^{-7} and 10^{-3} is larger than the corresponding expected fade levels difference between 10% and 0.2% of the (total) worst month.

As an illustration, Fig. 19 (curves A and B) shows the performance of a system operating at 14/11 GHz band and whose characteristics are such that the long-term criterion at 10^{-7} is exactly met. Curves A and B refer to the performance in terms of percentages of time, when the system is affected by propagation statistics typical of the European coastal climate (curve A) and of the Alpine/Mediterranean climate (curve B).

In the case where FEC is used, the situation requires more careful analysis. On one hand, the difference in (C/N+I)s required at the input of the demodulator for the two levels of BER is smaller than in the non-coded case due to the coding gain and this tends to constrain the design on the short-term requirement; on the other hand, better performance than a BER of 10^{-7} is needed for 10 % of the worst month in order to compensate for the bursty nature of the error occurrence, and this sets a high performance requirement under clear-sky conditions.

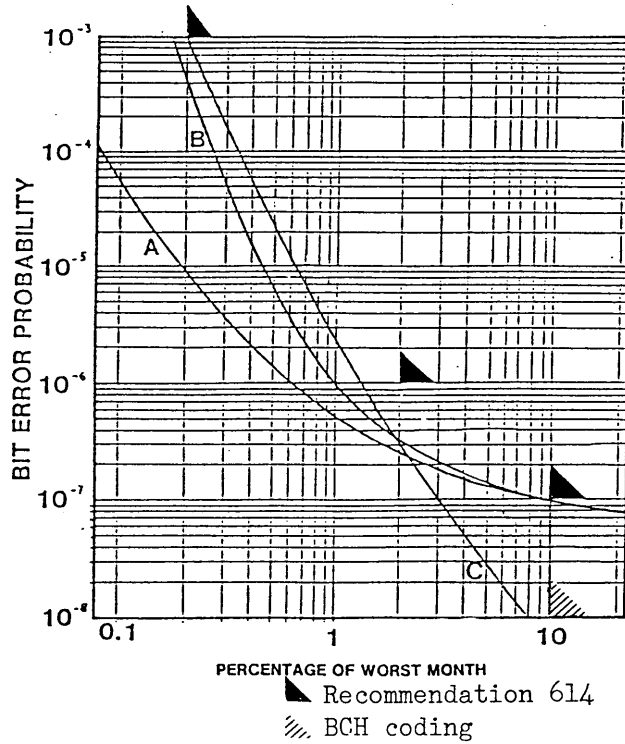

FIGURE 19 - Performance of a system operating at 14/11 GHz band, designed to just meet the objectives of Rec. 614

- Curve A: No FEC European coastal climate
- Curve B: No FEC Alpine mediterranean climate
- Curve C: BCH 7/8 FEC Alpine mediterranean climate

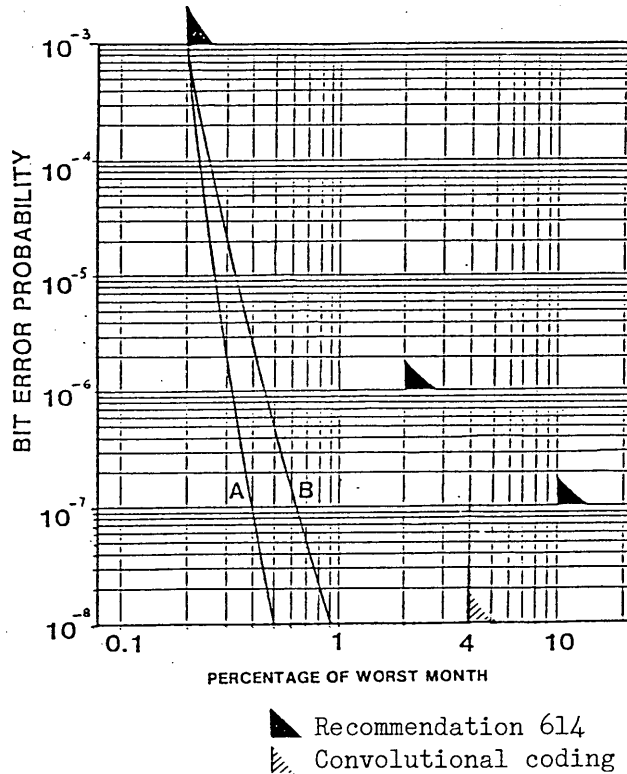

FIGURE 20 - Performance of a system operating at 14/11 GHz band, designed to just meet the Rec. 614 objectives

- Curve A: 1/2 convolutional FEC Alpine mediterranean climate
- Curve B: 3/4 convolutional FEC Alpine mediterranean climate

Figures 19 and 20 illustrate this: Fig. 19 (curve C) shows the performance of a satellite link with the BCH 7/8 block code and Fig. 20 (curves A and B) the performance of a link convolutionally encoded with FEC rate 1/2 and 3/4 respectively, when the system is dimensioned in order to just meet the short-term criterion under propagation statistics of the Alpine/ Mediterranean climate, which is the worst for Europe.

6. Conclusions

This annex discusses the error distribution characteristics in satellite communication systems employing several types of FEC as well as their effects on DM, SES and ES which are used to define Recommendation G.821 and which have been analyzed:

- 1) the FEC, both block coding and convolutional coding, causes errors to exhibit a bursty distribution;
- 2) the probability of DM in the FEC system might be greater than that in the non-FEC system under the condition of the same average BER;
- 3) there will be no substantial difference in the probability of SES for the same BER whether the FEC is used or not;
- 4) the probability of ES will be less in the FEC system than in the non-FEC system for the same BER;
- 5) the influence of burst errors may decrease when the satellite link multiplexes a number of channels;
- 6) error distribution can be modelled mathematically by expansion of the Poisson distribution. This item needs further study.

REFERENCES

PHAM H.N., AMADESI P.; DUTRONC J.; WELLER E. [1989] Performance Design Criteria for Digital Satellite Links in the ISDN. Proc. 8th ICDS, April.

CCIR Documents

[1986-90]: 4/93 (EUTELSAT)

REPORT 706-2

AVAILABILITY OF CIRCUITS IN THE FIXED-SATELLITE SERVICE

(Question 24/4, Study Programme 24A/4)

(1978-1982-1986)

1. Introduction

This Report discusses the concept of availability as it applies to the hypothetical reference circuit (Recommendation 352) and the hypothetical reference digital path (Recommendation 521) in the fixed-satellite service.

It indicates the philosophy which has been applied in deriving availability criteria, and provides information on some of the parameters which affect them.

The concepts of reliability and availability in respect to radio-relay systems for television and telephony as discussed in Report 445 have been noted with the objective of achieving consistency, insofar as is possible, between corresponding considerations for radio-relay systems and for the fixed-satellite service.

2. Definition of availability

In the context of an end-to-end connection, availability comprises a number of component parts, and these are discussed in CCITT Recommendation G.106. As applied to the satellite HRC and HRDP, availability is concerned only with equipment availability and propagation availability.

A precise definition of availability of satellite circuits is given in Recommendation 579, which also gives availability objectives.

* Referring to the term of "any year", see Note 11 of Recommendation 353.

3. General considerations

The availability of a telephone or television circuit in the fixed-satellite service is determined by interruptions. An interruption is a period in which there is complete or partial loss of signal, excessive noise, or a discontinuity or severe distortion in the signal. Several aspects have been considered:

- a definition of that which constitutes an interruption;
- a description of the time aspects, such as the length of an interruption, the period between successive interruptions, etc.;
- a determination, for the purposes of specifying availability objectives, of whether all interruptions should be included within the objective, or if not, what specific types of interruption should be excluded.

In the case of telephony an interruption is taken into account in the determination of availability if it would cause a call to be disconnected making it necessary to re-establish the connection. Any interruption of a circuit of 10 consecutive seconds or more is considered to make the circuit unavailable.

The Handbook on Satellite Communication (Fixed-Satellite Service), Geneva, 1985, contains an extensive discussion on availability. In particular, it discusses the impact on availability of factors such as the following:

- mean time between interruptions. This is to ensure that interruptions of extended duration do not occur too frequently;
- total interruption over a long period. This ensures a maximum value of availability for the system;
- mean duration of interruption. This ensures that, if an interruption occurs, it is not too long;
- the rate of occurrence (e.g. measured on an hourly basis);
- the total interruption time over a period (e.g. of any month or year);
- the statistically defined duration of interruptions, which could be specified by several points on a statistical distribution.

4. Equipment availability

A number of different causes of interruption are included under this heading. They are:

- satellite-related effects, including partial or complete failure of any of the systems on board, plus eclipse outages;
- earth-station related effects, including failure of any equipment as far as the terrestrial network interface, outages caused by human error, sun transits and the effects of natural disasters.

Substantial discussion of many of these mechanisms, plus information regarding availability achieved in practice with operational satellites and earth stations is given in the Handbook on Satellite Communications (Fixed-Satellite Service) referred to above.

5. Propagation availability

This heading covers interruptions caused by interference and propagation effects. Limited information is available at present on the impact of intra- and inter-system (including radio-relay) interference as they affect availability, and studies in this area are necessary.

Some studies have been carried out into the impact of propagation on availability. In particular, it has been found necessary to distinguish between short breaks due to propagation mechanisms of less than 10 consecutive seconds which are covered by performance recommendations, and those of 10 consecutive seconds or more which contribute to unavailability. In this respect an "availability factor" has been used which can be defined as:

$$\text{availability factor} = \frac{\text{total time for which outages of } < 10 \text{ s duration occur}}{\text{total time for which all outages occur}} \times 100\%$$

The meaning of "outages" depends on whether an analogue or digital circuit is considered, and a precise definition in each case is given in RECOMMENDS 4 of Recommendation 579.

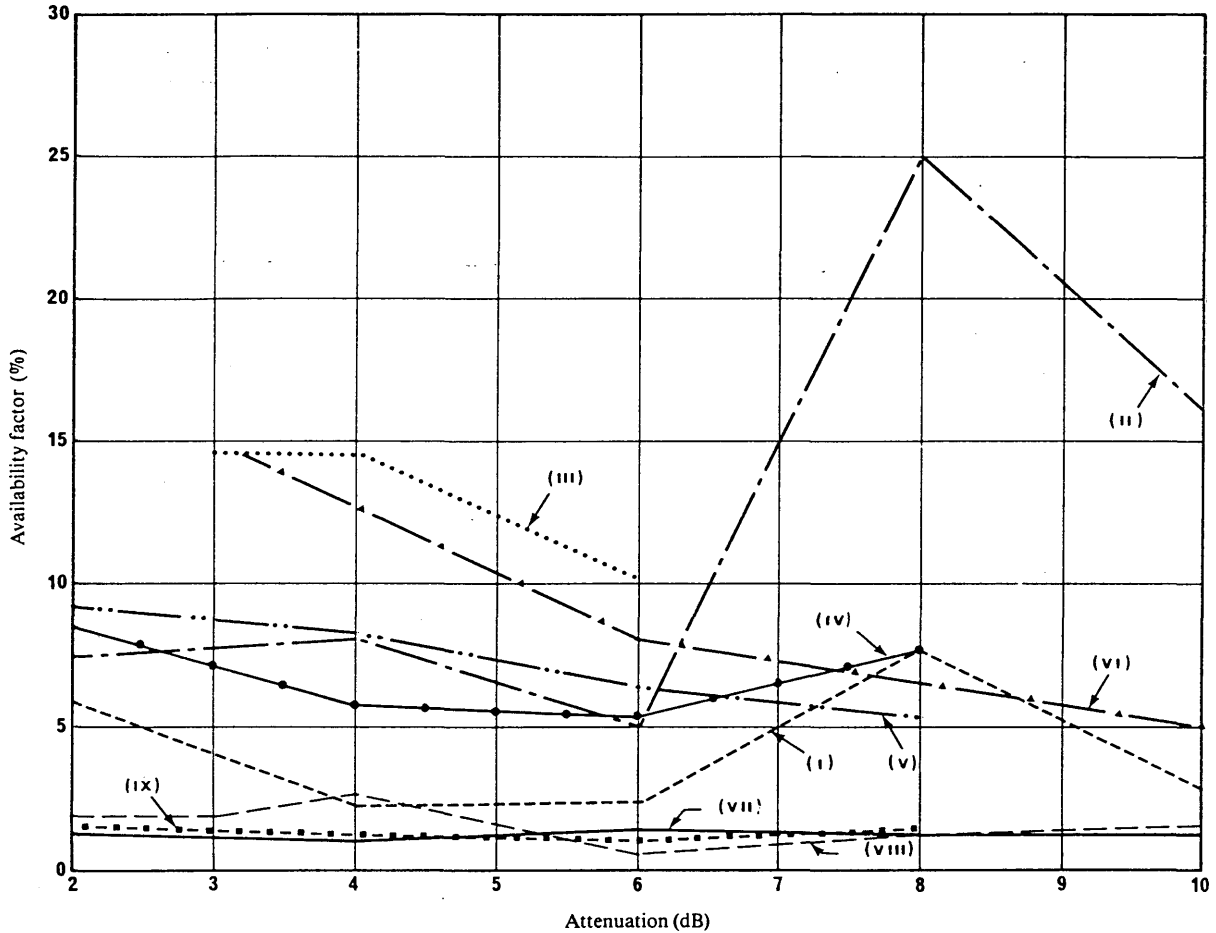

FIGURE 1 - Graph of propagation availability factor versus attenuation

(I)	- Denmark,	11.8 GHz,	elevation = 26.5°,	climate D
(II)	- Denmark,	14.5 GHz,	elevation = 26.5°,	climate D
(III)	- Denmark,	11.4 GHz,	elevation = 12.5°,	climate D
(IV)	- United Kingdom,	11.8 GHz,	elevation = 29.9°,	climate E
(V)	- United Kingdom,	14.5 GHz,	elevation = 29.9°,	climate E
(VI)	- Japan,	11.5 GHz,	elevation = 6.6°,	climate M
(VII)	- Canada,	13 GHz,	elevation = 20°,	climate K
(VIII)	- Canada,	13 GHz,	elevation = 31°,	climate E
(IX)	- Canada,	13 GHz,	elevation = 29°,	climate K

6. Effect of propagation on availability

This section summarizes the information available to date on the way propagation effects contribute to unavailable time. Much of the information has been studied by Study Group 5, who have analysed the data in terms of available time (with attenuation events less than 10 s, corresponding to "severely errored seconds") and unavailable time (with attenuation events greater than 10 s), in accordance with the definition of unavailable time given in Recommendation 579.

The limited information available is presented in Tables I and II as percentages of worst month. Table I is derived from satellite beacon measurements, Table II from radiometer measurements.

TABLE I – Percentage of the worst month for which the indicated values of attenuation were exceeded

A division into available and unavailable time (see Recommends 4 of Recommendation 579) has been made at each attenuation value.

Attenuation level exceeded (dB)	Denmark Elevation 26.5°						Denmark Elevation 12.5°		UK Elevation 29.9°				Japan Elevation 6.6°	
	11.8 GHz				14.5 GHz		11.4 GHz		11.8 GHz		14.5 GHz		11.5 GHz	
	Single site (% of month)		Site division (% of month)		Single site (% of month)		Single site (% of month)		Single site (% of month)		Single site (% of month)		Single site (% of month)	
	Available time	Unavailable time	Available time	Unavailable time	Available time	Unavailable time	Available time	Unavailable time	Available time	Unavailable time	Available time	Unavailable time	Available time	Unavailable time
2	0.0070	0.112	0.0110	0.143	0.0165	0.213	0.0343	0.201	0.015	0.16	0.03	0.30	0.96	5.7
3														
4	0.00053	0.0222	0	0	0.0038	0.0462	0.00355	0.0215	0.0022	0.035	0.009	0.10		
6	0.00028	0.0106	0	0	0.00070	0.0138	0.00035	0.00305	0.0008	0.014	0.0022	0.033	0.16	1.84
8	0.00047	0.0056	0	0	0.0013	0.0039	0	0.00131	0.0005	0.006	0.0009	0.016		
10	0.000096	0.0033	0	0	0.00014	0.00070	0	0					0.027	0.52
15	0.00017	0.00054	0	0	0	0	0	0					0.008	0.17
20	0	0	0	0	0	0	0	0						

TABLE II – Percentage of the worst month for which the indicated values of attenuation were exceeded in Canada

Attenuation level exceeded (dB)	Climate K 13 GHz				Climate E 13 GHz	
	Site 1, elevation 20°		Site 2, elevation 29°		Elevation 31°	
	Available time	Unavailable time	Available time	Unavailable time	Available time	Unavailable time
2	0.017	1.10	0.0081	0.51	0.014	0.68
3	0.007	0.54	0.0042	0.31	0.0046	0.22
4	0.0039	0.36	0.0028	0.22	0.003	0.11
6	0.0022	0.16	0.0017	0.16	0.0004	0.058
8	0.0011	0.089	0.0017	0.12	0.0005	0.041
10	0.0007	0.056	0.0007	0.099	0.0004	0.031

The following general conclusions have been drawn from Table I:

- For elevation angles in the range 26°-30° and for attenuation values of 2-8 dB, the ratio of attenuation time during available time to that during total time was found to be between 3% and 10%. At greater values of attenuation, this proportion tended to increase, since event duration would decrease as the attenuation approached its maximum value.
- At lower elevation angles, 6°-12°, the ratio of attenuation time during available time to that during total time was found to be about 14% at the 3 dB attenuation value, decreasing to about 5% at values in the range 10-15 dB. For even greater values of attenuation, the above ratio is likely to increase again. Scintillations would be expected to make a greater contribution to the attenuation time at the lower elevation angles than in the cases for the measurements corresponding to the higher elevation angles.

The site diversity data are based only on attenuation values of 2 dB; no simultaneous attenuation value of 4 dB was measured at both sites during the experiment in Denmark. The only data supplied therefore correspond to the 2 dB value. The ratio of attenuation time during available time to that during total time was found to be very close to that for a single site. However, for regions of the world with higher rainfall rates, the ratio in the diversity case may be greater than for a single site as a result of the increased impact of site diversity in such climates.

The data contained in Table II are based on radiometer measurements made in Canada at 13 GHz. Propagation data was collected at six sites where fades from 2-10 dB were recorded and the fade durations calculated for those lasting shorter than 10 s and those lasting longer or equal to 10 s. Results for two typical K climate sites and one E climate site have been presented. These results indicate that the availability would be in the range 1-4%. Using the availability factor definition given in section 5 above, these results reduce to less than 1%. The data also indicate that for system design margins in the 3-6 dB range, a total unavailable time of up to 0.54% of the worst month could be experienced.

Further information was provided by Australia where propagation measurements [CCIR, 1982-86a] at 11 and 14 GHz for three different locations, including both tropical and more temperate zones, show that the availability factor is of the order of 4% or less.

From consideration of all the information presented above, it is concluded that an availability factor of 10% is a conservative working value.

REFERENCES

CCIR Documents

[1982-86]: a. 4/297 (Australia).

REPORT 214-4

**THE EFFECTS OF DOPPLER FREQUENCY-SHIFTS AND SWITCHING
DISCONTINUITIES IN THE FIXED-SATELLITE SERVICE**

(Question 7/4)

(1963-1966-1974-1978-1986)

1. Introduction

In the fixed-satellite service system, the received signal will be subject to the following phenomena:

- Doppler frequency-shifts due to the relative velocities between satellite and earth stations;
- discontinuities of transmission delay and of Doppler shift due respectively to the difference in the lengths of the radio paths and in the different relative velocities, on switching from one satellite to another.

This Report considers the probable magnitude of these phenomena and their effect on various types of communication signal.

2. Doppler frequency-shifts (applicable to non-geostationary satellites)

The magnitude of the total Doppler frequency-shift between the terminals of a system in the fixed-satellite service depends upon the wavelengths used and the relative velocities of the satellite with respect to the earth stations. The major component of the effect of the Doppler shift, i.e. the shift of the carrier or a reference-frequency of the transmission, can be removed in the receiver; however, it may be necessary also to compensate for the differential shift across the radio-frequency spectrum of the signal that produces a frequency "stretch" or "shrinkage" of the baseband signal. Depending upon the relative locations of the earth stations and the orbit, the Doppler shifts between transmitting earth station and satellite and also between satellite and receiving earth station can either add or subtract. If 5000 km is taken as a probable minimum orbital height for a communication satellite, then the "stretch" or "shrinkage" of the baseband signal will not exceed 2 parts in 10^5 . In most practical cases, the orbital height will be greater and the Doppler shift would be considerably less than this, and in the particular case of the geostationary satellite, there would be no significant Doppler shift.

The maximum value of the Doppler shift, resulting from transmission to, or from, a space station on a satellite in a circular orbit, can be estimated from the relationship:

$$\Delta F \approx \pm 1.54 \times 10^{-6} \times F \times s \quad (1)$$

where

ΔF : Doppler frequency-shift,

F : operating frequency,

s : number of revolutions per day (24 hours) of the satellite with respect to a fixed point on the Earth.

This relationship may also be used for calculating the maximum differential Doppler frequency-shift over a frequency band. A few values of s for various circular equatorial orbit altitudes are provided below (Table I) to facilitate the calculations for individual cases.

TABLE I

Revolutions per day relative to the Earth, s	Altitude for circular equatorial orbits (km)	Period (h)
0	35 600	24
1	20 240	12
2	13 940	8
3	10 390	6
4	8 080	4.8
5	6 420	4
6	5 170	3.4
7	4 190	3

In a frequency-division multiple-access (FDMA) system, each participating station uses a portion of the frequency band of the satellite repeater. Since the transmissions from each station are independent in time, there is no adverse effect from any relative time-shift. There will, however, be a Doppler frequency-shift in the transmission from each station which varies with time.

For satellites employed to relay signals simultaneously from a number of earth stations, special consideration of Doppler shift may be necessary.

Table II shows the maximum possible Doppler frequency-shifts at the satellite at 6 GHz. The figures are based on equatorial orbits and assume that the satellite moves in the same direction as the surface of the Earth.

Because of various perturbing forces, the position of a geostationary satellite varies. If the satellite position is maintained within $\pm 0.1^\circ$ of longitude and latitude, the maximum relative velocity of a satellite with respect to an earth station is less than approximately 3.8 m/s, and the maximum Doppler frequency-shift will not exceed 76 Hz at 6 GHz.

To prevent interference between adjacent radio-frequency channels caused by Doppler frequency-shifts, guard bands can be used. Depending on the location of the stations, the signal transmitted by one station may be shifted upward, while that from a station on an adjacent channel may be shifted downward. Alternatively, the frequency shifts may be corrected by available techniques.

For example, allowing a guard band equal to the maximum possible Doppler frequency-shift shown in Table II for a ten-channel system, the total guard bands would then be 18 times the figures shown (at 6 GHz).

TABLE II — *Maximum Doppler frequency-shift*

Period (h)	6	8	12	24
Approximate altitude (km)	11 000	14 000	20 000	36 000
<i>Minimum elevation of antenna: 5°</i> Maximum Doppler frequency-shift at 6 GHz (kHz)	27.7	18.5	9.3	0.0

In the time-division multiple-access (TDMA) system, all earth stations transmit on the same nominal carrier frequency. This requires that the transmitter carrier be on only during that interval of the frame assigned to the station. During transmission, the carrier would probably be modulated by phase-shift keying or frequency-shift keying. Because of the Doppler frequency-shift, transmissions will arrive at the satellite and be repeated at frequencies which vary above and below the nominal carrier frequency. To accommodate this shift, the earth-station receivers must be capable of adjusting to the sudden changes in carrier-frequency which will occur. This may impose the requirement for increased interburst guard time and for more time within the burst to be allowed for carrier recovery and burst synchronization for satellites in a non-geostationary orbit [Gabbard, 1968].

2.1 *Telephony*

When frequency-division multiplex telephony is used, it is necessary to limit the bandwidth or the apparent geocentric angular velocity of the satellite to prevent unacceptable differential Doppler frequency-shifts (unless corrections are applied to compensate for the Doppler effects).

According to CCITT Recommendation G.225, the difference between an audio-frequency applied to one end of the circuit and the frequency received at the other end should not exceed 2 Hz. The question of error in reconstituted frequency is still under study in CCITT Study Group XV.

It may be noted that an error of 2 Hz is not exceeded in a single satellite link, if the product of the baseband (MHz) times the number of revolutions per day of the satellite relative to the Earth, s , does not exceed 0.666; however, additional error is likely to be introduced by the multiplex equipment.

Doppler effects will also shift the pilot frequencies used in FDM telephony for satellites with such angular velocities. Possible methods which could be used for correction of these shifts are:

- a suitable variable time-delay device;
- the carrier-frequencies used in the frequency-division multiplex equipment could be automatically controlled to compensate for the effects of Doppler shift and so reduce the overall frequency errors to acceptably small values.

The first of these methods has the advantage of effectively cancelling the errors resulting from the movement of the satellite, in a manner similar to that in which they are introduced (i.e. by change in transmission delay during the pass). This method would, therefore, also eliminate all the effects of Doppler shift on the baseband signals and by suitable arrangements, would avoid switching discontinuities when transferring the information flow from one satellite to the next in the orbital pattern. Control of the variable delay could be performed, either by using predicted orbit information or on a servo basis employing a pilot signal transmitted from the earth station to the satellite and back to the same earth station (loop method). The loop method has the following advantages:

- it would ensure that only the correct frequencies were received at the satellite. This facility could be of particular importance for certain systems, for example, those using closely-spaced channels or blocks of channels with single-sideband modulation in the Earth-to-satellite direction;
- Doppler frequency "stretch" might to some extent be obviated, e.g. by splitting the receiving bandwidth into appropriately separated portions and providing independent compensations for the blocks of circuits arriving from each of the other earth stations.

Alternatively, compensation for the variable delays could be applied only at the receiving end and controlled by pilot signals originating at the distant stations. In this case, the Doppler frequency "stretch" or "contraction" of the baseband would need to be accommodated by adaptations of the frequency-division multiplex equipment at each earth station. Administrations are requested to submit to the CCITT their recommendations, or findings concerning such adaptations involving control of the earth-station frequency-division multiplex equipment, either on a loop basis, as is described under the first method above, or on a route-by-route basis.

Doppler-shift correction may be necessary in any system in the fixed-satellite service using single-sideband amplitude modulation.

2.2 *Telegraphy and data transmissions*

If telephone channels comply with the requirement of CCITT Recommendation G.225 this implies that, for telegraph and data channels derived from such telephone channels, the effect of Doppler frequency-shift may be ignored or has been adequately compensated for (see § 2.1).

2.3 *Phototelegraphy*

If phototelegraphy channels are derived from telephone channels complying with the requirement of CCITT Recommendation G.225, the effect of Doppler frequency-shift may be ignored as being adequately compensated for.

2.4 *Wide-band data*

It should be noted that Doppler correction would need to be provided for carrier-derived phototelegraphy or data channels requiring wider bandwidths than a single telephone channel (e.g. group or supergroup bandwidths).

2.5 *Television*

The change in field frequency introduced by Doppler frequency-shift is very small. In normal monochrome television practice, the accuracy of the field frequency at the programme source is likely to be the limiting factor as far as disturbance to domestic receivers is concerned and Doppler shift will not be of concern.

It may ultimately be desirable to correct for the effects of Doppler shift on colour television signals, but the initial tests made with the satellites have demonstrated that standard colour receivers and, in particular, those using crystal controlled sub-carrier oscillators, will operate satisfactorily, with the order of Doppler frequency-shift likely to be encountered in a practical system in the fixed-satellite service.

3. **Switching discontinuities (applicable to non-geostationary satellites)**

Satellites which rise and set can be used by any two or more earth stations only while mutually visible. These stations must then switch or "hand-over" to another mutually visible satellite, to maintain communication with some orbit systems, or with excessively separated earth stations; relatively long interruptions may occur when mutual visibility of the first satellite is lost before another satellite has been acquired. Such interruptions can be avoided by the use of controlled, equally separated satellites of sufficient number in orbits having a recurrent earth-track [Dagleish and Jefferis, 1965]. Such satellite orbit systems are often referred to as systems of phased satellites. The phased circular equatorial orbit system is the simplest and best-known such system.

Even though such systems can prevent hand-over interruptions, there will generally be slight discontinuities of overlap of communication between two stations at the instant of hand-over, depending on whether the propagation path via the new satellite is shorter or longer than that via the former satellite. The calculation of these propagation path lengths or delay times, and their difference, is dependent upon simple geometric relationships which are explained in Report 383 on the effects of transmission delays.

In the case of multi-hop connections, the switching discontinuities in the different hops will not often be coincident in time, so that the number of discontinuities per 24 hours will be approximately $n \times m$, where n is the number of hops and m the mean number of switching discontinuities per 24 hours per hop. With systems employing phased satellites, the time differences for some pairs of earth stations would not exceed 10 ms; whilst for other pairs of earth stations, the time differences would be up to 20 ms or even more. In unphased satellite systems, the time differences would have durations between 0 and 30 ms or more. It should be noted that these discontinuities are predictable and that counter-measures are possible. The use of variable delay devices could reduce these switching discontinuities to negligible proportions.

Note. — An earth station using any satellite, non-geostationary or geostationary, may have its circuits interrupted for predictable periods when the satellite in use has approximately the same orientation from an earth station as the Sun or another satellite at the same frequency, or when the satellite uses a solar power supply without batteries and is eclipsed by the Earth. To avoid interruptions of these types, alternate routing via surface circuits or via a different satellite may be used during periods of outage.

3.1 *Telephony*

Time differences, of up to perhaps 20 ms during transfer from one satellite to another, should not cause difficulty with telephone conversations. However, a discontinuity in transmission of this duration can cause errors in existing telephone MF signalling systems such as the Intercontinental CCITT No. 5 and TASI. Signalling techniques, (such as CCITT No. 6), that employ high-speed pulsing rates, may be much more susceptible to errors from this source.

3.2 *Telegraphy and data transmissions*

The effects of present interest are those due solely to differences in transmission time between one satellite path and another, and these are of two types:

- lengthening or shortening of telegraph elements when the transmission time differences are relatively large, i.e., exceeding a significant part of an element;
- phase discontinuities of voice-frequency tone, sometimes giving rise to telegraph distortion, whenever the transmission time differences exceed a fraction of the time occupied by one cycle of the highest baseband frequency utilized by a telegraph channel of a broadband system carrying voice-frequency telegraphy [Zuhrt, Reger and Vollmeyer, 1959].

According to preliminary information from one source (see Annex I), it appears that, in an unprotected 50-baud start-stop telegraph channel the average number of character errors caused by discontinuities of up to about 7.5 ms may not exceed about 0.25 per discontinuity. The average number of character errors increases probably to about 1.0 for discontinuities of duration about 10 to 12 ms, whilst it may approach 2.0 or more for discontinuities of duration up to 20 ms or 30 ms.

Time duration of the discontinuities likely to be encountered in non-geostationary satellite systems would cause character errors in synchronous telegraph systems and in time-division multiplex telegraph systems. Time discontinuities can falsify selection signals such as used in telex, causing incorrect routing and, particularly on automatic systems, the possibility of incorrect charging might arise.

Automatic error-correcting (e.g. ARQ) equipment is used on some telegraph circuits, for example when the traffic is extended over HF radio links. It may be noted that ARQ would not only protect against errors arising from switching discontinuities, but also against errors arising from other causes. Justification for any special treatment of circuits routed through systems in the fixed satellite service should take into account the relative frequency of error producing disturbances in the satellite links and in their terrestrial extensions as well as in international circuits using other means. If, after account has been taken of the various sources of error in telegraph channels, it seems necessary to take special measures to deal with errors caused by satellite switching discontinuities, then it appears that consideration might be given to the possibility of using some device such as a buffer store. This might commence to store the telegraph signals on receipt of a "satellite change" signal, and would retransmit at a slightly higher rate after the satellite switching operation.

Another method of reducing the number of errors due to satellite switching would be to use a suitable variable delay device.

Switching discontinuities of up to perhaps 20 ms would affect data transmission by causing:

- errors to occur in one or more blocks,
- loss of block phase.

Provided the switching from one satellite to another is fairly infrequent, the errors of the first type would not be serious, and would in fact be similar to the effects of occasional switching or noise disturbances to be expected on normal line circuits. The loss of block phase results directly from the time discontinuity and has no equivalent in line systems.

Block phase would thus need to be re-established on data circuits each time a switch from one satellite to another occurs, unless means are adopted to compensate for the delay discontinuity. However, if the switch-overs are not unduly frequent, and re-phasing of the data transmission system is arranged to take place automatically, the loss of circuit time due to this cause would not be a serious disadvantage.

3.3 Phototelegraphy

The effect of these discontinuities would be an immediate displacement (either in an advance or a retard direction) of any succeeding elements of the picture, relative to the position before switching. For equipment conforming to CCITT standards and using a drum speed of 60 r.p.m., a delay discontinuity of 20 ms would produce a displacement of about 2% of the picture width, e.g. 0.5 cm displacement in a picture 25 cm wide. This displacement would be a serious defect in most pictures or in typescript, meteorological charts, etc. With higher scanning rates, the displacement would increase in proportion. The amount of such displacement that could be accepted as tolerable is, of course, a matter to be decided in consultation with the CCITT. It seems likely, however, that switching discontinuities of the order of 20 ms would produce unacceptable distortion in the majority of cases, and would, therefore, need to be avoided, either by suitable delay-compensation techniques or by arranging that the picture transmissions do not occur during switching times.

3.4 Television

Switching from one non-geostationary satellite to the next is very similar to, and will generally produce the same effects as, switching between "non-synchronous" programme sources, and can result in temporary disturbance to the receiver field time-base. The actual time over which the disturbance exists will vary in practice depending upon the relative phase relationship at the moment of switching, but will normally lie between 0.5 s and 2.0 s.

The change in transmission delay on switching may introduce a small discontinuity in the sound signal which, although noticeable, should not be disturbing.

As switching in a system in the fixed satellite service will be infrequent, the effect on both vision and sound signals would not prove too serious.

4. Summary

The significance of Doppler frequency-shift and switching discontinuities in systems in the fixed-satellite service varies with the type of service or signal transmitted, and with the characteristics of the satellite orbit. In general, geostationary satellites are not expected to introduce significant Doppler frequency-shifts or switching discontinuities. Non-geostationary satellite systems will introduce greater Doppler frequency-shift and switching discontinuities.

The major component of the Doppler frequency-shift can be removed in the radio-frequency receiver, but there will remain a "stretch" or "shrinkage" of the baseband spectrum due to differential frequency shift. The effect on monochrome television will be insignificant and the effect on colour television will probably be tolerable. In telephony, with the general use of broadband single-sideband frequency-division multiplexing techniques, the changes in baseband spectrum (differential Doppler) will require compensation in the form of transmission delay equalization of the entire baseband or of automatic control of the carrier frequencies used in the multiplex equipment. It is felt that such compensation is feasible. Telegraph, data and phototelegraphy channels, derived from channels adequately corrected for telephony, should not require any further consideration of Doppler effects.

It appears that, unless special steps are taken, time discontinuities due to satellite switching may lead to error rates on telegraph channels which, for certain pairs of earth stations with particular orbital configurations, could exceed the desirable limit suggested in CCITT Recommendation R.54 of 2 errors per 100 000 telegraph characters. Some discussion of this matter, and of possible means of mitigating the effects on telegraph transmission, is given in Annex I.

The attention of the CCITT and the CMTT is drawn to the problems which may arise in systems in the fixed-satellite service due to Doppler frequency-shifts and switching discontinuities; the CCITT with regard to telephony, telegraphy and data transmission and the CMTT for television transmission, including the related sound channel.

REFERENCES

- DALGLEISH, D. I. and JEFFERIS, A. K. [January, 1965]. Some orbits for communication-satellite systems affording multiple access. *Proc. IEE*, Vol. 112, 1, 21-30.
- GABBARD, O. G. [August, 1968] Design of a satellite time-division multiple-access burst synchronizer. *IEEE Trans. Com. Tech.*, Vol. COM-16, 589-596.
- ZUHRT, H., REGER, W. and VOLLMEYER, W. [June-July, 1959] Telegraph distortion and error rates in voice-frequency telegraphy due to interruptions and phase-jump (in German). *NTZ*, 12, 6 and 7.

ANNEX I

1. CCITT Recommendations

CCITT Recommendation R.57 calls for a maximum isochronous distortion over a single telegraph link not exceeding 10%.

CCITT Recommendation R.54 suggests, in the considerations, an error-rate not exceeding 2 per 100 000 telegraph characters due to distortion as a desirable overall transmission objective.

2. Telegraph error-rates in 50-baud start-stop telegraph systems

In a preliminary series of experiments, the relationship between the duration of switching discontinuities and telegraph error-rate in 50-baud start-stop telegraph systems has been explored. The error-rate is dependent, to a small extent, on the nature of the transmitted text. It appears that the error-rate may not vary greatly when the duration of the switching discontinuity is varied between 0 and about 7.5 ms; the average number of errors is then about 0.25 per switching operation. For durations exceeding about 7.5 ms, the error-rate increases; this may be explained by the evident fact that, in these circumstances, the lengthening or shortening of the telegraph elements approaches or exceeds 50% of the duration of the elements. The preliminary experiments suggest that the average number of character errors per discontinuity may be about 1.0 for discontinuities of duration of about 10 to 12 ms, whilst it may approach 2.0 or more for discontinuities of duration up to and exceeding 20 ms. These results, as stated above, apply to telegraph signals at a speed of 50 bauds; the duration of each element is 20 ms and it is not unreasonable to find that, for discontinuities of a duration up to about 30 ms, there may not be more than two telegraph character errors.

3. Compensation by means of variable-delay correction devices**3.1 Compensation with moderate accuracy**

It would be possible to greatly reduce character errors due to satellite switching if suitably controlled variable delay devices could be connected in tandem with satellite links, so that the overall signal delay could be kept constant. Compensation to an accuracy of the order of 200 μ s would deal with character errors due to the lengthening or shortening of telegraph elements. The development of such broadband delay devices would have the additional advantage of substantially eliminating differential Doppler-shift effects in the transmitted baseband; these would otherwise call for special control of supergroup and group translation oscillators to preserve the centering of voice-frequency telegraph signals in their appropriate filter bandwidths.

The effects of phase jumps at the instant of satellite switching would remain, and while the character error-rate would be less than that estimated to occur without compensation, a reliable estimate of the probable error-rate would require experimental investigation.

3.2 Compensation with high accuracy

To avoid character errors due to phase jumps at the instant of satellite switching, delay compensation to an accuracy corresponding to $\pm 15^\circ$ at the highest baseband frequency involved appears to be necessary. For telegraph channels carried in the highest frequency telephone channels of a 1200-channel system with baseband frequencies up to 5 MHz, an accuracy of some 0.01 μ s would be required. The probable limit of predicted satellite slant range, and therefore of transmission delay, is of the order of 50 μ s. Consequently, direct compensation on a predicted basis in a single step to an accuracy sufficient to substantially remove telegraph errors is impracticable. Consideration might, however, be given to additional measures, for example, an electronically controlled variable-delay device, which has its delay changed until the baseband signals over the two satellite paths displayed complete correlation in time, the switch-over then taking place.

Another possibility to which attention might be drawn is the employment of a relatively slow "fade-over" instead of an abrupt switch-over. The major effects of sudden phase changes might thereby be avoided and only a small proportion of telegraph channels suffer from amplitude effects. FM voice-frequency telegraph systems can tolerate at least 15 dB reduction of signal level and printed error-rates of the order of one in 80 000 might be achieved, but this possibility requires theoretical and experimental investigation. The effect of such a "fade-over" on telephone, data and facsimile circuits would need to be assessed.

4. Summary of means of compensation

In considering possible methods of mitigating the effects of switching discontinuities on telegraph performance, it must be borne in mind that in any telegraph channel there may be a number of causes of error.

Telegraph errors due to satellite-switching discontinuities might be reduced in number by:

- 4.1 "buffer store" systems, which would commence to store on receipt of a "satellite change" signal transmitted over the system and re-transmitted at a slightly higher rate after completion of the change;
- 4.2 time discontinuity correction of moderate accuracy used in conjunction with any of the following measures:
 - 4.2.1 placing of the telegraph channels in the lower part of the baseband spectrum;
 - 4.2.2 inter-satellite switching, which takes place at the point where the telegraph signals are d.c.;
 - 4.2.3 introducing slow "fade-over" devices to mitigate transients caused by rapid switching between satellites;
 - 4.2.4 recoding of the telegraph information into special codes, such as those developed by Hamming, which give correction facilities without the necessity for retransmission;
- 4.3 precise compensation of transmission delays to minimize the delay discontinuity at change-over.

In addition, it would be possible to use ARQ or some equivalent system; this would be particularly useful in the event that the satellite link is extended by an HF radio link or another type of link liable to introduce a relatively large number of telegraph errors.

SECTION 4C: EARTH STATION AND BASEBAND CHARACTERISTICS - EARTH STATION ANTENNAS
- MAINTENANCE OF EARTH STATIONS

REPORT 391-6

**RADIATION DIAGRAMS OF ANTENNAS FOR EARTH STATIONS IN THE
FIXED-SATELLITE SERVICE FOR USE IN INTERFERENCE STUDIES
AND FOR THE DETERMINATION OF A DESIGN OBJECTIVE**

(Question 1/4 and Study Programme 1A/4)

(1966-1970-1974-1978-1982-1986-1990)

1. Introduction

In the determination of coordination distance or for the assessment of interference between earth stations and radio-relay stations, and for coordination studies between earth stations and space stations of different satellite systems sharing the same frequency bands; it is required that the gain of the earth-station antenna be known in the relevant direction. It is also desirable that radiation characteristics in planes other than the principal planes be known, particularly in the case of interference calculations between satellite systems.

In addition, as discussed in Report 390, it is necessary to assemble data on the side-lobe performance of new antennas in order to establish an appropriate design objective for side-lobe levels.

2. Characteristic radiation patterns of antennas

In calculating mutual interferences between radio-relay systems and satellite communication systems, it is preferable that the statistical properties of antenna side-lobe levels, as well as those of side-lobe peaks, are known. This is particularly true when there is more than one interfering source. Measurements made on a number of existing antennas, also theoretical studies, have shown that the statistical distribution of the antenna side-lobe amplitudes are approximately expressed by the Rayleigh distribution function. The median (50%) value of the side-lobe peaks is about 2.0 dB higher than that of the side-lobe level distribution.

Using the above information, reference curves for earth-station antenna side-lobe characteristics have been computed and are shown in Fig. 1 [Shinji *et al*, 1976].

Measurements made on offset-fed parabolic antennas [Grace and Miller, 1966] and on Gregorian-type asymmetric antennas have shown that the side-lobe peaks of these types of antennas follow the log-normal statistical distribution. This is maintained both in the angle dependent and angle independent side-lobe regions and allows the side-lobe characteristics to be described in terms of the mean value and standard deviation of side-lobe peak statistics.

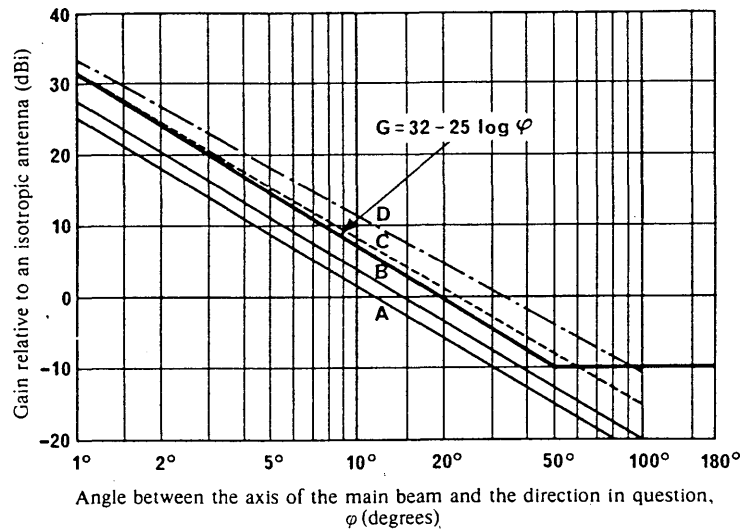

FIGURE 1 - Statistical side-lobe relationships for typical earth station antennas

- A = Median (50%) of side-lobe level distribution
- B = Median (50%) of side-lobe peak distribution
- C = Worst 10% of side-lobe peak distribution
- D = Worst side-lobe peak distribution value

2.1 Representation of measured data on antenna of large diameter to wavelength ratio ($D/\lambda > 100$) by a reference radiation diagram

Data obtained in 1976 for earth station antennas of 26 to 32 m in diameter ($D/\lambda = 550$ to 670) and the theoretical studies referenced above became the basis for adopting the formula

$$G = 32 - 25 \log \varphi \quad (\text{dBi}) \quad (1)$$

where G is the gain relative to isotropic antenna and φ is the angle (in degrees) between the axis of the main beam and the direction in question.

The WARC-79 has agreed on a method for the evaluation of the radiation diagram as shown in Annex I.

Analysis of test results on a substantial number of Standard A (G/T requirement prior to 1984) class antennas of the INTELSAT system whose D/λ vary from approximately 400 to 700 are shown in Figures 2a and 2b for circularly co-polarized (in both senses of polarization) patterns.

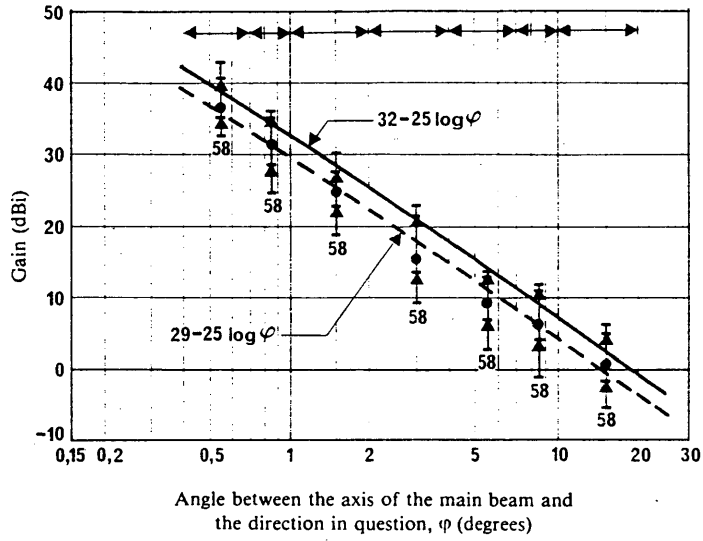

FIGURE 2a - Distribution of side-lobe levels in circularly polarized co-polar patterns for INTELSAT Standard A Antennas

Transmit side-lobe pattern analysis

←→ sample width

┆ maximum value
 ▲ worst 10%
 ● median value
 ▲ best 10%
 ┆ minimum value

58, number of samples

Antenna data:

Type: INTELSAT Standard A (G/T requirement prior to 1984)

Diameter: approx. 30 m

Frequency: 5990-6400 MHz

Polarization: Left and right hand co-polarization

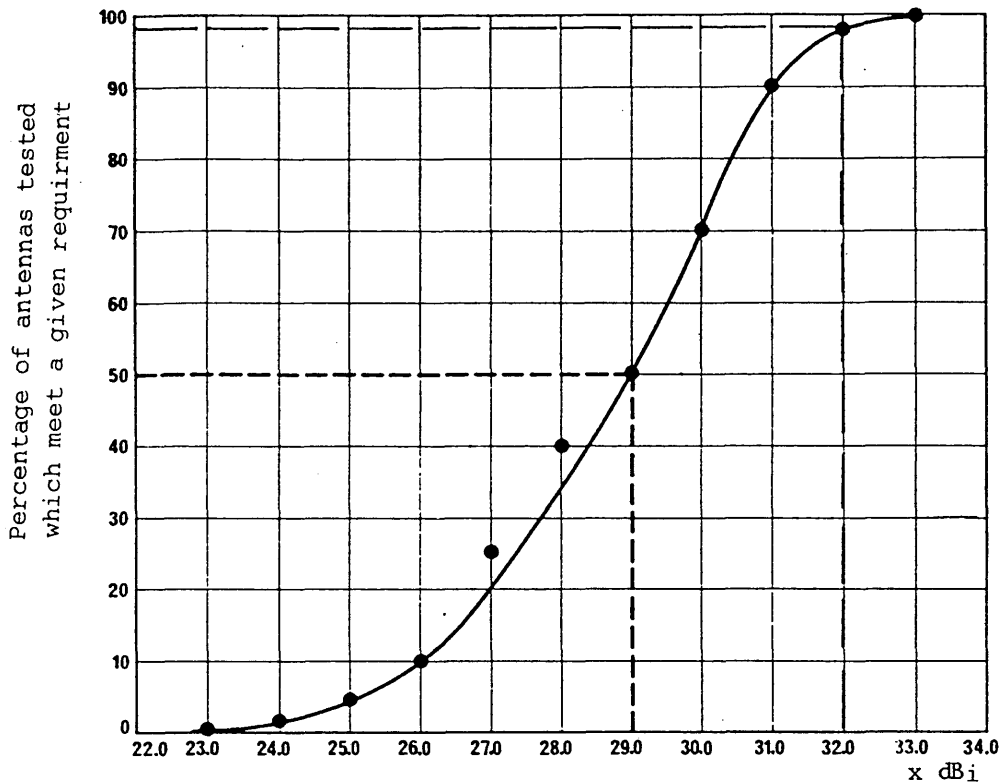

FIGURE 2b - Statistical distribution of the value of x for INTELSAT Standard A antennas which meet the requirement: Gain envelope = $x - 25 \log \phi$ (dBi)

Figure 2c shows the levels exceeded by 10% of co-polarization side lobe peaks, as determined by the method described in Annex II, of three Cassegrain antennas designed to operate in the frequency bands above 10 GHz ($D/\lambda \geq 100$). The method described in Annex II gives realistic statistics that take account of the slope of the pattern within the sample window.

Measurements conducted by INTELSAT on 93 INTELSAT antennas installed between 1977 and 1984 demonstrate side-lobe performance characteristics over the tested angular range of approximately 1° to 20° away from main beam centre, that meet (i.e. have at least 90% of their side-lobe peaks within) the existing recommendation of $G = 32 - 25 \log \phi$, and that approximately half of these antennas meet the proposed new reference radiation gain envelope of $G = 29 - 25 \log \phi$ for that range of angles.

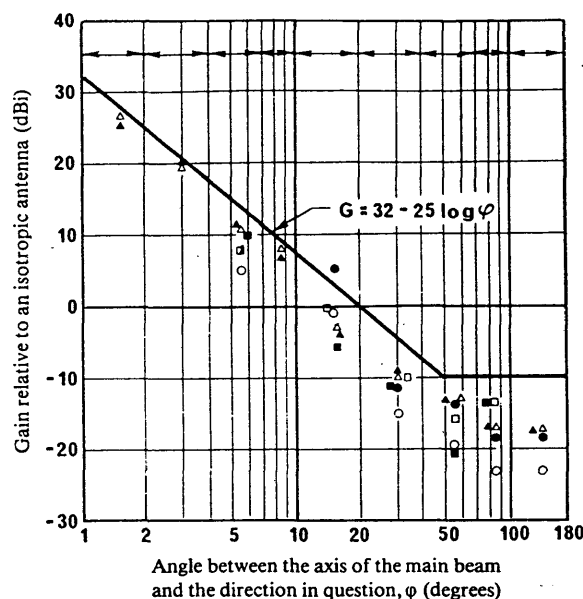

FIGURE 2c - Statistical data of side-lobe peaks of three Cassegrain antennas at the frequencies above 10 GHz (co-polarization)

Levels exceeded by 10% of the side-lobe peaks processed in accordance with Annex II

- 14.25 GHz $D/\lambda = 618$
- 12.126 GHz $D/\lambda = 526$
- △ 14.22 GHz $D/\lambda = 379$
- ▲ 11.92 GHz $D/\lambda = 318$
- 14.25 GHz $D/\lambda = 380$
- 11.58 GHz $D/\lambda = 309$
- ←→ Sample width

2.2 Large antennas with improved side-lobe characteristics ($D/\lambda > 100$)

An offset-fed reflector antenna has low side-lobe characteristics because there is no aperture blockage. An example of side-lobe characteristics for this type of antenna is given in Fig. 3c. This antenna has a shaped sub-reflector and a beam waveguide feed, while the main reflector is part of a paraboloid of revolution. Further details about this type of antenna can be found in Annex I of Report 390.

Careful study to define the various antenna components may, however, improve the characteristics, even in the case of a conventional Cassegrain antenna as shown in Figs. 3a and 3b.

The radiation patterns of a 32 m Cassegrain antenna designed to cover the 875 MHz bandwidth at 6 GHz and the 800 MHz bandwidth at 4 GHz were obtained and processed in accordance with the method described in Annex II. Figure 3b shows the levels exceeded by 10% of co-polarization side-lobe peaks of that antenna.

Measurements conducted on six EUTELSAT 14 GHz antennas ranging from 5.6 metres to 18.0 metres during the 1980s similarly demonstrate side-lobe performances in the angular range up to about 20 degrees off-axis, and again these results show that the gain envelope of $G = 29 - 25 \log \phi$ dBi is met by at least 90% of the side-lobe peaks in the majority of cases. The measurement technique used included storage of the data and subsequent computer analysis to present the results automatically in the form described in Annex II, Figure 8. The results were computed separately for side-lobe peaks of 2 dB, 3 dB and 10 dB, but the statistics were found to be similar for all three definitions.

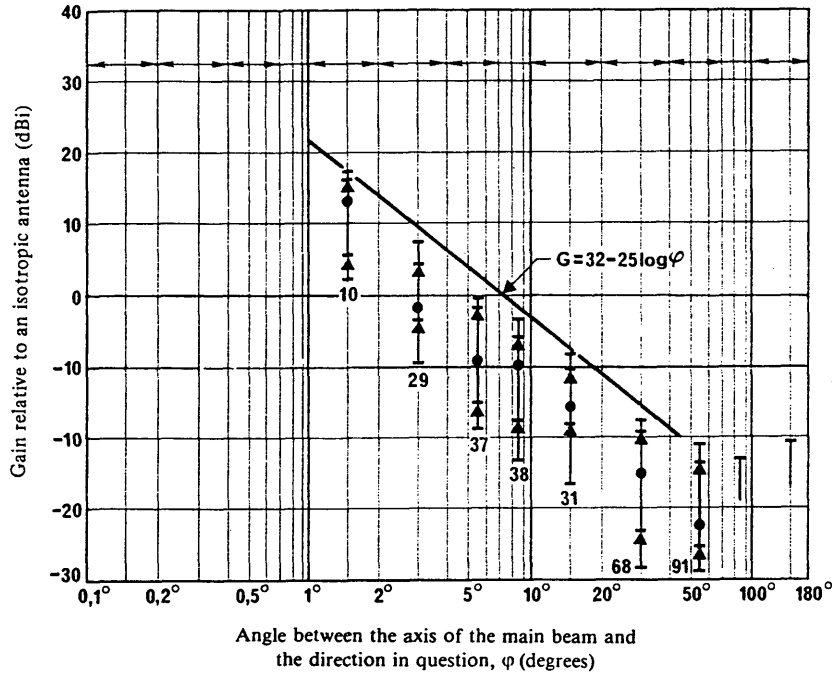

FIGURE 3a – Statistical distribution of side-lobe peaks

34 m antenna
3 990 MHz
Co-polarization

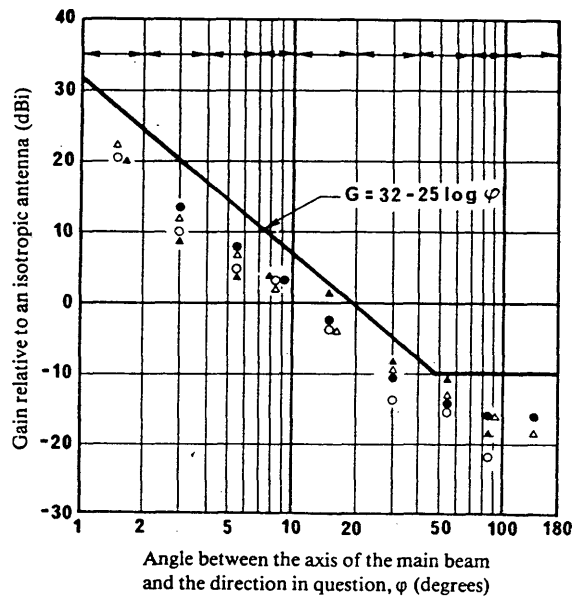

FIGURE 3b – Statistical data of side-lobe peaks of a 32 m Cassegrain antenna (co-polarization)

Levels exceeded by 10% of the side-lobe peaks processed in accordance with Annex II

- 6725 MHz $D/\lambda = 718$
- 6150 MHz $D/\lambda = 656$
- △ 3950 MHz $D/\lambda = 419$
- ▲ 3400 MHz $D/\lambda = 363$
- ↔ Sample width

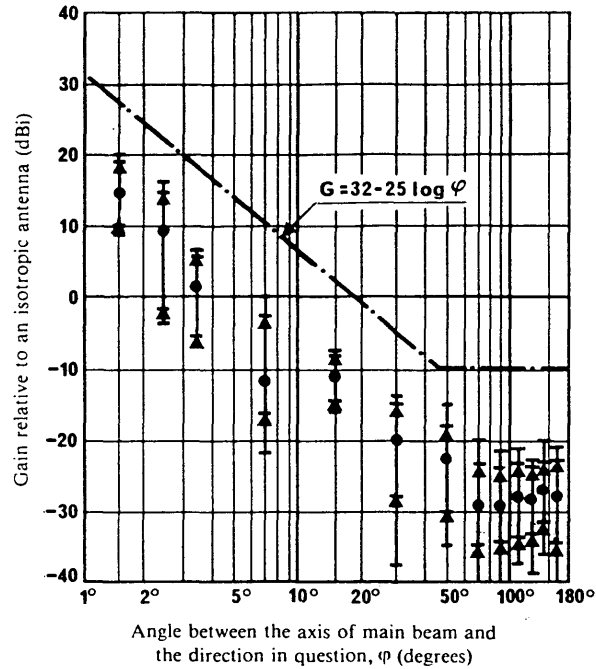

FIGURE 3c - Statistical distribution of side-lobe peaks for an offset Cassegrain antenna with $D/\lambda = 1131$ and $f = 29.5$ GHz (azimuth cut)

2.3 Reference radiation pattern for $D/\lambda < 100$

Theoretical considerations and the available data concerning radio-relay antennas (Report 614) suggested that the reference diagram given by the formula (1) may lead to error if attempts are made to apply it to antennas with $D/\lambda < 100$, and a new formula for the reference radiation diagram has been suggested. This is given by:

$$G = 52 - 10 \log (D/\lambda) - 25 \log \varphi \quad \text{dBi} \quad (2)$$

However, offset antennas are capable of providing improved performance as noted in section 2.4.

As an example, results of measurements of the statistical distribution of the side-lobe peaks for a small antenna with a conventional symmetrical parabolic reflector of 3.3 m diameter ($D/\lambda = 66$) are given in Fig. 4.

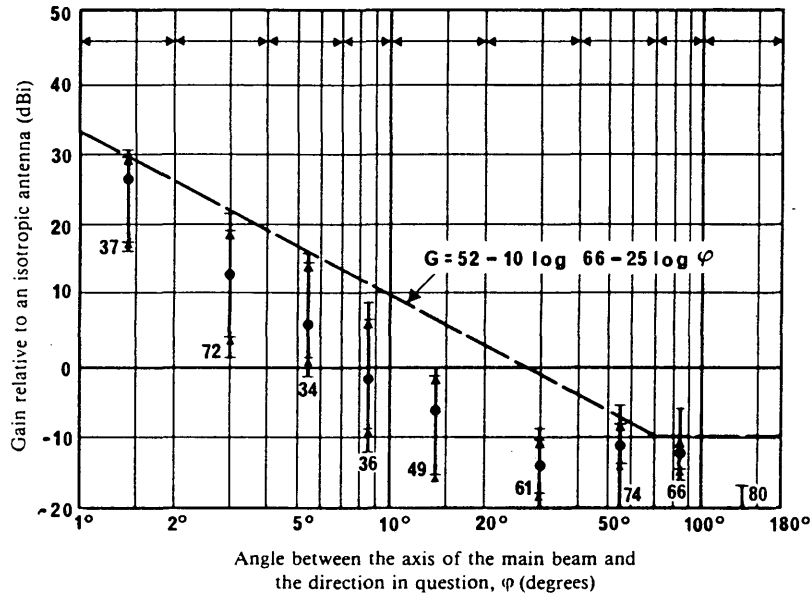

FIGURE 4 - Statistical distribution of side-lobe peaks for a small compact Cassegrain antenna with $D/\lambda = 66$ and $D = 3.3$ m at $f = 6.0$ GHz

Further details about the theoretical background for such a formula can be found in Report 614. This formula should not be used for $D/\lambda > 100$.

It should be noted that this formula should be assumed to apply only to the region beyond the first side-lobe peak, that is, at and beyond ϕ (degrees) $\approx 100 \lambda/D$. In addition, it should never be assumed that the reference antenna gain falls below -10 dB relative to isotropic.

In cases where D/λ is not given, it may be determined from the expression $20 \log (D/\lambda) \approx G_0 - 7.7$ where G_0 is the main lobe antenna gain in dB.

The performance of twelve models of axisymmetric antennas ranging in size from 2.8 to 7.0 m in diameter, which were manufactured from designs predating 1982, was measured in accordance with the methodology described in Annex II. This data is presented in Figure 5. The reference earth station antenna radiation pattern depicted in this figure is plotted as an envelope formed by the diameter-to-wavelength ratios (96 to 35) which apply. It can be seen that, with the exception of side-lobes close to the main lobe or antenna axis, these older antennas conform to the reference radiation pattern for off-axis angles up to 20 degrees. It is evident that some redesign of the feed supports and the illumination distribution of these antennas, to reduce reflections and spill over of RF energy, could result in a performance which fully meets the reference pattern requirements.

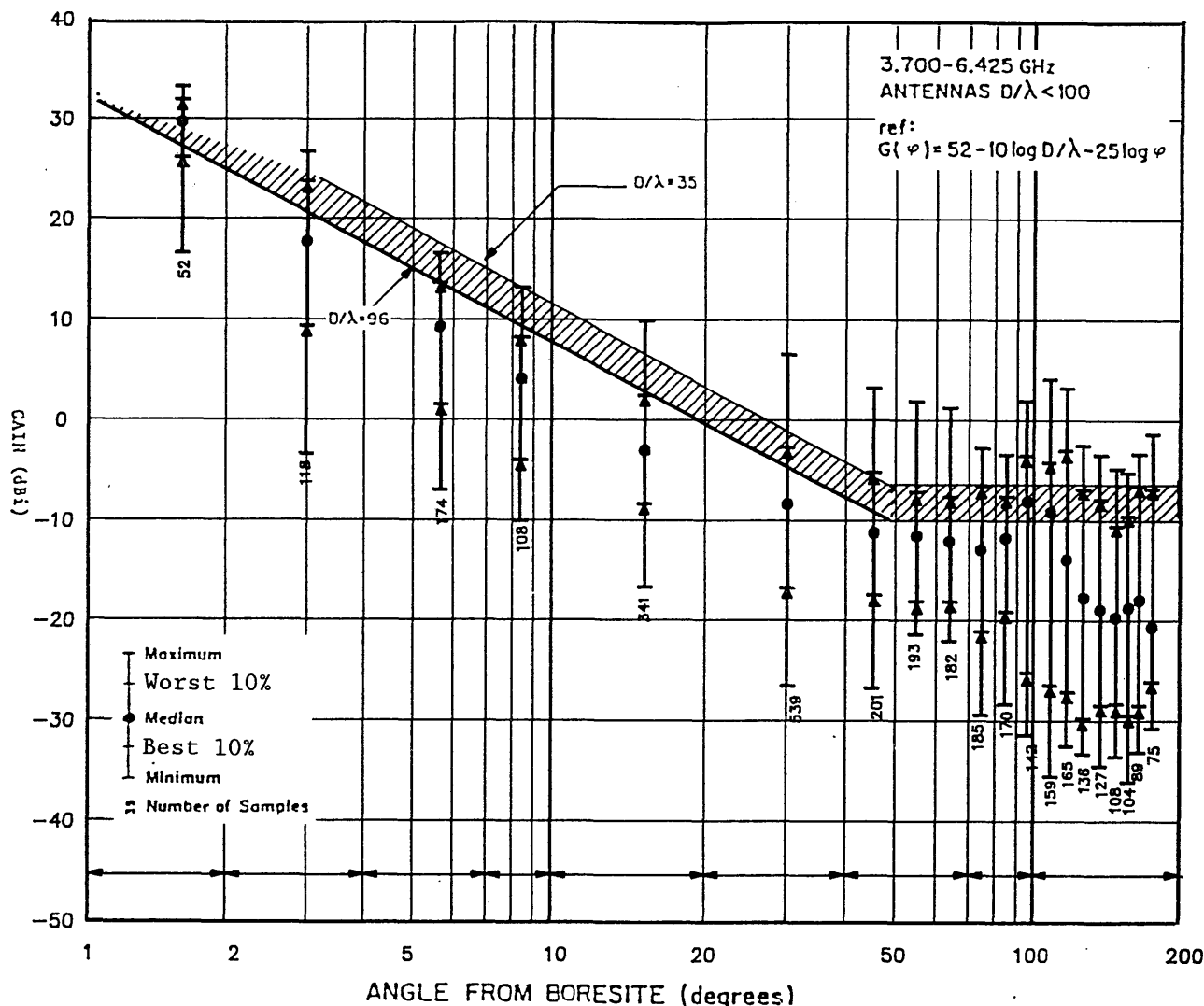

FIGURE 5

Statistical plot of side-lobe peak values for antennas with $D/\lambda < 100$ in the 3 700 - 4 200 MHz and 5 925 - 6 425 MHz frequency bands

2.4 Antennas with improved side-lobe characteristics ($D/\lambda < 100$)

For some applications small earth station antennas with improved side-lobe characteristics may be necessary. Further details including offset shaped antennas can be found in Report 998.

2.5 Polarization considerations

The reference radiation diagram is that which is obtained in the principal plane of the antenna with a co-polarized test antenna. Mutual interference between stations, particularly earth stations and space stations in different systems, is directly dependent upon the discrimination obtained through the side lobes of the respective antenna system. For the co-polarized case (i.e. matched polarization) the reference radiation diagram given in the formula in § 2.1 is appropriately used. When systems operate in orthogonal polarizations, this discrimination is expected to be enhanced. Few data are available at the present time and it is not possible to develop a similar reference diagram. The question of polarization is discussed in detail in Report 555 and Report 1141.



3. Design objectives for future earth-station antennas

Based on the information contained in this Report and the work carried out by Interim Working Party 4/1 in relation to the importance of antenna radiation pattern in the utilization of the geostationary orbit, Recommendation 580, is concerned with the radiation diagrams for use as design objectives for earth-station antennas. In order to review this — Recommendation at a later date, administrations are invited to continue to submit data relating to patterns of earth-station antennas with improved side-lobe characteristics.

Report 998 outlines measures which may be taken to reduce the side-lobe levels of small antennas. It should be noted that, in the past, there has been a tendency to design large axisymmetric antennas with a uniformly illuminated aperture. Report 998 considers the impact of the use of tapered illumination, as has been previously reported for only asymmetric antenna designs.

4. Conclusions

Because of the wide variety of applications when sharing of frequency bands is involved, studies are needed, both for antennas with $D/\lambda < 100$, and for antennas with $D/\lambda > 100$, so that the most useful and practical reference radiation diagram is available. Reports 390 and 998 give a useful discussion of the characteristics in the side-lobe regions.

To ensure that the information contained in this Report (as well as in the resulting Recommendations) be representative of current practice, administrations are requested to submit measured antenna pattern data, particularly in regard to peak side-lobe characteristics and polarization pattern characteristics. The side-lobe pattern gains should be given relative to isotropic gain referred to the feed horn flange. Administrations are also requested to provide brief technical descriptions of the antennas with particulars of the steps taken to ensure a low side-lobe performance. Preferably the peak side-lobe data should be given as the statistical distribution of the peaks within suitable sample widths of the angle relative to the main beam axis (see Fig. 43)⁸. A method for evaluation of side-lobe data taking account of the slope of the antenna side-lobe characteristics within an angular segment is given in Annex II. Administrations should preferably take account of the slope of the antenna side-lobe characteristics in preparing statistical data intended for this Report.

The information should be suitably annotated with relevant data such as antenna diameter, frequency of operation, type of antenna, polarization, and if possible, including some indication of site effects.

REFERENCES

- GRACE, S. K. and MILLER, S. N. [November, 1966] Experimental determination of antenna sidelobe statistics. *Proc. IEEE (Lett.)*, Vol. 54, 11, 1593-1594.
- SHINJI, M., TAKANO, T. and YAMADA, Y. [1976] Some statistical properties of antenna side-lobes. *Trans. Inst. Electron. and Comm. Engrs. Japan*, Vol. 59-B, 1, 74-76.

ANNEX I

REFERENCE PATTERN OF THE WARC-79

The reference pattern in Fig. 6, as agreed to by the WARC-79, is given by the following extract from Appendices 28 and 29 of the Radio Regulations:

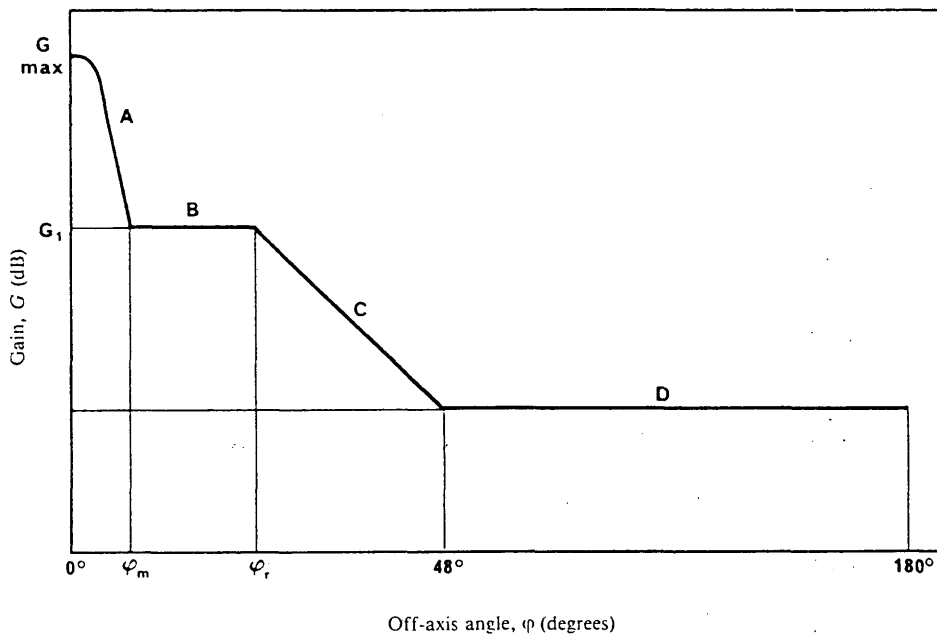

FIGURE 6 - Reference radiation pattern of an earth-station antenna (after the WARC-79)

- A: main lobe
- B: first side lobe
- C: other side lobe
- D: residual gain

Determination of the antenna gain

"The relationship $\varphi(\alpha)$ may be used to derive a function for the horizon antenna gain, $G(\text{dB})$ as a function of the azimuth α , by using the actual earth station antenna pattern, or a formula giving a good approximation. For example, in cases where the ratio between the antenna diameter and the wavelength is not less than 100, the following equation should be used:

$$G(\varphi) = G_{\max} - 2.5 \times 10^{-3} \left(\frac{D}{\lambda} \varphi \right)^2 \quad \text{for } 0 < \varphi < \varphi_m \quad (39a)$$

$$G(\varphi) = G_1 \quad \text{for } \varphi_m \leq \varphi < \varphi_r \quad (39b)$$

$$G(\varphi) = 32 - 25 \log \varphi \quad \text{for } \varphi_r \leq \varphi < 48^\circ \quad (39c)$$

$$G(\varphi) = -10 \quad \text{for } 48^\circ \leq \varphi \leq 180^\circ \quad (39d)$$

where:

D : antenna diameter }
 λ : wavelength } expressed in the same unit

$$G_1: \text{ gain of the first sidelobe} = 2 + 15 \log \frac{D}{\lambda}$$

$$\varphi_m = \frac{20\lambda}{D} \sqrt{G_{\max} - G_1} \text{ (degrees)}$$

$$\varphi_r = 15.85 \left(\frac{D}{\lambda} \right)^{-0.6} \text{ (degrees)}$$

When it is not possible, for antennas with $\frac{D}{\lambda}$ of less than 100, to use the above reference antenna pattern and when neither measured data nor a relevant CCIR Recommendation accepted by the administrations concerned can be used instead, administrations may use the reference diagram as described below:

$$G(\varphi) = G_{\max} - 2.5 \times 10^{-3} \left(\frac{D}{\lambda} \varphi \right)^2 \quad \text{for } 0 < \varphi < \varphi_m \quad (40a)$$

$$G(\varphi) = G_1 \quad \text{for } \varphi_m \leq \varphi < 100 \frac{\lambda}{D} \quad (40b)$$

$$G(\varphi) = 52 - 10 \log \frac{D}{\lambda} - 25 \log \varphi \quad \text{for } 100 \frac{\lambda}{D} \leq \varphi < 48^\circ \quad (40c)$$

$$G(\varphi) = 10 - 10 \log \frac{D}{\lambda} \quad \text{for } 48^\circ \leq \varphi \leq 180^\circ \quad (40d)$$

where:

D : antenna diameter }
 λ : wavelength } expressed in the same unit

$$G_1 = \text{ gain of the first sidelobe} = 2 + 15 \log \frac{D}{\lambda}$$

$$\varphi_m = \frac{20\lambda}{D} \sqrt{G_{\max} - G_1} \text{ (degrees)}$$

The above patterns may be modified as appropriate to achieve a better representation of the actual antenna pattern.

In cases where $\frac{D}{\lambda}$ is not given, it may be estimated from the expression $20 \log \frac{D}{\lambda} \approx G_{\max} - 7.7$, where G_{\max} is the main lobe antenna gain in dB."

The equations quoted above include the evaluation of antenna radiation pattern close to the axis of the main beam, which is not a part of the radiation pattern currently quoted in the CCIR and recent experimental data has indicated that it may be necessary to modify the equation quoted above for the gain of the first side lobe.

Measurements made on a number of symmetric Cassegrain antennas have shown that the relative first side-lobe levels (generally ≤ -14 dB) do not exhibit a clear dependence on D/λ . Figure 7 shows the data which has been converted into absolute first side-lobe levels from the knowledge of the peak gain of each antenna. It can be seen that the above formula for G_1 under predicts the first side-lobe gain particularly for larger antennas. Based on these considerations, the following equation is considered to be a more appropriate representation of the first side-lobe gain:

$$G_1 = 20 \log (D/\lambda) - 7 \quad \text{dBi}$$

Whereas this equation represents an approximate mean of the measured data, it is evident that individual design features of an antenna, e.g. aperture illumination efficiency, would produce variations in the first side-lobe levels as is indicated by the spread of the data shown in Fig. 7.

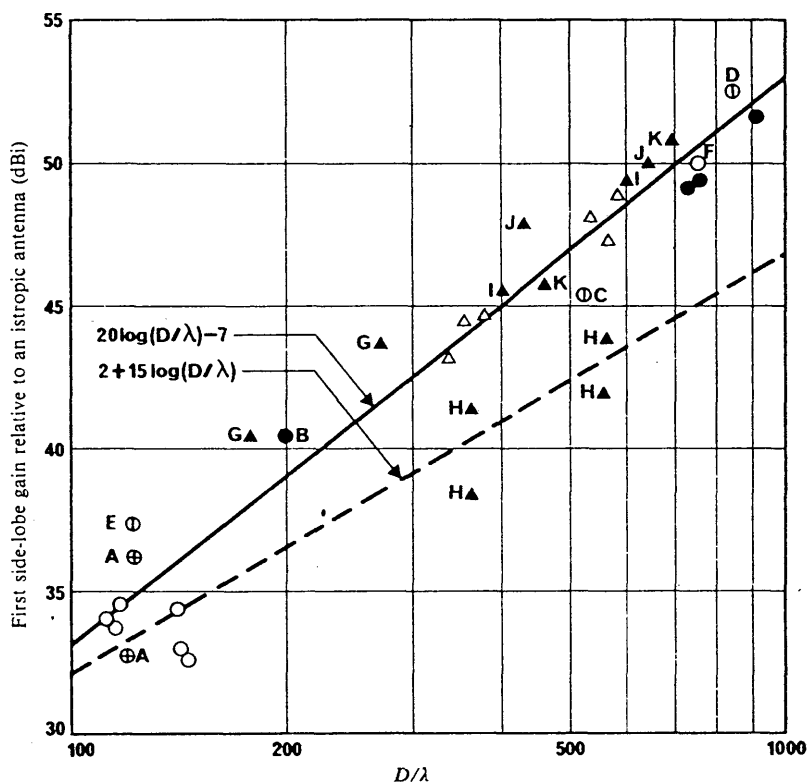

FIGURE 7 - Measured absolute first side-lobe levels for symmetric Cassegrain antennas

UK	Japan	
○ 3 m (11/14 GHz)	A ⊕ 10 m (4 GHz)	G ▲ 13 m (6/4 GHz)
△ 27.4 m (4/6 GHz)	B ● 6 m (6 GHz)	H ▲ 27.5 m (6/4 GHz)
● 19 m (11/14 GHz)	C ⊙ 13 m (12 GHz)	I ▲ 29.6 m (6/4 GHz)
	D ⊙ 13 m (19.5 GHz)	J ▲ 32 m (6/4 GHz)
	E ⊙ 2 m (19.5 GHz)	K ▲ 34 m (6/4 GHz)
	F ○ 11.5 m (19.5/29.5 GHz)	

For angles beyond 1° to 1.5° , however, the above equations simplify to those now used in the CCIR for antenna of $D/\lambda > 100$.

Furthermore, it is recommended that the compatibility of these formulas with the search for an efficient utilization of the geostationary orbit should be studied.

ANNEX II

STATISTICAL PROCESSING METHOD OF SIDE-LOBE PEAKS

The measured data may be processed following the guidelines given below:

In compiling statistical data it is necessary to exclude peaks that result from experimental error or are in other ways not significant.

The following definition of what constitutes a peak is suggested:

A peak is defined as an off-axis angle such that for both an increase and a decrease in angle, a reduction in level of at least 2 dB will occur before the level increases again by at least 2 dB.

The angular regions within which the samples are taken shall be defined as those shown in Fig. 8. A side-lobe peak exactly on the border of two angular regions or windows is included in the lower window.

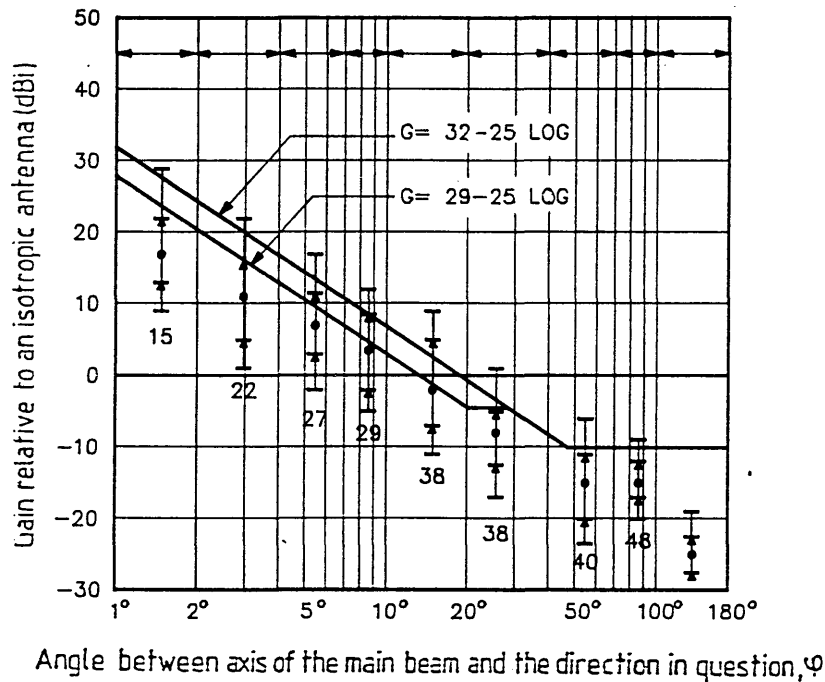

Figure 8 - Example of distribution of side-lobe peaks

Within each of the above windows, the levels of each peak should be normalized to the geometric angular mean of the window by taking into account the slope of the reference pattern that relates to this window, thus:

$$P'_i = P - m \log \left(\frac{\sqrt{\phi_L \cdot \phi_H}}{\phi_P} \right) \quad (3)$$

where:

- P : measured peak amplitude (dB),
- P'_i : normalized peak amplitude (dB),
- m : slope of the reference pattern (see Note 2),
- ϕ_L, ϕ_H : angular limits of sample window i ,
- ϕ_P : off-axis angle of peak P ($\phi_L < \phi_P \leq \phi_H$).

The statistical data in specific angular regions is then drawn in the middle of the respective angular region.

Note 1. — Further studies are required in the definition of a peak in order to have refined methods for processing side-lobe levels. The studies should consider actual side-lobe angular widths accounting for the total operating frequency range and the D/λ of the antenna. Special attention is also required in the case where an insufficient number of side-lobe peaks (less than 10) is present in the specified angular regions.

When the number of side-lobe peaks is less than 10 in the specified angular regions, side-lobe levels may be evaluated following the method given below. As shown in Fig. 9, the ratio between the sum of angular width $\Delta\phi_i$ occupied by each side-lobe peak exceeding the reference diagram and the total sampled angular width ϕ is not greater than 10%:

$$\Sigma \Delta\phi_i / \phi \leq 10\%$$

Studies are also required in the adoption of the figures such as 10% and 10 side-lobe peaks used in this method.

Note 2. — Presently, the processing of the data has used the slope of $-25 \log \phi$. If the slope changes in the future from this value (for example, due to new technological development) statistical distribution process will have to change accordingly.

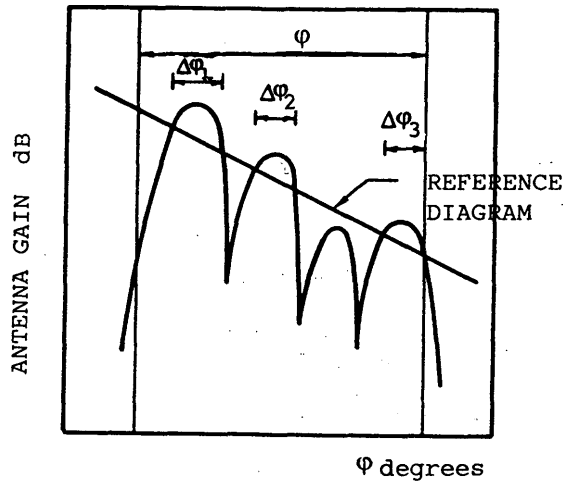

Figure 9 Angular width of side-lobe peaks exceeding the reference diagram

REPORT 390-6

EARTH-STATION ANTENNAS FOR THE FIXED-SATELLITE SERVICE

(Question 1/4 and Study Programme 1C/4)

(1966-1970-1974-1978-1982-1986-1990)

1. Introduction

The desired characteristics for most earth-station antennas are:

- high gain in the direction of wanted signals;
- low gain in the direction of unwanted signals;
- high efficiency;
- low effective noise temperature for the entire receiving system;
- steerability over the expected range of satellite positions;
- continuous pointing towards the satellite with the required accuracy;
- minimum variation in performance due to local conditions of wind and weather;
- minimum variation in illumination of the satellite by the earth station;
- high discrimination between orthogonally polarized signals.

For some applications, multi-beam and/or multi-band antennas will be advantageous.

2. Mechanical and structural aspects**2.1 Construction of reflectors and associated support structures**

The design of support structures must ensure that the shape, relative position and relative attitude of the various reflecting surfaces is very accurately maintained in spite of changes in elevation angle, wind velocity, ambient temperature, ice load and solar heating.

2.2 Surface accuracy of reflectors

The shape of reflecting surfaces must be accurately set and maintained under all operating conditions to avoid loss of gain and a consequent increase in side-lobe levels. This loss may be conservatively estimated from [Ruze, 1966] by:

$$\text{loss of gain} = 0.00761 e^2 f^2 \quad \text{dB} \quad (1)$$

where,

e : surface r.m.s. error, in mm;

f : frequency in GHz.

For example, at 11 GHz, an error of only 1 mm may reduce the gain by as much as 1 dB.

At 4/6 GHz, errors in the main reflector profile of approximately 1 mm r.m.s., correlated over distances of about 1.5 m, make a major contribution to side-lobe levels within about 2° of the axis; errors of 0.5 mm r.m.s. within individual reflector panels make a significant contribution to the side-lobe level between 2° and 10° off axis. Improvements in panel profile accuracy can therefore lead to a useful reduction in overall side-lobe level, dependent on contributions from other sources.

2.3 *Antenna pointing and tracking requirements*

For many systems, loss of signal due to imperfect pointing must be held to a few tenths of a dB. For a 30 m diameter antenna operating at 4 GHz, this would dictate a pointing accuracy of about 0.01° . This can be accomplished either by automatic tracking of a beacon signal or by computer programme steering.

Automatic tracking can have several methods of implementation. The most sophisticated type derives error signals from the misalignment of the antenna beam with the satellite direction. The simplest system is the hill climbing or simple step tracking system which emulates the manual process of peaking up the received signal. A third category is the smoothed step track approach which takes advantage of the fact that the orbits of nominally geostationary satellites are highly predictable and processes data from several well chosen step cycles to update a mathematical model of the track. The antenna is then positioned on predictions from the model and will maintain a very high pointing accuracy since noise perturbations on the stepping data are smoothed out over a period of time [Edwards and Terrell, 1983].

Automatic correction, or automatic tracking, may be carried out not only by means of satellite beacon signals but by also using wideband working signals. The pointing inaccuracy of an antenna equipped with an autotrack system should be defined not only by the angular misalignment between the equi-signal direction and the satellite direction, but also by the gain losses in the satellite direction as compared with the maximum gain.

For smaller antennas operating with geostationary satellites, manual positioning at infrequent intervals might suffice.

If the satellite position is maintained within a narrow angular range, economy may be effected by limiting the operative pointing angle of the antenna. Such a limited steerable configuration is particularly suitable for an offset type antenna with an asymmetrical reflector. A polar-mount type antenna fed by a system of reflectors may be one of the various possibilities for a limited steerable antenna. Another limited steerable antenna is a beam-steerable antenna which is capable of having access to multiple geostationary satellites without moving the main reflector. Offset type beam-steerable antennas using a torus reflector or a spherical reflector may be useful for conserving the frequency spectrum because of their low side-lobe performance, as well as reducing the cost of earth stations; these factors are discussed in Annex V. It should however, be realized that limited steerability may impose penalties on certain operational features of the earth station, e.g. with respect to maintenance and testing using a radio star.

It should be noted that the possibility of using earth-station antennas with small diameter without tracking and therefore of low cost and easy to operate, is very dependent on the orbital inclination of the geostationary satellite and on the geographical location of the earth station relative to the sub-satellite point. On the basis of studies carried out in Italy [Quaglione and Giovannoni, 1983] it was concluded that a difference in longitude between the earth station and the sub-satellite point may significantly reduce the need for angular tracking. For example, if this difference in longitude is 50° , the antenna diameter could be increased by about 20% for an earth station located at 30° latitude. It was further concluded that for the worst case of an earth station located on the same meridian as the sub-satellite point, in which the latitude of the earth station does not have a significant impact:

- for a maximum acceptable loss of gain of 1.0 dB and assuming an orbital inclination of 0.1° , the earth-station antenna gain must not exceed 52 dB (corresponding to about 8 m diameter at 6 GHz, 3.5 m at 14 GHz and 1.6 m at 30 GHz) if tracking is to be avoided.
- for a maximum acceptable loss of gain of 0.5 dB and again assuming an orbital inclination of 0.1° , the antenna gain must not exceed 48 dB (corresponding to about 5 m diameter at 6 GHz, 2.2 m at 14 GHz and 1.0 m at 30 GHz).

2.4 *Weather protection*

The possibility of ice formation on antenna surfaces and the effects of frozen precipitation such as snow, sleet and freezing rain are additional factors which affect the design of antennas for operation in freezing climates. Some additional considerations in respect to these factors are:

- satisfactory operation during snow, sleet and freezing rain can be ensured by heating the reflector surfaces and critical portions of the support structure;
- the antenna should be designed to withstand extreme conditions of combined wind and ice loading.

The provision of a radome for weather protection of a steerable antenna is no longer thought necessary and has the serious disadvantage of degrading the system performance.

Rain on reflector surfaces of Cassegrain antennas causes distortion of the antenna radiation patterns. Both the main-lobe direction and the tracking beam minimum are shifted but the effect is small and can be ignored in practice. More important effects are the degradation of gain and increase of the minimum of the tracking lobe, and they can be significant at frequencies exceeding 10 GHz [Marinčić and Popović, 1975].

3. Performance of earth-station antennas

3.1 Types of antennas

Several kinds of earth-station antennas are now in use: parabolic reflectors with Cassegrain, Gregorian or focal point feeds; and horn reflectors.

Parabolic reflectors with Cassegrain feeds are the most common and can be divided into several types: near field and point source feed, both designed for high efficiency. Multi-reflector feeds of the near field type are expected to come into common use.

3.2 Gain of the main lobe

The maximum gain achievable is largely a function of the uniformity of illumination of the antenna aperture and the accuracy of the reflector surface. High efficiencies may be achieved by suitably shaping the main and sub-reflectors, so that they no longer are truly paraboloidal or hyperboloidal respectively. Shaping results in an almost uniform illumination while still maintaining a plane wave front.

3.3 The level of side and back lobes

The side lobes of earth-station antennas have a direct influence on the level of inter-network interference. This is particularly important for those antenna side lobes that lie within a few degrees of the direction of the geostationary orbit. Every effort should therefore be made to develop earth-station antennas with the lowest practicable side-lobe envelope gains.

The side and back lobes of an antenna depend primarily on the amount of energy which spills over the edges of primary and secondary reflectors, the amount of energy obstructed by and reflected by various parts of the structure and the primary feed pattern; these factors are discussed in detail in Annex I.

In the case of a small antenna ($D/\lambda < 100$), the side-lobe level in the angular region near the principal axis is generally higher than that of a large antenna. An off-set dual reflector antenna, such as an off-set Gregorian or off-set Cassegrain antenna would however have superior side-lobe characteristics relative to the conventional symmetrical reflector systems in the angular region quoted above viz., that region which is of concern in systems using closely spaced satellites. This aspect is discussed further in Report 998.

Existing earth-station antennas exhibit radiation patterns which generally follow the reference radiation diagram expressed by the equation:

$$G = 32 - 25 \log \varphi$$

indicated in Recommendation 465. Experimental confirmation of the superior properties of off-set antennas is given in Report 998, where a number of antennas of this type are described. This experimental data shows that earth-station antennas designed to achieve low side-lobe levels could satisfy a more stringent design objective than the one described by the present reference radiation pattern.

Further data are required to establish an appropriate design objective. Administrations are therefore encouraged to submit measured radiation patterns of earth-station antennas as requested in Report 391. It is particularly necessary to obtain data on antennas covering a wide range of D/λ and frequencies so that the range of application of the design objective can be established.

3.4 Noise temperature

All side and back lobes of an antenna, as well as the main beam, contribute to its noise temperature. For most purposes it is sufficient to assume that side lobes at elevation less than -10° "see" ground at a temperature of 290 K. Between -10° and 0° the temperature may be taken to be 150 K; between 0° and 10° to be 50 K and between 10° and 90° to be 10 K. The power in the side lobes may be expressed as a percentage of the total power and divided among these four regions.

Noise temperature contributions due to extraterrestrial sources are discussed in more detail in Annex II to this Report.

A typical breakdown of noise temperature for a large Cassegrain antenna designed for a 4 GHz, and operating at 5° angle of elevation might be:

Main beam	25 K
Near side-lobes	2 K
Sub-reflector spill-over	8 K
Main reflector spill-over	<u>5 K</u>
Sub-total	40 K

Typical cryogenically cooled preamplifiers have a noise temperature of about 20 K, bringing the total system noise temperature, including waveguide losses to about 70 K. If a non-cryogenically cooled (uncooled parametric) preamplifier were to be used, the system noise temperature might be of the order of 80 to 120 K.

3.5 *Figure of merit of the system*

A very useful indication of the performance of an earth station is the figure of merit defined as:

$$G/T = 10 \log \left[\frac{\text{antenna power gain}}{\text{system noise temperature (K)}} \right] \quad (2)$$

Antenna power gain and system noise temperature are conveniently referred to the input of the low-noise receiver, noting that the noise contributions of the receiver stages following the reference point are included. Thus, in the case of an antenna of 58.8 dB gain and a system temperature of 65 K, the value of G/T would be 40.7 dB(K⁻¹).

The G/T of an antenna may be measured directly by the use of a radio star as a reference source. This procedure is outlined in Annex III.

Alternatively, the G/T of an earth station may be determined by separate measurement of system noise temperature and of antenna gain, where the antenna gain is measured by conventional techniques.

3.6 *Multi-band antennas*

Additional factors must be taken into account if the antenna is to be usable over a wide range of frequencies without appreciable degradation of its characteristics. Paraboloidal antennas with focal point feeds are not suitable for multi-band operation. Horn reflectors are suitable for multi-band use, but they present difficult construction and structural problems.

Cassegrain antennas can be used for multi-band operation by optimizing the design of the primary feed horn and the sub-reflector system. Such an antenna has been designed and built for operation at 4, 6, 20 and 30 GHz [Mori, 1973]. This 12.8 m diameter antenna has a focused beam feed, with the band separation equipment located in the fixed antenna pedestal. Aperture efficiencies, excluding band separation system losses are between 50 and 62%. Median values of side-lobe peaks are almost always below the value $32 - 25 \log \phi$ (dB) where ϕ is the angle between the axis of the main beam and the direction in question; noise temperatures are 48 K and 68 K at 4 and 18 GHz respectively, at an angle of elevation of 5°.

3.7 *Polarization discrimination*

In many situations earth-station antennas may be required to provide a high degree of discrimination between orthogonally polarized signals, of the order of 30 to 35 dB; this is discussed further in Report 555 and Report 1141

3.8 Wideband characteristics of a large aperture antenna

To cope with increasing traffic requirements, it may be required that earth-station antennas utilize the additional bandwidth now allocated to the fixed-satellite service. A Cassegrain antenna capable of transmitting in the frequency range 5850-6725 MHz (875 MHz bandwidth) and receiving in the range of 3400-4200 MHz (800 MHz bandwidth) was constructed recently in Japan. The measured results of antenna performance characteristics showed that:

- side-lobe envelope is below the value of $32-25 \log \phi$ (dBi);
- axial ratio is better than 0.34 dB in the 6 GHz band and 0.41 dB in the 4 GHz band. Measured results of axial ratio of the antenna system can be found in Report 555.

4. Radiation hazards associated with earth-station antenna systems

The transmitter powers required at earth stations may be of the order that will produce high power flux-densities in specific areas in the near and far field of the antenna system, which may be a hazard to humans. A method of predicting the power flux-densities for a 30 m antenna system is described in Annex IV, which will be of assistance in determining whether or not a safe radiation level will be exceeded.

5. Measurements of antenna patterns of earth stations

Antenna patterns are usually measured using a remote signal source which may be terrestrially located (boresight) or located in a geostationary satellite.

The boresight method is sometimes difficult, expensive and inaccurate due to effects of the surrounding terrain. Insufficient distance in a boresight facility gives errors in side-lobe levels due to phase errors caused by the near field effect; however, these errors can be removed by sub-reflector displacement in the case of Cassegrain antennas [Claydon, 1970; Teshirogi, 1978]. It was recently demonstrated that a 32 m antenna main beam gain and near in side lobes could be measured with an accuracy of better than 1 dB at 6/4 GHz by using a boresight facility located about 5 km away from the antenna [CCIR, 1982-86].

In order to achieve adequate receiving sensitivity for the measurement of side lobes distant from the main beam and within the capability of current satellite transmitters, a narrow-band receiver with a frequency sweep technique must be employed. For example, a receiving bandwidth of 10 Hz has been used by the French Administration in conjunction with a frequency which is sweeping at the rate of 10 Hz/s. The extent of the sweep frequency should more than cover the expected nominal drift of the satellite transmitter. The system as designed has enabled the measurement of side-lobe levels down to 0 dBi to be achieved using a geostationary satellite with an e.i.r.p. of 10 dBW.

If a second antenna is available at the same site for transmitting and receiving a constant reference signal, a coherent detection method can also be used. This allows precise transmit and receive pattern measurements at operational elevation angles via a geostationary satellite down to -10 dBi or even lower. Several tests have been carried out with two Intelsat Standard-A 32 m antennas at the same site, using Intelsat-V satellites as a source. A reliable measurement of side lobes was possible down to -80 dB from beam centre level.

REFERENCES

- CLAYDON, B. [October, 1970] Effects of phase errors caused by axial displacement of the feed horn or sub-reflector in a shaped dual reflector system. IEE Conference on Earth Station Technology.
- EDWARDS, D. J. and TERRELL, P. M. [October-December, 1983] The smoothed step-track antenna controller. *Int. J. Sat. Comm.*, Vol. 1, 2, 133-139.
- MARINČIĆ, A. and POPOVIĆ, B. [1975] Radiation diagrams of parabolic-cylinder Cassegrain antenna covered with a water film. COST/TELECOM 2/TD 29/75, Faculty of Electrical Engineering, Belgrade, Socialist Federal Republic of Yugoslavia.
- MORI, Y. [April, 1973] Experimental earth station for a domestic satellite system. *Japan Telecomm. Rev.*, Vol. 15.2, 101-110.
- QUAGLIONE, G. and GIOVANNONI, M. [May, 1983] Orbital inclination effects on communications satellite system design. *IEEE Trans. Aerospace Electron. Systems*, Vol. AES-19, 3, 447-453.
- RUZE, J. [April, 1966] Antenna tolerance theory - a review. *Proc. IEEE*, Vol. 54, 4, 633-640.
- TESHIROGI, T. [August, 1978] Measurements of a large Cassegrain antenna at reduced distance by defocused sub-reflector. International Symposium on Antennas and Propagation (ISAP '78), Sendai, Japan, Proc. B-1-4, 187.

CCIR Documents

[1982-86]: 4/29 (Japan).

ANNEX I

RADIATION CHARACTERISTICS OF ANTENNAS OF
EARTH STATIONS OUTSIDE THE MAIN BEAM

In the planning and construction of earth-station antennas, with respect to the most effective use of the geostationary orbit, it is necessary to have an understanding of the factors contributing to the generation of side lobes and methods of reducing these side lobes by special techniques or the use of different types of antennas.

1. Factors which influence side-lobe levels**1.1 Influence of aperture illumination**

Various techniques, such as tapered illumination, can be used to obtain low side-lobe levels.

In the choice of illumination functions, a compromise has to be made between side-lobe suppression and aperture efficiency. If it is, for instance, desired to minimize side lobes near the main lobe, an illumination function has to be chosen which leaves the edges of the feed and the reflectors practically free of current, resulting in lower aperture efficiency. The design objective is an illumination which is as symmetrical with respect to rotation as possible, so that the illumination of the H-plane of the aperture is equal to that of the E-plane; this symmetrical illumination can be achieved by dual mode excitation and/or hybrid mode excitation of the feed system.

1.2 Influence of spillover

To illuminate the sub-reflector of a symmetrical Cassegrain antenna, a feed radiating in the direction of the main beam of the antenna is required. Hence, there are interfering radiation contributions in the forward direction due to spillover of the feed main lobe past the sub-reflector and to side lobes of the feed itself.

In large antennas the influence of spillover is considerably lower than that of other phenomena for angular directions within about 5° of the main beam (see Fig. 1), but becomes increasingly significant beyond this angular direction. One approach to reducing this effect is by ensuring that the sub-reflector extends to at least the -20 dB point of the feed radiation pattern.

For some large antennas, side lobes of the feed dominate the antenna side-lobe pattern at angles between 20 and 80° from the main lobe. This contribution to the antenna side-lobe pattern can only be avoided by the use of feeds with inherently low side lobes.

It is possible to direct spillover radiation away from the main beam by employing an offset type antenna. Offset feeding also allows the use of a larger sub-reflector, which will intercept a very high proportion of the feed main lobe radiation, without incurring the penalty of high aperture blockage:

1.3 Influence of blockage and diffraction

The feed or sub-reflector placed in the aperture of a reflector antenna, together with its supports, have a serious effect on the antenna side-lobe pattern because, by blocking the antenna aperture, they alter the aperture illumination pattern and therefore the radiation pattern [Boithias and B  h  , 1971; Kreutel, 1976]. The effects of this blockage can be reduced by decreasing the blocked area of the aperture, or by using antenna types which do not have significant physical blockage, such as horns or offset-fed reflectors [Mizuguchi *et al.*, 1976].

Microwave energy can be diffracted over wide angles by the edges of the sub-reflector and main reflector, the magnitude of this effect depending on the edge illumination level of these reflectors. This effect may be reduced by attaching a microwave absorber around the edges of the sub-reflector and main reflector with only a small effect on the antenna noise temperature.

1.4 Influence of scatter

A plane wave from the main reflector of a symmetrical antenna is scattered by the feed or sub-reflector and their supports, producing side lobes determined by the position and orientation of the supports. If the supports are attached within the main reflector, a spherical wave originating at the focus of the main reflector is also scattered by the supports. It has been observed that circular and elliptical struts produce a smaller number of side-lobe peaks than solid polygons and periodic lattice struts [Claydon and Dang, 1982]. The scatter may be reduced by surface treatment of the struts to randomize the scatter, curving the struts or attaching microwave absorbers to them, although this latter action may tend to increase the antenna noise temperature.

1.5 *Influence of phase distortion on the feed pattern*

Phase distortion in the aperture illumination of a parabolic reflector results in an expansion of the main lobe and an increase of the side-lobe levels. This phase distortion may arise if the feed system has no point shaped phase centre and thus no spherical phase front.

In Cassegrain antennas, phase distortion arising in the feed horn can be equalized by changing the shape of the main reflector. It should be noted that such phase distortion can result in beam deflection in systems with multiple reflector feed systems.

1.6 *Influence of surface tolerances of the main reflector*

Surface errors due to manufacturing tolerances, wind, temperature differences and gravity, result in an increase in the side-lobe levels.

Deformation due to the weight of the upper and lower halves of the main reflector causes a cubical phase error across the aperture. This phase error produces side-lobe asymmetry in the elevation plane.

1.7 *Polarization*

Some of the above-named contributors to the antennas side lobes in the principal plane of polarization can also give rise to side-lobe levels in other polarization planes. Further information on polarization in the side lobes is given in Report 555.

2. **Quantitative contributions of major contributors**

The side-lobe levels at a given angle for a large Cassegrain type antenna are a summation of the field components radiated from different parts of the antenna system simultaneously. Examples of the relative contributions of these parts are given in Fig. 1.

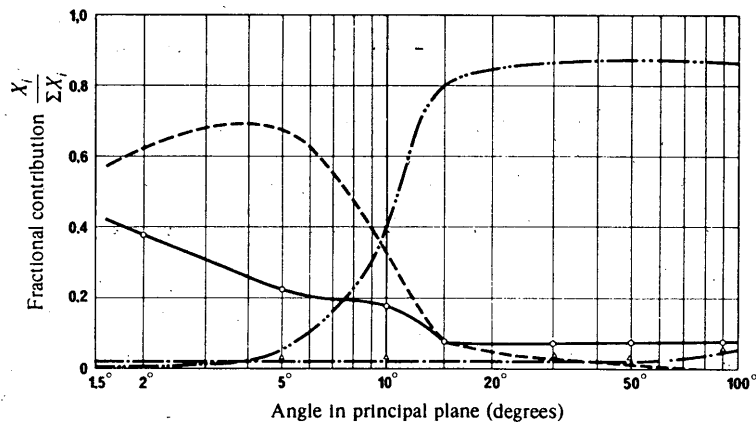

FIGURE 1 — *Relative contribution of various parts of 600 λ Cassegrain antenna to wide angle gain envelope*

- Main annular aperture
- - - Struts in principal plane
- · - · Feed (including diffraction around subreflector)
- · · Struts in plane normal to principal plane

3. Comparison of earth-station antenna types

3.1 Comparison of types of antennas

In order to compare relative side-lobe characteristics, radiation patterns of practical antennas were measured in the United States of America according to type, as follows:

- Cassegrain antennas,
- prime focus fed antennas,
- off-set reflector antennas,
- horn reflector with conical horn feed, or
- Cassegrain feed (Casshorns).

For comparison purposes, Fig. 2 shows measured patterns of the different antennas listed above. The envelope of these patterns could be described by a general expression of the form:

$$\frac{G(\varphi)}{G} = \frac{1}{1 + \left(\frac{\varphi}{\varphi_0}\right)^n} \text{ for } 2 < \frac{\varphi}{\varphi_0} < 100 \quad (3)$$

with G representing the main beam gain of the antenna. (For $n = 2.5$, this formula shows the same rate of decrease in side-lobe level as a function of φ , the angle of the main beam axis, as does the formula of the reference radiation diagram, $G(\varphi) = 32 - 25 \log \varphi$.) The patterns are normalized in terms of half beamwidths, i.e., φ/φ_0 , where φ is the off-axis angle and $2\varphi_0$ is the half-power beamwidth.

The improvement of the off-set fed reflector and horn reflectors is basically due to the fact that aperture blockage is practically non-existent in these antennas, and direct radiation from the feed is reduced in the forward sector relative to Cassegrain antennas. Design aspects of small earth-station antennas are discussed further in Report 998.

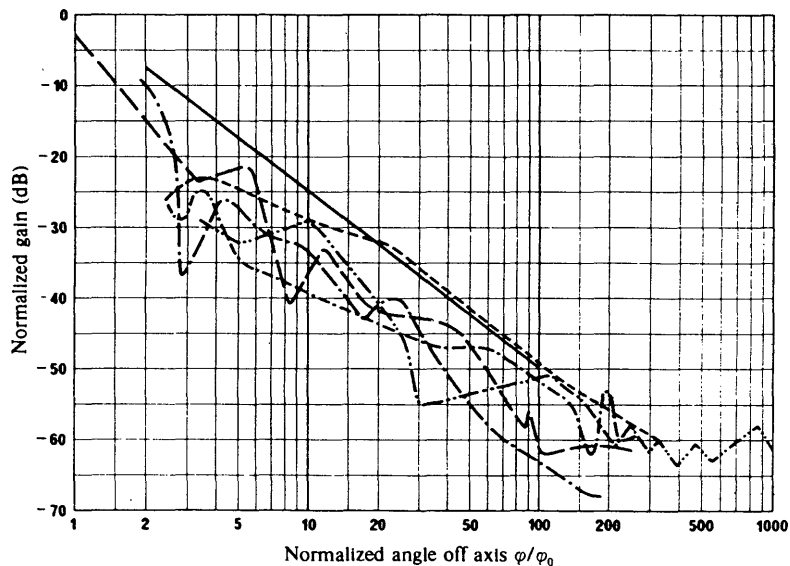

FIGURE 2 — Measured patterns of various types of antenna

- $G(\varphi) = \left[1 + \left(\frac{\varphi}{\varphi_0}\right)^{2.5}\right]^{-1}$
- - - - Cassegrain antenna $D = 600 \lambda$
- · - · Prime focus fed antenna $D = 600 \lambda$
- · - · Off-set reflector antenna $D = 100 \lambda$
- - - - Horn reflector with conical feed $D = 250 \lambda$
- - - - Horn reflector with Cassegrain feed $D = 128 \lambda$ (Casshorn)

3.2 Reduction technique of side lobe due to scattered radiation by subreflector supports

Scattered radiation strongly appears at angles determined by the position and orientation of supports, because the phase of induced current on the supports coincides with the direction of those angles. Therefore, if the incident wave to the supports is scattered randomly to all directions, side-lobe degradation at specified angles can be reduced [Ogawa *et al.*, 1977 and Matsunaka *et al.*, 1981]. Figure 3 shows an example of the reduction in side lobes attainable as a result of reduced scattering from supports with microwave scattering material.

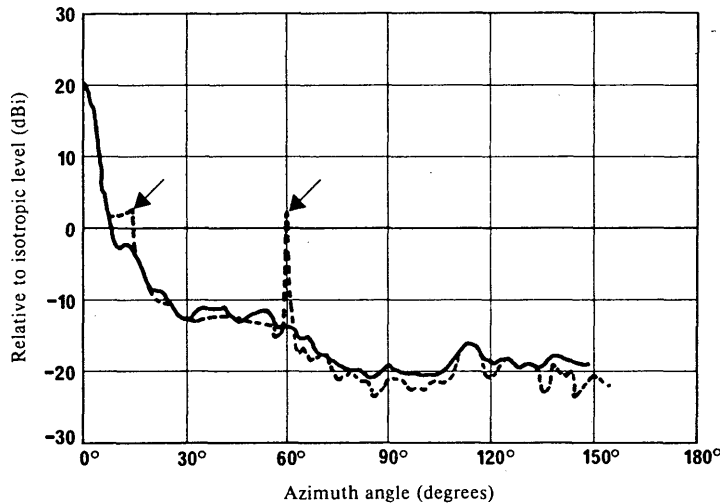

FIGURE 3 – Reduction effect of scattered radiation by corrugated metal

(Linear polarization, 29.5 GHz)

— With specially curved metallic plates
 - - - Without specially curved metallic plates

Figure 4 shows some results of an experimental investigation made on an axisymmetric Cassegrain model antenna of 3 m at 36.25 GHz. A suitable combination of curved struts and a properly designed scattering structure on it, produced the best results.

4. Characteristics of antenna radiation fields of special interest

4.1 Radiation fields close to earth-station antennas

There is special interest in the nature of radiation fields in the back of, and close to earth-station antenna, to evaluate the possibility of re-using earth station frequencies for terrestrial systems.

Theoretical calculations of such fields have been made, and patterns have been taken to confirm them. Signal levels were measured in the rear sector of a Cassegrain antenna having a ratio of diameter to wavelength D/λ , of the order of 600. Figure 5 shows the gain of the antenna relative to isotropic, taken on an arc some 30 m distant from the rear of the antenna. Figure 6 shows the apparent gain measured along a straight line in the back of the antenna in the plane of the axis of the main beam. (Apparent gain is obtained from the measured field corrected for free-space loss, and is given in dB above an isotropic antenna.)

These measured values were of the order of those indicated by both the near-field theoretical calculations, and by the far-field radiation patterns for such antennas.

4.2 Site shielding by obstacles in the near- or far-fields

The earth-station location may be selected so that it has a degree of shielding from unwanted radiations by means of obstacles in the antenna near- or far-fields. The site shielding factor may be defined as the difference between path loss over the obstacle and path loss for the same distance with no obstacle, expressed in dB.

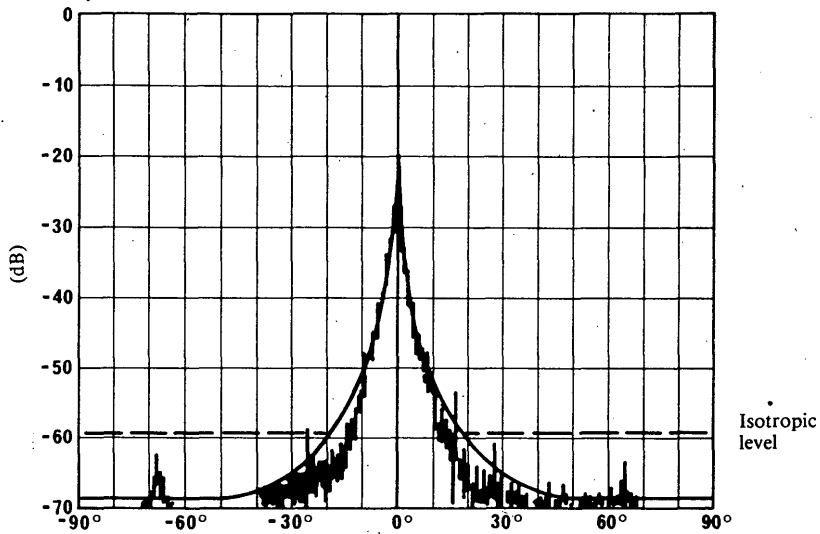

a) Straight struts

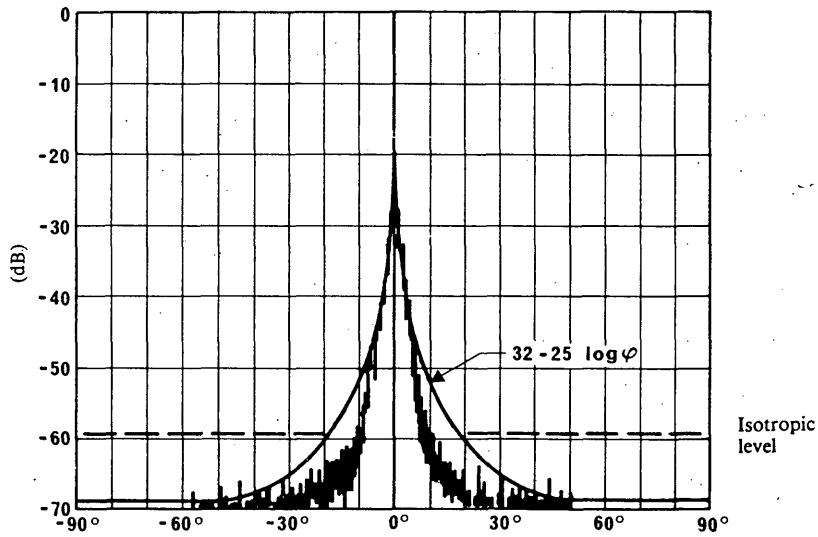

b) Curved struts with special scattering surface

FIGURE 4 – Improvement in the side-lobe performance of a symmetrical antenna by using an optimized support configuration

In one example a pit was constructed to encircle a 10 m diameter antenna which could operate with satellites in a segment of the geostationary-satellite orbit. Measurements of the shielding properties of the antenna-pit combination were made in the 4 and 6 GHz fixed satellite bands. Figure 7 shows a composite of measurements taken in the 4 and 6 GHz bands for satellites at different locations in the orbit segment. A reduction of approximately 25 dB was measured between the shielded antenna data points and the unshielded pattern.

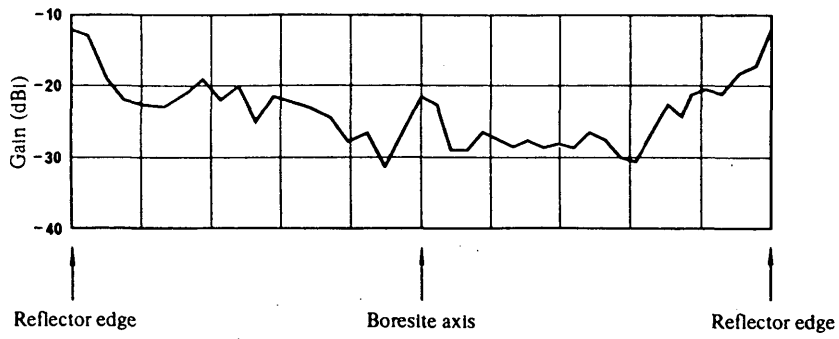

FIGURE 5 — Ground level measurements on arc about 30 metres distant behind the antenna

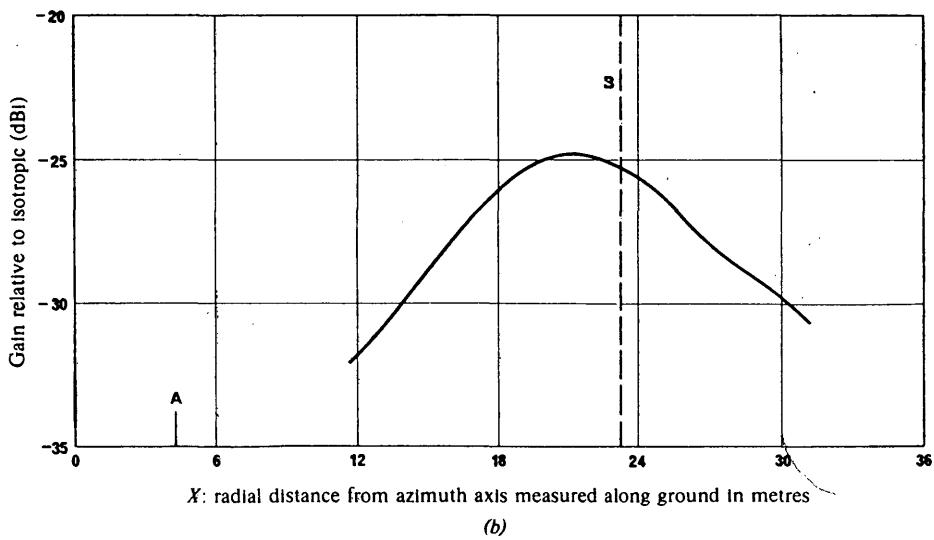
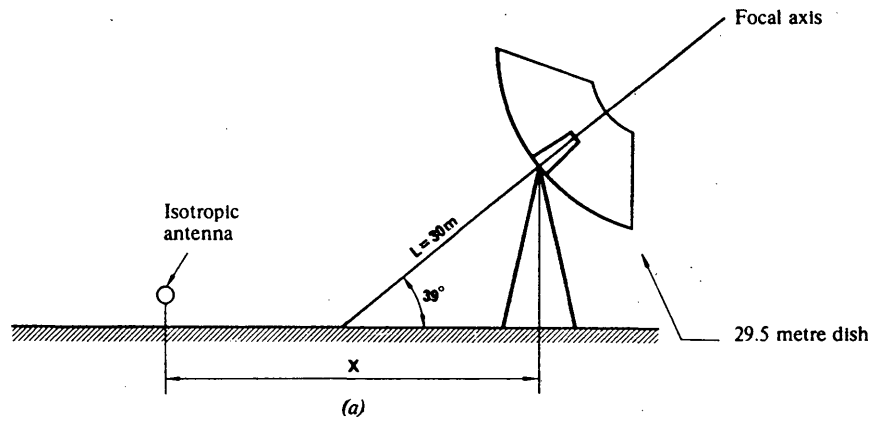

FIGURE 6 — Apparent antenna gain behind a 29.5 metre earth station antenna

A: Base of tower B: Approximate intersection of focal axis with ground, $L = 30$ m
 $f = 6403$ MHz

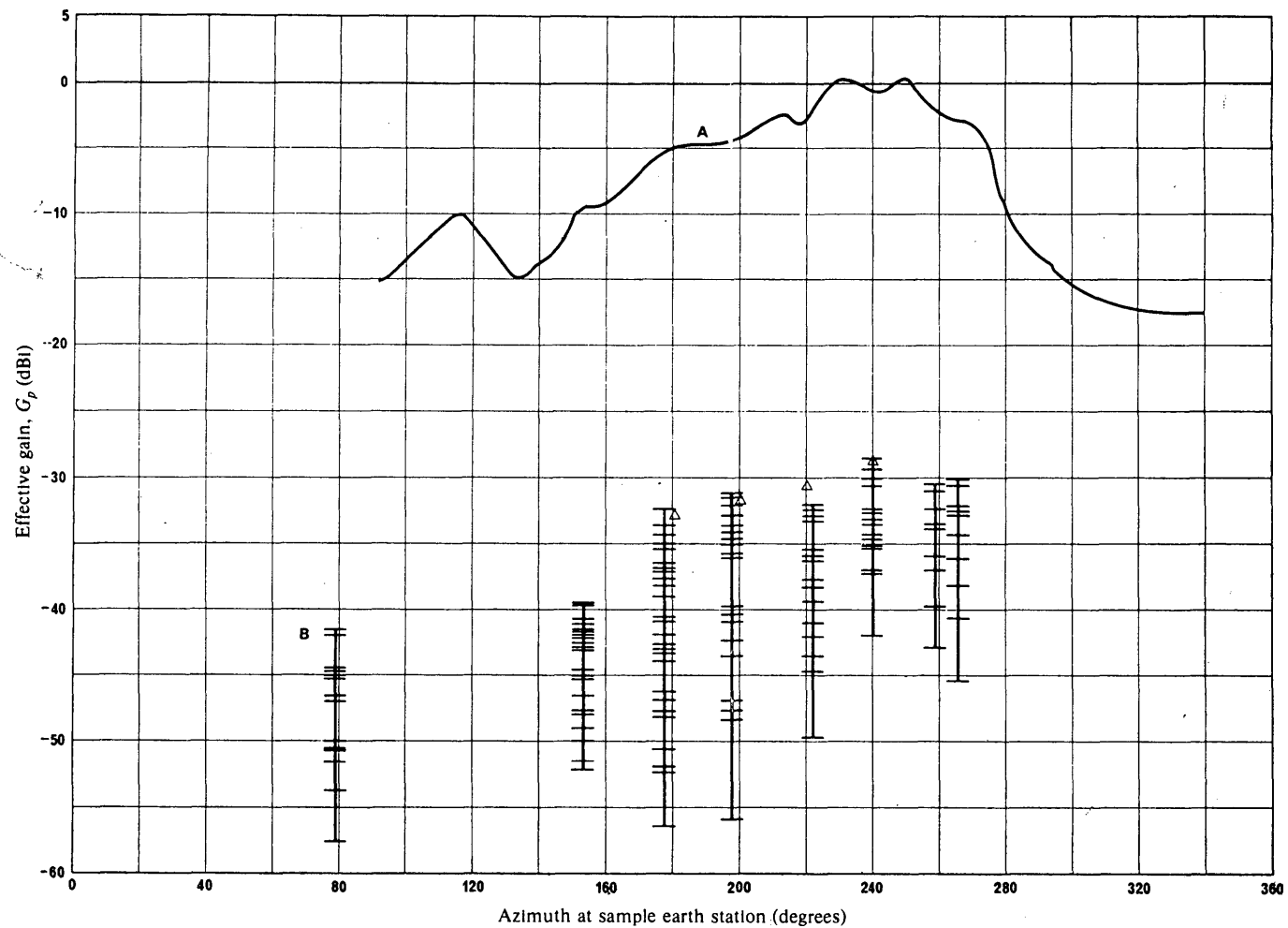

FIGURE 7 - Effective horizontal gain pattern for different satellite positions (4 and 6 GHz)

A: Maximum antenna gain for unshielded 10-metres antenna in the horizontal plane

B: Measured and calculated gain values of antenna pit combination (Δ calculated values)

A method of determining site shielding factor is by calculation of obstacle knife edge diffraction loss but this is inaccurate when it is applied to obstacles within the antenna near-field. A computer study based on fundamental principles has therefore been carried out [Dalglish, 1975; Streete and Shinn, 1974] on the effect of knife edge diffraction in the near-field of a large 4 GHz antenna and the results show good agreement with practical tests scaled to 9 GHz.

It can further be shown that a simple modification of the basic knife edge diffraction formula may be made to take account of the expected side-lobe response of the antenna. This modification permits the calculation of site shielding factors due to nearby obstacles which, subject to certain constraints, (in particular that the obstacles are beyond the Rayleigh distance, defined as $D^2/2\lambda$, where D = antenna diameter and λ = wavelength), are within 3 dB of the computer method.

The calculated site shielding factor then becomes:

$$20 \log \left(\frac{\pi^2 \theta}{90} \sqrt{\frac{d}{\lambda}} \right) + 25 \log \left(1 - \frac{\theta}{\alpha} \right) \quad \text{dB} \quad (4)$$

where the other symbols are given the meaning shown in the legend to Fig. 8. The first part of the expression determines the basic attenuation of interference due to the knife edge ridge and the second part is the correction for the change of direction of arrival of the interference due to the obstacle.

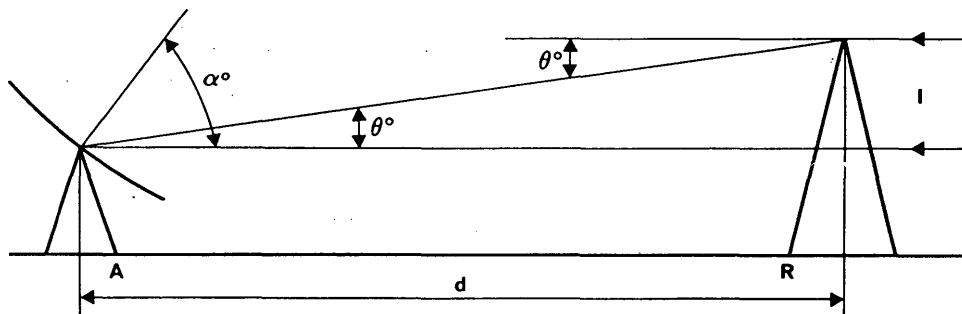

FIGURE 8 - Site shielding for earth station antennae

α : Elevation angle of antenna in degrees	A: Antenna
θ : Diffraction angle in degrees	R: Ridge
d : Distance between antenna and ridge in metres	I: Interference

5. Interference cancellers

The interference rejection characteristics of an earth station may be modified by electronic means (see Report 875). Typically, the signal received by a reference antenna is combined with the signal received by the main antenna in the proper phase and amplitude to effectively cause the side-lobe gain to become zero in the direction of an undesired signal. This effectively cancels the interfering signal.

These devices have been in limited use for some time but have not yet been perfected so that they can be relied on for operational use. Their further development should be encouraged in the interest of spectrum conservation.

REFERENCES

- BOITHIAS, L. and BEHE, R. [1971] Directivité maximale en dehors de l'axe des ouvertures rayonnantes équiphases. *Ann. des Télécomm.*, Vol. 26, 9-10, 325-340.
- CLAYDON, B. and DANG, N. [September, 1982] The choice of sub-reflector support geometry for earth station antennas. 12th European Microwave Conference, Helsinki, Finland.
- DALGLEISH, D. I. [7 April, 1975] The influence of interference on the siting of earth-stations. IEE Conf. Publ. 126, International Conference on Satellite Communication Systems Technology, London, United Kingdom.
- KREUTEL, R. W. [1976] Wide-angle sidelobe envelopes of a Cassegrain antenna. *COMSAT Tech. Rev.*, Vol. 6, 1, 71-88.
- MATSUNAKA, N., BETSUDAN, S. and KATAGI, T. [June, 1981] Side-lobe level reduction by improvement of strut shape. IEEE Antennas and Propagation Society (AP-S) International Symposium and URSI, Los Angeles, USA.

- MIZUGUCHI, Y., AKAGAWA, M. and YOKOI, H. [October, 1976] Offset dual reflector antenna. IEEE Antennas and Propagation Society (AP-S) International Symposium, Mass., USA.
- OGAWA, E., HORI, T., TAKANO, T. and ISHIDA, N. [1977] Some studies on 20/30 GHz band Cassegrain antenna for the domestic communication system earth station. Paper Tech. Group on Antenna Propagation, Institute of Electronics Communication Engineers of Japan, AP77-22 (1977-06).
- STREETE, M. A. and SHINN, D. H. [1974] Site shielding for earth-station antennae. *Electronics Lett.*, **8**, 120-121.

BIBLIOGRAPHY

- GOULD, R. G. and SCHMITT, C. [28-30 June, 1977] Interference reduction techniques for earth stations. 2nd Symposium and Technical Exhibition on Electromagnetic Compatibility, Montreux, Switzerland, 285-292.
- IEE [April, 1975] Interference cancellation to an earth station. IEE Conf. Publ. No. 126, International Conference on Satellite Communication Systems Technology, London, United Kingdom.

ANNEX II

NOISE TEMPERATURE CONTRIBUTIONS DUE TO EXTRATERRESTRIAL SOURCES

1. Introduction

At the frequencies of interest to the fixed-satellite service, the contribution to antenna noise temperature by the background component of cosmic noise, may be neglected and only the discrete sources need be considered. These discrete sources, such as the Sun, the Moon and some of the more intense radio nebulae, such as Cassiopeia A, Taurus A, Cygnus A and Orion A, are distributed over the celestial sphere, but have small angular dimensions and are only rarely intercepted by an earth station receiving antenna.

In practice, only the Sun and the Moon will give rise to a significant contribution to the antenna noise temperature of an earth station. In the case of the Sun, its apparent temperature (the antenna temperature depends on the apparent solar temperature and the fraction of the antenna beam included) is very high, and the noise received in the side-lobes of the earth-station antenna may also be important.

The apparent noise temperature of the quiet Sun at 4 GHz varies from 23 000 K at sunspot minimum to 90 000 K at sunspot maximum. The temperature of the quiet region is observed as 12 000 K at 12 GHz and 9200 K at 18 GHz with a 13 m antenna, respectively, and the apparent diameter of the Sun is observed as 0.6°. The variation of the average temperature of the solar disc is about 3 dB to the quiet value at 9.4 GHz and less than 1 dB at 17 GHz at the maximum activity, showing the inverse tendency to frequency.

In addition, solar radio bursts may give rise to an increase in the noise temperature. These occur most frequently at sunspot maximum, when for 1% of the time the apparent noise temperature at 4 GHz will be about 50% greater than that of the quiet Sun. For smaller percentages of the time, the increase in apparent noise temperature will be considerably greater.

At maximum, noise from the Moon can increase the system noise temperature by about 250 K at 4 GHz.

2. Occurrence of solar noise interference

A detailed study of the occurrence of solar interference in the receiving system of an earth station antenna, in the case of equatorial satellite orbits, has been carried out in the Federal Republic of Germany [CCIR, 1963-66].

A zone of interference is defined which depends on the angular width of the source, the antenna radiation diagram, and the permissible increase in noise temperature of the earth-station receiving antenna, of the order of 15 dB. This zone is approximately circular, and appears to be about 1.0° in angular diameter when received by typical 30 m antennas at 4 GHz. Interference occurs when the radio sun enters the zone of interference. The given angular diameter was calculated for the case of a quiet sun at sunspot minimum (26 000 K at 4 GHz). Sunspot activity would lead to an extension of the zone of interference.

For satellites in equatorial orbits at altitudes greater than, or equal to, 10 400 km, no earth station is free from solar interference. For stations located in the northern hemisphere, interference occurs only in the six-month period between the autumnal and vernal equinoxes, and for stations in the southern hemisphere it occurs only in the remaining six months. At any station, there are two periods in the particular six-month interval in which interference occurs; each of these periods may include several consecutive days. For geostationary satellites, interference occurs once a day.

The difference in time between the occurrence of interference at two different earth stations may be calculated from a knowledge of the satellite position and the earth-station coordinates. The time difference in occurrence between earth stations in the same hemisphere is approximately 35 minutes at maximum and shows little variation with satellite longitude over a wide range of values.

The duration of any individual occurrence of interference can be deduced from the size of the zone of interference and the angular velocities of the Sun and satellite relative to the earth station. The maximum duration of interference for an angular diameter of the zone of interference of 1.0° is about four minutes for geostationary satellites.

The expected duration per year of solar interference when operating with synchronous satellites can be obtained by applying the following procedures with reference to Figs. 9-11:

- use Fig. 9 to find the maximum increase in noise temperature according to the operating frequency and the diameter of the earth-station antenna. Note that Fig. 9 is based on a quiet Sun noise temperature of 26 000 K at 4 GHz. Correction would be needed if the actual Sun noise temperature exceeds this value;
- determine the allowable increase in system noise temperature according to the required quality of signal;
- from the ratio of the allowable to the maximum increase in noise temperature, use Fig. 10 to deduce the size of the zone of interference according to the D/λ of the earth station;
- for the size of the zone of interference found above, use Fig. 11 to find the expected duration per year of solar interference taking the latitude of the earth station into account.

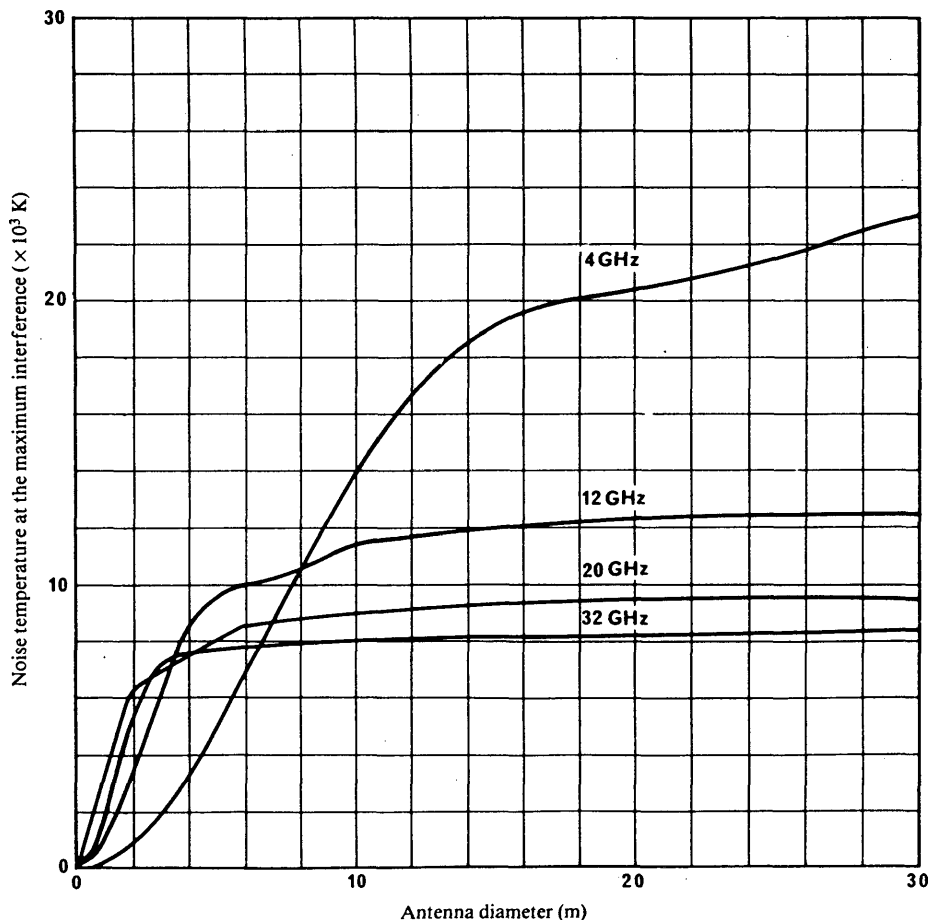

FIGURE 9 - Maximum increase in noise temperature due to solar interference

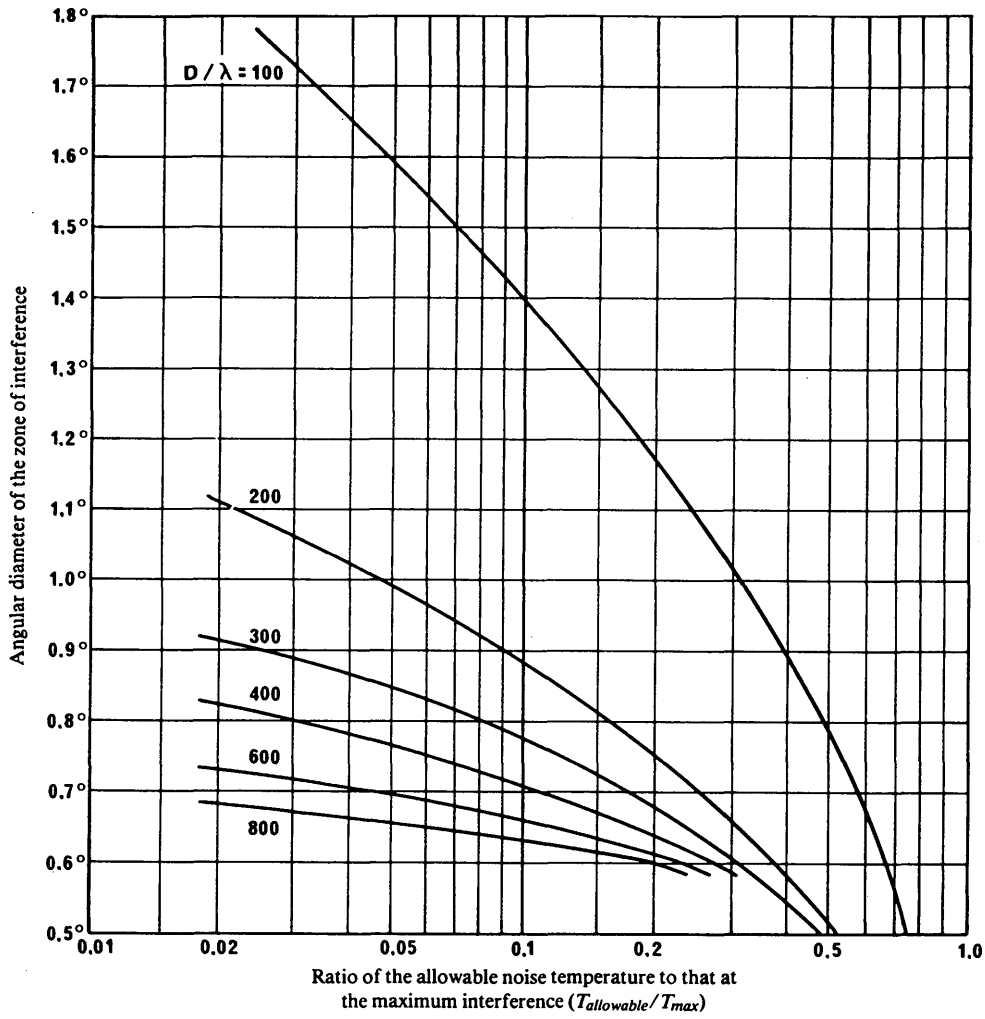

FIGURE 10 - Size of zone of solar interference

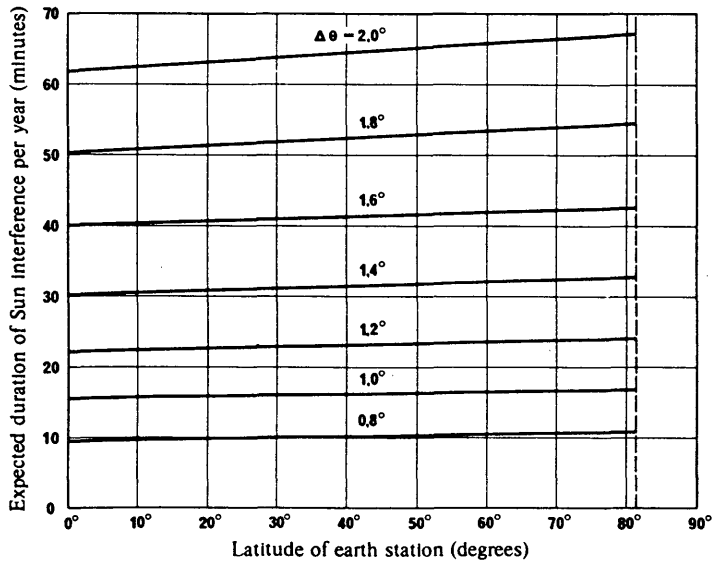

FIGURE 11 - Expected duration of interference due to the Sun for a satellite in the geostationary orbit

$\Delta\theta$ is the angular diameter of the zone of Interference

REFERENCES

CCIR Documents

[1963-66]: IV/223 (Federal Republic of Germany).

ANNEX III

MEASUREMENT OF THE RATIO G/T WITH THE AID OF RADIO STARS

1. Introduction

It is desirable to establish a practical method of measuring the ratio G/T with high accuracy, which will permit comparison of values measured at various stations. This Annex describes a method for the direct measurement of the ratio G/T using radio stars. It should be noted however, that the radio star method is not practical in certain cases and a possible alternative method for the direct measurement of G/T is to use a carrier signal transmitted from a satellite as described in [Sion, 1981]. It could be a useful operational method since it is less complicated than the radio star method, but care should be taken not to exceed the maximum permissible power flux-density specified by the Radio Regulations whilst the measurements are being conducted. The method should be verified in practice.

2. Method of measurement

By measuring the ratio, r , of the noise powers at the receiver output, the ratio G/T can be determined using the formula:

$$\frac{G}{T} = \frac{8\pi k (r-1)}{\lambda^2 \Phi(f)} \quad (5)$$

where:

k : Boltzmann's constant;

λ : wavelength (m);

$\Phi(f)$: radiation flux-density of the radio star at the frequency (f) at measurement ($\text{Wm}^{-2} \text{Hz}^{-1}$);

$r = (P_n + P_{st})/P_n$;

P_n : noise power corresponding to the system noise temperature T ;

P_{st} : additional noise power when the antenna is in exact alignment with the radio star.

G (antenna gain) and T (system noise temperature) are referred to the receiver input.

In equation (5), account is taken of the fact that the radiation of the star is generally randomly polarized and only a portion corresponding to the received polarization is received. The radiation flux-density $\Phi(f)$ is obtained by radio astronomical measurements.

This method has a basic advantage when compared with the calculation of G/T from G and T measured separately; instead of two absolute measurements, only one relative measurement is necessary to determine the ratio.

3. Suitable radio stars

The discrete radio sources Cassiopeia A, Cygnus A and Taurus A appear to be the most appropriate for measurements of G/T by earth stations. The flux-density of Cygnus A, however, may not be sufficient in every case.

The declination of all these radio stars is such that they may not be entirely suitable sources for earth stations situated in some southern latitudes.

Table I gives values of the flux-density of the radio stars indicated [Sato and Ogawa, 1982].

For the measurements at frequencies above 10 GHz, the use of the radio waves from planets, Venus for example, as well as above-mentioned radio stars is advantageous. The radio waves from planets have such advantages that flux-densities increase with frequency and their solid angle is very small giving rise to negligible correction errors due to angular extension. The flux-density $\Phi(f)$ is expressed by:

$$\Phi(f) = \frac{4\pi k T_b(f)}{\lambda^2} (1 - \cos \psi) \quad (6)$$

where,

$T_b(f)$: brightness temperature of a planet (K),

ψ : semi-diameter.

TABLE I — Flux-densities from radio sources

Radio Source	Cassiopeia A	Taurus A	Cygnus A
$\Phi(4)$ Flux-density at 4 GHz ($\text{Wm}^{-2} \text{Hz}^{-1}$)	1.067×10^{-26} ⁽¹⁾	679×10^{-26}	483×10^{-26}
$\Phi(f)$ Flux-density at f GHz	$\Phi(4) \left(\frac{f}{4}\right)^{-0.792}$ ⁽¹⁾⁽²⁾	$\Phi(4) \left(\frac{f}{4}\right)^{-0.287}$ ⁽²⁾	$\Phi(4) \left(\frac{f}{4}\right)^{-1.198}$ ⁽¹⁾

⁽¹⁾ Value for January 1965 (see § 4.3).

⁽²⁾ Where f is between 1 and 16 GHz. The formulae may be used provisionally up to 32 GHz.

⁽³⁾ Where f is between 2 and 16 GHz.

The value of $\Phi(f)$ derived from equation (6), is substituted in equation (5) to obtain the value of G/T of an earth station. The value of ψ can be found elsewhere in American Ephemeris and Nautical Almanac (US Government Printing Office, Washington DC 20402). In the case of the planet Venus, the values $T_b(f)$ are thought to be about 580 K and 506 K at 15.5 and 31.6 GHz, respectively [Yokoi *et al.*, 1974]. Since the values of $T_b(f)$ are based on a limited amount of measured data at the frequencies mentioned, and has not yet been determined for other frequencies, administrations are urged to make and contribute studies of the value of $T_b(f)$, as a function of frequency over as wide a range of frequencies as possible, to confirm and extend the results given here.

4. Correction factors and assessment of errors

The corrected value of G/T is given by:

$$(G/T)_c = G/T + C_1 + C_2 + C_3 + C_4 \quad (7)$$

where:

C_1 : atmospheric absorption;

C_2 : correction for angular extension of radio stars;

C_3 : change of flux with time;

C_4 : change of flux with frequency.

All factors to be given in decibels.

4.1 Atmospheric absorption

A simple correction for atmospheric absorption for angles of elevation above 5° , is given by:

$$C_1 = A / \sin \alpha \quad (8)$$

where:

A is the one-way absorption for a vertical path in dB,

α is the angle of elevation.

At 4 GHz, $A = 0.036$ dB; the value at other frequencies is shown in Fig. 12.

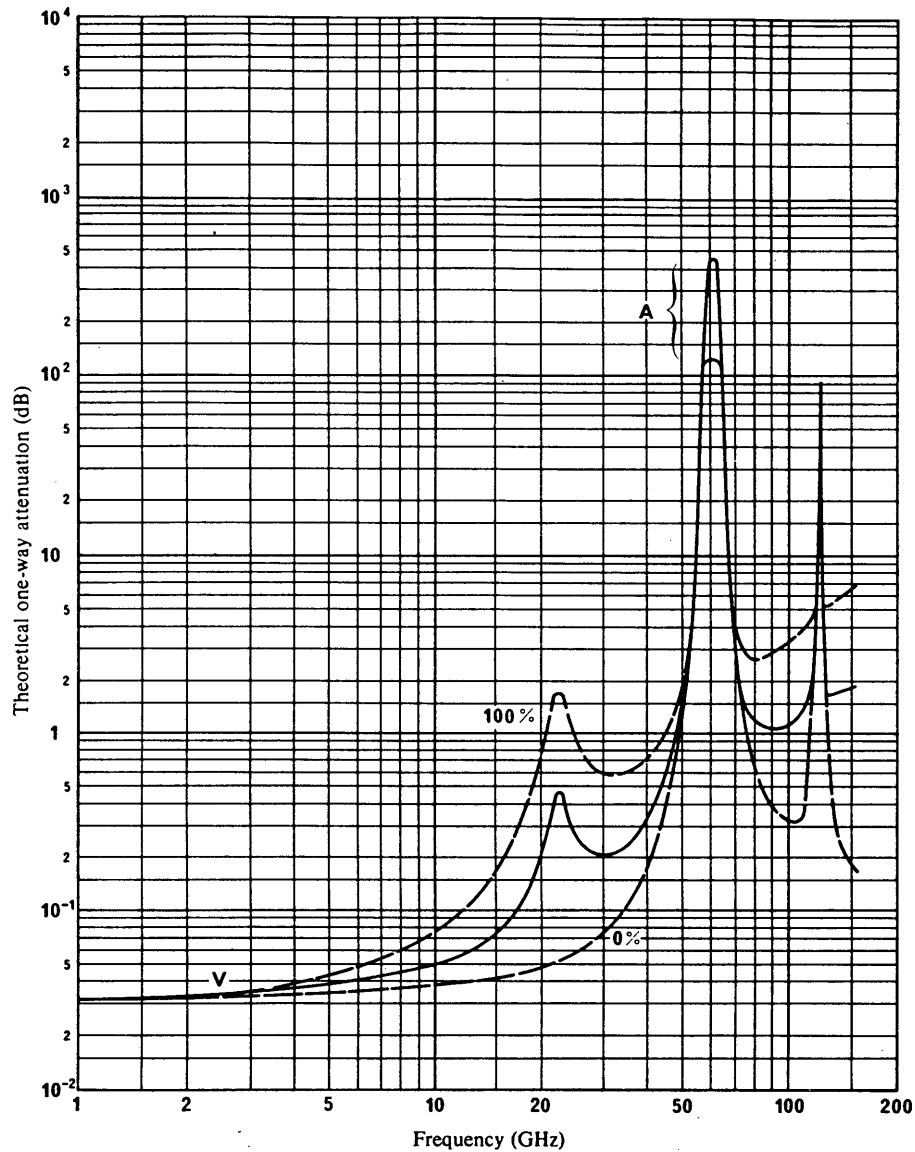

FIGURE 12 - Theoretical one-way attenuation for vertical paths through the atmosphere (calculated using the United States' standard atmosphere for July at 45°N latitude). Solid curves are for a moderately humid atmosphere, dashed curves for vertical attenuation represent the limits for 0 and 100% relative humidity

A: Limits of uncertainty

V: Vertical

4.2 Angular extension of radio stars

If the angular extension of the radio star in the sky is significant compared with the antenna beamwidth, a correction must be applied. This correction, C_2 , is shown in Fig. 13.

The curve for Cassiopeia A is calculated [Kanda, 1976] by numerical convolution of the observed brightness map [Rosenberg, 1970] with the antenna power pattern, approximated by a $(\sin x)/x$ function. The brightness distribution of Cassiopeia A can be well modelled by the annular distribution shape of which the inner diameter is 0.044° and the outer diameter is 0.071° , and the ratio of inner-to-outer brightness is 0.391. Using this model, the correction factor can also be calculated easily by combining two disc models for which the correction factor can be expressed by a conventional formula. The results using this model agree with the detailed calculation by Kanda within the error of 0.06 dB.

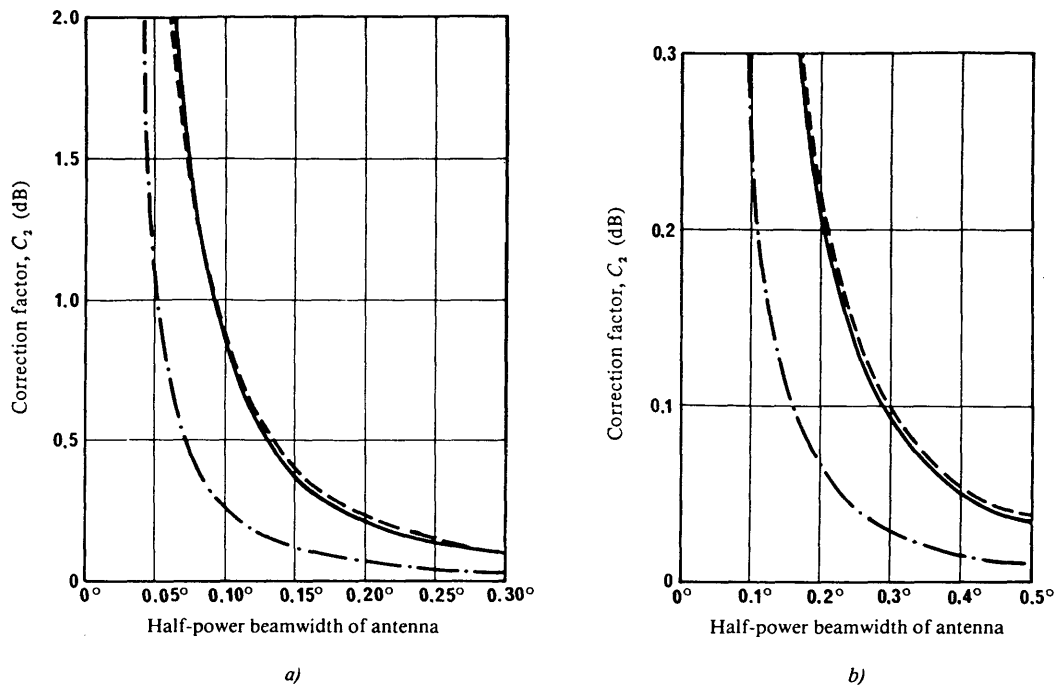

FIGURE 13 - Correction factor for the angular extent of radio stars

— Cassiopeia A
 - - - Taurus A
 · - - - Cygnus A

The curves for Taurus A and Cygnus A have been obtained by the same method as that used for the curve for Cassiopeia A. The calculations were based on the high resolution brightness distribution maps observed at 5 GHz for Taurus A [Wilson, 1972], and observed at 5 GHz for Cygnus A [Hargrave and Ryle, 1974].

The measured brightness distribution for Cygnus A can be adequately described by the dual columnar shape with 0.02 min of arc in each column's diameter and 2.06 min of arc in angular distance.

If the annular model for Cassiopeia A and the dual columnar model for Cygnus A are adopted, a convenient approximation is available for the correction factor. These models may also be useful to measure the half-power beamwidth of antennas by observing half intensity width of the drift curve. This also means that the correction factor for the angular extension of radio stars can be determined from the observed drift curve itself without the knowledge of the half-power beamwidth of the antenna.

4.3 Change of flux with time

Cassiopeia A is subject to a frequency dependent reduction of flux with time [Dent *et al.*, 1974]. The correction may be obtained from:

$$C_3 = (0.042 - 0.0126 \log f)n \quad \text{dB} \quad (9)$$

where:

n : number of years elapsed, with $n = 0$ in January 1965;
 f : frequency (GHz).

4.4 Change of flux with frequency

The variation of flux with frequency is also shown in Table I.

4.5 Polarization effects

Taurus A is elliptically polarized and it is necessary to use the mean of two readings taken in two orthogonal directions. These precautions are not necessary for measurements using Cassiopeia A or Cygnus A.

4.6 Assessment of errors

The maximum relative error is given by:

$$\frac{\Delta(G/T)}{G/T} = \frac{\Delta\Phi(f)}{\Phi(f)} + \frac{\Delta r}{r} \times \frac{r}{(r-1)} \quad (10)$$

where errors in $\Phi(f)$ and r are considered.

The relative error which results from the measurement of the power ratio r is particularly marked when the star noise (P_{st}) is insufficient in relation to the system noise (P_n), because $r/(r-1) \rightarrow \infty$ when $r \rightarrow 1$. The measurement accuracy would be considerably reduced when r is less than 2 dB. This would occur at the following values of G/T :

Cassiopeia A:	36 dB(K ⁻¹)
Taurus A:	37 dB(K ⁻¹)
Cygnus A:	39 dB(K ⁻¹).

If $r = 2.5$ (4 dB), for example, r must be measured to ± 0.01 (0.05 dB) if the error term is not to exceed 0.02 (approx. 0.1 dB).

The error contribution due to:

$$\frac{\Delta\Phi(f)}{\Phi(f)}$$

is approximately 0.02. There is an additional uncertainty of ± 0.01 in the corrections applied. Thus the total maximum error, for high elevation angles, is about 0.05 or approximately ± 0.2 dB.

REFERENCES

- DENT, W. A., ALLER, H. D. and OLSEN, E. T. [February, 1974] The evolution of the radio spectrum of Cassiopeia A. *Astrophys. J.*, Vol. 188, L11-L13.
- HARGRAVE, P. J. and RYLE, M. [1974] Observations of Cygnus A with 5-km radio telescope. *Monthly Notices Roy. Astron. Soc. (GB)*, Vol. 166, 305-327.
- KANDA, M. [September, 1976] An error analysis for absolute flux-density measurements of Cassiopeia A. *IEEE Trans Instr. and Meas.*, Vol. IM-25, 3, 173-182.
- ROSENBERG, I. [1970] Distribution of brightness and polarization in Cassiopeia A at 5.0 GHz. *Monthly Notices Roy. Astron. Soc. (GB)*, Vol. 151, 109-122.
- SATO, T. and OGAWA, A. [January, 1982] Exact gain measurement of large aperture antennas using celestial radio sources. *IEEE Trans. Ant. Prop.*, Vol. AP-30, 1, 157-161.
- SION, A. [1981] New method for direct G/T measurement using satellite signals. *Electron. Lett.*, Vol. 17, 23, 883-885.
- WILSON, A. S. [1972] The structure of Crab Nebula at 2.7 and 5 GHz-I. *Monthly Notices Roy. Astron. Soc. (GB)*, Vol. 151, 229-253.
- YOKOI, H., YAMADA, M., AKAGAWA, M., OGAWA, A. and MIZUGUCHI, Y. [March, 1974] Flux-densities of celestial radio sources at 15.5 and 31.6 GHz. *Trans. Inst. Electron. and Comm. Engrs. Japan*, Vol. 57-B, 3, 184-190.

BIBLIOGRAPHY

- BAARS, J. W. M., GENZEL, R., PAULINY-TOTH, I. I. K. and WITZEL, A. [April, 1977] The absolute spectrum of CAS A; an accurate flux density scale and a set of secondary calibrators. *Astron. and Astrophys.*, Vol. 61, 99-106.

ANNEX IV

SAFETY ASPECTS OF RADIO-FREQUENCY RADIATION
FROM FIXED EARTH-STATION ANTENNA SYSTEMS

This Annex provides information from which the maximum power flux-densities to be expected from an earth-station antenna system using paraboloidal type antennas may be calculated with respect to the power radiated at the antenna feed.

The maximum power flux-densities have been evaluated for the following three zones:

- the far-field zone, defined as that extending from infinity to $(2D^2)/\lambda$

where:

D : antenna diameter in metres,

λ : wavelength in metres;

- the near field zone, bounded by the antenna aperture and $(2 D^2)/\lambda$;
- the zone bounded by the feed primary (and secondary, if any) reflectors and the radiating aperture.

Ground reflections may have a significant effect on the power flux-density observed at certain locations, and in computing the expected flux-density it has been assumed that the effective flux could increase by a factor of 4 as compared with the free space field. This means that the calculation should produce conservative results.

In order to illustrate the use of the information given in this Annex an example calculation has been performed in which a maximum power flux-density of 10 mW/cm² has been assumed. The resulting data are shown in Fig. 14, in which for a particular value of antenna diameter, the maximum powers radiated from the antenna feed are shown for:

- the far field
- centre of aperture
- near-field peak.

The field in the zone bounded by the feed and the radiating aperture is not shown in Fig. 14. This field will be very high in certain directions and is unlikely to be intercepted by humans in the normal operation of the earth station.

Although 10 mW/cm² has been used in the above example, other values of the safe power flux-density can be accommodated in Fig. 14 by a simple movement of the ordinate scale. In this respect administrations should use the value of power flux-density they consider most appropriate.

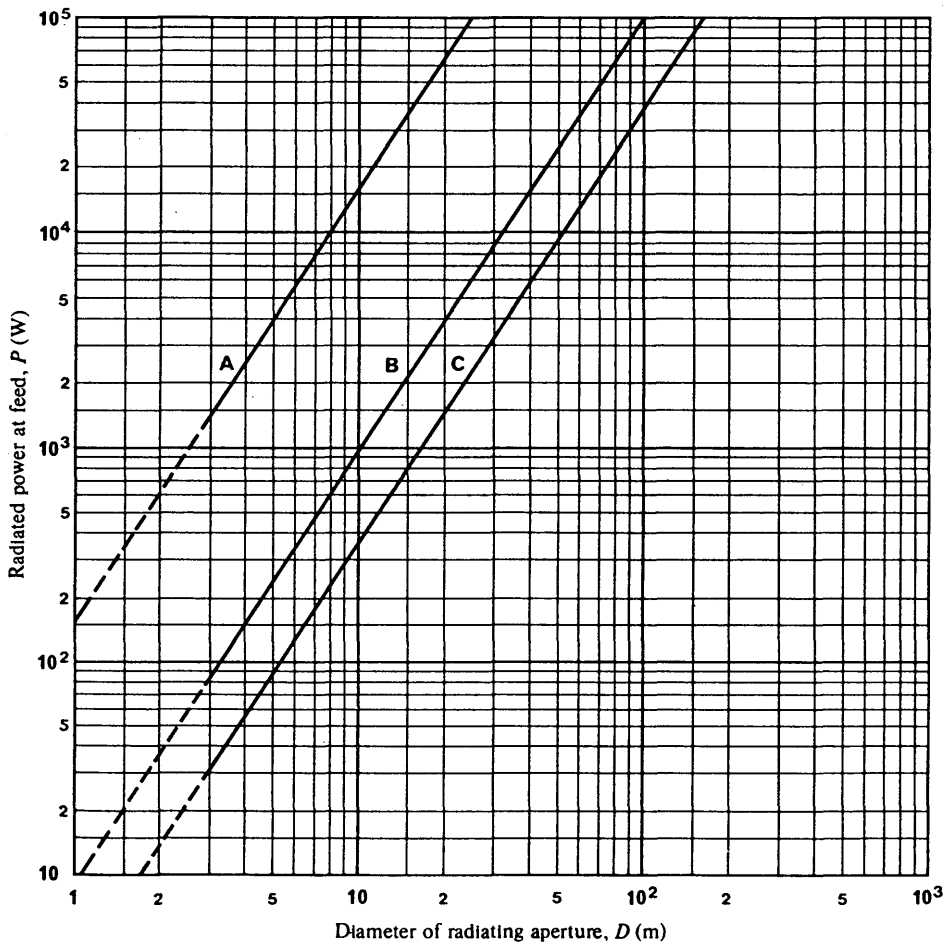

FIGURE 14 - Radio-frequency radiation hazards. Calculated levels of radiated power for the assumed maximum safe exposure limit of 10 mW/cm² on axis of radiated beam

- A: Far-field boundary
- B: Centre of aperture plane
- C: Near-field peak

Note.—If a point is marked on the Figure to represent the antenna diameter and radiated power under consideration and this lies to the left of the curve or curves, the assumed maximum safe pfd (10 mW/cm²) could be exceeded in the zone(s) indicated by the title(s) of the curve(s) to the right of the point.

ANNEX V

FEATURES OF BEAM-STEERABLE ANTENNA FOR EARTH STATIONS

A beam-steerable antenna that can have access to geostationary satellites without moving the main reflector has the following features:

- fixed main reflector system without heavy bearings and drives;
- operative in a strong wind;
- surface accuracy unchanged in spite of the change in elevation angle of antenna beam;
- multi-beam capability for multi-satellite operation.

A beam-steerable earth-station antenna using a torus reflector has been constructed. Such a simple single reflector system might not be able to be used for a large-scale antenna, because the reflector reduces antenna gain and bandwidth due to phase errors caused by spherical aberration [Kreutel, 1980]. Furthermore, asymmetry due to the offset configuration degrades cross-polarization characteristics.

An offset spherical reflector antenna with satisfactory electrical performance has _____ been developed [Watanabe *et al.*, 1984]. The antenna is composed of an offset type spherical main reflector, two sub-reflectors and a feed horn. Both spherical aberration of the main reflector and asymmetry due to the offset configuration are successfully cancelled by the use of specially shaped multiple sub-reflectors. An experimental antenna at 52/34 GHz, which is a scaled model of a 20 m class antenna in the 6/4 GHz band, was constructed. Scanning angles of $\pm 8^\circ$ in the azimuth direction and $\pm 1^\circ$ in elevation direction keeping the aperture efficiency of about 60% have been successfully demonstrated. Furthermore, the side lobes are about 10 dB lower than the reference radiation diagram of Recommendation 580.

A 30/20 GHz dual-beam earth station antenna has been developed [Hori *et al.*, 1989] for economical and reliable implementation of a satellite communication system via the Japanese communication satellites CS3-a and CS3-b. This antenna is simultaneously accessible to the two satellites, separated by 4 degrees in the geostationary orbit, and achieves low side-lobe characteristics. The antenna is composed of six reflectors, in which two feed systems with dual auxiliary reflectors are separately employed for the two beams, while the double-torus sub- and main-reflectors are shared by both beams. The main reflector is 5.1 m wide and 4.7 m high. The "effective" D/λ ratio of this antenna is 272 at an operating frequency of 19.45 GHz. The wide-angle radiation pattern satisfies the Recommendation 580 design objectives.

REFERENCES

- HORI, T. and TANAK, T. [April 1989] 4-reflector type torus earth station antenna for simultaneous dual-satellite access. Sixth International Conference on Antennas and Propagation, University of Warwick, UK.
- KREUTEL, R. [1980] - The multiple-beam torus earth station antennas. IEEE International Conference on Communications (ICC '80), 8-12 June, Seattle, WA., USA, Conf. Record 25.4.
- WATANABE, F., MIZUGUCHI, Y. and YAMADA, M. [1984] - A beam-steerable antenna with an offset spherical reflector for earth station. AIAA 10th Communications Satellite Systems Conference, AIAA-84-0672.

REPORT 998-1

PERFORMANCE OF SMALL EARTH-STATION ANTENNAS
FOR THE FIXED-SATELLITE SERVICE

(Question 1 /4 and Study Programme 1A /4)

(1986-1990)

1. Introduction

Inter-network interference due to radiation from earth-station antenna side lobes and reception through the side lobes is one of the dominant factors which determines the minimum separation between satellites. A reduction in the minimum required spacing could substantially increase the number of networks that could use the geostationary-satellite orbit.

The radiation diagrams of large earth-station antennas have been studied extensively in the CCIR (see Report 391). The performance that can be obtained with careful design with an axisymmetrically fed Cassegrain antenna is now well understood and Recommendation 580 gives a side-lobe gain design objective. There are less data for smaller antennas and it is often assumed that their side-lobe performance is worse than that of the larger antennas. However, this is not necessarily so; techniques for improving side-lobe performance may be more easily implemented in the design of small antennas.

At a time when the demand for domestic satellite communication is increasing rapidly, it is important that urgent consideration be given to ways in which good side-lobe performance can be obtained from small antennas. The relevant factors which contribute to the side-lobe performance are itemized in this Report and special attention is drawn to the limiting effect these factors have when the electrical size of the reflecting surfaces is small.

2. Axisymmetric antennas**2.1 Dependence of side lobe level on aperture illumination**

There are a number of factors which affect the side-lobe performance of an antenna. These can be summarized as:

- aperture illumination function,
- edge illumination of main and sub-reflector,
- edge diffraction of main and sub-reflector,
- blockage effects,
- feed spill-over,
- phase errors.

The side-lobe envelope due to the aperture illumination function provides the basis of the complete envelope for the antenna. If all other factors, such as spill-over, edge diffraction and aperture blockage, were effectively removed, then the illumination function would determine the level of side-lobe suppression.

As an example, for a 100 wavelength diameter circular aperture with a tapered illumination function of -15 dB at its edge, the various practical aperture distributions produce different idealized radiation envelopes, viz:

<i>Distribution</i>	<i>Side-lobe envelope</i>
Parabolic	25 - 36 log ϕ
Parabolic squared	17 - 24 log ϕ
Gaussian	20 - 28 log ϕ
Inflected Bessel	17 - 22 log ϕ
Hansen one dimensional	21 - 30 log ϕ

For reference, the side-lobe envelope with uniform illumination would be 31 - 30 log ϕ .

The forms of these aperture distributions are shown in Fig. 1a. These results are supported in [Rusch and Potter, 1970] which also shows that the wide angle radiation envelope is dependent only on the illumination taper at the edge of the aperture while for close-in side lobes the slope factor also contributes.

These illumination distributions, of course, have an effect on the aperture efficiency of the antenna. If side-lobe suppression is required, this tends to conflict with a desire for high aperture efficiency. The shadowed areas in Figure 1b indicate the theoretical relationship between the maximum aperture efficiency and the side-lobe level, which is defined as the maximum level of any side-lobes and may not be identical to the first side-lobe level [Goto and Watanabe, 1978]. However, the degradation in aperture efficiency is only a relatively slowly varying function. Curves in Figure 1b illustrate the degradation of aperture efficiency with first side-lobe level for the various illumination distributions.

2.2 Effect of blockage

It would seem that by choosing the correct illumination function, almost any practical radiation envelope could be accommodated; however, aperture blockage, which appears in axisymmetric systems, will be seen to be a limiting factor:

Typically, for a sub-reflector of diameter d wavelengths and a main reflector of D wavelengths, a pattern is generated whose axial gain is given by [Rusch and Potter, 1970]:

$$G_B = 20 \log \left(\pi \cdot \frac{d^2}{D} \right) \quad \text{dBi}$$

The pattern generated by this sub-reflector blockage is that of a uniformly illuminated aperture. Since, in general, sub-reflectors are much smaller than the main reflector, this blockage pattern is much wider than the main reflector pattern. The two patterns can thus combine in and out of phase, reinforcing and cancelling. Depending on the exact details of the system, this effect produces changes in envelope as shown in Figures 2a and 2b.

2.3 Predicted radiation patterns of Cassegrain antennas

The composite effect of limiting factors such as sub-reflector and horn blockage, sub-reflector spillover, diffraction, horn flange effect and vertex plate effect on the side-lobe performance of a small dual reflector axisymmetric antenna is presented in Figure 2c. The main aperture distribution used for this study had a high edge level of about -7 dB [Ghosh and Abud Filho, 1987; Ekelman and Gilmore, 1986].

As shown in § 2.1, the side-lobe levels may be reduced by tapering the aperture distribution. In a dual-reflector (Cassegrain), this can be achieved by using shaped-reflector profiles. The reflector profiles can be defined by applying the geometric optics solution to achieve the nominal aperture distributions shown in Fig. 3 [James, 1980]. The resultant sidelobes are computed by taking into account both the reflector current distribution, feed spillover (where the sub-reflector edge-illumination from the feed must be kept at least 20 dB below the on-axis value), and geometrical theory of diffraction taking into account both sub-reflector and main-reflector edge-diffraction contributions [James, 1980]. Calculations were carried out for four nominal aperture distributions: Case "A" is uniform giving maximum gain, and case "D" is the

classical Cassegrain with -15 dB edge taper. Two intermediate distributions "B" and "C" are also shown. The effect of aperture illumination on the first side-lobe level is summarized in Table I (see also [James, 1980]).

Also shown in this table is the increase in level due to the central blockage for the axisymmetric antenna. Note the rapid deterioration in side-lobe level as the blockage increases for the low side-lobe level design. Other effects such as reflector surface error, feed spill-over and the sub-reflector diffractions will also affect the side-lobe level of low side-lobe level designs. Figure 4 shows the first side-lobe level relative to isotropic for an axisymmetric antenna with $d/D = 0.1$, for $D/\lambda = 150, 75$ and 50 with aperture illuminations as indicated in Fig. 3.

It is evident from Fig. 4 that it will be necessary to taper the aperture illumination to ensure that the first side-lobe level is below the suggested specified curve.

Figure 5 shows the calculated side-lobe level for an axisymmetric antenna with $D/\lambda = 75$, $d/D = 0.1$ and aperture illumination "B". The pattern is between the planes of the struts and the surface error component of radiation has been neglected. The dots indicate the side-lobe peaks calculated from the reflector currents. The departure from a gradual decrease in level for each consecutive side lobe is due to the central blockage. For $\phi > 550(\lambda/D)$, feed spill-over and reflector edge diffraction effects predominate (continuous curves). A comparison of the two curves shows that when the sub-reflector edge taper is reduced from -15 dB to -20 dB, the overall level of this contribution is reduced by approximately 3 dB. However, the feed must be carefully designed to ensure that the phase remains essentially constant down to the -20 dB level.

For antennas designed to cover both receive and transmit bands, the approximate sub-reflector size d/D must be increased as D/λ decreases to ensure that the feed spillover past the sub-reflector is maintained below the relevant side lobe specification [James, 1987]. This factor further increases the difficulty of meeting side lobe specifications as D/λ decreases.

Although phase errors are also relevant to the radiation performance of antennas, the effect is not a limiting factor in this consideration. Detailed analysis has been reported over many years, for example [Harris, 1978] and the control of phase errors is well understood. In principle there is little difference between the mechanisms at work in the larger antenna field and those under consideration here.

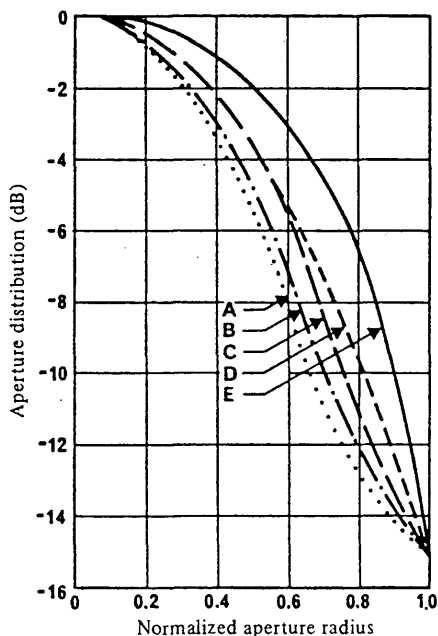

FIGURE 1a - Various aperture illumination distributions

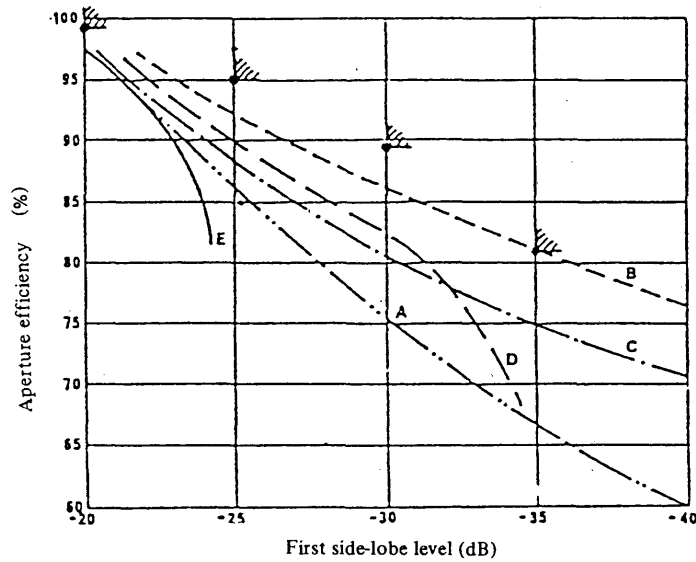

FIGURE 1b - Variation of aperture efficiency for different first side-lobe levels and various illumination functions

- Curves A Hansen one-dimensional
- B Inflected Bessel
- C Parabolic squared
- D Gaussian
- E Parabolic

▨: Theoretical relationship between the maximum aperture efficiency and the maximum level of side-lobes

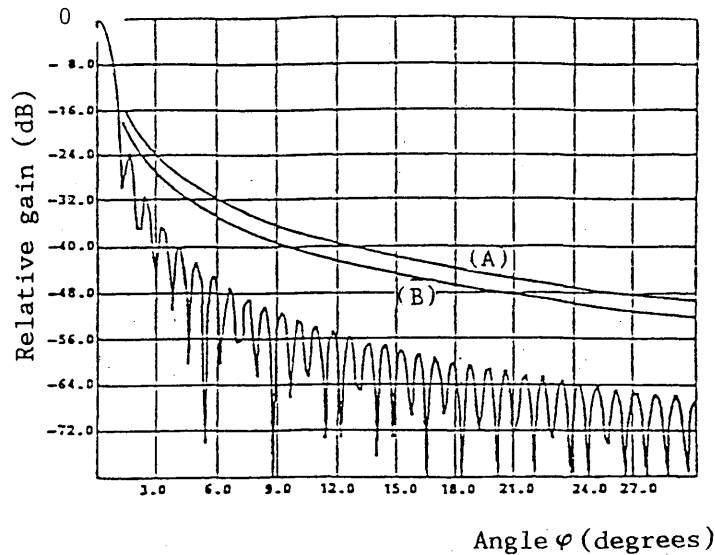

FIGURE 2a - Theoretical radiation pattern calculated by simple field integration in the main reflector aperture of the 4.5 m antenna, without considering diffraction effects ($D/\lambda = 67.5$)

- (A) $52 - 10 \log D/\lambda - 25 \log \varphi$,
- (B) $49 - 10 \log D/\lambda - 25 \log \varphi$.

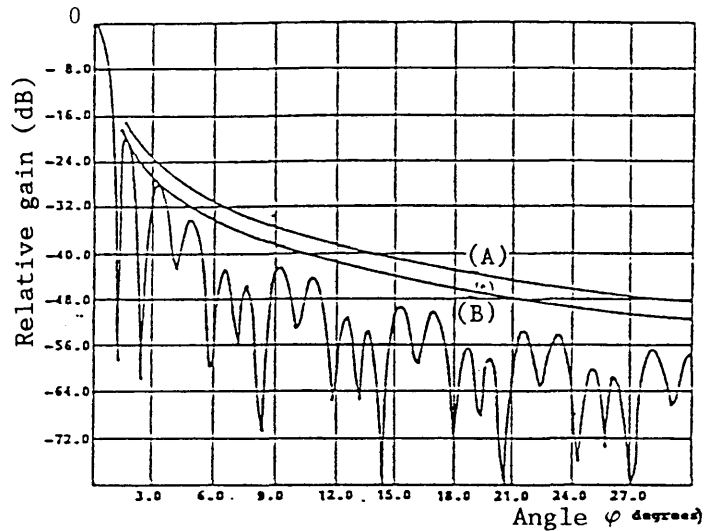

FIGURE 2b - Field integration in the main reflector aperture of the 4.5 m antenna including sub-reflector blockage effects without considering diffraction ($D/\lambda = 67.5$; $d/D = 0.14$)

$$(A) \quad 52 - 10 \log D/\lambda - 25 \log \varphi,$$

$$(B) \quad 49 - 10 \log D/\lambda - 25 \log \varphi.$$

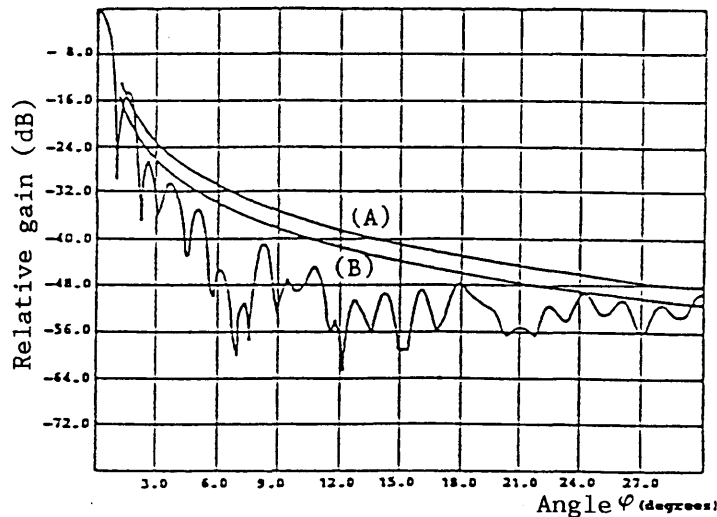

FIGURE 2c - Theoretical radiation pattern of a 4.5 m Cassegrain antenna calculated by Physical Optics including both horn and sub-reflector blockage effects, the sub-reflector spillover, the horn flange effect, and also the sub-reflector vertex plate effect ($D/\lambda = 67.5$, $d/D = 0.14$, sub-reflector edge level = -15dB)

$$(A) \quad 52 - 10 \log D/\lambda - 25 \log \varphi,$$

$$(B) \quad 49 - 10 \log D/\lambda - 25 \log \varphi.$$

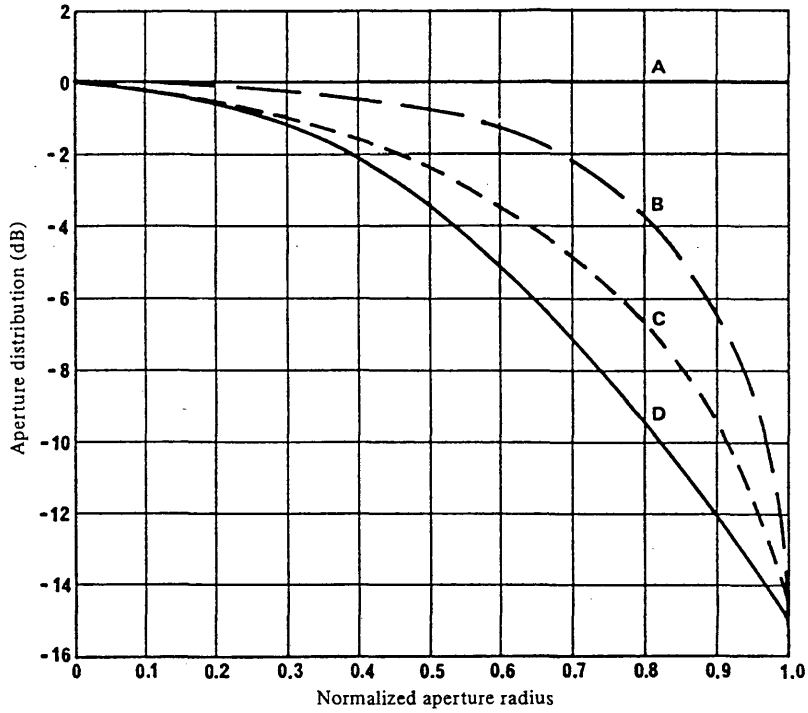

FIGURE 3 - Four typical design aperture distributions for a Cassegrain antenna using shaped reflector profiles

- Cases "A" : uniform giving maximum gain
- "B" and "C" : intermediate distributions
- "D" : classical Cassegrain

TABLE I - Effect of aperture distribution on gain and first side-lobe level

Distribution (see Fig. 3)	Relative gain (dB)	Required increase in reflector dimensions to restore gain to uniform case "A"		Relative level of first side lobe (dB)		
				Sub-reflector size (d/D)		
		Diameter	Area	0	0.1 ⁽¹⁾	0.15 ⁽¹⁾
"A" (uniform)	0	0	0	-17.5	-17	-16
"B"	-0.4	5%	10%	-20.5	-19	-17.5
"C"	-0.6	7%	15%	-23	-21	-19
"D" (classical)	-1.0	12%	25%	-29	-24	-21.5

⁽¹⁾In plane of struts, first side-lobe level is increased by approximately 1 dB for case "A" and 2 dB for case "D".

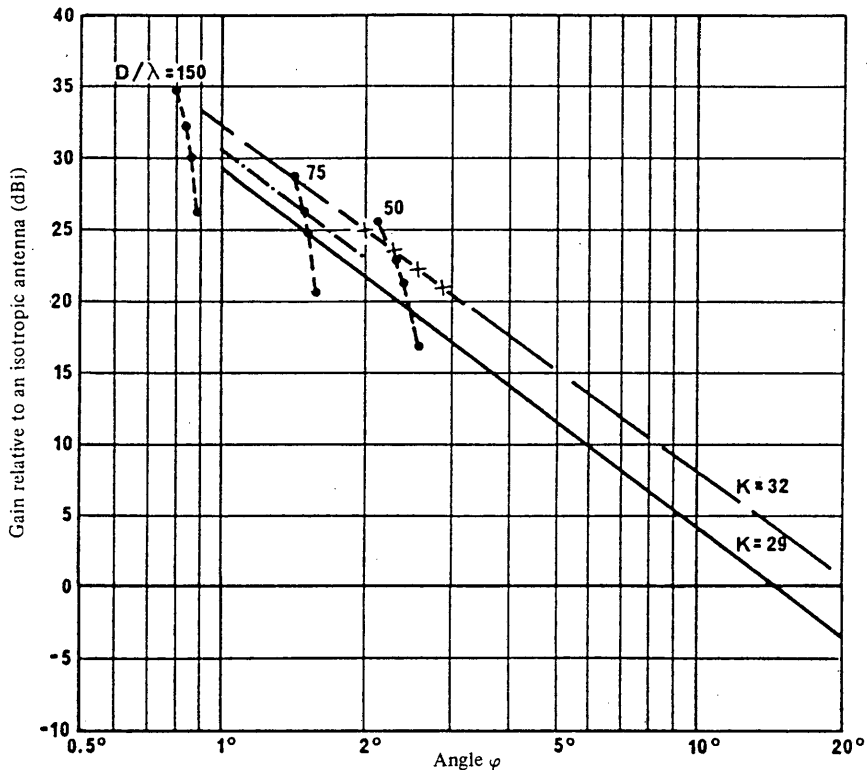

FIGURE 4 - First side-lobe level relative to isotropic for three antenna diameters, $D/\lambda = 150, 75$ and 50

- — — — — $K = 32$
 - $K = 29$
 - — · — · — · — $K = 49 - 10 \log (D/\lambda), D/\lambda = 75$
 - x — x — x — x — $K = 49 - 10 \log (D/\lambda), D/\lambda = 50$
 - Axisymmetric antenna with $d/D = 0.1$. Each dot corresponds to the four aperture distributions "A"- "D" ("A" at top) shown in Fig. 3.
- Also shown are possible side-lobe limits where K is defined by $G = K - 25 \log \phi$ (dBi)

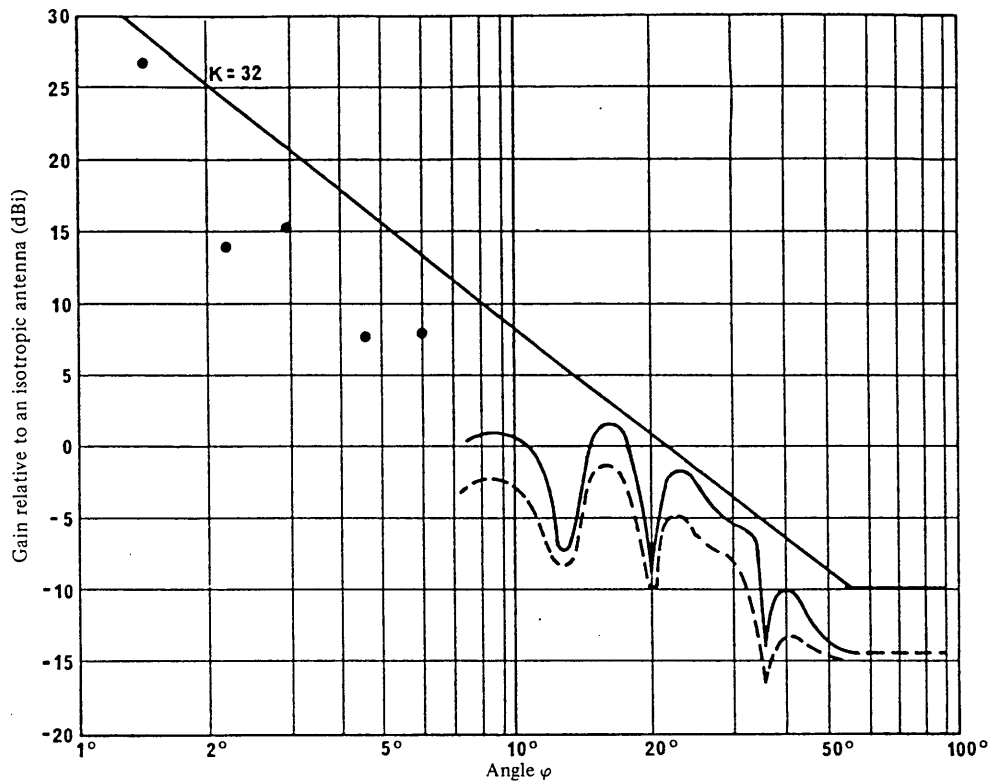

FIGURE 5 - Theoretical radiation diagram of an axisymmetric antenna
 $D/\lambda = 75$, $d/D = 0.1$, and aperture distribution "B"

Sub-reflector spill-over and reflector (sub and main) edge diffraction contribution:

- — — — -15 dB sub-reflector edge illumination
- - - - -20 dB sub-reflector edge illumination
- locations of near-in side lobes calculated from reflector current integration

2.4 Measured radiation patterns of axisymmetric antennas

As a practical example, Figure 6 presents typical measurement results obtained with a 4.5 m Cassegrain antenna developed in Brazil. A full consideration of measured results has indicated that antennas of this type (receive/transmit - dual reflector - axisymmetric) which are designed considering not only side-lobe performance but also VSWR, noise temperature and gain (in both transmit and receive bands) may have difficulty in satisfying the CCIR Recommendation 580-1 side-lobe template scheduled to come into force after 1991.

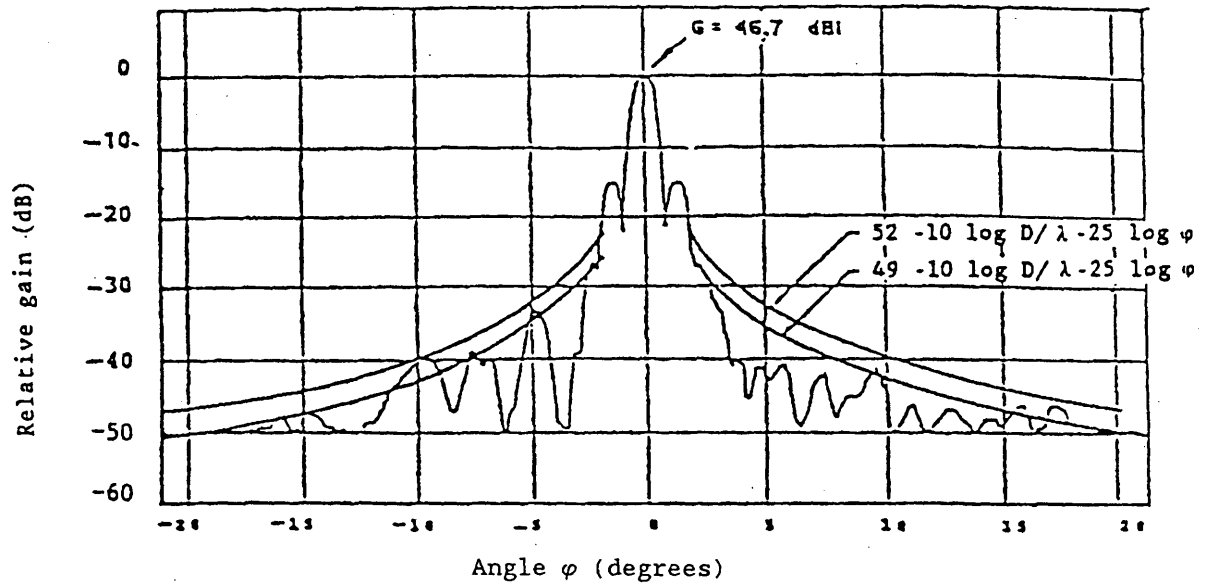

$f = 6.315$ GHz

FIGURE 6 - Measured radiation pattern of a 4.5 m Cassegrain antenna in the azimuth plane

transmit: $f = 6.315$ GHz, $G = 46.7$ dBi, efficiency = 53%, $D/\lambda = 95$

receive: $f = 4.1$ GHz, $G = 44.5$ dBi, efficiency = 75%, $D/\lambda = 61.5$

As described in § 2.3, the ratio between the size of the sub-reflector and main reflector d/D must be increased as D/λ decreases. It implies that a prime focus feed configuration using an axisymmetric single parabolic reflector would be advantageous for small earth station antennas. Figure 7 shows a measured radiation pattern of a 1.8 m diameter prime focus feed antenna at 14.25 GHz ($D/\lambda = 85.5$) designed for 14/12 GHz receive-transmit operation. The near-axis side lobes are below $29-25 \log \phi$ (dBi). The aperture efficiency is above 60% in both bands.

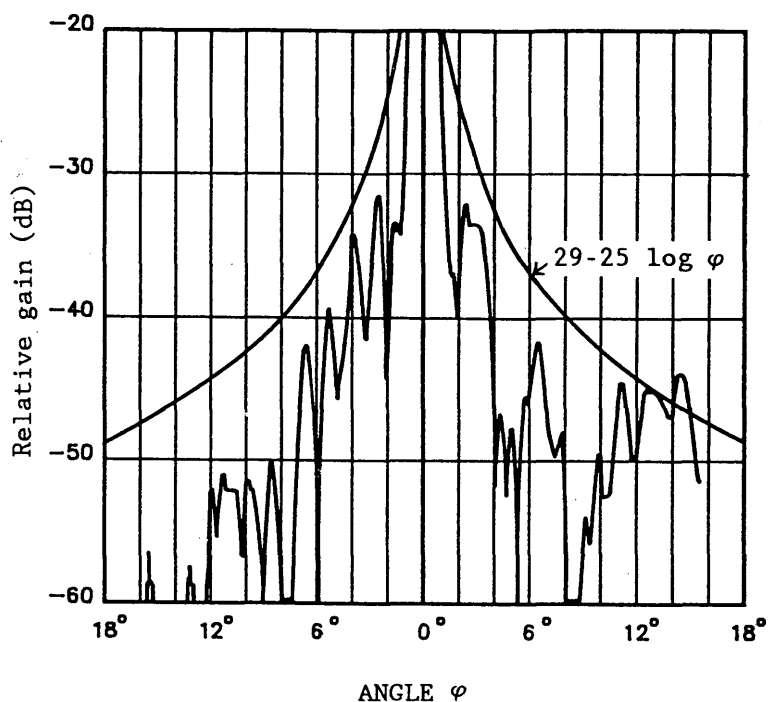

FIGURE 7 - Measured radiation pattern of a 1.8 m diameter prime focus feed antenna at 14.25 GHz ($D/\lambda = 85.5$)

Summarizing therefore, some kinds of axisymmetric small antennas can have low side-lobe characteristics such as $29-25 \log \phi$ dBi. In order to achieve significant improvement in the side-lobe envelope close to the boresight without degrading the antenna aperture efficiency it may be necessary to employ configurations which lead to an unblocked aperture. Such arrangements occur in offset reflector antennas and these are discussed below.

3. Asymmetric (offset) antennas

Although the geometry of an asymmetric or offset antenna is less straightforward than that of an axisymmetric reflector, the removal of all blockage effects brings about major improvements in the antenna side-lobe performance in both the near-in and far-out angular regions. A further advantage of the offset configuration is that the reaction of the reflector upon the primary feed can be reduced to a very low order.

The offset configuration has suffered from cross-polarization problems especially in front-fed designs. When illuminated by a linearly polarized prime focus feed, the offset reflector generates a cross-polarized component in the radiated field. In the case of circular polarization, the phase relationship of this effect causes a recombination of the radiated linear fields into a circularly polarized component of the same hand. The effect results in a phase gradient across the aperture and hence a beam squint on one side or the other of the electrical boresight, depending on the hand of circular polarization.

For these reasons, and the problem of mechanical asymmetry, and also from cost considerations, the offset antenna has been somewhat neglected in the past. However, it is now common and widely used at small earth stations. In the following paragraphs the advantages of the configuration are shown to be exploitable and the performance disadvantages avoidable, in order to go beyond the limitations of axisymmetric systems at smaller diameters.

3.1 Types of offset antenna

Similar to its axisymmetric counterpart, the offset parabolic reflector can be utilized as a single reflector fed from the vicinity of its prime focus or arranged in a dual reflector system where the main reflector is illuminated by a combination of a primary feed and sub-reflector. For both Gregorian and Cassegrain systems, two types of antenna design can be considered, one using conic section reflectors and the other shaped reflectors.

3.2 Offset parabolic antennas

An offset parabolic antenna fed from the vicinity of the prime focus of the parabolic main reflector is the simplest offset antenna. The aperture distribution of an offset parabolic antenna mainly depends on the illumination pattern of the primary feed. If the feed has a rather narrow beam width, antenna side lobes in the near-in angular region can be reduced because of the low edge illumination level, and side lobes in the far-out region are also suppressed because of the low spill over level. However, the low side-lobe design causes low aperture efficiency. In general, the values of efficiency and side-lobe level of an offset parabolic antenna, which are frequency dependent, are usually spread from the receive band to the transmit band.

Figure 8-a shows a typical radiation pattern of a 1.8 m diameter offset parabolic antenna for 14/12 GHz bands ($D/\lambda = 70 \sim 90$). The near-in side-lobes are below $29-25 \log \varphi$ (dBi) in both receive and transmit bands. For cross-polarization discrimination, the antenna has at least 30 dB of on-axis isolation, and an isolation of at least 10 dB up to an off-axis angle of 7 degrees.

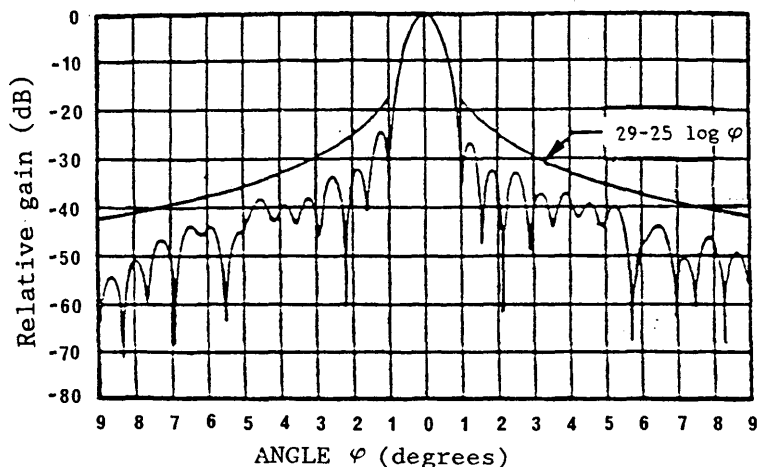

FIGURE 8-a - Radiation pattern of a 1.8 m diameter offset parabolic antenna for 14/12 GHz bands

Measured frequency is 14.25 GHz ($D/\lambda = 85.5$)

Low-side lobe performance of a very small offset parabolic antenna can be achieved in return for low aperture efficiency. For example, it was confirmed by measurement that a 30 cm diameter antenna for 30/20 GHz band ($D/\lambda = 19$ to 29) satisfies the $49-10 \log (D/\lambda) - 25 \log \varphi$ (dBi) template in both receive and transmit bands. The aperture efficiency of the antenna is about 55%.

The performance of modern receive only antennas operating for example in the 12/11 GHz band with D/λ ratios down to 20 can meet the $29-25 \log \varphi$ ($\varphi \geq 3^\circ$) template in the near side-lobe region. Figure 8-b shows an example a measured radiation pattern of a 55 cm diameter offset parabolic antenna.

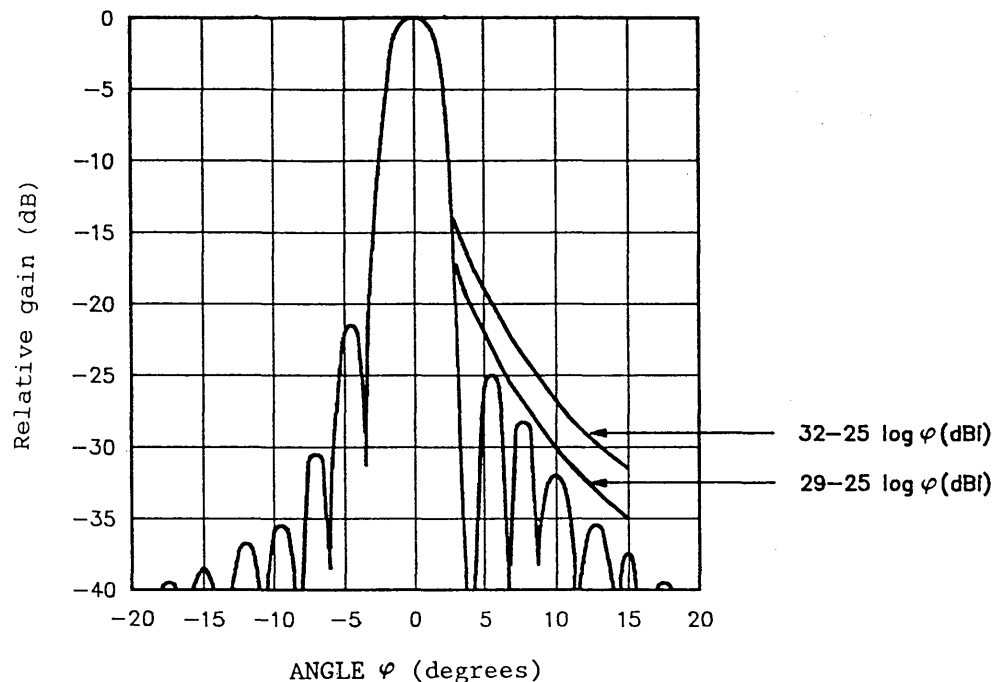

FIGURE 8-b - Measured radiation pattern of a 55 cm diameter receive only antenna

($f = 12.0$ GHz, $G = 34.0$ dBi, efficiency = 53%, $D/\lambda = 22$)

As another example, the measured side-lobe envelopes of offset parabolic antennas with quasi-elliptic shaped edge reflector of $D/\lambda = 53, 32$ (the aperture in the major axis: 4m, 2.4m) using the 3.95 GHz band are shown in Figure 9. [Inoue and Masamura, 1983]. They indicate better performance than $G = 49 - 10 \log(D/\lambda) - 25 \log \varphi$ for φ between $(100 \lambda/D)^\circ$ to 40° measured in a plane containing the major axis of the reflector.

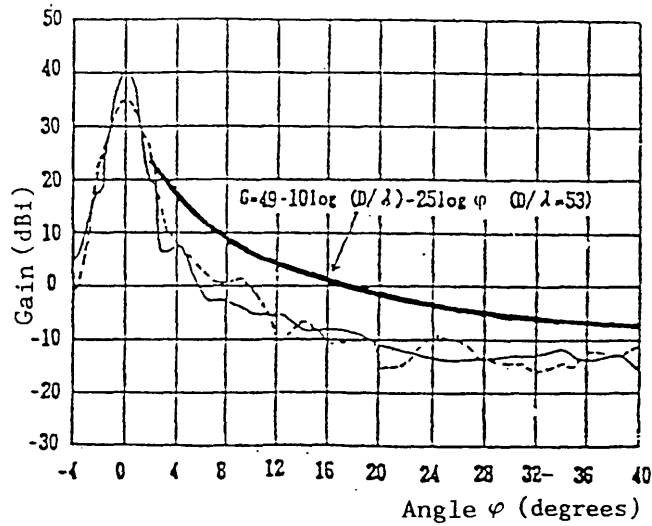

FIGURE 9 - Peak envelope patterns of offset parabolic antennas

(Frequency - 3.95 GHz)

_____ $D/\lambda = 53$

..... $D/\lambda = 32$

_____ $1.89^\circ \leq \phi \leq 40^\circ; D/\lambda = 53 ((100 \lambda/D)^\circ \leq \phi \leq 40^\circ)$

3.3 Offset dual reflector antennas

A dual offset reflector has been reported [Burdine and Wilkinson, 1980] for operation in the 6/4 GHz bands. This has a main aperture size of 7.6 m with a Gregorian optical arrangement. The main reflector aperture distribution has a -20 dB edge taper with absorber placed around the sub-reflector. Figure 10 shows the near side lobes. The side-lobe envelope of this antenna is approximately $32 - 50 \log \phi$ out to 5° and $32 - 40 \log \phi$ out to 16° in both receive and transmit bands. At angles greater than 40° from boresight, the peak radiation side-lobe level is about -25 dBi.

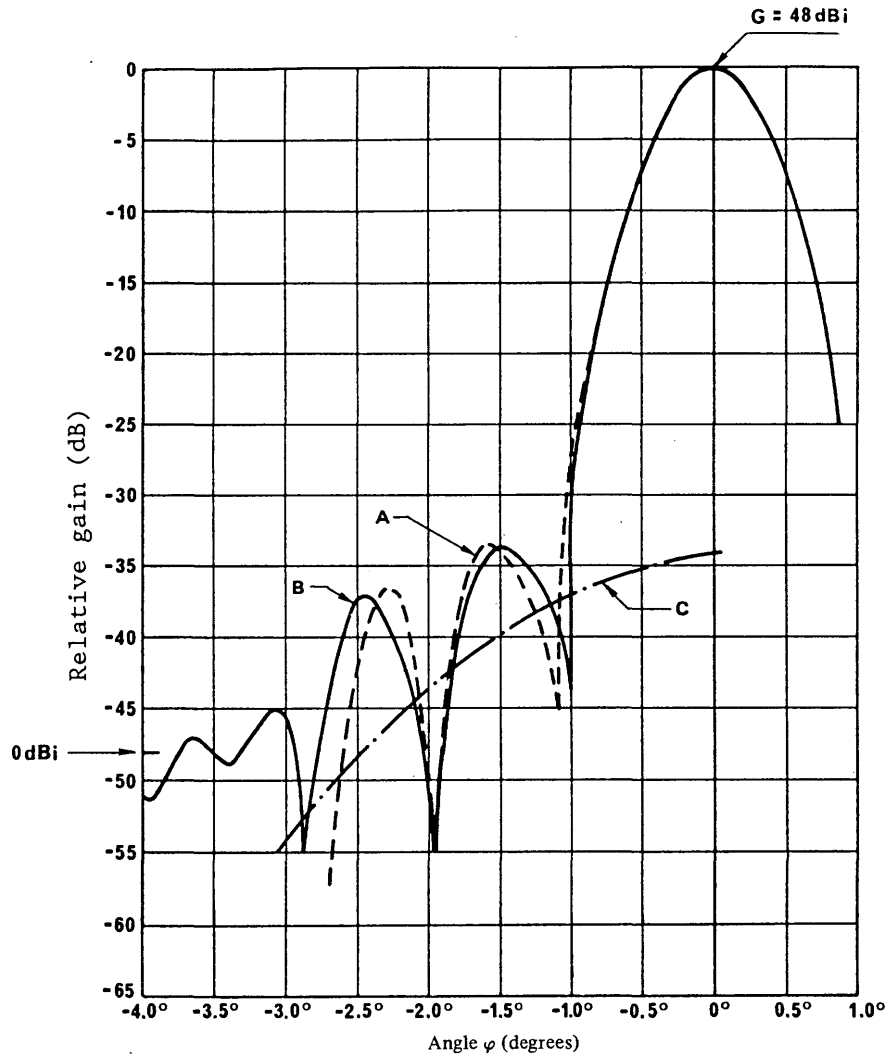

FIGURE 10— Near side-lobe patterns for Gregorian dual offset antenna (receive band)

- Curves A : predicted from aperture distribution
- B : measure
- C : mean gain for side lobes generated by surface errors 3.5 mm r.m.s. in correlation interval

To reduce edge diffraction and scatter which cause some of the antenna side-lobes, a microwave absorber can be attached to the outer edges of the reflectors and to the support structure. This technique can produce an appreciable improvement in side-lobe levels for off-axis angles in excess of about 50°, and the increase in noise temperature due to the absorber is estimated to be less than 4.4°K at all elevation angles. In [Mizuguchi, *et al.*, 1976] the side-lobe envelope of an offset Gregorian antenna of $D/\lambda = 66$ is expressed as being:

$$44 - 10 \log (D/\lambda) - 33 \log \phi \quad \text{for } 1.5^\circ < \phi < 25^\circ$$

and:

$$- 22 \text{ dBi} \quad \text{for } \phi > 25^\circ$$

These examples prove the advantages of an unblocked system and the following sections describe the theoretical approaches which can be applied to circumvent the previously mentioned disadvantages and improve the radiation patterns of the basic designs.

3.4 Shaped offset dual reflector antenna

It has been shown [Westcott and Brickell, 1978] that not only can the reflector profiles be designed to eliminate the cross-polarized component, but at the same time control over the aperture illumination distribution in the offset plane of the antenna can be exercised.

Mitra *et al.* [1982], Westcott and Brickell [1978] and Bjøntegaard and Pettersen [1983] have published differing approaches. They all formulate the problem in terms of simultaneous non-linear partial differential equations. There are several paths to a solution from this point. One method uses numerical integration and assumes no general solution exists but produces good approximate solutions in important cases. Another method adopts the exact solution approach and solves a non-linear second order differential equation of the Monge-Ampere type. In general, the methods can lead to either offset Cassegrain or Gregorian designs from baseline conic sections.

The synthesis procedure for the design of offset dual reflector antennas described by Bjøntegaard and Pettersen [1983] enables a prescribed aperture illumination distribution to be produced whilst maintaining rotational symmetry of phase fronts, i.e., negligible cross-polarization. The procedure has been applied to the design and manufacture of small earth-station antennas for the 11-12 GHz and 14 GHz bands. Antennas with aperture diameters of 1.8 m and 3.3 m are now available with high efficiency, low side lobes and high cross-polar discrimination. A typical measured azimuth pattern is shown in Fig. 12.

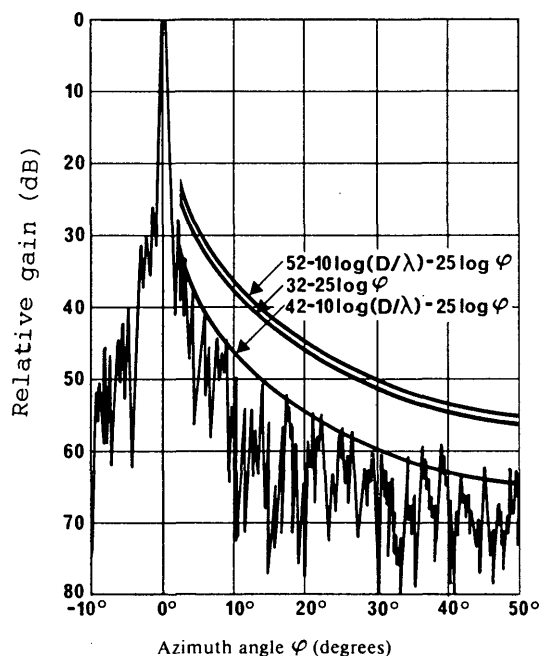

FIGURE 11 - Measured azimuth pattern of a shaped offset Gregorian antenna ($f = 12$ GHz, $D = 1.8$ m, $D/\lambda = 72$)

Lee *et al.* [1979] and Westcott and Brickell [1978] describe computations which follow the above approaches with practical solutions in all cases.

Using such optimization methods, it is possible to produce designs which give very good cross-polar performance while keeping excellent antenna efficiency and side lobes. This is illustrated in Figure 12 which correspond to actual measurements on an industrially produced antenna. [Begout *et al.*, 1987]

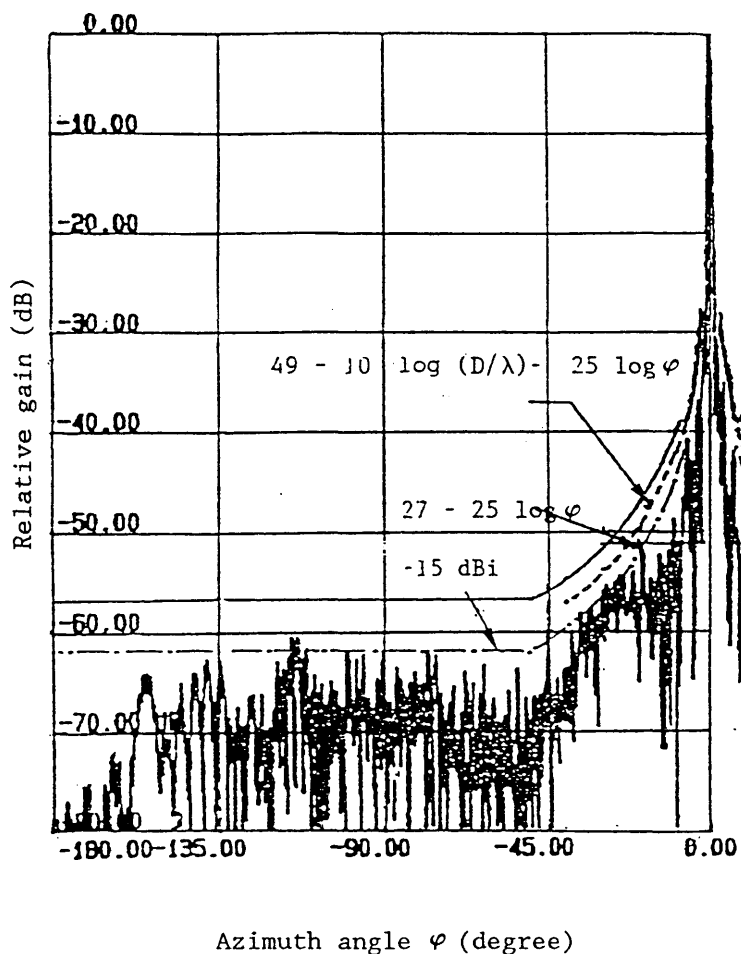

FIGURE 12 - Measured azimuth pattern of a shaped offset Gregorian antenna
($f = 14.5$ GHz, $D = 1.8$ m, $D/\lambda = 85$)

Frequency bands: 14 - 14.5 GHz
10.7 - 12.75 GHz

Efficiency: 72% (Tx)
70% (Rx)

Cross polar discrimination: better than 30 dB

In the above shaping techniques, geometrical optics (GO) approximation is generally used. When the GO shaping method is applied to small antennas, the difference between the desired or designed radiation pattern and that realized due to scattering effect becomes a problem. In particular, in the case of offset antenna, the effect causes the side-lobe characteristics to be asymmetrical and stands in the way of side-lobe suppression. One of the attractive techniques for overcoming this limit is a physical optics shaping method. Surfaces of reflectors are designed by a computer-aided optimization technique, rigorously taking into account the scattering phenomena of electromagnetic waves [Nomoto and Watanabe, 1988]. The measured radiation pattern of a 1.2 m shaped offset Gregorian antenna of 14/11 GHz band designed by this method is shown in Figure 13. Though the aperture diameter is about 50 wavelengths, the antenna produces extremely low side lobes, a high efficiency of more than 72%, and excellent polarization purity over a wide frequency range. The peak envelope of the antenna side lobe is below $25 - 25 \log(\varphi)$ dB, which is superior to that of Recommendation 580 by 7 dB to 10 dB.

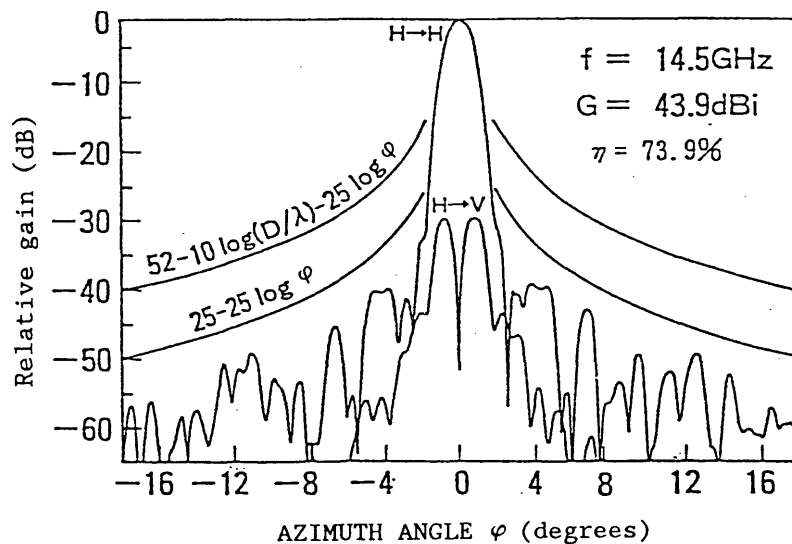

FIGURE 13 - Measured radiation patterns of 1.2 m shaped offset Gregorian antenna ($f = 14.5$ GHz, $D/\lambda = 58$)

3.5 Polarization performance of conic section reflector designs

In an offset reflector antenna the tilted field, however, will have a cross-polarized component in the reflector coordinate system, although it has pure polarization in the coordinate system orientated to its own axis. It has been demonstrated [Rudge and Adatia, 1975; Jacobsen, 1977] that for a single reflector antenna, an improved feed design can reduce or eliminate the undesirable cross-polarization component as well as eliminating the beam squint in a circular polarized offset antenna.

In the case of the dual reflector system we have a further additional degree of freedom in the geometrical configuration. In their simplest form, these have the axes of the main reflector and sub-reflector co-linear. Thus, for a perfectly linear polarized feed in this arrangement it can be established by vector resolution that the field lines in the feed aperture, map into a family of curved lines in the antenna aperture with an implied presence of cross-polarized components (see Fig. 14). This field curvature must therefore be eliminated to produce a purely polarized symmetric aperture field distribution.

Mizuguchi *et al.* [1976] produced a geometrical relationship to allow a dual reflector system to be optimized for low cross-polar performance. The relationship is given by:

$$\cos \psi_0 \text{ (degrees)} = \frac{(1 - B^2) \sin \alpha}{(1 + B^2) \cos \alpha - 2B}$$

where B is the inverse of the eccentricity of the sub-reflector. The other parameters are shown in Fig. 15.

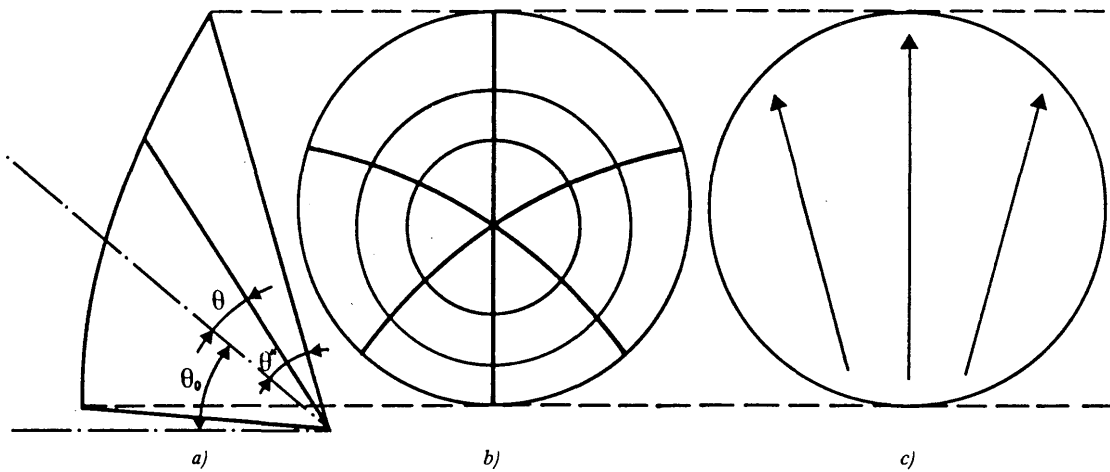

FIGURE 14

- a) Offset parabolic reflector cross section
- b) Projection of concentric circles onto aperture plane
- c) Aperture field lines for linearly polarized primary feed

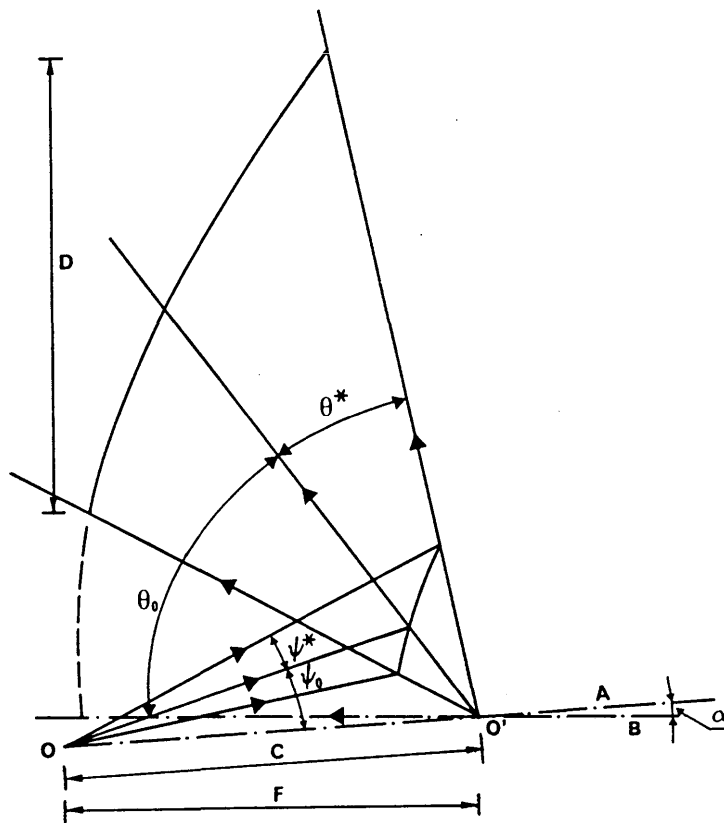

FIGURE 15 - The dual offset antenna geometry and parameters

A : hyperbolic axis

B : parabolic axis

4. Summary and conclusions

If side-lobe levels, especially those close to boresight, are required to be significantly reduced below $32 - 25 \log \phi$ for antennas with a diameter less than 150 wavelengths, then the axisymmetric dual reflector configuration suffers severe limitations due to aperture blockage by the sub-reflector, primary feedhorn and support struts. Only very careful attention to design detail in these areas will permit satisfactory performance to be achieved by such antennas.

Although the geometry of any asymmetric or offset dual reflector system is less straightforward than that of the former system, the removal of all blockage effects brings about major improvements in side-lobe performance. Moreover, it is apparent that design techniques exist that can circumvent the cross-polarization performance limitations hitherto experienced with the offset configuration. Recent design studies and experimental work on asymmetrical antennas have shown that the Recommendation 580 objective should be attainable by antennas smaller than 150 wavelengths, with a substantial margin [Claydon *et al.*, 1983; Bjontegaard and Pettersen, 1983].

In the effort to promote effective use of the geostationary orbit it is necessary to draw the attention of administrations to the limitations of small antennas with respect to their side-lobe envelopes. In order to relieve the problems of frequency sharing and coordination with terrestrial systems, it is very desirable that administrations should encourage the development of antennas with improved side-lobe performance.

Administrations are invited to submit data on the performance of small earth-station antennas.

REFERENCES

- BEGOUT E., BOURGEOIS A. and LAPEYRE P. [1987] - High Performance antennas for TVRO, data RO and USAT applications. APS (Session AP 22) URSI meeting 1987 - Blacksburg (Virginia, USA) - Vol. 2, p. 910-913.
- BJØNTEGAARD, G. and PETTERSEN, T. [1983] An offset dual-reflector antenna shaped from near-field measurements of the feed horn: theoretical calculations and measurements. *IEEE Trans. Ant. Prop.*, Vol. AP-31, 6, 973-977.
- BURDINE, B. H. and WILKINSON, E. J. A. [November, 1980] Low sidelobe earth station antenna for the 4/6 GHz bands. *Microwave J.*, Vol. 11, 53-58.
- CLAYDON, B., STEVENS, F. A., BUTCHER, M. E. and MEHLER, M. J. [April, 1983] A low side-lobe offset Gregorian antenna for small earth stations. IEE Conf. Publ. No. 219, Part 1, IEE Third International Conference on Antennas and Propagation (ICAP '83), University of East Anglia, Norwich, UK.
- EKELMAN, E. P. AND GILMORE, S. W. [January 1986] - Comments on "A note on the shaping of dual reflector antennas". *IEEE Trans.* Vol. AP-34, No. 1.
- GHOSH, S. AND ABUD FILHO, E. [July 1987] - A new technique to account for the various blockage effects in the analysis of a "horn sub-reflector" configuration. 1987 SBMO International Microwave Symposium, Rio de Janeiro.
- GOTO, N. AND WATANABE, F. [1978] - The optimum aperture efficiency of Cassegrain antennas with a specified side-lobe level. *Trans. IECE Japan*, Vol. 61-B, 5, 321-326.
- HARRIS, A. B. [1978] The contribution of the reflector profile errors to antenna side-lobe radiation. *Electron. Lett.*, Vol. 114, 11, 343-345.
- INOUE, T. and MASAMURA, T. [1983] - Satellite communication system using TDM and SSMA. *IEEE Vol. AES-19*, No. 6, 906-914.
- JACOBSEN, J. [1977] On the cross-polarization of asymmetric reflector antennas for satellite applications. *IEEE Trans. Ant. Prop.*, Vol. AP-25, 276-283.
- JAMES, G. L. [1980] Analysis of radiation pattern and G/T for shaped dual-reflector antennas. *Proc. IEE*, Vol. 127, Pt. H, 52-60.
- JAMES, G. L. [1987] Radiation-pattern control of Cassegrain antennas. *Proc. IEEE*, Vol. 134, Pt. H, 217-222.
- LEE, J. J., PARAD, L. I. and CHU, R. S. [March, 1979] A shaped offset fed dual reflector antenna. *IEEE Trans. Ant. Prop.*, Vol. AP-27, 2, 165-171.
- MITTRA, R., HYJAZIE, F. and GALINDO-ISRAEL, V. [1982] Synthesis of offset dual reflector antennas transforming a given feed illumination pattern into a specified aperture distribution. *IEEE Trans. Ant. Prop.*, Vol. AP-30, 2.
- MIZUGUCHI, Y., AKAGAWA, M. and YOKOI, H. [October, 1976] Offset dual reflector antenna. *IEEE Antennas and Propagation Society (AP-S) International Symposium, Mass., USA.*
- Nomoto and Watanabe [1988] Shaped reflector design for small-sized offset dual reflector antennas. *The Transactions of the Institute of Electronics, Information and Communication Engineers*, Vol. J71-B, 11, pp. 1338-1344.
- RUDGE, A. W. and ADATIA, N. A. [27 November, 1875] New class of primary-feed antennas for use with offset parabolic-reflector antennas. *Electron. Lett.*, Vol. 11, 597-599.
- RUSCH and PÖTTER [1970] *Analysis of Reflector Antennas*. Academic Press. 96.
- WESTCOTT, B. S. and BRICKELL, F. [November, 1978] Geometrical optics shaping of dual offset reflectors for zero cross-polarization. IEE Conf. Publ. No. 195. IEE International Conference on Antennas and Propagation, London, UK.

BIBLIOGRAPHY

- WESTCOTT, B. S., STEVENS, F. A. and BRICKELL, F. [February, 1981] GO synthesis of offset dual reflectors. *Proc. IEE*, Vol. 128, Pt H, 1, 11-18.



REPORT 868-1 •

**CONTRIBUTIONS TO THE NOISE TEMPERATURE OF AN
EARTH-STATION RECEIVING ANTENNA****Antenna noise temperature measurements**

(Question 13/4)

(1982-1986)

1. Introduction

The noise temperature of an earth-station antenna is one of the factors contributing to the system noise temperature of a receiving system, and it may include contributions associated with atmospheric constituents such as water vapour, clouds and precipitation, in addition to noise originating from extra-terrestrial sources such as solar and cosmic noise. The ground and other features of the antenna environment, man-made noise and unwanted signals, and thermal noise generated by the receiving system which may be referred back to the antenna terminals, could also make a contribution to the noise temperature of the earth-station antenna. Numerous factors contributing to antenna noise, particularly those governed by meteorological conditions, are not stable and the resulting noise will therefore exhibit some form of statistical distribution with time. A knowledge of these factors and their predicted variation would be a valuable aid to earth-station designers, and there is therefore the need to gather information on the antenna noise characteristics of existing earth stations in a form which can best be interpreted for future use.

This Report presents results of antenna noise measurements made at 11.45 GHz, 11.75 GHz, 17.6 GHz, 18.4 GHz, 18.75 GHz and 31.65 GHz. From the results measured at 17.6 GHz and 11.75 GHz, cumulative distributions of temperatures have been derived together with the dependency of the clear sky noise temperature on the elevation angle.

2. Measuring equipment

The antenna noise temperature measurements have been performed in the Netherlands using a series of radiometers equipped with a 10 m Cassegrain antenna fed by a corrugated horn. These measurements have also been performed in Japan using noise adding type and Dicke type radiometers equipped with 13 m and 10 m Cassegrain antennas, and an 11.5 m offset Cassegrain antenna.

Noise measurements made in the Federal Republic of Germany were carried out on a 18.3 m diameter antenna using the y -factor method, under clear sky conditions.

• This Report should be brought to the attention of Study Group 5.

3. Results of measurements

Figure 1 shows the cumulative time distribution of the measured antenna noise temperature at 11.75 GHz and 17.6 GHz. The noise temperature shown in Fig. 1 is the value measured at the output flange of the feedhorn.

The main contribution to the antenna noise temperature is caused by atmospheric attenuation. Other contributions are caused by cosmic effects and radiation from the ground.

The measurements presented in Fig. 1 have been performed at an angle of elevation of the antenna of 30°. The measurement period was between August 1975 and June 1977. The conditions during the measuring period can be considered as being typical for the local rain conditions.

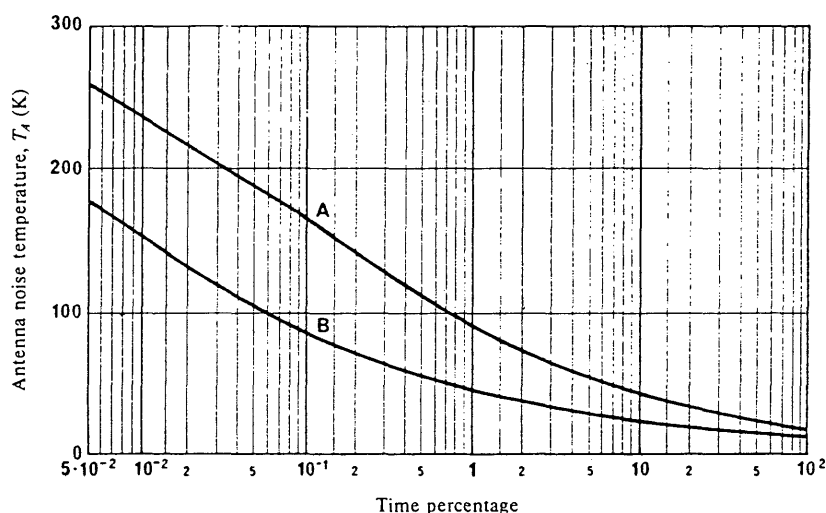

FIGURE 1 - Measured antenna temperature as a function of the percentage of time each level was exceeded

Curves A: 17.6 GHz, 7200 hours

B: 11.75 GHz, 8100 hours

Angle of elevation: 30°

Figure 2 shows the elevation dependence of the antenna noise temperature at clear sky conditions. The value of antenna noise temperature of Fig. 2 corresponds to those of Fig. 1 at the 50% time percentage. An analysis of the measurement results given in Fig. 2 showed that the antenna noise temperature consists of an elevation dependent part and a component which is roughly constant.

This constant part is formed by:

- cosmic background microwave radiation having a value on the order of 2.8 K [Penzias, 1968];
- noise resulting from earth radiation. This contribution changes slightly with the angle of elevation of the antenna due to the side-lobe performance of the radiation diagram. A value on the order of 4 to 6 K is expected from this source;
- a noise contribution due to ohmic losses of the antenna system which is of the order of 0.04 dB. This component is expected to be 3 to 4 K.

The elevation dependent part of the antenna noise temperature is caused by losses due to water and oxygen in the atmosphere and in order to estimate this elevation dependent part the curves of measured points in Fig. 2 may be approximated by the following function (see Report 720), and is accurate to 1% for elevation angles greater than 15°:

$$T_A = T_c + T_m (1 - \beta_o^{\csc \alpha}) \quad \text{K} \quad (1)$$

where:

T_A : antenna noise temperature;

T_c : constant part of the noise temperature;

T_m : mean radiating temperature of the absorbing medium;

β_o : transmission coefficient of the atmosphere in the zenith direction;

α : angle of elevation of the antenna.

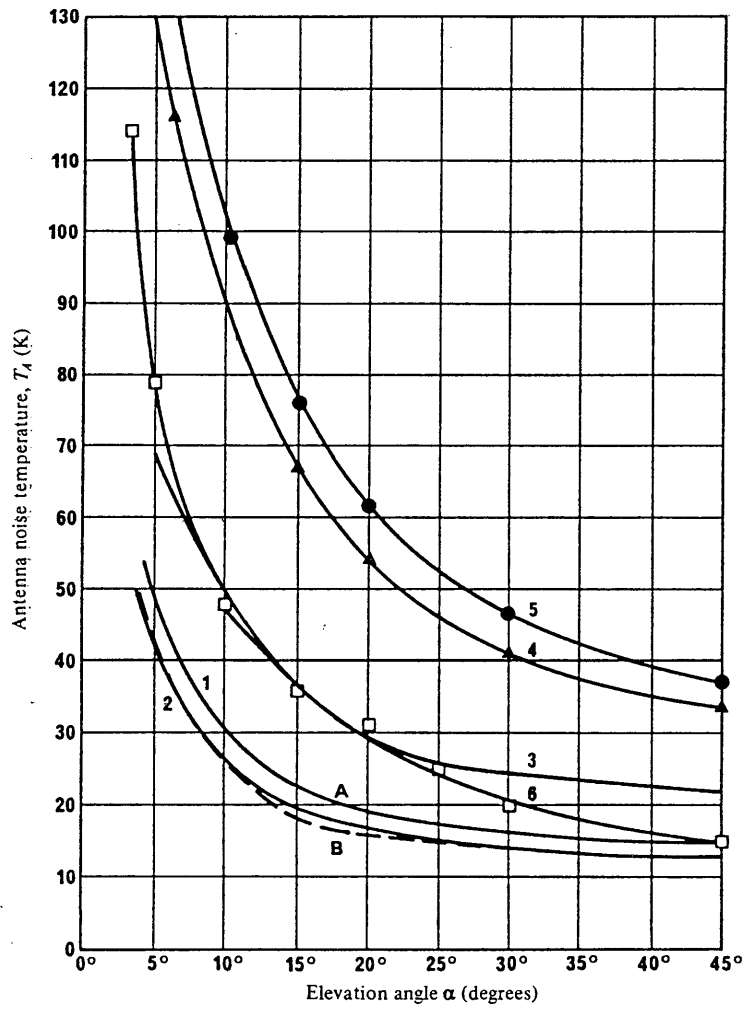

FIGURE 2 - Antenna noise temperature (T_A) as a function of the angle of elevation (α) of the antenna under clear sky conditions

Note 1. - Curves 1 to 6 are identified by reference to Table I.

Note 2. - Measurement conditions were as follows:

Characteristics	Temperature (K)	Relative humidity (%)	Absolute humidity (g/m^3)	Barometric pressure (mbar)
Curves 1 and 3	279	82	6	1016
Curve 2				
A: calculated	294	51	10	1018
B: measured				
Curve 4				
▲: measured	296	50	10	1006
Curve 5				
●: measured	290	49	7	1013
Curve 6				
□: measured	281.5	66	6	1017

In the range of angles of elevation between 5 and 90°, the constants of the function T_A are as given in Table I.

TABLE I

Reference No. (see Fig. 2)	Frequency (GHz)	Antenna diameter (m)	T_c (K)	β_0	Measuring technique	Reference station
1	11.75	10	8.3	0.9858	Radiometer	10 m OTS Netherlands
2	11.45	18.3	7.3	0.988	γ -factor	18.3 m OTS/IS-V Federal Republic of Germany
3	17.6	10	8.3	0.9738	Radiometer	10 m OTS Netherlands
4	18.4	13	9.3	0.940	Radiometer	13 m CS Japan
5	31.65	10	11.5	0.934	Radiometer	10 m ECS Japan
6	18.75	11.5	4.5	0.970	Radiometer	11.5 m CS Japan

Based on the constants given in Table I and for $\alpha = 90^\circ$ in equation (1), the second term in this expression leads to the value of the zenith sky temperature caused by atmospheric attenuation. The zenith brightness temperature can be found by the addition of the zenith sky temperature and the cosmic microwave background radiation temperature. In this particular case, where atmospheric losses are very low, simple addition is allowed.

The zenith sky temperature can also be calculated using the humidity at the earth surface as input parameter (see Report 720). The result of such calculation and the value found by measurements are summarized in Table II.

TABLE II

Frequency (GHz)	Zenith sky temperature		Zenith brightness temperature measurements (K)
	Calculation (K)	Measurements (K)	
11.75	3.2	3.9	6.7
17.6	7.8	7.2	10.0
18.4	14.7	16.7	19.5
31.65	14.3	18.3	21.1

Note. — Administrations are invited to submit further data on noise temperature of earth-station receiving antennas in the form which will enable Question 13/4 to be addressed.

REFERENCES

PENZIAS, A. A. [September, 1968] Measurements of cosmic microwave background radiation. *IEEE Trans. Microwave Theory Tech.*, Vol. MTT-16, 9, 608-611.

REPORT 875-1

**A SURVEY OF INTERFERENCE CANCELLERS
FOR APPLICATION IN THE FIXED-SATELLITE SERVICE**

(Study Programme 32B/4)

(1982-1990)

1. Introduction

One of the principal limitations in achieving greater utilization of the RF spectrum and geostationary orbit for the fixed-satellite service (FSS) is mutual interference among satellite networks serving the same or adjacent geographical areas. Primary attention has been focused on antenna radiation characteristics of earth stations as a means of reducing satellite orbit spacings. Other approaches for increasing communication capacity include frequency reuse techniques such as co-channel cross-polarization transmission, improved modulation techniques, higher power satellite transmitters, and lower noise receivers, among others. The associated technical parameters have been identified in Report 453.

Some of these techniques increase the susceptibility of satellite networks to mutual interference, so their efficacy must be measured by the overall performance of the system to be improved. However, the deleterious effects of some of these techniques may be reduced through the employment of interference cancellers. This technique has experienced a long period of development in related technologies associated with relatively costly equipment implementation, primarily because the applications were associated with interference environments assumed to be deliberate and hostile. However, this is not the case with domestic or international commercial communications systems where the basic RF characteristics of potentially interfering systems are known. Thus, the opportunity exists for the introduction of interference cancelling devices which are cost effective. Some recent developments applicable to satellite communication systems are reviewed in the following paragraphs.

2. General applications

There are two general sources of interference in which cancellers are being applied. One source is caused primarily by environmental factors, such as heavy precipitation, which distort the signal characteristics of a system during up-link and down-link transmissions. Systems using cross-polarized channels in the same frequency band, particularly above 10 GHz, are susceptible to this type of intra-system interference. The distortions are in the form of attenuation and phase shift differences in the orthogonal components of the signal which degrade the original polarization isolation levels. Devices have been developed which correct the depolarization effects and essentially cancel the non-orthogonal elements in the affected channels. These techniques are discussed in Report 555 and [White *et al.*, 1975; Chu, 1971; Persinger *et al.*, 1981; Nouri and Braine, 1980; Pelchat and Baird, 1977].

The other more familiar source of interference is from external systems operating in the same frequency band within the field of view of the desired system. Inter-satellite interference protection is primarily achieved by earth-station antenna discrimination. However, other techniques can contribute to the reduction of interference or the effects of interference.

The basic principle of interference cancellers are to construct a replica of an interfering signal in both amplitude and phase, and subtract it from the wanted signal plus interference entering the receiver system (see Report 390, Annex 1). Analysis and experiments have been performed and evaluated with cancellation techniques at baseband, IF and RF levels (Pontano, 1980; Pontano and Fuenzalida, 1971; American Nucleonics Corporation, 1974; Horton, 1976; Shklarsky et al., 1979; White et al., 1975; Kaitsuka and Inoue, 1984). The preferred techniques are affected by the characteristics of the wanted and interfering signals, the state-of-the-art in technology and the cost of implementation. The importance of cancellers will undoubtedly increase as the orbital arc becomes occupied with everincreasing numbers of communication satellites.

3. Examples of interference cancellers

A few examples of these techniques recently reported in the technical literature are described below. The results obtained by the various investigators were in the absence of any significant thermal noise.

3.1 Baseband interference cancellers

For angle-modulated carriers, a method of interference cancellation at baseband [Pontano, 1980] was achieved by mixing wanted and interfering RF signals into the experimental system depicted in Fig. 1. It should be noted that this approach requires that the interference be received directly as the input for the interfering channel. This can be achieved by having a separate antenna directly facing the interference source. The interference signal is mixed with the wanted carrier at RF or IF. The low frequency components resulting from this process were shown to be the replica of the baseband interference. Cancellation was achieved by subtracting this replica from the demodulated baseband signal plus interference. Laboratory tests showed this method reduced interference by about 15 dB for a wide range of operating parameters.

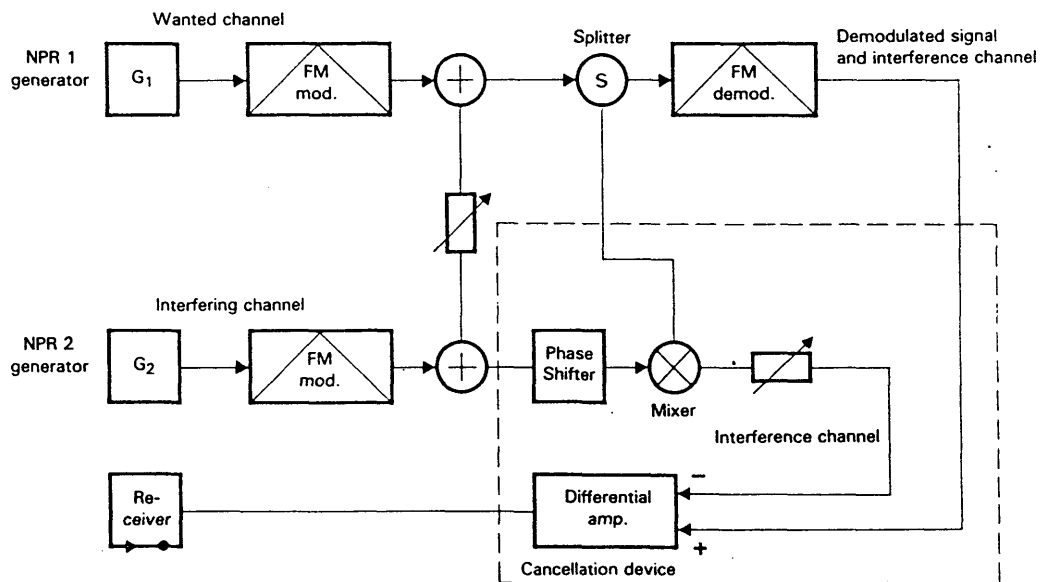

FIGURE 1 — Block diagram of test set-up

In cases where a separate interfering signal is not available for purposes of control or reference, another technique has been proposed for angle modulation signals [Pontano and Fuenzalida, 1971]. In this approach, the information contained in the envelope waveform of the combined wanted and interfering carriers is used to reconstruct the baseband interference. For effective cancellation, the interference source should be separated from the wanted carrier by the sum of the highest modulating frequencies. Analysis and experiments revealed that the detected envelope of the desired carrier plus the interfering carrier is equal to the demodulated interference component shifted by plus or minus 90° . Once identified, the interference can be removed by subtraction. As much as 15 dB of interference reduction was achieved for a range of tested parameters (frequency separation, carrier-to-interference ratios, and modulation indices). The best results occurred at the lower modulation indices and larger carrier frequency separations.

For frequency modulation (FM) signals where the interfering signal is small and cannot be received separately, it is possible to detect the interference at baseband with a crystal detector. A pure FM signal has a constant envelope and the addition of interference results in amplitude modulation which can be detected, and thus removed by subtraction. However, in laboratory tests, this technique was successful in cancelling only those interference components which had not experienced spectral foldover. Since only the first order component can be assured of cancellation, the interference must be small compared to the wanted FM signal.

The higher order terms become troublesome if the interference power is significant. They limit the degree of interference cancellation which can be realized in a baseband cancellation technique since the phasing required to cancel the first order term is not the same as that required to cancel the higher order terms. A preferable approach in these circumstances is to cancel interference at RF or IF prior to demodulation, where all orders of the baseband interference spectrum are suppressed.

3.2 Cancellation at IF

Another technique investigated for FM systems was to subtract the IF or RF spectra of an interfering signal prior to the receiver demodulator as shown in the test set-up of Fig. 2. It was assumed in this case that the interfering signal was available separately. It should be emphasized that the auxiliary channel (interference only) required "virtually identical" down conversion and filtering as the main channel (wanted signal plus interference). Also, the electric lengths for the interference signal in the two channels had to be nearly identical in order that the modulation on the two signals at the cancellation point was coherent. Phasing of the cancellation signal was refined with a variable phase shifter. Test results showed that the IF interference spectrum was reduced by approximately 25 to 30 dB across the IF filter bandwidth. The advantages of this technique were:

- simplicity;
- first order and higher order terms are cancelled simultaneously;
- cancellation was possible with any value of C/I ; and
- lower impulse noise was experienced compared to baseband cancellation methods.

3.3 Interference suppression bridge

Another passive technique, demonstrated in laboratory tests, uses a bridge network to suppress the interfering signal at the receiver with an auxiliary signal derived from an interference channel. A simplified block diagram of this set-up is shown in Fig. 3. Ideally, the bridge circuit output phase angle must remain at 180° and the power amplitude must remain equal to the interference across the desired frequency band and continuously with time. The objective of the test was to determine the performance of the system for various phase angle and power amplitude errors generated by the bridge.

Tests were conducted using a signal tone at approximately 3807 MHz and interfering signals at 3809 ± 4.5 MHz and 3950 MHz. Suppression of the interfering signals from 15 dB to 50 dB was achieved with this technique, the latter associated with relatively narrow band interference signals under clear weather conditions.

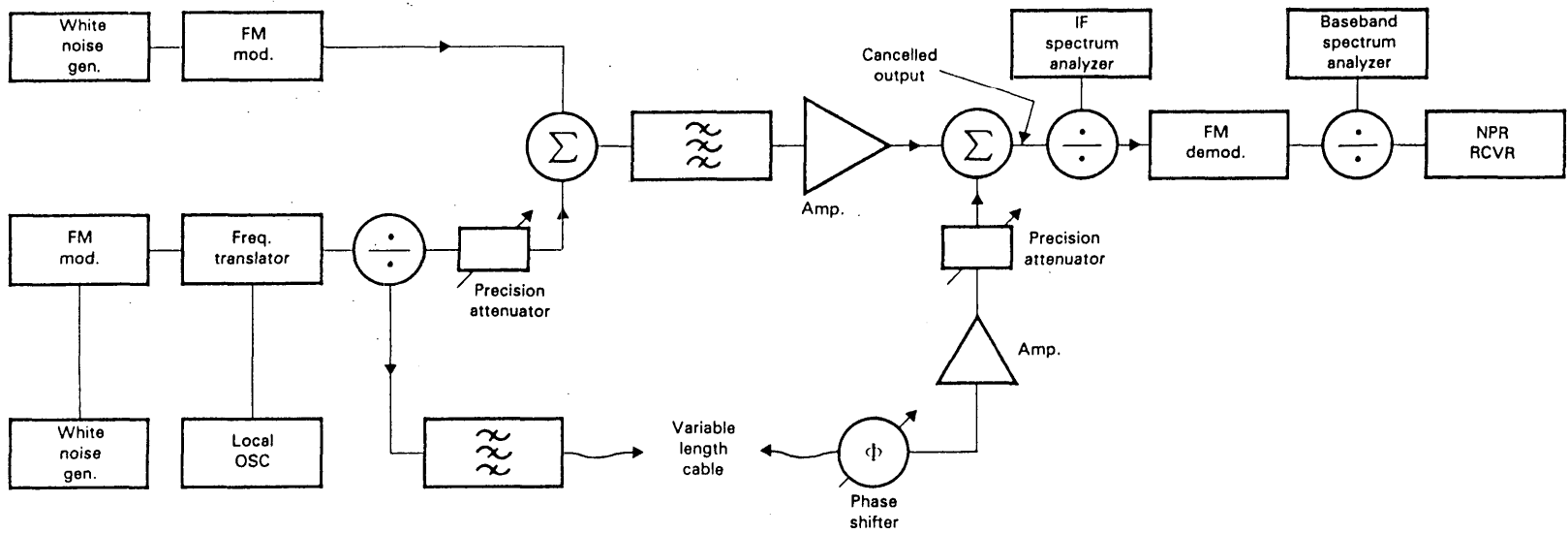

FIGURE 2 — IF cancellation test set

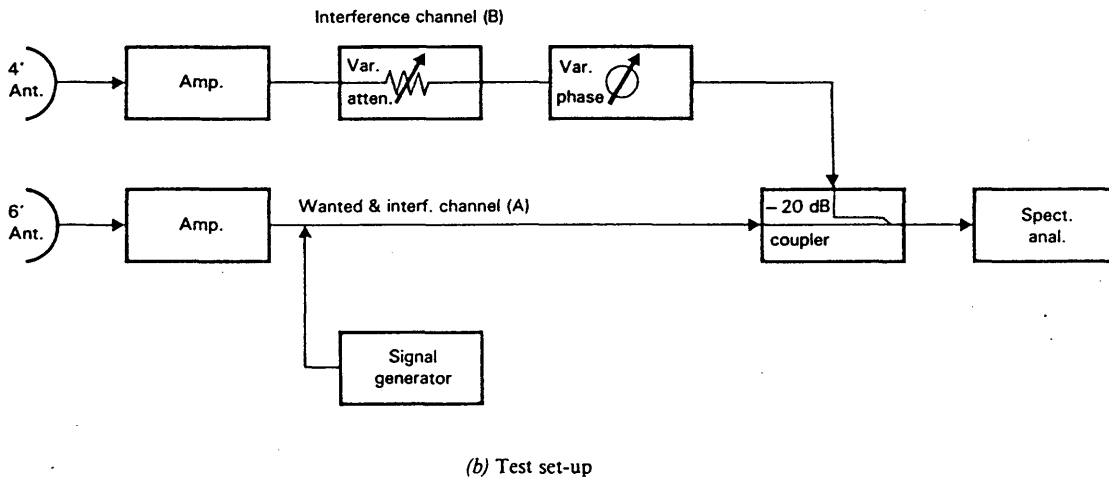
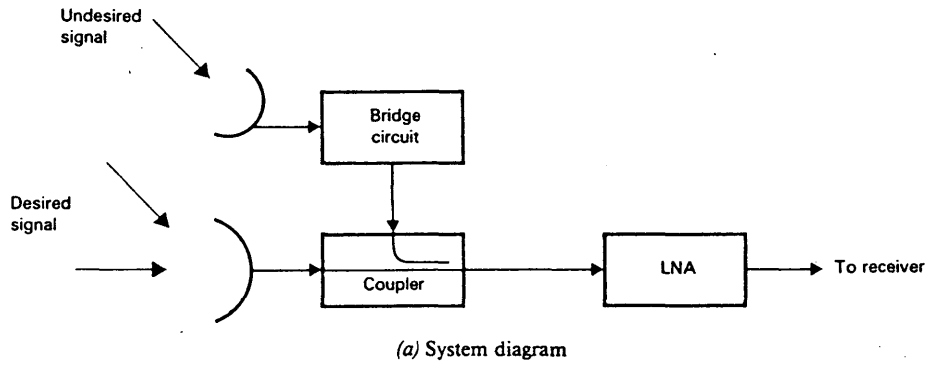

FIGURE 3 — Bridge interference suppression system

3.4 Adaptive cancellation systems

Active or servo-controlled cancellation systems capable of interference reductions on the order of 50 to 60 dB have been developed and operated for many years from VLF (3 to 30 kHz) to SHF (3 to 30 GHz) frequencies [American Nucleonics Corporation, 1974]. Applications have included collocated interference, where a nearby transmitter with known characteristics is the interference source, and remote interference where the source can be either casual or deliberate. For the remote case, an auxiliary antenna directed toward the interfering source is used to obtain a reference sample of the interference. In some applications, it is possible to obtain this signal from a side lobe of the main antenna. Different properties of the desired and interfering signals (such as direction of arrival, amplitude, polarization, modulation, etc.) can be used for purposes of discrimination. A functional block diagram of an adaptive cancellation system is depicted in Fig. 4. The interference transmitter duplicates the interfering signal in amplitude but with reverse polarity. A closed-loop servo arrangement provides continuous automatic adjustments of amplitude, time delay and phase to compensate for variations of these properties due to propagation effects. A coupler samples the output signal to the receiver, and if cancellation is imperfect, an error signal is sent to the servos. The high gain servo loops adjust the signal controller parameters so as to drive the residual interference level toward zero. The synchronous detectors restrict the control loop response to signals which are coherent with the reference or interfering signal. The amount of cancellation attainable depends on the instantaneous bandwidth of the interfering signal. For narrow-band signals, 60 dB of cancellation is obtainable. For 5 or 6 MHz bandwidths, remote interference has been suppressed by 50 to 60 dB. For noise-like signals with instantaneous bandwidths of 500 MHz, approximately 20 dB of cancellation has been claimed.

An adaptive co-channel interference suppression system (CISS) developed specifically for satellite communication applications, is depicted in Fig. 5 [Horton, 1976]. An estimated replica of the interfering signal is subtracted from the desired plus interfering signal in the power combiner following the low noise amplifier (LNA) of the receiver system. The signal output (error signal) has the desired signal plus the residue from the subtract operation. An adaptive filter in the interference channel adjusts the amplitude and phase of the interfering signal to provide this replica. The adaptation is accomplished using a least mean square algorithm. The quadrature correlator processes the error signal and the interference signal (auxiliary antenna) to provide the necessary correlation of amplitude and phase between these two signals. The outputs of the correlator act as control voltages to drive the attenuators in the adaptive filter.

Steady state is achieved when the correlation has reached a minimum. Laboratory tests revealed that as much as 20 to 30 dB interference suppression was achieved, depending on C/I levels.

An early application of adaptive cancelling techniques was that undertaken by the United Kingdom when they experienced severe interference at the Goonhilly earth station caused by a radio-relay station located some 300 km away. An adaptive tuneable canceller operating at IF was developed and brought into operation early in 1975 and was instrumental in reducing the effects of the interference to an acceptable level [White *et al.*, 1975].

An Orthogonal sensing interference cancellation system, which can be applied to any type of modulation even if desired and interference signals are co-channel, is depicted in Fig. 6 [Kaitsuka and Inoue, 1984]. In the vector modulator, which adjusts the amplitude and the phase of the interference signal from the auxiliary antenna, the input signal is divided into orthogonal components. The amplitude of each component is controlled independently and subsequently combined.

Each control signal is a combination of the output of an integrator and a low frequency sinusoidal signal, which are orthogonal to each other. The output of the vector modulator changes sinusoidally, in terms of amplitude and phase for sensing, and makes the envelope of the residue signal fluctuate. As this envelope fluctuation includes error information for control, the error voltages are taken out by envelope and phase detection using the two orthogonal low frequency signals.

As this system has only one frequency converter, its phase and gain changes have negligible effect on cancellation performance. But systems depicted in Fig. 4 and Fig. 5 need two converters. It is necessary for them to have RF/IF amplifiers of the same characteristics.

Experimental results show that more than 40 dB cancellation was achieved over a 50 MHz bandwidth for CW, FM(TP,TV) and PSK signals. In the field test on a 45 km path, sufficient cancellation performance and response were obtained even during fading periods. Another field test using a small earth station with a 4.5 m diameter antenna, located close to an interference transmitter, was performed. In this test, both the satellite communication signal and the interference from terrestrial link were FM-TV signals. Clear video pictures and sound were obtained after cancellation.

For the cancellation of interference from a satellite in a neighbouring satellite system, when the direction to the interference source is known with an accuracy determined by the satellite's station-keeping system, in some cases it is more cost-efficient to install an additional feed in the primary antenna of the receiving earth station than to use an auxiliary antenna. The offset of this feed from the main one will depend on the angular separation between the wanted and interfering satellites.

The efficiency of the canceller may be significantly increased by using a priori parameters referring to the wanted and interfering signals (e.g. specially inserted pilot signals in the free parts of the spectrum or in free time slots, energy dispersal signal, etc.).

In the USSR such a dual-feed antenna system with a 4 m dish was used in the "Moskva Globalnaya" satellite system for interference cancellation from the "Moskva" satellite system. The additional feed (a pyramidal horn) was connected to the main one via a directional coupler and an electrically controllable microwave phase shifter and attenuator. The angular separation between the wanted and interfering satellites was 3°. This adaptive cancellation system used the distinction between the wanted and unwanted dispersal signals and secured additional interference suppression up to 20 dB.

3.5 Adaptive filtering of narrow-band interference

A technique for suppressing narrow-band interference where the frequency of the interferer is unknown (and may even vary in a slow manner) was applied to a wideband digital communication system [Shklarsky *et al.*, 1979]. Implementation of this technique is depicted in the block diagram of Fig. 7. The system tracks the centre frequency of an interferer and centres a notch filter around that frequency. It functions by making use of the real-time Fourier transformation properties of surface acoustic wave filters. The conditions required are:

- the interferer bandwidth is less than the bandwidth of the desired signal, and
- in the Fourier domain, the interferer amplitude is greater than that of the desired signal.

An automatic gain control (AGC) feature allows the system to handle a large dynamic range of input signal. Substantial reductions in interference were obtained during system tests:

4. Conclusions

The examples of interference cancellers described in this Report are only a sample of the current literature on this subject. However, interference cancellers, as a means of reducing satellite inter-system interference, are still in an early stage of development. Up to the present, the method pursued by the ITU and recommended by the CCIR has been to impose limits on antenna side-lobe patterns and radiated power flux-densities in order to avoid excessive interference between systems. Interference cancellers have been used in relatively isolated situations where an existing or newly constructed earth station experienced unexpected interference from a nearby source. The need for additional antennas and signal processing equipment is a burden that a communication network planner would prefer to avoid. More development is required to reduce equipment complexity and costs before interference cancellers are likely to have wide application in FSS systems. The results of the experiments carried out in the USSR show that it is possible to use an additional feed in the primary antenna for the cancellation of interference from a neighbouring satellite when the direction to the interfering source is known. This method seems to be in some cases more cost-efficient compared to the use of an auxiliary antenna.

On the other hand, a great deal of interest has been evidenced [Chu, 1971; Persinger *et al.*, 1981; Nouri and Braine, 1980; Pelchat and Baird, 1977; Makino *et al.*, 1980] in the development of interference cancellers for intrasystem applications associated with cross-polarization techniques. Since the interfering signal can be characterized and defined internally, the developments in this field are likely to result in practical, commercial equipment in the near future. The products of this type of interference canceller will likely benefit the development of inter-system applications.

The CCIR should continue to study this subject and report on its progress.

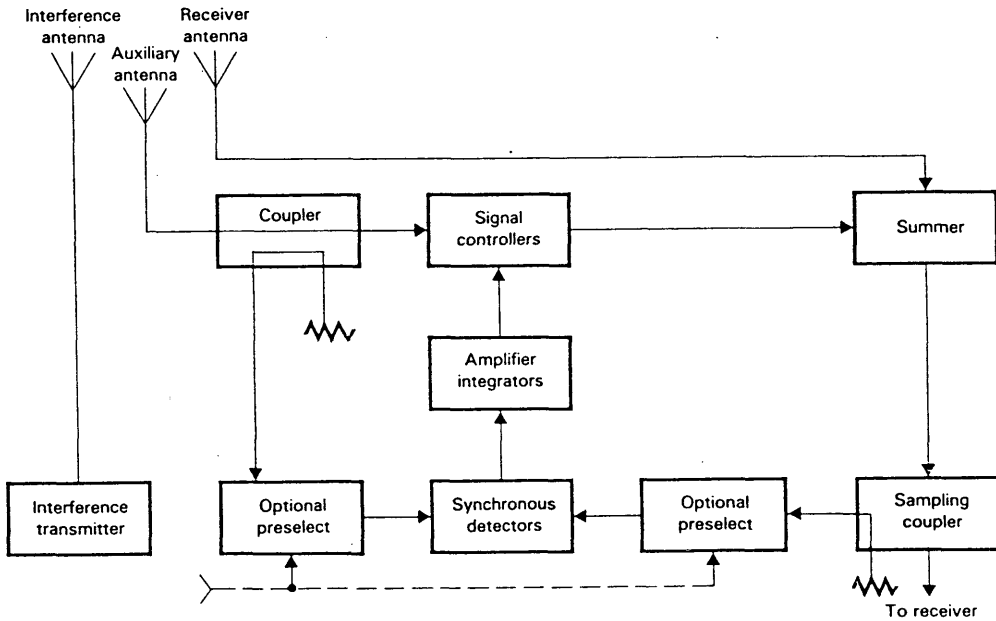

FIGURE 4.— Adaptive interference cancellation system

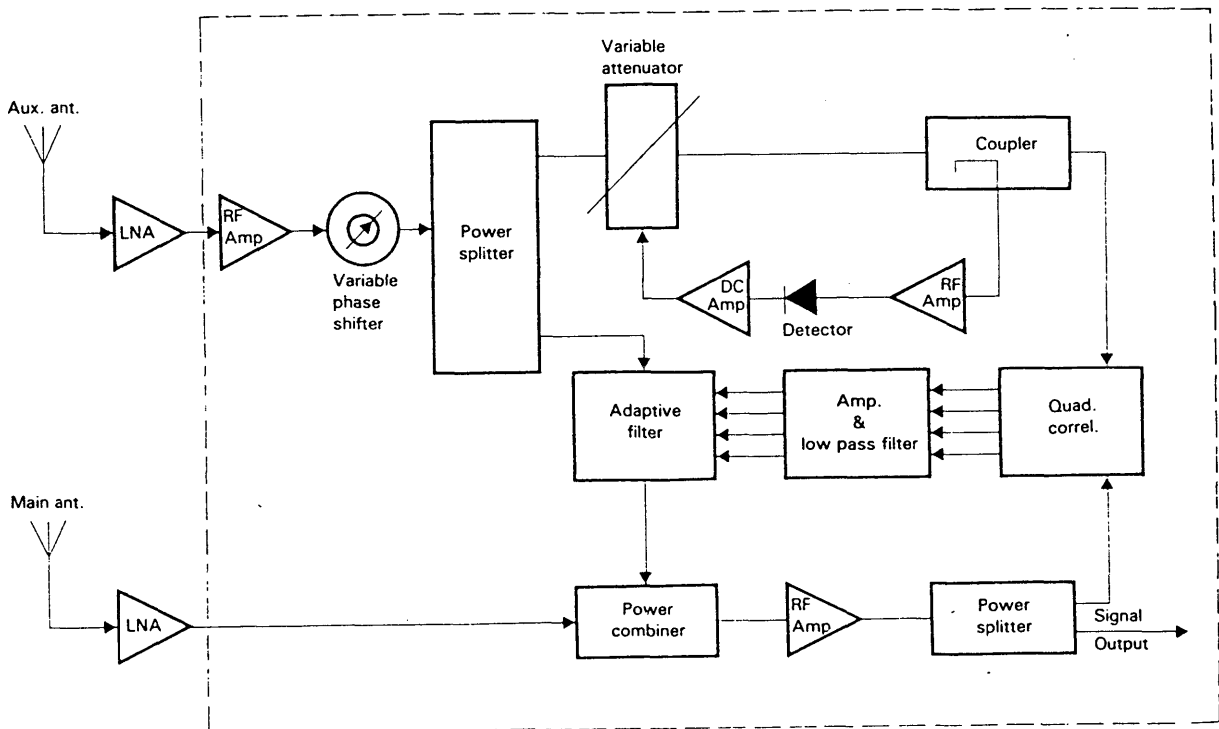

FIGURE 5 — Block diagram of the co-channel interference suppression system

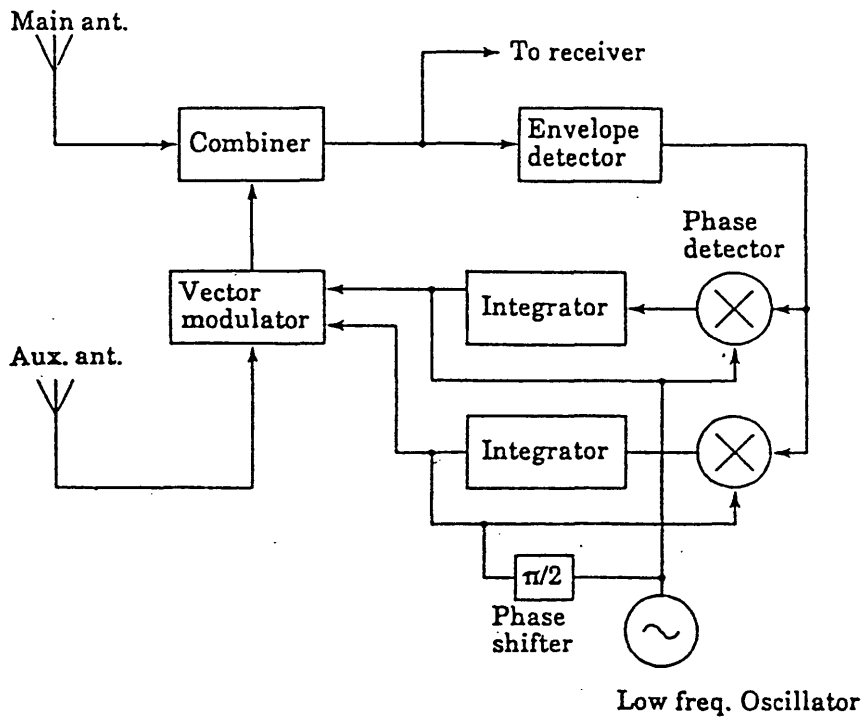

FIGURE.6 -Orthogonal sensing interference cancellation system

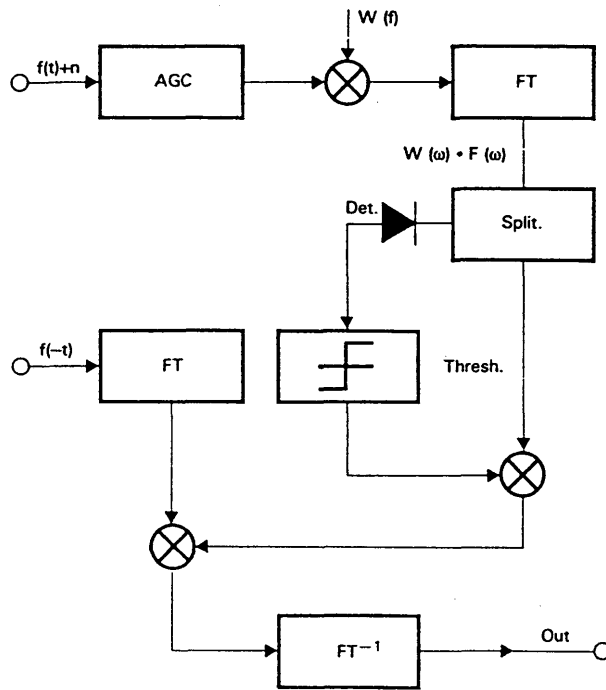

FIGURE 7— Block diagram of adaptive system

AGC: Automatic gain control
 FT: Fourier transform

REFERENCES

- AMERICAN NUCLEONICS CORPORATION [1974] New system cuts interference and permits closer channelling. *Microwave System News*.
- CHU, T. S. [November, 1971] Restoring the orthogonality of two polarizations in radio communication systems - I. *BSTJ*, Vol. 50, 9, 3063-3069.
- HORTON, E. D. [29 November-1 December, 1976] An adaptive co-channel interference suppression system to suppress high level interference in satellite communication earth terminals. IEEE National Telecommunications Conference (NTC '76), Dallas, Texas, USA, Conf. Record, Vol. 1, Session 13, Digital satellite communications, 13.4-1.
- Kaitsuka, T. and Inoue, T. (July, 1984) Interference cancellation system for satellite communication earth station. IEEE Trans. on Communication, vol. COM-32, No. 7, 796-803.**
- MAKINO, H., ORINO, Y., ORUI, S., FUKETA, H. and INOUE, T. [April, 1980] A new adaptive control system for compensating cross-polarization couplings on the up and/or down path in frequency reuse satellite communication systems. AIAA 8th Communications Satellite Systems Conference, Orlando, Florida, USA.
- NOURI, M. and BRAINE, M. R. [1980] An adaptive interference control system for earth-satellite links above 10 GHz. *Marconi Rev.*, Vol. XLIII, 216, First Quarter, 14-28.
- PELCHAT, M. G. and BAIRD, C. A. [26-28 September, 1977] Simplified techniques for adaptive polarization crosstalk reduction. IEEE Electronics and Aerospace Systems Convention (EASCON-77), Arlington, Va., USA, Conf. Record, 31-3.
- PERSINGER, R. R., GRUNER, R. W., EFFLAND, J. E. and DiFONZO, D. F. [13-16 April, 1981] Operational measurements of a 4/6-GHz adaptive polarization compensation network employing up/down-link correlation algorithms. IEE Second International Conference on Antennas and Propagation, Hestlington, York, UK, Conf. Publication No. 195, Part 2: Propagation, 181-187.
- PONTANO, B. A. [2 December, 1980] Methods of interference cancellation for improved orbit and spectrum utilization. IEEE National Telecommunications Conference (NTC '80), 30 November - 4 December, Houston, Texas, USA, Conf. Record, Vol. 2, Session 33: Recent activities and techniques in efficient orbit utilization, 33.4.1-33.4.5.
- PONTANO, B. A. and FUENZALIDA, J. C. [1971] A study of interference between multichannel angle-modulated signals. COMSAT Tech. Memo CL 22-71.
- SHKLARSKY, D., DAS, P. and MILSTEIN, L. B. [29 November, 1979] Adaptive narrowband interference suppression. IEEE National Telecommunications Conference (NTC '79), 27-29 November, Washington, DC, USA, Conf. Record, Session 15: New techniques in spread spectrum communications, 15.2.1-15.2.4.
- WHITE, N., BRANDWOOD, D. and RAYMOND, G. [April, 1975] The application of interference cancellation to an earth station. Satellite communication system technology. IEE Publication No. 126, 233-238.
-

REPORT 212-3

**USE OF PRE-EMPHASIS IN FREQUENCY-MODULATION SYSTEMS
FOR FREQUENCY DIVISION MULTIPLEX TELEPHONY
AND TELEVISION IN THE FIXED-SATELLITE SERVICE**

(Study Programme 27A/4)

(1963-1966-1970-1974)

1. Introduction

The use of pre-emphasis in systems in the fixed-satellite service for frequency-division multiplex telephony using frequency modulation results in a useful improvement in the signal-to-noise ratio in the higher frequency channels of the system and thus enables the space-station transmitter power and bandwidth requirements to be reduced.

The use of pre-emphasis for television modifies the energy distribution in the radio-frequency emission of systems in the fixed-satellite service, in such a way as to reduce, substantially in some circumstances, the possibility of interference within and between systems in the fixed-satellite service and between systems in the fixed-satellite service and radio-relay systems using the same frequency bands.

The use of pre-emphasis for television may also enable the effective frequency deviation of the system in the fixed-satellite service to be increased, thereby improving the signal-to-noise ratio; however, too large an increase in deviation could offset the reduction of interference potential.

The deviation and pre-emphasis used to obtain the best possible transmission of some television signal standards may differ appreciably from those recommended for telephony.

The use by different administrations of the facilities offered by active systems in the fixed-satellite service, including the shared use of space-station repeaters, would be facilitated by the use of agreed pre-emphasis characteristics for such systems employing frequency-modulation.

At the present time it has not been found possible to recommend a preferred pre-emphasis characteristic for systems in the fixed-satellite service used for television. This matter is a subject for further study, but some information which may be of assistance in these studies is given in § 3 of this Report.

2. Telephony

The effect of pre-emphasis will be to improve the signal-to-noise ratio in the high frequency channels and to reduce it in the low frequency channels. This may in turn affect the carrier-to-noise ratio at which the noise in the worst channel reaches 50 000 pWp at a point of zero relative level. Each of these effects will have repercussions on the satellite power and bandwidth required to meet the noise objectives of Recommendation 353. Furthermore the optimum characteristic for a system operated at or below threshold for a considerable proportion of the time may not be the same as that for systems which normally operate above threshold.

The threshold margin of present satellite systems is generally sufficient to prevent them from operating below threshold for all but very small proportions of the time and the same is expected to be true for future systems. For general use, therefore, a pre-emphasis characteristic with a relatively wide range of attenuation will be optimum.

Measurements of signal-to-noise ratios in an operational system have confirmed that the network described in Recommendation 464 which has an 8 dB range of attenuation, gives satisfactory results in practice.

However, for systems operating nearer to threshold, a narrower range of attenuation may be found to be optimum.

3. Television

In the transmission of colour television signals, special attention must be paid to:

- noise in the video bandwidth;
- distortion, especially that which may affect the chrominance channel video frequencies (around 4.4 MHz for 625-line systems);
- subjective threshold of the receiver.

The insertion of a pre-emphasis network has the goal of:

- improving the signal-to-weighted noise ratio;
- reducing distortion.

These goals must be attained with minimum impairment of the receiver subjective threshold.

For a given system bandwidth, the signal-to-weighted noise ratio can be improved by modifying the shape of the video noise spectrum, i.e., by modifying the deviation that the various components of the video signal produce on the radio-frequency carrier.

The criteria which influence the design of an optimum emphasis characteristic may differ in different colour television systems. In the following sections the results of studies made by some administrations on the PAL and SECAM systems are given.

The optimization of the pre-emphasis characteristic for colour television is closely dependent upon the form of the weighting curve adopted for noise measurement. Although this is specified for 625-line system I in Recommendation 567, it has not been universally adopted and thus it will be difficult to agree on a single new pre-emphasis characteristic. The work reported here indicates a possible approach to the problem.

3.1 625-line PAL systems B, G and H

Theoretical calculations have shown [CCIR, 1966-69a] that, for a given signal-to-unweighted noise ratio, the maximum signal-to-weighted noise ratio is obtained when the de-emphasis characteristic produces a spectrum of noise which is uniform with frequency across the video band (0-5 MHz). Applying this principle to a particular noise weighting curve [CCIR, 1966-69b] a new pre-emphasis curve shown in Fig. 1 has been derived which can be shown to improve the signal-to-noise ratio by about 2 dB (assuming a triangular noise distribution). This compares with an improvement of about 1 dB using the pre-emphasis curve of Recommendation 405 (with the same noise weighting curve).

Experiments made to investigate the influence of a limitation in the radio-frequency band using the new pre-emphasis curve have shown that the differential distortions in the presence of emphasis were reduced by a factor of between 5 and 15 depending on the form of the modulating signal, compared with distortions measured without emphasis. On the other hand, the luminance-to-chrominance ratio was slightly increased. The overall picture quality measured subjectively was essentially unchanged. Other experiments made with a receiver operating close to threshold, showed that in general the use of pre-emphasis raised the level of threshold assessed subjectively, for example, by 1.5 to 2 dB for the emphasis of Fig. 1 of this Report, or Fig. 1 curve B of Recommendation 405 or certain other pre-emphasis curves.

Other studies [Lari and Tomati, 1972] also show that by a suitable selection of a pre-emphasis curve, it is possible to achieve some saving, either in satellite transmitter power or in the bandwidth required, for the same values of signal-to-weighted noise ratio and margin above subjective threshold.

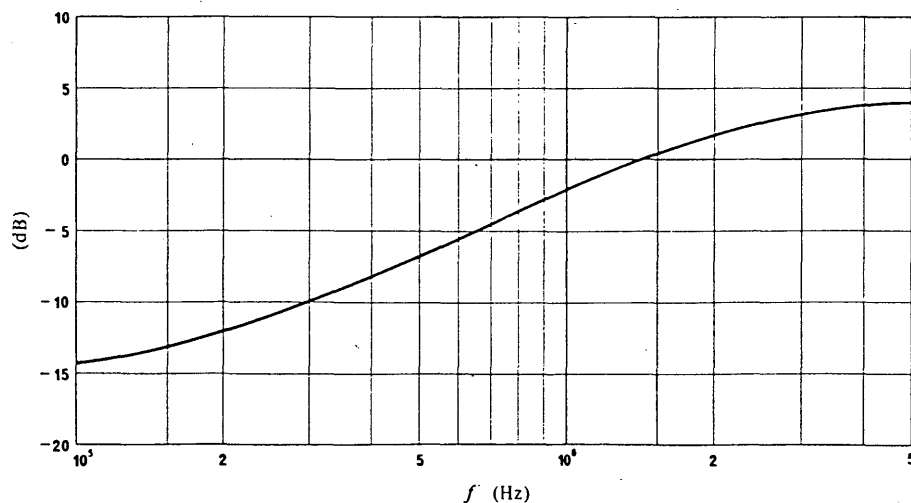

FIGURE 1 — Experimental pre-emphasis characteristics for the PAL system

3.2 625-line SECAM system

In the SECAM colour television system, in which the colour information is transmitted by frequency modulation of a sub-carrier at 4.43 MHz, the demodulation of the sub-carrier is subject to the well-known behaviour of frequency demodulators at threshold. Thus, when the noise in the chrominance channel becomes significant, the picture deteriorates rapidly. It becomes necessary to determine the limits of noise in both the luminance and chrominance channels.

These limits have been derived from subjective tests of pictures degraded by thermal noise [CCIR, 1970-74a]. For the degradation of the chrominance signal N_2 , to be equal to the degradation of the luminance signal N_1 , the following relationship should be satisfied:

$$8.5 \text{ dB} < 10 \log \frac{N_2}{N_1} < 9.5 \text{ dB} \quad (1)$$

where N_1 is the power of the weighted noise in the luminance signal measured at the output of the network as described in Recommendation 567 and N_2 is the power of the filtered noise in chrominance signal measured at the output of the band-pass filter as described in Recommendation 567.

The pre-emphasis network designed for black and white 625-line television systems, described in Recommendation 405, is now used for colour television. When so used, it produces the non-optimum value of 12 dB as shown in equation (2):

$$10 \log \frac{N_2}{N_1} \approx 12 \text{ dB} \quad (2)$$

Therefore, a new pre-emphasis network for SECAM colour television seems desirable. The network and its transfer function are similar to the one described in Recommendation 405:

$$\frac{1}{y} \cdot \frac{1 + j\omega\tau_p}{1 + j\omega \frac{\tau_p}{y}} \quad (3)$$

where $20 \log y$ is the maximum attenuation of the network in dB, and τ_p is the time-constant of the network in ns.

Values proposed for this transfer function are:

$$y = 8 \quad (\text{instead of } y = 5 \text{ as in Recommendation 405):$$

$$\tau_p = 227 \text{ ns} \quad (\text{instead of } \tau_p = 508 \text{ ns as in Recommendation 405}).$$

These values are in conformity with the limits given in relation (1).

Figure 2 shows this characteristic in relation to the one given by Recommendation 405 for 625-line television systems at equal overall image impairment. It is clear that the new curve is below the former one in the greater part of the video band; therefore, the radio-frequency spectrum congestion will be less with a network of this type than with the network presently recommended, and the non-linear video distortions due to the bandwidth limitation will be reduced.

Further studies are necessary to ensure that satellite links using the new characteristic will conform in all respects with the specification of Recommendation 567 concerning the hypothetical reference circuit.

3.3 625-line PAL system 1

A study has been carried out [CCIR, 1970-74b] to check the validity of the pre-emphasis characteristics shown in Figs. 1 and 2 for the case of 625-line PAL system 1. The subjective effect of signal/noise degradation has been evaluated using the method of "impairment units" (imps) [Lewis and Allnatt, 1968] and using the noise weighting networks specified in Recommendation 567.

The noise was assumed to have a substantially triangular characteristic as will normally be the case when the system is operating near the threshold. The results of this evaluation indicated that, for PAL system 1, the network of Recommendation 405 gives better results than the other two networks. This may well be due to the fact that the latter have been derived for other television systems using either a different video bandwidth or different chrominance sub-carrier modulation and for different noise weighting networks. Whilst it may eventually be possible to find a new pre-emphasis characteristic which will show some improvement over that of Recommendation 405, there seems to be no justification for a change at present. Further study is required which should include the effect on various distortions in addition to signal/noise ratio.

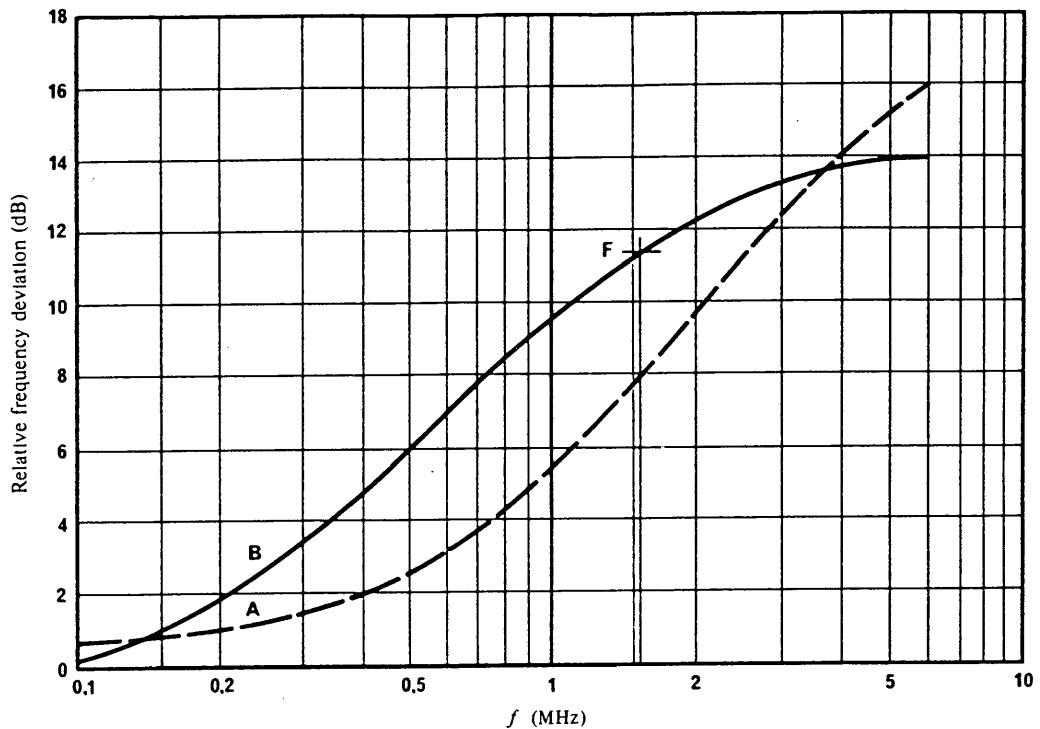

FIGURE 2

A: Calculated pre-emphasis curve proposed for the SECAM system
 B: Pre-emphasis curve recommended in Recommendation 405
 F: Reference frequency

REFERENCES

LARI, M. and TOMATI, L. [1972] Studio di un circuito di enfasi ottimizzato per trasmissioni TV a colori su sistemi a modulazione di frequenza e suo uso (Study of an optimum pre-emphasis circuit for frequency modulation colour television transmission and the use of the circuit). *Elettronica e Telecomunicazioni*, 5.

LEWIS, N. W. and ALLNATT, J. W. [1968] Subjective and objective impairments in television pictures. IEE Conf. Publ. No. 46, Part I.

CCIR Documents

[1966-69]: a. Doc. CMTT/161 (Annex) (Italy); b. Doc. CMTT/160 (Italy).

[1970-74]: a. Doc. 4/68 (France); b. Doc. 4/168 (United Kingdom).

BIBLIOGRAPHY

CCIR Documents

[1966-69]: Doc. IV/258 (France).

[1970-74]: Doc. 4/85 (Italy).

REPORT 384-6*

ENERGY DISPERSAL IN THE FIXED-SATELLITE SERVICE

(Study Programme 27A/4)

(1966-1970-1974-1978-1982-1986-1990)

1. Introduction

It is clear from studies of frequency sharing between the fixed-satellite service and terrestrial radio-relay systems and between different fixed satellite networks that, to ensure that mutual interference between the systems is kept to a tolerable level, it will be essential in most cases to use energy dispersal techniques to reduce the spectral energy density of the transmissions of the fixed-satellite service during periods of light loading. The reduction of the maximum energy density will also facilitate:

- efficient use of the geostationary satellite orbit by minimizing the orbital separation needed between satellites using the same frequency band; and
- multiple-carrier operation of broadband transponders.

The amount of energy dispersal required obviously depends on the characteristics of the systems in each particular case and this question is appropriate to studies of frequency sharing under Study Programmes 27A/4. It is clear, however, that it is desirable that the maximum energy density under light loading conditions should be kept as close as possible to the value corresponding to the conditions of busy hour loading.

In this Report, the results of some theoretical and experimental studies of energy dispersal techniques, separately applicable to analogue frequency-modulation and to digital radiocommunication-satellite systems, are reported.

It is concluded that substantial energy dispersal can be obtained in most circumstances. However, there are some possible limitations on the efficiency of the dispersal and these are mentioned in the Report.

2. Energy dispersal for analogue FM systems**2.1 Multi-channel telephony systems**

Annex I examines a number of methods of maintaining a high degree of carrier energy dispersal in telephony systems, with particular reference to the dependence of the obtainable dispersal on the complexity of the means of dispersal and the attendant increase in occupied radio-frequency bandwidth as a function of distortion. The methods fall into one or other of two general cases; one which adds a dispersal waveform not necessarily of constant magnitude to the input signal and the second which, in addition, effectively controls the deviation sensitivity of the frequency modulator. Various arrangements of these two methods are discussed in Annex I and illustrated in Fig. 1.

Method 1(a) is the simplest; consisting of the addition of a dispersal waveform of fixed magnitude. The relative effectiveness of this method (i.e. the ratio of the maximum dispersed power per 4 kHz to the maximum power per 4 kHz under full load conditions), using each of four low-frequency dispersal waveforms is shown in Fig. 2 for an assumed 10% increase in occupied radio-frequency bandwidth. The four waveforms are considered in greater detail in Annex I.

It is evident from Fig. 2, that the low-frequency triangular waveform (Curve D) is the most effective of these waveforms, but it suffers from the disadvantage of producing a higher level of interference into some single-channel-per-carrier (SCPC) systems due to the long dwell time of the dispersed unwanted signal within the bandwidth of the wanted signal. (Other methods of dispersal which cause less interference to SCPC transmissions are mentioned in § 4.) Apart from this, the only one that appears to offer possibilities for general application is that of low-frequency noise (Curve C). Dispersal by low-frequency noise has the advantage that the frequency band can be readily altered to suit whatever sub-baseband range is available, and that it does not depend for its effectiveness on a precisely specified waveform. However, it has been found in practice that it can be difficult to generate and apply.

* This Report should be brought to the attention of Joint Working Group 10-11S and the CMTT.

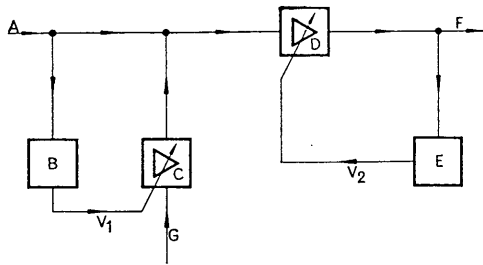

- A: Baseband signal input
- B: R.m.s. detector
- C: Amplifier 1
- D: Amplifier 2
- E: R.m.s. detector
- F: Output to frequency-modulator
- G: Dispersal waveform

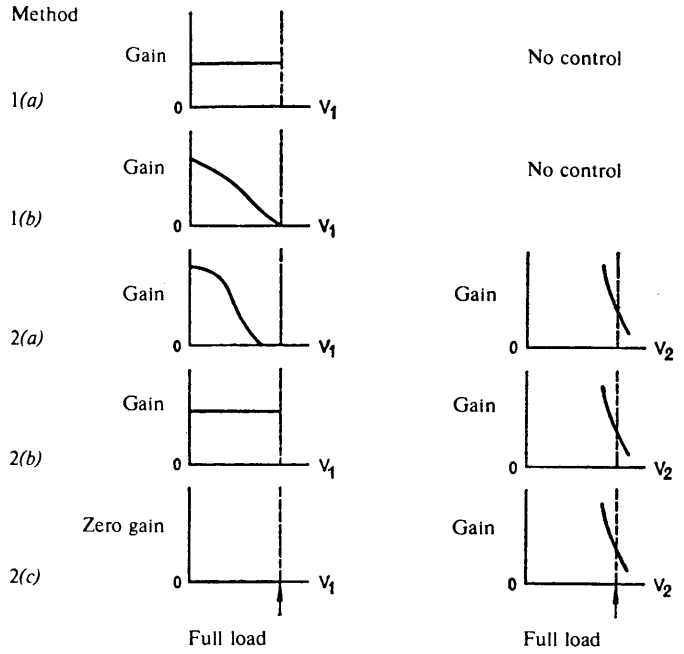

FIGURE 1 — Simplified block diagram
(Possible filters, buffer-amplifiers and gain-regulating pilots omitted)

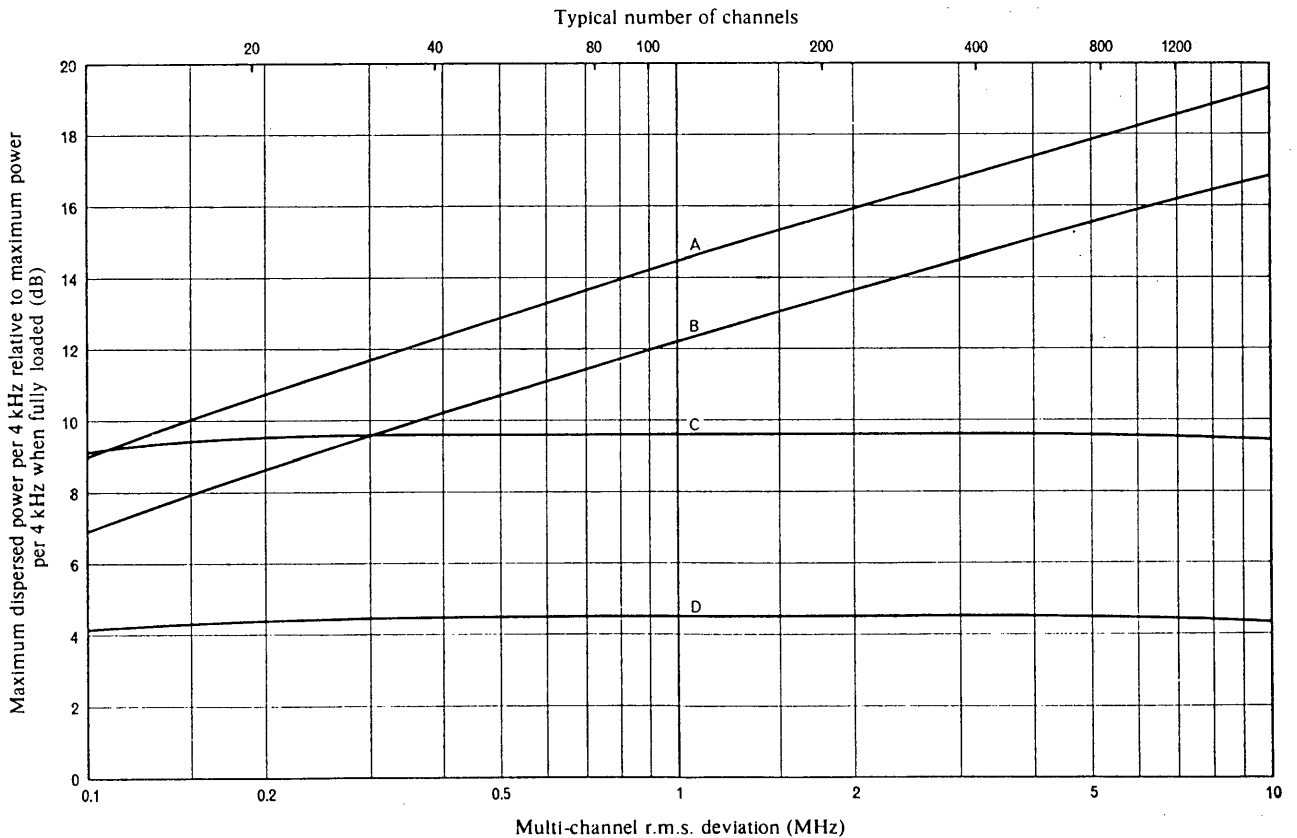

FIGURE 2

On the other hand, for the triangular waveform, careful attention has to be paid to the linearity of the waveform since departures from linearity will cause variations in the spectral density with consequent deterioration in the dispersal efficiency. Removal of the high order harmonics of the triangular waveform by means of a filter will cause non-linearity in the form of rounding of the peaks which will again reduce the effectiveness of the dispersal. This reduction will be less serious however, if there are some pilot tones during light-loading conditions. The decision on whether or not to employ such a filter in any particular case will need to take account of the conflicting requirements to minimize interference with the low-frequency baseband channels on the one hand and the loss in dispersal efficiency on the other.

It would be useful to study the possibility of using, instead of noise, a known pseudo-random signal with uniform spectrum in the low-frequency band. This would make it possible to suppress the signal at the receiver, thus avoiding certain disadvantages of this method.

Considering now the methods of application of the dispersal waveform, the use of Method 1(a) would result in an undue increase in the occupied bandwidth if it were desired to approach the busy-hour loading conditions. Hence, Method 1(b), which incorporates automatic means of adjusting the degree of dispersal applied according to the state of the loading of the system, offers a much more attractive arrangement.

Method 2 is more complicated than Method 1, but turns to advantage the need to provide energy dispersal by improving system noise performance when the deviation sensitivity is increased under light loading conditions. The obvious disadvantage of this method is the need to provide overall gain regulation, while the extent of the advantage which would accrue under conditions of light loading is dependent on traffic loading outside the busy periods of the day. Of the variants of Method 2 discussed in Annex I, Method 2(a) would seem to be the most suitable for general application.

With any method which requires the amount of added dispersal to be changed abruptly as the loading varies, careful attention must be paid to the choice of delay time between the change in loading and the time of switching the dispersal.

In considering the amount of dispersal which can be achieved in practice, it has to be borne in mind that the fully loaded condition will not necessarily provide the degree of dispersal postulated by the Gaussian distribution as in Annex I, § 1 (see Report 792). It would be unwise to assume that, in practice, this ideal condition is attained, until there is some convincing support for such an assumption. It has been shown by practical measurements using white noise loading that systems which apply a triangular dispersal waveform can maintain the dispersal of carrier energy to within 2 dB of the dispersal under simulated fully busy-hour loading conditions. It is not yet known how closely this condition will be approached with actual traffic loading but it seems unwise to assume that the energy will be dispersed to within less than 3 dB of that applying with busy-hour load conditions, without some increase in radio-frequency bandwidth.

2.2 *Television systems*

Annex II considers the general problem of energy-dispersal techniques for television systems and gives the results of an experimental study, to determine the subjective effects of the addition of various low-frequency waveforms to 625-line/50 fields-per-second television signals. The results show that a "symmetrical" triangular waveform is preferable to other waveforms considered and that the subjective effect of adding this waveform, (of peak-to-peak amplitude up to 50% of the peak-to-peak amplitude of the video signal before pre-emphasis), is negligible, provided that:

- the dispersal waveform is locked in both phase and frequency to the field frequency;
- suitable simple means of removing the added waveform are used at the receiving earth station;
- the transmission system does not introduce intermodulation between the dispersal waveform and the vision signal.

By a "symmetrical" triangular waveform is meant a wave in the form of an isosceles triangle (i.e. with equal rise and fall times). Sawtooth waveforms, with either rise or fall times approaching zero were also considered (see Annex II).

Studies have shown that when a TV signal modulated by a dispersal waveform interferes with terrestrial and satellite multichannel FDM telephone systems, the spectral power density at the frequency detector output acquires a predominantly discrete character. The spectral components of the interference are separated from each other by a value equal to the dispersal waveform repeat frequency. At a dispersal waveform repeat frequency below 4 kHz, the interference components are distributed over all the telephone channels, which in the group spectrum are also 4 kHz apart. When the dispersal waveform frequency is increased to the half-line or line frequency, the interference components fall within every second or fourth channel and the interference level in these channels rises by up to 3 or 6 dB respectively. The effect of this additional impairment would depend on the parameters of the systems concerned.

If only the television aspects of the problem are taken into consideration, there is little to choose between the 12.5 and 25 Hz "symmetrical" sawtooth waveforms. There is a slight instrumental advantage to be gained by using the latter and it is considered, therefore, that, for the energy dispersal of 625-line/50 fields-per-second television signals, a synchronized 25 Hz "symmetrical" triangular waveform should be used and it is not expected that significantly different results would be obtained by using a synchronized 30 Hz "symmetrical" triangular waveform with 60 fields-per-second television systems.

To determine the dispersal effect produced by this method, it will be assumed, for the purpose of example, that the overall system performance restricts the permissible peak-to-peak amplitude of the dispersal waveform to 30% of the peak-to-peak amplitude of the video signal. Considering a 625-line system employing the normal pre-emphasis network (Recommendation 405), this peak-to-peak deviation of the dispersal waveform will be 9.4% of the peak-to-peak deviation of the video signal without pre-emphasis. Using the symbol ΔF in MHz for the peak-to-peak deviation of the video signal, the dispersal obtained is approximately:

$$10 \log \left(\frac{\text{maximum energy per 4 kHz}}{\text{total energy}} \right) = 10 \log \frac{0.004}{0.094 \Delta F} = -(14 + 10 \log \Delta F) \quad \text{dB}$$

For comparison, the theoretical dispersal obtained in the telephony case, (assuming a Gaussian spectral distribution and a peak-to-r.m.s. ratio of 12 dB as in Annex I), is:

$$-\left(28 + 10 \log \frac{\Delta F}{8} \right) = -(19 + 10 \log \Delta F) \quad \text{dB}$$

which means that the television case is likely to be only some 5 dB below optimum for some 10% increase in radio-frequency bandwidth.

In the interests of bandwidth economy, it would be desirable to be able to control the deviation on the lines of Method 1(b) of Annex I. It is not obvious that any simple method is possible as it would presumably be necessary to monitor the energy concentration in the radio-frequency spectrum.

In addition to the methods of energy dispersal discussed above, two other systems are described in § 5 and 6 of Annex II. The first describes dispersal by video transformation, the second describes dispersal techniques used to improve protection to SCPC telephony transmissions for which the dispersal signal has the frequency of the television line frequency. Section 6 of Annex II also describes a composite energy dispersal technique where the dispersal signal consists of a triangular waveform at frame rate frequency and a waveform either triangular or sinusoidal at half-line rate frequency. This technique can be used to reduce the effects of the interference caused in both FDM telephone systems and SCPC carriers.

Finally, it should be noted that the use of any of the above mentioned methods of energy dispersal for colour television would demand an even higher degree of system linearity than that required for monochrome transmission.

3. Energy dispersal for digital modulation systems

Annex III examines the need for energy dispersal in systems using digital modulation and outlines two methods of baseband code conversion which ensure that the transmitted RF spectrum is maintained in a condition approximating the ideal which would be achieved if the information bit stream was completely random.

Dispersal of the spectra of transmissions in the fixed-satellite service employing digital modulation methods is likely to be necessary in many cases. The use of a pseudo-random number sequence to randomize the digital information at the transmitter, followed by its removal at the receiver, provides a simple method of achieving a high degree of dispersal.

It will not normally be necessary for bit rates of a few tens of megabits per second and above, to apply the dispersal signal to the preamble of a TDMA system, since the spectral density due to this part of the transmission will usually be comparable with that obtained with ideal dispersal.

The length of the pseudo-random number sequence chosen will depend on the degree of dispersal required. However, it will not generally be necessary to use a sequence which is longer than the frame duration in single access systems, or greater than the burst duration in TDMA systems, and frequently sequences of shorter lengths than these will be adequate.

4. Conclusions

It appears that the most promising methods of energy-dispersal are as follows:

- for frequency-modulation telephony systems: the addition of a signal below the baseband, controlled according to the loading as in Method 1(b) of Fig. 1. The controlled signal may be noise or a “symmetrical” triangular waveform but the actual implementation is generally easier with the latter;
- for frequency modulation television systems: the addition of a “symmetrical” triangular waveform, synchronized to the picture frequency as in Method 1(a) of Fig. 1;
- for digital modulation systems: code conversion by which the message bit stream is multiplied by a pseudo-random pulse train, using methods similar to those outlined in Annex III.

Currently triangular dispersal waveforms are applied to frequency modulated carriers in most fixed satellite networks. The extent to which the theoretical advantage of triangular dispersal waveforms is approached in practice depends on the linearity of the waveform used. The use of these methods could provide energy dispersal as great as that provided under full-load conditions, however, the excess of the dispersal power per 4 kHz over that achieved under full-loading conditions (assuming a Gaussian spectrum), is unlikely in practice to be less than 3 dB for telephony and 5 dB for television. With this level of energy dispersal the addition to the radio-frequency bandwidth occupied, has not presented any difficulties.

The energy dispersal currently being obtained from triangular dispersal waveforms is proving satisfactory in practice except when the wanted signal is a single-channel-per-carrier system. With the use of low frequency (≤ 1 kHz) triangular dispersal waveform on multi-channel systems, a wanted single-channel-per-carrier system can be exposed to nearly the full power of an interfering carrier for short periods. This problem might be overcome in frequency modulated television systems, by using video signal transformation for dispersal, or by using a triangular dispersal waveform at the television line frequency.

ANNEX I

ENERGY DISPERSAL TECHNIQUES FOR USE WITH ANALOGUE FREQUENCY MODULATION TELEPHONY SIGNALS

1. General

In studying ways of achieving high degrees of carrier energy dispersal, it is useful to know what is the dispersing effect of the fully-loaded baseband signal, to have some reference value with which to compare what can be obtained artificially. It is legitimate, for the general class of wide-deviation frequency-modulation systems under consideration, i.e. those in which the multi-channel r.m.s. deviation (δF) exceeds the highest baseband frequency, which in turn greatly exceeds the lowest baseband frequency; to assume that the mean power spectrum under the conventional busy-hour loading conditions is of Gaussian form. Hence, the dispersing effect obtained under these conditions is:

$$10 \log \left(\frac{\text{maximum energy per 4 kHz}}{\text{total energy}} \right) = 10 \log \frac{0.004}{\sqrt{2\pi} \delta F} = -(28 + 10 \log \delta F) \quad \text{dB}$$

(δF is expressed in MHz)

The dispersing effect when δF is less than the highest baseband frequency can be calculated using the information contained in Report 792.

Possible arrangements for maintaining a high degree of carrier energy under conditions of reduced loading, by the methods discussed in this Annex, are shown diagrammatically in Fig. 1.

2. Dispersal by added waveforms

2.1 *Method 1(a)*

The simplest way of bringing about some degree of carrier energy dispersal is to add to the baseband signal, a suitable low-frequency dispersing waveform of fixed magnitude, as in Method 1(a) of Fig. 1. Of a variety of dispersal waveforms that have been proposed, the following are examined in this Report:

- a sinusoidal signal (Curve A of Fig. 2),
- a sinusoidal signal plus 30% third harmonic added in suitable phase (Curve B of Fig. 2),
- a band of low-frequency noise (Curve C of Fig. 2),
- a low-frequency triangular waveform (Curve D of Fig. 2).

To provide some basis for comparing the efficiencies of these waveforms, the maximum energy spectral density, which they produce when applied to an unmodulated carrier, has been calculated for an assumed 10% increase in occupied radio-frequency bandwidth. The results are plotted in Fig. 2, relative to that which would occur under the conditions of busy-hour loading; the curves of Fig. 2 have been designated A-D as described above. Some approximation occurs here, because difficult questions of the relation between signal distortion and radio-frequency bandwidth limitation have been avoided by assuming:

- Carson bandwidth occupancy (with peak-to-r.m.s. ratio of 12 dB) throughout;
- that this bandwidth formula may also be applied to the sum of the signal and dispersed r.m.s. deviation when the dispersal is by noise band;
- in other cases, that the occupied radio-frequency bandwidth is increased by the peak-to-peak dispersal deviation.

The errors so incurred are not thought to be large, and in any case should be in the same sense for all waveforms. As a further approximation, each type of dispersing waveform is represented in Fig. 2 by a single curve. The relation between the typical channel capacities and r.m.s. deviations implied by the two abscissae scales is based on the information given in the Annex to Report 708.

2.1.1 *Sinusoidal dispersal*

It is evident from Curve A of Fig. 2 that carrier energy dispersal by a sinusoidal signal is rather inefficient, while Curve B shows that a sinusoidal signal with 30% of third harmonic is only about 2 dB better. For a typical 20-channel transmission, the maximum power density in either case, exceeds that which occurs under full-loading conditions by about 10 dB. It is a feature of both these types of dispersal, that the amount by which the dispersed power-density exceeds that at full loading increases, with the r.m.s. multi-channel deviation, and hence, with channel capacity. For example, the excess for 1200 channels is about 18 dB.

2.1.2 *Triangular dispersal*

The most effective way, for a given increase in occupied bandwidth, of dispersing the energy present in a single spectral line is, at least theoretically, by the application of a triangular waveform. The dispersed power-density is inversely proportional to the permitted percentage increase in radio-frequency bandwidth and Curve D of Fig. 2 shows that, if a 10% increase in occupied bandwidth is permitted, the dispersed power per 4 kHz exceeds that under full-loading conditions by only about 4.5 dB for most numbers of channels.

With the use of low-frequency (≤ 1 kHz) triangular dispersal waveform on multi-channel systems a wanted single-channel-per-carrier system can be exposed to nearly the full power of an interfering carrier for significant periods of time.

The triangular waveform evidently offers a simple and efficient means of dispersing the energy present in isolated spectral lines of telephony transmissions. It must be remembered, however, that its effectiveness depends upon faithful preservation of the shape of the wave until it appears as frequency-modulation, particularly when a high degree of dispersal is required. If 32 dB of dispersal were required for a 1200-channel transmission, for example, flattening of the extremities of the wave by only 0.25% might lead to a local doubling of spectral energy density.

The triangular signal may have to be filtered before being applied, to prevent the harmonics of the fundamental from disturbing the lower channels of the telephone multiplex. For triangular waveform frequencies of up to 150 Hz and for a low frequency multi-channel baseband of 4 kHz, filtering causes deformation at the angles of the signal waveform and thus at the energy density peaks at the extremities of the modulation spectrum under light-loading conditions.

Table I below, shows measured values for the increase in energy density at the extremities of the spectrum in relation to the density at the centre frequency of the spectrum, for a 132-channel multiplex, as a function of the frequency of the triangular waveform. Discontinuous single step regulation was used for this system.

TABLE I

Frequency of triangular waveform (Hz)	Increase in energy density (dB)
20	3
80	5
150	7

The low-pass filter used was a 7-pole Chebitchev-type filter with a cut-off frequency of 2.7 kHz and an attenuation at 4 kHz equal to 34 dB.

It is, however, possible to take account of the presence of the continuity pilot at the modulator input provided it is generated independently of the telephone multiplex. Under the same measurement conditions as indicated earlier, the application of a pilot at a level of -20 dBm₀ makes it possible to reduce the energy density peaks at the extremities of the band from 7 to 3 dB.

2.1.3 *Dispersal by a band of low-frequency noise*

A form of carrier energy dispersal that is not critical in its application and shares with triangular dispersal the property of yielding a maximum energy spectral-density, inversely proportional to the amplitude of the waveform, may be accomplished by adding a band of low-frequency noise to the multi-channel baseband. Curve C of Fig. 2 shows that, for a 10% increase in occupied bandwidth, the maximum dispersed power per 4 kHz exceeds that under full-loading conditions by about 9.5 dB for all numbers of channels.

Note. — When the level of the dispersal signal is not fixed, the required amount of dispersion can be attained by the methods given in [CCIR, 1970-74].

2.2 *Method 1(b)*

An obvious variant of Method 1(a), would incorporate automatic means for adjusting the degree of artificial energy dispersal, applied according to the state of loading of the system, as shown in Method 1(b) of Fig. 1. It might, in fact, be possible in this way, using say, noiseband dispersal, to maintain the maximum energy spectral-density of a transmission quite close to its full-loading value without any increase in occupied radio-frequency bandwidth. The performance that could be achieved in practice, would depend on the distortion produced by the interaction (via radio-frequency bandwidth limitation and other transmission characteristics) of the dispersal waveform and isolated tones and active telephone channels under light-loading conditions. It is probable that the matter can only be settled experimentally, since there is as yet no generally accepted way of calculating the distortion that frequency-modulation signals undergo during transmission, even for the simplest case of white-noise loading.

A particular method which has been proposed for applying the variable degree of dispersal to which the present sub-section relates, relies on filling a suitable proportion of unoccupied telephone channels with simulated speech (i.e. band-limited noise). Although full dispersal could in this way be maintained without increase of bandwidth, the complexity of the apparatus likely to be required for the method is a serious disadvantage, as is the probable necessity for applying it at the audio switchboards from which the baseband originates.

3. Dispersal by automatic deviation control

3.1 *General*

It would clearly be possible to adjust the signal level entering the system frequency modulator so as to maintain the r.m.s. (or peak) frequency deviation at some constant value. The desired level could be obtained merely by subjecting whatever the baseband content happens to be, to sufficient amplification, or by so amplifying after the addition of some fixed or variable amount of artificial dispersal. The overall baseband transmission loss of the system would be kept sensibly constant by a compensating adjustment of the post-demodulation gain through the medium of a system pilot tone. The possibilities are discussed in the following paragraphs.

3.2 *Method 2(a)*

The most general method of carrier energy dispersal considered in this Report, of which the others are in a sense degenerate forms, is Method 2(a) in Fig. 1. This consists in adding to the baseband, before the application of automatic deviation control, a source of artificial energy dispersal whose amplitude is made to depend upon the loading conditions. The use of this method might add little or nothing to the occupied radio-frequency bandwidth. Furthermore, if the application of artificial dispersal were delayed until the approach of light-loading conditions, a valuable decrease in the sensitivity of the system to thermal noise, distortion and interference might result. The magnitude of this decrease would depend upon what fraction of the fully-loaded baseband power was attributable to speech signals. As for Method 1(b), some determination of the baseband distortion associated with this method is desirable, although, other things being equal, such distortion would be less than in the earlier method, because the increased deviation-per-channel under light-loading conditions would render the system less sensitive to the radio-frequency distortion components produced.

With regard to the choice of a means of artificial dispersal to be added to the baseband, this might consist of any of the low-frequency dispersal waveforms considered in § 2. The noise-band waveform resembling one or more perpetually active telephone channels is perhaps to be preferred, because it is moderately efficient and because it has the same dispersing effect for a given r.m.s. deviation as the baseband signal, it permits accurate deviation control by a simple r.m.s. detector and presents no difficulties of application at large amplitudes.

3.3 *Method 2(b)*

As a trivial simplification of the foregoing method, the amplitude of the added dispersing waveform might be set at some fixed value. There would be some increase in occupied radio-frequency bandwidth, although not so much as in Method 1(a) for the same degree of dispersal.

3.4 *Method 2(c)*

The complete omission of artificial dispersing waveforms from the modulating signal would reduce dispersal by automatic deviation control to its simplest form. The effectiveness of the method would seem to depend on the baseband spectrum retaining some moderate degree of complexity even under light-loading conditions. Unfortunately, it may not be possible to count upon this; in the complete absence of telephone channel activity, the system loading would degenerate to a number of pilot tones, carrier leaks and the like. There might be enough of these in a large system to yield some semblance of evenly distributed baseband power, but this is unlikely to be true of low-capacity systems. In such systems, particularly if many of the carrier leaks were at an unusually low level, the lowest levels of loading might derive from a very small number of prominent pilots.

It can readily be shown that, if the loading of a system results from only one or two prominent tones in the baseband, the radio-frequency spectral-densities may exceed those obtained under full-load conditions by many decibels. It would, therefore, be unwise to rely upon the presence of a few tones to bring about, by application of automatic deviation control alone, a similar degree of energy dispersal to that which results from full-loading.

REFERENCES

CCIR Documents

[1970-74]: Doc. 4/273 (U.S.S.R.).

ANNEX II

ENERGY DISPERSAL TECHNIQUES FOR USE WITH ANALOGUE FREQUENCY
MODULATION TELEVISION SIGNALS**1. Introduction**

In a television transmission system using frequency-modulation a large proportion of the radiated power may be concentrated on or near the radio carrier-frequency under certain modulation conditions, e.g. when a television picture with large areas of the same brightness is being transmitted. Energy dispersal can be achieved by adding a suitable low-frequency waveform to the video signal before modulation.

To obtain information on the degree of degradation which would be introduced when this type of energy dispersal technique is used, an experimental study has been made to determine the subjective effects, on 625-line monochrome television signals, of adding and removing, by several methods, various low-frequency waveforms which are suitable for energy dispersal purposes.

2. Dispersal waveform

The amplitude and shape of the dispersal waveform which is added to the video signal before modulation, must produce the required amount of carrier energy dispersal without introducing a significant degradation in the transmission performance of the system. This latter requirement also depends upon the efficiency of the method used to remove the added waveform and on the overall linearity of the transmission system. Two forms of triangular waveform (the "symmetrical" triangular and the "sawtooth" waveform), having repetition frequencies centred around 50, 25 and 12.5 Hz, have been considered in some detail to determine which waveform is to be preferred.

It was thought that the most favourable result would be obtained by synchronizing the dispersal waveform to the field-frequency of the television signal and also, that the relative phasing of the synchronized signals might, in some cases, give variations in picture impairment. These effects were examined by using both synchronized and unsynchronized dispersal waveforms and, as far as impairment to the received picture is concerned, the tests showed that there is a considerable advantage to be gained by using a synchronized, rather than an unsynchronized waveform. As the generation of waveforms synchronized to the television field-frequency presents no practical problems, the remaining experiments were confined to synchronized waveforms.

The process of synchronization should normally ensure correct phasing of the waveform with respect to the television field information. With the 50, 25 and 12.5 Hz "sawtooth" and the 25 and 12.5 Hz "symmetrical" waveforms, all points of inflection will occur during the field-blanking interval and the discontinuities in the slope of the waveform will not appear as an impairment to the picture. With the 50 Hz symmetrical waveform, only alternate points of inflection can coincide with the field-blanking interval and the remaining points occur at the mid-point in each television field (i.e. across the middle of the picture).

It was thought likely that the peak-to-peak level of waveform which would be required for energy dispersal purposes, was between 10 and 50% of the peak-to-peak amplitude of the video signal before pre-emphasis, and the tests were confined to this range of levels.

A method of increasing the level of dispersal without, at the same time, increasing the peak frequency deviation is described by Kumysh [1970] and Shavdiya and Ignatkin [1974]. In this method it is proposed that the spikes formed at the edges of the video signal pulse as a result of the normal pre-emphasis network, be subjected to non-linear processing prior to modulation. This process decreases the peak-to-peak amplitude of the video signal, thereby providing the possibility of increased dispersal within the original bandwidth of the system.

A further factor to be taken into account in the design of dispersal systems is the likely presence of "natural" dispersal resulting from imperfections of system components. For example, systems involving up converters may introduce a significant level of dispersal as a result of "jitter" within the oscillators included in these units. Further study is required to determine what contribution "natural" dispersal may make to the problem of co-ordination, without at the same time introducing unacceptable reduction in system performance of the dispersed system.

3. Linearity of the transmission channel

When there are non-linearities in the transmission channel, intermodulation phenomena may appear between the dispersal waveform and the video signal. In such cases, there may be serious defects in the television picture, especially in colour pictures. For example, tests made with the PAL system and a symmetrical triangular dispersal waveform at 50 Hz (synchronized in the field scan) and about 0.5 V peak-to-peak amplitude, measured

before pre-emphasis at a point where the video signal is at the nominal reference level (see Recommendation 270), showed that the subjective quality index of the picture was equal to 3 in the six-grade quality scale (Note 2 in Report 405) under the following conditions:

- differential phase 8°
- differential gain 10%
- short-term non-linearity 10%.

It would seem advisable to continue the study of this subject, so as to determine the permissible limit of non-linearity for various television systems, in a satellite television link using energy dispersal.

4. Removal of dispersal waveform

At the receiving earth station, the dispersal waveform must be removed from the baseband signal, and the following methods have been proposed:

4.1 Waveform cancellation

The dispersal waveform can be removed from the baseband signal by "cancelling" it with a locally generated dispersal waveform which is added in anti-phase. It may be useful to transmit the dispersal waveform in a subsidiary channel as an alternative to regenerating the waveform locally.

Two methods of cancellation are possible. In the first method the dispersal waveform may be added in anti-phase, after demodulation. In the second method the local oscillator in the earth-station receiver is frequency modulated by the anti-phase dispersal waveform. This has the advantage that, since the energy dispersal is cancelled before demodulation of the frequency-modulation signal, no increase in the IF bandwidth is necessary. Recent experiments indicate that waveform cancellation followed by clamping (as described in § 4.2) is an effective method, and removes the dispersal waveform more completely than one or two stages of clamping alone.

4.2 Black-level clamping

The effects of the dispersal waveform may be removed from the baseband signal by using a well established television technique known as "black-level clamping". The "clamp" is a device which is normally used to remove low-frequency distortion from a television signal by means of a sampling and error correcting process [Savage, 1962; Doba and Rieke, 1950].

The amount by which a low-frequency error-signal may be reduced by "clamping" is a function of the frequency of the error signal and of the level of random noise present on the video signal. As initial satellite systems may have to handle video signals having a poor signal-to-noise ratio, the characteristics of the clamps used in these experiments were adjusted to be consistent with the optimum performance which can be obtained with 625-line systems operating under conditions of poor signal-to-noise ratio. A typical characteristic for sinusoidal error-signals is given in Table II.

TABLE II

Error-signal frequency (Hz) (sine-wave)	50	25	12.5
$\frac{\text{Peak-to-peak error-signal output}}{\text{Peak-to-peak error-signal input}}$ (dB)	-15	-21	-27

(It should be noted that as the frequency of the error signal decreases, both the efficiency of the clamp and the visibility of flicker on a picture increase; on a subjective impairment basis, therefore, these two effects tend to cancel each other out.)

The effect of clamping an error signal having a triangular shape, produces a result which is similar to that which would be obtained if the error waveform were differentiated and with the levels which may be necessary in a practical energy-dispersal system, a single clamp of the type described does not reduce to an acceptable level the impairments introduced by any of the various waveforms under consideration.

At this point a major difference between the "sawtooth" and "symmetrical" waveforms should be mentioned. Because the slope of the "sawtooth" waveform is constant during the "active" part of each television field, the only impairment which may be observed on a picture monitor after the video signal has been clamped, is a slight, and probably insignificant shading across the picture. However, the very high slope of the dispersal waveform during the field-blanking interval causes a serious distortion of the waveform during this period, the magnitude of which is dependent upon the level of dispersal waveform being used. In practice, this distortion is most undesirable, as it can interfere with both synchronizing and vertical interval test signals which occur during the field-blanking interval. It is also extremely difficult to remove this form of distortion once it has been introduced into the video waveform.

With the "symmetrical" waveform, the residual impairment left after a single clamping operation can be observed as a picture impairment. With the 50 Hz waveform, the impairment appears as a disturbance across the middle of the picture. For the 25 and 12.5 Hz waveforms, a picture "flicker" can be observed. This effect is also dependent on the level of dispersal waveform being used, but the application of a further clamp will reduce the flicker effect to a level where it is imperceptible, even with a dispersal waveform amplitude of 50% of the peak-to-peak amplitude of the video waveform.

Although the characteristics of the waveform distortion left after twice clamping the signal are somewhat different in character, the magnitude of the residual distortion when a "symmetrical" dispersal waveform is used is some 10 to 20 dB less than when a "sawtooth" waveform is used.

4.3 *Frequency feedback*

The dispersal signal may be removed by the use of narrowband frequency feedback techniques applied to the IF stage of the receiver. This method has the advantage that it allows the effective receiver bandwidth to be reduced thereby improving the noise threshold of the receiver.

In a particular application of the above mentioned principle, a dispersal signal of 2.5 Hz was selected. At the receiver the dispersal signal is removed by means of a negative feedback circuit containing a low frequency filter with a cut-off frequency lower than the lowest frequency of the video signal. The frequency deviation caused by the dispersal signal is thereby reduced by a value dependent on the degree of feedback employed, and a reduction of 15 dB is readily achievable; the amplitude of the video signal being unaffected.

5. **Dispersal by video signal transformation**

With angular modulation of the television signal, carrier energy dispersal can be provided by reversing the polarity of the video signal line by line and replacing line and frame synchronizing pulses by bursts of sinusoidal oscillations. The period of each burst is equal to that of the corresponding synchronizing pulse, and the peak-to-peak amplitude of the sinusoidal oscillation is equal to that of a video signal.

The test results obtained by this carrier dispersal method are given in [Mustafidi and Finogeev, 1976].

6. **Line frequency energy dispersal waveform**

The conventional television energy dispersal waveform, a triangular wave at one-half the field frequency, is ineffective in providing protection for single-channel-per-carrier (SCPC) transmissions. This is because, with the resulting frequency sweep rate of about 1 MHz per 1/50 s, the time spent by the television carrier within the SCPC receive passband is much greater than the response time of the receiver IF filter. As a result the demodulator in the SCPC receiver is periodically exposed to the full television carrier power.

Studies in the United States [YAM, 1980], the USSR [Borodich, 1982; Dorofeev, 1984] and France [Gay, 1986] indicate the possibilities of using energy dispersal at the television line rate to reduce the protection margin needed for PCM-PSK SCPC against FM TV carriers by about 9-10 dB in comparison with one half-field frequency dispersal. Figure 3a shows the protection ratio calculated as a function of the dispersal signal frequency (f_d) with a 32 kHz bandwidth SCPC channel and a dispersal signal deviation of 1 MHz peak-to-peak (ΔF). (Interference is regarded as permissible if it increases the bit error probability from 10^{-7} to 10^{-6} .) Figure 3b shows by way of example the variations in the bit error ratio as a function of the dispersal signal frequency, measured in an SCPC channel centred on the centre frequency of the interfering signal. Figure 4 shows BER variations in a simulated SCPC link as a function of dispersal signal frequency and for different frequency deviations of a carrier modulated only with a triangular dispersal waveform. The improvement of the protection margin achieved by using half-line rate energy dispersal varies as a function of the picture content and television system. This improvement can be as small as 4 dB as shown in Figures. 5a, 5b and 5c.

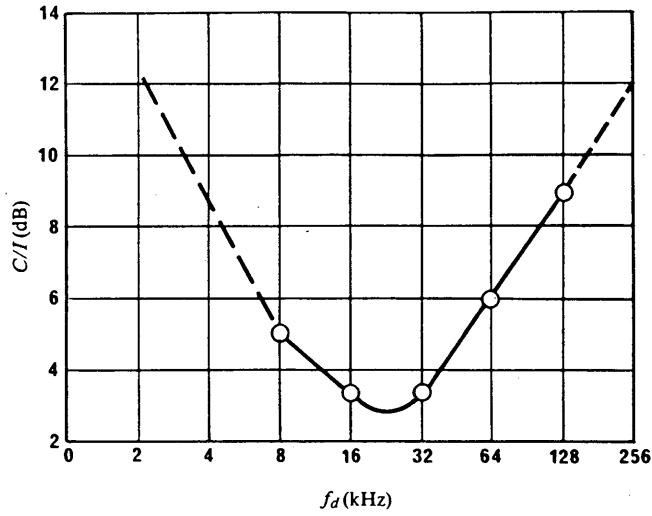

FIGURE 3a - Protection ratio (C/I) as a function of the dispersal signal frequency (f_d)

B = 32 kHz
 Δf = 1 MHz
 C/I without dispersal = 18.4 dB
 \circ calculated points

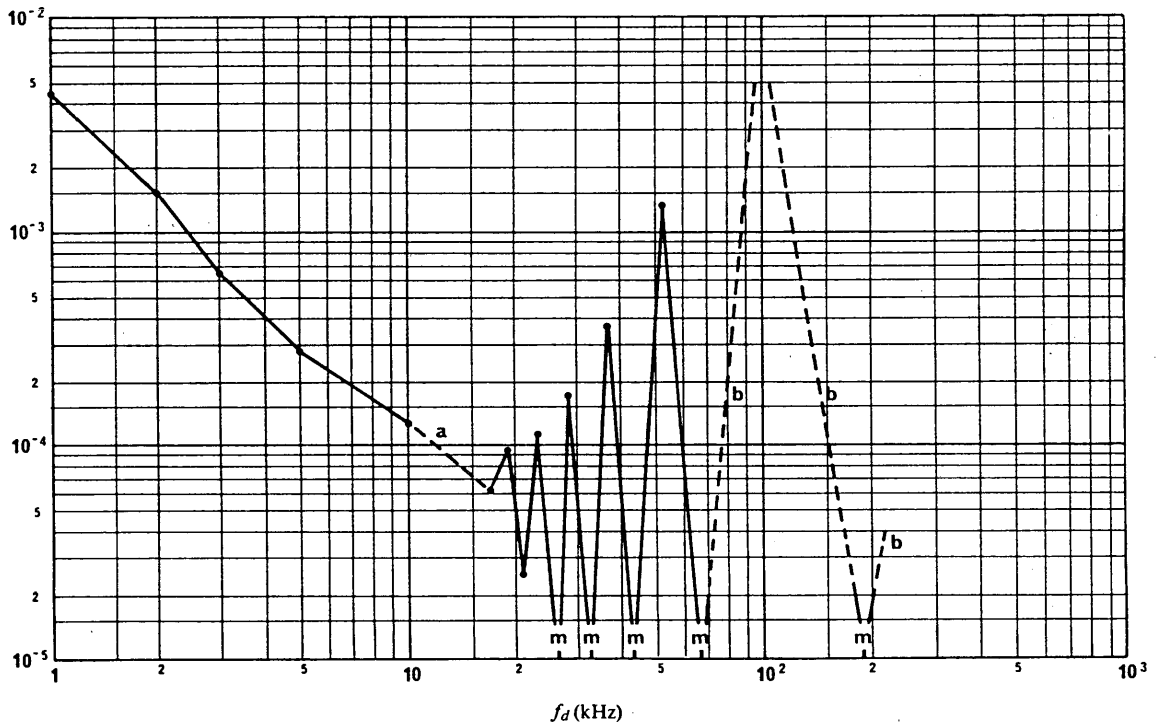

FIGURE 3b - Bit error ratio (BER) as a function of the dispersal signal frequency (f_d)

B = 32 kHz
 Δf = 1 MHz
 C/N = 15 dB
 C/I = 0 dB

a: BER fluctuations
 b: error bursts and SCPC MODEM cut-off
 m: TV interfering signal cancellation precisely in the SCPC channel chosen

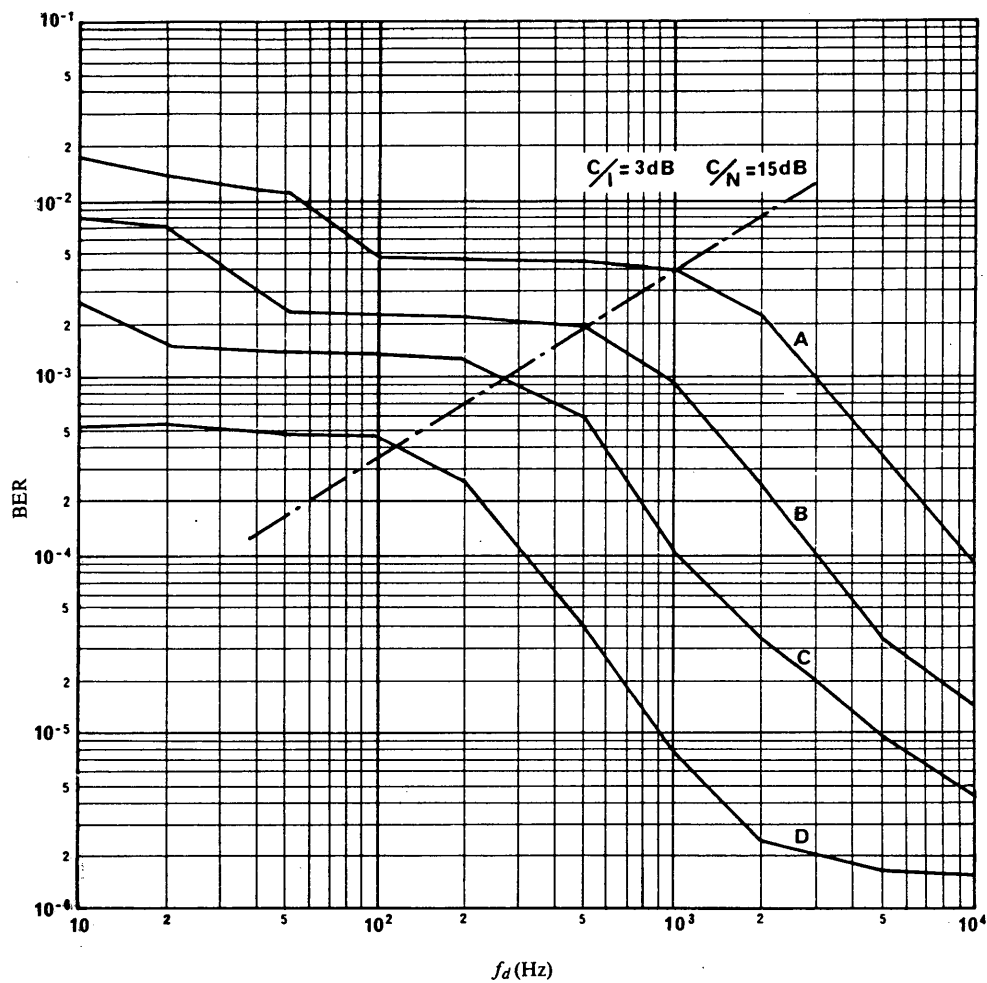

FIGURE 4 - Bit error ratio (BER) as a function of dispersal signal frequency (f_d) with peak-to-peak deviation as parameter (Δf)

- Curves A: $\Delta f = 0.5$ MHz
- B: $\Delta f = 1$ MHz
- C: $\Delta f = 2$ MHz
- D: $\Delta f = 5$ MHz

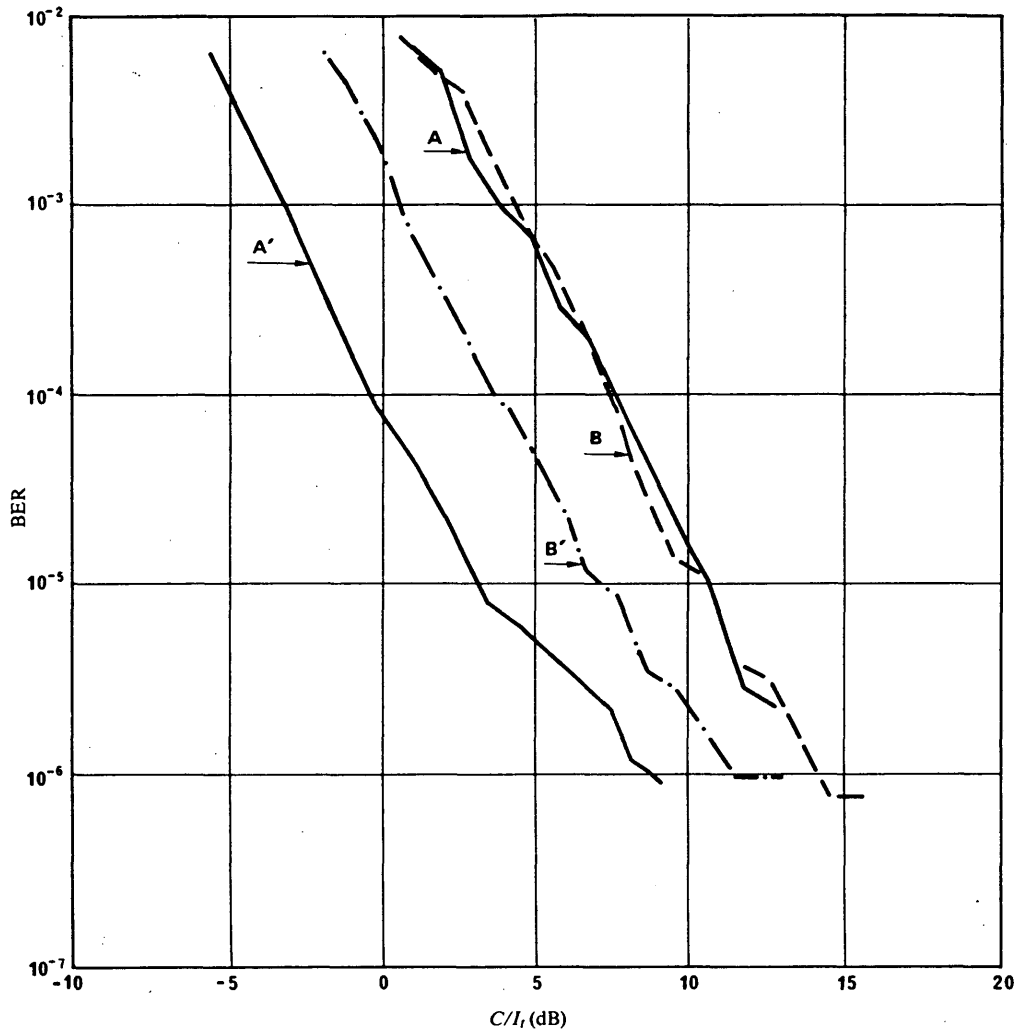

FIGURE 5a - BER as a function of the level of an interfering TV (I_i) carrier modulated by a black picture for two different frequency dispersal wave forms

$$\text{BER} = f(C/I_i), \quad C/N = 15 \text{ dB}$$

- Curves A : SCPC channel at the centre of the TV signal spectrum with energy dispersal at 1/2 frame rate
 A' : SCPC channel at the centre of the TV signal spectrum with energy dispersal at 1/2 line rate
 B : SCPC channel at the edge of the TV signal spectrum with energy dispersal at 1/2 frame rate
 B' : SCPC channel at the edge of the TV signal spectrum with energy dispersal at 1/2 line rate

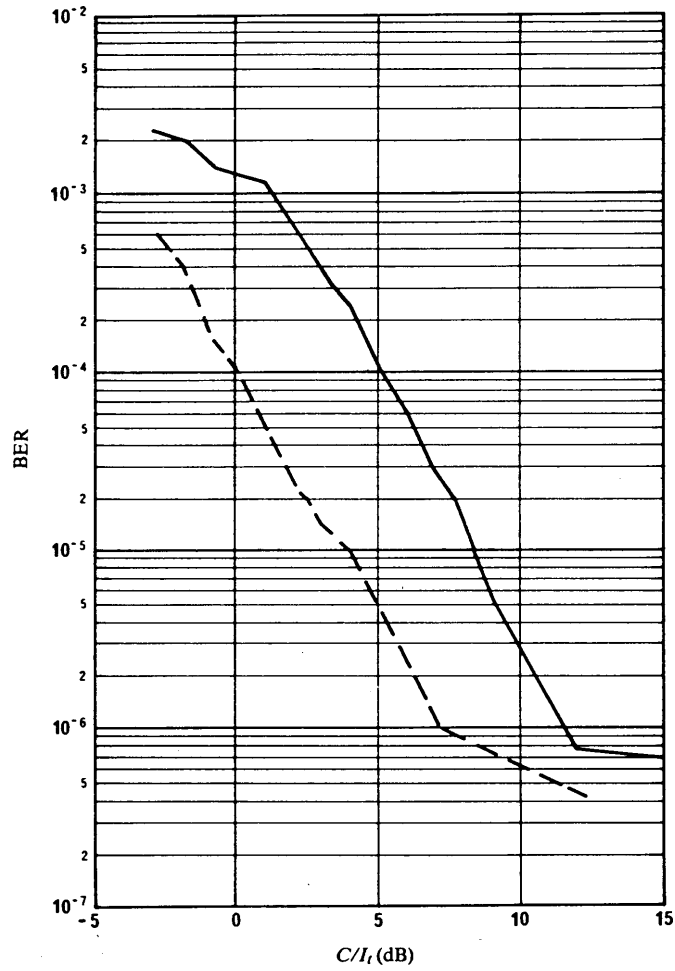

FIGURE 5b - BER as a function of the level of an interfering TV carrier (I_i) modulated by a colour bar picture in the SECAM system for two different frequency dispersal wave forms

$BER = f(C/I_i), \quad C/N = 15 \text{ dB}$

Energy dispersal:

- 1/2 frame rate
- - - - - 1/2 line rate

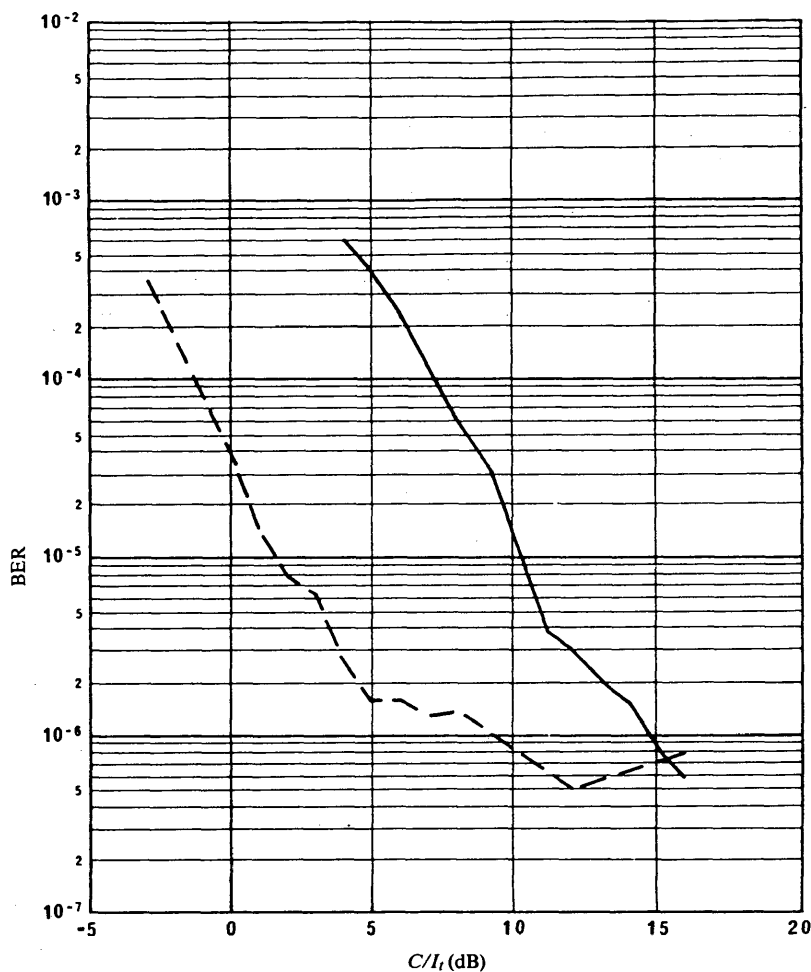

FIGURE 5c - BER as a function of the level of the TV carrier (I_1) modulated by a colour bar picture in the PAL system for two different frequency dispersal wave forms

$$\text{BER} = f(C/I_1), \quad C/N = 15 \text{ dB}$$

Energy dispersal:

————— 1/2 frame rate
 - - - - - 1/2 line rate

The use of a line frequency dispersal waveform will result in a level of interference to satellite and terrestrial radio-relay circuits of low modulation index FDM/FM carriers higher than would be caused by a low-frequency dispersal signal (frame frequency or less) [Kantor et al., 1980; Borodich, 1976]. The effect of this additional impairment would depend on the parameters of the systems concerned, and degradations of more than 7 dB can be observed [Albuquerque and Mukunda, 1984].

In view of the interfering potential of FM TV signals to SCPC systems and terrestrial radio-relay systems, it may be advantageous to use a composite dispersal signal with slow (e.g. frame frequency) and fast (e.g. line frequency) components. Figure 6 shows the protection ratio of SCPC systems as a function of the ratio of the line frequency dispersal signal deviation Δf_l to the total dispersal signal deviation Δf . This relation shows that the permissible level of FM TV interference to SCPC systems can be increased considerably by adding a line frequency component to the slow dispersal waveform.

Figure 7 (based on results from [Albuquerque and Mukunda, 1984] and [Albuquerque et al., 1986]) shows the excess of interference, with respect to the amount which would be caused by a frame rate spreading waveform, as a function of the ratio $\Delta f_0/\Delta f$. Carriers 1, 2 and 3 are, respectively, a low modulation index 1200 channel satellite carrier, a 300 channel terrestrial carrier and a 2700 channel terrestrial carrier.

Figures 6 and 7 indicate that a mixed spreading waveform with $\Delta f_0/\Delta f$ around 0.75 offers an excellent compromise solution. Indeed, this is better than frame rate, as far as interference into low modulation index FDM/FM carriers is concerned, and, according to Figure 6, it degrades performance only slightly, with respect to line rate, when the interference into narrow-band carriers is considered.

Analytical studies [Henriques and Albuquerque, 1987] as well as recent measurements [Dutronic et al., 1989] have shown that in fact a mixed spreading waveform could even lead to lower requirements in terms of C/I compared to those obtained with a line rate dispersal only.

Measurements carried out with both triangular and sinusoidal waveforms as the fast spreading component lead to the conclusion that a mixed spreading system based on either of the two waveforms would exhibit similar performance.

Figure 8 shows the minimum acceptable value of C/I which allows a given degradation of the C/N in a 64 kbit/s QPSK SCPC channel not to be exceeded. The curves given for two values of the degradation (0.5 and 1 dB) confirm that the use of a mixed spreading waveform with Δf (half line rate)/ Δf (total) around 0.75 is a satisfactory solution. In Figure 8, the half line-rate component was either a triangular symmetrical waveform or a sinusoidal waveform. The two waveforms provide comparable results in terms of C/I requirements. This comes from the fact that the RF spectra in both cases (using a sinusoidal waveform or a triangular one) are very similar, and hence the interference created to the SPC channel is also similar.

The use of a sinusoidal waveform offers however advantages over that of a triangular waveform because the cancellation of the sinewave can be thought to be much easier than that of a triangular waveform. Hence, low values of residual energy dispersal waveform power can be expected, even with simple circuitry for home receivers, available on the market at low price, and the impairment on the quality of the television signal should be insignificant.

The adoption of a mixed energy dispersal modulation scheme consisting of a triangular component at Δf (half-line rate)/ Δf (total) between 0.75 and 1 appears therefore a viable solution. Measurements have shown that the peak spectral density of the FM TV signal is not increased if this scheme is used in replacement to other energy dispersal schemes, and therefore in this way the modulated FM TV carriers can meet the power flux density limits of the Radio Regulations. Further work is however required to provide a quantitative evaluation of the additional complexity which would be introduced in the receivers and on the subjective assessment of the quality of the television signal after the removal of the composite energy dispersal waveform.

For illustrative purpose Figure 9 shows a method for the removal of the composite energy dispersal waveform, based on a conventional sample integrate/feedback type clamp to remove frame rate ED, supplemented by a sinusoidal half-line ED removal arrangement.

The peaks of the half-line component are arranged to fall at the line synchronization pulse points. Sampling at these points is used to monitor both components of ED.

The half-line removal circuit generates a half line-rate sinewave from the synchronization pulses. Its amplitude is controlled in closed loop by processing samples of the output video signal so as to drive the residual half-line components to zero. A 180° phase ambiguity caused by the divide-by-two operation is removed by the bi-polar attenuator.

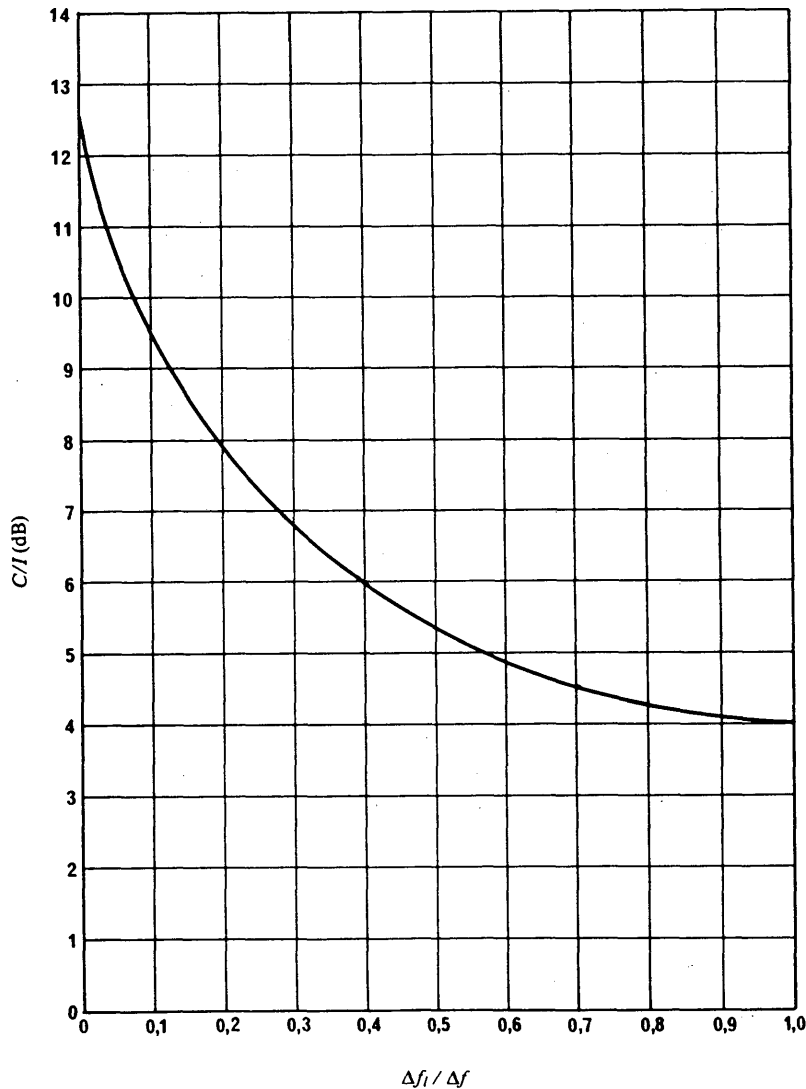

FIGURE 6 - Protection ratio for the case of a composite dispersal signal

$$B = 32 \text{ kHz}, \quad \Delta f = 1 \text{ MHz}, \quad f_i = 15 \text{ kHz}$$

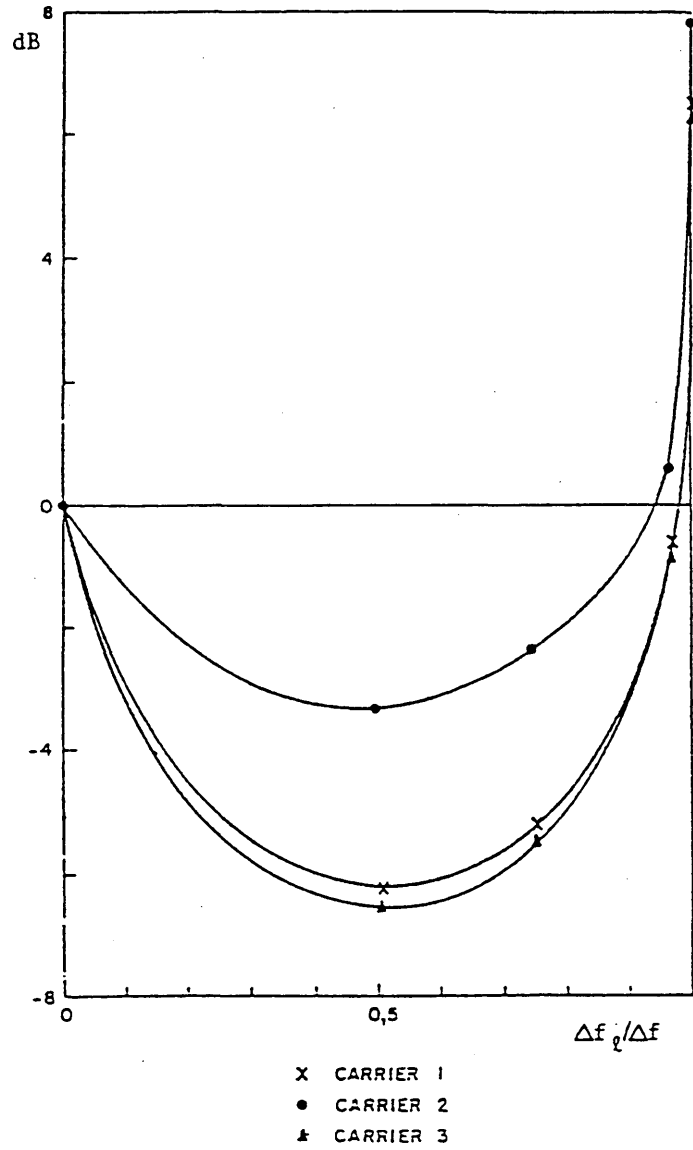

FIGURE 7

Excess of Interference with Respect to the Use of a Frame Rate Spreading Waveform as a Function of the Relative Intensity of the Line Rate Component, for 3 Different Interfered-With FDM/FM Carriers.

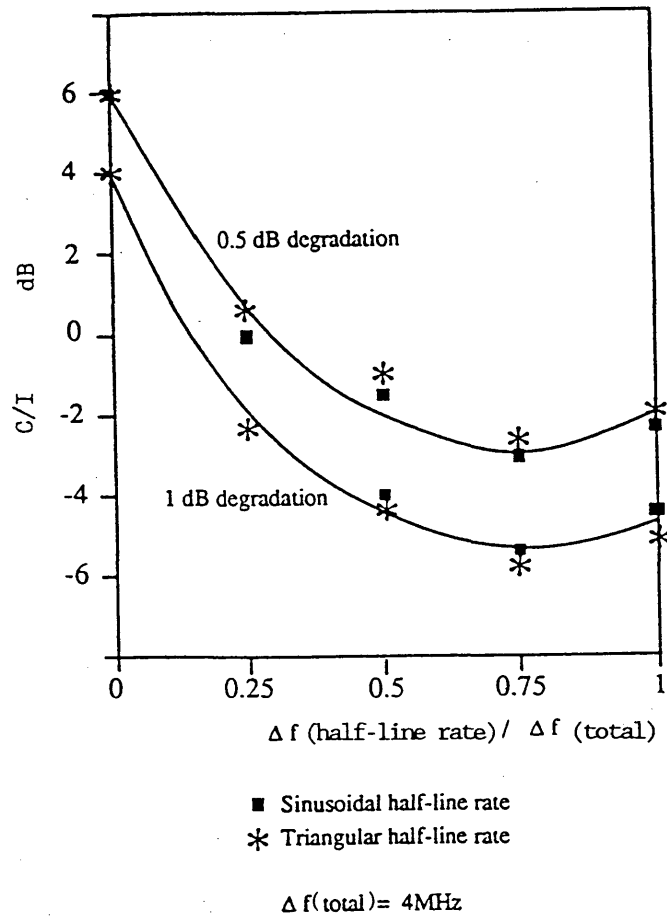

Figure 8 : Required C/I as a function of the relative intensity of the half-line rate component

Interference from a TV carrier using mixed (triangular frame rate / half-line rate) energy dispersal into a QPSK SCPC carrier at 64 kbit/s.

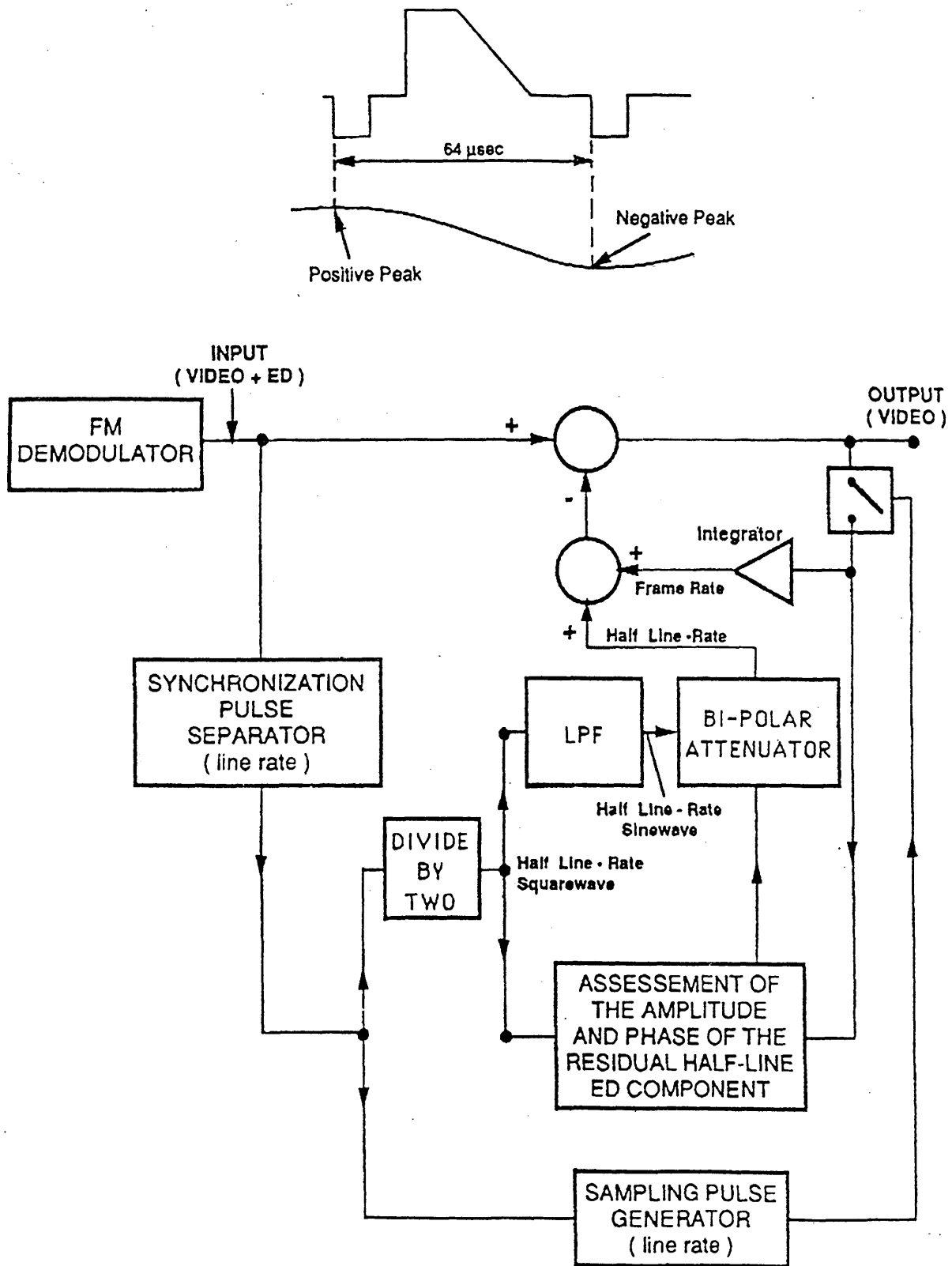

Figure 9: EXAMPLE OF A METHOD FOR THE REMOVAL OF A COMPOSITE FRAME RATE / HALF LINE - RATE ENERGY DISPERSAL WAVEFORM

REFERENCES

- ALBUQUERQUE, J.P.A. and MUKUNDA, R. [1984] - Interference effects from carriers modulated by a spreading waveform into FDM/FM and PSK carriers, INTELSAT technical memorandum, IOD-E-84-10.
- ALBUQUERQUE, J.P.A., MUKUNDA, R. and SHIMBO, O. [1986] - On the choice of an efficient TV energy dispersal waveform for interference reduction, IEEE Trans. on Comm., Volume COM-34, 965-969.
- BORODICH, S.V. [1976] Iskazheniya i pomekhi v mnogokanalnykh sistemakh radiosvyazi s chastotnoi modulyatsiei (Distortions and interference in multichannel FM radicomunication systems). *Sviaz*, Moscow, USSR.
- BORODICH, S.V. [1982] Rashchet pomekh vyzvannykh meshayushchimi signalami v sistemakh peredachi "odin kanal na kazhdoy nesushchei" (Calculation of interference caused by unwanted signals in SCPC transmission systems). *Trudy NIIR*, 4.
- DOBA, S. and RIEKE, J. W. [1950] Clampers in video transmission. *Trans. AIEE*, 69, 477.
- DOROFEEV, V.M. [1984] O vybere chastoty signala dispersii v sistemakh sputnikovoi svyazi (Choice of dispersal signal frequency on the satellite telecommunication lines. *Elektrosviaz*, 9, 8-10.
- DUTRONC, J., PHAM HUU N. and COLCY, J.N. [1989] - Spreading techniques to reduce FM/TV interference into SCPC signals. Proc. of 8th ICDSC Conference.
- GAY, Ph. [1986] - Effet de la dispersion d'énergie à fréquence ligne d'une porteuse TV-FM sur des liaisons SCPC-MDP4-MIC, CNET Note Technique NT/LAB/MER/207.
- HENRIQUES, H.A., and ALBUQUERQUE, J.P.A., [June 1987] - Interference from TV carriers modulated by a spreading waveform into digital carriers. Proceedings of the IEEE International Conference on Communications, Seattle, 50.3.1-50.3.5.
- KANTOR, L. Ya., MINASHIN, V. P., POVOLOTSKY, I. S., SOKOLOV, A. V. and TALYZIN, N. V. [1980] Sistema sputnikovogo televizionnogo veshchaniya "Moskva" (Television broadcasting satellite system "Moskva"). *Elektrosviaz*, 1, 6-10.
- KUMYSH, E. I. [1970] Obrabotka televizionnogo signala v liniyakh svyazi s chastotnoi modulyatsiei (TV signal processing in FM links). *Trudy NIIR*, 1.
- MUSTAFIDI, K. P. and FINOGEEV, G. M. [1976] Rasseyanie energii nesushchei pri peredache televideniya (Carrier energy dispersal in television transmission). *Elektrosviaz*, 1, 11-16.
- SAVAGE, D. C. [1962] Three types of television signal stabilizing amplifier. Report of International Television Conference, IEE, 251, London, United Kingdom.
- SHAVDIYA, Yu. D. and IGNATKIN, V. S. [1974], Predyskazhenie signalov tsvetnogo televideniya na liniyakh svyazi s CLM (Pre-emphasis of colour TV signals on FM links). *Trudy NIIR*, 4.
- YAM, S. E. [Spring, 1980] New TV energy dispersal techniques for interference reduction. *COMSAT Tech. Rev.*, Vol. 10, 1, 103-148.

ANNEX III

ENERGY DISPERSAL TECHNIQUES FOR USE WITH DIGITAL SIGNALS

1. General

When the information pulse train has a random pattern, the energy of the RF carrier is sufficiently dispersed to reduce the peaks of the power flux-density at the surface of the Earth produced by emission from the space station. If, however, the information pulse train includes a fixed pattern having a periodic repetition rate, some line components appear in the spectrum of the RF carrier, and it follows that some of the peaks of the power flux-density at the surface of the Earth may exceed the level recommended by the CCIR.

The purpose of the energy dispersal techniques described here is to reduce the peaks of the spectrum by producing a transmission pulse train similar to a random pattern, irrespective of any patterns in the information pulse train. Two methods of energy dispersal techniques are described in § 3.

2. Spectra of PSK digital signals

The power spectrum of a carrier modulated by ideal phase reversals consists of "lines" which for a pseudo-random sequence of N symbols of t seconds per symbol are separated by $1/Nt$ Hz. The power spectrum of these lines is given approximately by the following equation:

$$W(f) \approx \frac{1}{N} \left\{ \frac{\sin \pi (f-f_c)t}{\pi (f-f_c)t} \right\}^2 \delta \left(f-f_c - \frac{n}{Nt} \right) \quad (1)$$

where:

N : length of the pseudo-random sequence (symbols)

t : symbol duration (seconds)

n : integer

f_c : RF carrier frequency (Hz)

δ : delta function.

The largest line is at $n = 1$.

As the sequence length approaches infinity, $N \rightarrow \infty$ then $Nt \rightarrow \infty$, and the "line" separation $\rightarrow 0$. In this case the power spectrum becomes continuous and thus:

$$W(f) = t \left\{ \frac{\sin \pi (f-f_c)t}{\pi (f-f_c)t} \right\}^2 \text{ per Hz} \quad (2)$$

In this case, it is seen that the maximum spectral-density occurs at the carrier frequency.

Equation (2) shows the mean value of the power spectrum with the idealized situation of a random pulse train. The actual modulating signal may be far from random. For example, in the case of PCM telephony employing 8 bits per sample, there is likely to be considerable periodicity at one-eighth of the bit rate, and during periods of light traffic loading the situation could arise that the transmitted signal consists almost entirely of zeros. Under these conditions the PSK spectrum will have much of its power concentrated into one, or a few, spectral lines and the dispersal factor could approach 0 dB.

In addition to the non-randomness in the information part of the signal there will also be repetitive patterns in the preambles of time division multiple access (TDMA) transmissions.

Also, in a practical system, the spectrum will be modified by pulse phasing and/or post-modulator filtering. However, this will have greatest effect towards the edges of the spectrum and the maximum spectral-density will not be greatly affected.

To ensure a desired degree of dispersal a pseudo-random sequence of Nt duration can be modulo-2 added to the information bit or symbol stream, as shown in Fig. 10.

For a reference bandwidth of 4 kHz, an energy dispersal factor (D) may be defined as:

$$D = 10 \log \frac{\text{total power}}{\text{maximum power per 4 kHz}} \quad (3)$$

When a pseudo-random sequence is utilized for energy-dispersal the degree of dispersal can be estimated by equations (1) and (3) when $1/Nt \geq 4$ kHz and by equations (2) and (3) when $1/Nt < 4$ kHz.

As it is indicated by the preceding equations, the degree of dispersal is proportional to N as long as the sequence duration is less than the reciprocal of the reference bandwidth. There is little additional dispersal to be gained after the sequence duration reaches 250 μ s (4 kHz reference bandwidth).

3. Energy dispersal techniques

3.1 Method 1: Pseudo-random scrambler

This method consists of maintaining the transmission pulse train in a state similar to that which it would have for a random pattern, irrespective of channel occupancy, by synthesizing a pseudo-random sequence from the information pulse train generated in a pseudo-random code generator using an exclusive OR circuit (Modulo-2 Adder). A schematic diagram of an energy dispersal circuit of the transmitting unit is shown in Fig.10a. In a receiving unit a pseudo-random code generator, generating the same code pattern as that in the transmitting unit, recovers the original information by synthesizing the pseudo-random code sequence, generated by the pseudo-random code generator, with the transmission pulse train in an exclusive OR circuit. Fig.10b shows a schematic diagram of such a receiving unit.

One of the merits of this technique is that the energy-dispersal can be achieved without any degradation of the quality of the information pulse train. On the other hand, a disadvantage of this technique is that it necessitates the synchronization of the pseudo-random code generator in the receiving unit with the pseudo-random code generator in the transmitting unit. However, in the case of TDMA systems, the synchronization between both pseudo-random code generators can be effected by utilizing the burst synchronization signal already provided by the receiving unit, hence no additional device will be needed for synchronization.

It should be noted that the symbol (or "chip") rate of the pseudo-random sequence need not necessarily be equal to that of the information pulse train.

Experimental digital television transmissions via satellite have been conducted [Hopkins *et al.*, 1981] and the energy dispersal factor has been measured. With a 60 Mbit/s 4 PSK signal and an 11 stage Pseudo-Random scrambling sequence the measured energy dispersal factor was 37 dB. The theoretical optimum dispersal with this type of signal would be 38.7 dB.

3.2 Method 2: Self scrambler

In this energy dispersal technique, shift registers having a feedback loop and a feedforward loop are installed in the transmitting and receiving units, respectively. In the transmitting unit a code conversion is performed for each bit of the information pulse train. At the receiver, each bit of the transmission pulse train is reconverted to recover the original information pulse train. Typical circuit arrangements of such scramblers and descramblers are shown in Fig.11a and 11b respectively.

One of the merits of this energy dispersal method is that no synchronization is needed between the scrambler and the descrambler. On the other hand, there is a disadvantage in that, if r is the number of the stages of the shift register, the initial state of this register affects the first r bits of the transmission pulse train and consequently a single bit error in the RF transmission channel affects the r bits immediately following the error bit. This method, however, can be used together with error detection and correction; and it may represent a suitable energy dispersal method for use in PCM data transmission systems, especially those operating in the continuous mode as distinguished from the TDMA mode.

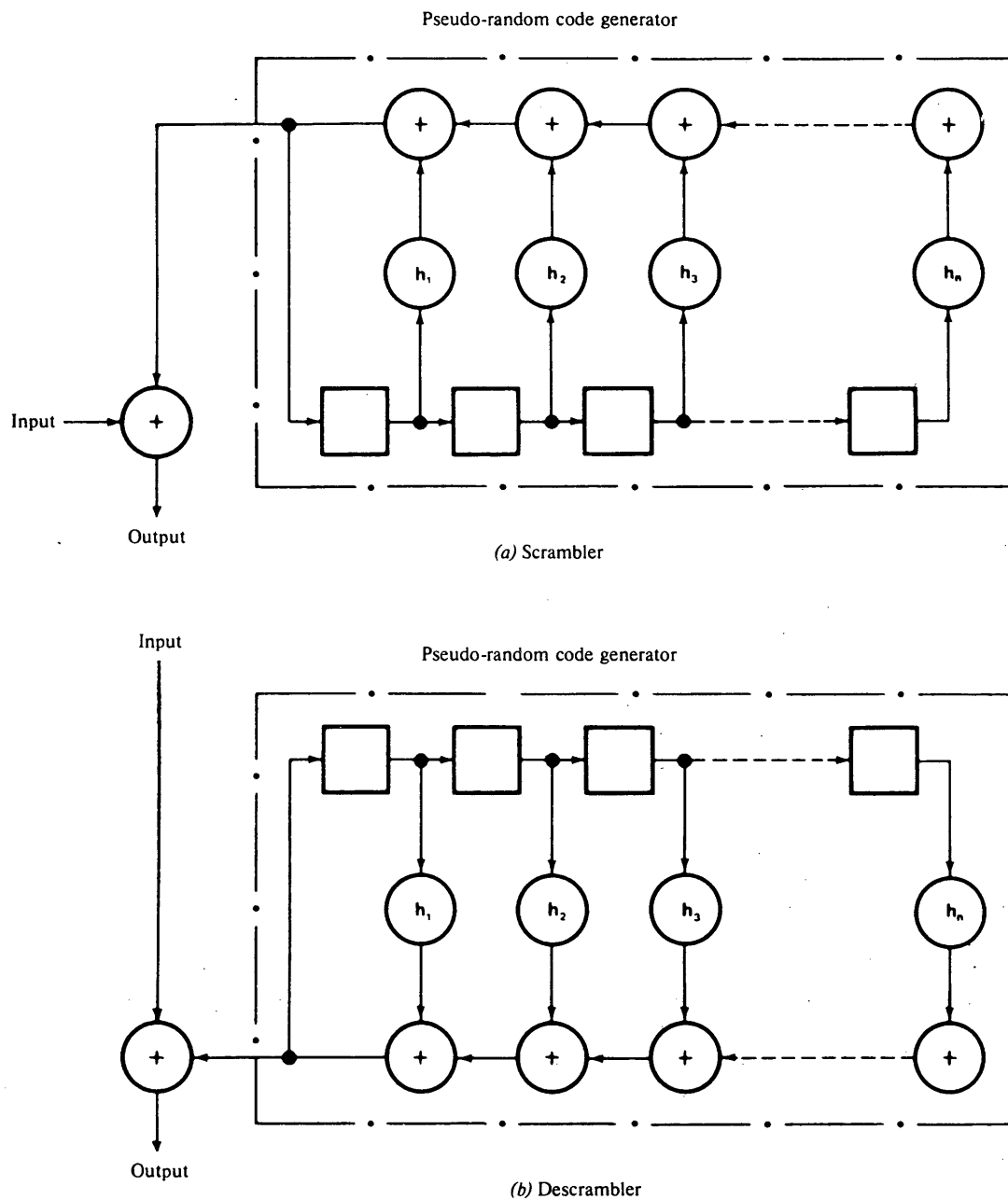
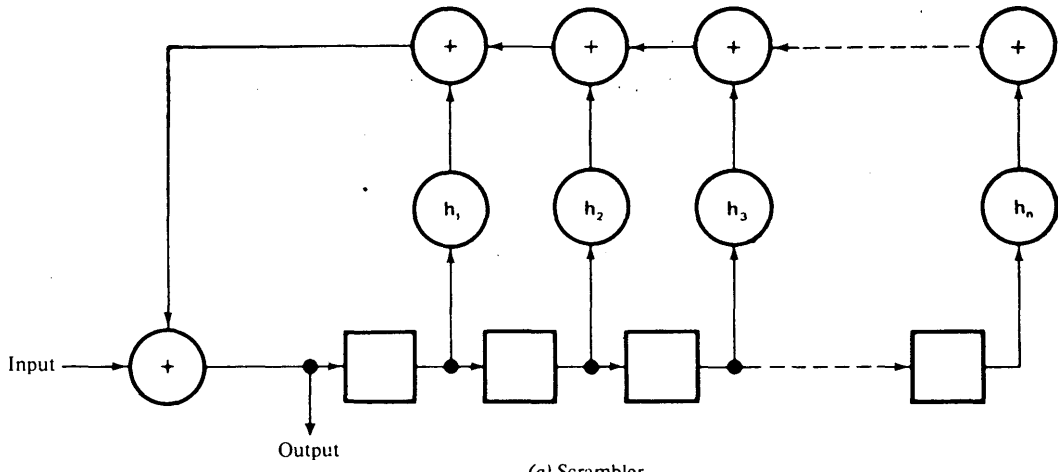
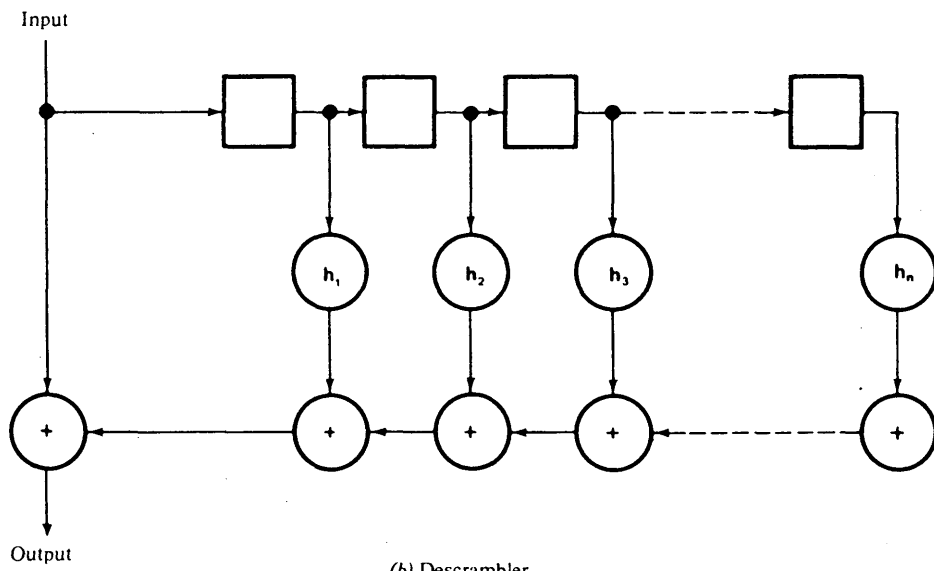

FIGURE 10. An example of energy-dispersal circuits using method 1

Note. — h_1, h_2, \dots, h_n represent the shift register internal connections which determine the code sequence.



(a) Scrambler



(b) Descrambler

FIGURE 11—An example of energy-dispersal circuits using method 2

Note. — $h_1, h_2 \dots h_n$ represent the shift register internal connections which determine the code sequence.

4. Energy dispersal factor for TDMA systems

The degree of dispersal obtained by Method 1 is directly proportional to the length of the pseudo-random sequence. However, there is no point in using a sequence which is greater than 250 μ s in duration since the spectral lines in the dispersed spectrum would then be at less than 4 kHz separation. In a TDMA system the pseudo-random signal generated at the receiver can be most readily synchronized with that at the transmitter, if the sequence starts again from the beginning in every TDMA burst. This means that sequence lengths will usually be less than 250 μ s and that the ideal dispersal will not be achieved.

The energy-dispersal effects for a TDMA signal depend on the length of the pseudo-random sequence, the frame length, the number of the bursts, the length of each burst, the scrambler methods and so on. If it is assumed for the sake of simplicity, that the length of each burst is equal to, or less than, 250 μ s, and that each burst is scrambled by the same pattern of the pseudo-random sequence in every frame, the energy dispersal factor (D) can be given approximately by the following equations:

$$D = 10 \log N + 10 \log B - K, \text{ when } N < M \quad (4)$$

$$D = 10 \log M + 10 \log B - K, \text{ when } N > M \quad (5)$$

where:

N : length of the pseudo-random sequence (symbols),

M : length of the information sequence (symbols),

B : number of the bursts in one frame,

K : margin for the energy-dispersal effect.

In the above equations, K is the statistical variation term indicating the decreasing degree of the energy dispersal effects caused by:

- the effect of the partial coincidence between an information sequence and a pseudo-random sequence;
- the effect of the difference between the length of the information sequence and that of the pseudo-random sequence;
- the effect of the carrier phase coherency between the bursts.

Among these effects, the first can be evaluated as follows: when the information sequence has weak frame correlation, the margin due to partial coincidence depends on the observation period of the power spectrum. On the other hand, when the information sequence has strong frame correlation, almost the same sequence pattern would be generated in every frame, so that its margin can be estimated by regarding the frame period as the observation period mentioned above.

The second effect could be made negligibly small by properly choosing the degree and the initial value of the pseudo-random sequence, if the length of the pseudo-random sequence is less than several times that of the information sequence.

The third effect is also negligibly small, since the carrier frequency of each burst is usually different by more than several hundred Hz from the adjacent bursts.

Clearly, the complexity of the system is greatly reduced if the pseudo-random sequence is applied only to the information part of the signal and not to the preamble of a TDMA burst. Generally the preamble will consist, at least in part, of a simple repetitive pattern. In some cases, it may even contain a period of unmodulated carrier. The results presented in Table III, below, show that for a repeated 0011 preamble pattern in a 4-phase PSK system, the preamble will not contribute significantly to the maximum spectral-density except perhaps for low bit rate systems. Other preamble patterns having the same duration as that assumed for Table III would be no more than 3 dB worse.

To illustrate what dispersal factors might be achieved in practice, Table III shows the values for a TDMA system in which the preamble is not dispersed. Certain assumptions were made as follows:

- frame length, 125 μ s;
- modulation, 4-phase PSK;
- preamble signal, 40 bits of alternating 0011;
- carrier frequencies of all stations are within 4 kHz of each other, but the symbol timing of different stations is not necessarily in phase;
- pseudo-random sequence generators are reset after every burst.

Statistical variation of the power spectrum is such that 1% of the spectral lines will exceed the r.m.s. envelope by 6.5 dB.

The calculation of maximum spectral power density determined by preambles in the 4 kHz band [CCIR, 1986-1990] shows that in some situations with a relatively high frame or packet preamble content and large earth station networks (for systems using variable-duration packets) the sync signal spectral power density may exceed the corresponding spectral power density of the information part of the signal. This phenomenon is more pronounced at low bit rates and long frame durations.

TABLE III — Illustrative energy-dispersal factors for a range of pseudo-random sequence lengths

Bit rate (Mbit/s)	Single access			10 equal station access						Resultant dispersal factors (dB)		
	Dispersal factors (dB)			Maximum power in a 4 kHz band (dB relative to total steady power)								
							(a) due to preambles			(b) due to information		
	10	50	250	10	50	250	10	50	250	10	50	250
Random modulating signal	31	38	45							31	38	45
127 bit pseudo-random sequence	12	12	12	-23	-37	-51	-20	-22	-22	20	22	22
511 bit pseudo-random sequence	18	18	18	-23	-37	-51	-20	-28	-28	20	28	28
2 047 bit pseudo-random sequence	24	24	24	-23	-37	-51	—	-29	-34	—	29	34
32 767 bit pseudo-random sequence	25	32	36	-23	-37	-51	—	—	-36	—	—	36
Typical fully loaded FM system occupying same bandwidth as the digital system (based on Gaussian spectrum and a ratio of RF bandwidth to baseband width equal to 15)	27	34	41									

5. An example of energy dispersal applied to an experimental TDMA system

Method 1 energy-dispersal techniques were utilized in the TTT system, an experimental, 50 Mbits/s TDMA system developed in Japan for use in satellite radiocommunications systems. In this system, only the information bits are scrambled, yet it is found that the peak value of the power spectrum is suppressed by about 20 dB.

It is noted that when energy dispersal using a pseudo-random sequence is applied to a TDMA system, the probability of false detection of a given "unique word" may increase to an extent depending on the manner in which the burst is synchronized.

False detection of the unique word can be avoided by changing the initial state of the pseudo-random sequence for every frame.

REFERENCES

- HOPKINS, D. K. W., OSBORNE, D. W., WELLS, N. D., WILSON, E. J. [1981] Experimental digital television transmissions through the OTS. Report of International Conference: Results of tests and experience with the European Test Satellite. IEE, London. Conf. Publ. No. 199.

CCIR Documents

[1986-1990]: 4/30 (USSR)

- JEFFERIS, A. K. [May, 1973] Spectral-energy dispersal in digital communication-satellite systems. *Proc. IEE*, Vol. 120, 5, 529-532.

REPORT 553-3

**OPERATION AND MAINTENANCE OF EARTH STATIONS
IN THE FIXED-SATELLITE SERVICE**

(Question 20/4)

(1974-1978-1982-1986)

1. Introduction

In addition to an appropriate organization responsible for the operation and maintenance of earth stations forming part of systems of the fixed-satellite service, some technical facilities are necessary for the line-up and maintenance of satellite radio links and communication equipment installed at earth stations.

To perform the necessary measurements over single or multiple destination satellite radio links, close co-operation is necessary between the earth stations. Comprehensive end-to-end measurements will have to be performed when the links are initially placed into service and also during the operation of the system.

The technical facilities referred to above consist of measuring- and test-instruments having performance characteristics which are based on the operational requirements and performance objectives specified for the system of the fixed-satellite service concerned.

For reasons of economy, it may be desirable to design earth stations to operate unattended by technical personnel for several hours each day or for several months at a time. Such earth stations are now in operation in regional networks.

2. Compatibility of equipment

In order to allow the measurements to be performed with the required accuracy and permit correct interpretation and comparison, compatible test instruments are required at all earth stations of a common satellite system. Furthermore, under special circumstances, for example when a carrier cannot be received on a looped back basis from the satellite, a facility for an "automatic report back" of test results would be very helpful, and this also would require compatibility of methods and equipment.

To obtain such compatibility, the characteristics of test instruments have in some cases been included in CCIR and CCITT Recommendations (for example Recommendation 482). International agreement has also been obtained for other equipments, for example, microwave link analyzers as used in the INTELSAT system. Furthermore, reference is made to IEC Publication 510 in which measurement methods for satellite earth stations are defined.

It is important that technical documents should be furnished by administrations so that the best possible specifications based on economic and technical considerations can be prepared, e.g. Annex I sets forth the reasons for the specification of filters in Recommendation 482, and Annex II deals with the compatibility of procedures and equipment for measurement of IF and baseband transmission parameters.

3. Equipment utilization

Procurement and storage of test instruments at earth stations would be simplified if it were possible to keep the number of necessary instruments to a minimum. Therefore, multi-purpose, multi-range instruments may be considered, taking into account the relevant reliability and availability aspects. As an example, when considering video test instruments for use in the intercontinental links in the fixed-satellite service, it is desirable that these test instruments can be used for measurements on 525/60 and 625/50 black-and-white and 525/60 NTSC, 625/50 PAL or 625/50 SECAM colour television systems.

Optimum utilization of test instruments at earth stations would be achieved if these instruments were purchased in accordance with uniform specifications agreed upon at an international level. This will avoid high investments for test equipment which might become obsolete after a short time of use.

4. Automatic test equipment

With system growth it can be expected that the large number of measurements necessary to facilitate system operation will require test instruments which will:

- considerably shorten measuring times;
- diminish as much as possible, human errors during measurements;
- require a minimum of manual control.

Consequently, automatic test instruments will be of increasing importance at earth stations, because such instruments are normally suited for both automatic and manual operation.

It may be possible for attending technicians to transport and utilize such test equipment when performing normal maintenance functions in unattended earth stations. Modern test equipment fulfils the above conditions. This was proved in a field trial performed between two earth stations, which is dealt with in Annex III.

5. List of equipment

As far as FDM-FM-FDMA modulation systems are concerned, typical lists of equipment have been prepared for specific systems [INTELSAT, 1971].

6. Design of unattended earth stations

One approach to the design of unattended earth stations is to:

- design the equipment from the outset to comply with the nominal characteristics during normal working, without a redundant chain of components kept on passive standby;
- ensure that a breakdown in any sub-system component would not result in the sub-assembly ceasing to function completely, but only in a deterioration in its characteristics;
- define parameters to guarantee continuity of service despite possible failures in certain sub-assemblies;
- reduce to a minimum the control and command equipment and to design them to offer a much higher degree of reliability than the routine components in the station.

The amount and type of control and monitor equipment to be incorporated into an unattended earth station should be determined by an analysis of the earth station availability and the grade of service required.

Guillarme and Penicaud [1975] and Lombard and Viana [1972] suggest possible modifications of the transmission parameters to enable service to be maintained under degraded equipment conditions, while Plottin [1975] briefly reviews methods which may be used to detect faults, to formulate commands and to ensure remote supervision of the essential transmission characteristics.

If an unattended small earth station lacks independent equipment for the transmission of monitoring signals to and the reception of central signals from a central station, the satellite link itself may be used for monitoring and remote control of the station by means of a voice channel activated from time to time. This is technically feasible without major problems, but high availability requirements may involve the need for redundancy of all essential functional units and automatic switch-over in the event of failures.

An example of a monitoring and control system is that designed for the internal network of earth stations of the TELECOM-1 system. These earth stations will be installed in the immediate vicinity of the user's premises and will be unmanned, with remote supervision from regional centres. An earth station includes a local management device comprising a microprocessor backed by appropriate memory units which enable the required management parameters to be extracted and displayed locally or remotely at a management centre: for example, input and output power of high power amplifier (HPA), alarms, on-off status of equipment, bit error ratio, etc. The management centre is equipped with a minicomputer which stores and processes the data on the status of the stations it controls, and produces station logistic data needed for the maintenance and support of the station. These management equipments permit the installation of networks comprising a large number of unmanned earth stations, and important savings in operational costs compensate largely for the additional expense entailed in providing them at the earth stations.

Modern monitoring systems based on microcomputer techniques offer the possibility of monitoring permanently or temporarily unmanned earth stations from a central control station. Experience with RAISTING 4 and 5 and USINGEN 1 has shown that multi-level microcomputer-assisted monitoring systems are particularly suitable for this purpose. The modular design of, for instance, a 3-level system, ensures sufficient flexibility for adaptation of operational requirements and allows a reasonable division of tasks between the centre and the associated earth stations.

The following functions may be fulfilled by the different levels:

First level is the equipment level. It issues alarms and status reports, provides switch over and adjustment instructions and receives status enquiries.

Second level is the earth-station level where more extensive status information can be obtained from reports of individual units and evaluated. Alarms or changes in status referring to the equipment are logged at this level by means of a printer.

The third level represents the central station for the remote control of several associated earth stations. It is the task of the central station to supervise the services (traffic relations) routed over satellite radio links and to carry out other activities such as service switching which are suitable for centralized treatment. Equipment switching or controlling instructions can also be carried out from this level.

REFERENCES

- GUILLARME, P. and PENICAUD, E. [11-13 November, 1975] Organisation d'un module d'interface AMRT à accès numérique réalisant la concentration de circuits par interpolation de la parole, Troisième Colloque international sur les télécommunications numériques par satellite, Kyoto, Japan.
- INTELSAT [1971] Satellite system operations guide. Vol. II.
- LOMBARD, D. and VIANA, O. [28-30 November, 1972] Concentration de la parole et accès multiple — Deuxième Colloque international sur les télécommunications numériques par satellite, Paris, France.
- PLOTTIN, G. [1975] Systèmes de réception à faible bruit et d'amplification de puissance pour stations terriennes sans surveillance. *Rev. des Télécomm.* 50, 160.

ANNEX I

CHOICE OF FILTER CHARACTERISTICS FOR PERFORMANCE
MEASUREMENTS USING WHITE NOISE TEST SIGNALS

When considering specifications for filters used for white noise performance measurements, two main criteria have to be taken into account:

- centre frequency;
- bandwidth characteristics.

1. When choosing the centre frequency it should be ascertained whether a suitable frequency for the channel size in question has already come into widespread use. (See Table II of Recommendation 482-2).

When centre frequencies have to be chosen which are not yet specified the preferred frequencies should be those which can be used for as many channel capacities as possible. If a new upper measuring frequency is needed and if there is no recommended frequency in the range between 0.9 and 0.965 of the effective cut-off frequency, a measuring frequency of approximately 0.95 of the effective cut-off frequency of the band-limiting low-pass filter should be chosen.

2. When specifying the bandwidth characteristics of new filters, a choice has to be made between coil-capacitor-type or crystal-type filters. For frequencies higher than 3886 kHz it seems desirable to use crystal-type filters.

Figure 1 shows the bandwidth (\pm kHz) of the various band-stop filters tabulated in Table II of Recommendation 482. These curves demonstrate that a set of generalized curves can connect the various values, and consequently any new filter specifications can be directly read off the diagram. As an example, dropping a vertical line from the 185 kHz centre frequency filter produces intercepts — at the following bandwidth points: ± 17 , ± 5 , ± 2.2 , ± 1.8 and ± 1.5 kHz. Reading from right to left on Table II these figures are noted.

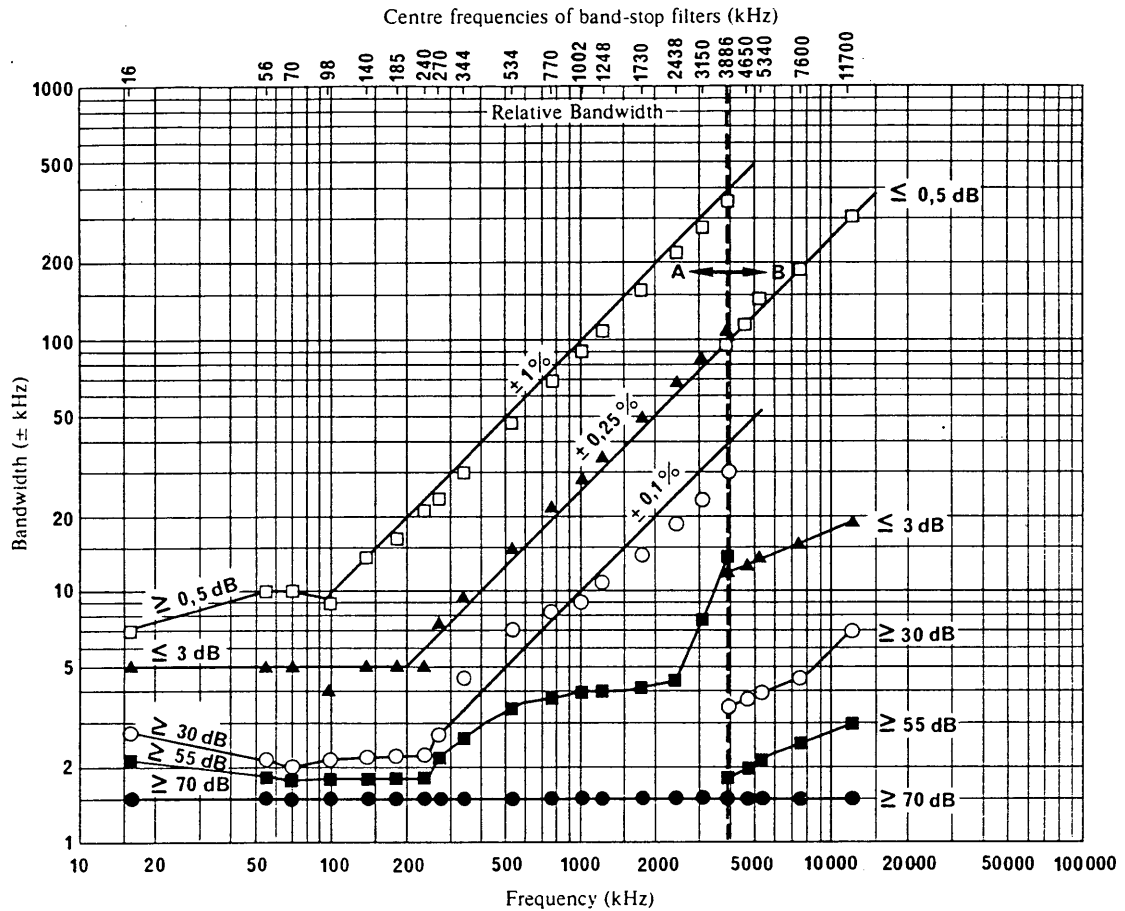

FIGURE 1 — Bandwidth (in ± kHz) of band-stop filters as contained in Table II of Recommendation 482

A: Coil-capacitor-type filters
 B: Crystal-type filters

ANNEX II

COMPATIBILITY OF PROCEDURES AND EQUIPMENT USED FOR MEASURING OF IF AND BASEBAND TRANSMISSION PARAMETERS IN THE FIXED-SATELLITE SERVICE

1. Introduction

It is necessary to measure transmission parameters or distortions both of single components and entire transmission systems — the latter being a link measurement with inclusion of one or several satellites. This means that the measurement equipment used for this purpose and produced by different manufacturers must be compatible with the measurement procedures and important parameters such as frequencies.

2. Compatibility of the measurement procedures

The IEC Sub-Committee 12E has made efforts to standardize the measurement procedures for all frequency levels involved: baseband, intermediate and radio frequencies.

IEC Publication 510 describes methods of measurement for radio equipment used in satellite earth stations, and IEC Publication 487 is concerned with methods of measurement for equipment used in terrestrial radio links. These publications define the same measurement procedures for both user groups, thus ensuring the compatibility of the measurement procedures.



3. Compatibility of the frequencies

The distortion measurement procedures mentioned above use a low sweep frequency f_S and several higher modulation frequencies f_M . Link measurements can only be carried out if the transmitter and receiver are provided with the same sweep and modulation frequencies.

3.1 Existing standards

For the area covered by the INTELSAT system, the compatibility of measurement equipment produced by different manufacturers was ensured by the following definitions shown in Table I.

TABLE I – INTELSAT frequencies

Frequency	Value	Tolerance	Measured parameters
Sweep frequency	18 Hz	$\pm 5\%$	–
Modulation frequency	92.5926 kHz 277.778 kHz	$\pm 20 \times 10^{-6}$ $\pm 20 \times 10^{-6}$	Non-linearity and group-delay distortion

Both chrominance subcarrier frequencies commonly in use have been accepted by INTELSAT.

The centre frequency used for measurements at the IF level is 70 MHz.

In the course of several generations of measurement equipment for radio relay systems certain measurement frequencies have been preferred and it would be advantageous to extend these frequencies to cover satellite communication systems. The preferred frequencies are shown in Table II.

TABLE II – Measurement frequencies used in terrestrial systems

Sweep frequency	Modulation frequencies	IF centre frequencies
70 Hz	83.333; 250; 500 kHz 2.4; 5.6; 8.2; 12.39 MHz 3.58 or 4.43 MHz (optional)	35; 70; 140 MHz

3.2 Extension of existing frequency standards

Whereas a sufficient number of modulation frequencies is available for terrestrial radio-relay systems, there are two additional frequency requirements for satellite systems, viz.:

- high modulation frequencies for measurements of differential phase and differential gain;
- a low modulation frequency, below 60 kHz, for measurements of non-linearity and group delay distortion in the newly introduced systems with 12 channels.

The preferred values proposed for satellite systems are shown in Table III.

TABLE III – Proposed frequencies from the INTELSAT system and additional frequencies from Table II

Frequency	Value	Tolerance	Measured parameters
Sweep frequency	18 Hz, 70 Hz	$\pm 5\%$	–
Modulation frequencies	55.5556 kHz 92.5926 kHz 277.778 kHz	$\pm 20 \times 10^{-6}$ $\pm 20 \times 10^{-6}$ $\pm 20 \times 10^{-6}$	Non-linearity and group-delay distortion
Optional frequency	3.58 MHz 4.43 MHz 8.2 MHz	$\pm 20 \times 10^{-6}$ $\pm 20 \times 10^{-6}$ $\pm 20 \times 10^{-6}$	Differential phase and differential gain

It is noted that for systems having very narrow bands, it is convenient to use integer fractions of already defined modulation frequencies.

A higher intermediate frequency may become necessary for transponder bandwidths exceeding 36 MHz. For this purpose, it seems convenient to use the frequency of 140 MHz defined in Recommendation 403.

ANNEX III

COMPUTER-AIDED LINE-UP OF A SATELLITE RADIO LINK

A typical line-up measurement is described in the INTELSAT Satellite Systems Operations Guide (SSOG), Volume II, § 7.

The tests to be performed between two earth stations (§ 7.2.2 to 7.2.9) are listed in Table IV.

TABLE IV – *Line-up tests and equipment required*

SSOG (§)	Title	Type of test equipment (¹)	Remarks
7.2.1	RF carrier frequency, EDF, e.i.r.p. and (C/N)		In-station test with monitor station
7.2.2 7.2.3	IF-to-IF frequency response IF-to-IF group delay response	A radio link measuring set (microwave link analyzer = MLA)	Earth station to earth station tests
7.2.4 7.2.5	Test-tone deviation and baseband level 60 kHz continuity pilot level	A level measuring set	
7.2.6	BB-to-BB non-linearity response	A radio link measuring set (microwave link analyzer = MLA)	
7.2.7 7.2.8	BB-to-BB frequency response BB-to-BB noise spectrum	A level measuring set	
7.2.9	White noise loading	A white noise measuring set	

(¹) All equipment has to be remote-controllable via IEC 625 or IEEE 488 bus.

Set-up and procedure for the field trial conducted in July, 1984.

Figure 2 is a block diagram showing the identical test set-ups at both earth stations (Raisting, Federal Republic of Germany and Ceduna, Australia).

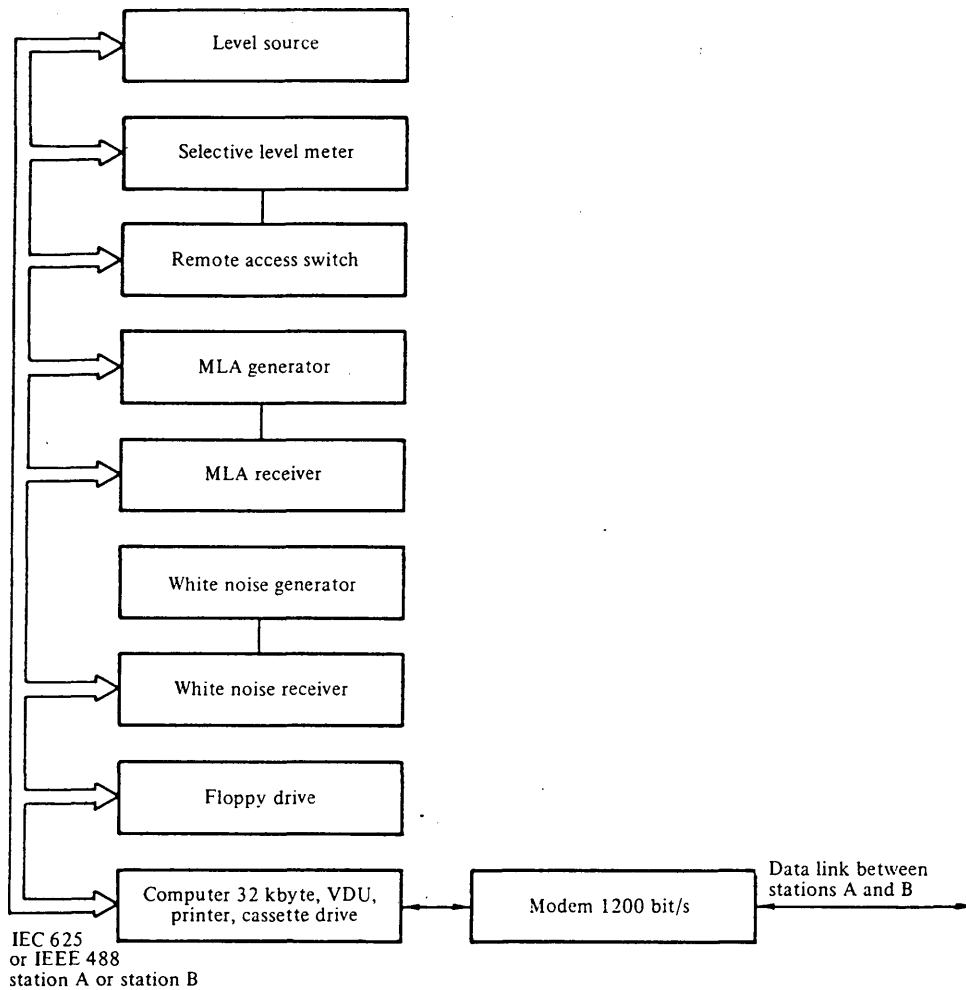

FIGURE 2 – Test set-ups at both earth stations (A and B)

At any time, one station acted as the master and the other as slave or *vice versa*. The master station was always the receiving station, the generating station was the slave station.

All initial settings of the instruments in master and slave station were carried out by the computer of the master station.

The complete system was operated via an extensive dialogue in clear text with the computer of the master station. On both computers (master and slave) there appeared clear instructions as to which manual operations were required by the operator at each particular stage of the measuring routine.

The computers communicated with each other via a 1200 bit/s data link.

Manual methods were used and will be used in future also to connect the measuring system with the test points of the telecommunications system and to switch the continuity pilot, pre- and de-emphasis and the energy dispersal function.

Besides a remarkable gain of time, a considerably better measurement security was achieved, which is an additional advantage. Wrong settings became practically impossible because all settings were automatically carried out according to dialogue instructions and in critical cases also via control loop (back-to-back in the station) with acknowledge signal to the master.

REPORT 554-4

THE USE OF SMALL EARTH STATIONS FOR RELIEF OPERATION
IN THE EVENT OF NATURAL DISASTERS AND SIMILAR EMERGENCIES

(Study Programme 22A/4)

(1974-1978-1982-1986-1990)

1. Introduction

At the World Administrative Radio Conference for Space Telecommunications, held in Geneva in 1971, Recommendation Spa2 - 13 of the Final Acts was put forward to plan and organize the use of satellite telecommunications in natural disaster areas. It is believed that the rapid availability of reliable communications immediately following a natural disaster would prove helpful in saving lives by virtue of improved relief activity co-ordination.

This Report discusses the configuration and characteristics of air transportable and vehicle equipped earth stations designed for use with geostationary satellites in the fixed-satellite service.

The discussion covers some possible types of modulation, required bandwidth, satellite e.i.r.p., earth-station e.i.r.p., low-noise receiver characteristics and high-power amplifier requirements, as well as antenna system parameters.

The parameters given below generally assume that the earth stations may need to operate with a global beam satellite transponder. If a station will be required to operate only within a region covered by a shaped satellite beam, it may be possible to relax these parameters.

2. Basic consideration

In the event of natural disasters, epidemics and famines, etc., the most urgent need is for a reliable communication link for use in relief operations. To set up these communications by the fixed-satellite service, it is desirable that a transportable earth station, with access to an existing satellite system, should be available for transportation to, and installation at, the disaster area.

To establish such a communication service, any satellite system compatible with the technical characteristics of the transportable earth station can be used.

2.1 Required services and associated channel capacity

The communication link for the relief operation connects the disaster area with designated relief centres, and the required transmission capacity would be at most 6 telephony circuits (including teletype) and an engineering service channel.

In addition, because a real time aerial site survey of the disrupted area is also considered to be highly desirable to better coordinate relief operations (priority evaluations), in some instances a one-way 2.048 Mbit/s, video-compressed channel could also be needed. Furthermore, a network of unattended platforms for continuous monitoring of main environmental data (1.2 kbit/s average throughput) on specific risk parameters can usefully integrate the emergency communications network covering the whole concerned territory, in order to help in the timely location of the disaster area [Lembo and Quaglione, 1987].

2.2 *Circuit quality*

The quality of circuits for emergency relief operations need not necessarily be of the high quality recommended by the CCIR for the fixed satellite service. An equivalent weighted signal-to-noise ratio of about 30 dB for a voice channel would appear to provide acceptable voice intelligibility for this purpose, but this will need further study.

2.3 *Selection of frequency band*

Geostationary satellite systems now operate in the 4 and 6 GHz bands, and therefore it is desirable at present to use these bands for the relief operation.

Where suitable satellites are available, it is preferable that relief operations should be conducted in bands which are not generally shared with terrestrial facilities. Bands such as 14/12 GHz and 30/20 GHz may be suitable in some circumstances.

2.4 *Associated earth station*

The transportable earth terminal could operate with any suitable existing earth station provided it is suitably equipped. Suitable earth stations would need to be identified so that they may be provided, in advance, with the additional equipment.

3. Preferred modulation methods

The choice of the form of modulation best suited to a system using a transportable earth station must take account of the power-limited condition of the down link together with the need for flexibility of access to the satellite system.

Of the several modulation methods described in Reports 509, a station of this type might employ frequency division multiplex FM, or single-channel-per-carrier (SCPC), FM, PCM/PSK, delta-modulated PSK.

The single-channel-per-carrier PCM/PSK has been in operation already, for example, in the SPADE system; but the other two single-channel-per-carrier systems are not in current use on a global basis. Companded single-channel FM and delta-modulation (DM/PSK) systems, however, are more effective in a power-limited environment. System efficiency may be further improved by use of forward error-correction coding techniques.

Examples of the required satellite e.i.r.p., the earth station e.i.r.p. and the bandwidth required for these modulation methods are shown in Table I. Some of the satellite e.i.r.p.'s shown in Table I may not be available in current satellite systems. It should also be noted that the subjective quality of transmission of each of the systems examined is not necessarily similar. Further studies on this point are necessary.

4. Characteristics of the transportable earth station

4.1 *System G/T ratio*

In the 4 GHz band, it will be reasonable to consider a system G/T in the range of 17.5 to 23.5 dB(K⁻¹) as an objective, but further study is necessary. Assuming an uncooled parametric amplifier of noise temperature of about 50 K and an antenna elevation angle of 10°, these values correspond to antenna diameters in the range 2.5 m to 5 m approximately.

In the 11 to 13 GHz bands, typical receiver noise temperatures range from 100 K (parametric amplifier) to 400 K (FET amplifier). With antennas having diameters around 3 m, G/T between 19 to 25 dB(K⁻¹) could be achieved.

In the 20 GHz band, it will be reasonable to consider a system G/T in the range of 14.5 to 24.5 dB(K⁻¹) as an objective. Assuming an FET amplifier of noise temperature of about 750 K, these values correspond to antenna diameters in the range of 1 m to 3 m approximately.

4.2 *Earth-station e.i.r.p.*

The earth-station e.i.r.p. depends on the type of modulation, the transmitting telephony capacity, and the satellite characteristics.

However, in case of multi-carrier operation, such as the SCPC transmission, the maximum output power of the transmitter must take account of a back-off level to reduce intermodulation noise to an acceptable level. Table I shows typical e.i.r.p. required for the transportable earth station.

5. Configuration of the transportable earth station

The earth station may be divided into the following major sub-systems:

- antenna,
- power amplifier,
- low-noise receiver,
- ground communication equipment,
- control and monitoring equipment,
- terminal equipment, including teleprinters and telephones,
- support facilities.

TABLE I — Examples of transmission system parameters in 6/4 GHz band

G/T ratio $\text{dB}(\text{K}^{-1})$ (diameter)	Type of modulation	Bandwidth per carrier	Satellite e.i.r.p. per carrier	Earth station e.i.r.p. per carrier	Earth station transmit power per carrier	Circuit quality (clear sky condition)
17.5 (2.5 m)	FDM-FM (for 6 ch)	250 kHz	14 dBW	57.5 dBW	45 W	S/N 30 dB
	SCPC 64 kbit/s PCM-QPSK	45 kHz	11 dBW	* 54.5 dBW	22 W	Bit error-rate: 10^{-4}
	SCPC 32 kbit/s Δ M-BPSK	45 kHz	5 dBW	48.5 dBW	5.6 W	Bit error-rate: 10^{-3}
	SCPC companded FM	30 kHz	1 dBW	44.5 dBW	2.2 W	S/N 22 dB (without compandor)
23.5 (5 m)	FDM-FM (for 6 ch)	250 kHz	8 dBW	57.5 dBW	11 W	S/N 30 dB
	SCPC 64 kbit/s PCM-QPSK	45 kHz	5 dBW	54.4 dBW	5.6 W	Bit error-rate: 10^{-4}
	SCPC 32 kbit/s Δ M-BPSK	45 kHz	- 1 dBW	48.5 dBW	1.4 W	Bit error-rate: 10^{-3}
	SCPC companded FM	30 kHz	- 5 dBW	44.5 dBW	0.6 W	S/N 22 dB (without compandor)

Note 1. - In the FDM-FM and S.C.P.C. companded FM systems, the use of a threshold extension demodulator is assumed.

Note 2. - Values of satellite e.i.r.p. and earth station e.i.r.p. are for a small earth station with antenna elevation of 10° excluding any margin. Earth stations with which the small earth station is communicating have a G/T of $40.7 \text{ dB}(\text{K}^{-1})$.

Note 3. - Satellite transponder characteristics are similar to those of the INTELSAT-IV global beam transponder and the transponder gain is assumed such that the difference between earth station e.i.r.p. and the corresponding satellite e.i.r.p. is 65 dB.

5.1 Weight and size

All the equipment, including shelters, should be capable of being packaged into units of weight which can be handled by a few persons. Furthermore, the total volume and weight should not be in excess of that which could be accommodated in the luggage compartment of a passenger jet aircraft such as a Boeing B707 (allowable weight 7000 kg) or a Douglas DC8-62 (allowable weight 10 000 kg). This is readily attainable with present-day technology.

5.2 *Antenna*

The form and dimension of an antenna are determined by the required gain and noise temperature. Other factors such as climatic conditions, the maximum weight and the ease of satellite acquisition and tracking, should also be considered.

One of the major requirements for the antenna is ease of erection and transportation. For this purpose, the antenna reflector could consist of several panels made of light material such as fibre reinforced plastic or aluminium alloy. The use of an antenna of a diameter from 2.5 to 6 m is foreseen.

The main antenna reflector may be illuminated by a front-fed horn or a feed which includes a sub-reflector. The latter type may have a slight advantage in G/T performance, since the curvature of both the sub-reflector and main reflector can be optimized, but ease of erection and alignment may take precedence over G/T considerations.

A manual or automatic pointing system may be provided commensurate with weight and power consumption, by monitoring a carrier signal from the satellite, having a steerable range of approximately $\pm 5^\circ$.

5.3 *Power amplifier*

Air-cooled Klystron and TWT (helix-type) amplifiers are both suitable for this application, but from the point of view of efficiency and ease of maintenance, the former is to be preferred.

Although the instantaneous transmission bandwidth is small, the output amplifier may need to have the capability of being tunable over a wider bandwidth, e.g., 500 MHz, since the available satellite channel may be anywhere within this bandwidth.

In the 30 GHz band, IMPATT, TWT and Klystron are suitable for this application.

The output powers required will be as given in the examples of Table I.

5.4 *Low-noise receiver*

Because the low-noise receiver must be small, light and be capable of easy handling with little maintenance, an uncooled parametric amplifier is the most desirable.

The noise temperature of this type of receiver is being improved year by year. A temperature of 50 K has been realized and even lower temperatures are expected in the future in the 4 GHz band. An FET amplifier is more suitable from the point of view of size, weight and power consumption than a parametric amplifier, but the noise temperature of the former is higher than the latter. A noise temperature of 100 K in the 4 GHz band and 400 K in the 12 GHz band has been realized by FET amplifiers. In the 20 GHz band, an FET amplifier with a noise temperature of 300 K or less at room temperature has been realized.

6. **Examples of small transportable earth stations**

In the 6/4 GHz band, a number of transportable earth stations are operating now with various antenna diameters. In the 14/12 GHz band, most of the transportable stations have antennas with around 3 m diameters.

6.1 *An example of a small transportable earth station for operation at 6/4 GHz*

An air-transportable earth station, which may also be carried by an 8-ton truck, has been manufactured using the principles outlined in § 5 above and satisfactory performance has been achieved [Okamoto *et al.*, 1977].

The station has a 3-metre diameter antenna, a peak e.i.r.p. of about 66 dBW and a G/T of about 20 dB(K⁻¹). The total weight is 5.5 tons and the power requirement, including air conditioning, is 7.5 kVA. The reflector is divided into seven sections each weighing about 20 kg, the total setting up time being about 2 hours by three persons. The station uses FDM-FM modulation and can support 6 two-way channels using a transponder similar to an Intelsat-IV-A global beam transponder, or 60 two-way channels using a shaped-beam transponder similar to Japanese CSE (Communication Satellite for Experimental Purpose) transponder, with a channel signal-to-noise ratio of about 43 dB.

6.2 Example of an emergency network and associated earth stations in the 14/12.5 GHz band

An emergency satellite network has been designed for operation in the 14/12.5 GHz frequency band via a EUTELSAT I transponder [Lembo and Quaglione, 1987]. This dedicated network, which is based on the use of wholly digital techniques, provides emergency voice and data circuits and a time shared compressed video channel for relief operations and environmental data collection as well. The network architecture is based on a dual "sub-networking" star configuration, for the two services and makes use of a "TDM/BPSK" and a "FDMA/TDMA/BPSK" dynamic transmission scheme, respectively for the "outbound" and "inbound" channels. The ground segment, is composed of: a common hub station for the two star networks designated as "Master", which is a fixed earth station having a 9.0 m antenna and a 80 W transmitter; a small number of transportable earth stations, having antennas of 2.2 m and 110 W transmitters; a number of fixed data transmission platforms with 1.8 m dishes and 2 W solid state power amplifier (SSPA) transmitters. Such platforms have a receive capability (G/T of 19 dB/K), in order to be remotely controlled by the master station, and their average transmit throughput is 1.2 kbit/s.

The transportable earth stations are mounted on a lorry, but when required, can also be loaded in a cargo helicopter for fast transportation. They have a G/T of 22.5 dB(K⁻¹) and are equipped with two sets each of one 16 kbit/s (vocoder) voice channel and one facsimile channel at 2.4 kbit/s. These earth stations which are also able to transmit a compressed video channel at 2.048 Mbit/s in SCPC/BPSK, are remotely controlled by the master station. The major features of this ad hoc emergency network are summarized in Table II.

6.3 Examples of air transportable and vehicle equipped small earth stations in the 14/12 GHz band

Various types of small earth station equipment are developed for the use of new satellite communication systems in the 14/12 GHz band in Japan. For implementing small earth stations, efforts of decreasing the size and improving the transportability for ease of general application have been undertaken. This allows the occasional or temporary use of these earth stations for relief operation elsewhere in the country or even world-wide. Such temporary earth stations are installed either in a vehicle or a portable type using a small antenna, and it is possible to use in an emergency.

The vehicle equipped earth station in which all necessary equipment are installed on the vehicle, such as a four-wheel drive van, permits to operate within ten minutes after arrival including all necessary works such as antenna direction adjustments.

A portable earth station is disassembled prior to transportation and re-assembled at the site within approximately 15 to 30 minutes. Size and weight of the equipment generally allow it to be carried by hand by one or two persons, and is within a limit of the IATA checked luggage regulations. Total weight of this type of earth station including power generator and antenna assembly is reported as low as 150 kg, but generally more than 200 kg. It is also possible to carry them by helicopters.

Examples of the small transportable earth stations under development for the Japanese communication satellites in 14/12 GHz band are shown in Table III.

TABLE 11 : EXAMPLE OF AN EMERGENCY SATELLITE COMMUNICATION NETWORK OPERATING AT 14 / 12.5 GHz

Station Designation	Antenna diameter (m)	G_T/T dB(K ⁻¹)	Transmitter power rating (W)	Primary power requirement (kVA)	Transmission Scheme		Service Capability
MASTER	9.0	34.0	80	15.0	TX	512 kbit/s-TDM/BPSK (+ FEC 1/2)	12x16 kbit/s (vocoder) voice channels
					RX	"n"x64 kbit/s- FDMA/TDMA/BPSK (+ FEC 1/2)	12x2.4 kbit/s facsimile channels
PERIPHERALS (transportable)	2.2	22.5	110	2.0	TX	64 kbit/s-TDMA/BPSK (+ FEC 1/2) and 2.048 Mbit/s-SCPC/QPSK (+ FEC 1/2)	2x16 kbit/s (vocoder) voice channels 2x2.4 kbit/s facsimile channels 1x2.048 Mbit/s video channel
					RX	512 kbit/s-TDM/BPSK (+ FEC 1/2)	
UNATTENDED PLATFORMS	1.8	19.0	2	0.15	TX	64 kbit/s-TDMA/BPSK (+ FEC 1/2)	1x1.2 kbit/s data transmission channel
					RX	512 kbit/s-TDM/BPSK (+ FEC 1/2)	

TABLE III

Example of a small transportable earth station
for the 14/12 GHz band

Example No.	1	2	3	4	5	6
Type of transportation	Vehicle equipped			Air transportable		
Antenna diameter (m)	2.6x2.4	1.8	1.2	1.8	1.4	1.2
e.i.r.p. (dBW)	72	70	62.5	70	64.9	62.5
RF bandwidth (MHz)	24-27	20-30	30	20-30	30	30
Total weight	6.4t	6.0t	2.5t	275kg	250kg	200kg
Package						
Total dimensions	-	-	-	<2m	<2m	<2m
Total number	-	-	-	10	13	8
Max. weight	-	-	-	45kg	34kg	20kg
Capacity of engine generator (kVA)	7.5	10	5	3	0.9+1.3	1.0
Required number of person	1-2	1-2	1-2	2-3	2-3	1-2

6.4 Examples of a small transportable earth station for operation at 30/20 GHz

Two types of 30/20 GHz small transportable earth stations, which can be transported by a truck or a helicopter, have been manufactured and operated satisfactorily [Saruwatari *et al.*, 1978 and Egami *et al.*, 1980].

Examples of small transportable earth stations for operation at 30/20 GHz are shown in Table IV.

TABLE IV – Examples of small transportable earth stations

Operating frequency (GHz)	Total weight (tons)	Power requirement (kVA)	Antenna		Maximum e.i.r.p. (dBW)	G/T (dB(K ⁻¹))	Type of modulation	Total setting-up time (h)	Normal location of earth station
			Diameter (m)	Type					
30/20	5.8	12	2.7	Cassegrain	76	27	FM (Colour TV 1 ch) ⁽¹⁾ or FDM-FM (TP 132 ch)	1	On a truck
	2	9	3	Cassegrain ⁽²⁾	79.8	27.9	FM (Colour TV 1 ch) ⁽¹⁾ and ADPCM-BPSK-SCPC (TP 3 ch)	1	On the ground
	1	1 ⁽³⁾	2	Cassegrain	56.3	20.4	ADM-QPSK-SCPC (TP 1 ch)	1.5	On the ground
	0.7	3	1	Cassegrain	59.9	15.2	FM-SCPC (TP 1 ch) or DM-QPSK-SCPC (TP 1 ch)	1	On a truck

⁽¹⁾ One-way.

⁽²⁾ The reflector is divided into three sections.

⁽³⁾ Excluding power for air conditioning.

7. Conclusion

A transportable earth station used with an existing satellite system can quickly establish a reliable telecommunication service, to assist in relief operations associated with natural disaster and similar emergencies.

The following points should be considered further in the final configuration:

- the determination of acceptable values of signal-to-noise ratios (analogue) or equivalent error-rate (digital) in a telephone channel, and the error-rate in a record channel;
- the technical implications of mutual interference between the transportable earth station on the one hand, and radio-relay and/or other satellite systems, on the other hand;
- the logistic aspects of transportation, installation and operation.

REFERENCES

- EGAMI, S., OKAMOTO, T. and FUKETA, H. [February, 1980] K-band mobile earth station for domestic satellite communications system. *IEEE Trans. Comm.*, Vol. COM-28, 2, 291-294.
- LEMBO D. and QUAGLIONE G. [May 1987] - User oriented networks in satellite communications. AFCEA European Symposium. Rome, May 1987, Session IV, 82-90.
- OKAMOTO, T., EGAMI, S. and OGUCHI, M. [July, 1977] Small transportable earth station for satellite communication. *Japan Telecomm. Rev.*, Vol. 19, 3, 230-234.
- SARUWATARI, T., TSUKAMOTO, K., YOKOYAMA, M. and SASAOKA, S. [October, 1978] Digital transmission experiments with the CS satellite. 4th International Conference on Digital Satellite Communications, Montreal, Canada, 283-290.
-

REPORT 869-2

**LOW CAPACITY EARTH STATIONS AND
ASSOCIATED SATELLITE SYSTEMS IN THE
FIXED-SATELLITE SERVICE**

(Question 23/4)

(1982-1986-1990)

1. Introduction

In Resolution No. 18 the Plenipotentiary Conference of the ITU, Torremolinos, 1973, urged the CCIR to study technical and operational questions relating to low capacity earth stations and associated satellite systems to assist developing countries and various administrations in their use. The CCIR subsequently adopted Question 23/4 relating to this subject. Developments in satellite communications technology now emerging can provide developing countries with the means to implement telecommunications networks designed to meet their special needs.

The prime need is for a system to cater to a large number of small communities, widely scattered, each of which could be expected to generate only a small amount of traffic. Each community therefore needs an economical, easily installed and maintained earth station, equipped for one or more telephone channels. The space segment must serve a relatively large number of such earth stations simultaneously at an appropriate standard of performance in terms of quality and reliability.

The above will be taken as a broad definition of the kind of low capacity system considered in this Report. The geographical area served by such a system may be national or regional, with facilities provided for access to existing national or international telecommunications networks.

This Report discusses some of the technical and operational factors which must be taken into account, and gives some examples in the Annexes, of possible system parameters, in response to Question 23/4.

2. System requirements

Typical facilities required of such a low capacity system would include:

- a few voice circuits at most locations and up to twelve voice circuits at a few locations;
- circuit characteristics which are compatible with the requirements for telex, low-speed data, and other such services;
- ability to provide conference-type circuits for health, education and other special needs;
- compatibility with existing networks with respect to:
 - signalling between switching machines, and
 - noise performance;
- an acceptable level of quality, reliability and availability for the overall system, including the propagation path;
- options for the reception of sound and television programmes.

From a design and operational point of view, typical requirements for a low capacity system would include:

- low cost, even at the expense of some loss of performance;
- ease of transportation, installation and maintenance;
- low power consumption of earth-station equipment;
- ability to operate earth stations in a wide range of environmental conditions;
- use of simple and efficient modulation techniques;
- use of simple and efficient multiple access systems;
- high reliability of earth-station equipment.

The factors affecting the ways in which these system requirements can be achieved is discussed in the following sections of this Report.

3. Frequency bands allocated to the fixed-satellite services

A number of frequency bands have been allocated to the fixed-satellite service in the Final Acts of the WARC-79. These include the 2.5 GHz band, the 4 GHz band, the 11 GHz band, the 12 GHz band, and the 20 GHz band in the space-to-Earth direction, and the 2.5 GHz band, the 6 GHz band, the 12 to 13 GHz band, the 14 GHz band, and the 30 GHz band in the Earth-to-space direction.

In making a choice of a frequency band the following factors should be considered:

- sharing with other services;
- system economic considerations, including the most effective balance between space-portion and Earth-portion costs;
- environmental factors such as propagation and wind loading.

3.1 *The 2.5 GHz band*

The 2.5 GHz band is quite narrow: 190 MHz wide in Region 2 and only 35 MHz wide in Region 3, with no allocation in Region 1. 35 MHz wide up-link frequency bands are also available at 2.5 GHz in Regions 2 and 3. Because of this, the ultimate system capacity of such 2.5 GHz systems is very limited. Sharing with both the broadcasting-satellite service and terrestrial fixed and mobile services is necessary. Power flux-density limits are imposed to regulate such sharing. It may be difficult to obtain a cost-effective balance between space-portion and Earth-portion system costs if a large number of earth stations are contemplated.

3.2 *The 6/4 GHz band*

This is the most widely used frequency band to date, being used by both international and domestic systems for heavy-route and thin-route telephony and data traffic and for radio and television programme distribution. Sharing with terrestrial, fixed and mobile services is necessary. Because of this, power flux-density limitations are imposed, and frequently coordination is necessary with existing microwave radio systems. Because the 6/4 GHz band is widely used, sub-systems are well developed and readily available.

Extensive use of this band in the fixed-satellite service will normally require coordination with other systems in the geostationary orbit. In the long term, this may require system designs which improve orbital utilization, particularly where the orbit is congested.

Operation in heavy rainfall conditions is not a serious problem at 6/4 GHz (see Reports 382 and 724).

3.3 *The 14, 11, 12 and 13 GHz bands*

Allocation decisions made at the WARC-79 in these frequency bands for space services are more complex. The 10.7 to 11.7 GHz band is allocated in the space-to-Earth direction on a world-wide basis, with power flux-density restrictions imposed to allow sharing with the fixed and mobile services.

The 11.7 to 12.1 GHz band, and part of the 12.1 to 12.3 GHz band, is allocated to the FSS in Region 2 with no power flux-density restrictions imposed. This lack of pfd constraints facilitates the use of small earth-station antennas.

The 12.2 to 12.75 GHz band in Region 3 and the 12.5 to 12.75 GHz band in Region 1 are allocated to the FSS in the space-to-Earth direction. There are power flux-density constraints imposed in these bands.

The Earth-to-space links for the above bands are likely to be the 12.75 to 13.25 GHz band and the 14.0 to 14.5 GHz band.

Sharing with the fixed and mobile services is necessary in these bands except in some parts of Region 2. However, the lack of such systems in many areas eases the problems of coordination and may not require the majority of earth stations to be inconveniently located.

Propagation attenuation through heavy rain puts additional requirements on system designs in these frequency bands, especially in heavy rainfall areas (see Reports 382 and 724). This can be compensated for by either earth stations with higher G/T values, space stations with higher e.i.r.p. values, or by designing the system to lower performance than is required for international connections.

At these higher frequencies, antennas with smaller diameters may be used to obtain G/T values similar to those achieved at the lower frequencies. This possible reduction in antenna size can reduce procurement and installation costs.

Equipment in this band is less widely used than in the 6/4 GHz band, but is becoming more readily available at competitive costs because of the implementation of several international and domestic satellite systems in the band.

3.4 *The 30/20 GHz band*

There are few operational systems (space and terrestrial) in this band at present, although experimental systems are being implemented. For this reason coordination with other space systems and with terrestrial fixed and mobile systems is not expected to be complex, but, in contrast, procurement of equipment in these bands is currently limited.

Propagation losses in heavy rainfall conditions are higher at 30/20 GHz than at 14/(11 and 12) GHz. Use of either up-link power control or site diversity may be necessary for most transmission systems.

3.5 *Summary of frequency band selection considerations*

At present, it appears that the most attractive frequency bands for the types of systems under consideration are the 6/4 GHz band and the 14/(11 and 12) GHz bands. A more detailed knowledge of system requirements and environment is necessary to make a final choice between these two alternatives.

4. **Propagation**

The effects of rain on radio propagation are of particular importance in the case of satellite circuits because these effects begin to be noticeable as from about 4 GHz depending on the rainfall intensity and the length of the propagation path through the rain. The effects may be classified as follows:

- attenuation,
- depolarization,
- scattering.

Each of these factors is of considerable importance in frequency planning situations. The basic problem created by rain is usually that of depolarization in transmissions below 10 GHz and severe attenuation in transmissions above 10 GHz. Thus in the 6/4 GHz band where satellites employing frequency re-use by means of orthogonal polarization are becoming the normal mode of operation, the cross polarization isolation can drop from a nominal figure of 30 dB to perhaps as low as 12 to 15 dB during heavy rainfall. Proper attention to this factor must be paid during the system design stage. To give an idea of the attenuation that may be caused by intense rain, reference to Report 721 shows that 60 mm/h of rain gives rise to an attenuation of 3 dB/km at 13.5 GHz and to an attenuation of 0.3 dB/km at 6 GHz. Such intense rain is rare in most climates, however, and usually occurs in rain cells of limited horizontal dimensions. This means, first, that the higher rainfall attenuation allowance even in tropical rainfall climates is only necessary if very high link availabilities are being considered, and second, that such high rainfall intensities are unlikely to affect more than one or a very few stations of a given network at the same time.

Rainfall characteristics vary greatly in different parts of the world, and reference should be made to Report 563 for general information on this. It should be noted however that local measured data on rainfall is the best basis for systems planning because the world-wide data in Report 563 cannot take into account local variations.

It should not be thought that intense rain presents an unsurmountable problem to the use of higher frequencies, for example those above 10 GHz, but it should be realized that, for efficient planning of a satellite network the rainfall characteristics of the projected earth-station locations should be very carefully examined. In this way those areas – normally limited – where rain could create difficulties may be clearly identified and proper allowance made in the planning of the system. For example, systems could be designed with availability values similar to those for the existing terrestrial services in countries where low capacity satellite systems are being considered. Lower link availability requirements would allow the use of the frequency bands between 10 and 15 GHz with margins similar to those required for the 6/4 GHz bands.

5. Modulation and multiple access methods

Low capacity earth stations will generally have relatively low G/T from economic considerations. Satellite links for such stations will be power limited and the efficient use of satellite radiated power per channel would be a major factor in the choice of the modulation method for low capacity systems. Modulation methods with low C/N_0 ratio requirements are therefore preferable. In addition, channel capacity, efficient use of the radio spectrum, flexibility in interconnection, interface with terrestrial network, possible need for interconnection into the international network, low investment costs and ease in installation and maintenance are other important considerations with regard to the choice of a modulation method for low capacity systems.

Of the possible modulation/multiple access techniques for fixed-satellite service it appears that the following techniques are currently most suitable for consideration in low capacity systems:

- FDM-FM-FDMA;
- SCPC : PCM-PSK or DM-PSK or syllabic companded FM.

FDM-FM-FDMA is the conventional technique commonly used in the fixed-satellite service. However, for a small number of channels it would operate in a pre-assigned mode and satellite power and bandwidth are not efficiently used if calling rates are low.

For low-capacity systems, single channel per carrier (SCPC) operation is attractive since it offers considerable flexibility and economy in terms of satellite power and bandwidth. The main advantages of SCPC systems are as follows:

- they permit the use of voice operated carriers thus saving satellite power;
- the absence of multiplexing equipment where the earth station can be located at or near the local exchange;
- channels can be established in unit steps;
- flexibility in transmission since each channel goes on a separate carrier;
- use of demand assignment is facilitated with SCPC techniques.

The choice of modulation for SCPC systems will sometimes favour frequency modulation with companders and emphasis and sometimes a digital system such as Delta modulation or PCM. No generalization in favour of one or another can be given at the present time and the choice will depend on particular factors applying to the specific application (e.g. equipment costs, maintenance skills available, requirements for data services, interference conditions, etc.).

The transmission parameters of different modulation methods are shown in Table I, from which it may be concluded that 32 kbit/s delta modulation and syllabic companded FM SCPC have advantages over the other alternatives.

TABLE I - Sample transmission parameters for different modulation methods

Type of modulation	Circuit quality	Required C/N_0 (dB(Hz))	Noise bandwidth per carrier
FDM-FM (for 12 ch.)	$S/N = 50$ dB	74	1.15 MHz
SCPC 64 kbit/s PCM-QPSK	Bit error ratio 10^{-5}	61	38 kHz
SCPC 32 kbit/s DM-BPSK	Bit error ratio 10^{-4}	56	38 kHz
SCPC companded FM	$S/N = 50$ dB (with companders)	55	25 kHz

5.1 *Demand assignment multiple access (DAMA)*

Satellite circuits can be used to establish telephone connections among earth stations in either of two basic ways: permanent assignment and demand assignment multiple access. A permanent assignment circuit "permanently" connects trunk equipment at one earth station with similar equipment at another. In contrast, a DAMA circuit is established between two earth stations only when needed for a call from one of the stations to the other.

Any system that assigns satellite circuits on demand will use the circuits and the modulation access equipment more efficiently than if the circuits were permanently assigned.

There are two types of demand assignment control. One is the distributed control, in which individual earth stations have control equipments with equal complexity. The SPADE system employs this type of demand assignment control. The other one is the centralized control, in which demand assignment control equipment complexity is confined to the central station to realize a simple low capacity earth station. In this case a two-way signalling channel for transmission and reception of demand assignment control signal is necessary. Common signalling channel can be provided by using a separate carrier with TDMA or FDMA operation. This configuration achieves high flexibility of control but the equipment becomes rather complicated. By employing random access method such as random packet transmission, equipment can be simplified.

6. **Interference considerations**

Systems in the fixed-satellite service generally share common frequency bands with terrestrial services as well as with other satellite networks, thus, band sharing gives rise to two basic interference situations:

- interference from and into terrestrial services;
- interference from and into other satellite networks.

To facilitate sharing with terrestrial services, the Radio Regulations limit earth station e.i.r.p. towards the horizon and space station power flux-density (pfd) at the surface of the Earth. These limits are given in Articles 27 and 28.

To improve orbit spectrum utilization and improve sharing among networks of the space services, Article 29 also includes restrictions on satellite station-keeping and antenna beam pointing accuracy. Article 29 also contains a provision aimed at minimizing earth station e.i.r.p. transmitted off axis in the direction of the geostationary orbit and provisions to control interference to geostationary fixed-satellite systems from any non-geostationary space system.

6.1 *Inter-network interference*

Report 455 identifies the major elements affecting frequency sharing between networks in the fixed-satellite service.

The fundamental element which limits sharing is interference. Interference causes a degradation in system performance. The measure of this degradation depends on the modulation type. For example, in analogue telephone links the degradation is measured in additional picowatts of noise introduced into a telephone channel, and in digital signals the degradation is measured in the increase in detector bit error ratio. In all cases, the impact of interference on system design is to require larger system margins.

A general study of inter-network interference appears elsewhere in CCIR texts (in particular in Recommendations 466, 483, 523, 524 and 671, and Reports 453, 454, 455, 710 and 867) so only the factors specific to low-capacity systems will be mentioned here.

The high sensitivity and transfer gain of a satellite intended for communication to a small coverage area permits the use of reduced e.i.r.p. from the associated earth stations, which tends to reduce the level of up-link interference into wide-coverage satellites of other systems. The high gain of the satellite receive antenna in such networks may make it more susceptible to interference from earth stations of other systems in the same coverage area, but the situation is eased if the satellite antenna gain is effectively reduced outside the coverage area.

If a small earth-station antenna is used to transmit to a wide-coverage satellite receiving antenna, the transmitter will need to have higher output power to compensate for low antenna gain. Consequently the spectral e.i.r.p. density in directions towards other satellites will tend to be high and this will tend to increase the minimum permissible orbital separation between the wanted satellite and other satellites which cover the same territory. In this case, better transmit side-lobe performance may be necessary, or the use of a larger antenna considered noting that the limits of Recommendation 524 are applicable.

The inherently high e.i.r.p. in the down link of a domestic satellite network tends to increase the interference into an international service earth station. Inter-network interference of this kind tends to be a greater problem, the wider is the disparity between the coverage areas of the two systems; this problem of interference between systems with considerable differences in system parameters (inhomogeneity) is discussed in Report 453. In this case, the limits of Recommendation 358 on pfd apply.

In general, the smaller is the ratio D/λ of the earth-station antenna the more difficult will be the interference problems vis-à-vis the adjacent satellite working in the same frequency bands and coverage area. However, it may be possible to overcome this problem by reducing side-lobe levels of the earth-station antenna and by coordination.

6.2 *Interference with terrestrial radio-relay systems*

When operating in the same frequency bands, satellite communications and terrestrial microwave radio-relay systems experience mutual interference problems. But, in the type of networks under discussion in this Report, this may not be a very severe problem as in the areas in which the small stations are to be located there may not be an extensive terrestrial radio-relay network. However, in cases where the earth stations are located in the vicinity of terrestrial radio-relay links the interference to and from these links needs to be considered.

The interference mechanism is fourfold, but only two of the mechanisms are pertinent to coordination with terrestrial systems. These are:

- earth station transmitter → terrestrial microwave receiver
- terrestrial microwave transmitter → earth station receiver

The CCIR states the tolerable amount of interference in its Recommendations 356, 558 and 357. In order to keep the actual amount of interference in the terrestrial networks below maximum tolerable values recommended by the CCIR, Article 28 of the Radio Regulations imposes limits to the earth station emissions and to satellite emissions. Moreover, Article 27 of the Radio Regulations imposes restrictions on the terrestrial station e.i.r.p. and transmitter power, in order to keep the interference to space networks below the limits recommended by the CCIR.

Several factors can be considered for reducing the level of mutual interference between satellite and terrestrial networks. Some examples are the following:

- *Application of spot beam antennas*

The use of spot beam antennas in up and down links usually helps abate the earth station's interference with the terrestrial station, because the required e.i.r.p. of the earth station decreases due to the enhancement in satellite sensitivity.

- *Application of earth-station antennas with low side lobes*

The use of earth-station antennas with low side lobes in transmit and receive frequency bands reduces the mutual interference between the earth station and terrestrial radio stations.

- *Application of topographical features, buildings, etc.*

Longer distances and the presence of buildings, etc. that block the propagation of radio waves between systems offer the most basic means to abate interference with the terrestrial system. Mountains and hills are useful for the purpose. In respect to urban areas experiment suggests that buildings standing in the way of in-coming interference waves can help reduce interference significantly (see Reports 390 and 382).

– *Miscellaneous*

When geographical features of the land, buildings and the like fail to contribute to the abatement of interference problems, their impact is reducible by putting up in front of a small antenna itself an antenna shield made of metal or wire netting and radio wave absorbing materials.

As discussed above, careful site selection and the adoption of appropriate interference abatement measures will enable the domestic satellite communications system consisting of small earth stations to share the frequency band with the terrestrial system for mutual benefit.

7. Earth-station characteristics

7.1 *Background*

The earth stations should be as simple as possible, should have the lowest possible primary power consumption and at the same time should have the smallest possible antenna consistent with the overall system design. Use of available infrastructural facilities, such as locating the earth terminal in an existing building (collocated with a rural telephone exchange for instance) would help in reducing the cost of the earth station installation. Further, the elimination of the terrestrial connecting links if it is possible, will lead to a reduction in the system cost.

It is assumed that most of the areas that will be served by this type of system will not be electrified at all times. Thus low primary power consumption is one of the major design considerations so that operation can be based on the use of a small battery charged by solar cells or some other available source.

7.2 *The earth-station antenna*

Antenna size is to be decided as a compromise between the mechanical factors of mass, wind loading, pointing error loss, inter-system interference, system capacity and other factors such as lobe patterns and gain. Concerning the factors due to mass, wind loading and pointing error loss, together with the need to standardize on a design that is stable but does not require too much expertise in the erection stages, a dimension of 3 to 6 m at 6/4 GHz and around 2 to 4 m at 14/(11 and 12) GHz is thought to be appropriate in the general sense. In this case, it is desirable that the side-lobe levels of the antenna be reduced as much as possible relative to the reference radiation diagram described in Report 391, in order to overcome the mutual interference problems between the earth station and terrestrial radio stations and not to decrease the utilization efficiency of the geostationary-satellite orbit. Low side-lobe antennas that satisfy such a requirement have already been developed as described in § 3.2 of Report 998. Individual cases, where for example larger rain attenuation margins may be thought necessary, could be equipped with larger antennas.

The utilization of too small an earth-station antenna may, in some cases, require an extremely high power HPA and low noise temperature LNA, which in turn can result in increased earth-station cost. It is possible in the design of a satellite system, however, to minimize these costs by optimization of the combined costs of the antenna, HPA, LNA, etc.

In selecting an antenna size, it should be remembered that the projected lifetime, including traffic growth factors, be given careful consideration. The antenna is essentially passive and maintenance free and will not become obsolete as quickly as other system elements.

7.3 *Typical earth-station noise temperature*

Current low noise amplifiers at 4 GHz of reasonably low cost are mostly based on GaAs FET devices. Typical uncooled LNAs available commercially have noise temperatures of 90 K to 150 K at 4 GHz and 250 K to 530 K at 11 GHz. Allowing about 40 K for antenna noise temperature at elevation angles not less than 30°, an achievable system noise temperature might be 130 K at 4 GHz and 290 K at 11 GHz.

7.4 *Earth-station transmitter*

In many rural areas the provision of primary power presents a problem and solar power and rechargeable batteries may be necessary. It is therefore necessary to keep the power consumption of the earth station low and use the smallest possible transmitter power. It is essential for the satellite to have a high sensitivity if the earth station size is to be kept small. If the transmit power is kept sufficiently low it allows in the rural station the use of entirely solid-state transmitters, which are not only less expensive, but far more reliable than thermionic devices.

7.5 SCPC equipment

SCPC equipment is in widespread use for thin route applications. However the existing systems have a great deal of operational flexibility that could be discarded in order to reduce costs. Use of crystal oscillators in the up and down converters instead of synthesizers will reduce the cost and increase the reliability of the earth station but consideration should be given to the resulting satellite operational flexibility loss.

If demand assignment multiple access is not used in the beginning, provisions should be made for future addition of this type of equipment, preferably of the centralized control type.

A signalling system compatible with voice operated carrier control should be used.

8. Space station characteristics

The characteristics of the space station or satellite play a crucial role in the design of the satellite network, since they directly affect many of the earth-station parameters. For operation with small size earth stations, the satellite (or the transponders that cater to the low capacity systems) need to meet certain distinct requirements. These are:

- generation of high e.i.r.p.s either by using spot beams, high power or some combination of the two depending on the service area;
- accurate station keeping both in the east-west and north-south directions to eliminate the need for providing tracking facilities on the ground terminals;
- increased sensitivity and higher transfer gain.

8.1 Coverage area and antenna size

The space station antenna beamshape in the idealized situation is determined by the coverage requirement, which in turn limits the antenna gain. Physical size constraints of the launch vehicle place limitations on the antenna main reflector dimensions, which, depending on the operating frequency, may conflict with the desired optimized coverage.

In general, beamwidths in the range of 17° (Earth coverage) to 0.6° and 17° to 2.5° are practical for the 14/(11 and 12) GHz and 6/4 GHz bands respectively.

Shaped beam technology using large reflectors and multiple feeds is being pursued as a means of providing more optimum beam shapes and for generating multiple spot beams of differing widths for serving specific coverage areas. However, it may be noted that the nature of a low capacity network may not in many cases permit subdivision of a specific coverage area into smaller zones for covering with multiple spot beams.

8.2 Space station e.i.r.p.

The total e.i.r.p. available from a satellite depends on a number of factors including:

- the amount of d.c. power available from the satellite power system, probably around 800 W to 1 kW for the smaller satellite designs;
- the efficiency of the transmitting devices, usually TWTAs, in converting d.c. power to RF power. Current smaller satellites usually produce 200 to 300 W of RF power;
- the transmit antenna gain, which as noted in the previous section, depends on coverage area and the antenna technology adopted.

The likely mass per transponder, the total mass available to the payload and the range of output powers available from space qualified transmitting devices are important factors in determining how many transponders will make up the payload, and therefore the per transponder RF power output. Space proven TWTAs in the 10 to 20 W range are available both in the 4 GHz and the (11 and 12) GHz band, while tubes with higher ratings are being qualified or under development, at least in the 11 to 12 GHz band.

The RF power output per transponder and transmit antenna gain (after allowing losses between transponder and antenna) finally determine the e.i.r.p. per transponder.

8.3 *Station keeping and antenna beam pointing*

The possibility of using small earth stations without tracking is very much dependent on the station-keeping accuracy of the satellite. The Radio Regulations (Article 29) specify the minimum east-west station-keeping accuracy, but depending on the gain of the ground station antenna a good station-keeping accuracy in the north-south direction is also required. Station-keeping accuracies of $\pm 0.1^\circ$ in both north-south and east-west directions can be routinely achieved. In such a situation the size of the ground station antenna that could be used will depend on the acceptable gain reduction due to resulting pointing errors and frequency of operation (see Report 390).

The satellite antenna beam pointing accuracy is equally important. Beam pointing accuracy of $\pm 0.3^\circ$ is achievable with the present technology. Use of very narrow beams requiring higher pointing accuracies would complicate the attitude control system.

8.4 *Transponder gain and sensitivity*

To operate with small earth stations, the transponder gain needs to be high, and this is facilitated by a high transmit and receive gain of the satellite antenna consistent with coverage requirement. In the case of satellite systems working with small stations a saturation flux-density of the order of $-90 \text{ dB(W/m}^2\text{)}$ may be required.

A high value of satellite figure of merit (G/T) coupled with high transponder gain would facilitate use of low transmit power from earth stations.

8.5 *Satellite positioning*

Positioning the satellite in geostationary orbit east or west of the wanted coverage area can offer improved performance. In this situation, because it is viewed obliquely, the coverage area on the earth's surface projects a smaller solid angle at the satellite, that is the projection of the coverage area on to the plane perpendicular to the propagation path reduces. The satellite can thus use a narrow-beam, higher gain antenna which can more than offset the extra path length involved, to give a net improvement in received signal level. This may also reduce the sensitivity of the earth stations to satellite station keeping. However, moving the satellite away from the coverage region may mean lower elevation angles for the earth stations with consequent impact on the antenna noise temperature and rain attenuation especially in the 14/(11 and 12) GHz and higher bands.

8.6 *Considerations in obtaining a space segment*

The space segment of the low capacity system could be obtained either by leasing transponders from an already existing system or by a dedicated satellite which may be part of a regional or national system. Leasing of transponders is attractive in that it is immediately available, is free from such risks as a failure in orbiting the dedicated satellite, has no problems of operating the satellite, and that the network could be realized quite quickly constrained only by the installation time of the ground segment. On the other hand, the dedicated satellite offers more flexibility in system design. In some cases a lease used initially followed by other arrangements in time might be the best course provided satellites with appropriate characteristics are available.

9. **Summary**

As the discussion in this Report indicates, there are many factors which need to be taken into account in providing the best satellite system to meet a given set of requirements. Some of the factors discussed included:

- propagation,
- type and performance of the multiple access methods,
- interference between adjacent radio systems, both in space and on the ground,
- earth-station technology,
- space-station technology.

No conclusions have been drawn as to what are the preferred parameters of a system using low capacity earth stations, as these depend so much on the particular requirements of each application.

There is no doubt that the technology exists for the establishment of satellite communications systems meeting the needs of developing countries and the needs of various administrations for the use of low capacity earth stations. Systems of low capacity earth stations for use in remote and rural areas are under consideration by GAS-7.

ANNEX I

SAMPLE LINK CALCULATIONS FOR POSSIBLE RURAL
DOMESTIC SATELLITE SYSTEMS**1. Introduction**

Satellite system technology is in a constant state of advancement. Hence, it is not appropriate to quantify, in the main Report, many of the parameters which are relevant to the design of a system of low-capacity earth stations and associated satellites. Nevertheless, to obtain a better understanding of the complex interactions of these parameters, it is necessary, as a minimum, to examine some sample link calculations. Much more detailed analysis would be required in the development of an actual system.

It would be necessary, for instance, to choose from among many alternatives of most of the parameters when implementing any specific system. Detailed trade-off studies would have to be undertaken to take into account sometimes conflicting requirements to minimize earth-system cost, achieve reasonable efficiency in the use of satellite and orbital resources and, at the same time, provide the service required. Ease of installation, operation and maintenance must also be taken into account.

2. Earth station general characteristics

The earth station should be so specified as to favour its production in mass-produced kit form, and to involve the simplest possible erection techniques.

Modular construction using entirely solid-state components would be desirable. The final design, considering normal trade-off between low price and reliability, should provide for:

- adequate stability under all climatological conditions for all components which affect the transmission parameters (gain, power output, frequency stability, etc.);
- SCPC techniques using a channel bandwidth between 20 and 40 kHz;
- a signalling system compatible with the voice operated carrier control used;
- the future addition of demand assignment multiple access equipment.

3. System feasibility considerations

The following example system characteristics are intended to represent a wide spectrum of possibilities using current technology to provide a "thin-route" satellite system.

The examples chosen here are indicative only. Extensive work, far more extensive than can possibly be represented here, would be essential to ensure that the final design implemented for any given set of requirements is economic, technically sound and compatible with other space and terrestrial radio systems.

Four satellite examples are included (see Table III) to illustrate service to two different sizes of coverage area at each of the frequency band pairs of 6/4 and 14/(11 and 12) GHz. The larger coverage area is that associated with a 3° satellite antenna beam which, when the satellite is overhead the centre point, covers a circular area on the Earth of about 2000 km diameter. Operating down to an angle of elevation of 30° increases this diameter dimension to about 4000 km. The smaller coverage area, under the assumption of a 1° satellite antenna beam, gives corresponding coverage area diameters of 700 km increasing to 1400 km at 30° elevation angle. Four examples of small earth stations have also been chosen (see Table II) to illustrate the interaction between space and earth-station performance.

TABLE II Example earth station characteristics

	6/4 GHz		14/12 GHz	
Antenna diameter (m)	3	4.5	2	3
Transmit gain (dBi)	43.4	46.8	47.7	50.7
Transmit 3 dB beamwidth (degrees)	1.2	0.8	0.75	0.5
Receive gain (dB)	39.8	43.3	45.5	49.0
System noise temperature T (K)				
$10 \log T$	21.1	21.1	24.6	24.6
Figure of merit GT (dB(K ⁻¹))	18.7	22.2	20.9	24.4

Note. Antenna efficiency of 60% is assumed.

TABLE III Example satellite characteristics

	3		1	
Approximate beamwidth of coverage area (degrees)				
Frequency band (GHz)	6/4	14/12	6/4	14/12
<i>Spacecraft</i>				
Antenna diameter (m)	1.1	0.45	2.0 ⁽²⁾	1.25
Receive beamwidth (degrees) ⁽¹⁾	3.2	3.2	1.75	1.2
Peak receive gain (dB)	34.2	34.2	39.4	42.7
Receive noise temperature (K)	800	1300	800	1300
Spacecraft GT at 3 dB contour (dB(K ⁻¹))	2.2	0.0	7.4	8.6
Peak transmit gain (dB)	30.6	32.0	35.8	41.0
TWTA power (dBW) ⁽³⁾	7	7	7	7
Saturated e.i.r.p. at 3 dB contour (dBW) (including 2 dB output loss) ⁽⁴⁾	32.6	34.0	37.8	43.0
Saturated power flux-density of transponder (dB(W/m ²))	90	90	90	90

⁽¹⁾ Includes an allowance of $\pm 0.1^\circ$ for beam pointing accuracy. It also assumes the same antenna for transmit and receive, thus the minimum beamwidth is determined by the receiving frequency.

⁽²⁾ Assumed maximum antenna reflector diameter

⁽³⁾ The use of a 5 W transponder in the example does not represent the limit of capability in these frequency bands.

⁽⁴⁾ As stated, transmit e.i.r.p. is based on the 3 dB gain contour in this example. It should be noted that the specified coverage will comfortably lie within this 3 dB transmit coverage.

Using compacted FM with voice activation, it can be seen from Table IV that with the representative system characteristics chosen, the larger coverage shows a capacity per transponder at 6/4 GHz of between about 500 to 1000 telephone channels and at 14/(11 and 12) GHz of between about 75 and 160 telephone channels depending on the performance of the earth station selected. For the smaller coverage area, the corresponding capacities are 1200 and 400 telephone channels at 6/4 GHz and 14/(11 and 12) GHz respectively, and of course these figures would also vary with the size of earth station.

As mentioned at the beginning of this section it must be remembered that these examples have in no way been optimized to better achieve the objectives of the small earth systems outlined in the main body of this Report. For example, some of the examples given are unlikely to be realizable using solid state earth-station transmitters. They are offered to aid an understanding of the various factors involved in designing a system. However, there is scope for further optimization, taking into account practical systems implementation.

TABLE IV - Example link budgets for small terminal to small terminal SCPC transmission

Approximate beamwidth of coverage area (degrees)	3				1	
	6.2/4		14.25/11.7		6.2/4	14.25/11.7
Frequency band (GHz)						
Earth station size (m)	3	4.5	2	3	3	2
Transponder input back-off ⁽¹⁾ (dB)	3	5	2.5	2.5	9	3
Up-link e.i.r.p./carrier (dBW)	46.8	42.2	56.4	53.1	37.4	48.7
Other degradations (dB)	0.5	0.5	1	1	0.5	1
Path loss (dB)	200	200	207.3	207.3	200	207.3
Satellite G/T (dB(K ⁻¹))	2.2	2.2	0	0	7.4	8.6
Up-link C/N_0 (dB(Hz))	77.1	72.5	76.7	73.4	72.9	77.6
Transponder output back-off ⁽²⁾ (dB)	2.3	3	2.1	2.1	5	2.3
Down-link e.i.r.p./carrier (dBW)	6.9	3.6	17.1	13.8	6.0	18.7
Rain attenuation (dB)	0	0	3	3	0	3
Other degradations (dB)	0.5	0.5	1	1	0.5	1
Path loss (dB)	196.2	196.2	205.5	205.5	196.2	205.5
Earth station G/T (dB(K ⁻¹))	18.7	22.2	19.3 ⁽¹⁾	22.8 ⁽¹⁾	18.7	19.3 ⁽¹⁾
Down-link C/N_0 (dB(Hz))	57.5	57.7	55.5	55.7	56.6	57.1
Intermodulation C/N_0 (dB(Hz))	58.6	57.8	66.8	63.4	60.4	59.5
Total C/N_0 (dB(Hz))	55.0	54.8	55.2 ⁽³⁾	55.0 ⁽³⁾	55.1	55.1 ⁽³⁾
Transmitter power/carrier (W)	2.2	0.35	8.3	1.7	0.25	1.4
Transponder capacity (channels) (after 40% voice activity)	550	1000	75	160	1200	400

⁽¹⁾ Assumes 1.6 dB loss in G/T during periods of 3 dB rain attenuation.

⁽²⁾ Refers to input or output back-off of the transponder as a whole. The exact relationship between these two (and the amount of intermodulation noise generated for a given carrier loading) depends on the actual transponder chosen for the payload.

⁽³⁾ This value corresponds approximately to a 3 dB fade in the up link or down link.

ANNEX II

EXAMPLE SYSTEMS

Example 1

One example of the facilities typically provided by a low capacity satellite system is given by the Alaskan Bush System, which is described briefly below.

Rural telecommunications are provided primarily by a US domestic satellite operating in the 4/6 GHz bands, although some villages and communities are served by line-of-sight radio relay systems, or VHF/UHF radio, or even cable (underground or sea).

The rural system, or Bush system, provides telephony service to each village with a population greater than twenty-five. This is accomplished with 150 earth stations, 100 of which are called Bush earth stations having 4.5 m antennas and are located in or near the villages. The extension of service to the remaining villages is provided by some other means, e.g., VHF radio. A Public Health Service (PHS) is provided to fifty-seven of these Bush earth stations. The PHS consists of several dedicated voice channels between the villages and their regional hospital, of which there are eight, to provide medical instruction on patient care to the local health aid, and in extreme cases to arrange for the evacuation (frequently by air) of the severely ill to the hospital. In addition, approximately thirty of the Bush earth stations are equipped to receive a single satellite TV transmission.

The Bush earth station electronics is installed, in most instances, in existing building space provided by the local community. The Bush earth stations were typically initially equipped with two SCPC channels with at least one channel being used for public telephone service. At fifty-seven of the Bush earth stations, the second channel is dedicated to the Public Health Service. While most Bush earth stations are equipped for two SCPC-FM channels, some have only one channel (no PHS), a few are equipped with up to seven channels, and one is equipped with sixteen channels.

The characteristics of the Bush network channel modems is given in Table V and the Bush system performance objectives are given in Table VI.

TABLE V - Bush network channel modem characteristics

	Bush channel end	Gateway (Bartlett) channel end
Channel spacing: (kHz)	30.0	30.0
C/N_0 (dB(Hz))	56.0	57.6
IF bandwidth (kHz)	25.7	25.7
C/N (dB)	11.9	13.5
Peak deviation (Hz)	6505	6505
Emphasis improvement (dB)	4.9	4.9
Compressor improvement (dB)	12.3	12.3
Subjective signal-to-noise ratio (dB)	45.3	46.9

Example 2

A second example of interest, of a satellite system designed in part to provide improved communication capability to rural and remote areas, is the 14/12 GHz portion of the Canadian ANIK-B system. The space portion of the system consists of a single satellite operating in the 11.7-12.2 GHz and 14.0-14.5 GHz bands. Signals with a maximum e.i.r.p. of approximately 51 dBW are provided through 20 watt TWAs to 2° antenna beams. Four such beams are used to provide Canada-wide coverage. Earth stations with antenna diameters of 1.2 m, 1.8 m, 2.5 m and 3.0 m are used in rural and remote areas. The system carries voice and data transmissions in the SCPC and TDMA modes of operation, and also the transmission of television programmes and other video signals. Applications of this system in the tele-health and tele-education areas are being developed as an alternative to transportation over large distances.

TABLE VI - Bush system performance objectives

	Bush channel end	Gateway (Bartlett) channel end
(a) 1-minute mean power for more than 20% of any month	18 000 pWp	13 000 pWp
(b) 1-minute mean power for more than 0.3% of any month	50 000 pWp	50 000 pWp
The noise is generally budgeted among the various sub-systems in the following manner:		
Up-link thermal noise, down-link thermal noise, satellite intermodulation noise, earth station out-of-band intermodulation, adjacent and cross polarized transponder intermodulation:	16 000 pWp	11 000 pWp
Earth station equipment noise:	500 pWp	500 pWp
Interference noise (includes interference from terrestrial and adjacent satellite sources):	<u>1 500 pWp</u>	<u>1 500 pWp</u>
Total noise budget	18 000 pWp	13 000 pWp

Example 3

A third example of a low capacity satellite system is one that would be used for Satellite News Gathering (SNG). This type of system is characterized by a number of highly transportable, small aperture, up-link stations that could be easily transported to the site of a breaking news story. The transportable stations would be capable of up-linking a video programme with its associated sound channels and providing two-way communication for coordination purposes.

Due to the physical size requirements of the transportable station antenna (between 1 and 2 metre diameter), frequency bands between 10 and 50 GHz would be most appropriate for these systems. Currently allocated up-link bands of the FSS fall in this range at 14 and 30 GHz. In one example of an SNG terminal, operating at 14 GHz, an e.i.r.p. of 70 dBW was used with a transmit antenna of about 1.8 m diameter.

SNG terminals require two way ancillary communications channels, in addition to vision and associated sound, to provide for communications capability with the satellite operator and the broadcaster's headquarters. It is most desirable that the ancillary channels between the SNG terminal and the satellite operator be available at all times, thus an SCPC channel would be appropriate for this purpose. Other coordination channels may be SCPC or multiplexer channels on a common carrier. These channels can make use of 16 kbit/s digital techniques.

Example 4

One appealing communication system using a satellite is a very low speed data transmission system that can be applied to such personal communication systems as low speed message terminals. When the communication system handles only low bit rate signals of less than several hundreds bit/s, the antenna can be made small enough to construct a transportable earth station.

A message terminal using a 30/20GHz band was developed for experimental purposes, and field tests were conducted using Japan's communication satellite. The terminal consists of an offset parabola antenna 30 cm in diameter and a 300 bit/s PSK modem which transmits packet type signals.

If the main earth station, which acts as the center station in the network, is assumed to have an antenna 3m in diameter, a transmitting power of only 0.1 W at the message terminal is sufficient to obtain a C/N of 15 dB under clear-sky conditions. Furthermore, if the transponder is assumed to provide maximum output power, 500 dual transmitting channels can be used.

Since frequency drift due to frequency conversion in a satellite and an earth station is usually large in the 30/20GHz band, rapid signal acquisition is required, especially in the case of packet type communication systems. The developed message terminal employs a new rapid frequency detection technique which is performed by the combination of a wideband pre-filter and improvements in S/N using auto-correlation techniques. Field tests showed that the signal acquisition time was only 0.3 sec with a receiving frequency deviation of 15 kHz whose value is 50 times that of the information bandwidth.

SECTION 4D: FREQUENCY SHARING BETWEEN NETWORKS OF THE FIXED-SATELLITE SERVICE
- EFFICIENT USE OF THE SPECTRUM AND THE GEOSTATIONARY-SATELLITE ORBIT

4D1: PERMISSIBLE LEVELS OF INTERFERENCE

REPORT 455-5

**FREQUENCY SHARING BETWEEN NETWORKS
OF THE FIXED-SATELLITE SERVICE**

(Study Programme 28C/4)

(1970-1974-1978-1982-1986-1990)

1. Introduction

The extent to which the same frequencies may be used by different satellite networks of the fixed-satellite service, without causing unacceptable interference, is a subject of considerable importance; bearing as it does on the efficient use of the frequency spectrum and the geostationary-satellite orbit.

Frequency sharing may be affected by:

- the number of satellites sharing a given frequency band channel;
- the orbits in which the satellites move;
- the radiation pattern of the earth-station and space-station antennas;
- any difference in polarization between wanted and interfering signals;
- the relative operating power flux-densities of the wanted and interfering signals, both at the satellites and at the earth stations;
- the interference reduction factor between the input to the space-station, and/or earth-station receiver, and the demodulated output at the earth station;
- the portion of the total noise allowance allocated to interference from other satellite networks.

The problems of frequency sharing between satellite networks are reviewed in this Report.

2. Calculation of interference levels

The extent to which satellite networks may share the same frequency band is predicated on the magnitude of the tolerable interfering-to-wanted carrier levels.

2.1 Ratio of wanted-to-interfering carrier levels

The ratio of down-link wanted-to-interfering carrier powers at an earth station can be expressed as follows:

$$(C/I)_D = R + G_4 - G_4(\varphi) + Y_D \quad (1)$$

where:

$(C/I)_D$: the wanted-to-interfering carrier power ratio at the input to the receiving system (dB);

R : the ratio of the power flux-density of the wanted signal to the power flux-density of the interfering signal (dB);

G_4 : the receiving gain of the earth-station antenna for the wanted satellite (dB);

$G_4(\varphi)$: the receiving gain of the earth-station antenna for the interfering satellite (dB);

Y_D : the polarization discrimination of the earth-station antenna against the interfering carrier (dB).

A similar expression can be used to determine the up-link wanted-to-interfering carrier ratio. A method for calculating these ratios for interference between geostationary-satellite networks is given in detail in Annex I.

2.2 Post-demodulation signal-to-interference noise ratio

In FDM-FM telephone links, the ratio of a 1 mW test tone to the interference power in the worst telephone channel can be expressed as follows:

$$10 \log \frac{1 \text{ mW test tone}}{\text{Unweighted interference power in a telephone channel of 3.1 kHz bandwidth}} = \left(\frac{C}{I}\right) + B \quad (2)$$

where:

B : the interference reduction factor (dB) between the input to the space-station and/or earth-station receiver and the demodulated output at the earth station (B is sometimes called the "receiver transfer factor");

$\left(\frac{C}{I}\right)$: the wanted-to-interfering carrier power ratio at the input to the receiving system (dB).

The value of the interference-reduction factor, B , depends on the type of modulation used on the various carriers. An expression similar to (2) can be used for analogue signals in general if the factor B can be meaningfully applied. Reference should be made to Report 388 for further information.

The case of digital transmission presents a number of difficulties, one of the most important being that the characteristics and performance of digital modulation systems, which may be used for future fixed-satellite networks, are not yet firmly established. Another difficulty is that the nature of digital detection makes it impossible to define the interference performance and the thermal noise performance independently (in contrast to analogue signals above threshold). Reference should be made to Report 388 which sets out the techniques for calculating interference noise in systems carrying multichannel telephony, for the different modulation methods likely to be encountered on wanted and interfering transmissions.

For interference into frequency-modulated television systems reference should be made to Report 449.

2.3 *Intermittent exposure to interference*

Generally, in the case of two satellites near to one another (whether they form part of a single system or belong to independent systems), the extent of any resulting interference depends upon whether they both receive signals from their corresponding earth stations at the time of proximity. If they do so, then the form of treatment given in previous sections of this Report will apply. If not, i.e., if one satellite is intentionally energized from the ground and the other only unintentionally, then the effect of any interference will be less marked. This may occur, for example, in an unphased satellite system when the separation between adjacent satellites is temporarily small, or in the case where an interfering satellite is in the vicinity of a geostationary satellite. In these cases, off-beam antenna gain reductions will apply both to the illumination of the interfering satellite and to the reception of its interfering emission. If the output spectral power density of the space-station repeater is a function of the flux illuminating the satellite, the power spectral density produced by the interfering satellite at the earth station would be below its normal operating value. Quite small angular separations between satellites might be tolerable in such situations.

3. **Permissible levels of interference between networks using geostationary satellites**

Interference between networks which use geostationary satellites does not vary greatly with time, and it is feasible to coordinate system characteristics so that the degradation of channel performance due to this interference does not exceed an acceptable level.

3.1 *The significance of the level of interference*

Considerable attention continues to be given to the question of what constitutes an acceptable level of interference. It is generally held that the operator of a system should be in essential control of his system's performance and that, therefore, interference should not be a major factor affecting that performance.

However, the gain of earth and space station antennas usually decreases monotonically with increasing angle off the direction of maximum gain. These antenna characteristics may be the only source of isolation between the networks, in which case there is an inverse relationship between the interference level and the separation angles. Thus, the greater the permissible interference between two networks serving more or less the same area on the earth surface, the smaller can be the orbital separation between the space stations of the two networks. Similarly, the greater the permissible interference between two networks whose space stations are in the same, or nearly the same, orbit location and serve different areas on the earth surface through narrow-beam antennas; the closer can those service areas be to each other, and the greater can be the number of times that the frequency band is reused in different parts of the world.

Thus, the greater the permissible level of interference, the higher will be the potential frequency re-use density between networks both on the geostationary-satellite orbit (smaller inter-satellite spacing) and on the earth surface (denser coverage). There is therefore, a conflict between the desire to bound, at relatively low levels, the interference between networks, to maintain reasonable design and operating integrity in a network, and the no less significant need to maximize frequency re-use and, thereby, orbit-spectrum utilization.

Following this theme, during the Plenary period 1986-1990 a number of theoretical and practical studies have been carried out into ways of improving the efficiency of the geostationary orbit, i.e. of increasing the capacity in crowded parts of the orbital arc and spectrum. Some of these studies have shown that there is considerable scope for achieving this end by amending the aggregate and single-entry interference allowances in order to permit more satellites to co-exist in given parts of the arc and operating in the same frequency bands [CCIR, 1986-90]. Further studies are encouraged on this topic, especially those which are based on actual populations of satellites in congested parts of the geostationary orbit, with a view to amending the recommended interference limits during the 1990-1994 Plenary period.

3.2 *Permissible levels of interference in FDM-FM telephony transmissions*

It is generally agreed that the maximum level of interference noise from all other satellite networks which may be regarded as permissible lies between 10% and 25% of the total noise recommended for the hypothetical reference circuit (HRC) (Recommendation 353) a further 10% being permitted for interference from terrestrial systems.

If the lower inter-network figure is taken, then the total interference entry from all sources does not exceed 20%; these levels allow the system operator good control over the performance of his system.

If the higher inter-network figure is taken, and if it is assumed that interference from all sources is additive, then it would seem that 35% of the total noise budget is allocated to sources of noise outside the direct control of the system operator. The practical situation may not be quite as severe as this. Thus, at some earth stations there may be far less than the full 10% of interference noise from terrestrial sources, and the maximum entry of interference from other networks may not fall in the same channel as the maximum entry of interference from terrestrial sources. Nevertheless, while such a high interference entry may increase the number of satellites that can be accommodated in the orbit, it has the following disadvantages:

- the loss by the system operator of control of the performance of his system is substantial;
- interference takes various forms and may lead to degradations of types not simply constrainable by a bound on channel noise power; for example impulsive interference might develop;
- the capacity of a satellite is reduced;
- the feasibility of a large measure of frequency re-use within a satellite network, which is in itself a very powerful method of increasing the efficiency of use of the orbit and spectrum, is reduced by the presence of so much external noise.

This is a general area needing further study.

A single entry of interference entering an FDM-FM wanted network will affect some of the carriers of the wanted system more severely than others. The effect of the interference on the various channels of the wanted system is also non-uniform, channels high in the baseband being affected more severely than the others. Thus, the maximum value of interference from the single entry will be experienced by relatively few of the channels in the wanted network. An entry from another network will probably have its most severe effect upon different channels. Thus, the total interference received in any one channel will be less than the sum of the maximum single entry values.

3.3 *Permissible levels of interference in FM-TV transmissions*

For video transmissions the performance specifications in the HRC are given in Recommendations 354 and 567 for the appropriate TV standards. Recommendation 483 recommends that the inter-network interference noise should not exceed 10% of the total noise in the HRC. An increase in this percentage should be studied further.

First, TV-FM transmissions are relatively insensitive high-power transmissions since they have to meet threshold conditions for a relatively large bandwidth. On the whole, a TV-FM transmission is not much more sensitive to interference than a 972-channel FDM-FM telephony carrier and is thus not likely to constitute the limiting case during coordination in which more sensitive carriers need to be protected. This would continue to hold true if an interference criterion were applied which is based on carrier sensitivity as discussed in § 3.2. Thus, there may be no need to increase the interference allowance for video in order to facilitate coordination.

Second, interference effects in an FM-TV transmission are highly dependent upon the character of the interference and it would be desirable for further study to be given to the relationship between baseband noise due to interference, the nature of the interfering signal, and the subjective picture quality which, as in the FDM-FM telephony case, is the ultimate, although not quantifiable, criterion. An increase of the allowable interference noise to 25% of the total baseband noise may well produce objectionable picture quality for some types of interference. The matter is aggravated by the fact that, unlike the FDM-FM telephony case, no trade-off between internal noise and that due to external interference, is possible; a "good" picture tends to be subjectively more sensitive to certain types of interference than a poorer picture.

Thus, a move towards increasing the permissible interference for FM-TV, may on the one hand, not be necessary, and on the other, not be readily possible.

In Annex III, an impairment method to evaluate degradation due to interference is described. Based on a study carried out using NTSC television signals, in the general case it may not be desirable nor appropriate to simply add the different predetection signals on a power basis to attempt to evaluate the degradation of the television signal. However in the case of network quality NTSC signal (Recommendation 567), a close agreement has been shown between the two very different methods: the "objective" method of Report 449 and the "subjective" method of Report 405 and Recommendations 500 and 600 of CCIR Volumes XI-1 and X/XI-2 in carrying out the calculations of Recommendation 483.

Further, in Annex III, results of experiments which related the C/I and S/N resulting in "just perceptible interference" for a variety of carrier types are presented.

3.4 *Permissible levels of interference in digital transmissions*

In the case of digital transmissions, Recommendation 522 gives the performance criterion in terms of the parameter most significant to the user; the bit error ratio. The long-term performance criterion stipulates that the bit error ratio should not exceed the provisional value of one part in 10^6 , 10-minute mean for more than 20% of any month.

To derive an interference criterion which, as before, should reflect a moderate impact of interference on total performance, one could remain in the bit error ratio domain. However, unlike the analogue FDM-FM telephony case, there is no simple linear relationship between contributions to the bit error ratio due to internal noise and that due to interference. As a consequence, one is obliged to relate the interference criterion to the actual performance criterion as a reference. Thus, one could choose as the interference criterion, that interference which would raise the bit error ratio from $10^{-6}/k$ to 10^{-6} where k is some positive number which would constitute the allowable increase in bit error ratio due to interference. The matter is discussed further in Report 793.

However, since it is necessary to refer to the performance criterion, it has been found to be advantageous to express the interference criterion in terms of a predemodulation parameter which is usually readily available. Having the choice between the wanted-to-unwanted carrier ratio (C/I) and the external-to-internal noise ratio (I/N), the latter is preferred, because it is largely independent of specific equipment characteristics. The resulting interference criterion is reflected in Recommendation 558. An allowance is also to be made for interference from terrestrial systems where a band is shared with such services.

This criterion has the further advantage that the contributions from various entries may be added in the power domain. In the digital case, as in the analogue FDM-FM telephony case, a trade-off between internal and external noise is possible within reason, and a large digital interference allowance may be considered to facilitate coordination. The effect of interference into digital systems is a function of the amplitude and phase distribution of the interfering carrier. Carrier offset of an interfering signal thus has little effect, as long as the main part of the interference spectrum falls within the wanted channel.

For phase modulated systems using differential encoding and coherent detection, the permissible level of interference can be calculated from the formula:

$$\frac{C}{I} \geq 10.8 - \frac{I}{N_{total}} - 20 \log \left[\sin \left(\frac{180^\circ}{m} \right) \right] + \Delta \quad \text{dB} \quad (3)$$

where:

C/I : ratio of wanted signal power to interference power;

I/N_{total} : ratio of the interference power under consideration to the total noise power including all interference power;

I/N_{total} : -7 dB (20%), -8.2 dB (15%) or -14 dB (4%) depending on the circumstances of the interference as defined in Recommendation 523; 10.8 dB is the theoretical value (C/N_{total}) dB required for BER = 10^{-6} for a two-phase system;

m : number of phase positions in the PM signal;

Δ : the estimated implementation loss. This will vary according to the demodulator characteristics and the number of phase positions, m .

Typical values for Δ are:

$2.5 + 0.5 \log_2 m$ dB for FDMA systems,

$3.0 + 0.7 \log_2 m$ dB for TDMA systems.

The interference power would be measured in the occupied bandwidth, which will approximate to the Nyquist bandwidth, $B = \frac{R}{\log_2 m}$, where R is the transmission rate in bit/s.

Further research is needed into the conditions under which Recommendation 523 is applicable, with regard to the frequency bandwidth at which the interference level is measured, the modulation characteristics and the performance of the modems.

The method described above for calculating the permissible interference level is based on the assumption that interference has the character of thermal noise. Report 388 contains data which may be used to assess the validity of this assumption for PSK interference.

3.5 Results of permissible level of carrier-to-interference ratio

The permissible level of interference has been calculated for various types of carrier combination taken from Table I of Annex III to Report 454. The criteria used for various signal types are summarized in Table I.

The interference calculation has been based on the assumption that the carrier center frequency of the interfered-with carrier coincides with that of the interfering carrier. The spectra of FDM/FM carriers have been assumed to be Gaussian for the purpose of these calculations. Furthermore, due account is taken of the difference in the bandwidths of interfered-with and interfering carriers. When the bandwidth of interfered-with carrier is larger than that of interfering carrier, multiple interference entries with different offsets are considered.

Table II provides the required C/I matrix in which the element (i,j) implies the required C/I to protect the carrier i against the carrier j, in order that it meets a given single entry criterion. For networks published before 1987 the corresponding values would be 1.8 dB higher since the single entry criterion for them was more stringent.

It is to be noted that for the interference to companded FDM/FM carriers the acceptable C/I would be reduced by the amount corresponding to a companding gain.

3.6 *Relationship between total allowable interference and individual entries*

The recommended maximum total interference value provides guidance to system designers, who are expected to design their systems to accommodate this level of interference without failing to achieve the required standards of system performance. Thus, the problem is to choose a value for the maximum single entry such that the minimum satellite angular separations will be suitable, and it will be feasible for all the necessary new satellite networks to be accommodated in orbit, as well as ensuring that the total interference in a network will not exceed the recommended value.

For a number of years the single interference entry was limited by CCIR Recommendations to 4/10 of the total allowable. This ratio corresponds approximately to the contribution to the total of each of the two neighbour-satellite networks among a homogeneous equi-spaced population, the satellites of which serve essentially the same area on the Earth surface.

In practice, this single-valued bound has proven unsatisfactory because:

- it is not associated with any given spacing between co-coverage neighbour-satellites and may be claimed for quite large spacings. This tends to be wasteful of orbit; and
- it is an insufficient safeguard to ensure that actual cumulative interference will not exceed the total allowable for which networks have been designed.

To remedy these shortcomings, a strategy may be used which is aimed at producing a reasonably high degree of homogeneity among all networks in a given fixed-satellite service band by imposing emission and sensitivity constraints on the transmit and receive systems respectively, of the earth and space stations in all networks. These constraints would be chosen in such a way that they allow "reasonable" implementation and transmission parameters to be used for acceptable inter-satellite spacing between co-coverage networks (e.g. 4° to 10° of arc). This strategy would be highly effective since it establishes an absolute interference between networks. At the same time, it would be relatively restrictive since the design and operating ranges of the technical parameters in all networks are necessarily bounded.

This strategy is designed to limit the total interference entering a network when all the interfering networks have service areas that overlap with the service area of the wanted network. This is a situation which is typical, for example, of certain arcs of the geostationary-satellite orbit which are extensively used for global coverage satellites. There are additional risks of large total interference levels when some of the networks involved have service areas which do not overlap the service area of the wanted network, and the risks will increase as the orbit becomes crowded with national-coverage satellites using high-performance antennas.

When the satellite network suffering inter-network interference uses FDM-FM emissions of various bandwidths it is unlikely that the maximum interference entries within the network or from other networks will all enter the same wanted channel. Therefore, the total interference in the worst-affected channel will be less than the arithmetic sum of all the separate worst-case single entries of interference. For this reason a ratio of about 1:3 between the maximum permissible single entry and the assumed total level may be valid. Recommendation 466 takes these principles into account in adopting a 2500 pW0p criteria for total inter-network interference, and a 800 pW0p criteria for single inter-network interference entries.

TABLE I
SINGLE ENTRY INTERFERENCE CRITERIA

- FDM/FM - Reference: CCIR Recommendation 466-4
800 pWOp
- SCPC/FM - Reference: CCIR Recommendation AB/4 & others
 - Noise-like interference: $C/I^* = C/N$ (operating) + 11.0 (dB)
 - TV/FM interference: $C/I^{**} = 13.5 + 2 \log \delta - 3 \log (i/10)$ (dB)
 - $\delta =$ bandwidth ratio of SCPC/FM carrier to TV/FM with energy dispersal only
 - $i =$ Pre-demodulation interference power in the SCPC bandwidth expressed as a percentage of the total pre-demodulation noise power ($10 \leq i \leq 25$)
- SCPC/PSK - Reference: CCIR Recommendation AB/4 & others***
 - Noise-like interference: $C/I^* = C/N$ (BER= 10^{-6}) + 12.2 (dB)
 - TV/FM interference: $C/I^* = C/N$ (BER= 10^{-6}) + 6.4 + $3 \log \delta - 8 \log (i/10)$ (dB)
 - $\delta =$ bandwidth ratio of SCPC/PSK carrier to TV/FM with energy dispersal only
 - $i =$ Pre-demodulation interference power in the SCPC bandwidth expressed as a percentage of the total pre-demodulation noise power ($10 \leq i \leq 25$)
- Digital - Reference: CCIR Recommendation 523-2
 $C/I^* = C/N$ (BER = 10^{-6}) + 12.2 (dB)
- TV/FM - Reference: CCIR Recommendation 483-1
 $C/I^* = C/N$ (operating) + 14 (dB)

Note - Assumed values of C/N are 10.0 dB for SCPC-FM, 15.7 dB for SCPC/PSK and digital carriers, 17.9 dB for TV/FM (17.5 MHz) and 16.0 dB for others.
- Assumed value of i is 20%.

- * I is the interference power contained in the bandwidth of the desired carrier.
- ** I is the total power of the interfering carrier.
- *** The criteria for TV/FM to SCPC/PSK is currently under further study by CCIR.

TABLE II
SINGLE ENTRY CARRIER-TO-INTERFERENCE RATIO (CIR) MATRIX

WANTED CARRIER	INTERFERING CARRIER																			
	1	2	3	4	5	6	7	8	9	10	11	12	13	14	15	16	17	18	19	20
1	26.4	24.4	25.2	25.2	25.3	22.7	22.8	23.4	21.2	21.4	21.5	20.1	20.2	20.2	18.1	16.5	16.7	17.3	16.0	16.3
2	17.8	16.4	16.9	16.9	17.0	18.3	16.4	16.8	14.0	14.2	14.3	13.1	13.1	13.1	11.2	11.6	9.8	10.3	9.1	9.4
3	26.6	28.2	25.8	25.8	25.9	23.9	24.0	24.8	22.8	22.7	22.8	21.6	21.6	21.6	19.6	20.0	18.2	16.8	17.8	17.6
4	34.4	33.6	33.9	33.9	34.0	32.8	32.6	33.0	31.3	31.8	31.6	30.4	30.4	30.4	28.5	28.9	27.1	27.7	26.4	26.7
5	36.1	35.6	35.9	35.9	36.0	34.7	34.8	35.1	33.5	33.7	33.8	32.7	32.7	32.7	30.8	31.2	29.4	30.0	26.7	29.0
6	28.3	26.4	26.7	26.6	26.6	25.7	25.8	26.0	24.8	25.0	25.0	24.1	24.1	24.1	22.4	22.5	21.1	21.6	20.4	20.7
7	36.4	33.8	34.1	33.7	33.7	33.3	33.4	33.7	32.7	32.7	32.8	32.9	32.2	32.2	30.7	31.0	29.5	30.0	28.8	29.1
8	41.8	37.2	37.4	36.6	36.6	37.1	37.1	37.1	37.0	37.1	37.2	37.2	36.8	36.8	36.8	35.6	35.9	34.5	35.0	34.2
9	30.0	27.2	27.6	27.2	27.2	26.3	26.3	25.4	25.7	25.8	25.9	25.2	25.2	25.2	23.8	24.1	22.6	23.1	22.0	22.3
10	37.8	34.3	34.9	34.1	34.1	32.8	32.8	32.9	32.5	32.6	32.6	32.2	32.2	32.2	31.1	31.3	30.0	30.5	29.4	29.7
11	41.0	37.8	38.3	37.2	37.2	35.1	35.1	35.0	35.2	35.2	35.2	35.1	35.1	35.1	34.3	34.5	33.4	33.8	32.8	33.1
12	31.1	28.2	28.6	28.1	28.1	26.5	26.5	26.4	26.1	26.1	26.2	25.7	25.7	25.7	24.6	24.8	23.5	24.0	22.9	23.2
13	38.3	35.3	35.8	35.1	35.1	32.6	32.6	32.4	32.3	32.3	32.3	32.1	32.1	32.1	31.3	31.5	30.4	30.8	29.9	30.2
14	41.1	38.1	38.7	37.9	37.9	34.7	34.4	34.2	34.3	34.3	34.3	34.2	34.2	34.2	33.6	33.9	33.0	33.4	32.6	32.8
15	34.1	31.2	31.7	31.1	31.1	28.6	28.2	28.2	27.5	27.4	27.4	27.2	27.2	27.2	26.6	26.7	25.9	26.2	25.4	25.6
16	41.9	39.0	39.5	38.9	38.9	36.1	35.3	35.2	34.1	33.9	33.7	33.7	33.7	33.7	33.6	33.7	33.2	33.4	32.8	33.0
17	38.2	35.3	35.8	35.2	35.2	32.7	32.2	32.1	30.9	30.5	30.3	30.0	29.8	29.7	29.4	29.4	29.0	29.1	28.7	28.6
18	43.8	41.0	41.5	40.8	40.8	38.4	37.7	37.7	36.1	35.8	35.1	34.7	34.3	34.1	34.2	34.2	34.0	34.1	33.9	34.0
19	36.7	33.8	34.3	33.7	33.7	31.3	30.8	30.7	29.5	29.2	28.9	28.6	28.2	28.1	27.6	27.7	27.2	27.4	27.0	27.1
20	45.3	42.4	42.9	42.3	42.3	39.8	39.3	39.2	37.9	37.4	37.0	36.4	35.5	35.2	34.4	34.4	34.5	34.5	34.4	34.4
21	48.7	45.8	46.3	45.7	45.7	43.3	42.6	42.8	41.5	40.8	40.3	39.4	38.5	38.0	37.4	36.4	36.1	36.6	36.4	36.4
22	43.0	40.1	40.6	40.0	40.0	37.5	37.0	36.9	35.8	35.4	35.2	34.7	34.2	33.9	32.3	32.1	31.2	31.3	31.0	31.1
23	8.0	4.6	5.6	5.6	5.9	2.6	2.8	3.4	1.0	1.2	1.4	-0.1	0.0	0.0	-2.1	-1.7	-3.6	-3.0	-4.3	-3.9
24	9.0	5.5	6.6	6.6	6.8	3.6	3.8	4.4	2.0	2.2	2.3	0.9	0.9	1.0	-1.1	-0.7	-2.6	-2.0	-3.3	-3.0
25	9.8	6.3	7.4	7.4	7.6	4.4	4.5	5.2	2.8	3.0	3.1	1.7	1.7	1.8	-0.3	0.1	-1.8	-1.2	-2.5	-2.2
26	14.5	11.1	12.2	12.1	12.4	9.2	9.3	9.9	7.5	7.8	7.9	6.5	6.5	6.5	4.4	4.9	3.0	3.5	2.3	2.6
27	17.5	14.1	15.2	15.2	15.4	12.2	12.3	12.9	10.5	10.8	10.9	9.5	9.5	9.5	7.4	7.9	6.0	6.6	5.3	5.6
28	17.7	14.3	15.3	15.3	15.5	12.3	12.5	13.1	10.7	10.9	11.1	9.6	9.7	9.7	7.6	8.0	6.1	6.7	5.4	5.7
29	18.9	15.5	16.5	16.5	16.7	13.5	13.7	14.3	11.9	12.1	12.2	10.8	10.9	10.9	8.8	9.2	7.3	7.9	6.6	6.9
30	23.7	20.2	21.3	21.3	21.5	18.3	18.4	19.1	16.6	16.9	17.0	15.6	15.6	15.6	13.6	14.0	12.1	12.7	11.4	11.7
31	26.7	23.2	24.3	24.3	24.5	21.3	21.4	22.1	19.7	19.9	20.0	18.6	18.6	18.7	16.6	17.0	15.1	15.7	14.4	14.7
32	29.7	26.2	27.3	27.3	27.5	24.3	24.5	25.1	22.7	22.9	23.0	21.6	21.7	21.7	19.6	20.0	18.1	18.7	17.4	17.7
33	29.0	27.7	27.9	27.9	27.9	27.0	27.1	27.4	25.9	26.1	26.2	25.1	25.1	25.1	23.2	23.6	21.8	22.4	21.1	21.5
34	30.0	27.9	27.9	27.9	27.9	27.5	27.5	27.7	26.7	26.8	26.9	25.9	25.9	26.0	24.2	24.6	22.9	23.4	22.2	22.5
35	30.9	28.0	28.5	27.9	27.9	27.7	27.8	27.8	27.1	27.3	27.3	26.5	26.6	26.6	24.8	25.3	23.7	24.2	23.0	23.3
36	34.4	31.5	32.0	31.4	31.4	28.9	28.4	28.3	27.9	27.9	27.9	27.8	27.8	27.8	27.3	27.5	26.5	26.9	26.0	26.3
37	34.4	31.5	32.0	31.4	31.4	28.9	28.4	28.3	27.9	27.9	27.9	27.8	27.8	27.8	27.3	27.5	26.5	26.9	26.0	26.3
38	37.5	34.6	35.1	34.5	34.5	32.0	31.5	31.4	30.3	29.9	29.7	29.2	28.7	28.5	27.9	27.9	27.6	27.9	27.6	27.7
39	39.9	37.0	37.5	36.9	36.9	34.5	34.0	33.9	32.8	32.4	32.2	31.7	31.2	30.9	29.5	29.3	27.9	28.0	27.9	27.9
40	40.5	37.6	38.1	37.5	37.5	35.1	34.6	34.5	33.4	33.0	32.8	32.3	31.7	31.5	30.1	29.9	28.5	28.6	27.9	27.9
41	40.4	37.5	38.0	37.4	37.4	34.9	34.4	34.4	33.2	32.8	32.6	32.2	31.6	31.4	30.0	29.8	28.4	28.4	27.9	27.9
42	41.5	38.6	39.1	38.5	38.5	36.0	35.5	35.4	34.3	33.9	33.7	33.2	32.7	32.5	31.1	30.9	29.4	29.5	28.6	28.6
43	46.1	43.2	43.7	43.1	43.1	40.7	40.2	40.1	39.0	38.6	38.4	37.9	37.4	37.1	35.7	35.5	34.1	34.2	33.5	33.2
44	46.5	43.6	44.1	43.5	43.5	41.1	40.6	40.5	39.4	39.0	38.8	38.3	37.7	37.5	36.1	35.9	34.5	34.6	33.9	33.5
45	47.8	44.9	45.4	44.8	44.8	42.3	41.8	41.8	40.6	40.3	40.0	39.6	39.0	38.8	37.4	37.2	35.8	35.8	35.2	34.6
46	43.8	40.9	41.4	40.8	40.8	38.4	37.8	37.8	36.6	36.3	36.0	35.6	35.0	34.8	33.4	33.2	31.9	31.9	31.9	31.9
47	42.8	39.6	40.1	39.5	39.5	37.0	36.5	36.5	35.3	34.9	34.7	34.3	33.7	33.5	32.1	31.9	30.5	30.5	30.0	30.0
48	44.2	41.3	41.8	41.2	41.2	38.8	38.3	38.2	37.1	36.7	36.5	36.0	35.5	35.2	33.8	33.6	32.2	32.3	31.6	31.3
49	44.2	41.3	41.8	41.2	41.2	38.8	38.3	38.2	37.1	36.7	36.5	36.0	35.5	35.2	33.8	33.6	32.2	32.3	31.6	31.3
50	44.5	41.6	42.1	41.5	41.5	39.1	38.6	38.5	37.4	37.0	36.6	36.3	35.8	35.5	34.1	33.9	32.5	32.6	31.9	31.6

TABLE II (continued)

	21	22	23	24	25	26	27	28	29	30	31	32	33	34	35	36	37	38	39	40
1	14.7	13.8	42.8	41.8	40.7	38.9	32.9	39.7	38.8	33.7	30.7	29.2	23.9	22.8	21.9	18.8	18.8	18.4	12.9	12.3
2	9.8	7.0	35.4	34.4	33.8	29.1	24.1	32.8	31.4	24.9	23.8	20.8	16.8	18.9	18.1	11.4	11.4	8.5	6.1	8.5
3	18.2	18.4	44.0	43.0	42.2	37.8	34.8	41.2	40.0	35.3	32.3	29.3	25.4	24.4	23.8	20.0	20.0	16.9	14.8	13.9
4	27.1	24.3	52.9	52.0	51.2	46.4	43.4	50.1	49.0	44.2	41.2	38.0	34.2	33.3	32.4	28.9	28.9	25.8	23.4	22.8
5	29.4	26.4	55.2	54.3	53.8	48.7	48.7	52.6	51.3	46.8	43.8	40.3	36.4	36.4	34.7	31.3	31.3	28.2	25.7	25.1
6	21.1	18.3	47.0	46.0	45.2	40.8	37.8	44.2	43.0	38.3	35.2	32.2	28.4	27.4	26.2	23.0	23.0	19.9	17.8	16.9
7	29.8	24.8	53.8	54.8	53.7	48.9	48.9	52.7	51.8	46.7	43.7	40.7	36.9	38.8	34.3	31.8	31.8	28.4	25.9	25.3
8	34.8	31.9	63.4	62.4	61.8	54.1	51.1	57.8	56.4	51.9	48.8	46.8	42.0	41.0	40.1	36.4	36.4	33.8	31.1	30.5
9	22.4	20.0	43.7	42.7	41.9	37.2	34.2	41.9	40.9	36.9	33.9	30.1	29.0	28.2	24.7	24.7	21.4	19.1	18.4	
10	30.0	27.8	54.3	53.3	52.8	49.7	44.7	53.8	52.3	47.8	44.8	41.8	37.7	36.4	35.7	32.2	32.2	29.2	26.7	26.1
11	33.4	30.9	59.8	58.8	58.0	53.2	50.2	57.0	55.8	51.0	48.0	45.0	41.2	40.1	39.2	35.7	35.7	32.7	30.2	29.6
12	23.8	21.0	49.8	48.8	48.0	43.2	40.2	47.0	45.8	41.0	38.0	36.0	31.2	30.1	29.2	25.7	25.7	22.7	20.2	19.6
13	30.8	28.1	57.0	56.0	55.2	50.8	47.4	54.2	53.0	48.2	45.2	42.2	38.4	37.3	36.4	32.7	32.7	29.9	27.4	26.8
14	33.0	30.9	59.8	58.8	58.0	53.3	50.2	57.0	55.8	51.0	48.0	45.0	41.2	40.1	39.2	35.3	35.3	32.7	30.2	29.6
15	28.9	23.8	52.8	51.9	51.1	44.3	43.3	50.0	48.9	44.1	41.1	38.1	34.3	33.3	32.3	28.8	28.8	25.7	23.3	22.7
16	33.2	31.8	60.4	59.7	58.9	54.1	51.1	57.9	56.7	51.9	48.9	45.9	42.1	41.0	40.1	36.7	36.7	33.5	31.1	30.5
17	29.0	27.8	54.9	53.9	53.1	50.4	47.4	54.1	52.9	48.2	45.1	42.1	38.3	37.2	36.4	32.9	32.9	29.5	27.4	26.8
18	34.0	32.9	62.4	61.4	60.8	54.0	53.0	59.8	58.4	53.8	50.8	47.8	44.0	42.9	42.0	38.4	38.4	35.0	32.4	31.8
19	27.2	25.9	58.8	57.8	57.7	48.9	48.9	52.7	51.8	46.7	43.7	40.7	36.9	38.8	34.9	31.8	31.8	28.4	25.9	25.3
20	34.8	33.8	64.0	63.0	62.2	57.8	54.4	61.2	60.0	55.2	52.2	49.2	45.4	44.3	43.8	40.0	40.0	36.9	34.4	33.8
21	36.8	34.9	67.8	66.8	65.7	60.9	57.9	64.7	63.8	58.7	55.7	52.7	48.9	47.8	46.9	43.8	43.8	40.4	37.8	37.2
22	31.1	30.4	61.7	60.7	59.9	55.2	52.1	58.9	57.7	52.9	49.9	46.9	43.1	42.0	41.2	37.7	37.7	34.4	32.1	31.2
23	-3.5	-6.4	22.2	21.2	20.4	18.7	12.7	19.4	18.2	13.4	10.4	7.4	3.4	2.4	1.7	-1.8	-1.8	-4.9	-7.3	-7.9
24	-2.6	-5.5	23.2	22.2	21.4	14.4	13.4	20.4	19.2	14.4	11.4	8.4	4.4	3.8	2.7	-0.6	-0.6	-3.9	-6.4	-7.0
25	-1.8	-4.7	24.0	23.0	22.2	17.4	14.4	21.2	20.0	15.2	12.2	9.2	5.4	4.3	3.4	0.0	0.0	-3.1	-5.6	-6.2
26	3.0	0.1	28.7	27.8	27.0	22.2	19.2	26.9	24.8	20.0	17.0	14.0	10.2	9.1	8.2	4.6	4.6	1.7	-0.8	-1.4
27	6.0	3.1	31.7	30.8	30.0	25.2	22.2	29.0	27.8	23.0	20.0	17.0	13.2	12.1	11.2	7.6	7.6	4.7	2.2	1.4
28	4.1	3.3	30.7	29.7	28.9	24.2	21.1	27.9	24.7	21.9	18.9	15.9	12.1	11.0	10.2	6.7	6.7	3.4	1.1	0.4
29	7.3	4.4	31.9	30.9	30.1	25.3	22.3	29.1	27.9	23.1	20.1	17.1	13.3	12.2	11.4	7.9	7.9	4.8	2.3	1.8
30	12.1	9.2	34.7	33.7	34.9	30.1	27.1	33.9	32.7	27.9	24.9	21.9	18.1	17.0	16.1	12.7	12.7	9.4	7.1	6.5
31	18.1	12.2	39.7	38.7	37.9	33.1	30.1	36.9	35.7	30.9	27.9	24.9	21.1	20.0	19.1	15.7	15.7	12.4	10.1	9.5
32	18.1	18.2	42.7	41.7	40.9	34.1	33.1	39.9	38.7	33.9	30.9	27.9	24.1	23.0	22.2	18.7	18.7	15.4	13.1	12.8
33	21.9	19.0	46.8	45.8	44.7	39.9	36.9	43.7	42.8	37.7	34.7	31.7	27.9	26.8	26.0	22.8	22.8	19.4	16.9	16.3
34	22.9	20.1	47.8	46.4	45.8	41.0	38.0	44.8	43.4	38.8	35.8	32.8	29.0	27.9	27.0	23.4	23.4	20.8	18.0	17.4
35	23.7	20.9	48.4	47.4	46.7	41.9	38.9	45.4	44.4	39.7	36.7	33.4	29.8	28.8	27.9	24.4	24.4	21.3	18.9	18.3
36	24.5	24.2	51.9	50.9	50.1	45.3	42.3	49.1	47.9	43.1	40.1	37.1	33.3	32.2	31.4	27.9	27.9	24.6	22.3	21.8
37	24.8	24.2	51.9	50.9	50.1	45.3	42.3	49.1	47.9	43.1	40.1	37.1	33.3	32.2	31.4	27.9	27.9	24.6	22.3	21.8
38	27.8	24.7	58.0	54.0	53.2	48.4	48.4	52.2	51.0	46.2	43.2	40.2	36.4	35.3	34.8	31.0	31.0	27.9	25.4	24.8
39	27.9	27.7	57.4	56.8	55.7	50.9	47.9	54.7	53.8	48.7	45.7	42.7	38.9	37.8	36.9	33.5	33.5	30.4	27.9	27.3
40	27.9	27.8	58.0	57.1	56.3	51.8	48.8	55.2	54.0	49.3	46.3	43.3	39.8	38.4	37.8	34.0	34.0	31.0	28.8	27.9
41	27.9	27.8	57.9	54.9	54.1	51.4	48.4	55.1	53.9	49.1	46.1	43.1	39.3	38.3	37.4	33.9	33.9	30.8	28.4	27.8
42	28.0	27.9	59.0	58.0	57.2	52.4	49.4	54.2	53.0	48.2	47.2	44.2	40.4	39.3	38.8	35.0	35.0	31.9	29.4	28.6
43	32.7	31.1	63.4	62.7	61.9	57.1	54.1	60.9	59.7	54.9	51.9	48.9	45.1	44.0	43.1	39.7	39.7	36.4	34.1	33.5
44	33.1	31.8	64.0	63.1	62.3	57.8	54.8	61.2	60.0	55.3	52.3	49.3	45.8	44.4	43.8	40.0	40.0	37.0	34.8	33.9
45	34.3	32.8	65.3	64.3	63.8	58.8	55.8	62.8	61.3	56.4	53.8	50.8	46.7	45.7	44.8	41.3	41.3	38.2	35.6	35.2
46	31.9	31.7	61.3	60.4	59.4	54.8	51.8	58.8	57.3	52.4	49.4	46.8	42.7	41.7	40.8	37.3	37.3	34.2	31.8	31.2
47	30.0	29.9	60.0	59.0	58.2	53.8	50.8	57.2	56.0	51.2	48.2	45.2	41.4	40.4	39.8	36.0	36.0	32.9	30.6	29.9
48	30.8	30.0	61.8	60.8	60.0	55.2	52.2	59.0	57.8	53.0	50.0	47.0	43.2	42.1	41.2	37.8	37.8	34.7	32.2	31.4
49	30.8	30.0	61.8	60.8	60.0	55.2	52.2	59.0	57.8	53.0	50.0	47.0	43.2	42.1	41.2	37.8	37.8	34.7	32.2	31.4
50	31.1	30.0	62.0	61.1	60.3	55.8	52.8	59.3	58.1	53.3	50.3	47.3	43.8	42.4	41.8	38.1	38.1	35.0	32.8	31.9

TABLE II (continued)

	41	42	43	44	45	46	47	48	49	50
1	12.5	11.4	4.7	4.3	5.1	22.5	22.5	19.4	19.4	22.5
2	5.6	4.5	-0.1	-0.5	-1.8	15.4	15.4	12.4	12.4	15.4
3	14.0	12.9	8.3	7.9	6.6	24.0	24.0	21.0	21.0	24.0
4	22.9	21.9	17.2	16.8	15.5	32.9	32.9	29.9	29.9	32.9
5	25.2	24.2	19.5	19.1	17.8	35.2	35.2	32.2	32.2	35.2
6	17.0	15.9	11.3	10.9	9.6	26.4	26.4	24.0	24.0	26.4
7	25.5	24.4	19.7	19.3	18.0	34.5	34.5	32.4	32.4	34.5
8	30.4	29.5	24.9	24.5	23.2	38.8	38.8	37.6	37.6	38.8
9	18.7	17.6	13.0	12.6	11.3	27.3	27.3	25.6	25.6	27.3
10	24.2	23.2	20.5	20.1	18.8	34.0	34.0	33.0	33.0	34.0
11	29.8	29.7	24.0	23.4	22.3	36.5	36.5	36.3	36.3	36.5
12	19.8	18.7	14.0	13.4	12.4	27.4	27.4	26.4	26.4	27.4
13	27.0	25.9	21.2	20.8	19.4	33.4	33.4	33.1	33.1	33.4
14	29.8	28.7	24.0	23.4	22.4	35.5	35.5	35.4	35.4	35.5
15	22.8	21.8	17.1	16.7	15.4	28.7	28.7	28.2	28.2	28.7
16	30.4	29.4	24.9	24.5	23.2	34.9	34.9	35.0	35.0	34.9
17	26.9	25.8	21.2	20.8	19.5	30.9	30.9	30.8	30.8	30.9
18	32.4	31.5	26.8	26.4	25.2	35.2	35.2	35.4	35.4	35.2
19	25.4	24.4	19.7	19.3	18.0	29.2	29.2	29.0	29.0	29.2
20	34.0	32.9	28.2	27.8	26.6	35.3	35.3	35.5	35.5	35.3
21	37.4	36.4	31.7	31.3	30.0	36.4	36.4	37.0	37.0	36.4
22	31.3	30.5	25.9	25.5	24.3	32.4	32.4	32.4	32.4	32.4
23	-7.8	-6.9	-13.5	-13.9	-15.2	8.6	8.6	8	8	8.6
24	-6.8	-7.9	-12.4	-13.0	-14.2	8.8	8.8	8.2	8.2	8.8
25	-6.0	-7.1	-11.8	-12.2	-13.4	8.9	8.9	8.3	8.3	8.9
26	-1.3	-2.3	-7.0	-7.4	-8.7	9.9	9.9	9.3	9.3	9.9
27	1.7	0.7	-4.0	-4.4	-5.7	10.5	10.5	9.9	9.9	10.5
28	0.7	-0.4	-5.1	-5.4	-6.7	14.5	14.5	13.6	13.6	14.5
29	1.9	0.8	-3.9	-4.2	-5.5	18.1	18.1	16.3	16.3	18.1
30	6.7	5.6	0.9	0.5	-0.8	21.0	21.0	19.1	19.1	21.0
31	9.7	8.4	3.9	3.5	2.3	22.8	22.8	21.0	21.0	22.8
32	12.7	11.6	6.9	6.5	5.3	24.4	24.4	22.8	22.8	24.4
33	14.5	13.4	10.7	10.3	9.1	26.5	26.5	23.5	23.5	26.5
34	17.5	16.5	11.8	11.4	10.1	27.5	27.5	24.5	24.5	27.5
35	18.4	17.3	12.7	12.3	11.0	27.9	27.9	25.4	25.4	27.9
36	21.9	20.8	14.1	13.8	12.5	27.9	27.9	27.9	27.9	27.9
37	21.9	20.8	14.1	13.8	12.5	27.9	27.9	27.9	27.9	27.9
38	25.0	23.9	19.2	18.8	17.4	27.9	27.9	27.9	27.9	27.9
39	27.4	26.4	21.7	21.3	20.0	28.0	27.9	27.9	27.9	27.9
40	28.0	27.0	22.3	21.9	20.6	28.4	28.0	27.9	27.9	27.9
41	27.9	26.8	22.2	21.8	20.5	28.5	27.9	27.9	27.9	27.9
42	29.0	27.9	23.2	22.8	21.4	29.6	29.0	27.9	27.9	27.9
43	33.4	32.4	27.9	27.5	26.2	34.2	33.4	31.9	31.9	31.6
44	34.0	33.0	28.3	27.9	26.4	34.4	34.0	32.3	32.3	32.0
45	35.3	34.2	29.4	29.2	27.9	35.9	35.3	33.5	33.5	33.3
46	31.3	30.2	25.4	25.2	23.9	31.9	31.9	31.9	31.9	31.9
47	30.0	28.9	24.3	23.9	22.4	30.4	30.0	30.0	30.0	30.0
48	31.8	30.7	26.0	25.4	24.4	32.3	31.8	30.0	30.0	30.0
49	31.8	30.7	26.0	25.4	24.4	32.3	31.8	30.0	30.0	30.0
50	32.0	31.0	26.3	25.9	24.4	32.4	32.0	30.3	30.3	30.0

However, for wide-band digital systems, all the various interference entries within the pre-demodulator bandwidth of the wanted system will be added together on a power basis and will affect all channels in the system; there will be no randomization of the incidence of interference between different channels. In these circumstances it can be clearly foreseen that the total interference level will be substantially greater and a higher ratio between the maximum permissible single entry and the recommended total interference level should be assumed. Also, it appears to be necessary to differentiate between the permissible total inter-network interference levels where frequency re-use is and is not employed, but this is a subject for further study. Recommendation 523 for digital telephony adopts a lower value of total inter-network interference for frequency re-use in satellite networks because a given level of external interference will have more impact on the capacity of such a network than the same level would have on a network that does not use frequency re-use techniques. If the single entry maximum appropriate for the case where frequency re-use is not used were applied also to the frequency re-use case, there is some possibility that the total level of interference from other satellite networks in some of the channels will exceed the applicable criteria. This might occur when the arc of the orbit close to the wanted satellite is heavily loaded. However, if different single entry maxima were recommended in the two cases, the process of frequency coordination would be made more complex and for that reason the same value is used.

Recommendation 466 recommends a lower value of total inter-network interference for frequency re-use satellite networks (2000 pW0p) because a given level of external interference will have more impact on the capacity of such a network than the same level would have on a network that does not use frequency re-use techniques for which the allowance is for 2500 pW0p.

If the single entry maximum appropriate for the case where frequency re-use is not used were applied also to the frequency re-use case, there is some possibility that the total level of interference from other satellite networks in some of the channels will exceed 2000 pW0p when the arc of the orbit close to the wanted satellite is heavily loaded. However, if different single entry maxima were recommended in the two cases, the process of frequency coordination would be made more complex and for that reason the same value is used.

It is clear that any attempts to increase the current levels of maximum interference must be accompanied by safeguards which ensure that cumulative actual interference does not exceed the increased total allowance materially and continuing study is required.

A number of studies have been made with respect to the ratio of aggregate interference to single-entry interference. A description of these studies and the results obtained are given in Annex IV .

Finally, there are certain transmissions which are quite incompatible with each other as regards mutual interference on a co-channel basis. An example is the interference which a high density carrier such as TV-FM with insufficient carrier energy dispersal, or a low-index high-capacity FDM-FM carrier, may cause in a low capacity carrier such as an analogue or digital SCPC transmission. Juxtaposition of such incompatible transmissions would produce extreme imbalance in the characteristics of two networks and should be avoided by convention or in coordination.

4. Relationship between $\Delta T/T$ ratios and single-entry interference criteria

Annex V to Report 454 presents the results of calculations of the $\Delta T/T$ ratios that correspond to the single-entry interference criteria applicable to the different types of systems. Annex III of Report 454 contains a description of a method for calculating interference which is based on Appendix 29, appropriately modified to give accurate results.

5. Technical means to facilitate coordination between networks using geostationary satellites

When two satellite networks are coordinated from a mutual interference standpoint, a number of parameter adjustments may be made in either or both networks in order to meet mutually acceptable interference levels. These adjustments can include changes in link parameters which result in changes in power density and sensitivity levels.

Report 453 identifies, conceptually, four-power density constraints, namely:

- the up-link power density (P_u);
- the interference power density to which a satellite receiver is afforded protection (I_u);
- the down-link power density (P_d); and
- the interference power density to which an earth station receiver is afforded protection (I_d).

It may be possible to achieve coordination on this basis, i.e. agreed limits on these four parameter values.

Rearrangement of transponder accesses to minimize the effect of differences in earth station antenna gains or G/T may also be employed to achieve coordination on the above four parameter bases.

If during the coordination process between two systems evidence is provided that the interference criteria cannot be met over the entire band then it may be necessary to consider segmenting the frequency band and thereby enabling the coordination of more homogeneous bandwidth segments. The (P_u/I_u) and (P_d/I_d) values may be considerably reduced by a frequency band segmenting procedure whereby coordination may be achievable with different values for the four parameters in different segments of a band. Particular attention should first be given to interference from high spectral density carriers such as FM television. Whenever possible these carriers should be limited to a segment of the RF band free of highly sensitive transmissions such as SCPC telephony. If similar transponder arrangements are used for both networks this could be achieved by allocating different transponders for each type of transmission. If coordination is performed at an early design stage, another possibility could be to arrange the transponder frequency plans so that the filter cross-over bands of one network fall within the usable bandwidth of the other. This makes it possible to locate the highest spectral density carriers of one network within the guard bands of the other.

If this is not possible it may be necessary to reduce the interfering spectral density by improving the TV energy dispersal technique. Conventional spreading of a TV carrier, such as is presently employed to alleviate interference in low capacity multichannel carriers, is relatively ineffective in protecting an SCPC transmission since it is based on uniform dispersal of the often otherwise undeviated TV carrier at the video frame rate, i.e. 50 or 60 Hz. The TV carrier, dispersed at such a low rate and over one or, at most, a few MHz, is seen by an SCPC carrier much like pulsed interference of the full TV carrier power with a duty cycle equal to the ratio of the SCPC occupied bandwidth to the peak-to-peak dispersal deviation.

To achieve improved interference reduction for this case, a spreading technique for analogue FM-TV has been proposed and tested by analysis and measurement. This technique simply uses a higher dispersal frequency, ideally of the same order of magnitude as the information element rate of the SCPC signal. In practice, this is approximated by a dispersal frequency at the video line rate. It has been shown that the video signal, for line rate dispersal, does not require additional RF bandwidth. The interference effect on SCPC is then much more like that of a white noise signal uniformly distributed over the dispersal bandwidth, because the SCPC receiver filter can no longer respond to the actual sweeping TV carrier but rather, sees it as occupying an appreciable instantaneous bandwidth. The use of line-frequency dispersal thus results in a C/I ratio comparable to that obtained with other types of transmissions.

Both triangular and sawtooth spreading are effective, and either spreading waveform is easily removable at the receiver. For additional information, see Annex II of Report 384.

It should be noted that single-frequency dispersal of analogue FM-TV at the video line rate may prove unattractive for the reduction of interference into FDM-FM multichannel telephony or other analogue FM-TV carriers since the dispersal frequency may appear in the baseband of other carriers sharing common elements of the transmission system with the dispersed carrier.

For either line rate or frame rate energy dispersal, if the separation between the SCPC and TV carrier frequencies is slightly greater than one half of the sum of the energy dispersal bandwidth and the low frequency peak-to-peak TV carrier deviation, interference at the full TV carrier level cannot occur.

Frequency interleaving could be another means to facilitate the coordination procedure. The extent to which closer satellite spacing and improved orbit/spectrum utilization may be achieved by interleaving the carrier frequencies of one satellite with those of a neighbouring satellite, is critically dependent on the type of modulation (e.g. FM or PSK) and the satellite multiple-access technique (e.g. single carrier or FDMA) applied to the wanted and interfering carriers. The achievable reduction in satellite spacing may be expressed in terms of an improved tolerance to RF interference which, depending on the modulation and satellite multiple-access techniques applied, may vary from about 0 to 12 dB.

For the case of frequency-modulated FDM telephony an improvement in required carrier-to-interference ratio is obtained when interleaved carrier frequencies are used. This is of interest in considering the efficiency of use of the orbit. The improvement is found to be up to about 12 dB, depending upon the modulation indices.

In the case of systems employing a variety of modulation and satellite multiple-access techniques, the maximum interleaving advantage may only be achieved by appropriate coordination and the allocation of traffic or transmission modes to specific satellite RF channels. However, this may not be possible in practice because of the difficulty in accurately forecasting traffic requirements or new applications and the loss of flexibility in reassigning traffic. As noted above in § 3.4, there will be little improvement in satellite spacing requirements to be obtained by interleaving digital signals in such cases, but this is not likely to be a limiting factor, since the spacing required by analogue signals will usually be greater.

In view of the above considerations, the advantages of frequency interleaving between satellites may, in practice, be restricted to relatively few applications.

Coordination may be facilitated by rearrangement of carriers among transponders to minimize mutual interference. Computer techniques for optimum carrier arrangements have been developed for this case.

Coordination may also be facilitated by adjustment of the positions of carriers within each transponder. Techniques to optimize this type of carrier rearrangement have also been developed.

However, it should be noted that such coordination by carriers in an FDMA network would cause substantial operational difficulties due to inability to respond to changes in user requirements. Nevertheless, the pressure of new systems may make such detailed coordination necessary in the future.

A simple method of presenting interference calculations for two adjacent satellite systems is described in Annex II.

6. Separation of satellites in space and time domains

6.1 *Introduction*

Frequency sharing between satellites of different networks is feasible if sufficient angular separation exists between their satellites, or if the transmitter of one is turned off when sufficient angular separation is not available. The methods for establishing the required spatial and temporal separations for geostationary and non-geostationary satellites are indicated in the following paragraphs.

6.2 *Separation angles between geostationary satellites*

Calculations made in [CCIR, 1966-69] show that the required separation angles between satellites are not unreasonable (of the order of 1° to 6°) in most cases. Larger separations are, however, required in the case of multi-channel systems with low modulation indices, or single-channel systems.

6.3 *Interference between geostationary and non-geostationary systems*

6.3.1 *Separation in the space domain through orbit gaps*

Angular separation between satellites with inclined orbits and geostationary satellites can be maintained in the space domain only if parts of the geostationary-satellite orbit are reserved for the equatorial crossings of moving satellites.

This approach puts a limit on the number of geostationary satellites that can be employed.

6.3.2 *Separation in the time and space domains*

Separation between satellites in the space and time domains means that, during periods of insufficient spatial separation, temporal separation is achieved by terminating transmissions from one of the satellites causing mutual interference.

The entire system using non-geostationary satellites includes hand-overs, antenna reorientations, and tracking, as part of the normal operating procedures. The need to transfer traffic from one satellite about to be turned off for interference reasons, to another, will not add unduly to the complexity of the overall system.

Figure 1 represents the zone within which interference between geostationary and non-geostationary satellites is possible. This is the volume limited by the surface of revolution around the axis of the Earth formed by straight lines tangent to the Earth and intersecting the plane of the equator at the geostationary orbit altitude.

Interference between geostationary and non-geostationary satellites can be prevented by terminating transmissions from one of them when insufficient angular separation exists for earth stations communicating via these satellites. If earth stations working with a non-geostationary satellite are designed for tracking hand-overs, and rapid antenna reorientations, then technically it should be feasible to cease transmissions from such a satellite when sufficient spatial separation is not available between it and a geostationary satellite. When the geostationary satellite orbit becomes fully utilized, this could mean that non-geostationary satellites should technically be capable of ceasing transmissions when they are in the zone of interference as shown in Fig. 1. However, this is a question which would need to be decided by the administrations concerned.

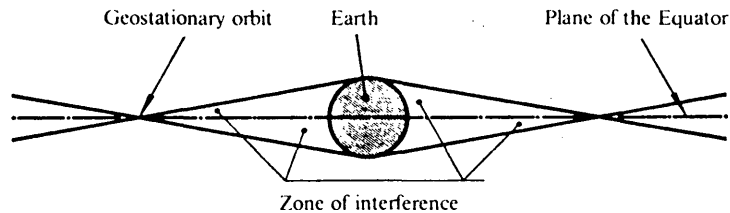

FIGURE 1 — *Zone of interference between geostationary and non-geostationary satellites*

7. Summary

This study shows that the minimum angular separation between satellites depends on the acceptable level of interference noise contributions in the baseband channels from other satellites and earth stations.

Frequency sharing between geostationary-satellite networks is feasible if sufficient angular separation is present. The actual spacing required for satellites in the geostationary-satellite orbit depends on system parameters such as e.i.r.p., radiation pattern of earth-station antennas, etc., and cannot be defined in general terms at this time.

Frequency sharing between the networks of geostationary and moving satellites is feasible if one of the satellites is turned off when sufficient angular separation is not provided. The decision on which satellite to turn off will have to be made by the administrations affected.

The actual spacing required between satellites also depends upon the permissible level of total interference and on the way in which this total is built up from the interference entries from individual satellites. The optimization of these levels and the determination of means for regulating them is an important matter for further study under Study Programme 28A/4.

REFERENCES

CCIR Documents

[1966-69]: 4/348 (USSR)

[1986-90]: 4/324 (IWP 4/1 report); 4/342 (U.K.); IWP 4/1 - 1506 (U.K.)

ANNEX I

METHOD OF CALCULATING THE WANTED-TO-INTERFERING CARRIER RATIOS
IN GEOSTATIONARY-SATELLITE NETWORKS**1. Introduction**

The amount of interference experienced between two satellite networks depends on the operating parameters of the networks involved. To assess the interference between radiocommunication-satellite networks it is usual to divide the computation process into two stages. The first stage of the calculation is to determine the wanted-to-interfering carrier ratios between any two potentially interfering carriers, at the appropriate receiver input terminals. The second stage is then to relate these ratios to the noise power in the baseband channel. This Annex provides the method for calculating the wanted-to-interfering carrier ratios. For the second stage, reference should be made to Report 388.

2. Method

The interference geometry between two satellite networks is shown in Figs. 2a and 2b. The minimum topocentric (as seen from a point on the Earth) satellite spacing angles should take into account the nominal geocentric satellite spacing angle, the satellite position uncertainties (longitude of the orbit nodes and orbit inclinations) and the geographical locations of the earth stations. The use of the geocentric angular spacing, φ , instead of the topocentric satellite spacing angle, is simpler for the computation and its use is justified by the fact that the two angles are nearly equal. Also, the topocentric spacing angle is always greater than the geocentric spacing angle and hence the calculations based on geocentric spacing angles are conservative.

Radiocommunication satellites require frequency assignments in two frequency bands, one for the up link and the other for the down link. It is current practice for frequency bands to be associated in pairs, one band being used for up links and the other for down links. Case I below, is concerned with the possibility of interference between two networks which have been assigned frequency bands in this way; thus interference from an up link enters the wanted up link and interference from a down link enters the wanted down link. However, it should also be feasible to use a pair of frequency bands in the reverse sense, for some networks, the up-link band for one network being the same as the down-link band for the network using an adjacent satellite; in these circumstances interference from an up link enters the wanted down link and interference from a down link enters the wanted up link. This is Case II.

2.1 Case I

The following propagation conditions are assumed to apply to the up-link and down-link wanted-to-interfering carrier ratios:

- due to propagation effects and local precipitation both the wanted and the interfering signals which are transmitted by earth stations situated at different points on the Earth's surface will fluctuate. Unless the e.i.r.p.s of the earth stations are adjusted so that the levels received by the satellites are always the same, a margin should be introduced in calculating the mean interference value to the up-link equation;
- the ratio of the wanted signal level to the interference level on the down link does not vary with time. Any interference strong enough to have an appreciable effect would be caused by other satellites close to those of the wanted network so that the discrimination due to the directivity of the earth-station antenna is insufficient to separate the wanted from the interfering signals. Hence the wanted and interfering signals will be attenuated to the same degree when propagation conditions vary, since they will travel through the same disturbed areas. Consequently, fluctuations caused in the received wanted signal will have no significant effect on the level of interference produced in the baseband and, therefore, a down-link margin may usually be neglected.

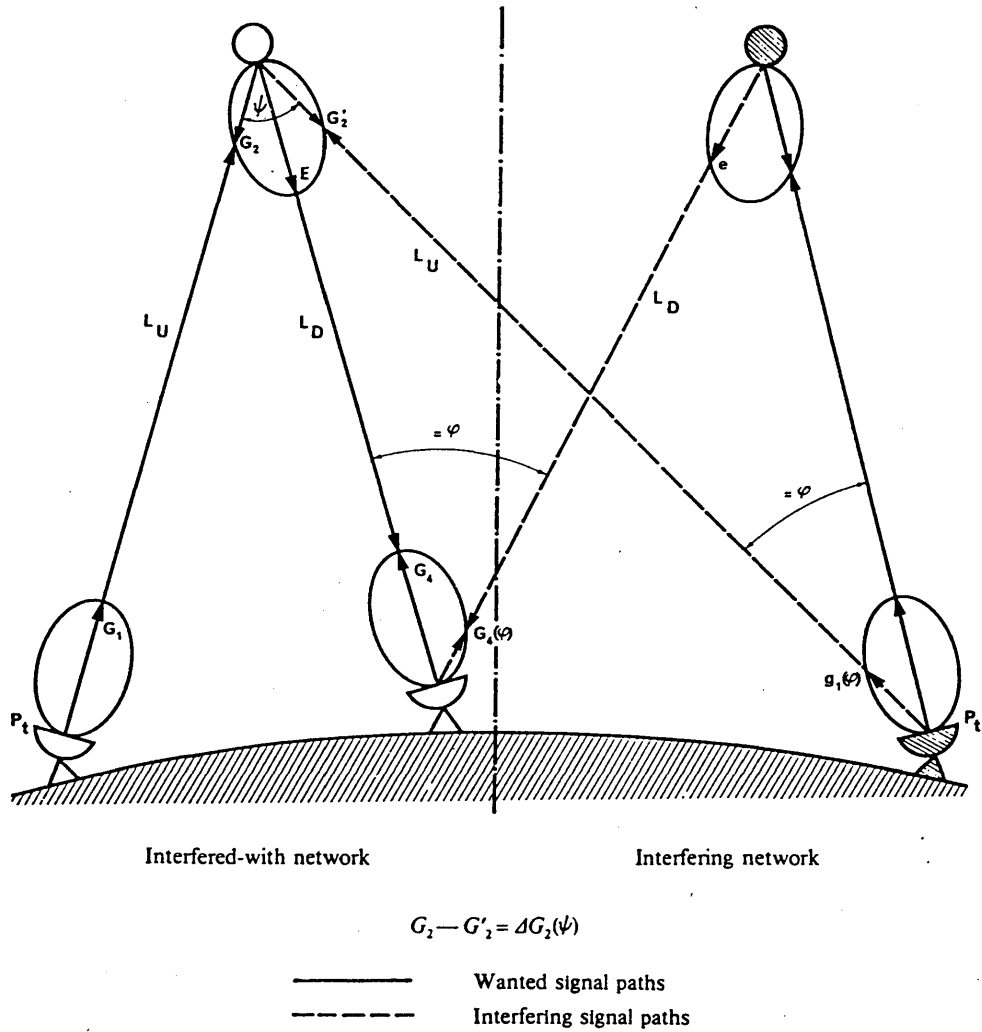

FIGURE 2a - Interference geometry between two satellite networks, Case 1 - up link of wanted network sharing frequencies with up link of interfering network.

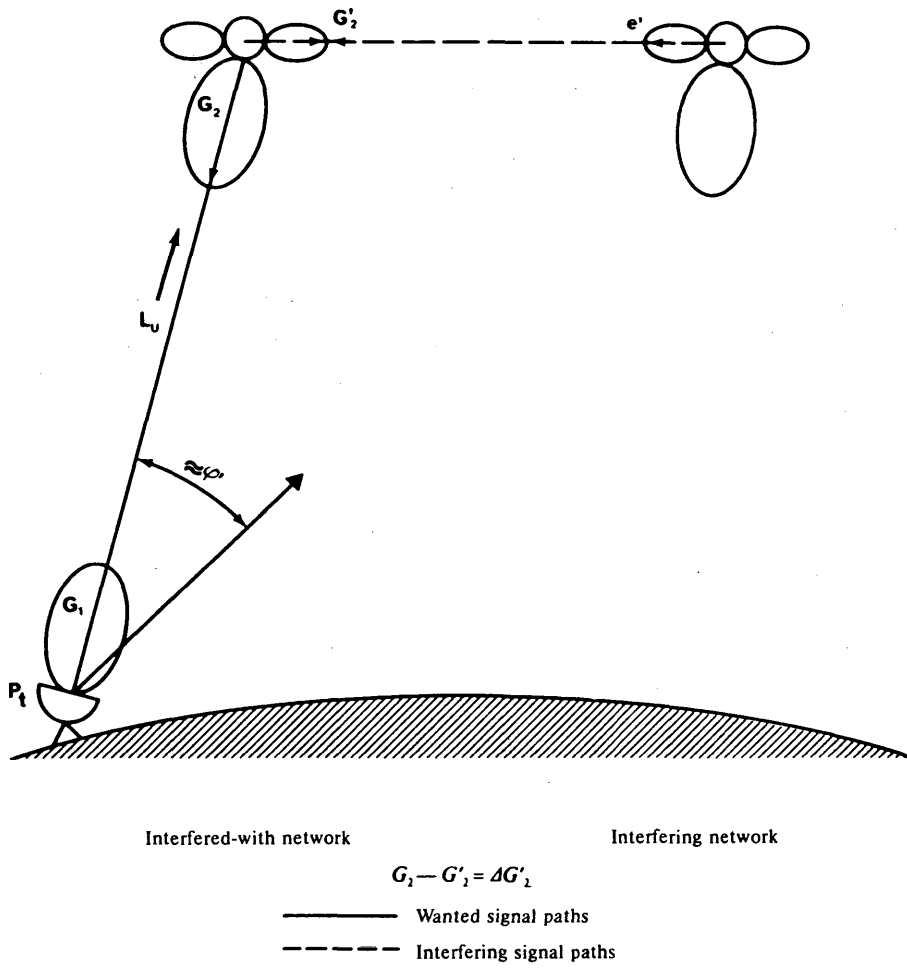

FIGURE 2b - Interference geometry between two satellite networks, Case II - up link of wanted network sharing frequencies with down link of interfering network

The first stage of the computation procedure requires solution of the two equations:

$$(C/I)_U = P_t + G_1 - \Delta L_U - M_U - p_i - g_1(\varphi) + \Delta G_2 + Y_U \quad \text{dB} \quad (4)$$

and

$$(C/I)_D = E + G_4 - \Delta L_D - e - G_4(\varphi) + Y_D \quad \text{dB} \quad (5)$$

where:

- $(C/I)_{U,D}$: up- and down-link wanted-to-interfering carrier ratios (dB);
 P_t, p_i : transmit powers of wanted and interfering carriers delivered to the associated earth-station antenna (dBW);
 G_1, G_4 : transmit and receive antenna gains of one or more wanted earth stations (dB);
 ΔL_U : path loss differential in the up link to the wanted satellite from the two earth stations, $\Delta L = L_{\text{wanted}} - L_{\text{interfering}}$ (dB);
 ΔL_D : path loss differential in the down link to the wanted earth station from the two satellites, ΔL as above (dB);
 M_U : up-link margin in the wanted network (dB);
 $g_1(\varphi)$: antenna gain component at the unwanted earth station towards the wanted satellite (dB);
 (φ) : geocentric minimum angular satellite spacing at the interfering earth station;
 ΔG_2 : differential in receive antenna gains at the wanted satellite toward the two earth stations, $\Delta G_2 = G_{2 \text{ wanted}} - G_{2 \text{ interfering}}$ (dB);
 Y_U : minimum polarization discrimination between interfering up-link carrier and wanted satellite receive antenna (dB);
 Y_D : minimum polarization discrimination between interfering down-link carrier and wanted earth-station receive antenna (dB);
 E, e : e.i.r.p. of the wanted and interfering carriers in the direction of the wanted earth station (dBW);
 $G_4(\varphi)$: antenna gain component at the wanted earth station toward the interfering satellite (dB).

Notes on some of the factors in the above equations:

- Powers and antenna gains associated with the wanted network are in capitals, those associated with the interfering network use lower case letters. Suffixes associated with the various antenna gains follow the signal path, viz: 1 = earth-station transmit, 2 = satellite receive, 3 = satellite transmit, 4 = earth-station receive.
- The antenna gains $g_1(\varphi)$ and $G_4(\varphi)$ should, if possible, be computed using measured earth-station antenna patterns. However, for preliminary calculations, the generalized earth-station antenna radiation pattern given in Recommendation 465 may be applied.
- For very precise calculations the topocentric angles may be used in the expressions for g_1 and G_4 .
- The terms ΔG_2 , E and e should, if possible, be computed using measured satellite antenna patterns. Variations of path geometry with time may affect these terms; however, these variations are likely to be small and may usually be neglected.
- In the absence of information on satellite antenna polarization, the factors Y_U and Y_D must be set at 0 dB. The subject of polarization discrimination is discussed in Reports 1141 and 555.

2.2 Case II

When a given up-link frequency assignment in a wanted network is the same as the down-link frequency assignment in an interfering network, the up-link carrier-to-interference ratio in the wanted network may be approximated by:

$$(C/I)'_U = P_t + G_1 - M_U + \Delta G'_2 - e' + Y' + 20 \log \varphi' - 35.2 \quad \text{dB} \quad (6)$$

where (in addition to the preceding definitions):

- $\Delta G'_2$: differential in receive antenna gains at the wanted satellite, in the directions of the wanted transmitting earth station and the interfering satellite,
 $\Delta G'_2 = G_{2 \text{ wanted}} - G_{2 \text{ interfering}}$ dB;

- e' : satellite e.i.r.p. of the interfering carrier in the direction of the wanted satellite (dBW);
- Y' : minimum polarization discriminations between the interfering-satellite carrier and the wanted-satellite receive antenna (dB);
- φ' : geocentric minimum angular satellite spacing for the wanted earth station (degrees).

The calculation of interference from an unwanted up link to the wanted down link, that is, from an earth-station transmitter into the wanted earth station receiver should be based on the techniques discussed in Reports 448 and 388. However, it should be possible to reduce such interference to a negligible level by a careful choice of earth station sites.

2.3 Link wanted-to-interfering carrier ratio

- For Case I, the overall wanted-to-interfering carrier ratio is obtained by combining the results of equations (4) and (5) using the following:

$$C/I = -10 \log \left[10^{-\frac{(C/I)_U}{10}} + 10^{-\frac{(C/I)_D}{10}} \right] \quad \text{dB} \quad (7)$$

- For Case II, the wanted-to-interfering carrier ratio* is obtained directly from equation (6).

3. Interference

Section 2 provides the formula for calculating the wanted-to-interfering carrier ratio. The specific effects on system service will depend on many additional factors such as: (1) type of service, e.g., telephony, television, data, etc., (2) type of modulation used, e.g., digital, FM, AM, (3) modulation parameters, and (4) desired carrier-to-system thermal noise ratio. Many different types of interfering signal interactions are possible. This is a subject of continuing investigation.

The most common types of transmission used for systems in the fixed-satellite service are: (a) FM telephony, (b) frequency-modulation television, and (c) digitally modulated carriers. The effect at baseband of interference between similar and dissimilar signal types is required in order to predict overall link performance and establish allowable interference guidelines. This Annex presents only a method for calculating the wanted-to-interfering carrier ratios which serve as an input parameter to such calculations.

4. Summary

A step-by-step method for the calculation of interference levels between two satellite networks for one set of parameters encompasses the following:

- 4.1 designate one satellite as the "wanted", the other as the "interfering" satellite;
- 4.2 choose the parameters required to solve equations (4), (5) or (6) for one of the potential interference entries and designate the parameters in accordance with § 4.1 above;
- 4.3 solve, for the set of parameters chosen, equations (4), (5) or (6);
- 4.4 determine the network wanted-to-interfering carrier ratio in accordance with § 2.3 of this Annex, as applicable.
- 4.5 using the result of § 4.4, and the modulation and frequency spacing data pertaining to the carriers under investigation, determine, by means of Report 388 the interference noise power in the interfered-with carrier;
- 4.6 repeat the above steps with the designations of "wanted" and "interfering" satellites reversed, wherever applicable;
- 4.7 repeat the above steps for all combinations of carrier and earth station which might be expected to cause interference in the two networks.

Note. — In some cases a given carrier will be subject to interference from more than one interfering carrier. In such cases, it seems permissible to add interference noise contributions on a power basis.

* Interference between earth stations needs to be considered separately since different propagation conditions and different criteria apply.

BIBLIOGRAPHY

CCIR Documents

[1966-69]: IV/348 (USSR).

ANNEX II

A METHOD OF PRESENTING INTERFERENCE CALCULATIONS
FOR TWO ADJACENT SATELLITE SYSTEMS

This method is based on the definition of two parameters of inhomogeneity between the two adjacent satellites, and a parameter of compatibility between the two satellite systems (including the respective earth stations). The satellites are assumed to serve the same geographical area and to use exactly the same up and down frequency bands. These restrictions can be removed later.

Consider first the case that the satellite system B interferes with the satellite system A. Define the receive inhomogeneity U_{BA} and the transmit inhomogeneity V_{BA} of the satellite B in respect to satellite A:

$$U_{BA} = P_B - P_A \quad (9)$$

$$V_{BA} = E_B - E_A \quad (10)$$

where:

P_A, P_B are the power flux densities (in dB) required for reception at the satellite indicated by the subscript, and E_A, E_B are the e.i.r.p. values (in dB) of the satellites, respectively. Note that, due to the assumptions above, the wanted values of one system are simultaneously the interfering values in the other system.

Define the compatibility factor K_{BA} (in dB) of system B in respect to system A:

$$K_{BA} = -10 \log \left\{ 10^{0.1(U_{BA} - \Delta G_B(f_{up}))} + 10^{0.1(V_{BA} - \Delta G_A(f_{down}))} \right\} \quad (11)$$

where:

$\Delta G_A, \Delta G_B$: the differences between the maximum gain and the side-lobe gain value at $\varphi = 1^\circ$ calculated from the reference radiation pattern (including the correction for D/λ for small antennas) of Report 391, for the earth stations in the system indicated by the subscript. (Note that for small antennas the side-lobe gain thus calculated is theoretical only):

f_{up}, f_{down} : up- and down-link frequencies.

It can then be shown that:

$$25 \log \varphi_{BA} = \left(\frac{C}{N} \right)_A - 10 \log \left(\frac{q}{1-q} \right) - K_{BA} \quad (12)$$

where:

$\left(\frac{C}{N} \right)_A$: the nominal carrier/noise ratio (in dB) at the input of the receiver of the earth station in system A:

q : the allowed single entry interference ratio (e.g. $q = 0.04$ for the 4% criterion) and

φ_{BA} : that angular spacing (as seen from the earth station) between the satellites, at which the single entry criterion is exactly satisfied for interference from system B to system A (account is taken for both up- and down-link interference).

K_{BA} is called the compatibility factor because an increase in K_{BA} makes the angular distance smaller (B is more tolerable to A).

It is illustrative to plot curves of constant K_{BA} using U_{BA} and V_{BA} as coordinate axes. Figure 3 shows an example, where the contour of $K_{BA} = + 11.3$ dB for antenna diameters $D_A = 5$ m and $D_B = 1$ m, $f_{up} = 14$ GHz and $f_{down} = 12.5$ GHz, is seen in the lower left-hand quadrant. In the shaded area $K_{BA} > 11.3$ dB. K_{BA} was chosen so as to correspond to $\theta_{BA} = 5^\circ$ in a system for which $(C/N)_A = 15$ dB and $q = 0.04$, as can be verified from equation (12). It is then clear that, if the satellites are spaced at 5° , the single entry criterion in the system A is satisfied everywhere inside the shaded area in the U_{BA}, V_{BA} plane.

Interference from system A to system B can be treated in the same manner. Only the subscripts are interchanged. It is noted that $U_{AB} = - U_{BA}$ and $V_{AB} = - V_{BA}$. For that reason the contour of K_{AB} can be plotted in the same figure, as shown in the upper right-hand corner of Fig.3. If $(C/N)_B = 15$ dB and $q = 0.04$, then again $K_{AB} = 11.3$ dB corresponds to 5° angular distance, and at that distance the single entry criterion is satisfied for the system B inside the curve. It is seen that, in this case, there are no values of U and V which would satisfy the single entry criterion simultaneously for both systems, at a 5° spacing between the satellites.

Figure 4 shows the same case as above except that contours have been drawn also for $D_B = 2$ m and $D_B = 3$ m. The allowable limits for the inhomogeneities between the satellites can at once be seen, for each choice of D_B , from the plot.

The restrictive assumption that the satellites serve the same geographical area and occupy exactly the same frequency bands can be removed by introducing an additive correction factor to both U_{BA} and V_{BA} . Both the effect of the antenna pattern of the satellite antennas and the only partly overlapping frequency bands can be included in these correction factors.

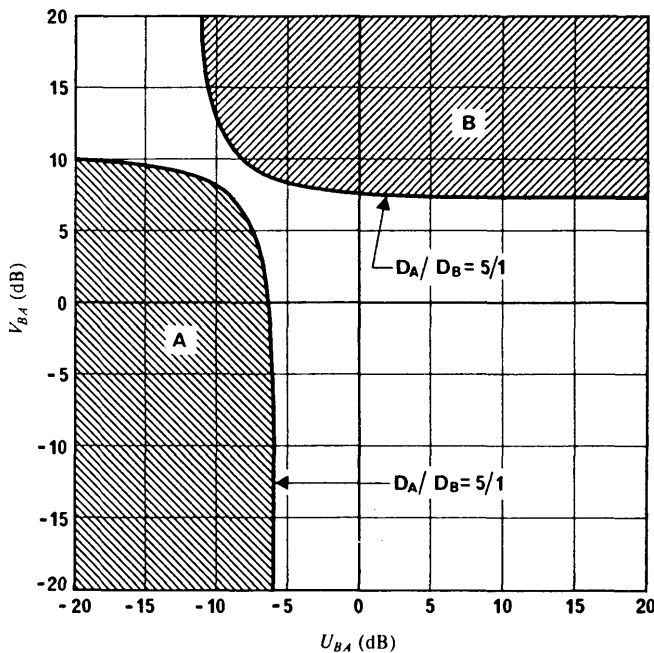

FIGURE 3 - Principle of the single entry interference plot

- A: Single entry criterion satisfied for system A
- B: Single entry criterion satisfied for system B

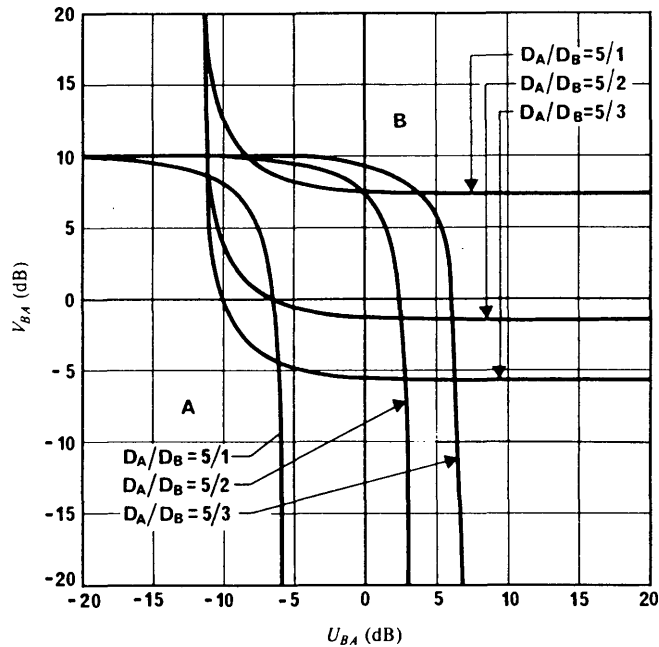

FIGURE 4 - Example of a single entry interference study. Angular spacing of satellites 5° . $C/N = 15$ dB (both systems), $q = 0.04$

A: Single entry criterion satisfied for system A
 B: Single entry criterion satisfied for system B

ANNEX III

INTERFERENCE INTO ANALOGUE TV SYSTEMS

Recommendation 483 specifies the permissible level of interference into a television channel as a percentage of the total noise and interference in that channel. Section D.3.2.1 of Recommendation 567 specifies the video signal-to-weighted-noise level in a hypothetical reference circuit carrying an analogue television signal. There are two very different methods to determine the pre-detection carrier to interference ratio (C/X) which would give results consistent with both of these recommendations. These are:

- a) the "objective" method that is described in section 3 of Report 449, and
- b) the "subjective" method, described here, based on CCIR Report 405, CCIR Recommendations 500 and 600, and work done in Canada [Bouchard G. *et al.*, 1984].

When using the objective approach the carrier-to-interference ratio(C/X) is related to the video signal-to-interference ratio (S/I) by the relationship.

$$(S/I) = (C/X) + B_v \quad (\text{in dB}) \quad (1)$$

where B_v is the video interference reduction factor. For an analogue frequency modulated NTSC television signal interfered with by a similar signal, B_v is approximated by the empirical relation

$$B_v = 6 + 20 \log_{10} (\Delta f) \quad (\text{in dB}) \quad (2)$$

where Δf is the peak-to-peak frequency deviation of the wanted signal. When using the subjective approach, i.e. the approach based on tests of television signal acceptability by viewers, a more indirect route must be followed. In this approach the basic unit is "impairment" of the television signal on the screen, rather than "interference" measured within the equipment.

Impairment can be related to the television picture quality Q by the relationship

$$I_m = (5 - Q) / (Q - 1) \quad (3)$$

Analysis of the subjective measurements reported in [Bouchard G. et al, 1984] suggests that for NTSC the impairment I_m of (3) can be related to the video weighted S/N_w ratio of Recommendation 567 by the empirical expression

$$I_m = \exp[30.9 - 8.41 \log_e (S/N_w)] \quad (4)$$

and that the impairments from different sources, i.e., from thermal noise, interfering signals, etc. can be added, i.e.

$$(I_m)_r = (I_m)_n + (I_m)_i \quad (5)$$

Further, the impairment due to an interfering NTSC frequency modulated signal can be related to the pre-detection carrier-to-interference ratio (C/X) of these signals by the equation

$$(C/X) = 16.9 - 8.7 \log_{10} (I_m)_i - 20 \log_{10} (\Delta f/12) \quad (6)$$

where Δf is the same peak-to-peak frequency deviation of the wanted signal that appears in equation (2). Use of equations (5) and (6) together with either (3) or (4) to specify the performance of the hypothetical reference circuit will produce the required C/X, the same quantity that is specified in a very different way by the equations (1) and (2).

It is instructive to compare the required C/X values from these two very different approaches. To do this numerically, it is necessary to assume a typical set of system characteristics. Let us assume that the video signal to noise ratio due to thermal noise alone is 53 dB as specified by Recommendation 567-2, and $\Delta f = 20$ MHz. The results using the two approaches are shown in Table III.



TABLE III - Required pre-detection carrier-to-interference ratio (C/X)

Interference or impairment as a percentage of the total link budget	Estimate Using objective Approach	Estimate Using Subjective Approach	Difference
10%	30.5 dB	30.17 dB	0.33 dB
20%	27.0 dB	27.11 dB	0.11 dB

The difference between the estimates of required C/X using the two approaches is quite small, given that they were both arrived at in different ways involving the use of empirical formula based on very different types of laboratory measurements. This very close agreement when typical values of fixed satellite systems are considered for CCIR network-quality transmission (S/N = 53 dB) leads to the conclusion that the simpler method described in section 3 of Report 449 may be used in applying Recommendation 483.

Since the measurements described in Report 449 were carried out using NTSC desired and interfering signals, equations (1) and (2) provide accurate estimates of the interference environment for this combination of interfering and interfered-with signals.

Where the network under consideration has a performance significantly different from that indicated in Recommendation 567-2, it should be noted that the two methods may not lead to the same permissible C/X ratio. Application of equations (1) to (6) for various values of weighted signal to noise ratios yields the C/X values indicated in Figure 5 for the two methods. From the results, it may be observed that the two methods give a very close (C/X) ratio in the range of (S/N) value from 51 to 55 dB. For other (S/N) values, the difference in the required pre-detection carrier to interference ratio between these two approaches becomes significant. Hence, we can conclude that the objective method can be used in confidence when calculating the required (C/X) ratio in the (S/N) range of 51-55 dB but the difference becomes significant outside that range.

An experiment was performed to estimate B_v for various other interfering carrier types [CCIR, 1986-90]. The object of this measurement program was to determine protection ratios that corresponded to "just perceptible interference" and S/N_w for the existing three analogue video standards when interfered with by various capacity FDM/FM carriers or a 120 Mbit/s TDMA carrier. The protection ratios, actually the C/I, when the interference effect just became perceptible, were measured as a function of the frequency offset between the center frequencies of the interfering and victim carriers. The S/N_w was determined only for the situation where the two carriers were co-frequency. The victim carrier was modulated with a colour bar waveform with sufficient amplitude to produce a peak-to-peak video deviation of 15 MHz.

The victim carrier was then combined with an interfering carrier, bandpass filtered with a 20 MHz filter and demodulated. This demodulated waveform was displayed on a picture monitor which was viewed under the reference conditions set out in Report 634. The perceptability of the interference was determined by an expert observer so that the level of picture impairment is equivalent to an approximate rating of 4.75 out of 5.0. Throughout the measurements, the carrier to thermal noise ratio C/N was held constant at 17 dB. This level corresponds to the nominal level maintained at that time in the INTELSAT System for half transponder video transmission.

Measurements were made for the following types of interfering carriers:

- a) Color Bar Modulated FM TV (same TV standard as the victim carrier)
- b) Frame Rate Energy Dispersal Frequency (EDF) Modulated FM (1 MHz peak-to-peak deviation)
- c) 24 channel/2.5 MHz bandwidth FDM
- d) 60 channel/5.0 MHz bandwidth FDM
- e) 132 channel/10.0 MHz bandwidth FDM
- f) 252 channel/10.0 MHz bandwidth FDM
- g) 252 channel/15.0 MHz bandwidth FDM
- h) 432 channel/15.0 MHz bandwidth FDM
- i) 972 channel 36.0 MHz bandwidth FDM
- j) 120 Mbit/s QPSK TDMA

The resulting values of B_v are presented in TABLE IV.

TABLE IV - Measured interference reduction factors, B_v (dB), for various interfering carrier types

	NTSC	PAL	SECAM
S/N_w without interference	48.9 dB	50.4 dB	50.5 dB
Color Bar	--	31.7	27.7
EDF	27.2	23.7	30.8
24/2.5	23.3	26.5	27.1
60/5	28.0	25.3	22.6
132/10	27.0	26.3	22.1
252/10	23.8	22.2	22.7
252/15	27.2	--	26.5
432/15	27.0	27.0	24.7
972/36	32.0	27.5	22.0
TDMA continuous	31.5	27.9	27.3
TDMA burst	31.3	28.9	28.0

Further work may be required to determine the value of B_v for other combinations of interfering and interfered-with signals. It would be useful to develop an empirical formula for B_v to simplify the calculations.

Note - The information in this annex should be taken into account in future considerations of Recommendation 483.

REFERENCES

BOUCHARD M. , CHOUINARD G. and TRENHOLM R., [December, 1984] "Subjective Evaluation of the Effects of Noise and Interference on Frequency Modulated NTSC Television Signals", CRC Report No. 1367, Department of Communications, Ottawa, Canada.

CCIR Documents

[1986-90]: 4/312 (USA) and 4/314 + Add.1 (Canada).

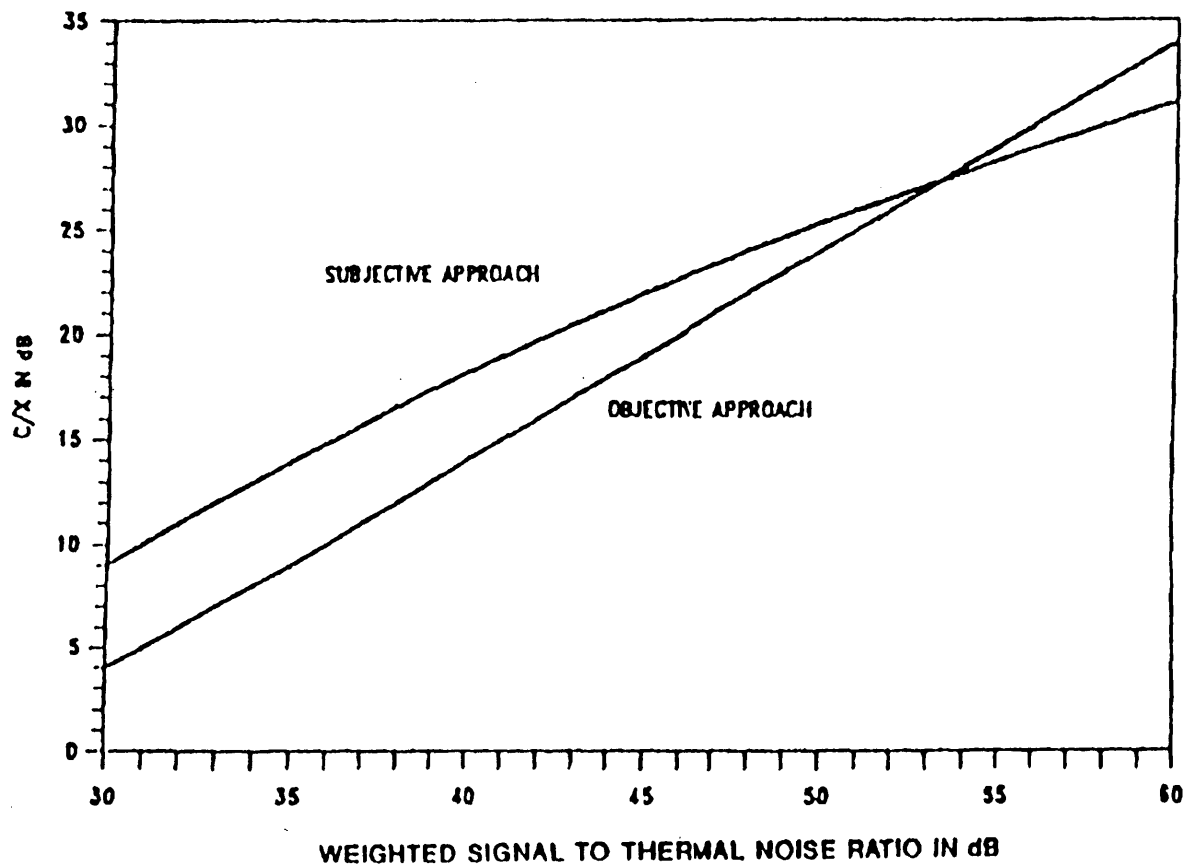

FIGURE 5: Graph of C/X versus S/N for FM/TV reception with interference equal to 20% of the total link budget

ANNEX IV

The relationship between aggregate and
single-entry interference levels1. Introduction

Inter-system interference between geostationary satellite networks depends to a great extent on the side-lobe characteristics of earth station antennas for co-coverage situations and on the characteristics of satellite antennas outside the coverage area when the coverage areas are separated. An optimum or judicious mix of satellite and earth station antenna discrimination is necessary for the efficient utilization of orbit/spectrum resources. An important aspect of this process is the determination of the interference effects of a number of satellite networks as compared to a pair of adjacent satellite networks. A comparison of single-entry versus aggregate interference effects is related to the determination of appropriate interference limits for such CCIR Recommendations as 466 and 523.

This annex presents several analyses [CCIR 1986-90a-e] involving a variety of satellite arrangements and interference conditions and provides the results obtained for the relationship between single-entry and aggregate inter-satellite interference.

2. Homogeneous model-variable satellite antenna discrimination2.1 General

Various degrees of satellite antenna discrimination can exist between satellite networks depending on the respective coverage areas of the satellite antennas. When the coverage areas overlap (co-coverage) little or no discrimination exists and network isolation is achieved with only earth station antenna discrimination. For separated coverage areas adequate discrimination can be achieved by a combination of earth station and satellite antenna discrimination. When the coverage areas are far apart most, if not all, of the discrimination can be provided by the satellite antenna.

These situations are combined in a homogeneous model which assumes an array of equally spaced satellites in which satellites with antenna discrimination are placed between co-coverage satellites. With this model estimates of the aggregate to single-entry interference ratios may be made.

2.2. Simplified model

This model assumes that the earth station antenna discrimination is proportional to $\varphi^{-2.5}$; i.e., the satellite spacing is greater than the off-axis angle corresponding to the first side-lobe plateau of the earth station antenna. No satellite station keeping or earth station pointing tolerances are included. Where satellite antenna discrimination exists it is assumed to be the same for all satellites.

A series of satellite networks are postulated; A, B, C etc. where satellite antenna discrimination can exist between each but no discrimination exists between individual A's, B's, C's, D's etc. Sequences can be postulated in which a number of satellites with antenna discrimination are placed between co-coverage satellites.

The equations which relate the multiple entry (ME) to single-entry (SE) ratio, (ME/SE) are of the following form in which all parameters are dimensionless numerical ratios:

$$\text{ME/SE} = W + X/\alpha \quad : \alpha \geq \alpha_c \quad (1a)$$

$$\text{ME/SE} = Y\alpha + Z\alpha \quad : \alpha \leq \alpha_c \quad (1b)$$

The parameter (α) is the satellite antenna discrimination and (α_c) is the value of discrimination which results in the highest value of (ME/SE).

Equation (1a) is the case where the highest single-entry is the adjacent satellite, and the minimum separation angle (ϕ_1) is determined by that entry. Equation (1b) is the case where the minimum separation angle is determined by the nearest satellite with no satellite antenna discrimination; (ϕ_1) being the angle between the nearest co-coverage satellite divided by the number of intervening satellites plus one. Thus, (ϕ_1) varies when $\alpha \geq \alpha_c$ and is constant when $\alpha \leq \alpha_c$.

Assuming 24 entries (twelve on either side of an interfered with network), constants for the above equations are.

Number of satellites between co-coverage satellites	W	X	Y	Z	α_c
1	2.1928	0.4601	12.404	2.6027	0.1768
2	2.4295	0.1632	38.809	2.5440	0.06415
3	2.5752	0.0776	82.406	2.4832	0.03125
4	2.6107	0.0421	145.943	2.3545	0.01789
5	2.6261	0.0267	231.574	2.3545	0.01134

This model can also be used for the co-coverage cross-polarization case where satellites with opposite polarizations are interleaved. In this case, the intervening number of satellites is one.

The ratio ME/SE equals $W + X$ for the co-coverage co-polar situation ($\alpha = 1 = 0$ dB). The ME/SE varies from two with one interfering satellite on each side of the interfered with satellite to 2.65 for 12 satellites on each side as shown in Figure 6.

Equation (1) is plotted in Figure 7 as a function of (α) and (ME/SE) for various sequences. The highest value of (ME/SE) is achieved for one unique value of satellite discrimination (α_c) and drops rapidly for higher or lower values. This occurs when the nearest satellite entry with proper discrimination is equal to the nearest satellite entry with no discrimination. Also it is noted that the value of (α_c) is a function of the sequence. It would appear highly unlikely that four equal level single-entries would occur in practice and thus a single-entry level based on the highest (ME/SE) shown in Figure 7 could be quite conservative.

Figure 7 is also useful in determining the satellite antenna discrimination required to make the contributions from adjacent satellites relatively small compared to the co-coverage satellites. A value of 25 dB of satellite antenna discrimination for the first side-lobe plateau would effectively isolate up to four intervening satellites between a pair of co-coverage satellites.

2.3 Model with complete earth station antenna patterns and tolerances

Homogeneity is again assumed. However, due to the segmented earth station antenna pattern and the manner in which tolerances are accounted for, the equations given for the simplified model cannot be used. For the following analyses, the assumptions are:

- 1) the earth station antenna discrimination is determined using Annex VII of Appendix 29 patterns which removes the restriction of being beyond the first side-lobe plateau of the earth station pattern;
- 2) the required composite earth station and satellite antenna discrimination is 30 dB;
- 3) the satellite station keeping tolerances are ± 0.1 degrees and the earth station pointing accuracy is assumed to correspond to the -1 dB relative gain angle.

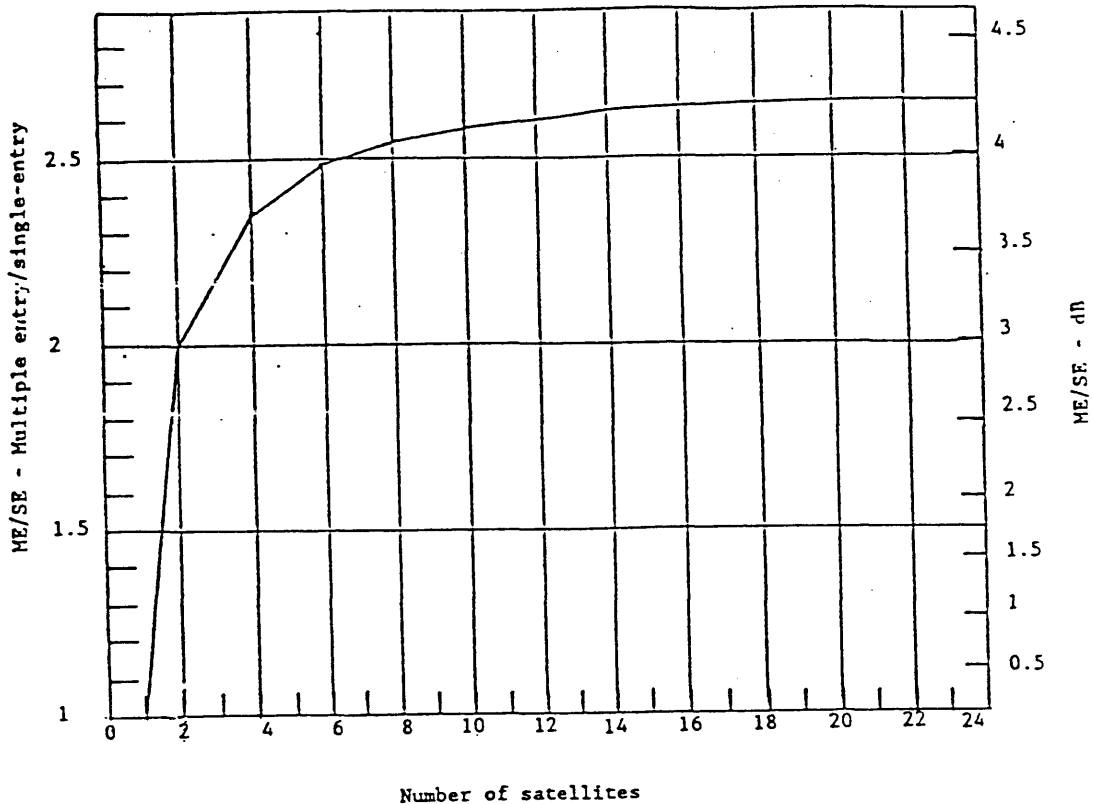

FIGURE 6

ME/SE versus number of co-coverage satellites

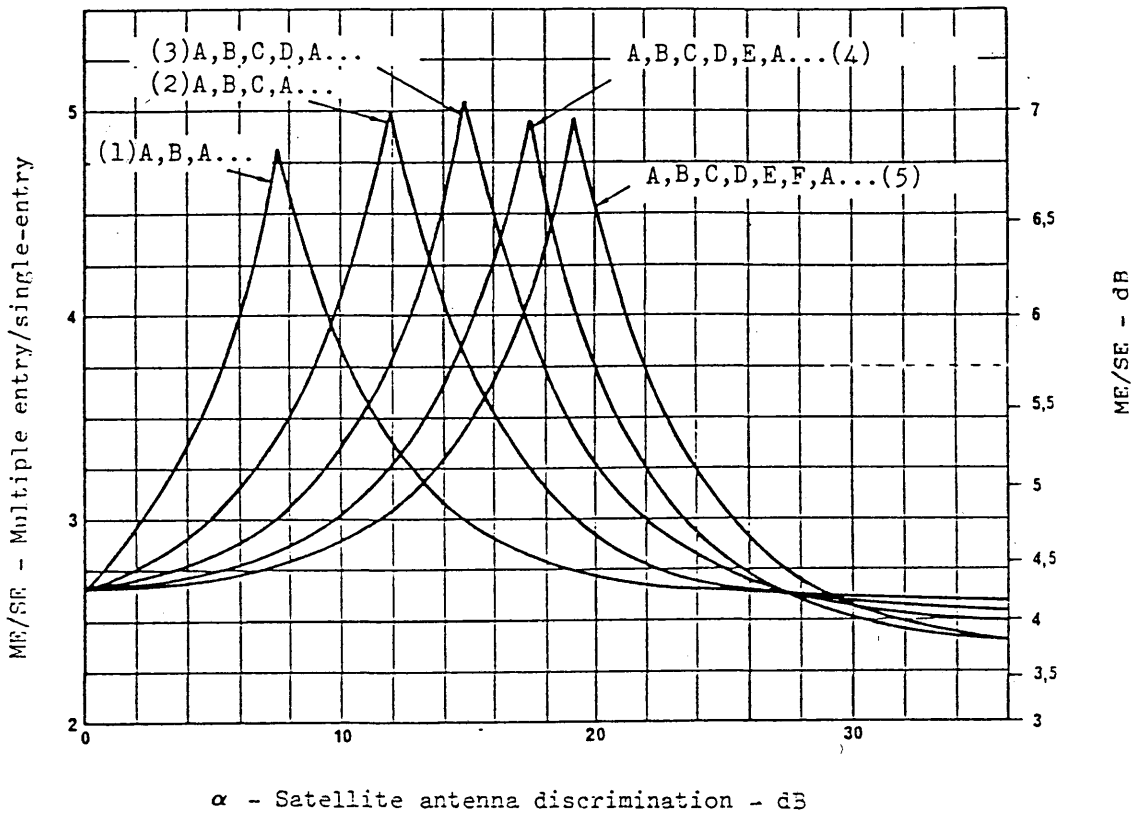

FIGURE 7 .

ME/SE versus α

Since the spacing between pairs of satellites is determined by worst case SE criteria, the nominal spacing between satellites is the angle where the earth station plus satellite antenna discrimination meets the SE required (30 dB assumed) plus the most unfavourable tolerance situation. For this model, the highest ME/SE will occur when the interfering satellites are at their minimum spacing with respect to the interfered with satellite. This is the condition assumed for these analyses.

Analyses similar to those of the simplified model can be made for various earth station antenna (D/λ)s and similar results can be obtained. Figure 8 shows the same functions as Figure 7 for an earth station $D/\lambda = 100$. The main-lobe and first side-lobe plateau of the earth station patterns distort the functions when ($\alpha < \alpha_c$) as compared to the functions of Figure 7. The peak (ME/SE) ratios are somewhat lower than in Figure 7 which is due to the incorporation of the tolerances.

Again, it would appear highly unlikely that the satellite antenna discrimination values required to provide four equal level entries would simultaneously occur in practice. Additionally, it is also highly unlikely that all the interfering satellites would be at their extreme worst case tolerances. If the satellite spacing corresponds to the maximum permissible single-entry level with most adverse tolerances, the ME level, when all satellites are at their nominal positions, may be considerably lower than the worst case condition.

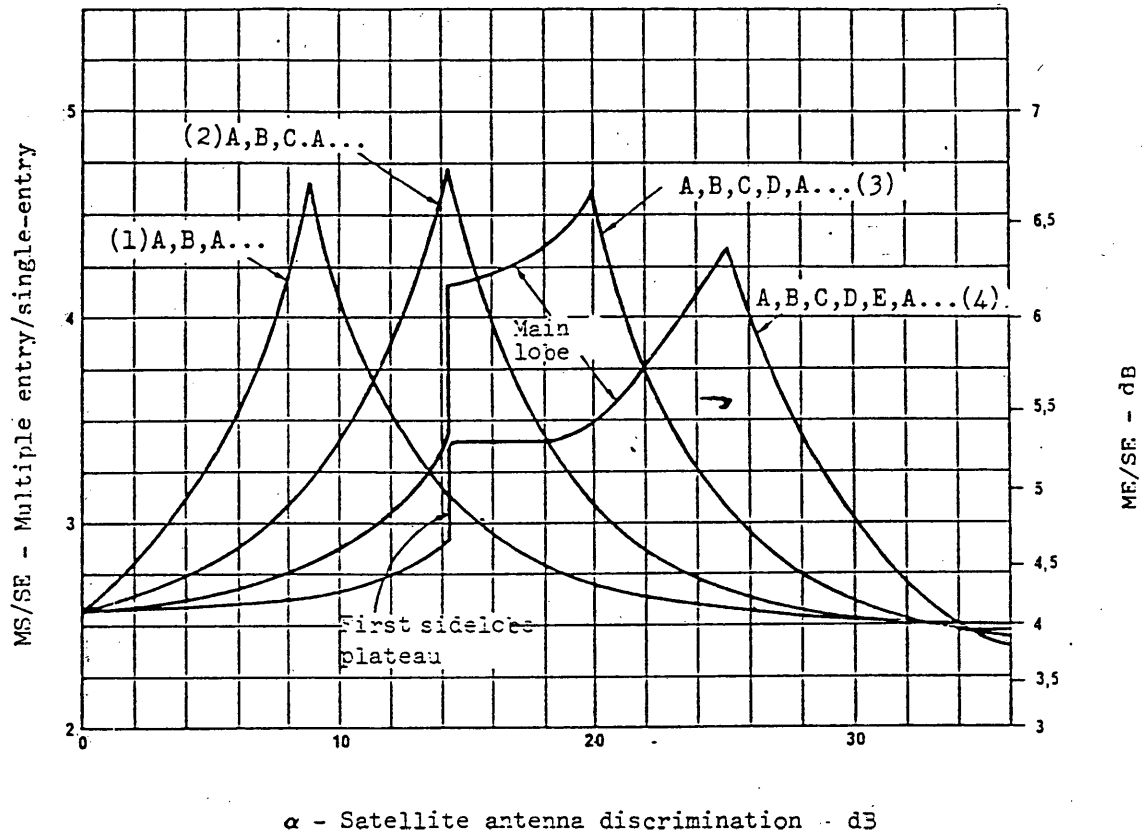

FIGURE 8

ME/SE versus α for $D/\lambda = 100$

2.4 Application

The above analyses do not account for any statistical advantage due to the random placement of interfering carriers with respect to desired carriers. The effective reduction of the ME/SE for FM carriers is significant. However, the effect is generally considered not significant for digital carriers because of their relatively flat spectral densities.

Thus, the above models and results are most applicable to digital carriers.

2.5 Summary

Of the two models analyzed the model which includes full earth station antenna patterns and other tolerances is considered more realistic. The following general conclusions are enumerated.

1) The satellite antenna discrimination corresponding to peak multiple entry to single entry ratios is a function of the number of satellites with antenna discrimination that are placed between satellites with no antenna discrimination. The satellite antenna discrimination corresponding to these peaks increases with the number of interleaved satellites. For a satellite antenna discrimination of 25 dB at the first side-lobe plateau, 2 to 3 satellites with this level of discrimination may be placed between co-coverage satellites with little effect on the multiple entry level.

2) The peak values of multiple-entry to single-entry ratios are in the range of 4.5 to 5.0. The peak values occur at specific satellite antenna discrimination values and drop rapidly as the values depart from these specific values. The probability of the specific set of conditions necessary for these peak values occurring in an actual situation is considered to be low and thus lower practical values should be considered. These peaks can also be intentionally avoided. Values less than 4 may be appropriate but further study is needed in this area.

3) Satellite antenna discrimination may not be adequate for co-locating satellites whose coverage areas do not overlap. Even if the satellite antenna discrimination is adequate, it is advantageous to space satellites with antenna discrimination (interleaved between co-coverage satellites) in order to increase the discrimination between satellites.

4) Satellite station keeping and earth station antenna pointing tolerances are a significant factor for closely spaced satellites.

3. Aggregate to single-entry interference ratio in a high-capacity orbit-use scenario

The geostationary orbit utilization is maximized when full use is made of spacecraft antenna discrimination, polarization discrimination and earth station antenna discrimination. Figures 8 and 9 of that annex illustrate the theoretical optimum use of the GSO.

It is important to determine the relationship between aggregate and single-entry interference in such an environment. This ratio provides an upper bound to the ratio experienced in practice, just as the same model provides an upper bound on orbit capacity.

In this situation, the interference is produced by a series of adjacent satellites, alternately adjacent coverage and co-coverage. Protection is provided by the earth station antenna, and, in the case of adjacent coverage satellites, the satellite antenna. The resulting interference is shown relative to that caused by adjacent co-coverage satellite. The protection afforded by the satellite antennas is assumed to be 25.5 dB.

Although actual service areas of a satellite network are likely to be fairly complex it is desirable to use as a model a service area configuration which is conceptually simple.

In this case, the model should allow for interference from those transmissions which are intended for the neighbouring areas which surround the "interfered with" area.

Figure 9 shows an array of cells representing the projections of a large number of transmissions on the Earth's surface. The topologically simple regular array has been chosen to simplify calculations showing, with a cross, each area which might be served from one orbital position. As the lines representing transmission to particular cells from one satellite position clutter the diagram, they have been deleted. The served areas are joined with dotted lines to illustrate what is meant, later, by a "shell" of interfering services.

Consideration has been given to interference arising in a situation where the area-to-area distances represent constant regular changes in protection angle at the satellite, but a "row-to-row" variation in down link power density is 4 dB (see e.g. Report 1001, Table I, for potential variations in power density). This condition is represented with alternate "rows" shaded differently. Rows shaded by hatching have the high power level.

Assuming antenna protection follows a $-25 \log \phi$ law. The interference level with respect to the singly-entry level is about 10.8 dB for one shell, 12.1 dB for two shells, and 12.8 dB for three shells.

As the number of shells in a practical situation may, but is unlikely to, exceed 3, the approximate worst condition for three shells may lead to a asymptotic interference level about 13 dB greater than the single-entry value.

Another analysis, based on rectangular cells rather than the hexagonal cells used above, resulted in an asymptotic value for the aggregate interference to single-entry interference ratio of about 11 dB; 10 equal-level entries plus 4 low-level entries. When this model was applied to Region 2 countries, the worst case ratio was found to be about 4 (or 6 dB) for ∞ -channel operation, i.e., there is no statistical advantage due to carrier offsets. More probable situations resulted in aggregate to single entry ratios of three or less.

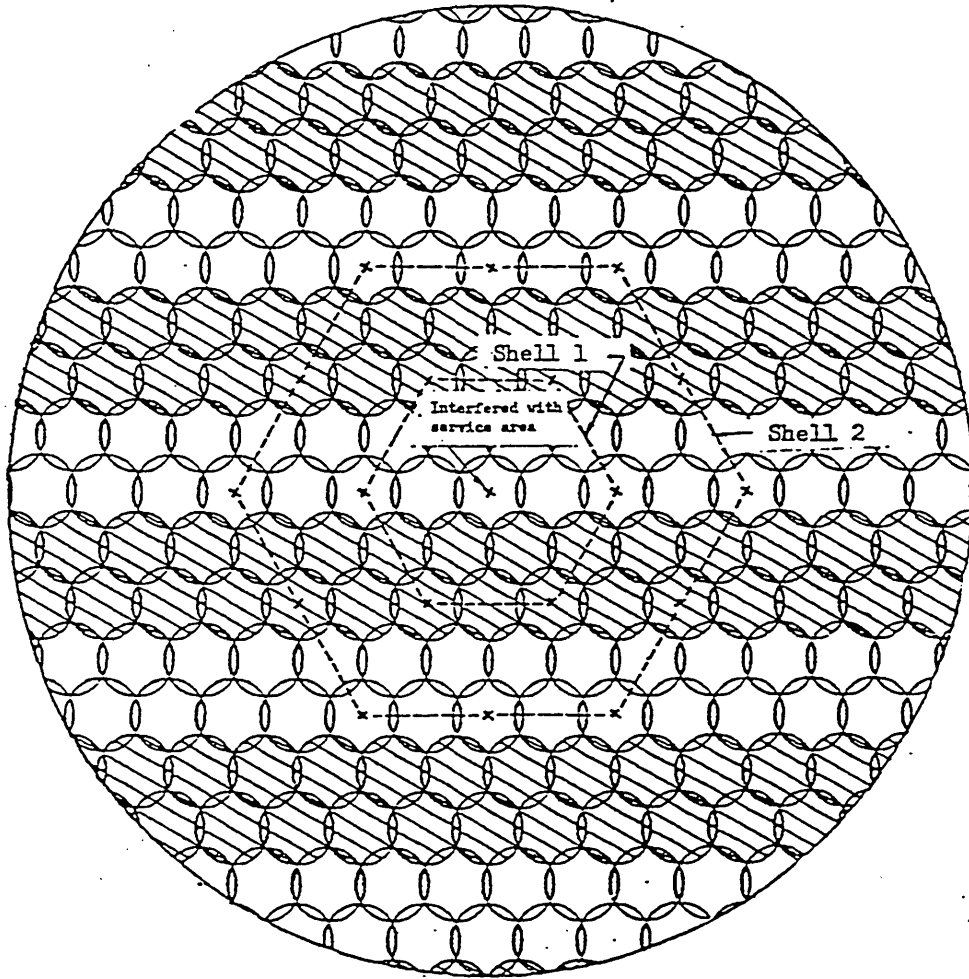

FIGURE 9

Multiple service areas located within subzone

4. Statistical estimates of aggregate to single entry interference ratios

The relationships between the maximum single entry interference level and the aggregate interference level for FDM/FM carriers and those for digital carriers have been examined through extensive computer simulation.

A mix of co-coverage and non-co-coverage networks has been considered in order to develop this relationship under a more realistic situation.

In the computer simulation, the aggregate interference into a FDM/FM carrier of a given satellite network due to FDM/FM carriers of other satellite networks is computed. The carriers, which are all equal within each network, have a variety of parameters, and the interfering carrier frequencies relative to the desired carriers are randomly assigned. These interfering carriers are transmitted in networks whose space stations are located at various orbital separations from the satellite with the wanted carrier.

The spacings between satellites are determined based on the co-channel interference assumption which is normally adopted in the course of internetwork coordination. They are determined such that, i) the maximum single-entry interference into every network, as calculated on the co-channel assumption, for all possible combinations of wanted and interfering satellites, does not exceed the applicable single-entry allowance; and ii) the total orbital arc occupied by all the satellites for that ordering is a minimum.

Three single entry levels, i.e. 600 pWOp, 800 pWOp and 1,000 pWOp with the co-channel assumption are considered to determine the spacings between networks. Then the carrier frequencies are randomly shifted so as to simulate the effect of frequency interleaving, and the aggregate interference in each network is evaluated. Therefore, in this interference model the single entry level in any combination of network does not exceed the applicable single-entry criterion.

Figure 10 depicts the cumulative distributions of the aggregate interference thus computed based on 600 pWOp, 800 pWOp and 1,000 pWOp single-entry levels. This figure displays the probabilities with which the aggregate interference exceeds the value on the abscissa after the simulation of random frequency interleavings is taken into account.

It is observed from Figure 10 that, as a result of frequency interleaving, the probability of the aggregate interference exceeding a value of 2.5 times the given co-channel based single-entry level for co-coverage as well as for non-co-coverage networks is less than 1%.

In computing the aggregate interference into digital carriers, another computer simulation was carried out for various types of digital carriers. As in the FDM/FM case, the spacings among networks are determined on the basis of the co-channel interference assumption. A number of satellite arrangements were considered to determine the statistical distribution of aggregate interference. It is noted that, in the case of digital carriers, little advantage due to frequency interleaving is expected.

The single entry criteria considered are 4% and 10% of the total noise power which would correspond to a BER of 10^{-6} .

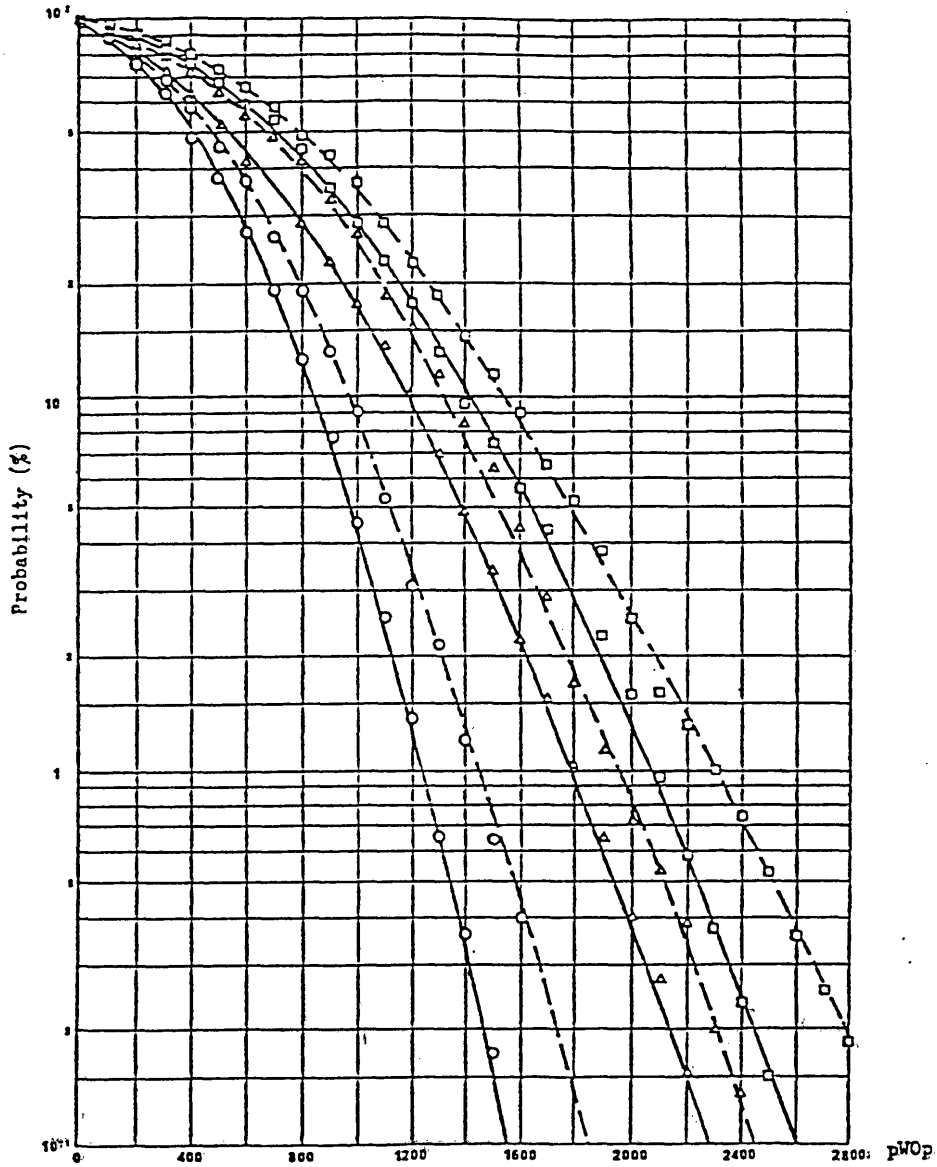

FIGURE 10

Distribution of aggregate interference (FDM/FM carriers)

————	Non-co-coverage	Single Entry
-----	Co-coverage	○ 600 pWOp
		△ 800 pWOp
		□ 1000 pWOp

Figure 11 shows the cumulative distributions of aggregate interference calculated, based on the 4% and 10% single-entry interference criteria. The distributions of aggregate interference are expressed in terms of percentage with respect to total noise power.

By reference to Figure 11 it is observed that the probability of the aggregate interference exceeding a value of 4.5 to 5 times the applicable single-entry criterion is close to 1%.

5. Examples of aggregate to single-entry interference ratios in an orbit-use arrangement similar to the FSS allotment plan

The allotment plan developed at WARC ORB-88 is an example of a high utilization of the geostationary orbit, if all allotments are brought into service as indicated by the Final Acts of the Conference. This is particularly the case for that portion of the GSO serving Region 1. It is useful to use these results of that Conference to examine the statistical characteristics of the ratio Γ between the appropriate single-entry interference criterion and the aggregate interference which would be experienced by the satellite networks in such an environment. This information is intended to be complementary to the information provided through the analytical modelling of sections 2 and 3 of this annex and the simulation of analogue networks in section 4.

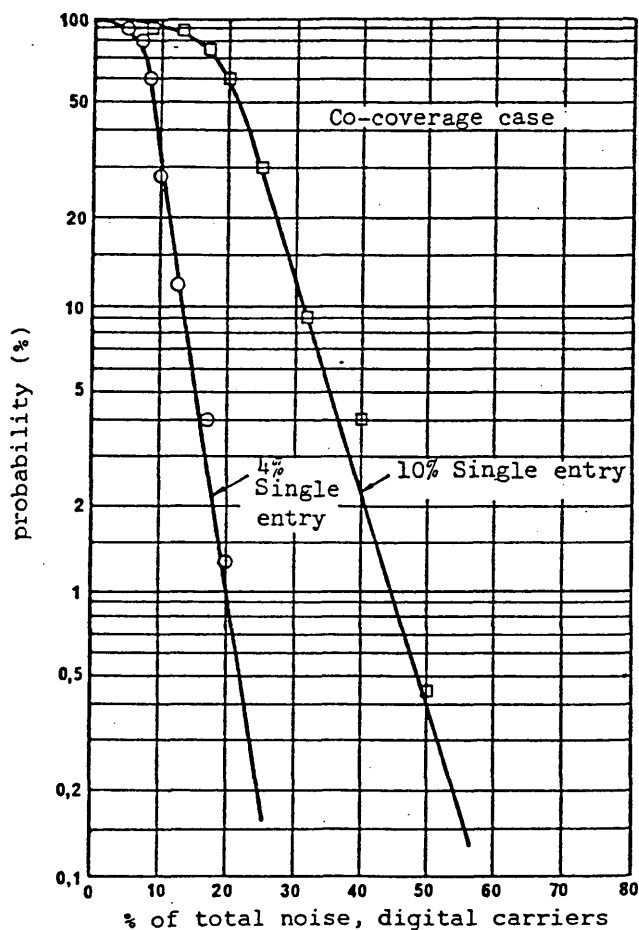

FIGURE 11

Distribution of aggregate interference (% of total noise, digital carriers)

5.1 Simulation example 1

One simulation study using the ORBIT-II computer program as made available by the IFRB in 1988 is reported in [CCIR, 1986-90h]. In this scenario the "requirements" were the 113 satellite beams of Part A of the allotment plan of WARC ORB-88 between 45°W and 50°E. This arc was chosen for examination because it is the most highly utilized orbital arc of the plan.

In this simulation only the "ordering" portion and the "analysis" portion of the ORBIT-II program were used. (The ordering portion is that portion of the program that selects the orbit positions of the required satellites such that all of the single-entry interference levels are less than a specified maximum interference "criteria".) This was done to simulate the situation in which satellite positions are chosen based on single-entry consideration.

The networks accommodated in the simulation had the same technical characteristics as specified in the allotment plan of WARC ORB-88. Specifically, co-channel frequency and co-polarized operation of the networks involved was simulated, representative of networks carrying wideband digital traffic. The one variation from the allotment plan technical parameters imposed on the simulation was that the single-entry (C/I) criterion was increased to simulate a highly-utilized orbit in which the "compression ratio" of the ORBIT-II synthesis result was equal to or slightly greater than unity. Specifically, syntheses with nominal (C/I) single-entry ratios of 33 and 35 dB provided results of a fully-utilized arc, with compression ratios of 1.088 and 1.112 respectively.

The ORBIT-II synthesis program provides several ordering routines, i.e. choices of which network to consider first. The "westerly first" routine was used in the synthesis reported here. Satellites operating in the 6/4 GHz frequency band were simulated.

The analysis portion of the program was used to determine the aggregate interference of each of the 113 networks in the 95° wide arc from 45°W to 50°E, and this aggregate value was compared with the single-entry criterion. The ratio "r" for each entry was calculated in dB and this set of 113 results was used to estimate the statistical characteristics of the random variable r. The estimates of the probability distribution function of this variable are shown in Figure 12 for both the 33 dB simulation and the 35 dB simulation described above. These cumulative histograms are estimates of the probability distribution function of the ratio r, a random variable from one network to the next. In generating the estimates of the probability distribution functions in Figure 12, correction was made for the fact that the compression ratio of the resulting orbital arrangements were greater than unity. The single-entry criterion of the "33 dB" simulation was reduced by $25 \log_{10} (1.088)$ to 32.09 dB, and the "35 dB" simulation's criterion was reduced by $25 \log_{10} (1.112)$ to 33.85 dB.

For this scenario, the probability distribution function estimates of Figure 12 may be used to estimate the required single-entry to aggregate interference criterion necessary to ensure that a specified percentage of networks experience an aggregate interference not greater than the aggregate interference criterion, i.e. the aggregate interference level to which they would presumably be designed to accommodate. In this example, if 90% of the networks are to experience aggregate interference levels below the aggregate criterion, the "33 dB" curve of Figure 12 suggests that the ratio between single-entry criterion and aggregate criterion should be in the order of 5.53 dB, and the "35 dB" curve suggests that this ratio be in the order of 5.61 dB.

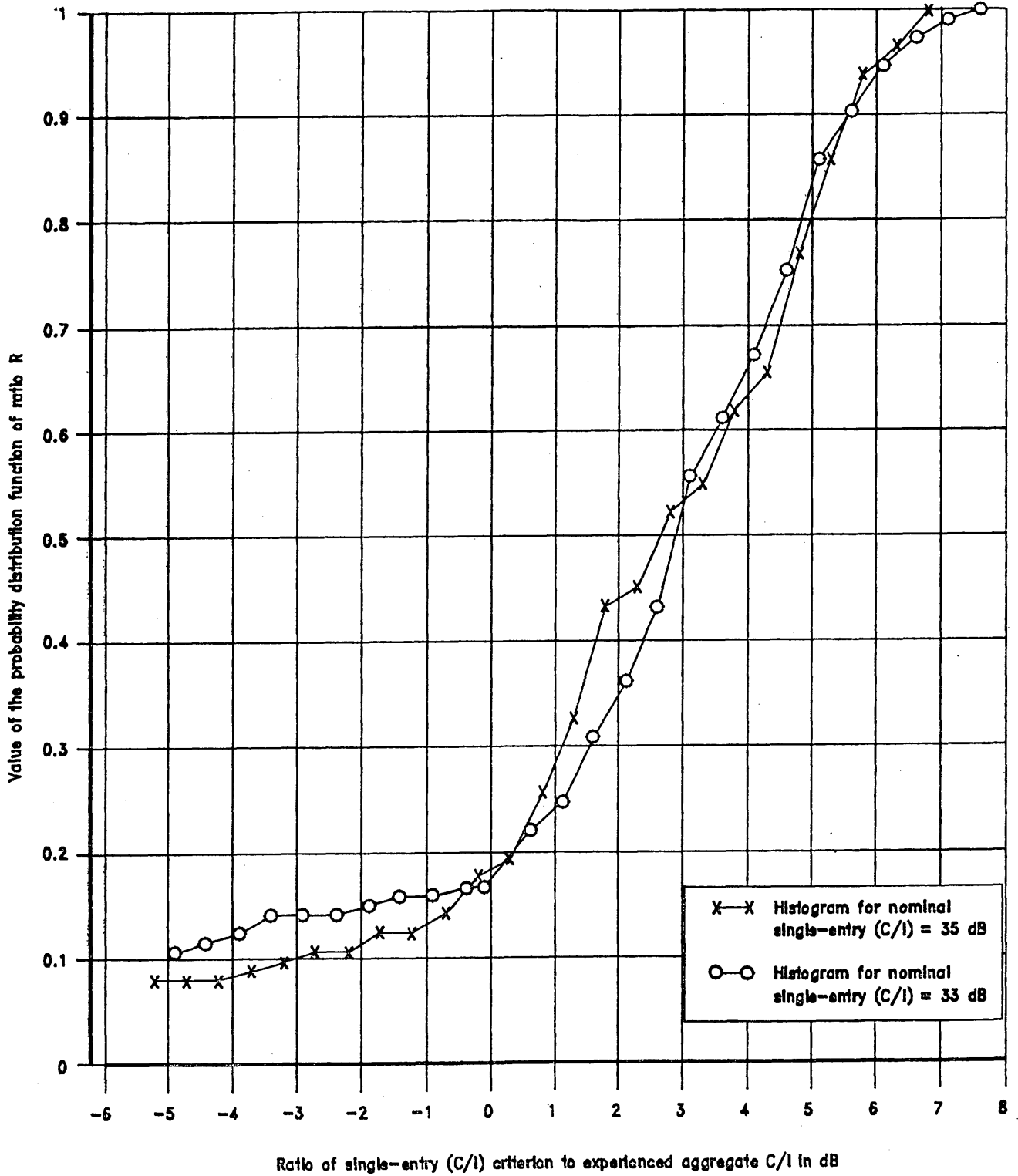

FIGURE 12

Cumulative histograms or estimates of the probability distribution function of the ratio of single-entry (C/I) criterion to experienced aggregate (C/I), R, in dB

5.2 Simulation example 2

In another simulation example, the aggregate interference between digital satellite systems was calculated using one hundred 6/4 GHz beams selected from the requirement for the national allotments in Part A of the Allotment Plan developed at WARC-ORB-88. These one hundred beams were chosen because they represent a highly utilized part of the GSO, i.e. the Europe/Africa region. Systems in Part B, or existing systems, were not included in the calculation.

Technical parameters used, such as carrier-to-noise ratio and antenna diameter, were in accordance with Section A of ANNEX 1 to Appendix 30B of the Radio Regulations. This ANNEX was used in the generation of the Allotment Plan at WARC-ORB-88. QPSK modulation without FEC is assumed in the calculation. By assuming a 2.5dB margin for the QPSK modulation, a C/N of 16 dB (BER 10^{-6}) was used, which coincides with the operational C/N value adopted in the generation of the plan. Thus, the single entry carrier-to-interference ratio corresponding to 4% and 10% of the total noise level at which the BER equals 10^{-6} is 30 dB and 26 dB, respectively. Satellite locations and the length of the total arc to accommodate the satellite systems were determined by using the ORBIT-II programme. The carrier to single entry interference ratio of 30 dB or 26 dB is satisfied for every satellite system.

After the locations were determined, the aggregate interference for each satellite system was calculated and its distribution was analyzed. Since the length of the total arc is adjusted so that the "compression ratio" becomes unity, the correction of the values required in Example 1 is not necessary in this case.

The calculated results are shown in Figure 13. In this example, the ratio of aggregate to single entry interference is not more than 2.8 to 3 (4.4 to 4.8dB) for a 90% probability and not more than 3.8 to 4.5 (5.8 to 6.6dB) for a 99% probability.

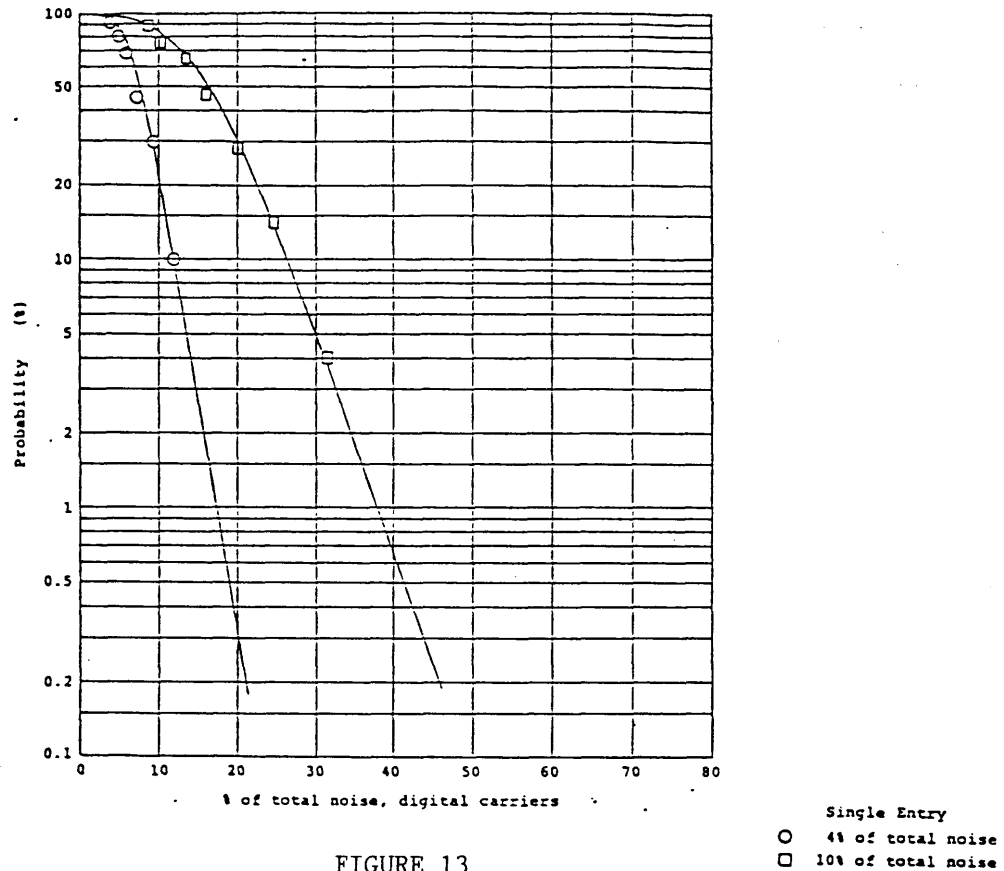

FIGURE 13

Distribution of aggregate interference (% of total noise)

5.3 Variations in interference between real satellite networks

The analytical and simulation studies presented in this report depend upon the interference discrimination of earth station and satellite antennas defined by the CCIR Recommendations. These Recommendations depict envelopes of antenna side-lobe gains which usually encompass peak values of these lobes instead of the actual antenna gains at specific off-axis angles. The results of these studies may be conservative in estimating aggregate interference since there are as many "nulls" as there are peaks in the antenna gain patterns. An estimate of actual aggregate interference might include a statistical variation in antenna side lobe gains as well as other non-homogeneous factors, such as variations in antenna beam sizes and RF signal characteristics. The inclusion of these factors may result in lowering the estimates of aggregate interference compared with that shown in the above models. Further study is urgently required.

6. Summary

Several models were studied to analyze the factors for determining an appropriate level of aggregate and single entry interference for coordination purposes. It was noted that where many homogeneous satellite networks cover the same or adjacent areas (little or no satellite antenna discrimination exists), the ratio of aggregate to single entry interference (ME/SE) is about 4 dB. In a similar model of homogeneous networks, where satellites with significant satellite antenna discrimination are interleaved between co-coverage (with earth station antenna discrimination) satellites, the ratio (ME/SE) has a sharply

peaked value of about 7 dB for unique values of satellite antenna discrimination and considerably lower (ME/SE) ratios for other values of satellite antenna discrimination.

A theoretical study of cellular groupings of service areas, where satellites serving these areas may be co-located in orbit, was made. This study indicated an asymptotic ratio of (ME/SE) of 11 to 13 dB. However, when applied to a practical scenario in Region 2 where the service areas coincided with actual country boundaries, the worst case ratio was 6 dB for co-channel frequency operation. Another analysis, using computer simulations with different types of traffic and frequency offsets between carriers, was applied to a practical mix of co-coverage and non-co-coverage satellite networks. The conclusions in this case were that for FDM/FM carriers, the probability of the ratio exceeding 2.5 or 4 dB, is less than 1%; and for digital carriers the probability of exceeding 7 dB is close to 1%.

Two simulation exercises were performed for a highly utilized part of the GSO based on requirements for the national allotments in the Allotment Plan generated in WARC ORB-88. Both exercises determine satellite positions based on the single-entry interference criteria and analysed the aggregate interference of each satellite system. One exercise shows that 90% of the satellite entries have an aggregate to single-entry interference ratio of less than 5.6 dB. The other exercise shows this ratio to be less than 4.8 dB.

REFERENCES

CCIR Documents

[1986-90]: a. 4/1(Rev.1) (IWP 4/1); b. 4/47 (USA); c. 4/57 (USA);
d. 4/60 (Canada); e. 4/63 (USA); f. 4/269 (Japan); g. 4/324 (IWP 4/1);
h. 4/330 (Canada).

REPORT 710-3

**INTERFERENCE ALLOCATIONS IN SYSTEMS
OPERATING AT FREQUENCIES GREATER THAN 10 GHz
IN THE FIXED-SATELLITE SERVICE**

(Question 28A/4)

(1982-1986-1990)

1. Introduction

At frequencies below 10 GHz, the effects of propagation variations (fading) are relatively small factors in the determination of internal link noise allowances and external interference allowances. At frequencies above 10 GHz, fading becomes an increasingly dominant factor in determining these allowances and the link design tends to be determined by the propagation losses expected for small percentages of time. There may be a need to define short-term as well as longer-term interference allowances in frequency bands above 15 GHz.

The way noise and interference are allocated in digital systems may be different from analogue systems. At frequencies above 10 GHz if the error rate performance objective for a small percentage time is met, during non-fading conditions the error rate is likely to be small.

A principal concern in interference allocations is the correlation between these interference entries and the desired signal.

The general factors affecting the interference allocations in analogue and digital systems are explored in this Report.

2. Propagation phenomena

At frequencies above 10 GHz rain attenuation is the primary cause of fading in satellite links. An example of a rain attenuation distribution is given in Fig. 1, which shows that the attenuation at 30 GHz with a 17° antenna elevation angle is 17.5 dB for 0.3% of the worst month for a typical Canadian City, Halifax, a light rain region. Much greater attenuation will be experienced in heavy rain regions where storm cells are more prevalent. Rain attenuation increases rapidly with increasing frequency in the 4 GHz to 30 GHz region as indicated by the curves shown in Fig. 1. The values also change considerably with geographic variations, as illustrated in Fig. 2 where 20 and 30 GHz data from Halifax and Tokyo are compared.

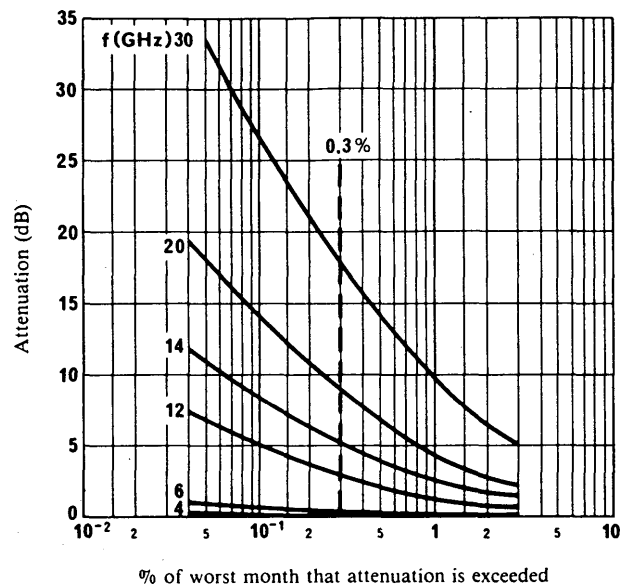

FIGURE 1 - Distribution of rain attenuation with a 17° elevation angle at Halifax for a satellite-Earth path

3. Link design and mutual interference considerations

Site diversity and adaptive up-link power control (UPC) may or may not be used on satellite links, and these factors need consideration in conjunction with the fading correlation of wanted signals and interference on the up links and down links.

3.1 Sources of interference

Interference may arise from a number of sources. For the purpose of this analysis, these are identified as:

- intra-system (internal) sources:
 - cross-polarized co-channel interference;
 - intermodulation, adjacent channel and other degradations;
- inter-system (external) sources:
 - interference from other satellite systems;
 - interference from other space services and terrestrial services.

Intra-system (internal) sources of interference are not always influenced by fading conditions. The interferences from other space services not using UPC and terrestrial services have almost constant interference values which are not changed in value by fading conditions. However, the interference from other satellite systems on the geostationary-satellite orbit can be controlled to a certain extent by using UPC. As a result, higher C/I values can be obtained when all FSS systems use UPC than when all systems use fixed e.i.r.p. on the up link.

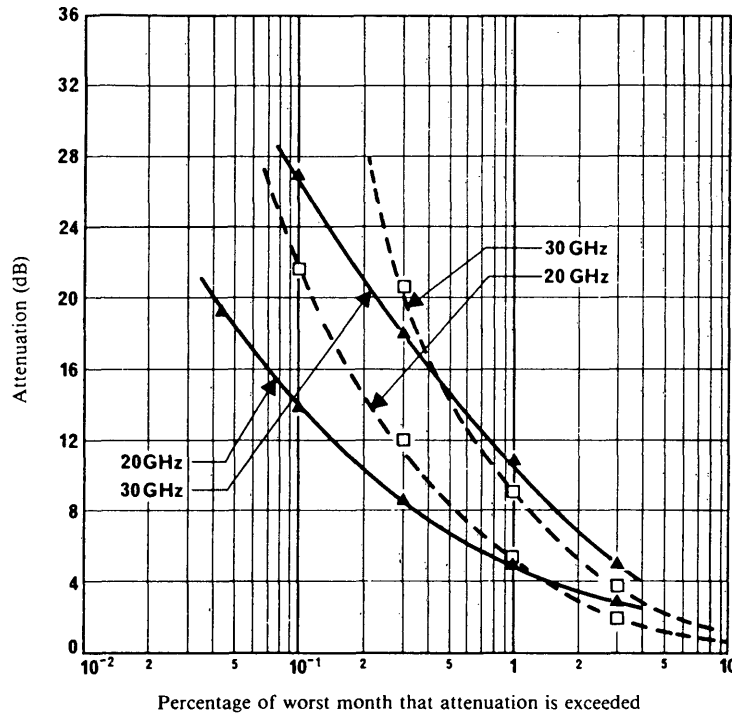

FIGURE 2 - Examples of geographical variations of rain attenuation in 20 and 30 GHz bands

▲ — ▲ Halifax Data (elevation angle 17°)
 □ - - □ Tokyo Data (elevation angle 48.5°)

3.2 Link design aspects

The design of a satellite link above 10 GHz is typically characterized, from the interference point of view, by the different interference behaviour in the down and up link.

For the down link, a high degree of correlation between the wanted signal fading and the interference fading from significantly contributing neighbouring satellites is expected so that $(C/I)_d$ will not significantly change with increasing attenuation, with or without diversity, when fixed e.i.r.p. is used. However, down-link power control of the desired or interfering signals will result in C/I variations. Further study of down-link power control is needed.

For an up link, apart from the case where there is a co-transmitted cross-polarized signal, simultaneous fading on the signal path and interference path is not likely because of the geographical separation of the earth stations. Thus, $(C/I)_u$ can be almost proportional to $(C)_u$ in an up link without adaptive power control. With power control, variations in $(C/I)_u$ will be significantly smaller under up-link fading conditions. Where cross-polarization isolation is employed for co-frequency transmissions from the same earth station, under conditions of fading co-channel interference is likely to be dominant.

In general, a low correlation between up-link and down-link fading can be expected so that simultaneous deep fades would occur for only a negligible percentage of time.

With these postulates, at the output of an FM receiver approximate relationships between the interference noise i , the thermal noise n and C are:

- (a) for the down-link i is nearly constant, $n \sim 1/C$ and $i/n \sim C$;
- (b) for an up-link without power control i/n is nearly constant, $i \sim 1/C$ and $n \sim 1/C$;
- (c) for a down-link with full up-link power control n and i are nearly constant.

Since i is nearly constant for (a) and (c), a short-term interference allowance may not need to be defined. However, for (b) a link having a large fading design in order to meet a short-term performance objective will have a very low n under faded conditions so that with current interference allowances, it is possible that $i \gg n$. In a fading up-link i_u and n_u will both increase proportionally, and when $i_u \gg n_u$, i_u and intermodulation noise (where applicable) will dominate the short-term performance. Thus, in the higher frequency bands, there may be a need to define a short-term interference allowance when a non-diversity up-link is used without adaptive power control. However, it should also be noted that a reasonable short-term interference allowance may result in a very low long-term up-link interference requirement which in turn may be detrimental to efficient utilization of the geostationary orbit and spectrum. Thus any short-term interference allowance should be as high as feasible in order to minimize any detrimental effects on orbit and spectrum utilization.

The effect of space diversity on up-link power control is to reduce the margins required to meet performance criteria, i.e. it is equivalent to a reduction in the fading range. Consequently, the effective fading range may be reduced such that a short-term interference allowance may not be necessary. Since this reduces the maximum value of C and, in turn, I to another network, orbit and spectrum utilization may be enhanced.

A satellite system operating above 10 GHz may have sufficient power margin in the system design that a minor amount of C/N degradation by interference during clear-air conditions is not a significant factor. However, where rain fading occurs, interference will degrade the system by causing a reduction in rain fade margins. Here, the reduction in design fade margin represents a true loss from a system point of view. For example, if the interference causes a 1 dB loss in fade margin, one would have to increase the transmitter power by 1 dB, reduce the data rate by 20%, or increase antenna diameter by 12% to make up the loss. The question of allowable interference may, therefore, be considered from the standpoint of degradation in system margins.

This margin reduction has been confirmed in a more recent analysis and raises the question whether the provisions of § 1.1 and 1.2 of Recommendation 523 may not, under certain circumstances, result in unacceptable interference for the small percentages of the time during which a signal is faded. It is noted that the problem is likely to be less severe in systems which use up-link power control. However, further study is recommended to assess the problem; specifically to consider the usefulness of a provision, in Recommendation 523, which would address the faded situation, and to consider the implications of the choice of a reference bit error ratio different from 1 in 10^6 .

4. Examples of interference allocations in systems above 10 GHz

4.1 Analogue modulation systems

A 30/20 GHz satellite system may use frequency-division multiple access, or alternatively may operate in the single-carrier-per-transponder mode. If the rain attenuation is severe, the system may use up-link power control, or alternatively might be designed such that operation during severe fading is possible without up-link power variation. Similar systems are possible in the 14/12 GHz bands, although, in general, fading is not so severe (see Fig. 1) and so less emphasis need be placed on system design for operation during severe fading conditions.

As a first example, consider the case where:

- the 30/20 GHz frequency band is used;
- a non-diversity up-link without UPC;
- down-link diversity is used and so down-link fading effects are neglected;
- a typical TWT satellite transponder is used;
- the desired performance is indicated by Recommendations 353 and 466.

Since the short-term performance determines the link design, the unfaded thermal noise is quite low. Two possible link designs are indicated in Table I, that for multi-carrier FDMA operation and that for single-carrier-per-transponder operation.

TABLE I – Example noise budgets, including inter-system interference for multi-carrier and single-carrier operations with up-link fading but without up-link power control
(based on Halifax propagation data at 30 GHz)

Noise characteristic(1)	Condition for 80% of month (pW0p)		Condition for not more than 0.3% of worst month (pW0p)	
	Multi-carrier operation	Single-carrier operation	Multi-carrier operation	Single carrier operation(2)
Intermodulation	2 000	0	112 400	0
Up-link interference	1 000	1 000	56 200	56 200
Down-link interference	1 000	1 000	56 200	15 850
Up-link thermal noise	300	300	16 870	16 870
Down-link thermal noise	600	600	33 740	9 510
Total	4 900	2 900	275 410	98 430

(1) Interference from terrestrial systems has not been considered in this example.

(2) Assumes a transponder characteristic with 12 dB output reduction for 17.5 dB input reduction.

A comparison of the performance of this example link with and without intermodulation noise indicates that the intermodulation noise has a major effect on short-term performance, contributing most of the increase of the short-term total noise from 98×10^3 pW0p to 275×10^3 pW0p. It should also be noted that the short-term performance specified in Recommendation 353 could be met in this example if thermal noise were the only impairment, but not if either intermodulation noise, or inter-network interference, as specified by Recommendation 466 for bands below 15 GHz, were experienced.

As a second example, consider the system of example one but with partial UPC, i.e. power variation of 8.5 dB in the transmitting earth station to reduce the effects of the 17.5 dB fading in the up link 0.3% of the time. The link performance for this system is indicated in Table II. In this example the short-term performance of Recommendation 353 is met when the system design is based primarily on long-term conditions and single-carrier-per-transponder transmission is used, but not when the same system is used in an FDMA mode of operation, although the inter-system interference contribution still remains 1/5 of the total noise.

TABLE II – Example noise budgets, including inter-system interference for multi-carrier and single-carrier operations with up-link fading and partial up-link power control
(based on Halifax propagation data at 30 GHz)

Noise characteristic(1)	Condition for 80% of month (pW0p)		Condition for not more than 0.3% of worst month (pW0p)	
	Multi-carrier operation	Single-carrier operation	Multi-carrier operation(2)	Single-carrier operation(3)
Intermodulation	2 000	0	16 000	0
Up-link interference	1 000	1 000	8 000	8 000
Down-link interference	1 000	1 000	8 000	3 200
Up-link thermal noise	2 000	2 000	16 000	16 000
Down-link thermal noise	4 000	4 000	32 000	12 800
Total	10 000	8 000	80 000	40 000

(1) Interference from terrestrial systems has not been considered in this example.

(2) Assumes 8.5 dB up-link power control and a 17.5 dB fade.

(3) Assumes 8.5 dB up-link power control and corresponding 5 dB down-link power variation (due to transponder non-linearity) for a 17.5 dB fade.

Operation of a similar system in the 14/12 GHz band, without UPC or site diversity, is indicated in Table III. In this system example the short-term performance of Recommendation 353 is met even without UPC or diversity operation if the system is designed to meet the long-term conditions of Recommendations 353 and 466. However, in this example as well, the normal allowance for intermodulation noise in the FDMA system option degrades the short-term performance.

TABLE III – Example noise budgets, including inter-system interference for multi-carrier and single-carrier operations with up-link fading but without up-link power control
(based on Halifax propagation data at 14 GHz)

Noise characteristic(1)	Condition for 80% of month (pW0p)		Condition for not more than 0.3% of worst month (pW0p)	
	Multi-carrier operation	Single-carrier operation	Multi-carrier operation	Single-carrier operation(2)
Intermodulation	2000	0	7096	0
Up-link interference	1000	1000	3548	3548
Down-link interference	1000	1000	3548	2000
Up-link thermal noise	2000	2000	7096	7096
Down-link thermal noise	4000	4000	14192	8000
-Total	10000	8000	35480	20644

(1) Interference from terrestrial systems has not been considered in this example.

(2) Assumes a transponder characteristic with 3 dB output reduction for 5.5 dB input reduction.

4.2 Digital modulation systems

Systems operating above 10 GHz are discussed in this section. The effect of interference into a 14/12 GHz system and a 30/20 GHz system using digital modulation is shown.

4.2.1 14/12 GHz systems

In order to assess the impact of interference from other satellite networks on digital satellite transmissions such as when forming part of an ISDN, an actual operating satellite network at 14/12 GHz was analysed. The margins for rain regions K and M were determined with interference allowance as per CCIR Recommendation 523.

The data rate used for the digital service is 2.048 Mbit/s and utilizes 3/4 rate convolution encoding with Viterbi decoding, operating in the linear region of the transponder. The rain attenuation is calculated for worst month percentages in rain regions and the resultant C/N is calculated against the requirements of BER of 10^{-3} for 0.2% of worst month, 10^{-6} for 2% of worst month, and 10^{-7} for 10% of worst month. Under fading conditions, it is assumed that when the up-link carrier fades due to rain in its area, the interfering carriers from other areas are not fading. Therefore, the C/I will degrade. In other words, under fading conditions it is assumed that the rain cells are localized and thus degradations to C/I apply uniformly due to all interference.

The fading on the up and down-links are assumed independent and only up-link fading was assumed.

In order to assess the effect of the interference from other satellite networks, this component is shown versus the percentage of worst month under the same fading conditions.

Table IV details the link budget for the system for various percentages of time for the worst month in rain region K. The following assumptions are made:

1) Operation is over the linear region of the satellite transponder, therefore up-link fading will cause the down-link carrier-to-thermal-noise rates to degrade linearly at the same rate in dB.

2) The intra-network interference from other carriers is assumed to remain constant and, thus, the C/I is assumed to vary linearly as the up-link carrier fades.

3) In the worst case the IM noise, assuming a large number of carriers, remains constant as the wanted up-link carrier fades. The carrier to IM noise will therefore vary at the same rate, in dB, as the wanted carrier.

4) The adjacent satellite interfering carriers are assumed to remain constant while the wanted up-link carrier fades.

Some form of fade compensation such as up-link power control may be used to compensate for the effect of fading. For a moderate K climate a modest amount of up-link power control of 3.4 dB would be sufficient for the system shown in the example using FEC.

TABLE I
INTELSAT 2.048 Mbit/s, region K, at 14/12 GHz
as per CCIR interference allowance

FADE DEPTH dB PERCENT TIME		0.0	0.8	1.7	2.1	3.3	5.8	7.2	10.0	13.3	16.7
			10.0	3.0	2.0	1.0	0.3	0.2	0.10	0.05	0.03
UP LINK	C/N THERMAL	21.8	21.0	20.1	19.7	18.5	16.0	14.6	11.8	8.5	5.1
	C/N XPOL	33.8	33.0	32.1	31.7	30.5	28.0	26.6	23.8	20.5	17.1
	C/N IM	19.8	19.0	18.1	17.7	16.5	14.0	12.6	9.8	6.5	3.1
	C/N ASI	20.5	19.7	18.8	18.4	17.2	14.7	13.3	10.5	7.2	3.8
	C/(N+I) TOTAL	15.8	15.0	14.1	13.7	12.5	10.0	8.6	5.8	2.5	-0.9
	C/I TOTAL	20.5	19.7	18.8	18.4	17.2	14.7	13.3	10.5	7.2	3.8
DOWN-LINK	C/N THERMAL	18.4	17.6	16.7	16.3	15.1	12.6	11.2	8.4	5.1	1.7
	C/N XPOL	33.8	33.0	32.1	31.7	30.5	28.0	26.6	23.8	20.5	17.1
	C/N TERR & IM	21.4	20.6	19.7	19.3	18.1	15.6	14.2	11.4	8.1	4.7
	C/N ASI	20.5	19.7	18.8	18.4	17.2	14.7	13.3	10.5	7.2	3.8
	C/(N+I) TOTAL	15.1	14.3	13.4	13.0	11.8	9.3	7.9	5.1	1.8	-1.6
	C/I TOTAL	20.5	19.7	18.8	18.4	17.2	14.7	13.3	10.5	7.2	3.8
TOTAL	C/(N+I) TOTAL	12.4	11.6	10.7	10.3	9.1	6.6	5.2	2.4	-0.9	-4.3
	C/I TOTAL	17.5	16.7	15.8	15.4	14.2	11.7	10.3	7.5	4.2	0.8
	REQUIRED C/N (BER 10 ⁻³)	6.7	6.7	6.7	6.7	6.7	6.7	6.7	6.7	6.7	6.7
	MARGIN	5.7	4.9	4.0	3.6	2.4	-0.1	-1.5	-4.3	-7.6	-11.0

Symbol definitions:

- C/N THERMAL: Carrier to thermal noise ratio
C/N XPOL: Carrier to cross polarization interference noise ratio
C/N IM: Carrier to intermodulation interference noise ratio
C/N ASI: Carrier to adjacent satellite interference noise ratio
C/N TERR & IM: Carrier to terrestrial and ground station intermodulation interference noise
C/(N+I): Carrier to thermal and interference noise ratio (combined power wise)
C/I: Carrier to adjacent satellite interference noise ratio

4.2.2 30/20 GHz systems

In deriving these examples, the following assumptions are made:

- 30/20 GHz 2-phase CPSK system;
- either all the fixed-satellite service systems involved use UPC or none do;
- two intra-satellite interference entries result from adjacent channels used in other (independent) homogeneous links;
- under non-fading conditions, the wanted carrier-to-intra-satellite interference ratio is taken to be 35 dB for both up and down links;
- external interference on the up link from other fixed-satellite service systems is assumed to increase the satellite thermal noise by 3 dB when power control is not used;
- cross-polarized signals on the up link are transmitted from the same earth station;
- circular polarization is assumed and cross-polarization discrimination (*XPD*) values are determined using the method in Report 564;
- satellite and earth-station antenna *XPD* values are taken as 30 and 35 dB respectively. (Because of the coherence of the cross-polar interference on each transmission path these values are combined with each other and with the atmospheric *XPD* value on a voltage addition basis);
- the rain attenuation figures at 30 GHz and 20 GHz are 17.5 dB and 9 dB respectively. (Values for 0.3% of the worst month in Halifax at 17° elevation angle: see Fig. 1.) The 9 dB fade condition at 20 GHz is assumed to increase the down-link thermal noise temperature by 3 dB;
- the fixed e.i.r.p. and power-controlled up links provide equal availabilities (i.e., equal maximum e.i.r.p.s) and the power-control system has a 14.2 dB dynamic range. (Clear-sky operating point with UPC corresponds to a bit error ratio around 10^{-8} and somewhat lower with fixed e.i.r.p.);
- there are two external interference entries on the down link from fixed-satellite service systems: these are assumed to be equivalent to intra-satellite interference;
- the probability that both the up and down links fade extensively at the same time is sufficiently small to be ignored;
- the interference from other space services and terrestrial services is taken to be 40 dB below carrier level for both up and down links when fixed e.i.r.p. is used.

Tables V and VI show examples of up-link and down-link noise budgets under unfaded and faded conditions. Under normal propagation conditions, atmospheric *XPD* is calculated from equation (15) in Report 564-2 (Geneva, 1982) to be 45 dB at 30 GHz and 40 dB at 20 GHz. When rain attenuation occurs, *XPD*s for 30 and 20 GHz decrease to 16.5 and 17.8 dB. (Values of $\epsilon = 17^\circ$ and $\tau = 45^\circ$ are used in equation (15) in Report 564-2 (Geneva, 1982).)

TABLE V - Example of possible up-link noise and interference allocations

	dB below signal			
	Unfaded		Faded	
	Without power control	With power control	Without power control	With power control
1. Cross-polarized co-channel interference	25.2	25.2	14.0	14.0
1.1 Earth-station antenna <i>XPD</i>	35	35	35	35
1.2 Atmospheric <i>XPD</i>	45	45	16.5	16.5
1.3 Satellite antenna <i>XPD</i>	30	30	30	30
2. Thermal noise plus other interferences	29.8	19.4	12.3	16.1
2.1 Intra-satellite interference (2 entries)	35	35	17.5	31.7
2.2 External system interference	33.8	25.3	16.3	22.0
2.2.1 Other FSS systems interference	35	35	17.5	31.7
2.2.2 Other services interference	40	25.8	22.5	22.5
2.3 Thermal noise	35	20.8	17.5	17.5
3. Total up-path $[C/(N + J)]_u$	23.9	18.4	10.1	11.9

TABLE VI – Example of possible down-link noise and interference allocations

	dB below signal	
	Unfaded	Faded
1. Cross-polarized co-channel interference	24.5	15.0
1.1 Earth-station antenna XPD	35	35
1.2 Atmospheric XPD	40	17.8
1.3 Satellite antenna XPD	30	30
2. Thermal noise plus other interference	24.7	13.7
2.1 Intra-satellite interference (2 entries)	35	35
2.2 External system interference (2 entries)	33.8	33.8
2.2.1 Other FSS systems interference	35	35
2.2.2 Other services interference	40	40
2.3 Thermal noise	25.8	13.8
3. Total down-path $[C/(N + I)]_d$	21.6	11.3

The up-link intra-satellite interference, external interference from other fixed-satellite service systems and thermal noise ratios are reduced to 17.5 dB below signal level when UPC is not used. By using UPC, intra-satellite interference and other fixed-satellite service systems interference can be maintained at 31.7 dB during faded conditions. As a result, a total up link $[C/(N + I)]_u$ of 11.9 dB can be achieved which is 1.8 dB better than for the case without UPC.

Table VII shows the total carrier-to-noise ratios $[C/(N + I)]_t$ derived from Tables I and II.

The difference in the total $[C/(N + I)]_t$ between with and without UPC in the up-link faded case is about 1.7 dB.

TABLE VII – Value of total $[C/(N + I)]_t$

Total $[C/(N + I)]_t$ (dB)					
Unfaded		Up link faded		Down link faded	
Without power control	With power control	Without power control	With power control	Without power control	With power control
19.6	16.7	9.8	11.5	11.1	10.5

5. Summary

An attempt has been made to identify certain possible sources of interference in analogue and digital systems in the fixed-satellite service operating in frequency bands above 10 GHz.

Possible link budgets have been calculated based on the assumptions identified.

The following tentative comments apply:

- with respect to efficient use of the geostationary-satellite orbit and spectrum it is preferable to utilize adaptive power control or space diversity on the up-links in order to reduce the effects of short-term interference;
- in the higher frequency bands (e.g. 30/20 GHz), if UPC or space diversity is not employed, a short-term interference allowance may need to be defined. Any short-term interference allowance should be chosen in such a manner that any detrimental effects on orbit and spectrum utilization are avoided;
- because the fading range increases substantially with increasing frequency, a single short-term interference allowance may not suffice for all fixed-satellite service bands above 15 GHz.

More study is urgently needed in order to obtain more substantive qualitative and quantitative conclusions with respect to interference allowances for satellite networks in the fixed-satellite service above 10 GHz. These studies should also take into consideration the allowances for interference from terrestrial services in those frequency bands where sharing with the fixed-satellite service is permitted.

REPORT 867-

MAXIMUM PERMISSIBLE INTERFERENCE IN SINGLE-CHANNEL-PER-CARRIER
AND INTERMEDIATE RATE DIGITAL TRANSMISSIONS IN
NETWORKS OF THE FIXED-SATELLITE SERVICE

(Study Programme 28C/4)

(1982-1986-1990)

1. Introduction

Single-channel-per-carrier (SCPC) and intermediate rate digital transmissions have become services widely used in fixed-satellite service systems and they are by their very nature, sensitive to interference from transmissions with high spectral density components. One of the most harmful of these is analogue FM-TV which, for appreciable periods of time, may have negligible inherent dispersal of its carrier energy and may, therefore, require substantial isolation from SCPC and intermediate rate digital transmissions when operating on the same frequency.

Artificial energy dispersal as successfully used in reducing interference from FM-TV transmissions into other FM-TV transmissions and into low-capacity analogue FDM-FM telephony transmissions has been considered as a means to alleviate the situation also for SCPC and intermediate rate digital transmissions.

One of the customary dispersal techniques applied to analogue FM-TV is the modulation of the carrier with a triangular waveform of a given peak-to-peak deviation at a frequency in the neighbourhood of the frame repetition rate ("slow triangular spreading"), and removal of that waveform upon reception. When the peak-to-peak deviation is greater than the occupied bandwidth of the interfered-with signal, the full interfering carrier power will be present within that bandwidth for about the time fraction corresponding to the ratio of occupied bandwidth B to the peak-to-peak dispersal deviation Δf . The ratio $\delta = B/\Delta f$ is, by analogy with pulse type signals, called the duty cycle. This causes the most severe interference from analogue TV transmission, to occur during the period of absence of the video baseband signals. This situation occurs only rarely, at random, and for a small percentage of the time.

The following summarizes the currently known effects of interference from one type of artificially dispersed FM-TV carrier on SCPC and intermediate rate digital transmissions as used in the fixed satellite services. This work has led to the development of one form of interference criteria for use in the calculation of interference.

2. Interference in 8-bit PCM 4-phase PSK single-channel-per-carrier transmissions

One of the most common carriers in use is 8-bit PCM 4-phase PSK SCPC at 64 kbit/s and the establishment of an interference criterion is based on the following considerations.

Monitoring of TV transmissions in the INTELSAT system indicates that TV carriers are modulated by video signals or test patterns most of the time and that for only very short periods the TV carriers are modulated by Energy Dispersal Signals (EDS) alone. These periods are of the order of 0.6% of the total transmission time. The average length of such periods is about 5 minutes. The longest continuous such period was found to be about 18 minutes. Thus, the probability of simultaneous occurrences of two or more such interferers is very small.

Additional measurements are needed to examine the validity of these statistical results in other satellite systems.

To establish a criterion to be used for protecting the uncoded SCPC/QPSK (64 kbit/s) transmissions, one TV carrier modulated with EDS alone is assumed to be present all of the time (one such entry representing time addition of all such interfering signals from different satellites). This type of interference is assumed to co-exist with other noise-like interferers. Therefore, the total pre-demodulation interference noise allowed by Recommendation 523-2 should be divided between these two dissimilar types of interference.

A model has been developed to derive the apportionment of the total allowed interference between the two types of interferers. The model assumes a contribution coming from an ED modulated TV carrier and a noise-like contribution which is equal to 2.5 times the single entry interference. The noise-like single entry interference is assumed to originate from a modulated carrier, whose spectral density (power in a bandwidth of 1 Hz relative to the total carrier power) in the proximity of the carrier frequency is -62 dBc/Hz. This value is appropriate for representing a high density FM carrier or a modulated TV carrier.

The following laboratory measurements were made. The SCPC transmission was operated at different carrier-to-noise ratio values above $C/N = 14.6$ dB ($E_b/N_o = 12.3$ dB) which corresponds to $BER = 10^{-6}$. Then, the ED modulated TV interferer was added and the value of the carrier-to-interferer carrier power was recorded which restored the BER to 10^{-6} . The results are presented in Figure 1 for different peak-to-peak EDS deviations. In the same figure, the relationship between the noise-like interference C/I (for both single entry and total noise-line interference) and degradation is shown.

Using Figure 1, by equating the total degradation caused by the TV (EDS modulated only) interference and noise-like interference with the criterion defined in Recommendation 523, the protection ratios for uncoded SCPC/QPSK (64 kbit/s) were determined, as shown in Figure 2.

These results can be approximated by the equation:

$$C/I = 21 + 3 \log \delta + 8 \log (10/i) \quad (1)$$

or

$$C/I = C/N + 6.4 + 3 \log \delta - 8 \log (i/10)$$

where

C/I = the ratio of the SCPC carrier power to the total carrier power of the interfering dispersed TV signal

C/N = the operating carrier-to-noise ratio which corresponds to $BER = 10^{-6}$

δ = (SCPC occupied bandwidth)/(TV peak-to-peak deviation by EDS)

i = pre-demodulation interference power in the SCPC bandwidth expressed as a percentage of the total pre-demodulation noise power ($10 \leq i \leq 25$).

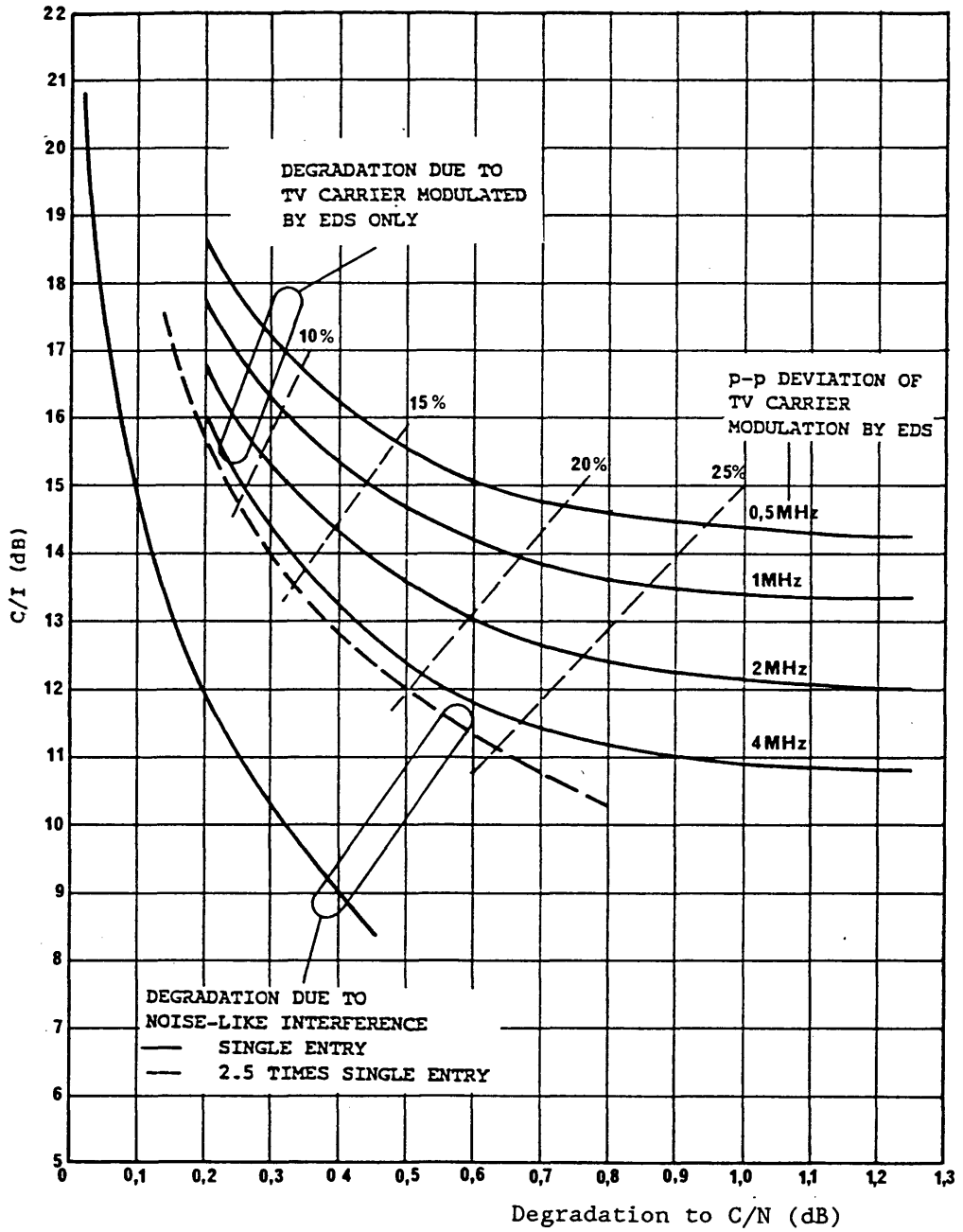

FIGURE 1

C/I vs degradation of C/N ratio

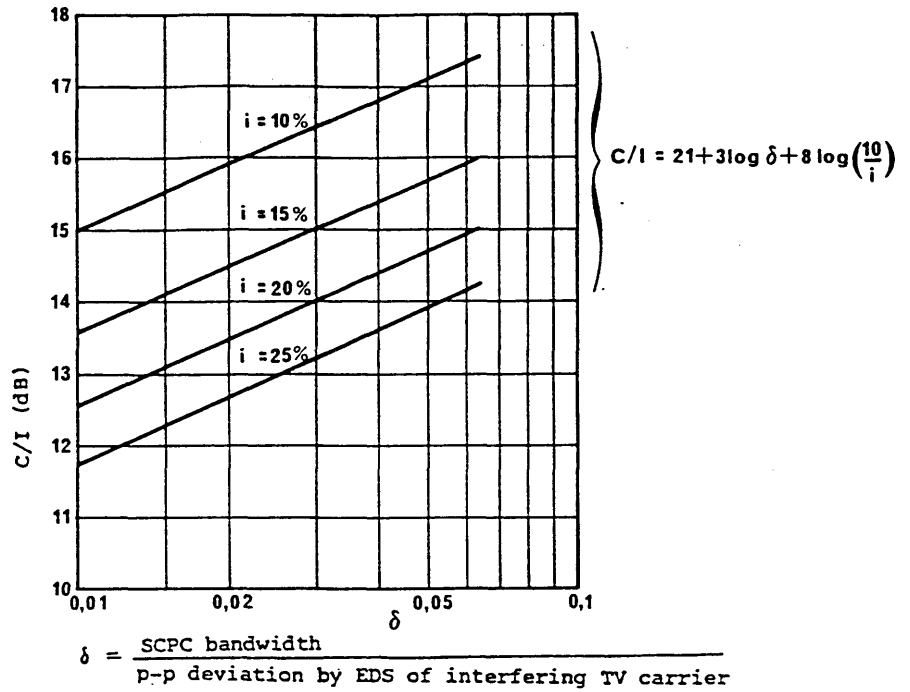

FIGURE 2

Protection criteria3. Encoded digital QPSK

Measurements have been carried out on various SCPC/QPSK systems using different rates and coding schemes e.g. EUTELSAT SMS carriers (64 kbit/s and 1920 kbit/s with rate $\frac{1}{2}$ FEC) and INTELSAT Business Service (IBS) (64 kbit/s and 1536 kbit/s rate $\frac{1}{2}$ FEC) and Intermediate Data Rate carriers (1544 kbit/s and 2048 kbit/s with rate $\frac{3}{4}$ FEC). The signal parameters are listed in Table I and are in accordance with the specification of these systems.

TABLE I

Encoded QPSK transmission parameters

Transmission parameter	INTELSAT				EUTELSAT	
Information rate IR (kbit/s)	64	1536	1544	2048	64	1920
Overhead bits, OH	16/15	16/15	0	0	16/15	16/15
Comosite rate CR (kbit/s)	68.27	1638.4	1544	2048	68.27	2048
FEC code rate, C	1/2	1/2	3/4	3/4	1/2	1/2
Transmission rate TR (kbit/s) (CR/C)	136.5	3277	2059	2731	136.5	4096
Nyquist bandwidth (0.5 TR)	68k	1.6M	1.0M	1.4M	68.3k	2048k
Composite rate E_b/N_o * (dB)						
for 10^{-6} BER	5.4	5.2	7.2	6.8	5.4	5.1
for 10^{-7} BER	-	5.8	7.8	7.4	-	-
for 10^{-8} BER	-	6.4	8.5	7.9	-	-
C/N* (dB) for 10^{-6} BER	5.4	5.2	8.9	8.6	5.4	5.1
for 10^{-7} BER	-	5.8	9.6	9.2	-	-
for 10^{-8} BER	-	6.4	10.2	9.7	-	-

* The values for E_b/N_o and C/N relate to the actual demodulator performance of the equipment used in the measurements.

The measurements resulted in curves of C/I versus degradation for BER values of 10^{-6} , for the 64 kbit/s case and 10^{-6} , 10^{-7} and 10^{-8} for the higher data rates [CCIR, 1986-1990].

3.1 Interference into 64 kbit/s carriers

The protection criterion which has been developed is based on measurements using two different interference models. One model is the same as described in section 2 for uncoded QPSK transmission. The model divides the total allowed interference between two types of interferers: one TV carrier modulated only with an Energy Dispersal Signal (EDS), and other carriers modulated by noise-like signals. In the model, the apportionment of the total allowed interference is determined from the different interference effects of the two types of interferers. The spectral density of -62 dBc/Hz is used to derive the noise-like interference.

The other model [Dutronic *et al.*, 1986] considered an interference scenario in which total interference is equivalent to 20% of the pre-modulation noise, shared equally between noise-like interference and a single TV carrier modulated by an energy dispersal signal. The energy dispersed carrier is, therefore, assumed to represent 10% of the total pre-demodulation noise, hence leading to an equivalent thermal noise increase of 0.5 dB (referred to as "C/N degradation").

The tests involved the measurement of the increase in mean BER caused by the introduction of the interferer for a given constant value of the C/N ratio (Carrier-to-thermal noise power ratio), set to give a BER of 1×10^{-6} in the absence of interference (5.4 dB for 64 kbit/s carriers). The measured increase in mean BER was converted into an equivalent thermal noise increase using the back-to-back modem noise performance curve.

The measurements thus provide a relationship between the C/I (ratio of the SCPC carrier power to the total carrier power of the interfering TV signal) and the degradation of the C/N in the SCPC channel caused by the presence of the TV interference as single source interference (modulated by EDS only).

Results using the two above-mentioned models agree well and lead to the following single entry interference criterion which can be used for intersystem coordination purposes:

$$C/I \text{ (dB)} = C/N + 9.4 + 3.5 \log \delta - 6 \log (i/10) \quad (2)$$

where

C/N: is the carrier-to-noise ratio which corresponds to a BER of 1×10^{-6} ;

i: is the total allowed interference power in the carrier bandwidth expressed as a percentage of the total pre-demodulation noise power ($10 \leq i \leq 25$, as defined in Recommendation 523).

From the results obtained with the two models used for the measurements, it can be observed that, for 64 kbit/s carriers, the interference due to a TV signal with EDS only represents the predominant source of interference as compared to the noise-like interference. It can be shown, in particular, that the two interference models provide for an equal apportionment of the aggregated interference power (for $i = 20\%$, this translates into a 0.5 dB C/N degradation due to the ED dispersed TV carrier).

Measurements using "live material" modulating the interfering TV carrier have also been carried out for 64 kbit/s, in order to determine the C/I which would lead to fixed levels of degradation of the carrier-to-noise ratio. The tests were conducted with a TV modulator sensitivity of 22 MHz/V and 1 MHz peak-to-peak energy dispersal. The results are shown in Figure 3. In this figure the necessary C/I for a 64 kbit/s channel, that gives rise to a stated degradation, are given as a function of frequency offset for "live material" interference. When the interferer with SCPC carrier falls within the energy dispersal bandwidth of the TV carrier, equation (2) applies. When the SCPC carrier is outside the energy dispersal bandwidth, curves of the type shown in Figure 3 apply.

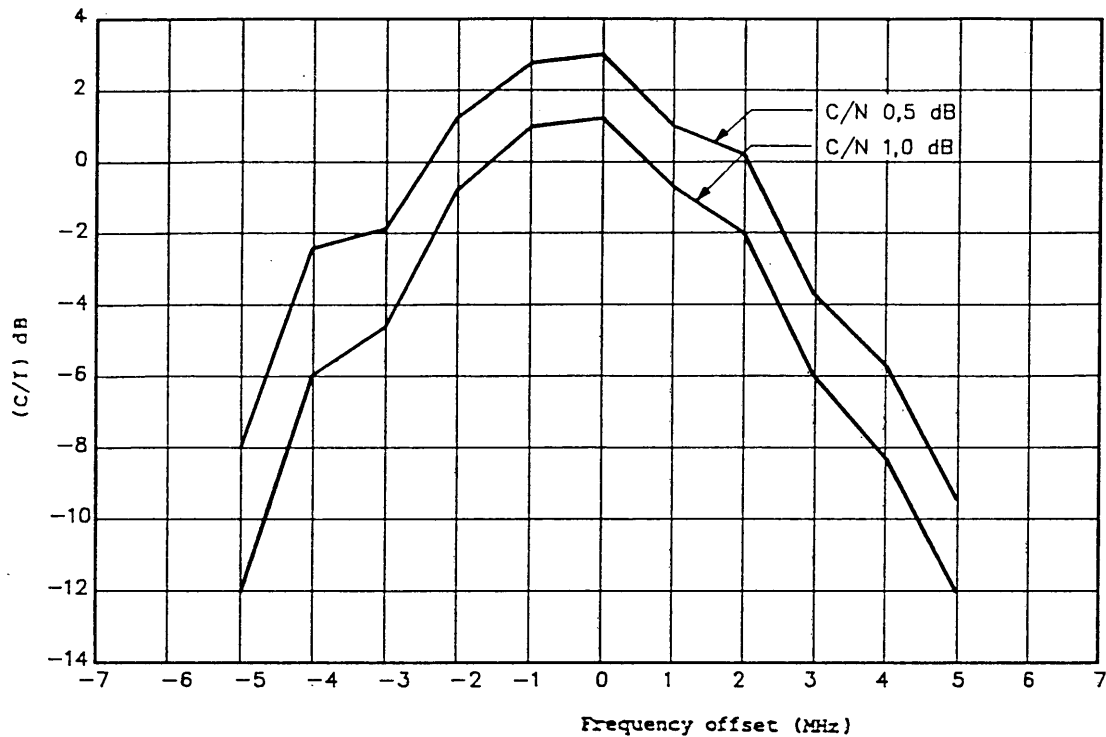

Bit rate = 68.27 kbit/s
 Live Material
 1 MHz p-p E.D.
 Modulator sensitivity = 22 MHz/v
 Operating C/N = 5.4 dB

FIGURE 3

C/I required for given degradation of C/N
 as a function of frequency offset

3.2 Measurements into higher bit rate carriers

Measurements have also been performed using higher bit rate carriers and two different rates of FEC encoding (Rate 1/2 and Rate 3/4).

For the interference model described in section 2, where a variable apportionment of the interference margin is made between noise-like interferers and the ED modulated TV interferer, the average interfering noise-like spectral density over the occupied bandwidth has been measured to be -66 dBc/Hz for 1536 kbit/s IBS, -65.2 dBc/Hz for 1544 kbit/s IDR and -65.7 dBc/Hz for 2048 kbit/s IDR.

The measurements resulted in curves of C/I versus degradation for BER values of 10^{-6} , 10^{-7} and 10^{-8} [CCIR, 1986-1990c].

Figures 4 and 5 show the C/I values required for $i = 15\%$ and $i = 25\%$ for a BER value of 1×10^{-7} .

A best fit to the measurement results obtained by using this model, has been found to be:

$$C/I = 9 + E_b/N_o + 3 \log \delta + 3.5 \log (R_i/64) - 8 \log (i/10) \text{ (dB)}, (\delta \leq 1) \quad (3)$$

$$C/I = 9 + E_b/N_o + 3.5 \log (R_i/64) - 8 \log (i/10) \text{ (dB)}, (\delta \geq 1) \quad (4)$$

where

E_b/N_o	=	operating energy per bit to noise density ratio which corresponds to a specified BER (dB)
δ	=	(QPSK occupied bandwidth)/(EDS peak-to-peak deviation)
R_i	=	information data in kbit/s rate not including FEC ($R_i \leq 2048$ kbit/s)
i	=	percentage of total pre-demodulation noise power contributed by interference ($10 \leq i \leq 25$)

For the interference model described in section 3.1, where a given percentage of the pre-demodulation interference power is allocated to the interference from the TV signal, measurements have been performed both for ED only modulation and "live material" modulation.

The tests were made using EUTELSAT 2 Mbit/s SMS carriers. carriers.

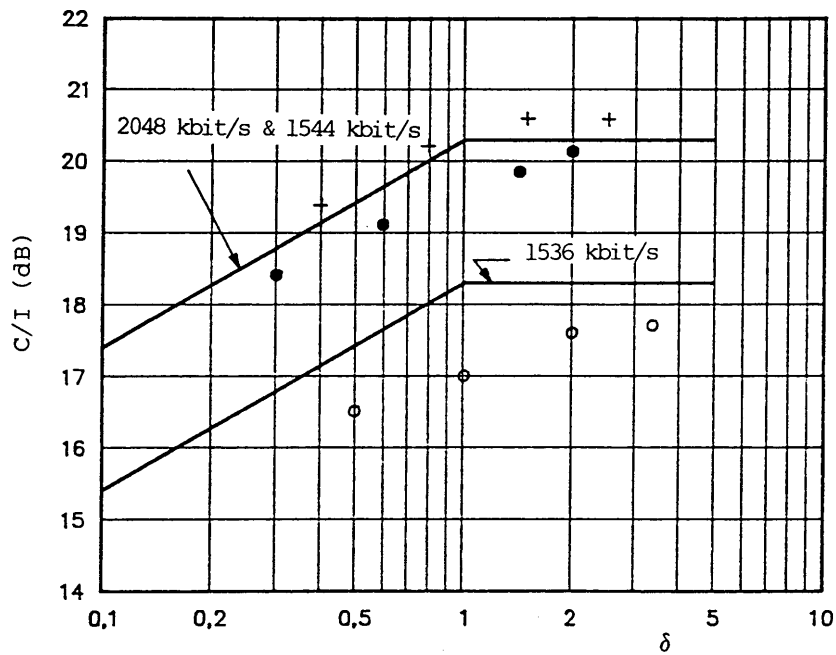

measured data
 + = 2048 kbit/s
 ● = 1544 kbit/s
 ○ = 1536 kbit/s
 — Criteria

FIGURE 4

C/I Vs duty cycle for i = 15%
BER = 10⁻⁷

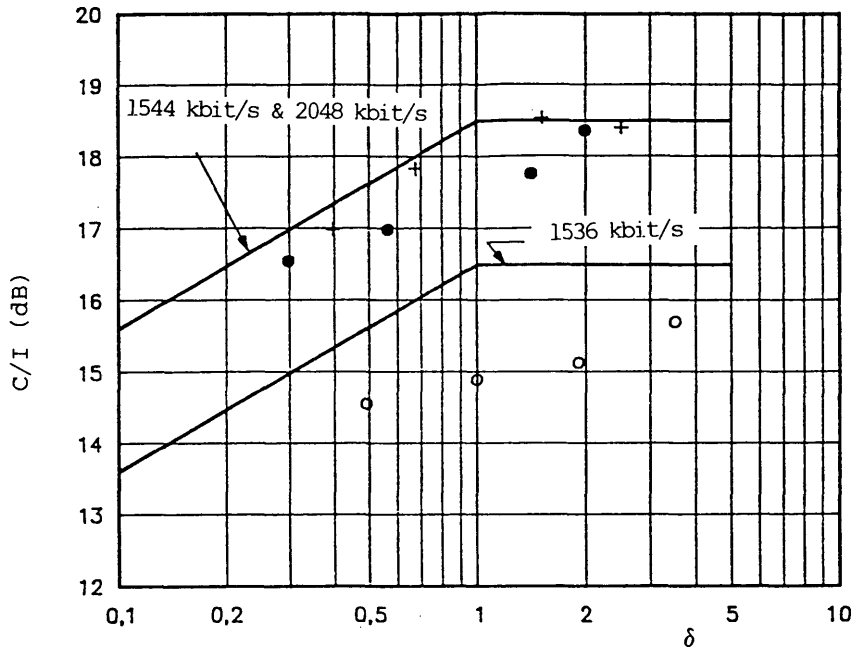

measured data

- O = 1536 kbit/s
- = 1544 kbit/s
- + = 2048 kbit/s

— Criteria

FIGURE 5

C/I Vs duty cycle for $i = 25\%$
BER = 10^{-7}

The second interference model with a fixed apportionment for the effect of the TV carrier interference equal to 10% as described in section 3.1 was also used to determine the C/I values required to obtain the given values of C/N degradation.

The carrier-to-interference noise ratio derived from the results of measurements is given by:

$$C/I = C/N + 9 + 3.5 \log \delta - 8 \log i/10 \quad \delta \leq 3 \tag{5}$$

$$C/I = C/N + 9 - 8 \log (i/10) \quad \delta \geq 3 \tag{6}$$

where

C/N: is the carrier-to-noise ratio which produces a BER of 10^{-6} ;

i: is the pre-demodulation interference power in the victim carrier bandwidth as a percentage of the pre-demodulation noise power (e.g 10% for an C/N degradation of 0.5 dB and 20% for an C/N degradation of 1 dB);

δ : victim carrier occupied bandwidth
EDS peak-to-peak deviation

Measurements using "live material" modulation on the interfering TV carrier have also been carried out for 2 Mbit/s, and where TV carrier was the sole source of interference, in order to determine the C/I which would lead to fixed levels of degradation of the carrier-to-noise ratio. The tests were conducted with a TV modulator sensitivity of 22 MHz/V and 1 MHz peak-to-peak energy dispersal. The results are shown in Figure 6. In this figure, the necessary C/I for a 2 Mbit/s channel, that gives rise to a stated degradation, is given as a function of frequency offset for "live material" interference.

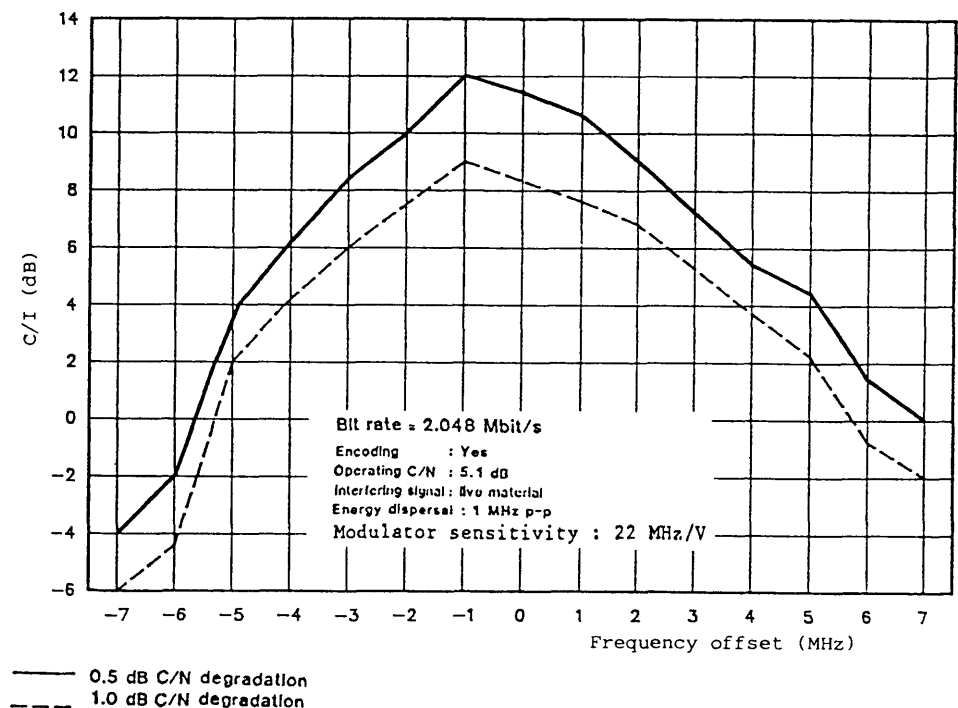

FIGURE 6

C/I required for given degradation of C/N as a function of frequency offset

4. Interference into low bit rate digital single-channel-per-carrier transmissions

Owing to the extensive use of satellite SCPC transmissions for business applications, many examples exist of systems which operate at bit rates lower than 64 kbit/s. The sensitivity of this type of carrier to the interference created by FM-TV transmission has been analysed for a typical VSAT system with the following characteristics:

- information rate: 19.2 kbit/s;
- FEC: convolutional of rate 1/2 with soft decision Viterbi decoding;
- modulation BPSK;

Tests have been conducted with various interfering signals:

- a CW signal with frame rate energy dispersal using various peak to peak deviations of the dispersion signal;
- live material;
- SECAM , S=22 MHz/V, 1 MHz peak-to-peak energy dispersal;
- PAL, S=25 MHz/V, 2 MHz peak-to-peak energy dispersal.

Fig. 7 gives a comparison of the sensitivity of a 64 kbit/s QPSK carrier and of the 19.2 kbit/s BPSK carrier to CW interference. The curves give the necessary C/I for limiting the C/N degradation to 1 dB, as a function of the duty cycle.

Fig. 7 shows that a low bit rate carrier at 19.2 kbit/s is less sensitive than a 64 kbit/s carrier to the dispersed CW interference and that the difference in the necessary C/I increases with decreasing values of .

In fact if the sensitivity was the same at the two bit rates, then under the same conditions of duty cycle, which is related to the time the sweeping carrier remains within the interfered-with bandwidth, the C/I required at 19.2 kbit/s would be only 3 dB less than the C/I required at 64 kbit/s because the modulation is BPSK and not QPSK. In practice the C/I required to protect a 19.2 kbit/s carrier is less than this difference.

One possible explanation to this phenomenon is the advantage brought about by the memory of the convolutional code. As the sweeping frequency of the interfering carrier remains constant and equal to the frame rate, there are much fewer bits which suffer from interference at each sweep in the case of a 19.2 kbit/s signal interfered with by a 2 MHz peak-to-peak signal (15 bits) than is the case for a 64 kbit/s signal interfered with by a 4 MHz peak-to-peak energy dispersal carrier (47 bits), although the duty cycle is around 0.02 in both cases. It can be considered that this is the result of the memory introduced in the message by the convolution operation at the transmit end, which results in a smaller number of bits being affected by the interference with the consequence that the digital transmission is more resistant.

The phenomenon is even more marked for $\delta = 0.01$ where only 7 bits are affected by the interferer during each sweep. Further studies and measurements could bring useful clarifications.

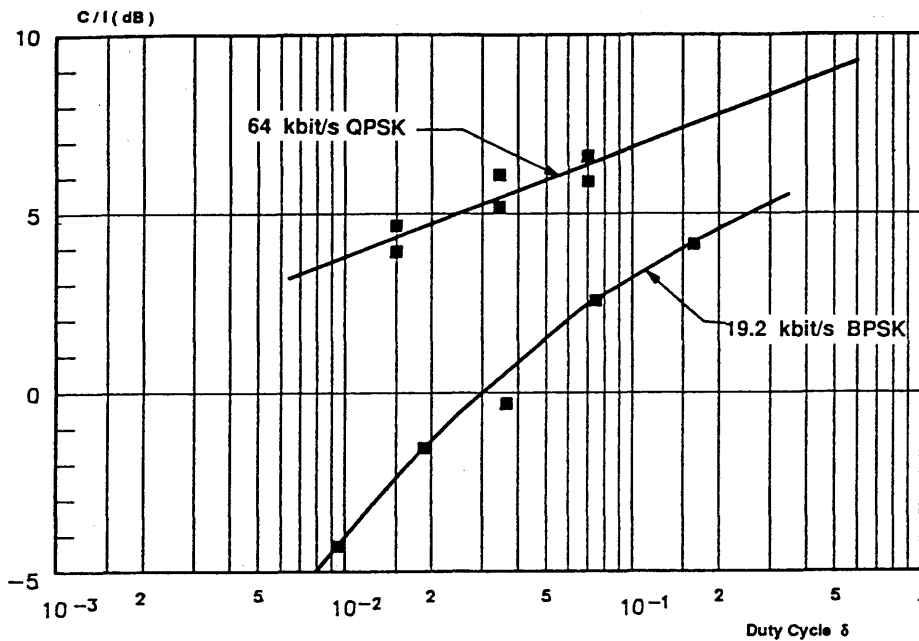
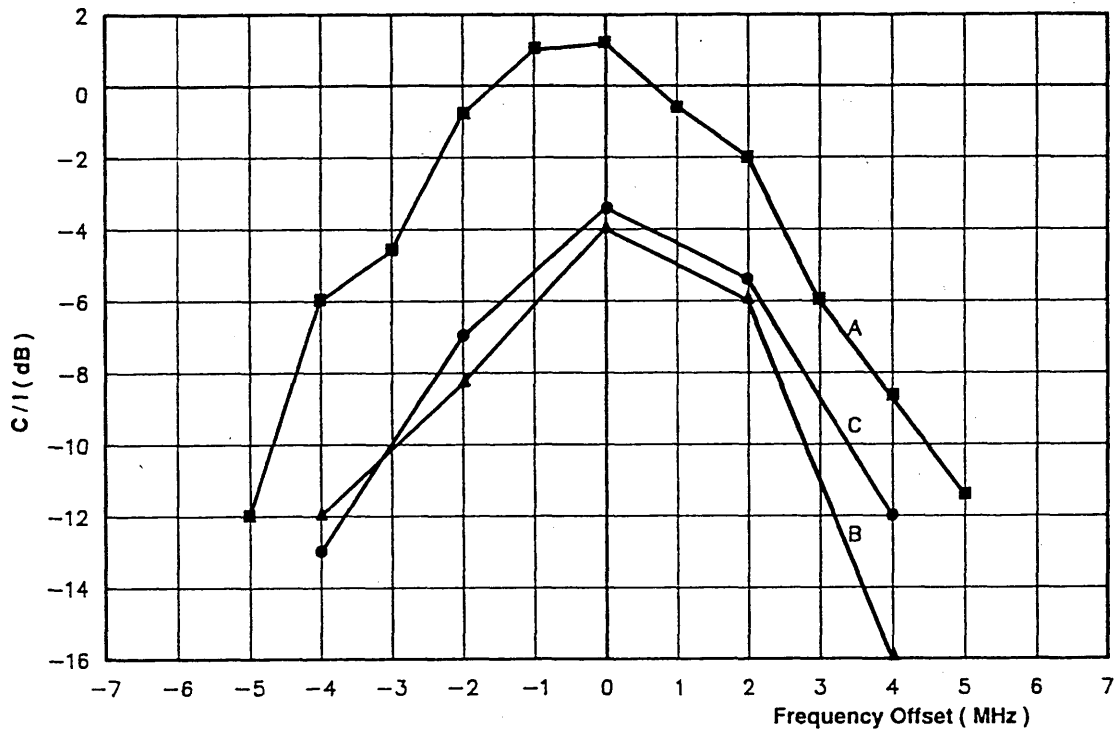

Figure 7 - C/I which causes a C/N degradation of 1 dB at BER of 10^{-6} as a function of the duty cycle

Fig. 8 gives results of measurements with live material interference, and compares them with those obtained with the 64 kbit/s signal. With this type of interferer (live material) the lower rate transmissions appear to be relatively more sensitive than the 64 kbit/s signals.

In fact if the two signals had the same sensitivity, then the curves measured at 19.2 kbit/s could be obtained by scaling down the measured curves at 64 kbit/s by 8.5 dB, of which 3 dB are due to the difference in the modulation scheme (BPSK, QPSK) and 5.5 dB are due to the difference in bandwidth of the modulated signals. In practice the C/I required to protect a 19.2 kbit/s carrier for various frequency offsets (with respect to the interfering carrier frequency) is larger than that which results from the simple rescaling.

However, although the low bit rate carriers are more sensitive to interference in the case of live material modulation, the C/I's required in that situation are still lower than in the case of a sweeping interfering carrier which represents the most constraining case.



Curve A : Bit Rate = 68.27 kbit/s, QPSK

Curve B : Bit Rate = 19.2 kbit/s, BPSK

Curve C : Bit Rate = 19.2 kbit/s, BPSK

Live Material Interference, SECAM
1 MHz p-p E.D.
Modulator Sensitivity = 22 MHz/V

Live Material Interference, SECAM
1 MHz p-p E.D.
Modulator Sensitivity = 22 MHz/V

Live Material Interference, PAL
2 MHz p-p E.D.
Modulator Sensitivity = 25 MHz/V

Figure 8 - C/I required for 1 dB degradation of C/N as a function of frequency offset

5. Live material TV Interference into 56 kbit/s and 1.544 Mbit/s Digital Carriers

In order to quantify the interference impact of FM Analogue TV carriers on low data rate digital QPSK carriers, a series of measurements were made using a test sequence to simulate live video material. This test sequence was developed to simulate the statistical behavior of live M-NTSC FM-TV as measured in bandwidths of 30 kHz and 1 MHz. A comparison of the long term average BER induced by the two types of signals verified that this test sequence represented a good approximation to the interference caused by live video. A BER of less than 10^{-6} in two consecutive 10^8 bit blocks was the objective for determining the C/I threshold for each frequency offset.

A series of measurements were made without introducing thermal noise to determine the threshold performance in the presence of high levels of interference as a function of frequency offset and peak video deviation. Higher C/I levels will be required on satellite links to allow for thermal link noise. For example, if the single entry interference objective is 4% of the total noise, the C/I ratios required would be 14 dB above the threshold value. Further study is required to determine the C/I required for a specific C/N degradation.

The results of these measurements were used to construct the threshold C/I video masks shown in Figures 9, 10 and 11. Figure 9 is the threshold mask for a 56 kbit/s unencoded QPSK carrier, Figure 10 represents a 56 kbit/s 7/8 rate FEC encoded QPSK carrier. Figure 11 is the threshold mask for a 1.544 Mbit/s 7/8 rate FEC encoded QPSK carrier.

The peak M-NTSC video deviations used are shown on the Figures 8, 9 and 10. In all cases, the baseband video signal included a 2.1 MHz peak-to-peak triangular frame rate energy dispersal signal and two audio subcarriers. One subcarrier at 6.2 MHz was unmodulated, the second subcarrier at 6.8 MHz was modulated with program audio.

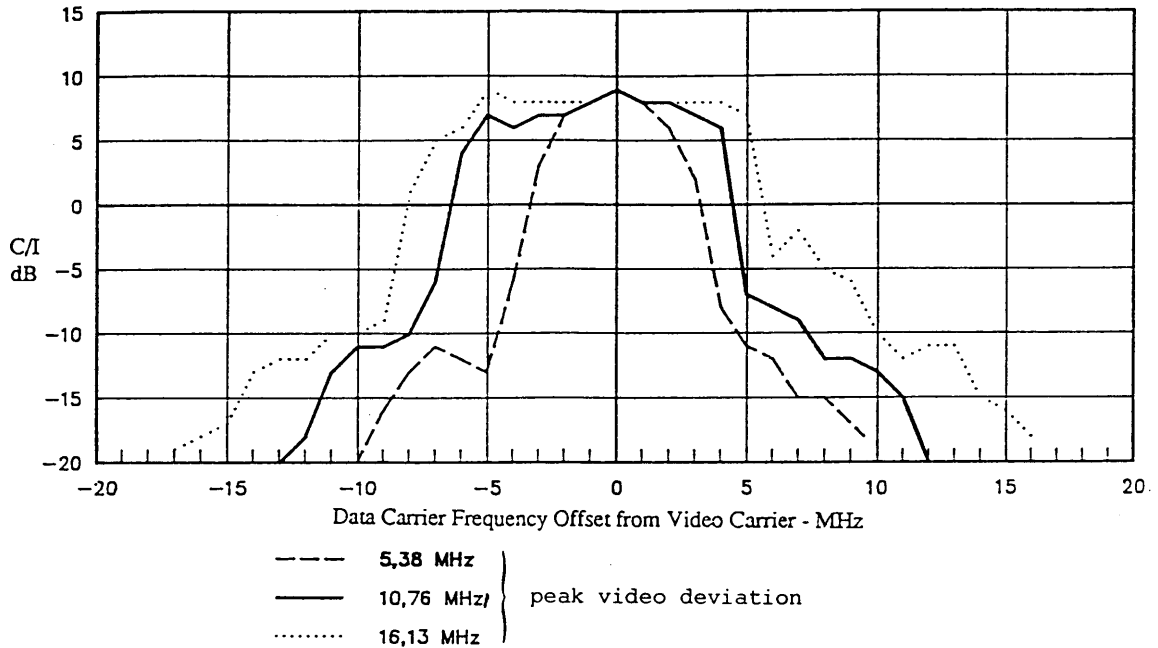

Figure 9

Threshold C/I Ratio for a BER $<10^{-6}$ for an uncoded 56 kbit/s carrier as a function of the Data Carrier Frequency Offset and Peak Video Deviation

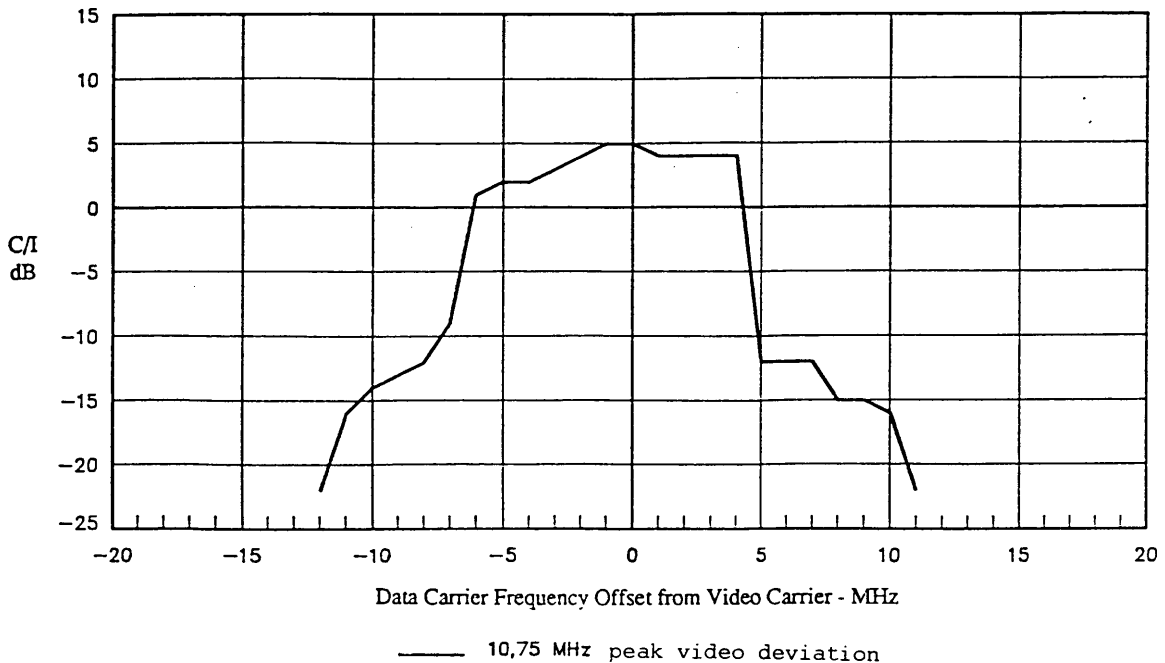

Figure 10

Threshold C/I Ratio for a BER $<10^{-6}$ for a 7/8 rate FEC encoded 56 kbit/s carrier as a function of the Data Carrier Frequency Offset

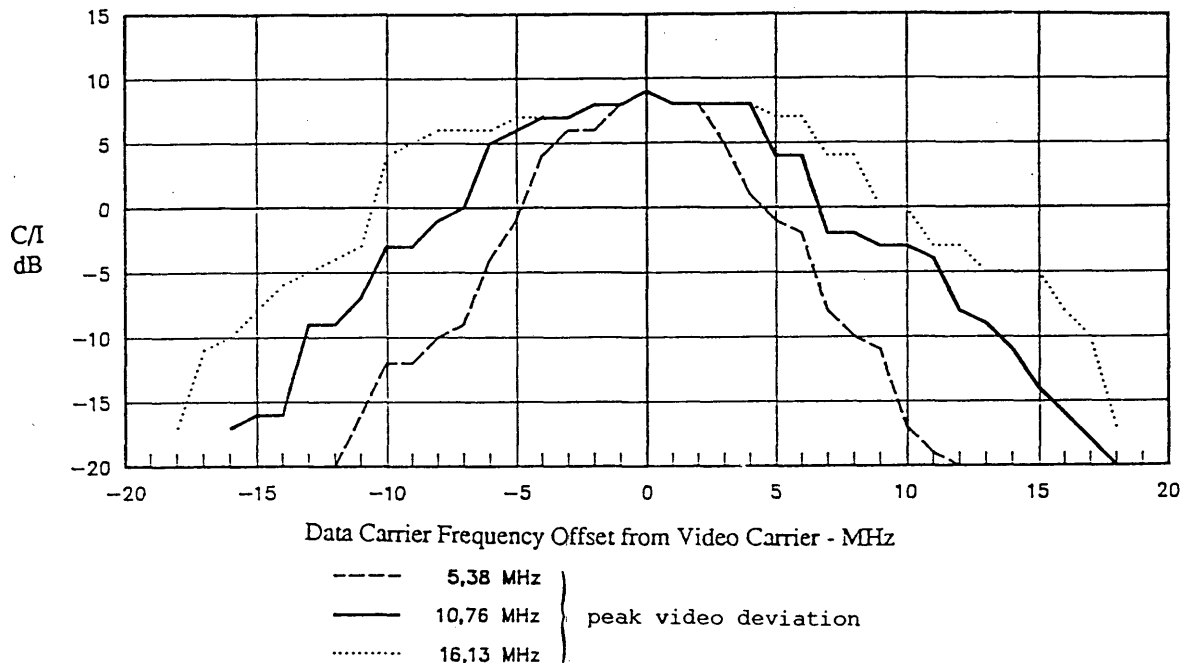

Figure 11

Threshold C/I Ratio for a BER $<10^{-6}$ for a 1.544 Mbit/s 7/8 Rate encoded carrier as a function of the Data Carrier Frequency Offset and Peak Video Deviation

6. Other measurements

Measurements have been reported by various sources [CCIR, 1986-90] on the isolation required between an interfering TV signal and a 64 kbit/s PCM/QPSK transmission. The interfered-with transmission was operated at a C/N ratio 1 dB above that required to produce a 10^{-6} BER. Thermal noise was introduced to degrade the C/N by 0.5 dB, and then the dispersed interfering carrier was added and adjusted to a level which restored the 10^{-6} BER in the interfered-with transmission.

This arrangement corresponds to an interference model in which total interference is about equivalent to 20% of the pre-demodulation noise, of which 10% is caused by thermal noise-like interference. As in the previously described interference model, a single energy-dispersed carrier entry is assumed to represent all such entries, each of which would be in the dispersed-only state for only a small fraction of the time, and all such fractions temporarily uncorrelated; hence, not additive in the interference level domain.

The QPSK modem was operated with and without rate 1/2 convolutional FEC encoding, and the TV interference was represented by a carrier with variable frame rate energy dispersal, but no other modulation. The peak-to-peak ED was varied between 0.5 and 4 MHz, and was removed for one set of measurements. The noise bandwidth of the QPSK demodulator was 69 kHz and the C/N ratios required to produce a 10^{-6} BER in the absence of interference were about 5.6 dB for the encoded case and about 14.5 dB for the unencoded case.

The measurement results for the unencoded case are similar to those presented in the preceding section; the results for the rate 1/2 FEC case are shown in Figure 12.

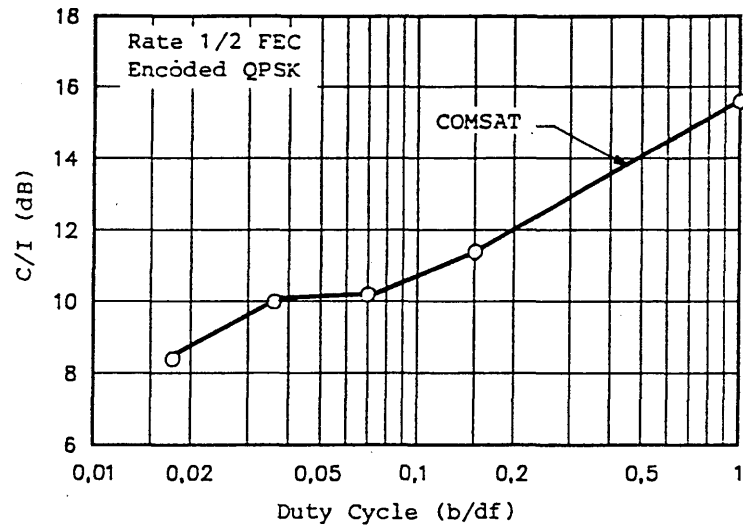

FIGURE 12

Required wanted-to-unwanted carrier ratio versus duty cycle to protect a rate 1/2 FEC encoded FCM/QPSK transmission against analogue FM/TV with only frame-rate energy dispersal. Measured for a degradation of 0.5 dB

7. The effect of line-rate dispersal

As suggested by Weinberger [1977] an increase of the dispersal frequency of the order of the line rate (about 16 kHz) should produce significant improvements in the effectiveness of energy dispersal as a means to reduce interference into SCPC transmissions.

Measurements [Yam, 1980] have confirmed this. These measurements were made with a sawtooth dispersal waveform at the line rate, and with a triangular dispersal waveform at one-half of the line rate. The peak-to-peak dispersal deviation Δf was varied from 0.25 MHz ($\delta = 0.15$) to 2 MHz ($\delta = 0.02$). The permissible increase in interfering RF power relative to that for frame-rate dispersal depended only slightly on the amount of thermal noise present, but rose fairly steeply with decreasing duty cycle. At $\Delta f = 0.25$ MHz the improvement amounted to about 2 dB, at 0.5 MHz to about 5 dB, and at 2 MHz to about 11 dB.

The results of more recent measurements of the effect of line-rate dispersal on FM television interference into PCM-PSK-SCPC transmissions are given in Report 384, § 6 and Figs. 4, 5 and 6.

The use of a line frequency dispersal waveform will result in a level of interference to satellite multi-channel telephone circuits and terrestrial radio-relay circuits up to 6 dB higher than would be caused by a low frequency dispersal signal frame frequency or less. The effect of this additional impairment would depend on the parameters of the systems concerned. See Report 384.

8. Interference in FM-SCPC Transmissions using syllabic companding

Using the procedure outlined in Section 2 of [CCIR, 1986-1990b] protection criteria have been developed for SCPC/CFM using two distinct bases for the criteria: (a) impulse noise counts above a threshold of -21 dBm0 and (b) subjective evaluations. The modem employed was designed to operate in the INTELSAT system in accordance with INTELSAT performance specifications for its VISTA service. The carrier-to-noise density C/N_0 at the normal operating point is 54.2 dB(Hz) which corresponds to a C/N of 10.2 dB. The threshold of this equipment is approximately a C/N_0 of 50.2 dB(Hz). The nominal IF noise bandwidth is 25 kHz with the deviation established such that for a 0 dBm0 test tone at 1 kHz the corresponding rms deviation is 5.1 kHz. The pre-emphasis cross-over frequency is at 1 kHz. The companding is 2:1 syllabic according to CCITT Recommendation G.162 with an unaffected level of 0 dBm0.

For the impulse count measurements, a threshold value of -21 dBm0 was used in accordance with CCITT Recommendation M.1020. The test instrument used for the impulse counts employed a 1 kHz tone at the transmit side which was removed by a notch filter at the receive side. The level of this tone was -10 dBm0. Degradations to the C/N, for this tone level and with the compander on, for the case of 6 impulses per 15 minutes, were measured as a function of the C/I ratios.

These results are shown in Figure 13 where C/I versus the degradation to the C/N is shown for the four values of energy dispersal peak-to-peak deviations. The calculated noise-like interference curve is shown in Figure 14 from which the protection criterion is derived:

$$C/I = 13.5 + 2 \log \delta - 3 \log (i/10) \quad (\text{dB}) \quad (7)$$

where

δ and i are as defined above.

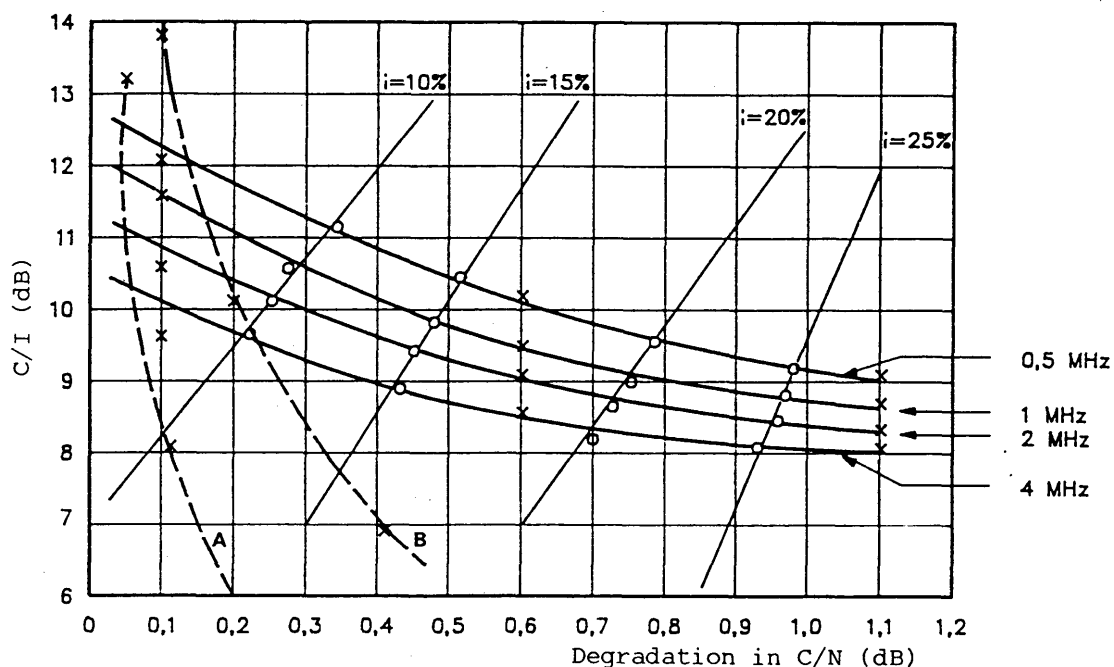

- A: C/I_{snl} (carrier to single entry noise-like interference ratio)
 B: C/I_{nl} (carrier to noise-like interference ratio)

Figure 13 - C/I Vs Degradation in C/N for a SCPC/CFM Modem based upon impulse noise counts (a constant impulse count criterion of 6 counts exceeding a threshold of -21 dBm0 in 15 min. interval was used)

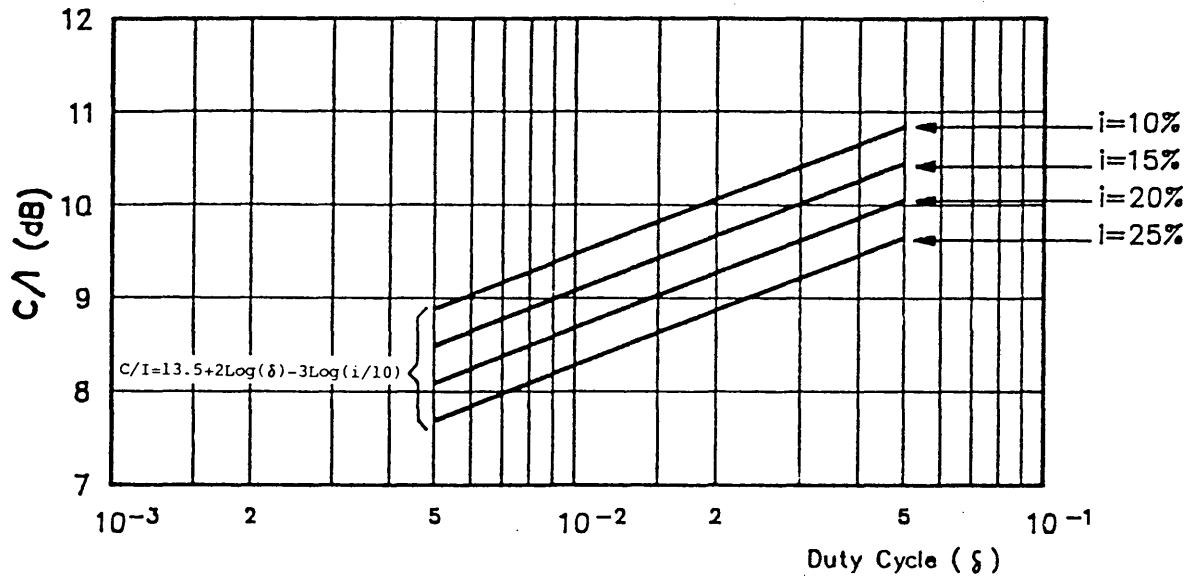

$$\delta = \frac{\text{SCPC bandwidth}}{\text{p-p deviation by EDS of interfering TV carrier}}$$

Figure 14 - C/I Vs Duty Cycle based upon impulse noise count for a SCPC/CFM modem

In the same way, subjective assessments of the degradation to the SCPC/CFM channel were made with a criterion based upon 1 audible "pop" per minute. The characteristic interference on the EDS at or near the nominal 54.2 dB(Hz) operating point is observed in the form of impulsive noise or "pops". These results are shown in Figure 15. The resulting criteria are of the form

$$C/I = 13 + 2 \log \delta - 3 \log (i/10) \quad (\text{dB}) \quad (8)$$

as shown in Figure 16 and are slightly lower than those based on impulse counts. Comparing Equations (7) and (8), it is concluded that the criterion of Equation (7) should be used as a single criterion for SCPC/CFM for both impulse count and subjective impairments, and is graphically shown in Figure 14.

9. Delta modulation

Certain systems may be implemented with delta modulation SCPC. Delta modulation is inherently less sensitive to interference than PCM-PSK-SCPC. This is due to the fact that bit errors caused by interference at the output of the PSK demodulator do not cause significant level variations in the delta modulated signals as they do in a PCM-PSK signal.

It should be noted that both delta modulation and companded-FM modulated SCPC transmissions require lower power signals than PCM-PSK-SCPC transmissions. This will tend to negate some of the advantage derivable from the reduced interference sensitivity relative to that of PCM-PSK-SCPC.

Further studies and measurements in the general area of interference to SCPC transmissions from artificially dispersed TV transmissions are required before definitive criteria can be adopted.

10. Use of digital TV transmissions

Efforts are under way in many countries to develop standardized digital TV signal formats and equipment for digital TV codecs with bit rates of 45 Mbit/s and 68 Mbit/s. The latter are already commercially available for use in terrestrial links. A 15 Mbit/s/30 Mbit/s codec is also under development and could be available in the near future.

The use of digital transmission will significantly alleviate the carrier inhomogeneity problem, because these signals appear as noise-like interference into an SCPC carrier. An example is shown in Figure 16 which is based on the results of an experimental study [Yam, 1980] performed to assess the interference potential of digital TV with respect to an SCPC/QPSK carrier. According to these results, the interference potential of the selected digital TV is 9 dB lower than that of TV/FM with line-rate energy dispersal, or 18 dB lower than that of TV/FM with frame-rate energy dispersal technique.

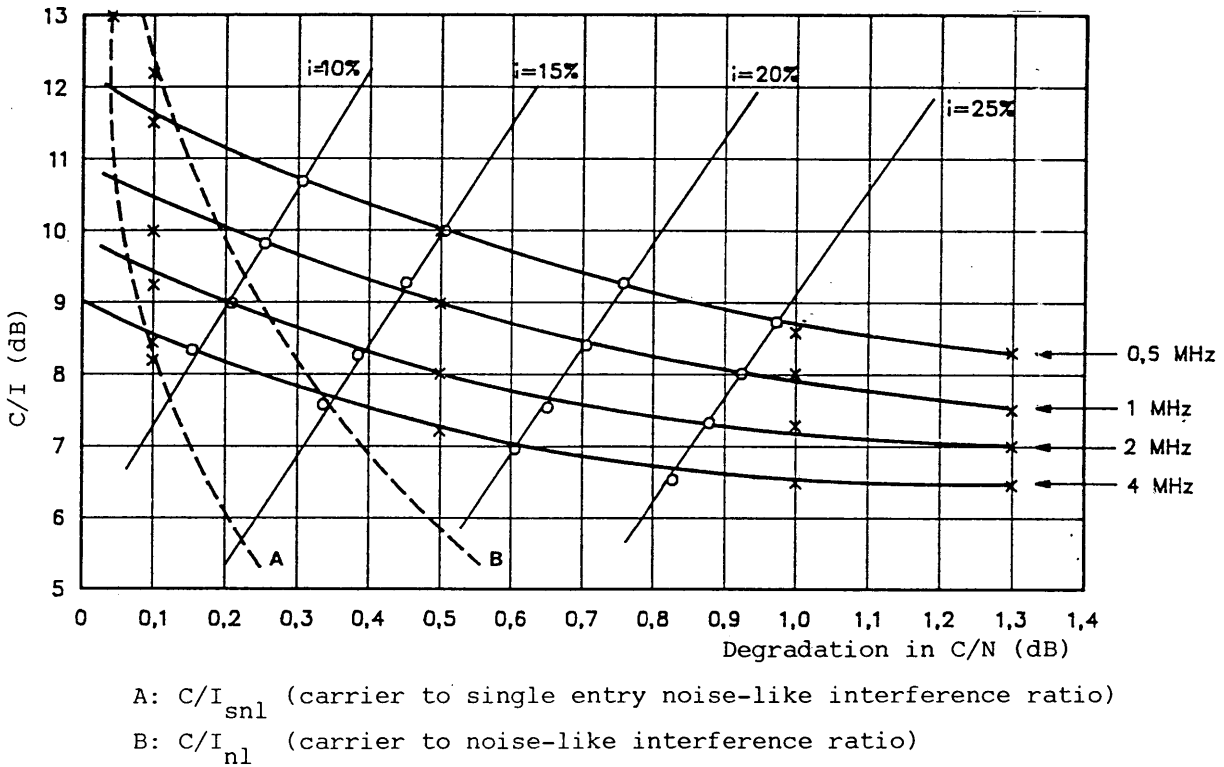

Figure 15 - C/I Vs Degradation in C/N for a SCPC/CFM Modem based upon subjective evaluation (1 pop/minute)

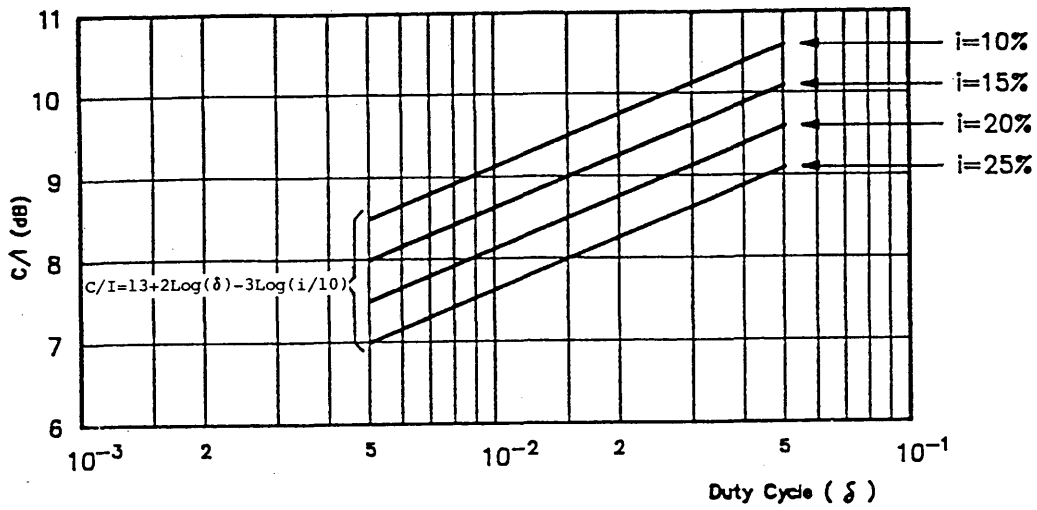
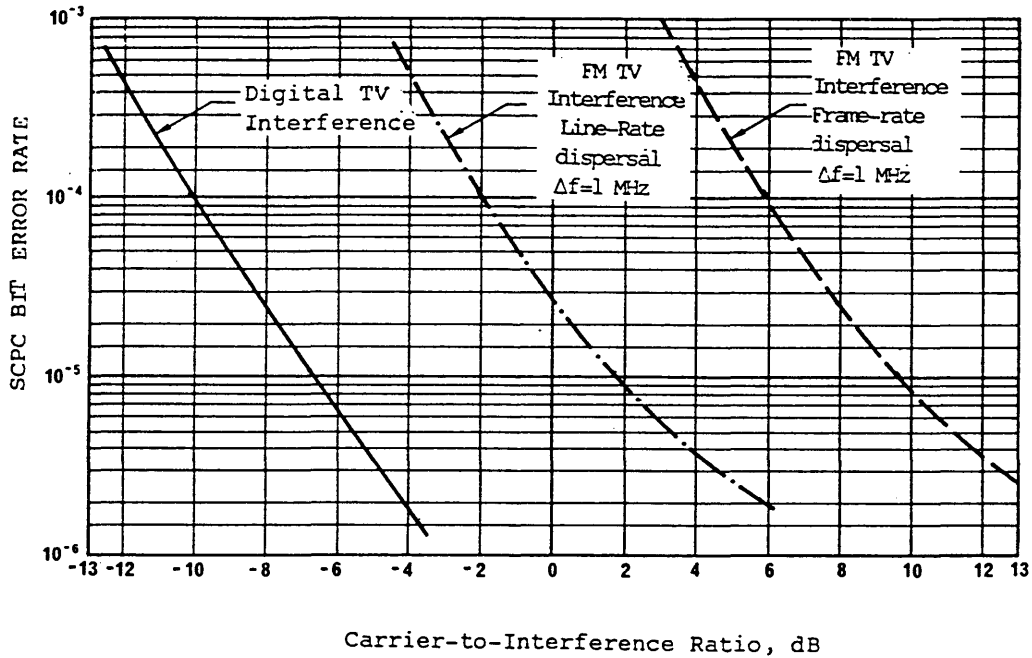

Figure 16 - C/I Vs Duty Cycle based upon subjective evaluation of a SCPC/CFM Modem (1 pop/min)



Parameters of Digital TV Carrier

Bit rate = 43 Mbit/s
 Bandwidth = 25.8 MHz

SCPC/PSK

(C/N) = 15 dB

FIGURE 17

SCPC BER vs C/I for C/N = 15 dB

11. Summary and conclusions

Further work is urgently needed on the subject of interference criteria into intermediate bit rate digital carrier transmissions. This work should include the effects on such systems using all types of modulation techniques, as well as the effects of other types of energy dispersal techniques.

Further studies and practical tests are also needed:

- to develop interference criteria for TV signals carrying "live programme" material:
- to investigate differences (if any) when TV carriers encoded in other formats than NTSC, SECAM, and PAL are used as the interfering signals.
- to identify means of using the line-rate energy dispersal technique in ways that do not increase interference into low-deviation terrestrial or satellite, FDM-FM transmissions:
- to investigate the use of composite line-rate and frame-rate dispersal techniques as a potential means of reducing interference effects into both SCPC and low deviation terrestrial or satellite FDM-FM transmissions;
- to demonstrate techniques, appropriate to the various possible applications of line-rate energy dispersal, and composite line-rate and frame-rate dispersal, for removing the dispersal waveform from the video signal without degradation of the signal quality.

It should also be noted that there may be practical difficulties in implementing line rate energy dispersal in feeder links to broadcasting satellites, since this would involve relatively complex equipment to remove the dispersal signals at domestic receiving terminals(see Report 384).

REFERENCES

DUTRONC, J., FREIXE, J.M., PROUSE, D. and COOKE, R. [1986] - FM/TV interference into Rate 1/2 encoded SCPC/QPSK, *Int. Journal of Sat. Com.*, Vol. 4 (1986).

WEINBERGER, H. K. [1977] TV energy dispersal waveform. IEEE National Telecommunications Conference (NTC '77). Conf. Rec. 41:1-1-41:1-3.

YAM, S. E. [Spring, 1980] New energy dispersal techniques for interference reduction. *COMSAT Tech. Rev.*, Vol. 10, 1, 103-150.

CCIR Documents

[1978-82]: a. 4/156 (INTELSAT); b. 4/157 (INTELSAT).

[1986-1990]: a. 4/43 (United States); b. IWP 4/1 - 1533 (INTELSAT); c. 4/287 (INTELSAT).

REPORT 1001-1

**OFF-AXIS e.i.r.p. DENSITY LIMITS
FOR FIXED-SATELLITE SERVICE EARTH STATIONS**

(Study Programme 28A/4)

(1986-1990)

1. Introduction

Interference from an earth-station transmitter into the satellite receivers of other networks can be related directly to the off-axis spectral e.i.r.p. density of the interfering earth-station antenna. This is a function not only of the earth-station antenna side-lobe performance but also depends on the transmitter power level and its spectral density which, in turn, will be influenced by the overall satellite system design.

The establishment of a recommended limit for off-axis spectral e.i.r.p. density can be approached from two viewpoints:

- limitation of the interference level entering another satellite taking particular account of interference to networks employing large earth-station antennas,
- determination of the on-axis e.i.r.p. requirements for earth stations, particularly those employing relatively small antennas and consideration of the on-axis and off-axis gain that such antennas could be expected to provide.

2. Consideration of an off-axis e.i.r.p. density limit for the 6 GHz band

An examination from both of the viewpoints mentioned above has led to the conclusion that the recommended limit should take the following form for up-link emission at about 6 GHz.

At any angle, φ , 2.5° or more off the main-lobe axis of an earth-station antenna, the e.i.r.p. per 4 kHz in any direction within 3° of the geostationary-satellite orbit should not exceed the following values:

<i>Angle off-axis</i>	<i>Maximum e.i.r.p./4 kHz</i>
$2.5^\circ \leq \varphi \leq 25^\circ$	$(E - 25 \log \varphi)$ dB(W/4 kHz)
$25^\circ < \varphi \leq 180^\circ$	$(E - 35)$ dB(W/4 kHz)

where the value of E should be within the range 32.0 to 38.5. The value of E should be as small as practicable, and will vary from one frequency band to another. For some satellite system applications, it may be desirable to develop an off-axis e.i.r.p. density limit by using a more stringent value of E (e.g. 32) in the near-in angular region (e.g. $\varphi \leq 7^\circ$) and then to relax the value of E at larger off-axis angles. This type of stepped limit would constrain the off-axis radiation in those angular regions where the value would be more effective in limiting interference to adjacent satellites.

From the viewpoint of tolerable interference into a satellite network with large station antennas, it may be noted that a value of 38.5 for E would permit a maximum e.i.r.p. density of 21.0 dB(W/4 kHz) to be radiated from an earth station at 5° off-axis.

From the viewpoint of the reasonable requirements of earth stations with small antennas, four cases that might be considered are:

Case 1: high density FM carrier – large station;

Case 2: FM-TV – small station (global satellite antenna);

Case 3: FM-TV – broadcast satellite up link;

Case 4: single-channel-per-carrier (SCPC) – narrow band.

Assuming the following,

- the satellite noise temperature ≤ 3000 K;
- the satellite antenna gain ≥ 16 dB;
- the earth-station antenna conforms to Recommendation 465 for off-axis angles less than 25° , but the side-lobe envelope has a constant level of -3 dBi beyond 25° ;
- $10 \log$ (earth station noise temperature) ≥ 19 .

(Values for the minimum power density at an off-axis angle of 5° are shown in Table I.)

TABLE I – Minimum off-axis e.i.r.p. density for typical carriers

	FDM-FM 1332 channels 36 MHz RF bandwidth	FM-TV	FM-TV broadcasting satellite up-link	SCPC global
Satellite G/T (dB(K ⁻¹))	-7	-17	0	-17
Up-link C/T (dB(W/K))	-125	-137	-134	-154
e.i.r.p. (dBW)	82	80	66	63
Earth station antenna transmit gain (dB)	60	53	46	53
RF power input to earth station antenna (dBW)	22	27	20	10
RF spectral power density input to earth station antenna (dB(W/4 kHz))	-8	0	-4	0
E_{5° (dB(W/4 kHz)) (1)	6.5	14.5	10.5	14.5

(1) Radiation at 5° assuming $32 - 25 \log \varphi$ relationship.

The worst interference would be from Case 2 where a 53 dB gain corresponds to a 10 m diameter antenna. The required transmitter power would be about 500 watts. With 27 dB (2 MHz) of spreading advantage, the nominal transmit power density would be 0 dB(W/4 kHz) resulting in an off-axis radiation of 14.5 dB(W/4 kHz) at 5° .

While Case 4 indicates a similar value for off-axis e.i.r.p. density radiations, other factors must be considered. Single-channel-per-carrier (SCPC) are low level carriers with a nominal earth station transmit level of 63.5 dB(W/channel). Since TV normally only has spreading at a slow rate (25 or 30 Hz), it is considered that the total carrier power must be considered as pulsed interference. In this case, at 5° the C/I would be 22 dB on the up link and 13 dB on the down link. While criteria for interference in these cases do not exist, an overall C/I of 20 dB has been adopted in some analyses for such pulsed interference. Recognizing the severe incompatibility of this situation, the conclusion is reached that adequate protection is not reasonably attainable by satellite separation nor by more severe e.i.r.p. restrictions since the down link is dominant. One solution is to restrict the uses of the two types of signals such that they would also be separated in frequency where the fixed-satellite service is involved on both up and down links. A second solution which might considerably relieve the problem noted above is a different method of carrier energy dispersal for television by transformation of the video signal as described in Annex II of Report 384.

Two examples from the Canadian TELESAT system [CCIR, 1974-78] show that at 6 GHz and an off-beam angle of 5° , a level of unwanted e.i.r.p. density in the approximate range 17-18 dB(W/4 kHz) is associated with single-channel-per-carrier transmissions from a 4 to 5 m diameter antenna and with TV transmissions from a 10 m diameter antenna.

As to Case 4, a study was made in Japan on the off-axis e.i.r.p. density per 4 kHz bandwidth for the SCPC-PSK carrier of the INTELSAT system and SCPC-FM and SCPC-PSK carriers of the MARISAT system [CCIR, 1978-82]. Based on the results of the above studies, it may be concluded that in the case of a transmission between Standard-B earth stations in the INTELSAT system, the worst value of off-axis e.i.r.p. density from the transmitting earth station is 6 dB higher than $35 - 25 \log \phi$ (dB(W/4 kHz)).

It should be noted that these figures are only an illustrative example of existing systems. In any event a Recommendation should not be tailored to a specific existing system but on the contrary future systems should be designed to meet the Recommendation in its final form.

Based on the foregoing, it is concluded that the utilization of the geostationary-satellite orbit at about 6 GHz could be protected, while permitting earth stations with antennas as small as 4 or 5 m in diameter to be used, by applying the following guidelines:

- care should be exercised in frequency planning to ensure that television transmissions in one network do not use the same frequencies as single-channel-per-carrier telephony transmissions in a network using a nearby satellite;
- in all other cases, earth stations should conform to the off-axis e.i.r.p. spectral density limits in the direction of the geostationary-satellite orbit indicated in the second paragraph of this section, the value of E lying within the range 32.0 to 38.5.

3. Consideration of off-axis e.i.r.p. density limit for the 10-15 GHz band

When considering an off-axis e.i.r.p. density limit at 10-15 GHz it is reasonable to assume that the satellite receive antenna will not normally provide wide angle coverage and on this account it may be possible to utilize lower earth-station e.i.r.p.s and hence lower levels of off-axis radiation than in the lower frequency bands. However, this may be counteracted by the fact that rain fading will be more severe.

3.1 Method of calculation of E

In general, the interference (I) from a transmitting earth station into an interfered-with space station ϕ° from the intended transmission is given by:

$$I = E - 25 \log \phi - L_{FS} - L_{CA} - L_R + G_S \quad (1)$$

where:

- E : constant to be determined for a limit formula related to a reference bandwidth,
- L_{FS} : free-space loss at the transmitting frequency,
- L_{CA} : clear-air attenuation,
- L_R : attenuation due to rain. (In the worst case $L_R = 0$, in clear-air conditions),
- G_S : gain of the antenna of the interfered-with satellite in the direction of the interfering earth station.

The single entry up-link interference, I , may be specified to be constrained to be equal to a fraction of the up-path thermal noise of the interfered-with space station. In that case:

$$I = 10 \log (kTB) - \Delta \quad (2)$$

where:

- Δ : thermal noise-to-interference power ratio,
- T : noise temperature at the satellite receiver input,
- B : bandwidth under consideration,
- k : Boltzmann's constant.

Then, in the worst case where $L_R = 0$:

$$E - 25 \log \phi = 10 \log kB + L_{FS} + L_{CA} - (G/T)_s - \Delta \quad (3)$$

where $(G/T)_s$: satellite figure of merit (dB(K⁻¹)).

If the free-space loss is 207 dB (14 GHz) and the clear-air attenuation is 0.5 dB this simplifies to:

$$E - 25 \log \phi = -21.1 - (G/T)_s + B - \Delta$$

Thus for given parameters ϕ , $(G/T)_s$, B and Δ , the parameter E which defines the permissible e.i.r.p. density form an earth station at angle ϕ° off-axis can be determined.

However, other factors should also be taken into account in choosing an off-axis limitation to the e.i.r.p. of emissions from transmitting earth stations in the 10-15 GHz bands. One such factor is the need to consider rain margins in the earth stations' e.i.r.p. budgets at these frequencies; another is that constraining the off-axis e.i.r.p. density values to certain limits may have a significant influence on the earth-station antenna diameter. An example of how antenna diameter varies with E for three different up-link rain margins is shown in Table IIa.

The impact on the parameter E of the need to take account of adverse propagation conditions, in a region of high rainfall (Brazil) is exemplified in Table IIb.

TABLE IIa - Required earth-station antenna diameters in an assumed television mode of operation to meet specified off-axis e.i.r.p. density values

E (dB(W/40 kHz))	Antenna diameter (m)		
	Rain margin 0 dB	Rain margin 3 dB	Rain margin 6 dB
33	12	17	24
36	8	12	17
39	6	8	12
42	4	6	8

Assumptions made in deriving Table IIa:

- TV carrier with 2 MHz peak-to-peak energy dispersal modulation only,
- reference bandwidth for E is 40 kHz,
- earth-station side-lobe gain given by $29 - 25 \log \phi$ (dBi),
- earth-station antenna efficiency 57-65%,
- 14 GHz operation,
- clear-air C/T required at satellite input is -127 dBW(K⁻¹),
- satellite G/T is -3 dB(K⁻¹).

TABLE IIb – Examples of the increase in off-axis e.i.r.p. density for systems designed to cope with large propagation fades

Carrier	E (dB(W/40 kHz))			
	(clear-sky model)		(deep-fade model)	
	A = 29	A = 32	A = 29	A = 32
TV-FM	26	29	36	39
4-PSK/60 Mbit/s	15	18	47	50
SCPC-PSK	16	19	48	51

Where earth-station side-lobe gain is $A = 25 \log \phi$ (dBi).

Assumptions made in deriving Table IIb:

- hypothetical (Brazilian) system with 2° half-power beamwidth,
- 60° earth-station elevation angle,
- rain attenuation model from Report 564,
- system availability 99.95%,
- 14 GHz operation.

3.2 Factors affecting E

In addition to the rain margin included in the interfering up-link design there are a number of variables which impact on the value of E for satellite services:

a) "Interfering" carrier type

Recognizing that, in transponders amplifying multiple FM carriers, power spectral density, and hence the interference potential, does not vary greatly between carriers of different capacity, consideration can perhaps be limited to cases in which a transponder carries the following signals:

- multiple FDM-FM carriers,
- multiple "high density" FDM-FM carriers,
- a single FDM-FM carrier,
- one PCM-PSK-TDMA carrier,
- SCPC PCM-PSK multiple carriers,
- FM-TV, single carrier, with 2 MHz carrier energy dispersal,
- SCPC FM multiple carriers.

The e.i.r.p. spectral density required for the up link of each of these carriers will further depend on whether it is destined for reception at large or small antenna receiving terminals.

b) "Interfered-with" carrier type

A similar range of cases as in a) above should be considered.

c) Interference objective

CCIR studies [1982-86a, b, c, d, e, f and g], have considered the possibility of increasing the interference allowance in the interest of decreasing satellite spacing.

d) Satellite spacing

In the frequency range 10-15 GHz, spacings of 3° for co-coverage satellites have been implemented, but increased demand for service has prompted consideration of 2° spacing in certain locations.

e) *"Interfered-with" satellite coverage area*

Satellite G/T values corresponding to typical regional and domestic coverages should be considered.

f) *"Interfering" earth station side-lobe gain characteristic*

As improved designs of earth-station antenna are brought into service, off-axis emissions will reduce.

g) *Rain margin included in the "interfered-with" up-link design*

Full consideration of all these factors would involve thousands of combinations, and a correspondingly wide range of E .

In deriving this list the assumption is made that the values of earth-station antenna diameter and transmitter power required to simultaneously meet the "wanted" up-link e.i.r.p. and the off-axis e.i.r.p. limit will be chosen. There may be circumstances where this is impractical, e.g. small transportable earth stations being used to provide short duration television up links from various locations in a satellite's coverage area.

Table III gives an example of the inter-relationship between parameter E and factors c) to f) inclusive. Both interfering and interfered-with carriers are frequency modulated by television signals and are assumed to be identical. Combinations of earth-station antenna size and transmitter power have been chosen which provide the required e.i.r.p. for the wanted carrier whilst just meeting the up-path interference objectives. (In the cases marked with an asterisk, larger antennas and lower transmitter powers would probably be chosen in practice, and in these circumstances the interference would be well within the prescribed limits.)

It should be noted that this example assumes two identical satellite systems. Wider variations in E and in the earth-station parameters would result from the inclusion of cases where the satellites in the interfering and interfered-with systems had different G/T values.

TABLE III.— Optimum E values and related parameters for FM-TV to FM-TV interference

Satellite G/T (dB(K ⁻¹))		-3				5			
Satellite spacing (degrees)		2		3		2		3	
Interference objective (% of up-path thermal noise)		20	50	20	50	20	50	20	50
Earth-station side-lobe gain 32 - 25 log ϕ	Antenna diameter (m)	10.7	6.8	6.4	4.1	26.9	17.1	16.2	10.3
	Transmitter power (W)	139	342	382	951	3.5	8.6	9.6	23.9
Earth-station side-lobe gain 29 - 25 log ϕ	Antenna diameter (m)	7.6	4.8	4.6	2.9*	19.0	12.1	11.5	7.3
	Transmitter power (W)	287	685	764	1 903*	7.0	17.2	19.2	47.8
Earth-station side-lobe gain 26 - 25 log ϕ	Antenna diameter (m)	5.3	3.4	3.2*	2.0*	13.4	8.5	8.1	5.1
	Transmitter power (W)	557	1 385	1 517*	3 794*	14.0	34.8	38.1	95.3
Off-axis e.i.r.p. parameter E (dB(W/40 kHz))		28.4	32.4	32.8	36.8	20.4	24.4	24.8	28.8

Assumptions made in deriving Table III:

- "interfering" and "interfered-with" earth-stations at 15° elevation,
- 14 GHz operation,
- satellite antenna gain the same for "interfering" and "interfered-with" up paths,
- earth-station antenna efficiency 65%,
- 3 dB rain attenuation on "interfered-with" up path only,
- up-path C/T of "interfered-with" TV carrier, -130 dBW(K⁻¹),
- modulation by energy dispersal signal only, 2 MHz peak-to-peak deviation.

3.3 *Values of E in current systems*

Tables IV and V show typical e.i.r.p. densities and E values generated by earth stations currently operating in INTELSAT, EUTELSAT and the United States domestic satellite systems, and also by small, transportable earth stations used for outside broadcasts in Europe (ENG).

Table VI shows earth-station e.i.r.p. densities which can be tolerated as up-path interference to typical INTELSAT and EUTELSAT carriers, assuming that the interfering earth station is within the receive coverage area of the interfered-with satellite. The calculations have been performed assuming single entry interference criteria of 600 pW0p for analogue carriers, and 4% of the total noise plus interference for a 10⁻⁶ bit error ratio for digital carriers.

Table IV - Off-axis e.i.r.p. densities produced by currently operating systems

Case	Transmission type	Satellite beam	Earth-station Standard (¹)	E (dB(W/40KHz))	
				29 - 25	32 - 25
				log ϕ	log ϕ
1	INTELSAT TV 2MHz pk-to-pk energy dispersal	East up 14/4 GHz (to Standard B)	C	26.5	29.5
2	EUTELSAT TV 2MHz pk-to-pk energy dispersal	Eurobeam	C	32.4	35.4
3	EUTELSAT TV 4MHz pk-to-pk energy dispersal	Eurobeam	C	29.4	32.4
4	INTELSAT FDM-FM high density 972 in 25 MHz	East up 14/4 GHz	C	30.4	33.4
5	EUTELSAT SMS 64 kbps (in 75 kHz)	SMS Beam	C	18.5	21.5
6	EUTELSAT SMS 64 kbps (in 75 kHz)	SMS Beam	E-1	33.0	36.0
7	EUTELSAT SMS 64 kbps (in 75 kHz)	SMS Beam	Eut3	36.3	N/A
8	INTELSAT IDMA	Not specified	C	19.4	22.4
9	EUTELSAT IDMA	Eurobeam	C	19.4	22.4
10	INTELSAT IDR 64 kbps in 51 kHz(3/4 FEC)	East up 14/4 GHz	E-2	29.4	32.4
11	INTELSAT IDR 2 Mbps in 1.7 MHz(3/4 FEC)	East up 14/4 GHz	E-2	30.6	33.4
12	INTELSAT IDR 8 Mbps in 6.8 MHz(3/4 FEC)	East up 14/4 GHz	C	19.3	22.3
13	INTELSAT FDM-FM 60 channels in 5 MHz	East up 14/4 GHz	C	18.4	21.4
14	INTELSAT FDM-FM 252 channels in 10 MHz	East up 14/4 GHz	C	24.8	27.8
15	INTELSAT IBS	14/12 GHz (to Standard E-1)	E-1	36.0	39.0 ⁽²⁾
16	INTELSAT IBS	14/12 GHz (to Standard E-2)	E-2	36.0	39.0 ⁽²⁾
17	INTELSAT IBS	14/12 GHz (to Standard E-3)	E-3	31.9	34.9
18	INTELSAT IBS	14/4 GHz (to Standard F-1)	E-1	36.0	39.0 ⁽²⁾
19	INTELSAT IBS	14/4 GHz (to Standard F-2)	E-1	36.0	39.0 ⁽²⁾
20	INTELSAT IBS	14/4 GHz (to Standard F-3)	E-1	36.0	39.0 ⁽²⁾
21	AUSSAT FM-TV	National (Aust)	13 m	35.7	—(3)
22	AUSSAT FM-TV	National (Aust)	6.8 m	41.0	—(3)
23	AUSSAT FM-TV	National (Aust)	4.6 m	46.2	—(3)

- (1) Earth-station Standard E-1 has 3.5 m diameter.
 Earth-station Standard E-2 has 5 m diameter.
 Earth-station Standard E-3 has 9 m diameter.
 Earth-station Standard Eut3 has 3.4m diameter.
 Earth-station Standard F-1 has 4.5 m diameter.
 Earth-station Standard F-2 has 7 m diameter.
 Earth-station Standard F-3 has 9 m diameter.
 Earth-station Standard C has 14-18 m diameter.

(2) The maximum e.i.r.p. for an earth-station with this connection at the edge of the beam would have the potential to exceed the off-axis limits. These earth-stations therefore require improved earth-station antenna side-lobe performance, or more on-axis gain if they are to meet the limit and therefore make the connection possible.

(3) AUSSAT only permits earth station antennas with side lobe performance conforming to 29-25 log (ϕ).

Assumptions made in deriving Table IV:

- standard INTELSAT, EUTELSAT and AUSSAT carrier and earth-station parameters.

TABLE V - Up-link characteristics of some 14 GHz satellite systems

Case	Signal type	RF band-width (MHz)	Sat G/T (dB(K ⁻¹))	Earth-station parameters			Side-lobe e.i.r.p./40 kHz and E factors			Country
				Diameter (m)	Gain (dBi)	Carrier power (dBW)	Up-link power density (Avg.) (dBW/40 kHz)	29 - 25 log φ		
								e.i.r.p. (φ = 2°) (dBW/40 kHz)	E	
A	B	C	D	E	F	G	H	J		
1	4-PSK/50 Mbit/s	25	0	5.5	56.0	24.5	-3.5	18.0	25.5	USA
2	4-PSK/56 kbit/s (562)	0.039	1.9	5.5	56.0	-4.8	-4.7	16.8	24.3	USA
3	FDM (3 800)	54	-1.5	10	60.6	24.7	-6.6	14.9	22.4	USA
4	SS/2-PSK/10 kbit/s (100)	5.0	-1.5	1.3	43.5	14.3	-6.7	14.8	22.3	USA
5	FDM (432)	17.5	-2.7	7.0	58.2	14.0	-12.4	9.1	16.6	USA
6	4-PSK/125 Mbit/s	72	-2.7	7.0	58.2	29.0	-3.6	17.9	25.4	USA
7	2-PSK/6.312 Mbit/s (8)	7.6	-2.7	4.5	54.3	17.8	-5.0	16.5	24.0	USA
8	TV FM (full carrier mode)	27	1.9	5.5	56.0	23.2	-5.1	16.4	23.9	USA
9	TV FM (full carrier mode)	16	0	5.5	56.0	24.5	-1.5	20.0	27.5	USA
10	TV FM (energy dispersal)	2	0	5.5	56.0	24.5	+7.5	29.0	36.5	USA
11	TV FM (energy dispersal)	2	0	3.5	52.0	28.5	+11.5	33.0	40.5	USA
12	TV FM (energy dispersal) (3)	2	-3	2.4	49.0	27.0	+10.0	31.5	39.0	
13	Single TV FM (energy dispersal) (1)	0.4	-1.0	8.0	59.5	26.0	16.0	37.5	45.0	Canada
14	Single TV FM (energy dispersal) (2)	0.4	+2.0	8.0	59.5	23.0	13.0	34.5	42.0	Canada
15	Dual TV FM (Energy dispersal)	0.4	-1.0	4.5	54.0	24.0	14.0	35.5	43.0	Canada
16	Radio-program	0.03	-1.0	3.1	51.0	8.0	9.5	31.0	38.5	Canada
17	SCPC (QPSK)	0.004	-1.0	2.4	49.0	0.4	10.4	31.9	39.4	Canada
18	90 Mbit/s (QPSK)	48.0	-1.0	8.0	59.5	24.5	-6.3	15.2	22.7	Canada
19	TV FM (energy dispersal)	0.6	-2.0	13.0	63.5	18.5	6.7	28.2	35.7	Australia
20	TV FM (energy dispersal)	0.6	-3.0	4.6	54.0	29.0	17.2	38.7	46.2	Australia

(1) Northern Coverage

(2) Typical

Assumptions made in deriving Table V:

- except in cases 10 to 15 and 19 and 20, power densities are averaged over total carrier bandwidth,

- up-link rain margins of 2 - 5 dB are included in columns F and G except for cases 19 and 20.

(3) Case 12 is for small transportable earth stations used for broadcasts in Europe.

TABLE VI - Off-axis e.i.r.p. densities which can be tolerated by currently operating systems

Case	Transmission type	Satellite beam	C/N	E.i.r.p.	E (1) (dB(W/40 kHz))
1	EUTELSAT TV (36 MHz)	Eurobeam	20.1	87.0	38.3
2	INTELSAT TV 1/2 transponder	East up 14/4 GHz	17.0	81.6	39.4
3	INTELSAT FDM-FM high density 972 in 25 MHz	East up 14/4 GHz	25.7	90.1	37.3
4	INTELSAT SCPC 4-phase/1/3 64 kbit/s (with 1/2 FEC)	West outer to	6.9	66.2	55.7
5	INTELSAT SCPC 4-phase/64 kbit/s (no FEC) (received by Standard B)	West inner Intelsat-VII East up 14/4 GHz	15.5	63.0	47.2
6	INTELSAT IDR 64 kbit/s (3/4 FEC, 51 kHz)	East up 14/4 GHz	9.7	56.3	46.5
7	INTELSAT IDR 2 Mbit/s (3/4 FEC, 1.7 MHz)	East up 14/4 GHz	9.7	71.3	46.5
8	INTELSAT TDMA (120 Mbit/s)	East Spot	15	88.0	40.2
9	EUTELSAT TDMA (120 Mbit/s)	Eurobeam	15	87.0	39.2
10	INTELSAT FDM-FM 60 channels in 5 MHz	East up 14/4 GHz	12.7	71.7	39.0
11	INTELSAT FDM-FM 252 channels in 10 MHz	East up 14/4 GHz	19.4	79.8	37.3
12	EUTELSAT SMS-SCPC (64 kbit/s, 75 kHz)	SMS Zone 3	9.5	55.0	42.5

(1) If tolerable Interference derives from an earth station working to a satellite spaced 3° from the "wanted" satellite.

Assumptions made in deriving Table VI:

- earth-station side-lobe envelope obeys 25 log ϕ law,
- standard INTELSAT and EUTELSAT carrier parameters,
- "interfering" earth-station within coverage area of "interfered-with" satellite,
- 800pW0p limit for analogue and 6% limit for digital carriers.

3.4 Considerations for the use of small earth-station antennas

The 10-15 GHz band allows more extensive use of small earth-station antennas than the 4-6 GHz band, leading to new applications for domestic satellite purposes or for outside television broadcasts via satellite.

For the first application, cases 10 and 11 in Table V give examples of energy dispersed analogue TV-FM in the United States domestic 14 GHz satellite systems. The *E* factors generated in these cases are approximately 41 for a 3.5 m diameter antenna and 37 for a 5.5 m diameter antenna with improved side lobes ($29 - 25 \log \phi$).

For the second application, it is foreseen that small transportable transmitting earth stations with diameters as small as 2.4 m will give a very flexible and easy to set up tool to be used at outside broadcasting locations. Case 12 in Table V gives typical up-link characteristics for such an outside broadcasting service with European coverage. The *E* factor in this example is approximately 39 for a 2.4 m diameter antenna with improved side lobes.

3.5 Discussion

As in the 6 GHz case, when FM-TV carriers interfere with SCPC carriers the interference must be considered to be pulsed at approaching full carrier power. This is because of the relatively slow scan rate of energy dispersal signals, and because where no energy dispersal is employed the bandwidth of a television carrier can reduce to less than the SCPC channel bandwidth during blanking intervals, even when video modulation is present. Thus for SCPC the 17 dB of energy dispersion which may be assumed in most cases of television interference, cannot be assumed. Alternative solutions to this particular problem must therefore be sought - e.g. location of SCPC carrier frequencies to avoid high spectral density parts of co-channel television carrier bands, or development of suitable improved energy dispersal techniques for television, which are still under study (see Report 384).

In order to reduce the number of variables to be considered, it would appear reasonable to aim at criteria for *E* which will allow satellites to be spaced at intervals of 3° (or more) for the time being. Tighter criteria might be required in the future when closer satellite spacings are needed.

Tables IV and V show that the E values produced by currently operating systems are mostly below 39 dB(W/40 kHz) if energy dispersal of television carriers is assumed.

Table VI indicates that many systems currently operating can tolerate interference from E values up to 36 dB(W/40 kHz). This table does not include cases where high gain domestic satellite spot beams are more vulnerable to up-path interference, however, and a margin of a few decibels should be allowed to cater for such cases.

3.6 Conclusions

A method of calculating the maximum earth-station off-axis e.i.r.p. density permitted by current interference objectives has been established and the impact of E on earth-station antenna diameters and transmitter powers has been assessed for various rain margins. The effect of propagation fades in areas of high rainfall rate has been exemplified. The factors affecting E have been identified and their inter-relationship examined for a typical example of up-path interference to an adjacent satellite. Finally, the off-axis earth-station e.i.r.p. densities generated in a range of existing services have been tabulated, and the tolerable limits also tabulated for a similar range of existing services.

It is clear that both the values of E generated in practice and the values permitted by the interference objectives vary over a wide range. Setting a high criterion would lead potentially to excessive interference for some carrier combinations, while a low criterion would impose severe constraints on earth-station antenna diameter in certain cases. Furthermore, although data for some small dish services has been included in this Report, small dish applications additional to those covered here seem likely to develop in the near future and these will need to be taken into account if a criterion for E is to be established.

In general, possible reductions in E from technology improvements such as lower antenna side-lobe gains may be offset by factors such as the trend to smaller antennas or the employment of higher up-link rain margins. As a result, the specification of a value for E in the 10-15 GHz band is premature at this time. Further studies are required in the areas covered in this Report.

REFERENCES

CCIR Documents

[1974-78]: 4/90 (Canada).

[1978-82]: 4/38 (Japan).

[1982-86]: a. 4/220 (IWP 4/1); b. 4/242 (United Kingdom); c. 4/245 (United Kingdom); d. 4/255 (United States of America); e. 4/283 (France); f. 4/320 (INTELSAT); g. 4/341 (Brazil).

REPORT 555-4

DISCRIMINATION BY MEANS OF ORTHOGONAL CIRCULAR AND LINEAR POLARIZATIONS

(Study Programmes 1B/4, 1C/4 and 28A/4)

(1974-1978-1982-1986-1990)

1. Introduction

The use of orthogonal polarization can provide an effective way of increasing the capacity of the geostationary-satellite orbit.

The possible applications for orthogonal polarization are:

- frequency re-use within the main beams of satellite and earth-station antennas;
- on adjacent satellites to permit closer satellite spacing;
- on neighbouring or overlapping, satellite spot beams to reduce interference;
- reduction of interference to low-power links from more powerful links via the same satellite.

Various factors must be taken into consideration, such as cross-polarization discrimination obtainable in different parts of antenna beams and in different frequencies within the operating bands, the characteristics of polarizers, the depolarizing effects experienced in the atmosphere and ionosphere, the stability of satellite orientation, and the implementation of polarization tracking and correction.

Further information on this subject, including advice on calculating the overall polarization discrimination of a link and some information on actual antenna cross-polar patterns, within beam and off-axis, is contained in Report 1141.

2. Factors affecting polarization discrimination**2.1 *Earth-station antenna systems*****2.1.1 *Earth-station antennas***

In the case where frequencies are re-used within one satellite, the main beam centre is the most important region.

In the boresight direction the polarization discrimination depends mainly on the feed components (orthomode transducers, polarizers, etc.). Within the main beam, but away from boresight, the discrimination depends mainly on the primary radiator (e.g. feed horn), but may also be affected by the use of offset reflectors or beam waveguides. The performance of different antenna designs is considered in Annex I to this Report, together with the results of measurements on a number of antennas.

2.1.2 *Earth-station polarizers*

In circularly polarized systems, polarizers are used to convert between linear and circular polarization. For linearly polarized systems, rotatable polarizers may be used to align earth-station polarization to that of the received wave. In both cases adjustable polarizers may be used to compensate for depolarization effects.

If a common polarizer is used for transmission and reception, it must cover both up-link and down-link frequencies, so that wide bandwidth characteristics are required. In addition, this polarizer will be required to carry high microwave power levels while meeting the requirements of low noise temperature. Figure 1a shows, as a function of frequency, the polarization discrimination of an earth-station polarizer specially designed for the purpose of frequency re-use and operating in the 6/4 GHz band. The noise temperature contribution is about 2 K at 4 GHz.

Another approach is to design feed systems in such a way that the transmit and receive frequency bands are separated so that narrowband polarizers and orthomode junctions with improved polarization discrimination can be used.

Figure 1b shows the measured polarization axial ratio of two narrow-band polarizers designed for an earth-station antenna employing circular polarization.

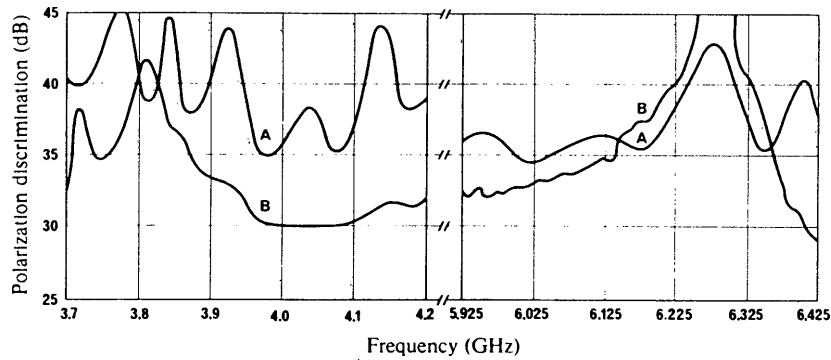

FIGURE 1a - Characteristics of polarizers for an earth station

A: Circular polarization
B: Linear polarization

2.1.3 Earth-station performance

In this section the overall performance of an antenna system consisting of antenna and polarizer is considered.

In the main beam, up to the -1 dB region, typical earth-station antennas could provide in excess of 30 dB of discrimination for circular polarization and 35 dB for linear polarization.

Well away from the main beam little cross-polar discrimination can generally be depended upon [Haide and Fitzgerald, 1977].

2.1.4 Measurement of earth-station antenna polarization discrimination

The practical difficulties of measuring discrimination ratios of individual components of a system are considerable, and additional analytical studies and experimental efforts are needed before a standard method can be recommended for measuring an earth-station antenna's polarization discrimination characteristics.

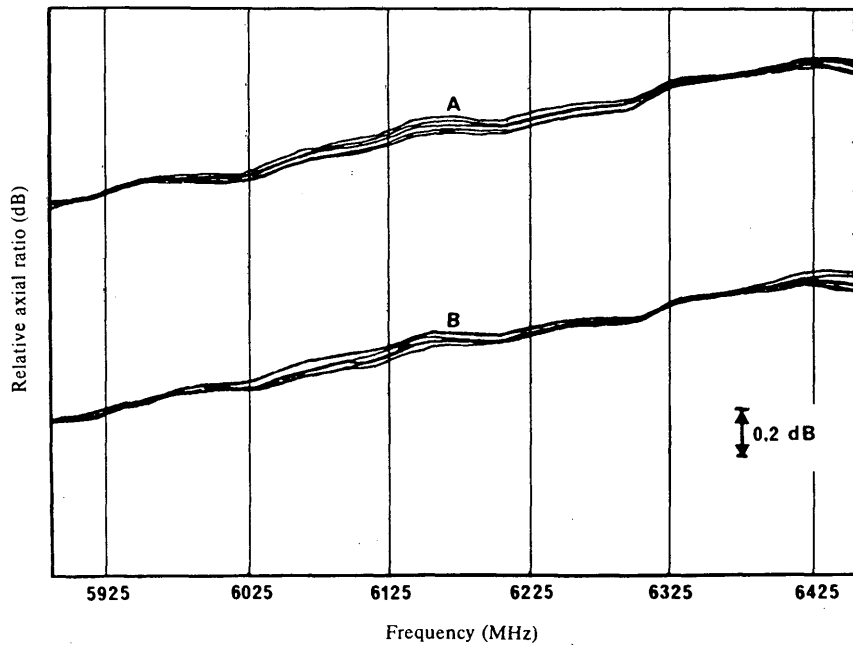
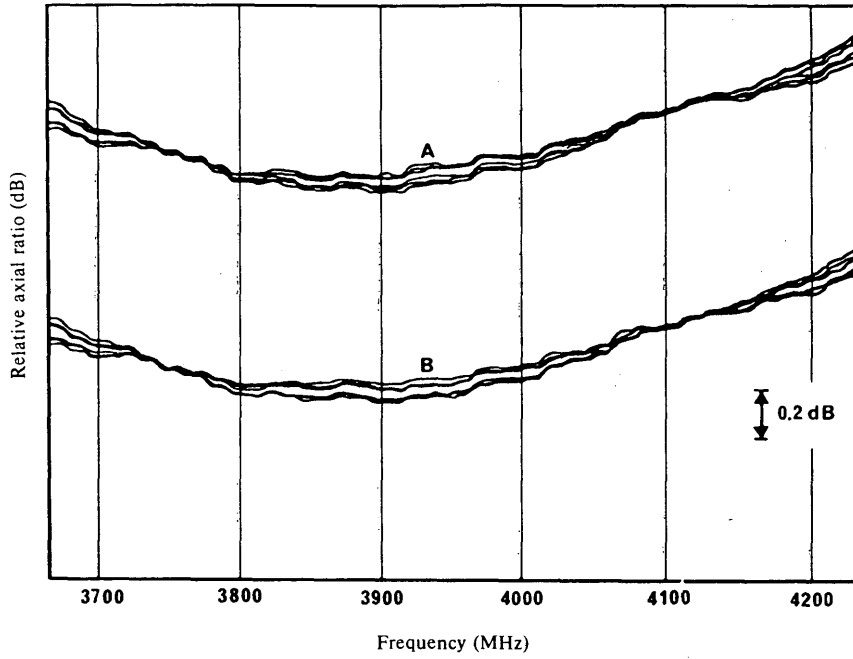

FIGURE 1b - Characteristics of 4 and 6 GHz-band polarizer

A: left-hand circular polarization
B: right-hand circular polarization

Accurate measurement methods can be divided into the satellite source method and the boresight facility method.

The satellite source method can be further divided into the direct isolation method and the reference antenna method. The direct isolation method measures the polarization discrimination of an earth-station antenna directly by taking the ratio of the power received at the cross-polar port to the power received at the co-polar port. The reference antenna method uses a polarization reference antenna to eliminate the depolarization of the satellite source from the measured data for the antenna under test.

The criteria of using the direct isolation method and the reference antenna method are shown in Annex II. Some considerations of the reference antenna method are also presented in Annex II.

By the use of a boresight facility, data of high repeatability can be obtained and various measurement techniques such as the swept frequency technique can be applied.

For nearly circular polarization (i.e., axial ratio (AR) ≤ 3 dB), the voltage axial ratio value in dB can be converted into polarization discrimination (XPD) by taking:

$$XPD \text{ (in dB)} = 24.8 - 20 \log AR \text{ (in dB), and vice versa}$$

$$AR \text{ (in dB)} = 17.37 \left[10^{\frac{-XPD \text{ (in dB)}}{20}} \right]$$

2.2 *Satellite antenna systems*

2.2.1 *Satellite antennas*

For satellite antennas the region of interest coincides with the beam coverage and extends to at least the -3 dB contour. Typical measurements presented in Annex I show that, in this region, satellite horn antennas with beam patterns having near perfect rotational symmetry about the focal axis can provide 40 dB of discrimination for both circular and linear polarization. Satellite antennas with aperture blockage may provide discriminations of 35 dB with linear and 30 dB with circular polarization within the same region. The problem of aperture blockage may be overcome by the employment of offset reflector designs. A practical dual linear polarized paraboloid reflector antenna with an elliptic beam of 2:1 aspect ratio can be expected to yield between 30 and 35 dB discrimination within the -3 dB region. Special designs utilizing gratings may have to be used to maintain high values of linear polarization discrimination.

2.2.2 *Satellite polarizers*

For satellites, the polarizers required for the generation of circular polarization, handle the transmit and receive bands separately and can be designed so as to achieve excellent polarization discrimination. For example, polarizers with 40 dB of polarization discrimination have been realized throughout 500 MHz bandwidths in the 4 GHz and 6 GHz bands.

2.3 *Propagation path*

2.3.1 *Faraday rotation*

Faraday rotation is important in the case of linear polarization but has negligible effect on circular polarization.

The change in angle of the electric field vector due to Faraday rotation depends upon the direction of propagation in relation to the Earth's magnetic field, the conditions in the ionosphere through which the wave passes, and the strength of the Earth's magnetic field. The magnitude of this rotation is also inversely proportional to the square of frequency. Ionospheric conditions depend on many factors including the season, time of day and solar activity. Faraday rotation may occasionally reach a peak value as high as 9° at 4 GHz, 4° at 6 GHz and 1° at 12 GHz. This peak value, however, depends on the geographical locations of the earth station and satellite and may be negligible in many cases for frequencies above 10 GHz. If Faraday rotation is significant at the frequency of operation, differential rotation of the planes of polarization must be provided at the earth station as the direction of rotation as seen in the direction of propagation, is opposite for transmit relative to receive.

2.3.2 *Precipitation*

Rain and snow are important factors which may degrade polarization isolation. Precipitation can cause differences in attenuation and phase shift between orthogonal linear components of the signal so that the discrimination between either linearly or circularly polarized signals is degraded. The effect of rain on linear polarization depends on raindrop orientation angles, relative to the plane of polarization, being equal to circular polarization for an angle of 45° and less at other angles. The primary depolarization effect is caused by the difference in phase shift, but above 10 GHz the difference in attenuation becomes important as well. It is possible to correct for rain-induced depolarization effects in an earth-station antenna; however, the correction for attenuation effects may reduce G/T by increasing waveguide and feed losses.

Experimental and theoretical work has shown that there is a good statistical correlation between co-polar attenuation and the discrimination between orthogonally polarized signals during rainfall. An empirical relationship has been found to provide a reasonable fit to the measured data and can be used to predict cross-polar discrimination at a site from co-polar attenuation statistics at frequencies between 8 and 40 GHz. However, although in some cases depolarization is associated with rain attenuation, in others it is not associated with significant attenuation and has been attributed to the presence of ice clouds along the path.

A more complete summary of measurements and theory is given in Report 722 (Volume V).

3. **Cross-polarization in satellite systems**

3.1 *Position and attitude of satellites*

The direction of the polarization plane of satellite antennas, as observed by earth-station antennas, varies as a function of satellite position relative to earth station location, and satellite attitude. These variations in the direction of the polarization plane can be kept small using current satellite attitude control and stationkeeping techniques.

3.2 *Polarization tracking*

For earth stations operating with linear polarization, tracking or periodic adjustment of the angle of polarization may be necessary to compensate for the effects of Faraday rotation and of the geometric factors discussed in § 3.1. Realignment of the angle of polarization may also be required when switching to another satellite or to another beam of the same satellite. For example, misalignments of the polarization plane of 1° and 6° result in polarization discriminations of 35 and 20 dB respectively. Polarization tracking may be achieved by rotating the entire feed assembly or by rotating only certain components such as an orthomode transducer or a suitable polarizer.

3.3 *Polarization correction*

Depolarization due to the propagation path is mainly caused by differential phase shift and differential attenuation caused by precipitation as previously described.

In satellite communication systems, the depolarization effect may occur on both the up link and down link, depending on the climate. In case the performance degradation of a dual polarized satellite system due to this effect is intolerable, polarization correction in either the up link or down link, or both, may be necessary.

3.3.1 *Polarization correction circuits*

Polarization correction can be made by correcting the effects of the differential phase shift and differential attenuation at the transmit and/or receive earth stations. Polarization correction circuits can be one of the following three types:

- (a) Circuits to correct for differential phase shift and differential attenuation are provided separately in the waveguide portions of the transmit and receive channels of the earth-station antenna.
- (b) Circuits to correct for differential phase shift are provided in the waveguide portions of the transmit and the receive channels of the earth-station antenna. Circuits to correct for differential attenuation are provided after a low noise amplifier and before a high power transmitter.
- (c) Circuits to correct for differential phase shift and differential attenuation are provided in the form of cross-coupling between the two orthogonal signal ports after low noise amplifiers and before the high power transmitters.

In a practical case configurations using different types on the up link and down link may be employed.

3.3.2 *Correction circuits for differential phase shift*

The function of the differential phase shifter in the configurations (a) and (b) is such that a variable phase shift of 0° to 180° can be given in any direction of the polarization ellipse. Generally, such a variable differential phase shifter can be composed of two rotatable polarizers connected in tandem and can consist of various combinations of 90° and 180° units.

3.3.3 *Correction circuits for differential attenuation*

The correction circuit for differential attenuation is used to cancel the residual depolarization component which remains uncompensated after the correction of the differential phase shift component. The function of the correction circuit should be such that the variable attenuation can be given in any orientation of the polarization ellipse. In a practical case, the circuits of a cross-coupling type composed of dividers, combiners, variable attenuators and variable phase shifters may be used.

3.3.4 *Control methods for correction circuits*

Two methods may be considered for the control of the correction circuits for the up link. One is called a prediction method, the other a pilot method. In the former, the control signals for the correction circuits of the up link are derived by predicting the differential phase shift and the differential attenuation from the information on the down link. In this method, the performance characteristics achieved by the correction circuits depend on the accuracy of the prediction. Therefore, enough data to support the correlation between polarization degradation on up and down links are required prior to applying this method to a practical case. In the latter, the correction circuits for the up link can be controlled by an error signal derived by detecting the phase difference and the amplitude ratio of a cross-polarized component to a co-polarized component in the up link using pilot signals which are emitted from the earth station and retransmitted from the satellite. In this method, highly reliable correction can be achieved compared to the prediction method, because more precise information about the error signals can be obtained and the transmitting earth station can monitor the polarization states of transmitted carriers. Generally speaking, therefore, a pilot method is recommended.

3.3.5 *Experimental results*

Measurements were made using Intelsat-IV-A (F-3). They were made using two different combinations of rotatable polarizers to correct for differential phase shift and have produced the results shown in Fig. 2. The results indicate that the added complexity involved in correcting for differential attenuation would produce only marginal further improvement.

3.4 *Comparison of linear and circular polarization*

It is useful to summarize the considerations which should be taken into account in choosing between circular and linear polarizations in satellite systems:

- Linear polarization requires adequate alignment to be maintained between the polarization directions of the satellite and earth-station antennas.
- For linear polarization at frequencies below 10 GHz, Faraday rotation may require polarization tracking at the earth station.
- The angle of polarization of a linearly polarized antenna may vary over its design bandwidth.
- The performance of polarizers, which are required in circularly polarized systems and may also be used in linearly polarized systems, may vary with frequency.
- Suitably aligned linearly polarized systems perform better than circularly polarized ones, in the presence of rain.

4. The modelling of polarization discrimination between adjacent satellites

Some work on modelling the polarization discrimination between adjacent satellites has been done based on single entry interference calculations and only for a European coverage area-see [Claydon et al. 1985]. This model did not include bistatic scattering, since sufficient models and data are not yet available. The results showed that in general, greater isolation and consequently greater orbit/spectrum utilization, can be obtained from systems using linear polarization rather than circular, though both showed a greater isolation than that available in a mixed polarization environment. This is due to the lower level of rain depolarization predicted by the current models for linear polarization. While traditional interference analysis simulates a worst case situation by including propagation degradations on the wanted path (to provide minimum carrier levels) and not on the interfering path (to provide maximum interference), this may not apply to two orthogonally circularly polarized systems. In this latter case both clear-sky and degraded conditions have to be considered. This additional complexity means that the dominant interference path may change with the prevailing environment.

5. *Conclusions*

As regards polarization discrimination and the efficient use of the frequency spectrum and the geostationary-satellite orbit, various factors should be taken into consideration. These are, for example, the question of choice of frequency re-use for a single satellite or for adjacent satellites; questions of the cross-polarized radiation patterns for wide angles as well as at the beam centre; and questions concerning system operation such as polarization tracking and correction. Techniques to reduce the cross-polarization component either in the case of circular or linear polarization such as, for example, adaptive techniques involving the use of pilot signals, are also the subject of study to be pursued.

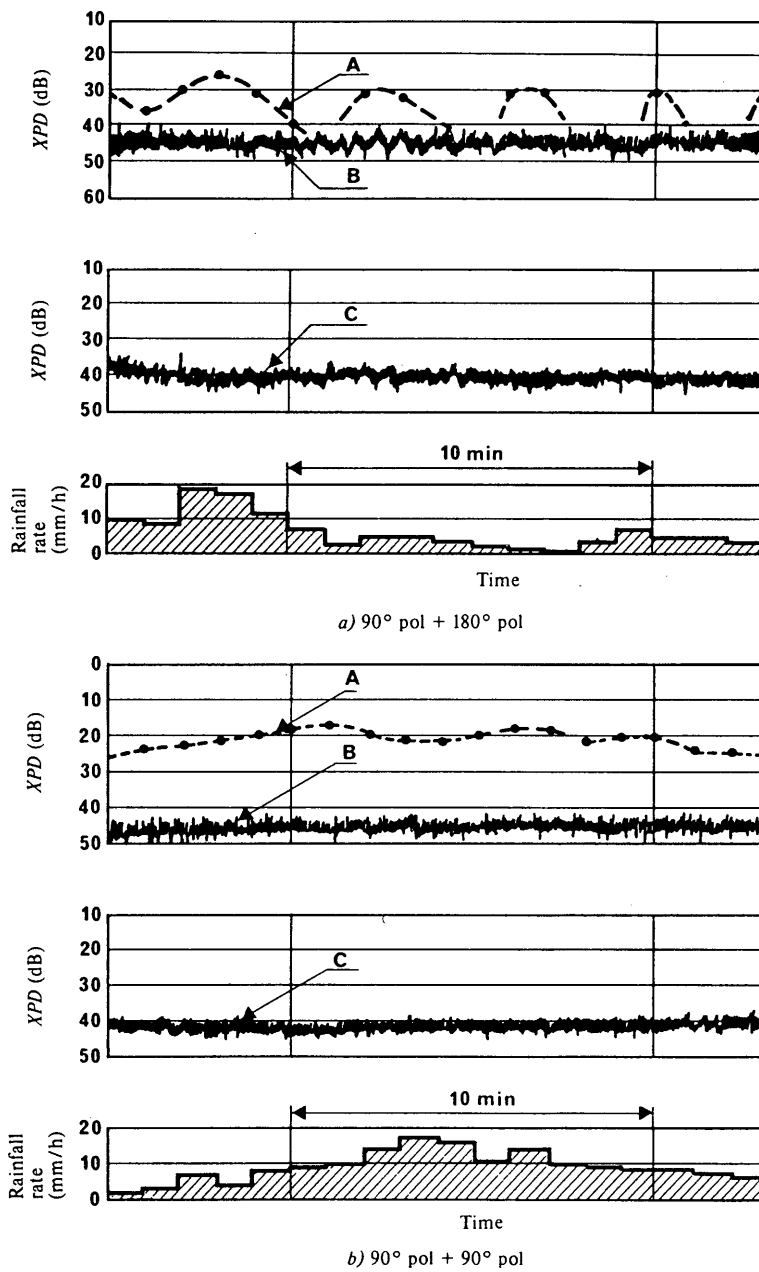

FIGURE 2 - Typical example of measured data in rainy weather

XPD: Cross-polarization discrimination

- A: uncorrected cross-polarization discrimination $f_1 = 3940$ MHz
- B: corrected cross-polarization discrimination $f_1 = 3940$ MHz
- C: corrected cross-polarization discrimination $f_2 = 3780$ MHz

Administrations are invited to submit further data on measured cross-polarization discrimination in the main beam of satellite and earth-station antenna systems and in the wide angle side lobes of earth-station antenna systems. The cross-polarized peak side-lobe data should preferably be given as a statistical distribution in the format used in Report 391. Descriptions of adaptive systems for polarization correction and measured results on polarization discrimination achieved over satellite paths, with and without such systems, are also solicited.

REFERENCES

- CLAYDON, B., EVANS, B., HANSELL, P. AND ADAMS, S. [April 1985] - Preferred Antenna Polarization of Satellite Networks. ERA Report No. 85.0085, Project No. 59-03.2454.
- HAIDLE, L. L. and FITZGERRELL, R. G. [May, 1977] Hemispherical power gain pattern measurements at 7.5 GHz. *IEEE Trans. Ant. Prop.*, Vol. AP-25, 3, 373-376.

ANNEX I

CROSS-POLARIZED RADIATION PATTERNS OF ANTENNAS

1. Theoretical considerations

The cross-polarized radiation pattern of a reflector antenna depends on both the feed horn and on the reflector configuration.

The cross-polarized radiation pattern of a conical horn in Fig. 3(a) shows a four-lobe structure characteristic of straight horns and symmetrical reflector configurations, with a null (high polarization discrimination) on-axis. The peaks of the cross-polarized pattern appear around the -10 dB contour of the co-polarized main lobe, well outside either the normal tracking range of an earth-station antenna or the coverage area of a satellite antenna. The cross-polarization discrimination within the main beam of a smooth-walled single-mode horn is too low for such a horn to be used in a dual polarization system. Improved performance may be achieved either by deliberately generating higher-order modes at discontinuities within the smooth-walled horn or by horns with corrugated walls so that they support hybrid modes containing less cross-polarized energy.

The performance of the feed horn is the dominant factor determining the polarization performance of a symmetrical reflector antenna. The curvature of the reflector or reflectors themselves should make a very small contribution to the cross-polarized lobes (of the order of 50 dB below the co-polarized peak). The effects of feed or sub-reflector supports may increase the cross-polarized radiation in some parts of the beam, but these effects are difficult to predict.

Figure 3(b) shows that the cross-polarized radiation pattern of a horn-reflector is fundamentally different from that of the symmetrical horn. Curved offset reflectors, as incorporated in horn-reflectors, characteristically give rise to two cross-polarized peaks on either side of the plane of symmetry of the reflector with maxima rather nearer to the co-polarized peak [Gans and Semplak, 1975]. This inherent weakness of offset reflectors may be substantially eliminated in practice, either by generating an appropriate asymmetrical higher mode in the feed horn [Rudge and Adatia, 1975] or by providing an appropriate curved offset sub-reflector. Figures 4(a) and (b) show measured cross-polarization of recently developed offset-fed dual reflector antennas with almost axially symmetrical beams [Mizugutch *et al.*, 1976]. Almost perfect cancellation of cross-polarization due to the asymmetrical reflectors takes place, so that only the residual cross-polarization of the feed horn is observed.

The curved offset reflectors incorporated in a beam waveguide feed give rise to similar cross-polarized lobes, but two such reflectors can be arranged so that their effects largely cancel one another out and the resultant cross-polarized lobes incident on the Cassegrain sub-reflector are more than 30 to 35 dB below the co-polarized peak [Gans, 1976].

A torus reflector or a spherical reflector with an offset type feed may be used for a beam-steerable antenna which is able to scan its radiated beam without moving the main reflector. These reflector antennas, however, have not only asymmetrical aperture distribution due to the offset configuration but also spherical aberration, i.e., phase error. Both the gain reduction caused by the aberration and the deterioration of cross-polarization performance caused by the asymmetry can be substantially eliminated by providing specially shaped multiple sub-reflectors [Watanabe and Mizugutch, 1983]. Figure 5a shows a measured example of cross-polarization of a recently developed offset spherical reflector antenna with the above-mentioned sub-reflectors, and Fig. 5b shows its scanning properties. Excellent cross-polarization characteristics over wide scanning angles are observed.

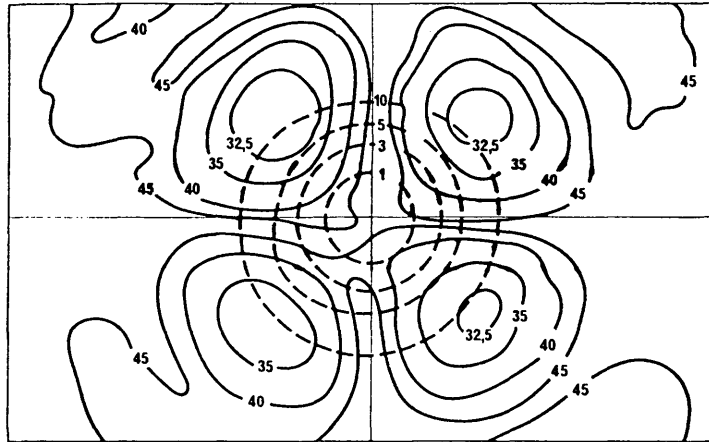

a) Conical horn with an almost axially symmetrical beam
(Beam symmetry factor ≈ 1.05)

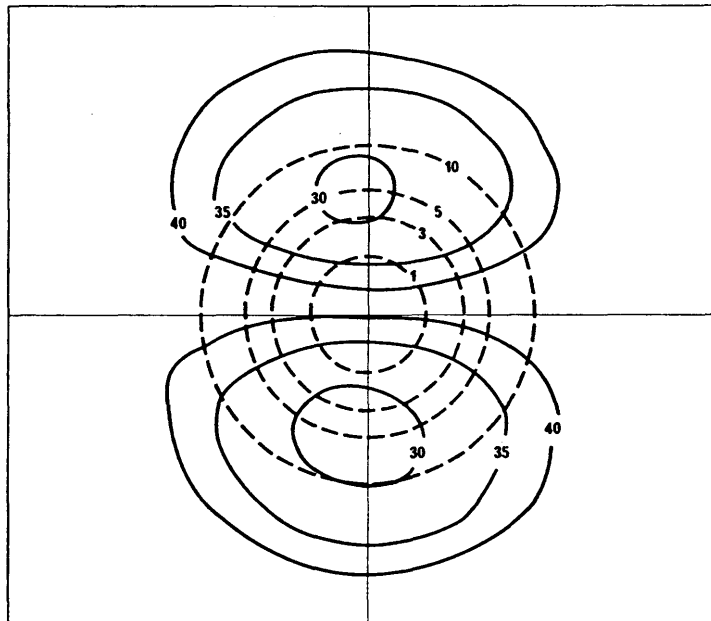

b) Conical horn-reflector with an almost axially symmetrical beam*
(Beam symmetry factor ≈ 1.05)

FIGURE 3 — Measured cross-polarization levels (linear polarization)

- Notes. — Solid line shows the contour of the cross-polarization level referred to the peak of the main beam in principal polarization.
- Dashed line shows the contour of the level of principal or normal polarization of the main beam.
- Figures in the diagrams show relative levels in dB referred to the peak of the main beam in principal polarization.
- The centre cross-point in the diagrams shows the peak of the main beam in principal polarization.
- The plane of electric vector in principal polarization is in the up-to-down direction on the diagrams in linear polarization.
- The axis of the horns of the horn-reflector antennas lies in the left-to-right direction in the diagram, with their vertex on the left side.

* Polarization plane perpendicular to horn axis.

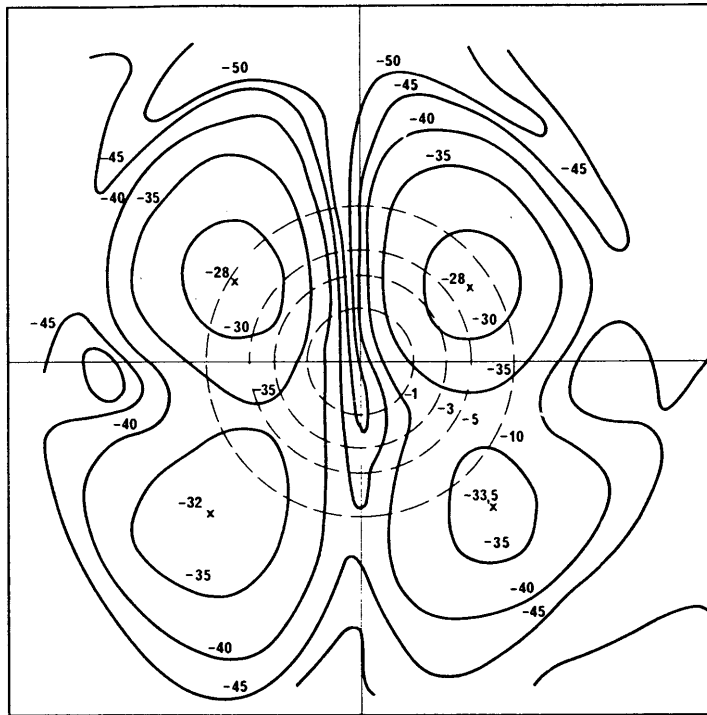

a) Offset Gregorian antenna with dielectric-loaded conical horn feed

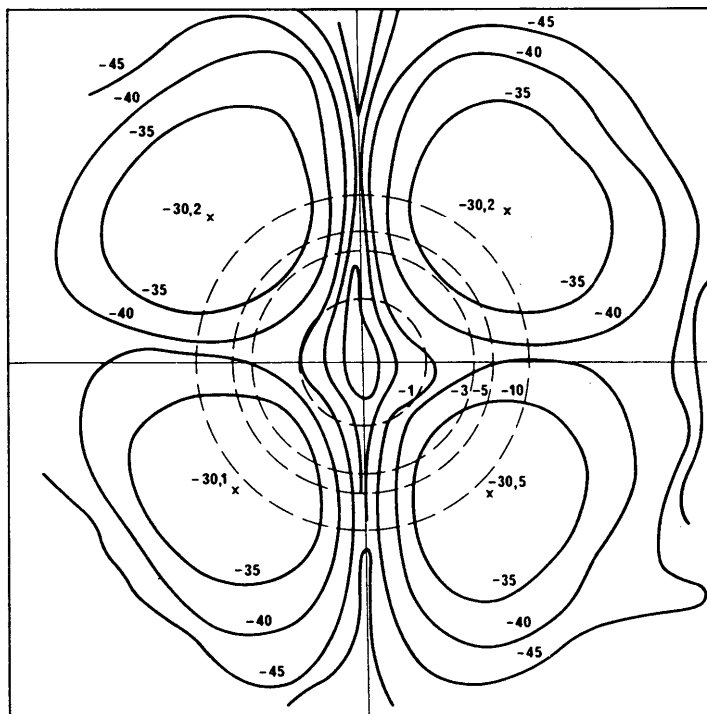

b) Offset Cassegrain antenna with corrugated conical horn feed

FIGURE 4 - Measured cross-polarization levels of offset dual reflector antennas (main polarization: horizontal)

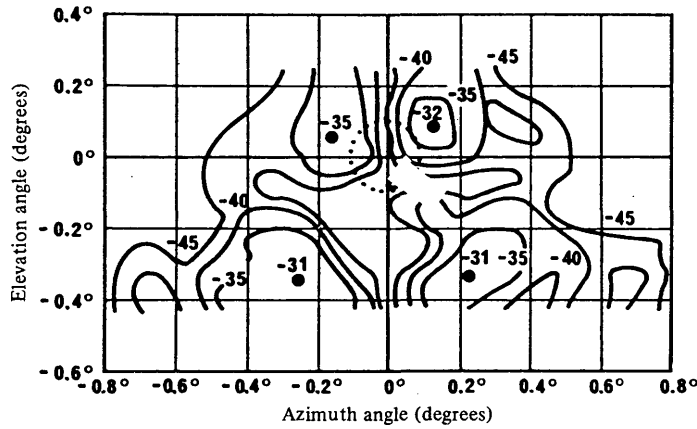

FIGURE 5a – Measured cross-polarization level of the offset spherical reflector antenna

(Principal polarization: vertical polarization)

--- Vertical co-polarization (-3 dB)

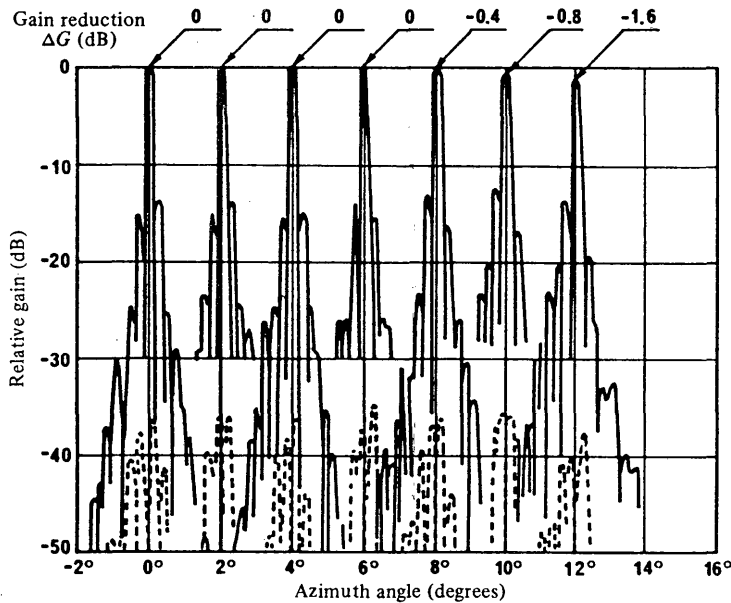

FIGURE 5b – Measured radiation patterns of the offset spherical reflector antenna versus scanning angle

$G_0 = 60.1$ dB

$f = 52$ GHz

— Vertical polarization

--- Cross-polarization

The discussion above has assumed linear polarization throughout. In the case of circular polarization the behaviour of both symmetrical and offset horns and reflectors is fundamentally different. In the case of symmetrical horns and reflectors the four cross-polarized lobes of the linearly polarized case become a single circularly symmetric lobe of the same magnitude and at the same distance from the co-polarized peak. In the case of horn-reflectors and curved offset reflectors there is only a very low level of cross-polarization (less than 50 dB below the co-polarized peak), but the co-polarized peak is displaced sideways by a fraction of a beamwidth, the sense of the displacement depending on the hand of circular polarization.

Earth-station antennas are generally exposed to the weather and parts of their surfaces will frequently be covered by films of water. Theoretical calculations have shown that the effects of these thin water films on the reflectors of practical earth-station antennas, will not degrade the isolation with linear polarization in directions near the antenna axis below about 35 dB at frequencies below 30 GHz [Popović, 1975 and 1976].

2. Earth-station antennas

Measurements made on 1.2 m and 3.0 m diameter Cassegrain earth-station antennas with corrugated horn feeds and designed to operate in the 11 and 14 GHz band in linear polarization provided the following results, when measured at 11.6 GHz:

TABLE I

Polarization discrimination of two antennas (dB)		
Antenna diameter	Region of the main beam	
	-1 dB	-3 dB
1.2 m	50	42.5
3.0 m	42.5	40.0

The polarization discrimination performance of these antennas is somewhat better at 11.6 GHz than at 14.25 GHz.

Measurements at 11.6 GHz on a Cassegrain-type antenna with a 10 m parabolic main reflector and a 1.1 m hyperbolic sub-reflector, supported by struts positioned in the 45° planes, revealed no significant differences in the co-polarization diagrams when the axis of the polarization vector was tilted by 45° from vertical, i.e. parallel to one pair of struts. However, the differences in the cross-polarization diagrams, as shown in Fig. 6, are evident with the cross-polarization discrimination improving when the polarization vector was parallel to the struts. For vertical polarization, lower values of polarization discrimination are measured in the planes parallel to the struts. This effect is caused by the different influence of the struts on the incident wave polarized parallel and perpendicular to them.

A series of measurements were made on a 32 m diameter Cassegrain earth-station antenna with a four-reflector beam-waveguide feed configuration. Figure 7 shows the polarization axial ratios including the overall antenna polarization performance measured by the phase-amplitude method using the Intelsat-IV-A (F-3) satellite and the boresight facility. The figure also shows the in-plant test data of the feed assembly. Figure 8 shows the cross-polarization contours of the same antenna at 3925 MHz measured by use of the boresight facility. The arrows indicate the polarization state: the length of an arrow is proportional to the polarization axial ratio (dB) and its direction shows the orientation of the major axis of polarization ellipse.

Similar measurements of polarization axial ratio were made on a 32 m earth-station antenna designed to cover 875 MHz and 800 MHz bandwidths in the 6 GHz and 4 GHz bands respectively. The antenna configuration is of a Cassegrain type with four-reflector beam-waveguide feed. Figure 9 shows the on-axis axial ratio of the overall antenna system measured by a bore-sight test facility, indicating that an axial ratio of better than 0.34 dB in the 6 GHz band and 0.41 dB in the 4 GHz band was achieved.

The measured performance of a symmetrical reflector antenna is shown in Fig. 10. It is a 32 m INTELSAT Standard A Cassegrain antenna with corrugated feed horn designed for high quality frequency re-use operation. In the main beam, up to -1 dB region typically more than 35 dB discrimination ($AR = 0.3$ dB) has been obtained with the complete system for circular polarization. The antenna itself without TM_{01} tracking mode coupler and polarizer exhibits typically more than 41 dB discrimination ($AR = 0.15$ dB).

Some examples of wide-angle pattern measurements using linear polarization with relatively small size earth-station antennas without polarizers, are shown in Figs. 11 and 12. However, other measurements on larger antennas have shown that such high discrimination may not always be achieved [Haidle and Fitzgerrell, 1977].

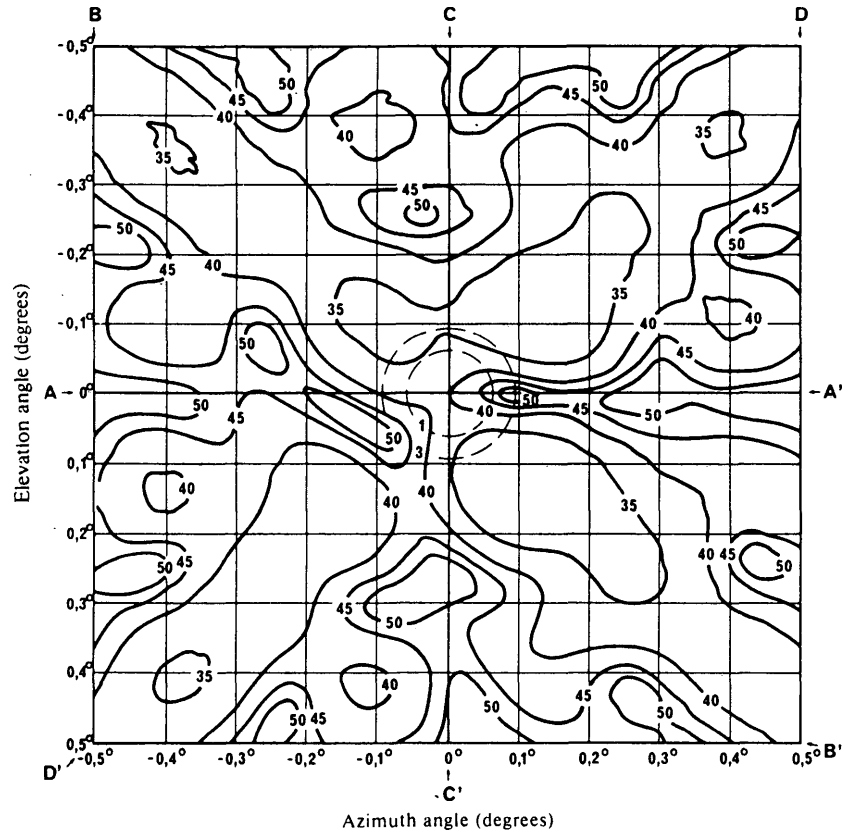

a) Vertical polarization

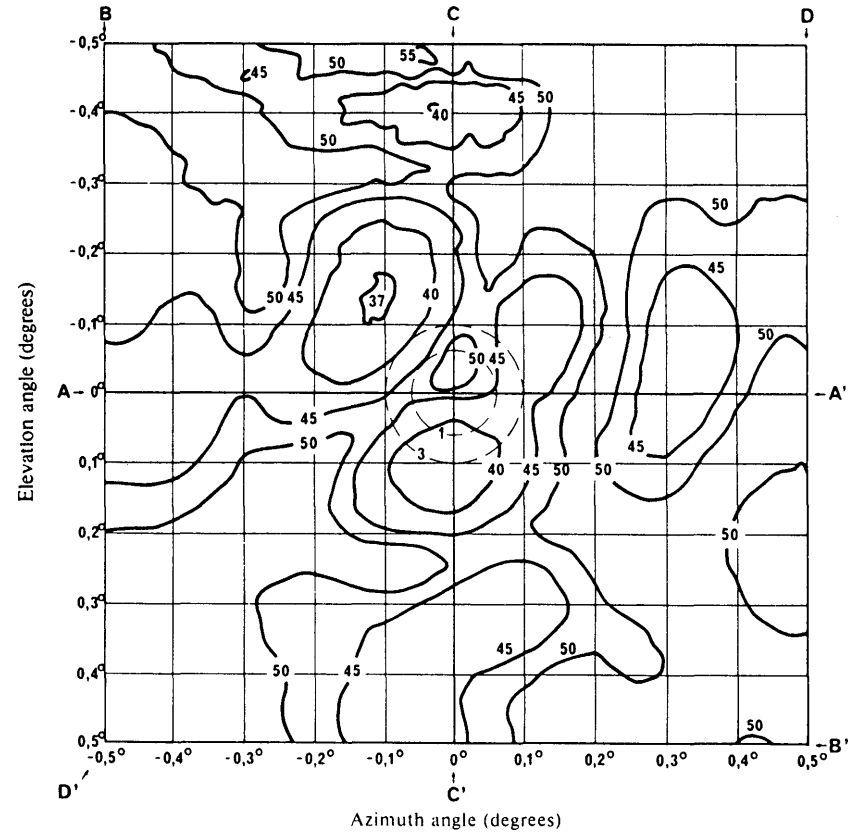

b) Polarization at 45° angle

FIGURE 6 - Measured cross-polarization levels of a 10 m antenna (11.6 GHz, linear polarization)

- Cross-polarization
- - - - - Co-polarization

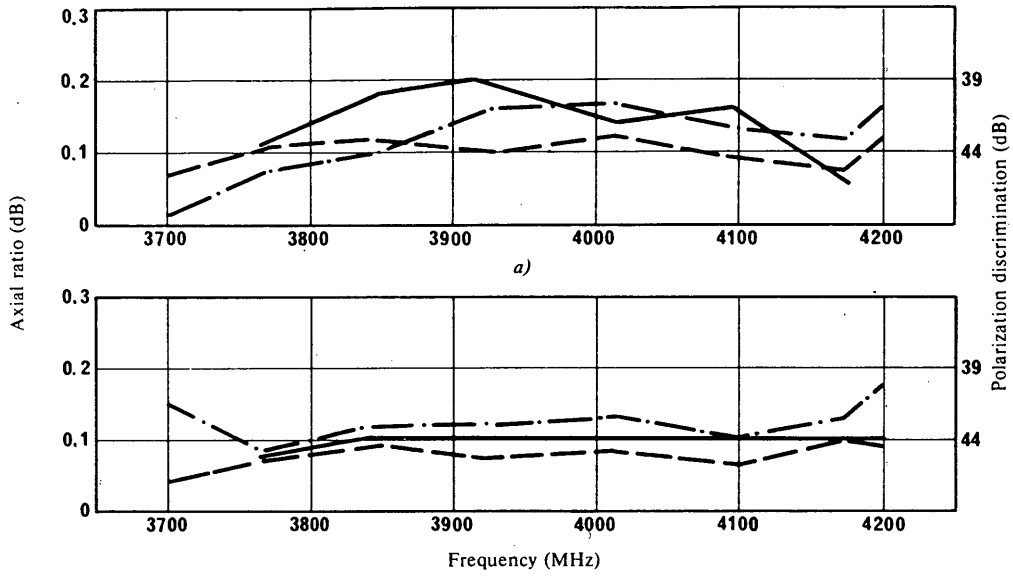

a) Left-hand circular polarization
b) Right-hand circular polarization

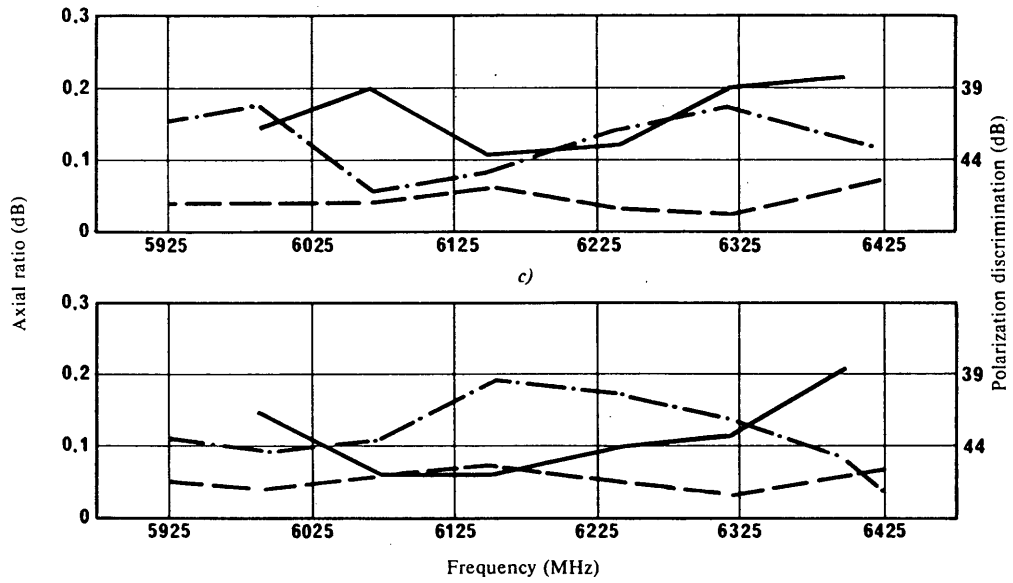

c) Right-hand circular polarization
d) Left-hand circular polarization

FIGURE 7 - Characteristics of earth-station antenna

- Overall performance measured by the reference antenna method using a satellite source
- · - · - Overall performance measured by the boresight source method
- In-plant data of the feed assembly

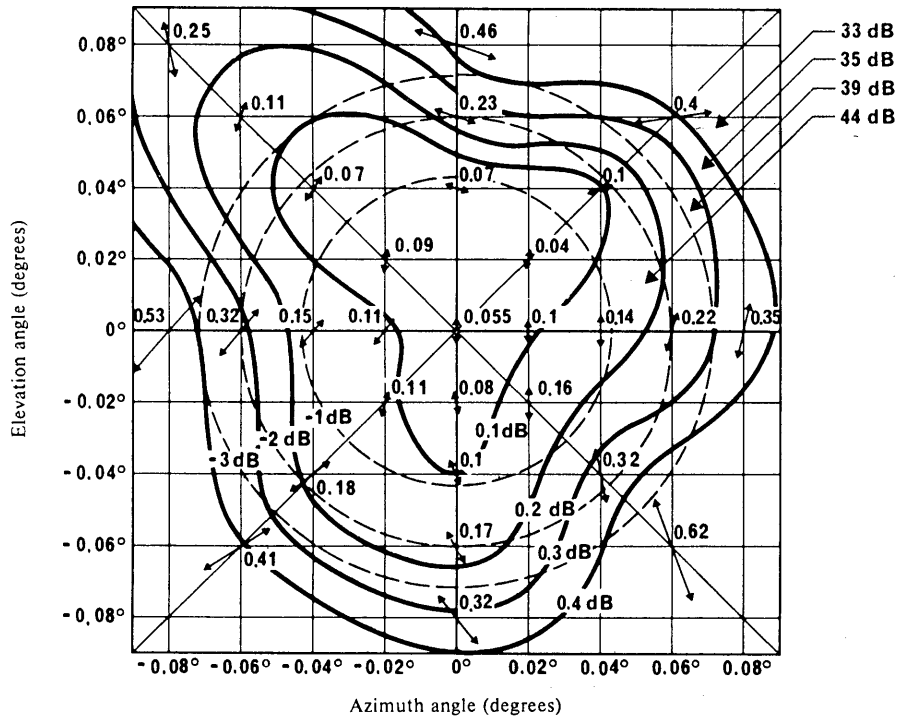

a)
f = 3925 MHz

Co-polar: right-hand circular polarization
Cross-polar: left-hand circular polarization

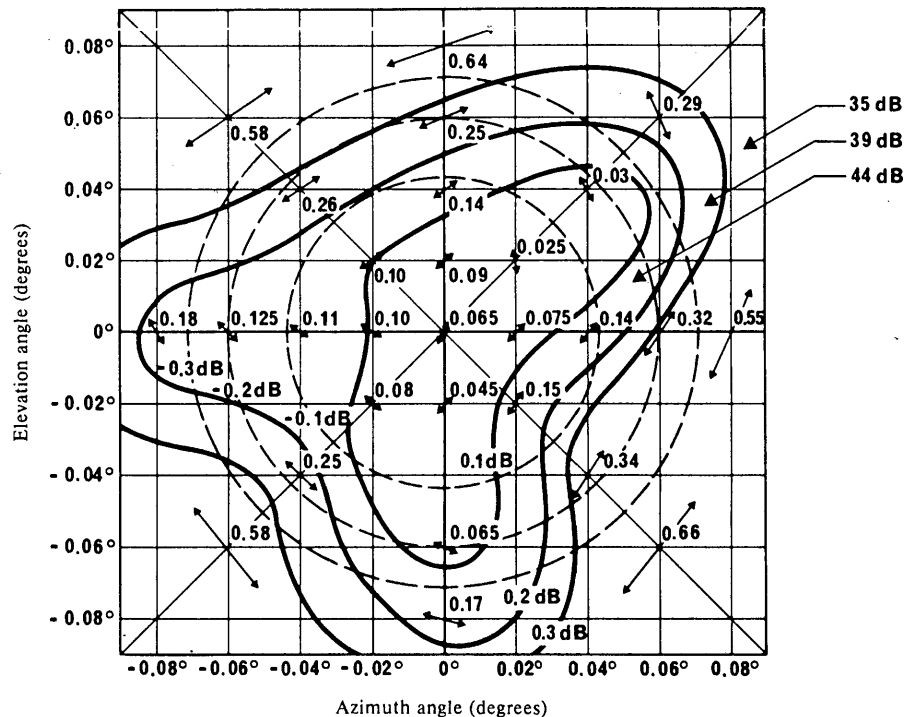

b)
f = 3925 MHz

Co-polar: left-hand circular polarization
Cross-polar: right-hand circular polarization

FIGURE 8 → Cross-polarization contours of earth-station antenna

———— Cross-polarization
- - - - - Co-polarization

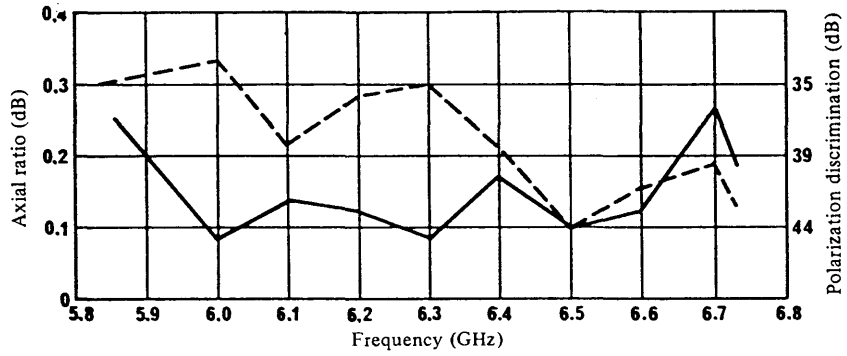

a) 6 GHz band

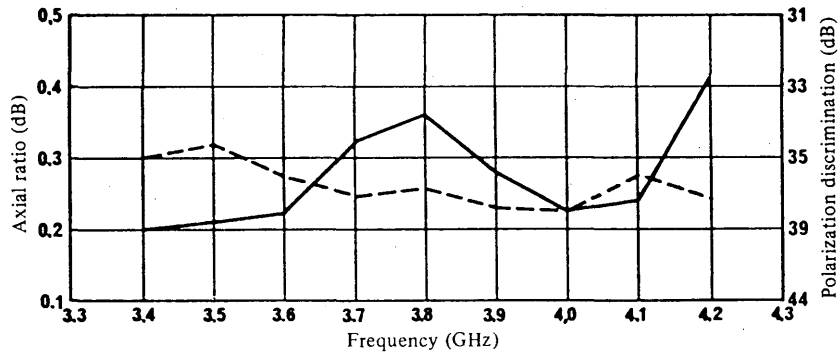

b) 4 GHz band

FIGURE 9 – Characteristics of wideband earth-station antenna

- Left-hand circular polarization
- - - Right-hand circular polarization

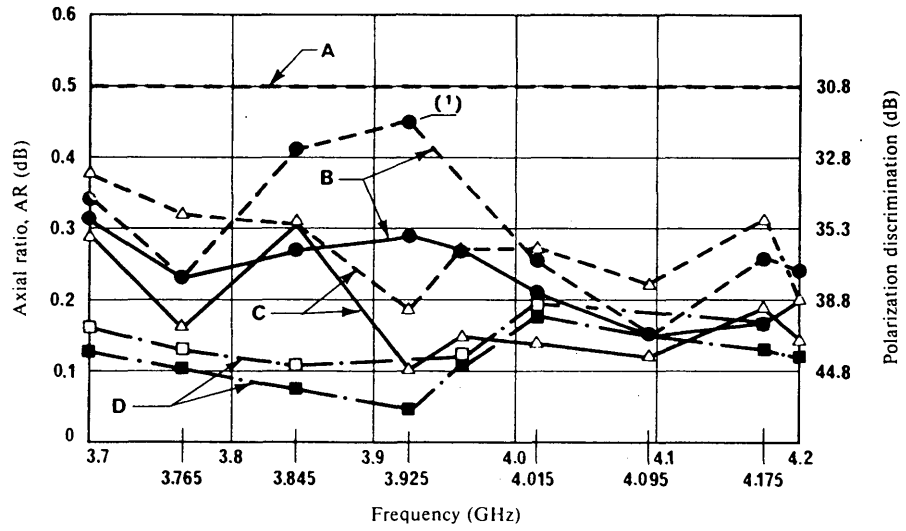

a)

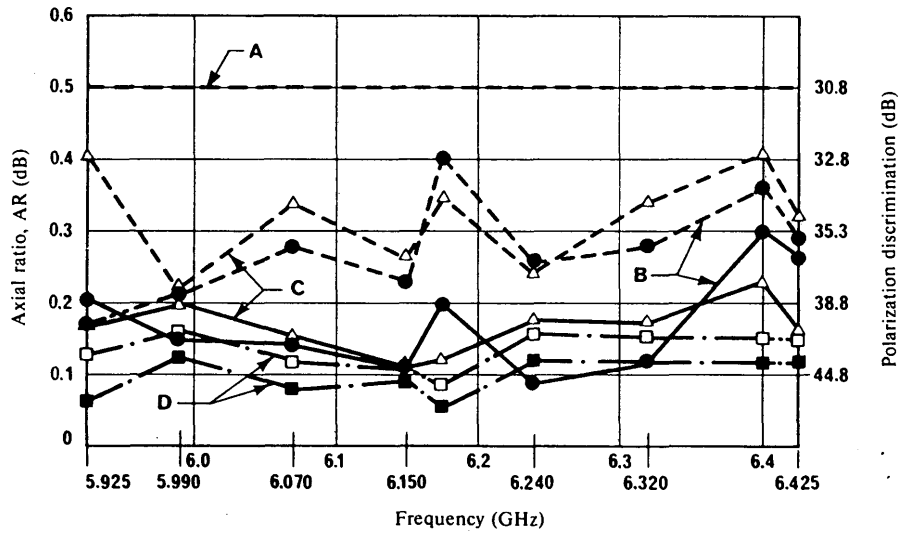

b)

FIGURE 10 - Axial ratio of the Raisting 4 antenna measured with boresight transmitter

- A: INTELSAT specification
 - B: LHCP: left-hand circular polarization
 - C: RHCP: right-hand circular polarization
 - D: RHCP/LHCP
- | | | |
|--|---|---|
| <ul style="list-style-type: none"> △ - - - △ ● - - - ● △ - - - △ ● - - - ● □ - - - □ ■ - - - ■ | <ul style="list-style-type: none"> } Within 1 dB beamwidth } On axis } On axis } within 1 dB beamwidth; | <ul style="list-style-type: none"> } but without TM_{01}-coupler and polarizer; converted from measurement with linear polarization |
|--|---|---|

(1) Single value only

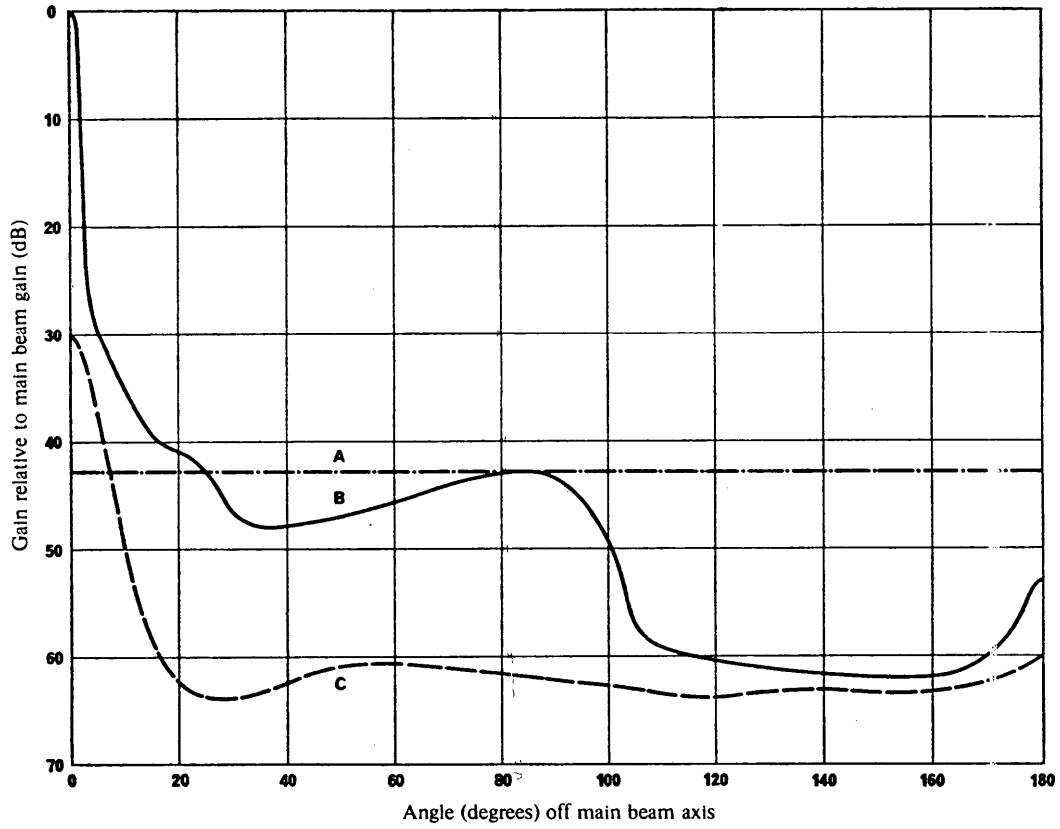

FIGURE 11 - Co- and cross-polarized pattern envelope of 10-foot (3 m) antenna

Smoothed envelope of side-lobe peaks in the horizontal plane at 6 GHz

- A: Isotropic
- B: Response to vertically polarized signal
- C: Response to horizontally polarized signal

Gain 42.8 dB at 6 GHz

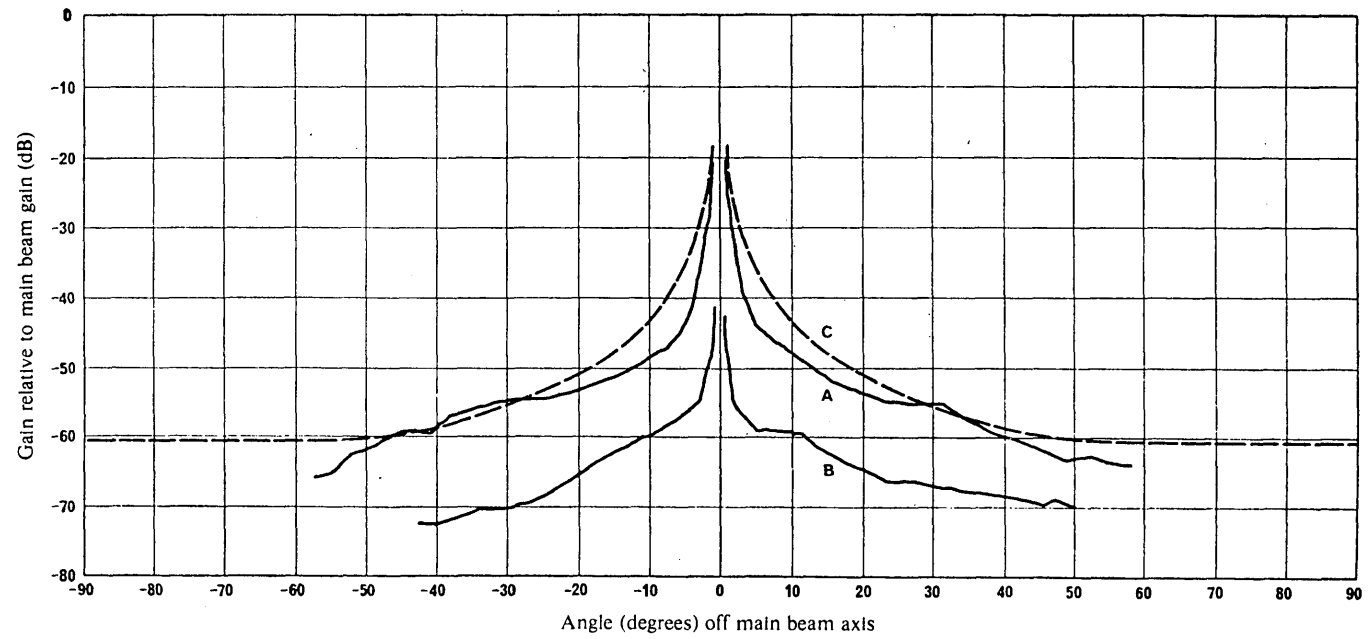

FIGURE 12 – *E*-plane co- and cross-polarized antenna patterns of a linearly polarized 12-foot (3.6 m) diameter Gregorian-fed circular reflector at 10.5 GHz

- A: Co-polarized
- B: Cross-polarized
- C: Reference pattern of Recommendation 465

Statistical data on the distribution of cross-polar side-lobe peaks are available from six sources:

- (a) in the angular range 0.5° to 4.0° , data from an existing INTELSAT Standard A station using a conical-horn reflector source radiator and a modified diplexer;
- (b) in the angular range 0.4° to 10° , data from a new 32 m antenna constructed for frequency re-use with Intelsat-V and using a corrugated horn-beam waveguide source radiator;
- (c) in the angular range, 1° to 120° , data from a smaller antenna ($D/\lambda = 162$) using a corrugated horn;
- (d) in the angular range 1.5° to 85° , data from two Japanese earth station antennas in the INTELSAT system. Both antennas are of the Cassegrain type with beam waveguide feed configurations;
- (e) in the angular range 0.4° to 10.0° , data from an existing INTELSAT standard A antenna, in the Netherlands, using a dual reflector beam waveguide feed system with a corrugated horn and a modified diplexer;
- (f) in the angular range, 0.4° to 20° , data from a substantial number of standard A antennas in the INTELSAT system brought into service after 1977 and tested for frequency reuse for operation with Intelsat V satellites;

Figure 13 summarizes the data in (a) through (e) above showing the worst 10% cross-polar side-lobe peak levels.

Figures 14 and 16 summarize the data in (f) above. These figures show the results of the analysis performed on the data accumulated from the verification testing of 29 INTELSAT Standard A antennas installed after 1977 demonstrating that they meet (i.e. have at least 90% of their side-lobe peaks within) the gain envelope given by $G = 32 - 25 \log \phi$. The statistical distributions of the transmit cross-polar side-lobe levels in sample widths extending to approximately 20° from the main beam centre are plotted and compared with two gain envelopes, that of $32 - 25 \log \phi$ and $23.6 - 20 \log \phi$. Slightly more than half the antennas tested meet the reference gain envelope of $23.6 - 20 \log \phi$ in the range of 1° to 7° away from main beam centre. In the range of 7° to approximately 20° away from main beam centre, fewer than half of these antennas meet the gain equation $G = 23.6 - 20 \log \phi$ indicating that in this angular range a different gain envelope may be appropriate. Additional studies will be required to characterize the antennas cross-polar side-lobe performance beyond 20° . From these data and from physical reasoning, several comments can be made:

- cross-polar discrimination cannot be expected in the angular region beyond 50° from the main beam;
- simple modification to existing antennas cannot be expected to produce significant cross-polar discrimination at wide angles.

Since the cross-polar side-lobe peaks and co-polar side-lobe peaks are at comparable levels for angles greater than 50° , and for the newer antennas the cross-polar peaks are at somewhat lower levels, it follows that they follow a law which has less rapid change with angle than the $25 \log \phi$ relationship.

The radiation pattern data of a 32 m Cassegrain antenna designed to cover the 875 MHz bandwidth at 6 GHz and the 800 MHz bandwidth at 4 GHz were obtained and processed in accordance with the method described in Annex II to Report 391. Figure 15 shows the levels exceeded by 10% of cross-polarization side-lobe peaks of the antenna.

If a $20 \log \phi$ relation is assumed, a cross-polar reference pattern of

$$G (\text{cross-polarization}) = 23.6 - 20 \log \phi$$

results. This is shown in Figs. 13 and 14 and it appears that this pattern generally includes the worst 10% cross-polar side-lobe levels of new antennas.

3. Satellite antennas

Measured cross-polarization contour diagrams for conical horns and conical horn reflectors, both used extensively on satellites, are shown in Figs. 3(a) and (b) for almost axially symmetrical beams indicating the high level of performance when rotational symmetry of the pattern can be approached.

It has been experimentally demonstrated that polarization isolation of 30 dB is achievable from reflector antenna configurations specially designed for satellite applications for linear and circular polarization, in a front-fed configuration (see Figs. 17 and 18). The elliptical beam shown in Fig. 18 is obtained by shaping the reflector. When the same antenna was used for circular polarization the contours for cross-polarization exhibited a complex structure indicating strut effects and interaction of the primary feed horn phase pattern.

It is to be noted that the front-fed configurations tested had relatively small apertures and hence the polarization discrimination and efficiency had been significantly and adversely affected by the presence of feed supporting struts. However, offset-fed configurations offer a greater potential in both respects (see Figs. 4(a) and (b) and Fig. 19). In the case of circular polarization, the overall cross-polar discrimination of these antennas is likely to be constrained by the achievable ellipticity of the polarizer.

Offset reflector configurations are of special value for satellites requiring shaped or multiple beams since the associated feed assemblies would otherwise provide excessive blockage. More complicated problems, including the interaction of adjacent feed elements, have to be taken into account in designing these antennas with high polarization discrimination.

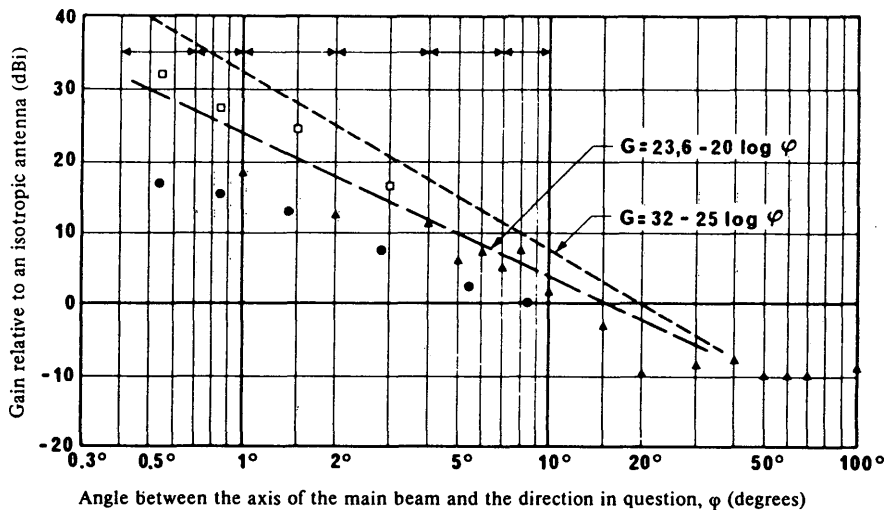

FIGURE 13 - Statistical distribution of cross-polar side-lobe peaks

- From Doc. 4/94 (Italy)
 - ▲ From Doc. 4/70 (USA)*
 - From Doc. 4/88 (Netherlands)
 - Co-polar reference radiation diagram
- | level exceeded by 10% of the side-lobe peaks

*Values are given for discrete angles of 1°, 2°, 4°, etc. as shown.

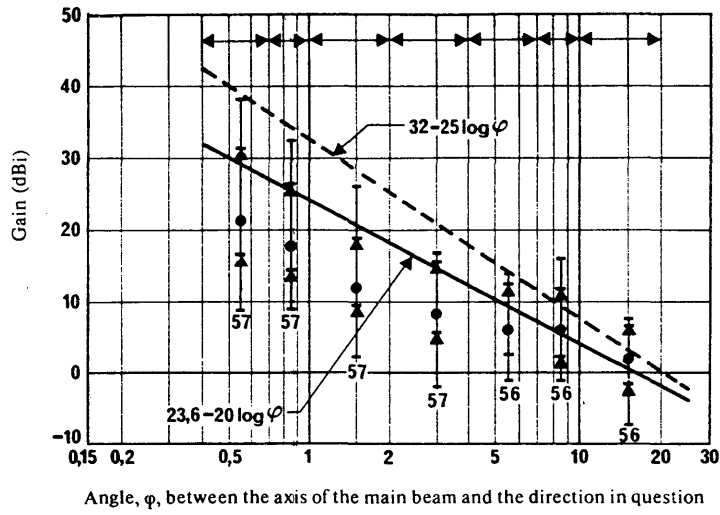

FIGURE 14 – Distribution of side-lobe levels in circularly polarized cross-polar patterns for INTELSAT Standard A antennas

Transmit-side-lobe pattern analysis

Antenna data:

Type: INTELSAT Standard A
 Diameter: approx. 30 m
 Frequency: 6990-6400 MHz
 Polarization: left and right hand cross-polarization

Sample width

- ⌈ : Maximum value
- ⌈▲ : Worst 10%
- : Median value
- ▲ : Best 10%
- ⌋ : Minimum value
- 56 : Number of samples

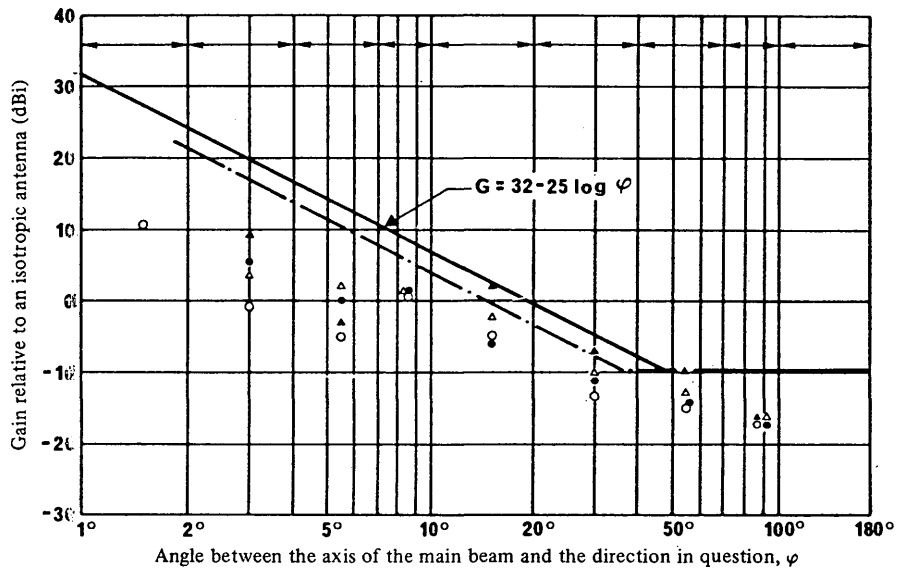

FIGURE 15 – Statistical data of side-lobe peaks of a 32 m Cassegrain antenna (cross-polarization)

Levels exceeded by 10% of the side-lobe peaks processed in accordance with Annex II to Report 391.

- 6.725 GHz $D/\lambda = 718$
- 6.150 GHz $D/\lambda = 656$
- △ 3.950 GHz $D/\lambda = 419$
- ▲ 3.400 GHz $D/\lambda = 363$

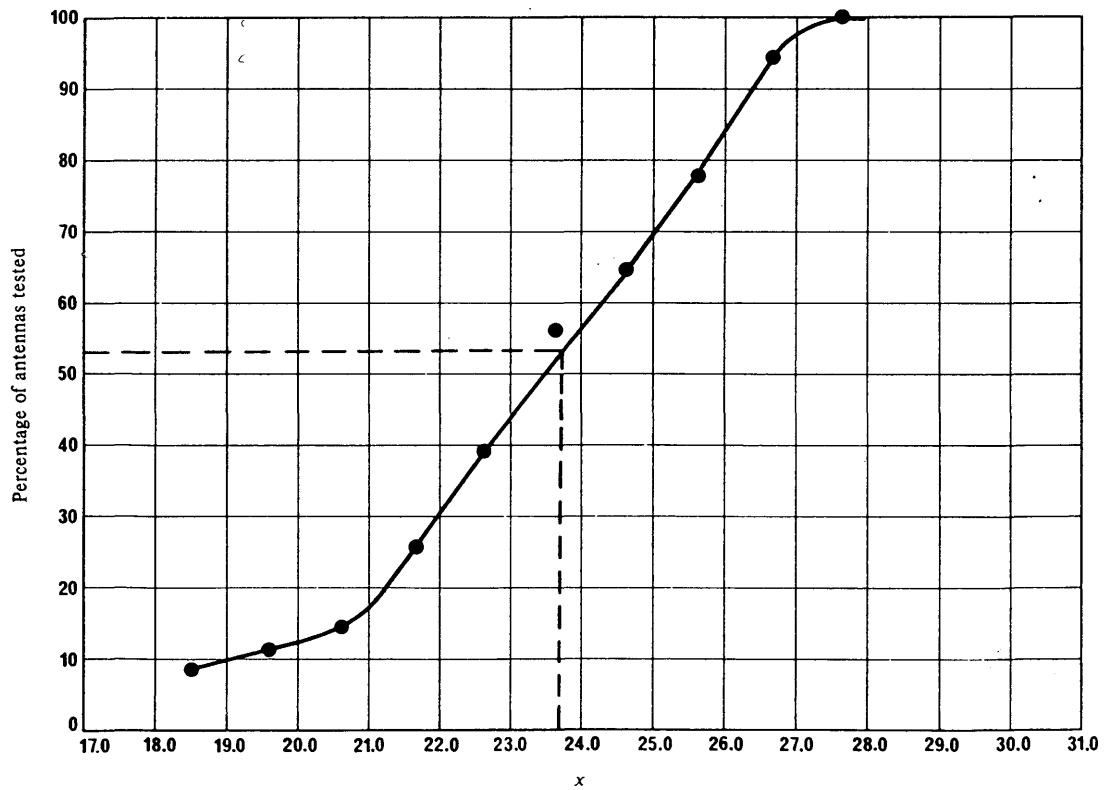
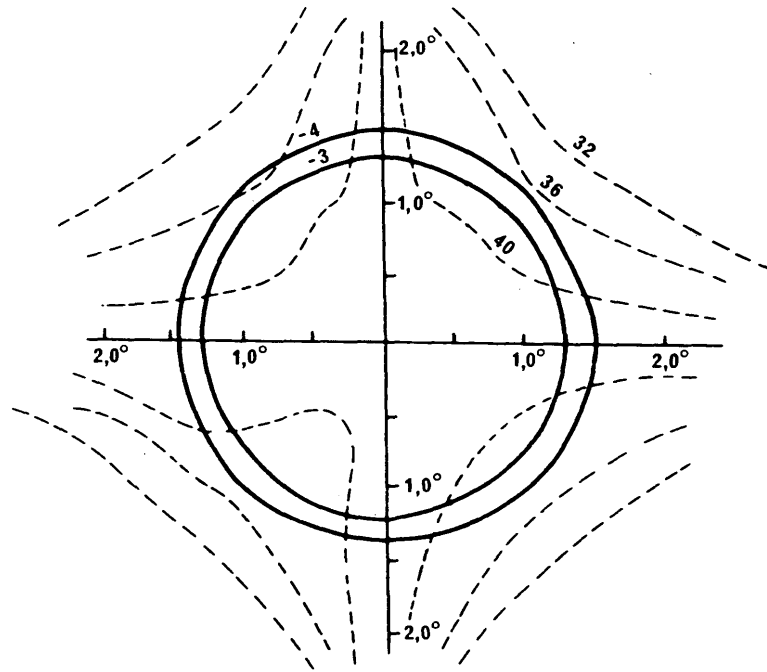
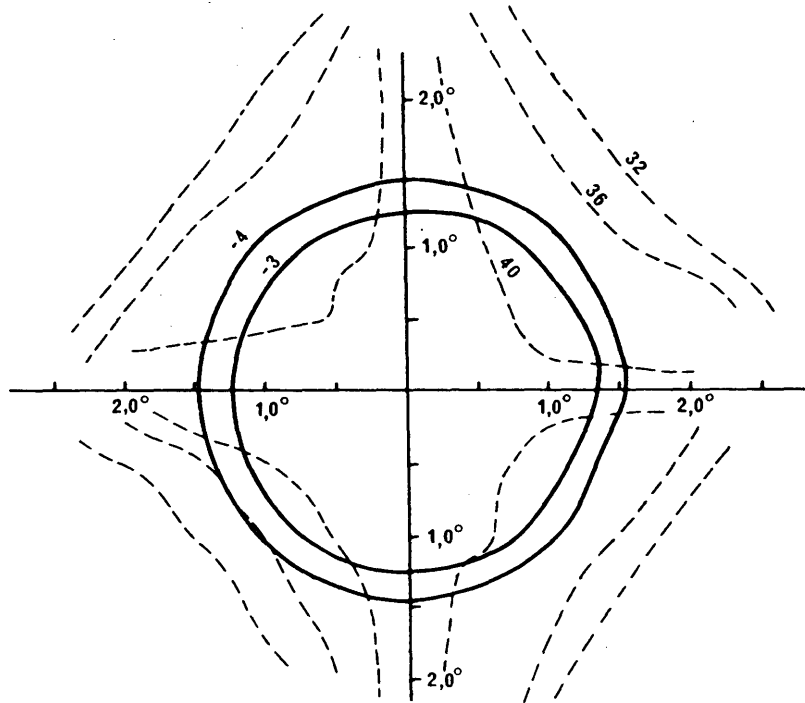

FIGURE 16 – INTELSAT Standard A antennas: cross-polar patterns

Gain envelope ($x - 20 \log \varphi$)



a) Port 1



b) Port 2

FIGURE 17 - Contour plots for linearly polarized circular beam
(values in dB)

————— Co-polar Isolines
 - - - - - Polarization Isolation Isolines

Frequency: 11.58 GHz
 Design BW (3 dB): $2.5^\circ \times 2.5^\circ$
 Measured peak gain: 36.4 dB

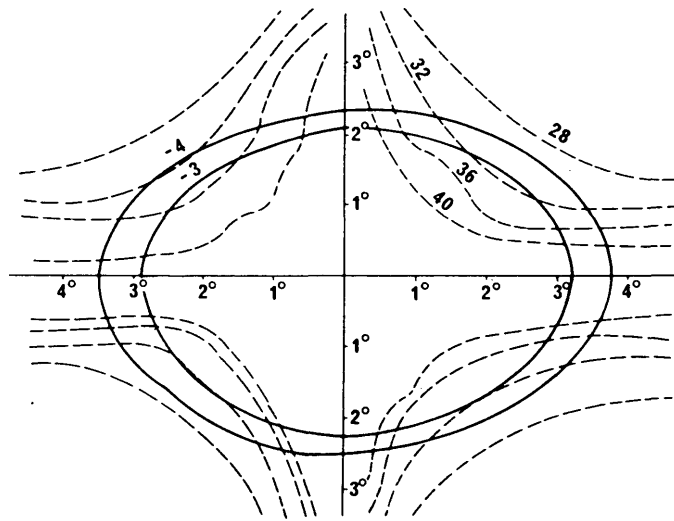

a) Port 1

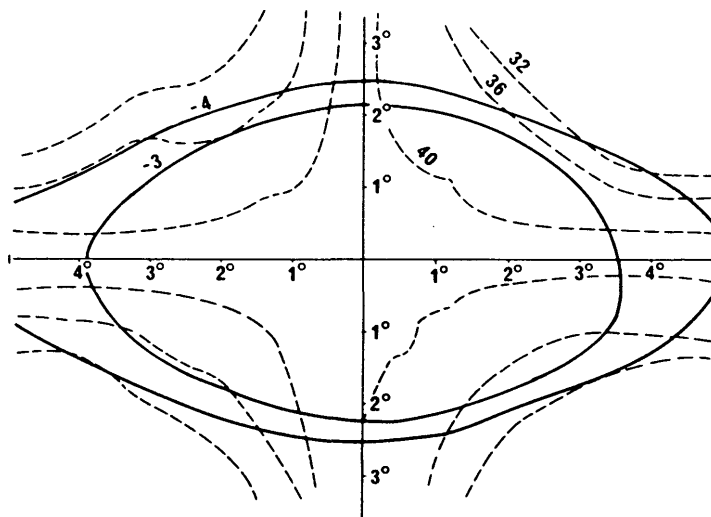

b) Port 2

FIGURE 18 - Contour plots for linearly polarized elliptical beam (values in dB)

———— Co-polar Isolines
 - - - - - Polarization Isolation Isolines

Frequency: 14.173 GHz
 Design BW (3 dB): 7.5° × 4.25°
 Measured peak gain: 28.8 dB

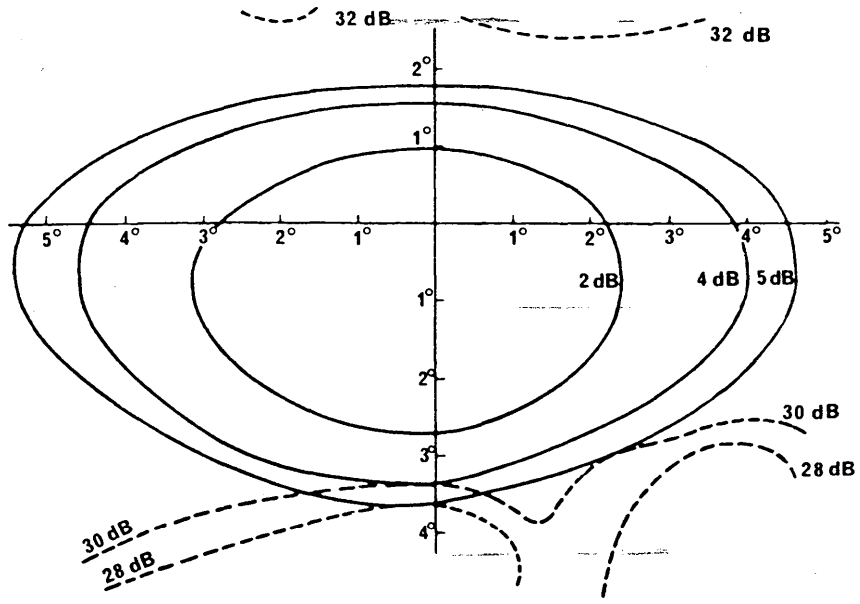

a) Port 1

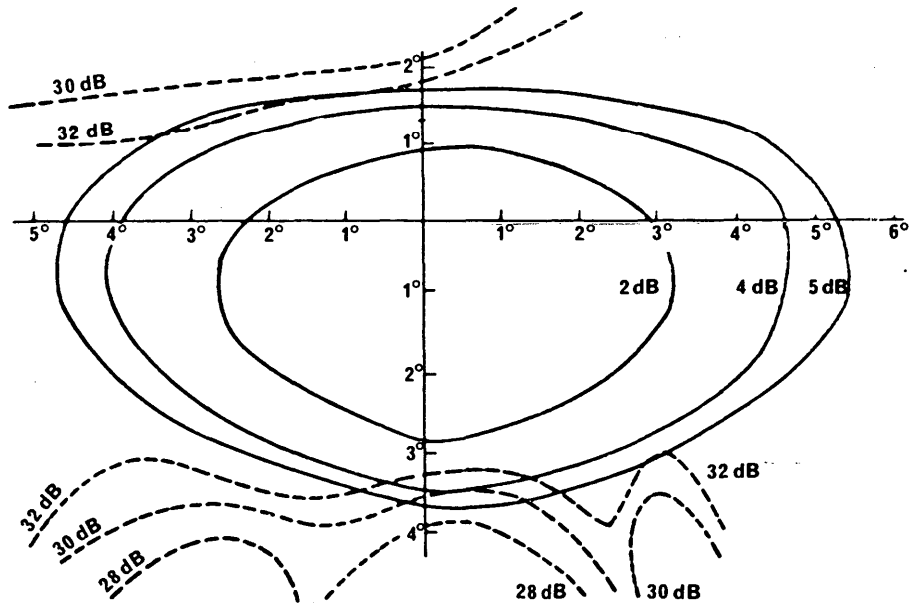

b) Port 2

FIGURE 19 - Contour plots for circularly polarized offset-fed antenna (values in dB)

- Co-polar isolines
- - - - - Polarisation isolation isolines

Frequency: 11.8 GHz
 Design BW (3 dB): $7.5^\circ \times 4.25^\circ$
 Measured peak gain: 28.8 dB

REFERENCES

- GANS, M. J. [March, 1976] Cross-polarization in reflector-type beam waveguides and antennas. *BSTJ*, Vol. 55, 3, 289-316.
- GANS, M. J. and SEMPLAK, R. A. [September, 1975] Some far-field studies of an offset launcher. *BSTJ*, Vol. 54, 7, 1319-1340.
- HAIDLE, L. L. and FITZGERRELL, R. G. [May, 1977] Hemispherical power gain pattern measurements at 7.5 GHz. *IEEE Trans. Ant. Prop.*, Vol. AP-25, 3, 373-376.
- MIZUGUTCH, Y., AKAGAWA, M. and YOKOI, H. [October, 1976] Offset dual reflector antenna. IEEE Antennae and Propagation Society (AP-S) International Symposium, Mass., USA.
- POPOVIĆ, B. [1975] Cross-polarization effects due to a water film on a Cassegrain reflector in frequency range 10 to 30 GHz. COST/TELECOM 2/TD 30/75. Faculty of Electrical Engineering, Belgrade, Socialist Federal Republic of Yugoslavia.
- POPOVIĆ, B. [1976] Off-axis cross-polarization due to a water film on reflector surfaces of a Cassegrain antenna. COST/TELECOM 2/TD 36/76, Faculty of Electrical Engineering, Belgrade, Socialist Federal Republic of Yugoslavia.
- RUDGE, A. W. and ADATIA, N. A. [1975] New class of primary-feed antennae for use with offset parabolic-reflector antennae. *Electron. Lett.*, Vol. 11, 597.
- WATANABE, F. and MIZUGUTCH, Y. [1983] An offset spherical tri-reflector antenna. *Trans. Inst. Electron. Comm. Engrs. Japan*, Vol. E66, 2.

BIBLIOGRAPHY

- SHKAROFSKY, I. P. and MOODY, H. J. [September, 1976] Performance characteristics of antennae for direct broadcasting satellite systems including effects of rain depolarization. *RCA Rev.*, Vol. 37, 3, 279-319.

CCIR Documents

- [1978-82]: 4/269 (Japan); 4/280 (Netherlands); 4/308 (INTELSAT); 4/327 (Germany (Federal Republic of)).

ANNEX II

DEPOLARIZATION MEASUREMENT OF EARTH-STATION ANTENNA

1. Choice of measurement methods using satellite source

If the satellite source has high purity polarization, the direct isolation method can be employed. In the case where the satellite has poor polarization performance, the measurement will become less accurate because of the satellite depolarization effect. The polarization reference antenna is required to eliminate the uncertainty caused by the satellite depolarization.

Both methods have been found feasible in practice. Figure 20 shows the criteria of choosing the measurement methods; the direct isolation method or the reference antenna method.

2. Considerations on the reference antenna method

An accurate polarization measurement was developed [DiFonzo and Trachtman, 1978], using a polarization reference antenna and a polarization matching network in which the signal null at one of the orthomode transducer ports is searched to determine the polarization state. This method may be referred to as the "null method".

The "phase-amplitude method" more recently developed [Sato and Makita, 1980] proved its effectiveness for the measurement of polarization axial ratios as small as 0.2 dB on large aperture antennas. The comparison of the null and phase-amplitude methods is shown in Table II.

The phase-amplitude method using a polarization reference antenna is considered to be a preferable and practicable method for the accurate polarization measurement of large aperture antenna.

Figure 21a shows the receive depolarization measurement configuration using the "phase-amplitude method". A carrier signal f_1 is transmitted from an earth station in order to obtain a satellite signal f_2 which is used for the receive depolarization measurement of the earth station. By the phase-amplitude detection of two received signals at the orthogonal transducer ports of the antenna, the overall down-link depolarization is obtained. The receive depolarization characteristics of the antenna concerned can be derived from the measured overall down-link depolarization subtracted by the transmit satellite depolarization vector. This vector can be obtained by the measurement using the polarization reference antenna with the feed assembly rotated by 90°. Figure 21b shows the transmit depolarization measurement configuration using the "phase-amplitude method". A carrier signal f_1 and the bi-phase modulated $f_1 \pm \Delta f$ are transmitted from the earth station in two orthogonal circular polarizations. The cross-polarization component caused by the up-link depolarization is contained in the looped-back co-polarization signal $f_2 \pm \Delta f$. The cross-polarization signal can be separated from the co-polarization signal by the phase-amplitude detection, since the signals of f_1 and $f_1 \pm \Delta f$ are correlated, and the overall up-link depolarization is obtained. By similar procedure to the receive depolarization measurement, the transmit depolarization of the antenna concerned can be derived by use of the polarization reference antenna.

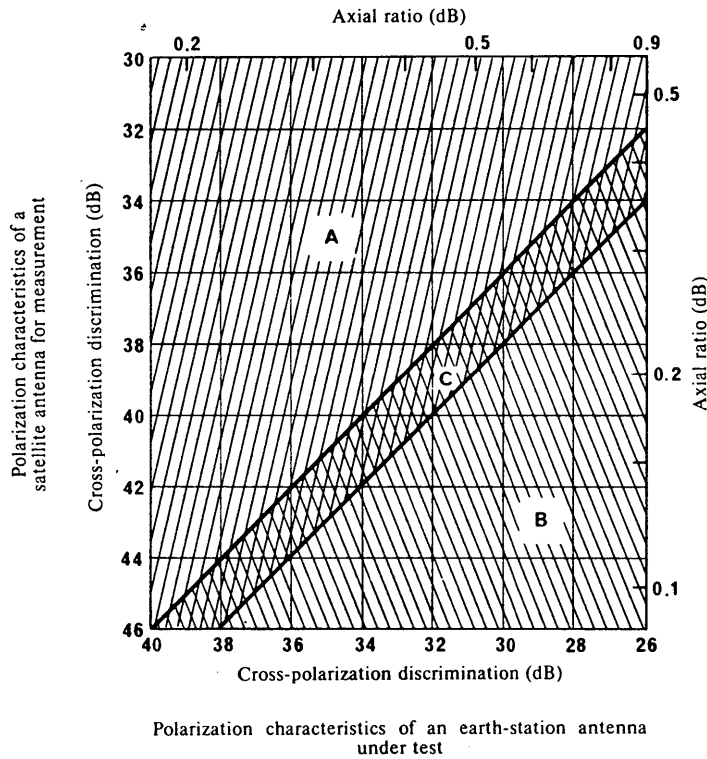
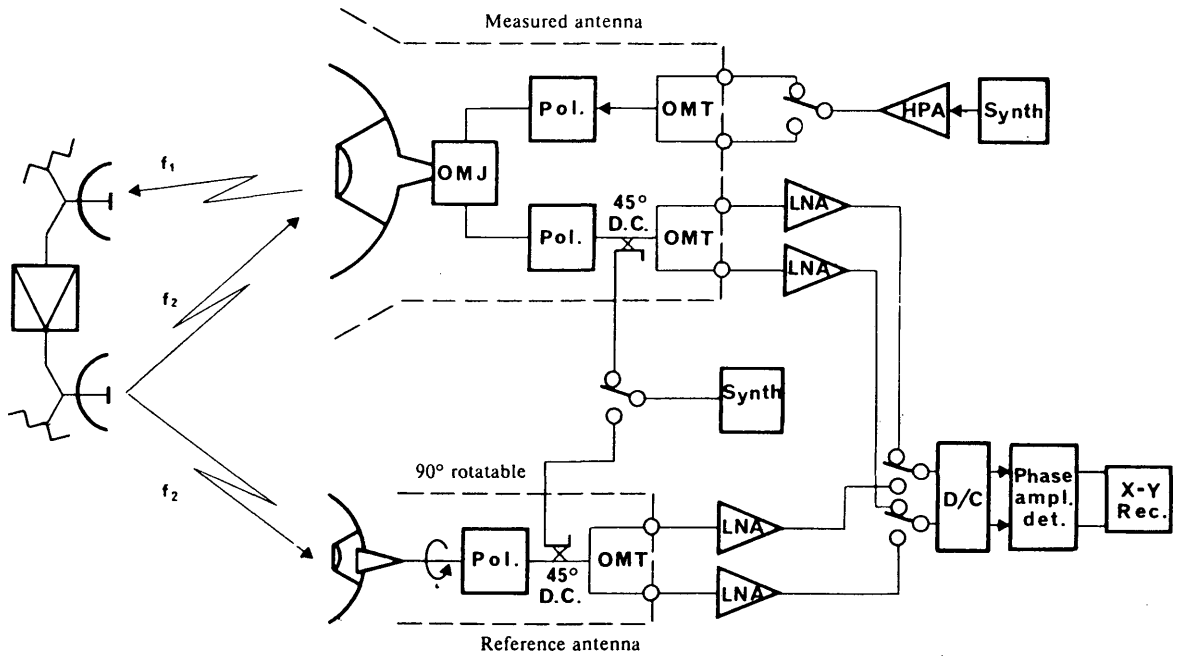

FIGURE 20 – Criteria of using either direct isolation method or reference antenna method

- A: reference antenna method
- B: direct isolation method
- C: grey area

TABLE II – Comparison of null method and phase-amplitude method

	Null method	Phase-amplitude method
Advantages	<p>Signal generator and detector are simple</p> <p>Polarization state (axial ratio and orientation) can be easily obtained by reading the angles of polarizers</p>	<p>Only electric signal processing can bring an accurate result</p>
Disadvantages	<p>It is very difficult to replace a large feed assembly with the polarization matching network</p> <p>It is impossible to measure overall performance of an antenna system. (The feed assembly is excluded from the measured components by this method)</p>	<p>45° directional couplers are required in the feed assembly of the measured antenna</p> <p>High-performance phase-amplitude detector is required</p>



a) Receive depolarization measurement

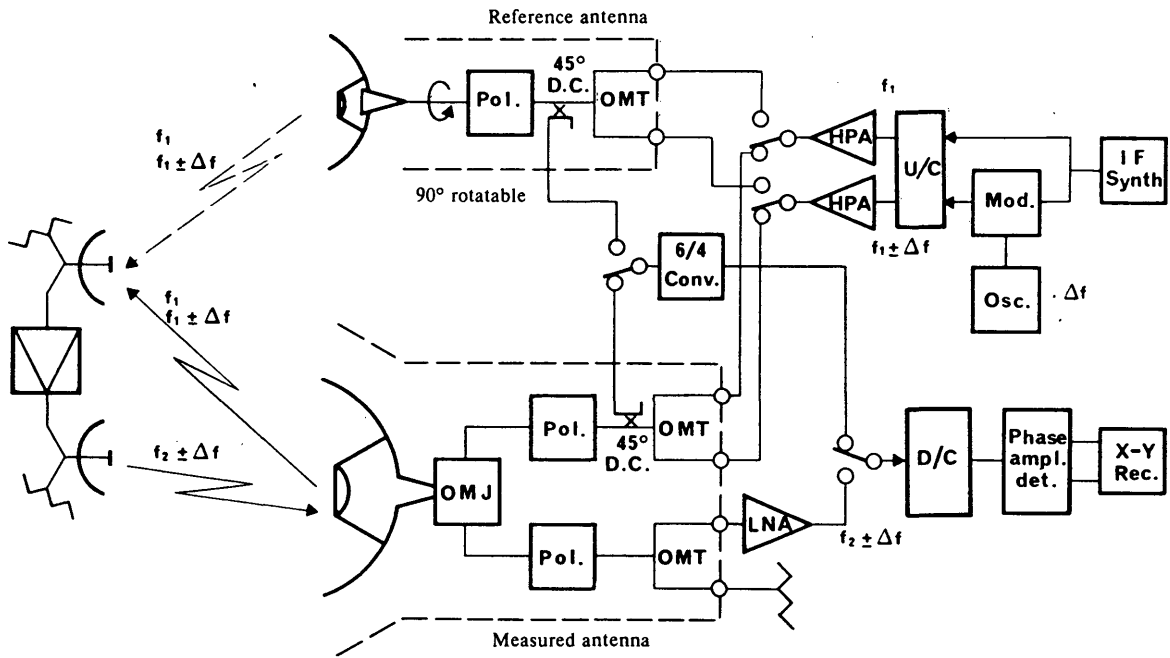

b) Transmit depolarization measurement

FIGURE 21 — Depolarization measurement configuration of earth-station antenna

- | | |
|----------------------------|----------------------------|
| OMJ : orthomode junction | D.C. : directional coupler |
| OMT : orthomode transducer | D/C : down converter |
| Pol. : polariser | U/C : up converter |
| HPA : high power amplifier | Rec. : recorder |
| LNA : low noise amplifier | |

REFERENCES

- DiFONZO, D. F. and TRACHTMAN, W. S. [Spring, 1978] Antenna depolarization measurements using satellite signals. *COMSAT Tech. Rev.*, Vol. 8, 1, 155-185.
- SATOH, T. and MAKITA, F. [1980] Measurement method of earth station and antenna polarization characteristics. IEEE Antennas and Propagation Society (AP-S)/URSI International Symposium, Quebec, Canada, A/J.5-1.
-

REPORT 1141

POLARIZATION DISCRIMINATION IN INTERFERENCE CALCULATION
(Study Programmes 28A/4, 1B/4 and 1C/4)

1. Introduction

(1990)

An effective method for increasing the capacity of satellite networks and, hence, the GSO is through the use of orthogonal polarisations. Possible implementations of this concept include:

- i) frequency re-use within the main beams of satellite and earth station antennas;
- ii) on adjacent satellites, permitting closer satellite spacing;
- iii) on neighbouring or overlapping satellite spot beams to reduce interference;
- iv) in the reduction of interference to low-power links from more powerful links via the same satellite.

However, one of the most important factors in implementing this concept is the cross-polarization discrimination obtainable from the relevant parts of both the satellite and earth station antenna beams and their side lobes, and in different frequencies within the operating band.

While co-polarized and cross-polarized responses have been considered for the BSS to the extent of producing Recommendations (Appendix 30, Radio Regulations), there are, as yet no corresponding Recommendations for the FSS. This Report proposes that the CCIR should gather the information, further to that provided by Report 555, necessary to produce design objectives for the cross-polarized patterns of earth station and satellite antennas, to complement those that have been and are being produced for the co-polarized patterns and thus facilitate the performance of interference calculations for system design and coordination purposes.

A further factor which impacts on the achievability of frequency re-use via orthogonal polarizations in large coverage satellite systems is the geometry of the polarization planes, and this factor is considered in this report.

The detailed estimation of mutual interference between satellite networks requires calculation of the values of polarization discrimination resulting from the use of different or identical polarizations of wanted and interfering systems. The purpose of this report is to show how polarization discrimination between adjacent networks can be estimated, taking into account the mutual geometries of the networks and the polarization plane misalignments as well as the co-to-cross polarization ratios of the earth station and satellite antennas.

2. Performance of satellite antennas

The cross-polarized reference pattern as used in the WARC BSS (SAT-77) down-link plan is given in Appendix 30 to the Radio Regulations. Up to 1989 two types of antenna configuration have been utilised to generate the WARC defined BSS national coverage. These employ elliptical beams and circular polarization. The first was an offset dual reflector system illuminated by a large corrugated horn with either a circular or elliptical aperture. The second a multi-element array fed single offset reflector. The inherently good polarization purity associated with the corrugated feed horn led to an overall cross-polarization performance which satisfied the WARC (SAT-77) requirements with up to a 5 dB margin. These requirements include 38 dB XPD on axis and 20 dB at beam edge, with positive values out to 10 beamwidths off-axis. With the second configuration, mutual coupling of the smaller feed elements led to a poor cross-polar performance. However, with careful tuning of the array this configuration could also meet the specification but with a smaller margin.

For the FSS, specifications of the cross-polarized component of the radiation characteristics have until now only been applied inside the coverage zone. Outside this region no significant studies have been performed and hence very little information is available. For FSS frequency reuse systems, the co-to-cross polarization ratio within the main beam (usually defined by the -4 dB contour) has been constrained to a value of 30 - 35 dB for both circular and linear polarization. In respect to the dual offset reflector configurations using circular polarizations this is generally achievable. However, in the case of the multi-element array fed single offset reflector with linear polarizations, it is necessary to overcome the poor polarization purity resulting from the asymmetrical reflector geometry. This requires a much more complex design, using dual-gridded reflectors with different foci for the feed arrays associated with each polarization.

3. Performance of earth station antennas

The co- and cross-polarized radiation templates as used in the WARC BSS (SAT-77) down-link plan for receiving earth station antenna are also given in Appendix 30 to the Radio Regulations. Linearly polarized single offset antennas have no difficulty in meeting these templates, which call for XPDs of 25 dB on axis, 11 dB at beam edge, and positive values out to 7 beamwidths off-axis.

For FSS applications, the co-polarized reference pattern is generally given by CCIR Recommendation 580 which states that 90% of transmit side lobe levels should be below $29 - 25 \log \varphi$ (dBi) for angles of φ between 1° and 20° . No maximum level for cross-polarized side lobes is given. In contrast recent United States Regulations stipulate a containment within the envelope given by $19 - 25 \log \varphi$ from 1.8° to 7° and -2 dBi from 7° to 9.2° . Previous work [Claydon, B. *et al.*, 1985] which was based on rather limited information and computer predictions, suggested that a suitable reference curve for cross-polarized levels of antennas optimized for transmit might be:

transmit	20 - 21 log φ dBi	$1^\circ < \varphi \leq 46^\circ$.. (1)
	-15 dBi	$\varphi > 46^\circ$	
receive	23.6 - 20 log φ dBi	$1^\circ < \varphi \leq 48^\circ$.. (2)
	-10 dBi	$\varphi > 48^\circ$	

Since then, further measured information on both axisymmetric and offset antennas has been made available and is discussed below.

Cross polarized radiation pattern measurement results outside the main beam were investigated for:

- a) A 3.7 m axisymmetric 14 GHz Cassegrain antenna in the worst-case (diagonal) plane. This did not meet the United States cross-polarized contour in the region affected by sub-reflector support struts.
- b) A 4.57 m axisymmetric 14 GHz compact Cassegrain antenna in which both reflectors are shaped and the feed and sub-reflector form an integrated unit. This met the United States cross-polarized contour with a margin of 10 dB although the results of the worst-case planes were not available.
- c) A 3.5 m dual offset 14 GHz Gregorian antenna in the worst-case plane. This met the United States cross-polarized contour by a 5 to 10 dB margin. Figure 2 illustrates the United States co- and cross-polarized contours, the United Kingdom [Claydon, B., et al., 1985] cross-polarized contour (transmit), and the measured contour of antenna c) above.
- d) Four axisymmetric 12 GHz antennas of French origin with XPDs (i.e. co-to-cross polarized gain ratios ($D_p(\varphi)$)dB) as follows:

Diameter (M)	On Axis XPD (dB)	Angular range for which XPD > 0 dB
1.2	23.5	24 deg.
1.8	24.0	21 deg.
2.4	26.0	14 deg.
3.5	29.0	14 deg.

The measured and envelope patterns are given in Annex II.

4. Orientation of polarization planes

It is possible to orient the polarization plane of a receive (linearly polarized) satellite or earth station antenna for two different optimum conditions, one to minimize clear-sky interference from an orthogonally polarized signal and the other to minimize the effects of depolarization due to rain. The means of calculating the optimum alignments in the two cases are described in Annex I.

5. Estimation of polarization discrimination

5.1 Definition of the polarization of a wave

The polarization vector of a wave is located in a plane orthogonal to the direction of the wave propagation.

Generally, this vector describes an ellipse. Two particular cases arise, firstly circular polarization where the two axis of the ellipse are equal, secondly linear polarization where one of the axes is zero.

If the radiated wave is linearly polarized, two orthogonal polarization planes exist, each polarization vector keeping a fixed direction.

If the radiated wave is circularly polarized, right and left hand rotations exist.

5.2 Case of linear polarization

Definition of polarization angle and of relative alignment angle.

The polarization angle ϵ is the angle between the vertical plane including the propagation direction (pointing of the earth station towards the satellite) and the polarization plane of the linearly polarised wave transmitted by the satellite or by the earth station pointed towards the satellite.

The relative alignment angle β is, in linear polarization, the angle between:

- the planes of polarization of the wanted and interfering signals (index 1 and 2);
- or the plane of polarization of the received signal and the plane of polarization of the receiving antenna.

In the co-polarized case, the angle β is given by:

$$\beta = |\epsilon_1 - \epsilon_2| + \delta \text{ with } \delta = \text{tolerances}$$

5.3 Definition of polarization decoupling ratio and of discrimination ratio

The ratio of polarization decoupling $D_p(\varphi)$ of an earth station or a satellite antenna is the ratio of the field component in the wanted polarization to the field component in the orthogonal polarization. φ is the angle between the directions of wanted and interfering signals. The discrimination ratio Y of a receive antenna is the ratio of the received power of the two waves of different direction and polarization.

5.4 Calculation of discrimination factor Y in linear polarization

5.4.1 Calculation of polarization discrimination Y_d in down link

The purpose of this calculation is to determine, in case of a wanted receiving earth station, the discrimination with respect to an interfering wave. Earth station radiation patterns have been established for co- and cross-polarization planes using experimental data.

The polarization angles are calculated for wanted and interfering signals using the coordinates of the 2 pointing directions of wanted and interfering satellite antennas and the coordinates of the reference earth station.

The derived value of discrimination Y_d takes into account the co-polarized wave coming from the interfering satellite, received by the earth station receiver (co-polarized $A_{//}(\varphi)$ and cross-polarized $A_{+}(\varphi)$ patterns).

The cross-polarized wave coming from the interfering satellite intercepted by the co-polarized pattern of the station is also taken into account. However, the additional isolation afforded by the ratio of crossed polarization transmit-to-crossed polarization receive may be neglected.

$$Y_d = -10\log(\cos^2\beta + \sin^2\beta \cdot 10^{-D_p(\varphi_b)/10} + \sin^2\beta \cdot 10^{-D_{p\text{ sat}}/10}) \text{ dB} \quad (3)$$

where:

φ_b is the topocentric separation between satellites

$D_p(\varphi_b)$ is the polarization decoupling of the wanted earth station:

$$D_p(\varphi_b) = A_{//}(\varphi_b) - A_{+}(\varphi_b) \text{ in dB}$$

$D_{p\text{ sat}}$ is the polarization decoupling (in dB) of the interfering satellite in the coverage area where the wanted station is located.

5.4.2 Calculation of the polarization discrimination Y_u in up link

The purpose of this calculation is to determine on a similar way to the preceding section, for a receive antenna of the wanted satellite, the discrimination Y_u with respect to an interfering wave in dB:

$$Y_u = -10\log(\cos^2\beta + \sin^2\beta \cdot 10^{-D_p(\psi_b)/10} + \sin^2\beta \cdot 10^{-D_{p\text{ st}}/10}) \text{ dB} \quad (4)$$

where:

ψ_b is the angle between the main radiation direction and the direction of interfering earth station.

$D_p(\psi_b)$ is the polarization decoupling of the wanted space station

$$D_p(\psi_b) = S_{//}(\psi_b) - S_{+}(\psi_b) \text{ in dB}$$

$S_{//}$ and S_{+} are the co-polarized and cross-polarized patterns of the wanted satellite antenna.

$D_{p\text{ st}}$ is the polarization decoupling (in dB) of the interfering earth station.

5.5 Calculation of discrimination factor in case of 2 polarizations, one circular, the other linear

In the case of an interfering wave in linear polarization (the linear polarization vector can be derived from two circular polarization vectors, right and left hand rotation), the discrimination obtained at the receive wanted antenna operating in circular polarization can be expressed in a way similar to above:

$$Y = -10 \log \frac{1}{2} (1 + 10^{-D_p(\varphi)/10}) \text{ dB} \quad (5)$$

where:

$D_p(\varphi)$ is the polarization decoupling of the receive antenna, in dB.

Similarly, in case of an interfering wave in circular polarization (the circular polarization vector can be composed of two orthogonal linear polarization vectors), the discrimination obtained at the receive wanted antenna operating in linear polarization is described by the same formula.

5.6 Application to actual cases

From the above relationships, the calculation of the polarization discrimination in various cases permits estimation of the improvement obtained in interference calculations. In particular the use of a polarization orthogonal to the one of the interference may be considered. These relationships do not take into account the effects of propagation conditions on the signal polarization plane; these are included in Annex I.

6. Effect of polarization plane geometry

Some fixed satellites at 6/4 GHz and many at 14/11 GHz utilize linear polarization. At 14/11 GHz and above where atmospheric conditions begin to affect propagation, the orientation of polarization would normally be chosen to minimize these effects. However, due to the curvature of the Earth, this optimization typically applies only to a portion of the service area as illustrated by the example in Fig. 1 below.

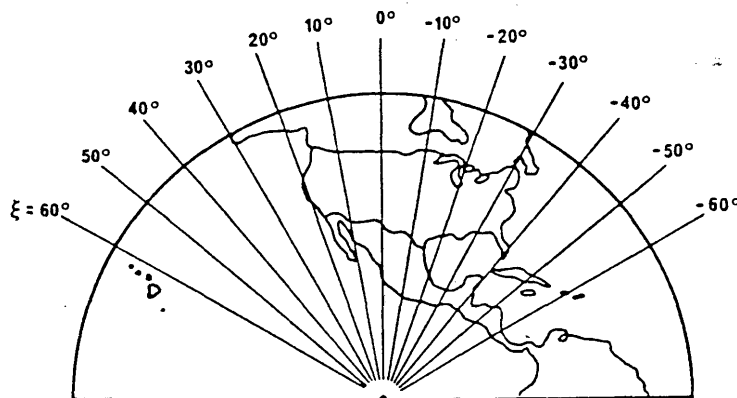

FIGURE 1 - Contours of constant polarization orientation ξ with respect to the plane containing the local vertical; satellite at 105° W longitude radiating linear polarization in the meridian plane

A graded polarization scheme for a large service area is feasible if, as is typically the case, the satellite antenna has multiple feeds. Such a scheme would maintain the polarization orientation close to optimum over the whole service area. The optimum orientation to minimize interference is, in general, different from the optimum orientation for minimum propagation degradation.

Modelling of the depolarization due to hydrometeors is covered ~~in Report 722~~ in Report 722. This report deals with the calculation of the angle between polarization planes due to the relative geometry of a pair of satellites and their corresponding service areas.

7. Conclusions

7.1 Insufficient information is currently available to adequately characterize the cross-polarized performances of either earth station or satellite antennas in the FSS, although reference patterns have been set for the BSS and antennas exist which meet them. In view of the protection against interference which would be afforded by antennas with good co-to-cross polar ratios in beam and reliable and positive ratios outside the main beam, further evidence is required by the CCIR to enable cross polar reference patterns for earth stations and satellites in the FSS to be established.

7.2 Equations whereby the overall polarization discrimination may be calculated, taking into account antenna performance and the geometrical factors, have been given.

7.3 A means of calculating the optimum alignment of antenna polarization planes has been shown for two possible orientations of a linearly polarized transmission. One orientation yields minimum propagation effects, while the other orientation minimizes mutual interference for a particular condition of rain depolarization.

REFERENCES

CLAYDON, B. EVANS, B.G. and HANSELL, P. [1985] "Preferred antenna polarization of satellite networks", Final Report, ERA Report No. 85-0085.

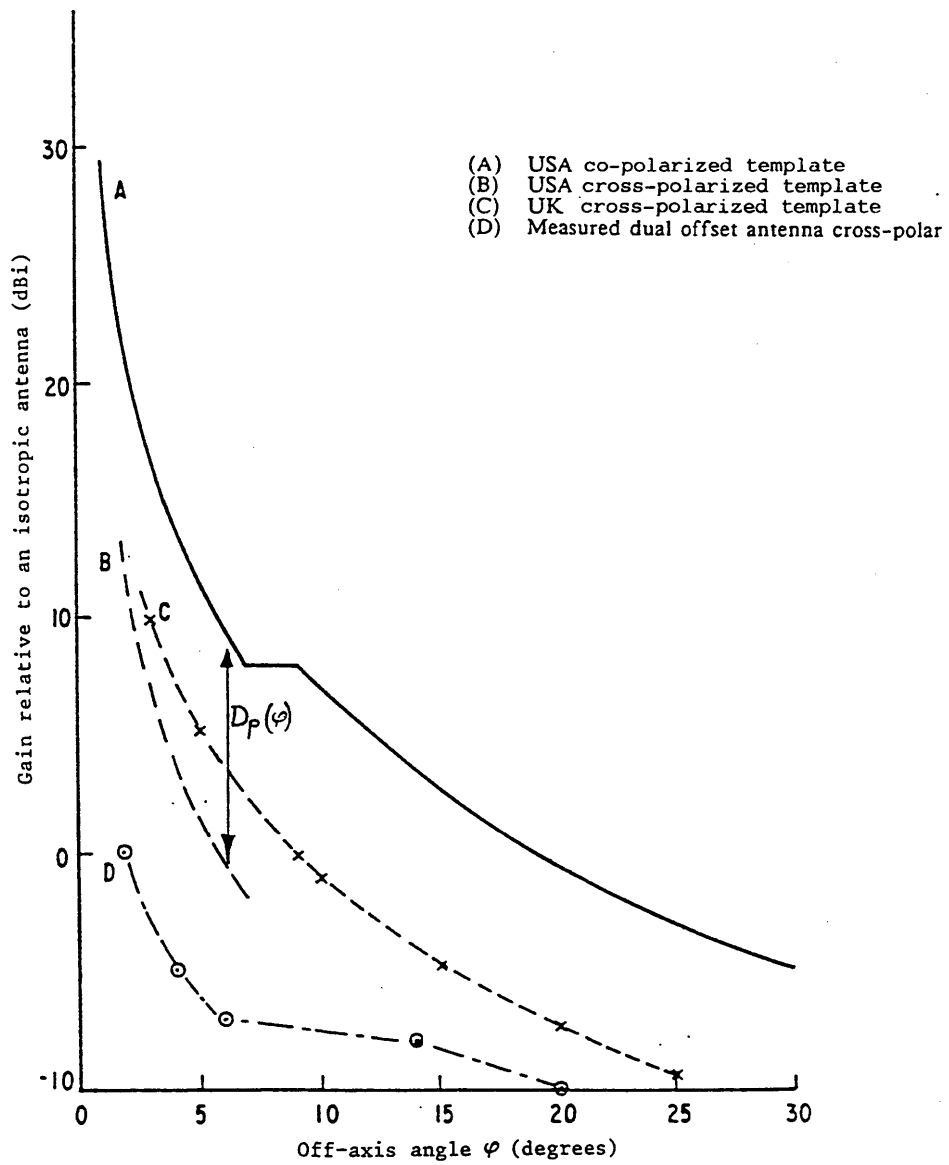

FIGURE 2
Summary of cross-polarization radiation templates

ANNEX I

OPTIMIZATION OF POLARIZATION ORIENTATION

1. Simple model of a satellite-Earth link

The satellite-to-Earth (or the Earth-to-satellite) link has been extensively analysed by several researchers; some typical analyses of depolarization effects are given in [Hogg and Chu, 1975; Shkarofsky, 1977 and Spellam, 1977]. In particular [Shkarofsky, 1977] gives a mathematical procedure which takes into account all known contributions to depolarization. The formulations in these references are however extremely complex and cumbersome. A simplified model, suitable for use in a first order analysis of interference; is given in Report 633. This model uses the concept of equivalent gain of a partial link (i.e. either the Earth-to-space or the space-to-Earth connection) thus:

The equivalent gain (as a power ratio) for one partial link can be represented by the following approximation:

$$\begin{aligned}
 G &= G_1 \cdot \cos^2 \beta + G_2 \cdot \sin^2 \beta \\
 G_1 &= G_{ip} \cdot G_{rp} \cdot A + G_{ic} \cdot G_{rc} \cdot A + G_{ip} \cdot G_{rc} \cdot A \cdot X + G_{ic} \cdot G_{rp} \cdot A \cdot X \\
 G_2 &= \left(\sqrt{G_{ip} \cdot G_{rc} \cdot A} + \sqrt{G_{ic} \cdot G_{rp} \cdot A} \right)^2 + G_{ip} \cdot G_{rp} \cdot A \cdot X + G_{ic} \cdot G_{rc} \cdot A \cdot X
 \end{aligned} \tag{1}$$

where:

- β : relative alignment angle, for linear polarization, between the received signal polarization plane and the plane of polarization of the receive antenna, and:
- G_{ip} : co-polar gain characteristic of the transmit antenna expressed as a power ratio (Recommendations 465 and 580, Reports 390 and 391 for earth stations, Report 558 for satellites),
- G_{ic} : cross-polar gain characteristic of the transmit antenna expressed as a power ratio (Report 555),
- G_{rp} : co-polar gain characteristic of the receive antenna expressed as a power ratio (Recommendations 465, 580 and Reports 390, 391 and 558),
- G_{rc} : cross-polar gain characteristic of the receive antenna expressed as a power ratio (Report 555),
- A : rain fade as a power ratio ≤ 1 (Report 564),
- X : rain depolarization as a power ratio ≤ 1 (Report 722).

The following sections give derivations for the angle, β , for the two scenarios:

- polarization aligned to minimize effects of rain fade, and
- polarization aligned to minimize interference.

Using the equivalent gain concept, the wanted carrier power, C , or the single-entry interfering power, I , on each partial link is simply given by:

$$C \text{ (or } I) = P_T - L_{FS} - L_{CA} + 10 \log G \quad \text{dBW} \tag{2}$$

where:

- P_T : wanted (interfering) transmitting antenna power (dBW),
- L_{FS} : free-space loss on the wanted (interfering) link (dB),
- L_{CA} : clear-air absorption on the wanted (interfering) link (dB),
- G : equivalent gain on the wanted (interfering) link (dB).

2. Polarization orientation to minimize interference due to rain depolarization

As illustrated in Fig.1, the apparent polarization plane at the Earth's surface is a function of the geographical coordinates of the boresite, the test point under consideration, and the satellite. Shkarofsky [1977] quotes the following formula for this polarization angle ε :

$$\tan \varepsilon = \frac{\sin \psi_b \cdot \cos \psi_p \cdot \sin (\lambda_p - \lambda_s) - \cos \psi_b \cdot \sin \psi_p \cdot \sin (\lambda_b - \lambda_s)}{\sin \psi_b \cdot \sin \psi_p + \cos \psi_b \cdot \cos \psi_p \cdot \sin (\lambda_b - \lambda_s) \cdot \sin (\lambda_p - \lambda_s)} \quad (3)$$

where:

- ψ : latitude,
- λ : longitude,
- b : boresight,
- p : test point,
- s : satellite.

In the above it is assumed that the polarization plane is optimized for minimum rain fade at the boresight, i.e. aligning with either the local horizontal or the local vertical. In functional form, equation (3) may be rewritten:

$$\varepsilon = f(\psi_b, \lambda_b, \psi_p, \lambda_p, \lambda_s)$$

To determine the interference component at test point, p , the difference in polarization angles is required.

Thus, if the wanted and interfering signals are "co-polar", the angle, β , in equation (1) may be expressed as:

$$\beta = |\varepsilon_1 - \varepsilon_2| + \delta \quad (4)$$

where:

$$\varepsilon_1 = f(\psi_{b_1}, \lambda_{b_1}, \psi_p, \lambda_p, \lambda_{s_1}),$$

$$\varepsilon_2 = f(\psi_{b_2}, \lambda_{b_2}, \psi_p, \lambda_p, \lambda_{s_2}),$$

b_1 : boresight of wanted satellite s_1 ,

b_2 : boresight of interfering satellite s_2 ,

δ : allowance for misalignment of earth-station antenna and rotational tolerances of satellite beams.

If the wanted and interfering signals are "cross-polar" the angle β_x in the worst case, is:

$$\beta_x = \frac{\pi}{2} - \varepsilon_1 - \varepsilon_2 - \delta \quad (5)$$

Under some circumstances the distinction between co-polar and cross-polar may be academic. Thus for the purposes of this analysis the following definition will be assumed:

if both wanted signals are aligned to the respective local horizontals or both are aligned to the respective local verticals, they will be considered co-polar.

3. Polarization orientation to minimize clear-sky interference

Minimum interference occurs when the polarization planes at the satellite orbit are orthogonal, i.e. when the polarization planes are either in the equatorial plane or in the plane of the Earth's North-South axis. Report 814 gives the following formula for the angle of polarization, ε' , when the polarization vector of the transmitted wave is parallel to the equatorial plane:

$$\tan \varepsilon' = \frac{\sin (\lambda_p - \lambda_s)}{\tan \psi} \sqrt{1 + \left(\frac{a \sin \xi}{1 - a \cos \xi} \right)^2} \quad (6)$$

$$\cos \xi = \cos (\lambda_p - \lambda_s) \cdot \cos \psi_p$$

a : radius of earth divided by radius of orbit ≈ 0.151

Thus, in functional form:

$$\epsilon' = g(\psi_p, \lambda_p, \lambda_s)$$

When the wanted and interfering signals are "co-polar", i.e. when both have polarization planes parallel to the equatorial plane or when both are perpendicular to the equatorial plane, the relative angle, β , between wanted and interfering polarization planes is given by:

$$\beta = |\epsilon'_1 - \epsilon'_2| + \delta \tag{7}$$

where:

$$\epsilon'_1 = g(\psi_p, \lambda_p, \lambda_{s_1})$$

$$\epsilon'_2 = g(\psi_p, \lambda_p, \lambda_{s_2})$$

s_1 : wanted satellite,

s_2 : interfering satellite.

Similarly when the two signals are cross-polar, the relative angle β_x is given by:

$$\beta_x = \frac{\pi}{2} - \epsilon'_1 - \epsilon'_2 - \delta \tag{8}$$

The variation of ϵ' is given in Fig. 3.

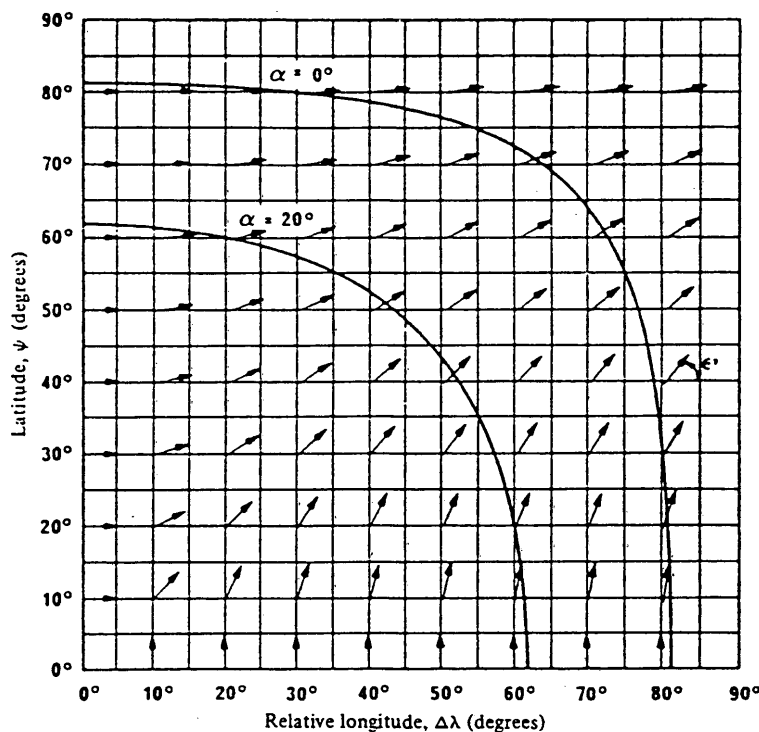

Figure 3 - Variation of received angle of polarization on the Earth

α : angle of elevation

REFERENCES

HOGG, D. C. and CHU, T. S. [September, 1975] The role of rain in satellite communications. *Proc. IEEE*, Vol. 63, 9, 1308-1331.
 SHKAROFSKY, I. P. [June, 1977] Depolarization due to precipitation in satellite communications. *RCA Rev.*, Vol. 38, 2, 257-309.
 SPELLMAN, M. [November, 1977] Lower crosspole levels for safe frequency re-use. *Microwaves*.

ANNEX II

MODELLING OF EARTH STATION ANTENNA CROSS-POLARIZED CHARACTERISTICS

This annex presents cross-polarized templates obtained from pattern measurements (CNET/La Turbie) of different diameter antennas (1.2 m, 1.8 m, 2.4 m, 3.5 m and 3.7 m at 12.625 GHz). For each antenna type, a measured and an envelope pattern are described.

In order to estimate the worst-case discrimination factor γ co-polarized $g_u(\varphi)$ and cross-polarized $g_+(\varphi)$ pattern envelopes have been obtained for the antennas given above.

a) In co-polarization, for the main lobe area where $\varphi < \varphi_1$ ($\varphi_1 = 1^\circ$ for large stations, $\varphi_1 = 100 \lambda/D$ degrees for small stations) the envelope pattern is extrapolated by a quadratic lobe defined between $g_u(\varphi_1)$ for $\varphi = \varphi_1$ and 0 dB for $\varphi = 0^\circ$.

b) In cross-polarization, no constraint other than the main polarization reference pattern is defined by CCIR. The cross-polarization level is such as $g_+(\varphi) < g_u(\varphi'_1)$ (with $\varphi'_1 = 2 \varphi_1$) for $0^\circ < \varphi < \varphi_1$. The two co- and cross-polarized envelopes are overlapping as they reach the isotropic level ($\varphi \geq \varphi_{ISO}$).

Finally, earth station diagrams have the following envelopes:

1) Small stations ($d < 100\lambda$)

gain = gain of antenna main lobe

$$\varphi_1 = 100\lambda/D \text{ (degrees)}$$

$$g(\varphi) = 52 - 10 \log D/\lambda - 25 \log \varphi - \text{gain}$$

$$\varphi'_1 = 2.2 \varphi_1$$

$$\varphi_2 = 25.1^\circ$$

$$\varphi_{ISO} = 10^{(52 - 10 \log (D/\lambda)/25)} \text{ (degrees)}$$

- for $0 < \varphi < \varphi_1$

$$g_+(\varphi) = g(\varphi'_1) \quad (1)$$

- for $\varphi_1 < \varphi < \varphi_2$

$$g_+(\varphi) = g(\varphi) - [g(\varphi_1) - g(\varphi'_1)] \cdot (\varphi_{ISO} - \varphi) / (\varphi_{ISO} - \varphi_1) \quad (2)$$

(if $\varphi > \varphi_{ISO}$, $g_+(\varphi) = g_u(\varphi)$)

- for $\varphi_2 < \varphi < 180^\circ$

$$g_+(\varphi) = 10 - 10 \log (D/\lambda) - \text{gain} \quad (3)$$

The envelope patterns shown in Figures 4 and 5 are obtained for stations of the following diameters: 1.20 m and 1.80 m at 12.625 GHz. In each case one example of the measured co- and cross-polarized pattern is given, but

the templates shown are averages from measurements on several antennas of the same type.

The measured patterns shown in Figures 4a and 5a are measured in CNET/La Turbie for these types of antennas.

2. Large stations ($d > 100\lambda$)

gain = gain of antenna main lobe

$$\varphi_1 = 1^\circ$$

$$g(\varphi) = 29 - 25 \log \varphi - \text{gain}$$

$$\varphi'_1 = 1.8 \varphi_1$$

$$\varphi_2 = 20^\circ$$

$$\varphi_3 = 26.3^\circ$$

$$\varphi_4 = 33.1^\circ$$

$$\varphi_{\text{ISO}} = 10^{(29/25)} \text{ (degrees)}$$

- for $0 < \varphi < \varphi_1$

$$g_+(\varphi) = g(\varphi'_1) \quad (4)$$

- for $\varphi_1 < \varphi < \varphi_2$

$$g_+(\varphi) = g(\varphi) - [g(\varphi_1) - g(\varphi'_1)] \cdot (\varphi_{\text{ISO}} - \varphi) / (\varphi_{\text{ISO}} - \varphi_1) \quad (5)$$

- for $\varphi_2 < \varphi < \varphi_3$

$$g_1(\varphi) = -3.5 - \text{gain}$$

$$g_+(\varphi) = g_1(\varphi) - [g(\varphi_1) - g(\varphi'_1)] \cdot (\varphi_{\text{ISO}} - \varphi) / (\varphi_{\text{ISO}} - \varphi_1) \quad (6)$$

(if $\varphi > \varphi_{\text{ISO}}$, $g_+(\varphi) = g_w(\varphi)$)

- for $\varphi_3 < \varphi < \varphi_4$

$$g_+(\varphi) = 32 - 25 \log \varphi - \text{gain} \quad (7)$$

- for $\varphi_4 < \varphi < 180^\circ$

$$g_+(\varphi) = -10 - \text{gain} \quad (8)$$

The envelope patterns shown in Figures 6, 7 and 8 are obtained for stations of the following diameters: 2.40 m, 3.50 m and 3.70 m at 12.625 GHz. In each case one example of the co- and cross-polarized measurements is shown, but the templates given were derived from the average of several antennas of the same type.

The measured patterns shown in Figures 6a, 7a, 8a, 6b, 7b and 8b were measured in CNET/La Turbie for these types of antennas.

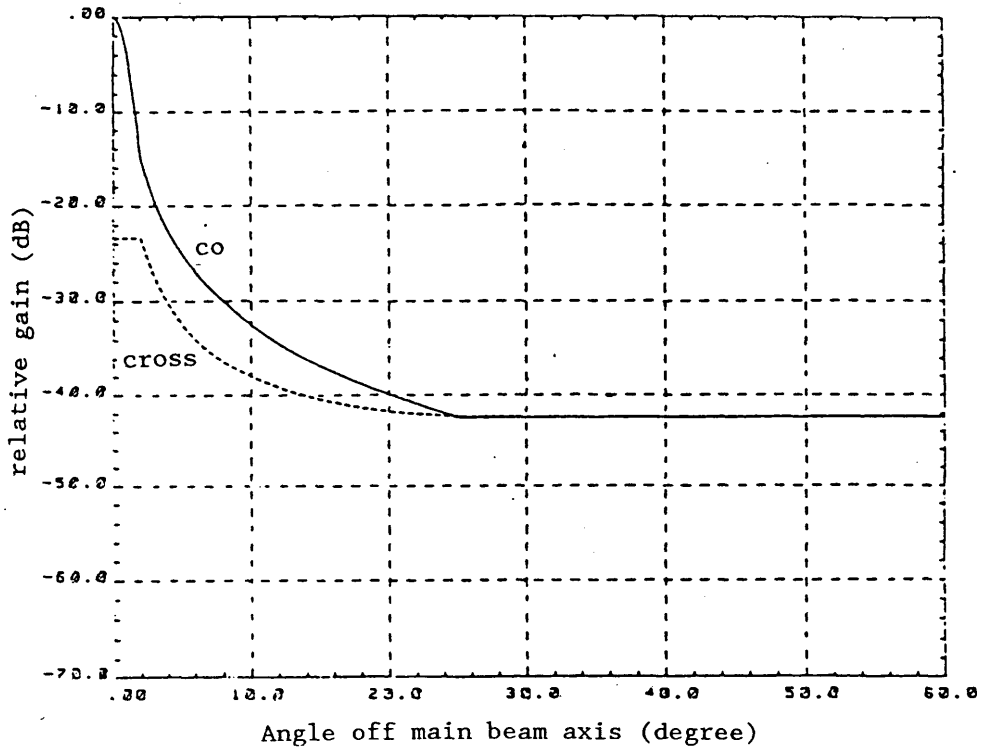

FIGURE 4

1.2 m antenna, f = 12.625 GHz, co- and cross-polarized templates

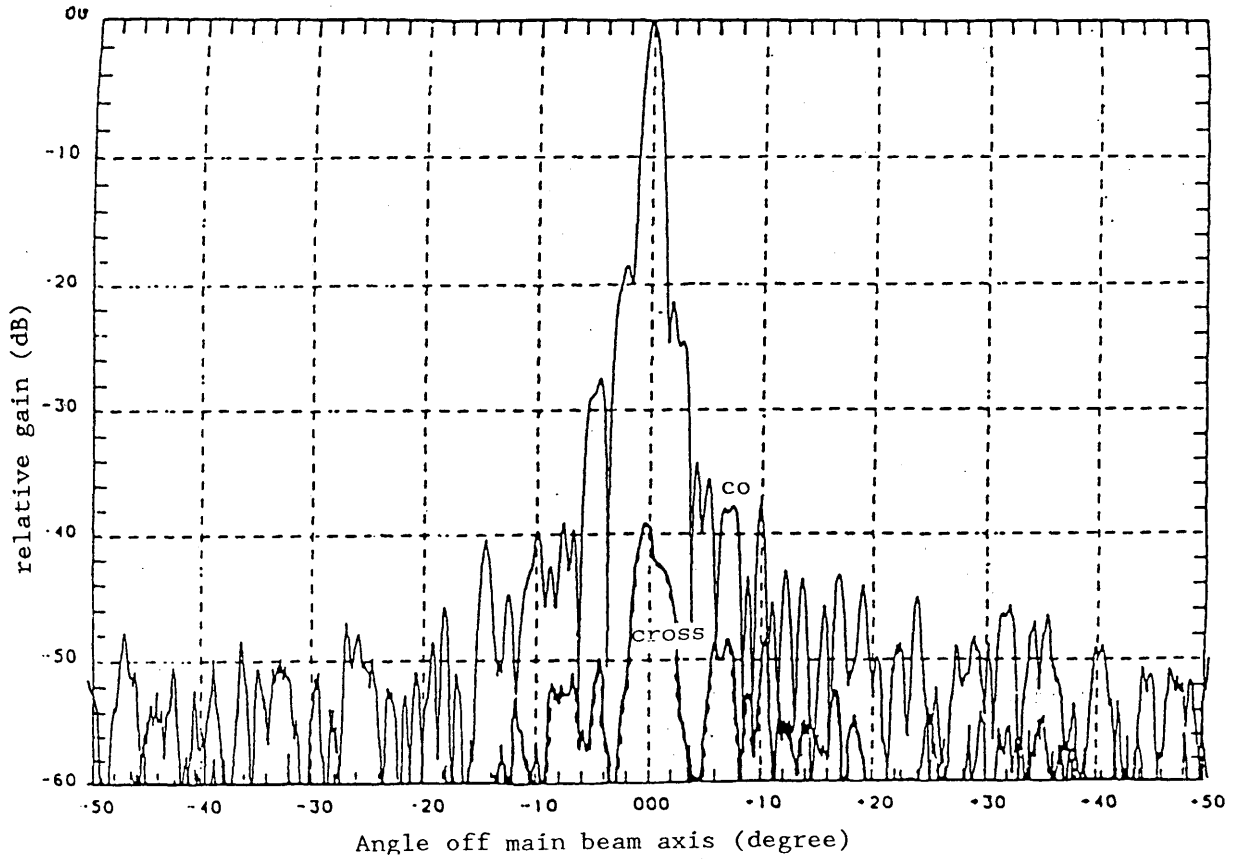

FIGURE 4a

1.2 m antenna, co- and cross-polarized measured patterns

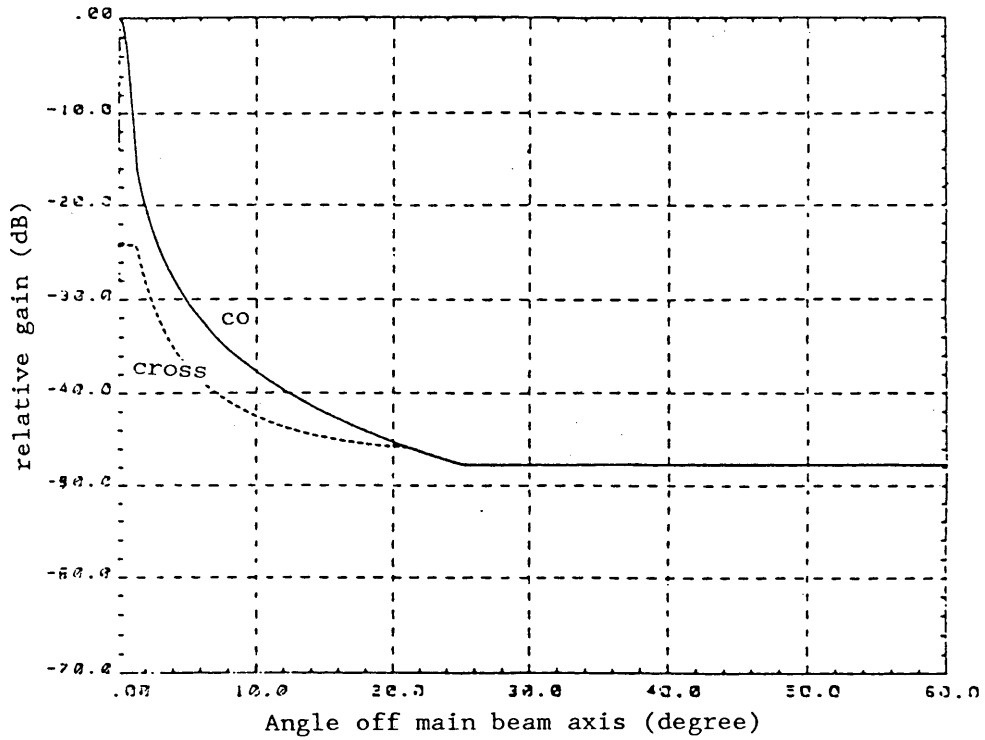

FIGURE 5

1.80 m antenna, f = 12.625 GHz, co and cross-polarized templates

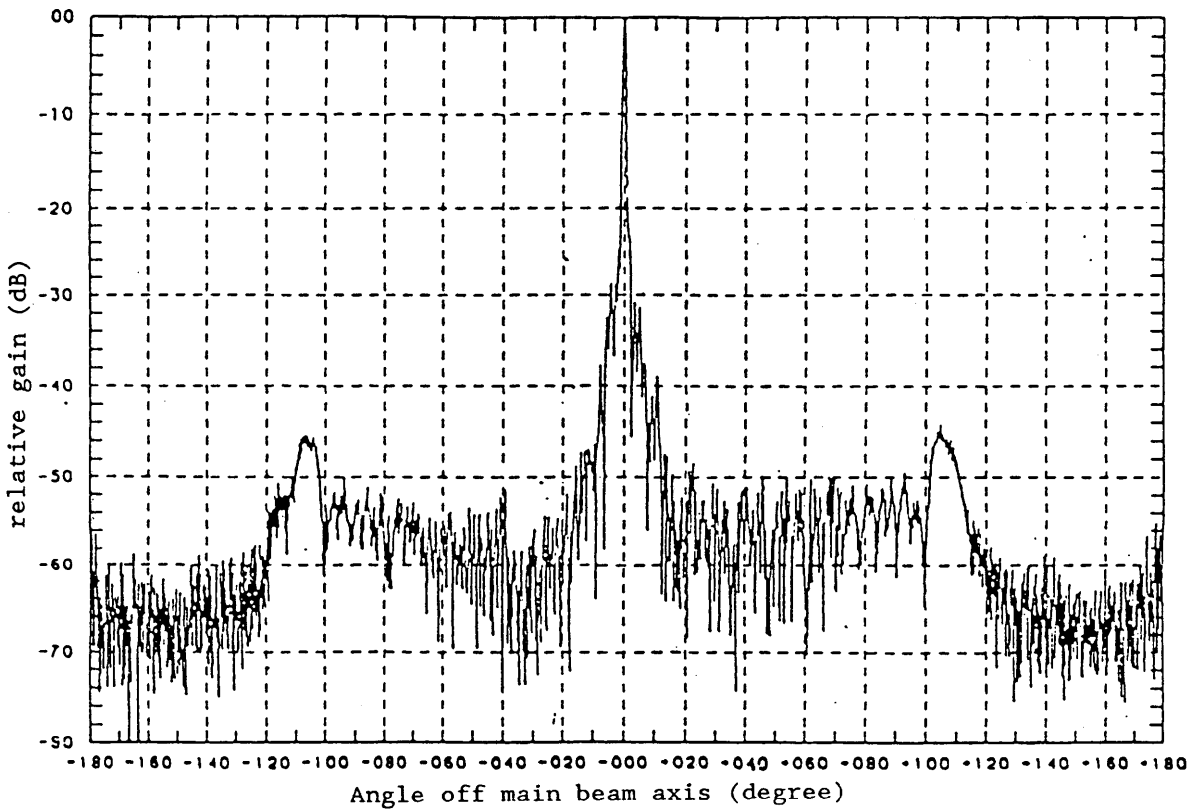

FIGURE 5a

1.80 antenna, co-polarized measured patterns

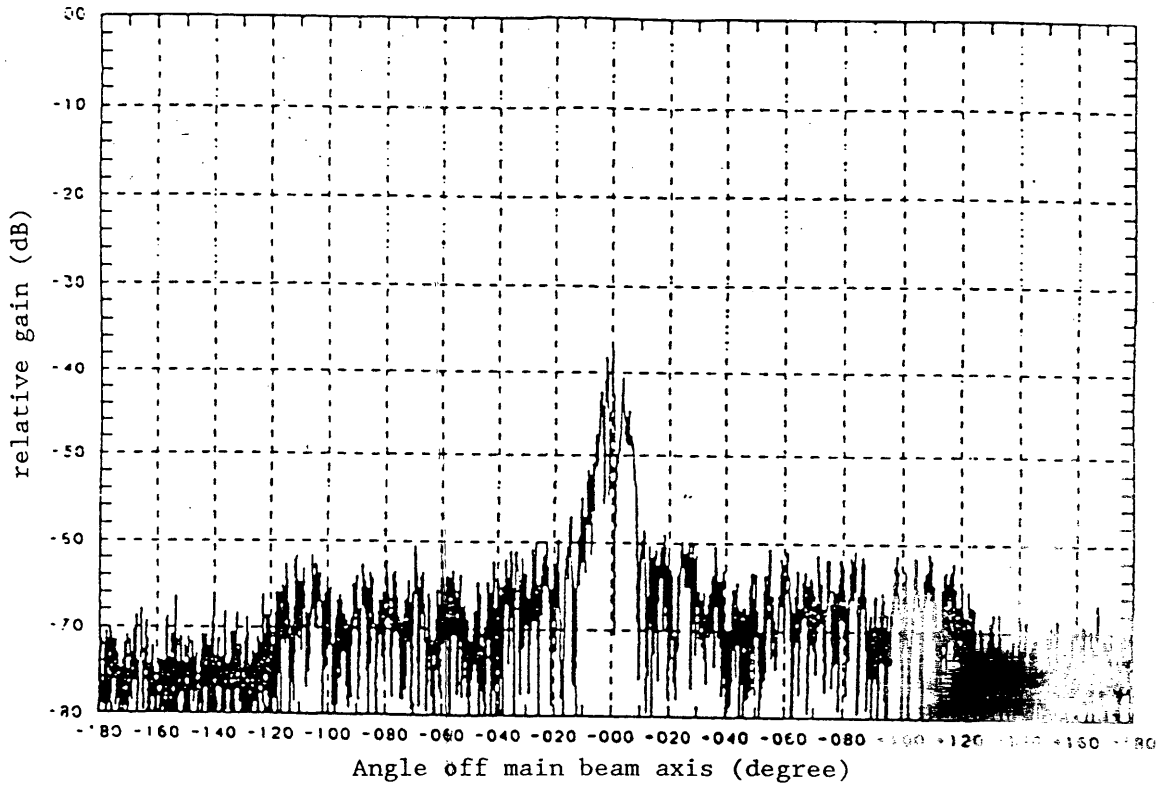

FIGURE 5b

1.80 antenna, cross-polarized measured patterns

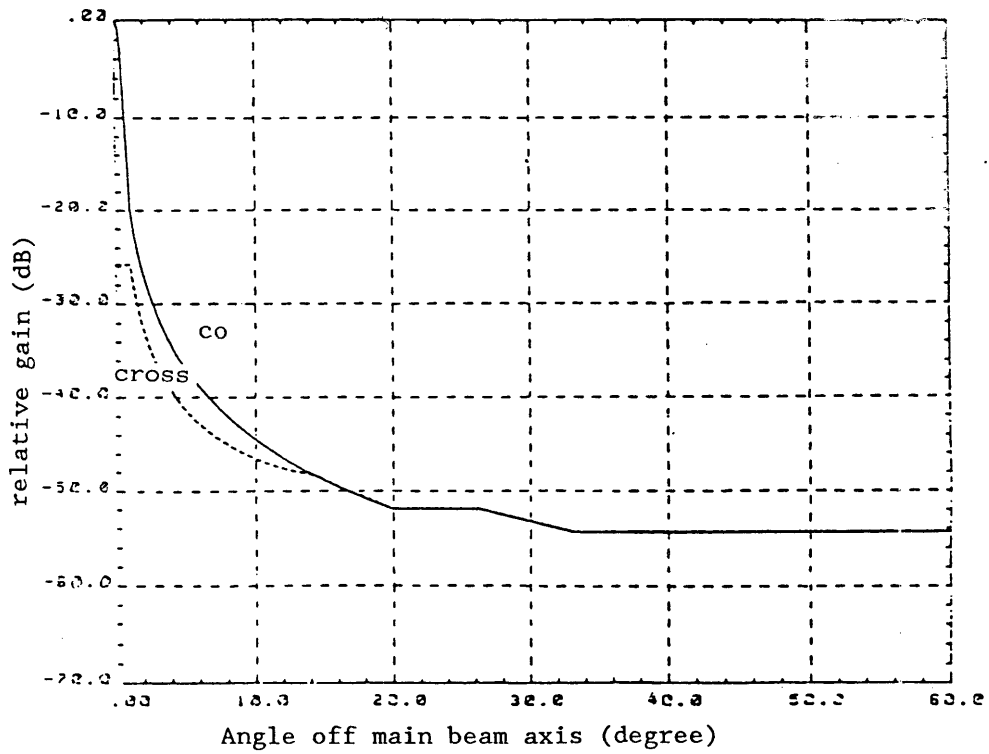

FIGURE 6

2.40 m antenna, f = 12.625 GHz, co and cross-polarized templates

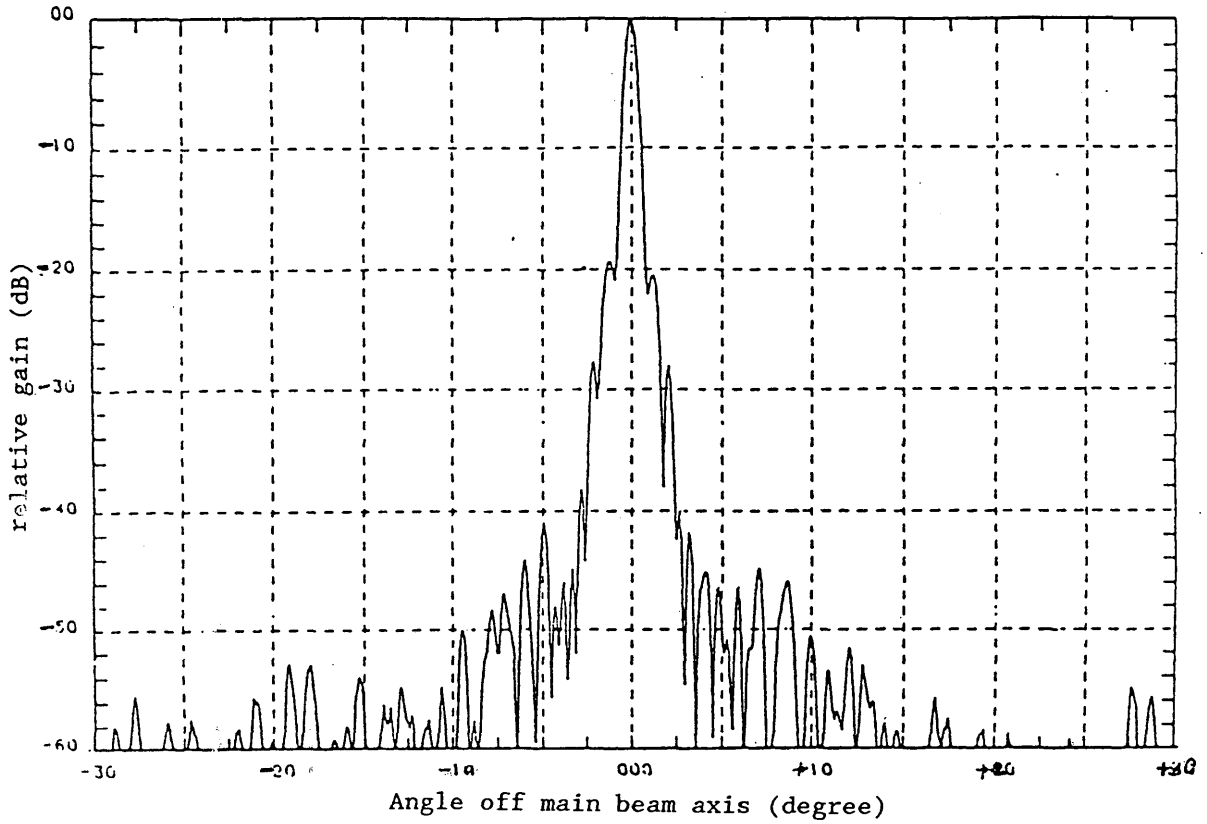

FIGURE 6a

2.40 antenna, co-polarized measured patterns

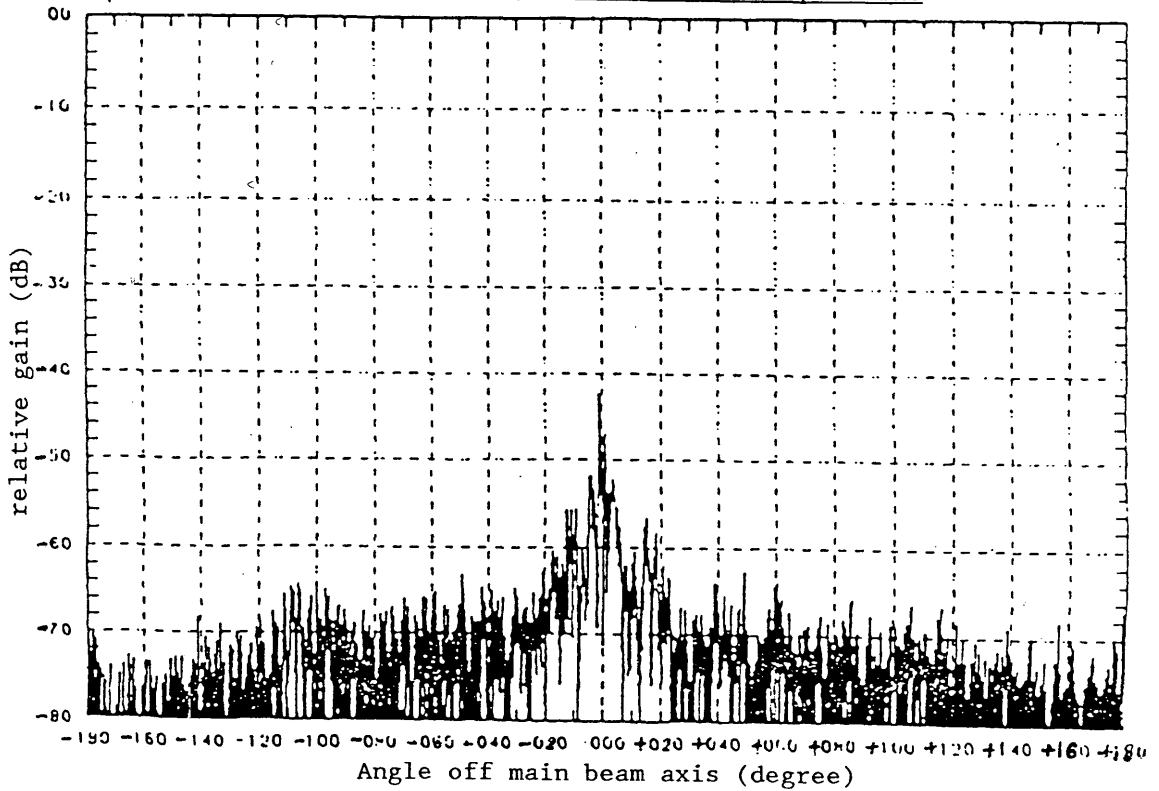

FIGURE 6b

2.40 antenna, cross-polarized measured patterns

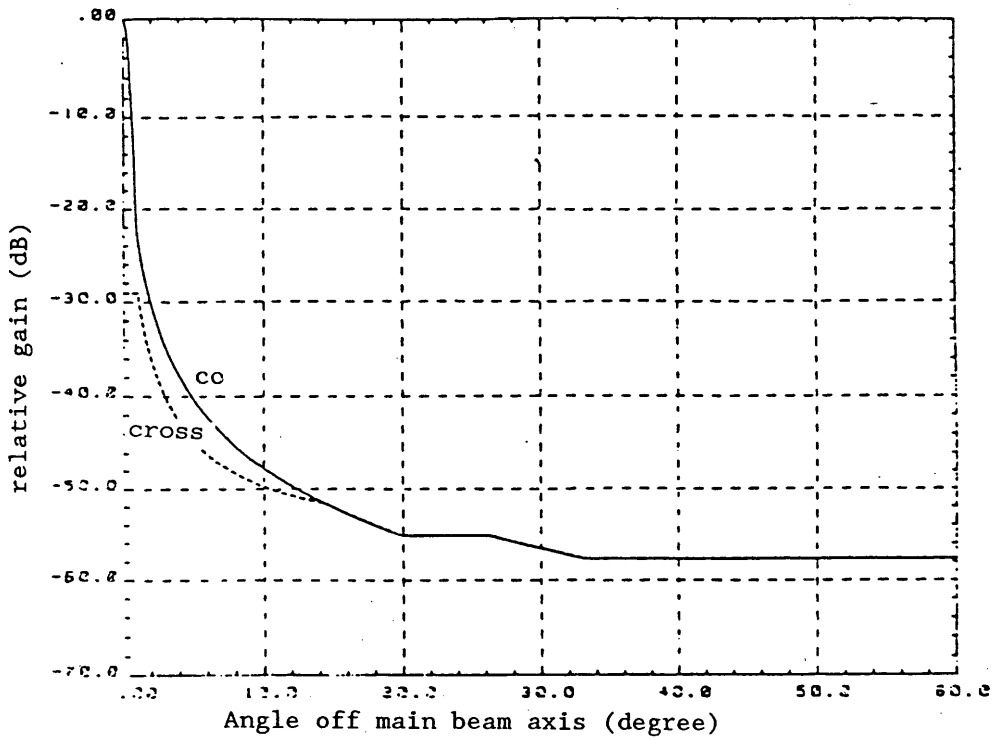

FIGURE 7

3.50 m antenna, f = 12.625 GHz, co and cross-polarized templates

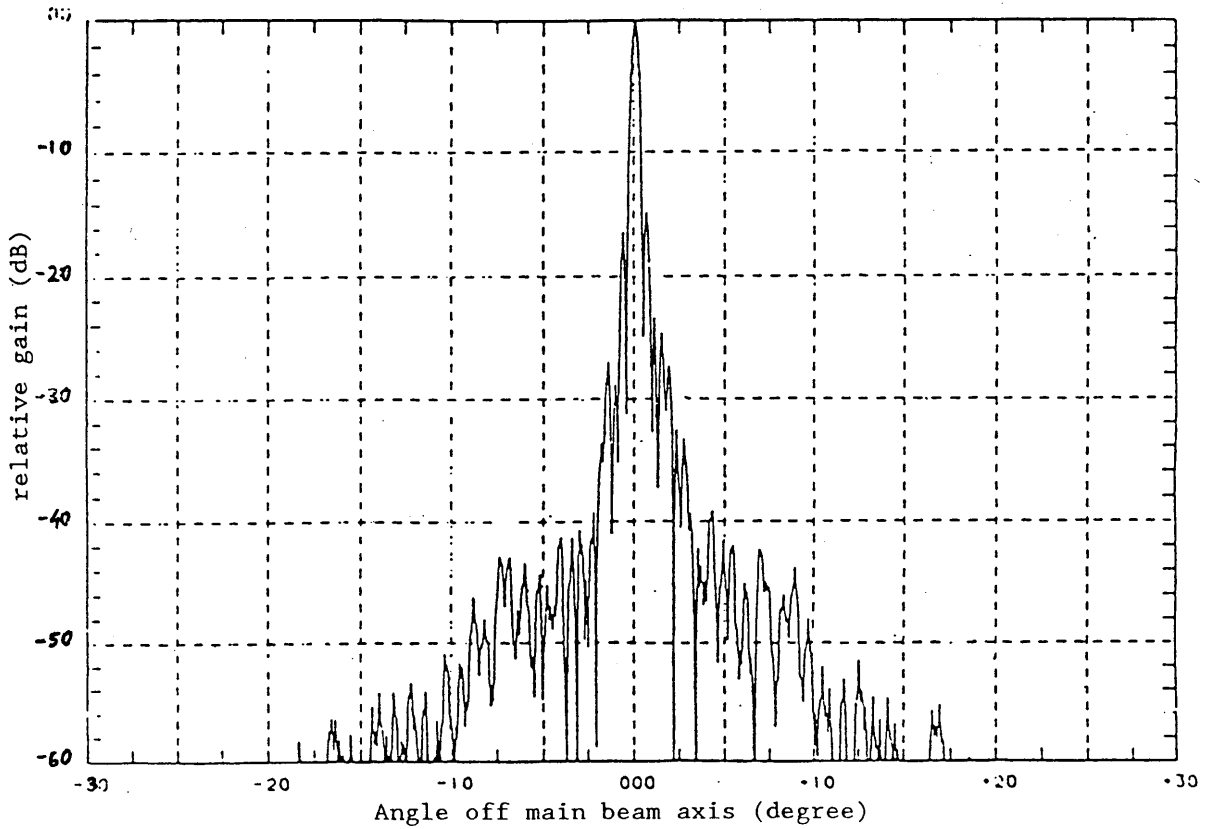

FIGURE 7a

3.50 antenna, co-polarized measured patterns

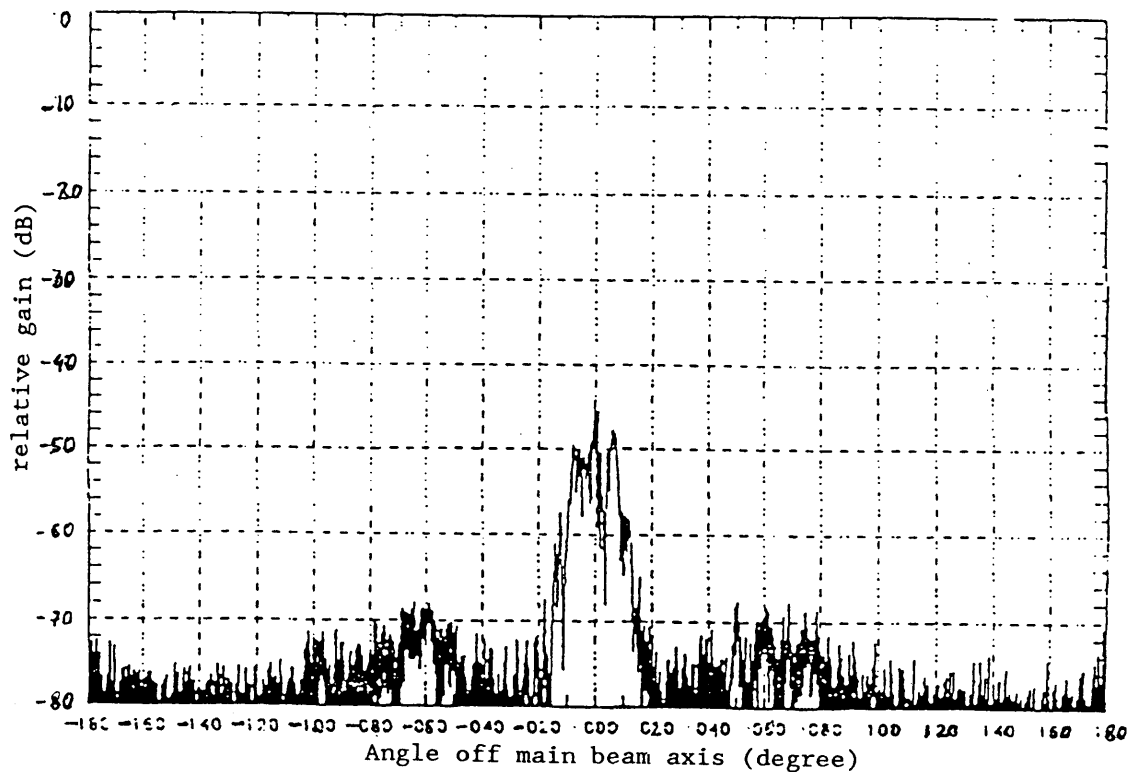

FIGURE 7b

3.50 antenna, cross-polarized measured patterns

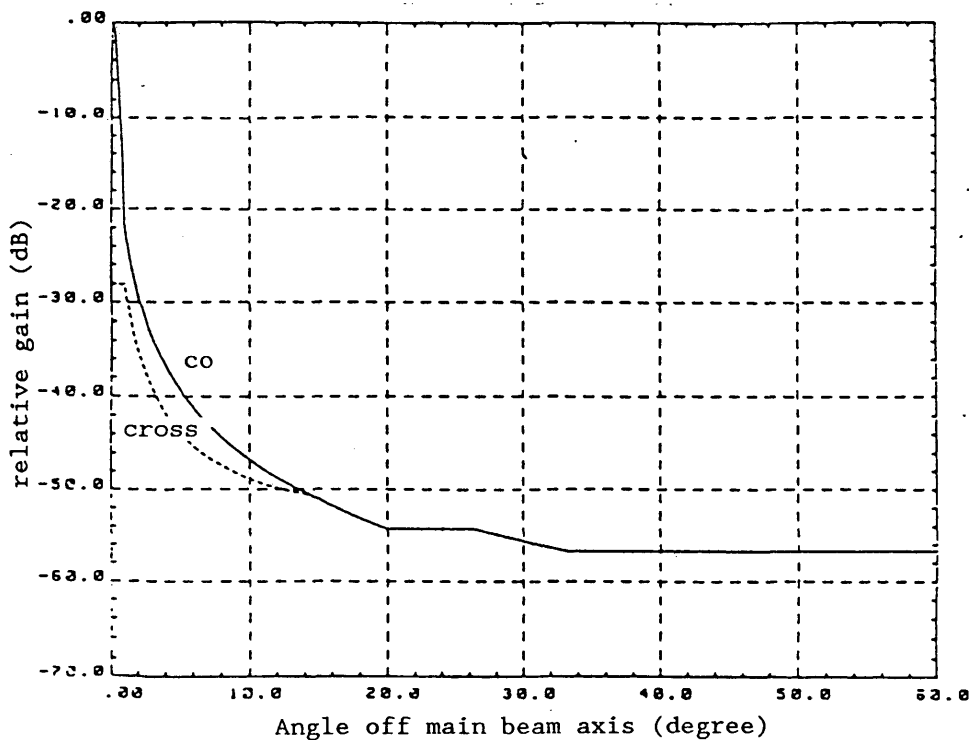

FIGURE 8

3.70 m antenna, f = 10.7 GHz, co and cross-polarized templates

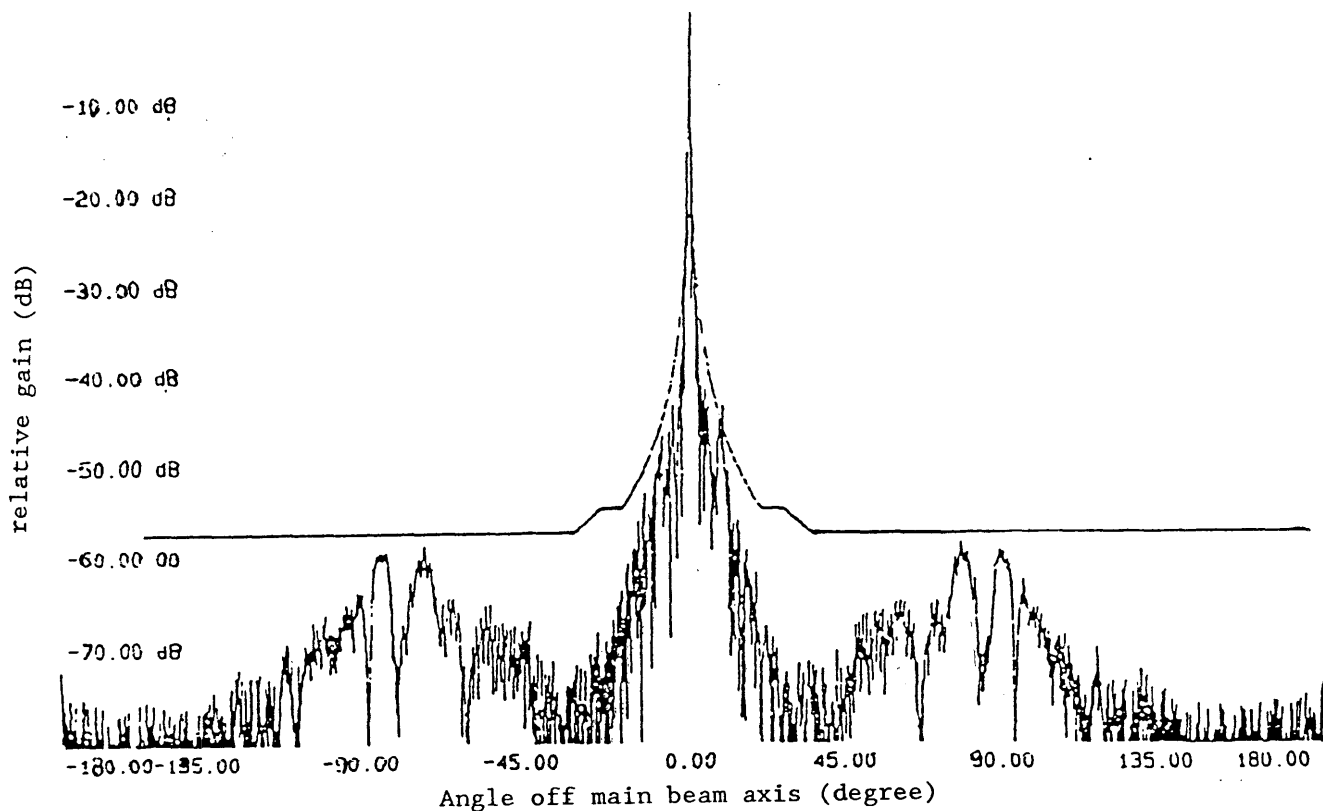

FIGURE 8a

3.70 antenna, co-polarized measured patterns

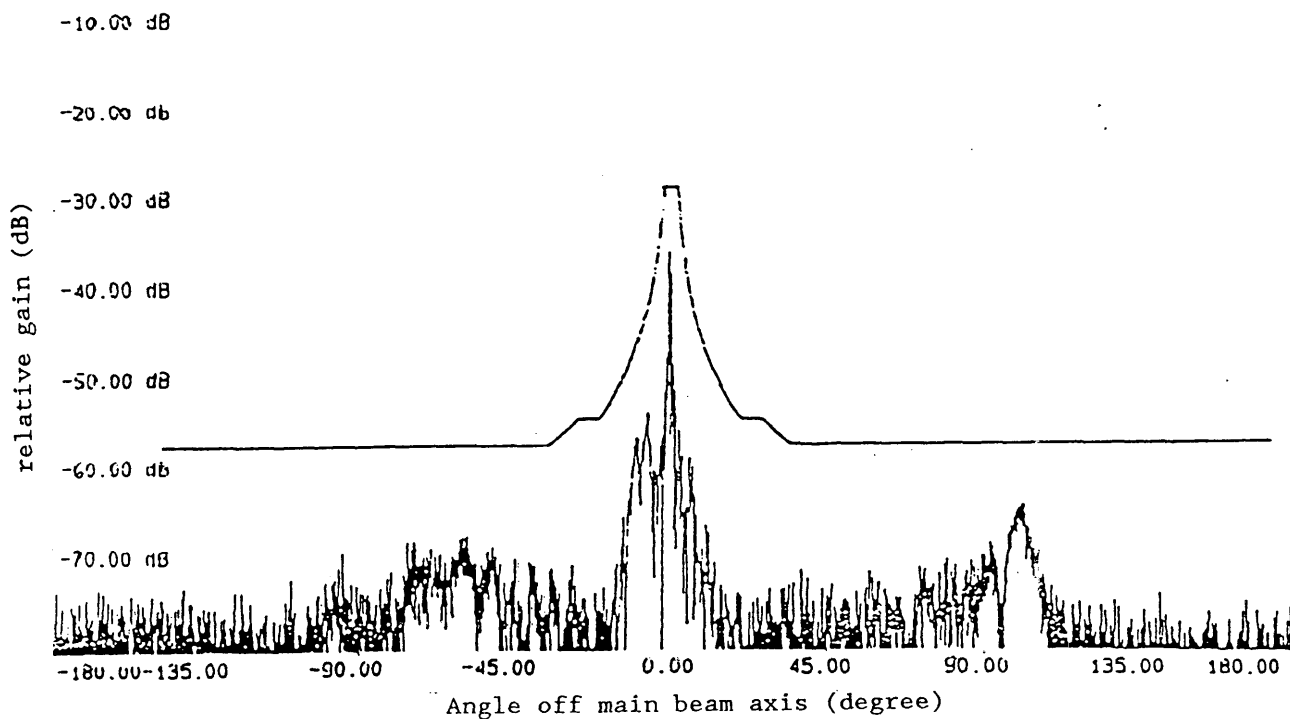

FIGURE 8b

3.70 antenna, cross-polarized measured patterns

PAGE INTENTIONALLY LEFT BLANK

PAGE LAISSEE EN BLANC INTENTIONNELLEMENT

SECTION 4D2: COORDINATION METHODS

REPORT 453-5

**TECHNICAL FACTORS INFLUENCING THE EFFICIENCY OF USE OF THE
GEOSTATIONARY-SATELLITE ORBIT BY RADIOCOMMUNICATION SATELLITES
SHARING THE SAME FREQUENCY BANDS**

General summary

(Study Programme 28A/4)

(Question 28/4)

(1970-1974-1978-1982-1986-1990)

1. Introduction

This Report responds to Study Programme 28A/4 and has made extensive use of the reports of Interim Working Party 4/1, which was set up in Geneva, September, 1968. Its current terms of reference are in Decision 2-7.

Some remarks of a fairly general character should be made before discussion of the more complex technical factors. First, it must be recognized that the maximum coverage of the surface of the Earth from any one satellite in the geostationary-satellite orbit, despite the advantages of this orbit, is limited by the geometry, especially in regard to the coverage of high-latitude regions of the Earth. Because of these considerations, there could arise competing demands upon certain parts of the orbit which might then become congested at an early date. This depends upon geographical factors, distribution of population, demand for telecommunication services, etc. On the other hand, other parts of the geostationary-satellite orbit might be little used for a number of years to come.

Solutions to the difficulties which could arise in congested parts of the orbit are dependent upon studies of all the major technical factors which govern the minimum separation needed to avoid interference between satellites employing common frequencies. The present Report provides a summary of the technical factors involved and makes reference to other Recommendations and Reports of Study Group 4 where these are relevant.

This Report is concerned primarily with technical factors, although some reference is made in it to other factors, mostly operational. It should, however, be emphasized that other factors are also of the greatest importance in achieving efficient use of the geostationary-satellite orbit and the frequency spectrum. Most important of all, perhaps, is the effective use of the procedures established by the World Administrative Radio Conference, Geneva, 1979, for the coordination of frequencies assigned to space and earth stations. Article 11 of the Radio Regulations refers. See also Report 454.

As certain parts of the geostationary-satellite orbit have become increasingly congested there is a need to consider satellite systems in the light of their use of the limited resources of bandwidth in the frequency spectrum and orbital-arc in the geostationary-satellite orbit. Both resources should be used efficiently but what, in fact, constitutes efficient use of the combined resource for the various different applications covered by the fixed-satellite service, is a complex question. In this context "efficiency" does not possess the strictly mathematical sense in which there is an ideal or theoretical maximum capacity of the orbit against which the efficiency of any particular system is expressed as a percentage. What is meant is the "effectiveness" of use, recognizing that this orbit is a commodity of limited proportions, even if we cannot measure or express its capacity in a single figure, permanently fixed for all time. We therefore understand that by aiming towards efficiency of use of the orbit, we mean to use it in the most economical manner.

Finally it should be noted that this Report is concerned with general principles. Reference should be made to other Reports for information on the specific technical problems of orbit and spectrum sharing, and these are listed at the end of this Report.

The contents of this Report are as follows:

2. Satellite network characteristics which affect orbit utilization
- 2.1 Satellite station-keeping
- 2.2 Earth-station antenna characteristics and general interference level

- 2.3 Off-axis spectral e.i.r.p. density level from earth-station antennas
- 2.4 Polarization discrimination
- 2.5 Satellite antenna gain pattern
- 2.6 Permissible interference level
- 2.7 The effect of modulation characteristics
- 2.8 On-board regeneration
- 2.9 Transponder linearization
- 2.10 Acceptable circuit noise standards for analogue circuits of domestic networks
- 2.11 Companding in analogue circuits

- 3. Homogeneous orbit utilization

- 4. Operational factors
 - 4.1 Optimization of frequency assignments
 - 4.1.1 Co-channel carriers
 - 4.1.2 Interleaved carriers
 - 4.2 Geographical factors
 - 4.2.1 Visible arc and service arc
 - 4.2.2 Effect of geographical factors on frequency re-use
 - 4.2.3 Examples of the effect of geographical factors on orbit utilization
 - 4.2.4 Influence of traffic patterns
 - 4.2.5 Inter-satellite links
 - 4.2.6 Crossed-beam arrangement of satellite networks
 - 4.3 Flexibility in the positioning of satellites
 - 4.4 Inhomogeneous orbit utilization
 - 4.4.1 Orbital spacing studies using specific system characteristics
 - 4.4.2 Optimization of heterogeneous orbit utilization
 - 4.4.3 Orbit and spectrum utilization methodologies
 - 4.5 Discussion of ABCD generalized parameters

- 5. Systematic use of allocated frequency bands
 - 5.1 Frequency-band pairing
 - 5.1.1 Pairing of frequency bands allocated to the fixed-satellite service
 - 5.1.2 Translation frequency considerations for narrow-band satellites
 - 5.1.3 Use of multiple frequency-band pairs in satellites
 - 5.2 Use of frequency bands for both up links and down links
 - 5.3 Use of frequency bands allocated to the fixed-satellite service for feeder links
 - 5.4 Use of new frequency bands

- 6. Network harmonization
 - 6.1 Coordination of fixed-satellite networks
 - 6.2 Computer techniques

- 7. Use of geosynchronous satellites in inclined orbits
- 7.1 Use of satellites in slightly inclined geostationary orbits
- 8. Time-phased introduction of orbit-conservation measures

2. Satellite network characteristics which affect orbit utilization

2.1 *Satellite station-keeping*

When the longitudinal position of geostationary satellites is subject to some uncertainty due to orbital drift or orbital inclination, a reduction in the potential geostationary-orbit capacity will result. Capacity is only slightly impaired by moderate orbital inclinations, but is greatly reduced when longitudinal positional drifts approach values comparable with the minimum permissible satellite spacing. The factors affecting the positioning of satellites and the accuracy of station-keeping that is technically feasible at present are considered in Report 556.

The Radio Regulations require all geostationary satellites of the fixed-satellite service to be maintained within $\pm 0.1^\circ$ of the longitude of their nominal position. Exceptions to this requirement exist for experimental stations and for systems whose advance publication takes place prior to 1 January 1982 and are put into service prior to 1 January 1987 (see Nos. 2618 and 2624 of the Radio Regulations).

Studies of improved station-keeping, conducted by the USA [CCIR, 1978-82a] and Interim Working Party 4/1 suggest that longitudinal station-keeping more accurate than the $\pm 0.1^\circ$ value—— incorporated into the Radio Regulations by WARC-79 is probably achievable technically. In situations where very small satellite separation angles are made possible by, for example, satellite spot beam or polarization discrimination, this may lead to a further improvement in orbit utilization. If accompanied by similarly close control of North-South station-keeping, this improvement in longitudinal station-keeping could reduce the cost of some earth stations because satellite tracking facilities might be unnecessary. However, improved station-keeping may cause some increase in operating cost.

In general, latitudinal station-keeping does not significantly affect the efficiency of use of the geostationary-satellite orbit, but studies reported by Italy [Quaglione and Giovannoni, 1983] point out that the efficiency with which a system operates can be affected in a significant way when no constraints on latitude/yaw errors are applied to frequency re-use systems with linear polarization and when the earth stations do not employ polarization tracking. The studies indicate that orbit utilization may be adversely affected because of the reduced capacity resulting from the less efficient use of individual systems. Similar adverse effects on the efficiency of use of the geostationary orbit may occur when frequency re-use by means of orthogonal linear polarization is employed by two satellites of different networks in the fixed-satellite service closely spaced or even co-located in the same longitudinal position of the geostationary orbit (see Report 555). This subject appears to justify additional study.

2.2 *Earth-station antenna characteristics and general interference level*

The radiation pattern of the earth-station antenna, more particularly in the first 10° from the principal axis and in the direction of the geostationary-satellite orbit, is one of the most important factors in determining the interference between systems using geostationary satellites. A reduction in side-lobe level or increase in D/λ (or both) will increase the efficiency of utilization of the geostationary-satellite orbit for a given carrier-to-interference ratio C/I . This efficiency may also be further increased by relaxing C/I .

It should be recognized that antenna patterns considerably better than the reference radiation pattern given in Recommendation 465 may be achieved by careful control of the side-lobe levels. High side-lobe response is caused mainly by scattering from blockage in the aperture of the antenna. There are antenna configurations which have no such blockage and their use is desirable. Some ways in which the constructional features of Cassegrain-type earth-station antennas may be designed so as to reduce side-lobe radiation are discussed in Report 390.

It is thought that the use of off-set feed geometry for small and medium-sized antennas is becoming feasible but it is not yet clear whether the use of such techniques for large antennas would involve undue economic penalties. Nevertheless it would be desirable for a recommendation to be made soon on the maximum side-lobe levels of earth-station antennas. For large antennas operating in the 4 and 6 GHz frequency bands, it might be appropriate to use the pattern given in Recommendation 465.

If an asymmetric (offset) antenna with small surface errors and heavily tapered illumination is used, a further reduction of 5 dB appears to be possible. This probably represents the lowest practical level for small diameter ($D/\lambda \leq 150$) antennas. It can also be approached for large axisymmetric antennas provided the surface errors are kept low and some aperture illumination tapering is applied. The use of the offset configuration for large antennas would possibly involve undue economic penalties.

The effect of three different side-lobe levels (assumed to hold for all D/λ) and the antenna diameter D/λ on satellite spacing ϕ_s for two values of C/I , equal to 35 and 25 dB, is shown in Fig. 1. The minimum diameter for a given satellite spacing is also shown. This has been determined by the location of the first minimum in the earth-station radiation pattern. It allows a sufficient margin of angular error for antenna misalignment and satellite pointing before C/I deteriorates significantly due to an adjacent satellite falling into the edge of the main beam.

Recommendation 580 provides a design objective for lower side-lobe gain for new antennas if the reflector diameter is bigger than 100 times the wavelength. Further consideration is needed on a design objective for smaller antennas.

It is evident that orbit utilization efficiency is enhanced when systems using earth stations with both high gain and a high figure-of-merit (G/T) are involved.

2.3 *Off-axis spectral e.i.r.p. density level from earth-station antennas*

The sensitivity of an earth-station receiver to down-link interference from other satellite networks operating in the same frequency bands is determined mainly by the earth-station antenna side-lobe gain. However, the severity of interference from an earth-station transmitter into the satellite receivers of other networks is caused by the off-axis e.i.r.p. level of the interfering earth-station antenna which is generally given as a spectral density. This quantity is determined by the side-lobe gain, the transmitter output power level and the spectral distribution of that power. This transmitter spectral power level is determined by such factors as the on-axis gain of the earth-station antenna, the satellite receiving antenna gain in the relevant direction, the noise figure of the satellite receiver, the nature of the modulating signal and carrier energy dispersal measures.

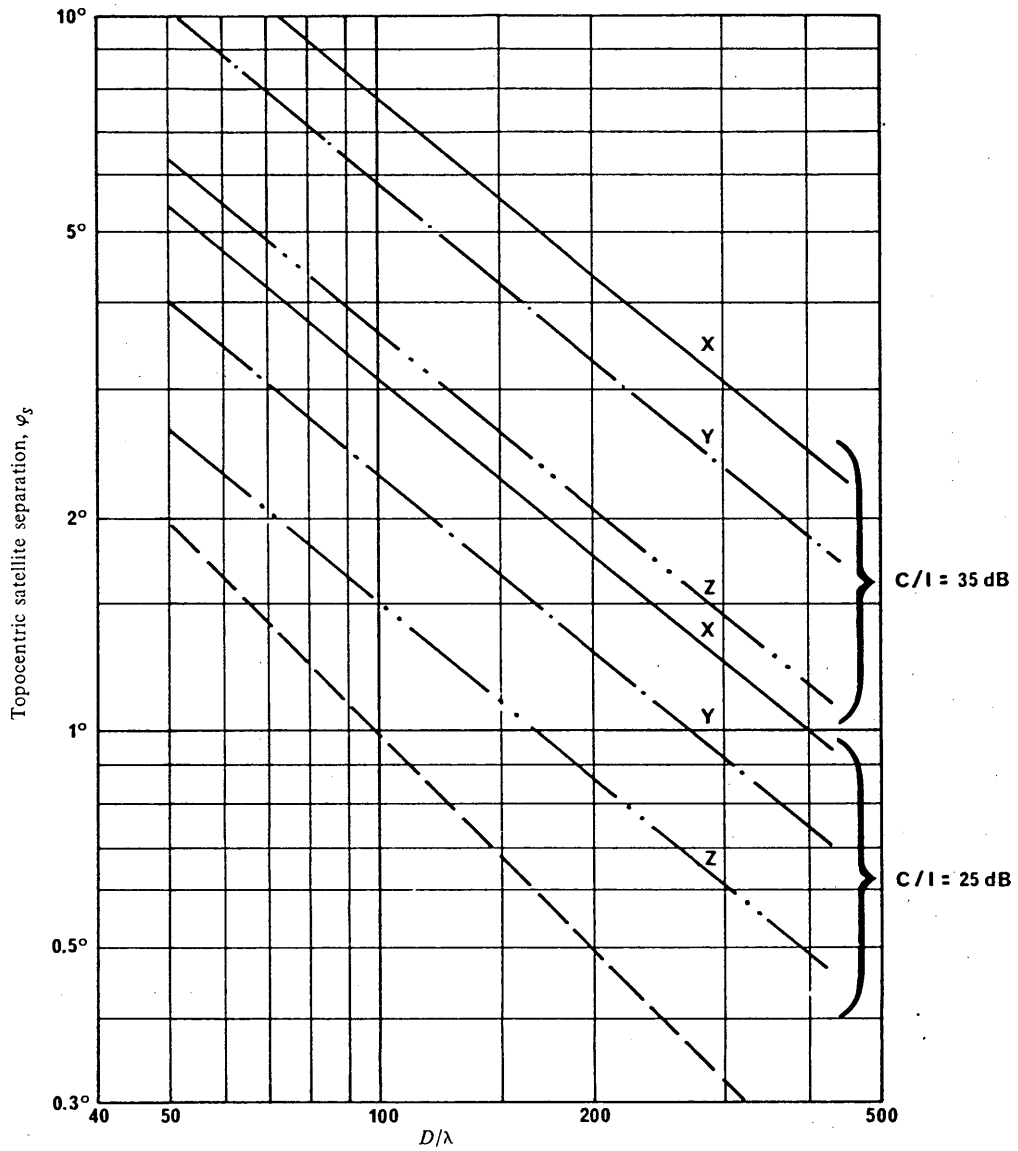

FIGURE 1 - Required satellite spacing for single-entry interference between homogeneous satellite networks as a function of earth-station antenna diameter (in wavelengths) and side-lobe characteristics for two values of C/I

- $G(\varphi) = 32 - 25 \log \varphi$
- · - $G(\varphi) = 29 - 25 \log \varphi$
- · · $G(\varphi) = 24 - 25 \log \varphi$
- - - First minimum in earth-station radiation pattern
Unspecified C/I ratio

To constrain interference between networks it is not sufficient to attain lower antenna side lobes at all earth stations, although this is important (see § 2.2 of this Report). It is also important to place a constraint of some kind on the spectral power level of earth-station transmitters. By applying this constraint in the form of a recommended limit on off-axis spectral e.i.r.p. density level, the system designer is given the maximum opportunity to trade-off the various factors which affect it to obtain the best solutions (see Recommendation 524 and Report 1001).

2.4 Polarization discrimination

The use of orthogonal linear or circular polarizations permits discrimination to be obtained between two emissions in the same frequency band from the same satellite or from closely adjacent satellites. This can augment discrimination provided by the directional properties of satellite and earth-station antennas. A detailed discussion of this topic is to be found in Report 555 and Report 1141.

By use of polarization discrimination, whether linear or circular, frequency re-use is possible in the same satellite beam. This technique is used in many currently operating satellites and is achieved by realizing discrimination values of 27-35 dB. To derive full advantage of the added bandwidth, the spacecraft power must be doubled, in which case the satellite capacity can be doubled. Where the spacecraft power is maintained in a bandwidth-limited system, up to 60% increase in the satellite capacity can be obtained.

Alternatively, orthogonal polarization can be used on adjacent satellites to reduce the satellite spacing, thus increasing orbit capacity. In this case, the discrimination must be obtained in the side-lobe of the earth-station antennas of the networks and even small levels of discrimination will permit significant reductions in spacing. Application of polarization discrimination in this way will generally preclude use of dual polarization on either satellite except in some very special cases, where frequency interleaving is feasible (see § 4.1.2).

If general benefit can be obtained from inter-network polarization discrimination, as described in this latter example, the CCIR should recommend on the following matters for each frequency band:

- a preferred mode of polarization should be defined, that is, circular or linear;
- for linear polarization, if used, standard orthogonal planes of polarization, as seen from earth stations, should be defined. For example, one plane might be in the North-South direction and the other plane would be orthogonal to it;
- minimum standards of polarization purity would be established for the main beam of all satellite and earth-station antennas whether or not dual polarization is used within that network. This standard should incorporate an allowance for the effect of satellite movement, but it would be less stringent than that required to permit dual polarization within a satellite network.

The CCIR should recommend a minimum polarization isolation factor for use in the coordination of systems that are able to make use of this protection.

In the case of linear polarization there are two basic alternative philosophies — the polarization planes are chosen either to minimize local propagation effects or to minimize interference potential and susceptibility. Report 1141 gives the geometric aspects for both philosophies, and also gives measured antenna cross-polarized patterns.

2.5 Satellite antenna gain pattern

The use of the same carrier frequencies to serve different areas on the surface of the Earth by nearly co-located geostationary satellites can be greatly facilitated by the use of satellite antennas having an effective beamwidth much less than the angle which the Earth subtends at the geostationary orbit, i.e. less than 17°. To obtain the necessary discrimination between the wanted signal and the unwanted signal, the main lobe patterns of satellite antennas should conform to the coverage areas as closely as possible, this being attainable by beam shaping in the plane normal to the direction of propagation. It should, however, be noted that it will be necessary to study ways in which the concept of coverage area should be defined. In addition, beam shaping within the coverage area is desirable in order to maximize the satellite e.i.r.p., particularly towards the earth-stations in the coverage area. Also, shaped beams can contribute to efficient orbit utilization through spectrum re-use and reduction of interference through the generation of a variable pattern. However, unless the capability exists for re-shaping the beam on board the satellite, efficiency may be reduced through the lack of orbital position flexibility.

Some currently operational networks provide coverage to several separate service areas on the same frequencies by using separate antenna beams, and making an allowance for a noise contribution from the imperfect isolation which is obtained. Three frequency re-uses on the same polarization can be achieved in the 6/4 GHz frequency band and for higher frequencies, many more re-uses from the same orbital location appear to be feasible.

The achievement of increased frequency re-use on the GSO by the use of satellite antennas of limited coverage is best accomplished by control of the radiation outside of the coverage area. This generally requires reduction of the first side-lobe level by the use of beam-shaped antenna configurations with no blockage of the aperture. Where the coverage area is relatively small, simple antenna configurations can be used, although the large physical size of such antennas may be constrained by spacecraft mass and launch vehicle capability. In this latter case, stringent requirements for satellite attitude control will be necessary whereas with the shaped beam configuration, less precision is required.

While the advantages of frequency re-use may not be fully realized if the control of the satellite beam position is inadequate, no substantial reduction of these advantages is likely so long as the spacecraft antenna beam position can be held to within a small fraction, 0.2 or less, of its beamwidth.

In order to facilitate the re-use of spectrum by narrow satellite antenna beams, the adoption of a reference satellite antenna pattern may be desirable. As the design of a satellite antenna is influenced by many system parameters, such as size and shape of the coverage area, required minimum gain, limitation of aperture size and flux-density, etc., it is rather difficult to define a satellite antenna reference pattern which will be applicable to the large variety of complex patterns which may be utilized. Report 558 provides a more detailed discussion on this problem. Recommendation 672 provides satellite antenna radiation pattern for use as a design objective in the fixed-satellite service. It should also be noted that requirements for satellite relocation on the GSO will have an impact on the antenna design limitations (see Recommendation 670 and Report 1602).

2.6 *Permissible interference level*

Studies show that greater capacity can be obtained from the GSO if more of the noise budget is allocated to interference between satellite systems. For example, below 10 GHz it is estimated that the capacity of the orbit might be increased by at least 75% if the inter-network interference noise component were raised from 10% of total noise to about 50% of total noise [CCIR, 1970-74a].

This matter is considered in some detail in Report 455.

For the most efficient orbit utilization, satellite systems would operate in an interference-limited mode, and while this would reduce the capacity per satellite it would increase the number of satellites that could be accessed.

2.7 *The effect of modulation characteristics*

Studies have been made [CCIR, 1970-74b, c, d] of the effect of modulation characteristics on orbit/spectrum utilization.

For FM systems, as the modulation index is increased, the capacity per satellite is reduced but the baseband noise density due to interference at a given carrier-to-interference ratio falls, permitting closer satellite spacing and generally resulting in an increase in the efficiency of use of the GSO. For digital transmissions using PSK, similar conditions exist, that is, the interference immunity of a signal is increased as the number of phases is reduced, again allowing closer satellite spacing. However, in this case, the utilization of the GSO tends to be optimized when the number of phases is in the range of four to eight, the orbit utilization tending to be decreased as either a higher or a lower number of phases is utilized.

In the case of angle modulated interference from a number of equidistantly spaced satellites into a PSK transmission, the interference effect shows a pronounced threshold characteristic in terms of the distance between the satellites. A reduction of the satellite spacing below the threshold results in a rapid increase of the interference effect. CCIR studies indicate the dependency of this threshold characteristic on various parameters such as permissible error rates, number of carrier phases, earth station antenna radiation pattern and number of interfering satellites.

The examination of technical factors affecting the utilization of the GSO has been made in most cases for systems providing communications in the fixed-satellite service only. However, the fixed-satellite service is also used specifically to provide up links to satellites (e.g. broadcasting satellites) in other services and therefore may involve technical characteristics not necessarily optimum from the standpoint of bandwidth/orbital arc utilization. In these cases, other criteria may be more important in achieving system designs.

2.8 *On-board regeneration*

A demodulation/regeneration/remodulation process on board the satellite effectively decouples the down-link and up-link noise. It is also effective in minimizing the signal degradation caused by cascade non-linear amplifiers and band-limiting filters in the end-to-end transmission chain.

These advantages allow satellites to be spaced more closely, or, for a given spacing, more extensive use of frequency re-use may be made within the satellite system.

For instance, on-board regeneration can typically reduce the spacings of satellites by 30%, or, for a given spacing, the number of re-uses may be increased by more than 60%.

2.9 *Transponder linearization*

Most present transponders use travelling wave tubes (TWTs) for the spacecraft high power amplifier. TWTs are non-linear, so that if a number of separate carriers are transmitted simultaneously, significant intermodulation products can be developed. In order to reduce the intermodulation noise, predistortion circuitry on board the spacecraft may be utilized. In this case, although the TWT itself is non-linear, the spacecraft amplifier chain can be linear up to saturation and have constant output level beyond saturation. The AM to PM conversion characteristics of TWTAs can virtually be eliminated as well. The linearized transponder will typically provide about 30% larger capacity for FM multi-carrier operation.

Alternatively, solid-state power amplifiers (SSPAs) can be used to provide more linear operation where the power requirements permit.

2.10 *Acceptable circuit noise standards for analogue circuits of domestic networks*

Within the constraints of the overall noise standards currently recommended by the CCITT, standards for satellite circuits can be chosen that should provide equivalent or somewhat better performance than comparable long distance terrestrial connections. Essentially it is envisaged that the noise allowance for a satellite circuit should correspond to the noise allowance of the terrestrial systems it notionally replaces. This method of establishing the satellite circuit objectives rather than the simple application of the Recommendation 353 standard, leads to a possible increase in a given system's capacity, and consequently to a possible improvement in the utilization of the geostationary-satellite orbit.

An analysis [Feder, 1976] demonstrated that for certain classes of circuits used in a national traffic situation, the standards applied generally to international telephone circuits via satellite can be relaxed while still providing an adequate service within a country. It will not be possible to take advantage of this for all connections and some special arrangements may be necessary to ensure conformity with international requirements when these "national standard" satellite circuits are to be connected to an international circuit. There are, of course, national traffic situations where standards exceeding those in Recommendation 353 may have to be applied.

The change in possible system capacity by departing from the 10 000 pW0p value, is an increase in the total number of channels per transponder in return for a relaxation of Recommendation 353.

2.11 *Companding in analogue circuits*

The use of the companders on FDM FM carriers can reduce satellite power and/or bandwidth requirements and can generally increase the efficiency of utilization of the geostationary satellite orbit above that achieved in a homogeneous FDM FM environment. In a non-homogeneous environment of both FDM FM

and CFDM FM* carriers, the efficiency of geostationary satellite orbit utilization is lower than for a corresponding homogeneous CFDM FM case. A typical 9 dB of companding gain can be effectively used to double the geostationary satellite orbit capacity by reducing intersatellite spacing or increasing individual satellite capacity. It is noted that only speech signals would be subject to the companding gain.

3. Homogeneous orbit utilization

The most efficient orbit utilization would be obtained if all satellites utilizing the GSO, illuminating the same geographical area and using the same frequency bands had the same characteristics, i.e. if they formed a homogeneous ensemble. However, in practice, satellite systems will have differences.

Consider two satellite systems A and B, using satellites having adjacent orbital positions. If A and B have widely differing characteristics, e.g., as regards satellite receiver sensitivity and down-link e.i.r.p. or as regards their associated earth-station characteristics, then the angular spacing necessary to protect A against interference from B may differ from that necessary to protect B from A. In practice, the greater of the two angles must be selected. The extent to which this may represent an inefficient utilization of the geostationary-satellite orbit is dependent on many factors in the design of the satellite systems using orbital positions near those of A and B. It is possible for the orbit to be more effectively utilized if inhomogeneity is taken into account during the satellite system design. The system parameters in particular, which should be given consideration are the e.i.r.p., and figure of merit (G/T) of the satellite and earth stations, and the relative immunity of the modulation system to interference.

As an example, Fig. 2 illustrates the effects of different satellite e.i.r.p.s on the required spacing between otherwise homogeneous satellites.

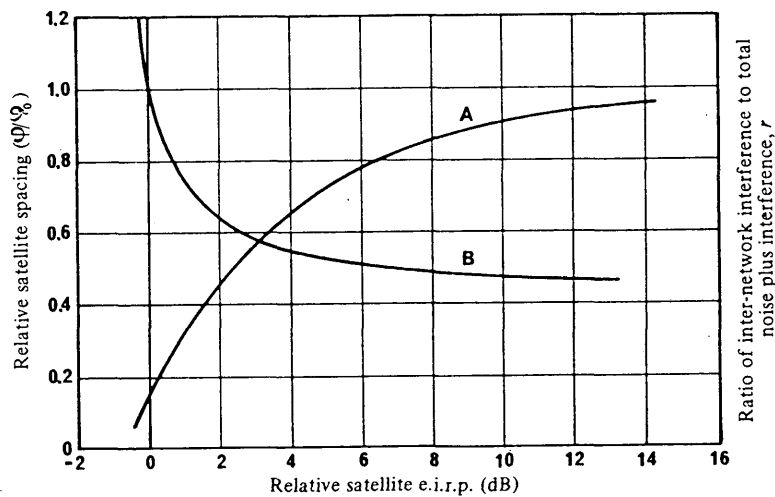

FIGURE 2 - Satellite spacing as a function of satellite e.i.r.p.

Curves A : variation of r with no intermodulation noise
 B : orbit-spacing variation with no intermodulation noise

* CFDM FM - Companded frequency division multiplex - Frequency modulation.

In order to improve the efficient use of the geostationary satellite orbit, it seems desirable to identify methods that achieve homogeneity between heterogeneous satellite networks. An initial task is to define bounds or constraints under which two satellite systems could be considered homogeneous [CCIR, 1986-90a.].

According to one approach two systems are considered homogeneous if the required intersatellite spacing between the two satellite networks is equal, i.e.

$$\Phi_{A-B} = \Phi_{B-A} = \Phi$$

The method to make satellite networks homogeneous by modifying the technical parameters of one of them is described in Report 1135.

4. Operational factors

4.1 Optimization of frequency assignments

4.1.1 Co-channel carriers

Quantitative studies of orbit and spectrum use require that the relationships between input carrier-to-interference ratio and baseband performance for various modulation systems be known. This is a specific technical problem which is not considered in detail in this Report. Report 388 and its bibliography provide a good summary of the conclusions on this subject. Report 449 gives the results of subjective and objective measurements of the effect of interference between frequency-modulated television signals.

4.1.2 Interleaved carriers

The technique of interleaving carrier frequencies, either between two networks or between the re-use modes of a network practising frequency re-use, is a useful means of reducing interference although generally limited to analogue systems. The advantage that may be obtained in this way is discussed in Report 455.

A special application of this technique has been used in conjunction with dual polarization frequency re-use by interleaving entire transponders. Where such transponders are used for analogue transmissions in a single carrier mode, significant reductions in interference, either between the two re-uses on one satellite or between that satellite and an adjacent satellite using the same configuration in an orthogonally polarized sense to the first satellite, can be realized.

4.2 Geographical factors

Geographical features affect the usable arc for a given service area and they interact in various degrees with the techniques employed for the re-use of frequencies.

4.2.1 Visible arc and service arc

The visible arc of a given area depends directly on the geographic features of latitude, size and shape.

- *Latitude:* For a single receiver and a specific minimum elevation angle, the length of the visible arc is a function of latitude only. Figure 3 shows the length of the visible arc for such a point as a function of latitude for angles of elevation from 0° to 40° . For an area that is narrow in latitude, so that all of its points are approximately at the same latitude, this length is decreased by the distance (measured in degrees of longitude) between its easternmost and westernmost points.
- *Size and shape:* The visible arc of an extended area of irregular shape is determined by the latitude and longitude of the two points in the area at which the elevation angle first falls below the minimum operating value as the satellite moves east or west, respectively. In general, the larger the service area and the higher its latitude, the smaller its visible arc. A long narrow service area has a smaller visible arc than a roughly circular one of the same area. For a service area near the equator, the east-west dimension tends to be the determining one; for a service area nearer one of the poles, the east-west dimension at the highest latitude is critical.

The service arc will usually be narrower and wholly within the visible arc, according to constraints imposed by such factors as:

- minimum elevation angle at earth stations;
- eclipse protection;
- the coverage of satellite antennas.

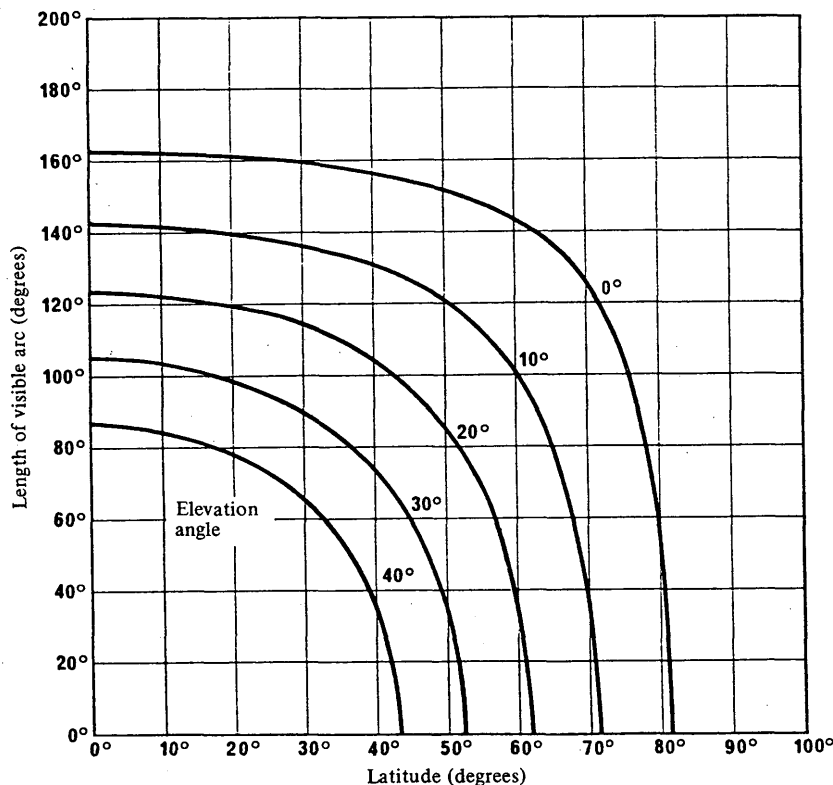

FIGURE 3 – Visible arc of a single earth station

4.2.2 *Effect of geographical factors on frequency re-use*

Frequency re-use can be achieved through three techniques: orthogonal polarization, earth-station antenna discrimination and satellite antenna discrimination. Geographic features have some effects on all three.

- *Orthogonal polarization:* Depolarization caused by rain is an important effect both with linear and with circular polarization and therefore, the discrimination obtainable for short periods of time depends on the climate (which determines the rain statistics) and the location, i.e. the latitude and longitude of the earth receiving station. The variation of the received polarization angle with latitude and longitude, which may or may not be significant depending on several factors, will be present only with linear polarization (see Report AK/4). Both these effects are discussed in detail in Report 814.
- *Earth-station antenna discrimination:* The effect of geography on the earth-station antenna discrimination is a minor one. It comes about because of the difference between geocentric and topocentric angles. The ratio of geocentric to topocentric angles between two satellites varies between 0.99 and 1.18 over the Earth's surface.
- *Satellite antenna discrimination:* The discrimination obtainable from satellite antennas with circular or elliptical beams, according to the reference pattern given in Report 558, has a plateau of 20 dB for distances of 1.3 to 3.15 beam widths from beam centre, with the gain decreasing beyond that at the rate of 25 dB per octave to a minimum of -10 dBi. Larger values of discrimination may be possible when shaped-beam technology is used. Examples are given in Report 558. The relative location of different service areas, which determines their separation and therefore the amount of satellite antenna discrimination achievable, is the single most important geographic factor affecting spectrum-orbit utilization.

4.2.3 *Examples of the effect of geographical factors on orbit utilization*

The following are typical examples of the effects of geographic features on the use of geostationary orbit by the fixed-satellite service:

- Region 2 is separated from Regions 1 and 3 by large bodies of water, with the boundaries running generally north-south. This leads to comparative isolation of Region 2.
- Regions 1 and 3 have a substantial portion of their common boundary running generally east-west. This causes strong interactions between their satellite systems.
- North and South America have relatively weak interactions because of their geographic separation. Satellites serving these two continents can be closely spaced and might even be collocated in some cases. Central America and the Caribbean islands have strong interactions with both North and South America.
- New Zealand is sufficiently separated from other service areas to allow its satellites to be closely spaced with those of its nearest neighbours.
- The many countries of Central America and the Caribbean islands all have very long service arcs because they have small areas and lie at low latitudes. It may therefore be possible to locate their satellites in portions of the arc that cannot or need not be used by others.
- The service areas at high latitudes, such as Canada, Alaska, Scandinavia and the north-east regions of the U.S.S.R., all have very short service arcs.

4.2.4 *Influence of traffic patterns*

The location of the earth stations using a particular geostationary satellite and the circuit network which the satellite network provides determines several primary characteristics of orbit utilization, including orbital location, satellite e.i.r.p., satellite antenna beamwidths and type of modulation.

The degree of inefficiency in the utilization of the orbit will depend upon the extent to which earth stations are, simultaneously, widely dispersed, require large beamwidths and have high channel capacity requirements, and thus necessitate high e.i.r.p.s and small modulation indices. These conditions will tend to make orbital positioning an inflexible matter.

4.2.5 *Inter-satellite links*

General aspects of inter-satellite links are discussed in Report 451. Aspects of this topic that affect the efficiency of use of the geostationary-satellite orbit and the spectrum are considered here.

A direct link offers the following advantages:

- the transmission delay between the terminal earth stations would be less than for a circuit relayed at a third earth station. This might be significant for telephony;
- the problems discussed in § 4.2.4 would be alleviated.

4.2.6 *Crossed-beam arrangement of satellite networks*

If satellites serving limited geographical areas and using common frequency bands are located at approximately the same longitude as their service areas, there will be a tendency for satellites adjacent in orbit to serve adjacent areas. Thus, the reduction in interference between the two networks that satellite spot beam antennas could provide may be quite small. If, however, it is possible to arrange satellite locations so that adjacent satellites serve well-separated geographical areas, and consequently adjacent geographical areas are served by satellites well-separated in orbit, then the directional properties of the satellite antennas can provide greater protection, particularly if these antennas are designed having regard to side-lobe reduction techniques.

The possibility of a crossed-beam arrangement for spot beam satellite systems has been proposed for improving bandwidth and orbital arc utilization. It can significantly reduce interference noise power and permit a closer satellite spacing. In favourable circumstances, this arrangement might lead to a reduction of the minimum satellite spacing of up to about 30% as against the case of the non-crossed-beam arrangement, but further study will be needed for each practical case.

4.3 *Flexibility in the positioning of satellites*

It may be necessary for a satellite to be moved from one orbital position to another within its service arc after entry into service in order to permit the access of a new network. The improvement in access to the orbit obtained in this way will be greater if the service arc is long. However, the provision of a long service arc may have a significant effect on the optimum design of a network, particularly satellite spot beam antennas, and it may have some impact on performance. The implementation of a change of orbital location in service may have significant operational impact (see Report 1002). Recommendation 670 provides flexibility in the positioning of satellites as a design objective.

4.4 *Inhomogeneous orbit utilization*

4.4.1 *Orbital spacing studies using specific system characteristics*

Studies have been made in which the satellite spacing required and the network capacities achievable have been calculated for systems with various arbitrarily chosen characteristics, earth station antennas being assumed to conform to Recommendation 465.

One study [CCIR, 1978-82b] shows that, in general, differences in baseband capacity in FM-FDMA networks are not likely to be an important source of inhomogeneity. In that study the required separation distances between two identical satellite networks of the INTELSAT-IV-A class with earth stations having G/T values about $40 \text{ dB}(K^{-1})$ were determined for various pairs of co-channel traffic types. Traffic types included various multi-channel FDMA traffic and frequency-modulated television traffic.

Separation distances that were required to meet the 600 pWOp single-entry interference maximum varied from 1° to 3.27° for various combinations of FM-FDMA traffic, and from 1.57° to 4.0° between various types of FM-FDMA traffic and analogue slowly-swept TV-FM traffic. This would indicate that for FDMA-FM systems, inhomogeneity due to variations in traffic type is less significant than differences in earth-station or space-station antenna characteristics.

However, the same study indicated that separation distances between SPADE SCPC traffic and high-spectral density carriers, including slowly-swept TV-FM carriers, could be as high as 6° .

Other studies are reported in Report 559. Some of the results may be summarized as follows:

- with earth station G/T about $40 \text{ dB(K}^{-1}\text{)}$ using PSK or wide-deviation FDM-FM, required satellite spacings in an homogeneously occupied arc of the orbit are typically between 1.5 and 3.0° ;
- with earth station G/T about $28 \text{ dB(K}^{-1}\text{)}$ the corresponding satellite spacing required for wide-deviation FM is 3 or 4° , but only about 1.5° would be required for PSK;
- with low-deviation FM, spacings may be two or three times as great as for wide-deviation FM;
- when a satellite serving earth stations with $G/T = 40 \text{ dB(K}^{-1}\text{)}$ is adjacent to one serving earth stations with $G/T = 28 \text{ dB(K}^{-1}\text{)}$, the required spacing may be two or three times as great as either network would need in an homogeneously used arc of the orbit.

Nevertheless, in practice there will be differences between networks and it is desirable to find ways of minimizing the effect of these differences on the efficiency of orbit-spectrum utilization. Two approaches that have been studied are:

- the optimization of heterogeneous orbit utilization;
- orbit and spectrum utilization methodologies;

and the results are reviewed in § 4.4.2 and 4.4.3. Studies of the application of constraints on network characteristics (see § 4.5) showed that this approach is not feasible at the present time.

Another study was also made to evaluate the change of orbit utilization efficiency when a new entrant is introduced in the GSO. The method is given in Annex I.

4.4.2 *Optimization of heterogeneous orbit utilization*

Studies made for the purpose of developing practical strategies for using effectively the GSO and the spectrum with very dissimilar networks have produced the results reported below.

The bandwidth and orbital arc utilization of a set of satellite networks is a function of both the bandwidth utilization and the minimum angular spacing required between the satellites in order to meet a given interference criterion. Assuming that the bandwidth utilization is not a variable, then a measure of the effectiveness of bandwidth and orbital arc utilization may be obtained from the angular spacing required between the various satellites and the orbital arc occupied by the set of satellites as a whole.

The angular spacing required between satellites is a function of many network parameters, e.g. antenna radiation patterns, multiple access modes, satellite transponder gains, energy dispersal and others.

In one study [CCIR, 1974-78] it was assumed that:

- some satellites serve earth-stations with large antennas only, and others serve earth-stations with small antennas only,
- satellite transponder gains can be adjusted to vary down-link to up-link noise ratios to minimize overall system interference, and
- satellite transponders are operated in a quasi-linear mode.

Conclusions may then be derived as follows:

- (a) Earth-station antenna gain tends to be a dominant factor in determining orbit spacing requirements. A gain difference of 20 dB can result in an orbit utilization ratio of 6.3 to 1 .
- (b) Satellite spacing requirements are determined by interference from the network employing small earth-station antennas to the network employing large earth-station antennas. Interference in the opposite direction may be less than between two networks employing large earth-station antennas.

- (c) Adjustment of the up-link to down-link noise allocation ratios in networks using adjacent satellites may allow closer satellite spacing. The ability to control satellite transponder gain is important in this respect.
- (d) Isolating satellite networks employing small earth-station antennas from those employing large earth-station antennas by grouping of satellites, coupled with a higher interference noise allocation for the earth stations with small antennas, can improve the overall orbit utilization. However, this technique is effective only if each group contains a minimum of several satellites and it will be necessary to use other techniques for minimizing the required satellite spacing within the groups in order that the total orbital arc required by each group shall not be too large.
- (e) Placing adjacent to each other satellites which do not have overlapping satellite antenna coverage areas may improve the overall orbit utilization.

It should be noted that satellite systems have been designed that are not in accordance with the preceding assumptions. In this case, the above postulated conclusions (a), (b), (c) and (d) are not necessarily valid.

Another study [CCIR, 1982-86a] examined the effect of space-station e.i.r.p. variations on orbit efficiency. The relationship is more complex than simply the difference in e.i.r.p.s of the different networks involved, because networks with different e.i.r.p.s. have other compensating different parameters such as differences in earth-station antenna diameter. In the study it was assumed that:

- a number of satellites are located in geostationary orbit as close as possible. All satellites serve the same service area or overlapping service areas;
- in one example analysed one centrally-located satellite had an e.i.r.p. some 10 dB *higher* than the other (homogeneous) satellites. In a second example analysed one centrally-located satellite had an e.i.r.p. some 10 dB *lower* than its neighbours;
- the differences in e.i.r.p. of the satellites in the orbit occupancy arrangements analysed were due to differences in spacecraft antenna gains, due in turn to differences in the size of their respective service areas;
- all satellites in each example analysed had the same overall C/N and C/I budgets such as those indicated by Recommendations 353, 466, 522 and 523;
- each network uses the same size earth-station antennas for both up link and down link, but the antennas of the lower powered network may be, and in fact would be, different from those of the higher powered network, if it is to have the same overall C/N and C/I budgets;
- all earth stations are large enough to have the same side-lobe antenna gain characteristics $K - 25 \log \phi$; (the particular value of K is not of concern);
- there is no inhomogeneity between the types of traffic carried on the different networks.

In summary, the study examined the relative orbit separations required when the different networks had the same value of (e.i.r.p. plus G/T) and widely varying values of e.i.r.p. and G/T . Spacecraft antenna discrimination between the networks and traffic inhomogeneities between the networks were not taken into account, since these factors are separable in considering orbit utilization.

It was found that under the study assumptions the necessary spacing between high-powered and low-powered satellite networks was larger than that between two identical low-powered networks with larger earth-station antenna, but was smaller than the necessary spacing between two identical high e.i.r.p. space stations. This result indicates there is not necessarily a significant reduction in orbit efficiency due to the siting of satellites with large e.i.r.p. differences in the same position of the geostationary orbit.

A definition of homogeneity of satellite systems with different service areas, and the analysis of homogeneity influence on maximum capacity of the geostationary orbit, are given by [Kantor, 1985].

Optimization of heterogeneous orbit situations seems best suited to solutions on a case-by-case basis, whereby different combinations of satellites are analysed to determine the optimum arrangement, and hence are very amenable to treatment by computer. Some specific example results generated by such computer programmes are given in [CCIR, 1970-74e, f, g].

This analytical technique has been applied to some of the preliminary characteristics of several proposed United States domestic satellite systems. Certain characteristics of the Canadian domestic system were also considered, although the characteristics assumed do not take into account all present operational parameters of the Canadian domestic system (including the critical FDMA case). With the stated assumptions it was demonstrated that despite appropriate positioning of satellites, this heterogeneous set of satellites cannot achieve acceptable interference levels at a uniform spacing of 3° , even with polarization discrimination. However, these same systems could use an average spacing of about 3° with careful coordination. To the extent that the actual system parameters differ from those assumed, the results would have to be re-examined on a case-by-case basis. This result can be compared with an ideal situation where a homogeneous set of FDM-FM networks, having earth-station antennas not less than 10 m in diameter, can achieve 2° to 3° orbital spacing.

A simple method of presenting interference calculations for two adjacent satellite systems is described in Report 455.

4.4.3 *Orbit and spectrum utilization methodologies*

Particular transmissions in satellite networks may cause relatively high interference to certain other transmissions. One particular case, where FM/video emissions with frame-rate carrier energy dispersal interfere with single-channel-per-carrier emissions, is discussed in Report 867. Such cases may be seen as severely inhomogeneous. Similar situations arise where there is interference between networks with large aperture and small aperture earth-station antennas. In principle, such inhomogeneity can be reduced by segregating highly incompatible emissions by orbit segmentation or by applying spectrum utilization methodologies.

Orbit segmentation would probably permit a reduction of inhomogeneity without constraining system characteristics to the same degree. However, orbit segmentation is likely to impose constraints on the choice of orbit location for satellites. In addition, at each of the junctions between orbital segments designated for different parameter ranges, there is likely to be an orbital arc that could not be used for satellites of networks proper to either range of values without excessive inter-network interference. The loss of the use of these arcs would significantly reduce the benefits that would arise from the reduction of inhomogeneity within the segments. Furthermore, it is noted that some satellite networks serve earth stations near to the limits of global coverage; because of this, their service arcs are very small, and it is necessary to locate these satellites in positions precisely determined by geographical factors.

The worst cases of interference occur between carriers with extremely inhomogeneous characteristics. The purpose of spectrum utilization methodologies is to restrict or even to prevent altogether, the occurrence of such cases of interference, so as to avoid excessive spacings between satellites, which would result in a waste of the orbit resource.

Various degrees of rigidity may be envisaged if carriers are divided into three classes, namely low capacity carriers, medium capacity carriers and high density carriers:

- rigid segmentation: frequency bands are split up into sub-bands, each exclusively dedicated to a class of carriers;
- flexible segmentation: frequency bands are split up into sub-bands, each dedicated on a priority and not an exclusive basis to a class of carriers;
- harmonization of utilization of the spectrum or gradient use of the spectrum: each band must be used from its lower limit upwards by low capacity carriers and from its upper limit downwards by high density carriers.

In a fourth option, narrow-band carriers are excluded from regions in which wideband carriers present high peak power density. In this case, small portions of the spectrum should be designated as high power density regions. In a fifth option, flexible utilization of the spectrum, SCPC carriers are selected to avoid the high energy density of FM-TV carriers.

These five options demonstrate that a choice must be made between operational flexibility and efficient use of the available spectrum. In any approach, there would be a reduction of the bandwidth available to some networks. It would also be necessary to make assumptions about the size of future network populations in each of the parameter ranges before decisions could be reached on the best way of splitting the total available bandwidth into segments. Once these decisions have been taken, it would not be feasible to change the segments for some tens of years, yet spectrum would be used with uneven intensity if the assumptions of network populations proved subsequently to be incorrect, or if these populations changed substantially with time; this would tend to erode the improvement in efficiency that would be expected to arise from reduction of inhomogeneity within the spectrum segments. However, this last remark does not apply to "harmonization of utilization of the spectrum or gradient use of the spectrum", since this option does not imply a division of the available bandwidth into several segments.

The above options are presented and discussed in detail in Report 1000.

4.5 Discussion of ABCD generalized parameters

The WARC ORB-88 used one set of generalized parameters, ABCD, to develop the Allotment Plan. A detailed description of this generalized parameter is given in Annex II. Three other variations of the ABCD parameters were developed by the CCIR and are described in CCIR Vol. IV, part 1 (1986) and [CCIR, 1986-90b.]. Other generalized parameters include isolation (see Report 673), normalized $\Delta T/T$ (see Report 454) and COS (see Report 673).

5. Systematic use of allocated frequency bands

5.1 *Frequency-band pairing*

5.1.1 *Pairing of frequency bands allocated to the fixed-satellite service*

The Table of Frequency Allocations of the Radio Regulations designates frequency bands in the FSS for Earth-to-space use and for space-to-Earth use. However, the Radio Regulations do not require a satellite to use a specific pairing of bands in this regard. Utilization of the GSO and the frequency spectrum would be made more efficient, and co-ordination of satellite networks would be facilitated if certain frequency bands were paired.

For historical reasons, the 6 and 4 GHz bands as allocated prior to the WARC-79 are commonly used in existing and planned FSS systems. Similarly, the pre-WARC-79 14 GHz and 11/12 GHz bands are being used together. No pattern of use has emerged yet for using the new FSS bands allocated at the WARC-79 in these parts of the spectrum. The studies made so far have not yet identified any particular pairings as the best technical arrangement. Indeed, the results obtained so far indicate that there are no very strong technical reasons for preferring one pairing to another.

There are a number of difficulties in implementing the principle of pairing frequency bands, including the following:

- only a few of the frequency bands allocated to the FSS have been taken into extensive use, and the best ways of using the others have yet to be studied widely and in detail;
- experimental satellites operating in more than one pair of frequency bands are already in orbit, and similar operational FSS satellites may be launched soon. In such satellites it may be desirable for the frequency bands to be cross-strapped in whole or in part;
- there are significant differences between the FSS frequency allocations in the three ITU Regions;

- the FSS frequency bands may be used for connections with satellites in other services, such as the broadcasting-satellite service and the various mobile-satellite services. In these cases, a carrier will be transmitted up to a satellite in an FSS band but it will be retransmitted in a band allocated to a quite different service, or *vice versa*.

Having regard to these difficulties, it may be doubted whether a future administrative Radio Conference would require that specific pairs of bands be used in future systems. Nevertheless, a list of frequency-band pairings might be developed using the following technical guidelines:

- the ratio of the mid-band frequencies of up-link and down-link bands should preferably be not so great that antenna design is made difficult, nor so small that duplexer design is made difficult;
- the paired bands, which will not necessarily include the full bandwidth of frequency allocations, should in most cases have equal bandwidth;
- where it is possible to avoid it, no frequency in one band should be a simple multiple of any frequency in its paired band;
- pairings already well established in practice should be retained;
- to the extent feasible, and required, consideration should be given to feeder links, having due regard for present utilization of the spectrum by the fixed-satellite service;
- the continued use of the established practice of cross-strapping from one pair of bands to another in a multi-band satellite should take into consideration the basic purpose of band pairing.

5.1.2 *Translation frequency considerations for narrow-band satellites*

Some satellites need to occupy only a part of the bandwidth of the frequency band allocated. In such cases the coordination of several narrow-band satellites occupying the same part of the geostationary-satellite orbit would be facilitated if all the satellites used the same effective translation frequency between up link and down link.

5.1.3 *Use of multiple frequency-band pairs in satellites*

In some satellite networks it may be economically and operationally advantageous to use more than one pair of frequency bands, because this will enable the effective bandwidth of the network to be increased. This is usually the most economical way of increasing the communication capacity of a network. Use of multiple-frequency bands has no significant impact on economy in the use of the frequency spectrum or the GSO while only one pair of frequency bands is heavily loaded in the relevant part of the orbit, but it has several disadvantages when the second pair of frequency bands is also intensively used, as follows:

- the process of co-ordination of frequency assignments will be made more complex and the optimization of the orbital location of satellites operating in the various frequency bands will no longer be independent, so that the efficiency of these processes will be reduced;
- the angular separations required in the different pairs of frequency bands will probably be different, raising the possibility that full use will be made of the orbit in only one pair of frequency bands.

The use of multiple band pairs on a single satellite in the fixed-satellite service may cause little loss in the utilization of the bandwidth and orbital arc if:

- networks using adjacent satellites have similar characteristics;
- the antenna gains and G/T_s of the earth stations are generally in the order of the largest practically attainable in all the bands used;
- certain parameters (including type of modulation, up-link and down-link noise allocations, and the interference noise allowance) of the systems within one band pair are designed and adjusted to maximize the utilization of bandwidth and the orbit.

In a non-homogeneous orbit utilization situation the loss of capacity would probably be greater, but no serious loss of effectiveness of orbit utilization seems likely to arise unless a substantial proportion of the satellites occupying an arc of the orbit uses multiple frequency band pairs. However, this matter requires further study.

Two strategies for reducing the impact of this problem in orbital situations where it could lead to inefficient usage have been suggested, namely:

- for certain multiple-band configurations it is possible to adjust system parameters to minimize the overall orbit/spectrum capacity losses. This generally corresponds to equalizing the required separation angles in the various bands;
- it may be feasible to make room in between two multi-band satellites for an additional satellite operating in only one pair of the frequency bands used on the multi-band satellites. This, however, may involve adjustment of the characteristics and parameters of the satellite networks.

It is recommended that these two possible strategies should be taken into account in determining the characteristics and parameters of satellite networks using more than one pair of frequency bands.

5.2 *Use of frequency bands for both up links and down links*

It may be feasible to increase the number of satellites using a pair of frequency bands in a given arc of the GSO if the frequency assignments are reversed between adjacent satellites, the up-link band assigned for one satellite being the down-link band for the next. This technique may, to some extent, compete with other methods of increasing the capacity of the orbit such as the use of high-gain satellite antennas or polarization discrimination to reduce interference between alternate satellites and it may make necessary some revision of the sharing criteria in frequency bands shared with terrestrial services. Nevertheless, the basic principle was adopted by the WARC-79 for broadcasting-satellite feeder links at 17.7-18.1 GHz (all Regions) and 10.7-11.7 GHz (Region 1 only). The extensions of the principle to both up links and down links of FSS networks are of interest and should be studied further (see Reports 557 and 561).

5.3 *Use of frequency bands allocated to the fixed-satellite service for feeder links*

Consideration needs to be given to the technically preferred frequency bands for connecting to satellites in services such as the maritime mobile satellite service, the aeronautical mobile satellite service, the land mobile satellite service and the broadcasting-satellite service. In the mobile-satellite services the bandwidth requirements for both up-links and down-links are relatively small. The total bandwidth likely to be required for connecting to broadcasting satellites would be much greater than the foreseen needs of these mobile-satellite services.

The desirable choice of frequency bands is under study in Study Programmes 30A/4 and 30C/4 and Report 561 and in this Report it is sufficient to indicate the principles which should be followed in order that optimum use of the geostationary-satellite orbit and the spectrum may be achieved.

5.3.1 Broadcasting-satellite service feeder links

The WARC-79 considered the problem of frequency-band allocations for the feeder links to the broadcasting satellites operating in the 12 GHz band and three specific frequency bands were allocated for this purpose to the FSS (Earth-to-space), but limited for the feeder links to the broadcasting satellites.

In addition, it should be understood that any band of the FSS (Earth-to-space) could also be used for feeder links, with the normal coordination procedures, with the exception of the band 14.0-14.5 GHz for which the use for feeder links to the broadcasting-satellite service is reserved for countries outside Europe and for Malta (see also Report 561).

The use of the three specified bands for broadcasting-satellite feeder links would cause little loss of spectrum to the FSS, but the use for broadcasting-satellite feeder links of other FSS up-link bands, except where the down-link frequency band is also shared by these two services, would have a severe impact on the FSS.

5.3.2 Mobile-satellite service feeder links

5.3.2.1 Introduction

Feeder links usually employ frequencies in bands allocated in the fixed satellite service, although feeder links may be established in the same bands as those used by the mobile-satellite service.

5.3.2.2 Propagation effects

The same propagation conditions that affect conventional FSS Earth-space links will affect feeder links to mobile-satellites. However, in the design of feeder links the link budget and propagation characteristics of the mobile-earth-station-to-space-station link must be taken into account.

5.3.2.3 Operational considerations

Mobile Satellite Services (MSS) currently use spectrum designated for use in the band 1 530 - 1 660.5 MHz. Additional application of this band for MSS is expected in the future. Feeder link bandwidth needs for mobile satellites will be determined by the use of the mobile-satellite allocations.

The spectrum for links between mobile earth stations and space stations can be reused only in orbital locations several tens of degrees apart due to low mobile earth station antenna discrimination, whereas the feeder link frequencies may be reused at locations as close as a few degrees apart. Thus the total feeder link bandwidth required would not be greater than the amount of bandwidth used for the satellite-to-mobile link channels multiplied by the amount of reuse employed.

The coverage area of the feeder link determines the land earth stations to which the mobile earth station can be connected. In many cases, the land earth stations must be located at specific points and it is often necessary for the mobile to have the capability to communicate with different land earth stations at any given time. Achieving connectivity between the mobile and land earth stations in more than one feeder link beam with one on-board satellite processor is not achievable in the near term. Therefore the necessary coverage area of the feeder link is often large and is determined by the operational requirements of the mobile satellite service.

Operation of narrow-bandwidth MSS feeder links in an FSS band, where FSS networks commonly employ the full band, may result in an uneconomical loss of capacity in such networks. On the other hand, the use of a band for only MSS feeder links would be expected to be less intensive than if it were also available for other FSS services. There may be cases where MSS systems and FSS systems will share the same location and frequency band or, hybrid MSS/FSS satellites may be used.

Non-contiguous FSS bands considerably smaller than those used for conventional FSS systems might be suitable for the required feeder link bandwidths e.g., no more than 100 MHz. Some MSS systems may use different feeder link bands in different parts of the world in order to achieve the necessary

coordination flexibility with other FSS systems. It is desirable, if technically feasible, for the feeder link harmonization (coordination) efforts to not be the determining factor in the location of MSS satellites. Necessary flexibility also suggests that MSS feeder links should not be accommodated in FSS bands subject to allotment planning.

5.3.2.4 Suitable bands

Several bands are now allocated to the FSS, some with special restrictions, which are not currently used extensively for conventional FSS services. These bands are in a portion of the spectrum suitable for use by MSS feeder links. However, extensive use of the lower portions of the spectrum, e.g., 6/4 GHz in a particular region of the GSO may make it necessary to use higher frequencies, having more difficult propagation characteristics, for MSS feeder links.

A pair of separated bands is necessary for down-links and up-links respectively. In order to permit reasonable satellite and earth station filtering, a separation of greater than 5 per cent between transmit and receive frequencies is necessary. In order to avoid separate transmit and receive antennas, a maximum frequency separation of 20-30 per cent would be appropriate.

5.3.2.5 Conclusion

The necessary spectrum bandwidth for individual mobile-satellite system feeder links appears to be significantly smaller than for conventional FSS systems. Bandwidth needs might be, for example, of the order of 20 MHz to 100 MHz. Further studies are necessary to verify the actual bandwidth needs of the MSS. Sharing between conventional (large bandwidth) FSS systems and MSS feeder links may result in capacity loss in one or both systems. Therefore bands other than those intensively used for current FSS systems may be more appropriate for MSS feeder links. However, an exclusive use of frequency bands for MSS feeder links would result in inefficient use of the spectrum because the extent to which MSS feeder links are implemented in a given geographical area will be variable.

Further study is needed regarding frequency bands suitable for meeting MSS feeder link requirements.

5.4 *Use of new frequency bands*

The allocation of new frequency bands for the FSS by the WARC-79, has greatly increased the potential capacity of the GSO. Many of these new frequency bands are above 10 GHz. Many studies will have to be carried out before it will be possible to assess how the use of these higher frequency bands will affect the application of the orbital economy techniques discussed in this Report, but the following effects can be identified now:

- the use of highly directional satellite antennas will be facilitated and this will considerably increase the opportunity for frequency re-use;
- radio propagation in the troposphere will be much worse than at the lower frequencies now in use. This will make necessary the use of larger down-link power margins and perhaps space diversity at the earth station. These matters are considered in Reports 552 and 721;
- the wider bandwidths available in some of these new frequency bands will facilitate the development of satellite networks of very high capacity.

Thus it seems probable that the new higher frequency bands will be attractive for satellite networks of very large capacity, but the lower frequency bands will be preferable for many systems. Priority should be given to propagation studies at these higher frequencies, and more particularly between 10 and 30 GHz.

At present 500 MHz of bandwidth is utilized at 6/4 GHz in each direction, up links and down links. At the WARC-79, an additional bandwidth was allocated to the FSS in both bands, approximately doubling the allocated bandwidth.

Full use of the FSS bands below 10 GHz is particularly attractive, wherever regulatory and coordination conditions permit, because the benign propagation media characteristics associated with this band help to support low elevation angle operation of earth-station antennas and cross-polarization frequency re-use, both of which contribute to the efficient use of the orbit and spectrum. However, in some countries, allocations to services other than the FSS may preclude use of some of the bands. A particular problem is sharing between the radiolocation and the FSS.

It is possible to treat the additional allocated bandwidth as separate bands and design the systems accordingly without any technical problem. However, in order to retain flexibility in the design of system architecture and to minimize the complexity of spacecraft interconnection, it is desirable to transmit and receive the full bandwidth through a single antenna especially at the earth station. Several studies and hardware developments were reported [CCIR, 1982-86b] demonstrating the technical feasibility of implementing earth-station and spacecraft hardware incorporating the expanded FSS bandwidth below 10 GHz.

Earth-station and spacecraft antenna feed systems are the most important elements with respect to bandwidth expansion. Tests on circularly-polarized feed horn components operating over the full bandwidth have demonstrated that complex spacecraft frequency re-use antennas operating over 800 MHz of bandwidth (3.4-4.2 GHz and 5.850-6.775 GHz) are achievable with current technologies, as are spacecraft antennas with simple beam coverages operating over the entire band (3.4-4.8 GHz and 5.850-7.075 GHz).

Earth-station antenna feed systems incorporating 800 MHz of spectrum (3.4-4.2 and 5.850-6.775 GHz) have also recently been demonstrated for various antenna sizes. Incorporating the full 3.4-7.075 GHz in a single earth-station antenna is deemed feasible. The realisation of other components with wider bandwidth presents less difficulty.

6. Network harmonization

6.1 *Coordination of fixed-satellite networks*

The Radio Regulations include administrative and technical procedures for identifying other satellite networks, existing and planned, with which a new network might cause or suffer too much interference, and other procedures for determining what changes must be made to ensure that the interference does not in fact exceed agreed permissible levels (see the Radio Regulations, Articles 11 and 13 and Appendices 3, 4 and 29. See also Reports 454 and 870).

These procedures are rigorous, and are laborious and time-consuming to carry out. Other technical methods for carrying out the coordination process are under study (see Reports 870 and 1003).

6.2 *Computer techniques*

According to studies carried out in Japan and the United States of America there exist computer programs that can be used to optimize the frequency assignments in two or more satellites. The purpose of optimization can be the minimization of the separation required between two satellites or the minimization of the maximum co-channel interference received at any one frequency. Other criteria for optimization may also be used. The programming approach taken in these two studies is somewhat different. These techniques can also be used for optimization of frequency plans within a frequency re-use satellite.

The use of such computer techniques could lead to significant reductions in required satellite separations, especially for satellites which do not practice frequency re-use. However, the required coordination between satellite systems might cause substantial operational difficulties due to inability to respond to changes in user requirements. Nevertheless, the pressure of new systems might make some coordination of frequency assignments of this type necessary.

7. Use of geosynchronous satellites in inclined orbits

7.1 Use of satellites in slightly inclined geostationary orbits

Considerable extension of the useful service life of geostationary satellites can be achieved if they are allowed to acquire slight orbital inclination. Operation of satellites in such, slightly inclined geostationary orbits is accompanied by several technical, operational and sharing implications. A comprehensive treatment of these implications may be found in Report 1138.

8. Time-phased introduction of orbit-conservation measures

To meet the increasing traffic requirements of satellite systems using the geostationary orbit, it is important that orbit-conserving techniques be introduced into operating systems as soon as they are technically feasible and their use is consistent with satisfactory operation of the systems involved. However, it is recognized that such techniques are not always consistent with minimum cost objectives in the design of the systems. Such orbit-conserving techniques include, but are not limited to, the following:

- reduction of the side lobes of earth-station antenna patterns;
- reduction in the off-axis e.i.r.p. of earth stations;
- techniques which reduce the orbit-separation requirements between systems carrying SCPC traffic and those carrying analogue TV traffic, including: improved energy-dispersal techniques, or flexibility in the choice of SCPC channel frequencies to those where the interference is at an acceptable level;
- flexibility in orbit location after launch to accommodate the introduction of new networks;
- improved spacecraft antenna characteristics including reduction of out-of-coverage radiation;
- global beams to be limited to a specified fraction of allocated bandwidth;
- increase in the maximum single-entry and aggregate interference levels through design of systems which will allow inter-network interference to be a larger percentage of their overall noise budget;
- improved modulation/coding techniques, such as digitization of video signals;
- cross-polarization isolation for frequency re-use;
- transponder linearization techniques;
- on-board regeneration where appropriate.

There is an urgent need to study the technical feasibility, the cost, the operational impact, and the improvement in orbit utilization of each of these techniques. They should be introduced in an orderly manner through Recommendations, taking into account the above factors, as rapidly as required to ensure that the capacity of the GSO is adequate to meet the traffic requirements of the systems using it. Their introduction may have to be more rapid in some frequency bands and in some portions of the GSO than in others.

REFERENCES

- FEDER, A. [1976] Transmission performance objectives for national satellite telephone circuits. *Austral. Telecomm. Res.*, Vol. 10, 2, 59-74.
- KANTOR, L. Y. [July, 1985] Homogeneity analysis of satellite communication systems. *Telecomm. J.*, Vol. 52, 7, 421-424.
- QUAGLIONE, G. and GIOVANNONI, M. [May, 1983] Orbital inclination effects on communication satellite system design. *IEEE Trans. Aerospace Electron. Systems*, Vol. AES-19, 3, 447-453.

CCIR Documents

- [1970-74]: a. 4/76 (United States of America); b. 4/58 (United States of America); c. 4/224 (United States of America); d. 4/245 (Canada); e. 4/55 (United States of America); f. 4/231 (United States of America); g. 4/233 (United States of America).
- [1974-78]: 4/47 (United States of America).
- [1978-82]: a. 4/72 (USA); b. 4/83 and Add.1 (Canada).
- [1982-86]: a. 4/229 (Canada); b. 4/85 (Interim Working Party 4/1); c. 4/6 (Interim Working Party 4/1); d. 4/82 (Interim Working Party 4/1).
- [1986-90]: a. 4/31 (USSR); b. 4/248.

BIBLIOGRAPHY

- MIZUNO, T., PRASANNA, S., MURATANI, T., OHKAWA, M. and MIZUIKE, T. [26-29 November, 1984] Frequency band segmentation as a means of increasing efficient use of the geostationary satellite orbit. IEEE Global Telecommunications Conference (GLOBECOM '84), Atlanta, Georgia, USA. Conf. Record, Vol. 1, 4.3.1-4.3.5.
- ROSENBAUM, A. S. [February, 1969] PSK error performance with Gaussian noise and interference. *BSTJ*, Vol. 48, 2, 413-442.

List of relevant CCIR Recommendations: 466, 483, 484, 523, 524, 671, 672 and 670.

List of relevant CCIR Reports: 388, 390, 391, 449, 454, 455, 555, 556, 557, 558, 561, 710, 867, 870, 998, 999, 1000, 1001, 1002, 1003, 1135, 1136, 1137, 1138 and 1140.

ANNEX I

ESTIMATING CHANGE OF ORBIT UTILIZATION EFFICIENCY
WHEN A NEW ENTRANT IS INTRODUCED

In the selection of orbital positions of new entrants it is desirable to measure the degree of congestion of the part of orbit affected and to estimate the change of utilization efficiency. This report provides a possible measure of these values and the values could be calculated at a number of possible orbital positions so that a possible coordination difficulty could be alleviated beforehand.

Three different measures are defined below, using information listed in advance publications or other appropriate sources.

1. Take the nominal location of the new satellite as the center of the geometry and consider all satellites within $\pm\alpha$. α is selected so as to neglect the edge effect of the finite arc segment. Denote the orbital arc occupied by those satellites as L_0 (Figure 4).
2. Expand the mutual spacing of the satellites selected in 1 so that the new system can be accommodated successfully. Expansion of the spacing is made either:
 - (i) proportionally for all satellites or
 - (ii) by adjusting the mutual spacings among all satellites using, e.g. ORBIT-II program, such that both single entry and aggregate interference criteria are met.

In the process of expansion, the service arc constraints shall be taken into consideration. The total arc so calculated is denoted as L (see the upper half of Figure 4). If the arc is not fully utilized, contraction can be made instead of expansion. In the case of contraction, the procedure stops when one of the satellites including the new system reaches either one of the criteria value.

3. Without taking into account the new system, apply the procedure of contraction to the rest of the satellites. The procedure is shown in the lower half of Figure 4. Denote the resultant length of the total arc as ℓ .
4. The numerical ratio, L/L_0 is defined as the expansion ratio (e). ℓ/L_0 is defined as the contraction ratio (c).

The ratios defined above are interpreted as follows:

- (a) The less the e/c ratio is, the less the congestion of the arc changes when the new system is introduced.
- (b) If the expansion ratio is greater than 1, the new system may need coordination between itself and the critical systems.

- (c) If the e/c ratio is greater than 1 but if the expansion ratio is less than 1, the new system will be smoothly accommodated.
- (d) If the e/c ratio is equal to 1, it is concluded that the system will be smoothly introduced. Other systems might be the main contributors to the capacity of that part of the orbit considered.

Hence, the e/c ratios of new entrants could be employed to measure how the use of the GSO changes.

Three example exercises were undertaken for ten incumbents and one new system for each, of which the new network was assumed to have the coverage Ex. 1, Ex. 2 or Ex. 3, as displayed in Figure 5. Table I shows the corresponding values of the e/c ratio, the expansion ratio and the contraction ratio. Thus the change of the utilization of the GSO is easily estimated.

These measures are considered as a useful indication and will help in carrying out preliminary exercises for selecting a preferable orbital position by administrations. It is envisaged that the number of times coordination is required could be reduced significantly by using these measures as a suggested requirement in selecting orbital positions for new entrants. To demonstrate the usefulness of these measures in a non-homogeneous environment, further studies are to be encouraged.

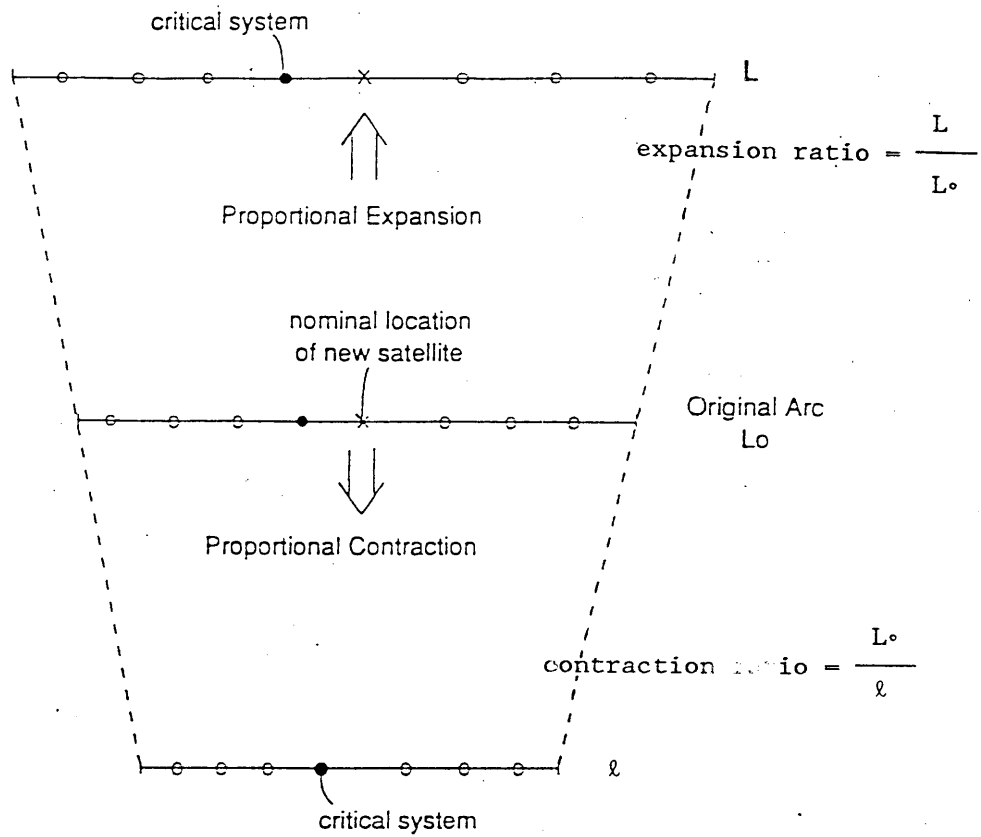

FIGURE 4 - Expansion (or contraction) of spacings

TABLE I - Example results

	Definition (i)			Definition (ii)		
	e/c	Expansion	Contraction	e/c	Expansion	Contraction
Ex. 1	1.43	1.43	1.00	1.20	0.86	0.72
Ex. 2	1.00	1.00	1.00	1.07	0.76	0.72
Ex. 3	1.00	1.00	1.00	1.00	0.72	0.72

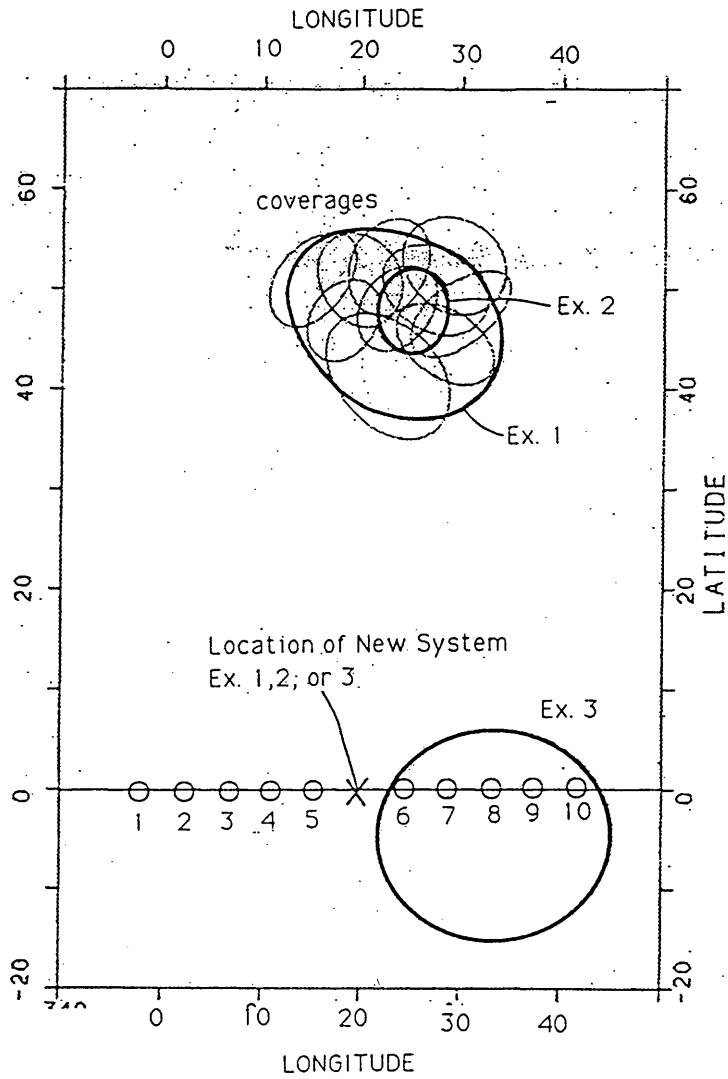

FIGURE 5 - Location of the new entrant and the coverage
(Among 3 new entrants, one of them is to be launched)

ANNEX II

GENERALIZED SATELLITE NETWORK PARAMETERS
FOR ORBIT MANAGEMENT**1. Introduction**

The WARC-ORB-85 decided that certain frequency bands that are allocated to the fixed-satellite service should be managed through the development of an allotment plan, and that certain other such bands should be managed through the development of improved regulatory procedures and the subsequent occurrence of multilateral planning meetings.

To enable such orbit management processes to take place, it is advantageous to develop one or more sets of generalized parameters that could be used to adequately describe fixed-satellite networks in such orbit-management environments. Particular generalized parameters have been used in the past for very specific applications, for example $\Delta T/T$ for the coordination threshold. Others have been studied for the purpose of improving efficiency of orbit utilization through constraints, for example, the A, B, C and D parameters. Still others have been developed for particular application and include characteristic orbital spacing (COS), isolation, and normalized equivalent noise temperature increases.

Such sets of generalized parameters must describe actual and planned satellite networks accurately enough that their application in an orbit management process is useful, and at the same time they must be simple and general enough that any fixed-satellite network can be modelled accurately by one or more computer programs that might be used in the planning process. Six such sets of possible generalized parameters are listed in § 4.5 of this Report, and are described in more detail in this Annex. Each of these methods permits a simplified determination of interference between fixed-satellite networks.

WARC ORB-88 has selected for Allotment Planning the A, B, C and D set of generalized parameters noted in § 4.5 of this Report, which is described in some detail in this annex. For other concepts which can aid coordination by permitting a simplified determination of interference between fixed satellite networks, see also § 4.5.

2. Generalized parameter set**2.1 Network Parameters A, B, C and D.**

The A, B, C, D generalized parameters specify the interference-producing capability (variables A and C) and the interference sensitivity (variables B and D) of a satellite network.

Since many different combinations of implementation parameters (such as antenna characteristics and transmitter powers) can result in a similar set of parametric values, it can be applied irrespective of the modulation characteristics and specific frequency used.

The generalized parameters selected by WARC-ORB-88 for the Allotment Plan are the A, B, C, D parameters based on power density averaged over the signal bandwidth. The purpose of this set is to generalize not only the standard parameters used, but also the type of traffic assumed in the allotment Plan. Under

this concept, the required input powers into the standard earth station and the particular space station antennas are first determined during the planning process. These are then converted into power density (P_1 and P_2 dB(W/Hz)) by dividing by the bandwidth of the signal type, which is in turn used to compute and record the Plan's generalized, A, B, C, and D parameters.

The equations shown below describe the A, B, C, D generalized parameters where:

- A = up-link off-axis e.i.r.p. density averaged over the necessary bandwidth of the modulated carrier;
- B = up-link off-axis receiver sensitivity*to interfering e.i.r.p. density averaged over the necessary bandwidth of the modulated carrier;
- C = down-link off-axis e.i.r.p. density averaged over the necessary bandwidth of the modulated carrier;
- D = down-link off-axis receiver sensitivity*to interfering e.i.r.p. density averaged over the necessary bandwidth of the modulated carrier;

$$A = P_1 \cdot g_1(\varphi)$$

$$B = \frac{1}{P_1 \cdot g_1 \cdot \Delta g_2(\psi)}$$

$$C = \frac{P_3 \cdot g_3}{\Delta g_3(\psi)}$$

$$D = \frac{g_4(\varphi)}{P_3 \cdot g_3 \cdot g_4}$$

where:

- P_1 = the power density, averaged over the necessary bandwidth of the modulated carrier, fed into the transmitting earth station antenna (W/Hz);
- g_1 = the maximum gain of the earth station transmitting antenna (numerical power ratio);

* Note that here the meaning is susceptibility to interference rather than the precise technical definition of sensitivity.

- $g_1(\varphi)$ = the earth station transmitting antenna radiation pattern (numerical power ratio);
 g_2 = the maximum gain of the space station receiving antenna;
 $g_2(\psi)$ = the gain in the space station receiving antenna in the direction of the earth station (numerical power ratio);
 $\Delta g_2(\psi) = g_2/g_2(\psi)$ - discrimination of the space station receiving antenna (numerical power ratio);
 P_3 = the power density, averaged over the necessary bandwidth of the modulated carrier, fed into the space station transmitting antenna (W/Hz);
 g_3 = the maximum space station transmitting antenna gain (numerical power ratio);
 $g_3(\psi)$ = the space station transmitting antenna gain in the direction of the earth station;
 $\Delta g_3(\psi) = g_3/g_3(\psi)$ - discrimination of the space station transmitting antenna (numerical power ratio);
 g_4 = the maximum gain of the earth station receiving antenna (numerical power ratio);
 $g_4(\varphi)$ = the earth station receiving antenna radiation pattern (numerical power ratio).

Thus, the $(C/I)_{\text{density}}$ equation,

$$(C/I)_{\text{den}} = \left[\frac{P_1' g_1'(\varphi) g_2(\psi')}{P_1 g_1 g_2} + \frac{P_3' g_3'(\psi) g_4(\varphi')}{P_3 g_3 g_4} \right]^{-1} \quad (\text{dB}(\text{Hz})^{-1})$$

reduces simply to:

$$(C/I)_{\text{den}} = [(A) B + (C) D]^{-1}$$

where $(C/I)_{\text{den}}$ is the protection ratio normalized by the ratio of the wanted and unwanted bandwidths. With this method, this ratio would be used to determine the orbit separation matrix of the networks for synthesizing the plan.

When a network is proposed, its A , B , C , D parameters would be calculated using the actual system parameters and power densities averaged over the signal bandwidth. These power densities would be the power into the antenna divided by the bandwidth of the actual signal proposed. According to Appendix 30B of the Radio Regulations, no coordination would be required if:

- a) the calculated values of A and C are less than or equal to the relevant reference set, and
- b) the proposed frequency assignments are ordered in such a way that the upper 60% of each allotment band is used for high density carriers (ratio of power spectral density peak in the worst 4 kHz to average over the necessary bandwidth of the modulated carrier is greater than 5 dB), and the lower 40% for low density carriers.

An example based on a review of some current systems and traffic types indicates that a large number of present carriers would be able to be implemented without coordination. Table II gives the required C/I ratios calculated for the Intelsat "regular FDM/FM" carriers, based upon a transponder loading of carrier separation of 1.33 times occupied bandwidth, and an acceptable interference of 800 pWp. Table III gives the required $(C/I)_{den}$, calculated from Table II by multiplying the entries by a factor of b'/b , where b and b' are the bandwidths of the wanted and unwanted signals respectively.

It can be seen from Table III that a $(C/I)_{den}$ criteria of 30 dB for establishing orbital positions for various service areas, would permit a large number of combinations of FDM/FM signals to co-exist in different networks. Those that are not covered are lower modulation index signals, with peak to average power ratios greater than 5 dB. This is demonstrated in Table IV.

For interference into digital signals with bandwidths wider than those of the interferer, assuming multiple interfering carriers within the passband of the wanted digital signal $C/I = (C/I)_{den}$. A C/I of 30 dB and an I/N of 6% would yield a C/N of 18 dB, which would provide a BER better than 1×10^{-7} . Thus, a $(C/I)_{den}$ of 30 dB would very likely be suitable for digital signals.

For interference of FDM/FM into digital signals with bandwidths much narrower than the interferer, then:

$$C/I = C/P_k = (C/P_{av})(P_{av}/P_k) \\ = (C/I)_{den} (1/k_p)$$

where k_p is the peak to average ratio of the interferer. P_k and P_{av} are the peak and average spectral densities respectively of the interferer.

In the case of interference from TV/FM, however, even with energy dispersal, it is unlikely that narrow band carriers can be co-channel with the carrier of the TV/FM signal because during energy dispersal of, say ± 1 MHz, the spectral power within the dispersion band is very high.

The requirement to coordinate with TV signals can be avoided if the TV carrier frequencies were pre-specified. With an energy dispersal bandwidth of say 2 MHz, SCPC and other narrow band carriers can avoid the TV energy dispersion band. This concept of "Micro-segmentation" is discussed in Report 1000.

TABLE II
C/I RATIO FOR INTELSAT FDM/FM SIGNALS

Interf. Wanted	12	24	60	60	132	132	132	252	252	432	432	432	792	Mod Index	BW	C/N dB
12	26.6	25.2	24.9	22.7	22.8	20.7	20.1	20.2	18.1	18.5	17.4	16.7	14.1	2.65	1.1	13.4
24	26.5	25.7	25.6	23.9	24.0	22.1	21.6	21.6	19.6	20.0	18.9	18.2	15.7	2.55	2.0	12.7
60	34.3	33.9	33.8	32.5	32.6	30.9	30.4	30.5	28.6	29.0	27.9	27.2	24.7	1.17	2.2	21.1
60	27.9	26.6	26.6	25.7	25.8	24.5	24.1	24.1	22.5	22.8	21.8	21.1	18.7	2.17	4.0	12.7
132	36.2	33.7	33.7	33.4	33.4	32.5	32.2	32.2	30.8	31.1	30.2	29.5	27.1	.96	4.4	20.7
132	31.8	28.9	28.9	28.0	28.0	27.4	27.1	27.1	25.9	26.2	25.4	24.8	22.5	1.61	6.7	14.4
132	32.2	29.2	29.2	28.1	28.1	27.5	27.2	27.3	26.1	26.4	25.6	25.1	22.9	1.85	7.5	12.7
252	37.8	34.6	34.6	32.4	32.4	32.2	32.1	32.1	31.3	31.5	30.9	30.5	28.4	.96	8.5	19.4
252	33.7	30.7	30.7	27.9	27.9	27.3	27.2	27.2	26.6	26.7	26.3	25.9	24.1	1.55	12.4	13.6
432	41.5	38.5	38.5	34.6	34.6	33.7	33.8	33.7	33.6	33.7	33.4	33.2	31.7	.82	13.0	21.2
432	39.3	36.3	36.3	33.0	33.0	31.6	31.4	31.4	31.1	31.2	31.0	30.7	29.4	1.07	15.7	18.2
432	37.8	34.7	34.7	31.7	31.7	30.0	29.6	29.6	29.4	29.5	29.2	29.0	27.7	1.27	18.0	16.1
792	40.6	37.5	37.5	34.5	34.5	32.8	31.4	31.4	30.1	30.1	29.8	29.8	29.2	1.24	32.4	16.5

TABLE III
(C/I)_{den} RATIO FOR INTELSAT FDM/FM SIGNALS

Interf. Wanted	12	24	60	60	132	132	132	252	252	432	432	432	792	Mod Index	BW
12	26.6	27.8	27.5	28.3	28.8	28.5	28.4	29.1	28.6	29.2	28.9	28.8	28.8	2.65	1.1MHz
24	23.9	25.7	26.0	26.9	27.4	27.4	27.3	27.9	27.5	28.1	27.8	27.7	27.8	2.55	2
60	31.3	33.5	33.8	35.1	35.6	35.7	35.7	36.4	36.1	36.7	36.4	36.3	36.4	1.17	2.2
60	22.3	23.6	24.0	25.7	26.2	26.7	26.8	27.4	27.4	27.9	27.7	27.6	27.8	2.17	4
132	30.2	30.3	30.7	33.0	33.4	34.3	34.5	35.0	35.3	35.8	35.7	35.6	35.8	.96	4.4
132	23.9	23.6	24.1	25.8	26.2	27.4	27.6	28.1	28.6	29.1	29.1	29.1	29.3	1.61	6.7
132	23.9	23.5	23.9	25.3	25.8	27.0	27.2	27.8	28.3	28.8	28.8	28.9	29.3	1.85	7.5
252	28.9	28.3	28.7	29.1	29.5	31.2	31.6	32.1	32.9	33.3	33.6	33.8	34.2	.96	8.5
252	23.2	22.8	23.2	23.0	23.4	24.6	25.0	25.7	26.6	26.9	27.3	27.5	28.3	1.55	12.4
432	30.8	30.4	30.8	29.5	29.9	30.8	31.4	31.9	33.4	33.7	34.2	34.6	35.7	.82	13
432	27.8	27.4	27.8	27.1	27.5	27.9	28.2	28.7	30.1	30.4	31.0	29.6	30.8	1.07	15.7
432	25.7	25.2	25.6	25.2	25.6	25.7	25.8	26.3	27.8	28.1	28.6	29.0	30.3	1.27	18
792	25.9	25.4	25.8	25.4	25.8	26.0	25.0	25.6	25.9	26.1	26.7	27.2	29.2	1.24	32.4

TABLE IV

Peak/average density ratios for INTELSAT FDM/FM carriers

No. of channels	Occupied bandwidth Bo MHz	C/P _k dB/4 kHz	P _k /P _{av} dB
12	1.1	20.0	4.95
24	2.0	22.3	4.69
60	2.2	22.4	5.10
60	4.0	25.3	4.70
132	4.4	24.2	6.21
132	6.75	27.5	4.77
132	7.5	28.0	4.73
252	8.5	27.0	6.26
252	12.4	30.0	4.91
432	13.0	27.6	7.52
432	15.7	30.8	5.15
432	18.0	31.5	5.03
792	32.4	34.1	4.98

Table IV gives total power to peak power (C/P_k) dB/(4 kHz)

$$\frac{P_k}{P_{av}} = \frac{P_k}{C} \frac{C}{P_{av}} = \frac{P_k}{C} \frac{B_o}{4 \text{ kHz}} = 10 \log_{10}(B_o/4000) - C/P_k \text{ (dB)}$$

Note - Signals with P_k/P_{av} ≤ 5.0 are signals usable without coordination.

2.2 Possible modifications to the parameters of FSS systems in the Plan adopted by WARC ORB-88

Further information needs to be given in addition to the above in connection with the use of the generalized parameters A , B , C , D in the fixed-satellite service (FSS) Plan adopted by WARC ORB-88.

All the generalized parameters are functions of an off-axis angle, φ for earth stations and ψ for space stations. The angles φ and ψ may take on values starting from zero. The generalized parameters B and D relate to the system's sensitivity to interference (the higher the values of the parameters, the greater the sensitivity), but do not directly determine the permissible radiated power of the interfering signal until the permissible signal-to-interference ratio C/I is indicated. In the FSS Plan the values of A , B , C , D relate to each individual system, whereas the value (C/I)_n = 26 dB adopted for planning purposes relates to aggregate interference. On this basis we obtain, using the equations given in § 2.1:

$$\sum e.i.r.p.i_e (\varphi_i) = [B (C/I)_{p/\Sigma}]^{-1}$$

where e.i.r.p.i_e (ϕ_i): effective isotropically radiated power of the interfering signal in the direction of the satellite of the wanted system; the summation is effected for all interfering systems, with the earth stations of the interfering systems located at the most unfavourable test points in their service areas (i.e. those from which they cause most interference),

B = B (ψ): generalized parameter for the wanted system,

$(C/I)_{p/\Sigma \uparrow}$: carrier-to-aggregate interference ratio provided for in the Plan at the input to the space station,

$$\sum e.i.r.p._{i_s} (\varphi_i) = [D (C/I)_{p/\Sigma \uparrow}]^{-1}$$

where $e.i.r.p._{i_s} (\varphi_i)$: effective isotropically radiated power of the signal from the space station of the interfering system in the direction of the wanted system earth station located at the most unfavourable test point of the wanted system's service area (the point for which $(C/I)_{p/\Sigma \uparrow}$ is at its minimum); the summation is effected for all space stations causing interference to the wanted system concerned,

$(C/I)_{p/\Sigma \downarrow}$: carrier-to-aggregate interference ratio provided for in the Plan at the input to the earth station.

When evaluating possible modifications to the actual FSS system parameters used to determine the generalized parameters A, B, C, D, account has to be taken not only of the constraints imposed by the generalized parameters, but also the mutual relationship between them. For this reason, most modifications prove unacceptable. For instance, reducing the parameters A and C in the area of the main lobe of the radiation pattern (i.e. reducing e.i.r.p.) increases the values of B and D, thereby reducing the system's noise immunity.

The condition $A \leq A_{p1}$ must be respected for all variations in the actual parameters. By definition, the condition $C \leq C_{p1}$ must also be respected; however, it may be assumed that there would be no objections to inclusion in the List of a system for which the condition $C \leq C_{p1}$ is fulfilled for all values of θ corresponding to a beam direction outside the edges of the wanted system's service area, but $C > C_{p1}$ within the service area. This may occur when a combination of narrow beams is used instead of the single space station antenna beam defined in the Plan. In particular cases, this may make it possible to provide the necessary coverage to only part of the territory of the service area notified for the purposes of establishing the Plan. The increase in C leads to a reduction in B. Both of these factors enable the system's earth stations to be simplified.

When $B > B_{p1}$, $D > D_{p1}$, the system only enjoys protection up to the level foreseen in the Plan; hence, the signals used in the system must enable operation when $(C/I) < (C/I)_{p1}$. An increase in the value of one of these parameters may be offset by a reduction in the value of the other, in accordance with the relationship:

$$(C/I)_{\Sigma}^{-1} = (C/I)_{\uparrow}^{-1} + (C/I)_{\downarrow}^{-1}$$

When the condition $A \leq A_{p1}$ is respected, the power radiated by the earth station, p_1 , can be reduced by way of a corresponding increase in the gain of the earth station antenna, g_1 , i.e. in the size of the antenna reflector.

Here, $g_1(\varphi)$ will increase in the area of the main beam of the earth station antenna pattern but, $g_1(\varphi)$ will not change in the area of the sidelobes. The interference caused to the space stations of other systems will not be altered or reduced. The parameter B will not be affected, in other words there will be no deterioration in the system's noise immunity on the uplink. If the same earth station antenna is used for reception, then its gain on reception g_4 will increase, and the parameter D will be reduced in the area of the sidelobes, but the system's noise immunity with respect to interfering satellites located within the main beam of the antenna pattern will remain unchanged. If it is applied in a system with a relatively large service area, such a modification of the parameters p_1 and g_1 , g_4 makes the systems more uniform, and is usually advantageous from the economic viewpoint [KANTOR, 1988].

Increasing g_1 , g_4 is effective in cases where the magnitude of B and D needs to be reduced outside the main beam.

The same effect may also be achieved by reducing $g_2(\psi)$ and $g_4(\varphi)$ in the area of the sidelobes by way of more sophisticated antenna design. The need to improve the values of B and D may arise at the stage of converting an allotment into an assignment, due to the fact that the values of these parameters obtained (even if they correspond to the planned values B_{p1} , D_{p1}) are insufficient to achieve the $(C/I)_{\Sigma}$ required for the signal transmission methods used in the system.

Similar modification of the actual parameters p_3 (reduction) and g_3 (decrease, i.e. an increase in the dimensions of the space station transmitting antenna) also results in a reduction in radiated power (C) outside the main beam, this reduction is brought about not only by the reduction in p_3 but also by $g_3(\psi)$. However, such a modification is constrained by a reduction in service area.

REFERENCES

- KANTOR, L.Y., Vybor iskhodnykh parametrov dlya planirovaniya ispolzovaniya geostatsionarnoi orbity FSS (Choice of basic parameters for the planning of use of the geostationary orbit for the FSS), Elektrosviaz, No. 8, 1988.
-

REPORT 454-5

**METHOD OF CALCULATION FOR DETERMINING IF COORDINATION IS
REQUIRED BETWEEN GEOSTATIONARY-SATELLITE NETWORKS SHARING THE SAME
FREQUENCY BANDS**

(Study Programme 28B/4)

(1970-1974-1978-1982-1986-1990)

1. Introduction

Increased use of the geostationary-satellite orbit by satellites and associated earth stations may increase the probability of interference between satellite networks when common frequency bands are used. The number of parameters characterizing a system is so large that it is useful to devise a simple method to determine whether there is any risk of interference between two given satellite networks. The method described in this Report is consistent with that given in Appendix 29 of the Radio Regulations and is applicable whenever two networks share a common portion of the assigned frequency band on at least one of their paths. It is based on the concept that the noise temperature of the system subject to interference undergoes an apparent increase due to the effect of the interference, the interfering signals being treated as thermal noise, whose spectral power density would be equal to the maximum spectral power density of the signals. The method can therefore be used irrespective of the modulation characteristics of the satellite networks concerned and the precise frequencies employed.

In this method, the apparent increase in the equivalent satellite link noise temperature (the equivalent satellite link noise temperature is defined in No. 168 of the Radio Regulations) resulting from an interfering emission caused by a given system is calculated (see § 2 below) and the ratio of this increase to the equivalent satellite link noise temperature, expressed in percentage, is compared to a threshold value (see § 2.3 and 3 below).

2. Procedure for calculation of the apparent increase in equivalent noise temperature of the satellite link subject to an interfering emission

2.1 Radiocommunication satellites require frequency assignments in two bands, one for the up-link and the other for the down-link. It is current practice for frequency bands to be associated in pairs, one of each pair being used for up-links and the other for down-links. Case I below is concerned with the possibility of interference between two systems which have been assigned frequency bands in this way. However, it should be feasible to use a pair of frequency bands in the reverse sense (bidirectional use) for some systems, the up-link band for one network being the same as the down-link band for the network using an adjacent satellite; this is Case II. These two cases cover all relative satellite positions from closely-spaced to near-antipodal positions.

Let A be a satellite link of network R associated with satellite S and A' be a satellite link of network R' associated with satellite S' . The symbols such as a , b and c refer to satellite link A and symbols such as a' , b' and c' refer to satellite link A' .

The parameters are defined as follows (for satellite link A):

T : the equivalent satellite link noise temperature, referred to the output of the receiving antenna of the earth station (K);

- T_s : the receiving system noise temperature of the space station, referred to the output of the receiving antenna of the space station (K);
- T_e : the receiving system noise temperature of the earth station, referred to the output of the receiving antenna of the earth station (K);
- ΔT : apparent increase in the equivalent noise temperature for the entire satellite link referred to the output of the receiving earth station antenna e_R , caused by interference emissions from other satellite networks;
- ΔT_s : apparent increase in the receiving system noise temperature of the satellite S, caused by an interfering emission, referred to the output of the receiving antenna of this satellite (K);
- ΔT_e : apparent increase in the receiving system noise temperature of the earth station e_R , caused by an interfering emission, referred to the output of the receiving antenna of this station (K);
- p_s : maximum power density per Hz delivered to the antenna of satellite S (averaged over the worst 4 kHz band for a carrier frequency below 15 GHz or over the worst 1 MHz band above 15 GHz) (W/Hz);
- $g_3(\eta)$: transmitting antenna gain of satellite S in the direction η (numerical power ratio);
- η_A : direction, from satellite S, of the receiving earth station e_R of satellite link A;
 $\eta_{e'}$: direction, from satellite S, of the receiving earth station e'_R of satellite link A';
Note. — The product $p_s g_3(\eta_{e'})$ is the maximum e.i.r.p. per Hz of satellite S in the direction of the receiving earth station e'_R of satellite link A';
 $\eta_{s'}$: direction, from satellite S, of satellite S';
- p_e : maximum power density per Hz delivered to the antenna of the transmitting earth station e_T (averaged over the worst 4 kHz band for a carrier frequency below 15 GHz or over the worst 1 MHz band above 15 GHz) (W/Hz);
- $g_2(\delta)$: receiving antenna gain of satellite S in the direction δ (numerical power ratio);
- δ_A : direction, from satellite S, of the transmitting earth station e_T of satellite link A;
 $\delta_{e'}$: direction, from satellite S, of the transmitting earth station e'_T of satellite link A';
 $\delta_{s'}$: direction, from satellite S, of satellite S';
- $g_1(\Phi)$: transmitting antenna gain of the earth station e_T in the direction of satellite S' (numerical power ratio);
- $g_4(\Phi)$: receiving antenna gain of the earth station e_R in the direction of satellite S' (numerical power ratio);
- Φ : topocentric angular separation between the two satellites, taking the longitudinal station-keeping tolerances into account.
Note. — Only the topocentric angle Φ should be used in dealing with Case I;
- Φ_g : geocentric angular separation in degrees between the two satellites, taking the longitudinal station-keeping tolerance into account.
Note. — Only the geocentric angle Φ_g should be used in dealing with Case II;
- k : Boltzmann's constant (1.38×10^{-23} J/K);
- l_d : free-space transmission loss on the down-link (numerical power ratio); evaluated from satellites to the receiving earth station e_R for satellite link A;
- l_u : free-space transmission loss on the up-link (numerical power ratio); evaluated from the earth station e_T to satellite S for satellite link A;

- l_s : free-space transmission loss on the inter-satellite link (numerical power ratio), evaluated from satellite S' to satellite S;
- γ : transmission gain of a specific satellite link subject to interference evaluated from the output of the receiving antenna of the space station S to the output of the receiving antenna of the earth station e_R (numerical power ratio, usually less than 1).

In the foregoing symbols, the gains $g'_1(\varphi)$ and $g_2(\varphi)$ are those of the earth stations concerned. In the event of precise numerical data relating to earth-station antennas not being available, the reference radiation pattern given in Recommendation 465 should be used.

Various ways of computing values for γ and T within a network are given in Annex II.

In order to simplify the calculations, it should be assumed that the basic transmission losses on the space-to-Earth path are identical, regardless of the satellite and earth station considered. Similarly, the basic transmission losses on the Earth-to-space path are assumed to be identical. For each of these two types of path, the losses are calculated using space-to-Earth or Earth-to-space distance of network R' and the centre frequency of the band shared by the two networks. These assumptions are reasonable in the case of the geostationary-satellite orbit because the difference in loss between the shortest and longest free space paths is only about 1.5 dB.

Case I – Wanted and interfering networks sharing the same frequency band in the same direction of transmission.

The parameters ΔT_s and ΔT_e are given by the following equations:

$$\Delta T_s = \frac{p'_e g'_1(\varphi) g_2(\delta_e)}{kl_u} \quad (1)$$

$$\Delta T_e = \frac{p'_s g'_3(\eta_e) g_4(\varphi)}{kl_d} \quad (2)$$

The increase in the equivalent satellite link noise temperature is the result of interference entering at both the satellite and earth-station receiver of link A. When satellites S and S' are equipped with simple frequency-changing repeaters having the same translation frequency. The interference received by link A is caused on the up-link and down-link by the same link A'.

This can therefore be expressed as follows:

$$\Delta T = \gamma \Delta T_s + \Delta T_e \quad (3)$$

$$\Delta T = \gamma \frac{p'_e g'_1(\varphi) g_2(\delta_e)}{kl_u} + \frac{p'_s g'_3(\eta_e) g_4(\varphi)}{kl_d} \quad (4)$$

Hence

Equation (4) combines the up-link and the down-link interference.

When the translation frequencies of the two satellites are not the same, different links in network R' may interfere with link A at the satellite and earth-station receivers; let these links be called A' and \bar{A}' respectively (the parameters such as \bar{a}' , \bar{b}' and \bar{c}' relate to link \bar{A}'). Then:

$$\Delta T = \gamma \frac{p'_e g'_1(\varphi) g_2(\delta_e)}{kl_u} + \frac{\bar{p}'_s \bar{g}'_3(\eta_e) g_4(\varphi)}{kl_d} \quad (5)$$

In the same way, the increase $\Delta T'$ in the equivalent noise temperature for the entire satellite link referred to the output of the receiving antenna of the receiving earth station e'_R under the effect of the interference caused by network R is given by the following equations:

$$\Delta T'_{s'} = \frac{p_e g_1(\varphi) g'_2(\delta_e)}{kl_u} \quad (6)$$

$$\Delta T'_{e'} = \frac{p_s g_3(\eta_e) g'_4(\varphi)}{kl_d} \quad (7)$$

When both satellites share the same translation frequency, then

$$\Delta T' = \gamma' \frac{p_e g_1(\varphi) g'_2(\delta_e)}{kl_u} + \frac{p_s g_3(\eta_e) g'_4(\varphi)}{kl_d} \quad (8)$$

When the two satellites have different translation frequencies (calling two links of the R network A and \bar{A} and denoting the corresponding parameters \bar{a} , \bar{b} , and \bar{c}):

$$\Delta T'' = \gamma' \frac{p_e g_1(\varphi) g'_2(\delta_e)}{kl_u} + \frac{\bar{p}_s \bar{g}_3(\eta_e) g'_4(\varphi)}{kl_d} \quad (9)$$

For the two multiple-access satellites this calculation must be made for each of the satellite links established via one satellite in relation to all of the satellite links established via the other satellite.

If only the up link or the down link of the wanted satellite network shares a frequency band with the interfering satellite network, the value for ΔT should be obtained from equation (3) with either ΔT_s or ΔT_e having a zero value, as appropriate.

Case II — Wanted and interfering networks sharing the same frequency band in opposite directions of transmission (bidirectional use).

Retaining the same notation the noise temperature increase ΔT_s referred to the output of the receiving antenna of the satellite of link A is given by:

$$\Delta T_s = \frac{p'_s g'_3(\eta_s) g_2(\delta_{s'})}{kl_s} \quad (10)$$

The apparent increase in equivalent link noise temperature is then given by:

$$\Delta T = \gamma \Delta T_s \quad (11)$$

The increase $\Delta T'$ in the equivalent noise temperature of the link A' caused by emissions from the satellite associated with the link A is given by:

$$\Delta T' = \gamma' \Delta T'_s = \gamma' \frac{p_s g_3 (\eta_s) g'_2 (\delta_s)}{k l'_s} \quad (12)$$

If only one band is shared by the two links A and A', interference between adjacent-satellite links will occur only into the link which uses the shared band for its up link.

Interference between earth stations associated with reverse-frequency assignment links is to be dealt with by coordination procedures analogous to those used for coordination between earth and terrestrial stations.

2.2 Consideration of polarization isolation

Polarization discrimination could also be used to reduce the probability of interference between satellite networks when different polarizations are used. In this case, the apparent increase in the equivalent satellite link noise temperature could be determined by the following expressions:

Case I

$$\Delta T = \frac{\gamma \Delta T_s}{Y_u} + \frac{\Delta T_e}{Y_d} \quad (13)$$

Case II

$$\Delta T = \frac{\gamma \Delta T_s}{Y_{ss}} \quad (14)$$

where the values of γ , ΔT_s and ΔT_e are those given in § 2.1 and the values of Y_u , Y_d and Y_{ss} are the polarization isolation factors (numerical ratio) for the up link, down link and inter-satellite link, respectively. Values of the polarization isolation factors are contained in Appendix 29 of the Radio Regulations. These values are matters requiring further study.

Since the polarization isolation factors depend on the types of polarization used by each network and the statistical distribution of orthogonal polarization levels, the polarization isolation factor described above shall be considered only if the polarization has been notified or published as requested in Article 11 of the Radio Regulations.

2.3 Comparison between calculated and predetermined percentage increase in equivalent satellite link noise temperature

In order to determine the largest value of $\Delta T/T$ it is necessary to insure that all potential situations are included. Inter-satellite network interference may be largest in either the up link or down link, thus sufficient data should be available to calculate both situations for each space-to-Earth service area and for each projected usage in accordance with Appendix 4 of the Radio Regulations. The $\Delta T/T$ expression is:

$$\frac{\Delta T}{T} = \frac{\Delta T_e}{T} + \frac{\gamma \Delta T_s}{T} \quad (15)$$

when $\gamma \Delta T_s/T \gg \Delta T_e/T$, the highest $\Delta T/T$ value occurs when γ/T is maximum. When $\Delta T_e/T \gg \gamma \Delta T_s/T$, the highest $\Delta T/T$ occurs when T is minimum. Thus, determinations need to be made using the values of γ and T associated with the maximum value of γ/T and using the minimum value of T and its associated value of γ . The greater of the calculated values of $\Delta T/T$ and $\Delta T'/T'$, expressed as percentage, should be compared with the corresponding predetermined values. The predetermined values are taken as 6% of the appropriate equivalent satellite link noise temperature (see Radio Regulations, Appendix 29):

- if the calculated value of $\Delta T/T$ is less than, or equal to, the predetermined one, the interference level from satellite link A' to satellite link A is permissible irrespective of the modulation characteristics of the two satellite links and of the precise frequencies used;
- if the calculated value of $\Delta T/T$ is greater than the predetermined one, a detailed calculation shall be carried out following the methods and techniques set out in Reports 388 and 455, during the co-ordination procedure between administrations.

The comparison of $\Delta T'/T'$ with the predetermined value shall be carried out in a similar manner.

As an example, it can be seen that in the case of a satellite link operating in accordance with current CCIR Recommendations using FM telephony and having a total noise in a telephone channel of 10 000 pWOp including 1000 pWOp interference noise from terrestrial radio-relay systems and 2000 pWOp interference noise from other satellite links, a 6% increase in equivalent noise temperature would correspond to up to 420 pWOp of interference noise.

Since, for new networks advanced published after 1987, the single-entry interference criterion specified in Recommendation 466 has been increased to 800 pWOp (from 600 pWOp), and the interference noise power in a telephone channel from all other satellite networks to 2500 pWOp from 2000 pWOp without frequency reuse (2000 pWOp from 1500 pWOp with frequency reuse), the corresponding value of the relative increase in equivalent satellite link noise temperature would be 6% (with frequency reuse) and 6.5% (no frequency reuse) for new networks. For a total noise power in a telephone channel of 10000 pWOp, including 1000 pWOp interference noise from terrestrial radio-relay networks and 2500 pWOp interference noise from satellite networks, 6 and 6.5% increases in equivalent satellite link noise temperature will correspond to interference noise in a telephone channel of 390 and 420 pWOp respectively, if the bandwidth of the interfering carrier is greater than that of the interfered-with carrier. When the interferer has a narrower bandwidth lower noise increases will result.

3. Procedure for signal-processing transponders

In cases where a change in modulation, or re-generation of the signal, occurs in the satellite, computation of the effects of up-link interference on the total link performance will require special procedures. In some cases, for example analogue signal processing transponders involving signal demodulation and re-modulation, it should be possible to compute an appropriate value for γ which will take into account the signal processing and relate the up-link interference contribution to the down-link. For these cases the calculation would be possible using equation (3) and the modified γ factor.

In other cases, it may not be possible to compute a γ which reasonably accounts for the signal processing in the satellite, such as with digital regenerating transponders. In these cases it will be necessary to treat the up link and down link separately, and separate up-link and down-link equivalent link noise temperatures will need to be determined. T_{seq} and T_{eq} would be values notified independently for the up link and down link respectively, T_{seq} being the total up-link equivalent system temperature referred and to the output of the receiving antenna of the earth station. Then $\Delta T_s/T_{seq}$ and $\Delta T_e/T_{eq}$ will be computed and compared with a predetermined value. This value should be taken as 6% for both the up link and the down link, pending further study.

4. Determination of the satellite links to be considered in calculating the increase in equivalent satellite link noise temperature from the data furnished for the advance publication of a satellite network

The greatest increase in equivalent satellite link noise temperature caused to any link of another satellite network, existing or planned, by interference produced by the proposed satellite network must be determined.

The most unfavourable potential transmitting earth-station site of the interfering network should be determined for each satellite receiving antenna of the network suffering interference by superimposing the "Earth-to-space" service areas of the interfering network on the space station receiving antenna gain contours plotted on a map of the Earth's surface. The most unfavourable potential transmitting earth station site is the one in the direction of which the satellite receiving antenna gain of the network interfered with, is the greatest.

The most unfavourable potential receiving earth-station site of the network suffering interference, should be determined in an analogous manner for each "space-to-Earth" service area of that network. The most unfavourable potential receiving earth station is the one in the direction of which the satellite transmitting antenna gain of the interfering network is the greatest.

Alternatively, the method described in Annex I may be used to account for the most unfavourable earth-station locations in determining $\Delta T/T$.

The receiving and transmitting antenna gains cited in the preceding two paragraphs are obtained from the respective antenna radiation patterns requested in Article 11 of the Radio Regulations as part of the Advance Publication Procedure. When one or both of the geostationary-satellite systems under consideration are in existence, it is preferable that actual measured satellite antenna patterns be utilized. Such measured patterns would permit more realistic assessment of the interference potential in the ensuing calculations.

When the satellite of the network suffering interference is equipped with simple frequency-translating transponders, the above determinations are made in pairs, one for the receiving antenna of a particular transponder and one for the "space-to-Earth" service area associated with the transmitting antenna of that transponder.

The calculation procedure described above may be used to determine the greatest increase in equivalent noise temperature caused to any satellite link in a proposed satellite network by interference produced by any other satellite network.

5. Data to be taken into consideration

To determine the increase in the equivalent satellite link noise temperature, it is necessary to know the correspondence between the up-link bands and the down-link bands. It would also be useful to know, for each frequency band, the number of the repeater and the designation of the beam used.

Moreover, the gain of the space station antennas might be given in the form of a radiation pattern plotted on a representation of the Earth as seen from the satellite. The diagram should indicate the maximum gain at mid-beam and the relative gains at each contour (2, 4, 6, 10, 20, 30 dB, ...). The contour corresponding to the service area should be indicated with a line different from that of the gain contours.

All this information would give a clearer picture of the complete link, thus facilitating the calculation of the apparent increase in its equivalent noise temperature.

6. Consideration of narrow-band carriers

The method of calculation described in this Report may underestimate the interference from slow swept TV carriers into certain narrow-band (single-channel-per-carrier-SCPC) carriers. Further studies are being conducted within CCIR to facilitate the accurate prediction of mutual interference between satellite networks under these circumstances. (See Recommendation 671 and Report 867)

7. Other considerations

7.1 Clear-air attenuation

Clear-air attenuation or gaseous absorption becomes a significant factor in determining operational parameters as higher frequencies are used. Since it also affects interference paths, it could be included in $\Delta T/T$ calculations. The procedure for accounting for clear-air attenuation needs further definition.

7.2 Transmission gain

To consider, for the determination of the link transmission gain γ , the use of Annex II of this Report as the transponder operating point provides a more precise measure of the link transmission gain than other parameters.

7.3 Link noise temperature in a multi-carrier mode

The inclusion of the effect of multi-carrier operation, including intermodulation, has to be considered for the determination of link noise temperature whenever a network operates transponders in multi-carrier mode. The absence of the intermodulation noise implies a single- or dual-carrier mode which, in turn, implies relatively high-capacity carriers. These high-capacity carriers are adequately protected with somewhat higher ΔT values.

8. Alternatives to current method

Studies have been made of alternative approaches to the application of $\Delta T/T$ with the objective of identifying possible improvements, in particular, by reducing the number of coordinations required. One such approach that has been proposed is contained in Annex III of this Report. This approach consists of using a set of predetermined values for $\Delta T/T$ which depends upon the types of wanted and interfering carriers involved, instead of the single value given in § 2.3. This approach is called "determination of interference using normalized values of the increases in equivalent link noise temperature".

Another approach, based on providing additional power density values for different averaging bandwidths, is described in Annex IV and is called "a power density-averaging bandwidth method of determining interference between satellite networks". Further studies are desirable on such alternatives. Relationships between $\Delta T/T$ ratios and single entry interference criteria are given in Annex V.

Important factors are to be considered in assessing the utility of the methods. These factors include:

- 1) simplicity of use both in terms of the mathematical formulation and in carrying out computations;
- 2) applicability to all space services;
- 3) requirement for data, the data required to use the method should be readily available, especially in the early stages of system design and implementation;
- 4) the accuracy of the results obtained by using the method;
- 5) ability to indicate the degree of difficulty which may be encountered during coordination;
- 6) ability to account for multiple interference entries into the wanted carrier.

ANNEX I

 $\Delta T/T$ CALCULATIONS FOR GEOSTATIONARY SATELLITES WITH UNSPECIFIED EARTH-STATION LOCATIONS

A method for computing $\Delta T/T$ when earth-station locations are not specifically known is presented as follows.

The topocentric angle (Φ_t) between two satellites is a function of the latitude and longitude of the earth stations with respect to the satellite sub-point. The latitude and longitude determine the geocentric angle (ψ) between the satellite sub-point and the earth station. As (ψ) increases, (Φ_t) decreases and the ranges to the two satellites (d_1 and d_2) increase. A ratio of topocentric angle (Φ_t) to geocentric angle (Φ_g) may be formed (Φ_t/Φ_g) as well as the ratios (d_1/d_0) and (d_2/d_0), where (d_0) is the distance from the satellite to its sub-point.

The ΔT_s and ΔT_e can be computed by using $G(\Phi_g)$ and (d_0) for (l_u) and (l_d) and adding a loss (ΔI) which is:

$$\Delta I = 25 \log (\Phi_t/\Phi_g) + 20 \log (d_1/d_0 \text{ or } d_2/d_0) \quad \text{dB}$$

which assumes the reference 25 log (Φ) earth station side-lobe envelope slope applies. The smallest values of (Φ_t/Φ_g) occur when earth stations are located on the equator (E-W). An orthogonal case is when the earth stations are located on a longitude midway between the satellites (N-S). For the (E-W) case (Φ_t/Φ_g), d_1 and d_2 were computed using the equations of Annex III of Appendix 29 to the Radio Regulations. As (Φ_g) approaches 0,

$$(\Phi_t/\Phi_g)_{E-W} \approx \frac{42\,166}{d} \cos T \quad \text{for } d_1 = d_2 = d$$

for earth stations located on the equator, where (T) is the angle between the earth stations as viewed from the satellite. For the (N-S) case:

$$(\Phi_t/\Phi_g)_{N-S} \approx \frac{42\,166}{d} \quad \text{for } d_1 = d_2 = d$$

for (Φ_g) up to at least 15-20° and for earth stations located along the satellite's mid-longitude line.

With these functions, ΔI is computed as a function of (ψ) for (Φ_g) up to 15° and is shown in Fig. 1. The angle (ψ) is to the nearest satellite and ($\psi + \Phi_g$) to the farthest satellite in the (E-W) plane.

If up-path interference is associated with (d_1) then down-path interference is associated with (d_2), or *vice versa*, and thus ΔI_u and ΔI_d are similarly associated. If the earth-station elevation angle (H) is limited, then the angle (ψ) is also limited. Approximate functions for (ΔI) are:

(E-W) Case:

$$\Delta I_d \approx A \pm 0.011 \Phi_g \text{ and } \Delta I_u \approx A \pm 0.011 \Phi_g \quad \text{dB}$$

where:

$$A \approx 1.32 + 0.0065 H + 0.006 \Phi_g \quad \text{dB}$$

for H and Φ_g - degrees

(N-S) Case:

$$\Delta l_u = \Delta l_u \approx 1.45 + 0.00056H + 0.006 \Phi_g \quad \text{dB}$$

The values of (ψ) can be determined by the location of the highest satellite antenna gain values as described in § 4. The (Δl) for earth stations located on other than the equator or mid-satellite longitude line can be estimated by extrapolation.

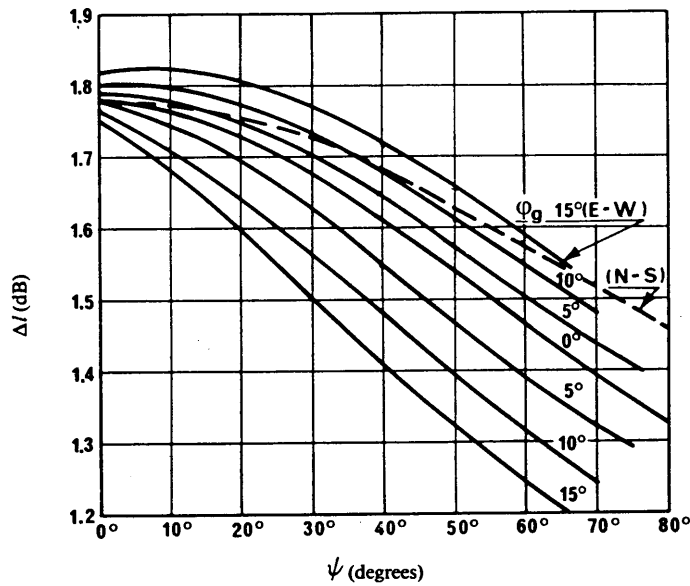

FIGURE 1 – Additional interference path loss as a function of geocentric angle between satellite sub-point and earth station

- Φ_g : geocentric satellite separation angle
- ψ : geocentric angle between satellite sub-point and earth station
- Δl : additional interference path loss when 35.796 km is used for free-space loss calculations and earth station off-axis antenna gain is proportional to $-25 \log \Phi_g$

ANNEX II

CALCULATION OF THE EQUIVALENT SATELLITE LINK NOISE TEMPERATURE AND THE TRANSMISSION GAIN

1. Introduction

The purpose of this Annex is to provide some guidance for determining, for simple frequency changing transponders, values of equivalent satellite link noise temperatures and transmission gains and in particular the sets of values for:

- the lowest equivalent link noise temperature and the associated transmission gain, and
- the value of transmission gain and associated equivalent link noise temperature that correspond to the highest ratio of transmission gain to equivalent satellite link noise temperature.

The equivalent satellite link noise temperature (T), referred to the output of the receiving antenna of the earth station, and the transmission gain (γ) of a satellite link using simple frequency-changing transponders, can be determined in several ways.

2. General formulation

2.1 Method 1

The transmission gain is expressed as follows:

$$\gamma = \frac{p_s g_3 (\eta_A) g_4 l_u}{p_e g_1 g_2 (\delta_A) l_d} \quad (1)$$

where g_1 and g_4 are the maximum (on-axis) transmitting and receiving earth station antenna gains, respectively.

2.2 Method 2

The transmission gain is expressed as follows:

$$\gamma = \frac{\text{e.i.r.p.}_s g_4}{W_s g_2 (\delta_A)^2} \frac{BO_i 4\pi}{BO_o \lambda^2} = \frac{(C/N_o)_d T_e}{(C/N_o)_u T_s} \quad (2)$$

The equivalent link noise temperature is expressed as follows:

$$T = \frac{(C/N_o)_d}{(C/N_o)_i} T_e \quad (3)$$

where:

$(C/N_o)_u$: up-link carrier-to-noise density ratio including only thermal and other background noises (numerical ratio);

$(C/N_o)_d$: down-link carrier-to-noise density ratio including only thermal and other background noises (numerical ratio);

$C/N_o)_i$: total link equivalent carrier-to-noise density ratio including only intra-satellite impairment (intra-satellite interference, intermodulation), thermal and other background noises (numerical ratio);

e.i.r.p._s: satellite saturation e.i.r.p. (W);

λ : the wavelength (m) of the up-link frequency;

BO_i : transponder input back-off with respect to single carrier saturation (numerical value);

BO_o : transponder output back-off with respect to single carrier saturation (numerical value);

W_s : saturation power flux-density at the satellite (W/m^2).

The product of the satellite saturation power flux-density and the satellite receiving antenna gain (i.e. $W_s \cdot g_2 (\delta_A)$) is the same for the satellite antenna beam-peak and beam-edge values. Hence the transmission gain (γ) is a maximum when the satellite e.i.r.p. is a maximum. This condition occurs at the satellite transmitting antenna beam-peak.

3. Derivation of two sets of T and γ

3.1 Lowest T and associated γ

The lowest equivalent link noise temperature, T_{min} , can be expressed as follows:

$$T_{min} = T_e + \gamma_{min} \cdot T_s + T_a \quad (4)$$

where T_a is other internal noise and γ_{min} , its associated transmission gain, is derived from equation (2) by considering the satellite saturation e.i.r.p. (e.i.r.p.) at beam-edge.

3.2 T and γ corresponding to the highest γ/T ratio

The value of γ and associated T that correspond to the highest ratio of transmission gain to equivalent link noise temperature can be determined by maximizing the following equation:

$$\frac{\gamma}{T} = \frac{\gamma}{T_e + \gamma T_s + T_a} \quad (5)$$

This equation is maximized when γ is maximum, i.e. when it is calculated at the satellite antenna beam peak rather than beam edge, consequently:

$$\gamma_{max} = \gamma_{min} \Delta g \quad (6)$$

Δg : satellite transmit antenna gain difference between beam-peak and beam-edge values (numerical power ratio).

The associated equivalent link noise temperature is, therefore, given by:

$$T = T_e + \gamma_{min} T_s \Delta g + T_a \quad (7)$$

4. Summary

The determination of T and γ in accordance with the above-mentioned formulae or by other methods needs to be made for each type of utilization in the satellite network in order to obtain the appropriate sets of values to be used for $\Delta T/T$ calculation.

These methods should not be used to derive values of T and γ from notified or published information by other administrations. Further studies are required concerning these parameters and their relationships.

ANNEX III

METHOD OF THE NORMALIZED EQUIVALENT NOISE TEMPERATURE OF THE SATELLITE LINK

1. Introduction

This method is based on the technique shown in Appendix 29 to the Radio Regulations and described in this Report appropriately modified to give precise results. To do so, the threshold of 6% used in Appendix 29 is replaced by thresholds which depend on the carriers involved and which meet the CCIR criteria.

2. Normalized values for the relative increase in the admissible equivalent link noise temperature

2.1 Definition

The method involves determining the overall increase in equivalent link noise temperature due to the various types of transmission in the two networks.

The normalized values for the relative increase in equivalent link noise temperature are given by:

$$\left(\frac{\Delta T}{T}\right)_N = \frac{I}{N_0 B_2}$$

where:

N_0 : thermal noise density corresponding to the equivalent noise temperature of the satellite link,

I/N_0 : ratio of interfering power to the thermal noise density of the wanted carrier,

B_2 : bandwidth defined by the ratio of the interfering carrier power P' to its maximum spectral power density p'_m :

$$p'_m = P'/B_2$$

2.2 Values for various carrier types

The calculation method for $(\Delta T/T)_N$ depends on the type of wanted and interfering carriers. Five types are considered:

- FDM-FM,
- SCPC-FM,
- digital SCPC (SCPC-DIG),
- wideband digital (DIG-BB),
- FM-television (FM-TV).

For a given type of wanted carrier and a given type of interfering carrier, the $(\Delta T/T)_N$ value obtained (using the method which corresponds to this pair of carrier types) depends on carrier parameters such as bandwidth and coding.

In order to limit the necessary computations, each general carrier type is broken down into various sub-headings so that, for each pair of carrier types, the carrier parameters no longer affect $(\Delta T/T)_N$ (as long as these parameters lie in the range specified for each type) (see Table I). Thus $(\Delta T/T)_N$ can be determined simply from the knowledge of the type of the two carriers.

Carriers are classified according to this type.

An initial analysis of the carriers leads to the identification of about 50 different types:

- about 20 FDM-FM, characterized by the number of channels and allocated band,
- several SCPC-FM, characterized by the allocated band,
- about 15 DIG-BB, characterized by the bit rate, type of coding, and number of states,
- several SCPC-DIG, characterized by the bit rate, type of coding, and number of states,
- several FM-TV, characterized by the allocated band and energy dispersal characteristics.

In order to simplify the presentation of the table of thresholds, the 50 types of carriers have been gathered in 12 categories as given in Table II.

The corresponding values of $\Delta T/T$ for each pair of wanted and interfering categories of types of carriers is given in Table III.

TABLE I - Standard carrier types

FDM-FM No.	Type	N/V	B_{oc} (MHz)	f_{min} (kHz)	f_{max} (kHz)	Δf_{st} (kHz)	Δf_m (kHz)
1	12 1.3	12	1.13	12.0	60.0	108.5	159.0
2	12 2.5	12	2.2	12.0	60.0	238.9	350.0
3	24 2.5	24	1.96	12.0	108.0	163.4	275.0
4	60 2.5	60	2.25	12.0	252.0	136.5	276.0
5	72 2.5	72	2.25	12.0	300.0	124.5	261.0
6	60 5.0	60	3.96	12.0	252.0	270.1	546.0
7	132 5.0	132	4.45	12.0	552.0	223.5	529.0
8	192 5.0	192	4.51	12.0	804.0	180.0	459.0
9	96 7.5	96	5.87	12.0	408.0	359.8	799.0
10	192 7.5	192	6.40	12.0	804.0	297.2	758.0
11	252 7.5	252	6.74	12.0	1052.0	259.7	733.0
12	132 10.0	132	7.50	12.0	552.0	430.0	1020.0
13	252 10.0	252	8.49	12.0	1052.0	357.4	1009.0
14	312 10.0	312	8.96	12.0	1300.0	320.0	1005.0
15	252 15.0	252	12.39	12.0	1052.0	576.4	1627.0
16	432 15.0	432	12.95	12.0	1796.0	400.2	1479.0
17	432 20.0	432	17.99	12.0	1796.0	615.8	2276.0
18	612 20.0	612	17.70	12.0	2540.0	453.7	1996.0
19	432 25.0	432	20.59	12.0	1796.0	727.3	2688.0
20	792 25.0	792	22.34	12.0	3284.0	498.4	2494.0
21	972 25.0	972	25.00	12.0	4028.0	410.0	2274.0
22	972 36.0	972	35.99	12.0	4028.0	796.7	4417.0
SCPCA No.	Type		B_{oc} (kHz)	f_{min} (kHz)	f_{max} (kHz)	Δf (kHz)	
23	0.020		20.0	0.3	3.4	5.8	
24	0.025		25.0	0.3	3.4	12.0	
25	0.030		30.0	0.3	3.4	8.5	
26	0.090		90.0	0.3	3.4	3.4	
27	0.180		180.0	0.3	3.4	3.3	
SCPCN No.	Type	N/E	B_{oc} (kHz)	Bit rate (kbit/s)			
28	0.064	4	38.0	64.0			
29	0.085	4	50.0	85.0			
30	0.128	4	150.0	128.0			
31	0.256	4	300.0	256.0			
32	0.502	4	600.0	512.0			
NUM-LB No.	Type	N/E	B_{oc} (MHz)	Bit rate (Mbit/s)			
33	2Q	4	1.44	2.048			
34	3Q	4	1.84	3.072			
35	4Q	4	2.25	4.096			
36	8Q	4	5.0	8.448			
37	10Q	4	5.0	10.0			
38	17Q	4	10.2	17.0			
39	25Q	4	18.0	24.6			
40	34Q	4	20.6	34.368			
41	40Q	4	20.0	40.0			
42	50Q	4	25.6	50.0			
43	120Q	4	75.0	120.0			
44	139Q	4	82.0	139.264			
45	147Q	4	110.0	147.0			
FM-TV No.	Type	Δf (MHz)	B_{oc} (MHz)	Δf_{pm} (MHz)	Δf_{pnm} (MHz)	f_{bal} (Hz)	
46	TV.17	4.75	17.5	1.0	2.0	60/30	
47	TV.20	4.8	20.0	1.0	2.0	50	
48	TV.30	6.2	30.0	2.0	4.0	50	
49	TV.35	5.0	30.0	2.0	4.0	50/25	
50	TV.36	11.0	32.0	1.0	2.0	50	

SCPCA: SCPC (analogue)
 SCPCN: SCPC (digital)
 NUM-LB: wideband (digital)
 N/V: number of channels
 N/E: number of states
 B_{oc} : occupied bandwidth

Δf : frequency deviation
 Δf_{pm} : frequency deviation (modulated carrier)
 Δf_{pnm} : frequency deviation (unmodulated carrier)
 f_{bal} : sweep frequency
 Δf_{st} : frequency deviation (test signal)
 Δf_m : frequency deviation (multiplex signal)

TABLE II - Categories of carrier

Type of carrier		No.
FDM-FM	$B_{oc} \leq 3$ MHz	1-5
	$3 \text{ MHz} < B_{oc} \leq 7$ MHz	6-11
	$7 \text{ MHz} < B_{oc} \leq 15$ MHz	12-16
	$B_{oc} > 15$ MHz	17-22
Wideband digital	$B_{oc} \leq 3$ MHz	33-35
	$3 \text{ MHz} < B_{oc} \leq 7$ MHz	36-37
	$7 \text{ MHz} < B_{oc} \leq 15$ MHz	38
	$B_{oc} > 15$ MHz	39-45
SCPC	PSK	28-32
	CFM	23-27
FM-TV	$\Delta f \leq 7$ MHz	46-49
	$\Delta f > 7$ MHz	50

B_{oc} : occupied bandwidth
 Δf : frequency deviation

TABLE III - Single carrier to single carrier $\Delta T/T$ threshold values

Wanted (1) carrier	Interfering carrier B_{oc} (MHz)	FDM-FM				Wideband digital				SCPC		FM-TV	
		< 3	3-7	7-15	> 15	< 3	3-7	7-15	> 15	PSK	CFM	$\Delta f < 7$	$\Delta f > 7$
FDM-FM *	< 3	13	12	12	11	8	10	10	8	9	1223	11	11
	3-7	23	14	12	12	11	10	10	8	29	4350	11	13
	7-15	40	20	14	12	17	10	10	8	56	8458	12	19
	> 15	102	46	24	14	40	19	11	8	148	22257	23	45
Wideband digital **	< 3	15	10	9	9	9	9	9	9	21	3085	9	9
	3-7	49	21	12	9	19	9	9	9	71	10712	11	21
	7-15	100	44	21	11	39	17	9	9	146	21853	22	44
	> 15	176	77	38	15	69	31	15	9	257	38565	39	77
SCPC	PSK **	9	9	9	9	9	9	9	9	9	9	2	2
	CFM *	11	11	11	11	11	11	11	11	11	11	21	36
FM-TV	$\Delta f \leq 7$	73	32	16	6	29	13	6	2	107	16046	16	32
	$\Delta f > 7$	23	10	5	2	9	4	2	1	34	5098	5	10

Note.- When several equal power interfering carriers of one of the types given in Table I are included in the wanted bandwidth, these values should be decreased in accordance with the number of these interfering carriers.

(1) The table reflects the value for the most sensitive carrier in any range.

* Criterion used: 800 pWp single entry and 7000 pWp total. For FM-TV interference a 20% allocation to external satellite interference is assumed.

** Criterion used: 6% single entry and 70% total. For FM-TV interference a 20% allocation to external satellite interference is assumed and a value of 12.3 dB is assumed for energy per bit to noise power density ratio (BER = 10^{-6}).

(2) This Table should not be used for carrier types not included in Table I.

3. Parameters used in the computation of I/N_0 and $(\Delta T/T)_N$

The parameters used are as follows:

- B_0 : bandwidth of the wanted signal (Hz),
- B_1 : bandwidth of the interfering signal (Hz),
- I/N_0 : ratio of interfering carrier power-to-noise power density,
- C/N_0 : ratio of wanted carrier power-to-noise power density,
- C/I : ratio of wanted-to-interfering carrier power,
- B_2 : bandwidth defined by the ratio of interfering power P' to its maximum spectral power density p'_m :

$$p'_m = P'/B_2$$

- α : fraction of interfering signal power received after filtering by the wanted signal receiver filter (see Report 388).
- N_0 : thermal noise power density corresponding to the equivalent noise temperature of the satellite link,
- N : noise power $N = N_0 \cdot B_0$.

Admissible normalized values for the relative increase in equivalent link noise temperature are given by:

$$\left(\frac{\Delta T}{T}\right)_N = \frac{I}{N_0 B_2}$$

4. Interference criteria

In the computation of $\left(\frac{\Delta T}{T}\right)_N$ for analogue FDM/FM signals, the equivalent link noise temperature should correspond to a noise power in a telephone channel of 7000 pWOp for systems with frequency re-use and 6500 pWOp for systems without frequency re-use (Recommendations 466 and 356).

For digital signals, the equivalent link noise temperature should correspond to 70% (for systems with frequency re-use) and 65% (for systems without frequency re-use) of the total noise power level which would give rise to a bit error ratio of 10^{-6} (Recommendations 523 and 558).

For TV/FM type signals, the criterion given in Recommendation 483 should be applied. Accordingly, taking into account interference from terrestrial radio links, the single-entry interference criterion referred to permissible video noise is 5%.

For an SCPC-FM signal, the criterion for interference from other than TV-FM signals is assumed to be 600 pWOp in a channel for an equivalent link noise temperature of 7000 pWOp for systems with frequency re-use and 6500 pWOp for systems without frequency re-use.

For an SCPC-FM or SCPC-PSK, the criterion for interference from TV-FM signals should correspond to Recommendation 671 and Report 867.

It should be noted that if the spectrum of the wanted signal is broader than the spectrum of the interfering signal, total interference due to all interfering signals from the same network within the bandwidth of the wanted signal should be considered.

5. FDM-FM wanted carriers

Baseband interference N_p is given in pWOp by (Report 388):

$$\begin{aligned} 10 \log N_p &= 87.5 - B - 10 \log \frac{C}{I} \quad \text{dB} \\ &= 87.5 - P + 10 \log b + 10 \log D(f, f_0) - 20 \log \frac{\delta f}{f} \\ &= -3 - 10 \log \frac{C}{I} \end{aligned}$$

where:

- B : interference reduction factor,
- b : telephone channel bandwidth (Hz),
- δf : r.m.s. test-tone deviation of the wanted signal (Hz),
- f_m : top baseband frequency of the wanted multiplex signal (Hz),
- $D(P, f_0)$: convolution product of wanted and interfering spectra,
- f_0 : separation between carrier frequencies of wanted and interfering signals (Hz),
- f : central frequency of the selected channel, located in the baseband of the wanted signal (Hz),
- $P = 10 \log p(f/f_m)$: pre-emphasis (dB).

Thermal noise after demodulation is given by:

$$10 \log N_{th} = 87.5 - P - 10 \log \frac{C}{N_0} + 10 \log b - 20 \log \frac{\delta f}{f} \quad \text{dB}$$

where:

$N_0 = kT$: noise density power on the wanted link

with k : Boltzmann's constant

and T : equivalent satellite link noise temperature as defined in No.168 of the Radio Regulations

thus:
$$10 \log \frac{N_p}{N_{th}} = 10 \log \frac{I}{N_0} - 3 + 10 \log D(f, f_0) \quad \text{dB}$$

$$\frac{N_p}{N_{th}} = \frac{I}{N_0} \cdot \frac{D(f, f_0)}{2}$$

The single entry criterion established by Recommendation 466 corresponds to $N_p = 800$ pWOp, for an N_{th} value equal to 7000 or 6500 pWOp. As an example, for 7000 pWOp which is applicable to systems with frequency reuse:

$$\frac{I}{N_0} = 0.1143 \frac{2}{D(f, f_0)} = \frac{0.2286}{D(f, f_0)}$$

hence:
$$\left(\frac{\Delta T}{T}\right)_N = \frac{0.2286}{D(f, f_0)} \cdot \frac{1}{B_2}$$

6. SCPC-FM wanted carrier

6.1 Interference from an FM-TV carrier

In this case the $10 \log C/I = 13.5 + 2 \log \delta - 3 \log(i/10)$ criteria must be respected (Rec. 671.).

$$\text{thus:} \quad \frac{I}{N_0} = \frac{C}{N_0} \cdot \frac{I}{C} = \frac{C}{N_0} \cdot \frac{i^{0.3}}{10^{1.65} \cdot \delta^{0.2}}$$

$$\text{thus:} \quad \left(\frac{\Delta T}{T}\right)_N = \frac{C}{N_0} \cdot \frac{i^{0.3}}{10^{1.65} \cdot \delta^{0.2}} \cdot \frac{1}{B_2}$$

$$\text{with:} \quad \delta = \frac{B_0}{\Delta f} \quad \text{and} \quad B_2 = \Delta f$$

where: Δf : peak-to-peak frequency deviation of TV signal due to energy dispersal (Hz).

i : percentage of total predemodulation noise allocated to internetwork interference.

For the example given in Table I, thermal noise is given by:

$$10 \log N_{th} = 188.7 - 10 \log C/N_0 - 20 \log \delta f \quad \text{dB}$$

δf : r.m.s. deviation of the SCPC-FM wanted signal (Hz).

After companding, the following is generally obtained:

$$C/N_0 = 10^{14.9} / \delta f^2$$

6.2 Interference from a carrier other than FM-TV

All other interfering signals have spectra significantly broader than the wanted signal spectrum (SCPC), thus:

$$\left(\frac{\Delta T}{T}\right)_N = \frac{N_p}{N_{th}}$$

where

$N_p = 800 \text{ pWOp}$: permissible single-entry interference criterion

$N_{th} = 6500 \text{ pWOp}$ or 7000 pWOp corresponding to systems without or with frequency re-use. Thus for 7000 pWOp :

$$\left(\frac{\Delta T}{T}\right)_N = \frac{800}{7000} = 11.4\%$$

7. Digital SCPC wanted carrier

7.1 Interference from an FM-TV carrier

In this case the $10 \log C/I = 10 \log C/N + 6.4 + 3 \log \delta - 8 \log (i/10)$ must be requested (Rec. AB/4).

$$\text{thus:} \quad \frac{I}{N_0} = \frac{C}{N_0} \cdot \frac{I}{C} = \frac{N}{N_0} \cdot \frac{i^{0.8}}{10^{1.44} \cdot \delta^{0.3}}$$

$$\text{thus:} \quad \left(\frac{\Delta T}{T}\right)_N = \frac{i^{0.8}}{10^{1.44} \cdot \delta^{0.3}} \cdot \frac{B_0}{B_2}$$

$$\text{with:} \quad \delta = \frac{B_0}{\Delta f} \quad \text{and} \quad B_2 = \Delta f$$

Δf : peak-to-peak frequency deviation of TV signal due to energy dispersal (Hz).

i = percentage of total pre-demod. noise allocated to internetwork interference.

For the example given in Table I, C/N_0 is given by:

$$C/N_0 = \frac{E}{N_0} \cdot D_u$$

where:

- E : energy per bit,
- D_u : useful bit rate,
- N_0 : noise power density.

7.2 Interference from a carrier other than FM-TV

All other signals have spectra significantly broader than the wanted signal spectrum (SCPC). Thus for systems with frequency re-use:

$$\left(\frac{\Delta T}{T}\right)_N = \frac{0.06}{0.7} = 8.57\%$$

8. Broadband digital wanted carrier

Recommendation 523 gives the CCIR criterion: $\alpha I/N_{th} = \frac{6}{70} = 8.57\%$ (for systems with frequency re-use)

8.1 Interference from a digital carrier

- if $B_0 > B_1$: $\alpha = 1$

then:
$$\frac{I}{N_0} = \frac{I}{N_{th}} \cdot \frac{N_{th}}{N_0} = \frac{I}{N_{th}} \cdot B_0 = 0.0857 B_0 \quad \text{and} \quad B_2 = B_1$$

thus:
$$\left(\frac{\Delta T}{T}\right)_N = 0.0857 \cdot \frac{B_0}{B_2} = 0.0857 \cdot \frac{B_0}{B_1}$$

- if $B_0 < B_1$: $\alpha = B_0/B_1$

then:
$$\frac{I}{N_0} = \frac{\alpha I}{N_{th}} \cdot \frac{N_{th}}{N_0} \cdot \frac{1}{\alpha} = 0.0857 B_0 \cdot \frac{B_1}{B_0} = 0.0857 B_1 \quad \text{and} \quad B_2 = B_1$$

hence:
$$\left(\frac{\Delta T}{T}\right)_N = 0.0857 \cdot \frac{B_1}{B_2} = 0.0857$$

8.2 Interference from an analogue carrier

- if $B_0 > B_1$: $\alpha = 1$

then:
$$\frac{I}{N_0} = \frac{I}{N_{th}} \cdot \frac{N_{th}}{N_0} = 0.0857 B_0 \quad \text{and} \quad \left(\frac{\Delta T}{T}\right)_N = 0.0857 \cdot \frac{B_0}{B_2}$$

- if $B_0 < B_1$:
$$\frac{I}{N_0} = \frac{\alpha I}{N_{th}} \cdot \frac{N_{th}}{N_0} \cdot \frac{1}{\alpha} = 0.0857 \cdot \frac{B_0}{\alpha} \quad \text{and} \quad \left(\frac{\Delta T}{T}\right)_N = 0.0857 \cdot \frac{B_0}{\alpha \cdot B_2}$$

9. FM-TV wanted carrier

In this case, the criterion is: $10 \log C/\alpha I \geq X$ dB, where X could be a variable. However, for the example given in Table VII, the value of X has been taken as 35 dB.

thus:
$$\frac{I}{N_0} = \frac{I}{C} \cdot \frac{C}{N_0} = \frac{1}{10^{3.5}} \cdot \frac{C}{\alpha \cdot N_0}$$

- if $B_0 > B_1$: $\alpha = 1$
$$\left(\frac{\Delta T}{T}\right)_N = \frac{C}{N_0} \cdot \frac{1}{10^{3.5}} \cdot \frac{1}{B_2}$$

- if $B_0 < B_1$:
$$\left(\frac{\Delta T}{T}\right)_N = \frac{C}{N_0} \cdot \frac{1}{10^{3.5}} \cdot \frac{1}{\alpha \cdot B_2}$$

For the example given in Table VII, where according to Recommendation 567, the required S/N is 53 dB. Allowing 20% of the total noise to external interference, the following must be satisfied:

$$\frac{S}{N_{in}} \geq 54 \text{ dB for 99\% of the time.}$$

The TV video signal-to-noise ratio after demodulation is given by:

$$10 \log \frac{S}{N_{in}} = 10 \log \frac{C}{N_0} + 20 \log \frac{r_1 \cdot \Delta F}{F_m} - 10 \log \frac{F_m}{3} + P + Q$$

ΔF : frequency deviation at low FM-TV signal frequencies (Hz),

F_m : maximum baseband frequency (Hz) of the FM-TV signal,

P : pre-emphasis,

Q : weighting,

r_1 : video-to-luminance signal ratio.

- in the case of a 625/50 TV system:

$$Q = 13.2 \text{ dB} \quad P = 11 \text{ dB} \quad r_1 = 0.714$$

$$P + Q = 24.2 \text{ dB}$$

thus: $C/N_0 = 10^{54 - K_{TV} - 10}$

with:

$$\begin{aligned} K_{TV} &= P + Q + 10 \log 3 r_1^2 \cdot \frac{\Delta F^2}{F_m^3} \\ &= 24.2 + 10 \log 1.53 \cdot \frac{\Delta F^2}{F_m^3} \end{aligned}$$

10. Conclusion

This method might be used for determining the need for coordination and as it reflects better than Appendix 29 to the Radio Regulations the actual interference situation, a certain number of coordination procedures might be eliminated.

Also, as a contribution to future planning efforts based on multilateral coordination, this method might provide a more precise means of determining mutual interference.

ANNEX IV

A POWER DENSITY-AVERAGING BANDWIDTH METHOD OF DETERMINING INTERFERENCE BETWEEN SATELLITE NETWORKS

1. Introduction

In the process of computing interference between satellite networks, three levels of detail may be postulated; 1) the initial $\Delta T/T$ calculations using Appendix 29 and Appendices 4 or 3 data, 2) if the $\Delta T/T$ threshold is exceeded more detailed calculations based on additional information (such as might be contained in Appendix 3) where the interference power in carrier bandwidths of interest are estimated and, 3) if unacceptable interference remains after 2) carrier frequency planning may be necessary.

A simple method for determining the interference between satellite networks at the level of detail postulated in No. 1 and No. 2 above is described in the following sections.

2. Description

This method for estimating the mutual interference levels among satellite networks is based on providing sufficient information to allow computation of the interference power (I) in any interfered-with carrier bandwidth. The interference power (I) is proportional to the interfering power density (P_O) times the interfered-with bandwidth of interest (B_r). The worst case (P_O) is determined for any transmitting bandwidth (B_t) by finding the portion of a band having a bandwidth (B_t) in which the total power (P) is maximum and thus $P_O(B_t) = P/B_t$.

In order to determine (I) for any carrier bandwidth (B_r) it is necessary to have a quantitative power density-averaging bandwidth function over the bandwidths of interest. The total band over which such a function would be provided is the band over which contiguous or potentially contiguous carriers could exist. This would typically be a transponder bandwidth for the fixed-satellite service. It can be demonstrated that only a small number of averaging bandwidths with associated power densities are needed to reasonably accurately describe a complete power density-averaging bandwidth function over a transponder bandwidth. Judicious selection of the values of averaging bandwidths can result in small reconstruction errors for the total functions. (See Appendix I - General formulation).

These power density-averaging bandwidth data points would be provided for the up-path (values of P_e and associated bandwidths) and for the down-path (values of P_s and associated bandwidths) including the values of P_e and P_s for the currently defined averaging bandwidths. An administration with an interfered-with network could then construct a total function.

Using these reconstructed functions, or the appropriate equations, values for $\gamma \Delta T_s$ and ΔT_e can be computed for all carrier bandwidths of interest using Appendix 29. From these values, $\Delta T/T$'s can be computed for all carriers and the interference power for all carriers can also be computed; i.e., $I = \Delta T \times K \times B_r$ where (K) is Boltzman's Constant. Thus the administration with the interfered with network can compute for each carrier: $\Delta T/T$, I, I/N, and (knowing the carrier power C), C/I. From this interference information an administration can decide if there is a need to coordinate or that more detail analyses are required or that the interference levels are acceptable.

An important requirement for any interference determination method is the ability to properly account for multiple interference sources into a wider band carrier; for example: a number of SCPC carriers transmitted from different earth stations and received by different earth stations in one network which are common sources of interference to a wide bandwidth carrier in an interfered-with network. This method addresses this requirement and accounts for multiple source interference in the determination of the power densities where this situation exists. The power density values where multiple carriers must be taken into account would be limited to very few averaging bandwidths. The important point to note is that these would be determined by the administration for its own network.

Where the transmitting earth stations are identical the power densities and off-axis e.i.r.p. densities can be obtained and will have the same power density-bandwidth functions as the satellite transponder function. When there are differences in the earth station transmitting antenna gains, the composite power density-bandwidth function can be different than the e.i.r.p. density function. One method which may be used to provide information for estimating up-path interference in a given bandwidth is to provide a power density-bandwidth function for each station type (carriers into all earth stations of one type are assumed to be in one earth station of that type). The off-axis interference from each earth station type can then be computed for bandwidths of interest. The worst case interference for a given bandwidth can then be estimated by comparing the values from the different earth station types.

A specific implementation of this method is described in Appendix I and examples are given using this specific implementation to indicate the improvement in accuracy that may be achieved when compared to the current Appendix 29 method.

This method can be applied to determining the need to coordinate and can continue to be used in the actual coordination. In the case of determining the need to coordinate, a $\Delta T/T$ based on the minimum interfered with carrier bandwidth of interest rather than the reference bandwidth would be used as the threshold.

3. Summary

The power density-averaging bandwidth method for estimating interference among satellite networks is an extension of the current $\Delta T/T$ method of determining the need to coordinate and has the following features:

- 1) The computations are well understood using the Appendix 29 methodology. Values of $\Delta T/T$, interference power (I), or I/N can be computed for any interfered-with carrier bandwidth. When the carrier power (C) is given, then C/I is also known. Thus it can be used in conjunction with a variety of interference criteria.
- 2) A small amount of additional information is required over that currently necessary for Appendices 4 and 3.
- 3) Interference from multiple narrow-band sources into wider bandwidth carriers are taken into account through an approximation.
- 4) This method can be applied to determining the need to coordinate and to actual coordination.

APPENDIX I

Application of the power density-averaging bandwidth method1. General formulation

Given a band of contiguous, or potentially contiguous, carriers, the worst case power density (P_o) in a bandwidth (B) is determined by finding the portion of the band having a bandwidth (B) in which the total power (P) are maximum:

$$P_o = P/B \quad (1)$$

Given values of power density (P_{o1}) and (P_{o2}) for bandwidths (B_1) and (B_2), the maximum value of (P_o) between (B_1) and (B_2) is limited as follows:

$$P_o = P_{o1} ; B_1 \leq B \leq B_2 \quad (P_{o2}/P_{o1}) \quad (2)$$

$$P_o = \frac{P_{o2}B_2}{B} ; B_2 (P_{o2}/P_{o1}) \leq B \leq B_2 \quad (3)$$

and the minimum (P_o) between (B_1) and (B_2) is

$$P_o = \frac{P_{o1}B_1}{B} ; B_1 \leq B \leq B_1 (P_{o1}/P_{o2}) \quad (4)$$

$$P_o = P_{o2} ; B_1 (P_{o1}/P_{o2}) \leq B \leq B_2 \quad (5)$$

The difference between these functions connecting the points is the maximum possible error.

When the power densities are expressed in dBW/Hz, and plotted against bandwidth on a logarithmic scale, the error parallelogram is formed as shown in Figure 2. As shown in the figure, the same process is used between subsequent points (P_{o2} , B_2 and P_{o3} , B_3 , etc.). The error is a function of (B) and ($P_{o1} - P_{o2}$).

For an equal error between points (P_{o1} , B_1), (P_{o2} , B_2), (P_{o3} , B_3), (P_{o4} , B_4), etc.; $B_2/B_1 = B_3/B_2 = B_4/B_3$ etc. (a geometric spacing).

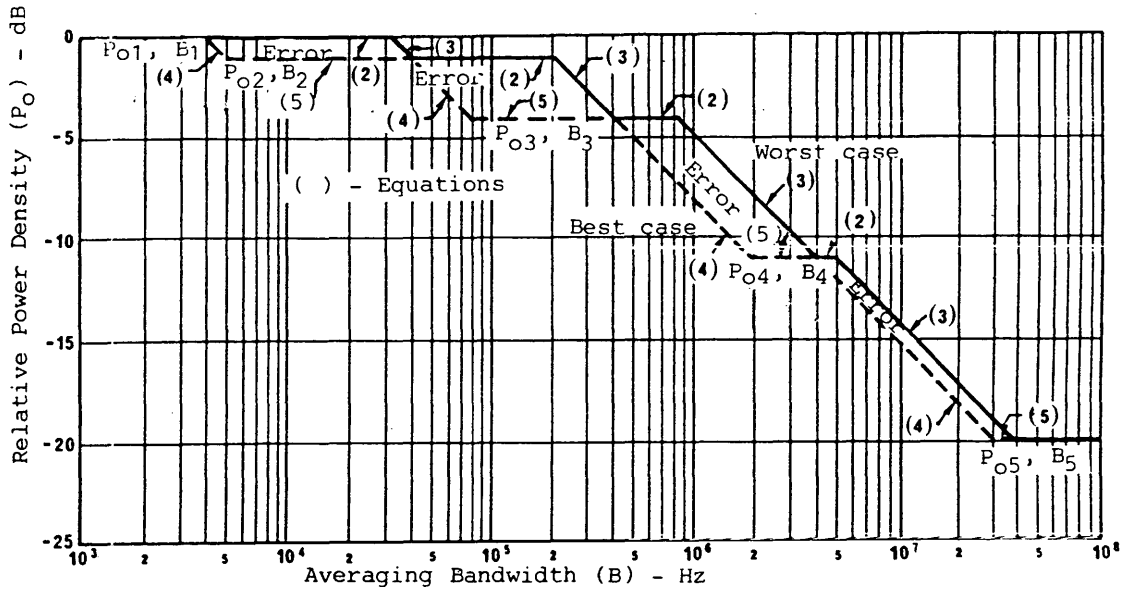

FIGURE 2

Example of construction of total function from five decade space data points

2. Specific formulation

The power density p averaged over any bandwidth b can be computed by the following expressions, which apply to both the Earth-to-space and space-to-Earth directions;

$$\begin{array}{lll}
 p(b)_{max} = p_1 & ; & b_1 < b < p_2 b_2 / p_1 & W/Hz \\
 - p_2 b_2 / b & ; & p_2 b_2 / p_1 < b < b_2 & W/Hz \\
 - p_2 & ; & b_2 < b < p_3 b_3 / p_2 & W/Hz
 \end{array} \quad (6)$$

and continuing to $b = b_t$.

Single Carrier Case

The data point (p_1, b_1) is currently required data. The next most important data point is (p_t, b_t) . For the FSS, b_t is most commonly a transponder bandwidth and p_t is the transponder power limit P_t divided by b_t for the space-to-Earth direction. For the earth-to-space direction P_t would be limited to the earth station transmitter power required to produce the maximum transponder output.

The data point (p_1, b_1) limits the bandwidth over which p_1 can exist and thus extrapolation of p_1 to larger bandwidths will not result in unrealistic total powers. Thus with these two data points:

$$\left. \begin{aligned} p(b)_{\max} &= p_1 & ; & \quad b_1 < b < P_1/p_1 & & W/Hz \\ & - P_1/b & ; & \quad P_1/p_1 < b < b_1 & & W/Hz \end{aligned} \right\} (7)$$

This represents a worst case power density-averaging bandwidth envelope for a single carrier of bandwidth b_1 and for the case of multiple carriers in a given bandwidth.

Multiple Carrier Case

When multiple carriers are contained in b_1 it is likely that the power densities for averaging bandwidths between b_1 and b_2 will be lower than given by equation (7). A third data point can be derived for this case from the following information: (1) the largest single carrier power P_a and (2) the carrier power P_b and its occupied bandwidth b_b of the carrier in which P_b/b_b is largest. Thus P_b/b_b is p_2 and b_2 is $b_b P_a/P_b$. The worst case density for any bandwidth b is:

$$\left. \begin{aligned} p(b)_{\max} &= p_1 & ; & \quad b_1 < b < P_a/p_1 & & W/Hz \\ & - P_a/b & ; & \quad P_a/p_1 < b < P_a b_b/P_b & & W/Hz \\ & - P_b/b_b & ; & \quad P_a b_b/P_b < b < P_1 b_b/P_b & & W/Hz \\ & - P_1/b & ; & \quad P_1 b_b/P_b < b < b_1 & & W/Hz \end{aligned} \right\} (8)$$

Application

This implementation is most amenable to be used as an alternative method for determining the need to coordinate. When used for this purpose the computations need only be made for the b corresponding to the minimum bandwidth of interest in the interfered with network. A complete $\Delta T/T$ versus b function provides a $\Delta T/T$ for all bandwidths in the interfered with network and thus provides some indication of the degree of difficulty which might be encountered during coordination.

3. Examples

Single Carrier Case

A common single carrier access would be a FM/TV carrier. For an example, 36 MHz transponder operating in the 6/4 GHz band with a maximum output power of 4 watts is assumed and this carrier uses a 1 MHz frame rate spreading. From this for the space-to-Earth direction:

- P_1 - 4 watts - 6 dBW (Maximum transponder power)
- b_1 - 36 MHz (Transponder bandwidth)
- b_2 - 4 kHz (Averaging bandwidth per App. 29)
- p_1 - $6 - 10 \log (1 \text{ MHz}) = -54 \text{ dB(W/Hz)}$ (Maximum power density in 4 kHz due to frame rate energy dispersal).

For this case equation (7) defines the worst case power density as a function of averaging bandwidth:

$$p(b)_{\max} = -54 \text{ dB(W/Hz)}; \quad 4 \text{ kHz} < b < 1 \text{ MHz}$$

$$= 6 - 10 \log b \text{ dB (W/Hz)}; \quad 1 \text{ MHz} < b < 36 \text{ MHz}$$

The earth-to-space function for a particular earth station would be the same shape with different values for P_e and p_e . Example parameters for determining the earth-to-space power density-averaging bandwidth function are:

- Earth Station transmitting antenna gain - 55dB
- Earth Station antenna receiving gain - 51dB
- Satellite transmitting antenna gain - 22 dB
- Satellite receiving antenna gain - 22 dB
- Transmission gain - -13 dB
- Equivalent Link Noise Temperature - 275 K

The earth station transmitting power to produce a transponder output power of 6dBW is 19dBW. Using a bar over to designate up-path parameters;

- \bar{P}_e - 19dBW (Maximum Earth station transmitter power)
- \bar{b}_e - 36 MHz (Bandwidth corresponding to \bar{P}_e)
- \bar{b}_1 - 4KHz (Averaging bandwidth per App. 29)
- \bar{p}_e - $19 - 10 \log (1 \text{ MHz}) = 41 \text{ dB(W/Hz)}$ (Maximum power density in 4 KHz).

From which the worst case power density as a function of average bandwidth is;

$$\bar{P}(b)_{\max} = -41 \text{ dB(W/Hz)}; \quad 4 \text{ kHz} < b < 1 \text{ MHz}$$

$$= 19 - 10 \log b; \quad 1 \text{ MHz} < b < 36 \text{ MHz}$$

These up-path and down-path functions are shown in Figure 3.

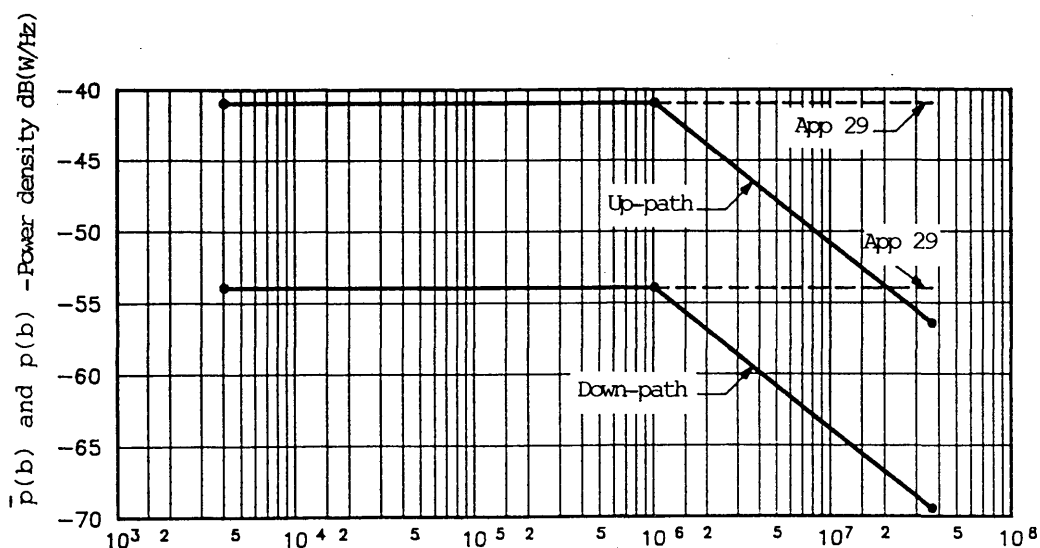

\bar{b} and b - Averaging bandwidth Hz

FIGURE 3

Power density - averaging bandwidth
Single carrier example

Multiple Carrier Case

For an example of a multiple carrier accessed transponder the same transponder parameters are assumed as for the single carrier case. The single carrier with the highest power P_1 is assumed to be a FDM/FM carrier requiring -3dBW of transponder power and has a bandwidth b_1 of 2 MHz. The bandwidth of this carrier should be greater than the reference averaging bandwidth, in this case 4kHz. The value of P_1/b_1 is -66 dBW/Hz. FM/SCPC carriers are also assumed, each requiring -18dBW of transponder power P_2 and 25 kHz of bandwidth b_2 . The value of P_2/b_2 is -62 dBW/Hz which is higher than the that of the carrier with the highest power. For this type SCPC, P_2 can exist in 4kHz so that p_1 is -54 dBW/Hz which is assumed to be the highest power density averaged over 4kHz in the transponder. Equation (8) applies and the pertinent parameters for the space-to-earth direction are;

- P_1 - 4 w - 6 dBW (Maximum transponder power)
- b_1 - 36 MHz (Transponder bandwidth)
- P_2 - -3 dBW (Highest single carrier power)
- b_2 - 2 MHz (Bandwidth of P_2)
- P_3 - -18 dBW (Power of carrier with highest (P_3/b_3))
- b_3 - 25 kHz (Bandwidth of P_3)
- p_1 - -54 dBW/Hz (Maximum power density in 4kHz)
- b_4 - 4 kHz (Averaging bandwidth per App. 29)

Thus the worst case power density for any averaging bandwidth between 4 kHz and 36 MHz is:

$p(b)_{max}$ - -54 dB(W/Hz)	; 4 kHz < b < 126kHz
- 3 - 10 log b dB(W/Hz)	; 126kHz < b < 791kHz
- 62 dBW/Hz	; 791kHz < b < 6.30MHz
- 6 - 10 log b dB(W/Hz)	; 6.30MHz < b < 36MHz

Example parameters for determining the earth-to-space power density-averaging bandwidth functions are those given for the single carrier access example above plus the following additional earth station parameters;

- Earth station transmitting antenna gain - 47dB
- Earth station receiving antenna gain - 43 dB
- Transmission gain - -21 dB
- Equivalent link noise temperature - 212 K

These earth station antenna gains correspond to an antenna diameter of about 4.5 meters while those given previously correspond to a diameter of about 11 meters. The 2MHz carriers are not used with the 4.5 meter earth station antennas. The SCPC carriers are used between any combination of 4.5 meter and 11 meter earth station antennas. From this, a set of parameters for each earth station type is developed. For example purposes, a very worst case is assumed for the P_2 for each earth station type; i.e., the P_2 which would produce maximum transponder output power. Again using a bar to denote up-path parameters the following are the parameters, for each earth station type.

For the 11 meter earth stations

$$\bar{P}_e - 19\text{dBW}$$

$$\bar{b}_e - 36\text{MHz}$$

$$\bar{P}_s - 10\text{dBW}$$

$$\bar{b}_s - 2\text{MHz}$$

$$\bar{P}_p - -5\text{dBW}$$

$$\bar{b}_p - 25\text{kHz}$$

$$\bar{p}_i - -41\text{dB(W/Hz)}$$

$$\bar{b}_i - 4\text{kHz}$$

For the 4.5 meter earth stations

$$\bar{P}_e - 27\text{dBW}$$

$$\bar{b} - 36\text{MHz}$$

$$\bar{P}_s - \bar{P}_p - 3\text{dBW}$$

$$\bar{b}_s - \bar{b}_p - 25\text{kHz}$$

$$\bar{p}_i - -33\text{ dB(W/Hz)}$$

$$\bar{b}_i - 4\text{kHz}$$

Applying equation (8) results in the following.

For the 11 meter earth stations

$$\begin{aligned} \bar{p}(b)\text{max} - -41\text{dB(W/Hz)} & ; 4\text{kHz} < b < 126\text{kHz} \\ - 10 - 10 \log b \text{ dB(W/Hz)} & ; 126\text{kHz} < b < 791\text{kHz} \\ - -49 \text{ dB(W/Hz)} & ; 791\text{kHz} < b < 6.30\text{MHz} \\ - 19 - 10 \log b \text{ dB(W/Hz)} & ; 6.30\text{MHz} < b < 36\text{MHz} \end{aligned}$$

For the 4.5 meter earth stations

$$\begin{aligned} \bar{p}(b)\text{max} - 3 - 10 \log b \text{ dB(W/Hz)} & ; 4\text{kHz} \leq b \leq 25\text{kHz} \\ - -41 \text{ dB(W/Hz)} & ; 25\text{kHz} \leq b \leq 6.30\text{MHz} \\ - 27 - 10 \log b \text{ dB(W/Hz)} & ; 6.30\text{MHz} \leq b \leq 36\text{MHz} \end{aligned}$$

These functions are shown in Figures 4 and 5.

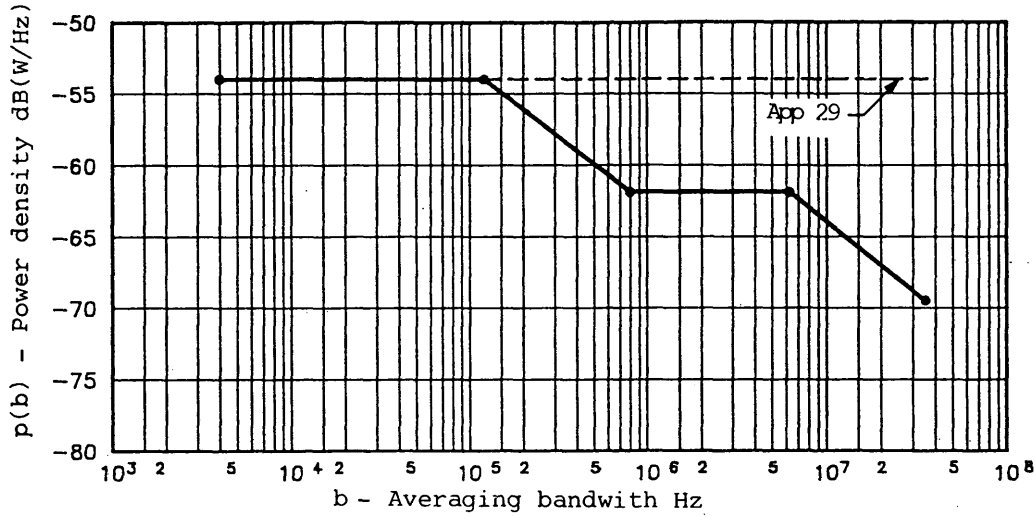

FIGURE 4
Power density - averaging bandwidth
Multiple carrier down-path example

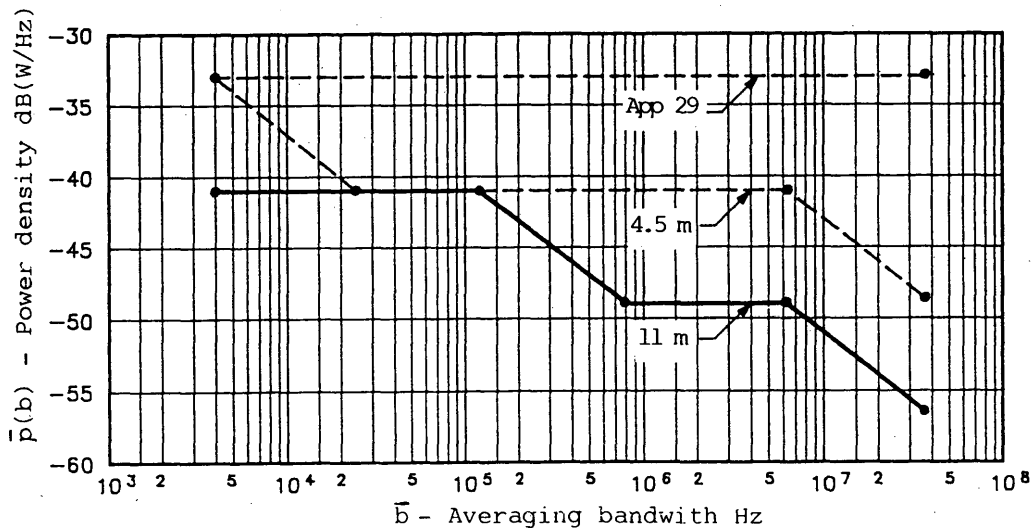

FIGURE 5
Power density - averaging bandwidth
Multiple carrier up-path example

The up-path interference is also a function of the off-axis earth station transmitting antenna gains as well as the power densities. If the off-axis gains were the the same for the above examples, then the envelope of the two functions is the worst case power density for any averaging bandwidth. If the off-axis gains are different, then a worst case off-axis e.i.r.p. density function can be developed.

Using the above multiple carrier example, $\Delta T/T$ calculations may be made where $p(b)_{\max}$ is used for P_s and $\bar{p}(b)_{\max}$ is used for P_e in Appendix 29. A topocentric angle of 4° , an earth station side-lobe envelope of $29 - 25 \log \phi$ and co-coverage conditions are assumed. The interfered with network has the same characteristics as the interfering network except for the carriers. The results of these calculations are shown in Figure 6. The current Appendix 29 calculations show a $\Delta T/T$ of 36% for all interfered with bandwidths. Using this method a $\Delta T/T$ of 14% is indicated for interfered with carrier bandwidths of 25 kHz to 126 kHz and the $\Delta T/T$ is less than 6% for interfered with carrier bandwidths greater than 600 kHz. With this method, the numerical value of $\Delta T/T$ is equal to the I/N in the interfered with carrier bandwidth.

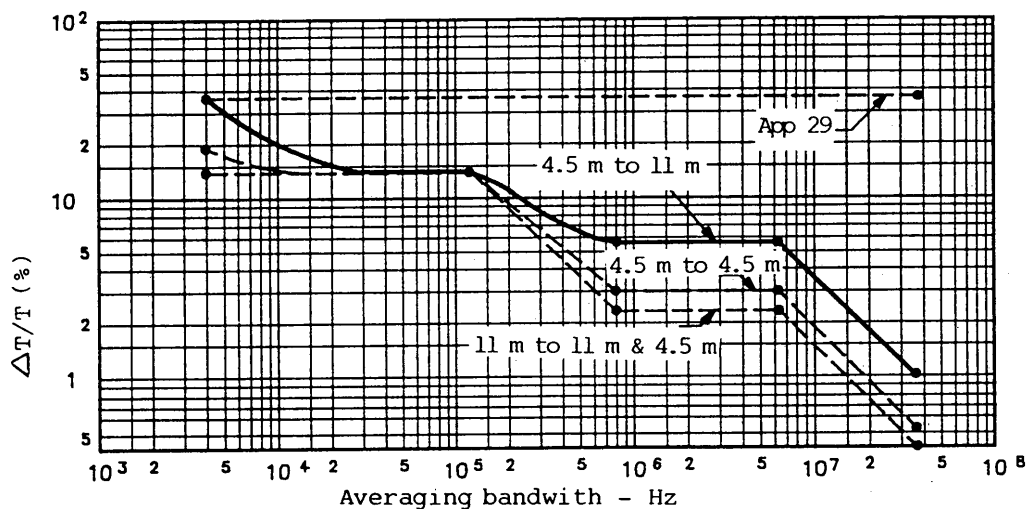

FIGURE 6
 $\Delta T/T$ vs averaging bandwidth
multiple carrier example

4. Data requirements

This power density-averaging bandwidth method has been developed with the view of minimizing the amount of additional data required and the availability of that data and at the same time providing a very significant improvement in the interference estimates.

The data required for the specific implementation can be related to Appendix 3 items (as modified by WARC ORB-88) as follows. The paragraph references are those resulting from WARC ORB-88.

<u>Satellite</u>		<u>Earth Stations</u>	
<u>Symbol</u>	<u>Reference</u>	<u>Symbol</u>	<u>Reference</u>
P_c	2.C.8(d)	\bar{P}_c	2.B.12(e)*
b_c	2.C.8(d)	\bar{b}_c	2.B.12(e)*
P_a	2.C.8(a)*	\bar{P}_a	2.B.12(a)*
b_a	2.C.7(c)*	\bar{b}_a	2.B.11(c)*
P_b	2.C.8(a)*	\bar{P}_b	2.B.12(a)*
b_b	2.C.7(c)*	\bar{b}_b	2.B.11(c)*
P_i	2.C.8(b)	\bar{P}_i	2.B.12(b)
b_i	2.C.8(b)	\bar{b}_i	2.B.12(b)

The additional data for Appendix 3 are the asterisk items which are: (1) the power and bandwidth of two particular carriers for both up-path and down-path and (2) the aggregate earth station transmitter powers for each earth station type.

* Optional items

ANNEX V

RELATIONSHIPS BETWEEN $\Delta T/T$ RATIOS AND SINGLE-ENTRY
INTERFERENCE CRITERIA

1. Introduction

This Report describes the method of calculation to determine the need for coordination between two satellite networks. Since the interfering signals are there treated as thermal noise, the method can be used irrespective of the modulation characteristics and capacities of carriers transmitted in each satellite network and their precise frequencies also do not need to be known. This Report is therefore approximate and should be conservative in such a way that it should not release from coordination two satellite networks having transmitted carriers for which the relevant single entry interference criteria would not be met if detailed interference calculations were made. Such single entry criteria represent the final objective to be observed if the mutual interference between any two satellite networks are to be kept within predetermined values.

The $\Delta T/T$ ratio which corresponds to a particular single entry has been calculated for several types of interfering and desired carriers, used in geostationary-satellite networks. For carrier modulation parameters other than those assumed in [CCIR, 1978-82a], the resulting values for $\Delta T/T$ may be different.

2. Relationship between $\Delta T/T$ and C/I

The method described in This Report is based on the concept that the noise temperature of the system receiving interference undergoes an apparent increase due to the effect of interference, the interfering signals being treated as thermal noise, whose spectral power density would be equal to the maximum spectral power density of the signals.

If I_0 is the maximum spectral power density of the interfering carrier, it can therefore be written:

$$\frac{C}{I_0} = \frac{C}{k \times \Delta T} \quad (1)$$

where C/I_0 is the carrier-to-interference density ratio, it being assumed that I_0 has been calculated as if the interference could be treated as thermal noise. The apparent increase in the noise temperature of the system receiving interference is ΔT and k is the Boltzmann's constant (J/K).

The carrier-to-noise density of the "desired" carrier, due to the total satellite link noise, can be written:

$$\frac{C}{N_0} = \frac{C}{k T} \quad (2)$$

where T is the equivalent satellite link noise temperature of the carrier receiving interference.

The combination of expressions (1) and (2) results in:

$$10 \log \frac{\Delta T}{T} = (C/N_0) - (C/I_0) \quad (3)$$

where the carrier-to-noise and the carrier-to-interference densities are expressed in dBHz.

It should be noted that I_0 corresponds to the maximum power density values which are notified by Appendices 3 and 4 of the Radio Regulations, and used in the calculations made according to Appendix 29 of the Radio Regulations and this Report.

3. Protection of FDM-FM carriers

In [CCIR, 1978-82a] the values of $\Delta T/T$ were determined for a wide range of interfering FDM-FM telephone carriers on the basis of 600 pWOp single-entry interference and 7000 pWOp system noise (i.e. noise excluding all interferences). The required values of carrier-to-filtered interference ratio (C/I_B) which correspond to a demodulated interference noise level of 600 pWOp at the top channel of the desired carrier, have been computed using the mathematical model of [Pontano *et al.*, 1973]. In this model frequency separation was not considered for each pair of carriers.

Borodich [1984] gives a formula expressing the relation between the apparent increase in equivalent noise temperature at the receiver input due to the interference and the noise power thereby caused in the audio-frequency channel:

$$\frac{\Delta T}{T} = \frac{P_{NI}}{P_{NT}} \frac{W'_I(0)}{D(\delta f, F)} \quad (4)$$

where:

P_{NI} : noise power (pW) caused by the actual interfering signal in the audio-frequency channel at the point of zero relative level;

P_{NT} : full power (pW) of the psophometrically weighted thermal and intermodulation noise in the audio-frequency channel at the point of zero relative level;

$W'_I(0)$: maximum normalized spectral power density of the interfering signal at the earth-station receiving antenna output;

$$D(\delta f, F) = \frac{1}{2} \left[\int_{-\infty}^{\infty} W_S(u) W_I(F - \delta f + u) du + \int_{-\infty}^{\infty} W_S(u) W_I(F + \delta f - u) du \right]$$

where:

D : convolution of the spectra of the wanted signal $W_S(F)$ and the interfering signal $W_I(F)$, measured in the same units as the spectral power density;

δf : difference between the wanted and interfering signal carrier frequencies.

Formula (4) is of a general nature and valid for all types of interfering signals, both analogue and digital.

The lowest value of 8.5% was found as the worst case amongst those analyzed in [CCIR, 1978-82a], for networks advance published before 1987.

Since, for new networks advance published after 1987, the single-entry interference criterion to be applied is 800 pWOp (instead of 600) and that the permissible noise power in a telephone channel resulting from the interference caused by all other satellite networks should not exceed 2500 pWOp (instead of 2000), the values of $\Delta T/T$ should be increased by a factor of 1.44 for such networks, compared to networks published before 1987. The minimum value of $\Delta T/T$ thus becomes 12.3%.

The same result can be obtained in general form directly from formula (4). As shown in [Borodich, 1983], in the worst case, when $\delta f = 0$, and the interfering signal spectrum is approximately uniform within the limits of the significant part of the wanted signal spectrum $D(0, F) \approx W_I(0)$ and formula (4) becomes:

$$\frac{\Delta T}{T} \approx \frac{P_{NI}}{P_{NT}} \quad (5)$$

From formula (5) it follows that in the worst case of wideband interference, the apparent increase in the equivalent satellite link noise temperature corresponding to the permissible noise level in the audio-frequency channel has the following value:

- for networks advance published prior to the end of 1987 (600 pWOp criterion)

$$\frac{\Delta T}{T} = \frac{600}{7000} = 0.0857 \quad \text{i.e.} \quad 8.57\%$$

- for new networks advance published after 1987 (800 pWOp criterion)

$$\Delta T/T = \frac{800}{6500} = 0.123 \quad \text{i.e.} \quad 12.3\%$$

If the spectrum of the wanted signal is significantly broader than the spectrum of the interfering signal, then $D(0, f_m) \approx W_S(f_m)$ whence

$$\left(\frac{\Delta T}{T} \right) \approx \frac{P_{NI} W_I(0)}{P_{NT} W_S(f_m)}$$

where $W_S(f_m)$ is the spectral power density of the wanted signal.

The value of $W_S(f_m)$ can be determined from the graphs in Figures 9d and 9e in Report 388-5.

If there are n narrow-band interfering signals with identical parameters, then:

$$\left(\frac{\Delta T}{T} \right) = \frac{P_{NI}}{P_N} \cdot \frac{W_I(0)}{\sum_{j=1}^n D(\delta f_j, f_m)}$$

where

δf_j is the difference between wanted and j -th interfering signal carrier frequencies.

When the interference to the FDM-FM carrier is from a TDMA carrier, then the $\Delta T/T$ ratio corresponding to 600 pWOp of interference will again have a minimum value of approximately 8.5% (for the 800 pWOp criterion - 12.3%), since the spectra of TDMA carriers are usually relatively flat.

4. Protection of TDMA carriers

For TDMA carriers encoded by an 8-bit PCM telephony signal, Recommendation 523 recommends that: the maximum level of interference power in any such 8-bit PCM system caused by the transmitters of another fixed-satellite network, averaged over any ten minutes, should not exceed, for more than 20% of any month, 6% of the total noise power level at the input to the demodulator which would give rise to a bit error ratio of 1 in 10⁶.

It is assumed that the internal system noise is 65% of the total system noise, the remaining 35% being attributed to terrestrial and satellite system interference.

The old criterion formerly applied for interference from one adjacent FSS network was 4%, for an interference allowance for all other satellite networks of 20%. Allowing a further 10% margin for interference from terrestrial systems, it was assumed that the internal system noise accounted for 70% of the total noise power.

The results of the appropriate calculations (see [CCIR, 1978-82a]) are given in Table IV.

TABLE IV - $\Delta T/T$ values for TDMA wanted carriers

Interfering carriers (channel/MHz)	432/17.5	96/7.5	TV/4 ⁽¹⁾		TDMA/36		TDMA/2.5	
Wanted TDMA carrier (MHz)	36	2.5	36	2.5	36	2.5	36	2.5
$\Delta T/T$ (%)	64	10.8	76	8.6	8.6	8.6	12.3	8.6

⁽¹⁾ 4 MHz peak-to-peak energy dispersal assumed.

Borodich [1984] gives a formula for calculating the apparent increase in the equivalent satellite link noise temperature $\Delta T/T$ corresponding to the single entry criterion defined in Recommendation 523:

$$\frac{\Delta T}{T} = 0.06 \frac{W_i(0) \Delta f}{0.65 S(\Delta f)} = 0.092 \frac{W_i(0) \Delta f}{S(\Delta f)} \quad (6)$$

where:

$W_i(0)$: maximum normalized spectral power density of the interfering signal at the earth-station receiving antenna output;

$$S(\Delta f) = \int_{-\frac{\Delta f}{2}}^{\frac{\Delta f}{2}} W_i(F) dF$$

Δf : receiver bandwidth at input to demodulator.

Formula (6) is of a general nature and valid for all types of interfering signal, both analogue and digital. It follows from formula (6) that in the worst case of wideband interference, $\Delta T/T = 0.092$, i.e. 9.2%.

5. Protection of SCPC-FM carriers *

For wideband interference, such as that from FDM-FM or TDMA carriers, the $\Delta T/T$ corresponding to 600 pW0p noise (or the subjective equivalent in the case of companded SCPC-FM) will be 8.5% by the same reasoning used in § 3.

If the TV-FM interfering signal is modulated only by the dispersal signal at the field or frame frequency, then in accordance with Report 867, the permissible single-entry interference criterion is:

* This section needs to be reviewed based on Recommendations 466 and 671.

$$C / I \geq 26 + 8 \log \delta$$

clearly,

$$K \Delta T \Delta f_S = P_I \delta$$

$$K T \Delta f_S = A P_I$$

whence

$$\left(\frac{\Delta T}{T} \right) = \frac{2.512 \cdot 10^{-3}}{A} \frac{P_S}{P_I} \cdot \delta^{0.2}$$

where

P_I = total noise power at the input of the demodulator,

P_S = power of the wanted signal at the input of the demodulator,

A = 0.7 or 0.65.

For a threshold ratio $(P_S/P_I) = 10$ dB

$$\left(\frac{\Delta T}{T} \right) = \frac{0.02512}{A} \cdot \delta^{0.2}$$

For interference from other SCPC-FM carriers, with the assumptions that voice-switching of carriers is used and that r.m.s. deviation is 3.4 kHz, the $\Delta T/T$ corresponding to 600 pW0p equivalent interference noise was found in [CCIR, 1978-82a] to be about 3%.

For new networks advance published after 1987 (single-entry interference criterion 800 pW0p), the corresponding values of $\Delta T/T$ are 12.3% and 4.32% respectively.

TABLE V - $\Delta T/T$ values for the single entry criterion in Recommendation 523 *

δ	0.01	0.02	0.03	0.04	0.05
P_S/P_I (dB)	17.5	19.1	20	20.7	21.3
$\Delta T/T$ (%)	0.84	1.17	1.43	1.61	1.76

* The values in this table may have to be brought in line with the interference criteria adopted for this transmission type.

6. Protection of SCPC-PSK carriers*

When the interfering signal can be considered as thermal noise, the same assumed single entry criterion and conclusions of the SCPC-FM case can again be derived. Therefore, the required $\Delta T/T$ ratio will have the same value as the specified single entry percentage criterion.

Another type of interference can now be analyzed, when the interfering signal is a slowly spread frequency modulated carrier, like a TV-FM carrier modulated by the energy dispersal waveform only.

Laboratory measurements have been made [CCIR, 1978-82b] and the results are in Annex 5.2.9.5.2 of the CCIR/SPM Report (page 5.196 of the English version). According to that Annex, "N identical CW interferers, all with identical, but uncorrelated, slow triangular energy dispersal", had their levels adjusted to ensure compliance with the 10% aggregate criterion of Recommendation 523 (for 8-bit PCM encoded digital carriers). If data available from such measurements are taken as an example of a single entry criterion, the resulting values for the required $\Delta T/T$ ratio for the protection of three different SCPC-PSK carriers, with allocated bandwidths of 22.5 kHz, 30 kHz and 45 kHz, from TV-FM slowly spread interfering carriers with a peak-to-peak energy dispersal deviation of 1 MHz would be around 1%.

A more rigorous calculation of the apparent increase in equivalent noise temperature $\Delta T/T$ due to the effect of a TV-FM signal modulated by the energy dispersal waveform with a level corresponding to the specified single entry criterion can be carried out using the formula in [Borodich, 1984]:

$$\frac{\Delta T}{T} = \frac{\delta}{0.7} \frac{P_S}{P_{N\Sigma}} \frac{P_I}{P_S} \quad (7)$$

where:

$\delta = \frac{\Delta f_{SCPC}}{\Delta f_{p-p}}$: ratio of the channel bandwidth Δf_{SCPC} to the peak-to-peak frequency of the interfering signal Δf_{p-p} :

$\frac{P_S}{P_{N\Sigma}}$: signal-to-noise power ratio at receiver input:

P_I : interference threshold for a given value of δ and a given signal-to-noise ratio ($P_S/P_{N\Sigma}$).

Methods of calculating the ratio P_I/P_S versus δ for different single entry criteria are given in [Borodich, 1982 and Zlotnikova, 1983].

Table VI gives results for the value of $\Delta T/T$ calculated for different values of δ . For calculation purposes, it was assumed that the interfering signal threshold, in accordance with Recommendation 523, does not exceed 6% of the total noise power at the demodulator input, which would give rise to an error ratio of 1×10^{-6} .

TABLE VI - $\Delta T/T$ values for the single entry criterion in Recommendation 523

δ	0.01	0.02	0.03	0.04	0.05
P_S/P_I (dB)	17.5	19.1	20	20.7	21.3
$\Delta T/T$ (%)	0.84	1.17	1.43	1.61	1.76

The calculation results show that when a TV-FM signal modulated by a field or frame frequency dispersion signal interferes with an SCPC transmission system, the provisional method under-estimates the interference and fulfilment of the criterion $\Delta T/T \leq 6\%$ does not guarantee that the error probability will remain within permissible limits.

With FDM-FM, TDM-PM and other interfering signals, it is correct to use formula (6).

* This section needs to be reviewed based on Recommendations 523 and 671.

Studies carried out in 1987 [Zlotnikova, Dorofeev] have shown that in the case of FDM-FM interference affecting a SCPC-PSK system, the criterion for single-entry interference differs from the 6% value given in Recommendation 523 and may range from 6% to 7.6%, since in existing FM systems the effective modulation index does not exceed 3. On the basis of these findings, equation (6) may be written:

$$\Delta T/T = A \frac{W_I(0) \Delta f}{0.65 S(\Delta f)} = B \frac{W_I(0) \Delta f}{S(\Delta f)} \quad (8)$$

Where A is a constant in the range 0.06 to 0.076 and B is a constant in the range 0.092 to 0.12.

It follows from (8) that in the case of FDM-FM interference affecting a SCPC-PSK system, the minimum $\Delta T/T$ value, corresponding to the 6% criterion for single-entry interference, may reach 9.2%.

7. Protection of FM-TV carriers

The assumed single-entry interference criterion based on Recommendation 483-1 could be:

$$P_I S(\Delta f) \leq 0.04 K T_Z \Delta f.$$

where

T_Z - aggregate receiving system noise temperature.

The equivalent satellite link noise temperature, in accordance with the definition in No. 168 of the Radio Regulations and Recommendation 483-1, is:
 $T = 0.8 T_Z$

whence
$$\left(\frac{\Delta T}{T}\right) = 0.05 \frac{W_I(0) \Delta f}{S(\Delta f)}.$$

In most cases, the spectrum of the FM-TV signal is significantly broader than the spectrum of the interfering signal; for n identical interfering signals:

$$\left(\frac{\Delta T}{T}\right) = 0.05 \frac{W_I(0) \Delta f}{n}.$$

If the interfering signal is an FM-TV signal, then

$$S(\Delta f) \approx \frac{1}{\Delta F \sqrt{2\pi}} \int_{-\Delta f/2}^{\Delta f/2} \exp\left[-\frac{1}{2}\left(f/\Delta F\right)^2\right] df$$

where ΔF - frequency deviation in the low frequencies (see Report 388).

8. Summary and conclusions

The $\Delta T/T$ ratio which corresponds to specific single entry interference objectives, for the case of interference between each pair of wideband carriers, has been presented in this Annex.

For the interference produced into FDM-FM carriers, the lowest value of the $\Delta T/T$ ratio is about 8.5%. When the desired signal is a TDMA carrier, this value will be about 6% in many cases.

The resulting $\Delta T/T$ values for the interference into SCPC carriers are summarized in Table VII. For the interference from FDM-FM, TV-FM and TDMA carriers, which can be considered with flat spectral power density within the bandwidth of the SCPC carrier, the $\Delta T/T$ value corresponding to a given single entry criterion will be the same as the percentage value of such criterion.

In summary, if the interfering signal is an FDM-FM, a modulated TV-FM or a TDMA carrier, the value of 6% for the decision threshold in this Report will be an adequate choice. For interference between two SCPC-FM carriers, the required $\Delta T/T$ may be close to the 6% criterion.

However, in some cases, the 6% criterion adopted by the WARC ORB-88 may not be entirely sufficient for the protection of SCPC-PSK carriers against TV-FM carriers.

TABLE VII—Summary results for the $\Delta T/T$ ratio for interference into SCPC carriers

From Into	Thermal noise-like interference (FDM, TV, TDMA)	Slowly-spread TV-FM	SCPC-FM
SCPC-FM	$\Delta T/T = 8.5\%$	No measurements available	$\Delta T/T$ value will be around 3%
SCPC-PSK	$\Delta T/T = 6\%$	$\Delta T/T$ value will be around 1%	Case not analyzed

REFERENCES

- BORODICH, S. V. [1982] Raschet pomekh vyzvannykh meshayushchimi signalami v sistemakh peredachi "odin kanal na kazhdoy nesushchei" (Calculation of interference caused by unwanted signals in SCPC transmission systems). *Trudy NIIR*, 4.
- BORODICH, S. V. [1983] Uproshchennaya metodika rascheta pomekh mezhdru setiami fiksirovannoy sputnikovoy sluzhby pri ikh koordinatsii (A simplified method of calculating interference between networks in the fixed-satellite service for coordination purposes). *Elektrsviaz*, 1, 14-17.
- BORODICH, S. V. [1984] O primeneni metoda predvaritelnoy otsenki vzaimnykh pomekh mezhdru sistemami fiksirovannoy sputnikovoy sluzhby (Application of a method for provisional estimation of interference between systems in the fixed-satellite service). *Elektrsviaz*, 9, 4-7.
- PONTANO, P., FUENZALIDA, J. and CHITRE, N. [June, 1973] Interference into angle-modulated systems carrying multi-channel telephony signals. *IEEE Trans. Comm. Systems*, Vol. COM-21, 6, 714-727.
- ZLOTNIKOVA, E. A. [1983] Opređenje zashchitnykh otnoshenii na vkhode priemnikov FM signalov pri vozdeistvii radioimpul'snykh pomekh (Determination of protection ratios at the receiver input of FM signals subject to impulsive radio interference). *Trudy NIIR*, 1.
- ZLOTNIKOVA, E. A. and DOROFEEV, V. M. [1987] - Otsenka meshayushchego vliyaniya ChRK-ChM pomekhi na sistemu s fazovoi manipulyatsiei. (Evaluation of the effect of FDM-FM interference on a PSK system). *Proc. NIIR*, No. 1

CCIR Documents

[1978-82]: a. 4/128 (Brazil); b. 4/156 (INTELSAT).

BIBLIOGRAPHY

INTELSAT [1978] Interference between slowly swept television and SCPC carriers. Doc. P'293. Special Preparatory Meeting (WARC-79). Geneva.

REPORT 870-2

**TECHNICAL COORDINATION METHODS FOR
COMMUNICATION-SATELLITE SYSTEMS**

(Study Programme 28B/4)

(1982-1986-1990)

1. Introduction

There is a need to assess the potential interference between satellite networks, and if this potential interference is greater than that allowable, then the parties concerned need to arrive at a mutually agreeable set of conditions for the operation of their respective networks. The methods for determining the need for coordination and the procedures to be followed are prescribed in the Radio Regulations. The methods and procedures for the coordination process are left to the discretion of the parties concerned. This coordination is typically bilateral. The intent of this Report is to summarize the various methods, procedures and techniques which can be used in the coordination process.

2. General approach

For the purpose of this Report, the network seeking access to the orbit is designated A. It is assumed that ΔT calculations based on information as required under Appendix 3 of the Radio Regulations and as published by the IFRB for registered* networks, for networks not yet registered but already coordinated, and for networks which are in the process of being coordinated have established the need to coordinate with networks B, C, D, etc., which may fall in any of the above categories. All such networks have precedence over the applicant's network A. The coordination process is initiated through a Request for Coordination to the affected administration(s) with a copy to the IFRB.

The mandatory information required under Appendix 3 which is submitted with the request for coordination is not sufficient to serve as the basis for coordination since it allows only ΔT calculations to be performed which establish the need for coordination in the first place. It is therefore necessary that the applicant provide more detailed information on his network A and request the notifying administration of each network B, C, D, etc., with which the need to coordinate has been established, to also provide more detailed information. Such more detailed information as may be furnished and sought is listed in Appendix 3, but often even more information may need to be exchanged between the applicant and the affected administration(s).

The information which is exchanged is then used to make the calculations necessary to achieve coordination. Achieving coordination may sometimes entail, in either the applicant's or the affected network or both, changes of certain parameters originally exchanged (including changes to mandatory information under Appendix 3), either as the result of negotiation or as the result of more recent measurements or analyses, may sometimes entail agreements at variance with Recommendations of the CCIR or provisions of the Radio Regulations, or may sometimes entail special agreed operating constraints on either network.

The results of a successfully completed coordination process may remain private unless they are based on optional information in Appendix 3. Agreements over and above those relating to such optional information but integral to the successful completion of the coordination process need not be published; however, it may be in the interest of either or both parties to submit a complete record of the coordination agreement to the IFRB. In those cases where an administration seeks aid from the IFRB in effecting coordination, the IFRB takes, for all practical purposes, the place of that administration in the coordination process and then automatically acquires access to all coordination details and agreements.

* A registered network is one whose assignments have been recorded in the IFRB Master Register.

Upon successful completion of the coordination process, the applicant administration would advise the IFRB of this fact along with a listing of all Appendix 3 information elements that had been used to achieve a successful coordination and would simultaneously notify the IFRB formally of its frequency assignments and all other notification elements (Appendix 3, Section IV, Forms of Notice), thus complying with all requirements for the registration of its assignments in the Master Register.

If this coordination also resulted in changes to the Appendix 3 information previously notified by other administrations, then this would also be notified to the IFRB by the affected administrations.

3. Coordination process

The coordination process can, for purposes of discussion, be divided into three phases.

The first involves the inspection of the actual or planned transmissions of the involved networks and an assessment of their interaction against "standard" interference criteria.

The second phase of the process is an investigation of potential changes to the transmission plan elements (transmission characteristics, frequency plans) or orbital locations which could lead to a solution of any interference problems identified in phase 1. Generally, the applicant administration will tend to have more latitude in considering such changes to its network than the administration operating an existing system; however, phase 2 would not expect either network to consider the acceptance of serious constraints on its current or planned mode of operation and type, distribution and quality of service. This phase should, through very detailed consideration of all technical and operational parameters, be capable of resolving specific and apparently relatively severe interference situations.

The third phase, if necessary, would be consideration and negotiation of system modifications and adjustments on either or both involved networks. Such changes may affect the quality and type of service and the future growth options of either or both networks.

In dealing with the resolution of interference conditions it must be borne in mind that any specific solutions found for the two networks under consideration may generate or aggravate problems with other networks; this may be particularly significant when considering space station relocations.

4. Technical considerations

Fundamentally, there are two initial facets to the coordination process:

- agreement on acceptable interference criteria, and
- agreement on the calculations of the interference.

CCIR Recommendations may be used for interference criteria but other criteria may be used by mutual acceptance. The calculations generally involve a translation of receiver output criteria to receiver input (RF) criteria and the RF interference path parameters. Since many of the parameters amenable to modification are associated with the RF domain, it may be convenient to classify approaches to coordination in this domain, i.e., based on RF criteria.

4.1 Interference domains

A first step in the coordination process is identification of the interference domains. Each band or band segment common to both networks for each satellite beam in the two space segments must be identified. Within each such band or band segment, those portions over which the space station and earth station receiving sensitivities (G/T) and space station and earth station e.i.r.p. densities remain constant in either network are identified.

This process yields all the interference domains. Certain portions of the spectrum may appear several times because they may represent intra-satellite frequency re-use. Where up-link frequencies and down-link frequencies or satellite beams or both may be paired in a variety of ways (switching of beam connectivity in a space station), all possible operational configurations need to be considered. Further, the number of domains will usually be bounded, at least in current space stations, by the transponder arrangement in the space stations and may, in simple space stations, encompass several or all transponders. Where two space stations have single satellite antenna beams (i.e., common-coverage transmit and receive beams) and all their transponders have uniform characteristics over the common frequency band there would be only one interference domain.

4.2 Coordination approaches

The selection of the methods used to effect coordination is determined by agreement between the participating administrations. The characteristics of the affected networks and the potential severity of the interference will influence the choice of the approach to be used for coordination.

Interference coordination can, in practice, be achieved with a variety of techniques. Among these are:

- the comparison of the *total carrier power* characteristics of transmissions with criteria of acceptable received *interfering power*;
- the comparison of the *power density* characteristics of transmissions with criteria of acceptable received *interfering power density*;
- the comparison of available inter-network *isolation* (normalized inter-network coupling loss) with criteria of required *isolation* between transmissions (normalized wanted-to-unwanted carrier ratio).

For the first case, RF criteria can be expressed as I/N or C/I and for the second case as I_0/N_0 or C_0/I_0 where I is the interference power, N is the internal link noise power and C is the desired carrier power and subscript 0 indicates power/Hz averaged over a reference bandwidth. In the third case, interference criteria are expressed in terms of the required C/I between two transmissions, normalized by the carrier-to-noise density ratios (C/N_0) which characterize the performance requirements of the two transmissions.

4.2.1 Carrier power approach

This approach is most applicable to the following cases:

- in frequency bands in which satellite networks are well developed and in which the satellite population is relatively high;
- for modulations which are well defined and may be of any type, e.g. SCPC, analogue, digital, FM-TV, etc.;
- in frequency bands in which this approach has been extensively used.

The mandatory information required under Appendix 3 is not sufficient to serve as a basis for coordination under an I/N or C/I approach. It is necessary for the applicant administration to submit more detailed information on his network. Other administrations having networks with which the need to coordinate has been established must also furnish more detailed information. To effect coordination using the I/N or C/I approaches requires a full exchange of Appendix 3 data including superscript information for each carrier type, earth-station type and satellite antenna beam within all bands or band segments common to both networks; and where available, individual frequency plans. Since this information is adequate for the C/I approach, it would appear desirable to proceed on this approach, since it provides a more accurate estimate of interference.

The interference domains must first be identified. For each of these it is necessary to identify the transmission (carrier) types which are used or are planned to be used in both networks. In the absence of known frequency plans the worst interference combination of the carriers of the two networks should be assumed. In most cases, this would correspond to frequency coincidence of the carriers. Where frequency plans are known, or where only one arrangement of transmissions in the two networks within a given interference domain is possible, the interference analyses are simplified.

For each domain, interference from each transmission type of one network into each transmission type of the other is calculated for coincident frequency assignments (or, where available, for the actual or planned frequency assignments) in each direction (i.e., from network A into network B and vice versa). Each interfering transmission is assumed to originate at the lowest-gain antenna of a transmitting earth station (i.e., the one having the highest off-axis e.i.r.p.) which does or is expected to use it. When the interfering transmission occupies a bandwidth much less than that of the interfered-with transmission, it should be assumed that transmissions of the interfering type occupy, at appropriate intervals, the whole band occupied by the interfered-with transmission.

It is then necessary to compare the resulting calculated values of C/I with the mutually acceptable single entry values. If these calculations show that acceptable values of C/I result in all cases, then a successful coordination has been effected.

If the interference criteria are not satisfied in one or more cases, then each case must be individually considered. Where the criteria are only slightly exceeded, it may be agreed that these interference levels could be tolerated by either network. In particular, the applicant administration may decide unilaterally that interference into its network, although somewhat exceeding the criteria value(s), would be acceptable and, if there is no other area of disagreement, it could claim immediately successful coordination. Otherwise, a number of measures may need to be considered in order to meet the mutually acceptable criteria.

4.2.2 *Power density approach*

This approach may be most applicable to the following cases:

- in frequency bands in which satellite networks are in the early stages of development and in which the satellite population is small;
- for modulations which have a nearly uniform power spectral density, e.g., digital modulations;
- where initial $\Delta T/T$ calculations result in values which are acceptable to each administration. This may be the case for some common domains between the networks;
- where there is a considerable degree of flexibility in one or both networks so that power density values can be modified.

In this approach, the initial assessment of interference may be made using the mandatory Appendix 3 data for each of the interference domains. This assessment can identify the particular domains in which potential interference is most severe and also whether up-link or down-link interference is most dominant. Each party could use the I_0/N_0 values acceptable to him based on his carrier modulation types.

It is possible that these calculations could result in mutually acceptable values of I_0/N_0 , in which case a successful coordination is effected. If the I_0/N_0 values are not acceptable, then several other steps may be taken. If up-link interference is the dominant source, changes in the up-link power densities and transmission gains may be made to reduce the mutual interference. Additionally, rearrangement of accesses by band segments may be made i.e., a modification of interference domains, so that a greater degree of homogeneity exists between the two networks, thus reducing the mutual interference.

The average power density in a transponder can be used to determine a minimum practical satellite spacing which may be an effective measure of achievable satellite spacing in the coordination process. Since power of a transponder is limited, the power density averaged over the transponder bandwidth is also limited. Using this average power density, a satellite spacing can be determined for a given interference criteria, taking into account expected inhomogeneities in traffic in detailed coordination between the networks. This satellite spacing can be used in the coordination process as a basis for determining achievable satellite spacings. If power densities higher than this average power density exist in a portion of the bandwidth of the transponder, then power densities lower than the average must also exist in other portions of the transponder bandwidth; a condition which can be used in a coordination process.

It may also be appropriate to use reference or averaging bandwidths consistent with the carriers employed instead of the 4 kHz and 1 MHz reference bandwidths of the Radio Regulations. These will generally result in lower values of I_0/N_0 , and can facilitate the coordination process, particularly where narrow-band carriers in one satellite operate opposite wideband carriers in another satellite. In this case, a satellite spacing based upon narrow-band carrier interference criteria may be used to obtain an acceptable interference criteria for the wideband carriers, thus avoiding detailed carrier frequency planning. Interference to narrow-band carriers from wideband carriers will be relatively uniform if the wideband carrier power density is relatively uniform.

The techniques enumerated above have formed a basis for the development of a power density-averaging bandwidth method of determining interference between satellite networks. The method is based on providing a sufficient number of power density-averaging bandwidth data points so that the interference in any bandwidth of interest may be reasonably approximated using the methods described in Appendix 29. This method may also be used in determining the need to coordinate. The details of this method are described in Annex IV of Report 454.

Where wideband carriers exhibit higher power densities in small portions of a transponder (analogue FM-TV or high density, low index FDM-FM), minimum satellite spacing may be achieved by the narrow-band carriers avoiding the high power density regions. In this situation, better spectrum utilization may be achieved if triangular function energy dispersal is not used on wideband carriers. However, there may be other factors which would justify the use of some minimal energy dispersal, e.g. consideration of existing systems and protection of terrestrial microwave radio systems.

The C_0/I_0 approach to coordination is essentially an extension of the I_0/N_0 approach. In this approach, an additional parameter, the minimum power density in each network is identified. It may be determined that mutually acceptable C_0/I_0 values are achievable even though acceptable I_0/N_0 values were not achievable. This approach allows consideration of power compensation in transponders i.e., higher powers could be assigned transmissions subject to greater interference and less power to those with little interference, thus eliminating or moderating individual interference severity. Power compensation would be an operational measure. This C_0/I_0 approach needs further study and clarification.

4.2.3 Isolation concepts

The conventional and link isolation concepts discussed in Annex I to Report 1135 offer another coordination method which does not involve the use of transmitted powers, power densities and noise powers.

4.2.3.1 Conventional isolation method

Under the conventional isolation approach a comparison is made between the available inter-network isolation - a measure of the electromagnetic coupling between two networks - and the isolation required between two interfering transmissions.

The required isolation is a fairly precise measure of the interference "incompatibility" between two transmissions, larger required isolation values indicating greater incompatibility. It is expressed in terms of the permissible wanted-to-unwanted carrier power ratio between two transmissions and their respective performance requirements (in the form of the required total link carrier-to-noise density ratio, C/N_0 , for each transmission).

To apply the isolation concept, one identifies the isolation domains and determines in each domain the available isolation. An isolation domain is characterized by any two networks' earth and space station antenna radiation characteristics, their receiving system noise temperatures and their link transmission gains.

In each domain, the interfering combinations of carriers are identified. From tables or graphs the required isolation between any two specific carriers is obtained and compared with the isolation available in the appropriate domain. A combination of carriers whose required isolation exceeds the available isolation in the pertinent domain requires that these carriers be coordinated with each other.

The difference between required and available isolation is a quantitative measure of the severity of the incompatibility; its magnitude is a useful guide for the steps to be taken to bring compatibility about.

4.2.3.2 Link isolation method

In this method, the available link isolation is also compared with the required carrier isolation to determine the need for coordination. When the value of available link isolation is less than the required carrier isolation, detailed coordination would be necessary.

Under this approach, the available link isolation is determined on the basis of information concerning the input and output back-offs of the transponder, the satellite e.i.r.p. and saturation flux density together with the major link design parameters. It is not necessary to resort to detailed carrier parameters as needed for the conventional isolation method.

The required carrier isolations are expressed in terms of the applicable single entry wanted-to-unwanted carrier power ratios between two transmissions and their respective down-link carrier-to-noise density ratios.

4.3 *Interference reduction*

Having identified the interference domains, there clearly is a need to understand what opportunities exist for mitigating the problem. In addition to those indicated above there are several, including those listed below, not necessarily arranged in order of preference:

4.3.1 *Carrier power approach*

- mutual frequency planning based on segmenting of actual carrier frequencies in order to reduce interference to an acceptable level;
- use of actual measured individual antenna patterns, or best estimates of the patterns when these are expected to be better than originally specified in submitted Appendix 3 information;
- the association of specific transmissions with specific earth stations if available or derivable. For example, in the case of partially overlapping or separate coverage areas of two networks, those earth stations of one network located farthest from the coverage area of the other network can be expected to cause and receive less interference than those more closely located earth stations;
- the use of power compensation within transponders. This can permit greater powers to be assigned to transmissions subject to greater interference and less power to those with little interference, thus eliminating or moderating the severity of interference in individual cases. Power compensation would be used operationally;
- the sensitivity to terrestrial interference at earth stations in a given network may be so low, or can be made so low, as to allow the terrestrial interference allowance to be transferred to the inter-satellite network allowance and thus resolve or alleviate cases of unacceptable interference;
- consideration of the probabilistic nature of the interference, i.e., when unacceptable interference is highly unlikely to occur or would occur only for a small percentage of the time, the relevant single-entry criterion might be relaxed. For example, in the case where analogue TV with artificial energy dispersal interferes with low capacity transmissions, the percentage of the time during which only artificial dispersal may be present would generally be small;

- the applicant administration could review its design characteristics such as antenna patterns, earth-station antenna size(s), satellite antenna beam shaping, etc. for possible pre-implementation design changes which would alleviate the interference situation;
- the interference criteria could be reassessed and by mutual agreement might be relaxed for specific transmissions, e.g., in cases where circuit performance need not comply with internationally recommended values;
- in certain cases, advantage could be taken of polarization discrimination;
- temporary acceptance of “unacceptable” interference might be a solution where an existing network is near the end of its use of a given space segment and will be replaced by a network which will meet the agreed criteria;
- the exclusion, or confinement, of certain transmissions from, or within, certain interference domains;
- the generation of a composite and thus less interference-sensitive transmission to multiple destinations or splitting of multiple destination transmissions in order to isolate one “critical” destination or source for special treatment;
- the avoidance of certain transmissions or transmission modes such as low index FM or analogue FM-TV without adequate energy dispersal;
- the restriction of connectivity between certain earth stations or earth station types within certain interference domains;
- the avoidance of operation in certain satellite gain modes (complete or transmission selective). Generally, gain modes which result in high up-link sensitivities or high up-link power levels should be avoided;
- the restriction in the number of certain transmissions or their use only with certain earth stations or earth station types;
- the relocation of space stations and/or repointing of satellite antenna beams.

4.3.2 *Power density approach*

- improved antenna pattern side lobes rather than those originally specified in Appendix 3 data;
- larger earth-station antennas;
- relocation of space stations and/or repointing of satellite antenna beams;
- use of orthogonal polarizations;
- agreement in cases where unacceptable interference is highly unlikely or would exist for small percentages of time.

Use of any or all of these measures, as appropriate, can result in successful coordination using an I_0/N_0 approach which entails essentially only Appendix 3 information.

4.3.3 *Isolation approach*

- the acceptance of reduced isolation for some transmission types;
- the separation of carrier frequencies;
- the adjustment of transmission performance, for example through the increase of the C/N_0 ratio of an interfered-with low capacity transmission or through the reduction of the C/N_0 ratio of an interfering high density transmission;
- the adjustment of other transmission parameters, e.g. increase or decrease of capacity, use of error correction coding, or of companding, etc.;
- the adjustment of major network characteristics such as link transmission gain (by changing satellite transponder gain), earth-station antenna gain and/or side-lobe characteristics, or polarization purity and type (sense or orientation);
- using up-link and/or down-link geographical constraints on the use of certain frequencies within a network's service area;
- relocation of space stations.

4.3.4 Consideration of satellite system implementation status

The extent to which above interference reduction techniques would be acceptable or appropriate in a given circumstance depends on the specific characteristics of the networks involved and on the status of individual satellite development and implementation. The following describes the possible stages of satellite system development, implementation and operation that could be encountered during coordination:

- *Initial concept and design:* A satellite system at this stage has been sufficiently defined such that technical information is available to meet the data requirements of Appendix 4 to the Radio Regulations. This includes specifications of orbit location and frequency, and while the paper design may have been completed, implementation has not begun.
- *Implementation:* Typically it may take several years to implement a satellite system. This includes construction of the satellite up to, but not including, its launch. Also during this time earth stations are designed and constructed and the system would have obtained regulatory recognition. Depending on the progress of the implementation programme there can be opportunities to make design changes to accommodate some interference reduction techniques. Appendix 3 data on the system should be available.
- *Operation:* At this stage the satellite system has been built, launched and is operating from a particular orbit location, with its associated earth segment. Many of the system features are fixed, although there may be some built-in flexibility such as beam repointing, transponder gain settings, carrier frequency planning, etc.
- *Second generation satellite system:* At the end of the useful life of a communications satellite, typically 10 years, it is likely to be replaced. At this time, there will be in place an extensive array of earth-station users. Therefore, there are a number of transmission parameters which must be retained in order to preserve continued service. On the other hand, the opportunity does exist to incorporate design changes to reduce potential interference situations developing in the environment. A second generation satellite thus has some of the characteristics of each of the three previous stages.

The interference mitigating measures mentioned above need to be studied further to determine their feasibility to be applied during these various stages of satellite system life. The timely introduction and periodic improvement of the techniques to improve the use of the geostationary-satellite orbit (GSO) as described in the various CCIR Reports and Recommendations provides a mechanism for facilitating access to the GSO for future satellite systems.

4.4 Calculation methods

A number of calculations must be made in using the coordination methods described above. I_0/N_0 computations are similar to the $\Delta T/T$ computations given in Appendix 29. Annex I of Report 455 defines the calculation method using the C/I method. This method may also be used for C_0/I_0 calculations. The relationship between the calculation method, the single entry criterion, and the total inter-network interference values are described in Reports 454. In Annex V of 454 a series of specific carriers is examined in terms of interference:

- protection of FDM-FM carriers;
- protection of TDMA carriers;
- protection of SCPC-FM carriers;
- protection of SCPC-PSK carriers.
- protection of FM-TV carriers.

Annex III to Report 454 also describes a method for calculating interference called "determination of interference using normalized equivalent noise temperature". This method is based on the technique shown in Appendix 29, appropriately modified to give precise results. The modification consists in replacing the single 6% threshold presently taken as the permissible limit for $\Delta T/T$ by a table of permissible $\Delta T/T$ values reflecting the CCIR criteria and taking into account the types of wanted and interfering carriers defined according to a standardized classification of carriers. Application of this method for multiple entry interference needs further study.

Other relationships are given in Report 454 which relate $\Delta T/T$ to various criteria types and associated criteria. Considering the difficulties in development of C/I criteria for coordination, $\Delta T/T$ calculation may be adequate for some interference situations.

In the case where C/I is used in the coordination process, acceptable values for C/I must be mutually agreed to for various carrier types. At present there are no universally accepted C/I values for all carrier types. There is a need to assess the feasibility of developing a set of acceptable C/I values in order to facilitate coordination on this basis.

In the FSS a number of Recommendations have been developed, e.g. Recommendations 466, 483 and 523. Where the wanted signal is of the FDM-FM telephony type, the noise power due to interference within the baseband should be compared with the values given in Recommendation 466 (400 pW0p for old networks and 800 pW0p for new networks); where the wanted signal is of the PCM-PSK telephone type, the interference level must be compared with the value given in Recommendation 523 (6% of the noise level at the demodulator input, resulting in a bit error ratio of 10^{-6}); where the wanted signal is of the FM television type, the noise power level due to interference must be compared with the value given in Recommendation 483.

In those cases in which the CCIR interference criteria are not exceeded, the coordination process is considered complete. Even in those cases in which the criteria are exceeded, the operators involved may agree to accept the increased interference.

5. Computational aids and orbit optimization techniques

During the detailed coordination, relevant CCIR Recommendations and various technical provisions in the Radio Regulations are observed. However, it has been recognized that further study is required to develop improved methods of technical coordinations to achieve more efficient and equitable use of the geostationary-satellite orbit and to alleviate the complexities of coordination tasks. One promising approach of achieving the efficient methods of technical coordination may be to use computer programs to assist these tasks.

The programs can be divided into two groups; synthesis and analysis. It is recognized that most of the synthesis programs contain analytic portions, but the purpose, constraints, and methods will in general be different from those associated with pure analysis programs. No one single program will be able to carry out all the calculations needed during the coordination process but with proper design a series of programs can materially aid the process.

Programs have been developed to optimize carrier assignments and orbital locations of satellites [CCIR, 1978-82]. Frequency assignment optimization programs may be used during various stages of technical coordination. Applications could include:

- early stage carrier frequency assignment coordination for entering a system;
- coordination and optimization of assignments between two networks against other existing satellite networks;
- optimization of carrier assignments during multilateral coordinations.

Orbit spacing programs can optimize spacing of multiple satellites. Application of such programs during coordination could include assessment of alternative orbit locations during bilateral or multilateral coordination. Several orbit and frequency assignment optimization programs and techniques have been developed. Annex I contains descriptions of some of these programs and an optimization technique which has been used.

6. Multilateral coordination

Although the coordination process has been typically performed on a bilateral basis, coordination can also be performed on a multilateral basis. This could be the most expeditious means for achieving coordination when satellite networks of more than two administrations are affected. The general methods and techniques described in this Report which may be employed during coordination are applicable to both bilateral and multilateral processes. Several more specific concepts and methods have been developed and are described in Report 1003.

7. Conclusions

This Report gives a general description of the methods currently employed to identify the need for coordination between fixed-satellite networks and the procedures involved in carrying out the detailed phases of coordination. The extensive analysis methods and computational aids which have been developed, have reduced the effort required to verify the acceptability of the new entrant to the ensemble of existing operators. Many of these tools will be usable, either directly or with modifications, for maximizing efficient use of the geostationary orbit. At the same time, the development of methods and techniques which would simplify the coordination process are also to be encouraged. This is of particular importance for multilateral coordination. As in many other instances, additional study of this subject is required.

REFERENCES

CCIR Documents

[1978-82]: 4/301 (United States of America).

BIBLIOGRAPHY

CCIR Documents

[1982-86]: 4/6 (IWP 4/1); 4/41 (Japan); 4/85 (IWP 4/1); 4/68 (USSR); 4/220 (IWP 4/1); 4/259 (USA); 4/280 (France); 4/324 (USA); 4/337 (USA).

[1986-1990]: 4/54 (United States)

ANNEX I

ORBIT MANAGEMENT TECHNIQUES

Development of computer tools which may assist system design, coordination and interference evaluation has been under way and some of the results are already available. This Annex provides information on two such programs; one for orbit spacing management and the other for frequency assignment optimization. In addition, examples of analyses to achieve reduced satellite spacings are also provided.

The program for orbit spacing minimization called ORBIT-II is capable in its current version of dealing with up to 200 satellites to determine an efficient orbital arrangement as well as optimizing satellite antenna beam shapes (circular or elliptical). The effect of frequency assignment is taken into consideration in the course of optimization [Ito *et al.*, 1979].

Application of the program includes:

- assessment of alternative orbit locations during bilateral or multilateral coordination;
- assessment of critical frequency slots during bilateral or multilateral coordination;
- identification of those systems influencing the accommodation of new systems.

The ORBIT-II program was used in the development of the 13/11 GHz and the 6/4 GHz allotment plans for the fixed satellite service at WARC ORB-88 after having been adapted by the IFRB during the 1986-88 period for use in a conference environment on the ITU computer. The basis for the allotment plan adopted by WARC ORB-88 was synthesized on the ITU computer using the ORBIT-II program. This synthesis process did not require human intervention beyond selection of the order in which the plan entries were considered. However,

because of (a) the fact that the Plan was generated only for the 6/4 GHz band and the evaluation for 13/11 GHz band was made afterwards, (b) the nature and magnitude of the requirements to be accommodated in the Plan, and (c) the characteristics of the algorithm used in the ORBIT-II program, it was necessary in developing an acceptable plan at the Conference to make extensive manual modifications to the basic plan synthesized initially by ORBIT-II. The preprocessor and plan-analysis portions of the ORBIT-II program were used extensively in these "Manual" improvements to the plan.

Because of the "predetermined arc" characteristics of the allotment plan adopted by WARC ORB-88 it may be necessary in the future to adjust the Plan to accommodate an assignment in accordance with the Plan at some orbital position other than its nominal orbital position. Since manual adjustment of the basic Plan with the aid of the ORBIT-II program was necessary in the synthesis of the Plan agreed-to by the Conference, it is reasonable to assume that a similar activity may be necessary to adjust the Plan to accommodate an assignment at a new position within its predetermined arc or to satisfy modifications to system technical parameters which are different than those in the Plan. For that reason it would seem appropriate to:

- i) understand how the ORBIT-II program is used in a manual synthesis mode of operation to modify an existing plan;
- ii) consider ways of making that manual planning process more efficient through computer automation if necessary or in a partial automation of the above process;
- iii) consider the longer-term possibility of developing an improved fully automatic synthesis algorithm.

Basically, the synthesis process of the ORBIT-II program consisted of the following three steps:

- i) generating an orbit separation matrix $[\Phi_{ij}]$ that specifies, for each pair of satellites and the technical parameters of the tentative Plan, the separation between satellite i and satellite j in order to result in the necessary single-entry interference from satellite j into satellite i ;
- ii) placing each of the N satellites of the Plan in the geostationary orbit, one at a time in a one-pass routine, such that all of single-entry interference levels in the Plan are met, i.e. such that each of the actual spacings Φ_{ij} are at least as large as the values; (the result of this one-pass process is the ordering of the N satellites on the GSO; the contribution of the planner in this process is to specify the order in which the N satellites are considered);
- iii) adjusting the position of the satellites on the GSO, without changing the ordering of the N satellites, so that the aggregate carrier to interference ratio of the satellites is maximized.

The manual-planning process used at WARC ORB-88 was to study the matrix $[\Phi_{ij}]$ to determine new orderings of the satellites, i.e. find new locally optimum solutions. By moving some satellites to completely new positions it was possible to select the new ordering of satellites on the GSO to produce a greater minimum aggregate C/I.

Initial improvement to the ORBIT-II package could provide computer-aids to the planner to reduce or eliminate the manual look-up tasks associated with the manual planning process, and to speed up the plan analysis routine that the planner used as a synthesis tool. Such a hypothetical "improved ORBIT-II" package could have:

- i) the $N \times N$ orbit separation matrix $[\Phi_{ij}]$ accessible to the planner in an interactive mode of operation. The planner would be able to ask through an intelligent terminal the value of Φ_{ij} for a particular ij pair, or small $[\Phi_{ij}]$ sub-matrices of perhaps ten networks that were candidates for a small arc of interest;
- ii) an ability to analyse a small arc of interest, perhaps 20° to 40° wide, rather than the complete 360° arc. This would speed up the program immensely when using it as a synthesis tool, because the processing time is approximately proportional to the square of the number of plan entries being considered; and,
- iii) a routine to do an exhaustive search of the $n!$ possible plans for a small number n of perhaps 6 to 8 that the planner is considering for a particular position of the arc.
- iv) a routine to display graphically, the minimum ellipse service area of administrations.

Such routines used in conjunction with the currently available ORBIT-II analysis routine could improve the planners ability to adjust the Plan.

It should be noted that some of those routines are already available in the currently available ORBIT-II. Thus, they should be effectively utilized in augmenting the capability of ORBIT-II.

In the longer term it may be possible and desirable to improve the ordering algorithm of ORBIT-II. Such a second generation synthesis program, should be based on a thorough understanding of the algorithms practiced by orbit planners.

A second program called CAP-N was developed to optimize the frequency assignment process for inter-system coordination. The program is capable of dealing with up to eight satellite networks so as to minimize the worst-case single entry interference between them [Mizuike *et al.*, 1984].

Application of the program includes:

- facilitation at an early stage of carrier frequency assignment coordination for an entering system;
- coordination and optimization of assignments between multiple networks against other existing networks;
- optimization of the carrier assignment during multilateral coordination.

Although CAP-N is intended to optimize frequency assignments among satellites, it can also be used to optimize the intra-system frequency assignments for networks using frequency re-use.

The combined use of two programs ORBIT-II and CAP-N, should facilitate both bilateral and multilateral coordination and will enhance the use of the geostationary orbit. Given the rapid expansion of domestic satellite systems in segments of the GSO, it is necessary to re-examine the technical basis for satellite positioning. Minimum orbit spacing should be determined by inter-system interference, which is principally influenced by the choice of certain system parameters such as transmit power, receiver sensitivity and antenna directivity. Other factors such as the type of modulation, channelization, filtering and acceptable performance and interference levels are also important. Taking these factors into account, a method was developed that evaluated the feasibility of reducing satellite spacing for co-coverage networks. The result of this evaluation for both single entry and aggregate interference indicated that it was possible to meet CCIR interference objectives for co-coverage networks with satellite spacings of less than 4° if any one of the following were employed:

- polarization interleaved satellite deployment;
- improved earth station side-lobe standard;
- more detailed frequency coordination between nearby satellites.

The details of this method have been published in a separate report [Sharp, 1984].

REFERENCES

- ITO, Y., MIZUNO, T. and MURATANI, T. [October, 1979] Efficient utilization of geostationary orbit through optimization. *IEEE Trans. Comm.*, Vol. COM-27, 10, 1551-1558.
- MIZUIKE, T., ITO, Y. and MURATANI, T. [May, 1984] Optimization of frequency assignment. IEEE International Conference on Communications (ICC '84), 14-17 May, Amsterdam, The Netherlands, Conf. Proc., Vol. 2, 599-602.
- SHARP, G. L. [March, 1984] Reduced domestic satellite orbit spacing. AIAA Communications Satellite Systems Conference, Orlando, Fla., USA.
-

REPORT 1000-1

SPECTRUM UTILIZATION METHODOLOGIES

(Study Programme 28A/4)

(1986-1990)

1. Introduction

Frequency band utilization methodologies are considered as a means of reducing inhomogeneity between networks in the frequency dimension. The more heterogeneous the types of carriers concerned, the more complex the coordination procedure becomes and the resultant required spacing between networks becomes greater.

To ameliorate this problem, various methods of spectrum utilization have been studied. For each approach the following is provided:

- a discussion of how the method would be implemented in practice;
- a discussion of the advantages and disadvantages of the method with respect to its impact on existing and planned systems.

2. Band segmentation methodologies

Spectrum segmentation can be achieved by several methods. The first method is designated as macro-segmentation, where frequency bands are segmented into large blocks, typically many transponder bandwidths wide resulting in only a few segments. Two different techniques for characterizing each of the segments can be used, the first by carrier classification and the second by parameter values. Different sets of rules can be used with each method.

The second method of segmentation is micro-segmentation. For this method, the segmentation is based on small blocks, typically the size of a transponder.

2.1 Macro-segmentation, carrier classification approach

Standard types of carriers are identified and several classifications are defined. Table I shows how 50 different carriers can be identified and placed in one of three classes.

Carriers are categorized by three types:

- high-density carriers: FM-TV
low-index FDM-FM
- low-capacity carriers: SCPC
low capacity or low-power analogue and digital carriers
- average carriers: medium- to high-index FDM-FM
TDMA
wideband digital carriers

This last type of carrier is compatible with either of the two former types as regards mutual interference. Thus only the first two types of carrier — high density and low capacity — would have to be segregated under a rational set of spectrum utilization rules; the average carriers could be placed anywhere. To accomplish this, the band allocated (generally 500 or 250 MHz wide) is divided into low-capacity and high-density sub-bands. This could be done by allotting the lower parts of the bandwidth to low-capacity carriers and the upper parts to high-density carriers and only carriers of the assigned class could use the sub-band. The optimum segmentation procedure will depend on the frequency bands in question.

For example, the following arrangement could be used:

<i>Sub-band (MHz)</i>	<i>Class</i>
4500 to (4500 + X)	Low capacity
(4500 + X) to (4500 + Y)	Average capacity plus non-overlapping low capacity and high capacity
(4500 + Y) to 4800	High density

While the use of a neutral sub-band provides for a limited amount of flexibility to accommodate small traffic imbalances within the classes, there is a major disadvantage in the inherent rigidity of this approach. For existing systems, if re-location of carriers to appropriate sub-bands is required, this would present a problem to some systems as there could be severe constraints from either equipment or from prior coordination agreements.

The rigidity of this approach could be alleviated by permitting networks to use any sub-band for any type of carrier but following a pattern corresponding to the classifications in use. For the example above, the order of use would follow increasing frequency for low-capacity carriers and decreasing frequency for high-density carriers. Where difficulties between networks result from such use, preference would be given to those carriers corresponding to the sub-band classification if the difficulty could not otherwise be resolved.

A limitation of this general approach, whichever sub-band rule is used, concerns situations where a high degree of traffic imbalance exists within a satellite network with respect to the classifications of carriers which have been identified. For example, in Canada and the United States, there are several networks which are comprised solely of high-density (FM-TV) carriers. Additionally, there are new networks presently being implemented which consist entirely of low-capacity carriers. For these two cases, orbital separation would be the only recourse.

Another limitation concerns situations where administrations have the need for both high- and low-density carriers, but only a total frequency requirement corresponding to a single transponder. For these administrations it may not be possible to utilize the transponder efficiently if rules of this type are observed.

TABLE I – Macro-segmentation, carrier classification example

FDM-FM No.	Type		N/V	B_{oc} (MHz)	f_{min} (kHz)	f_{max} (kHz)	Δf_{st} (kHz)	Δf_m (kHz)	Categories		
									FC	M	HD
1	12	1.3	12	1.13	12.0	60.0	108.5	159.0	x		
2	12	2.5	12	2.2	12.0	60.0	238.9	350.0	x		
3	24	2.5	24	1.96	12.0	108.0	163.4	275.0		x	
4	60	2.5	60	2.25	12.0	252.0	136.5	276.0		x	
5	72	2.5	72	2.25	12.0	300.0	124.5	261.0		x	
6	60	5.0	60	3.96	12.0	252.0	270.1	546.0		x	
7	132	5.0	132	4.45	12.0	552.0	223.5	529.0		x	
8	192	5.0	192	4.51	12.0	804.0	180.0	459.0		x	
9	96	7.5	96	5.87	12.0	408.0	359.8	799.0		x	
10	192	7.5	192	6.40	12.0	804.0	297.2	758.0		x	
11	252	7.5	252	6.74	12.0	1052.0	259.7	733.0		x	
12	132	10.0	132	7.50	12.0	552.0	430.0	1020.0			x
13	252	10.0	252	8.49	12.0	1052.0	357.4	1009.0			x
14	312	10.0	312	8.96	12.0	1300.0	320.0	1005.0			x
15	252	15.0	252	12.39	12.0	1052.0	576.4	1627.0			x
16	432	15.0	432	12.95	12.0	1796.0	400.2	1479.0			x
17	432	20.0	432	17.99	12.0	1796.0	615.8	2276.0			x
18	612	20.0	612	17.70	12.0	2540.0	453.7	1996.0			x
19	432	25.0	432	20.59	12.0	1796.0	727.3	2688.0			x
20	792	25.0	792	22.34	12.0	3284.0	498.4	2494.0			x
21	972	25.0	972	25.00	12.0	4028.0	410.0	2274.0			x
22	972	36.0	972	35.99	12.0	4028.0	796.7	4417.0			x
SCPCA No.	Type			B_{oc} (kHz)	f_{min} (kHz)	f_{max} (kHz)	Δf (kHz)				
23	0.020			20.0	0.3	3.4	5.8		x		
24	0.025			25.0	0.3	3.4	12.0		x		
25	0.030			30.0	0.3	3.4	8.5		x		
26	0.090			90.0	0.3	3.4	3.4		x		
27	0.180			180.0	0.3	3.4	3.3		x		
SCPCN No.	Type		N/E	B_{oc} (kHz)	Bit rate (kbit/s)						
28	0.064		4	38.0	64.0				x		
29	0.085		4	50.0	85.0				x		
30	0.128		4	150.0	128.0				x		
31	0.256		4	300.0	256.0				x		
32	0.502		4	600.0	512.0				x		
NUM-LB No.	Type		N/E	B_{oc} (MHz)	Bit rate (Mbit/s)						
33	2Q		4	1.44	2.048					x	
34	3Q		4	1.84	3.072					x	
35	4Q		4	2.25	4.096					x	
36	8Q		4	5.0	8.448					x	
37	10Q		4	5.0	10.0					x	
38	17Q		4	10.2	17.0					x	
39	25Q		4	18.0	24.6					x	
40	34Q		4	20.6	34.368					x	
41	40Q		4	20.0	40.0					x	
42	50Q		4	25.6	50.0					x	
43	120Q		4	75.0	120.0					x	
44	139Q		4	82.0	139.264					x	
45	147Q		4	110.0	147.0					x	
FM/TV No.	Type	Δf (MHz)	B_{oc} (MHz)	Δf_{pm} (MHz)	Δf_{pnm} (MHz)	f_{bal} (Hz)					
46	TV.17	4.75	17.5	1.0	2.0	60/30					x
47	TV.20	4.8	20.0	1.0	2.0	50					x
48	TV.30	6.2	30.0	2.0	4.0	50					x
49	TV.35	5.0	30.0	2.0	4.0	50/25					x
50	TV.36	11.0	32.0	1.0	2.0	50					x

SCPCA: SCPC (analogue)
 SCPCN: SCPC (digital)
 NUM-LB: wideband (digital)
 N/V: number of channels
 N/E: number of states
 B_{oc} : occupied bandwidth
 Δf : frequency deviation

Δf_{pm} : frequency deviation (modulated carrier)
 Δf_{pnm} : frequency deviation (unmodulated carrier)
 f_{bal} : sweep frequency
 Δf_{st} : frequency deviation (test signal)
 Δf_m : frequency deviation (multiplex signal)
 FC: low capacity
 M: average
 HD: high density

2.2 Macro-segmentation, parameter value approach

A different approach for determining sub-band segments, based on limits on particular values for parameters such as earth-station e.i.r.p., modulation type, carrier bandwidth and various combinations of the A, B, C and D parameters, has been studied [Mizuno, *et al.*, 1984].

The results of this analysis show that the division of the 6/4 GHz frequency band into two segments reduces the required satellites spacing to half, relative to the unsegmented case. The analysis also shows that the greatest improvement can be achieved on the basis of carrier bandwidth, up-link e.i.r.p., and down-link e.i.r.p. Figure 1 shows some of the results.

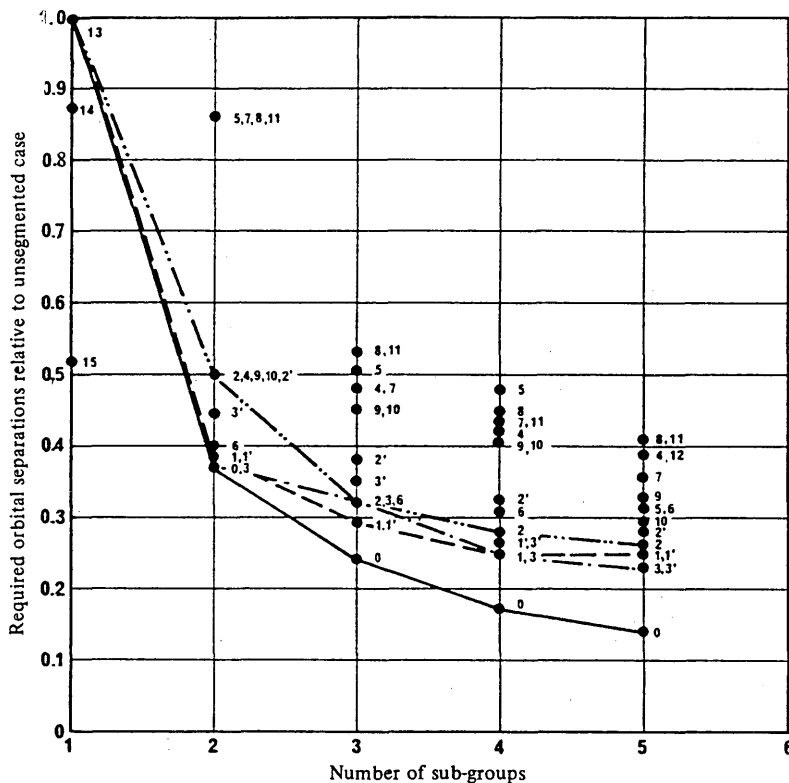

FIGURE 1 - Required satellite separations in 6/4 GHz frequency band (excludes multiple-beam considerations)

- 0 Optimum
 - 1 Bandwidth
 - 2 Up-link e.i.r.p.
 - 3 Down-link e.i.r.p.
 - 4 Parameter A
 - 5 Parameter B
 - 6 Parameter C
 - 7 Parameter D
 - 8 A/B
 - 9 C/D
 - 10 Max (A/B, C/D)
 - 11 Min (A/B, C/D)
 - 12 Type of modulation
 - 13 Without segmentation
 - 14 Excluding coexistence of TV-FM and SCPC-PSK
 - 15 Excluding coexistence of TV-FM and (SCPC-PSK and SCPC-FMI)
- Prime indicates that e.i.r.p.s of INTELSAT carriers are maximum.

In terms of the impact of both the parameter value and carrier classification approaches to macro-segmentation on existing and planned systems, every segmentation scheme would impose a rearrangement of carriers within systems. This could be difficult to implement, particularly in complex multibeam satellites where the location of carriers is governed by several complex considerations related to coverage and connectivity. If strict band segmentation schemes were applied in these cases the efficiency in use of the spectrum and orbit may well be reduced.

2.3 *Micro-segmentation*

Using the micro-segmentation method for band segmentation, bands of the order of a transponder bandwidth are considered for sub-division. A carrier classification approach is used such that sub-bands are identified for use by high-density carriers and for avoidance by low-capacity carriers. In contrast to macro-segmentation, the sub-bands are identified relative to a transponder bandwidth (e.g. 36 MHz) instead of an entire frequency band (e.g. 500 MHz). Figure 2 illustrates the problem of available capacity for highly sensitive carriers in the absence of micro-segmentation.

Considering, for example, satellites using 36 MHz transponder bandwidths, the sub-bands below could be identified, where f_0 is the transponder centre frequency and X would be a band limit to be determined.

<u>Sub-band (MHz)</u>	<u>Carrier classification</u>
$(f_0 - X)$ to $(f_0 + X)$	High density and average
$(f_0 + X)$ to $(f_0 + 18)$	Low capacity and average
$(f_0 - 18)$ to $(f_0 - X)$	Low capacity and average

Another example could consist of regularly spacing (e.g. every 40 MHz) the central frequencies of high-density carriers (particularly FM-TV carriers) to permit the less constrained use of highly sensitive carriers (particularly SCPC carriers) outside the small bands defined around the central frequencies of high-density carriers.

Although there are often differences in the repeater frequency plans and the transponder frequencies of satellite systems, a spacing of 40 MHz could be appropriate for carriers having the same polarization in the 6/4 GHz range subject to confirmation through additional studies of new networks; further study would be needed to define the spacing for the 14/11-12 GHz and 30/20 GHz ranges.

In practice, micro-segmentation is already being employed amongst a number of networks. Centre frequencies of transponders are in many cases avoided in the development of SCPC frequency assignment plans.

The width of the sub-bands where placement of low-density carriers should be avoided is probably in the range of 2 to 10 MHz; this to be the subject of further study. These methods could be augmented in some cases by alternating the polarization of overlapping high-density carriers in transponders off-set by approximately one-half of a transponder bandwidth. Using the example 36-MHz transponder bandwidth, the spacing between the centres of the sub-band would then be 20 MHz. The following non-exhaustive list of advantages and disadvantages of micro-segmentation has been compiled:

Advantages:

- increasing the available capacity for highly sensitive carriers as illustrated in Figure 2.
- the reduction of incompatibility problems between high and low density carriers;

- permitting a closer spacing of "co-channel" satellites in the GSO;
- it would further encourage the use of lower density TV carriers, e.g. better energy dispersal and digital techniques.

Disadvantages:

- a priori micro-segmentation would be of limited utility for adjacent satellites having dissimilar transponder plans and bandwidths - as is common amongst existing systems;
- it would reduce the flexibility of frequency planning in transponders for leased use, and also fix the number of high density carriers thus limiting the capacity for growth in conventional FM video traffic;
- where dual polarization employing off-set frequencies is used, the provision of sub-bands around the designated high density carrier frequencies may considerably reduce the bandwidth available for SCPC carriers;
- it would preclude the effective use of television in dual polarized transponders in some multi-beam satellites.

Interfering networks: FM-TV carriers

Wanted network: SCPC carriers

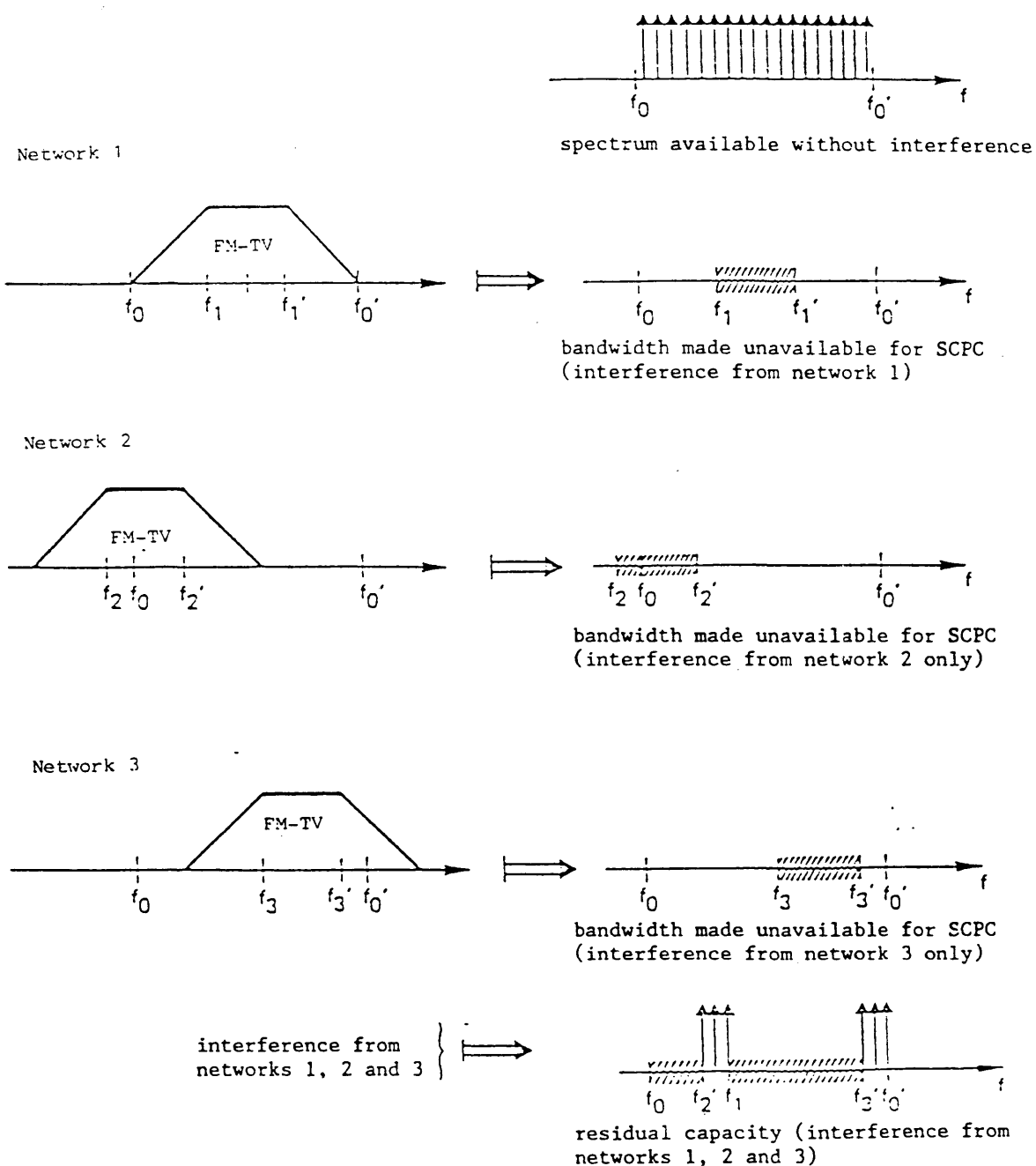

FIGURE 2

Capacity loss for low-capacity carriers in the absence of a micro-segmentation plan

3. Other methodologies

3.1 *Harmonization of spectrum utilization*

Rather than segmentation, it would be possible to provide for harmonious utilization of the spectrum by using the following rule:

TV and high-density carriers may occupy the frequency band allocated from the top downwards; SCPC and low-capacity carriers may occupy it from the bottom upwards, or *vice versa*, depending on the range in question. This would alleviate the problems in many cases and would avoid rigid utilization. This could be established as a guideline.

Like macro-segmentation, however, this approach does not offer solutions where a high degree of traffic imbalance is present.

3.2 *Flexible utilization*

Under this approach, inhomogeneities among adjacent satellite frequency plans would be considered during the coordination phase, using the guideline that SCPC carriers would not be located at or near FM-TV carrier frequencies within the energy dispersal band referred to in § 2.3.

4. Summary

The following observations can be made:

- even without strict segmentation, very considerable improvement in orbital utilization efficiency is obtainable by the avoidance of co-frequency assignment of TV-FM and SCPC carriers. This may be achieved in practice by allocating TV and SCPC to separate segments through flexible arrangements. However, it should be noted that for administrations with only a low traffic requirement, this may lead to inefficient use of the space segment;
- any rigid scheme of segmentation is likely to entail more penalties than benefits;
- guidelines leading to harmonious utilization might be useful to develop, particularly for frequency bands currently lightly used.

REFERENCES

MIZUNO, T., PRASANNA, S., MURATANI, T., OHKAWA, M. and MIZUIKE, T. [26-29 November, 1984] Frequency band segmentation as a means of increasing efficient use of the geostationary satellite orbit. IEEE Global Telecommunications Conference (GLOBECOM '84), Atlanta, Georgia, USA. Conf. Record, Vol. 1, 4.3.1-4.3.5.

REPORT 1135

OPTIMIZATION METHODS TO IDENTIFY SATELLITE ORBITAL POSITIONS

(Study Programme 28A/4)

(1990)

1. Introduction

Various measures to alleviate inter-system interference have been proposed and discussed in CCIR Report 453, in order to achieve an efficient utilization of the orbit and radio spectrum.

In this report, a new concept of identifying orbital locations for entering satellites through the use of optimization methods is discussed as a promising measure for reducing inter-system interference, as well as the frequency of inter-system coordination between new entrants and existing networks. This concept is potentially very useful in accommodating new entrants. Since it attempts to select orbital locations which minimize the interference impact of a new satellite within an existing satellite population, it should minimize the coordination efforts required to implement the new satellite.

Optimization methods are dependent upon the technical assumptions which are used as optimizing parameters. These assumptions may need to be carefully selected to properly characterize the new system within the existing satellite environment. Various optimization methods are available, some of which are described below and which present different sets of optimizing parameter assumptions and procedure. Further study is required to determine the suitability of each approach to effectively characterize the new satellite system of the existing satellite population.

2. Method based on the use of isolation

Two isolation methods, conventional isolation and link isolation, are described in Annex I of this report. The following process is described for the link isolation but is equally applicable for the conventional isolation method.

Orbital positions for entering satellites are identified using the following optimizing sequence:

Phase 1

The available link isolation matrices for all possible combinations of entering networks and for all possible combinations of the existing and entering networks are generated. Figure 1 schematically shows an example of the link isolation matrix corresponding to the interference from the network J to the network I. The lowest value among all elements of the link isolation matrix implies the minimum available link isolation $ALI_{\min}(I, J)$ for the interference from the network J to the network I. In the same way, the minimum link isolation $ALI_{\min}(J, I)$ from the network I to the network J can be derived.

Phase 2

The calculation of the minimum available isolation among the existing and entering networks is made following the above mentioned procedure, using the preferred orbital locations submitted by the administrations for the new networks.

Phase 3

An ordering of the entering networks is determined using the evolutionary model. In this model, the best ordering for all entering networks in the given arrangement of the existing networks is determined under an assumed launching sequence for the entering networks and a given link isolation criterion which is in excess of the required link isolation of a high proportion of carrier combinations.

Phase 4

For the satellite ordering so determined, further adjustment of the positions of new entrants is undertaken such that the minimum available isolation in the most affected network is maximized on the basis of the following objective function:

$$h(\varphi) = \max_{\varphi} \left\{ \min_{I, J} [ALI_{\min}(I, J)] \right\} \quad (1)$$

where

I, J "belong to" all existing and entering networks.

3. Method based on the use of normalized ($\Delta T/T$)

In this method, the available normalized ($\Delta T/T$) for each carrier type classified in accordance with Annex III to CCIR Report 454 is used. The optimization process is carried out in the following way:

Phase 1

Identification of possible cases of interference.

Phase 2

In the case of network pairs deployed in a potential interference configuration, comparison of satellite antenna radiation patterns and service areas for determination of cross-gains (gain of one satellite antenna in the direction of an earth station in the other network) for the worst-case earth station sites.

Phase 3

Determination of relative noise temperature increases for each network pair in a potential interference situation (see CCIR Report 454, Annex III).

Phase 4

Determination of required spacings between satellites by comparing relative temperature increases computed in Phase 3 with maximum acceptable increases defined in Table III (Annex III of Report 454), taking into account a $25 \log \varphi$ decrease in earth station antenna side lobes:

$$\varphi_{ij} \text{ required} = \bar{\varphi}_{ij} \left[\frac{(\Delta T/T)_c}{(\Delta T/T)_n} \right]^{0.4} \quad (2)$$

where:

- $\varphi_{ij} \text{ required}$: required spacing between the two satellites under consideration,
- $\bar{\varphi}_{ij}$: spacing used in Phase 3 computations (new satellites located at the mid-point of their service arc),
- $(\Delta T/T)_c$: relative temperature increase computed in Phase 3,
- $(\Delta T/T)_n$: maximum acceptable relative temperature increase for the carriers involved.

The required spacing for a satellite pair is the maximum value obtained from applying equation (2) to all carrier pairs which might be in an interference configuration.

Phase 5

Determination of orbital locations of new satellites in order to maximize the ratios of the available orbital spacing to the required spacing among the satellite population. This optimization process is equivalent to minimizing the relative excess of interference in the most affected network, expressed by the ratio between the available normalized $(\Delta T/T)_c$ to the required value $(\Delta T/T)_n$.

Therefore the objective function is:

$$\min \left[\max \left\{ (\Delta T/T)_c / (\Delta T/T)_n \right\} \right] \quad (3)$$

4. Method based on the use of COS

The process of choosing tentative orbit positions for new satellite networks and then making minor modifications to these tentative positions can be carried out to ease timing problems when the complete coordination of the network is a time-consuming one within a five year time-frame and the construction of the space station is a similarly time-consuming one. The overall process can be done in three phases, as follows:

Phase 1: Initial tentative choice of orbital position

Sub-phase 1.1

Choose an arc within which the new or replacement satellite might be coordinated and operated. This arc should be wide enough that it is highly likely that a solution can be found, but not larger than necessary because the complexity of the problem increases as the number of satellites in the arc considered increases.

Sub-phase 1.2

Calculate the generalized parameters φ_{ij} for each of the existing networks in the arc being considered, and the new network. Also calculate the parameters φ_{ij} relating to the interaction between network i and network j . (φ_{ij} is defined as the spacing between networks i and j necessary to protect network i a specified amount from network j .)

Sub-phase 1.3

Use the $[\varphi_{ij}]$ matrix of phase 1.2 to find an orbital arrangement among the networks involved to allow the new networks to be included in the arc under consideration. If no position can be found the arc under consideration must be widened and/or the parameters used to determine the $[\varphi_{ij}]$ matrix tightened, and sub-phase 1.3 repeated.

Phase 2

Detailed coordination of networks at the orbit positions chosen in phase 1 under Article 11 of the Radio Regulations is carried out in this phase. This includes traffic coordination and timing of traffic introduction as required, imposing constraints on earth station antenna characteristics and location as necessary, etc. This coordination process is simplified, however, by not having the orbit positions of the networks part of the list of items under discussion.

Phase 3

This phase is unnecessary if phase 2 can be completed successfully. If, however, that is not possible, phase 1 is carried out again with the ϕ_{ij} elements reduced to find an orbital arrangement within which phase 2 can be completed successfully.

The characteristics of the COS generalized parameter are described in Annex II.

5. Method based on the principle of network homogeneity

Two mutually affected FSS networks are inhomogeneous when the first network requires more protection against interference from the second than the second requires against interference from the first. Accordingly, when coordinating such networks, the largest value of angular separation between satellites has to be adopted in order to protect the first network, thereby making less efficient use of the geostationary orbit. Homogeneous networks, on the other hand, require the same amount of protection from mutual interference, with the result that they require the same values of angular separation between their satellites, even though the necessary permissible values of carrier-to-interference ratio (C/I) may often be different.

Clearly, homogeneous networks according to the above definition use the geostationary orbit more efficiently.

Making FSS networks homogeneous by modifying the technical parameters of one of them (new network) or, in exceptional cases, both of them, provides an effective means of optimizing satellite orbital positions.

It is first necessary to identify the particular carriers in two networks which are limiting the satellite separation angles in the two directions. These carriers are used in the following computations. After adjustments have been made to equalize the angle, it is then necessary to determine that the interference to other carriers in both networks are acceptable.

Let us consider mutual interference between two FSS networks, an existing network (network 1) and a new network for which coordination is initiated (network 2). Their parameters are related by the following equations:

Interference/carrier ratio in network 1:

$$(I/C) = \frac{P_1' g_1' (\varphi_{1-2}) g_2 (\psi) l_1}{P_1 g_1 g_2 l_1'} + \frac{P_3' g_3' (\psi') g_4 (\varphi_{1-2}) l_2}{P_3 g_3 g_4 l_2'} \quad (4)$$

Interference/carrier ratio in network 2:

$$(I/C)' = \frac{P_1 g_1 (\varphi_{2-1}) g_2' (\psi') l_1'}{P_1' g_1' g_2' l_1} + \frac{P_3 g_3 (\psi) g_4' (\varphi_{2-1}) l_2'}{P_3' g_3' g_4' l_2} \quad (5)$$

Noise/carrier ratio in network 2:

$$(N/C)' = \frac{P_{N2}' l_1'}{P_1' g_1' g_2'} + \frac{P_{N4}' l_2'}{P_3' g_3' g_4'} \quad (6)$$

where:

- P_1, P_1' - transmitter powers at the inputs to the earth station antennas;
- g_1, g_1' - earth station transmitting antenna gains;
- g_2, g_2' - gains of the space station receiving antennas at the edges of their service areas;
- g_3, g_3' - gains of the space station transmitting antennas at the edges of their service areas;
- P_3, P_3' - space station transmitter powers at the inputs to the transmitting antennas;
- g_4, g_4' - earth station receiving antenna gains;
- l_1, l_1' - carrier losses on the Earth-to space link;
- l_2, l_2' - carrier losses on the space-to-Earth link;
- P_{N2}, P_{N2}' - thermal noise powers at the outputs of the space station receiving antennas;
- P_{N4}, P_{N4}' - thermal noise power at the outputs of the earth station receiving antennas;
- ψ, ψ' - angles between the directions from the space stations to the earth stations of their own network and to the nearest earth stations of the other (interfering) network;
- $\varphi_{1-2}, \varphi_{2-1}$ - angular separations between satellites required to obtain specified values of (I/C) and $(I/C)'$, respectively.

The parameters of network 1 are assumed to be known and do not change during the optimization process.

To optimize the position of network 2's satellite on the orbit, network 2 needs to be made homogeneous with network 1. This is achieved by establishing the condition of homogeneity in equations (4) and (5), i.e.

$$\varphi_{1-2} = \varphi_{2-1} = \varphi \quad (7)$$

and selecting values for the parameters of network 2 which will satisfy equations (4), (5) and (6) for specified values of (I/C) , $(I/C)'$, $(N/C)'$. Of the network 2 parameters involved in equations (4), (5) and (6), the parameters g_2' and g_3' are specified and cannot be altered, insofar as their magnitudes are determined by the dimensions of the service area; the parameters p_{N2}' and p_{N4}' may also be considered as being specified and unchangeable, since they are determined by the noise temperature of the receiving units. We are left with four parameters p_1' , p_3' , g_1' and g_4' which may be modified. However, the values of g_1' and g_4' are interrelated insofar as the same antenna is used at the earth station for transmission and reception; the following relationship may thus be stated:

$$\alpha = g_1'/g_4' = (\lambda_2/\lambda_1)^2 \eta_1/\eta_4, \quad (8)$$

where:

λ_1, λ_2 - wavelengths on the Earth-to-space and space-to-Earth links;

η_1, η_4 - coefficients of use of the reflector area for transmission and reception.

Consequently, the optimization problem boils down to determining the three unknowns p_1' , p_3' and g_1' from the three equations (4), (5) and (6).

These equations have to be solved for a number of values of φ and corresponding values of ψ' so as to obtain a series of values for p_1' , p_3' and g_1' , and the most acceptable values are then selected. In accordance with Recommendation 465, the values $g_1(\varphi)$, $g_1'(\varphi)$, $g_4(\varphi)$, $g_4'(\varphi)$ should be expressed in the form:

$$g(\varphi) = Z_a \varphi^{-2.5} \quad (9)$$

where:

$$Z_a = (\lambda/D) \cdot 10^{5.2} \quad \text{for} \quad D/\lambda < 100$$

$$Z_a = 10^{3.2} \quad \text{for} \quad D/\lambda > 100$$

In order to avoid cumbersome expressions, it is convenient to express the solutions to equations (4), (5) and (6) in the form:

$$\frac{p'_3}{p'_1} = \alpha \frac{g'_2}{g'_3} \frac{(C/N)' p'_{N4} l'_2 - (C/I)' Z'_{a4} \varphi^{-2.5} p_3 g_3(\psi) (l'_2/l_2)}{(C/I)' Z_{a1} \varphi^{-2.5} p_1 g'_2(\psi') (l'_1/l_1) - (C/N) p'_{N2} l'_1} ; \quad (10)$$

$$p'_1 = (I/C) \varphi^{2.5} p_1 \left[\frac{Z'_{a1} g_2(\psi) l_1}{g_1 g_2 l_1} + \frac{Z_{a4} g'_3(\psi') l'_2 p_1}{g_3 g_4 l_2 p_3} \left(\frac{p'_3}{p'_1} \right) \right]^{-1} ; \quad (11)$$

$$g'_1 = \frac{\varphi^{-2.5}}{p'_1 g'_2} \frac{Z'_{a1} p_1 g'_2(\psi') (l'_1/l_1) p'_{N4} l'_2 - Z'_{a4} p_3 g_3(\psi) (l'_2/l_2) p'_{N2} l'_1}{(I/C)' p'_{N4} l'_2 - (N/C)' Z'_{a4} \varphi^{-2.5} p_3 g_3(\psi) (l'_2/l_2)} . \quad (12)$$

It is a simple matter to calculate from these equations a series of values for the parameters p'_1 , p'_3 , g'_1 of the new network for a number of values of φ and ψ' with a view to selecting the most acceptable values. Thus, for example, if the antennas of the new network's earth stations have already been ordered before coordination is initiated or already exist, in other words it is not feasible to alter their dimensions in practice, then from the series of values of φ and ψ' for which the values p'_1 , p'_3 , g'_1 have been calculated we can select a value of φ for which the value of g'_1 corresponds to the size of the existing or ordered antennas. When this has been done, it only remains to modify the new network's powers p'_1 and p'_3 to make it homogeneous with the existing network and thereby secure a minimum angular spacing between the satellites.

In complicated cases, in order to achieve homogeneity it may prove necessary to modify the permissible values of $(C/N)'$, $(C/I)'$, or even to reduce the permissible value of (C/I) .

When it is necessary to consider mutual interference between a new network and several existing networks several attempts can be made to modify the technical parameters of a new network to make it homogeneous with each of the existing networks and then to select compromise values of these parameters.

Further study is necessary to extend this method to this more complicated situation.

The effectiveness of the optimization method described above may be illustrated by the following example.

Example

The existing network has the following parameters:

Network 1

Antenna diameter $D = 12$ m, $g_1 = 3.4 \cdot 10^5$, $g_4 = 1.76 \cdot 10^5$,
 $g_2 = g_2(\psi) = g_3 = g_3(\psi) = 250$, $p_1 = 104$ W, $p_3 = 5$ W, $(N/C) = 0.01585$ (18 dB),
 required protection ratio $(C/I) = 1.585 \cdot 10^3$ (32 dB), $l_1 = 1.112 \cdot 10^{20}$,
 $l_2 = 4.27 \cdot 10^{19}$. The service area of network 1 is contiguous with the service
 area of network 2.

The new network has the following parameters:

Network 2

Antenna diameter $D = 7.5$ m, $g'_1 = 1.328 \cdot 10^5$, $g'_4 = 6.87 \cdot 10^4$,
 $g'_2 = g'_2(\psi') = g'_3 = g'_3(\psi') = 3.4 \cdot 10^3$, $p'_1 = 20$ W, $p'_3 = 2.34$ W,
 $(N/C)' = 0.01$ (20 dB), $(C/I)' = 3.162 \cdot 10^3$ (35 dB), $l'_1 = l_1$, $l'_2 = l_2$,
 $p_{N2} l'_1 = 5.524 \cdot 10^6$, $p_{N4} l'_2 = 2.12 \cdot 10^6$.

With the specified parameters for protection of network 1 against interference from network 2, i.e. in order to attain $(C/I) = 32$ dB, an angular separation between satellites $\varphi_{1-2} = 6.1^\circ$ is required, whereas to protect network 2, i.e. to attain $(C/I) = 35$ dB, an angular spacing $\varphi_{2-1} = 8.45^\circ$ is required. In other words, the networks are inhomogeneous.

After network 2 has been made homogeneous with network 1, the calculations using equations (10), (11), (12), give the following results.

Selecting $\varphi = 6.1^\circ$, i.e. the lower of the two options, the parameters of network 2 have to be modified as follows:

$$p'_1 = 107.37 \text{ W}, p'_3 = 2.17 \text{ W}, g'_1 = 7.0625 \times 10^4.$$

This corresponds to an antenna diameter $D = 5.47$ m.

If we wish to maintain the size of network 2's antennas, $D = 7.5$ m, then $\varphi = 4.79^\circ$, $p'_1 = 172.45$ W, $p'_3 = 0.978$ W, $g'_1 = 1.327 \times 10^5$.

Accordingly, by modifying p'_1 and p'_3 for network 2, it has been made homogeneous with network 1 and the necessary angular spacing between satellites has been reduced from $\varphi_{2-1} = 8.45^\circ$ to $\varphi = \varphi_{1-2} = \varphi_{2-1} = 4.79^\circ$, i.e. by 43%.

6. Advantages due to optimization

Studies have been made to quantify the benefits of introducing an optimization process for identifying orbital positions for new networks through example exercises.

The results of the exercise indicate that, if the positions for new networks had been selected at random and non-optimized positions had been selected, a significant advantage would have been forgone by comparison with a selection made using the optimization process. Moreover, particularly with a large number of existing networks, the optimization process can result in savings of time and effort in inter-system coordination activity.

7. Computer tools

These two approaches described in sections 2 and 3 may be used in cases where large numbers of networks are implicated and require iterative optimization algorithms to be implemented. These tasks need to be performed using computer tools.

Two activities are currently underway for the development of computer software which are potentially capable of fully executing the optimization processes described in sections 2 and 3. One makes use of the link isolation method [CCIR, 1986-90a] and the other follows the normalized ($\Delta T/T$) method [CCIR, 1986-90b].

ANNEX I

Isolation method1. *The concept of isolation*1.1 Conventional isolation method

The isolation between two networks can be derived as follows: in the basic c/i equation (see Table I of this Annex for a definition of symbols):

$$c/i = \left[\frac{p'_1 g'_1 (\varphi) g_2 (\psi)}{p_1 g_1 g_2} + \frac{p'_3 g'_3 (\psi) g_4 (\varphi')}{p_3 g_3 g_4} \right]^{-1} \quad (1)$$

the ratios $p'_1/(p_1 g_1 g_2)$ and $p'_3/(p_3 g_3 g_4)$ can be substituted from the internal up- and down-link power budgets in the interfering and interfered-with networks as follows:

$$p'_1/(p_1 g_1 g_2) = \frac{(c/n)'_u b' T'_2}{(c/n)_u b T_2 g'_1 g'_2} \quad (2)$$

$$p'_3/(p_3 g_3 g_4) = \frac{(c/n)' T'_1 b'}{(c/n) T_1 b g'_3 g'_4} \quad (3)$$

Defining

$$(c/n)'/(c/n)'_u = n'_1 \quad (4)$$

$$(c/n)/(c/n)_u = n_1 \quad (5)$$

and transferring b , b' , (c/n) and $(c/n)'$ to the left-hand side produces the "isolation equation":

$$(c/i) \frac{(c/n)' b'}{(c/n) b} = \left[\frac{n_1 (g_2/T_2) g'_1 (\varphi)}{n'_1 (g'_2/T'_2) g'_1 \Delta g_2 (\psi)} + \frac{(g_4/T_1) g_4 (\varphi')}{(g'_4/T'_1) g_4 \Delta g'_3 (\psi)} \right]^{-1} \quad (6)$$

The left-hand side of equation (6) contains only parameters describing interfering transmissions and their interaction, and its magnitude is called the required isolation; the right-hand side comprises predominantly major network design characteristics, is equal to the inter-network coupling loss and is called the available isolation. Since the two parameters φ and φ' are topocentric inter-satellite spacings, the available isolation is a function of inter-satellite spacing.

From equation (2), required and available isolation may be defined as follows:

Required isolation is defined as the wanted-to-unwanted carrier power ratio (c/i) required to protect one transmission against unacceptable interference from another, normalized with respect to the necessary carrier-to-noise density ratios (c/n_0) of the two transmissions.

and:

Available isolation (inter-network coupling loss) of a network A relative to a network B is defined as the ratio of powers received at two points from a transmission originating in network B, normalized with respect to the effective noise temperatures at the points of reception. The two points of reception are the receivers in network B and network A, respectively.

The basic isolation equation is subject to further refinement:

- when an interfering transmission has a smaller necessary bandwidth than the wanted transmission, some allowance for additional interference contributions in the c/i term must be made. It would be convenient to assume that, in such a case, all interference would be due to an array of interfering carriers of the same type, equally spaced in frequency. In the case of interfered-with FM transmissions, if $(c/i)_{req j}$ were to denote the required c/i ratio for the j th interfering carrier, and if it were assumed to produce the total permitted interference, the effective c/i which should be used for the c/i term of the left-hand side of equation (6) would be:

$$(c/i)_{req\ eff} = \sum_{all\ j} (c/i)_{req\ j} \quad (7)$$

with the summation of the contributions of all carriers whose necessary bandwidths overlap that of the interfered-with carrier. An equivalent expression can be derived for the case of a digital transmission that is subject to interference;

- in some cases, up- and down-link polarization discrimination may be available. Such discrimination would increase the available isolation or decrease the required inter-satellite spacing. Good estimates of polarization discrimination are available for conditions of satellite collocation and co-coverage ($\psi, \psi', \varphi, \varphi' = 0^\circ$). For other conditions, additional data should be collected;
- the terms n_1/n'_1 , T_l and T'_l are not independent of the transmission parameters assumed. The term n_1/n'_1 is controllable through the incorporation of suitable satellite gain steps in the satellite design and the choice of appropriate settings, thereby affecting up-link power requirements. The link noise temperatures T_l and T'_l could be split into transmission-dependent and transmission-independent components; the transmission-dependent components could be made part of required isolation;
- the isolation concept needs to be adapted to be usable with networks which have only up- or only down-link interference, or have other than simple frequency-translating satellite transponders;
- account needs to be taken of the condition ψ and/or $\psi' < 0^\circ$, i.e., where service areas overlap.

One type of homogeneity implies equality of all major design and operating parameters in the two (or more) networks. Another type of homogeneity implies equal reciprocal required intersatellite spacing for two networks. Equality in the value of available isolation for two networks, each with respect to the other, generally does not imply equality in the corresponding required intersatellite spacing, i.e. equal reciprocal available isolation does not produce intersatellite spacing homogeneity. The same holds true for the generalized parameters C/I and $\Delta T/T$. Two systems are homogeneous if while calculating actual interference, a permissible value in one direction is achieved at a satellite angular separation φ_{1-2} and inversely at φ_{2-1} , and $\varphi_{1-2} = \varphi_{2-1}$. These homogeneous systems may change their parameters and still have the same required isolation.

Examples of application

Table II shows a matrix of carrier types, giving the isolation that would be required between networks to limit the single-entry interference to 600 pW0p and to 4% of the baseband noise for TV.

1.2 Link isolation method

In the link isolation method, equation (6) is further modified by replacing the c/n cluster in the right-hand bracketed term by appropriate alternative terms. From CCIR Report 454 (with a slight modification of equation (2), Annex II of Report 454):

$$\frac{(c/n)}{(c/n)_u} = \frac{4\pi b_i e_{sat} \epsilon_4 T_2}{\lambda_u^2 b_o f_{sat} \epsilon_d \epsilon_2 T_r} \quad (8)$$

where λ_u = wavelength of up-link carrier
 b_i, b_o = input and output transponder backoff, respectively
 e_{sat} = transponder saturated e.i.r.p.
 f_{sat} = saturation power flux-density.

Combining the parameters of (8) for the wanted and interfering networks and inserting its result into (6) yields

$$(c/i) \frac{(c/n)' b'}{(c/n) b} = \epsilon_4' \frac{T_r}{T_r'} \left[\frac{e_{sat i} b' f_{sat o}}{e_{sat i}' b' f_{sat o}} \cdot \frac{g_4 g_1(\varphi)}{\epsilon_1' \Delta \epsilon_2(\psi')} + \frac{g_4(\varphi')}{\Delta \epsilon_3(\psi)} \right]^{-1} \quad (9)$$

It is noted that although the square-bracketed term of equation (9) is basically independent of carrier-combination, T_r and T_r' are both carrier specific.

The dependency of the available isolation on the carrier parameters is dealt with in the following way.

The link noise temperature T_{ρ} is expressed as follows (see equation (3) of CCIR Report 871):

$$T_{\rho} = \frac{(c/n)_d}{(c/n)} T_4 \quad (10)$$

where T_4 is the receive noise temperature of the earth station. By substituting equation (10) into equation (9), the terms (c/n) and $(c/n)'$ appear on both sides of equation (9) and they can be eliminated. Furthermore, moving the terms $(c/n)_d$ and $(c/n)'_d$ to the left-hand side yields the link isolation equation as follows:

$$(c/i) \frac{(c/n)'_d b'}{(c/n)_d b} = \frac{g'_4/T'_4}{g_4/T_4} \left[\frac{e_{sat} f'_{sat} h}{e'_{sat} f_{sat} h'} \cdot \frac{g'_1(\varphi)}{g'_1 \Delta g_2(\psi')} + \frac{g_4(\varphi')}{\Delta g_3(\psi) g_4} \right]^{-1} \quad (11)$$

where $h = b_1/b_0$ and $h' = b'_1/b'_0$. Since h and h' are the transponder operating parameters, they are constants for all carriers involved in the concerned links* (linear and non linear transponder operations would yield different constant values of h and h').

By analogy with the conventional isolation method, the left-hand side of equation (11) is called the required carrier isolation and the right-hand side is the available link isolation.

The available link isolation is uniquely determined given information on transponder gain-setting and operating back-offs along with the major network characteristics including transmit and receive earth station types. The available link isolation for a pair of links is, therefore, constant irrespective of the specific carriers transmitted on either link.

The required carrier isolations are link-specific, but representative values can be determined through theoretical analysis and/or statistical analysis of data available for existing satellite networks.

* A satellite link consists of a transmitting earth station type, a receiving earth station type and the related path through a satellite transponder with specified characteristics, such as gain-setting and operating back-offs.

Examples of the required isolation values for some carrier combinations are given in Table III. These values were obtained by analyzing operational carrier parameters as well as using appropriate CCIR criteria for single entry interference.

If interference is either in the up-link only or in the down-link only a slightly different expression for (11) will result. However, the main features of the link isolation method described above remain the same.

TABLE I - Definition of symbols used

c/i	wanted-to-unwanted carrier power numerical ratio
p_i, g_i, T_i	carrier power (p), nominal antenna gain (g) and receiving system noise temperature (T) as encountered at the four antennas which comprise the entire transmission path: $i = 1$ earth-station transmit; $i = 2$ satellite receive; $i = 3$ satellite transmit; $i = 4$ earth-station receive
p'_i, g'_i, T'_i , etc.	primed parameters are those associated with the interfering transmission or network
T_l, T'_l	link noise temperature at the interfered-with and the interfering receive earth station, respectively
$\Delta g_2(\psi') = g_2/g'_2(\psi')$	satellite receiving antenna discrimination (1) in the interfered-with network, in the direction ψ' of the interfering network's service area
$\Delta g_3(\psi) = g'_3/g_3(\psi)$	satellite transmitting antenna discrimination (1) in the interfering network in the direction ψ of the interfered-with network's service area
$g'_1(\varphi)$	earth-station transmit antenna gain in the interfering network in the direction φ of the interfered-with network's satellite (2)
$g_4(\varphi')$	earth-station receive antenna gain in the interfered-with network in the direction φ' of the interfering network's satellite. (3) Generally $\varphi \cong \varphi'$ so that, with a common reference antenna pattern ($A + B \log \varphi$), $g'_1(\varphi) = g_4(\varphi')$
$(c/n)_u, (c/n)$	required up and total link carrier-to-noise ratio, respectively (primed for the interfering network)
b, b'	necessary bandwidth of the interfered-with and the interfering transmission, respectively

(1) Spatial discrimination only, relative to beam edge gains g_2, g'_3 .

(2) Co-polarization with g'_1 assumed.

(3) Co-polarization with g_4 assumed.

TABLE II**
Required isolation * between transmissions (in dB)

Wanted \ Interfering		High-index FDM-FM				Medium-index FDM-FM				TV-FM	
		12 ch	60 ch	252 ch	792 ch	60 ch	132 ch	432 ch	792 ch	600(1)	2000(1)
SCPC	PSK CFM	30.2	29.4	30.5	33.4	38.4	38.0	38.7	39.8	47.8	44.7
		29.2	28.4	29.5	32.4	37.4	37.0	37.7	38.8	44.7	40.5
High-index FDM-FM	12 ch	27.6	28.4	29.7	32.6	36.8	37.0	37.9	39.0	40.5	35.9
	60 ch	24.5	26.7	29.4	32.5	33.4	35.2	37.6	38.9	37.4	35.2
	252 ch	24.5	23.6	27.4	32.0	32.0	31.4	35.3	37.7	32.4	32.1
	792 ch	24.5	23.6	24.4	29.9	32.0	31.6	31.9	34.6	27.9	27.9
Medium-index FDM-FM	60 ch	24.5	27.5	29.6	32.6	34.6	36.0	37.7	38.9	38.5	35.5
	132 ch	24.6	25.5	29.1	32.5	32.0	34.0	37.2	38.7	35.9	34.5
	432 ch	24.6	24.1	26.4	31.6	32.1	32.3	34.3	37.0	31.5	31.0
	792 ch	24.6	23.9	24.5	30.3	32.2	31.8	32.3	35.2	29.1	28.9
TV	TV-FM	27.4	28.0	28.8	31.8	32.0	34.0	36.6	37.5	33.0	33.0
r.m.s. modulation index		2.65	2.17	1.55	1.24	1.10	0.96	0.82	0.76		

* To meet current CCIR single-entry interference criteria.
(1) Peak-to-peak deviation (kHz) of frame rate energy dispersal.
ch: Channel.

** The data in this table need to be reviewed based on Recommendation 466-5 and Report 1134.

TABLE III

Means and Standard Deviations of Required Carrier Isolation, derived from the Link Isolation Method (in dB)

Interfering carrier	Wanted carrier	FDH/FH						SCPC		Wideband Digital		TV/FH
		36ch 2.5MHz	72ch 5.0MHz	132ch 7.5MHz	192ch 10.0MHz	312ch 15.0MHz	792ch 36.0MHz	FM	PSK	60Mbit/s 30.0MHz	120Mbit/s 60.0MHz	2 σ_{p-p} Dispersal
FDM/FH	36ch/2.5MHz	31.6/2.4*	31.2/2.2	32.9/2.2	32.9/2.5	34.1/2.3	36.4/2.6	28.9/2.6	35.3/2.4	39.5/2.2	35.5/1.2	48.5/1.7
	72ch/5.0MHz	32.3/2.1	29.5/1.9	31.6/1.9	31.9/2.2	33.4/2.1	36.1/2.1	27.6/2.5	34.1/2.3	38.3/2.1	34.7/0.7	47.1/1.5
	132ch/7.5MHz	33.1/2.2	31.4/1.5	31.6/2.1	32.3/2.2	34.0/2.1	37.2/2.2	27.8/2.6	34.3/2.4	38.7/2.2	35.8/1.3	46.5/1.6
	192ch/10.0MHz	32.9/2.7	32.7/1.8	33.7/1.9	31.2/2.6	34.8/2.3	37.3/2.3	28.7/2.6	35.1/2.5	39.6/2.4	36.1/1.3	46.4/1.8
	312ch/15.0MHz	32.9/3.0	32.3/2.1	33.5/2.2	32.8/2.6	33.3/2.9	36.6/2.6	28.0/3.0	34.4/2.8	39.1/2.6	37.3/2.3	44.0/2.1
	792ch/36.0MHz	31.3/2.6	29.3/2.1	34.4/1.7	31.8/2.2	32.2/2.1	33.4/2.3	27.0/2.6	33.5/2.4	38.5/2.2	34.4/1.3	38.0/2.8
SCPC	FM	32.8/2.9	31.9/3.0	33.3/3.1	32.5/3.0	33.1/2.8	34.5/2.9	32.4/1.9	30.9/2.0	35.1/3.0	32.3/2.5	51.5/3.2
	PSK	30.3/3.0	30.4/2.9	31.7/2.9	30.6/3.0	32.1/3.7	33.1/2.7	31.6/2.4	28.8/2.0	33.6/2.9	30.8/2.4	51.8/2.6
Wideband	60Mbit/s/30MHz	23.6/3.0	23.0/2.3	24.3/2.3	23.3/2.8	24.4/2.7	26.8/2.9	18.7/2.8	27.9/2.7	30.8/2.2	28.4/1.6	30.5/2.1
Digital	120Mbit/s/60MHz	29.9/2.4	29.3/1.4	30.5/1.5	29.6/2.2	30.7/2.0	33.1/2.2	25.0/2.1	34.2/2.0	32.7/2.4	31.1/1.8	34.8/2.0
TV/FH		25.5/3.2	24.8/2.6	25.0/3.0	25.2/3.0	26.0/3.0	26.7/2.3	19.6/3.4	27.1/2.8	31.0/2.7	31.4/2.6	32.6/2.6

* X/Y
X: mean value of required carrier isolation (dB)
Y: upward standard deviation of carrier isolation (dB)

ANNEX II

The COS generalized parameter

The *characteristic orbital spacing (COS)* of a network may be defined as the minimum spacing required between a hypothetical series of identical satellites serving a given service area, with the satellites assumed to be spaced equally across the visible arc.

The required orbital separation between two non-co-coverage dissimilar networks can be expressed in terms of the COS and an appropriate multiplicative factor, which is particularly simple for the cases where:

- the off-axis e.i.r.p. of the earth stations are equal, and
- the off-axis e.i.r.p. of the space stations are equal.

For example, if the up-link and down-link service areas are the same, and the wanted and unwanted networks are separated by a satellite discrimination of D dB,

$$\text{required orbital separation} = (\text{COS}) \times 10^{-\frac{D}{25}}$$

If the up-link and down-link service areas were different, the expression is not much more complicated.

The COS is therefore, in essence, a property of a given network. It applies whether or not in practice there is more than one satellite serving a given service area. It is readily quantifiable, without necessitating the detailed consideration of technical parameters, traffic types used, interference standards, etc. Due to its quantifiable nature, it can be readily standardized, and used as a basis for equitably defining any sharing scheme for the spectrum orbit resource.

 REPORT 1003

METHODS FOR MULTILATERAL COORDINATION AMONG SATELLITE NETWORKS

(Study Programme 28B/4)

(1986)

1. Introduction

The wish to improve the current bilateral coordination process has led to the study of multilateral coordination with the particular objective of identifying the techniques appropriate to a multilateral environment. The problem consists in ensuring mutual coordination for a set of N networks distributed over a section of the orbit, such that the interference received by any one of these networks from the $(N - 1)$ others does not exceed an allowable value.

Several methods have been developed that could be used in multilateral coordination with the objective of reducing the difficulties inherent in multilateral coordination to the point at which there can be confidence that the coordination process will be successful.

This is a difficult problem in view of the numerous variables involved and data processing techniques obviously have to be used. Even so, the problem is so complex that it is likely to remain insoluble if enhanced calculation methods are not used. These methods and techniques are described in detail below.

2. Multilateral coordination techniques

Because of the large number of potential interfering situations that may need to be resolved in a multilateral coordination, methods are needed to limit the scope of the problem to manageable levels. The following techniques are approaches to limit the scope of the problem by identifying, and limiting, the potential interference problem in prescribed ways.

2.1 *Coordination orbital arc (COA)*

Multi-network coordination within a "coordination orbital arc (COA)" is an approach to coordination that is applied at a given portion of the geostationary-satellite orbit (GSO). This Report presents only the coordination implications of the COA. Considerations regarding the division of the orbit into COA are beyond the scope of this Report.

Under this approach, the process of harmonizing systems would be pursued with the participation of those administrations interested in a particular COA rather than among all administrations.

The advantages of this method of using COA for coordination are deemed to be as follows:

- the orbit harmonization or coordination meeting among administrations concerned in a COA will be more efficient and easier than the case where all administrations participate;
- grouping homogeneous satellite systems or optimizing techniques of satellite positions and frequency assignment may be more easily applied in a smaller forum;
- new technology can be introduced within a given orbital arc with the agreement of the administrations concerned in that COA.

However, care must be taken in the application of this concept so that the activities of one COA do not constrain future activities in an adjacent COA. Some flexibility may be lost by an administration identified with one COA wishing to use an orbital position in another COA. Also it may be less efficient than other methods due to the need for providing unallotted orbital portions either between adjacent COAs or between sub-COAs.

2.2 *Sub-regional groupings*

Another way to limit the scope of multilateral coordination is to take advantage of sub-regionalization (geographical and in the geostationary-satellite orbital arc) and any natural isolation that exists between regions and sub-regions. The choice of sub-regional boundaries would affect the degree of isolation; therefore, the boundaries should be defined with care. In particular, there may be difficulties for inter-regional networks which provide service across multiple sub-regions. Further efforts should be made to have the same technical standards applied in each sub-region, otherwise difficulties could arise in implementing these systems.

Additional study is needed to identify other techniques which can be used to limit the number of satellite networks that would be concerned and affected in the multilateral coordination process.

2.3 *Multilateral harmonization with three elements (harmonization M3)*

The objective of harmonization M3 is to ensure equitable access of satellite networks to the GSO and spectrum without suppressing their peculiarities. Specifically, this harmonization which would include three elements (spectrum utilization methodologies, maximum flexibility in satellite location and optimization of orbital position on the basis of equitable interference) is aimed at giving each network the same conditions of access to the orbit and spectrum, deferring to each network the specifications of its own specific parameters, as well as the choice of the date when the requirements are defined. This harmonization could be applied to any intensively used bands.

2.3.1 *Spectrum utilization methodologies*

The least favourable cases of interference arise between carriers with extremely inhomogeneous characteristics. The purpose of spectrum utilization methodologies is to limit the occurrence of such interference cases, which necessitate large angular separations between satellites and detract from the efficient utilization of the orbit/spectrum resource. Various possible options are described in Report 1000. The most flexible options seem to be the most appropriate for multilateral coordination purposes.

2.3.2 *Maximum flexibility in satellite location*

Optimum utilization of the orbit/spectrum resource presupposes minimum constraints on the management of orbital positions. This may be effected by stipulating the "flexibility of the initial location" and by relocating satellites in service.

2.3.2.1 *Maximum flexibility of initial location*

In order to make best use of the orbit/spectrum resource within a system of multilateral coordination, the optimum allocation of orbital positions to new networks should be based on the greatest possible number of configurations. This presupposes that the "initial service arc" of each new satellite should be as long as possible. The initial service arc may be defined as the orbital arc which is visible from all points within the service areas of the system at an elevation angle greater than or equal to 10°.

2.3.2.2 *Relocation of satellites in service*

Report 1002 deals with flexibility of satellite location. It demonstrates that satellite relocation is an effective way of enhancing the flexibility of orbit management and ensuring better utilization of the spectrum resource. Nevertheless, technical and technological problems, coupled with operational constraints and their implications, may make implementation of this procedure difficult.

2.3.3 *Optimization of orbital positions with equitable interference*

In order to guarantee equitable access to both orbit and spectrum, the orbital positions would have to be optimized by seeking an equitable distribution of interference. This means that when new networks are introduced, the orbital positions allocated should minimize the greatest interference suffered by any given network. For purposes of comparison, interference should be expressed relative to the permissible levels defined by the CCIR.

Orbital positions should be optimized in the light of the following constraints:

- allocation of initial positions to new networks within their service arcs, which should be as long as possible (see § 2.3.2.1);
- for networks which are liable to be relocated, allocation of new orbital positions within their arc of possible relocation, termed the "permanent service arc";
- maintenance of other satellites in their previous orbital positions.

In order to meet all the needs expressed, levels of interference above the permissible levels recommended by the CCIR may have to be accepted. Equitable interference is in this case reflected in a distribution of the excess interference among all networks.

2.4 *Other harmonization techniques*

Further study is required to determine the feasibility of developing other interference-reducing techniques, e.g. polarization discrimination, power compensation etc., in similar prescribed ways to facilitate multilateral coordination and harmonize potential interfering situations.

3. **Interference calculation techniques**

The current procedure for coordination among networks comprises two separate stages:

- the method in Appendix 29 to the Radio Regulations, which is employed to determine whether coordination between two networks is required;
- if coordination is necessary, detailed interference calculations may be required for each type of carrier involved.

The first stage is a simple, but approximate method for evaluating the potential for interference. The second stage generally requires a more accurate interference calculation process. This latter method is commonly used for bilateral coordination.

In the multilateral environment, the decisions of the WARC-ORB-85 on the improved regulatory procedures planning method, known also as the multilateral planning method (MPM), applies in certain highly used fixed-satellite service frequency bands. In the MPM process, coordination is further divided into two stages:

- the first stage, in which a few basic parameters of each system are determined, such as their orbital position, operating frequency band, etc., and
- the second stage, in which detailed coordination is carried out between networks on a bilateral or a multilateral basis subject to the decisions of the first stage.

This Report describes new calculation methods to make this process tractable.

3.1 *Generalized parameters*

Several methods have been identified which use generalized parameters to characterize each satellite network with a minimal number of parameters in order to manage the orbit/spectrum resource as well as to calculate the potential interference between networks. These methods provide the maximum flexibility to the users with respect to meeting their requirements while, at the same time, providing for control of the interaction between networks.

Generalized parameters can be employed for several purposes:

- to provide network design guidelines containing the elements necessary to produce a certain level of orbit utilization efficiency, while retaining a degree of flexibility for the network designer;
- to establish threshold conditions to identify the need for coordination;
- to expedite the resolution of some problems without the need for detailed examination during the coordination process.

3.2 *Specific generalized parameter models*

Several generalized parameter models have been identified to date and are described in detail in Annex III of Report 453. These are:

3.2.1 *Parameters A, B, C and D*

These parameters are defined in § 2.1 of Annex III to Report 453 (CCIR Vol. IV, part 1, 1986)

These parameters are considered to help in limiting the inhomogeneity and yet are expected to allow considerable flexibility in the design of satellite systems. This could be achieved by constraining them to a range of values that are small enough to produce a significant increase in orbit/spectrum utilization efficiency.

Parameters A and C are the up- and down-link interference potentials to other systems respectively, and B and D are the up- and down-link interference sensitivity respectively.

3.2.2 *Variations on the ABCD approach*

Two variations on the ABCD approach have been proposed to improve on some of the perceived shortcomings of the original ABCD set. The variations of the ABCD approach involve modifications to the original parameters A, B, C and D to reflect their impact on the environment outside the intended coverage. One of these variations can take into account the aggregate interference environment.

3.2.3 *Isolation*

Isolation is the value of coupling loss between two interfering networks. It is calculated with the known major design characteristics of a satellite system (antenna gain and side-lobe characteristics, noise temperature and link transmission gain). Its magnitude is a function of inter-satellite spacing. Two transmissions that interfere with each other require a specific isolation to operate on the same frequencies without causing unacceptable interference to each other. This "required isolation" is calculated from the applicable interference criterion and the performance characteristics of the two transmissions (C/I , C/N_0).

The difference (in decibels) between a specific value of "required isolation" and the available isolation (the inter-network coupling loss) is a measure of the effort required to coordinate specific transmissions. Among other applications, isolation is useful for controlling satellite density by setting a maximum value of available isolation and thereby controlling inter-satellite spacing through the coordination of transmissions to achieve this available isolation. An equivalent satellite spacing concept can be derived through which satellite networks serving separated geographic areas can receive the same isolation as satellite networks serving co-coverage areas.

3.2.4 *Characteristic orbital spacing technique*

The characteristic orbital spacing of a satellite network is the orbital spacing required between each satellite in the hypothetical situation in which there are a large number of identical satellites, all serving the same service area, closely packed on the geostationary orbit. To calculate this characteristic orbital spacing, one takes into account such network parameters as earth-station antenna characteristics, earth-station e.i.r.p. and G/T , space station e.i.r.p. and G/T , space station station-keeping, necessary network C/I ratio, etc.

Based on the characteristics of two networks i and j , including their characteristic orbital spacings (COS) ϕ_{ii} and ϕ_{jj} and their spacecraft antenna characteristics, one can calculate the orbital spacings ϕ_{ij} between networks i and j . If there are N networks or space stations to be considered in a portion of the geostationary orbit, $i = \{1, 2 \dots N\}$, then one can calculate in this way the entries ϕ_{ij} of an $N \times N$ triangular matrix, including the N diagonal elements ϕ_{ii} . This matrix can then be used by either manual, automatic, or computer-aided synthesis techniques to develop an efficient orbital arrangement for the N satellites, taking account where necessary of the locations of existing satellites. Having synthesized such an arrangement, or perhaps several such arrangements, a more rigorous analysis is necessary to verify that all aggregate carrier-to-interference ratios are at acceptable values.

Once such an orbital arrangement is agreed upon, detailed coordination of traffic in each of the N satellites can proceed. If there are extraordinary difficulties encountered in this second stage of the process, it may be necessary to re-examine the orbital arrangement to overcome these difficulties.

3.2.5 *Determination of interference between satellite networks using normalized equivalent noise temperature increases*

This method attempts to produce precise evaluation of interference levels by using the simple calculation technique of " $\Delta T/T$ " as described in Report 454.

This method is based on the two following elements:

- distribution of carriers according to a "standardized classification of carriers" into 50 types;
- replacement of the single 4% threshold, currently adopted as the admissible limit for $\Delta T/T$ (Appendix 29 to Radio Regulations), by a table of acceptable values for $\Delta T/T$ taking into account the types of wanted and interfering carriers in accordance with the standardized classification of carriers.

As a contribution to planning efforts based on MPM, this method might provide a precise means of determining mutual interference.

4. Summary

The multilateral coordination process is an extension of the bilateral coordination process. However, because of the many satellite systems possibly involved in the coordination, techniques and methods are needed to be developed in prescribed ways in order to facilitate the multilateral coordination. Further study is required to determine the best way of using various interference-reducing techniques in this process. In addition, a comparison of the applicability of the various generalized parameter models in the multilateral coordination process needs further urgent study.

REPORT 1137

STOCHASTIC APPROACH IN THE EVALUATION OF
INTERFERENCE BETWEEN SATELLITE NETWORKS

(Study Programme 28A/4)

(1990)

1. Introduction

The spacing achievable between satellites in the GSO is governed by the inter-system interference deemed to be acceptable to each network. The computation of such interference is currently performed on the basis of deterministic methods which, in general, assume worst case conditions in order to guarantee protection from unacceptable levels of interference in all cases. This approach leads to estimates of interference which in some cases are unduly conservative. The result is that orbit capacity is not used as efficiently as it might otherwise be.

The increasingly high demand for orbit/spectrum resources has led to a number of approaches aimed at accommodating increased numbers of satellites in the GSO. Some of these approaches are described in Report 453. The approach taken in this new report aims at a more accurate method of assessing interference that takes advantage of stochastic elements in the interference environment. These elements include earth station antenna side lobe gains, earth station locations, satellite longitudinal station-keeping tolerances, satellite network parameters and the great variety of transponder frequency plans that are encountered in real-world situations.

Many of the characteristics of satellite networks which affect performance have random (or stochastic) effects. It is an established practice to design communication links on the basis of their statistical properties. These are usually time varying statistics, i.e. the fraction of time that channel performance exceeds a given value. These statistics relate to "availability" objectives. However, the stochastic aspects discussed in this report are not necessarily of this nature, but concern the effects and the statistical characterization of parameters involved in a satellite link which cannot be precisely known.

This report describes studies which have been initiated in Brazil, INTELSAT and the United States. Studies conducted in Brazil concern the randomness of earth station antenna side-lobe gains, earth station locations and transponder frequency plans. The INTELSAT studies involve earth station antenna side-lobe gain, interfering transponder frequency plans and satellite network parameters. The United States studies are related to station-keeping tolerances. Several of the studies have been on the same subject. However their analyses use different approaches and, therefore, have not been combined. These studies are continuing and while no definitive conclusions should be immediately inferred concerning interference criteria, a body of results has been generated which is

described in the following paragraphs. These results indicate the potential value of continuing further investigations in this area.

Many of the concepts described in this report have been practised informally in one or other coordinations between specific pairs of fixed-satellite networks but have neither been widely used nor analysed rigorously in a systematic manner. This report puts such practices on a rigorous footing, makes them available for general use, and is the vehicle within Study Group 4 for further development and application of such concepts.

2. Statistical modelling

2.1 Studies conducted in Brazil

In this section, some results are presented to quantify, the effects on interference computation of the randomness in earth station antenna side-lobe gain, earth station location and interfering transponder frequency plans. The case concerning earth station sidelobe antenna gains, when such gains are assumed to be exponentially distributed, can be dealt with analytically. However, that is not the case when the randomness of earth station locations and transponder frequency plans are considered, unless very particular situations are analyzed [Albuquerque and Fortes, 1988]. For this reason, some of the quantitative results presented in the following subsections were obtained through computer simulation. They refer to specific situations within the WARC-ORB'88 FSS Allotment Plan.

2.1.1. Effects of the Statistical modelling of antenna side lobe gains

The gains on the sidelobe of earth station antennas were modeled as exponentially distributed random variables. The deterministic computation, used for comparison purposes, was based on the assumption that the off-axis gain is given by $G(\varphi) = 32 - 25 \log \varphi$ (dBi), where φ is the angle between the direction under consideration and the mainlobe axis. Let N_0 be the interference noise permissible level (e.g., 800 pWOp for single-entry or 2500 pWOp for aggregate). If, within the statistical approach, the actual noise N is allowed to exceed N_0 with probability p , that is $P[N \geq N_0] = p$, then the noise level that can be accepted in a deterministic computation changes from N_0 to N_1 . In Figure 1, the ratio N_1/N_0 is presented as a function of p for single-entry and for 4 entries. This ratio determines the relative interference increase that one can accept in a deterministic computation if the permissible level of interference is allowed to be exceeded with probability p .

For single-entry the satellites are separated by 1 degree and for 4 entries they are placed as indicated in Figure 2 (with $\varphi = 1^\circ$). The ratio between up-link interference noise and down-link interference noise is a parameter α which, for the results presented in Figure 1, was taken as 1/3. Final results depend on

α and φ but are not extremely sensitive to variations of these parameters within reasonable limits.

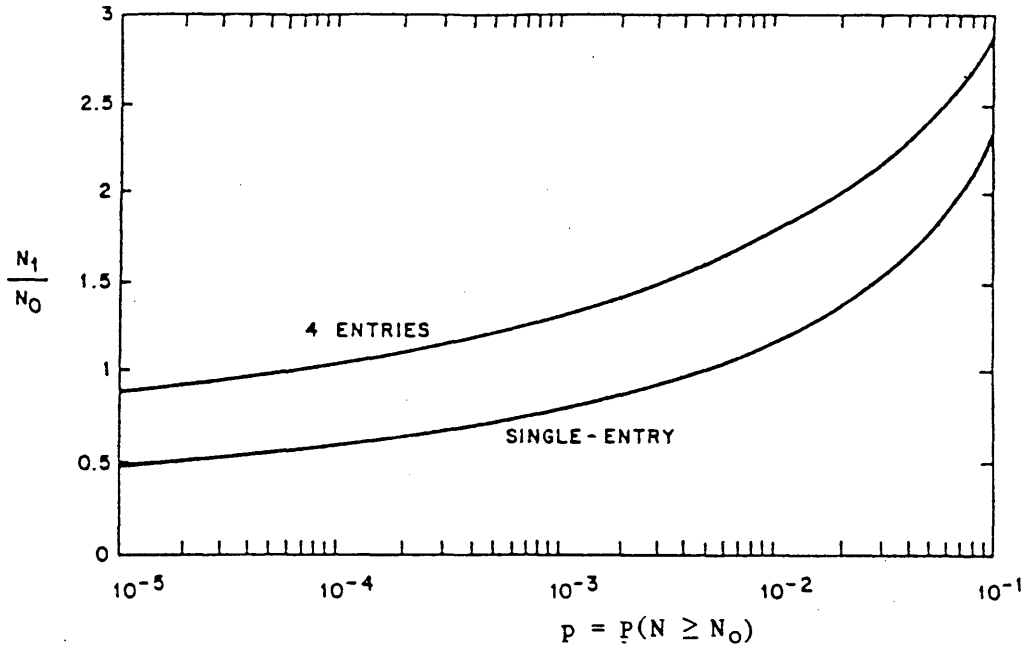

FIGURE 1 - Ratio N_1/N_0 for $\varphi = 1^\circ$ and $\alpha = 1/\delta$ when sidelobe gains are modeled as exponentially distributed random variables (single-entry and 4 entries)

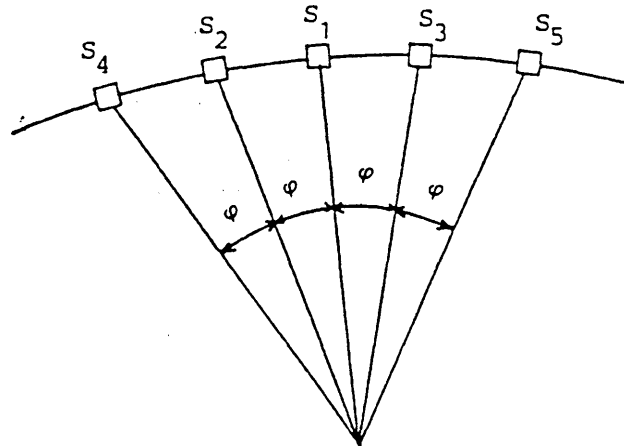

FIGURE 2 - Four interfering networks. Satellites S_2 , S_3 , S_4 and S_5 interfering into the network corresponding to satellite S_1 .

A more interesting example is presented in Figure 3. It refers to networks having their orbital positions and coverage areas in conformity with the allotments B00001, B00002, and B00003 in the FSS WARC ORB-88 allotment plan. In this case, the ratio α between up-link interference noise and down-link interference noise was taken as 1/6 for all networks.

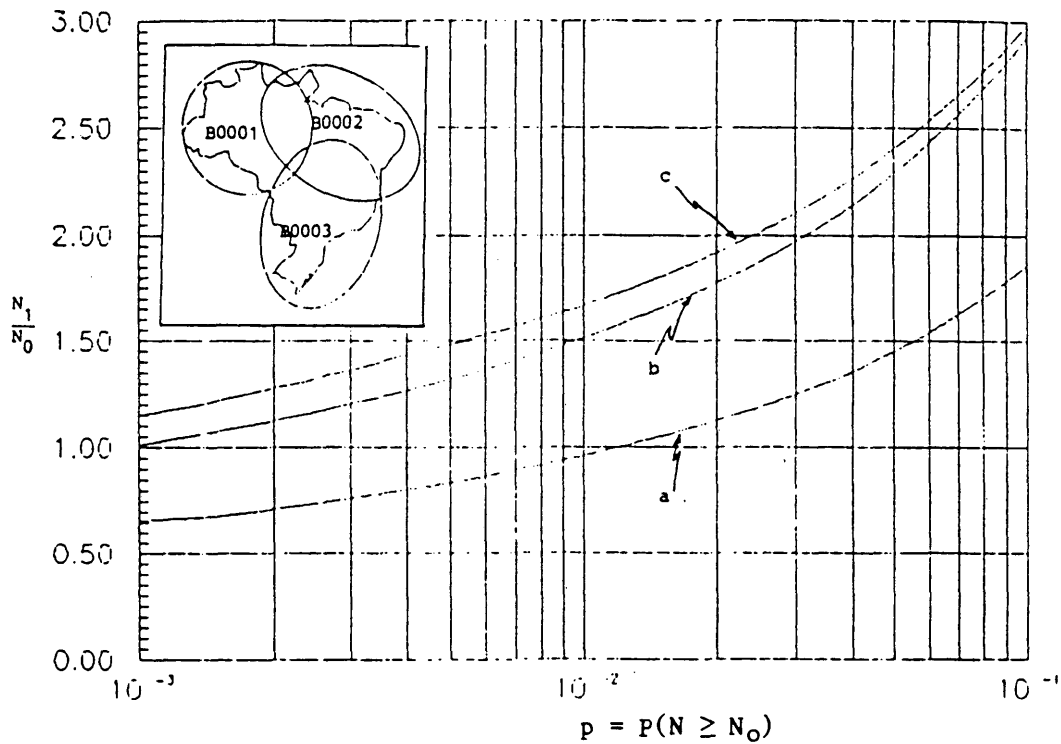

FIGURE 3 - Ratio N_1/N_0 when earth station antenna sidelobe gains are modeled as exponentially distributed random variables (interference on B00002):

curve a: interferer: B00003

curve b: interferer: B00001

curve c: interferer: B00001 and B00003.

Satellite orbital positions: B00001: 65.0°W

B00002: 61.1°W

B00003: 68.7°W

2.1.2 Effects of the statistical modelling of earth station locations

In this case, the earth station location was assumed to be completely random within the coverage area. The satellite antenna gains are now random variables having probability density functions which depend on the probability density functions

corresponding to earth station locations and on the satellite antenna patterns. In the result that follows, the satellite antenna patterns in Report 558 have been used.

Figure 4 presents the ratio N_1/N_0 (with the deterministic computation based on the worst-case condition) as a function of the probability p . It refers to networks having its orbital positions and coverage areas in conformity with the allotments TCD, LBY, SDN2, NIG, NGR and CAF in the FSS Allotment Plan. Again, the ratio α was taken equal to $1/6$ for all networks.

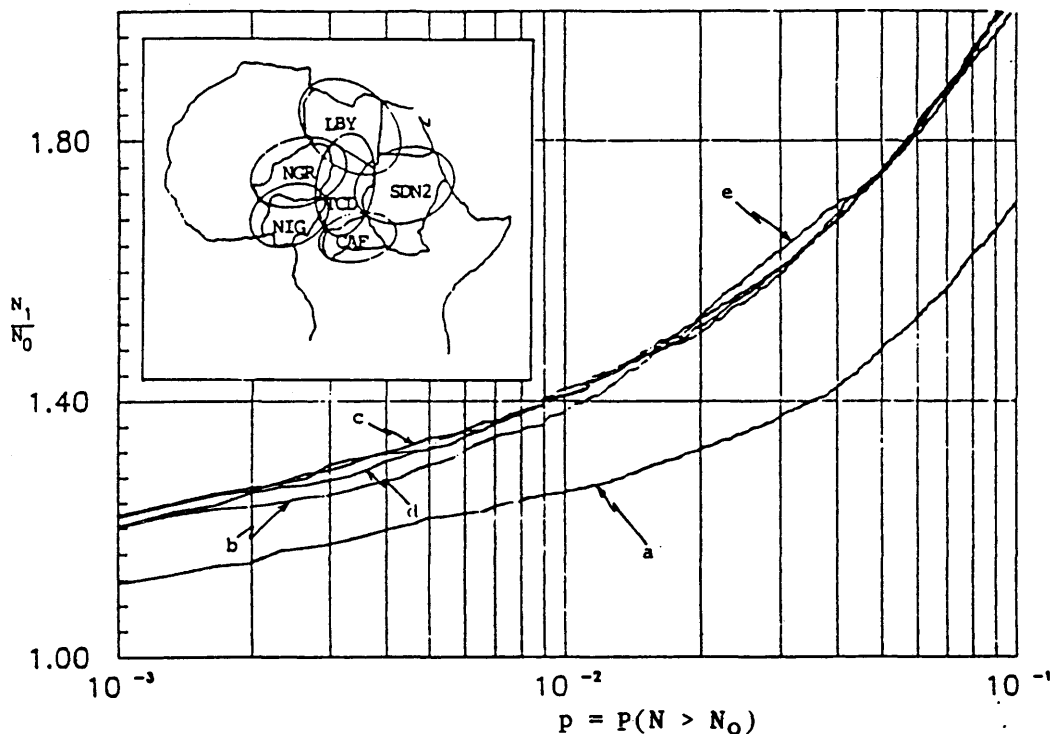

FIGURE 4 - Ratio N_1/N_0 when earth station locations are randomly located within the corresponding coverage area (interference on TCD).

curve a: interferer: LBY

curve b: interferers: LBY and SDN2

curve c: interferers: LBY, SDN2 and NIG

curve d: interferers: LBY, SDN2, NIG and NGR

curve e: interferers: LBY, SDN2, NIG, NGR and CAF

Satellite orbital positions: TCD: $10.5^{\circ}W$

LBY: $28.5^{\circ}E$

SDN2: $1.4^{\circ}E$

NIG: $42.5^{\circ}E$

NGR: $38.5^{\circ}W$

CAF: $14.8^{\circ}E$

2.1.3. Joint effects of the statistical modelling of antenna sidelobe gains and earth station locations

The results in this section refer to the situation in which the earth station antenna sidelobe gains and the earth station locations within the corresponding coverage areas are simultaneously taken as random variables. As in Section 2.1.1, networks having their orbital positions and coverage areas in conformity with the allotments B00001, B00002 and B00003 in the FSS Allotment Plan are considered. Again, α was taken equal to 1/6 for all networks. Throughout the computer simulation the part of the B00002 beam covering the Atlantic Ocean was taken out of the coverage area to avoid having earth stations located over the ocean.

Figures 5a and 5b present results corresponding to the interferences on network B00002 due to network B00001 and network B00003, respectively. For comparison purposes, these figures illustrate separately the effect of the randomness in antenna sidelobe gains, in earth station locations and in both.

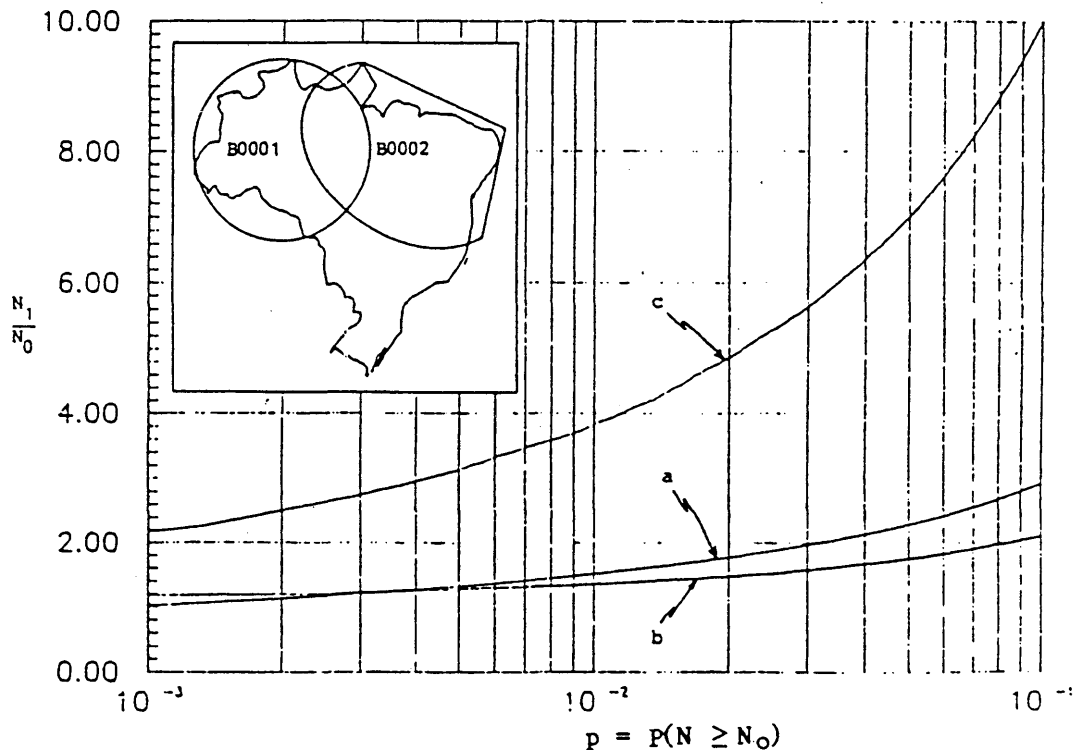

FIGURE 5a - Ratio N_1/N_0 when antenna sidelobe gains (curve a), earth station positions (curve b) and both (curve c) are randomly modeled. (Interference on B00002 due to B00001).

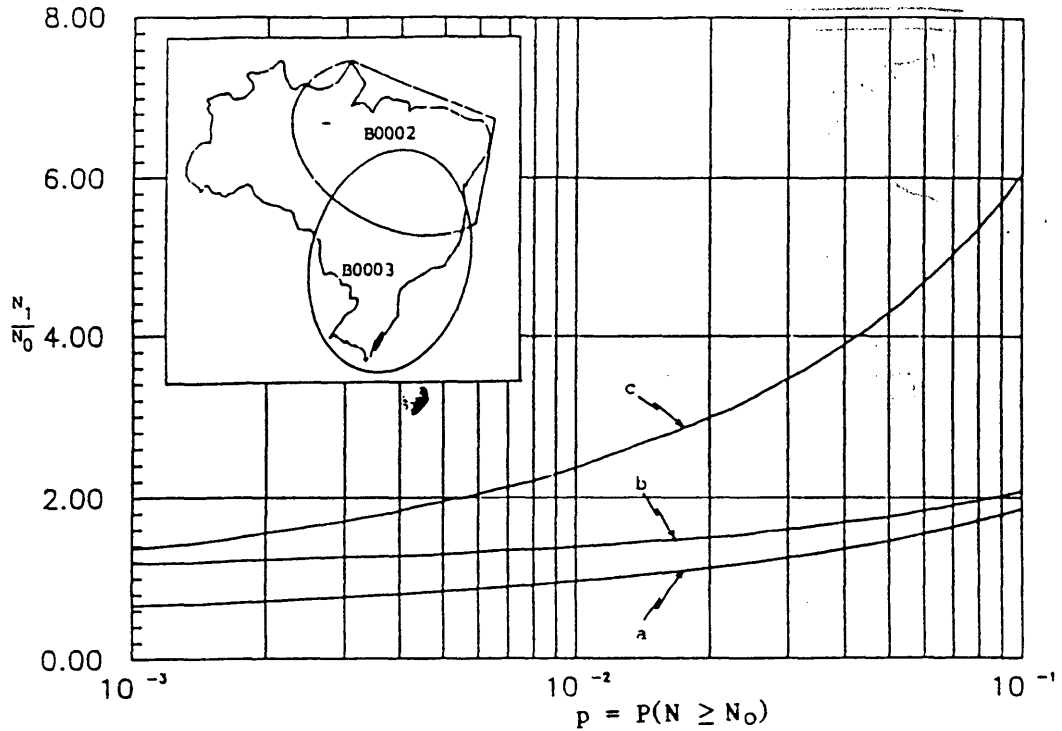

FIGURE 5b - Ratio N_1/N_0 when antenna sidelobe gains (curve a), earth station locations (curve b) and both (curve c) are randomly modeled. (Interference on B00002 due to B00003).

Figure 6 presents the curve of N_1/N_0 versus p when the aggregate interference on B00002 is considered and both effects (random antenna sidelobe gains and random earth station locations) are taken into account.

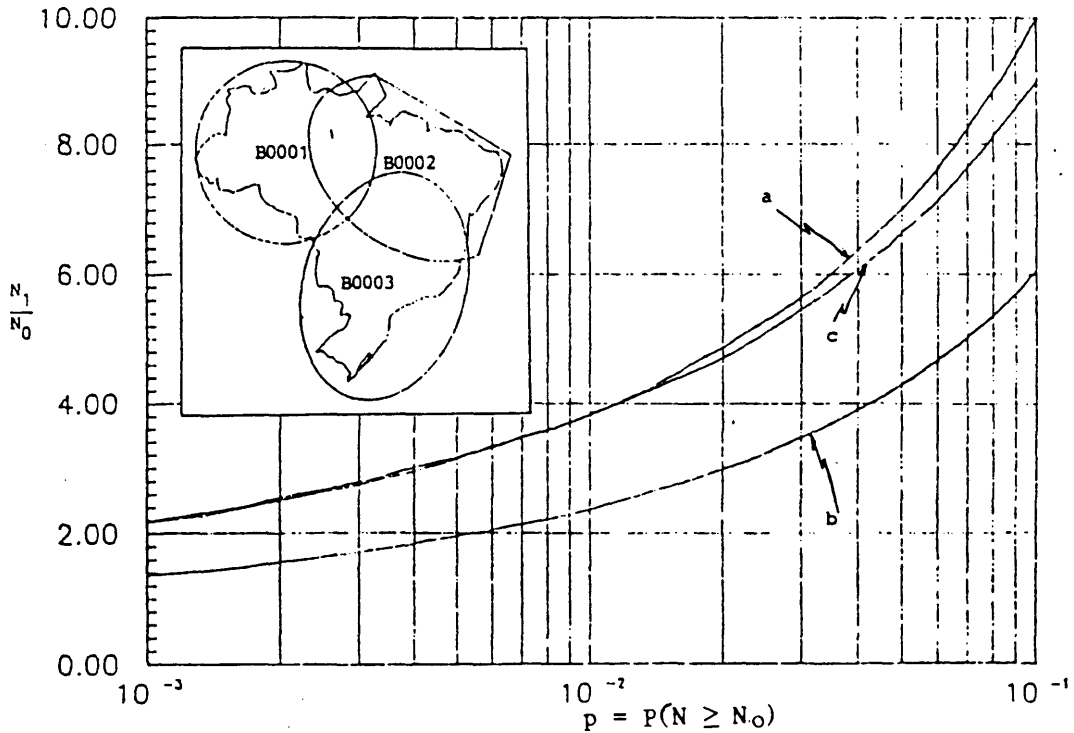

FIGURE 6 - Ratio N_1/N_0 when antenna sidelobe gains and earth station locations are randomly modeled. (Interference on B00002).

- curve a: interferer: B00001
- curve b: interferer: B00003
- curve c: interferers: B00001 and B00003

2.1.4 Effects of the statistical modeling of the interfering transponder frequency plan

To illustrate the effect of the use of a statistical model in the characterization of the interfering transponder frequency plan, a simple example is considered in this section. The victim is a narrowband carrier centered at a given frequency f_v . The interfering transponder frequency plan contains 2 FDM/FM carriers, whose center frequencies f_a and f_b are modeled as random variables. Taking as a reference the lowest transponder frequency, the example assumes that $f_v = 15$ MHz and that the pair (f_a, f_b) has a constant probability density function within the region of the plane (f_a, f_b) which corresponds to feasible values of these two centre frequencies and zero outside. Such a region depends on the characteristics of the two FDM/FM carriers, which are considered as follows.

Carrier a: Occupied Bandwidth - 18 MHz; rms multichannel deviation - 2.2 MHz

Carrier b: Occupied Bandwidth - 9 MHz; rms multichannel deviation - 1.2 MHz.

We further assume that the ratio of the power of carrier "a" to that of carrier "b" is 0.36 and that both carriers have a Gaussian shaped power spectral density. The above parameters correspond to FDM/FM carriers with 432 and 192 baseband channels, respectively.

For this particular example, it has been possible to determine the probability density function of the ratio of the total interfering power within the victim carrier bandwidth to the value of this total interfering power corresponding to a worst-case situation ($f_a = f_b$). If baseband interference noise is assumed to be proportional to RF interfering power, this probability density function also applies to the ratio N_1/N_0 considered in the two previous sections.

In Figure 7, the ratio N_1/N_0 is presented as a function of p . This figure includes the situations corresponding to 1, 2 and 4 interfering

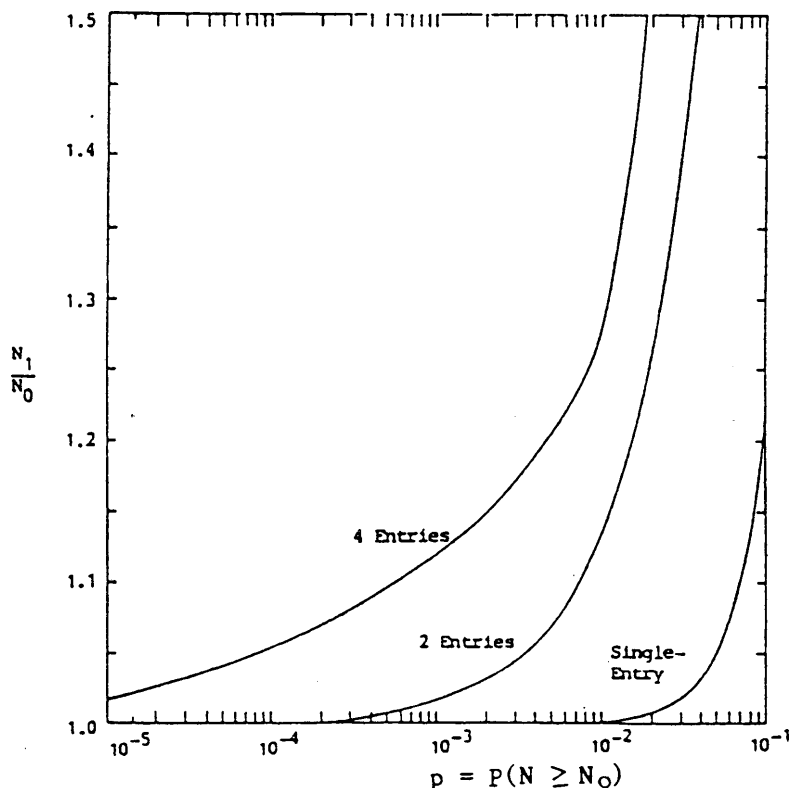

FIGURE 7 - Ratio N_1/N_0 for a random interfering transponder plan (1, 2 and 4 interfering networks).

2.2 Studies conducted at INTELSAT

2.2.1 Statistical modelling of antenna side-lobe gains

This section presents the results of the analysis conducted at INTELSAT by modelling the side-lobe radiation patterns using the Gamma distribution. Some examples of application of this model in assuming interference satellite networks, are also presented.

The Gamma distribution model was based on the data which consisted of measured side-lobe radiation patterns of 226 INTELSAT Standard A earth stations and 109 INTELSAT Standard B earth stations. The measurements of each radiation pattern were made in four quadrants at one degree intervals from 1° to 14° . Linear interpolation between nearest neighbours was used to obtain the corresponding values of side-lobe gain. The computation of statistical quantities such as means and variances has been described in [Kadrichu *et al.*, 1987]. The results were then used to approximate the distribution of the above gains by a Gamma density function.

The mean and standard deviation of a Gamma probability density function are characterized by the fact that its mean can be greater or less than its standard deviation which is typical of the characteristics of the measured data especially when the angle is small. This property is what motivates the choice of Gamma density function.

To choose a probability density function which is representative of a particular data set, first, the free parameters in the probability density function must be estimated on the basis of the given data and, then, a measure of how closely the continuous distribution approximates the statistics of the data must be defined. From the result of the fitness test, it is concluded that the Gamma density appears to be a better fit than the exponential model.

Interference model

The model of interference between satellite networks is described in [Lang, R., 1982; Mizuno *et al.*, 1986].

The interference-to-carrier power ratio (I/C) at the receive station can be expressed in terms of deterministic constants K_{ui} , K_{di} and statistical earth station gains G_{ei} as:

$$I/C = \sum_{i=1}^{n_t} K_i G_{ei} \quad (1)$$

where

$$K_i = \begin{cases} K_{ui} & i=1, \dots, n_u \\ K_{di} & i=n_u+1, \dots, n_t; \quad n_t=n_u+n_d \end{cases} \quad (2)$$

Basically the user is interested in knowing what the probability is for the carrier to interference ratio, C/I, to be greater than some specified value, c/i . This probability can be conveniently calculated in terms of the (I/C) p.d.f. as follows:

$$\begin{aligned} P(\rho) &\equiv \text{Prob } (C/I) > \rho = \text{Prob } (C/I) > c/i & (3) \\ &= \text{Prob } (i/c) > (I/C) = \int_{I/C}^{\infty} f_{I/C}(i/c) di/c \end{aligned}$$

where $f_{I/C}(i/c)$ is the probability density function of I/C. As a result, the problem is essentially reduced to computing the probability density function of I/C.

Since the random variable I/C is expressed in equation (1) as a sum of independent random variables, G_{ei} , the method of characteristic function is employed to calculate $f_{I/C}(i/c)$. Assuming the G_{ei} are independent random variables, the pdf of I/C is:

$$f_{I/C}(I/C) = \frac{f_{Ge1}(\frac{I/C}{K1})}{K1} * \frac{f_{Ge2}(\frac{I/C}{K2})}{K2} * \dots \quad (4)$$

Here * represents convolution. The characteristic function of a random variable G_{ei} with a Gamma distribution is:

$$\phi(\omega) = \frac{c^{b+1}}{(c - j\omega)^{b+1}} \quad (5)$$

where c and b are the free parameters of the Gamma distribution.

The characteristic function of I/C with each of the G_{ei} assumed to be independent and possessing a Gamma distribution is:

$$E[e^{j\omega I/C}] = \prod_{i=1}^{n_t} \frac{c_i^{b_i+1}}{(c_i - j\omega K_i)^{b_i+1}} \quad (6)$$

The inverse Fourier transform of equation (6) yields the probability density of I/C. Equation (3) may then be employed to compute probabilities.

Impact on orbital utilization

Figure 8 gives the 90% mask (10% probability of exceeding the criterion or required C/I) of side-lobe gain of Standard A, Standard B and its combinations as a function of orbital spacing.

Figure 9 gives a typical example of Standard A side-lobe masks (80% through 99.9%) as a function of orbital separation together with the reference pattern ($32 - 25 \log \phi$).

It is seen from Figures 8 and 9 that the savings in orbit spectrum usage could be considerable using Gamma distribution compared with the reference radiation pattern. The savings could be as much as 20% to 38% for the 90% mask for Standards A and B respectively.

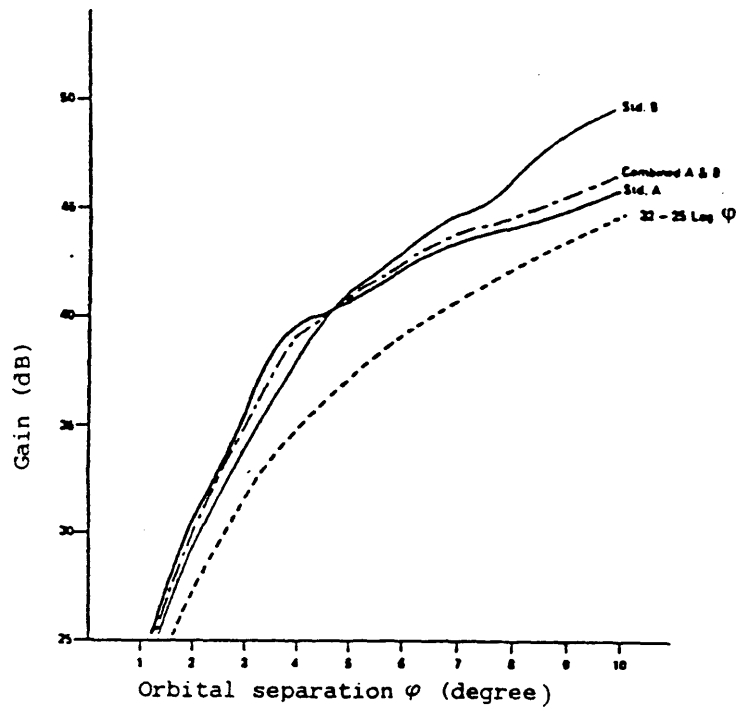

FIGURE 8

90% mask of side-lobe gain of Standard A and Standard B earth stations

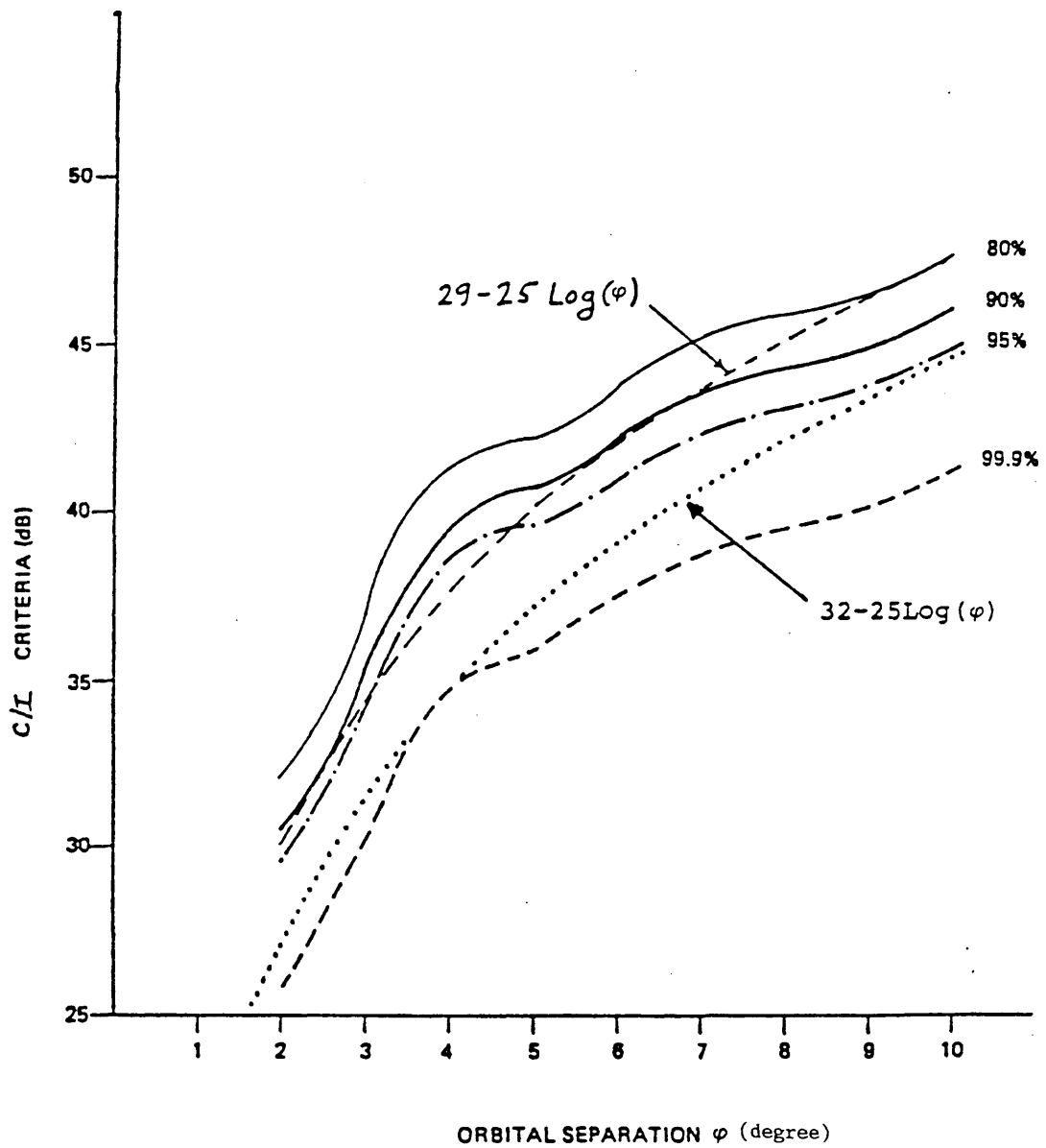

FIGURE 9

Z Masks (80% through 99.9%) as a function of orbital separation for standard A sidelobe

2.2.2 Computer Simulation Results of the Statistical Modelling of the Interfering Transponders Frequency Plans and Randomness of Satellite Network Parameters

2.2.2.1 Simulation Model

The following simulation procedure was used to generate statistical data on aggregate interference from adjacent satellite networks.

Analogue FDM/FM Carriers

Fourteen different co-coverage satellite networks were considered in the simulation and fourteen different satellite networks were considered with the carrier parameters corresponding to those used for coordination purposes. In all cases the earth station side-lobe characteristics were assumed to meet CCIR Recommendation 465-2.

The following procedure was followed:

- the satellites were randomly ordered in the orbit;
- for a given ordering of satellites in the orbit, the spacing between satellites is determined such that i) the maximum single-entry interference into every network, as calculated on a co-channel assumption, for all possible combinations of wanted and interfering satellites does not exceed the applicable single-entry level; and ii) the total orbital arc occupied by all the satellites for that ordering is a minimum;
- in individual networks, the carrier centre frequency is shifted randomly within the range of the bandwidth of the carrier. The interference reduction factors are calculated taking into account the centre frequency differences between the wanted and interfering carriers, and the interference contributions from all of the interfering carriers of each interfering network within the bandwidth of the wanted carrier. Subsequently, aggregate interference into the wanted carrier is calculated by adding the baseband interferences from each interfering network on a power basis.

The generated statistics show the effects of the inhomogeneity of the satellite system parameters and carrier interleaving.

Digital Carriers

Basically the same approach as in the above section was followed in obtaining statistical data for digital carriers, with the exception that the carrier centre frequencies were not randomly shifted. The reason for this was that the spectra of digital carriers were assumed to be flat. The obtained statistical data reflected the randomness of satellite networks characteristics.

2.2.2.2 Statistical data and aggregate interference distribution function

The statistical data obtained by the simulation were used to obtain the parameters of a log-normal distribution function to model the distribution of aggregate interference noise power.

FDM/FM carriers

Under the assumption that the aggregate interference power is distributed log-normally, the probability that aggregate interference noise exceeds a certain level X is given as

$$P(I_n \geq X) = 1 - \frac{1}{\sqrt{2\pi}\sigma} \int_{0^+}^X \frac{1}{I_n} \exp \left[-\frac{1}{2\sigma^2} \left(\log_e \frac{I_n}{\mu} \right)^2 \right] dI_n \quad (7)$$

Parameters $\log_e \mu$ and σ are the mean and standard deviation of the normal distribution of $\log_e I_n$ and 0^+ reflects the fact that $\log_e I_n$ is defined only for $I_n > 0$.

Using the generated data and defining I_n as

$$I_n = \frac{\text{Aggregate interference power in pWOp}}{1\ 000} \quad (8)$$

The parameters of the log-normal distribution were determined for several single-entry levels as shown in Table I.

TABLE I

Parameters of the log-normal distribution

Parameters \ Single entry (pWOp)	600	800	1 000
μ (pWOp /1 000)	0.46	0.62	0.77
σ (pWOp /1 000)	0.48	0.48	0.48

Figure 10 shows the statistical data and computed probabilities of exceeding a certain aggregate interference level using (7) and parameters in Table I.

A careful inspection of the parameters in Table I reveals a few simple facts. Parameter μ is very much affected by the level of single entry, while σ remains constant over the whole range of single entries. In addition, the ratio

$$\frac{\mu}{I_n^*} = \text{constant} = 0.77, \quad (9)$$

where I_n^* represents the value of I_n , as defined in (8), which corresponds to the given single-entry. (For example, $I_n^* = 1$ for single-entry of 1 000 pWOp.) This leads to a single distribution function for the normalized aggregate interference for FDM/FM carriers as follows.

From (7), replacing I_n and μ by

$$i_n = \frac{I_n}{I_n^*} \quad \text{and} \quad \mu' = \frac{\mu}{I_n^*} = 0.77 \quad (10)$$

with $\sigma = 0.48$, we get

$$P(i_n \geq X) = 1 - \frac{1}{\sqrt{2\pi} \cdot 0.48} \int_{0^+}^X \frac{1}{i_n} \exp \left[-\frac{1}{2(0.48)^2} \left(\log_e \frac{i_n}{0.77} \right)^2 \right] di_n \quad (11)$$

where i_n is now aggregate interference relative to single-entry and (11) gives the probability with which i_n will exceed x .

Probability (11) is plotted in Figure 11 and compared with statistical data for different single-entries.

Digital Carriers

In the case of digital carriers, the single-entry and the total interference level criteria are expressed as percentages of the total noise power as defined by CCIR Recommendation 523-2. Thus,

$$I_n = K \text{ Total noise} \quad (12)$$

Then, we can express (7) as

$$P(K \geq X) = 1 - \frac{1}{\sqrt{2\pi} \sigma} \int_{0^+}^X \frac{1}{K} \exp \left[-\frac{1}{2\sigma^2} \left(\log_e \frac{K}{\mu} \right)^2 \right] dK \quad (13)$$

In the above formula,

$$K = \frac{\text{Aggregate interference in \% of total noise}}{100} \quad (14)$$

Using the same approach as in the case of analogue carriers and the statistical data, obtained as described in 2.2.2.1, the parameters μ and σ in (13) are determined as shown in Table II.

TABLE II

Parameters of the Log-normal distribution

Parameter	Single entry (% of total interference power)	4	10
	μ		0.08
σ		0.38	0.38

The computed distributions using parameters from Table II and statistical data are shown in Figure 12.

After examination of the parameters in Table II, the same conclusions as in the case of analogue carriers can be drawn. Consequently, a single distribution function can be derived for the normalized aggregate interference.

Denoting single-entry interference power as

$$I_{SE} = K_{SE} \text{ Total interference noise power} \quad (15)$$

and replacing K and μ in (13) by

$$k = \frac{K}{K_{SE}} \text{ and } \mu' = \frac{\mu}{K_{SE}} - 2, \quad (16)$$

we get the general formula

$$P(k \geq x) = 1 - \frac{1}{\sqrt{2\pi}\sigma} \int_{0^+}^x \frac{1}{k} \exp \left[-\frac{1}{2\sigma^2} \left(\log \frac{k}{2} \right)^2 \right] dk \quad (17)$$

Now, k represents the ratio

$$k = \frac{\text{Aggregate interference (\% of total noise power)}}{\text{Single-entry (\% of total noise power)}} \quad (18)$$

Figure 13 shows the general distribution of the normalized interference for digital carriers and the statistical data obtained by computer simulation.

2.2.2.3 Summary of results

The results of the studies described in the sections show that for both FDM/FM and digital carriers, the same type of distribution was obtained. In addition, for the range of the single entry criteria modelled, it was possible to derive a single distribution for the aggregate interference normalized to the single entry criterion for each FDM/FM and digital carrier.

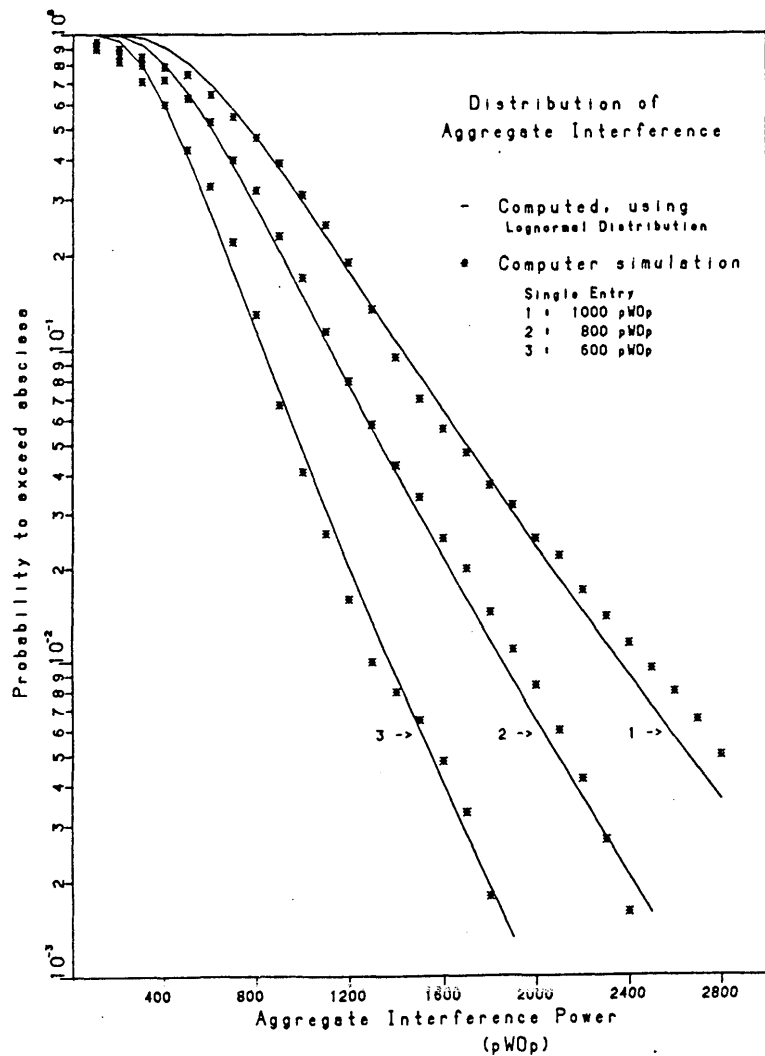

FIGURE 10
Distribution of Aggregate Interference Power
for FDM/FM Carriers
(Co-coverage case)

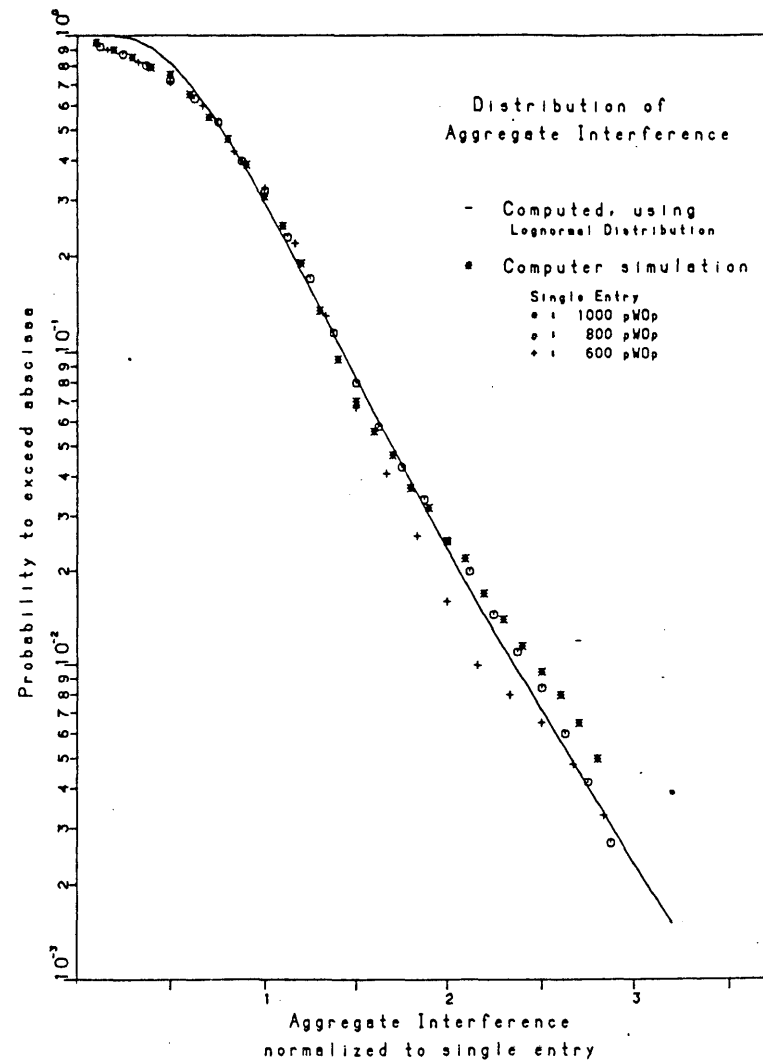

FIGURE 11
Distribution of Normalized Aggregate
Interference for FDM/FM Carriers
(Co-coverage)

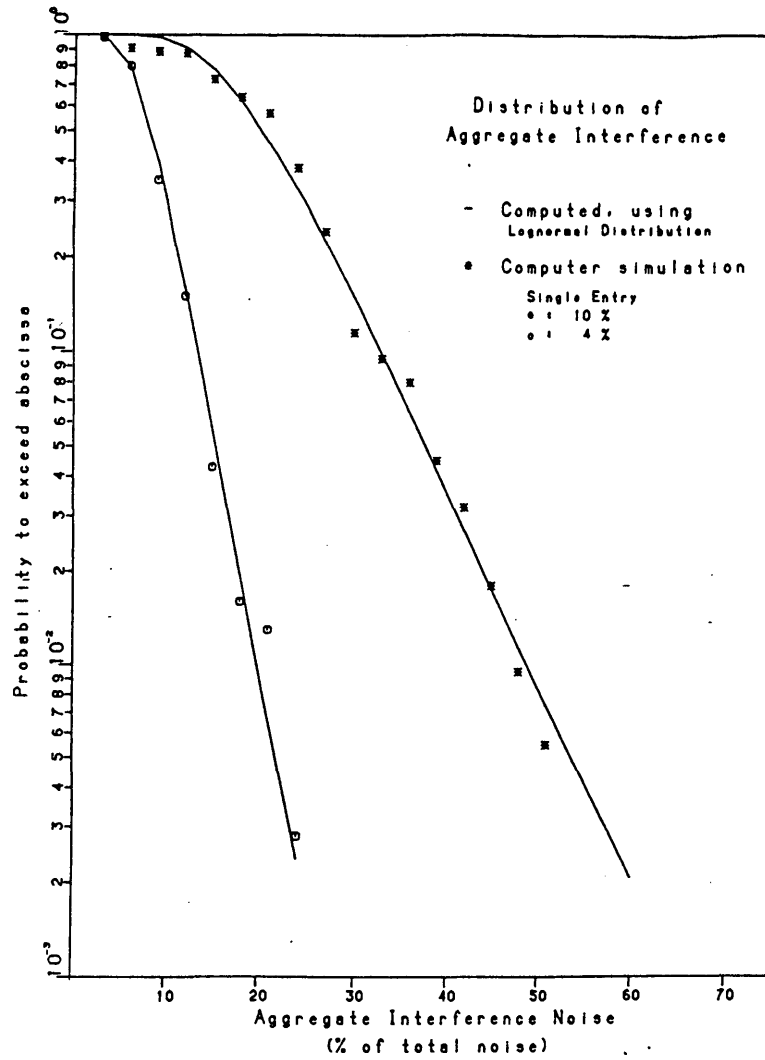

FIGURE 12

Distribution of Aggregate Interference Power for Digital Carriers (Co-coverage case)

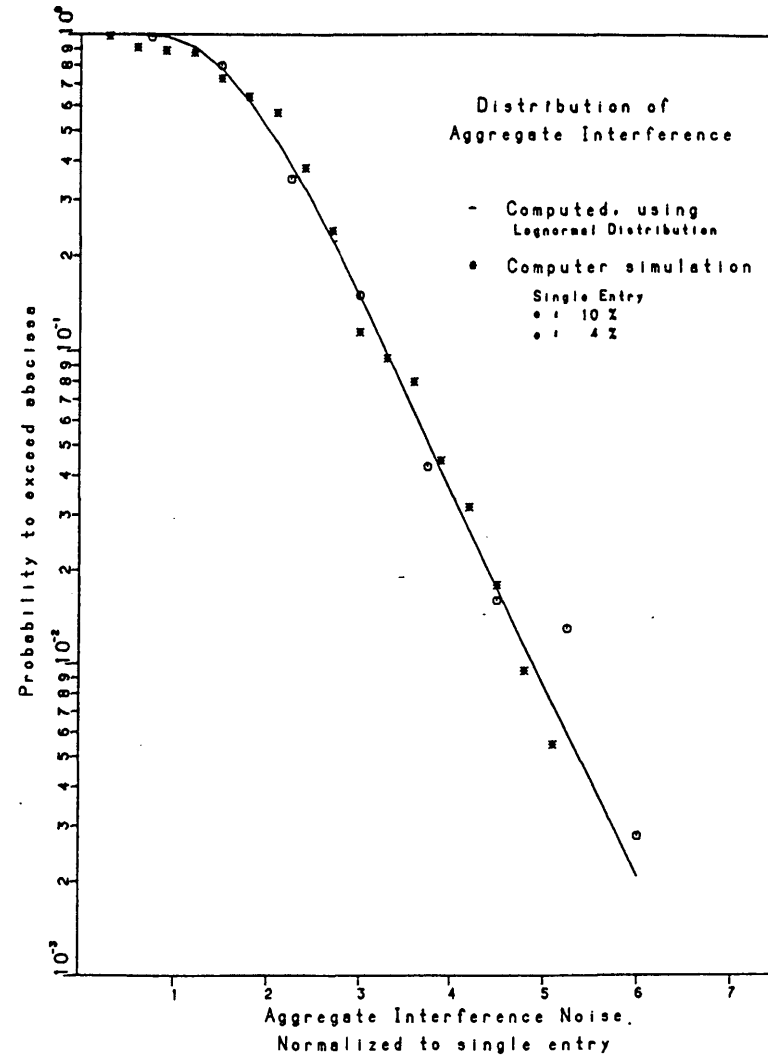

FIGURE 13

Distribution of Normalized Aggregate Interference for Digital Carriers (Co-coverage case)

2.3 Studies conducted in the United States

2.3.1 The Effect of Station-Keeping Error Modeled as a Random Variable

This section considers the impact of station-keeping error on interference and on orbit utilization when this error is considered a random variable. The situation is depicted in Figure 14.

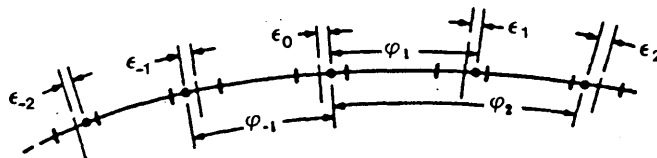

Fig. 14. Illustration of satellite configuration.

As shown, the actual angular separation between the wanted and j th interfering satellite is denoted φ_j , where j is indexed positively to the right and negatively to the left of the wanted satellite. The station-keeping error of the j th satellite is denoted ϵ_j and that of the wanted satellite is denoted ϵ_0 .

Let α_j be the nominal angular spacing between the wanted and j th interfering satellite. The convention is taken that both α_j and actual spacing φ_j are non-negative quantities (i.e., absolute values), so that the relation between the two is given by [Jeruchim and Moore, 1982]

$$\varphi_j = \alpha_j + \epsilon_j \operatorname{sgn}(j) - \epsilon_0 \operatorname{sgn}(j) \quad (19)$$

where $\operatorname{sgn}(\)$ is the signum function.

An initial idea of the impact of station-keeping error has been obtained under the following assumption [Jeruchim and Moore, 1982.] The orbit occupancy model is the homogeneous co-coverage case, taking account only of

downlink interference. The earth station antenna sidelobe gain is taken to be of the form

$$G(\varphi) = \frac{10^A}{\varphi^B} \quad (20)$$

and it is assumed that all φ_j in (19) are such that they do correspond to the sidelobe region. The station-keeping error ε_j is modeled as a uniformly distributed random variable, with mean value equal to the nominal position, and with maximum error of E_{\max} ; hence the probability density function of ε_j is

$$f(E) = \begin{cases} 1/2 E_{\max}, & |E| \leq E_{\max} \\ 0, & \text{elsewhere} \end{cases} \quad (21)$$

for all j . If $\Delta\varphi$ is the nominal intersatellite spacing, then

$$\varphi_j = |j| \Delta\varphi + (\varepsilon_j - \varepsilon_0) \operatorname{sgn}(j) \quad (22)$$

The interference-to-carrier ratio is given by

$$\frac{I}{C} = \frac{10^A}{G_0} \sum_{\substack{j=-N \\ j \neq 0}}^N r_j \varphi_j^{-B} \quad (23 \text{ a})$$

where G_0 is the maximum gain of the receiving earth station antennas and r_j is the ratio of interfering to wanted signal power at the input to the antenna. For the homogeneous model we can approximate and bound $r_j \approx 1$, so that

$$\frac{I}{C} = \frac{10^A}{G_0} \sum_{\substack{j=-N \\ j \neq 0}}^N \varphi_j^{-B} \quad (23 \text{ b})$$

where φ_j is given by (22).

Equation 23 b has been evaluated by Monte Carlo simulation, taking 10 equally spaced interfering satellites ($N=5$). An illustrative result is shown in Figure 15 where the parameter ϵ_r is the relative maximum station-keeping error; $\epsilon_r = E_{\max}/\Delta\varphi$. Figure 15 shows distributions of I/C for different values of ϵ_r . Each curve is the result of generating $1.1 \cdot 10^6$ random numbers (100,000 trials each for ϵ_j , $j = \pm 1, \pm 2, \pm 3, \pm 4, \pm 5$, and ϵ_0).

The impact on orbit utilization can be obtained by finding the nominal satellite spacing required, $\Delta\varphi_0$, to satisfy a certain probability P that the C/I with ideal station-keeping is exceeded, when the original nominal spacing is $\Delta\varphi$. Table III shows the ratio $\Delta\varphi_0/\Delta\varphi$ for various values of P , for several values of maximum relative station-keeping error $\epsilon_r = E_{\max}/\Delta\varphi$, and for different values of antenna sidelobe decay slope β . The values of $\Delta\varphi_0/\Delta\varphi$ should be compared to the usual deterministic rule-of-thumb $\Delta\varphi_0/\Delta\varphi = 1 + 2\epsilon_r$ which ensures that the actual spacing is never less than that with ideal station-keeping. Compared to this rule-of-thumb, the statistical approach affords a reduction in spacing of about 13% (for $\epsilon_r = 0.1$, $P=90\%$, $\beta=2.5$), and as high as about 27% (for $\epsilon_r = 0.4$, $P=90\%$, $\beta=2.5$).

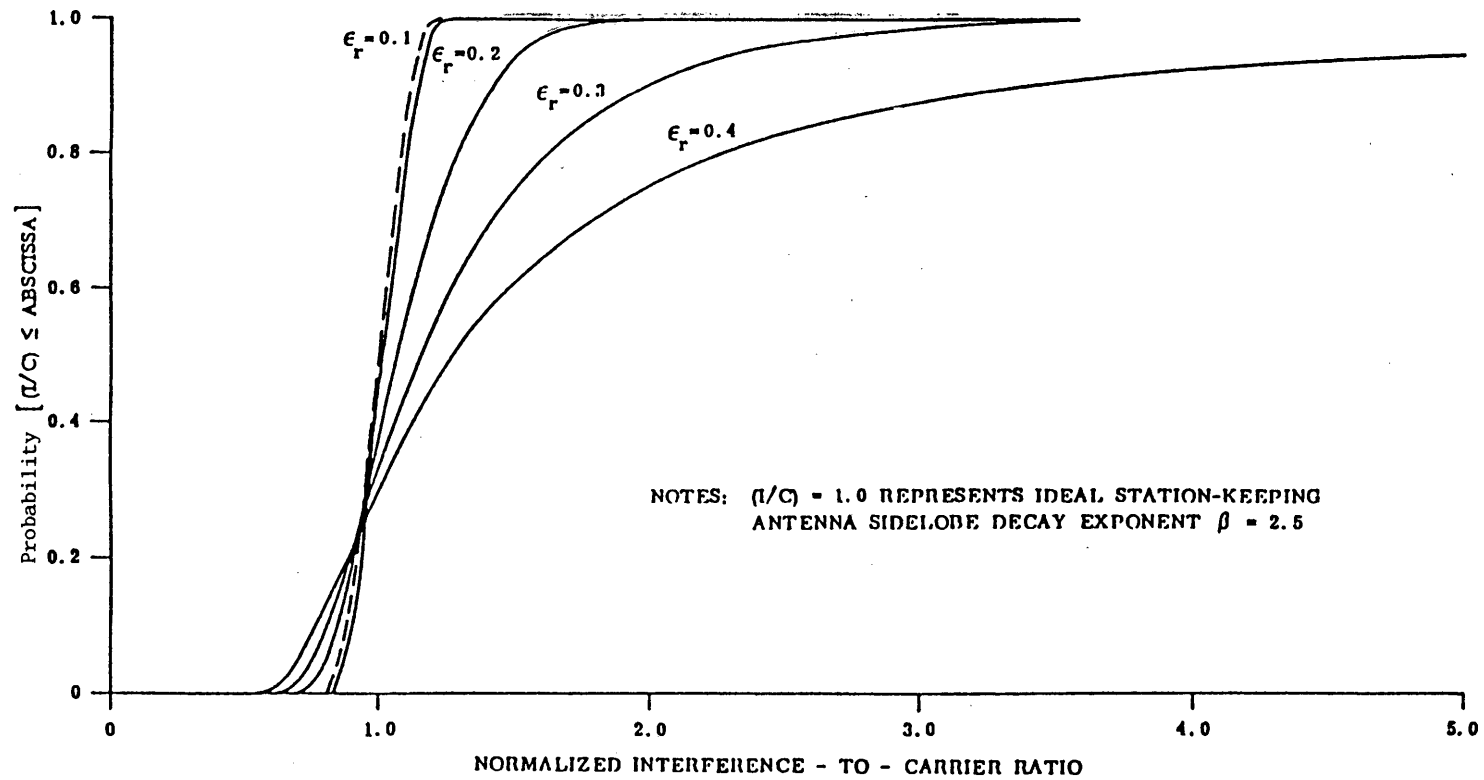

Figure 15 - Distribution Function of (I/C) for Antenna Sidelobe Decay Exponent Equal to 2.5 for Various Station-Keeping Accuracies

Table III - Satellite Spacing For P Percent Exceedance
Relative to Spacing for Ideal Station-Keeping

Percent of Time C/I) Exceeded	Relative Station-Keeping Error, $\epsilon_r = 0.1$			Relative Station-Keeping Error, $\epsilon_r = 0.2$			Relative Station-Keeping Error, $\epsilon_r = 0.3$			Relative Station-Keeping Error, $\epsilon_r = 0.4$		
	$\beta = 2.5$	$\beta = 3.0$	$\beta = 3.5$	$\beta = 2.5$	$\beta = 3.0$	$\beta = 3.5$	$\beta = 2.5$	$\beta = 3.0$	$\beta = 3.5$	$\beta = 2.5$	$\beta = 3.0$	$\beta = 3.5$
P=90%	1.046	1.058	1.058	1.124	1.136	1.144	1.212	1.217	1.253	1.307	1.344	1.371
P=95%	1.064	1.064	1.067	1.143	1.156	1.17	1.264	1.282	1.307	1.379	1.413	1.454
P=99%	1.075	1.081	1.081	1.176	1.194	1.205	1.302	1.338	1.357	1.454	1.498	1.509
P=100%	1.11	1.11	1.117	1.235	1.258	1.266	1.384	1.415	1.442	1.55	1.59	1.63

3. Advantages in coordination approaches

3.1 Improvement in Efficient Use of the Orbit (Statistical Advantage)

The practice of computing interference on a deterministic, essentially worst-case basis is at variance with the statistical approach. The value of that approach is that if less than ideal performance can be accepted for some relatively small fraction of the time, some significant savings may be realized in one domain or another. The results of the studies reported in the previous sections indicate the possibility of savings in the orbit/spectrum resource.

To illustrate such a possibility, consider again Figure 1. Let us suppose that $\text{Prob} [\text{interference} > N_0] = 0.1$; that is, the interference criterion N_0 is exceeded with "probability" 10%. Figure 1 indicates that this increase in interference level would occur if, using antenna sidelobe gain of $32-25 \log \varphi$, one accepted a deterministic computation of interference equal to about $2.35 N_0$ for the single interfering network case and about $2.8 N_0$ for the four interfering networks case. In the conventional situation, only N_0 is accepted in conjunction with the standard $32-25 \log \varphi$ pattern. Hence, in the case at hand, we have potential spacing improvements by factors of $(2.35)^{0.4} = 1.41$ and $(2.8)^{0.4} = 1.51$, respectively, for the two interference scenarios.

One tentative conclusion from this example is that, for a given un-availability objective, it would be possible to

accept a higher amount of single-entry and aggregate interference, when that interference is computed according to the existing Recommendation on sidelobe antenna gain, with the consequence that successful coordination could be effected with closer satellite spacings.

The example indicates that the "statistical advantage" (N_1/N_0) depends upon whether there is interference from only one or from four networks. This is a manifestation of the fact that the distribution of the sum of a number of random variables will generally be a function of the exact number and relative magnitude of these variables. Now, the orbit occupancy/coverage area model, which specifies the exact interference environment, ultimately establishes the number of interferers and their relative strengths, which in turn determine the distribution of the total interference and thence the possible statistical advantage.

The interference environment, as dictated by the orbit occupancy/coverage area model, is itself a random quantity in the sense that it will not generally be known exactly, at least until coordination is initiated, and may subsequently change. It is, therefore, necessary to examine a variety of likely interference environments in order to assess the corresponding range of statistical advantage. This should be the subject of further study.

3.2 Statistical Advantage From Antenna Sidelobe Gain

Returning to the problem of the statistical advantage arising from treating antenna sidelobe gains as random

quantities, there is a possible alternative to the approach suggested above (a higher computation of interference) for actually realizing this advantage in practice. This alternative arises from examination of Figure 9, which indicates the satellite spacing (for a single interferer) at which particular C/I criterion is satisfied using the 32-25 log φ envelope, the 29-25 log φ envelope, and for various probabilities using the statistical approach. It can be seen that the 29-25 log φ envelope provides protection at least to the 90% probability level for $\varphi \leq 7^\circ$ and at least equal to the 80% probability level for $7^\circ \leq \varphi \leq 10^\circ$. Therefore, one possibility for realizing the statistical advantage might be to adopt the 29-25 log φ sidelobe envelope for interference calculations using a deterministic approach.

3.3 Statistical Advantage From Transponder Traffic

Another random phenomenon which offers the potential for some statistical advantage is the variability in transponder traffic. That is, transponder frequency plans change over time to respond to demand, and for any given wanted carrier the nature of the interfering carriers will vary with time. Thus, the worst combination of interfering carriers will occur only for some fraction of the time. The resulting variation in aggregate interference for two different scenarios has been depicted in Figure 7 and Figure 10-13, respectively. The basis of the latter figures appears to be closer to real-world situations. Figures 10-11, which

apply to interference into FDM/FM, indicate the possibility of a substantial statistical advantage. These figures indicate that an interference level of 1.2 * single-entry criterion would be exceeded for 20% of the time, the un-availability figure of Rec. 466. For this un-availability, this means the single-entry criterion could be increased to about 1600 pW for a 2000 pW aggregate criterion. This translates into substantially closer satellite spacings, about 2/3 of the original spacing for a 25 log ϕ antenna sidelobe gain slope. For digital wanted signals Figures 12-13 show some potential improvement, though less than with FDM/FM.

3.4 Summary

The two random phenomena discussed--sidelobe gains and transponder traffic--have a significantly different temporal behavior, which may affect how they can ultimately be taken advantage of, because of the current stipulation that the interference levels in Rec. 466 and 523 be averaged over certain short periods. The antenna gains are not time-varying (except possibly in a very minor way due to environmental conditions), so that a particular realization of an interference scenario stays as it is, once it is established. On the other hand, transponder traffic is

definitely time-varying, perhaps on the same order of time scale as the averaging period. The question of the time-variability of a random factor needs further study.

In summary, taking advantage of random or stochastic elements in the environment means that networks cannot be protected against worst-case exceedance of the interference criterion except with a certain probability. This notion is already incorporated in CCIR Recommendations on total noise as well as on interference. In order to realize in practice any advantage due to this approach, it would be necessary to increase the allowable interference noise as compiled on a deterministic basis or possibly modify certain standards, such as the antenna sidelobe gain envelope.

Before specific recommendations can be made, further studies are required on the statistical properties of interference when all relevant factors are taken together on the impact of the orbit occupancy/coverage area model and on the temporal aspects. However, coordinating networks can begin to take note of stochastic elements which may help bring about successful coordination.

4. Estimation of the stochastic characteristics of system parameters

The overall objective in the examination of interference between satellite networks as a stochastic process is to estimate the statistical properties of that interference. An important element in that examination is to estimate the stochastic characteristics of significant elements of these satellite networks.

Whether the basic characteristics of network elements are obtained by direct measurement, by analysis, or by simulation, they must be modelled as stochastic variables. This involves estimating their probability density functions, if possible as simple expressions such as exponential, gamma or Gaussian functions, so that they can be included in further analysis. For instance, it is necessary to estimate the probability density function of such parameters as:

- earth station antenna side-lobe gain as a function of angle away from the boresite direction of that antenna;
- similar characteristics of spacecraft antennas;
- earth station locations within the coverage areas;
- transponder frequency plan parameters, e.g. carrier centre frequency, carrier bandwidth, carrier power.

At another level, it may be advantageous to measure or otherwise determine the stochastic characteristics of such networks as the aggregate interference into the satellite network. This may be estimated by analysis of the interference from examination of the basic equations describing that interference, or it may be estimated directly by simulation. Examples of the latter approach can be found in section 2.2.2; further examples of the application of this approach may be found in sections 4 and 5 of Annex IV of Report 455.

5. Conclusions

Initial results presented in this report show that significant benefits in the GSO utilization could be achieved by statistical approaches as compared to deterministic and most often worst case assumptions currently used in computing interference between satellite networks.

Further studies of statistical interference evaluation should be made. In particular, efforts should be directed towards defining appropriate concepts based on the statistical properties of interference, which will lead to a better use of the GSO.

References

J.P.A. Albuquerque and J.M.P. Fortes, "Statistical Aspects in the Evaluation of Interference Among Satellite Networks", IEEE ICC'88 Conference Record, Philadelphia, June 1988, pp. 7.2.1-7.2.5.

Jeruchim, M. and Moore, J., "The Effect of Station-Keeping Error on the Distribution of Carrier-to-Interference Ratio," IEEE Trans. Commun., July 1982.

Kadrichu, A., Prasanna, S. and Mukunda, R., [1987] "Stochastic Evaluation of Interference Aggregation", ICC'87 Conference Record, Volume 3 of 3, pp. 1733-1739.

Lang, R., [1982] "Statistical model for sidelobe interference in satellite networks", INTEL 198, Dept. of Electrical Engineering & Computer Science, the George Washington University, Washington D.C. 20052.

Mizuno, T., Kadrichu, A., Prasanna, S., et al, "Development of Software for Intersystem Coordination", AIAA 11th Communication Satellite Systems Conference, March, 1986.

Mizuno, T., Kadrichu, A., Prasanna, S. and Henriques, H., "Interference Problems in Digital Satellite Communications", 7th International Conference on Digital Satellite Communications, May 1986, pp. 659-666.

CCIR Documents

[1986-1990]: 4/72 (INTELSAT)

REPORT 557-2

**THE USE OF FREQUENCY BANDS ALLOCATED TO THE
FIXED-SATELLITE SERVICE FOR BOTH THE UP LINK AND
DOWN LINK OF GEOSTATIONARY-SATELLITE SYSTEMS**

(Study Programme 28A/4)

(1974-1982-1986)

1. Introduction

Frequencies in two different bands are assigned to a radiocommunication satellite, one for up links and the other for down links and it is usual for a given band to be used for up links or down links but not for both. Thus, two inter-system interference paths may arise, as follows:

- interfering earth station transmitter to wanted space station receiver, and
- interfering space station transmitter to wanted earth station receiver.

When the frequency bands occupied by two systems overlap, satellite spacing must be sufficient to reduce this interference to an acceptable level.

However, if two such satellites are separated by the minimum required orbital arc, it may be feasible to use another satellite, located between them and occupying the same frequency bands, the bands being assigned in the reverse sense. Thus, for example, the up-link frequency band of the third satellite would be the same as the down-link band of the other two. This may increase the total capacity of the spectrum and orbital arc occupied. The inter-system interference path that may arise between pairs of satellite systems with reversed frequency assignments are:

- interfering space station transmitter to wanted space station receiver,
- interfering earth station transmitter to wanted earth station receiver.

This Report examines this possible frequency utilization mode as regards space radiocommunication services considered alone, and also its effect on terrestrial services in shared frequency bands. Study so far has been confined entirely to the geostationary-satellite case, but consideration should also be given to the problems that would be raised by the bidirectional allocation of frequencies to geostationary satellites in bands also used by non-geostationary satellites.

2. The increased orbit capacity obtainable by reverse frequency assignments

The carrier-to-interference ratio at the receiver input of an earth station which receives an emission from another earth station through a repeating geostationary space station, in the presence of a second similarly operating system, the space station of which is separated by a geocentric angle ϕ from the first space station may be approximated by:

where

- p_e, p'_e : the available transmitting powers at the earth station antenna inputs of the wanted and the interfering system, respectively;
- p_s, p'_s : the available transmitting powers at the space station antenna inputs of the wanted and the interfering systems, respectively;
- g_1, g_2, g_3, g_4 : the nominal main beam antenna gains in the wanted system; the suffixes follow the transmission path: 1 = earth station transmit, 2 = space station receive, 3 = space station transmit, 4 = earth station receive;
- $g'_1(\varphi), g_4(\varphi)$: the antenna gain at the interfering transmitting earth station in the direction of the wanted space station, and the antenna gain at the wanted receiving earth station in the direction of the interfering space station, respectively;
- $g_2(\delta), g'_3(\eta)$: the receiving antenna gain at the wanted space station in the direction of the interfering transmitting earth station, and the transmitting antenna gain at the interfering space station in the direction of the wanted receiving earth station, respectively (δ and η are the discrimination angles between the wanted and interfering directions).

When, in the interfering system, the directions of up- and down-link frequencies are reversed from those in the wanted system, the carrier-to-interference ratio may be approximated by equation (2), it being assumed that all significant interference will be received from satellites in orbital positions within 60° of the wanted satellite.

$$(C/I)_r^{-1} \approx \frac{p'_s g'_3(\nu) g_2(\varepsilon) l_u^*}{p_e g_1 g_2 l_0} \quad (2)$$

where

- $g_2(\varepsilon), g'_3(\nu)$: the receiving antenna gain at the wanted space station in the direction of the interfering space station, and the transmitting antenna gain at the interfering space station in the direction of the wanted space station, respectively;
- l_u, l_0 : the free-space attenuations in the wanted system's up link, and between the interfering and the wanted space stations, respectively, in the same frequency bands.

To assess the orbit utilization obtainable with the use of reverse-direction frequency assignments relative to that obtainable with co-direction assignments only, several normalizing and simplifying assumptions can be made:

(a) Homogeneity of systems

- equal earth station and satellite powers:

$$p'_e / p_e = p'_s / p_s = 1$$

- equal space station antenna beamwidths:

$$g_2 = g_3 (= g'_2 = g'_3)$$

- equal earth station antenna diameters and side-lobe patterns of the form:

$$g_1(f) = a_1 / \rho^b$$

$$g_4(f) = a_4 / \rho^b$$

where ρ is the angle off the beam axis and where a_1, a_4 and b are parameters:

- (b) topocentric and geocentric angular spacing between space stations to be small and about equal. With this assumption,

$$l_0 \approx \varphi^2 l_u$$

- (c) underestimation of interference between co-direction frequency systems by postulating:

$$g_2(\delta) = g'_3(\eta) = 1$$

as representative for separate-coverage networks:

* The values for ν and ε will not be less than 60° .

- (d) overestimation of interference between reverse-direction frequency systems by postulating $g_2(80^\circ) = g'_3(80^\circ) = 1$ (space stations see each other at an angle of about $\pi/2$ off their beam axes);
- (e) in a given frequency band, assume the space station receiver noise temperatures to be about 10 times the earth-station receiver noise temperatures; and assume the up link carrier-to-thermal noise ratio to be not less than twice the down link carrier-to-thermal noise ratio.

With these assumptions, summing the interference contributions from many co-direction frequency systems at uniform satellite spacing φ_c , one obtains the approximate expression:

$$(C/I)_c^{-1} \approx \frac{2\zeta(b)}{\varphi_c^b} \left[\frac{a_1}{g_1 g_2} + \frac{a_4}{g_3 g_4} \right]^* \quad (3)$$

where a_1 and a_4 correspond to the transmitting and receiving earth-station antennas, respectively, in the wanted system.

When co-direction and reverse-direction frequency space stations are alternated, with spacing φ_{rc} , along the orbit, summation of all the interference contributions yields:

$$(C/I)_{rc}^{-1} \approx \frac{2\zeta(b)}{(2\varphi_{rc})^b} \left[\frac{a_1}{g_1 g_2} + \frac{a_4}{g_3 g_4} \right] + \frac{3\zeta(2)}{20 g_1 g_2 \varphi_{rc}^2} \quad ** \quad (4)$$

Since, for both cases, the interference in the wanted system should be the same (for equal capacity at equal performance), setting $(C/I)_c$ equal to $(C/I)_{rc}$ establishes a relationship between φ_c and φ_{rc} :

$$(\varphi_{rc}/\varphi_c)^b \approx 2^{-b} + \varphi_{rc}^{b-2} \frac{0.1233}{(a_1 + a_4 g_1/g_4) \zeta(b)} \quad (5)$$

When dealing with co-coverage systems, assumption (c) above produces too pessimistic results. For this case it is appropriate to make the assumption:

$$g_2(\delta) = g_2 = g'_3(\eta) = g'_3$$

However, for co-coverage one should also allocate more inter-network interference to facilitate the coordination between earth stations. To that end it would seem appropriate to allow not 50%, as was done for the separate-coverage case, but 90% of the reversed direction inter-network interference to be caused by interference between earth stations. With these assumptions, one obtains another equation:

$$(\varphi_{rc}/\varphi_c)^b = 2^{-b} + \varphi_{rc}^{b-2} \frac{0.617}{(a_1 + a_4 g_1/g_4) g_2 \zeta(b)} \quad (5a)$$

in which the absolute gain of the satellite antennas appears. So as to minimize the expected orbit utilization improvement, the smallest reasonable value for g_2 should be chosen; this would be the beam-edge gain of a global beam: $g_2 = 40$ (16 dB).

Equations (5) and (5a) may be solved for the "relative orbit utilization ratio" φ_c/φ_{rc} as a function of φ_c , for specific frequencies and antenna patterns.

Postulating two types of patterns for earth-station antennas, namely, the CCIR reference pattern for which $a_1 = a_4 = 0.063$ and $b = 2.5$, and an advanced-design pattern for which, optimistically, $a_1 = a_4 = 0.016$ and $b = 3.0$, and assuming a ratio $g_1/g_4 \approx f_{up}^2/f_{down}^2 = 2.25$ (which corresponds to the band pairings 6/4 GHz, 15/10 GHz and 30/20 GHz), one can derive the curves shown in Fig. 1.

* $\zeta(b)$, Riemann's Zeta function.

** The contribution from reverse-direction frequency systems was taken twice over in order to account for an equal amount of interference between the earth stations.

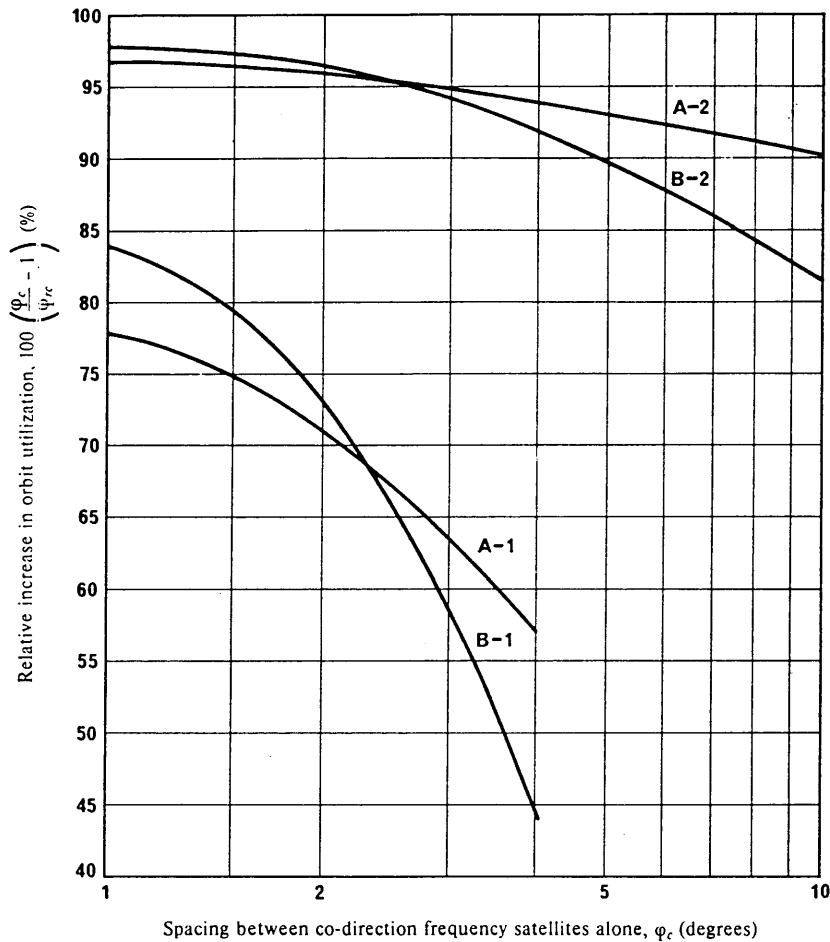

FIGURE 1 - Increase of orbit utilization with reverse-direction frequency systems relative to that with co-direction frequency systems alone

System A: $a_1, a_4 = 0.063$; $b = 2.5$

System B: $a_1, a_4 = 0.016$; $b = 3.0$

Suffix 1 : separate-coverage networks

Suffix 2 : co-coverage networks

It is apparent that the use of reverse-direction frequency assignments on alternate satellites holds the promise of substantially better orbit utilization than the use of only co-direction frequency assignments, particularly with implementation and operating parameters which allow close spacing between co-direction frequency space stations.

The foregoing argument applies to homogeneous orbit utilization as described above, but a similar advantage may not be obtained in an heterogeneous situation.

3. Interference between quasi-antipodal space stations with reverse frequency assignments

Space stations which use narrow-beam antennas and high values of e.i.r.p. may cause interference into each other when they are at nearly antipodal locations (Fig. 2).

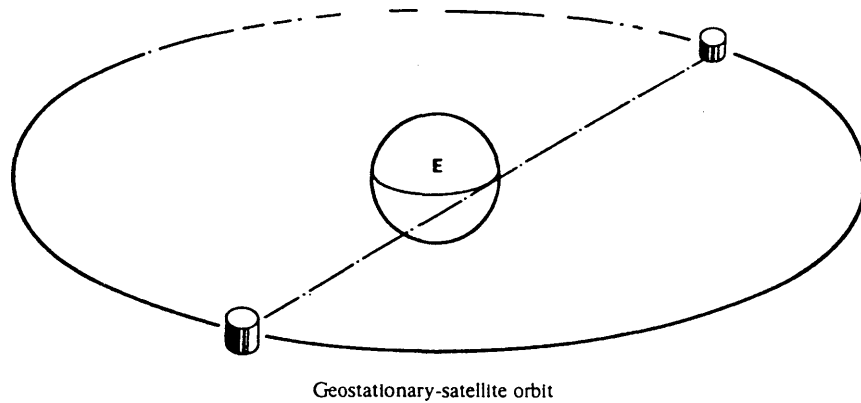

FIGURE 2 — Geometry of near antipodal satellites

E: Earth

To avoid such interference, appropriate sharing criteria must be adopted.

The level of near-antipodal interference power may be assessed as follows:

Let the receiving antenna gain at a space station in the direction of the equatorial limb (i.e., toward a near antipodal space station) be designated by g_a and let the near antipodal space station radiate an e.i.r.p. designated by e'_s in the direction of its earth limb (i.e., toward the first space station), then the received interference power is given by:

$$i = \frac{e'_s g_a}{l_a} \quad (6)$$

where l_a is the antipodal free-space attenuation between the two space stations:

$$l_a \approx 1.27 f^2 \times 10^{19} \quad (7)$$

with f = frequency in GHz.

When considering the thermal noise power at the receiver input, given by $n = kT_R B$ where T_R is the receiving system noise temperature and B is the effective receiver bandwidth, one may assume that the receiving system noise temperature is frequency-dependent. Stipulating a receiving system noise temperature at a spacecraft of 1500 K at 6 GHz, it is suggested that for other frequencies the noise temperature be considered to follow a half-power law:

$$T_R(f) = 1500 (f/6)^{0.5} = 612 f^{0.5} \quad \text{K} \quad (8)$$

Furthermore, signal characteristics in the fixed-satellite service indicate that a reference bandwidth of 1 MHz might be appropriate for interference assessments. Hence, it is suggested that e'_s in equation (6) be the (interfering) equivalent isotropic radiated power in a 1 MHz bandwidth, and that the thermal noise power also be normalized to 1 MHz.

Then, the interference-to-thermal noise ratio in a 1 MHz bandwidth may be expressed by:

$$I/N = \frac{e'_s g_a}{l_a k T_R B} = \frac{e'_s g_a}{1.07 f^{2.5} \times 10^5} \quad (9)$$

Assuming further that the up-link thermal noise in a space communications system accounts for no more than 1/3 of the total intra-system noise, and that the interference be allowed to be about 1/20 of the intra-system noise, the ratio I/N should not exceed a value of 3/20. Hence, equation (9) may be reformulated to establish a relationship between the permissible e.i.r.p., e'_s , in a 1 MHz bandwidth, from the interfering space station and the antenna gain in the interfered-with space station, both in the direction of the equatorial earth limb (points A or B in Fig. 3):

$$e'_s g_a < 1.6 f^{2.5} \times 10^4 \quad (10)$$

Figure 4 shows the relationship between e'_s and g_a for various frequency bands of interest.

Where these bands are used in the down link and are shared with terrestrial services, limitations on power flux-density establish maximum values for e'_s , as shown for the frequency bands 4, 6, 12 and 20 GHz. Values of g_a corresponding to values of e'_s greater than the limits shown can safely be used.

Where the bands are used in the up link and are shared with terrestrial services, permissible values for e'_s need not be less than those from terrestrial transmitting stations; these are shown for the frequency bands 6, 12, 20 and 30 GHz. Values of g_a corresponding to values of e'_s greater than those indicated for terrestrial emissions can safely be used.

In exclusive bands, restrictions on both e'_s and g_a may have to be adopted in order to avoid interference between near antipodal space stations.

It must be emphasized that these restrictions apply only in the directions towards the equatorial earth limit; i.e. towards points A and B of Fig. 3.

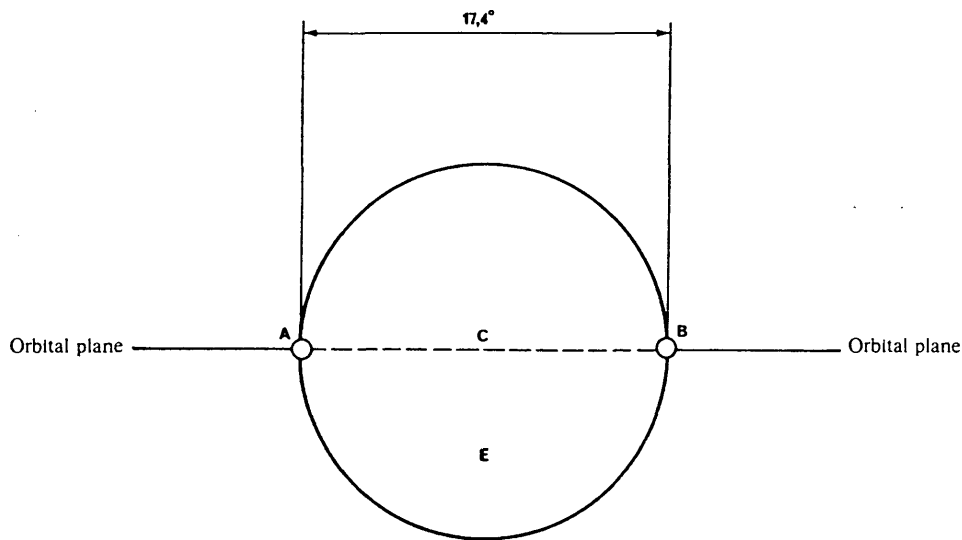

FIGURE 3 — The Earth and the geostationary-satellite orbit as seen from a geostationary-satellite

C: Equator
E: Earth

Report 1005 discusses the particular case of constrained reverse band working (RBW) using spot beams directed away from the rim of the Earth to high elevation angle earth stations. Such an approach would offer protection for quasi-antipodal space stations.

4. The effect of the bidirectional use of frequency bands on other techniques for improving orbit utilization efficiency

Polarization discrimination or spot-beam satellite antennas could be used to provide isolation between communication satellites which are closely spaced in orbit using the same frequency band assignments. The minimum spacing between satellites could be halved if polarization discrimination were used, and reduced to one-third or even less, if satellite spot-beam antennas, or a combination of both techniques, were used. However, frequency re-use techniques such as polarization discrimination introduce inhomogeneity into the satellite system which might reduce or even eliminate the further improvement in orbit capacity which reversed frequency band operation could otherwise provide. This tendency for one orbital economy technique to exclude the advantage of another would not arise if polarization discrimination on spot-beam antennas were employed for frequency reuse within a single satellite.

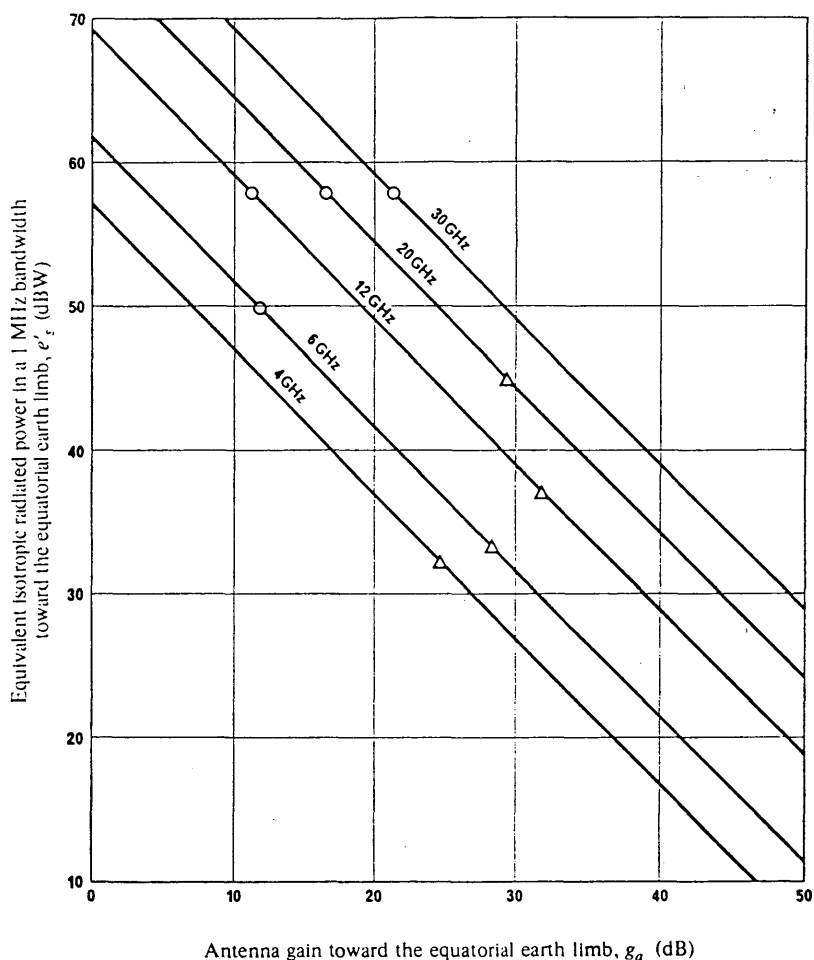

FIGURE 4 — Relationship between the maximum permissible values of e'_s towards the equatorial earth limb

- Terrestrial station emissions
- △ Power flux-density limits

5. Interference between earth stations with reversed frequency band assignments

The physical spacing which is necessary to limit interference between earth stations using reversed frequency bands is one of the major earth segment problems. When there is no site shielding, it is estimated that a separation of between about 100 km and 140 km would be needed between earth stations using the same bands in the opposite sense in a temperate climate if interference noise per telephone channel from this source is to be limited for most of the time to 1000 pW. The separation should perhaps be less where the earth stations operate at high angles of elevation or have good site shielding. Care should be taken to avoid coupling between earth stations via common volumes in the main beams in the troposphere.

If reversed frequency band assignment is to be taken into use, it will be desirable for administrations to determine a preferred direction of transmission (i.e., space-to-Earth or Earth-to-space) for each frequency band used in this way. It will then be particularly desirable for earth stations which have been assigned frequency bands in the mode which is not preferred to be located where site shielding is good, in order to minimize interference to and from earth stations which have been assigned frequency bands in the preferred mode.

6. Bidirectional use of frequency bands shared with terrestrial services

Reverse band working (RBW) of space services in bands shared with terrestrial services would lead to a number of serious consequences which require consideration. It is the purpose of this section to expose some of the new problems which will arise where the satellite systems employ global beams or spot beams directed near to the rim of the Earth. Report 1005 suggests that the difficulties may be somewhat alleviated where satellite systems operating as part of a domestic or sub-regional network serving high elevation angle earth stations employ spot beams directed away from the rim of the Earth.

6.1 *New problems for terrestrial services*

In shared frequency bands, space-station transmitters interfere with terrestrial service receivers over wide areas in the down-link bands. In particular this places constraints upon terrestrial systems which would desirably be oriented towards the azimuth at which the geostationary-satellite orbit intersects the horizon. Also, in up-link bands the Radio Regulations place limits on terrestrial power and e.i.r.p. If reversed frequency band operation were used in the space service, both of these disadvantages would be suffered by terrestrial services in all shared bands, although the effect would be reduced if additional discrimination were to be available from the satellite antenna.

Interference is also suffered in up-link bands by terrestrial receivers in the vicinity of earth stations. To limit such interference, the operation of both services is coordinated, and terrestrial services are constrained in the vicinity of earth stations. This constraint will often be minimized in geographical extent by concentrating several earth stations in one locality. If reversed frequency bands were used in the space service, it would be necessary to site the earth terminals in well-separated locations to limit interference between earth terminals. This would usually extend the area within which terrestrial services are constrained. Furthermore, within these areas the feasibility of expanding existing terrestrial systems, say by taking into use additional frequency bands not used by the space service for up link, may be severely curtailed.

Finally, it would appear that the terrestrial system noise allocation for interference from space services would have to be divided between interference received from satellite and earth-station transmitters both in terms of interference levels and the proportion of time during which these levels may be tolerated. This could lead either to greater limitation of terrestrial services in the vicinity of earth stations or to more restrictive sharing criteria. However, Report 1005 discusses this aspect further.

6.2 *New problems for space services*

The problem of interference between earth stations using frequency bands in opposite modes is referred to in § 5. In shared bands, this problem would make more difficult the problem of finding suitable sites for earth stations where interference from existing terrestrial services combined with entries from earth-station and space-station transmitters, referred to in § 6.1, would probably require a reduction in the maximum permissible power flux-density from space stations. This could have an economic impact on future systems. However, Report 1005 offers offsetting factors which may somewhat alleviate these difficulties for domestic and sub-regional satellite systems using spot beams directed some distance away from the rim of the Earth and so serving high elevation angle earth stations.

6.3 *Total impact on spectrum utilization*

It is possible that the improvement in spectrum utilization foreseen by this technique for the space service would be negated by a reduction in the value of the spectrum for the terrestrial service. This point should be studied carefully.

7. Conclusions

Bidirectional use of up- and down-link frequencies in the fixed-satellite service may lead to an enhancement of the utilization of the geostationary-satellite orbit and the radio-frequency spectrum. However, in order to keep interference from near antipodal space stations within tolerable bounds, restrictions may have to be placed on the equivalent isotropic radiated power densities or on the antenna gains, or on both, in directions toward the geostationary-satellite orbit which are not shielded by the Earth.

In frequency bands in which power flux-density limits have been imposed upon space station emissions, reverse-frequency space stations may use substantial receive antenna gains in the antipodal directions without experiencing unacceptable interference. In frequency bands where space station receivers are exposed to interference from sharing terrestrial station emissions, they cannot realize high receive antenna gains in the antipodal directions, but reverse-frequency space station emissions in the antipodal directions may assume substantial values of e.i.r.p.

However, there are other valuable techniques of spectrum and orbit economy, such as the reduction of earth-station antenna side-lobe response, polarization discrimination and the use of satellite antenna directional discrimination. The application of these techniques may diminish the additional advantage to be obtained from using frequency bands in both up- and down-link directions.

Furthermore, in frequency bands shared with terrestrial services, the use of frequency bands in both up- and down-link directions would have disadvantages for both services; in particular:

- terrestrial services would have their e.i.r.p. and transmitter power limited in bands which would not otherwise be used for communication satellite up links;
- terrestrial services might suffer interference from satellite emissions in bands which would not otherwise be used for communication satellite down links;
- the development and growth of terrestrial services in the vicinity of earth stations is likely to be more severely restricted;
- it might be necessary to make the sharing criteria more restrictive, in view of the additional interference modes, unless account can be taken of the different time percentage performance and availability criteria and the effects of propagation that apply for those time percentages.

However, Report 1005 suggests that all of these difficulties could, in certain circumstances, be ameliorated if reverse band working (RBW) were to be introduced primarily with satellite systems operating as part of domestic or sub-regional networks serving high elevation angle earth stations and so able to employ spot beams directed some distance, a beamwidth or so, away from the rim of the Earth.

It might also be necessary to modify the existing interference allowances between networks of the FSS to take into account the new sources of interference from the reverse band operation arising from: interference between satellites at nearby orbital locations; interference between nearby earth stations and interference between antipodal satellites.

It is concluded that the use of frequency bands in both up- and down-link directions may lead to improved efficiency of orbit utilization and that it might be of particular value in bands which are allocated exclusively for space radiocommunications services. However, further study of the problems involved is necessary.

REPORT 999*

DETERMINATION OF THE BIDIRECTIONAL COORDINATION AREA

(Study Programme 28B/4)

(1986)

1. Introduction

In frequency bands allocated to the fixed-satellite service in the Earth-to-space and also the space-to-Earth direction, emissions from transmitting earth stations may cause interference in receiving earth stations operating on the same frequencies. It is therefore necessary to coordinate transmitting and receiving earth stations with each other in the same way as coordination is accomplished between earth and terrestrial stations in frequency bands shared between the fixed and the fixed-satellite services.

To minimize the administrative effort required in coordinating earth stations, it may be desirable to provide a simple method by which it can be established whether or not, in a given case, the probability of potential interference is low enough to make more detailed and burdensome consultation between administrations unnecessary.

* This Report should be brought to the attention of Study Groups 2, 5, 8, 9, 10 and 11.

The level of interference in a receiving earth station due to emissions from a transmitting earth station is dependent on, *inter alia*, the physical distance between the two stations; decreasing with increasing distance. This suggests that the concept of the coordination area as set forth in Report 382 may be suitable as a means to establish for one type of earth station, a geographical area such that an earth station of another type located, or to be located, outside that area would not be expected to result in the occurrence of unacceptable interference at the receiving earth station.

The following describes a method for the determination of the coordination area for a transmitting earth station in the fixed-satellite service, to be used in coordinating with receiving earth stations of the same service, in bidirectionally allocated frequency bands. This coordination area is referred to as the "bidirectional coordination area" to distinguish it from the coordination area relative to terrestrial services which is the current subject of Report 382. Since much of the material contained in Report 382 will also be valid for the determination of the bidirectional coordination area, the method described here only contains those elements in which it differs from Report 382.

2. General

The following sections describe a procedure for the determination of the bidirectional coordination area for an earth station transmitting in a frequency band allocated in both the Earth-to-space and the space-to-Earth direction, to be used for the purpose of establishing whether or not coordination with a receiving earth station is required.

The procedure applies to earth stations operating with geostationary satellites, in the fixed-satellite service, and uses the same basic concepts for determining the coordination area as that of Report 382. However, the method is different in a number of respects, and these differences are discussed in the following sections.

This Report should be used in connection with Report 382 which it modifies in certain areas.

Specifically, when determining the bidirectional coordination area, Report 382 is the basic text to be used, but the following sections of this Report should be substituted for the elements of Report 382 indicated below:

Section of Report 999	replaces	Element of Report 382
§ 3		§ 2.3
§ 4		Definition of G_r in § 2.2
§ 5		§ 4.2.4

3. Determination of the maximum permissible interfering power $P_r(p)$

It is the objective of the coordination area to identify conditions under which unacceptable interference may occur in a receiving earth station. A probability for unacceptable interference prevails when the noise temperature increase ΔT at a receiving earth station, due to emissions from a transmitting earth station, exceeds the values of:

$$\Delta T_1 = 0.05 T_e \text{ (or } 0.02 T_e \text{)*} \quad \text{K} \quad \text{for more than } p = 20\% \text{ of the time;} \quad (1a)$$

$$\Delta T_2 = T_e (10^{M/10} - 1) \quad \text{K} \quad \text{for more than } p = 0.005\% \text{ of the time;} \quad (1b)$$

in the reference bandwidth B ,

where:

T_e : earth-station noise temperature (clear sky) in K;

M : down-link margin (dB).

Table I shows appropriate values for T_e , M and B for various frequency ranges, as well as the resulting values for ΔT_1 and ΔT_2 .

* The term in parentheses refers to SCPC transmissions.

TABLE I – Receiving system characteristics *

	Frequency range (GHz)		
	0.6-7.25	7.25-14.8	14.8-40.0
T_e (K)	100 (150)	130 (185)	160 (240)
M (dB)	2.0	5.0	10.0
B (MHz)	1.0 (0.04)	1.0 (0.04)	1.0 (0.04)
ΔT_1 (K)	5.0 (3.0)	6.5 (3.7)	8 (4.8)
ΔT_2 (K)	58 (87)	280 (420)	1400 (2100)

* Values in parentheses are representative of SCPC transmissions. It would normally be appropriate to use the unbracketed values to determine the coordination area. A separate coordination area can, however, be produced for narrow-band (SCPC) transmissions using the values in parentheses. A receiving earth station situated inside the SCPC area but outside the (smaller) normal area would require coordination only if it were to receive SCPC transmissions, and then only for the frequencies affected.

The fairly high values for ΔT_2 , shown for the higher frequencies in Table I, are considered reasonable under the stipulation that, where receiving earth stations do not provide at least these down-link margins, they would have to use diversity reception which combats interference in the same way as it does atmospheric attenuation.

Therefore, the values of maximum permissible interference are calculated from the values in Table I by:

$$P_r(p) = 10 \log [k\Delta T(p)B] \quad \text{dB (W/MHz)} \quad (2)$$

which produces the single entry values shown in Table II.

TABLE II – Maximum permissible values of $P_r(p)$ *

	Frequency range (GHz)		
	0.6-7.25	7.25-14.8	14.8-40.0
$p = 20\%$	-161.6 (-177.8)	-160.5 (-176.9)	-159.6 (-175.8)
$p = 0.005\%$	-151.0 (-163.2)	-144.1 (-156.3)	-137.1 (-149.3)
B (MHz)	1.0 (0.04)	1.0 (0.04)	1.0 (0.04)

* Values in parentheses are representative of SCPC transmissions.

It should be noted that if these values are used in connection with equations (1), (2), (11) and (18) of Report 382, the values used for P_r must be those for the same reference bandwidth B .

The term $M(p)$ is obtained with the values for $P_r(p)$ from Table II as:

$$M(p) = P_r(0.005\%) - P_r(20\%) \quad \text{dB} \quad (3)$$

4. Determination of G_r for propagation mode (1)

The determination of the antenna gain G_r of the receiving earth station which in this Report takes the place of the receiving terrestrial station of Report 382* gives recognition to the two facts that:

- a) the main beam is not directed towards the physical horizon but towards a satellite at some, perhaps a large elevation angle,
- b) its direction is constrained by the possible locations of the geostationary satellites.

For example, in view of b) above, the horizon antenna gains of a transmitting and a receiving earth station will not generally assume their maximum values towards each other on a great-circle path. In fact, on an azimuth on which one antenna has its maximum horizon gain, the other will generally "look back" at it through its far side lobes (-10 dB). An exception may be earth stations located near the equator.

This general non-simultaneity of the occurrence of maximum horizon antenna gains of two earth stations towards each other allows coordination contours to be much smaller than with the assumption of maximum horizon gain in all directions for a receiving earth-station antenna.

To determine G_r , therefore, in the absence of any knowledge regarding the location of a receiving earth station, one uses the procedure described in Annex I to Report 382 which, in any case, is also used for the determination of G_t , the horizon antenna gain of the transmitting earth station, for which the bidirectional coordination area is being determined. Note that the relevant adopted earth-station antenna reference diagrams should be used.

Since it is not known beforehand towards which orbit location a receiving earth-station antenna beam is directed, the horizon antenna gain must be determined for the entire geostationary arc. To that end the procedure of Annex I to Report 382 is performed:

- for an orbital arc which reflects the latitude of the transmitting earth station,
- for a 0° site horizon elevation angle, and
- from minimum elevation to minimum elevation; this being reasonably:

$$\begin{aligned} \varepsilon_{min} &= 3^\circ \text{ for } 0.6 \leq f < 7.25 \text{ GHz} \\ &= 5^\circ \text{ for } 7.25 \leq f < 14.8 \text{ GHz} \\ &= 10^\circ \text{ for } 14.8 \leq f \leq 40.0 \text{ GHz} \end{aligned}$$

This yields the horizon antenna gain profile for a zero degree horizon, for all azimuths and for a site location assumed to have the same latitude as the transmitting earth station. The procedure involves the intermediate step of determining the minimum angular separation between all directions to the visible geostationary-satellite orbit and the horizon at 0° elevation. Figures 1, 2 and 3 show the resulting curves of horizon discrimination angle θ as functions of azimuth α and counter-azimuth α' , with the station latitude λ as a parameter. Using the current earth-station antenna reference diagram**, a curve of horizon antenna gain as a function of α and α' can then be constructed. Figure 4 gives an example of the horizon antenna gain G_r as a function of α and α' for $\lambda = 40^\circ$ and an earth-station antenna reference diagram conforming to $G(\theta) = 32 - 25 \log \theta$ dB.

The assumption of a 0° horizon elevation angle is conservative since the increase in antenna gain due to a raised horizon would, in practice, be more than offset by any real site shielding which, for the receiving antenna site, must be assumed to be zero. The use of the transmitting antenna site latitude for the determination of the receiving antenna horizon profile produces a small azimuthal error which is largest at the higher latitudes and on (long) over-water interference paths; for practical purposes this error will never exceed about 2 dB in transmission loss and can be ignored.

* As G_r in equation (2) and as the sum of $42 + \Delta G$ (dB) in equation (11) of Report 382.

** For earth-station antenna reference diagrams which are functions of the ratio of diameter to wavelength, it may be necessary to select a value of this ratio which is sufficiently protective of earth stations which are likely to be implemented.

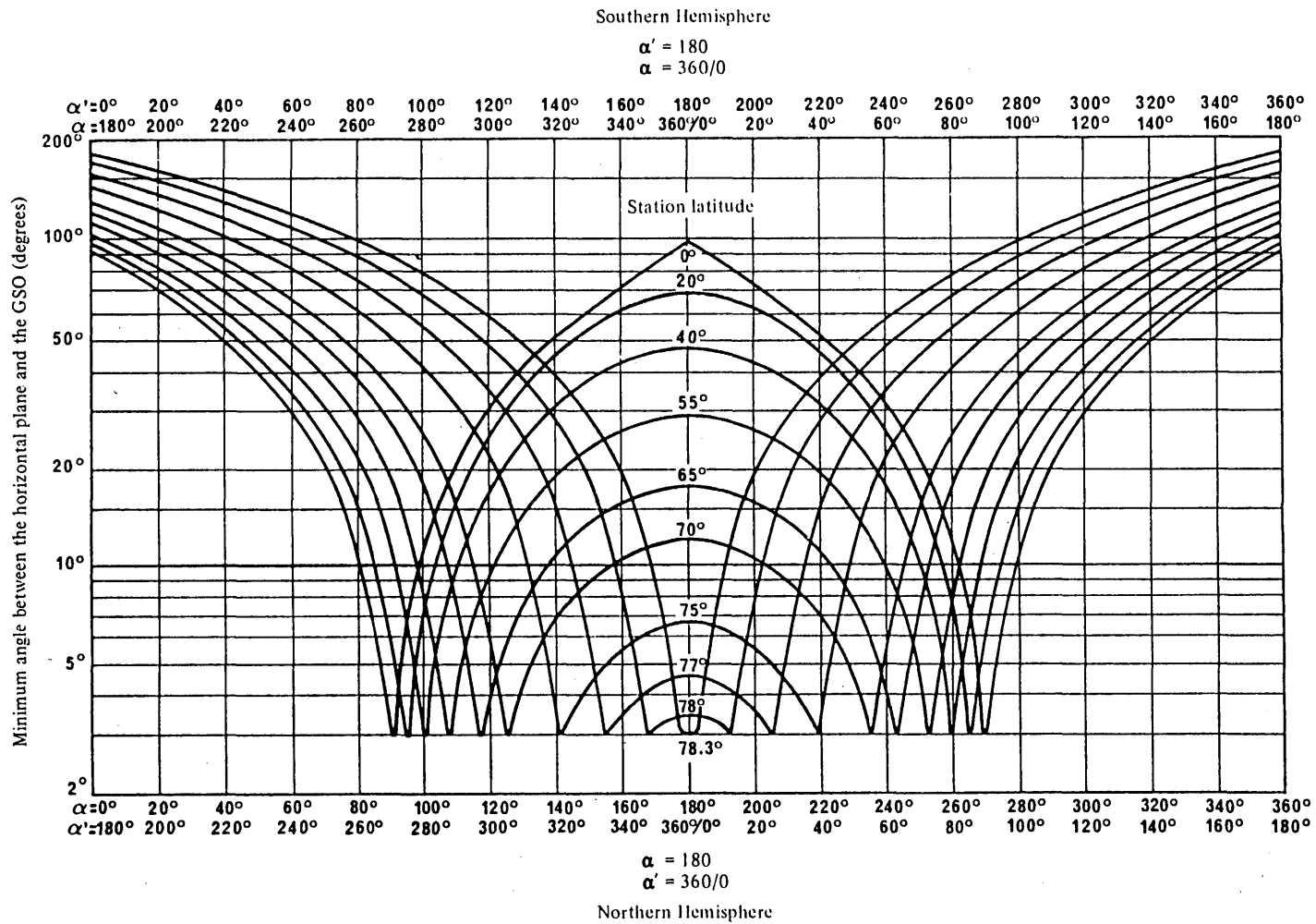

FIGURE 1 - Minimum angular distance between points on the geostationary-satellite orbit (GSO) and the horizontal plane
(Minimum elevation angle, $\epsilon_{min} = 3^\circ$)

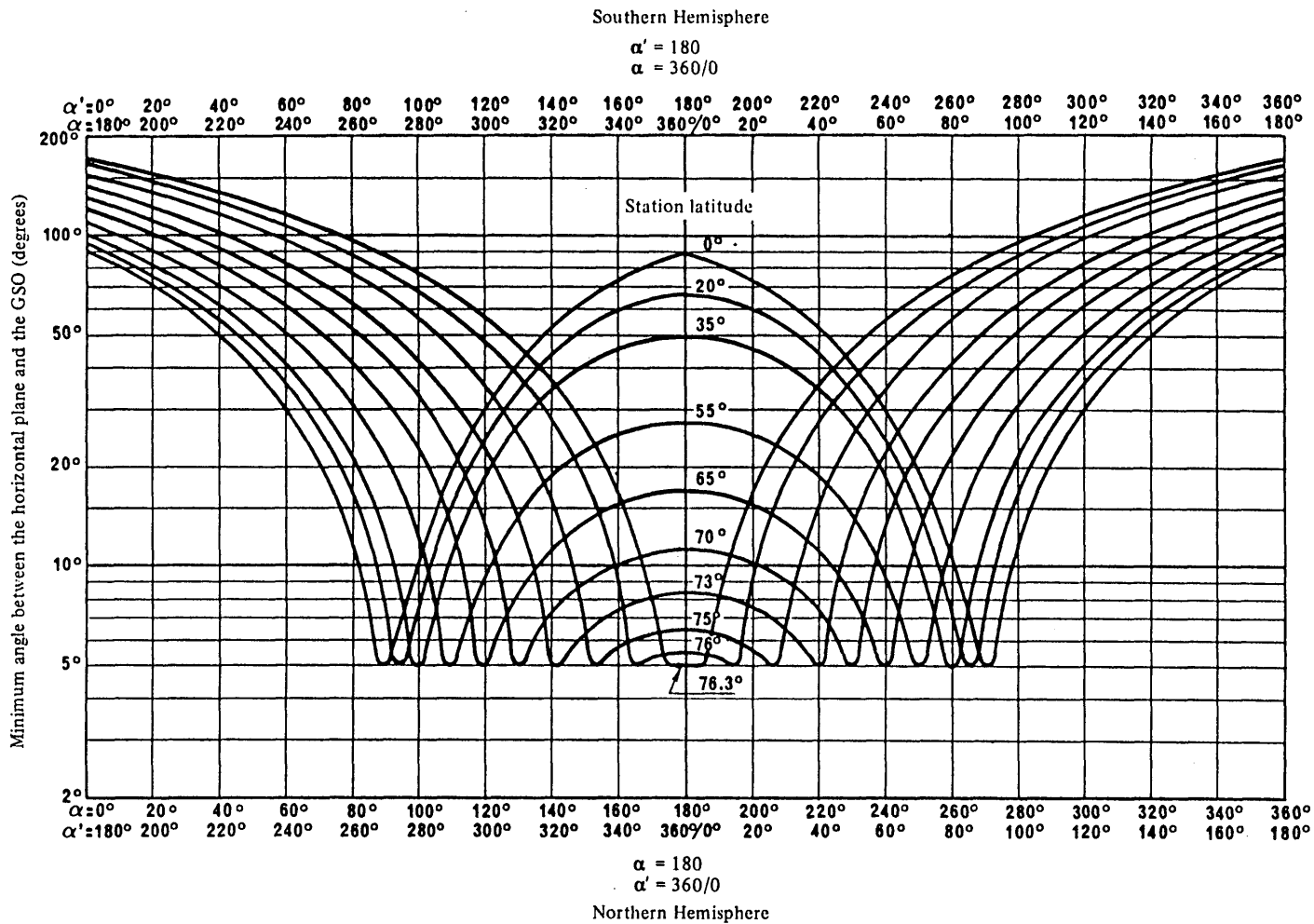

FIGURE 2 - Minimum angular distance between points on the geostationary-satellite orbit (GSO) and the horizontal plane
 (Minimum elevation angle, $\epsilon_{min} = 5^\circ$)

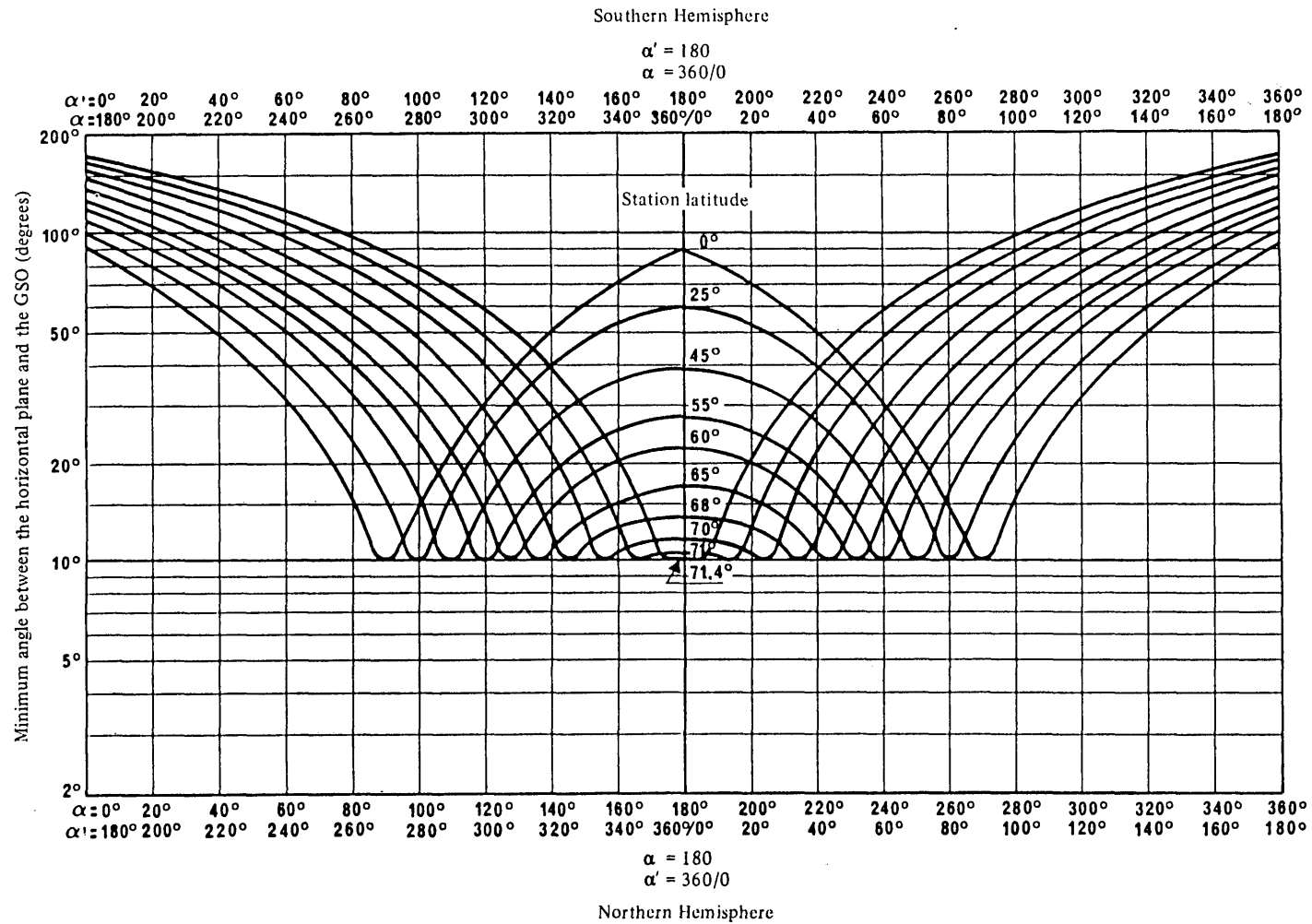

FIGURE 3 – Minimum angular distance between points on the geostationary-satellite orbit (GSO) and the horizontal plane
(Minimum elevation angle, $\epsilon_{min} = 10^\circ$)

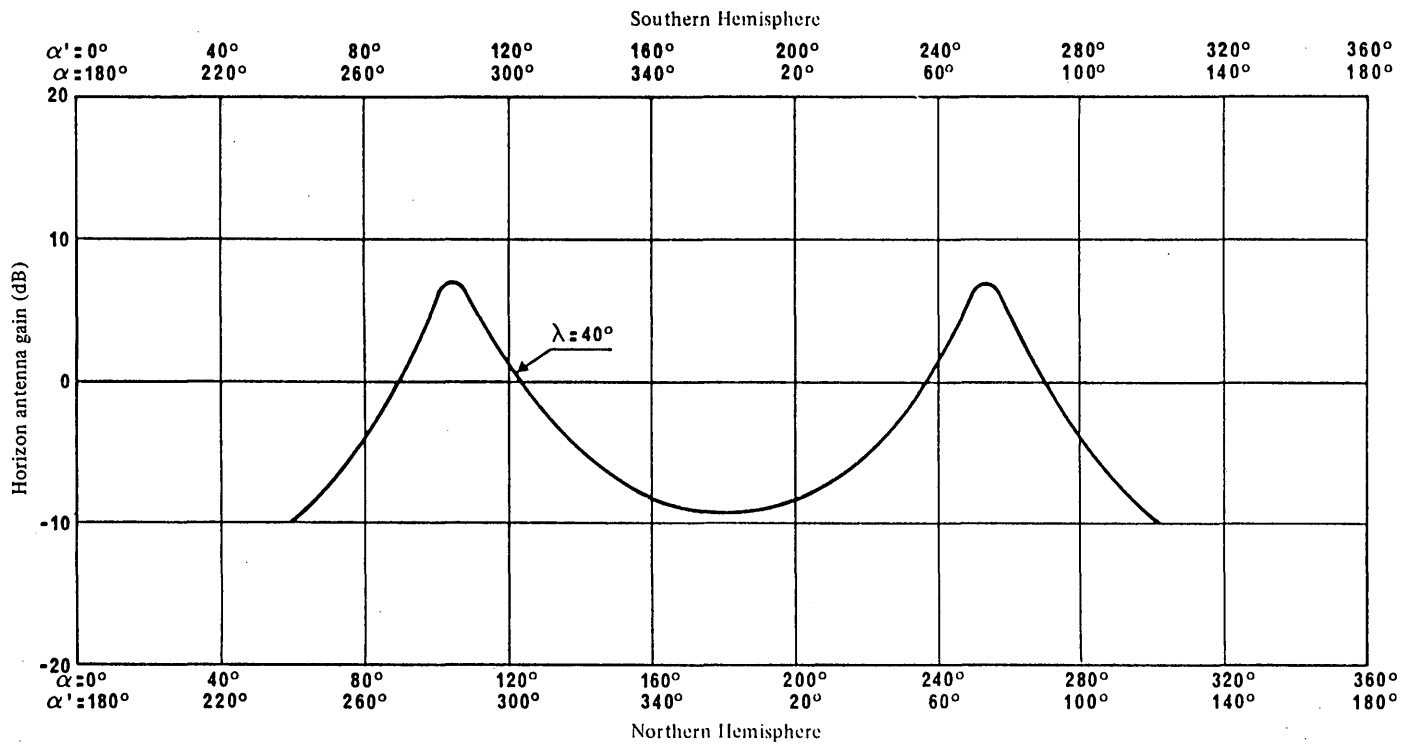

FIGURE 4 – Full arc horizon antenna gain for 0° horizon elevation angle
 (Minimum main beam elevation angle: 10°)
 Assumed earth-station antenna reference diagrams $G(\theta) = 32 - 25 \log \theta$ (dB)
 $\alpha' = (\alpha + 180^\circ) \text{ modulo } (360^\circ)$

When horizon antenna gain profiles have been determined for the transmitting and the receiving antenna as described above, they have to be added as prescribed by equations (2) and (11) of Report 382 for every azimuth at the transmitting earth station. However, a given azimuth at a transmitting earth station is the "back" or opposing azimuth at a receiving earth station. Therefore, a value of G_r , determined for the azimuth α at the transmitting earth station, must be added to that value G_r which is found for the azimuth $\alpha' = (\alpha + 180^\circ)$ modulo 360° on the receiving earth-station horizon antenna gain profile. The function A modulo B is defined as:

$$A \text{ modulo } B = A - B \cdot (\text{integer of } A/B) \quad (4)$$

For example:

$$\begin{aligned} \alpha &= 192^\circ \\ A &= \alpha + 180^\circ = 372^\circ \\ B &= 360^\circ \\ \text{Integer of } A/B &= 1.0 \\ A \text{ modulo } B &= 12^\circ = \alpha' \end{aligned}$$

Thus, the sum of $G_r + G_r$ required to calculate $L_b(p)$ of equations (2) and (11) of Report 382 for all azimuths around a transmitting earth station is, in this application, given by:

$$G_r + G_r = G_r(\alpha) + G_r(\alpha') \quad \text{dB} \quad (5)$$

for each azimuth α at a transmitting earth station.

It should be noted that, while no site shielding can be assumed for the receiving earth station, any site shielding that may exist at the transmitting earth station is considered in the normal fashion, as discussed in § 3.2 of Report 382, using the horizon elevation angle θ .

Finally, for the determination of the coordination area for propagation mode (1) the values of $P_r(p)$ for 0.005% of the time from Table II of this Report should be used.

Figure 5 gives an example of a coordination area determined by this method. Figure 6 shows the sum of the antenna gains $G_r + G_r$ for this example; both involved antennas having the reference diagram $32 - 25 \log^2 \theta$ (dB).

5. Determination of the bidirectional rain scatter area

For the determination of the bidirectional rain scatter area for a transmitting earth station proceed as follows:

- Step 1:* Determine, from Fig. 24 of Report 382 and for the latitude λ of the earth station, the elevation angle ϵ_s and the azimuth α_s to the satellite with which the earth station is to operate.
- Step 2:* Determine the "beam intersection distance" d_s from the earth station to the point at which the beam axis attains the maximum rain bearing altitude h_R from:

$$d_s = \frac{2h_R}{\sqrt{\tan^2 \epsilon_s + h_R/4250} + \tan \epsilon_s} \quad \text{km} \quad (6)$$

where:

$$h_R = 5.1 \cos(1.06 \lambda) \quad \text{km} \quad (7)$$

- Step 3:* Mark the distance d_s on the azimuth α_s from the earth-station location on a map of a scale of the order of 1:3 000 000. This point is the geographical location of the beam intersection point and is the reference point around which the bidirectional rain scatter contour is to be constructed.

- Step 4:* Determine the maximum visibility distance d_{max} for the beam intersection point from:

$$d_{max} = 130.4 \sqrt{h_R} \quad \text{km} \quad (8)$$

and the reference azimuth α_r from:

$$\alpha_r = \cos^{-1}(0.153031 \tan \lambda) \quad (9)$$

where λ is the latitude of the beam intersection point (approximately equal to that of the earth station).

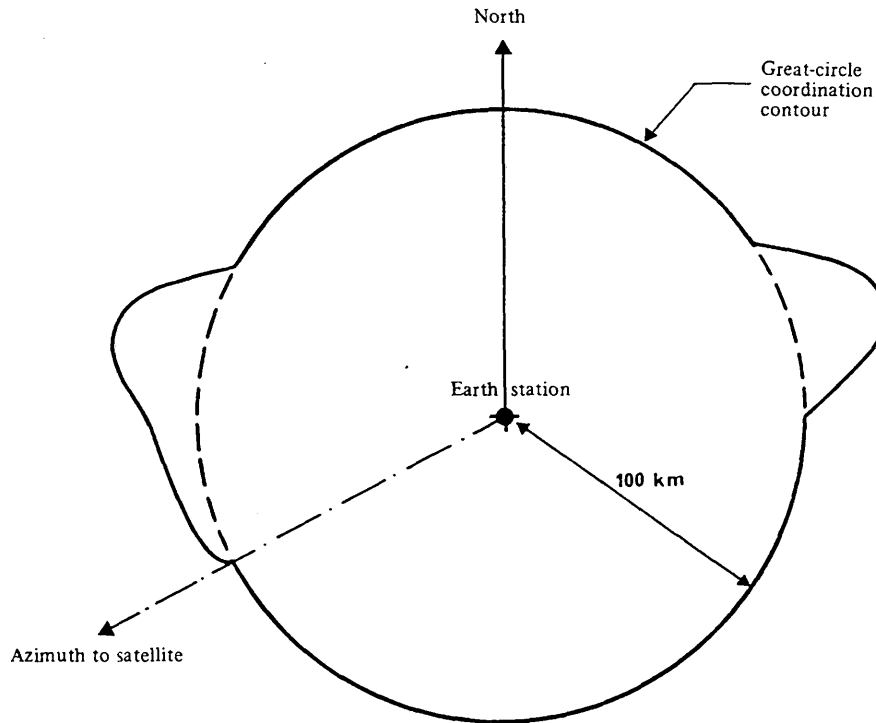

FIGURE 5 – Example of bidirectional great-circle coordination area

Assumptions:

$$f = 18 \text{ GHz}$$

$$P_{t'} = 40 \text{ dB(W/MHz)}$$

$$\lambda = 40^\circ \text{ N}$$

Elevation angle to satellite: 20°

Azimuth to satellite: 243.3°

Radio climatic zone: A_2 (Report 382)

Horizon elevation angle: $\theta = 0^\circ$

Results:

$$L_b(p) = 177.1 + G_{t'} + G_r \text{ dB (Table II of this Report and equation (2) of Report 382)}$$

G_r (in lieu of: $42 + \Delta G$ dB) (Fig. 4 of this Report and equations (2) and (11) of Report 382)

$G_{t'} + G_r$ (in lieu of: $(G_{t'} + 42 + \Delta G)$ dB) (Fig. 6 of this Report and equations (2) and (11) of Report 382)

$$\beta_z = 0.1754 \text{ dB/km (equation (7b) of Report 382)}$$

$$\beta_a = 0.0081 \text{ dB/km (equation (8) of Report 382)}$$

$$\beta_v = 0.0298 \text{ (equation (9) of Report 382)}$$

$$A_h = 0 \text{ dB } (\theta = 0^\circ) \text{ (equation (10) of Report 382)}$$

$$M(p) = 22.5 \text{ dB (equation (3) of this Report)}$$

$p_x = p = 0.005\%$ (by test *) (Table II of this Report and equations (6) and (11) of Report 382)

$$L_i(p_x) = L_m(p_x) = L_b(p) \text{ (equations (12) and (13) of Report 382)}$$

$$d_i = (G_{t'} + G_r + 32)/0.223 \text{ km (equations (6) and (11) of Report 382)}$$

* Applying the procedure discussed in the Note at the end of § 3.2.2 of Report 382.

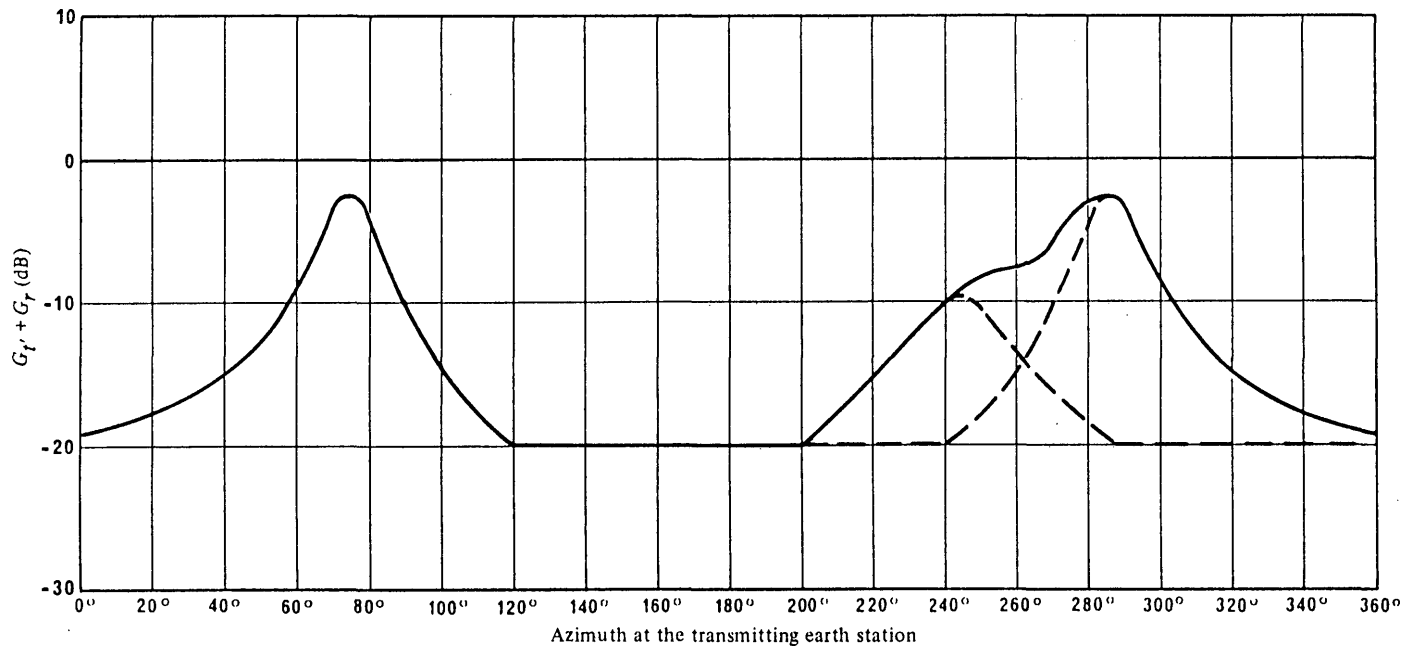

FIGURE 6 – Composite horizon antenna gain $G_T + G_r$ for the example of Fig. 5

Step 5: From the beam intersection point, mark on the map the distance d_{max} in the:

- Northern Hemisphere, on the two azimuths α_r and $360^\circ - \alpha_r$;
- Southern Hemisphere, on the two azimuths $180^\circ - \alpha_r$ and $180^\circ + \alpha_r$.

To determine the required receiving earth station antenna beam discrimination angle δ proceed as follows:

Step 6: Plot, if necessary by linear interpolation, on the appropriate figure among Figs. 12-21 of Report 382, a loss distribution curve which corresponds as closely as possible to the distance d_{max} ; call this curve L_d . The curve L_d need only be drawn for values of p_x greater than 0.005% on the abscissa scale for the applicable rain climate.

Determine the criteria distribution $L_2(p_x)$ as indicated in § 4.1 of Report 382, using $p = 0.005\%$, $\Delta G = -10$ dB and:

$$M(p) = M_0 = P_r(0.005\%) - P_r(20\%) \quad \text{dB} \quad (10)$$

as obtained from the appropriate values given in Table II, and plot $L_2(p_x)$ on the same graph on which L_d has been plotted, using the abscissa (p) scale for the rain climate of concern. The resulting curve for $L_2(p_x)$ extends from the right-hand edge of the graph to the left and upwards, ending at a point above $p = 0.005\%$ on the appropriate abscissa scale.

Step 7: If the $L_2(p_x)$ curve lies in its entirety above the L_d curve, the discrimination angle δ (see below) for the receiving earth-station antenna is small and can be assumed to be 1° . Go directly to Step 10; otherwise continue.

Step 8: If the $L_2(p_x)$ curve crosses, or lies entirely below, the L_d curve, determine the maximum vertical dB difference, $\text{Max}[L_2(p_x) - L_d]$, between the two curves (a positive dB value), reading off the ordinate scale. The value $\text{Max}[L_2(p_x) - L_d]$ is the dB difference between the two curves at either $p = 0.005\%$, or at that value of p_x (on the applicable abscissa scale) at which the two curves have the same slope (see example of Fig. 8).

Step 9: The value of $\text{Max}[L_2(p_x) - L_d]$ is the required isolation deficiency ΔL which needs to be made up by receiving earth-station antenna discrimination relative to the gain at 1° off the boresight:

$$\Delta L = \text{Max}[L_2(p_x) - L_d] \quad \text{dB} \quad (11)$$

When ΔL is zero or negative, the discrimination angle (see below) is 1° ; go directly to Step 10.

When ΔL is positive, calculate:

$$\delta = 10^{\Delta L/25} \quad \text{degrees} \quad (12)$$

which is the required maximum-distance discrimination angle, to be used in Step 10.

Equations (11) and (12) above are appropriate for the reference antenna pattern $G(\theta) = 32 - 25 \log \theta$ (dB) which is assumed for the receiving earth station.

Step 10: Draw on the map from both of the two maximum distance marks of Step 5 equal distance arcs of width δ clockwise and counter-clockwise as measured from the location of the beam penetration point. These two arcs, each having a total width of 2δ , are the first boundary elements of the bidirectional rain scatter area.

Step 11: Mark a circle of 100 km radius around the location of the beam penetration point, and draw straight lines from the two northern edges of the two 2δ arcs tangential to the northern rim of the 100 km radius circle,* and from the two southern edges of the two 2δ arcs tangential to the southern rim of the 100 km radius circle.

* Administrations are invited to examine whether the 100 km would in all likely practical situations constitute a sufficiently conservative assumption.

The entire area bounded by the two 2δ arcs, the four straight lines, and the 100 km radius circle sections* between the two northern and the two southern tangent points with the straight lines constitutes the bidirectional rain scatter area.

Figures 7 and 8 illustrate the construction of the bidirectional rain scatter area**.

6. Relationship with other CCIR tests

The method described in this Report complements that of Report 382 and amendments to either Report may require consequential amendments to the other. Other relevant CCIR texts are Reports 569 and 724 of Study Group 5.

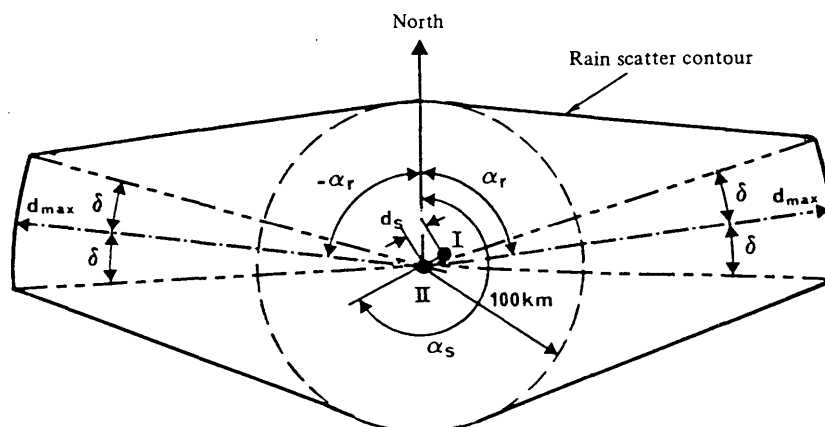

FIGURE 7 – Example of bidirectional rain scatter area

I: location of the transmitting earth station
II: location of the beam penetration point

Assumptions:

f = 11 GHz
 P_r = 30.0 dB(W/MHz)
 λ = 40° N
 ϵ_s = 20°
 α_s = 243.3°
 Rain climate: K (Report 382)

Results:

d_s = 10.2 km (equation (6))
 h_R = 3.74 km (equation (7))
 d_{max} = 252 km (equation (8) and also plotted on Fig. 8 of this Report)
 α_r = 82.6° (equation (9) of this Report)
 M_0 = $-144.1 + 160.5 = 16.4$ dB (equation (10) of this Report)
 $L_2(p_v)$ = $164.1 + 16.4 [1 - 0.339 (9 - 5 \log p_v - 1.58)]$ dB
 (equation (18) of Report 382 and also plotted on Fig. 8 of this Report)
 ΔL = 26.0 dB (obtained from Fig. 8 of this Report)
 δ = 11.0° (equation (12) of this Report)

* Of which there is always at least one.

** The resulting rain scatter area contains the loci of all receiving earth-station locations for which directions towards the geostationary-satellite orbit intersect the beam axis of the transmitting earth-station antenna. The boundaries of the area are established by consideration of antenna discrimination.

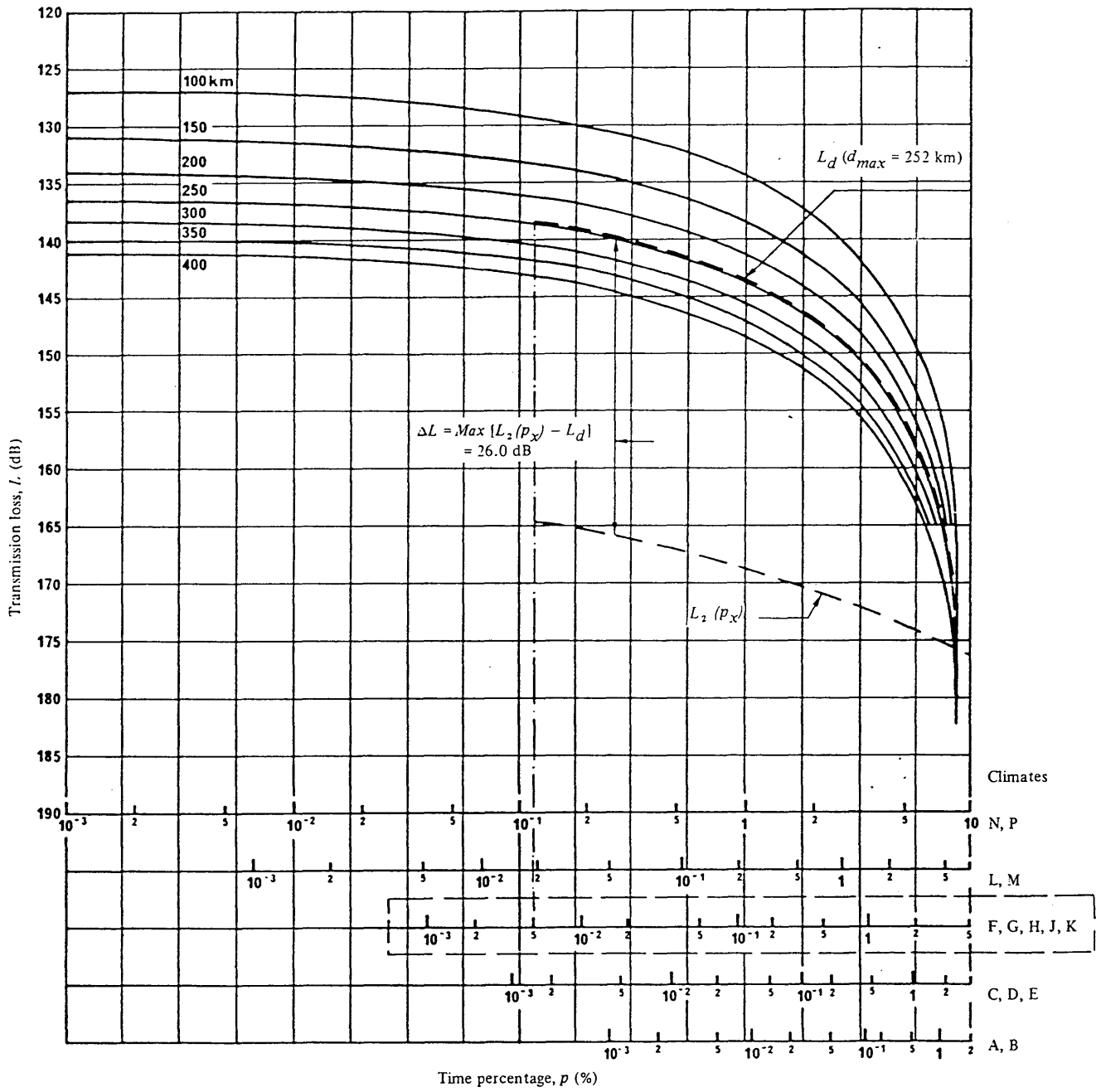

FIGURE 8 - Transmission loss versus time percentage for the different rain climates with hydrometeor scatter distance as a parameter
 $f = 12 \text{ GHz}$

This graph is, except for the added entries, identical to Fig. 16 of Report 382 and has been used to represent propagation conditions at 11 GHz in connection with the example of Fig. 7, of this Report.

REPORT 1140

SATELLITE NETWORKS FOR MORE THAN ONE SERVICE
IN ONE OR MORE FREQUENCY BANDS

(Study Programme 28A/4)

(1990)

1. Introduction

Recommendation COM 6/D of WARC ORB-88 considers that for economic and practical reasons. Administrations may find it desirable to utilize multi-band and/or multi service satellite networks using the geostationary orbit. Accordingly organizations are launching satellites which contain multiple services in one or more frequency bands. COM 6/D invites CCIR to continue its technical studies into the efficient use of the geostationary-satellite orbit as it pertains to the multiband and multiservice satellite networks.

Before continuing the invited technical studies, it is necessary to identify coordination problems of such satellites. This report is concerned with such problems. The material is contained in sections 2, 3, and 4.

Section 2 describes the coordination methods, the applicable allocations, and parts of the Radio Regulations. In addition, it describes the type of networks associated with the different methods.

Section 3 is an analysis of the potential problems which may be presented when combinations of the different networks are on the same satellite.

Section 4 derives observations based on one example of a multiple network satellite.

2. Description of the situation for networks with more than one service in one or more frequency bands

The procedural approaches for coordination and notification of frequency assignments to geostationary satellite networks are indicated in Table I along with their distinguishing characteristics.

As indicated below, there are multiple combinations of frequency bands that can be put on a single satellite platform. When this occurs, it results in the need to deal with multiple coordinations.

A single band of a satellite may also be subject to multiple coordination procedures. An example of this is the 12 GHz FSS band in which a network may be simultaneously subject to the procedures of Articles 11, 14, 15 and even Resolution 33. The coordination network possibilities are described below.

TABLE I

Method	Allocations (GHz)	Regulations
BSS Plan (Sat-77)	BSS 11.7-12.5 (Reg 1) BSS 11.7-12.2 (Reg 3) FSS 14.5-14.8 (Reg 1 & 3) FSS 17.3-18.1 (Reg 1 & 3)	Appendix 30, Art 15 Appendix 30, Art 15 Appendix 30A, Art 15A Appendix 30A, Art 15A
BSS Plan (Sat-83)	BSS 12.2-12.7 (Reg 2) FSS 17.3-17.8 (Reg 2)	Appendix 30, Art 15 Appendix 30A, Art 15A
FSS Plan	FSS 4.5-4.8/6.725-7.025 } FSS 10.7-10.95 } FSS 11.2-11.45 } FSS 12.75-13.25 }	Appendix 30 B (WARC ORB-88) Resolution COM 4/2 Resolution COM 4/1
Improved procedures (MPM)	Certain FSS bands	Resolution COM 6/3 (WARC ORB-88)
Simplified procedures (unplanned bands and services)	Remaining FSS bands and all other space services allocations	Existing Art 11/13 + modifications from WARC ORB-88
Unplanned BSS Article 14	Remaining BSS bands Footnote	Resolution 33 Article 14

2.1 Registered networks

These are networks that have completed coordination/registration procedures with their frequency assignments and orbit locations recorded in the IFRB Master Register. Due to already agreed coordination constraints some of these networks may have little, if any, degrees of freedom remaining to accommodate additional satellites. The flexibility available to such networks to successfully conclude subsequent coordinations will greatly depend on the level of congestion present in the orbital arc at the time coordination is undertaken.

2.2 Assignment Plans

Networks using orbit spectrum which are part of BSS assignment plans (BSS Plans: SAT-77 and SAT-83); Orbit positions and operating parameters are defined by the Plans and in practice there is little flexibility in modification of orbital position short of seeking a formal plan change; there is only limited flexibility in equipment parameters choice.

2.3 Allotment Plan Networks

Those networks use spectrum which is part of the fixed satellite allotment plan (WARC ORB-88); the degrees of freedom will be limited by regulation. There may be some orbit position flexibility possible through use of the predetermined arc (PDA) mechanism. However, this is dependent on the stage of development of the network.

2.4 Networks subject to MPM procedures

These networks are those to which a multilateral planning meeting (MPM WARC ORB-88) applies. Coordination is based on Articles 11 and 13. The MPM will probably apply to congested orbital arcs where there will be little degree of freedom.

2.5 Unplanned band networks

Those networks in unplanned bands use the procedures in Articles 11 and 13.

3. Multiple coordination pairs

Satellite networks requiring multiple coordinations, in accordance with the categories described above, can be examined by pairs. The pairs below correspond to the coordination network possibilities described in the sections above; i.e. 1 is 2.1, 2 is 2.2, 3 is 2.3, 4 is 2.4, and 5 is 2.5.

The basis for the pairing analyses below may be explained by reference to the figure below. Satellite A has



frequencies that must be coordinated in procedures 1, 2 and 5. Satellite B has frequencies in procedures 5, 3 and 4. Satellite networks in A and B must coordinate with each other because they are using the same, unplanned (5) fixed satellite spectrum. In addition, however, satellite A may also have to coordinate in procedures 1 and 2, and satellite B may also have to coordinate in procedures 3 and 4. Thus, the pairs refer to the impact on coordination when one of the pair procedures is on satellite A and one is on B.

- 1 & 5 Bilateral (or multilateral) coordination, as appropriate, will be conducted between administrations responsible for the networks under the current procedures of Articles 11 and 13.
- 5 & 2 These apply to already coordinated satellite networks which are part of multilateral planning meetings (MPM), the allotment plan or the BSS feeder link/assignment plans, and also have frequency assignments which are part of unplanned band allocations. Some of these situations may be particularly difficult, because the networks involved have fixed orbital positions.
- 5 & 3
- 5 & 4
- 4 & 3 When there is a multilateral coordination (improved procedures) involving a satellite network in the allotment plan, there may be some degree of flexibility for the network using allotment frequencies due to the flexibility built into the allotment plan with the predetermined arc concept.
- 2 & 4 A multilateral coordination can accommodate the consequential effects of fixed satellite frequencies on BSS assignment plan satellites, through multiple ways of making adjustments. In addition, the BSS could use its plan modification provisions.

- 1 & 4 There are many registered networks which are in the bands which might have multilateral coordinations. These networks were coordinated under Art. 11/13, and have status. However, administrations with registered systems may participate in a multilateral negotiation.
- 2 & 3 This coordination may need to utilize the full flexibility available in both Plans when an administration's assignment in a BSS Plan is in the orbital arc of its allotment. If it is, and the conversion of the allotment into an assignment is in conformity with the Plan, the coordination with other FSS systems has been accomplished.
- 1 & 2 The coordination problems are non-existent since they are mutually exclusive. If the system is in the Master Register, it has completed Coordination/Notification, and will have already avoided or cleared coordination with frequencies of the BSS assignment plans.
- 1 & 3 Any satellite network whose frequencies are in allotment plan bands would have to be incorporated through a relevant procedure of Ap.30B.

4. Experience with coordination of hybrid satellites

From a review of the TELE-X example, summarized in the annex, the following observations may be made:

In general it is true that in the preliminary phase of the coordination of a satellite system, any extra constraints on e.g. the orbital position, may cause an additional burden on the coordination process.

However, it must also be pointed out that after launching and as the process of coordination continues with new systems other constraints may be equally important. It is obviously a fact, that in the operational phase of any satellite an orbital relocation would be quite difficult anyway. The reason for this difficulty is that in this phase normally coordination agreements have already been reached with other existing systems, and a relocation would have an impact on those coordination agreements.

It is evident that the coordination experience of other operators of hybrid satellites would be of value in this context, and Study Group 4 is encouraged to provide information on such experience.

5. Summary

It is recognized that it is necessary to develop overall criteria for optimizing the orbital positioning of satellite networks having more than one service in one or more frequency bands. Some of the points to be taken into account include:

- when multiple coordinations occur individual methods should be applied to utilize all the flexibility available with full recognition of the rights inherent in each procedure;
- the rights and constraints of coordinated/registered networks and of those in coordination should be fully taken into account;

- administrations could in a cooperative spirit, take account of the desired orbit positions, frequency bands, and parameters at a proposed satellite network, which could assist in accommodating a new multi-band/service satellite;
- constraints imposed by the procedures can lead to difficulty in reducing interference levels for all services in a multi-service satellite. This was recognized for the fixed satellite service in draft Recommendation 670. The recommended flexibility in relocation would facilitate the resolution of interference problems if it could be applied to all procedures and services.

Additional technical information needs to be developed to illustrate the problems associated with such multiple coordination satellites particularly when one of the networks on the satellite has an orbit position fixed by a plan.

REFERENCES

CARLSSON B. [1987] Tele-X, a nordic satellite system for broadcasting and business services. New Systems and Services in telecommunications, VII. Editors: Cantraine, Destiné.

CCIR Documents

[1986-90] IWP 4/1-1515.

ANNEX

An example of a satellite network subject
to more than one coordination method1. The Tele-X experience

In [CCIR, 1986-90] different coordination procedures are described, which might be applicable for satellite systems which have allocations in different frequency bands. In the following text some information is given, which pertains to an actual case.

An example of a satellite system which has to be coordinated according to different procedures is Tele-X. Tele-X is a Swedish satellite which was successfully launched into orbit on 2 April 1989. The payload of the satellite includes DBS as well as FSS services [Carlsson, B., 1987].

The DBS service uses channels in the frequency band 11.7-12.5 GHz according to the WARC 77 Plan. The channels used are 26, 32 and 40. According to the Plan the satellite position must be 5° east.

Two transponders for business services are allocated in the FSS frequency band. The frequencies used are 12585-12750 MHz for the downlink and 14085-14250 MHz for the uplink (see Fig. 1).

2. Existing agreements

Tele-X has been coordinated with the EUTELSAT I network, as well as with Telecom 1 and INTELSAT.

3. On-going coordination

Tele-X is in the process of being coordinated with EUTELSAT II and Telecom 2.

4. Observations

Coordination appears to be more complicated in the preliminary phase of the coordination of a hybrid satellite, than for a satellite system subject only to one coordination method. However, when the satellite system has been coordinated with existing satellite systems other constraints may be equally important.

It must also be pointed out that in some cases there may be economic reasons for choosing hybrid satellites, something that also should be considered.

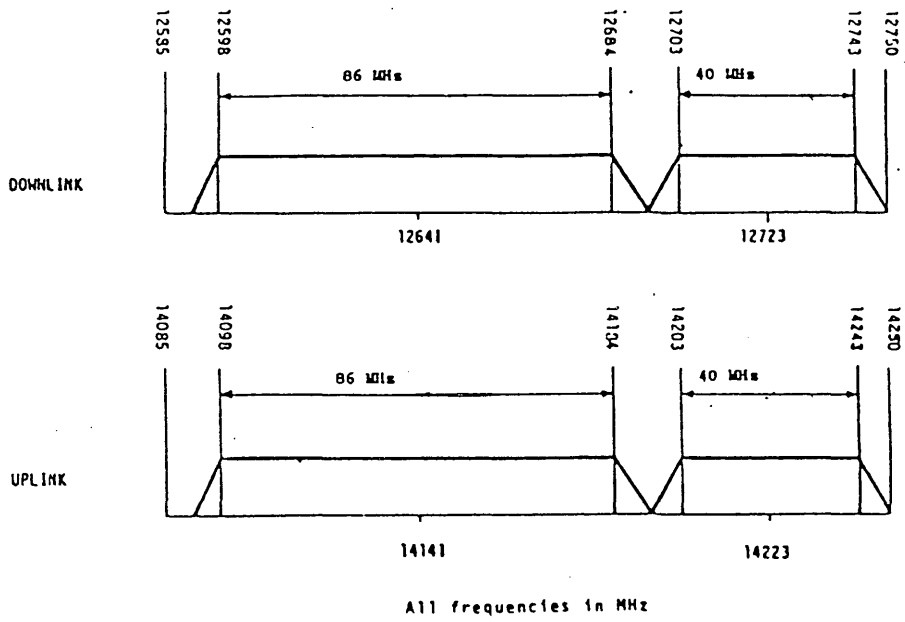

FIGURE 1 - Transponder frequency plan

REPORT 1138

INTRA-SERVICE IMPLICATIONS OF USING SLIGHTLY INCLINED GEOSTATIONARY
ORBITS FOR FIXED SATELLITE SERVICE NETWORKS

Operational, sharing and coordination considerations

(Study Programme 28D/4)

(1990)

1. Introduction

Communication satellites normally operate in a nominal geostationary satellite orbit. Forces, such as the gravitational attraction of the sun and moon, solar pressure, and irregularities in the Earth's gravitational field, will perturb a satellite's orbit from the equatorial plane. Station-keeping fuel is consumed to resist such perturbations and thus maintain the satellite within acceptable east-west and north-south limits of its nominal position. Of the two actions, the north-south station-keeping requires an order of magnitude more propellant than east-west station-keeping. Usually, the useful life of the satellite ceases shortly after all the fuel allocated for station-keeping is consumed.

When north-south station-keeping is not employed, the orbital plane's inclination relative to the Earth's equatorial plane changes continually, at a maximum of about 0.85° annual rate for small inclination angles. This change of inclination is cyclical, with a period of about 55 years and a natural maximum inclination limit of about 15° . The effect of orbit inclination on the apparent motion of the satellite, as seen from any point on the Earth within visible range of the satellite, is the characteristic "figure-of-eight" excursion in the north-south direction. The effect on the satellite antenna beam pointing is a more complex issue which depends not only on the orbit inclination, but also on the characteristics of the satellite attitude control system.

The IFRB, in its Rules of Procedure, indicated that the IFRB considered that satellites in orbits with inclinations up to 5° would be considered geostationary satellites and in Document JIWP/ORB(2)-38 requested that the CCIR study among others, the following related problems:

- the technical aspects of coordination between geostationary satellites and those in inclined geostationary orbits;
- the technical aspects of coordination between satellites in inclined geostationary orbits.

This report limits its considerations to the operational implications, and sharing and coordination impacts between networks of the FSS.

2. Strategies for extension of operational life of an in-orbit geostationary satellite by slightly inclined orbit operation

There are two strategies for extending the operational life of in-orbit geostationary satellites. These are based on the fact that the useful operational life is largely determined by the north-south station-keeping fuel, which is about ten times as much as east-west station-keeping fuel.

- (1) If a satellite has nearly exhausted its station-keeping fuel, but is otherwise operating satisfactorily, its useful in-orbit life could be extended significantly if its remaining fuel was used only for longitudinal station-keeping.
- (2) A satellite intended for a geostationary mission is inclined by a few degrees at the start of its operating life. Solar/lunar gravitation will incline the orbit to an equatorial track over a few years. The inclination will continue to increase unless fuel is spent to counteract the effect of the Sun and the Moon. This strategy permits a satellite to be maintained in a circular geostationary orbit of relatively low inclination with a smaller initial fuel load than an initial geostationary orbit would require.

However, any increase in the operational life of a satellite must be matched by lifetimes of on-board sub-systems.

3. Technical aspects of slightly inclined geostationary orbit operation

The following technical considerations are of importance for satellite systems in slightly inclined geostationary orbits.

- (1) Earth station antenna pointing error
Earth station antenna main beams must be kept pointed at the space station, within an acceptable mispointing tolerance. Automatic tracking is usually used at earth stations having relatively large antennas. For slightly inclined geostationary orbit operation, even small size earth station antenna with relatively low gain may have to track the satellite.

In addition, earth stations operating at high latitudes will experience 24-hourly periods during which their operational elevation angle may become so low as to degrade communication performance. When the space station's orbit inclination exceeds the earth station's nominal elevation angle, the earth station will experience complete outage.

Generally, earth station antenna will need automatic tracking sub-systems for inclined geostationary orbit operation. The required performance of the antenna tracking sub-systems depends on the degree of the orbital inclination, earth station antenna size and the isolation geometry, especially at high latitudes.

- (2) Space station antenna pointing error

The apparent movement of a geostationary space station in an inclined circular orbit takes the form of a narrow figure-eight. Therefore, a satellite antenna beam traces a complex path on the earth surface. Because of the resulting space station antenna pointing error, the associated

satellite antenna beam footprint will move constantly. Thus, satellite antenna beams may have to be steered to cover the service area; alternatively it might be necessary to reduce minimum beam gain so as to cover the whole service area. Otherwise, interference between satellite networks may increase and some loss of peripheral coverage for earth-coverage beams may occur.

The effect on the satellite antenna beam pointing depends not only on the orbit inclination, but also on the characteristics of the satellite attitude control system.

If the satellite attitude is constrained to have the pitch axis perpendicular to the orbit plane (as is the case when the satellite is spin stabilized or of the body-stabilized class, with a body-fixed momentum wheel), the effects of orbit inclination on antenna beam pointing are approximately proportional to the inclination and take the form illustrated in Figure 1, which shows the effects of a 9 degree inclination at three different points on the Earth's disc as seen by the satellite. In the absence of inclination, each point would be seen as a dot, while, with a non-zero inclination, the same point is seen by the satellite as a locus, over each orbit cycle. The loci represent the variations of the AZ/EL angles, in satellite axes, under which each ground point is seen from the satellite; thus, they also represent the motion of the antenna beam at each point. A fixed "overtilt" of the pitch axis with respect to the orbit plane, for a satellite of these classes, improves the situation in the regions near to the suborbital point and, to a lesser degree, for other co-meridional regions, but causes a deterioration in the regions toward the eastern and western edges of the earth disc.

A satellite antenna pointing error compensation method for spin stabilized satellites and its software control system have been developed, based on the concept mentioned above, to reduce the received signal level variation due to satellite antenna coverage dispersion. An experiment using Japanese experimental communication satellite, CS, on inclined orbit was performed to verify the pointing error compensation algorithm and developed software control system. The experimental results show that this method can reduce received signal level variation due to orbital inclination and the developed software control system works well. [Izumisawa et al., 1983].

Conversely, if the satellite is maneuverable in attitude (having either a 3-axis, or a gimballed momentum wheel, or equivalent type attitude control system, such as INTELSAT VII), then the effects of orbit inclination can be drastically reduced by the proper choice of the roll and pitch distortion correction factors, as shown by a comparison of Figure 2 with Figure 1.

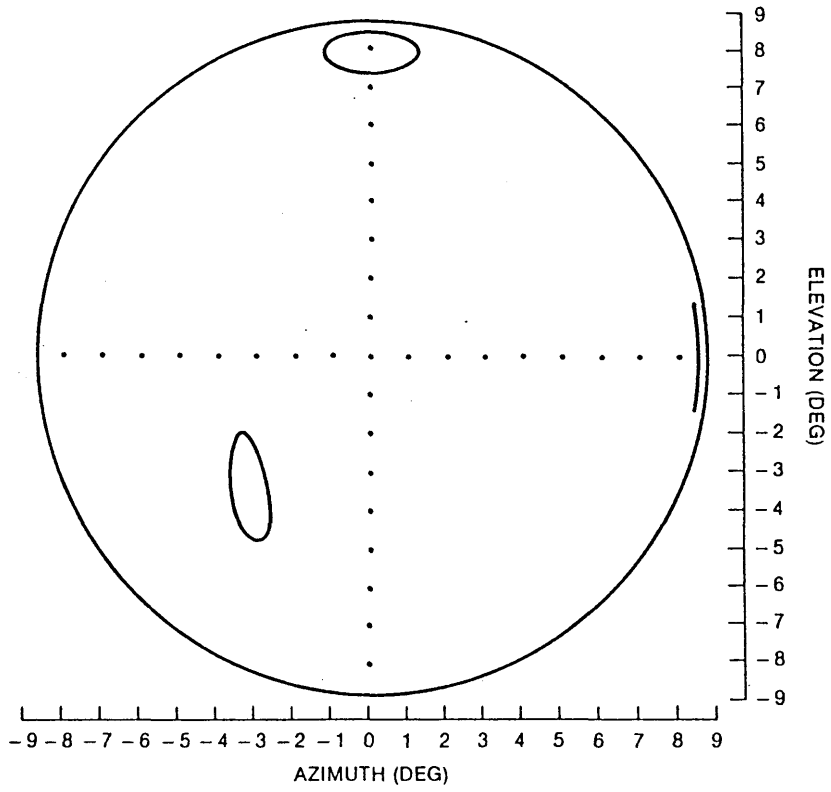

FIGURE 1. Effect of 9° Orbit Inclination on Satellite Antenna Beam Pointing for a Satellite with one Body-Fixed Wheel

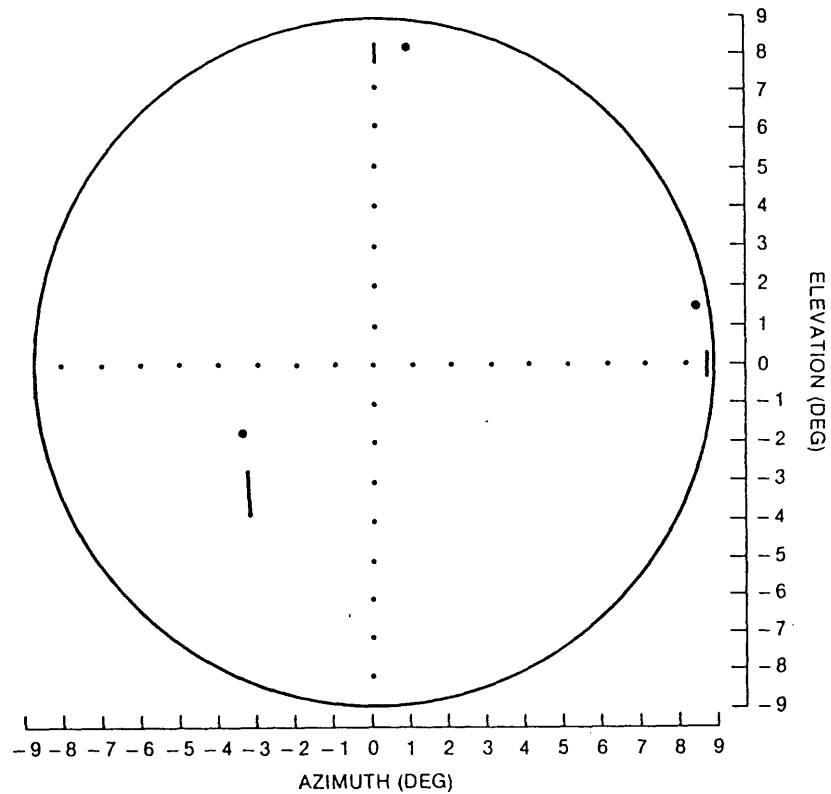

FIGURE 2. Effect of 9° Orbit Inclination on Satellite Antenna Beam Pointing for a Satellite with Steerable Momentum

(3) Rotations of the plane of polarization

As the inclination of a geostationary satellite increases, a linearly polarized satellite antenna beam will exhibit an increasing deviation of its polarization plane from the polarization plane associated with the nominal geostationary orbit location. This deviation will be largest during equator crossings and adds to yaw orientation errors. The resulting variable misalignment between the linear polarization planes of the

satellite and the earth stations poses no significant problem as long as the orbit inclination and the yaw errors remain moderate. However, when the orthogonal polarization is used, for intra-network frequency reuse by another nominally co-located space station, polarization isolation will decrease rapidly with increasing orbit inclination. Depending on the isolation geometry, it may become necessary to maintain polarization orthogonality at the affected earth stations; e.g. by polarization tracking.

For circular polarization, this problem does not exist.

(4) Effects on digital signal transmission

The variable geometry of an inclined orbit increases delay and doppler variations along the transmission path. Because of these variations, digital links may need extra buffering to maintain network synchronization. An increase of doppler buffer capacity using large scale memory LSIs, frequently employed in various digital equipment, can be applied without a significant increase of hardware size or cost.

In addition, doppler effects due to inclined orbit operation may affect carrier frequency control for narrow-band carriers. However, the effects of carrier frequency variation depends on system parameters such as the modulation and demodulation scheme and bit rate. Further study is required on this problem.

4. Interference between satellite networks

During slightly inclined geostationary orbit operation, there are basically three factors impacting interference between two satellite networks. These are:

- The exocentric angular separation between the service areas of the networks as seen from either satellite;
- The exocentric angular width of the service areas as seen from either satellite;
- The topocentric angular spacing between the satellites as seen from an earth station of either network.

These factors cause the net antenna discrimination (earth station and satellite antenna) between the two networks to vary in time. In case where satellite networks have a common service area (co-coverage networks), earth station antenna is the basic element providing discrimination between the networks. Where satellite networks have separated service areas (non-co-coverage networks), both, the earth station and satellite antenna contribute to the discrimination between the networks.

4.1 Geometric Considerations

The geocentric angle Φ_g between two slightly inclined geostationary satellites with latitudes (γ_1 and γ_2) and longitudes (Φ_1) and (Φ_2) may be determined by:

$$\cos \Phi_g = \cos \gamma_1 \cos \gamma_2 \cos(\Phi_1 - \Phi_2) + \sin \gamma_1 \sin \gamma_2 \quad (1)$$

The latitude γ and longitude excursions $\Delta\Phi$ of a satellite as a function of the orbit inclination angle i and the satellite phase angle position in the orbit $\Delta\gamma$ as measured from the ascending node are:

$$\gamma = \sin^{-1} (\sin i \sin \Delta\gamma) \quad (2)$$

$$\Delta\Phi = \tan^{-1} (\cos i \tan \Delta\gamma) - \Delta\gamma \quad (3)$$

With small angle approximations for $\sin i$ and $\cos i$, equations (2) and (3) become:

$$\gamma = i \sin \Delta\gamma \quad \text{radians} \quad (4)$$

$$\Delta\Phi = -0.25 i^2 \sin 2\Delta\gamma \quad \text{radians} \quad (5)$$

The longitudinal excursions of a satellite in a circular geostationary orbit can be determined from the above equations. Figure 3 shows a plot of the maximum excursions as a function of inclination.

For two satellites having inclinations i_1 and i_2 , designating $\Delta\gamma_0$ as the phase angle difference between the satellite orbit positions ($0 \leq \Delta\gamma_0 \leq 2\pi$) and Φ_s as the angle between the ascending nodes, the minimum value of the geocentric angular separation Φ_g may be derived from the preceding equations and is closely approximated by

$$(\Phi_g)_{\min} = 0.5 i_1 i_2 \sin \Delta\gamma_0 + \Phi_s \quad \text{radians} \quad (6)$$

Equation (6) may be expressed as the ratio of the minimum geocentric angle to the geocentric angle of the nodes:

$$(\Phi_g)_{\min}/\Phi_s = 1 + (i_1 i_2 \sin \Delta\gamma_0)/2 \Phi_s \quad (7)$$

where i_1 , i_2 and Φ_s are small compared to one radian.

Depending on the phase angle difference between the satellite orbit positions $(\Phi_g)_{\min}$ can be less than or greater than Φ_s ; i.e. when $\pi \leq \Delta\gamma_0 \leq 2\pi$ or $0 \leq \Delta\gamma_0 \leq \pi$ respectively (See Fig. 4). If either i_1 or i_2 is zero, then $(\Phi_g)_{\min} = \Phi_s$. The worst phase angle difference is $3\pi/2$ and equation (7) for that value is:

$$(\Phi_g)_{\min} = 1 + i_2 i_1/2\Phi_s \quad (8)$$

When there is some inclination in the orbit of either of a pair of satellites, the time averaged value of angular spacing is always greater than the nodal spacing Φ_s . The portion of time T_1 in which Φ_g is less than Φ_s under worst case phase angle conditions is approximately:

$$T_1 = 0.64[(i_1 i_2 \Phi_s)/(i_1 + i_2)]^{0.5} \quad (9)$$

When $i_1 = i_2$, T_1 varies from 1 hour twice daily for a Φ_s of 2° to about 2.25 hours twice daily for a Φ_s of 10° for equal inclinations and worst case phase angle. A plot of equation (9) is shown in Figure 5 for a Φ_s of 3° .

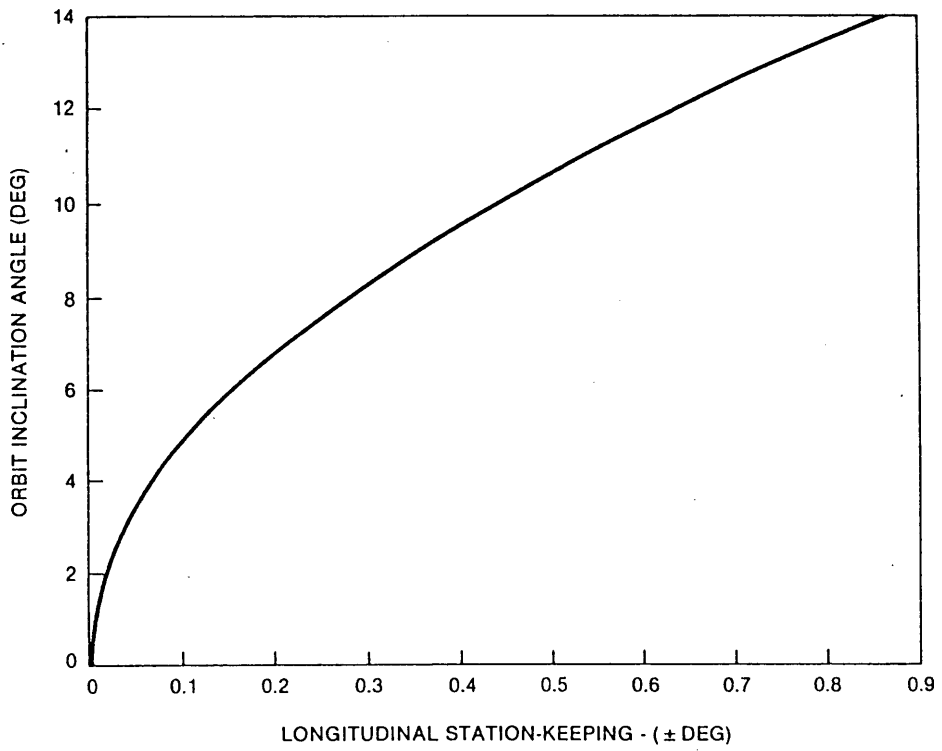

FIGURE 3. Orbit Inclination Where Longitude Excursion Equals Station-Keeping

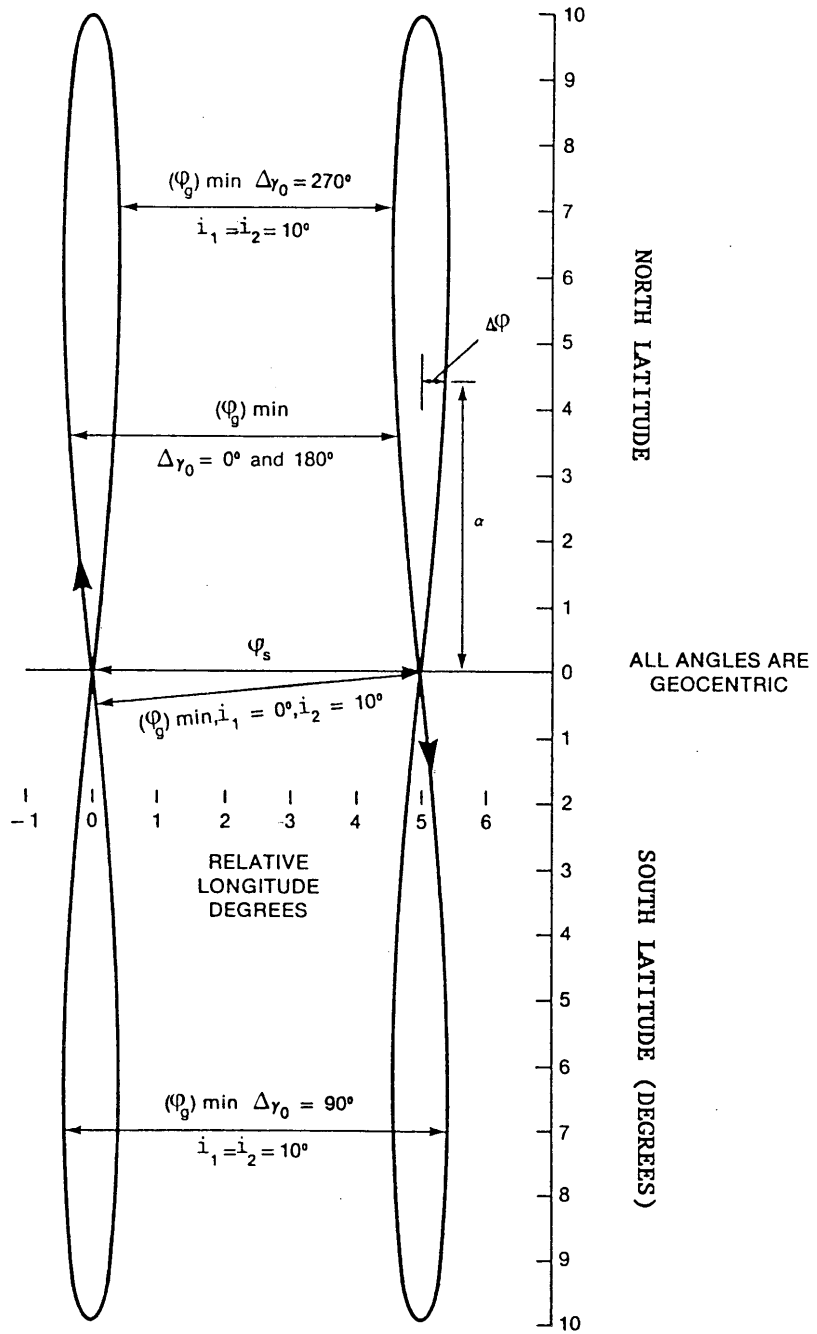

FIGURE 4. Inclined Circular Geostationary Orbit Geometry

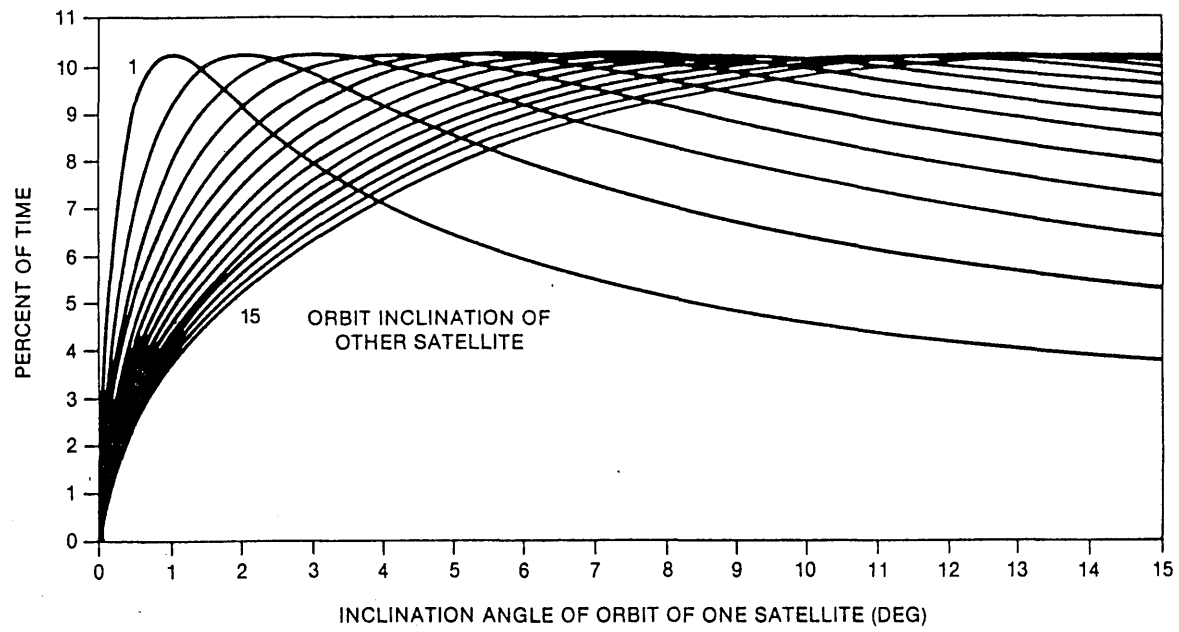

FIGURE 5. Percent of Time Satellite Spacing is Less Than Nodal Spacing

4.2 Co-coverage Networks

Under co-coverage conditions, little if any, satellite antenna discrimination exists so that only the earth station antennas provide spatial discrimination. For tracking earth stations, the discrimination is a function of the angular spacing between the satellites. Assuming a $-25 \log (\Phi)$ sidelobe envelope slope, equation (7) may be expressed as;

$$\Delta d \leq 25 \log_{10} \left[1 + \frac{i_1 i_2 \sin \Delta \gamma_0}{2 \Phi_s} \right] \quad (\text{dB}) \quad (10)$$

Where Δd is the loss in discrimination, in dB with respect to the earth station antenna discrimination at a nominal spacing of (Φ_s) .

Figure 6 shows the antenna discrimination for $i_1 = 7^\circ$ and $i_2 = 9^\circ$ and a nominal satellite spacing $\Phi_s = 1^\circ$.

As shown in Figure 6, the nodal phase difference appears to be a critical factor determining the relative earth station antenna discrimination. Depending on the nodal phase difference, relative earth station discrimination can be larger or smaller than nominal, reaching a minimum at 270° of nodal phase difference. It is important to note that for either i_1 or i_2 equals zero, the minimum relative discrimination also becomes zero. Practically, this means that the discrimination between a geostationary satellite network and a slightly inclined geostationary orbit network will always be larger or equal to the nominal discrimination which would have been achieved if the two networks were geostationary.

The worst case discrimination loss (corresponds to the minimum discrimination at 270° nodal phase difference) as a function of inclinations of two satellites spaced 2° , is shown in Figure 7.

For the very worst case, $i_1 = i_2 = i$ and $\Delta \gamma_0 = 270^\circ$, equation (10) becomes

$$\Delta d \leq 25 \log_{10} [1 - i^2/2 \Phi_s] \quad (\text{dB}) \quad (11)$$

Plots of this function are shown in Figure 8 which demonstrates the effects of the satellite nodal spacing Φ_s .

The probability that the two orbits would have equal inclinations and also the most adverse phase angle should be quite small. It is also to be noted that the value of Δd in equation (10) is a peak value and is approached for short periods of time. The portion of time in which the change in discrimination is between 0 dB and Δd is determined by equation (9).

For the worst case discrimination loss to happen it would be necessary that

- both (adjacent) satellites be in significantly inclined orbits and that
- a nodal phase difference of about 270° exists.

The combination of the two events does not seem likely to occur under normal circumstances when station-kept satellites are left without north-south station keeping in order to extend their operational life.

If two satellites initiate inclined geostationary orbit operation approximately at the same time (say, in the same year) the phase shift between their orbit's lines of nodes will be negligible because the conical motion of the orbit normals, produced by identical force fields, will be identical. Only if one of the satellites initiates inclined geostationary orbit operation a few years after the other will a nodal phase difference be appreciable. But in such a case, the satellite which initiated inclined orbit operation later will not have any significant orbit inclination, until additional years of combined operation accumulate. The phase angle difference does not significantly change with time and the change in inclination of two adjacent satellites will be nearly the same. Thus when unfavorable conditions exist, they remain unfavorable until a satellite maneuver is made to change the conditions. However, when two adjacent satellites are initially placed in inclined geostationary orbits, the inclinations and phase angle difference can have any value. Therefore, it is of interest to estimate the probabilities associated with Δd . It is assumed that the inclinations and phase angle difference are statistically independent, that the inclinations have a constant probability density function between 0 and I_0 , and that the phase angle difference probability density function is constant between 0 and 2π . With these assumptions equation (10) may be expressed as:

$$\overline{\Delta d} \leq 25 \log_{10} [1 + Ki_0^2 / 2 \Phi_s] \quad (\text{dB}) \quad (12)$$

Where $\overline{\Delta d}$ is the value of Δd which will not be exceeded with a probability P , and K is the normalized value obtained from the above assumed probability functions for a given value of P . For $P = 90\%$, the value of K is about -0.3. For P values of 95% and 99%, the values of K are about -0.44 and -0.78. For $P = 50\%$ the value of K is zero.

Assuming a satellite nodal spacing of 2° and that both satellites have inclinations of 5°, the worst case discrimination loss Δd is 1.25 dB as shown in Figure 7. From equation (12) the maximum value of discrimination loss Δd is 0.36 dB with a 90% probability. For a 9° inclination, the corresponding discrimination loss is 4.73 dB and the discrimination loss which will not be exceeded with 90% probability is 1.25 dB.

From the preceding equations, values of Δd can be equated to changes in satellite spacing so that the interference could be equal to or less than that with 0° inclinations, (1 dB is equivalent to about $0.1\Phi_s$) i.e., the spacing could be adjusted. It is also noted that Δd can also be negative; i.e. that discrimination is increased. If it is assumed that the phase angle $\Delta\gamma$ is a random value among an ensemble of satellites (plus and minus values of Δd are equally probable) and that nodal spacing changes are

made to equate minimum spacings, the net effect would be that an ensemble of satellites would occupy the same orbital arc as would be occupied if all inclinations were 0° .

Thus, it is not evident that the number of orbit node positions in a given orbital arc will be adversely affected by orbit inclinations.

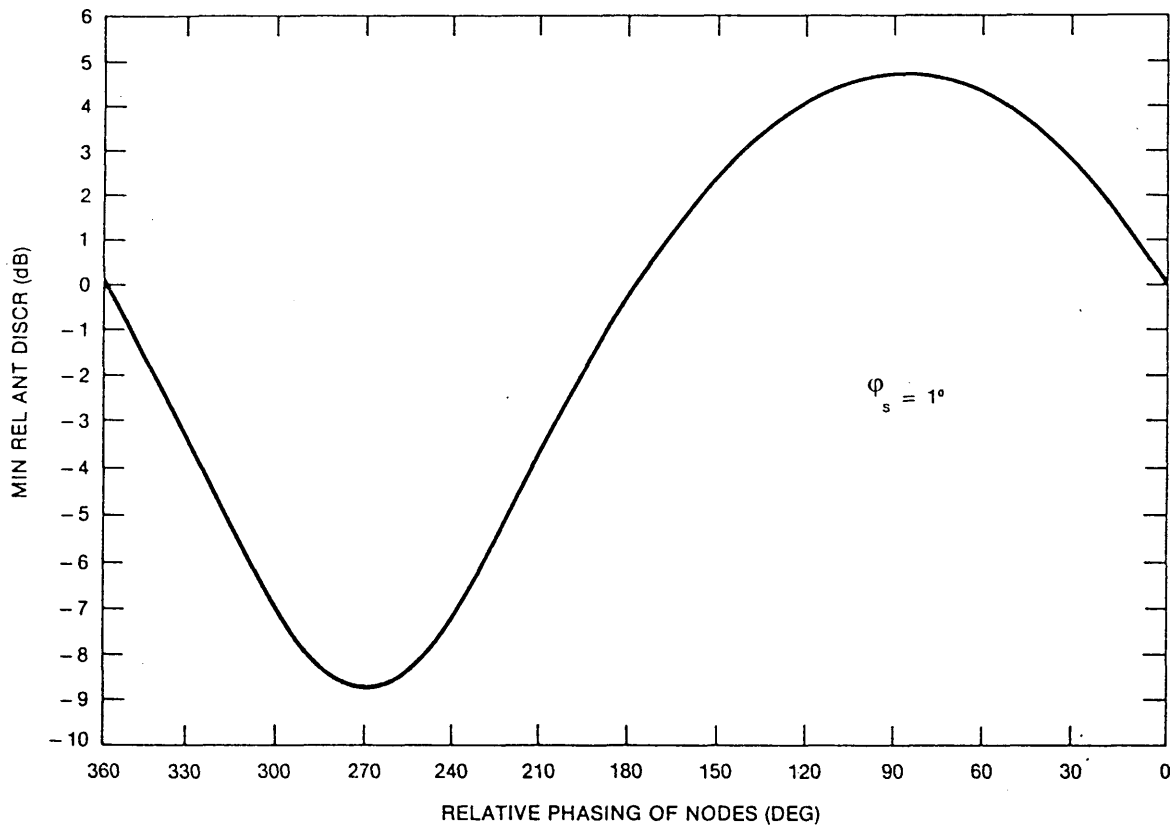

FIGURE 6. Minimum Relative Earth Station Antenna Discrimination versus Nodal Phase Difference for 9° and 7° Inclined Geostationary Orbit Satellites

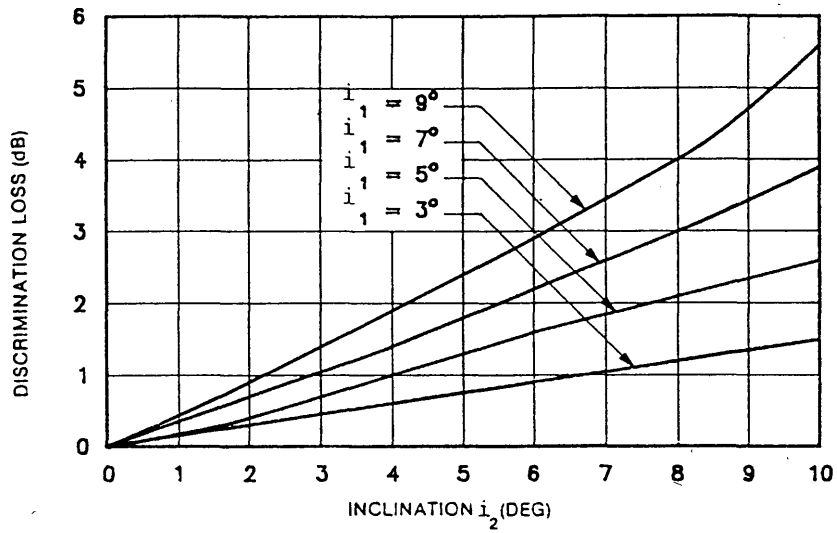

FIGURE 7. Earth station discrimination loss (worst case) for two inclined geostationary orbit satellites

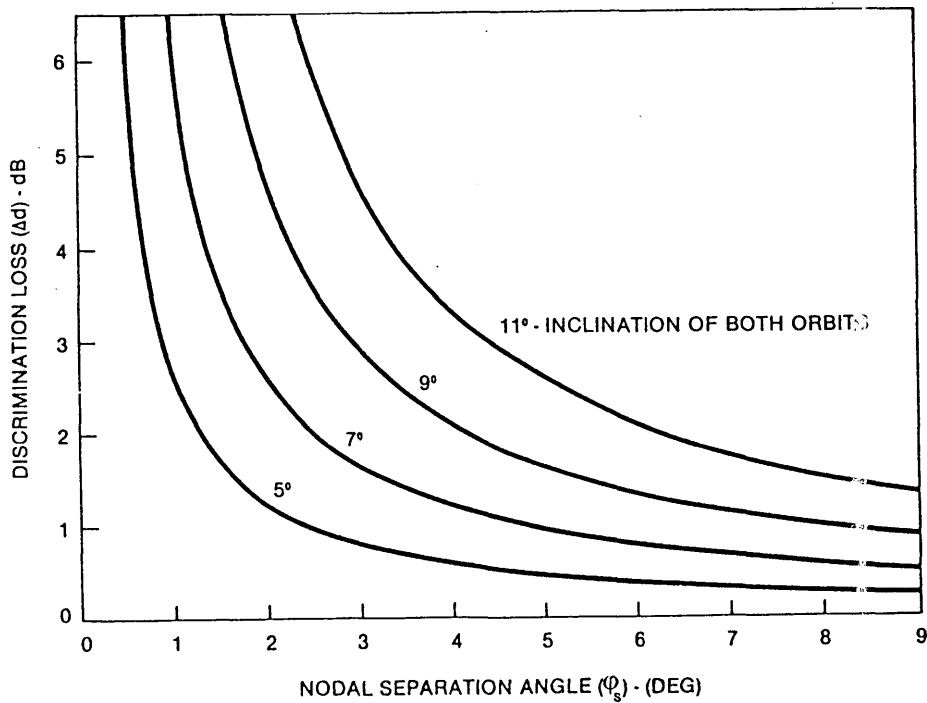

FIGURE 8. Worst Case Discrimination Loss

4.3 Non-co-coverage networks

The analysis in this case is considerably more complex than in the co-coverage case and thus, a parametric approach used in the co-coverage case is difficult to apply. Therefore, the total discrimination between two satellite systems achieved through the earth station and satellite antenna discriminations was analyzed using the following model.

A satellite in the inclined geostationary orbit was assumed to have a circular beam of a certain diameter. The beam was directed towards different points on the earth and the motion of a point at the edge of the beam, as a consequence of the motion of the satellite in the inclined orbit, was plotted in the satellite coordinates. The impact of the motion of the satellite beam was computed as a change of the satellite antenna gain at a point close to the coverage area. This point was chosen to correspond to point A at the satellite antenna reference pattern in Figure 9. Nominally, if there was no motion of the satellite antenna, due to the inclination of the satellite orbit, the discrimination achieved at this point, through the satellite antenna would be 22 dB, referred to the edge of coverage. The point was so chosen to analyse the worst case situation. The gain variation was expressed relative to this nominal gain. The discrimination between this satellite system and a neighboring geostationary satellite system achieved through the earth station antenna operating in the inclined orbit satellite system, was also computed and expressed relative to the discrimination achieved if both systems were geostationary. The total relative net discrimination achieved through the satellite and earth station antennas was computed as a function of time, for satellite beamwidths of 1.5° and 3°, and for inclinations of 3°, and 9°. The satellite beam was directed towards three different areas on the Earth, as shown in Figure 10.

The results in Figures 11-14 show that the net discrimination between a slightly geostationary inclined orbit satellite network and a geostationary satellite network is very much impacted by the relative positions of the coverage areas of the two networks. In some cases (see Fig. 14), the net discrimination is practically always greater than nominally achieved if the two networks were geostationary. These are the cases where the impact of the satellite antenna discrimination is negligible. In some other cases, where the impact of the satellite antenna is significant, there is a loss of the net discrimination (compared to nominal) for a certain period of time during the day. The magnitude of the loss and its duration are functions of the inclination, satellite spacing and the width of the coverage area. However, it should be emphasized that, due to the choice of point A on the satellite antenna pattern (Fig. 9) the above results represent the "worst case". In many cases, the relative positions of satellite network coverage areas will be such that the motion of the coverage area due to the slightly inclined orbit operation will have a negligible effect on the net discrimination between the two networks. In these cases, the variation of the overall discrimination will be determined by the discrimination of the earth station antenna, which for this case (one slightly inclined geostationary and one geostationary network) is always equal to or greater than nominal.

Further studies are needed for the cases involving two slightly inclined geostationary orbit satellite networks.

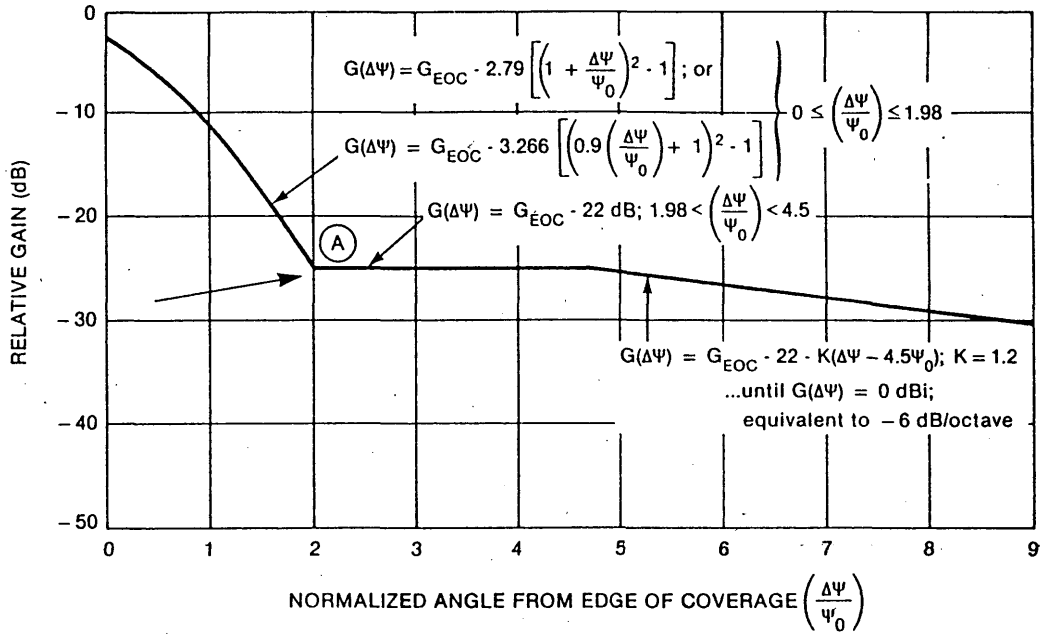

FIGURE 9. Satellite Antenna Reference Pattern

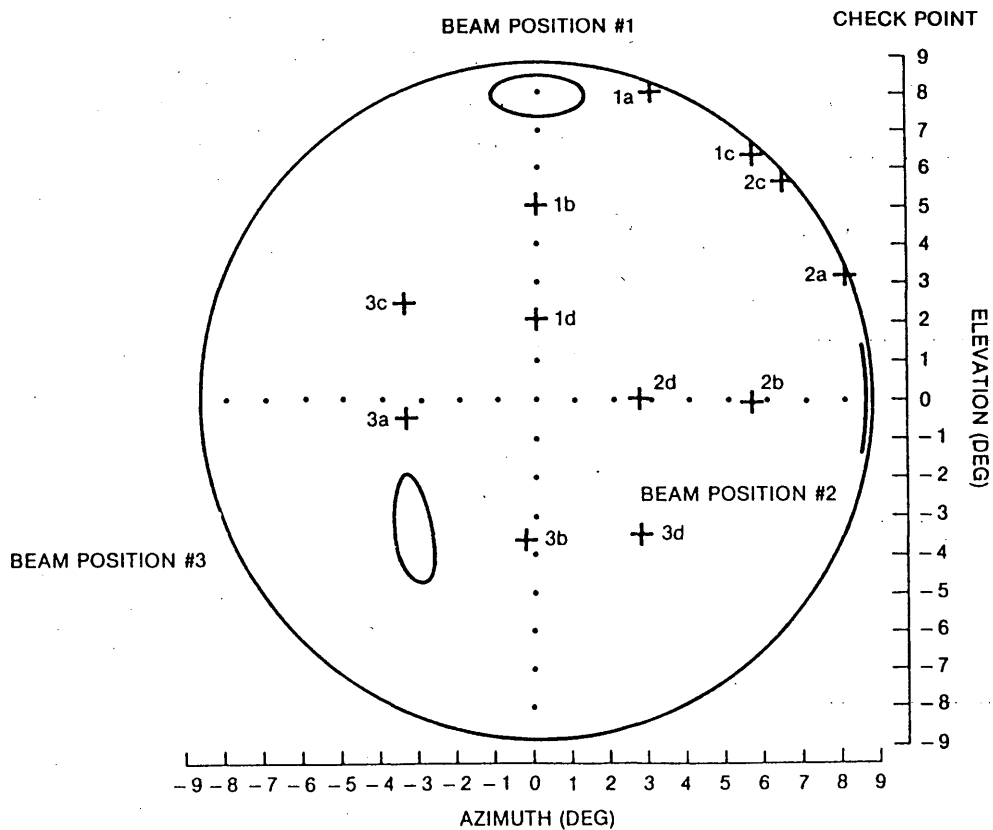

FIGURE 10 The Motion of Satellite Beams at the Earth (Inclination 9°) and Check Points

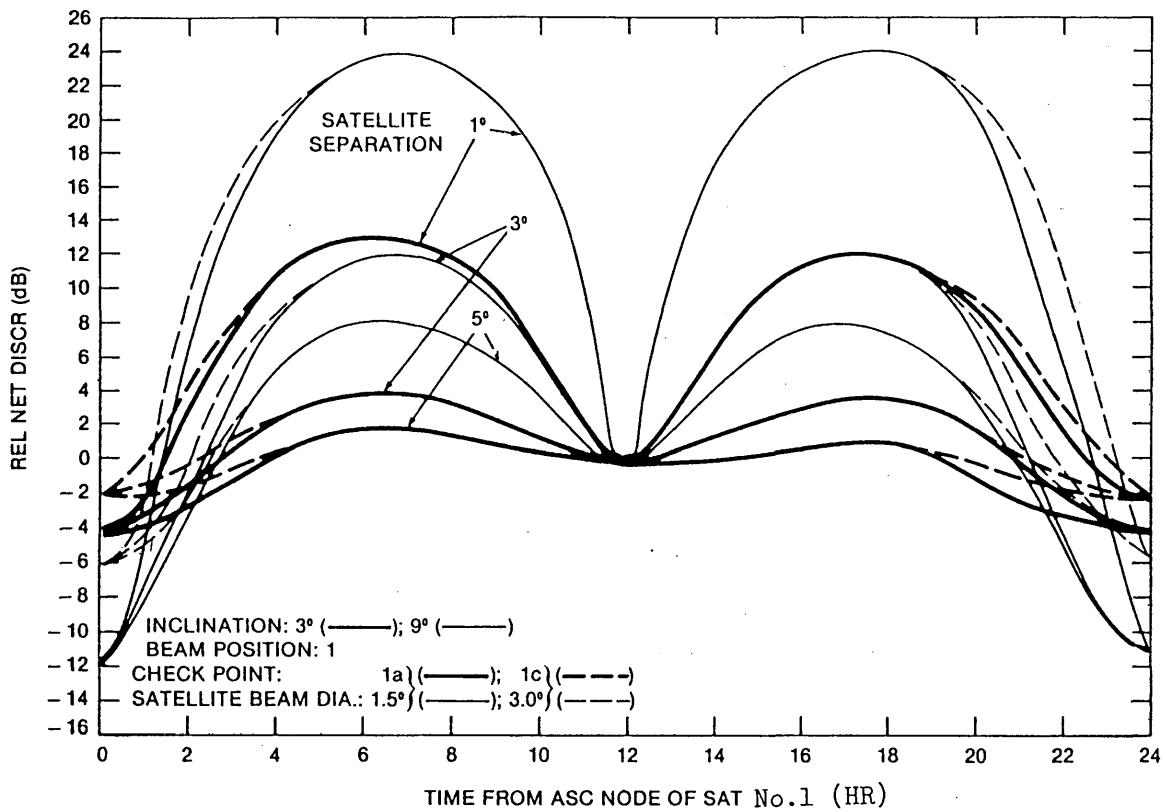

FIGURE 11. Relative Net Discrimination as a Function of Time

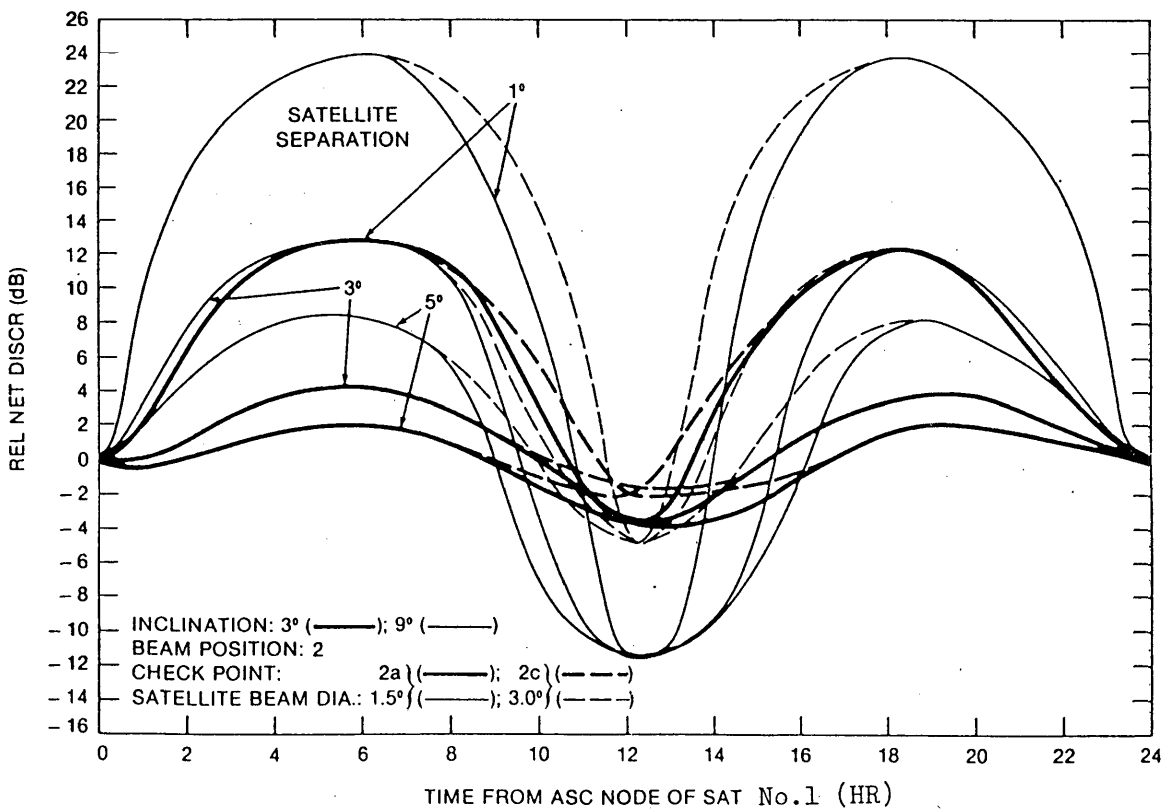

FIGURE 12. Relative Net Discrimination as a Function of Time

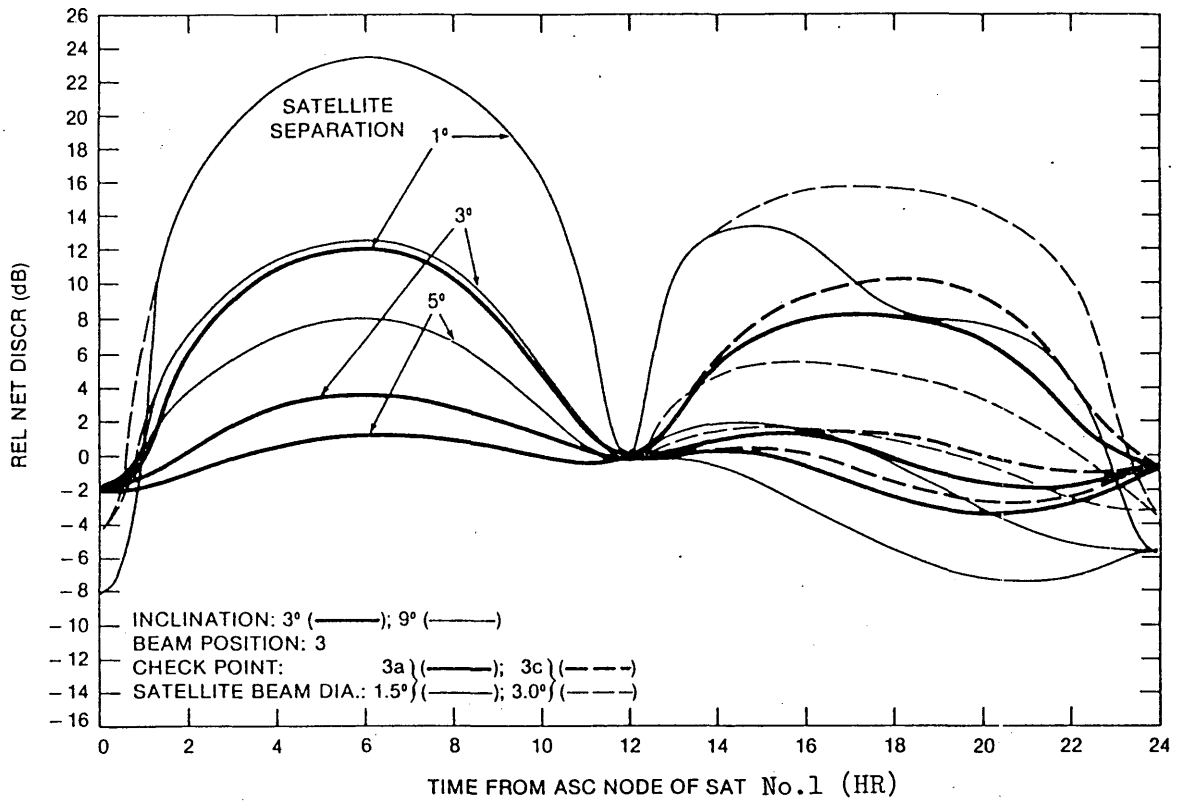

FIGURE 13. Relative Net Discrimination as a Function of Time

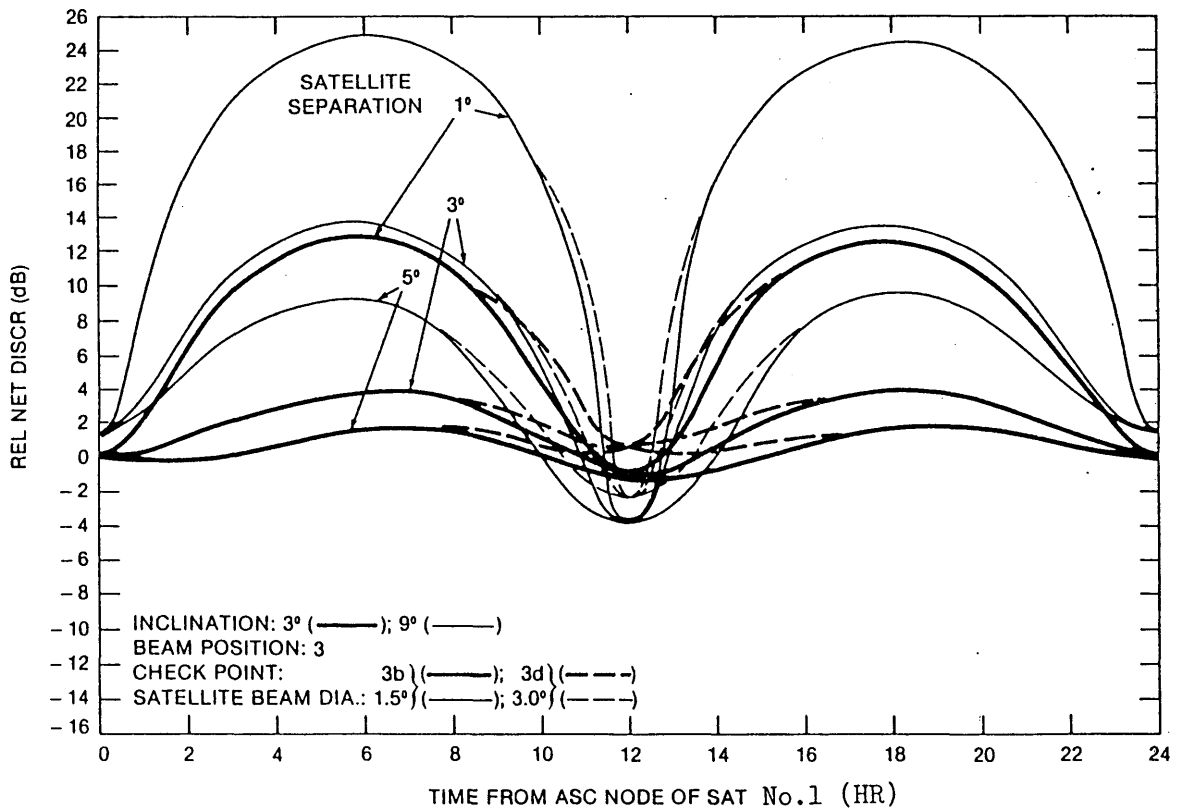

FIGURE 14. Relative Net Discrimination as a Function of Time

4.4 Control of nodal phasing

In the previous sections, it was shown that the loss of the earth station antenna discrimination becomes significant when nodal phase difference between two neighbouring satellites approaches 270° . However, it is possible at moderate cost in station-keeping fuel to prevent the occurrence of worst orbital phasing of two neighbouring satellites through controlling the orbital nodes, a form of second order station-keeping.

Figure 15 shows, in the lower pair of curves, the yearly requirements in terms of orbital velocity changes (ΔV) for a satellite subject to tight north-south station-keeping (curve A) and for one subject to maintenance of its orbital node at 90° right ascension (curve B). The velocity changes, which are proportional to the amount of station-keeping fuel needed to produce them, become equal after about 9 years. When considering total cumulative fuel requirements for the two modes of operation, node phasing would require the same amount of fuel as north-south station-keeping only after 16 years (upper curve pair). For a 7 year satellite operation with no north-south station-keeping, the maintenance of a node at 90° right ascension would use only half as much fuel as full north-south station-keeping.

In practice, it will not be necessary to maintain a node at 90° right ascension - what is needed is a node correction which prevents the occurrence of the worst case interference geometry. How much fuel will be required depends, inter alia, on the difference in the inclination of the satellites; in favorable situations no node control may be needed even though the satellites of two potentially interfering networks may both be in slightly inclined geostationary orbits.

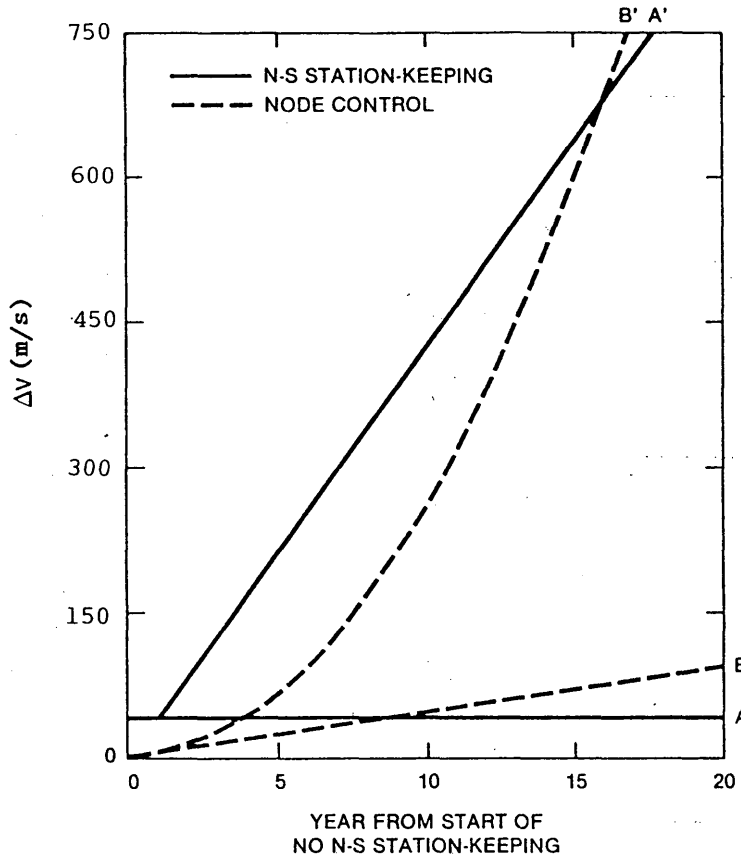

FIGURE 15. Yearly (Lower Curve Pair) and Cumulative ΔV Requirements

5. Coordination considerations

From the previous analyses there appears to be no intrinsic limitation on the coordination of networks using circular slightly inclined geostationary orbits.

In the case of a geostationary network and a network using a slightly inclined geostationary orbit, the isolation between the networks will be equal to or greater than it would be in the case of the two geostationary satellite networks under co-coverage conditions. Thus, coordination will be the same as if both networks were geostationary.

If both satellite networks use slightly inclined geostationary orbits, some decrease in isolation as compared to the isolation between geostationary satellite networks might occur under the most unfavourable nodal phasing of the satellites and under co-coverage conditions. However, this can be determined and accounted for in coordination.

Under non-co-coverage conditions, satellite antenna discrimination is involved and this adds complexity in terms of estimation of interference effects. These effects can also be determined and accounted for in coordination.

However, there is the case where coordination was achieved on the basis of essentially 0° inclination but at some later date the inclination is allowed to increase. It would appear that in most practical cases, the increase in interference would not be significant, i.e. the probability that all conditions are simultaneously present for worst case interference is considered to be quite small. Hence, in most such cases, there will be no need to re-coordinate a network previously coordinated as geostationary and planning to suspend North-South station-keeping with other geostationary networks.

While, generally, the inclined orbit operation of a network's satellite is supportable on the basis of internetwork coordination agreements that assume the network's satellite to be geostationary, there may be some circumstances where geostationary internetwork coordination agreements provide insufficient protection for inclined geostationary orbit operation. Thus, there is a need to determine the conditions for which geostationary internetwork coordination agreements would not suffice to prevent unacceptable internetwork interference from occurring when one or more networks commence inclined geostationary orbit operation.

6. Further studies

This report deals with some of the considerations of satellites operating in slightly inclined geostationary orbits (SIGO). The analyses described are limited to inter-satellite networks with co-coverage and non-co-coverage service areas and thus certain areas of work need to be studied further. (See Study Programme 28D/4).

REFERENCES

IZUMISAWA et al [October 1983]. "A control method of antenna pointing error due to orbital inclination for a spin-stabilized satellite". IAF 83-67, 34th Congress of the International Astronautical Federation, Budapest.

REPORT 1004-1

PHYSICAL INTERFERENCE IN THE GEOSTATIONARY-SATELLITE ORBIT

(Question 34/4)

(1986-1990)

1. Introduction

Question 34/4 calls for a number of studies to be carried out (DECIDES 1 to 4) relating to the effects of physical interference from inactive drifting satellites on or near the geostationary orbit.

Study is also required concerning the physical interference between operational satellites in the geostationary orbit (DECIDES 1 and 3).

2. Current situation

The geostationary orbit is currently populated by some 200 satellites, both operational and defunct and a large number of elements from the launch of these satellites. The population of the latter debris is not well-defined as present-day sensors cannot detect objects which are less than about 1 m in diameter. Various estimates have been made of the current collision probabilities which have been presented in differing forms. When adjusted to equivalent parameters, most studies estimate the collision probability to be about 10^{-6} per year for current satellites. In these studies a uniform distribution of satellites in the orbit was assumed.

3. The effects of collision in the GSO

Satellite construction is necessarily aimed at producing lightweight but rigid structures, strong enough to withstand launch accelerations and vibration. Apart from the main thrust ring, most components of the structure are manufactured from lightweight honeycomb materials. The only strong and massive parts are various equipment boxes, flywheels and batteries. External antennas, antenna feeds and solar panel structures are again generally lightweight and may be unable to support themselves in normal Earth gravity.

A collision between small debris and these external parts is likely to shear off the parts, punch holes through them, and, in the case of antennas and feeds, mechanically distort them. Some motion would be imparted to the spacecraft itself. There may be degradation or loss in communications capacity, degradation or loss of d.c. and RF power and the emission of signals that may cause interference to other satellite networks. The affected active satellite may not be completely incapacitated. However, if the debris were to strike the satellite body, much further debris may be created. At that orbital location, the result would be an increase in collision probability, the value depending on the actual pattern of the satellite break-up. A means of calculating the change and models that may be applicable can be found in [Chobotov, 1983; CCIR, 1982-86]. Certain studies suggest that the debris would be dissipated around the orbit at a rate dependent on the velocity imparted to the debris. However, the short- and long-term effects of a collision need further study to define the probabilities more precisely.

* This Report should be brought to the attention of Study Groups 2, 8, 10 and 11.

4. Collision countermeasures

Since the probability of collision increases with the population density it is sensible to attempt to keep the total population as nearly static as practicable, while allowing for growth in the number of satellites in the future. This could be done by the timely removal of satellites that are of no further use or are no longer viable. Spacecraft litter such as rocket stages are abandoned in a transfer orbit which has a low perigee and an apogee at geosynchronous altitude, hence they cross the GSO at least once a day. The lifetime of an object in a transfer orbit depends on the initial perigee height, the initial longitude of the ascending node and the season. If these three parameters are chosen correctly then the apogee height will decay quite rapidly and the upper stage will not be a collision hazard to satellites in the GSO [Mueller and Graf, 1979]. The use of large structures for satellite GSO injection that are subsequently detached in the GSO should be used with caution since they would generate further hazards. Some other techniques that have been considered are extra shielding, retrieval and servicing, avoidance manoeuvres, removal to a lower orbit or a higher orbit (satellite "graveyard").

Avoidance manoeuvres have already taken place and it is an operational technique that has been applied by some administrations to reduce the risk to certain satellites. The technique requires tracking that is expensive to implement and operate, and which is not currently available to all users of the orbit and its precision is currently insufficient to provide an effective countermeasure. On-board collision detection and tracking equipment is also not considered to be a viable alternative at this time.

Another possibility is to use the on-board fuel of the spacecraft to raise or lower the orbit, i.e., place the spacecraft in a "graveyard" orbit.

Graveyard orbits are thus the best option among those that have so far been considered. The technique would be to fire thrusters in a sequence to provide a sufficient change in satellite velocity that would result in a new higher altitude orbit of sufficient height to avoid all reasonable chances of intercepting the GSO again.

Removal to a lower orbit may be considered as a viable means of controlling the population of the orbit, however the decay time is long, thus causing a collision hazard to other non-GSO satellites, and also to the GSO injection orbits.

Clearly, the fuel mass required for this manoeuvre depends on satellite mass, the specific thrust of the fuel and the altitude (ΔV) required. Calculations have been made based on the Olympus satellite (beginning of life (BOL) mass 1500 kg) and ECS (BOL mass 500 kg). These show that an absolute minimum altitude change of 80 km and 60 km respectively would be required, needing a total of 1.29 kg and 0.73 kg of station-keeping fuel. In both cases this is less than 1% of the total station-keeping fuel (certain N-S station-keeping is included in these examples) and a loss of operational availability of 2 and 3½ weeks respectively (assumed lifetimes 5 and 7 years).

5. Practicalities of transfer to a satellite "graveyard" in a higher orbit

Propulsion systems carried on board current satellites usually comprise an apogee boost motor for orbital injection and a number of small thrusters to perform station-keeping manoeuvres during the life of the satellite. A common fuel tank or tanks are generally used for fuel storage for both types of manoeuvres. From a variety of propulsion systems and techniques there are only four viable techniques that might be applied. In the first, no modifications to the spacecraft would be required, only the need to ensure that sufficient fuel for the manoeuvre is available. Present-day measurement techniques employed on spacecraft and operational regimes present a level of error that is of the order of 6 months' station-keeping fuel; however better measurement systems could be developed.

A second approach would be to fit a completely independent propulsion system of adequate size for the "graveyard" operation. This would be relatively easy to accomplish, using proven elements but presents some concern about reliability since it would not be used or tested for a considerable time.

The third approach would be to include separate fuel tanks in the existing system, overcoming some of the reliability problems mentioned above and saving some mass.

Lastly, the fitting of in-line fuel tanks would remove even more of the reliability questions, albeit with the additional requirement to sense main tank exhaustion (by means of a gas detector). With each of these options there is a need to terminate any current manoeuvre commands and either initiate the "graveyard" transfer or telemeter the status to the operations centre.

However, from a practical point of view, a more serious difficulty associated with the removal of satellites from the geostationary orbit is the economic penalty associated with the removal of an operational satellite from service before all the fuel has been expended. Although some satellite operators have begun the practice of retiring their satellites into super-synchronous orbits, others have followed different practices. A sound strategy is, therefore, required on the retirement of satellites in order to deal with premature satellite failures or exhaustion of station-keeping fuel.

This problem can be overcome with the establishment of clear guidelines and information on how satellites may be safely retired. Unfortunately, as stated earlier, the operator must be capable of predicting when just the right amount of fuel for retirement remains. Otherwise, the satellite may be retired too early, resulting in an unnecessary loss of revenue; conversely, not enough fuel may be left to execute the retirement maneuvers.

Other difficulties associated with executing retirement maneuvers relate to the issuing of commands to the retiring spacecraft as it passes by other, operating spacecraft. Since retirement maneuvers can involve many hours of such commands as the drift rate of the satellite increases westwardly, interference with other satellites is a real risk. This requires coordination with the operators of these satellites, and is similar to the arrival on station of new satellites or, the relocation of existing satellites to new orbital slots.

Annex I contains information on some practices followed by some countries to retire a satellite at the end of its life. Other administrations and satellite operators are encouraged to provide similar information in order to develop an appropriate guideline and procedure for this practice.

6. Other effects of drifting satellites

Only one other significant effect occurs for a drifting and inactive satellite. This is to cause blockage of the RF links to and from active satellites.

For a worst-case analysis of spacecraft [Chobotov, 1983], 7 such cases occurred in a 6 month period, leading to an upper limit of 0.039 events per year per degree of beamwidth with the typical figure at about 5.6×10^{-4} per year per degree of beamwidth.

Events of this nature are some 1400 times more likely to occur as collisions, due to the much larger cross-sectional area of the down-link beam in comparison with the size of a satellite.

The impact on outage is quite small – even allowing 10 s per complete passage at 10 km range – at most 10^{-7} of the service will be affected in some directions by this mechanism. Mean loss at a particular earth station would be lower as a result of geometric considerations.

7. Collision between operational satellites and countermeasures

As the number of satellites in the geostationary orbit increases, it will become common that two or more satellites are placed and operated at the same longitudinal position of the orbit. Accordingly the situation that an operational satellite encounters physical interference with another operational satellite will also be possible in the future.

In this case, special collision countermeasures may be necessary. These may include avoidance maneuvers controlled by on-board spacecraft processors and sensors or by ground command.

If the relative motions of the satellites are accurately monitored by means of low-cost ground tracking, ground controlled avoidance maneuvers are the most favourable option because they bring no additional requirement to the spacecraft design.

One possible method for relative motion monitoring of cooperating spacecraft is differential angle observation at a ground tracking station. For such a group of satellites, the azimuth and elevation angles of the satellites are measured differentially by one auto-tracking antenna, from which the relative motions are estimated in three-dimensional position and velocity. A high accuracy is expected for the relative motion estimation because the error which is commonly included in the measurement for each satellite is removed from the differential observation. It has been reported that the relative position is estimable with an accuracy of a few hundreds of meters, where a 13 meter diameter antenna tracks the satellite beacons at the frequency band of 20 GHz. [Kawase, 1989].

Other possible methods for the relative motion monitoring should also be studied, such as ranging from three ground stations and ground optical tracking. This should include examination of the accuracy/cost performance.

Cooperation between administrations may be necessary to satisfactorily employ the methods described.

8. Conclusions

Current estimates of the probability of collision between satellites are considered acceptably low. However, it is clear that these probabilities will rise with increasing use of the GSO. Further studies are urgently required to determine the relevant factors that may contribute to physical interference, to evaluate the risk that this phenomenon could present in the future and to identify the various solutions and the associated cost/benefits that are feasible. It seems that the RF blockage effects of drifting satellites will pose little or no threat to communications links; however, the model applied was simple and further study may be necessary to address the effects of diffraction and scattering.

REFERENCES

- CHOBOTOV, V. A. [1983] Classification of orbits with regard to collision hazard in space. *J. Spacecraft*, Vol. 20, 5.
- MUELLER and GRAF [25-27 June, 1979] A study of the lifetime of geosynchronous transfer orbits. AAS/AIAA Astrodynamics Specialist Conference, Princeton, Ma, USA.
- Kawase, S. [1989] - Real-time relative motion monitoring for co-located geostationary satellites. *Journal of the Communications Research Laboratory*, Volume 36, No. 148.

CCIR Documents

[1982-86]: 4/246 (United Kingdom).

BIBLIOGRAPHY

- AIAA [23 January, 1981] Position paper, Space debris. Prepared by the AIAA Technical Committee on Space Systems.
- BRITISH AEROSPACE [1985] The collision hazard in geostationary Earth orbit and its consequences. British Aerospace Report TP8196.
- CHOBOTOV, V. A. [1981] Collision hazards in space. Aerospace Corporation Report SD-TR-81-11.
- HECHLER, M. The probability of collisions on the geostationary ring. MAO Working Paper, No. 121 ESOC.
- HECHLER, M. and VAN DER HA, J. C. [July-August, 1981] Probability of collisions in the geostationary ring. *J. Spacecraft*, Vol. 18, 4.

ANNEX I

SOME PRACTICES FOR RETIRING SATELLITES AT THE END OF LIFE

Canada has, so far, retired four spacecraft. Each one had its perigee raised beyond the required minimum. Since there was ample fuel available, the perigee of the Anik A-1 satellite (retired in July 1982) was raised over 340 km and its apogee was raised by 460 km. The perigee of Anik A-2 (retired in October 1982) was raised 92 km, and its apogee was raised 178 km. Because of unforeseen thruster malfunctions, the perigee of the Anik A-3 satellite (retired in May 1984) could only be raised by 59 km, while its apogee was raised 85 km. The Anik B satellite was retired in December 1986 with a perigee altitude of 112 km and an apogee altitude of 148 km above geosynchronous altitude.

The experience of the Canadian domestic satellite operator, Telesat, has been that fuel estimates can be both optimistic (as they were for Anik A-3 and Anik B) and pessimistic (as for Anik A-1 and Anik A-2). One approach to predict fuel exhaustion, used by Telesat and others, is to empty one-half of the fuel load and then extrapolate the exhaustion of the remaining fuel.

Japan retired its "CS" domestic communication satellite in 1985. An orbit transfer maneuver to a "graveyard" orbit was initiated on 19 November 1985. The repositioning maneuver was divided into six maneuver sequences to maintain the required apsis height, even if all fuel was exhausted during one of the maneuvers. Satellite tracking through an unused mission band (30/20 GHz band) was adopted to avoid interference to operational satellites in the sequence, and telemetry and command communications with the satellite were stopped when displacement between it and operational satellites was small enough to cause interference. As a result, fuel was exhausted in the third maneuver sequence and the satellite was transferred into "graveyard" orbit at an altitude about 380 km higher than geostationary orbit and drifting 4.9 degrees westward per day. 2.2 kg of fuel was consumed in these maneuvers.

PAGE INTENTIONALLY LEFT BLANK

PAGE LAISSEE EN BLANC INTENTIONNELLEMENT

SECTION 4D3: SPACECRAFT STATION KEEPING - SATELLITE ANTENNA RADIATION PATTERN
- POINTING ACCURACY

REPORT 556-4

**FACTORS AFFECTING STATION-KEEPING OF GEOSTATIONARY
SATELLITES OF THE FIXED-SATELLITE SERVICE**

(Study Programme 28A/4)

(1974-1978-1982-1986-1990)

1. Introduction

On certain portions of the geostationary-satellite orbit, where satellite density is relatively light, station-keeping accuracy is not a prime requisite in limiting interference between systems. The introduction of new satellite systems will, however, increase the satellite density; therefore, in order not to restrict the development of new systems, it would be desirable to keep all satellites on station within a reasonable tolerance.

Report 453, considering some of the technical factors which affect the efficient utilization of the geostationary-satellite orbit, has drawn attention to the fact that the efficiency could be increased if the position of the satellites could be more closely controlled. The orbit capacity is only slightly impaired by moderate orbit inclinations, but the reduction in capacity could become substantial when longitudinal drift approaches a significant fraction of the satellite spacing (see also Nos. 2616, 2617 and 2619 of the Radio Regulations.)

2. Factors affecting the satellite position

When the longitudinal positions of satellites are subject to some uncertainty due, for example, to orbit drift or orbit inclination, a reduction in the potential geostationary-satellite orbit capacity will result. The extent of this reduction is related to the magnitude of the longitudinal variation and the nominal spacing between satellites. For example a longitudinal variation of 1° for satellites which would need a separation of 5° if station-keeping were perfect, will reduce the efficiency of orbit utilization to 79% of the theoretical maximum, and that this efficiency would fall to 62% if the required spacing were reduced to 2.5° .

Movement of geostationary satellites in longitude arises mainly from the following causes:

- orbital inclination;
- orbital period variations;
- orbital eccentricity;
- errors in determination of orbital elements.

These sources are considered separately in the following paragraphs.

2.1 Orbital inclination

The principal effect of the gravitational fields of the Sun and the Moon on a quasi-geostationary satellite is to change the angle of inclination of the orbital plane. For satellites in the equatorial plane, the initial rate of change of inclination is currently about 0.86° per year, but this value varies from year to year between 0.75° and 0.95° for astrodynamical reasons. The rate of change tends to decline as inclination increases. A minor source of inclination variation is in the thruster execution errors of attitude and orbit control manoeuvres. These errors are due to thrust level uncertainty and thrust vector linear and angular alignment errors. Although their effects can be calibrated and therefore kept to within very small values, they should be accounted for in accurate error budgeting. Seen from the Earth, orbital inclination causes a daily excursion of the satellite north and south of the equatorial plane. There is also a longitudinal component in this motion, the satellite moving in a figure-of-eight path. Figure 1 shows the magnitude of this longitudinal motion; it is $\pm 0.11^\circ$ for an angle of inclination of 5° , and becomes increasingly significant for larger angles of inclination. The elimination of orbital inclination by the use of secondary propulsion systems places substantial demands upon the satellite propulsion unit at the present stage of technical developments.

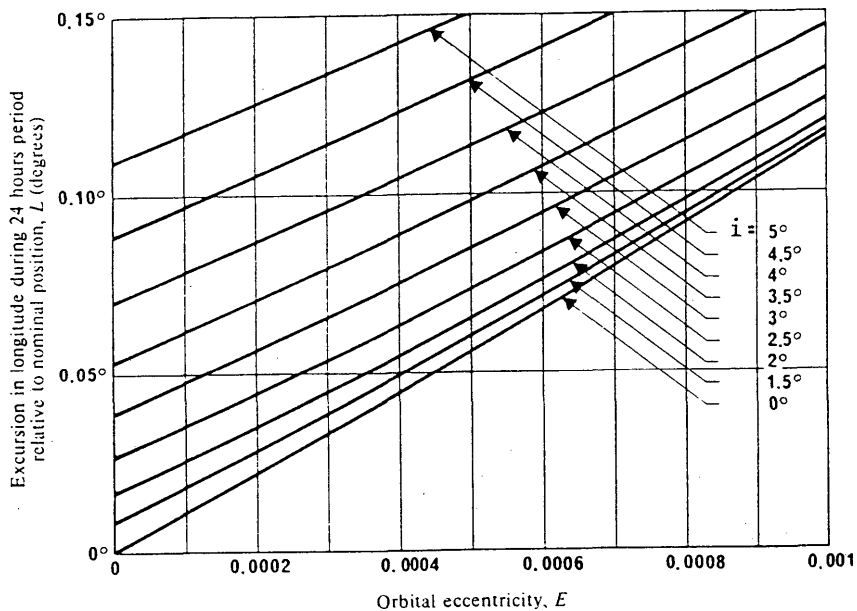

FIGURE 1 - Maximum daily variation of longitude due to eccentricity and inclination of orbit

i (degrees): orbital inclination

Note. - The peak-to-peak daily deviation in longitude is twice the value indicated in the above figure.

2.2 Orbital period variations

At about 76.8° east and 108.1° west longitude, a satellite in the geostationary-satellite orbit which has been given an accurate initial orbital period will not drift either to the east or to the west. The Earth's gravitational field decreases around the geostationary-satellite orbit in both directions from these stable points. There are two points of unstable equilibrium located at approximately 161.8° east and 12.2° west longitude. At other points in the orbit, forces due to non-uniformities in the Earth's gravitational field will act upon a satellite so as to increase or reduce its period, causing the satellite to drift slowly to the east or west. The consequential error in longitude must be reduced to an acceptable value from time to time, and an accuracy of perhaps a few hundredths of a degree could be achieved given daily corrections. However, correction at this frequency raises technical difficulties, since it is necessary to establish orbital elements after each correction to measure the effect achieved. An accuracy of 0.1° involving corrections perhaps every few weeks, without considering the longitudinal effects of orbit eccentricity, should be readily achievable. Thruster execution errors of attitude and orbit control manoeuvres also produce small changes in the orbital period. Their effects, although small, are accountable in accurate error budgets.

To change the longitudinal position of a geostationary satellite requires at least two operations of the east/west station-keeping thrusters - one to start the drift and the second to stop it. Drift rates of 1° per day or 10° per day are realized by changes in the orbital velocity (ΔV) of about 2.8 m/s or 28.5 m/s, respectively. These velocity changes may be compared with those required for the normal station-keeping operation of a geostationary satellite. Satellite specifications have typically required a total ΔV capability of about 53.5 m/s per year of which north/south station-keeping accounts for about 50 m/s per year, east/west station-keeping accounts for 2.5 m/s per year and attitude control requirements account for an equivalent of about 1 m/s per year. Therefore, a single

repositioning manoeuvre at the rate of 10° per day (total ΔV required is 57 m/s) is equivalent to about 13 months of normal east/west and north/south station-keeping. If the propellant were hydrazine, with a specific impulse of about 220 s, and the satellite had a mass of 1000 kg, then 26 kg of hydrazine would have been expelled to reposition at a rate of 10° per day irrespective of the total longitudinal change.

2.3 Orbit eccentricity

Eccentricity of the satellite orbit causes a daily longitudinal excursion of apparent position. Thus an eccentricity of 0.001 can cause an excursion of $\pm 0.11^\circ$ about the mean position (see Fig. 1). Although eccentricity can be reduced to any desired extent upon initial injection into a geostationary orbit, it will change with time. The main cause of the change in eccentricity is solar radiation pressure which causes the eccentricity to vary cyclically over the year. The extent of this annual variation is likely to be in the range 0.0002 to 0.002 for current and foreseen satellite configurations, depending upon the ratio of the projected area to the mass of the satellite. If uncorrected, it has been shown in some studies that this will cause a maximum daily longitudinal excursion in the range $\pm 0.02^\circ$ to $\pm 0.25^\circ$ at the peak of the cycle. However, it should be possible to reduce this considerably by suitable correction.

The correction frequency and propellant penalty (when the ΔV requirement for correction exceeds that required to compensate the orbital period variations) are a function of the amplitude of the uncorrected excursions with respect to their budgeted limits.

A minor cause of geostationary satellite orbit eccentricity variation is the luni-solar gravity. This causes monthly cyclic variations, whose magnitude is smaller than the minimum value in the above range. An additional source of eccentricity change is in the thrust execution errors. The effects of all sources is to be included in accurate error budgets.

2.4 Errors in determination of orbital elements

The precision with which a satellite can be maintained in its designated longitudinal position depends to some extent upon the accuracy with which its orbital element can be determined. However, given suitably located measuring stations and appropriate measuring techniques it is certainly possible to determine satellite angular positions to better than 0.001° .

Where ranging data is received at a single tracking station, not only are errors in determination of orbital elements larger compared with errors using ranging data received at two tracking stations but also it is quite difficult to determine orbital elements satisfactorily at very small inclination angles (near zero). Therefore, with one ranging station, it would be necessary to increase the frequency of orbit determination and manoeuvre. If the satellite azimuth is measurable to an accuracy of 0.003° in addition to the range, a single measuring station is sufficient to determine satellite position to an accuracy of 0.003° . This is achievable by the auto-tracking antenna in the frequency region of 20 GHz or higher, aided by appropriate calibration of the measuring system [Kawase *et al.*, 1981]. Thus, the uncertainty in longitude due to errors of measurement could be made negligible.

3. Present capability

The Intelsat, the Canadian Anik, the Japanese CS and BSE spacecraft, and other systems have successfully demonstrated that a longitude station-keeping capability of $\pm 0.1^\circ$ can be achieved with little or no propellant penalty, even at unstable points in the geostationary satellite orbit. Station-keeping of this order does not seriously affect the life of the spacecraft. Japan's CS and BSE satellites have achieved $\pm 0.1^\circ$ with no penalty in spite of being placed at unstable points in the orbit and the semi-major-axis of these satellites has been determined to an accuracy of 50 m using eight hours of ranging data from two tracking stations. It should be noted, however, that an increase in the precision of station-keeping entails an increase in the computing capability and associated costs, an increase in the frequency of the east-west corrective manoeuvres, and a possible increase of propellant requirement or equivalent decrease of satellite life, depending on the characteristics (area/mass ratio) of the satellite.

For instance, Japan's CS was experimentally maintained within $\pm 0.03^\circ$ of longitude and latitude at 135° E for a few months. In this precise station-keeping, the frequency of East-West manoeuvres was twice a week and that of North-South manoeuvres was every 2 weeks; while in the normal station-keeping within $\pm 0.1^\circ$ those frequencies of manoeuvres were every 3 weeks and every 10 weeks, respectively [Arimoto *et al.*, 1982]. It should be noted that this performance may not be achievable by some existing operational satellites or experimental satellites.

An extensive discussion of the current technologies involved in station-keeping sub-systems is included in Report 843. This material describes both chemical and electrical engines, their performance, and compares their advantages.

4. Conclusions

To sum up, it is an important objective for geostationary satellites to be maintained with high standards of station-keeping, taking into account all possible kinds of apparent satellite movement (longitudinal residual movement, residual orbit eccentricity and orbit inclination) as well as the accuracy with which the actual position of the satellite can be determined.

As the minimum required satellite spacing can be decreased by improved communication techniques, the ultimate orbit capacity will become more and more a function of the achievable satellite station-keeping tolerance and all possible technological means of attaining reduced station-keeping tolerances should be explored.

REFERENCES

- ARIMOTO, Y., SEIOMI, T., NISHIGAKI, T., KAWASE, S. and MURAKAMI, H. [1982] Orbit control of communication satellite based on one station tracking. Proc. 13th International Symposium on Space Technology and Science, Tokyo, Japan.
- KAWASE, S., KAWAGUCHI, N., TANAKA, T. and TOMITA, K. [March, 1981] Precise calibration of geostationary satellite tracking systems. *IEEE Trans. Aerospace Electron. Systems*, Vol. AES-17, 2, 166-172.
-

REPORT 1002-1

FLEXIBILITY IN THE POSITIONING OF SATELLITES

(Study Programme 28A/4)

(1986-1990)

1. Introduction

In order to make most efficient use of the geostationary orbit and to carry out bilateral or multilateral coordination of satellite networks, it is sometimes necessary to change the announced position or even the actual occupied position of a satellite. In many cases the orbital change required is small, of the order of one degree, but in other cases shifts of several degrees are necessary if full advantage of spacecraft antenna discrimination is to be taken in accommodating a new requirement. Simulation studies using the ORBIT-II programme have provided quantitative evidence of the advantage to be gained through the ability to re-position a satellite after initial positioning in orbit (see Report 870).

Satellite relocations are technically and operationally feasible and have already been demonstrated on various classes of satellites. However, flexibility of orbit location does present technical and operational difficulties. The potential advantages and the difficulties of satellite re-positioning are discussed in this Report.

It should be considered in the context of burden sharing, that the feasibility of accepting repositioning rather than some other burden will depend upon the character of the affected earth and space stations. Certain features need to be specified for the space station at the design stage, in order to make repositioning feasible at all.

Two different forms of relocation have been considered, namely i) a reduction in the existing spacing of satellites in the orbit and ii) a complete reappraisal of the sequence of satellites in an orbital arc. An advantage of i) is that satellites could, if necessary, continue to transmit to tracked earth stations during the relocation process, since the paths of the satellites would not cross. The main disadvantage of this scheme is that it requires several satellites to move. Though scheme ii) may require fewer satellites to move, those which did move would be likely to be moved further, and would therefore suffer penalties in terms of service outages, fuel burn and change of coverage areas which are unlikely to be operationally acceptable.

The introduction of flexible satellite positioning will have major implications for the coordination procedures, but it must be recognized that it will only be applicable to certain services. The categories of services that will not be amenable to satellite relocation are the Broadcast Satellite Service (BBS) and other services on multi-mission satellites which incorporate the above. Multi-mission satellites may be limited in the degree to which orbital re-positioning is feasible even where BSS links are not incorporated.

2. Orbit efficiency and system considerations

It should be noted that it is not possible to say with certainty which geographical areas would need to be covered at some time in the future from a given part of the orbit. Full advantage could therefore be taken of this means of optimizing the use of the orbit only if networks were designed so that their satellites could be relocated, if necessary, within a service arc after having been put into service. This ability to relocate satellites after they have entered service could also be of great value in allowing room to be found in orbit for new satellites for unforeseen networks. Such relocation may be more cost-effective than alternative technical solutions – such as improved earth-station antennas or new, sophisticated, modulation techniques.

However, at this point in time, it is difficult to ascertain the technical feasibility and cost effectiveness of building satellite system networks to achieve substantial orbit position flexibility. Relocating a satellite within its service arc should be acceptable during the paper design phase, whereas during the development and construction phase, orbit changes should be confined to predetermined limits where the technical and cost penalties are reasonable (and acceptable). This can only be determined on an individual basis. At present, a relocation capability of satellites of $\pm 2^\circ$ from the nominal orbital positions appears feasible. Operational systems should not be moved in orbit unless done voluntarily, and any increased interference imposed by the need for accommodating new systems should be guided by the Recommendations of the CCIR.

The impact on system margins due to decreased elevation angles can be significant depending on the frequency of operation. Consider, for example, the case of a system trying to meet the CCIR performance and availability criteria (Rec. 522, Rec. 614, Rec. 579)

In the 14/11 GHz band, with a rain rate of 30 mm/hr for 0.025% of the year a decrease in elevation angle from 10° to 6° corresponds to an increase in fade margin of about 3 dB. For a rain rate of 55 mm/hr for 0.025% of the year the corresponding variation in fade margin at 14/11 GHz band is 6 dB.

For the 6/4 GHz band, the changes are negligible for elevation angles above approximately 5 degrees.

3. **Potential problems associated with satellite re-positioning**

3.1 *Service arc limitations*

The service arc of satellites serving areas which are very extensive in longitude would be short because their visible arc is small. A possible way of extending the service arc is the sub-division of the service area between two satellites, well separated in orbit and connected by inter-satellite links. However, such a method would be costly.

It has been observed that multi-purpose satellites may provide services in addition to those of the fixed-satellite service and these other applications may determine the orbital position required. For meteorological services, for example, the concept of visible arc may not be relevant.

3.2 *Earth-station antennas*

A change in satellite location would require adjustment to earth-station antenna pointing direction and (for linear polarization) adjustment of the plane of polarization. However, with small earth-station antennas and with satellites kept on station to within $\pm 0.1^\circ$ East-West and North-South, earth-station antennas may not need to be steered to track the satellite in normal operation. Many small earth stations will not have technical staff permanently assigned to them. An increasing number of networks will be limited to manual antenna tracking and only a limited range of adjustment of the beam pointing direction. Thus, even a small change in satellite position could present severe mechanical and operational problems and might involve visits by technical staff to all earth stations in the network and interruptions to service. Antenna foundations should be designed to allow for worst-case changes in pointing direction as appropriate for each earth-station site and service arc.

Changes in earth-station antenna elevation might affect the clear-sky G/T and the severity of propagation degradations. Such effects may be significant in climates where rain is heavy and the angle of elevation at the earth station is low. The up-link and down-link e.i.r.p. margins should be increased where necessary to take account of the possible need to move the satellite.

Changes in earth-station antenna elevation, azimuth and e.i.r.p. might invalidate coordination with terrestrial radio stations operating in the same frequency bands. It would, therefore, be desirable to take into account possible future satellite movements in the initial frequency coordination process.

Changes in elevation are accompanied by a change in azimuth also. The change can range from a very small value, for earth stations at high latitudes, to 180° for earth stations on the equator and near the sub-satellite point. From a system point of view, however, it is the elevation angle changes which are the more significant since these will impact on path loss variations, and fade margins required under fading conditions.

3.3 Operational considerations

3.3.1 Earth station repointing

The most obvious impact on the earth station network would be the need for changes to the antenna pointing and polarization angle settings. This is only considered a significant problem for antennas which lack tracking capability. Movement of the order of 10° in bands shared with the terrestrial network may cause coordination problems.

3.3.2 Repointing of very small antennas

The e.i.r.p. of satellites in the FSS are increasing and soon it may become possible to employ ground receivers with antennas of less than 1 m in diameter. The ease with which people with little or no experience could repoint antennas depends very much on the size and type of antenna used. However, the need for polarization adjustments would present a problem unless circular polarization were used.

3.3.3 Repointing of 1 - 2 meters antennas

In the case of medium power satellites used for TV distribution SMATV* etc, antenna sizes of between 1.0 and 2.0 meters are typically required in the beam centre. These non-tracking earth stations could be repointed over a range of $\pm 10^\circ$ without too much physical difficulty.

With such antennas it would also be necessary to change the polarization orientation for linearly polarized transmissions. Polar mounted antennas greatly simplify the job of moving between different satellite positions and are also being increasingly used in conjunction with automatic repointing and polarization adjustment equipment.

For the cases described in this and the above sub-section, the logistics of arranging the repointing would have to be taken into account. For networks which involve large numbers of earth stations the time required to repoint the entire network could result in unacceptable outage times.

* Satellite Master Antenna TV

3.3.4 Repointing of 2 - 5 meters antennas

In the 14/11 GHz band an antenna of this size has a narrow beamwidth, and is therefore more likely to have tracking, whereas at 6/4 GHz an antenna of this size is still unlikely to have tracking.

Antennas of this size are frequently employed in the case of, either, lower power satellites or, for reception outside the main coverage area of higher power satellites. More importantly in this case, is the fact that antennas with insufficient steering range would have difficulties regarding repointing.

Any movement of the satellite(s) outside of their nominal station-keeping constraints would lead to substantial operational difficulties for some services, irrespective of how slowly the satellite position was changed. In the case where 4.6 m 14/11 GHz band earth stations are used, a satellite drift of 1° in longitude would require pointing adjustments of all earth stations. Since the antenna beamwidth would be about 0.25° , the pointing would have to be updated four times during the manoeuvre to keep performance loss due to mispointing within 3 dB. This situation is operationally extremely difficult and expensive.

It would be impracticable for antennas in this category to be adjusted by unskilled persons, so sufficient time and money would have to be allowed for trained technicians to attend all the terminals involved, which may run into hundreds to thousands. This would be quite a major undertaking and should not be dismissed lightly.

Some multiple satellite systems are seeking to employ multiple-beam earth stations for simultaneous access to more than one satellite. Should such earth stations proliferate then the allowable movement of one satellite relative to the others in the system would be severely constrained.

3.3.5 *Service disruption*

If the satellite has to pass through the orbital position of another satellite operating in the same frequency bands in moving from its old location to the new one, interference may arise if both networks are kept in operation. Further, the mechanics of the move may dictate that some of the major sub-systems of the relocating satellite be temporarily deactivated, e.g. solar panels or antennas may have to be locked in position during the move, precise and continuous attitude control may be difficult. Thus, there could be circumstances when some or all of the traffic normally carried by the satellite would have to be re-routed during the relocation period, which may last several days.

Some of these problems might not arise if there was a spare satellite in orbit. It would then be possible to locate the spare satellite in the new operational position, and to transfer service from one satellite to the other by pointing over the earth-station antennas. In this way the problems of maintaining a unidirectional service during a change of satellite location might be completely solved, but there would be less amelioration of the problems of operating a group of unattended earth stations operating in a fully-interconnected two-way mode.

An important consideration, both operationally and commercially, is the length of time for which an outage would occur during repositioning of a satellite. This will depend on the amount of fuel that can be used for such purposes, whether a spare in-orbit satellite is available and the longitudinal change required. In some cases, the length of time for all the non-tracking earth stations to be repointed may prove to be the critical factor.

3.4 Coverage areas and satellite antennas

A consequence of moving the satellite from one location to another would be to distort the coverage areas on the ground. The extent to which this impacts on the overall performance will depend on many factors including, the use of single or multiple beam satellites, the size of the beams, the extent to which the satellite is moved and the degree of repointability of the satellite antennas (see Figs. 3 and 4).

With the satellite repointed towards the nominal beam centre, the coverage areas differ only slightly at the extremities. In the worst case, near the equator, the satellite antenna beamwidth would need to be increased by about twice as much as at higher latitudes. This would be of greater significance for shaped beams than for spot beams.

A satellite antenna is usually designed to provide optimum coverage of a given geographical area from a specific location on the geostationary-satellite orbit. If the satellite is required to have a large service arc, it would usually be necessary to be able to change the pointing angle of the beams while the satellite is in orbit. In addition, it would be necessary for the cross-section of the beams to be shaped so that the footprints covered the service areas from any point on the service arc. The gain of the satellite beams is therefore likely to be less than it would be if their shapes were optimized for a single orbital location. In consequence there may also be a greater tendency to interfere with other satellite networks and a greater liability to suffer interference.

For large service areas at any microwave frequency and for smaller service areas at the higher microwave frequencies, the use of reconfigurable compound antenna systems with beams made up of a large number of high gain "beamlets" provides an efficient solution to the problem of steering beams and adjusting their cross section so that the performance of the system is maintained and the interference situation is not aggravated.

For smaller service areas, conventional spot beams will be more commonly used. Studies reported so far indicate that, for the assumed satellite systems, a satellite performance penalty not exceeding 1 dB and an interference penalty not exceeding 2 dB would arise for a re-positioning capability of $\pm 10^\circ$. In a practical situation a smaller relocation should prove sufficient to achieve adequate benefit. Keeping within these penalty limits would probably entail the following requirements:

- satellite beams must be steerable about the pitch axis of the satellite. When the satellite has only one beam, it may be feasible to obtain sufficient control in pitch by biasing the attitude control system of the satellite. When there is more than one beam, it may be necessary to steer the beams in pitch independently;
- in some circumstances it will be necessary to steer beams about the roll axis of the satellite: the factors which make roll control more likely to be necessary are:
 - smallness of beam coverage area; for example, an equivalent diameter of 200 km or less,
 - high latitude of service area,
 - large difference between satellite longitude and service area longitude.

Steering of multiple satellite antenna beams generated by a single reflector presents an additional difficulty which increases as the beam size is reduced. This problem will be particularly severe in the higher frequency bands, where very high gain satellite antennas may be needed to overcome propagation losses.

Even with means of beam steering in both pitch and roll, the loss of network performance may exceed 1 dB if there is a large longitude difference between the satellite and the service area.

These conclusions are based on studies made assuming service areas which are approximately square. Further studies assuming very differently shaped service areas and also the use of multiple beams to cover the required service area, would be desirable.

The situation is considerably eased if the satellite antenna can be optimized to the new service area during the later stages of fabrication or even while in orbit. If such techniques are available, there may actually be advantages in occupying an orbit position with modest elevation angles. This can perhaps best be shown by way of an example. Consider a satellite network with two spot beams, one serving an area at 40° N and the other serving an area at a longitude 20° further east and at a latitude 10° N. When the satellite is moved westwards by 50° of longitude from an initial position on the longitude of the 40° N service area, (that is to say, the satellite is moved until earth stations are beginning to lose sight of it), the following phenomena will be observed:

- a) the minimum area of cross-section of the beams required to cover each service area will decrease. This would permit higher gain to be used on an optimized satellite;
- b) the aspect of the service areas as seen from the satellite becomes more distorted and skewed as they approach the edge of the Earth's disc;
- c) the angle of elevation of the satellite seen from earth stations will decrease, the path length will increase and the propagation loss due to rain will also increase;
- d) as seen from the satellite, the directions of the beam axes measured about the pitch axis of the spacecraft will change by about 5.5° ;
- e) similarly the angle of the beam axes will change about the roll axis of the spacecraft by about 0.15° for the 10° latitude service area and by about 0.3° for the 40° latitude service area;
- f) the relative angles between the two beam axes, measured in pitch and roll, will change from about 3.4° and 4.5° respectively to 2.97° and 4.4° respectively.

Larger changes of beam pointing angle occur for extreme differences in longitude between satellite and service area.

Figure 1 gives an approximate quantification of a) and c) for a hypothetical square service area at 40° latitude, the rain loss being assumed to be 1 dB at 30° elevation and varying with the secant of the angle of elevation. This rain loss assumption is broadly valid for heavy rain at 4 GHz but it would be optimistic for rainy areas at 11 GHz. Combining beam gain, path loss and propagation loss due to rain, it is seen that there is a very broad optimum angle of elevation around 20° , but the penalty for using a higher angle of elevation is quite small. A higher angle of elevation would be preferable for rainy areas at 11 GHz and higher frequencies.

3.5 *Solar eclipse*

Satellites with insufficient battery capacity to sustain services in full during eclipse might be limited to orbital locations where eclipse occurs outside busy traffic periods. This constraint should be avoided, where possible, in the fixed-satellite service by providing sufficient battery capacity to maintain all services during eclipse.

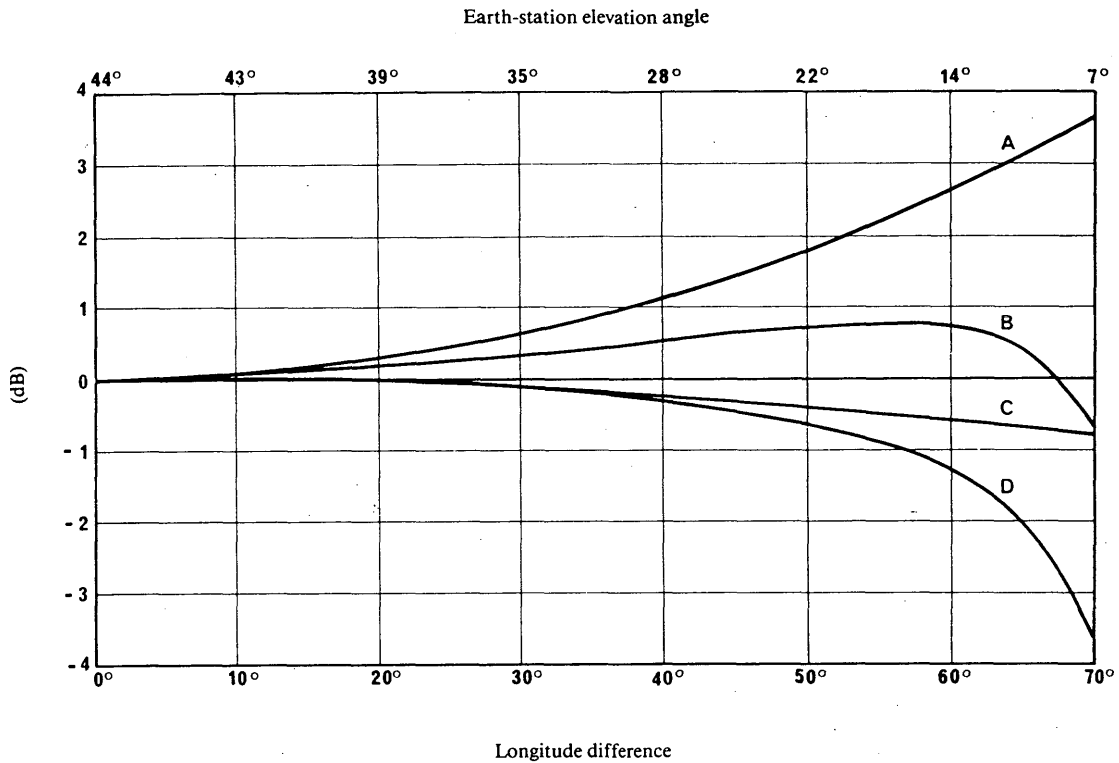

FIGURE 1 - The effect on network performance of covering a 10° square country at 40° latitude for a range of specific alternative orbital locations

(Parameters are expressed relative to the zero longitude difference case)

- A : antenna gain
- B : system performance (summation of A + C + D)
- C : path loss
- D : propagation loss

3.6 Propellant required for changing orbital location

The factor that determines the capability and speed with which a satellite can be moved around in orbit is the amount of stationkeeping fuel that can be used for such purposes. For a medium sized satellite, a movement of 10° in about one day would require a year's stationkeeping fuel.

It is therefore desirable to limit the number and extent of the repositionings for any one satellite, in order not to impose too severe a penalty in terms of antenna coverage and stationkeeping fuel.

The fuel requirement for repositioning a satellite in orbit is a function of orbital velocity, duration of transit, spacecraft mass and propulsion efficiency (see Report 556). The manoeuvre is performed by means of applying two velocity increments, $+\Delta V$ and $-\Delta V$ to the satellite separated by the time period of repositioning. Annex I outlines the calculation of a range of orbit repositioning manoeuvres using classical orbit motion equations. Using this approach and assuming parameters for a typical spin stabilized spacecraft e.g., Anik-D, the trade-offs on fuel consumption versus drift time for relocations of 5°, 10°, 15° and 20° are given in Fig. 2.

The above comments obviously apply only to post-launch relocations. For relocation prior to launch, the fuel and time penalty would in general be considerably less than that associated with movement while in geostationary orbit since it would only require incremental changes to the launch profile.

It can be seen from Fig. 2 that a rapid relocation to minimize traffic dislocation would involve a large penalty in station-keeping fuel and hence would impact on the operational life of the spacecraft (see Annex I).

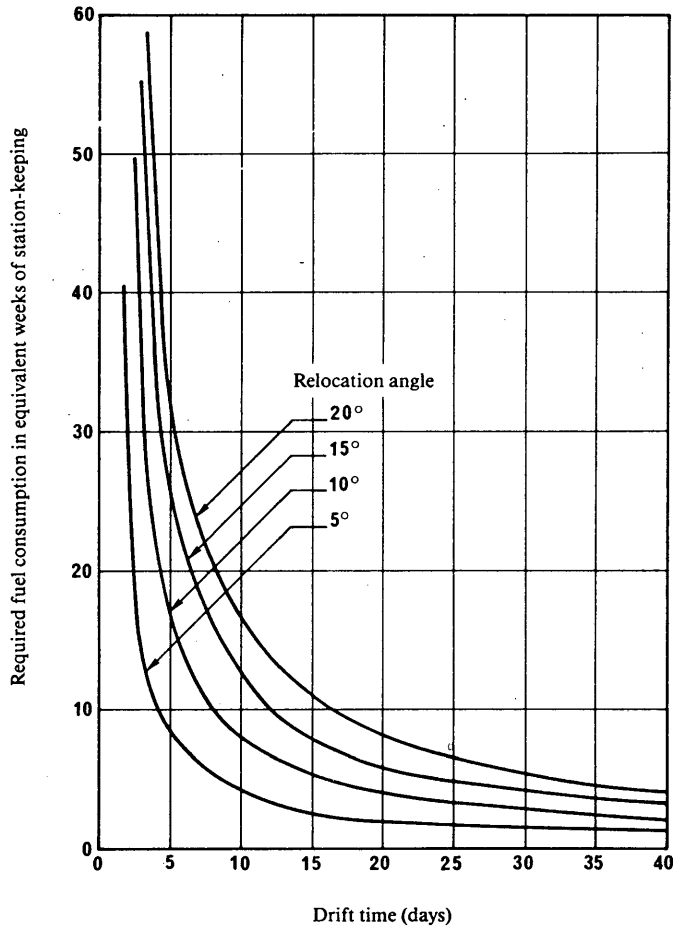

FIGURE 2 – Satellite fuel consumption for longitudinal relocation

Mass of spacecraft : 634 kg
 Masse of fuel : 109 kg
 Service life : 7 years

3.7 Control during relocation

The transfer orbit to reposition a satellite is slightly elliptic with the perigee (for movement from East to West) or apogee (for movement in the opposite direction) being tangential to the geostationary orbit. Thus, with respect to geostationary axes, the satellite will appear to oscillate. If it is necessary to by-pass other satellites en route, the very remote possibility of collision must be taken into account. This is another factor in determining the relocation drift rate and any temporary change in inclination.

It is also necessary to coordinate the telemetry, tracking and telecommand signals while the satellite is in radial proximity to the other satellites (see Report 845).

For satellites with large extended structures – e.g. solar panels or unfurlable antennas – it may also be necessary to take the acceleration stresses on these structures into account in determining the drift rate and the satellite attitude during the manoeuvre. Allowance should be made for recommissioning tests when the satellite has reached its new station.

3.8 *Other problems identified*

A number of other problems have been identified, however, studies have not been made and little can be said at this time. These are:

- if a satellite were to operate in a planned frequency band, for example the broadcasting-satellite band at 12 GHz, as well as in the fixed-satellite service, it may not be free to move to assist the entry into orbit of a new satellite of the fixed-satellite service. Similar situations may arise in other cases of satellites which combine different services;
- further constraints may arise if on-board RF or some other types of tracking system are used;
- no assessment has been made of the effect of satellite relocation on satellites using inter-satellite links; this should be the subject of a study.

4. **Examples of relocated satellites**

A number of satellites, both experimental and operational, have been moved from one position to another on the geostationary arc. The experimental satellites ATS-6 and Hermes were moved significantly in orbit to carry out different phases of their experimental programme (not to accommodate additional satellites). ATS-6 was moved from a position over the United States of America to a position over India, and later returned to a position over the United States of America. Hermes was moved from its original position at 116° W to a new position at 142° W, from which it was able to carry out an experimental programme with earth stations in Canada and Australia. These large orbital movements are not expected to be typical with operational satellites, but they do indicate that large orbital changes are in fact possible.

Movements of operational satellites are not common, but do occur. The Canadian Anik-A1, A2 and A3 satellites were moved between 104° W and 114° W in such a way that operational traffic was not constrained by the moves. More recently, the Anik-C2 satellite was moved from 112.5° W to 105° W over a period of about 20 days to provide temporary service in the United States of America. In the process, about three equivalent weeks of station-keeping fuel was used. The satellite will be moved again when the temporary service provision is completed. Many other satellites have been moved small amounts in the geostationary arc for various reasons; these are only typical examples.

5. Second generation satellite considerations

There may be opportunities for orbit position changes during the transition from one generation of a satellite system to the next. It is clearly desirable to maintain services from the same orbit location from one generation to the next but, given that there is generally a period of several months during which simultaneous operation of a new and an old satellite may be possible, it is feasible that relocation could be achieved during this transition period in some circumstances.

6. **Conclusions**

It is recognized that to design a system for flexibility of orbital location might impair the performance and increase the cost of the satellites, particularly since it may often require the provision of a facility for re-directing the beams by command to maintain the required coverage. Other additional costs may arise in operating the

system when the position of a working satellite is being changed. Nevertheless, it is also evident that if all satellite networks have a large service arc, there is a greater probability that unforeseen new networks will be successfully coordinated. It is therefore desirable that a wise balance be struck between the flexibility of a large service arc and the minimization of system costs.

Two schemes of relocation have been considered: the scheme in which satellite spacings are slightly reduced, and the scheme in which satellite paths would be required to cross in order to create a new ordering.

It can be concluded that:

- frequent changes of satellite location are not likely to be acceptable because of the cost in satellite thruster fuel and in loss of operational time. There may also be substantial cost and operational penalties in the Earth segment in some networks due to the need to re-adjust antenna pointing directions. Nevertheless, a change of satellite position once in the lifetime of a satellite should be tolerable if the benefit to another network is substantial;
- the problems of changing satellite location can be substantially reduced, often at relatively little cost, if the design and coordination of earth stations and satellites take account, from the beginning, of the possible need to change location at some time after entry into service, including the connectivity and service arc requirements of the operational network.

It appears that the most promising approach, both in terms of simplicity, and minimum inconvenience to users, would be to operate a "reduced spacing" scheme, whereby each satellite may be moved by a relatively small amount. A value of $\pm 2^\circ$ should be possible for satellites using existing technology. Inconvenience to users would be minimized by only relocating if absolutely necessary, and in any case by not relocating more often than once in the design lifetime of the satellite.

It is recognized that the difficulties of changing satellite antenna characteristics after launch might be insuperable in particular cases, if so, it would be beneficial if the design of the spacecraft were such that the antenna coverage patterns could be adjusted as late in spacecraft manufacture as is practicable.

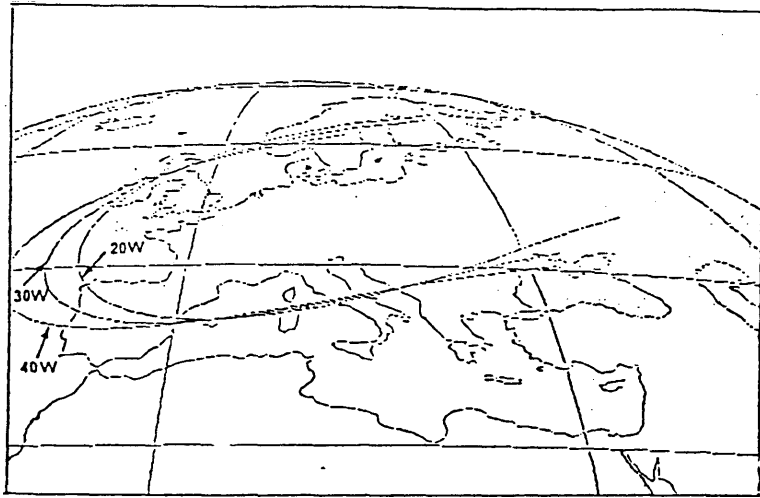

FIGURE 3 - Effect of $+10^\circ$ satellite shift on a single $4^\circ \times 2^\circ$ elliptical beam (with repointing)

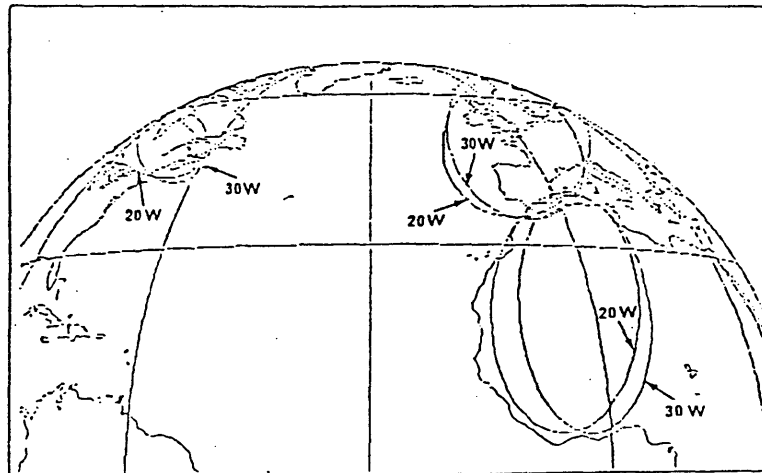

FIGURE 4 - Effect of 10° satellite shift on a multiple beam satellite (with satellite repointing)

BIBLIOGRAPHY

CCIR Documents

[1982-86]: 4/87 (United Kingdom); 4/88 (United Kingdom).

ANNEX I

FUEL CONSUMPTION AS A FUNCTION OF DRIFT RATE
AND ANGULAR DISPLACEMENT FOR RELOCATION OF A SPACECRAFT

Using standard orbital motion equations and the rocket equations for mass expulsion and assuming standard small increment approximations the following set of equations may be derived.

Given a required angular displacement of α° (positive for movement from East to West, negative for West to East) to be accomplished in n periods (days) then:

$$\frac{\alpha}{n} = \frac{P_t - P_0}{P_0} \times 360$$

or

$$P_t = P_0 \left(1 + \frac{\alpha}{360 n} \right) \quad \text{s} \quad (1)$$

where:

P_0 : normal period = $2\pi \sqrt{r_1^3/\mu}$ (s)

P_t : period of transfer orbit

The semi-major axis A of the transfer orbit is:

$$A = \frac{r_1 + r_2}{2}$$

or:

$$r_2 = 2A - r_1 \quad \text{km} \quad (2)$$

where:

r_1 : geostationary orbit radius = 42 164 km,

r_2 : apogee radius of transfer orbit (km).

The period of an orbit is given by:

$$P_t = 2\pi \sqrt{\frac{A^3}{\mu}} \quad \text{s} \quad (3)$$

where:

μ : gravitational constant of the Earth,

$$= 3.986 \times 10^{-5} \text{ km}^3/\text{s}^2$$

Hence from equations (1), (2) and (3), the quantity r_2 can be determined.

The orbital velocity for a circular orbit is given by:

$$V_0 = \sqrt{\frac{\mu}{r_1}} \quad \text{km/s} \quad (4)$$

When the energy of the orbit is incrementally changed and the orbit becomes elliptical it can be shown that the perigee velocity is:

$$V_1 = \sqrt{2\mu \left(\frac{1}{r_1} - \frac{1}{r_1 + r_2} \right)} \quad \text{km/s} \quad (5)$$

Hence the incremental velocity ΔV is:

$$\Delta V = V_1 - V_0 \quad \text{km/s} \quad (6)$$

Finally from the rocket equation the mass of propellant fuel required is given approximately by:

$$M_p \approx 2M_0 \frac{\Delta V}{gI_{sp}} \quad \text{kg} \quad (7)$$

where:

g : acceleration due to gravity at the Earth's surface = 9.809 m/s²,

I_{sp} : specific impulse of the thruster motors,

M_0 : original mass of the spacecraft.

In Fig. 1 the parameters for Anik-D as given below were assumed:

M_0 = 634 kg,

I_{sp} = 154.8 s for radial pulsed mode operation (for a three-axis stabilized spacecraft, a continuous thrusting mode can be employed which is more efficient, and consequently the absolute fuel consumption is correspondingly lower),

station-keeping fuel = 15.6 kg/year average,

maximum rate of fuel expended = 40 kg/h (for a three-axis stabilized spacecraft, this rate is typically reduced to 8 kg/h).

REPORT 558-4

SATELLITE ANTENNA PATTERNS IN THE FIXED-SATELLITE SERVICE

(Study Programme 1B/4)

(1974-1978-1982-1986-1990)

1. Introduction

Satellite antenna patterns have a significant effect on the utilization of the geostationary-satellite orbit, particularly when narrow beamwidths are employed. Improved control of satellite antenna patterns, particularly side-lobe levels, can lead to better utilization of the orbit, as discussed in Report 453. A continued improvement in orbit utilization might give rise to the possible need for a reference radiation pattern. This Report is an examination of the problems in defining such a reference radiation pattern and offers examples for further study.

2. Design considerations of satellite antennas

The satellite antenna is an integral part of a dynamic platform in a space environment. Mass and size are of paramount importance and are constrained by the launch vehicle payload envelope. The platform attitude stability, orbit inclination and longitudinal variations introduce tolerances which must be considered in the satellite antenna design.

Some satellite antennas are required to radiate beams of high polarization purity. This aspect of antenna design is discussed in Reports AK/4 and 555.

2.1 *Satellite antenna types*

The particular type of antenna utilized will depend on frequency, beamwidth and launch vehicle payload envelope (physical size and mass). Minimum beamwidths will depend upon the precision with which the satellite attitude can be stabilized as well as service requirements, such as area of coverage and frequency re-use.

Current pointing stabilities for spacecraft antenna platforms which do not employ radio-frequency tracking, are of the order of $\pm 0.2^\circ$. Unless tracking capability is included in the satellite, the antenna gain is limited to about 50 dB on-axis gain by the pointing stability. Higher gains require a considerable increase in satellite complexity.

At frequencies above 1 GHz, horns have been used for the larger beamwidths and focus-fed parabolic reflectors for smaller beamwidths. These two types have been used extensively in the past, but many spacecraft are currently using an offset-fed reflector and multi-beam lens antennas are also used on some prototype spacecraft. In the long term where TDMA systems may employ beam switching which would imply a multiplicity of very narrow beams on the satellite. This could lead to a need for beam steering flexibility to adapt to new earth-station location requirements.

2.2 *Main lobe patterns*

Ideally, the radiation pattern of the antenna should be such that energy is concentrated toward the earth stations in the network.

From a practical standpoint, the radiation pattern of a satellite beam should provide uniform illumination of the coverage area and none outside it (Fig. 1). This objective can be approached, but to do so requires the use of an antenna which is larger and heavier than a simple antenna which would provide almost as much gain within the coverage area. A simple antenna, having appreciable radiation outside the coverage area also provides a tolerance for attitude and orbital control errors. Figure 2 shows how the minimum gain in the coverage area varies with aperture area, assuming that the main lobe radiation pattern is of the form $(\sin^2 x)/x^2$. It is noted that there is an optimum aperture size for a given coverage area at a given frequency, but the aperture can be varied over a range of 2.4 to 1 about this optimum with only 0.5 dB variation in minimum gain. Another factor which also tends towards broader beamwidths, is the gain slope at the edge of coverage which increases with narrow beamwidths. This factor is significant because the platform instabilities, in conjunction with gain slope, affect the stability of the power levels throughout the network. Thus, there will be a tendency to minimize antenna size and mass and to provide tolerance for attitude and orbital control errors by using an aperture which is even smaller than this optimum, corresponding to a relative aperture area of less than 1 as shown in Fig. 2.

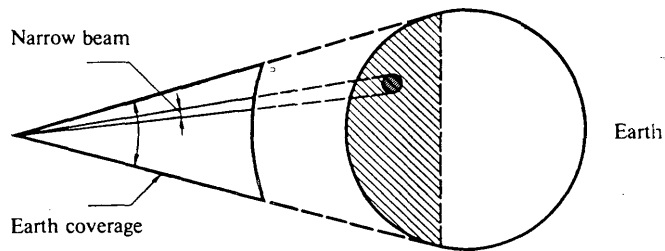

FIGURE 1 — Ideal satellite antenna patterns

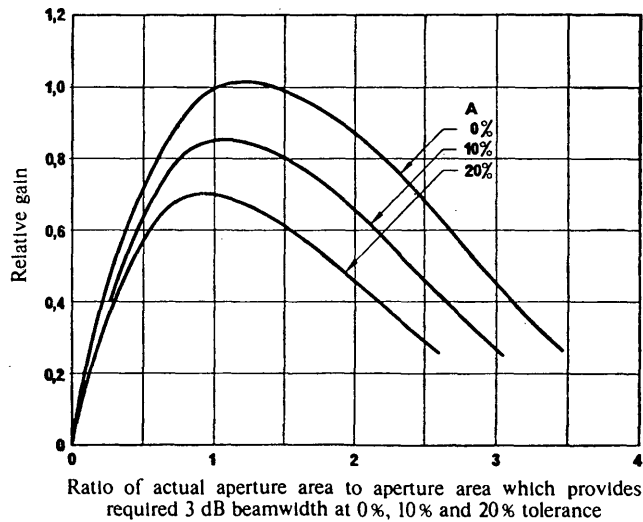

FIGURE 2 — Gain in the coverage area versus aperture area

A: Tolerance for antenna pointing errors as a percentage of 3 dB beamwidth

While there is an incentive to use the smallest aperture to give the required coverage, this is only possible if the required gain can also be met. In many practical cases, the minimum aperture which meets the gain requirement will not meet the coverage requirement and a shaped design must be used.

The concept of shaped beam antennas was first considered as a means of equalizing the energy over the coverage area as illustrated in Fig. 3 which shows the idealized patterns of a $(\sin^2 x)/x^2$ function and the sum of two displaced $(\sin^2 x)/x^2$ functions producing a 3 dB gain ripple. The minimum gain between the 3 dB points will be approximately the same for both patterns, but the aperture area required to produce the shaped beam, is an order of magnitude larger and the gain slope at the 3 dB points is much greater. Beam shaping can also be applied in the plane orthogonal to the beam axis in order to obtain a better match between coverage area and service area.

The use of shaped beam antennas has three practical advantages to the system designer and leads to improved orbit utilization. These are:

- more uniform distribution of the energy over the service area leading to better use of the spacecraft mass/power budget;
- achievement of higher gain while still covering large surface areas permitting reductions in transmitting powers and related mass/power considerations;
- the use of larger apertures decreases the radiation outside the coverage area.

Recently, there has been a considerable amount of research and development effort in the area of shaped beam antennas for spacecraft including configurations which use a multi-feed parabolic reflector and the multi-beam lens antenna. Annex I contains examples of some of these shaped beam antenna patterns.

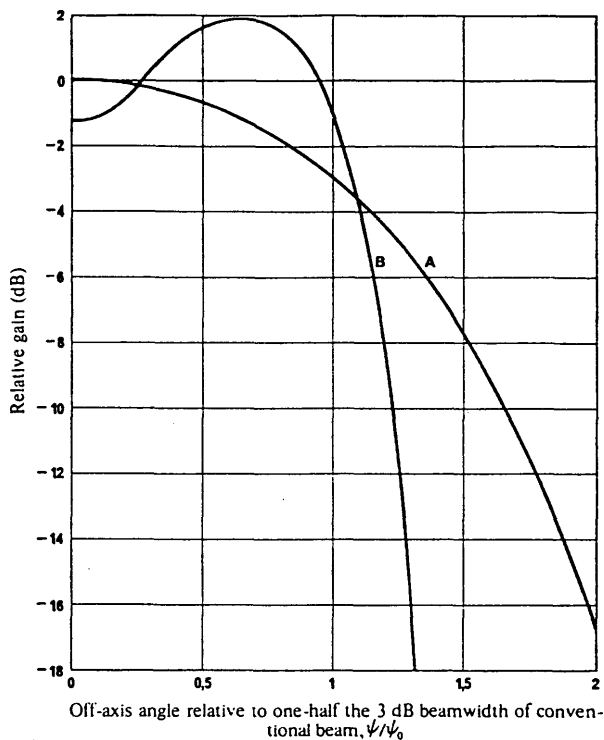

FIGURE 3 — Shaped and conventional beams

- A: Conventional beam: $\frac{\sin^2 x}{x^2}$
- B: Example (shaped beam)

Note. — In the formula for the relative gain of the conventional beam, $\frac{\sin^2 x}{x^2}$, the argument, x , can be expressed as $1.39 \frac{\psi}{\psi_0}$ radians. Thus, when $\psi = \psi_0$ the relative gain of the conventional beam becomes: $\frac{\sin^2 1.39}{1.39^2} = 0.707^2 = 0.5$; ratio - 3 dB

2.3 Side-lobe gain pattern

In terms of orbit utilization and interference reduction, side-lobe radiation patterns are most significant. Side lobes are the result of several design features of the antenna systems, including diffraction and spill-over around the edges of a reflector or subreflector, aperture blockage, amplitude and phase distribution over the aperture, and off-focus feeds. Aperture blockage can be a limiting factor in reflector systems if the D/λ is low. The amplitude and phase distribution over the aperture is significant for all antenna types. As the aperture illumination is varied from uniform to more tapered distributions, the peak gain decreases slightly and the side lobes are significantly reduced where blockage is not a factor. This effect is shown in Fig. 4.

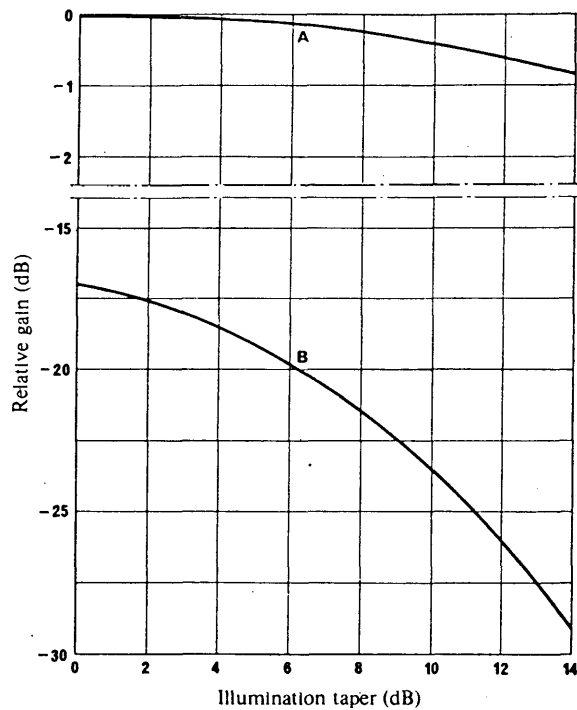

FIGURE 4 - Effects of aperture illumination

A: main lobe
B: first side lobe

For single focus-fed prime focus parabolic reflectors with 10 dB illumination tapers and a D/λ of about 10, the first side-lobe level is usually about -20 dB relative to on-axis gain. As the D/λ is increased, the first side-lobe level will decrease to about -25 dB relative to the on-axis gain. Aperture blockage accounts for higher side-lobe levels at low D/λ . For focus-fed parabolic reflectors for earth coverage ($D/\lambda \approx 4$) the first side lobe would be about -15 dB relative to the on-axis gain. Changing the illumination taper does not materially improve the near side-lobe levels when aperture blockage is the limiting factor. It is likely that antennas without significant aperture blockage will have to be used to achieve low side-lobe levels. This leads to asymmetrical arrangements which have potential disadvantages in other respects.

The slope of the envelope of the side lobes must also be considered. For antenna types, other than horns, and where no special attention is given to side-lobe reduction, the slope is generally of the order of -7.5 dB/octave of off-axis angle. For horns without reflectors the slope is more typically of the order of -9 dB/octave.

When emphasis is placed on low side-lobe levels, first side-lobe levels of -30 dB relative to the on-axis gain and side-lobe envelopes of -12 dB/octave appear attainable. These values are generally achievable with antenna types with effectively no aperture blockage.

For multiple feed parabolic reflector systems, the side-lobe levels increase with displacement of the main lobe. As the displacement of the main lobe increases, the side-lobe levels on the axial side (coma side lobes) increase, while those opposite tend to merge with the main lobe. The coma side lobes tend to increase less rapidly when large illumination tapers or large f/D ratios are employed. Figure 5 shows the first coma side-lobe level as a function of normalized off-axis angle for an $f/D = 1$ and a 20 dB illumination taper antenna. The relative angular position of the first coma lobe is approximately coincident with the position of the normal first side lobe. Thus, if multiple feeds are utilized to form complex main lobe shapes (offset angles of the order of one beamwidth) some of the coma lobes may fall within the coverage area. When spatially separate beams are generated with multiple feeds, the coma side lobes may fall within the coverage areas of other satellite systems.

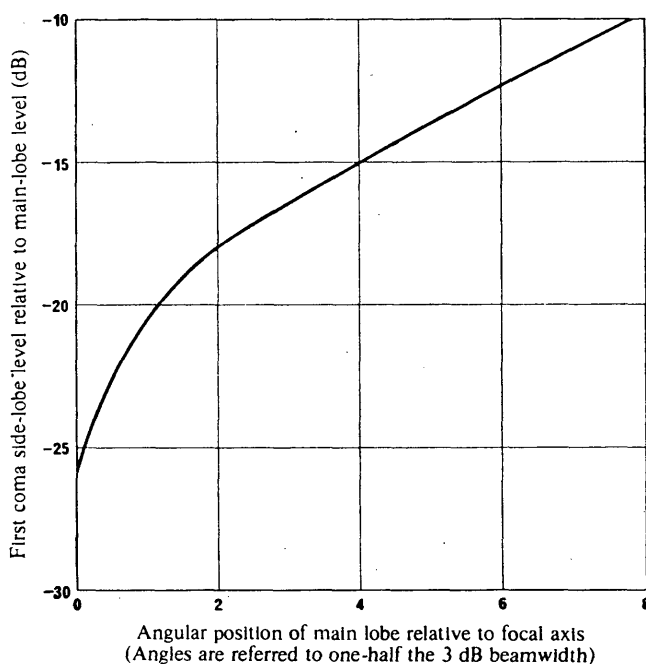

FIGURE 5 – First coma side-lobe level versus angular position of main lobe relative to focal axis

20 dB taper, $f/D = 1$

Coma side lobes are a fundamental property of off-focus fed parabolic reflector antennas and can result in high side-lobe levels. Multiple feeds mounted within the aperture on a common reflector also increase the aperture blockage which increases the level of the near side lobes.

Beam shaping can also be achieved with arrays. Because of the relatively small angular coverage required, a few high gain elements can be used. However, grating lobes may be an important consideration in the side-lobe regions.

As noted previously, the degree to which polarization is maintained in the side-lobe regions is uncertain at this time and requires study.

Annex II contains selected measurements of side-lobe levels of several different shaped beam antennas.

3. Orbit utilization

3.1 *Effects of side-lobe envelopes*

Ultimately, main lobe gain must be reduced or aperture size increased, or both, in order to improve orbit utilization. The first effect is shown in Fig. 4. By increasing the illumination taper, the first side-lobe level is reduced, and the side-lobe envelope slope is increased. However, the relative position of the near side lobes is not significantly altered. Figure 6 shows the relative improvement in orbit utilization (assuming a homogeneous system with circular narrow-beam satellite antennas and a -7.5 dB/octave side-lobe envelope slope) as the overall side-lobe envelope level is reduced. It is assumed that a number of narrow beams are formed at a point in the geostationary orbit (no earth station discrimination), and then the relative number of beams which can be formed for a given interference is computed as a function of the side-lobe envelope level. Side-lobe envelope improvements of relatively small amounts have significant effects on orbit utilization.

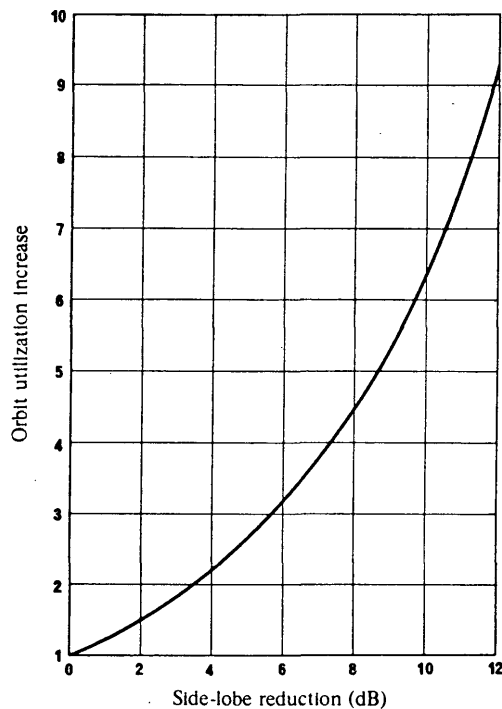

FIGURE 6 – *Effect of side-lobe level on orbit utilization*

The effect of increasing the aperture size is to reduce the off-axis angle at which the side-lobe peaks occur, even though the side-lobe levels may not be improved. It was shown in Fig. 2 that there is a relatively large range of aperture size over which minimum antenna gain over a given area is not significantly changed for un-shaped beams. When beam shaping is employed, the aperture size is increased. The relative improvement in orbit utilization as aperture size is increased, is directly related to aperture area.

The satellite beamwidths fall generally into three categories:

- beamwidths of about 17° (earth coverage);
- beamwidths of 17° from earth coverage to about 5 to 10° ;
- narrow beamwidths, considerably less than earth coverage.

For the full earth coverage case, the main lobe encompasses the Earth and somewhat beyond with no side-lobes directed towards it. Beyond the Earth's edge as viewed from a satellite, the only concern is the possible interference to a satellite operating with reserve frequencies; for example, transmitting in the 6 GHz band and receiving on 4 GHz. Figure 7 shows typical measured patterns for Intelsat-IV and IV-A global coverage antennas out to angles far beyond the Earth's edge.

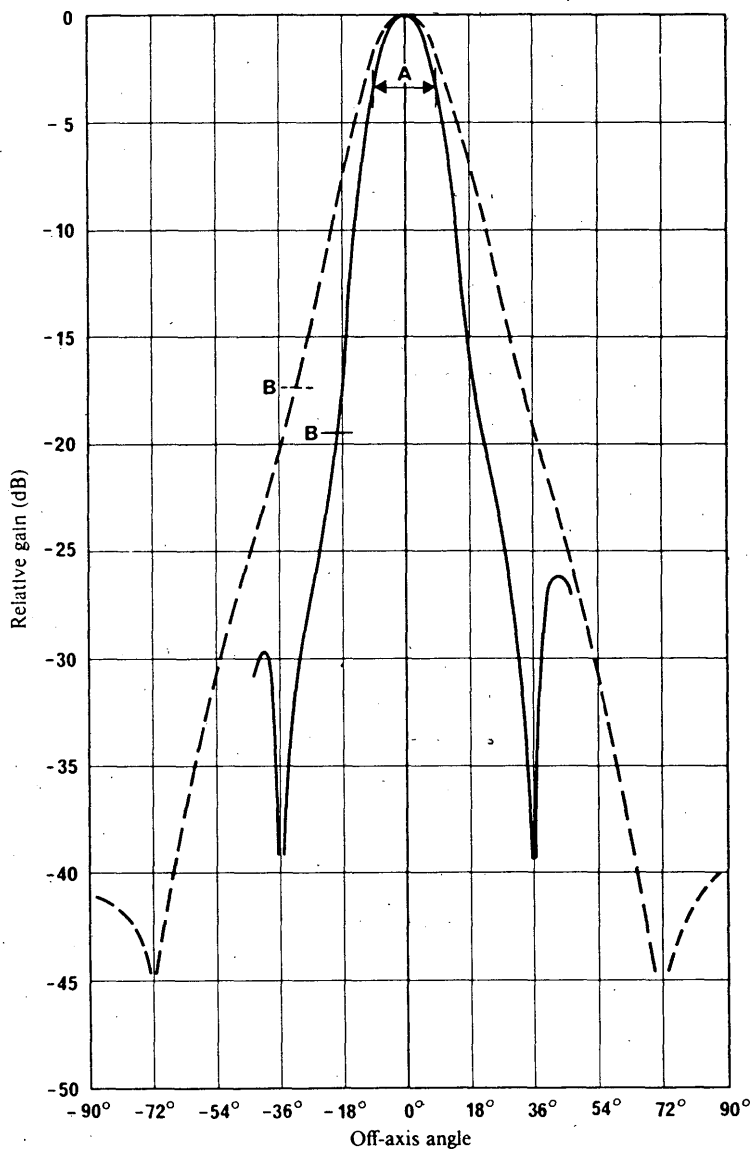

FIGURE 7 - Circularly polarized global coverage satellite antennas - typical measured patterns at $f = 3950$ MHz

- Intelsat-IV, conical horn with flat 45° reflector
 - - - Multimode conical horn, for use on Intelsat-IV A
- A: angle at Earth edge as viewed from a geostationary satellite
 B: isotropic levels

For the second case, the main lobe and the first side-lobe area are the principal sources of interference to earth terminals, and for the third case, the higher order side lobes also represent a source of interference to earth stations.

With satellite antennas having less than earth coverage, the earth station antenna radiation patterns must also be considered in assessing orbit utilization. Considering a limiting condition where adjacent satellites provide coverage to adjacent earth areas, two conditions can be postulated: (1) the earth station D/λ is considerably larger than the satellite D/λ ; and (2) the earth station D/λ is comparable or less than the satellite D/λ . In the first case, most of the discrimination is achieved with the earth station antennas. Operation with overlapping of the satellite first side lobe is quite feasible. For the second case above, where little discrimination is achieved from the earth-station antennas, the first side-lobe region of the satellite antenna may be very significant. Near side-lobe levels ≤ -30 dB could materially enhance orbit utilization when the satellite antenna D/λ is comparable to or greater than, the earth-station antenna D/λ . This level may be achievable with certain antenna designs in non-adjacent coverage areas.

3.2 *Narrow-beam antenna steerability*

Another aspect which should be considered in the design of satellites using narrow-beam antennas, is the steerability of these antennas. It is anticipated that, as the satellite orbit density increases, repositioning of existing satellites may be necessary to accommodate new satellites. (see Recommendation 670 and Report 1002).

The repositioning capability of a satellite may be very restricted if the satellite antenna beam angle with respect to the satellite platform is fixed. While the usable arc of the geostationary-satellite orbit for a given system is limited by line-of-sight considerations, it should not be unduly restricted by steerability limits of narrow-beam satellite antennas. This matter is discussed in Report 1002.

3.3 *General design considerations*

The simplest type of antenna beam is one of circular or elliptical cross section. The footprint on the ground of such a beam will be a distorted ellipse, the distortion being progressively more pronounced as the service area is more removed from the sub-satellite point. For a given antenna beam cross section, the position of the satellite relative to the coverage area determines the size and shape of the coverage area. In some cases, some shaping can be achieved by varying the shape of the reflector or the feed horns, but this may have undesirable effects on antenna efficiency and side-lobe levels. However, as the example of Fig. 8 clearly shows, shaped beam coverage is more efficient than elliptical coverage. Radiation to the shaded area is lost energy.

In planning a shaped beam an important factor is the minimum curvature circle conforming with a part of the actual coverage contour, as shown in Fig. 8. The minimum circle (or ellipse) determines the size of the satellite antenna reflector and also such important factors as antenna gain, RF and DC power requirements, and sometimes minimum spacecraft dimensions. These factors, in turn, may affect the cost of the spacecraft and its launcher.

In some applications, it is important to guarantee a minimum power flux-density throughout the entire coverage area. If this is set by the requirements at the edge, then a simple beam (such as would result from a single feed and parabolic reflector) would create an unnecessarily high power flux-density in the centre of the area. A better solution would be to require a shaped beam giving more uniform illumination within the entire area. Outside the coverage area, the power flux-density will fall off more rapidly, thereby reducing the interference potential. It may be necessary to coordinate the antenna pointing and axial rotation tolerances with the gain slope along its beam edges.

Figure 9 presents in simplified form some of the advantages of shaped beams. If the cross section of the coverage area corresponds to the 3 dB beamwidth of a circular (or elliptical) simple beam, the required power flux-density will be achieved at the edges. The same value could be achieved, for example, by a composite arrangement of four narrower beams. The obvious advantages are the more uniform power level within the coverage area and less unwanted radiation outside the coverage area. The shaded portion A in Fig. 9 represents unnecessary power in the coverage area while the shaded portions B represent unwanted radiation in the neighbouring areas.

For purposes of preliminary design, it is generally sufficient to specify the required power flux-density and the desired earth-station locations or the boundaries of the service area. With the help of computers, it is then possible to determine the number of antenna horns and their sizes, arrangement, and phasing to achieve the best beam shape. This optimization process usually results in a nearly uniform power distribution over the service area.

In the design of multi-beam coverages it is also possible and desirable to optimize the characteristics of the on-board multiple beam antenna sub-system, such as number and dimension of the beams, optimum pointing, etc., to guarantee the coverage of a given number of earth stations, against various system requirements and constraints.

By means of suitable computer-aided design strategies, of the type shown in [Lo Forti, R. and Perrone, A., 1984], it is in fact possible to take into account the constraints of the link budgets (weather statistics, propagation effects, geographic location of the stations, frequency assignments and interference levels) in order to assign more satellite resources (G/T and e.i.r.p.) to earth stations which are disadvantaged from the link budget viewpoint.

This kind of non-uniform power flux-density distribution design is particularly attractive at higher frequency bands (for example 20/30 GHz) where system constraints such as rainfall attenuation may be variable from zone-to-zone within the same service area.

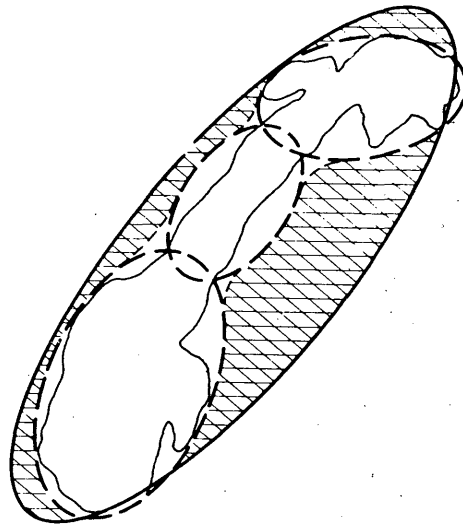

FIGURE 8 – Example of efficient shaped beam coverage

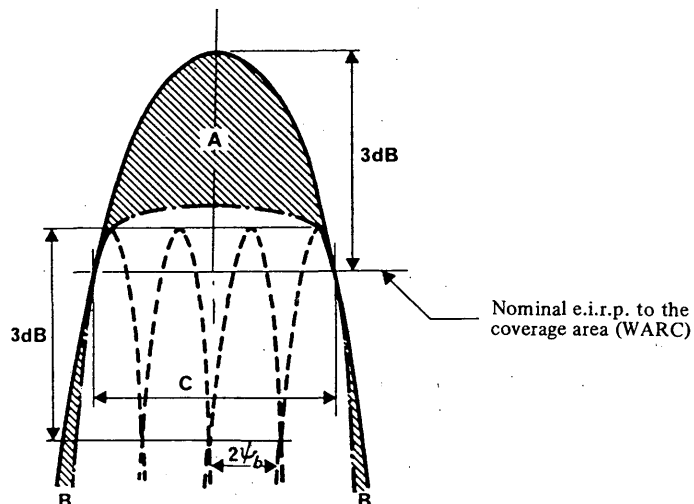

FIGURE 9 – Shaped beam cross-section

--- Elementary beams of the shaped beam antenna

- A: unnecessary power in the coverage area
- B: unwanted radiation in the neighbouring area
- C: width of the coverage area = 3 dB beamwidth of unshaped beam antenna
- ψ_b : 3 dB beam-width of elementary beam

4. Satellite antenna reference radiation patterns

4.1 Single feed circular beams

It appears desirable to develop limits on the radiation levels in out-of-coverage areas as a means to maximizing orbit capacity.

As noted previously, the radiation pattern of the satellite antenna is important in the region of the main lobe as well as the farther side lobes. Thus, the possible patterns commencing at the -3 dB contour of the main lobe are divided into four regions. These are illustrated in Fig. 10.

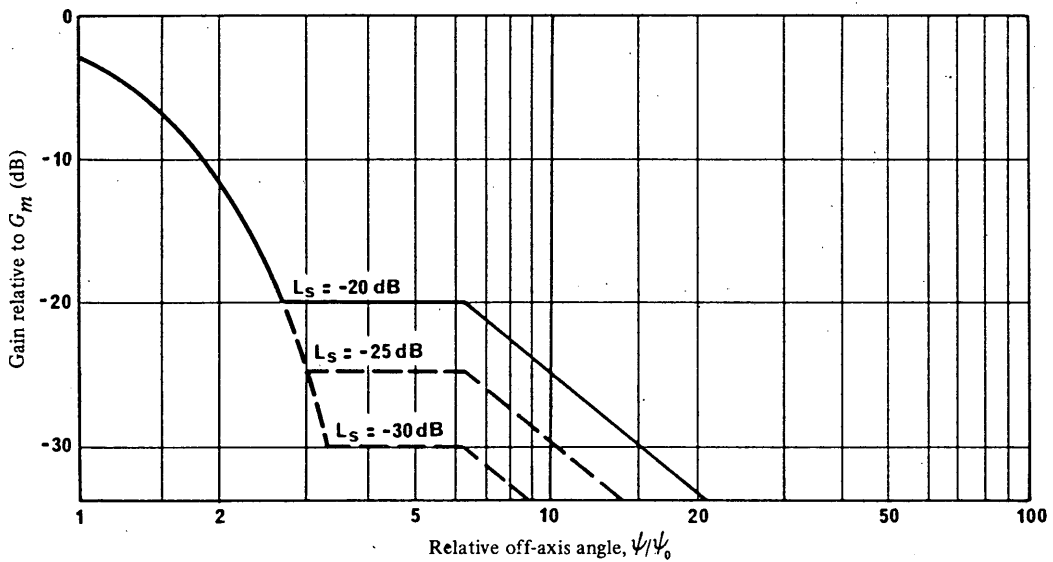

FIGURE 10 - Radiation pattern envelope functions

Curves A : $G(\psi) = G_m - 3 \left(\frac{\psi}{\psi_0}\right)^2$ dBi for $\psi_0 \leq \psi < a\psi_0$ (I)
 B : $G(\psi) = G_m + L_s$ dBi for $a\psi_0 < \psi \leq b\psi_0$ (II)
 C : $G(\psi) = G_m + L_s + 20 - 25 \log \left(\frac{\psi}{\psi_0}\right)$ dBi for $b\psi_0 < \psi \leq \psi_1$ (III)
 D : $G(\psi) = 0$ dBi for $\psi_1 < \psi$ (IV)

where:

- $G(\psi)$: gain at the angle (ψ) from the axis (dBi),
- G_m : maximum gain in the main lobe (dBi),
- ψ_0 : one-half the 3 dB beamwidth in the plane of interest (3 dB below G_m) (degrees),
- ψ_1 : value of (ψ) when $G(\psi)$ in equation (III) is equal to 0 dBi,
- L_s : the required near-in side-lobe level (dB) relative to peak gain,
- a, b : the numeric values are given below:

L_s	a	b
-20	2.58	6.32
-25	2.88	6.32
-30	3.16	6.32

Difficulties arise, however, in attempting to apply the postulated pattern to a non-circular beam. Administrations are therefore requested to submit measured radiation patterns for antennas with other than simple circular beams.

4.2 *Single feed elliptical beams*

The above functions define a maximum envelope for the first side lobes at a level of -20 dB relative to peak gain and this pattern applies to antennas of fairly simple designs. However, in the interest of a better utilization of the orbit capacity, it may be desirable to reduce this level to -30 dB and to use antennas of more sophisticated design. The pattern adopted by the RARC-83, given in Report 810, was somewhat relaxed from the above, in keeping with an assessment of what was feasible at that time. The pattern adopted by the WARC-BS-77 for broadcasting satellite antennas meets this requirement and is now being achieved and should therefore apply in that case. An illustration of this level of performance is given in Annex III, which shows the measured radiation pattern of an elliptical beam generated by a dual-reflector antenna with offset feed operating at 12 GHz bands. Additional studies may be desirable to ascertain the feasibility of achieving these reduced side-lobe levels in common practice, particularly with respect to the 6/4 GHz bands.

4.3 *Multiple feed shaped beams*

A similar pattern applicable to shaped beams must be based on analysis of several shaped beams and also on theoretical considerations. Additional parameters must be specified, such as the diameter of the elemental beamlet and the level of the first side lobe. In addition the cross-section and means of measuring angles form part of the pattern definition.

The important consideration in producing such a reference is the discrimination to be achieved from the edge of coverage of all types of antenna, including the most complex shaped beam antenna, as a function of angular separation of the coverage areas as seen from the orbit. The radiation pattern of a shaped beam antenna is unique and it is mainly determined by the following operational and technical factors:

- shape of the coverage area,
- satellite longitude,
- maximum antenna aperture,
- feed design and illumination taper,
- normalized reflector aperture diameter (D/λ),
- local length to aperture diameter ratio (F/D),
- number of frequency re-use and independent beam ports,
- number of feed elements utilized,
- bandwidths,
- polarization orthogonality requirements,
- total angular coverage region provided,
- stability of feed element phase and amplitude excitations,
- reconfigurability requirements,
- number of orbital positions from which beam coverages must be provided,
- reflector surface tolerances achieved,
- beam pointing (i.e. derived from satellite or independent beam positioning via Earth-based tracking beacons),
- component beam degradations due to scan aberrations that are related to the specific reflector or antenna configuration (i.e. single reflector, dual reflector, shaped reflector systems without a focal axis, direct radiating array, etc.).

In view of this, there may be some difficulties in developing a single reference radiation pattern for shaped beam antennas.

The reference pattern of Fig. 10 is unsatisfactory for shaped beam antennas, since a key parameter to the reference pattern is ψ_0 , the -3 dB half-beamwidth, whereas the beam centre of a shaped beam is ill-defined and largely irrelevant to the out-of-beam response. A simple reference pattern consisting of four segments, as illustrated in Fig. 11 might be more satisfactory for the basis of a reference pattern. The slope of the skirt of this pattern would be a function of the angular distance outside the average contour.

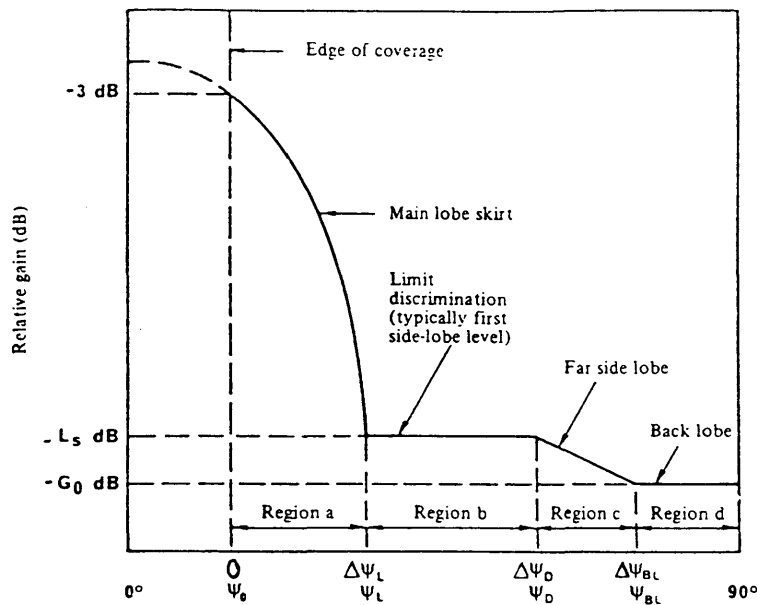

FIGURE 11 – Possible form of reference radiation pattern

$\Delta\psi$: off-axis angle relative to edge of coverage
(assumed to be equivalent to the -3 dB contour)

ψ : off-axis angle relative to reference point

The particular direction in which to measure this angular distance is also a parameter which needs definition. One method is to measure this angle orthogonally from the constant gain contour which corresponds most closely to the coverage area. Difficulties arise with this method where portions of the gain contours are concave such as occurs with crescent-shaped patterns. For this type of pattern, the orthogonal direction away from a contour could intersect the coverage area again. From an antenna design standpoint, the difficulty in achieving good discrimination in the concave portion of a pattern increases with the degree of concavity. An alternative method which could circumvent these problems is to circumscribe the coverage area by a contour which has no concavity and then measure the angles orthogonally from this contour; this contour being considered as edge of coverage. Other methods of defining the direction of measurement are possible, e.g. the centre of a circumscribing ellipse could be used as a reference point (see § 5.1 and 5.2), but an unambiguous definition is needed for any reference pattern.

Once the direction is defined, the radiation pattern can be separated into four regions of interest:

Region a: Main lobe skirt (edge of coverage to angle of limit discrimination)

This region is assumed to cover what is considered to be adjacent coverage regions. The required isolation between satellite networks would be obtained from a combination of satellite antenna discrimination and orbital separation.

A simple function which could be applied to this region could be in a form similar to that given in equation (I) of Fig. 10.

Region b: Non-adjacent coverage region

This region begins where the radiation pattern yields sufficient discrimination to allow nearly co-located satellites to serve non-adjacent areas ($\Delta\psi_L$ in Fig. 11). The limit discrimination (L_s) may be between -20 and -30 dB.

Region c: Far side-lobe region

Region d: Back-lobe region

Each of these regions covers the higher order side lobes and is applicable to very widely spaced service areas and, in those frequency bands used bidirectionally, to parts of the orbit. In the latter case, care must be exercised when considering very large off-axis angles since unpredictable reflections from the spacecraft bus and spill-over from the main reflector might have significant effect. A minimum gain envelope of 0 dBi is suggested pending more information (Region d in Fig. 11).

5. Shaped beam radiation pattern models

For shaped beam modelling purposes, prior to the actual design of an antenna, a simplified reference pattern might be used. Two models which can generate such patterns and their associated parameters are presented below. Both models are suitable for computer-aided interference studies and, in conjunction with satellite centred maps, for manual application. The models form the basis of a recommended pattern or patterns (Rec. 672.). However, it would be advisable to only apply the resultant pattern "profiles" in the direction of an interference sensitive system. That is, they should not be applied in directions where the potential for interference to other networks does not exist (i.e., off the edge of the Earth, unpopulated ocean regions, etc.).

5.1 Representation of coverage area

Various methods have been proposed in the past for the service area representation of FSS antennas. In one method, the angular distance outside the coverage area is measured in a direction normal to the service area geography (constant gain contour) as seen from the satellite. In practice, the gain contour is designed to fit the service area as closely as possible and therefore the difference between using the service area and the constant gain contour is expected to be very small. However, difficulties will arise with this method in certain cases where portions of gain contours are concave such as with crescent shaped patterns. For such patterns, the orthogonal direction away from the contour could intersect the coverage area again thereby causing ambiguity (see Figure 12a). Another difficulty with this representation is that for a given location outside the coverage area there could be more than one point on the service area at which the line joining the observation location to the point on the service area is normal to the service area contour at that point (see Figure 12a).

However, a method has been developed which circumvents the difficulties cited above using angular measurements normal to the coverage area and patterns containing concavities. This method involves a number of graphical constructions and is described in a set of step-by-step procedures in Annex IV.

In addition, these step-by-step procedures can be simplified by use of convex-only coverage contour. To produce a convex-only coverage contour, the same procedure as described in Annex IV is undertaken, except that only convex corners; i.e. those in which the circle lies inside the coverage contour are considered. This resultant coverage contour is illustrated in Figure 12b.

Another way of representing the shaped beam patterns is by circumscribing the actual coverage area by a minimum area ellipse. The angular distance is measured from the edge of the ellipse in a direction normal to the periphery of the ellipse. The advantage would be it is relatively easy to write highly efficient computer programmes to define such an angular measurement procedure. However, this representation tends to considerably overestimate the area defined by the actual service area.

Another method is a hybrid approach which gives an unambiguous definition for representing the shaped beam coverage area. In this method a minimum area ellipse circumscribing the geographic coverage is used to define the centre of coverage area. The centre of coverage area does not necessarily represent the beam centre and is used only to define the axis of pattern cuts. Once the centre of coverage area is defined, the minimum area ellipse has no further significance.

A convex polygon is then used to define the coverage area boundary. The number of sides forming the polygon are determined based on the criteria that it should circumscribe the coverage area as closely as possible and should be of convex shape. A typical example is shown in Figure 12c for the service area representation. The angular directions are radial from the centre of coverage area.

For an observation location outside the coverage area, the direction of applying the template and the angular distances are unambiguously defined with reference to the centre of coverage area. However, this method tends to under-estimate the angular spacing between the gain contours outside the coverage area when the angle of the radial with respect to the coverage contour significantly departs from normal.

In summary, it would appear that the most acceptable method, both in accuracy and ease of construction, is the use of the convex-only coverage contour with the angular distances measured along directions normal to the sides of the contour, as shown in Figure 12b.

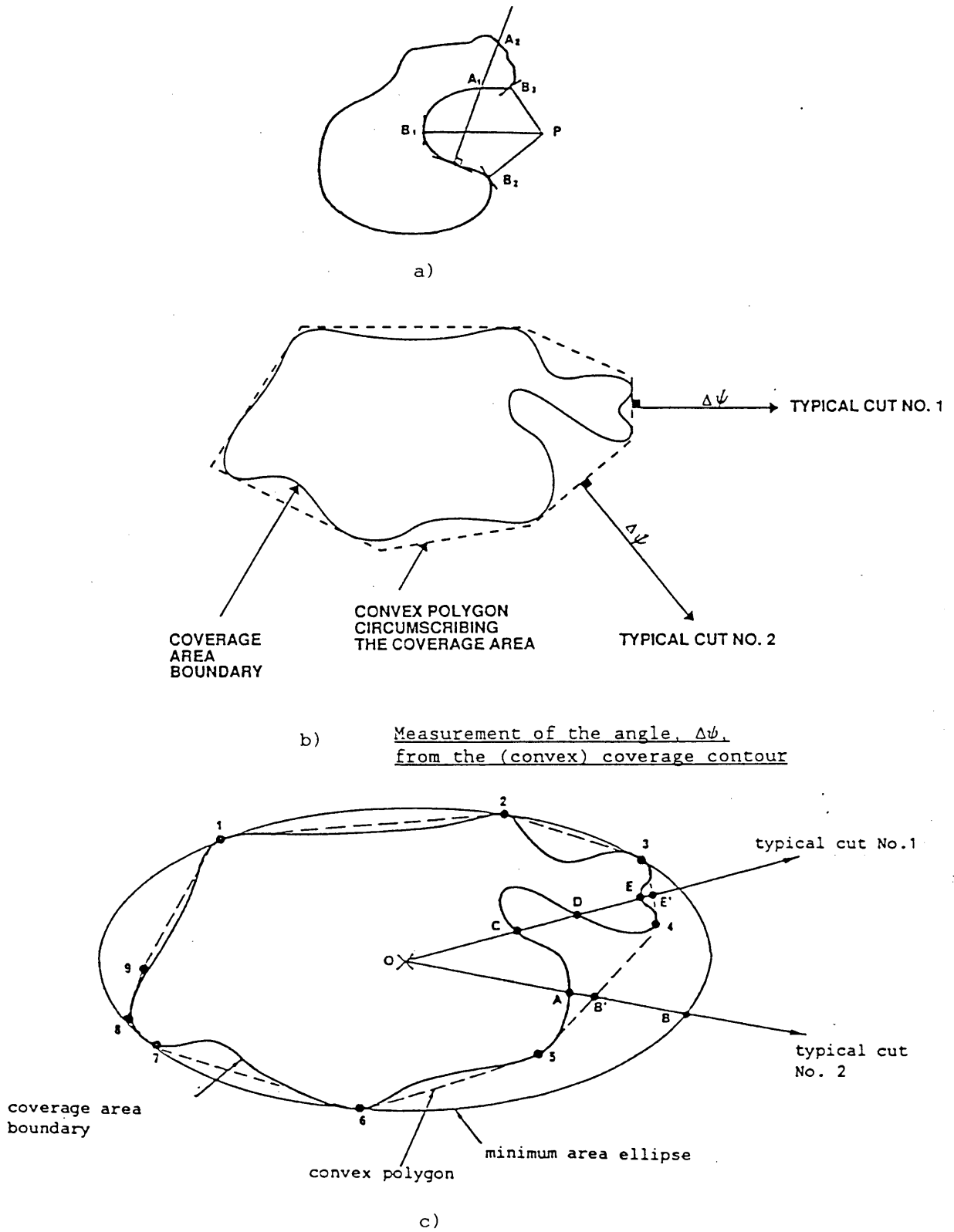

FIGURE 12 - Different representation of coverage area

5.2 Equivalent peak gain

In situations where it is not necessary to tailor the beam to compensate for the variation in propagation conditions across the service area, the minimum coverage area gain achieved at the coverage area contour is considered to be 3 dB less than the equivalent peak gain (G_{ep}). In practice the actual peak gain may be higher or lower than the equivalent peak gain and may not necessarily occur on-axis.

In some situations there could be a large variation of propagation conditions over the service area or service requirements may warrant special beam tailoring within the service area. In these cases the minimum required relative gain (relative to the average gain on the coverage area contour) at each polygon vertex is computed and linear interpolation based on the azimuth from the beam axis may then be used to determine the relative gain at intermediate azimuths. Under this scenario the gain at the coverage area contour is direction dependent.

Note that for a shaped beam, the gain variation within the coverage area is not related to the roll-off of gain beyond the edge of coverage. The antenna performance within the coverage area, including the gain, is not related to the interference introduced into adjacent systems. The gain variation within the coverage area, therefore, need not be characterized in shaped beam reference patterns.

5.3 Elemental beamlet size

The side-lobe levels are determined by the aperture illumination function. Considering an illumination function of the form:

$$f(x) = \cos^N \left(\frac{\pi}{2} \cdot x \right) \quad |x| \leq 1 \quad (1)$$

which is zero at the aperture edge for $N > 0$. The elemental beamlet radius, as a function of the side-lobe level in dB and the D/λ ratio, is, over the range of interest, approximately given by:

$$\psi_b \approx (16.56 - 0.775L_s) \lambda/D \quad \text{degrees} \quad (2)$$

where L_s is the relative level of the first side-lobe (dB).

This expression illustrates the trade-off between antenna diameter, side-lobe level and steepness of the main-lobe skirt regions. It is derived by curve fitting the results obtained using the derivation in [Silver, 1984] for different side-lobe levels. This relationship has been used as a starting point in the models described below.

5.4 Development of co-polar pattern models

Generalized co-polar patterns for future shaped beam antennas based on measurements on several operational shaped beam antennas (Brazilsat, Anik-C, Anik-E, TDRSS, Intelsat-V, G-Star, Intelsat-VI, Cobra) and on theoretical considerations are presented herein. The correlation between the antenna pattern models and measured pattern cuts are given in Annex V.

Previous modelling did not appear to quantify the beam broadening effects. The following models include two separate approaches which deal with these effects, which are essential to predicting shaped beam antenna performance accurately.

5.4.1 First model

The shaped beam pattern given in this section is in terms of the primary as well as the secondary parameters. The primary parameters are the beamlet size, coverage area width in the direction of interest and the peak side-lobe level. Secondary parameters are the blockage parameter, surface deviation and the number of beamwidths scanned. The effect of secondary parameters on the antenna radiation is to broaden the main beam and increase the side-lobe level. Although the dominant parameter in beam broadening is the number of beamwidths scanned, the effect of the other two parameters are given here for completeness. However, the effect of blockage on side-lobe level should not be overlooked. Though it is true that, due to practical limitations, a satellite antenna design calls for maintaining the blockage free criteria, there is normally a small amount of edge blockage. Particularly, edge blockage is quite likely for linear dual-polarization antennas employing a common aperture as is the case of dual gridded reflectors used for Anik-E, G-Star, Anik-C, Brasilsat, etc. This is because of the required separation between the foci of the two overlapped reflectors for the isolation requirements and for the volume needed for accommodating two sets of horns.

In the far side-lobe regions there is very little measured information available on which to base a model. Reflections from the spacecraft structure, feed array spill-over, and direct radiation from the feed cluster can introduce uncertainties at large off-axis angles and may invalidate theoretical projections. Measurement in this region is also extremely difficult and therefore further study is required to gain confidence in the model in this region. In the interim, a minimum gain plateau of 0 dBi is suggested.

It should be noted that the suggested pattern is only intended to apply in directions where side-lobe levels are of concern. In uncritical directions, e.g. towards ocean regions or beyond the limb of the Earth or in any direction in which interference is not of concern, this pattern need not be a representative model.

General co-polar Model 1

The following three-segment model representing the envelope of a satellite shaped beam antenna radiation pattern outside of the coverage area, is proposed:

Main lobe skirt region:

$$G_{\text{dBi}}(\Delta\psi) = G_{\text{ep}} + U - 4V \left(\frac{\Delta\psi}{Q\psi_0} + 0.5 \right)^2;$$

$$0 \leq \Delta\psi \leq W \cdot Q \cdot \psi_0$$

Near-in sidelobe region:

$$G_{\text{dBi}}(\Delta\psi) = G_{\text{ep}} + \text{SL}; W \cdot Q \cdot \psi_0 \leq \Delta\psi \leq Z \cdot Q \cdot \psi_0$$

Far sidelobe region:

$$G_{\text{dBi}}(\Delta\psi) = G_{\text{ep}} + \text{SL} + 20 \log (2 \cdot Q \cdot \psi_0 / \Delta\psi);$$

$$Z \leq \Delta\psi \leq 18$$

where $\Delta\psi$ is the angle from the edge of coverage (in degrees)

$G_{dB}(\Delta\psi)$ is the gain in dBi at $\Delta\psi$

G_{ep} is the equivalent peak gain ($G_{ep} = G_e + 3.0$) in dBi.

ψ_0 is the half-power diameter of the beamlet in degrees
 $(\psi_0 \approx (33.12 - 1.55 SL) \lambda/D)$

D is the size of the reflector

SL is the sidelobe level relative to the peak in dB

$U = 10 \log A$, $V = 4.3429B$ are the main beam parameters

$$B = \left\{ \ln(0.5/10^{0.1SL}) \right\} / \left[\left\{ (16.30 - 3.345SL) / (16.56 - 0.775SL) \right\}^2 - 1 \right]$$

$$A = 0.5 \exp(B)$$

$$W = (-0.26 - 2.57SL) / (33.12 - 1.55SL)$$

$$Z = (77.18 - 2.445SL) / (33.12 - 1.55SL)$$

and Q is the beam broadening factor due to the secondary effects.

$$Q = \exp \left[8\pi^2 (\epsilon/\lambda)^2 \right] \cdot [\eta_1(\Delta)]^{-0.5}$$

$$\cdot 10^{(0.000075 \delta^2 / [(F/D_p)^2 + 0.02]^2)} \quad (3)$$

The variables in equation (3) are defined as:

ϵ is the r.m.s. surface error

Δ is the blockage parameter (square root of the ratio between the area blocked and the aperture area)

δ is the number of beamwidths scanned away from the axial direction

$$= \theta_0 / \psi_0$$

θ_0 = angular separation between the centre of coverage, defined as the centre of the minimum area ellipse, to the edge of the coverage area.

$\eta_1(\Delta) = (1 - \Delta^2)$; for central blockage

$= [1 - (1 - A(1 - \Delta)^2) \Delta^2]^2$; for edge blockage

(4)

A in equation (4) is the pedestal height in the primary illumination function $(1 - Ar^2)$ on the reflector and r is the normalized distance from the centre in the aperture plane of the reflector ($r = 1$ at the edge). F/D_p in equation (3) is the ratio of the focal length to the parent parabola diameter. For a practical satellite antenna design this ratio varies between 0.35 to 0.45.

The far-out side-lobe gain depends on the feed-array spillover, reflection and diffraction effects from the spacecraft structure. These effects depend on individual designs and are therefore difficult to generalize.

As given in equation (3), the beam broadening factor Q depends on the r.m.s. surface error ϵ , the blockage parameter Δ , number of beams scanned δ , and F/D_p ratio. In practice, however, the effect of ϵ and Δ on beam broadening is normally small and can be neglected. Thus, equation (3) can be simplified to:

$$Q = 10^{(0.000075\delta^2 / [(F/D_p)^2 + 0.02])} \quad (5)$$

Equation (5) clearly demonstrates the dependence of beam broadening on number of beams scanned and the satellite antenna F/D_p ratio. This expression is valid for δ as high as nine beamwidths, which is more than sufficient for global coverage even at 11/14 GHz band; for service areas as large as Canada, United States or China the value of δ is generally one to two beams at 6/4 GHz band and about four beams at 11/14 GHz band, in the application of this model. Thus, for most of the systems the value of Q is normally less than 1.1. That is, the beam broadening effect is generally about 10% of the width of the elemental beamlet of the shaped-beam antenna.

Neglecting the mainbeam broadening due to blockage and reflector surface error, and assuming a worst-case value of 0.35 for F/D_p ratio of the reflector, the beam broadening factor Q can be simplified as:

$$Q = 10^{0.0037\delta^2}$$

In the 6/4 GHz band, a -25 dB side-lobe level can be achieved with little difficulty using a multi-horn solid reflector antenna of about 2 m in diameter, consistent with a PAM-D type launch. To achieve 30 dB discrimination, a larger antenna diameter could be required if a sizeable angular range is to be protected or controlled. In the 14/11 GHz fixed-satellite bands, 30 dB discrimination can generally be achieved with the 2 m antenna and the use of a more elaborate feed design.

The above equations for the reference pattern are dependent upon the scan angle of the component beam at the edge of coverage in the direction of each individual cut for which the pattern is to be applied. For a reference pattern to be used as a design objective, a simple pattern with minimum parametric dependence is desirable. Hence, a value or values of Q which cover typical satellite coverages should be selected and incorporated in the above equations.

A steeper main beam fall-off rate can be achieved for a typical domestic satellite service area as compared to very large regional coverage areas; and conversely a reference pattern satisfying a regional coverage will be too relaxed for domestic satellite coverages.

Therefore it is proposed to simplify Model 1 into the following two cases for the FSS antennas. For these cases a -25 dB side-lobe plateau level is assumed.

Normalized curves for the baseline reference pattern with a -25 dB near-in side-lobe gain plateau are shown in Figure 13 by plotting the gain as a function of the normalized angle ($\Delta\psi/\psi_0$). The parameter of the curves is the shaping factor S . The curve $S = 1$ is for pencil beam antennas ($\theta_0 = \psi_0$) with no beam broadening ($Q = 1$) and the curve $S = 1.2$ is for the pencil beam case with 20 per cent main beam broadening. As the value of the shaping factor reduces, the main beam gain falls at a steeper rate. For a given coverage, S becomes smaller when the beamlet size (ψ_0) shrinks, which occurs when a larger antenna (D/λ) is used. Also, the width of the constant side-lobe region becomes narrower for highly shaped beams with smaller value of S .

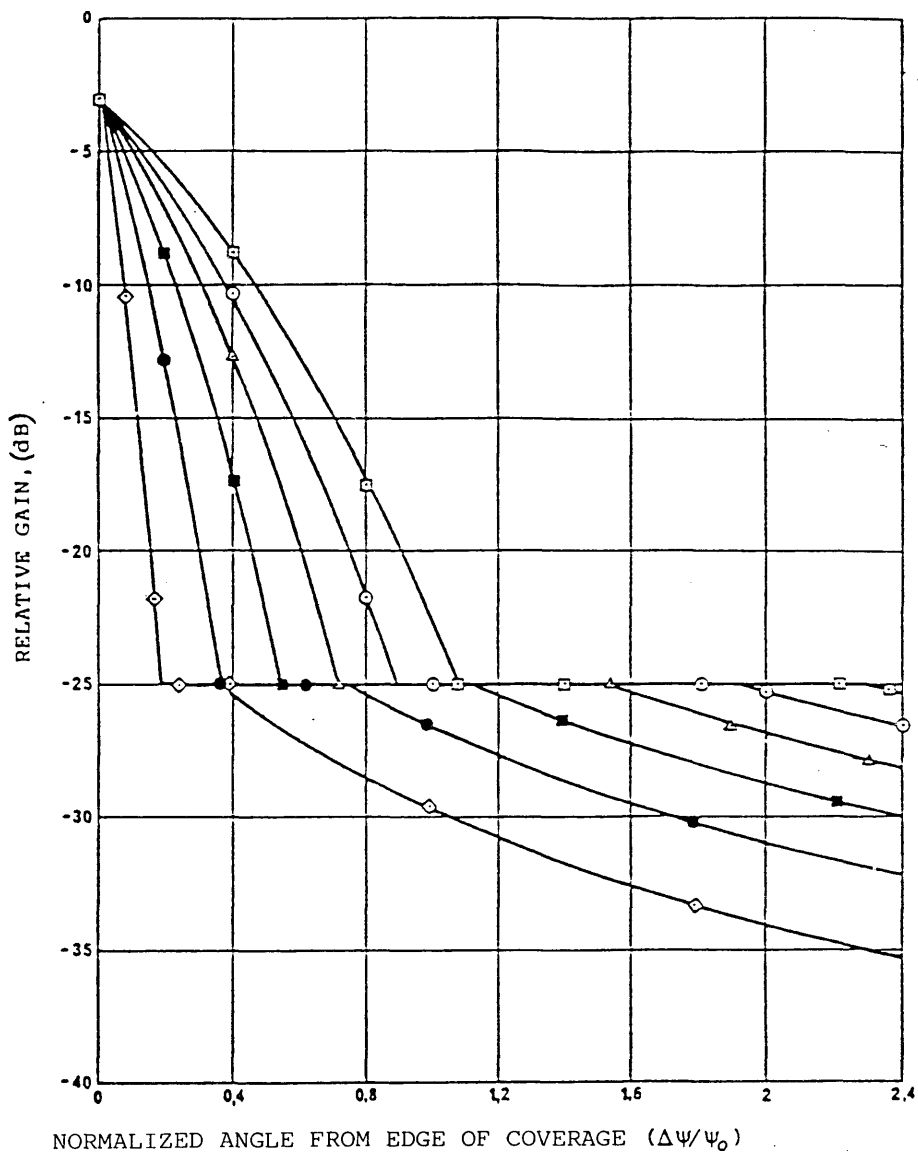

FIGURE 13

Proposed baseline reference pattern for shaped beam satellite antennas with peak sidelobe level of -25 dB. Parameter of the curves is the shaping factor(s)

a) Small Coverage Regions ($\delta < 3.5$)

Most of the domestic satellite coverage areas fall under this category. The beam broadening factor Q is taken as 1.10 to represent reference patterns of modest scan degradations for small coverage regions as:

$$G_{dB_i}(\Delta\psi) = G_{e_p} + 0.256 - \frac{10.797}{\psi_0^2} (\Delta\psi + 0.55 \psi_0)^2;$$

$$0 \leq \Delta\psi \leq 0.0794 \psi_0$$

$$= G_{e_p} - 25; \quad 0.9794 \psi_0 \leq \Delta\psi \leq 2.1168 \psi_0$$

$$= G_{e_p} - 25 + 20 \log (2.1168 \psi_0 / \Delta\psi);$$

$$2.1168 \psi_0 \leq \Delta\psi \leq 18$$

b) Wide Coverage Regions ($\delta > 3.5$)

Examples for wide coverage regions are the hemi-beam and global coverages of Intelsat and Inmarsat. In order to represent the pattern degradation due to large scan, a value of 1.3 is taken for the Q factor. The reference patterns applicable to these coverages ($\delta > 3.5$) are defined as:

$$G_{dB_i}(\Delta\psi) = G_{e_p} + 0.256 - \frac{7.73}{\psi_0^2} (\Delta\psi + 0.65 \psi_0)^2;$$

$$0 \leq \Delta\psi \leq 1.1575 \psi_0$$

$$= G_{e_p} - 25; \quad 1.1575 \psi_0 \leq \Delta\psi \leq 2.5017 \psi_0$$

$$= G_{e_p} - 25 + 20 \log (2.5017 \psi_0 / \Delta\psi);$$

$$2.5017 \psi_0 \leq \Delta\psi \leq 18$$

5.4.2 Second model

There will be many difficulties in providing a relatively simple pattern that could be applied to a range of different satellite antennas without prejudice to any particular design or system. With this thought the template presented here by Model 2 does not intend to describe a single unique envelope, but a general shape. The template may be considered not only for a single antenna application, but as an overall representation of a family of templates describing antennas suitable for the many different applications.

In the development, an attempt has been made to take full account of the beam broadening that results from component beams scanned away from boresight of a shaped-beam antenna. A careful attempt has been made to encompass the effects of interference and mutual coupling between adjacent beamlets surrounding the component beamlet under consideration. To avoid complexity in the formulation, two additional adjacent beamlets along the direction of scan of the component beamlets have been considered. The variation in beam broadening with F/D ratio has also been taken into account, tested over the range $0.70 \leq F/D \leq 1.3$ and modelled for an average scan plane between the elevation plane and azimuth plane. If the modelling had been done for the azimuth plane only, sharper characteristics than predicted might be expected. Other assumptions made in the model are as follows:

- i) the boundary of component beams corresponding to the individual array elements has been assumed to correspond to the ideal -3 dB contour of the shaped coverage beam;
- ii) the component beamlet radius, ψ_b , is given by equation 2 and corresponds to an aperture edge taper of -4 dB;
- iii) the value of B which controls the main beam region, is directly modelled as a function of the scan angle of the component beam, the antenna diameter D and the F/D ratio of the antenna reflector.

The value of F/D used in this model is the ratio of focal length to the physical diameter of the reflector. The model is valid for reflector diameters up to 120λ , beam scanning of up to 13 beam widths and has shown good correlation to some 34 pattern cuts taken from four different antennas.

Recognizing that at some future date it may be desirable to impose a tighter control on antenna performance, this model provides two simple improvement factors, K_1 and K_2 , to modify the overall pattern generated at present.

General co-polar Model 2

The equations to the various regions and the corresponding off-axis gain values are described below. Those gain values are measured normal to the coverage area at each point and this technique is allied to the definition of coverage area described in Annex IV.

At present, the values of K_1 and K_2 should be taken as unity, $K_1 = K_2 = 1$.

These equations are normalized to a first side-lobe (L_s) of -20 dB in this description. Ultimately, the particular value of the first side-lobe level chosen for the given application would be substituted.

- a) The main lobe skirt region: ($0^\circ \leq \Delta\psi < C\psi_b$)

In this region the gain functions is given by:

$$G(\Delta\psi) = G_0 - K_1 B \left[\left(1 + \frac{\Delta\psi}{\psi_b} \right)^2 - 1 \right] \quad (\text{dBi}) \quad (6)$$

where G_e is the gain at the edge of coverage (dBi).

$G(\Delta\psi)$ is the reference pattern gain in dBi

$\Delta\psi$ is the angle in degrees from the (convex) coverage contour in a direction normal to the sides of the contour.

$\psi_b = 32\lambda/D$ is the beamlet radius in degrees
(corresponding to $L_s = -20$ dB in equation 2).

$B = B_0 - (S - 1.25)\Delta B$, for $S \geq 1.25$ and

$B = B_0$, for $S < 1.25$

$B_0 = 2.05 + 0.5 (F/D - 1) + 0.0025 D/\lambda$

$\Delta B = 1.65 (D/\lambda)^{-0.55}$

Equations for both the elevation and azimuth planes are given here in order to maintain generality.

azimuth plane: $B_0 = 2.15 + T$

elevation plane: $B_0 = 1.95 + T$

where $T = 0.5 (F/D - 1) + 0.0025 D/\lambda$

azimuth plane: $\Delta B = 1.3 (D/\lambda)^{-0.55}$

elevation plane: $\Delta B = 2.0 (D/\lambda)^{-0.55}$

D is the physical antenna diameter (in meters)

λ is the wavelength (in meters)

S is the angular displacement A between the antenna boresight and the point of the edge-of-coverage, in half-power beamwidths of the component beam, as shown in Figure 14.

i.e. $S_1 = A_1/2\psi_b$ and $S_2 = A_2/2\psi_b$

$C = \sqrt{1 + \frac{(20 K_2 - 3)}{K_1 B}} - 1$ and corresponds to the limit where

$G(\Delta\psi)$ corresponds to a $-20 K_2$ dB level with respect to peak equivalent gain G_0 , i.e. $G(\Delta\psi) = G_0 + 3 - 20 K_2$.

- b) Near side-lobe region: $C \psi_b \leq \Delta\psi < (C + 0.5)\psi_b$

This region has been kept deliberately very narrow for the following reasons. High first lobes of the order of -20 dB occur only in some planes and are followed by monotonically decreasing side-lobes. In regions where beam broadening occurs, the first side-lobe merges with the main lobe which has already been modelled by B for the beam skirt. Hence it is necessary to keep this region very narrow in order not to over-estimate the level of radiation. The gain function in this region is constant and is given by:

$$G(\Delta\psi) = G_e + 3 - 20 K_2 \quad (7)$$

- c) Intermediate side-lobe region: $(C + 0.5)\psi_b \leq \Delta\psi < (C + 4.5)\psi_b$

This region is characterized by monotonically decreasing side-lobes. Typically, the envelope decreases by about 10 dB over a width of $4\psi_b$. Hence this region is given by:

$$G(\Delta\psi) = G_e + 3 - 20 K_2 + 2.5 \left[(C + 0.5) - \frac{\Delta\psi}{\psi_b} \right] \text{ (dBi)} \quad (8)$$

The above expression decreases from $G_e + 3 - 20 K_2$ at $(C + 0.5)\psi_b$ to $G_e + 3 - 10 - 20 K_2$ at $(C + 4.5)\psi_b$.

- d) Wide-angle side-lobe region: $(C + 4.5)\psi_b \leq \Delta\psi < (C + 4.5)\psi_b D$
where $D = 10^{[(G_e - 27)/20]}$

This corresponds to the region which is dominated by the edge diffraction from the reflector and it decreases by about 6 dB per octave. This region is then described by:

$$G(\Delta\psi) = G_e + 3 - 10 - 20K_2 + 20 \log \left[(C + 4.5)\psi_b / \Delta\psi \right] \text{ (dBi)} \quad (9)$$

In this region $G(\Delta\psi)$ decreases from $G_e + 3 - 10 - 20K_2$ at $(C + 4.5)\psi_b$ to $G_e + 3 - 16 - 20K_2$ at $2(C + 4.5)\psi_b$. The upper limit corresponds to where $G(\Delta\psi)$ equals 3 dBi.

- e) Far-out side-lobe region: $(C + 4.5)\psi_b D \leq \Delta\psi \leq 90^\circ$
where $D = 10^{[(G_e - 27)/20]}$

$$G(\Delta\psi) = 3 \text{ (dBi)} \quad (10)$$

These regions are depicted in Figure 15.

The model can also be extended to the case of simple circular beams, elliptical beams and to shaped-reflector antennas. These cases are covered by adjustment to the value of B in the above general model:

- i) For simple circular and elliptical beams B is modified to a value, $B = 3.25$
- ii) For shaped-reflectors the following parameters are modified to,
- | | |
|-------------------|-----------------------------|
| $B = 1.3$ | for $0.5 \leq S \leq 0.75$ |
| $= 1.56 - 0.34 S$ | for $0.75 \leq S \leq 2.75$ |
| $= 0.62$ | for $S > 2.75$ |

where $S = (\text{Angular displacement from the centre of coverage})/2 \psi_b$

and $\psi_b = 40 \lambda/D$

$K_2 = 1.25$

It should be noted that the values proposed for shaped-reflector antennas correspond to available information on simple configurations. This new technology is rapidly developing and therefore these values should be considered tentative. Furthermore, additional study may be needed to verify the achievable side-lobe plateau levels.

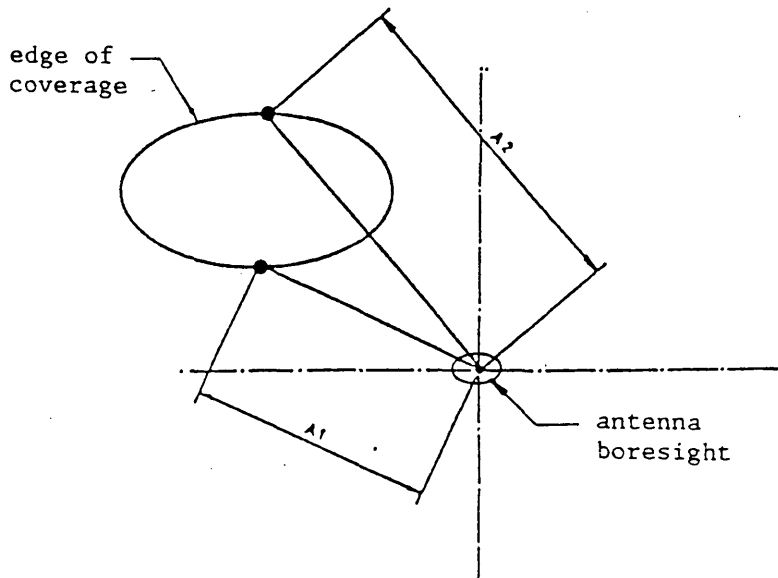

(i) Boresight outside the coverage zone

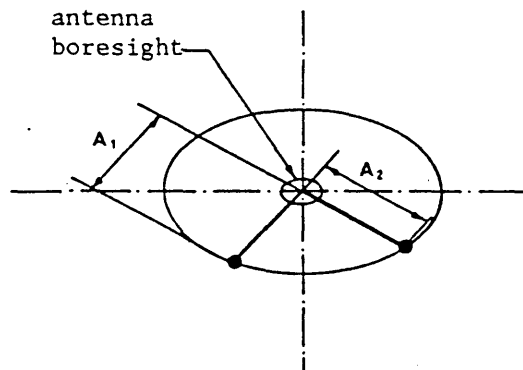

A₁, A₂ - Angular deviation (in degrees) of the two points on the edge of coverage from the antenna boresight.

(ii) Boresight inside the coverage zone

FIGURE 14

A schematic of a coverage zone

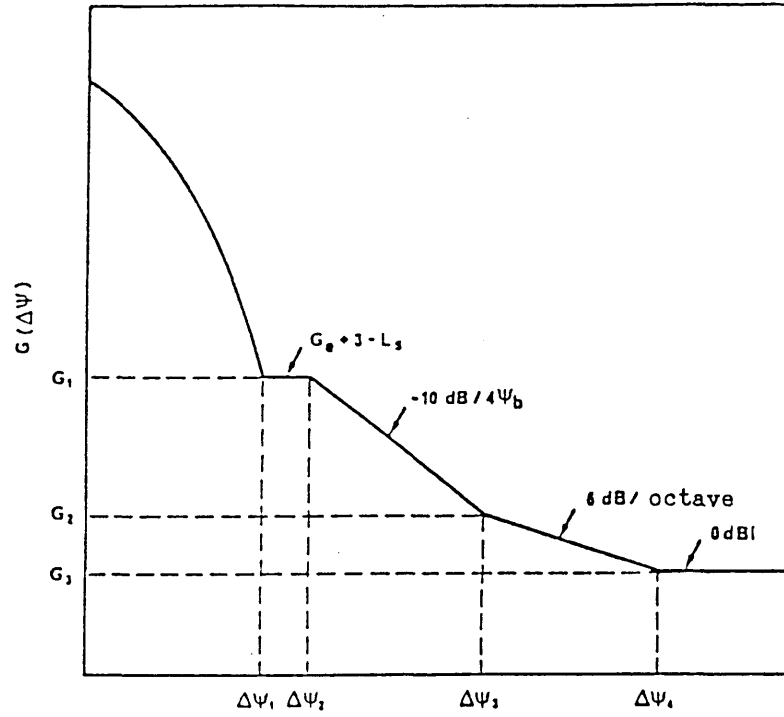

L_s is the first side lobe level

FIGURE 15

Different regions in the proposed model 2

Use of improvement factors K_1 and K_2

The improvement factors K_1 and K_2 are not intended to express any physical process in the model, but are simple constants to make adjustments to the overall shape of the antenna pattern without changing its substance.

Increasing the value of K_1 from its present value of 1, will lead to an increase in the sharpness of the main beam roll-off.

Parameter K_2 can be used to adjust the levels of the side-lobe plateau region by increasing K_2 from its value of unity.

5.5 Cross-polarized model

Most communication satellite networks employ frequency re-use via cross-polarized transmissions. Whilst there is only limited information on the cross-polarized characteristics outside the main beam it is generally recognized that the cross-polarized discrimination in the side-lobe region is of similar magnitude to the co-polarized discrimination. Thus in interference studies the co-polarized and cross-polarized contributions will be equally significant. Further study is required on the cross-polarized characteristics of satellite antenna, in particular outside the main beam. For linear polarization, several geometric factors come into play when the interference between two satellites is considered. Report 1141 discusses these factors.

Cross-polarized radiation patterns are very sensitive to the type and sense of polarization, antenna design parameters, and feed element radiation characteristics. Also, the cross-polarized radiation levels depend on the azimuthal plane and hence it is not possible to describe the radiation in a circularly symmetric template. Thus, the cross-polarized radiation is more complex to model into a template. However, different templates have been proposed in the past for describing the cross-polarized radiation (see Reports 555, 1141 and 810). A reasonable template within the main beam for future satellites can be described as:

$$G_x = G_o - 30 \text{ for } 0 < \psi/\psi_o \leq \psi_x/\psi_o$$

where ψ_x is the off-axis angle corresponding to the intersection of the -30 dB plateau with the co-polarization pattern.

5.6 Shaped beam pattern roll-off characteristics

The main beam roll-off characteristics of shaped beam antennas depend primarily on the antenna size. The angular distance $\Delta\psi_L$ from the edge of coverage area to the point where the gain has decreased by 22 dB (relative to edge gain) is a useful parameter for orbit planning purposes. It is related to the antenna size as:

$$\Delta\psi_L = C (\lambda/D)$$

For central beams with little or no shaping, the value of C is 64 for -25 dB peak side-lobe level. However, for scanned beams C is typically in the range 64 to 80 depending on the extent of main beam broadening (see Figure 13).

6. Correlation of the model with measured data

Annex V gives the comparison of the models given in this report with measured satellite antenna pattern data.

7. Summary

In conclusion, caution must be exercised in relating satellite antenna radiation patterns for shaped beams to a particular component beam. Difficulties may also be encountered in the design of shaped beam antennas for multi-frequency band operations. The validity range of the models proposed, therefore, has to be inspected carefully and the applicability to complex shaped beams generated by sophisticated multi-beam antennas has to be further studied.

Shaped beam antennas can provide a main beam tailored to the service area and excellent control of side-lobe radiation outside the service area. On the other hand, the use of shaped beams may restrict the possible re-positioning of satellites unless the beam can be reconfigured by telecommand (see Report 1002).

Differences in the main beam skirt length and subsequent roll-off are apparent between the templates of the two models. The discrepancies may be narrowed or eliminated with further investigation. Therefore, administrations are invited to provide further information in order to test the accuracy of the models.

In some circumstances, the eventual application of a satellite antenna radiation reference pattern may affect both the technical complexity, the volume of computer simulation and RF testing associated with the satellite antenna system.

The parameters of the satellite antenna design objective pattern, if too constraining, could lead to the need to employ side-lobe suppression techniques, requiring the introduction of extra feed horns and their associated amplitude and phase combiners. This would involve additional mass and volume in the satellite antenna system.

Efficient use of the geostationary orbit can be enhanced by employing spacecraft antennas with the best available radiation patterns for their application. Administrations should therefore endeavour to use such patterns which may minimize interference coupling between networks. A new Recommendation [672] has been developed, based upon the elements in this report. The antenna patterns set forth are intended as a spacecraft antenna design objective for use by administrations when designing their networks.

REFERENCES

- LO FORTI, R and PERRONE, A [1984] - Computer aided design for optimum multi-beam antenna coverage. IEEE Antenna and Propagation Symposium, Boston.
- SILVER, S. [1984] - Microwave antenna theory and design, Chapter 6, Peter Peregrinus Ltd., Hertfordshire, England.

BIBLIOGRAPHY

- DION, A. and RICARDI, L. [February, 1971] A variable coverage satellite antenna system, *Proc. IEEE*, Vol. 59, 2, 252-262.
- DUNCAN, J. W. [October 1969] Maximum off-axis gain pencil beams. *Proc. IEEE*, (Lett.), Vol. 57, 10, 1791-1792.
- TAYLOR, T. T. [January, 1960] Design of circular apertures for narrow beamwidth and low side-lobes. *IRE Trans. Ant. Prop.*, Vol. AP-8, 1, 17-22.
- TILLOTSON, L. C. [December, 1968] A model of a domestic satellite communication system. *BSTJ*, Vol. 47, 10, 2111-2137.
- CCIR Documents*
- [1982-86]: 4/21 (United States of America); 4/96 (United States of America); 4/94 (United States of America).
- [1987-91]: IWP 4/1 Report to the 14th meeting; 4/16 (Canada); 4/11 (Japan).

ANNEX I

SATELLITE ANTENNAS WITH SHAPED BEAMS

1. Introduction

Due to the difference in the range and the atmospheric attenuation from a satellite to various points on the Earth, a conventional global beam with maximum gain toward the centre of the Earth is non-optimum because it has the highest gain where the path losses are minimum. Since the paths tangential to the Earth are the longest and since their path through the atmosphere is the longest, the antenna gain ought to be highest in this region and somewhat less in the direction normal to the Earth's surface. Shaped global beams of this kind are desirable, from the point of view of the efficient use of satellite power. Antennas with such beams have been studied and developed using techniques of dielectric-loading of a horn [Satoh, 1972] or of an array of multiple horns [Ajioka and Harry, 1970].

2. Beam shaping techniques

Given a suitable parabolic reflector, the heart of the antenna system for a shaped beam consists of the feed horns and the circuits which route power to the horns to produce the optimum reflector illumination for a specific beam shape formation. Capacity can be increased and frequencies more efficiently used by employing both senses of polarization. Clusters of 15 horns or more can be arranged in several rows, forming the beams for each polarization. These groups of horns and the circuits that feed them are usually common for the transmit and receive frequency bands.

Mutual coupling between feeds may be considered in two respects. First, in the case of an individual beam, it results in weak parasitic excitation of all other feeds in proximity to the driven feed. Secondly, when several component beams are excited simultaneously to form a group, the effect of mutual couplings is to change the input impedance of each feed so that the intended relative amplitude and phase division between feeds is not exactly realized. Thus, the major advantage of predictive computations is to obtain estimates of the number of feeds required and their approximate positions in the focal plane of the antenna, but these predictive computations cannot be expected to provide accurate predictions of isolation contours.

Examples of antenna systems utilizing this technique are those used in the Palapa-B satellite for Indonesia and the Anik-C satellite for Canada which are shown in Figs. 16 and 17 respectively.

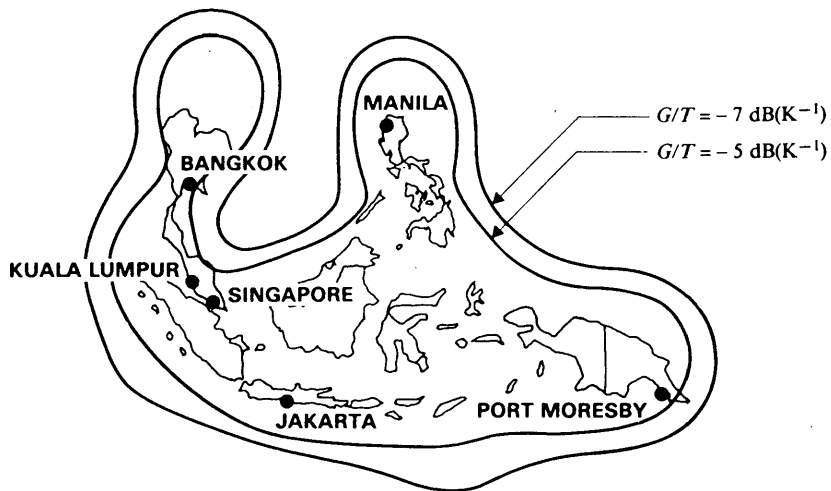

a) Receive

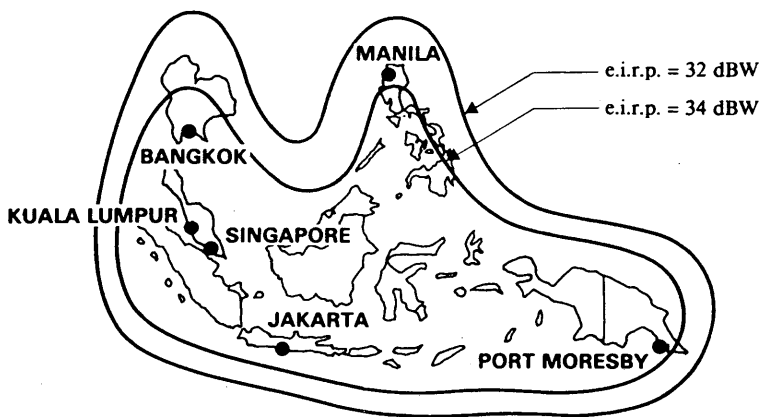

b) Transmit

FIGURE 16 - Palapa-B coverage

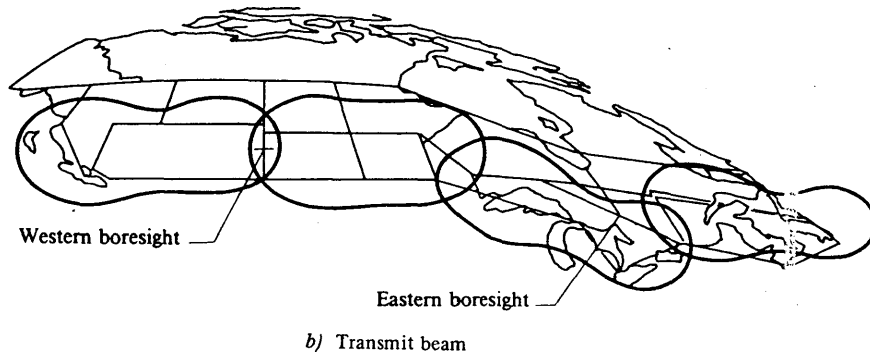
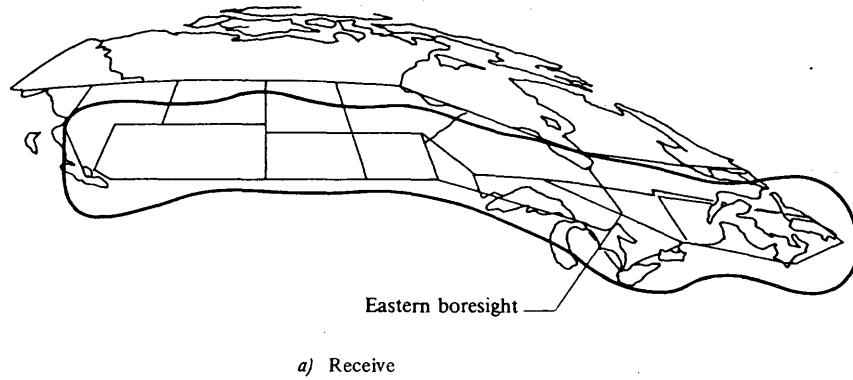

FIGURE 17—Anik-C coverage

REFERENCES

- AJIOKA, J.S. and HARRY, H. E. [May, 1970] Shaped beam for earth coverage from a stabilized satellite. *IEEE Trans. Ant. Prop.*, Vol. AP-18, 3, 323-327.
- SATOH, T. [March, 1972] Dielectric-loaded horn antennae. *IEEE Trans. Ant. Prop.*, Vol. AP-20, 2, 199-201.

ANNEX II

SHAPED BEAM ANTENNA SIDE-LOBE MEASUREMENTS

Some measured data on the beyond edge of coverage discrimination of several different shaped beam antennas is presented herein. The data falls generally into three categories:

Category 1: where efforts were made to achieve high discrimination,

Category 2: where discrimination was of less concern, and

Category 3: where no concern was given to side-lobe levels.

Category 1

Figure 18 shows data for the Intelsat-V Indian Ocean and hemispheric beams. The measured performance of a developmental antenna is shown in Fig.19; it has an aperture of 3.2 m and is designed to operate in the 4 GHz band. This antenna is an offset-fed, multiple feed, reflector type antenna intended for use on a future satellite. In this case side-lobe reduction techniques were employed to achieve a high degree of discrimination outside the coverage area in the directions of interest. Another example is shown in Figure 20 of a low side-lobe design antenna which has an aperture of 2.5 metres. This antenna is an offset Cassegrain type with cluster feeds intended for use on a future Japanese domestic satellite.

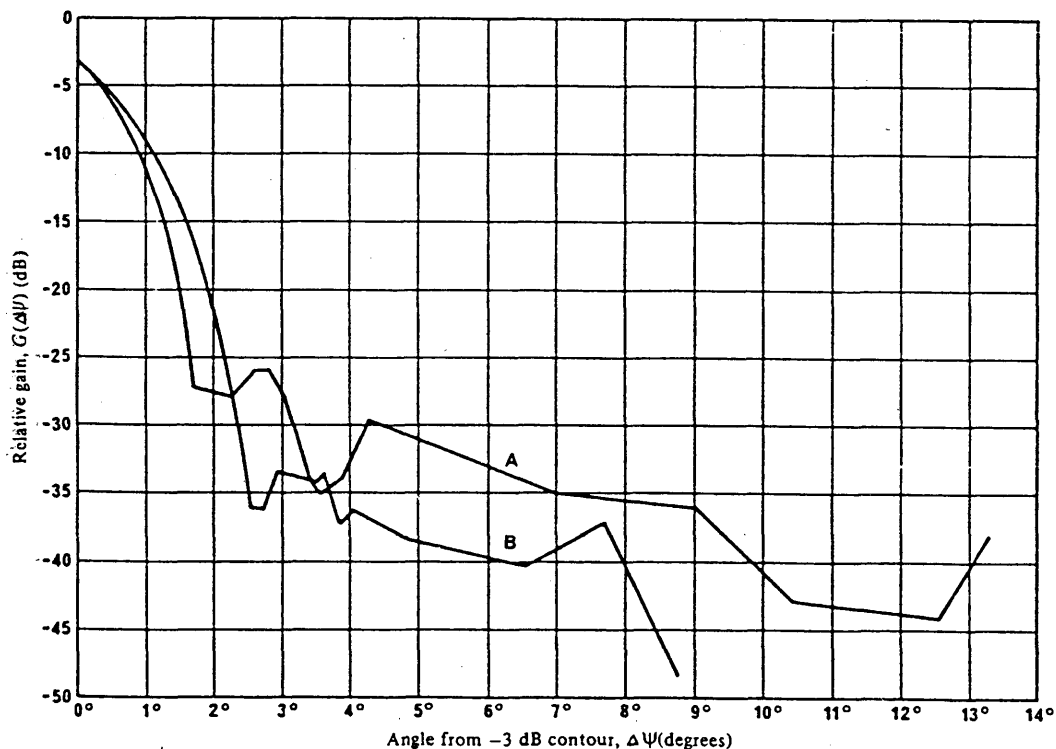

FIGURE 18 - Intelsat-V measured data; side-lobe levels in direction of concern

Frequency = 4 GHz

A: Indian zone beam (4.6° beamwidth)

B: Hemispheric beam (8° beamwidth)

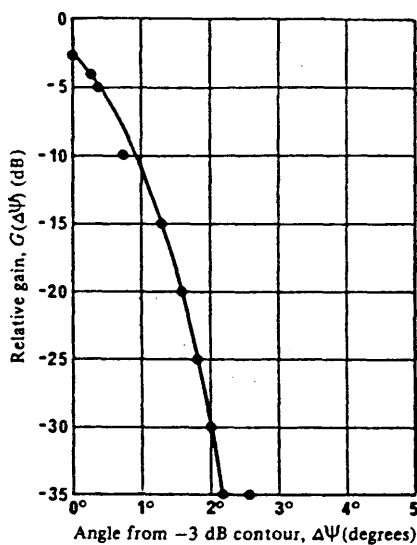

FIGURE 19 - Measured data for developmental offset-fed, multiple feed, reflector antenna after side-lobe control

-3 dB beamwidth = 4.08°
Frequency = 4 GHz

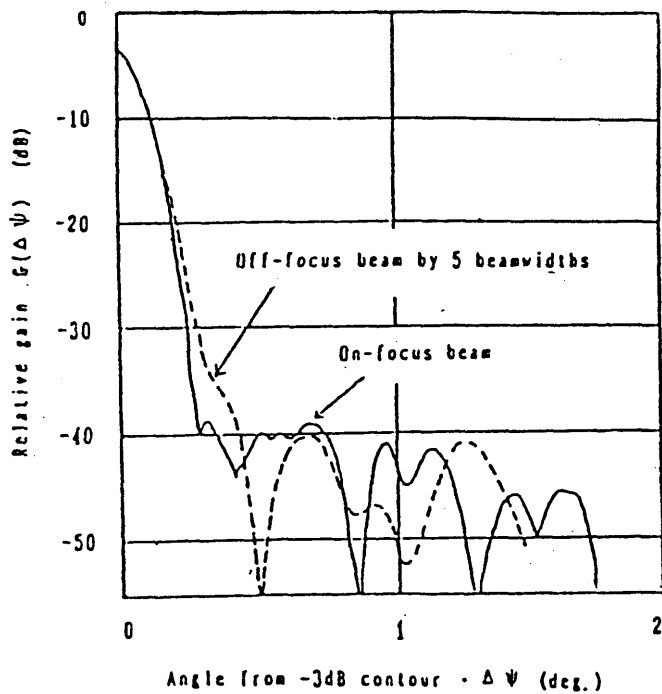

FIGURE 20

Measured data for developmental antenna; side-lobe level in directions of concern

$D/\lambda = 250$

Frequency = 30 GHz

Category 2

Figure 21 shows data for the Intelsat-V Indian Ocean and hemispheric beam in directions which were of less concern with respect to achieving high discrimination. These are also offset-fed, multiple feed, reflector type antennas.

Category 3

Figure 22 shows data for the same developmental antenna indicated in Category 1 before measures were taken to reduce side-lobe levels.

Figures 23 and 24 are shaped beam pattern profiles obtained from an RCA domestic satellite 6/4 GHz bands shaped beam antenna system. The patterns were produced by a 28 wavelength non-deployed offset reflector with an F/D (focal length-to-aperture diameter ratio) of approximately 0.65, in the transverse focal plane. There were no side-lobe or beam skirt shape constraints imposed on the antenna design.

Another shaped beam antenna design for an RCA 14/11 GHz bands domestic satellite was examined utilizing the shaped beam pattern cuts of Figs. 25 and 26. This shaped beam antenna system employs a nominal 60 wavelength diameter, fixed offset reflector with an F/D of approximately 0.65. As with the previous designs, no pattern roll-off or side-lobe constraints were imposed.

Spot beams

Measurements were made for the lens antenna with 61 feed elements, depicted in Fig. 27 adjusted for a spot beam. Figure 28 shows measured data for an Intelsat-V spot beam offset-fed reflector antenna operating in the 11 GHz band.

General comment

The extent of the main-lobe skirt broadening is variable and is a function of many other design factors of the antenna. However, for a given coverage area, the use of shaped beams will generally provide much better beyond edge of coverage discrimination than a simple beam. The incremental cost of providing shaped beam coverage is a small percentage of the total spacecraft cost.

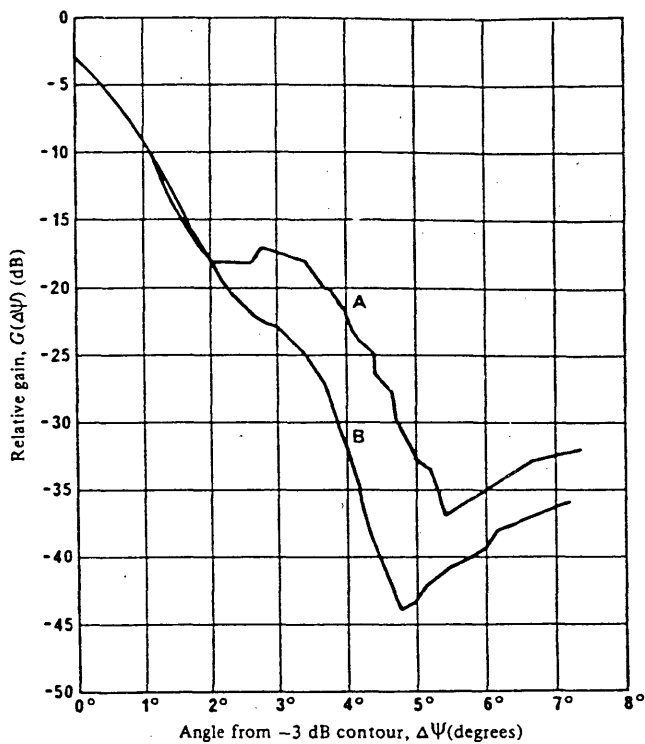

FIGURE 21 - *Intelsat-V* measured data: side-lobe levels in directions of less concern
Frequency = 4 GHz

- A: Hemispheric beam (9.75° beamwidth)
- B: Indian zone beam (6.6° beamwidth)

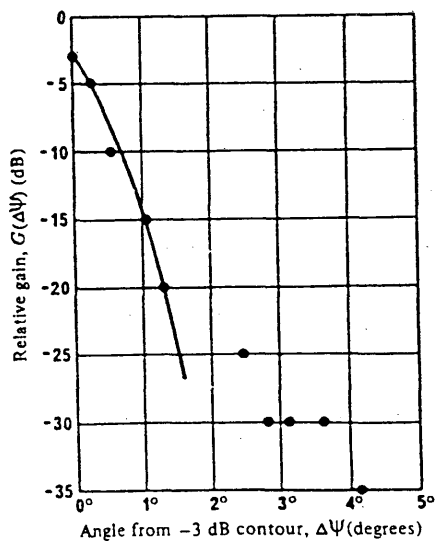

FIGURE 22 - *Measured data for developmental antenna before side-lobe control*
-3 dB beamwidth = 2.31°
Frequency = 4 GHz

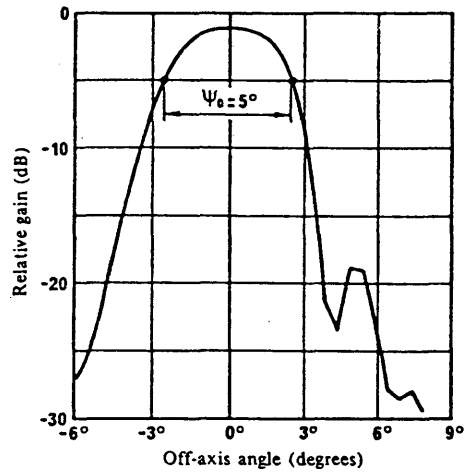

FIGURE 23 - 6/4 GHz band dual-mode shaped beam
28 λ aperture

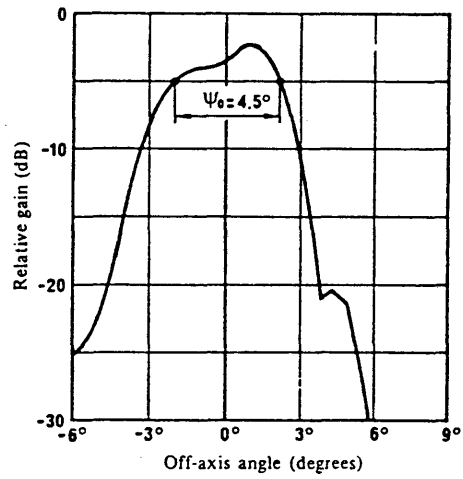

FIGURE 24 - 6/4 GHz band dual-mode shaped beam
28 λ aperture

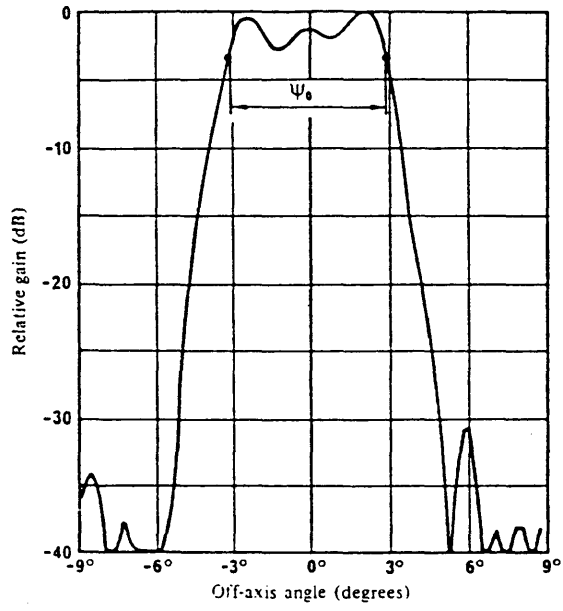

FIGURE 25 - 14/11 GHz band shaped beam
60 λ aperture

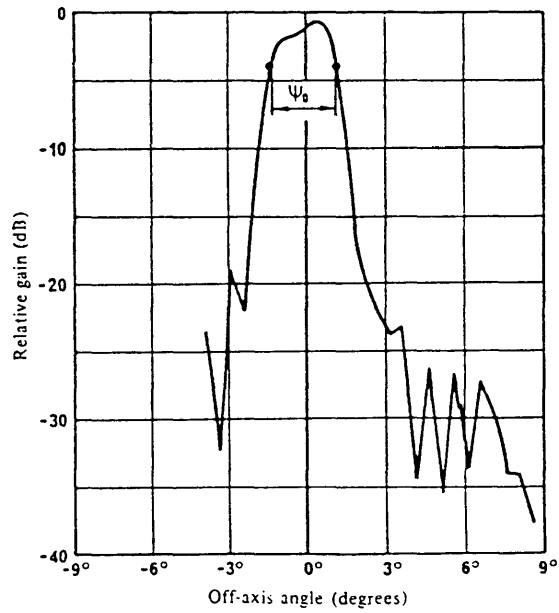

FIGURE 26 - 14/11 GHz band shaped beam
60 λ aperture

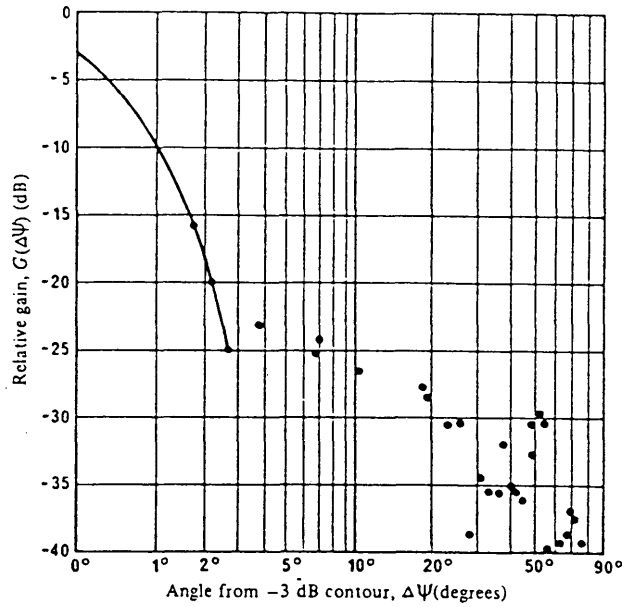

FIGURE 27 - Out-of-beam data for 61 element feed array satellite lens antenna
 Frequency = 8 GHz -3 dB beamwidth = 20°

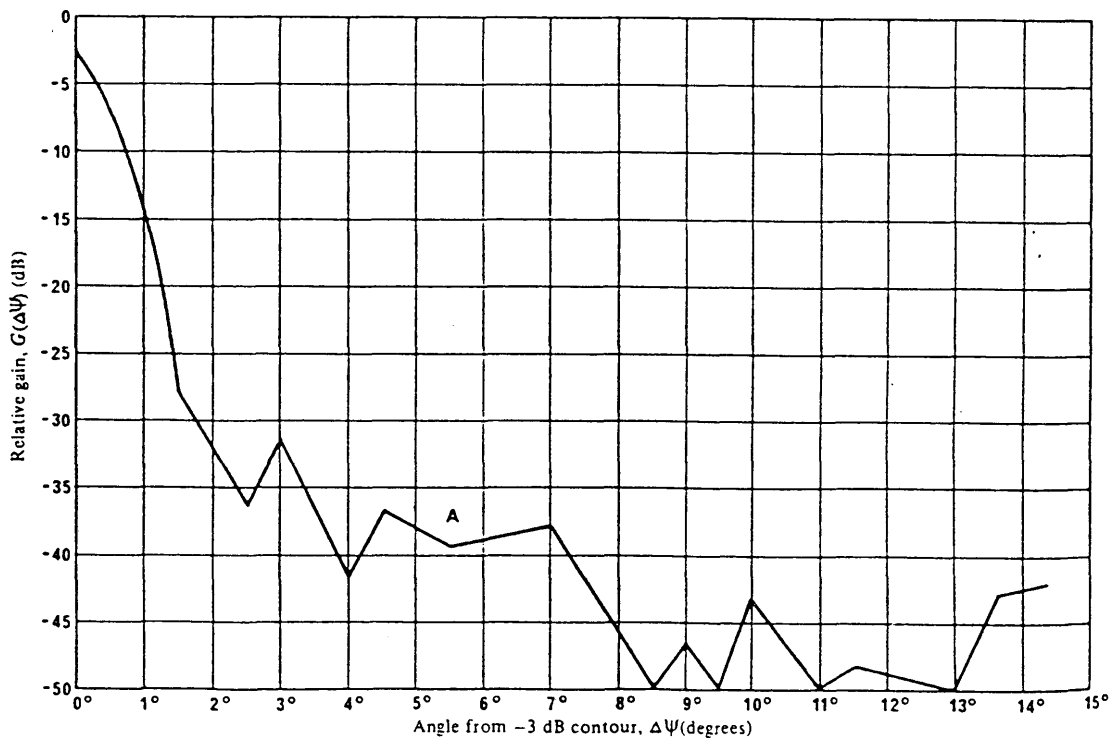

FIGURE 28 - Intelsat-V measured data
 Frequency = 11 GHz
 A: West spot beam (1.6° beamwidth)

ANNEX III

RADIATION PATTERN OF OLYMPUS ANTENNA

The ESA Olympus satellite which is under construction will carry several communications payloads, one of which is a direct broadcasting satellite transponder to cover Italy (TVB 1). The TVB 1 antenna is designed to satisfy the WARC-BS-77 requirements for Italian broadcasting satellites.

An engineering model (EM) of the TVB 1 antenna is currently under test and typical down-link radiation patterns are presented in the Figs. 29 and 30 for the antenna principal planes.

The radiation pattern envelope requirements for the co-polar antenna design are those masks presented in the Radio Regulations, Appendix 30, Annex 5 and for convenience are superimposed on the recorded patterns to aid comparison.

The antenna performance has been measured on a far field open-air test facility having an interfering reflectivity of typically -50 dB. There is therefore some unavoidable uncertainty on the recorded patterns which increases as the levels recorded decrease. A recorded level of -40 dB with respect to beam peak could in reality be about -37.5 dB in actual level (worst case).

The result of incorporating a closed loop RF sensing system into the antenna means that the radiated beam will be able to be repointed. This is achieved by rotation of the main reflector only, to realize a maximum of 0.25° beam repointing in any direction relative to the antenna reference system in order to maintain an overall 0.1° pointing accuracy required by the WARC-BS-77. The effect of such repointing in the anticipated RF sensing acquisition range is expected to have an insignificant effect on radiation performances particularly since the corresponding reflector rotation is only about half the required beam scan.

The wide beam axis co-polar radiation pattern as presented in Fig.29 indicates compliance with the WARC-BS-77 mask.

The cross-polar performance of the antenna (not shown) has been raised 20 dB relative to main beam levels but it is still compliant with the WARC-BS-77 mask with the exception of a small area on boresight*.

The narrow beam axis co-polar radiation pattern of Fig. 30 shows that the WARC-BS-77 mask is marginally exceeded for a range of ψ between 12° to 25° either side of beam boresight.

The co-polar patterns in both axes exhibit quite good symmetry in the side-lobe regions even in the area of the narrow beam co-polar non-compliance. This implies a good measurement range and no significant local site reflections.

Half-power beamwidths are measured to be $2.32 \times 1.00^\circ$ compared with the WARC-BS-77 Recommendation of $2.38 \times 0.98^\circ$. Notwithstanding this and the previously mentioned minor deviation from the WARC mask, full compliance with Appendix 30 of the Radio Regulations is achieved by respecting the permissible e.i.r.p. envelope. The actually radiated peak e.i.r.p. is well below the level recommended in the Radio Regulations.

* The cross-polar radiation requirement around boresight has been relaxed in consultation with the Italian authorities since this is believed to be an unnecessary requirement (as also discussed in Report 810). Moreover, the implications, of this, if any, would be of concern solely to the Italian Administration as it only affects their territory.

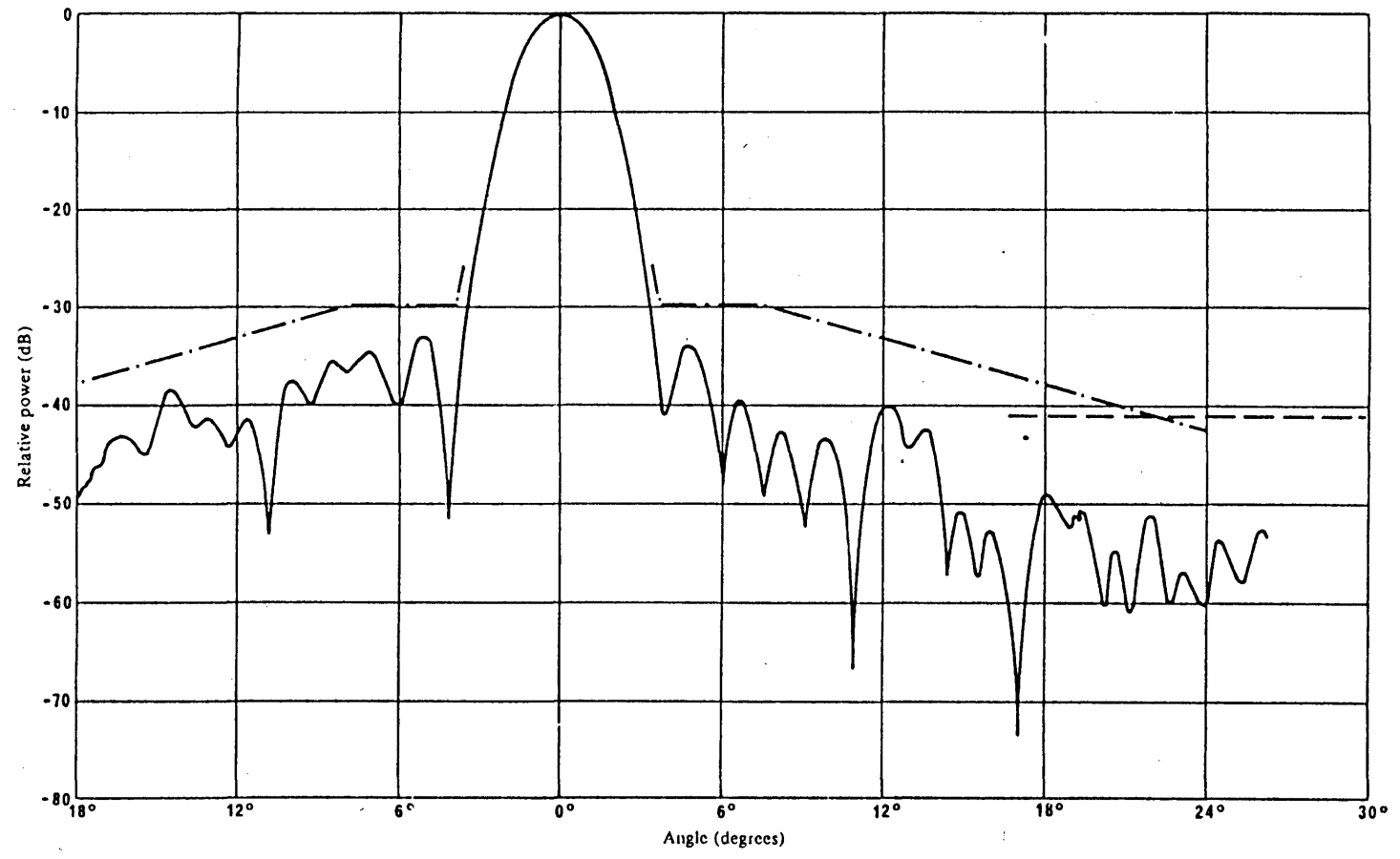

FIGURE 29 - Wide beam axis co-polar radiation pattern
Frequency = 12 300 MHz

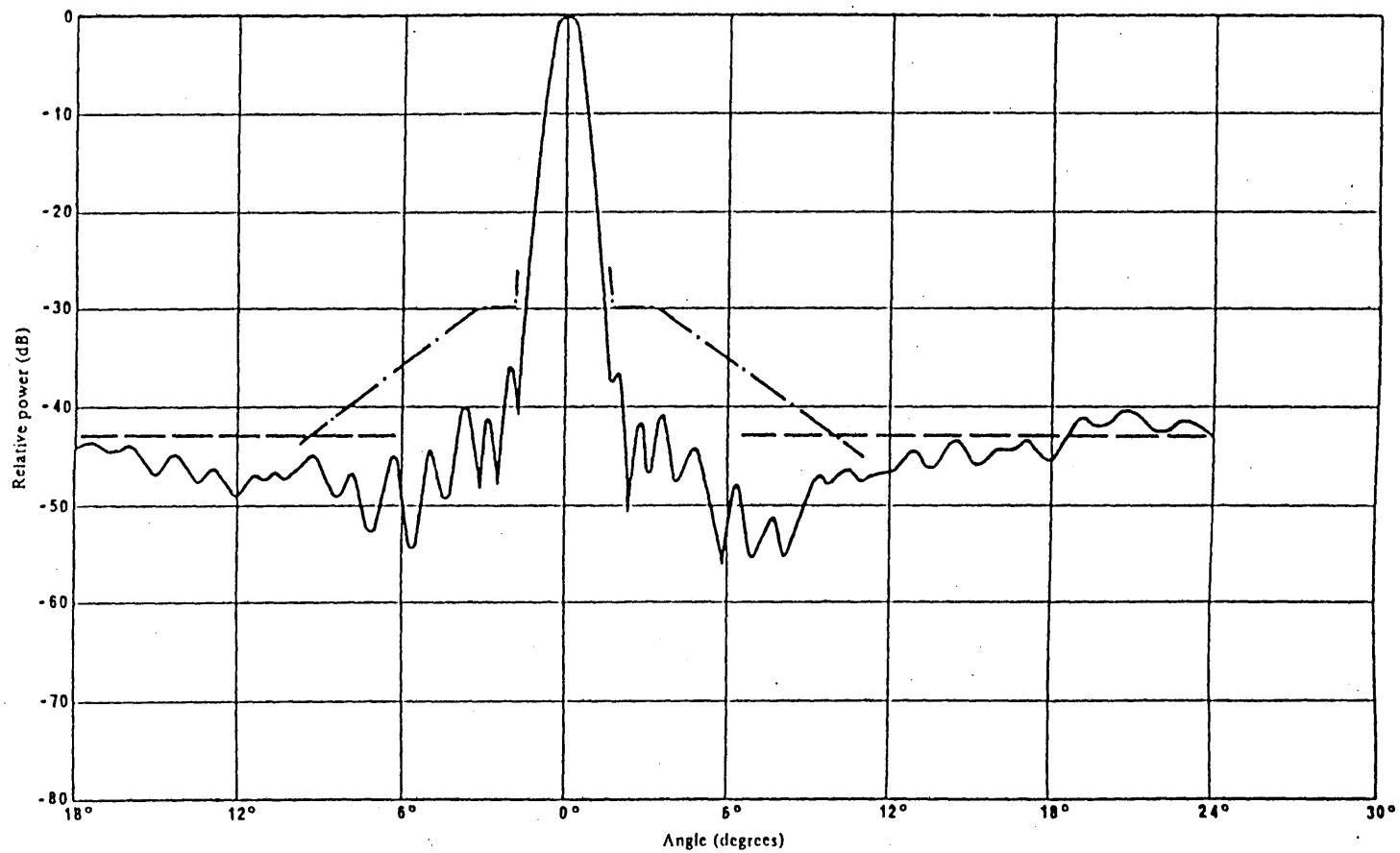

FIGURE 30 - *Narrow beam axis co-polar radiation pattern*
 Frequency = 12 300 MHz

ANNEX IV

1. Defining coverage area contours and gain contours about the coverage area1.1 Defining coverage area contours

A coverage area can be defined by a series of geographic points as seen from the satellite. The number of points needed to reasonably define the coverage area is a function of the complexity of the area. These points can be displaced to account for antenna pointing tolerances and variations due to service arc considerations. A polygon is formed by connecting the adjacent points. A coverage area contour is constructed about this polygon by observing two criteria:

- the radius of curvature of the coverage area contour should be $\geq \psi_b$;
- the separation between straight segments of the coverage area contour should be $> 2 \psi_b$ (see Figure 31).

If the coverage polygon can be included in a circle of radius ψ_b , this circle is the coverage area contour. The centre of this circle is the centre of a minimum radius circle which will just encompass the coverage area contour. If the coverage polygon cannot be included in a circle of radius ψ_b , then proceed as follows:

- Step 1 For all interior coverage polygon angles $< 180^\circ$, construct a circle of radius ψ_b with its centre at a distance (ψ_b) on the internal bisector of the angle. If all angles are less than 180° (no concavities) Steps 2 and 4 which follow are eliminated.
- Step 2 a) For all interior angles $> 180^\circ$, construct a circle of radius ψ_b which is tangent to the lines connected to the coverage point whose centre is on the exterior bisector of the angle.
- b) If this circle is not wholly outside the coverage polygon, then construct a circle of radius (ψ_b) which is tangent to the coverage polygon at its two nearest points and wholly outside the coverage polygon.
- Step 3 Construct straight line segments which are tangent to the portions of the circles of Steps 1 and 2 which are closest to, but outside the coverage polygon.
- Step 4 If the interior distance between any two straight line segments from Step 3 is less than ($2 \psi_b$), the controlling points on the coverage polygon should be adjusted such that reapplying Step 1 through 3 results in an interior distance between the two straight line segments equal to ($2 \psi_b$).

An example of this construction technique is shown in Figure 31.

1.2 Gain contours about the coverage area contours

As also noted in 558, difficulties arise where the coverage area contour exhibits concavities. Using a $(\Delta\psi)$ measured normal to the coverage area contour will result in intersections of the normals and could result in intersections with the coverage area contour.

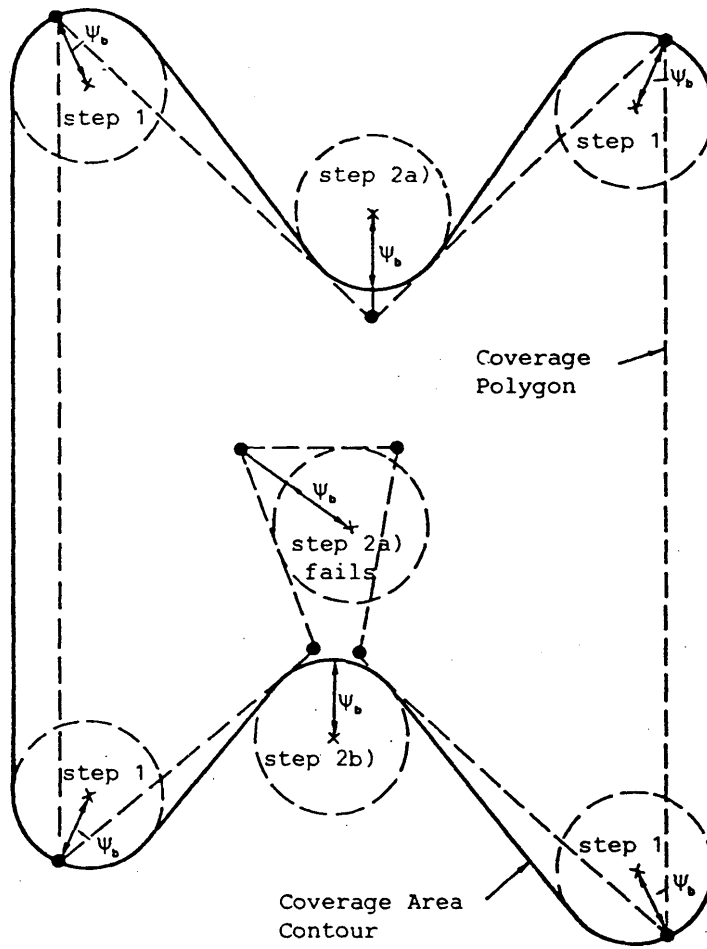

FIGURE 31
Construction of a coverage area contour

In order to circumvent this problem as well as others a two step process is proposed. If there are no concavities in the coverage contours, the following Step 2 is eliminated.

Step 1 For each $(\Delta\Psi)$, construct a contour such that the angular distance between this contour and the coverage area contour is never less than $(\Delta\Psi)$.

This can be done by constructing arcs of $(\Delta\Psi)$ dimension from points on the coverage area contour. The outer envelope of these arcs is the resultant gain contour.

Where the coverage area contour is straight or convex, this condition is satisfied by measuring normal to the coverage area contour. No intersections of normals will occur for this case.

Using the process described in Step (1) circumvents these construction problems in areas of concavity. However, from a realistic standpoint some problem areas remain. As noted in Report 558, side-lobe control in regions of concavity can become more difficult as the degree of concavity increases, the pattern cross-section tends to broaden and using the Step (1) process, discontinuities in the slope of the gain contour can exist.

It would appear reasonable to postulate that gain contours should have radii of curvature which are never less than $(\psi_b + \Delta\Psi)$ as viewed from inside and outside the gain contour. This condition is satisfied by the Step (1) process where the coverage area contour is straight or convex, but not in areas of concavity in the coverage area contour. The focal points for radii of curvature where the coverage area contour is straight or convex are within the gain contour. In areas of concavity, the use of Step (1) can result in radii of curvature as viewed from outside the gain contour which are less than $(\psi_b + \Delta\Psi)$.

Figure 32 shows an example of the Step (1) process in an area of concavity. Semi-circular segments are used for the coverage area contour for construction convenience. Note the slope discontinuity.

To account for the problems enumerated above and to eliminate any slope discontinuity, a second step is proposed where the concavities exist.

Step 2 In areas of the gain contour determined by Step (1) where the radius of curvature as viewed from outside this contour is less than $(\psi_b + \Delta\Psi)$ this portion of the gain contour should be replaced by a contour having a radius equal to $(\psi_b + \Delta\Psi)$.

Figure 33 shows an example of the Step (2) process applied to concavity of Figure 14. For purposes of illustration, values of the relative gain contours are shown, assuming (ψ_b) as shown and a value of $B = 3$ dB.

This method of construction has no ambiguities and results in contours in areas of concavities which might reasonably be expected. However, difficulties occur in generating software to implement the method, and furthermore it is not entirely appropriate for small coverage areas. Further work will continue to refine the method.

To find the gain values at specific points without developing contours the following process is used.

Gain values at points which are not near an area of concavity can be found by determining the angle ($\Delta\Psi$) measured normal to the coverage area contour and computing the gain from the appropriate equation: 6, 7, 8, 9 or 10. The gain at a point in concavity can be determined as follows.

First a simple test is applied. Draw a straight line across the coverage concavity so that it touches the coverage edge at two points without crossing it anywhere. Draw normals to the coverage contour at the tangential points. If the point under consideration lies outside the coverage area between the two normals, the antenna discrimination at that point may be affected by the coverage concavity. It is then necessary to proceed as follows.

Determine the smallest angle ($\Delta\Psi$) between the point under consideration and the coverage area contour. Construct a circle with radius ($\Psi_b + \Delta\Psi$), whose circumference contains the point, in such a way that its angular distance from any point on the coverage area contour is maximized when the circle lies entirely outside the coverage area; call this maximum angular distance $\Delta\Psi'$. The value of $\Delta\Psi$ may be any between 0 and $\Delta\Psi$; it cannot be greater than but may be equal to $\Delta\Psi$. The antenna discrimination for the point under consideration is then obtained from equations 6, 7, 8, 9 or 10 as appropriate using $\Delta\Psi'$ instead of $\Delta\Psi$.

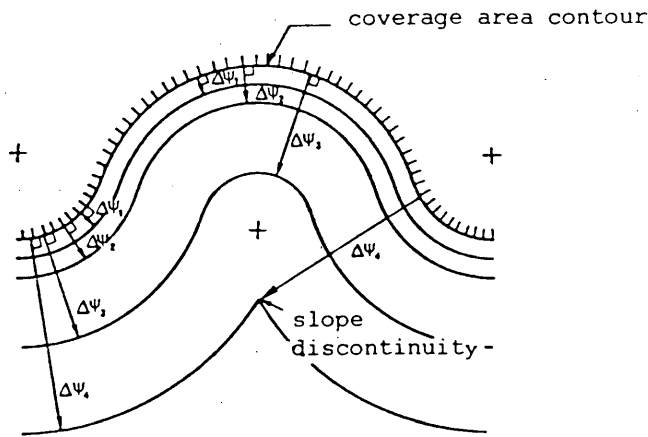

FIGURE 32

Gain contours from Step (1) in a concave coverage area contour

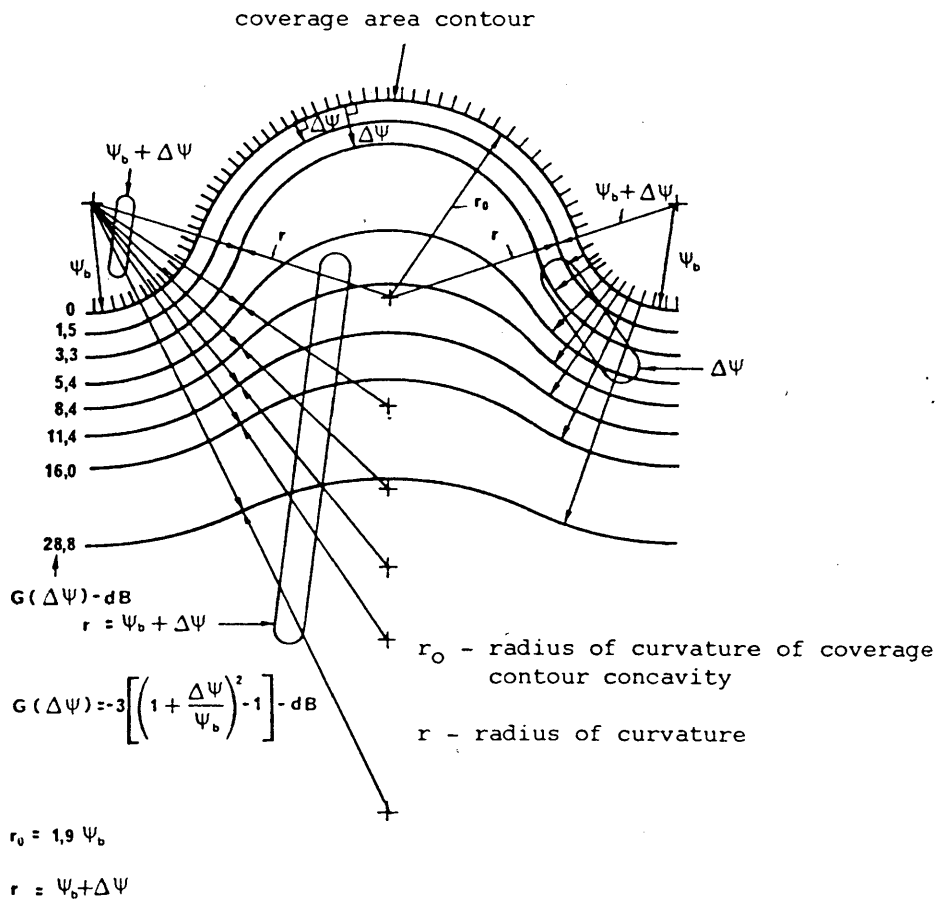

FIGURE 33

Construction of gain contours in a concave coverage area contour - Step (1) plus Step (2)

ANNEX V

COMPARISON OF MEASURED SATELLITE ANTENNA PATTERNS
FOR BOTH SHAPED-BEAM MODELS

Figures 34 and 35 represent Anik-E measured data compared against Model 1.

Figure 36 depicts the INTELSAT VI Indian Ocean Region (IOR) zone 3 coverage with a number of selected cuts.

Figure 37 represents a comparison of side lobe gain taken along the odd numbered cuts shown (in Figure 36) against the Model 1 pattern. Figure 38 shows two selected cuts from the 14 cuts on the INTELSAT VI IOR zone 3 beam (in Figure 36) against Model 2.

Figure 39 represents the coverage contours for the COBRA 2 European beams formed by a linear array of five rectangular horns. Figure 40 shows two selected cuts from the 12 cuts for COBRA 2 compared against Model 2.

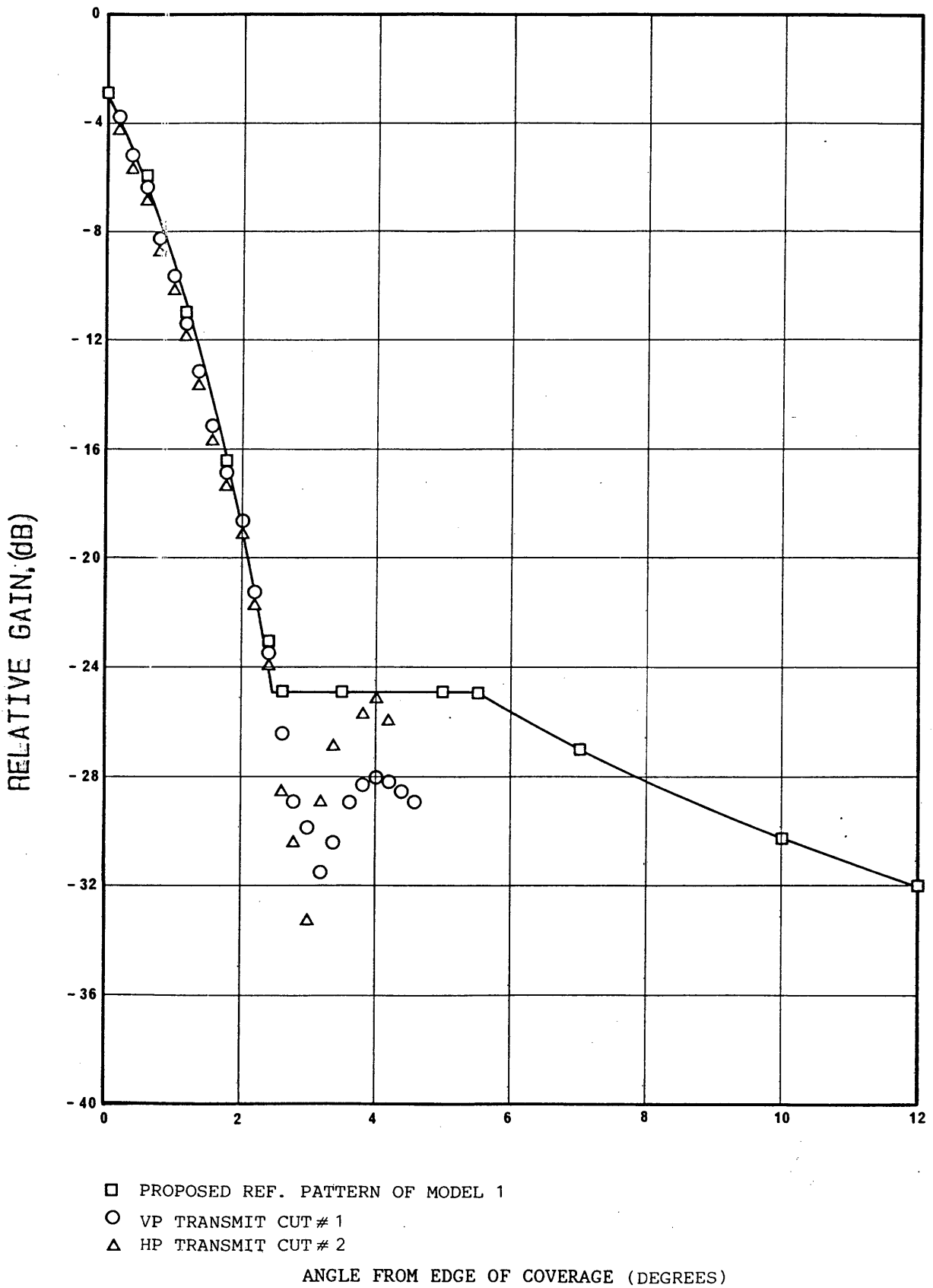

FIGURE 34 COMPARISON OF ANIK-E 6/4 GHz BAND MEASURED DATA WITH PROPOSED REFERENCE PATTERN (D/λ = 28.06, FREQUENCY = 4.14 GHz)

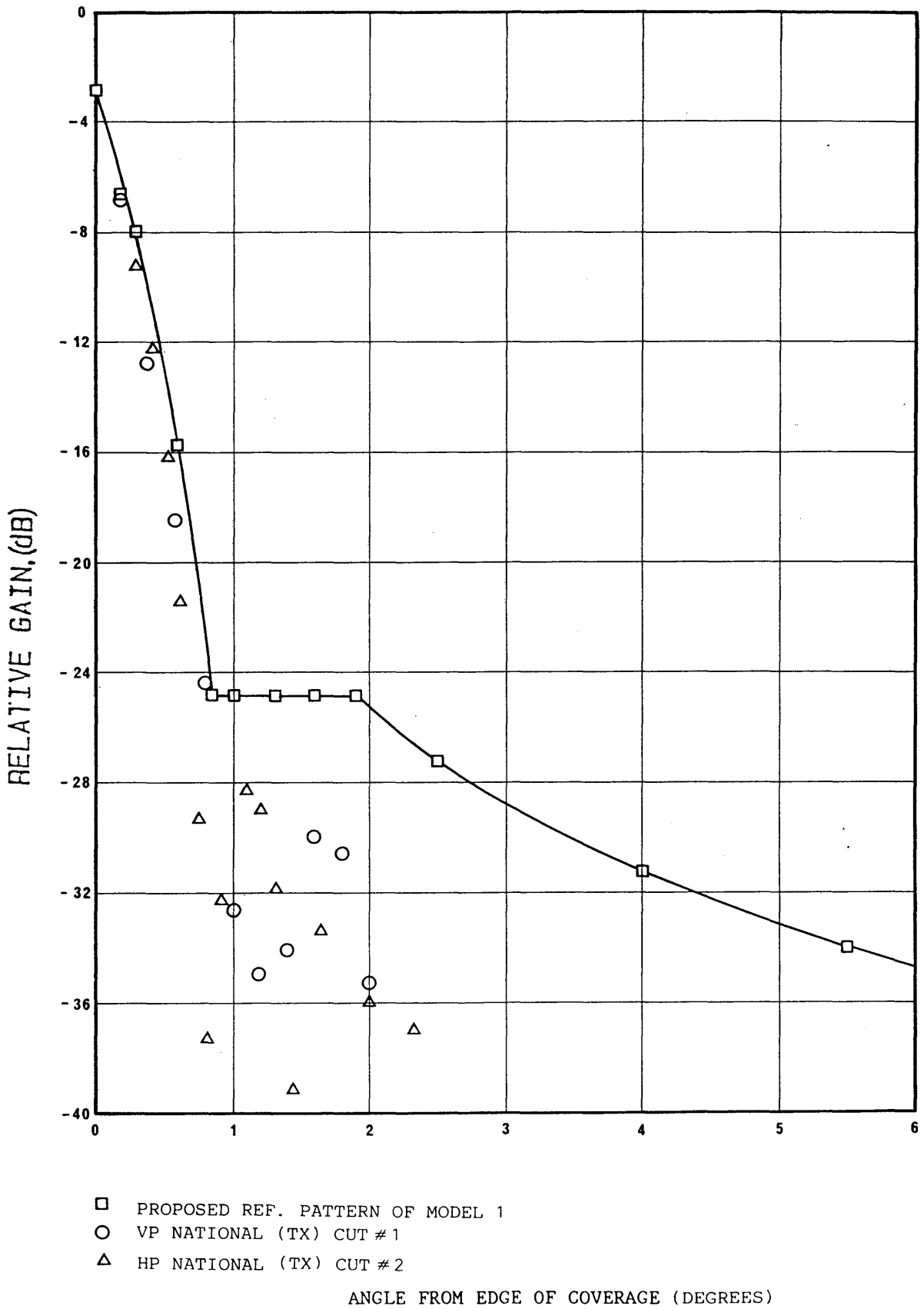
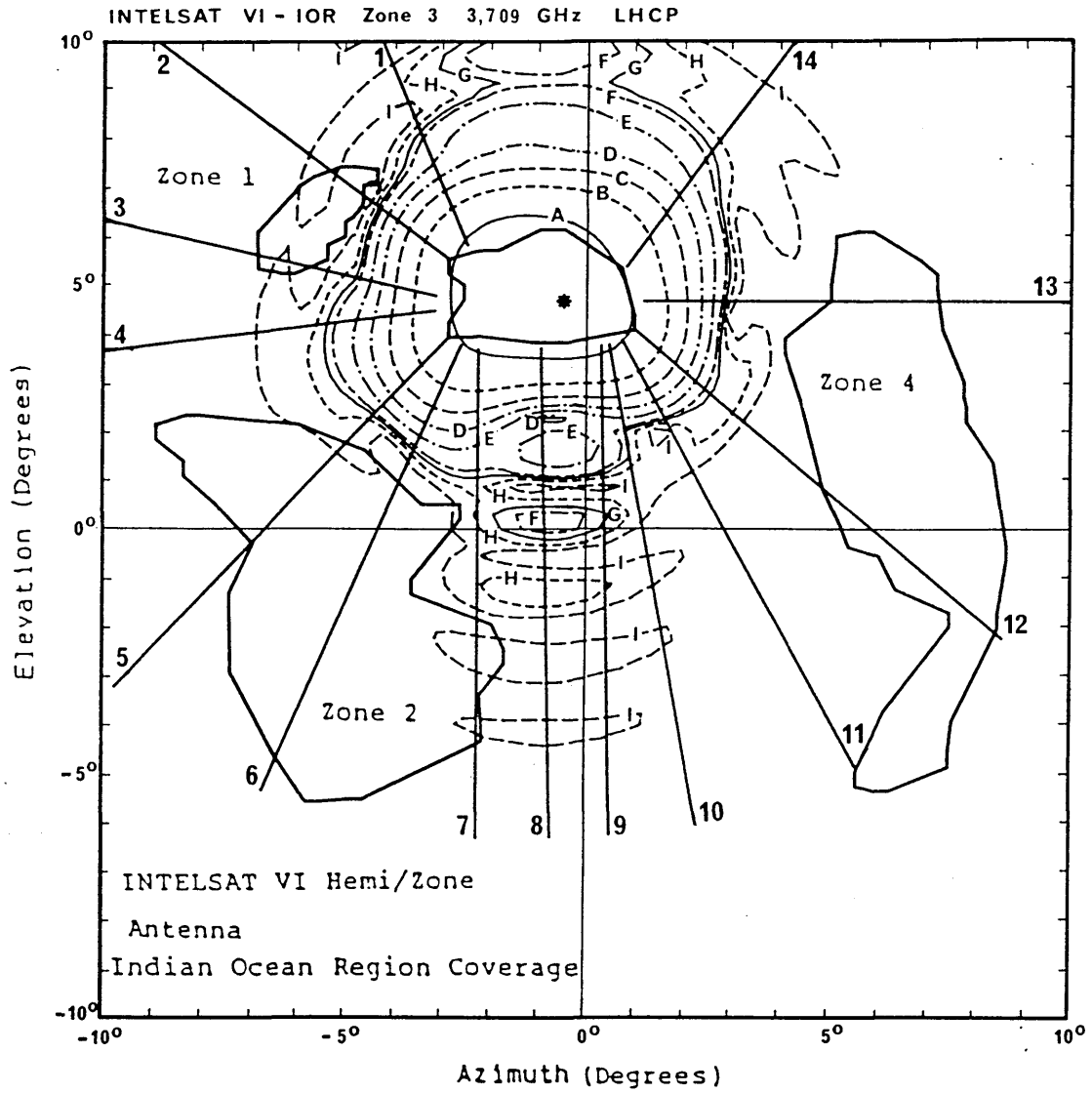

FIGURE 35 COMPARISON OF ANIK-E 14/12-11 GHz BANDS MEASURED DATA WITH PROPOSED REFERENCE PATTERN (D/λ = 80.76, FREQUENCY = 11.913 GHz)



Contour
Levels in dB

Contour Label	Level (dB)	Line Style
A	30.30	————
B	25.00	-----
C	20.00	-----
D	15.00	-----
E	10.00	-----
F	5.00	-----
G	3.00	-----
H	0.00	-----
I	-5.00	-----

Fig. 36 Shaped Beam for Indian Ocean Region Zone 3

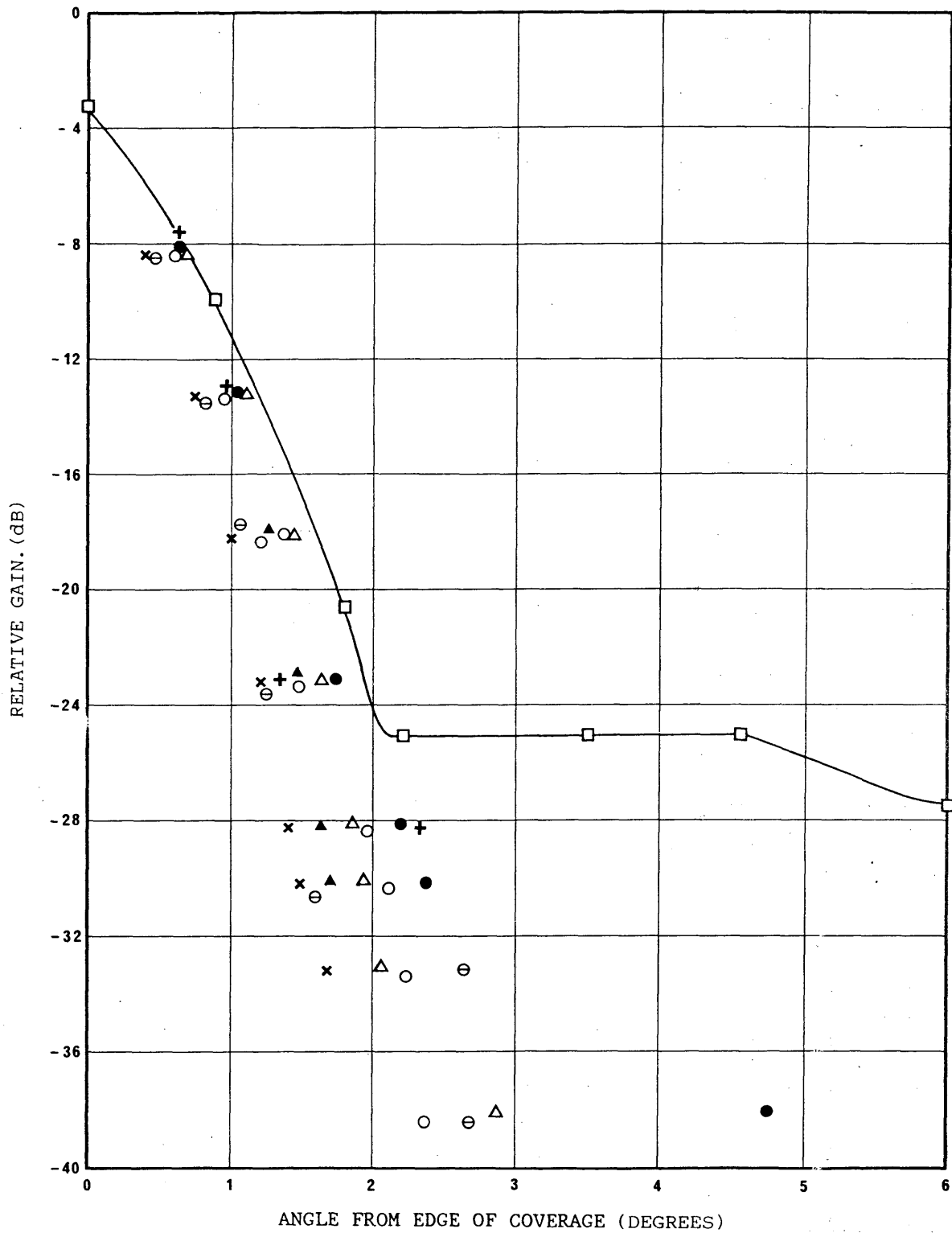

- PROPOSED REF. PATTERN OF MODEL 1
- CUT # 1
- × CUT # 3
- △ CUT # 5
- CUT # 7
- + CUT # 9
- ▲ CUT # 11
- ⊖ CUT # 13

FIGURE 37 COMPARISON OF INTELSAT VI CONTOUR DATA WITH PROPOSED REFERENCE PATTERN (D/λ = 39.6, FREQUENCY = 3.708 GHz)

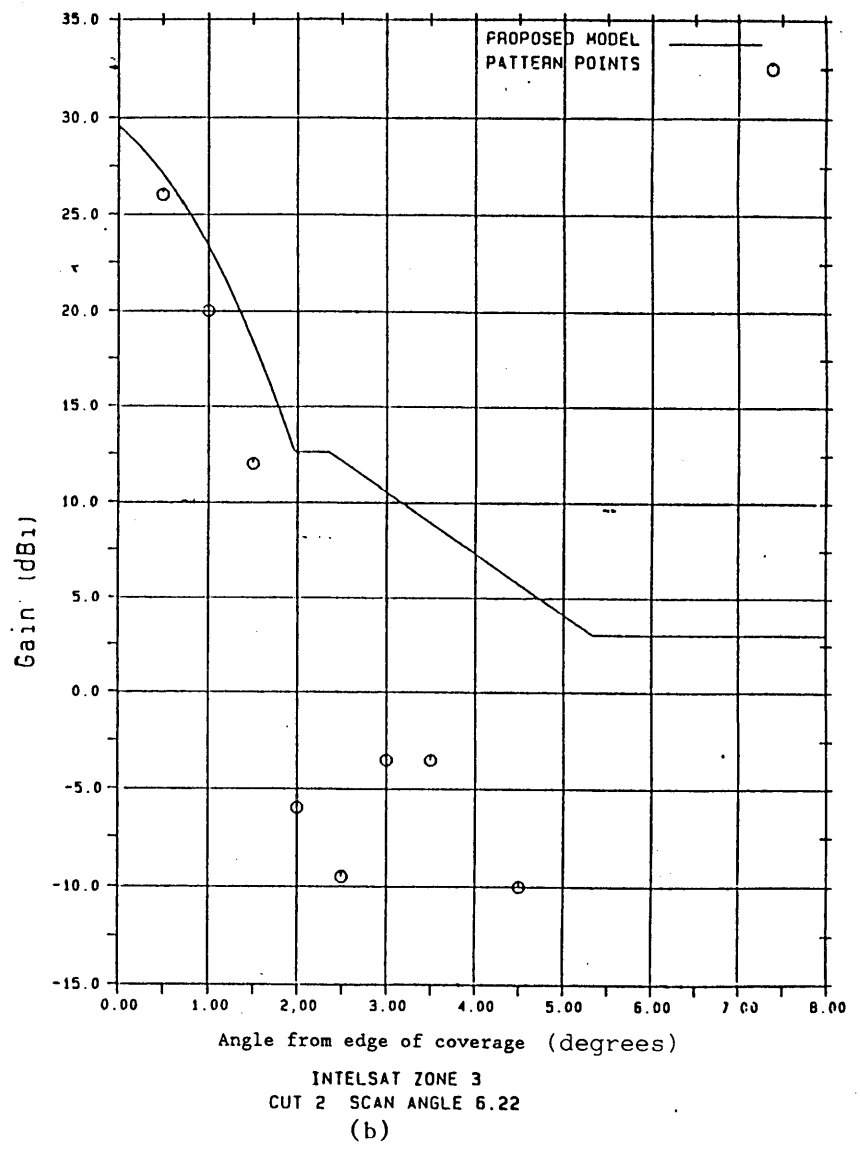
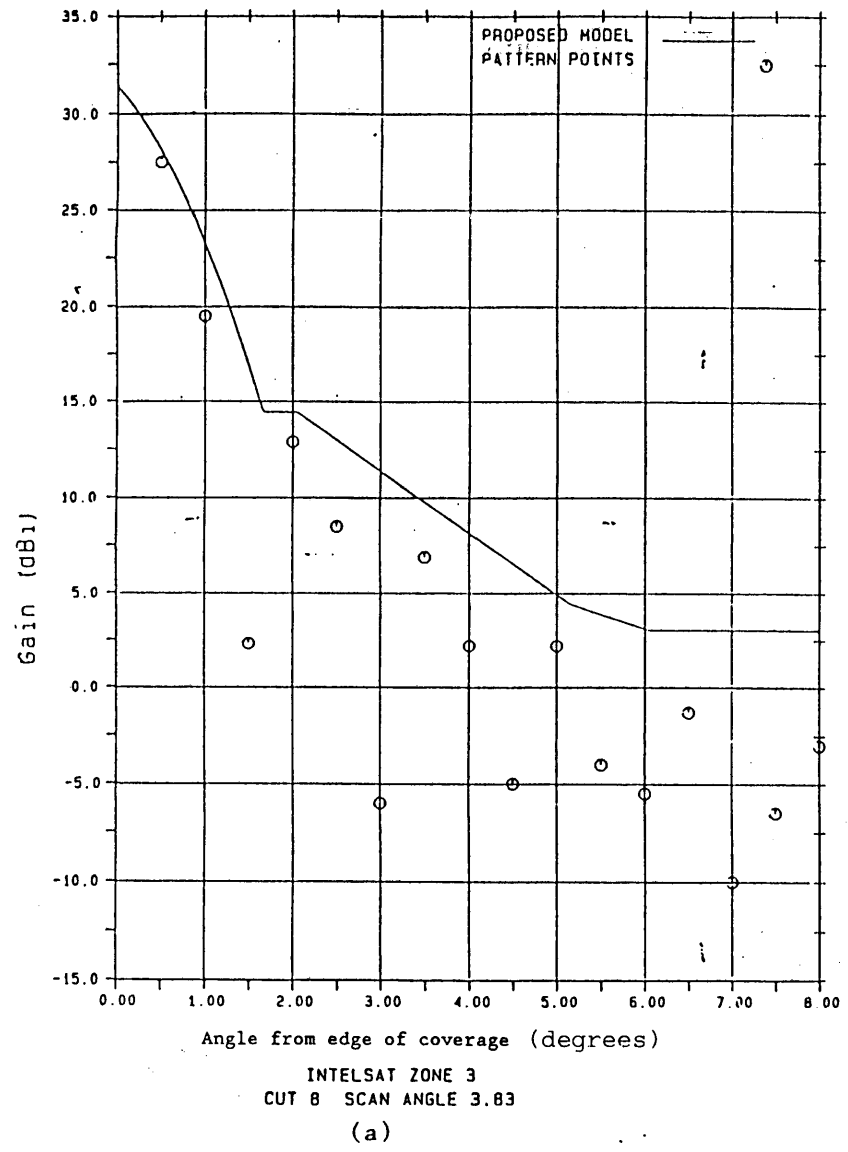
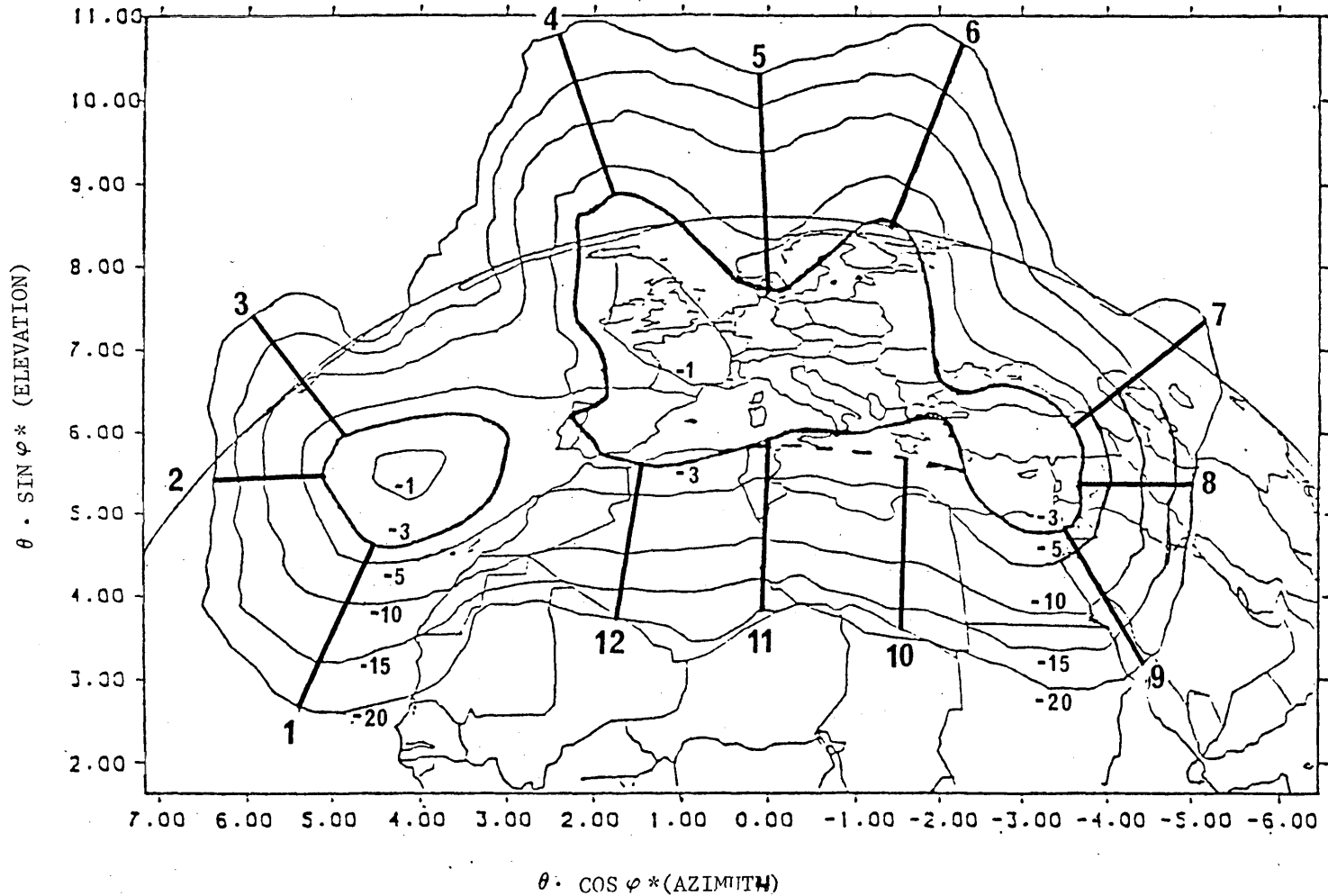

FIGURE 38

Comparison of the INTELSAT VI radiation pattern with the proposed model 2

ARRAY / PLAIN REFLECTOR AT 11.20 GHz - COBRA ANTENNA : COPOLAR
 PEAK = 32.67 dBi



* θ and φ are the circular polar coordinates as seen from the spacecraft
 FIGURE 39

COBRA 2 - Copolar contour plot obtained with a reflector and a 5 element array

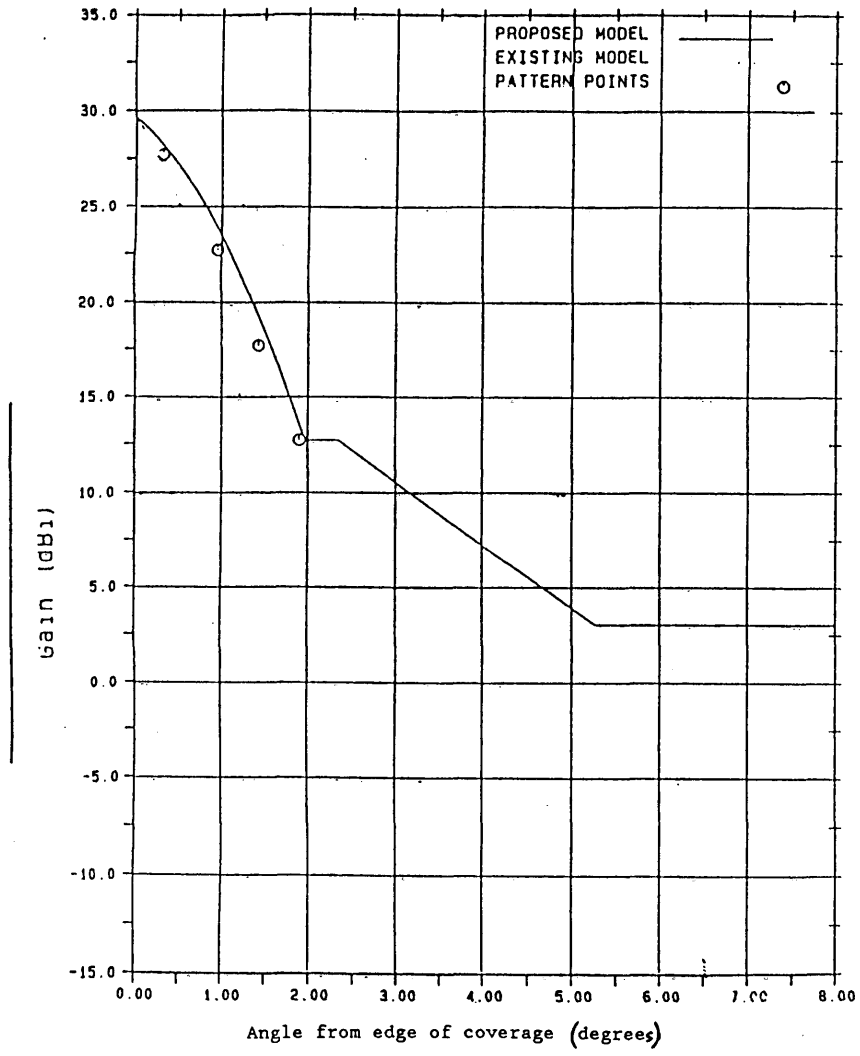

COBRA 2
CUT 9 SCAN ANGLE 4.2
(a)

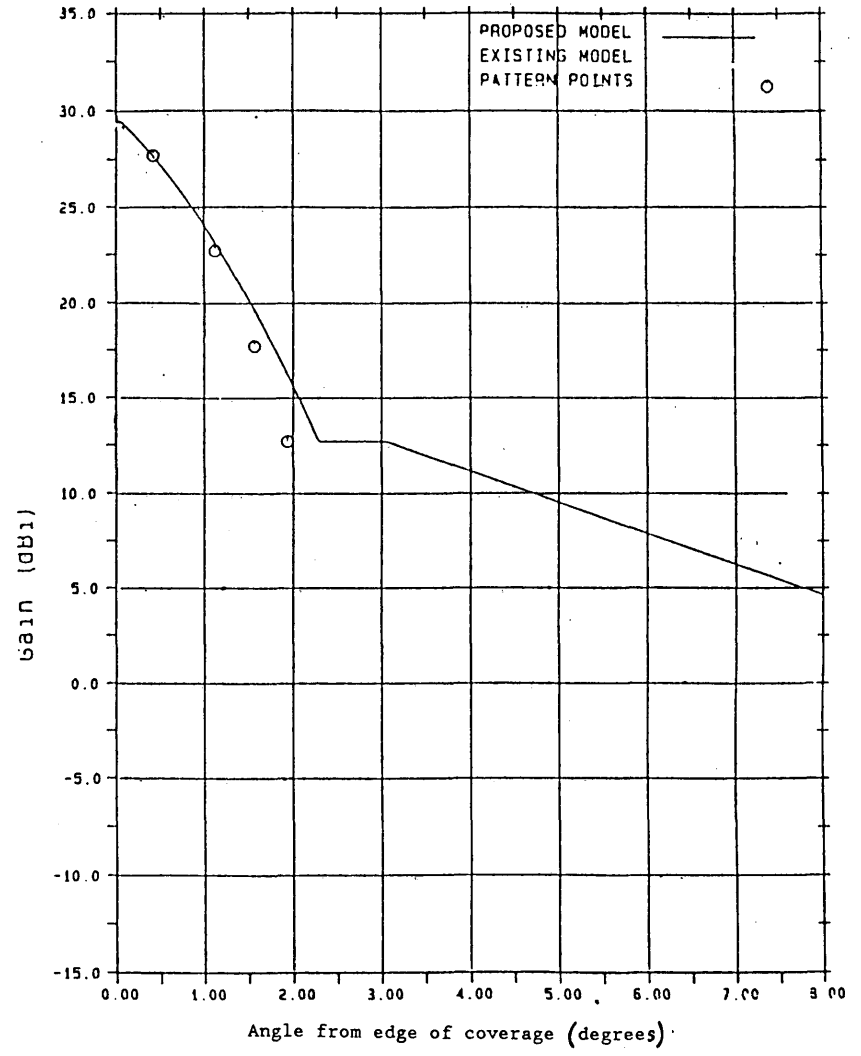

COBRA 2
CUT 12
(b)

FIGURE 40

Comparison of the COBRA 2 radiation pattern with the proposed model 2

REPORT 1136

GEOSTATIONARY SATELLITE ANTENNA POINTING ACCURACY

(Study Programme 28A/4)

(1990)

1. Introduction

The determination of regulations on satellite antenna beam pointing accuracy is driven by elements, such as: avoidance of interference with other systems and efficient utilization of the geostationary satellite orbit.

For the satellite designer, the definition of a beam pointing accuracy is the result of a broad trade-off which involves the spacecraft bus, its configuration, the design of the structures, the choice of the materials, the Attitude Control System (ACS) concept, the selection of its critical components, the spacecraft propulsion system, the thermal control system, the orbit control tolerance (stationkeeping accuracy) and other elements specific to each one of these areas. For the satellite operator, the attainment and maintenance of the pointing accuracy to which the spacecraft has been designed implies the implementation of the appropriate operation plan, and the careful monitoring of telemetry data which can only be considered, under normal conditions, an indirect indication, but not a direct measurement, of the beam pointing error. A direct measurement of this would require the use of ground based equipment capable of determining the location of the ground intersection with the axis of maximum radiation of the satellite-based antenna beam, or, more practically, of measuring signal strength variations at a number of stations properly located around the periphery of the beam [Keigler and Muhlfelder, 1986].

The initial attainment of accurate beam pointing can be achieved via the spacecraft's telecommand and data handling sub-systems and appropriate ground control. This is a complex matter and is essential for the attainment of the required service coverage areas; it may also be employed to maintain correct beam pointing during operational service. An outline of a mathematical model which may be employed to achieve this end is given in Annex I, and a more detailed treatment is contained in Ref. V.

The remainder of this report presents first a brief survey of the various elements which contribute to beam pointing errors and of the options available for accurate beam pointing. It then discusses attainable performances in view of current operational experience and on the basis of different types of antenna, beam configurations, and coverage area. Finally, it addresses the issues of orbit utilization efficiency and of antenna gain loss as a function of beam pointing accuracy.

An example of the effect of the satellite antenna pointing on the GSO utilization efficiency is presented based on a specific model of homogeneous satellite networks.

2. The pointing error budget

Errors which contribute to the mispointing of an antenna boresight axis can be conveniently subdivided into four classes: constant, seasonal or long term, daily, and short term. Much of the contribution of the various error sources depends on what is assumed as a pointing reference, what control system concept or spacecraft configuration is selected, and how accurately the spacecraft is maintained around its nominal orbital station.

Mechanical alignment errors and tolerances within the earth sensor itself, the sensor mounting plate, the master alignment cube, the spacecraft frame, the antenna structure and the deployment mechanisms, and errors in gravity compensation fixtures all contribute to a constant error. Another source of error is in the alignment of the spin axis of fixed momentum storage devices (momentum wheels, or rotors of spin-stabilized spacecraft). Further contributor to a constant error is the effect of long term variation in sensor characteristics, material properties, material "creep", etc.

Seasonal errors are typically due to seasonal variations in Earth radiance and thermally induced variations in control electronics as well as deformations in structures. Another component into the long term error is due to the triaxiality drift of the spacecraft in its longitude deadband.

Errors with daily period are partly due to effects similar to those of the seasonal class, partly due to the daily orbital motion of the satellite within its stationkeeping tolerances (eccentricity librations in longitude and latitude oscillations due to orbit inclination).

Finally, short term errors are due to various sources within the attitude control system electronics and components, and disturbance torques due to orbital manoeuvres (stationkeeping).

Because of the statistically independent nature of these various error terms, an estimate of the expected total error is normally obtained by the Root Sum Square (RSS) method, applied to within each class, and by the sum of the subtotals of each class. A worst case absolute error sum is overconservative.

3. System design options

Various options are available to the spacecraft designer to meet given beam pointing requirements. They range over spacecraft configuration, structural design, material selection, control system configuration, component selection, and various other elements including operational procedures.

An optimized design is not simple, but rather the result of complex techno-economic trade-offs, which, for the stringent pointing accuracies required in modern communication satellites, push the limits of technology.

The spacecraft configuration, the design of the pertinent structures and the material selection bear a significant component in the beam pointing error. A "sophisticated" spacecraft bus design can be used with a relatively unsophisticated attitude control system, whereby the pointing accuracy of the various antenna beams is related to the accuracy and stability of the orientation of the entire spacecraft. This approach, which could be defined as the "traditional" approach, relies on independently minimizing each one of the four classes of errors.

An alternative to the "traditional" approach is offered by a spacecraft bus design using a control system concept capable of compensating or eliminating some of the component errors altogether. A possible choice is a multiloop control system, in which the basic attitude control system orients and stabilizes the spacecraft as a rigid body, while the antennas are independently steered and pointed to their respective stations by auxiliary tracking loops operated by ground based r-f beacons. By directly tracking a ground beacon, the pointing error of an antenna can be freed of most of the structural-dependent portion (a significant portion of the constant, seasonal, and daily components). Control systems of this type are being employed on current or planned satellites but adherence to stringent design factors is needed to ensure adequate performance. These factors are due to the complex nature of the sensor which includes the reflector, the feed system, and the ground beacon. If the further improvements in antenna pointing accuracy as precise as 0.015° are indicated from the system investigations, it is necessary to improve the RF sensor feed, to develop a highly accurate antenna drive mechanism and to adopt this mechanism to drive the sub-reflector which has higher eigen frequencies than the main reflector. Figure 1 indicates the benefits in terms of pointing accuracy which may be obtained by the use of beacon tracking antenna control systems. Beacons located toward the edge of the antenna coverage tend to produce strongly non-linear characteristics. Additional practical difficulties of implementation, as for the INTELSAT system, appear when a spacecraft may need to be relocated and operate at different longitudes. The difficulty is in the availability of ground stations (for location of a beacon) which satisfy the same geometrical relationship to the spacecraft at the different longitudes.

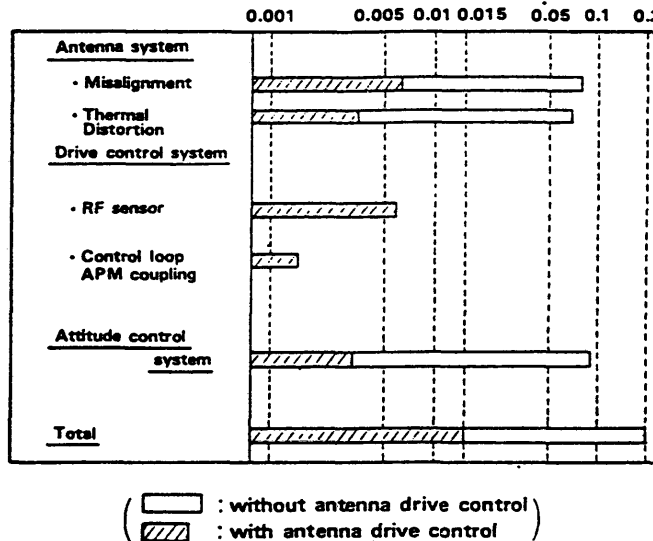

Figure 1 - Antenna pointing error budget

Another possibility for maintaining beam pointing accuracy can be found in Annex I.

4. Attainable performance

[Durling, 1983] gives a brief history of the improvements in pointing accuracy for spin-stabilized satellites. Figure 2 reproduced here, tabulates the improved pointing accuracies obtained over a period of approximately 20 years (1963-1983):

Three-axis stabilized spacecraft have demonstrated similar levels of pointing accuracy over the years [Keigler and Muhlfelder, 1986].

SYNCOM (1963-64) had an achievable pointing accuracy of 0.5 degree. obtained via a sun sensor. A significant improvement was realized with the INTELSAT IV spin stabilized spacecraft launched between 1971-1974 i.e. a nominal 0.2 degree pointing accuracy. Earth pointing for INTELSAT IV was accomplished using sun sensors and earth sensors, employing either analogue or digital error-processing in the despun control electronics (DCE) units. Sun sensors were used for most of the mission, except for eclipse operations, where earth sensors were employed.

An end-of-life report issued by INTELSAT [Scalici et al., 1989] indicates that the on-orbit pointing accuracy of the INTELSAT IVAs, launched in the 1975-1978 period was significantly better than the INTELSAT IVs, despite the fact that the INTELSAT IVAs were inherently less stable than the older INTELSAT IVs (due to different mass properties). For these INTELSAT IVA spacecraft, earth pointing was provided by the same combination of earth and sun sensors as on INTELSAT IV. However, the analogue mode of operation with despun control electronics could use only earth sensor inputs. Figure 3 depicts a histogram of pointing errors for the INTELSAT IVA (F-6) spacecraft.

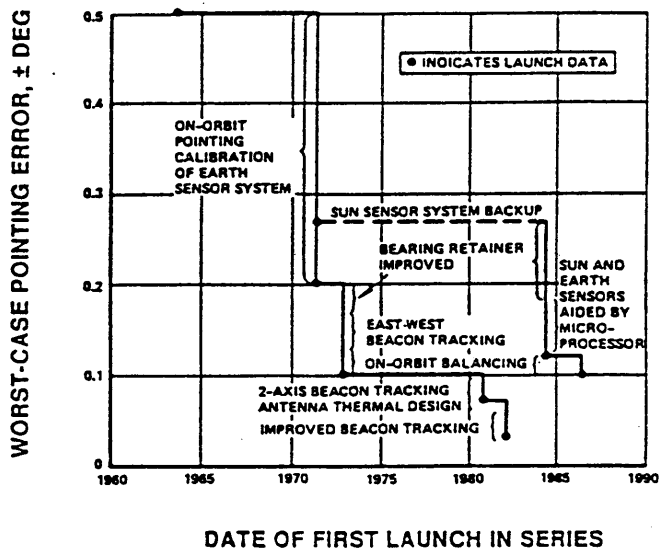

Figure 2 - History of improvements in pointing accuracy

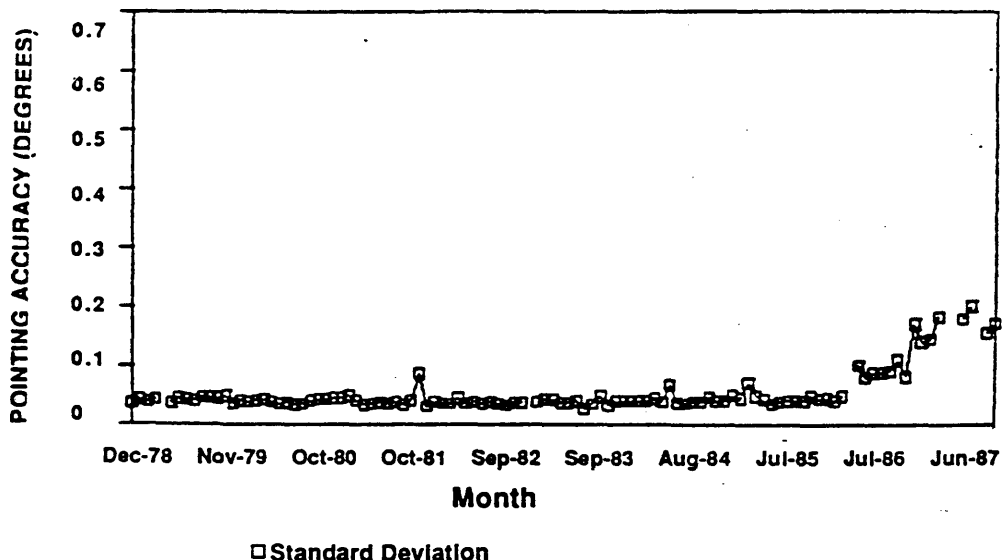

Figure 3 - IVA-F6 pointing performance.
Launch to end-of-life

Beam pointing accuracy currently attainable by the orientation and stabilization of the entire spacecraft, or of the payload platform in the case of spin-stabilized spacecraft, is of the order of $\pm 0.1^\circ$ in any plane containing the beam axis. For large spacecraft carrying complex, multibeam antennas the attainable performance is somewhat less accurate ($0.18^\circ - 0.2^\circ$ for INTELSAT V, 0.15° for INTELSAT VI). Significantly better performances are difficult to attain except for spacecraft of relatively compact characteristics.

Beacon tracking techniques can be successfully used to reduce pointing errors to significantly less than 0.1° for simple antenna subsystems. For example, the fixed/mobile multibeam antenna system of the Japanese ETS-VI satellite, scheduled to be launched in 1992, can maintain pointing accuracy within 0.015° for each of multiple beams having beamwidths of 0.3° . This is achieved by adopting the beacon tracking system with the sub-reflector drive. The tracking system consists of four-horn monopulse feeds and a receiver operating in conjunction with a 27 GHz beacon transmitting from a reference earth station. Figures 4 and 5 illustrate this example. Satellites with complex antenna subsystems can have a combination of large and small antenna beams produced by different antennas. Unless each one of the beams uses a beacon tracker, the pointing error of the beams not controlled by a beacon would, at best, be equal to the attitude error of the platform itself. If beacon tracking is employed, a beacon generating earth station would be required for each and every antenna, which could be costly for a large number of beams. In addition some spot beams may share the same reflector and therefore not all the spot beams of that antenna would achieve the same pointing accuracy as the spot beam (master beam) in which the beacon earth station is located. The situation is aggravated by the separation of the beams. If the master beam and another beam (slave) are both near the edge of the Earth's disc, but in nearly opposite positions with respect to the Earth centre, some of the corrective actions of the beacon tracker (those which correct the effects of satellite yaw errors or of orbit inclination) will further deteriorate the pointing error of the slave beam. This effect could be minimized by the development of sensor systems, capable of independently detecting yaw errors in order to provide appropriate attitude control corrections. In no case, however, can the beam pointing accuracy of a multibeam antenna with transoceanic coverage attain the same levels as single-beam antennas with national or regional coverage.

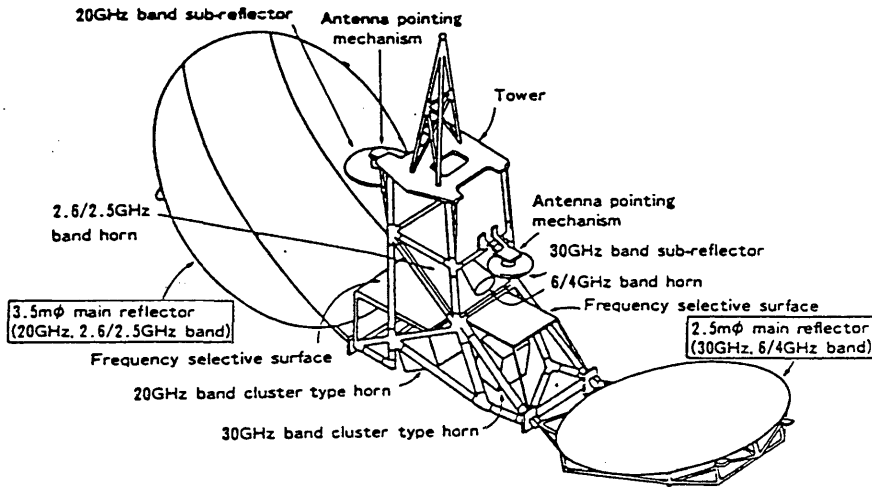

Figure 4 - Configuration of the antenna system

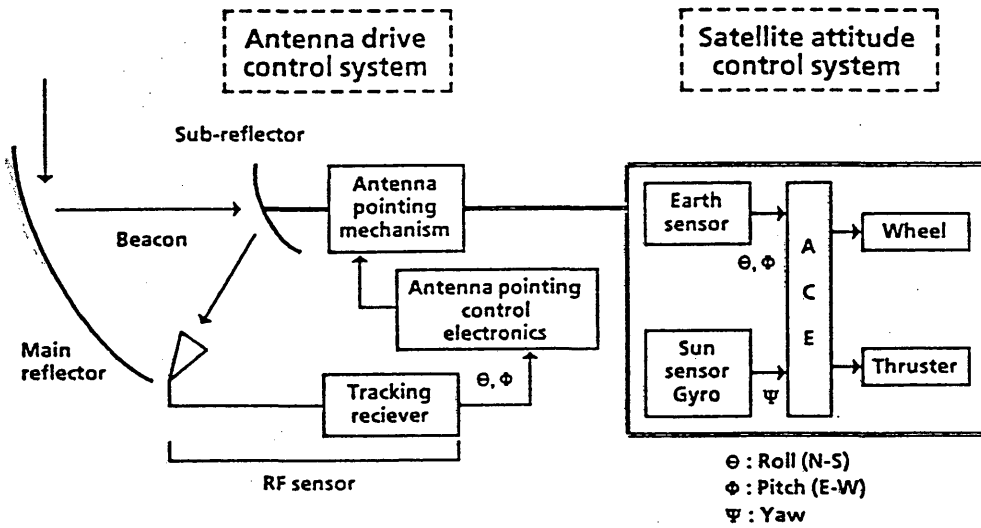

Figure 5 - Antenna pointing control system

5. Orbit utilization efficiency and gain loss

Antenna-beam pointing errors produce both a loss in orbit utilization and a loss in antenna gain. These effects result from the larger beamwidth required to cover a determined area in the presence of a given pointing error. For instance, if a 1° circular coverage is required for a given area, the presence of a 0.2° pointing error requires that a 1.4° circular beam be used in order to guarantee the 1° coverage. For this example, the effective loss in antenna gain is $20 \log (1.4/1.0) = 2.9$ dB. The effective loss in spacecraft antenna gain affects the achievable spacecraft receive G/T as well as the achievable spacecraft down-link e.i.r.p. Lower spacecraft G/T means higher e.i.r.p. for the earth stations, and the loss of the spacecraft e.i.r.p. means either a larger and heavier spacecraft or a bigger or better earth station.

For all beams it can be observed that, for a fixed pointing error, the larger the coverage area, the smaller is the gain loss. For beams of circular cross-section, this is illustrated in Figure 6. From the figure it can also be observed that even when the Radio Regulation is adhered to, gain losses of nearly 5 dB and 3 dB may arise for antennas of 0.8 and 1.6 degree beamwidth, respectively. In general, for beamwidths less than about 1° , the gain loss is quite significant if the pointing error is not kept below about 10% of the beamwidth.

If the pointing error is kept to 10% of the beamwidth, the gain loss is limited to 1.6 dB.

The effects of beam pointing errors on orbit utilization efficiency based on the homogeneous model are illustrated with examples using minimum coverage beam size of 1.6° .

The examples presented here have been developed using the ORBIT II program. The exercises include all the ITU Region 1 and some Region 3 countries, totalling 95 coverages.

The technical parameters assumed in the exercises are as follows:

i) Earth station parameters

Antenna size:	5 m
Noise temperature:	200 K
Uplink frequency:	6.775 GHz
Downlink frequency:	4.5 GHz
HPA output power:	Variable depending on size of coverage area
	25 dBW (minimum)
	35 dBW (maximum)
Sidelobe characteristics:	$32 - 25 \log \varphi$ (dB)

ii) Space station parameters

Antenna total beamwidth: Variable (dependent on size of coverage area)
 Minimum is 0.8° or 1.6°
 (total half-power beamwidth)
 e.i.r.p.: 40 dBW
 Noise temperature: 3000 K
 Sidelobe decay constant*: 3.5

iii) Interference criteria

All networks satisfy the aggregate carrier-to-interference power ratio (C/I) of greater than 24 dB.

Pointing errors of 0.0° , $\pm 0.1^\circ$, $\pm 0.2^\circ$, and $\pm 0.3^\circ$ were used to determine the required width of the orbital arc for a minimum beamwidth of 1.6° . The results are summarized in Table I. They show the total orbital arc required to accommodate the 95 coverages and the percent increase in orbital arc, relative to the ideal 0° mispointing case, as a function of the pointing error.

From the results which apply for the specific model explained above, one can see that the impact of a $\pm 0.2^\circ$ pointing error on orbit utilization efficiency is less than 10%, while it becomes significant at $\pm 0.3^\circ$. For larger beams, this impact becomes significant at larger pointing errors.

As another example of what benefits might accrue in beam-to-beam discrimination from reducing pointing errors from 0.3° to either 0.2° or 0.1° , a set of seven "test" beams were evaluated in terms of their mutual discrimination from a reference beam.

For this analysis three different circular beamwidths were selected: 1.6° , 2.4° and 3.2° . By using a computer program the mutual off-axis angles between each of the test beams and the reference beam were computed as were the corresponding sidelobe gains*. Each of the beams was assumed to be perturbed by 0.3° , 0.2° and 0.1° ; the resulting relative sidelobe gains were then re-computed for each of these antenna pointing errors. This was done by increasing the selected beamwidth from its nominal value to an oversized beamwidth, by a factor equal to twice the pointing error. The locations of the beam boresights were selected in order to cover a wide range of beam separation angles, from approximately 1.4° to 9.2° . Thus, the following cases were analyzed:

* The relative sidelobe gain of the satellite antennas circular beams is defined by

$$g(\psi) = 10 \log \left[\frac{1}{1 + (\psi/\psi_0)^\alpha} \right]$$

where ψ_0 is one-half of the half-power beamwidth and α is the sidelobe decay constant, set to 3.5 to approximate the antenna reference pattern depicted in CCIR Report 558, for the case of single-feed circular beams.

<u>Nominal Beamwidth</u> (without pointing error)	<u>Practical Beamwidth</u> (including pointing errors)		
	$\pm 0.1^\circ$	$\pm 0.2^\circ$	$\pm 0.3^\circ$
1.6°	1.8°	2.0°	2.2°
2.4°	2.6°	2.8°	3.0°
3.2°	3.4°	3.6°	3.8°

The results of this analysis are shown in Figure 7. As expected, the discrimination improvements with reduced pointing errors are more pronounced with the smaller size coverage beams. The differential sidelobe gain from 0.3° to 0.2° or from 0.3° to 0.1° also reached an asymptotic value at off-axis angles of approximately twice the nominal beamwidth. The maximum expected improvements in beam-to-beam discrimination can be summarized as follows:

Discrimination improvement

<u>Nominal beamwidth</u> (without pointing error)	<u>Improved</u> <u>Pointing accuracy</u>	<u>Improved</u> <u>Pointing accuracy</u>
	$\pm 0.3^\circ$ to $\pm 0.2^\circ$	$\pm 0.3^\circ$ to $\pm 0.1^\circ$
1.6°	1.45 dB	3.05 dB
2.4°	1.05 dB	2.18 dB
3.2°	0.92 dB	1.70 dB

Thus, for the smallest beam size, 1.6°, reducing pointing errors from 0.3° to 0.1° produced a net discrimination 1.6 dB better than using the somewhat less stringent reduced antenna pointing error tolerance (0.3° to 0.2°).

For the medium size beam, 2.4°, the differential in discrimination improvement was only 1.13 dB, comparing 0.3° to 0.1° versus 0.3° to 0.2°. Finally, for the largest size beam examined, 3.2°, the differential in discrimination was less than 1 dB.

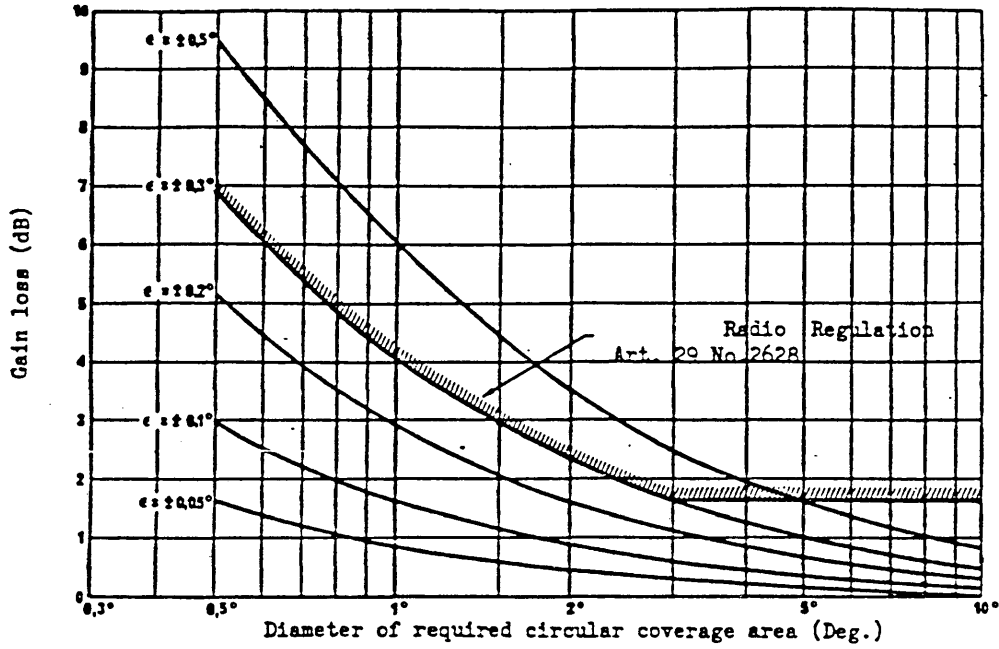

FIGURE 6 - Circular beam antenna gain loss due to pointing error

$\epsilon = \pm 0.3^\circ$ or 10% beamwidth

TABLE I

Orbital arc requirements (1.6° beamwidth)

Pointing error (Degrees)	Total arc (Degrees)	Relative increase (%)
0	88.2	---
+0.1	93.9	6.5
+0.2	96.77	9.8
+0.3	109.76	23.4

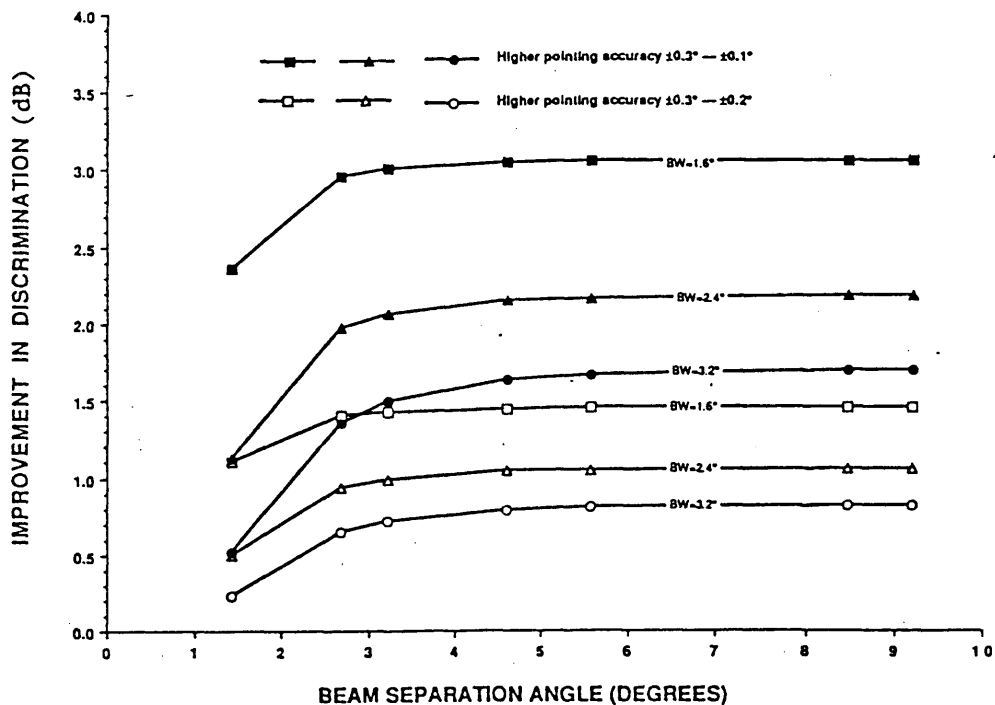

FIGURE 7

Effect of higher pointing accuracy on
satellite beam discrimination

6. Conclusions

The results of this study clearly show that spacecraft antenna pointing errors are most significant for small coverages.

For such coverages, usually a single antenna on board a single spacecraft is used and utilization of the beacon tracking technique could be very beneficial. In such cases, it is possible to trade the additional cost of a larger spacecraft with the additional cost of a beacon tracking system. However, for large platforms carrying complex antenna assembly that generate multiple beams, such a trade-off is not simple. The use of complex and expensive multiple beacon trackers may be required. In cases of beams with broad coverage or multiple narrow beams with broad separation and sharing the same reflector a lower beam pointing accuracy is attainable with the currently available technology.

REFERENCES

1. KEIGLER, J.E., MUHLFELDER, L. [1986] "Optimum Antenna Beam Pointing for Communication Satellites", AIAA 11th Communication Satellite Systems Conference, paper 86-0613.
2. AAGESEN, S., SCALICI, F. and SITAPAR, A. [January, 1989] INTELSAT technical memorandum "End of life report for INTELSAT IV/IVA satellites in orbit".

3. DURLING, G.W. [1983] 13th International Symposium on Space Technology and Science, Tokyo, Japan. "High power and pointing accuracy from body-spun spacecraft".
4. KAWAKAMI, Y., et al. [1987] "On-board Ka-Band Multibeam Antenna System with High Pointing Accuracy for ETS-VI", GLOBECOM'87, page 952.
5. MASHBITS, L.M. [1982] - Zony obsluzhivaniya sistem sputnikovoi svyazi (Service areas of satellite communication systems). Radio 1 Svyaz, page 169.

ANNEX I

Method of satellite beam pointing control from the ground

A possibility for both attainment and maintenance of correct coverage areas considered by [Mashbits, 1982 - see Ref. 5 of main text] is the correction of satellite antenna pointing errors by adjustment of the position of the satellite antenna relative to the satellite by commands sent from the earth station of the space maintenance service. These commands are generated at the computing centre on the basis of signal strength measurements at several test points (earth stations) located toward the edge of planned coverage area.

Using ground commands the satellite antenna is repositioned a number of times (three angles ψ_1 , ψ_e , σ are changed). For each (j-th) position of the satellite antenna signal levels at the test points are measured at linear receiver outputs U_{ij} , where i is the test point number. The results of these measurements are transmitted to the computing centre.

At the computing centre the following problems are solved:

- a) on the basis of attitude measurements the satellite coordinate parameters are determined for a given time;
- b) using the data obtained in a) above, the known coordinates of the test points, the known antenna radiation pattern and data of measurements obtained at the test points (relative values $U_{i2}/U_{i1}, U_{i3}/U_{i1}, \dots$ are used) the satellite orientation angles are determined (ψ_r, ψ_p, ψ_y);
- c) using the data obtained in a) and b) the coordinates of the coverage area and the destabilization loss $\eta_d = W_o - W_{kmin}$ are calculated. (W_o is the planned value of the p.f.d., W_{kmin} - minimum value of p.f.d. in the k-th test point, located in the most unfavourable position.) If η_d exceeds the given nominal value then optimum values of satellite antenna orientation angles are determined which would ensure minimum value of η_d ;
- d) in order to visualize and document the situation, the service polygon and satellite antenna coverage areas (planned and actual areas before and after correction) are represented on a map of specified format by means of a graphic plotter.

The mathematical model (set of computer software) has been developed to solve the task described above, a consolidated flowchart of it is given in Figure 8.

PAGE INTENTIONALLY LEFT BLANK

PAGE LAISSEE EN BLANC INTENTIONNELLEMENT

SECTION 4 E: FREQUENCY SHARING BETWEEN NETWORKS OF THE
FIXED-SATELLITE SERVICE AND THOSE OF OTHER
SPACE RADIOCOMMUNICATION SYSTEMS

REPORT 560-2

SHARING CRITERIA FOR THE PROTECTION OF SPACE STATIONS
IN THE FIXED-SATELLITE SERVICE RECEIVING
IN THE BAND 14 TO 14.4 GHz

(Study Programme 2L/4)

(1974-1978-1982)

1. Introduction

Study Programme 2L/4* requires the study of the criteria for frequency sharing between the fixed-satellite service (Earth-to-space) and the radionavigation and radionavigation-satellite services at frequencies of the order of 14 GHz. This Report deals with those aspects concerning interference to geostationary space stations of the fixed-satellite service and derives provisional values for the limits to provide sufficient protection.

2. Protection of space station receivers in the fixed-satellite service against interference from radionavigation transmitters in the band 14 to 14.3 GHz

Since pulse-code modulation transmissions are likely to predominate in satellite systems working in the region of 14 GHz it would be appropriate to relate interference power to a bandwidth of 1 MHz. In accordance with previous studies of similar sharing problems, an interference power level not greater than 1/10 of the thermal noise at the satellite receiver input, is taken to be the objective.

A wide range of satellite antenna beamwidths, corresponding to various coverage requirements, is likely to be used in satellite systems in these bands. However, if the average geographical density of distribution of the interfering terrestrial stations, is the same for different coverage areas, it can be shown that the aggregate interference power at the satellite receiver input, is independent of the beamwidth of the satellite receiving antenna. The number of in-beam interfering transmitters will, in practice, vary with the size and location of the coverage area, and it is necessary to assume a typical beamwidth for the satellite antenna and make a suitable allowance for multiple interference entries.

In the following calculation a beamwidth of 1° has been assumed for the satellite antenna as a typical example.

TABLE I — Calculation of permissible power flux-density of interference at the satellite

Satellite receiver noise temperature	1500 K
Noise power in any 1 MHz band at receiver input	-137 dBW
Permissible interference power at receiver input in any 1 MHz band	-147 dBW
Satellite receiver antenna average gain relative to isotropic, for 1° beamwidth	43 dB
Effective aperture (<i>S</i>) of the antenna relative to 1 m ²	0.5
10 log <i>S</i>	-3
Permissible power flux-density of total interference at the satellite in any 1 MHz band	-144 dB(W/m ²)
Allowance for multiple entries in any 1 MHz bandwidth	-6 dB
Permissible power flux-density at the satellite from any single interfering transmitter in any 1 MHz bandwidth	-150 dB(W/m ²)

* Study Programme 2L/4 was deleted at the end of the study period 1982-1986.

In estimating the allowance to be made for multiple in-beam entries it is necessary to assume a model representing the future use of the band 14 to 14.3 GHz by the radionavigation service. Different types of radar transmitters are expected to use the band, including low-power FM or CW radars for distance and speed measurements. For these applications solid-state devices would be used with small antennas randomly oriented and having a beamwidth of a few degrees, and their use could become extensive. For other applications AM pulse radars with rotating beams might be used. As a guide in assessing the overall number of simultaneous in-beam interference entries into a geostationary satellite, a simple model has been assumed, in which the average density of low-power FM radar transmitters is taken as one per 100 km², and the beamwidths as 6° randomly oriented in the horizontal plane. With these assumptions it is shown in Annex I that, in a 1 MHz bandwidth, a single satellite would, on average, be within the antenna beam of four such transmitters. This model is of course, highly simplified but is thought to justify provisionally an overall allowance of 6 dB, for multiple in-beam entries, bearing in mind that there will also be a large number of off-beam interference entries at lower level.

It is thus concluded that, to provide adequate protection to the fixed-satellite service, when the number of simultaneous interference entries is small, the peak value of power flux-density set up at any point on the geostationary-satellite orbit by any radionavigation transmitter in the band 14 to 14.3 GHz should not exceed -150 dB(W/m²) in any 1 MHz band.

3. Expression of power flux-density as a function of transmitter density

Although the limit derived in § 2 assumes only 4 simultaneous in-beam entries per MHz, it allows a reasonably high geographical density of simultaneously active transmitters when account is taken of the random distribution of their frequencies and antenna directions. However for some radionavigation applications it is possible that low-power devices may be used with much greater densities and in such cases the limiting power flux-density per transmitter would need to be reduced accordingly.

Assuming as before, that the radionavigation antennas are randomly oriented in the horizontal plane, the number of simultaneous in-beam interference entries in a 1 MHz band, received by a satellite antenna which is illuminating the earth at a low angle of elevation is given by:

$$n = DA \frac{\theta}{360}$$

where D is the average density per km² of the radionavigation transmitters simultaneously active within the 1 MHz band, A is the area of the Earth's surface covered by the satellite receiving antenna (in km²) and θ is a representative average value for the beamwidth in degrees of the radionavigation transmitting antennas.

Assuming as in § 2 and in Annex I, that the average value for θ is taken as 6°, and the coverage area A is 1.2×10^6 km², then

$$n = D \times 2 \times 10^4$$

Thus, when n is greater than 4, the maximum value of peak power flux-density which any transmitter may produce at the geostationary-satellite orbit would be given by:

$$-150 - 10 \log n/4 \quad \text{dB(W/m}^2\text{) in any 1 MHz band}$$

$$-187 - 10 \log D \quad \text{dB(W/m}^2\text{) in any 1 MHz band.}$$

Annex II gives an example calculation for a particular type of radar using this frequency band.

4. Protection of space station receivers of the fixed-satellite service against interference from satellites in the radionavigation satellite service in the band 14.3 to 14.4 GHz

It is assumed that satellites in the radionavigation satellite service employed in this band will be geostationary satellites providing the radio sextant type of system (see Recommendation 361-2 (Kyoto, 1978)). The permissible interference power at the fixed satellite receiver input will remain at -147 dBW in any 1 MHz band as shown in Table I, and to allow for four multiple entries a factor of 6 dB is appropriate. However, a different approach is required in applying this to the radionavigation satellite service, since it is necessary to envisage coordination between these space services rather than a power flux-density limit. The criterion to be used in this procedure should therefore be that the interference power produced at the fixed satellite receiver input by any radionavigation satellite should not exceed -153 dBW in any 1 MHz band.

ANNEX I

ESTIMATE OF NUMBER OF SIMULTANEOUS INTERFERENCE
ENTRIES FROM RADIONAVIGATION TRANSMITTERS

As a guide to estimating the allowance to be made for simultaneous interference entries from radionavigation transmitters, a simple model is assumed in which low-power FM radar transmitters operating on the same nominal frequency channel, are assumed to be distributed throughout the coverage area of the satellite antenna beam. The radar antennas are randomly oriented in the horizontal plane. A derivation of the average number of simultaneous in-beam entries is as follows:

Radar antenna beamwidth	6°
Transmitter bandwidth	50 MHz
Average geographical density of transmitters within satellite coverage area	1 per 100 km ²
Approximate area covered by satellite antenna having 1° beamwidth	1.2×10^6 km ²
Number of transmitters within the coverage area	12×10^3
Number of radar antennas directed within $\pm 3^\circ$ of a geostationary satellite	$12 \times 10^3 \times (6/360) = 200$
Average number of radars within a 1 MHz band simultaneously pointing at a satellite	$200 \times (1/50) = 4$

ANNEX II

ESTIMATE OF THE POWER FLUX-DENSITY SET UP BY
EQUIPMENT KNOWN AS "WHISTLER RADARS"

The Whistler radar is a portable device with a range of up to 3.7 km. Its main characteristics are the following:

Operating frequency band	14.0 to 14.03 GHz
Maximum antenna gain	25 dB
Beamwidths — Elevation	10°
Azimuth	3°
Power at antenna input	— 13 dBW
Modulating waveform	10 Hz triangular
FM deviation	± 7.5 MHz
Minimum detectable signal	— 150 dBW in a bandwidth of 150 Hz.

It is readily seen that the maximum e.i.r.p. of the device is 12 dBW and the resulting power flux-density at the geostationary orbit thus about -151 dB(W/m²) in 15 MHz, or about 10 dB less than stipulated in § 2 for the single entry; assuming main beam-to-main beam transmission (low elevation angle of the interfered-with space station).

REPORT 872

SHARING CRITERIA BETWEEN INTER-SATELLITE LINKS CONNECTING
GEOSTATIONARY SATELLITES IN THE FIXED-SATELLITE SERVICE AND THE
RADIONAVIGATION SERVICE AT 33 GHz

(Study Programme 31A/4)

(1982)

1. Introduction

Report 451 considers the technical characteristics of inter-satellite links of the fixed-satellite service, and indicates that in the near term there may be a need for a limited form of inter-satellite link having a relatively short inter-satellite spacing and operating between about 15 and 33 GHz.

At the WARC-79 a band in this range was allocated to the inter-satellite service (32 to 33 GHz), shared with the radionavigation service.

The feasibility of sharing between inter-satellite links of geostationary satellites in the fixed service and the radionavigation service is considered in this Report.

2. Characteristics of inter-satellite links in the frequency range 32 to 33 GHz

The probable characteristics of inter-satellite links operating in the frequency range 32 to 33 GHz are outlined in Report 451, where it is assumed that the links would probably be few in number, would be used for relatively short inter-satellite distances to minimize transit-time delay, and, if required soon, would rely as much as possible on existing spacecraft technology. Parameters which might represent typical links are presented in Table I. The links considered in this Report are assumed to connect satellites at varying orbital separations, to employ tracking antennas of 2 m diameter and to operate at a carrier-to-noise ratio of 25 dB such that the inter-satellite link contributes a relatively small part of the allowable channel noise.

From the figures derived, it is possible to assess the levels of interference caused to, and received from, the radionavigation services.

It is recognized that the link considered in Table I is only one possible design of an inter-satellite link, and other designs involving techniques such as FM remodulation have also been postulated. However, such links would be characterized by a lower transmitter power density and probably a lower susceptibility to interference, so it is considered that the characteristics given represent a sufficiently conservative case.

3. Characteristics of the radionavigation service at 32 to 33 GHz

It is not possible to predict, with precision, the technical characteristics that will be adopted for systems in the radionavigation service. However, certain assumptions have had to be made and they are detailed in Table I. Two antenna gains have been postulated, one for ground and one for airborne installations. Also there is a possible interference source due to pulsed radionavigation service sources, but only continuous sources have been considered because these cause the worst interference.

4. Interference from inter-satellite links to the radionavigation service

The interference from an inter-satellite link is considered in terms of power flux-density at the Earth's surface.

There are two factors contributing to this pfd, firstly the power per MHz into the inter-satellite service link antenna (P_T) which is proportional to the inter-satellite link distance, and secondly the off boresight gain ($G(\theta)$) (see Report 558) towards the Earth of the transmitting antenna. Both of these are dependent upon the separation angle ϕ (see Fig. 1) and it can be shown that the pfd on the surface (pfd_{ISL}) is approximately equal to:

$$\begin{aligned} pfd_{ISL} &\approx P_T(\phi) + G(\theta) - (\text{spreading loss}) - 164 \quad \text{dB(W/(m}^2 \cdot \text{MHz))} \\ &\approx \text{required carrier power } (-113 + 1 \text{ dB(W/MHz)}) \\ &\quad - \text{total antennas gain (108 dBi) + path loss} \\ &\quad + \text{antenna gain in the direction of the Earth} - \text{spreading loss} \end{aligned}$$

and with respect to the separation angle this becomes:

$$\approx -220 + 20 \log \left[\frac{8\pi \cdot 4.22 \times 10^7 \sin(\phi/2)}{\lambda} \right] + 54 - 25 \log \left(\frac{163 - \phi}{0.32} \right) - 164$$

and results in the expression:

$$pfd_{ISL} \approx 10 \log \left[\frac{8\pi \cdot 4.22 \times 10^7 \sin(\phi/2)}{\lambda} \right]^2 - 25 \log \left(\frac{163 - \phi}{0.32} \right) - 330 \quad \text{dB(W/(m}^2 \cdot \text{MHz))}$$

Figure 2 shows the pfd estimate from the characteristics assumed and over separation angles from 40° to 160°. Note that the term used above for off-beam antenna gain reduces to -10 dB for a satellite separation angle ϕ of 46.6°. This results in the flattening and discontinuity shown in Fig. 2.

5. Interference from the radionavigation service to inter-satellite links

Interference from the radionavigation service will depend mainly on the receiving antenna gain of the inter-satellite link in the direction of the Earth ($G(\theta)$), and the e.i.r.p. from the radionavigation service.

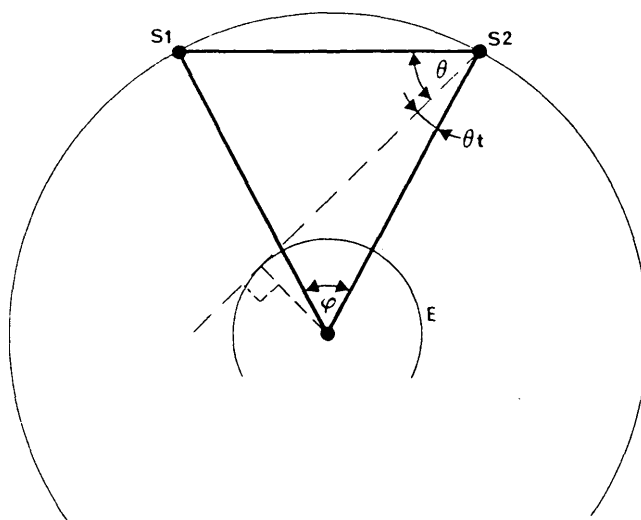
FIGURE 1 — *Inter-satellite link*

S1: Satellite 1
 S2: Satellite 2
 φ : separation angle
 θ : off boresight gain angle
 θ_t : tangential angle (constant)
 E: Earth

Assuming that the total interference power must be limited to one tenth of the receiver system noise, then a carrier to overall interference ratio of 35 dB would be appropriate (compared with 25 dB carrier-to-noise ratio).

Thus for these conditions the maximum e.i.r.p. (e.i.r.p._{RN max}) from the radionavigation service can be estimated for different separation angles, thus:

$$\begin{aligned} \text{e.i.r.p.}_{RN \max} &\approx \text{path loss} - \text{max. permitted interference} - G(\theta) \\ &\approx 215 - 148 - G(\theta) \\ &\approx 13 + 25 \log \left(\frac{163 - \varphi}{0.32} \right) \quad \text{dB (W/MHz)} \end{aligned}$$

Figure 2 shows the maximum e.i.r.p. for separation angles from 40° to 160°.

6. Results

From the curves in Fig. 2 it can be seen that a given pfd limitation to protect the radionavigation service places a maximum value on the permissible separation angle of the inter-satellite link. Conversely the maximum link separation angle to which the inter-satellite links may be limited determine the maximum permissible e.i.r.p. limitation on the radionavigation service.

6.1 *Inter-satellite link to the radionavigation service*

Taking an antenna gain value of 50 dB and a noise power figure of -139 dB (W/MHz) for the radionavigation service, this would give a limit of -155 dB(W/m² · MHz) on the inter-satellite link, leading to an angular separation limit of 140°.

6.2 *Radionavigation service to inter-satellite link*

From § 6.1 above a maximum separation angle of 140° would give an aggregate e.i.r.p. limitation of about 60 dBW.

7. Conclusion

It is concluded that there will be no interference problems for either service for short links (separation angle up to 90°). For long links the satellite link is more capable of causing or receiving interference, and based on the assumed characteristics of Table 1 it appears that it may be necessary to limit separation angles to about 140°. A lower limit on separation angles will be required for multiple interleaved links, the characteristics of which should be the subject of further studies.

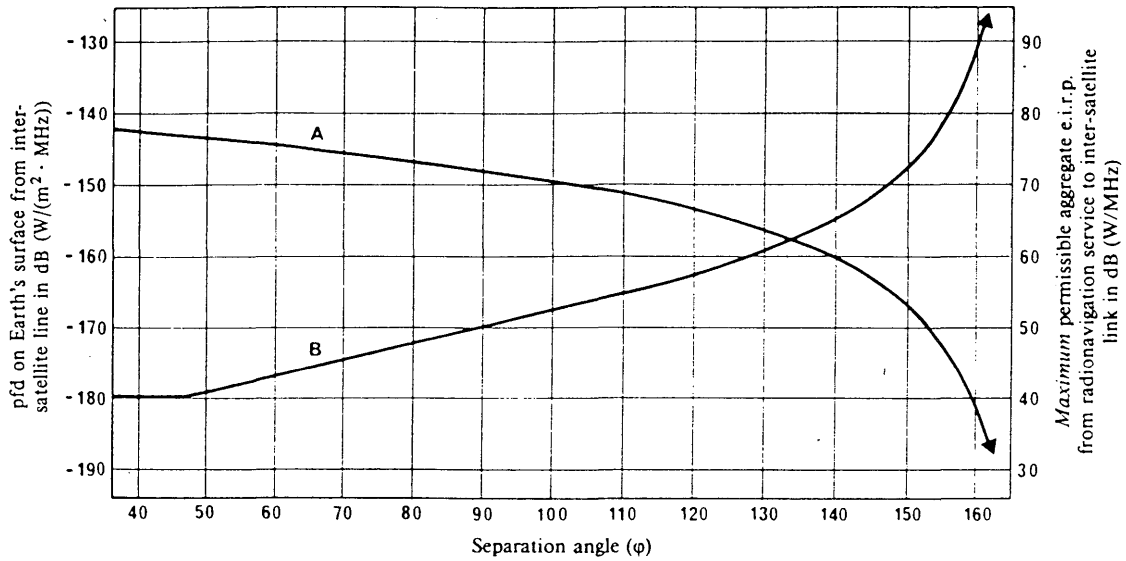

FIGURE 2 — Criteria for the case of interference between an inter-satellite link and the radionavigation service

Curves A: radionavigation service to inter-satellite link (e.i.r.p. RN_{max})
 B: inter-satellite link to radionavigation service (pfd_{ISL})

TABLE I — Assumed characteristics of inter-satellite link (ISL) and radionavigation service (RN)

	ISL	RN
Receiver system noise temperature T (K)		
$10 \log T$	31	30
Receive, transmit antenna diameter (m)	2	—
Receive, transmit antenna gain (dBi)	54	50 (35 ⁽¹⁾)
Receiver noise power per MHz, (dB(W/MHz)) (referred to antenna port)	-138	-139
Carrier to noise ratio (dB)	25	—
Required carrier at receiver (dB(W/MHz))	-113	—
Maximum permissible interference level, below noise (dB)	-10	-10
Maximum permissible unwanted signal level (dB(W/MHz))	-148	-149
Combined tracking loss (dB)	1	—
Path loss (Earth to space, geostationary orbit) (dB)	215	—
Half power beamwidth (ISL) (degrees)	0.32	—

(1) Airborne.

REPORT 561-4

**FEEDER LINKS TO SPACE STATIONS
IN THE BROADCASTING-SATELLITE SERVICE ***

(Study Programme 30A/4)

(1974-1978-1982-1986-1990)

1. Introduction

Frequency bands allocated to the broadcasting-satellite service are, by definition, in the space-to-Earth direction. Feeder links to broadcasting satellites, operating in any frequency band must, under the current provisions of the Radio Regulations, use the Earth-to-space allocations of the fixed-satellite service. For the purpose of this Report, the term "fixed-satellite service" is as defined in the Radio Regulations, but excludes feeder links to broadcasting satellites.

The WARC-79 allocated a number of Earth-to-space bands for the specific use by feeder links for the broadcasting-satellite service. These specific Earth-to-space bands are 10.7 to 11.7 GHz (Region 1), 14.5 to 14.8 GHz (all Regions except Europe less Malta) and 17.3 to 18.1 GHz (all Regions). Except for the band 17.3 to 17.7 GHz, these bands are shared with other services.

Since, however, the up-link requirements of the broadcasting-satellite service, particularly around 12 GHz, are expected to be fairly substantial and feeder links for broadcasting satellites may be drawn from any fixed-satellite Earth-to-space allocation (though subject to coordination in bands not exclusively designated for feeder links), and since the higher frequency bands for that purpose may be unattractive to some administrations, the problem of using Earth-to-space allocations by both the fixed-satellite and the broadcasting-satellite services remains a matter of concern.

The simultaneous use of the 14 to 14.5 GHz band by broadcasting-satellite systems and around 12 GHz by the fixed-satellite service having different space-to-Earth allocations will be a problem in congested parts of the orbit. In addition to individual and community type broadcasting-satellite services in the 12 GHz band, it is envisioned that interactive services (voice, data, and video) may be provided through the use of earth stations with small aperture antennas. This may place additional requirements and constraints on both services.

This Report evaluates the impact of sharing, associated with using fixed-satellite allocations for feeder links to broadcasting satellites and examines alternative techniques and approaches to providing the necessary feeder links to the broadcasting-satellite service and flexibility in the fixed-satellite service, having regard to the Plans developed by the World Administrative Radio Conference for the Planning of the Broadcasting-Satellite Service, Geneva, 1977 (Regions 1 and 3) (WARC-BS-77) and the related subsequent Regional Administrative Radio Conference for the Planning of the Broadcasting-Satellite Service in Region 2 (RARC SAT-R2), Geneva, 1983.

In addition, Report 1006 examines the protection of feeder links to broadcasting satellites from fixed-service emissions.

2. Technical and operational characteristics required for feeder links to broadcasting satellites**2.1 General**

This section presents some of the preferred characteristics of feeder links in the fixed-satellite service from the point of view of broadcasting satellites.

* This Report needs to be reviewed to take into account the results of WARC ORB-88.

The requirements placed on these feeder links will vary from band to band. There are, however, certain requirements in satellite design which tend to limit the proximity of the feeder link and the down-link frequencies. A balance must be chosen between the two frequencies so that they are neither too close nor too far apart; too small a frequency separation makes good filtering difficult to achieve, while too large a separation causes design problems.

Generally it is thought that the feeder link contribution to the overall performance degradation of a broadcasting-satellite link should be minimal. The apportionment of the total noise budget between the feeder link and down link will generally be different for each band pair.

Flexibility in locating the feeder link earth station anywhere within the down-link service area will generally be desirable. In some cases, there may also be a requirement to provide fixed or transportable feeder links from any point within or outside the down-link service area, especially in the case of large countries with several service areas from the same orbital location or regional broadcasting-satellite services.

Such flexibility has an impact on the reuse of the feeder link frequencies, and there are several approaches which could be used to reduce the amount of spectrum required.

If the feeder link power flux-densities at the geostationary orbit were of a uniform level, the sharing situation would be eased. Such uniform feeder link power flux-densities would result from the use of a standardized maximum gain satellite receiving antenna.

If the satellite receiving antenna could be of the highest directivity technically feasible, the possibility of re-using the feeder link frequency channels would be increased, and the bandwidth requirements minimized. To take advantage of this possibility, the feeder link transmitting earth station would have to be located near the boresight of the broadcasting satellite down-link service area, if the same satellite antenna were to be used for both transmitting and receiving. In any case the up-link service area would be significantly smaller than that of the down-link which may cause operational problems as noted above.

If the feeder link earth station location cannot be located near the boresight then special antenna techniques, or indeed separate antennas, might be required on the satellite. Either steerable receiving spot-beams or lower gain (wider beamwidth) antennas would be required in the case of a need to access the satellite from different locations in a time sequential order. If simultaneous feeder links from different locations were required the use of narrow-beam high-gain antennas may not be practicable.

It may be necessary to take account of the broadcasting-satellite service functions in considering feeder links.

Annex I contains a description of the feeder links in use for the French TDF1 direct broadcasting satellite.

2.2 *Broadcasting-satellite systems around 12 GHz*

The WARC-BS-77 established certain technical standards which affect the feeder links for Regions 1 and 3. One important requirement is that the reduction in the quality in the down link due to thermal noise in the feeder link is taken to be equivalent to a degradation in the down-link C/N not exceeding 0.5 dB for 99% of the worst month. To limit the impairment to this value, the C/N on the feeder link must be about 10 dB higher than that required for the down-link C/N , which in this case would mean a feeder link C/N of up to 24 dB, if the modulation indices were the same.

The Conference also established a value of 30 dB as the total protection ratio to which each broadcasting satellite transmission must be protected. Similarly, with the division of overall performance requirements, the total protection ratio of the feeder link of a broadcasting satellite may have to be of the order of 40 dB, with a single-entry protection ratio which may be as high as 45 dB. Standards for either of these two latter values have not yet been established. For interference caused by the adjacent channels, recent simulation experiments have shown that the operation of broadcasting-satellite power tubes at saturation reduces interference received from the adjacent channels by about 4 dB relative to that observed under reduced-drive conditions of the power tube. This improvement may also benefit adjacent-channel interference planning of feeder links in Regions 1 and 3.

For Region 2, the RARC SAT-R2 concluded that an overall co-channel protection ratio of 28 dB is required, and that is reflected in the development of the Region 2 Plan. Also, it was decided that, for feeder links, a noise temperature increase of 10% at satellite receiver input should be the threshold which, if exceeded by actual interfering emissions, would require coordination.

Further information is to be found in Report 952, in Appendix 30 of the Radio Regulations, and in the Final Acts of the RARC SAT-R2 (Geneva, 1983).

3. Feeder link bandwidth requirements

3.1 Down-link allocations

The feeder link bandwidth requirement has to be viewed in the context of the overall bandwidth allocated to the broadcasting-satellite service. These are summarized in Table I.

TABLE I — *Bandwidth allocated to the broadcasting-satellite service below 40 GHz*

Part of the spectrum	Amount of bandwidth (MHz)
700 MHz	170
2.5 GHz	190
12 GHz	800 (Region 1) 400-600 (Region 2) 750 (Region 3)
22 GHz	450 (Regions 2 and 3)

3.2 Reduction of bandwidth required for feeder links to 12 GHz broadcasting satellites

Substantial bandwidth has been allocated to the broadcasting-satellite service for its space-to-Earth links, and it is foreseen that these bands will ultimately be used extensively for television with frequency re-use obtained by means of high-gain satellite transmitting antennas and the use of cross-polarization techniques. A similar measure of frequency re-use will, no doubt, be obtained in the feeder link direction by means of high-gain satellite receiving antennas, but it is doubtful whether this technique can provide a significantly greater degree of frequency re-use in the feeder link than in the down link, in parts of the world where broadcasting coverage areas are relatively small. The usage of the fixed-satellite Earth-to-space bands for broadcasting-satellite feeder links, could be reduced if means could be found for a further measure of frequency re-use in the feeder link. Four possible ways of achieving this have been identified:

3.2.1 Feeder link frequency re-use using the higher directivity of the transmitting earth-station antenna, relative to broadcast receiving antennas

If the space segment of satellite-broadcasting systems serving a multi-national area of continental extent consisted of many satellites spaced at intervals of a few degrees over the geostationary-satellite orbit, then the extent to which frequencies may be re-used at different positions in the orbit depends, in the case of Earth-to-space transmissions, on the off-beam discrimination of earth-station transmitting antennas and satellite receiving antennas. In the case of space-to-Earth transmissions, it depends on the off-beam discrimination of satellite transmitting antennas together with that of earth-station receiving antennas at the broadcasting receiving terminals. Since the off-beam discrimination of earth-station transmitting antennas is generally expected to be considerably greater than that of the (necessarily) small broadcast receiving antennas, greater frequency re-use may be achievable on Earth-to-space transmissions. Consequently, the total bandwidth required for feeder links to broadcasting satellites could be less than that on the down link.

However, the plan adopted by the WARC-BS-77, as mentioned in § 2, would not enable any appreciable bandwidth reduction for the feeder links mentioned above. This is illustrated in a study of the efficient use of frequencies for the Western Pacific and Asian area, in the 12 GHz band [CCIR, 1974-78]. The results of this study are shown in Fig. 1. In this figure inter-satellite spacing, is taken as a parameter in calculating the carrier-to-interference ratio (C/I) in the feeder links between two satellite systems. In the case of $\varphi = 0^\circ$, the value of C/I results in -3 dB for the worst and 49 dB for the best, in the orbital range 34° E to 158° E; but in most cases the value of C/I becomes less than 40 dB, which may be regarded as the required protection ratio for the feeder link, so that use of different feeder-link frequencies is mostly needed for the satellites sharing the same orbital positions. In the case of $\varphi = 6^\circ$, the value of C/I becomes greater than 40 dB even at the most interfered-with orbital positions around 74° E, when earth-station antennas greater than 4.5 m diameter are used. In the case of $\varphi = 12^\circ$, the C/I becomes greater than 40 dB for the antennas having a diameter greater than 2.5 m ($D/\lambda > 117$ at 14 GHz) even at the most interfered-with orbital positions:

The C/I value of 40 dB in the study was assumed as the single entry value. However, as discussed in § 2.2, the value of 40 dB may perhaps be that corresponding to all entries of interference. Thus the desired single entry value of C/I might be as high as 45 dB.

3.2.2 Polarization discrimination

In certain cases it is possible that the use of polarization discrimination would allow the frequency re-use in the feeder links to be increased. The aspects which should be taken into account are described in Report 555. Further study is required to determine the overall bandwidth required to provide feeder links to broadcasting satellites, in the Regions 1 and 3 Plan, taking into account the advantage to be gained from frequency re-use by means of polarization discrimination.

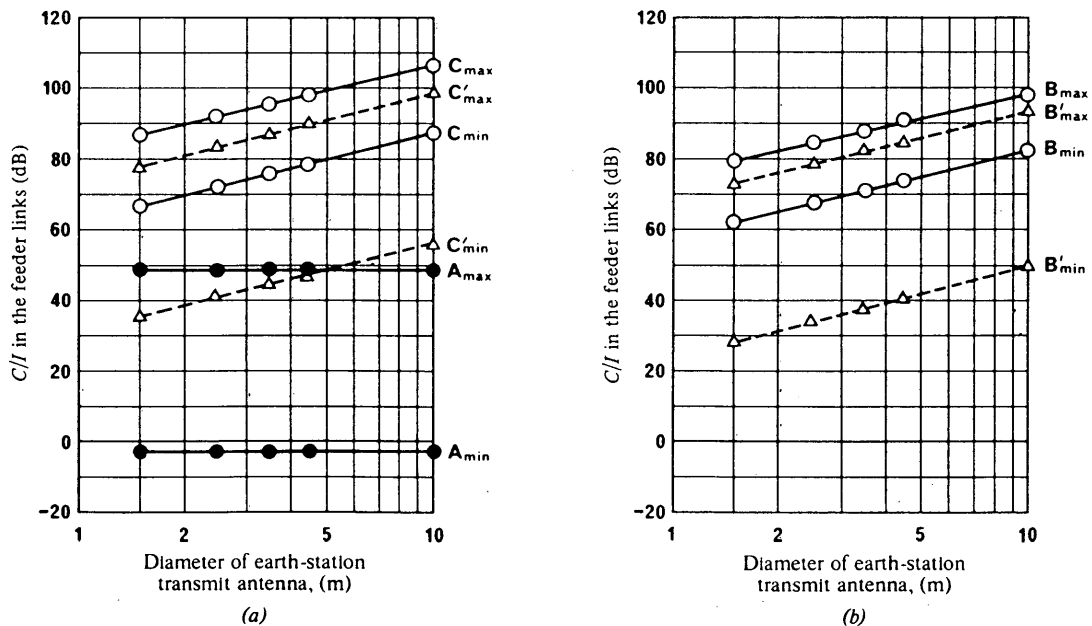

FIGURE 1 — Carrier-to-interference ratio in the feeder links for the broadcasting-satellite service in the 12 GHz band in the Western Pacific and Asian area, as established by the WARC-BS-77

A_{max} : max. C/I for $\varphi = 0^\circ$, at 140° E

A_{min} : min. C/I for $\varphi = 0^\circ$, at 44° E

B_{max} , B_{min} : max. and min. C/I_s for $\varphi = 6^\circ$, at 128° E

B'_{max} , B'_{min} : max. and min. C/I_s for $\varphi = 6^\circ$, at 74° E

C_{max} , C_{min} : max. and min. C/I_s for $\varphi = 12^\circ$, at 128° E

C'_{max} , C'_{min} : max. and min. C/I_s for $\varphi = 12^\circ$, at 74° E

φ : inter-satellite spacing, C/I : for single interference entry

Note.— Orbital position, polarization, and satellite beam dimension are assumed to be the same as in the down link, but station-keeping and antenna pointing errors are not taken into account in this calculation.

Studies suggest that, for Region 1, a translation of the WARC-BS-77 down-link plan may be possible for feeder links in the band 17.3 to 18.1 GHz. Under certain conditions, independent planning of orbit locations may be possible. Further information can be found in Report 952.

3.2.3 *Alternative modulation methods for the feeder links*

An initial study has been made of the technique of reducing feeder link bandwidth requirements by the use of narrow-band modulation with modulation conversion in the satellite [Baker and Bolingbroke, 1975]. Substantial reductions in feeder link bandwidth can be obtained, for example, by the use of low deviation frequency modulation, or multi-level PSK in conjunction with digital encoding and processing of the video signal. The use of low deviation frequency modulation would, however, involve signal processing at the satellite, and the use of digital encoding would involve demodulation, decoding and remodulation at the satellite.

The use of higher efficiency modulation in the feeder links may require very high up-link protection ratios which are difficult to adhere to in practice. On the other hand, video signals contain a large amount of redundant elements, and techniques have been developed which would remove some of this redundancy at no loss in transmission quality. These techniques are known as source coding. If source coding were applied to broadcasting satellites, substantial bandwidth savings would be possible with conventional modulation, and the feeder link protection ratio would not have to be increased. The use of source coding, as that of higher-density modulation methods, would require processing in the satellite.

In general the disadvantage of alternative modulation methods for the feeder links, is the consequent increase in satellite complexity, mass and cost, and some reduction in satellite reliability. The need to use such techniques may also delay the implementation of satellite broadcasting systems in some cases.

3.2.4 *Integrated sound-vision systems*

If the sound channel is time multiplexed within the video-signal (e.g. the sync. pulse interval), then a saving in the overall RF bandwidth of the modulated carrier can be achieved. The extent of the bandwidth saved and the extent of additional cost and complexity of the broadcast receivers needs further study. Two such vision and sound transmission systems have been developed for use in the broadcasting-satellite service. One system is known as C-MAC/Packet (see Reports 1073 and 1074). The other is a digital sub-carrier system with a 525-line NTSC picture signal for system M [CCIR, 1978-82a] (see Report 634, § 3.1.8). These systems allow transmission within the nominal 27 MHz channel bandwidth of the WARC-BS-77 Plan, and their immunity to interference is not less, nor the interference caused by them greater, than those of the composite coded signals assumed in the development of the 1977 Plan.

Television sound may be transmitted by means of one or more sub-carriers above the vision signal and the need for adequate sound channel performance should be taken into account in planning feeder links. This consideration may affect the adjacent channel protection ratio needed.

4. **Use of allocations to the fixed-satellite service (Earth-to-space) as feeder links for the broadcasting-satellite service**

4.1 *Use of the 14.0 to 14.5 GHz band*

An example is used to demonstrate interference by a broadcasting-satellite service feeder link transmission to a satellite with Intelsat-V characteristics, and the reverse situation of interference by a fixed-satellite service up-link transmission to a broadcasting-satellite feeder link. The interfering signals are assumed to be co-frequency and co-polarized.

The following are the system assumptions made in the example for the two interfering signals:

Regarding the broadcasting-satellite up-link transmissions:

Satellite receive antennas beamwidths:	1°, 2°, 4°
Satellite receiving system noise temperature:	3000 K
Transmit earth station diameter:	2, 4, 8 m
Up-link carrier/noise ratio:	25 dB
RF bandwidth:	27 MHz
Energy dispersal:	600 kHz peak-to-peak

These assumptions result in the following consequential system parameters (at 14 GHz):

TABLE II

Satellite receiving system		Transmit earth station			
Antenna beamwidth	Beam edge G/T	e.i.r.p.	Power into antenna		
			2 m	4 m	8 m
1°	6 dB(K ⁻¹)	72.7 dBW	380 W	97 W	24 W
2°	0 dB(K ⁻¹)	78.7 dBW	1500 W	380 W	97 W
4°	-6 dB(K ⁻¹)	84.7 dBW	6000 W	1500 W	380 W

Regarding the INTELSAT system, three representative transmission types will be assumed, with the following characteristics:

TABLE III

Type	Modulation	Capacity	e.i.r.p.	Protection ratio
A	FDM-FM	24 ch.	69 dBW	29 dB ⁽¹⁾
B	FDM-FM	972 ch.	81 dBW	33 dB ⁽¹⁾
C	CQPSK-TDMA	120 Mbit/s	82 dBW	30 dB ⁽²⁾

⁽¹⁾ To produce 600 pW_{0p} of noise power in the worst channel due to interference from an analogue FM-TV transmission.

⁽²⁾ Minimum permissible for a single entry from any high power transmission contained within the occupied band of 72 MHz.

Assuming coincident or overlapping, 14 GHz space station receive antenna coverages of both a broadcasting satellite and an Intelsat-V, and assuming further that the earth stations transmitting to the broadcasting satellite meet the CCIR reference earth-station antenna pattern; compliance with the required protection ratios given above would necessitate the following geocentric angular separations between the broadcasting satellite and an Intelsat-V:

TABLE IV

Characteristics of the broadcasting-satellite system		Spacings for interfered-with satellites INTELSAT carrier types		
		A	B	C
Satellite antenna receive beamwidth	Transmitting earth station antenna diameter	24 ch. FDM-FM	972 ch. FDM-FM	Q-CPSK 120 Mbit/s
1°	2 m	5.0°	2.4°	1.7°
	4 m	2.9°	1.4°	< 1.0°
	8 m	1.7°	< 1.0°	< 1.0°
2°	2 m	8.7°	4.2°	2.9°
	4 m	5.0°	2.4°	1.7°
	8 m	2.8°	1.4°	< 1.0°
4°	2 m	15.1°	7.2°	5.0°
	4 m	8.7°	4.2°	2.9°
	8 m	5.0°	2.4°	1.7°

The advantages of decreased broadcasting-satellite receiving antenna beamwidth in reducing interference conditions are clearly shown; however, the reduced coverage could prevent transmission to the broadcasting satellite from certain areas within the boundaries of the service area, or from outside the service area.

Present INTELSAT planning provides for an appreciable number of FDM-FM carriers of only 24 channels capacity with numerous FDM-FM carriers having capacities anywhere between 24 and 972 channels. The geocentric angular separations required between a broadcasting satellite and an Intelsat-V are, for such carriers, appreciable. They might be achievable if broadcasting satellites were spaced from each other by twice the above angles, but that would result in only just one fixed-service satellite location alternating with one broadcasting-satellite location. Where a ratio of n fixed-service satellites to one broadcasting satellite would be desirable, the broadcasting-satellite spacing would have to be further increased by $n - 1$ times the spacing required between the fixed-service satellites.

One could, with the INTELSAT system, take advantage of the fact that it provides currently only limited up link (14 GHz) coverage and use for broadcasting-satellite feeder links, satellite receive beams of less than 1° beamwidth, and transmit earth stations of greater than 8 m antenna diameter to alleviate the problem; but this could be a severe constraint on the broadcasting-satellite service and may not be acceptable. Alternatively, one might align carrier frequencies between broadcasting-satellite feeder links and Intelsat-V carriers; or attempt to realize some up-link polarization discrimination.

In the other direction, interference from fixed-satellite service earth stations into broadcasting satellites is far from negligible. With the parameters for the INTELSAT 972-channel carrier and an assumed required single entry protection ratio of 45 dB in the broadcasting-satellite service feeder links, the following geocentric satellite separations would be required at 14 GHz:

TABLE V

Broadcasting-satellite received beamwidth	Satellite spacings for different INTELSAT transmit earth-station diameters		
	8 metres	12 metres	16 metres
1°	11.6°	8.8°	6.8°
2°	6.7°	5.0°	4.0°
4°	3.8°	3.0°	2.3°

The system parameters given in this Section for the fixed-satellite service are those of INTELSAT-V. Other systems in the fixed-satellite service, particularly those intended for domestic and regional service, may require greater spacings than those indicated in the Tables.

In this case, increase in sensitivity of the broadcasting-satellite receiver correspondingly increases its sensitivity to interference from transmissions of earth stations in the fixed-satellite service, and may result in increased satellite spacing requirements.

It may be concluded that interference problems could arise between up links of fixed-satellite service systems and feeder links to broadcasting satellites when they use a common frequency band. However, specific solutions to these problems may be available through frequency coordination and the use of appropriate technology. See also Report 952 which deals with problems encountered on system examples for the fixed-satellite service which are more sensitive than the system considered here. It is concluded that individual cases of sharing between networks in the fixed-satellite service and broadcasting-satellite feeder links require detailed examination, taking into account the projected design and operating parameters. Two additional examples are given of studies for Regions 1 and 3.

4.1.1 Example 1

An analysis carried out by Japan calculated the interference for particular cases in the band 14.0 to 14.5 GHz between up links to fixed satellites serving Region 3 having the characteristics shown in Report 561 for Intelsat-V and feeder links to broadcasting satellites in Region 3 operating according to the 12 GHz Geneva Plan shows the following results [CCIR, 1978-82a]:

- For the technical parameters used in the study, the worst value of the carrier-to-interference ratio (C/I) on broadcasting-satellite feeder links interfered with by up links to INTELSAT-V in the Indian Ocean Region would be greater than the assumed protection ratio of 45 dB. The worst value of the C/I of up links to INTELSAT-V interfered with by feeder links to the broadcasting satellite would be greater than 31 dB required for interference noise power of 400 pW0p (changed to 600 pW0p by Recommendation 466 in a 24-channel FDM-FM system).
- As for the interference situation between the assumed international fixed satellite positioned at 65° E and the broadcasting satellites, 15 m earth-station antennas of the fixed-satellite system would cause interference to the broadcasting satellites in the orbital range from 62° E to 74° E. Therefore, the required orbital separation for protecting the broadcasting-satellite feeder links may be about 10°. On the other hand, interference from broadcasting-satellite earth stations to space stations in the fixed-satellite service would arise only from the feeder link earth stations to those broadcasting satellites nearest to the fixed satellite within 3° separation.
- As for the interference situation between the broadcasting satellites and the assumed domestic or sub-regional FSS satellites, located within the broadcasting-satellite positions, the interference to the broadcasting satellites would be dominant. As a result, use of 4.5 m earth-transmitting antennas in the fixed-satellite system would cause interference to the broadcasting satellites which are located within about 30° from the fixed satellites, with protection ratios of less than 45 dB.

If different transmission characteristics and orbital locations were assumed for Intelsat-V, some of which may soon be employed (SCPC, 12-channel carriers, 66° E longitude position etc.), they might lead to different conclusions concerning the required orbital separation between fixed and broadcasting satellites using the 14.0 to 14.5 GHz band in the Earth-to-space direction. Further study is necessary to take into account the range of system parameters that might be used.

4.1.2 Example 2

The study conducted by the French Administration [CCIR, 1978-82b] in this example assumed the fixed-satellite orbital position located between two broadcasting satellites spaced 6° apart, and an FSS service area partially overlapping one of the BSS service areas. For this study and a particular set of assumptions, it was concluded that even in the case of FSS networks using high-capacity FDM-FM carriers, adequate protection from interference to the FSS from the BSS feeder link cannot be assured

unless the FSS satellite is placed near to those positions for which interference is minimum. The choice of these positions may entail severe constraints incompatible with the requirements of the FSS (such as the service arc). Furthermore, the use of a band shared between broadcasting-satellite feeder links and the up links of the fixed-satellite service over an entire Region would presuppose that sharing is feasible at least for certain orbital positions, irrespective of the possible characteristics of the systems; however, it has been seen that in the case of SCPC or low-capacity channels in the FSS, it is impossible to find a position that suits the purpose.

4.2 Use of higher than 14.0 to 14.5 GHz frequency bands

Two frequency bands have been allocated to feeder links to BSS at 14.5 to 14.8 GHz and 17.3 to 18.1 GHz. In areas of Region 3 where high rainfall rates occur, the use of the upper band may not be desirable due to adverse propagation effects. The 14.5 to 14.8 GHz band, on the other hand, may have insufficient capacity to meet the feeder link requirements.

The e.i.r.p. requirements of feeder-link earth stations in Regions 1 and 3 in the neighbourhood of 18 GHz are estimated to lie between 78 and 85 dBW depending on the system characteristics. The high value would be achievable with an 8 m equivalent diameter high-efficiency antenna and about 250 W of transmitter power available at the antenna input terminals (see also § 5.1 of Report 952).

In establishing feeder-link power requirements for the Regions 1 and 3 feeder-link plan, attention may have to be given to noise introduced by AM-PM conversion in current high-power tubes (see also § 3.3 of Report 952).

5. Use of allocations to the fixed-satellite service (space-to-Earth) for feeder links serving the broadcasting-satellite service

If it were decided to use the reverse-direction approach as provided for in the band 10.7 to 11.7 GHz in Region 1, i.e., broadcasting feeder link assignments to be made in a space-to-Earth band allocated to the fixed-satellite service, the following interference modes would ensue:

- (a) interference from fixed-satellite service space stations into space stations of the broadcasting-satellite service, and
- (b) interference from earth stations transmitting to broadcasting satellites into earth stations receiving from fixed-service satellites.

For interference condition (a) above, one may assume the previously introduced parameters for a broadcasting-satellite feeder link which led to a wanted carrier power at the broadcasting-satellite receiver of about -95 dBW. Assuming that a single-entry feeder link protection ratio of 45 dB would be required, the interference power at the broadcasting-satellite receiver input must not exceed a level of -140 dBW. The net attenuation between the output of an interfering fixed-satellite space station transmitter and the broadcasting-satellite receiver, is the free space loss A between the two space stations, less the sum of the antenna gains ΣG (transmit antenna gain of the fixed satellite; receive antenna gain of the broadcasting satellite) of the two kinds of space stations in the direction of each other, i.e., their respective antenna gains at an angle of not less than about 70° off their respective main beam directions. The following inequality applied:

$$P_{FS} + \Sigma G(70^\circ) - A(\varphi) \leq -140 \text{ dBW} \quad (1)$$

which, with

$$A = 90 + 20 \log f_{\text{MHz}} + 20 \log \varphi^\circ \quad \text{dB} \quad (2)$$

and the assumption of $f = 11\,000$ MHz yields an equation for the minimum value of the satellite separation angle φ with the two variables P_{FS} (available carrier power at the transmit antenna terminal of the fixed satellite) and ΣG , as follows:

$$\log \varphi = \frac{P_{FS} + \Sigma G - 31}{20} \quad (3)$$

Table VI below shows the relationship between ϕ (in degrees), P_{FS} (in dBW) and ΣG (in dB).

TABLE VI

P_{FS} (dBW)	ΣG (dB)		
	0	10	20
0	0.03°	0.09°	0.3°
5	0.05°	0.16°	0.5°
10	0.09°	0.3°	0.9°
15	0.16°	0.5°	1.6°
20	0.3°	0.9°	2.8°

It can be seen that even with 100 W (20 dBW) of available fixed-satellite carrier power and 20 dB of total joint antenna gain an inter-satellite spacing of less than 3° would be required.

As an example, Intelsat-V has an available carrier power of 10 W (10 dBW), and it should readily be possible to maintain the joint antenna gain between two space stations to less than about 10 dB, so that inter-satellite spacings of about 3/10 of a degree would be feasible. This corresponds to a linear distance of about 230 km. Since differences in orbit altitude between two space stations may from time to time be appreciable (perhaps up to 75 km), one would in practice have to maintain a sufficiently large spacing so as not to produce unfavourable relative geometries between the spacecraft, which, for certain periods of time, might place one of the space stations into a somewhat higher gain region on the other's antenna pattern; however, a minimum spacing of about 0.3° appears to be safe.

As regards potential interference from earth stations transmitting to broadcasting satellites into fixed-satellite service receiving earth stations, it is obvious that the two types of earth stations could not be co-located. In general one may wish to choose their relative locations in such a way that main beam intersection and intersection of the first side lobes in the troposphere will be avoided and hold each station's horizon antenna gain to the direction of the other station at levels 10 dB below isotropic. This will put some restrictions on the possible locations of the earth stations; it would be easy in countries at low latitudes and only moderately restrictive in high-latitude countries.

Considering again the three carrier types used previously for the INTELSAT-V system and stipulating that, for 0.01% of the time the applicable protection ratios could be reduced by 10 dB, one obtains, with the further assumptions of a 150 K INTELSAT earth station receiving system noise temperature and a nominal required down-link carrier/thermal noise ratio of 19 dB for FDM-FM carriers, and of 25 dB for TDMA, the following values for required basic transmission loss (in dB) between the two sites, exceeded for all but 0.01% of the time, for various broadcasting-satellite feeder link earth station transmitter powers:

TABLE VII

INTELSAT carrier type	Feeder link earth-station transmitter power				
	22 W	90 W	350 W	1400 W	5600 W
24 ch. FDM-FM	140 dB	146 dB	152 dB	158 dB	164 dB
972 ch. FDM-FM	131 dB	137 dB	143 dB	149 dB	155 dB
120 Mbit/s CQPSK	119 dB	125 dB	131 dB	137 dB	143 dB

It can be shown that nearly all these values for the required attenuation (0.01% of the time) would result in site separation distances of less than 100 km, in some cases much less. If, in addition, site shielding were available to provide additional isolation between the sites, even shorter separation distances would be necessary.

Further study is required on the potential effects on radio-relay systems of proposals for both up links and down links of space systems operating in bands shared with terrestrial services. In addition, it must be studied as to whether this mode of utilization produces operational constraints on feeder links to broadcasting satellites.

6. Conclusions

This Report has shown that the accommodation of part of the feeder link requirements of the broadcasting-satellite service in one of the existing Earth-to-space allocations of the FSS not exclusively designated for feeder links may result in severe mutual constraints of the two services upon each other since:

- the feeder link requirements for the Plans have to match those of the down link, the number of required feeder link channels is of the same order of magnitude as that for down links, but may be greater, and orbital positions are not subject to choice;
- protection ratio requirements in feeder links to broadcasting satellites may be high, and inter-satellite spacing may have to be appreciable;
- certain orbit locations and/or certain radio-frequency channels may be unavailable to either of these two services;
- inter-network coordination procedures in force in those Earth-to-space allocations to the fixed-satellite service which are not specifically earmarked for broadcasting-satellite feeder links may not be compatible with the Plan provisions and implementation options.

As a consequence it appears necessary to give consideration to technical solutions which would alleviate or avoid the problems; with due regard to current or near future limitations upon implementing such solutions which would include the consideration of techniques suitable to minimize the total feeder link bandwidth requirements.

Among the bandwidth minimization techniques, the following have been identified:

- spectrum compression through the use of high density transmission modes in the feeder link (low-index modulation and/or source coding). These techniques require signal processing in the satellite and will have an impact on spacecraft complexity, and system reliability and cost;
- increased spectrum re-use through the careful use of improved isolation techniques, such as polarization isolation and/or earth and space station antenna gain and side-lobe control. The cost impact is believed to be moderate when only one or a very few antenna systems would be involved.

Among the strategies and techniques of reducing the impact on Earth-to-space allocations to the fixed-satellite service, one worthy of continued consideration is that of sharing with the fixed-satellite service in frequency bands allocated to the latter in the space-to-Earth direction. However, where such bands are also allocated to terrestrial services, a relatively large number of interference interfaces would exist. Further study is required for the development of appropriate sharing criteria.

It would ease the impact of the fixed-satellite service if broadcasting-satellite feeder links made maximum use of the bands allocated for this specific purpose as shown in the Introduction to this Report.

REFERENCES

BAKER, A. E. and BOLINGBROKE, P. J. [7-10 April, 1975] Earth-to-space links for broadcasting satellites. IEE Conf. Publ. 126. IEE Conference on Satellite-Communication-Systems Technology, London, UK.

CCIR Documents

[1974-78]: 4/289 (United States of America).

[1978-82]: a. 10-11S/20 (Japan); b. 10-11S/69 (France).

BIBLIOGRAPHY

CCIR Documents

[1974-78]; 4/237 (Japan); 11/387 (Netherlands).

ANNEX I

FEEDER LINKS TO THE FRENCH TDF1 DIRECT BROADCASTING SATELLITE

1. Introduction

The French TDF1 direct broadcasting satellite launched on 25 October 1988 has been fully operational since 15 December 1988 at orbital position 19° W. The purpose of this contribution is to provide a brief description of the technical characteristics of the feeder links to the satellite.

2. Technical characteristics of the feeder links

The one feeder link with five programme channels necessary to feed programmes to the TDF1 satellite is set up from a station specially constructed by TDF at Bercenay-en-Othe. This station has been dimensioned so as to comply with the decisions of WARC ORB-88.

The links are set up in the 17.3 - 17.7 GHz band with the e.i.r.p. of 84 dBW adopted for France by WARC ORB-88.

In order to achieve this high value, each channel is equipped with a klystron capable of supplying a maximum power of 1200 W, the nominal operating power being around 600 W.

The microwave multiplexer and antenna waveguide unit introduces an attenuation of some 5 dB per channel. The high efficiency of the 8 m diameter transmitting antenna secures a gain of more than 61 dBi, thereby achieving the wanted 84 dBW.

In order to ensure the necessary availability for a direct broadcasting service, all the equipments in each transmission chain are duplicated by a back-up.

3. Impact of the up link on quality

In a direct broadcasting system, any gain in quality on the up-link will improve quality at a multitude of receiving sites. The dimensioning of the feeder-link station and the figure of merit of the satellite reception system are designed so as to ensure that the feeder link's contribution to impairment of the down-link carrier-to-noise ratio is less than 0.5 dB, even when atmospheric conditions are unfavourable at the feeder-link station site.

Maximum benefit can thereby be derived from the e.i.r.p. of 64 dBW achieved in each channel of the satellite by the 230 to 260 W travelling wave tubes.

4. Programmes fed to the satellite

The programmes broadcast are D2-MAC/packet coded in the Paris area, before being routed to the feeder-link station via a radio-relay link, which has a negligible impact on overall quality. The signal received at Bercenay is demodulated and then remodulated in line with direct satellite broadcasting standards.

REPORT 712-1

**FACTORS CONCERNING THE PROTECTION OF FIXED-SATELLITE EARTH STATIONS
OPERATING IN ADJACENT FREQUENCY BAND ALLOCATIONS
AGAINST UNWANTED EMISSIONS FROM BROADCASTING SATELLITES
OPERATING IN FREQUENCY BANDS AROUND 12 GHz**

(Question 25/4)

(1978-1982)

1. General

The high space station e.i.r.p. required for individual reception in the broadcasting-satellite service may lead to substantial levels of unwanted emissions at frequencies outside the channel occupied by a broadcasting-satellite emission. For the broadcasting-satellite channels closest to the edges of an allocated band, these unwanted emissions may set up power flux-densities in the direction of a fixed-satellite earth station operating near the edges of adjacent fixed-satellite bands which may greatly exceed the levels of interference acceptable to the earth station.

Whether or not such levels of unwanted emissions cause unacceptable interference to fixed-satellite earth stations depends on a number of factors including:

- the orbital spacing between the broadcasting satellite and the fixed satellite and the corresponding fixed satellite earth-station antenna discrimination that may be achieved,
- the level of filtering in the broadcasting-satellite transmitter and the earth-station receiver that may be realized in practice,
- the frequency separation between channels closest to the frequency separating the allocations,
- the interference criterion used in defining the permissible maximum spectral power flux-density, and
- additional factors providing isolation, such as satellite antenna discrimination.

2. Estimated levels of unwanted emissions from 12 GHz broadcasting satellites

Report 807 discusses the various sources of unwanted emissions from broadcasting satellites. Figure 1 reproduces two curves from this Report which can be used to estimate the worst-case levels of spectral power flux-density produced by such emissions, as a function of the frequency difference from the centre of a broadcasting-satellite channel. The levels of spectral power flux-density given in Fig. 1 correspond to a beam-centre e.i.r.p., from the broadcasting satellite of 69 dBW. Against this, the values of e.i.r.p. associated with approximately 90% of the frequency assignments made in the broadcasting-satellite plan for Regions 1 and 3, lie in the range of 64 ± 1.5 dBW. This fact should be kept in mind when interpreting the data presented in Figs. 4 to 7 and the examples of orbit spacing and frequency separation presented in § 5. More study is required to establish which curve between the two shown, may appropriately represent the operational conditions. The signal used in the calculation of curve A in Fig. 1 consisted of 100% saturated colour bars. Such a signal is not used in normal broadcasting.

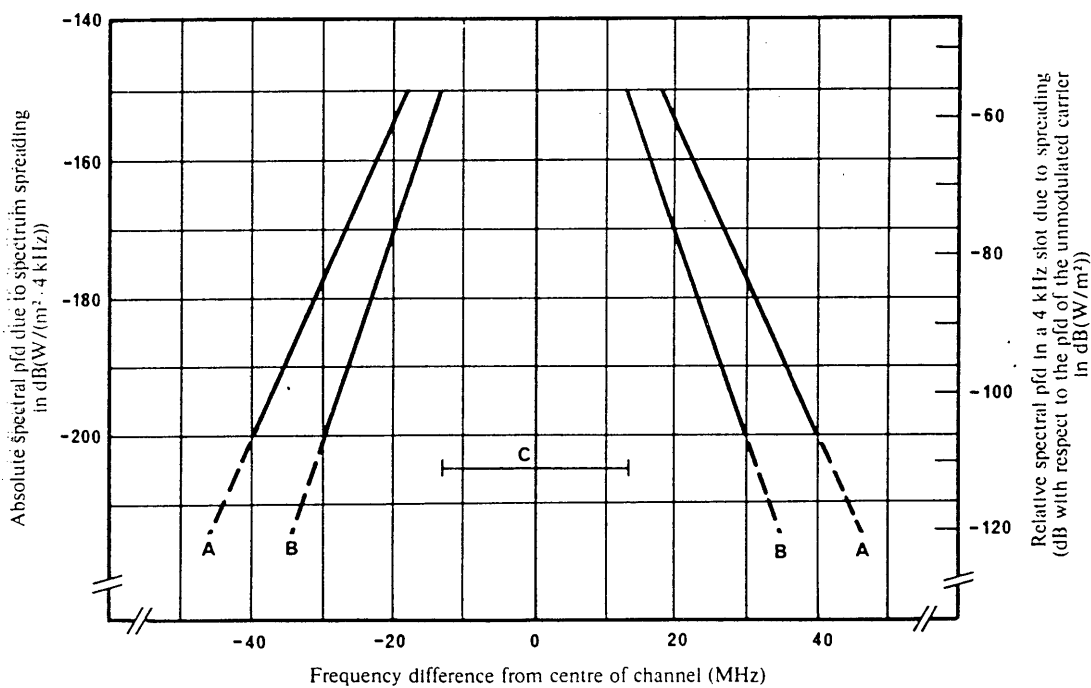

FIGURE 1 — Typical out-of-band envelopes of the radio-frequency spectrum radiated by a TV broadcasting-satellite

- A: Envelope for 100 per cent colour-bar baseband signal, modulator AC coupled
- B: Envelope for line 330 insertion test signal, modulator AC coupled
- C: Nominal channel bandwidth (27 MHz)

Note 1. — For the left-hand scale, it is assumed that the satellite e.i.r.p. corresponds to a pfd of -94 dB(W/m²) at the centre of the beam for an unmodulated carrier.

Note 2. — Minimum energy dispersal of ± 7.9 kHz is assumed.

Note 3. — Pre-emphasis according to CCIR Recommendation 405 is assumed.

However, recent measurements under conditions of NTSC 75% colour bar baseband signal with no RF filtering reported in Annex I of Report 807 indicate that unwanted emissions from a 27 MHz broadcasting-satellite channel with peak deviations ranging from 5.3 to 16.8 MHz appear significantly larger than indicated in Fig. 1. Further study of these measurements and the interference effects on the fixed-satellite service is urgently needed.

3. Worst-case maximum permissible levels of spectral power flux-density at the interfered-with receivers

Examples of fixed-satellite systems using the bands adjacent to the Region 1 11.7 to 12.5 GHz broadcasting-satellite service band are given in Table I, along with calculations of the worst-case maximum permissible pfd at the interfered-with fixed-satellite service earth-station receiver. The criterion used in these calculations was that the overall interference due to unwanted emissions should be at a level 10 dB below the thermal noise level of the interfered-with system. The possible benefit of antenna directivity has not been included in the calculations. Moreover, no account was taken of the spectral shape of either the unwanted emissions, nor of the interfered-with received signal. Under these assumptions, the maximum permissible spectral power flux-density of unwanted emissions in the band below 11.7 GHz is seen to be about $-200 \text{ dB(W/(m}^2 \cdot 4 \text{ kHz))}$ for a narrow-band fixed satellite signal and $-195 \text{ dB(W/(m}^2 \cdot 4 \text{ kHz))}$ for a maritime satellite feeder link. In the band above 12.5 GHz, the limit is $-171 \text{ dB(W/(m}^2 \cdot 4 \text{ kHz))}$ for a narrow-band data satellite-link. The frequency at which the maximum power flux-density from the broadcasting satellite is specified will be called the "protected frequency". For narrow-band signals it will be the centre frequency of the narrow-band fixed satellite channel in question.

When considering the use of narrow-band signals in the upper part of the 10.7 to 11.7 GHz band, the foregoing maximum permissible spectral power flux-densities apply directly. However, when wide-band carriers are used in the upper part of the 10.7 to 11.7 GHz band, the relatively rapid roll-off characteristics of out-of-band emissions from broadcasting-satellite space stations will tend to reduce the effect of interference on such carriers.

TABLE I — Examples of systems in the 10.7 to 11.7 GHz and 12.5 to 12.75 GHz bands in Region 1 and the maximum pfd limits of unwanted emissions from broadcasting satellites to protect them

Parameter	System		
	10.7 to 11.7 GHz		12.5 to 12.75 GHz
	Maritime satellite to earth station link	Fixed satellite to earth station link	Fixed satellite to earth station link (data carrier)
Boltzmann's constant in dB(W/(Hz-K))	-228.6	-228.6	-228.6
Receive noise temperature (K)	300	100	100 ⁽²⁾
Receive thermal noise level ⁽¹⁾ (dB(W/4 kHz))	-167.6	-172.6	-172.6
Maximum interference level in a 4 kHz bandwidth into receiver in dB(W/4 kHz)	-177.6	-182.6	-182.6
Gain of receive antenna (dB)	60	60	45.8
Effective maximum allowable pfd at the interfered-with receiver in dB(W/(m ² · 4 kHz))	-194.6	-199.6	-185.4

⁽¹⁾ A level of interference of 10 dB below thermal noise level is assumed.

⁽²⁾ This system noise temperature is at the edge of current technology. Some current applications may typically have higher noise temperatures.

As an example of a broadband system in the 10.7 to 11.7 GHz band, some calculations have been made for a 20 MHz 612 channel carrier used in the INTELSAT system.

For the calculations it was assumed that an effective single entry interference noise contribution of about 500 pW0p should be tolerable due to out-of-band interference.

Taking the worst case, where the interference spectrum is represented by curve A of Fig. 1, the required carrier-interference ratio for the example considered, was found to be 25.6 dB. Then, taking an average e.i.r.p. density of 16.4 dB(W/MHz) for the INTELSAT system, together with the relationship between cumulative interference e.i.r.p. and band-edge power flux-density given in Fig. 2, the values of maximum permissible unwanted band-edge spectral density may be derived. The results are given in Fig. 3 as a function of the bandwidth of the wanted carrier.

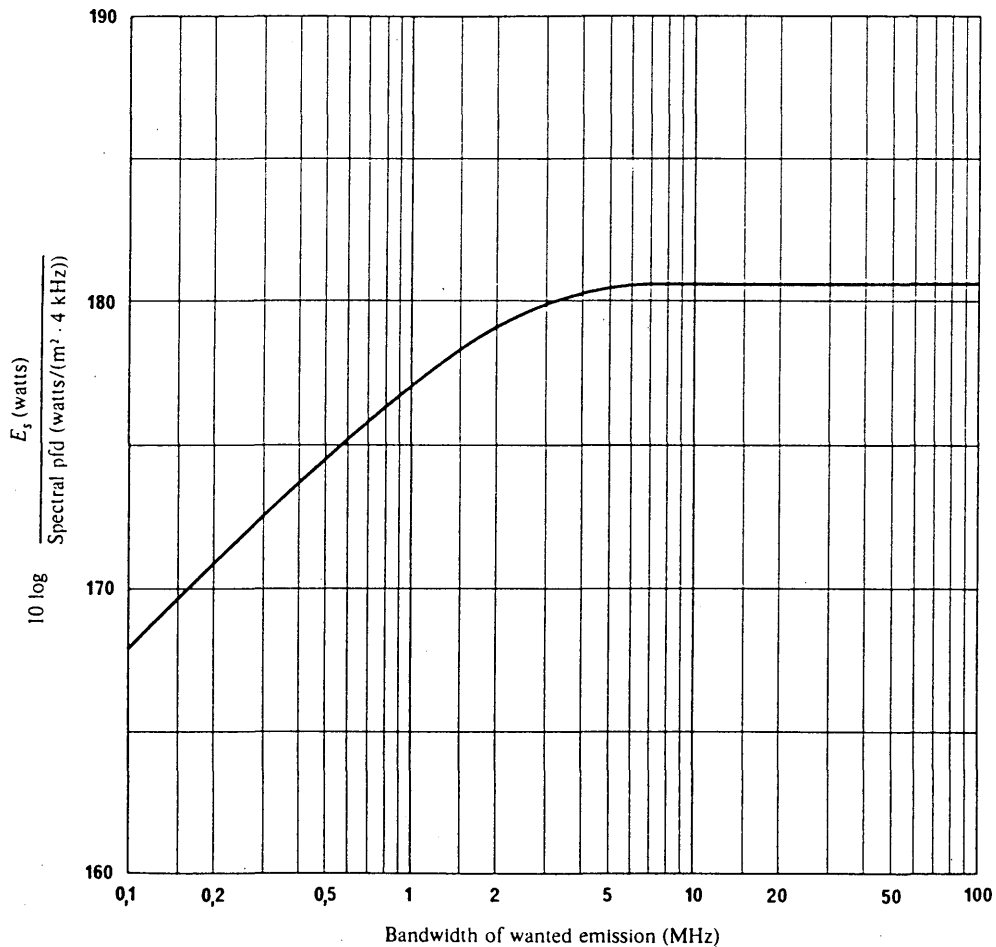

FIGURE 2 — The ratio of E_s to the interference spectral pfd at the edge of the broadcasting-satellite frequency allocation, as a function of the wanted carrier bandwidth, where

E_s : The maximum permissible cumulative Interference e.i.r.p. within the bandwidth of the wanted carrier, which is located at the edge of the band occupied by the fixed-satellite service, a guard-band of 4 MHz being allowed

Note. — This Curve corresponds to Curve A of Fig. 1.

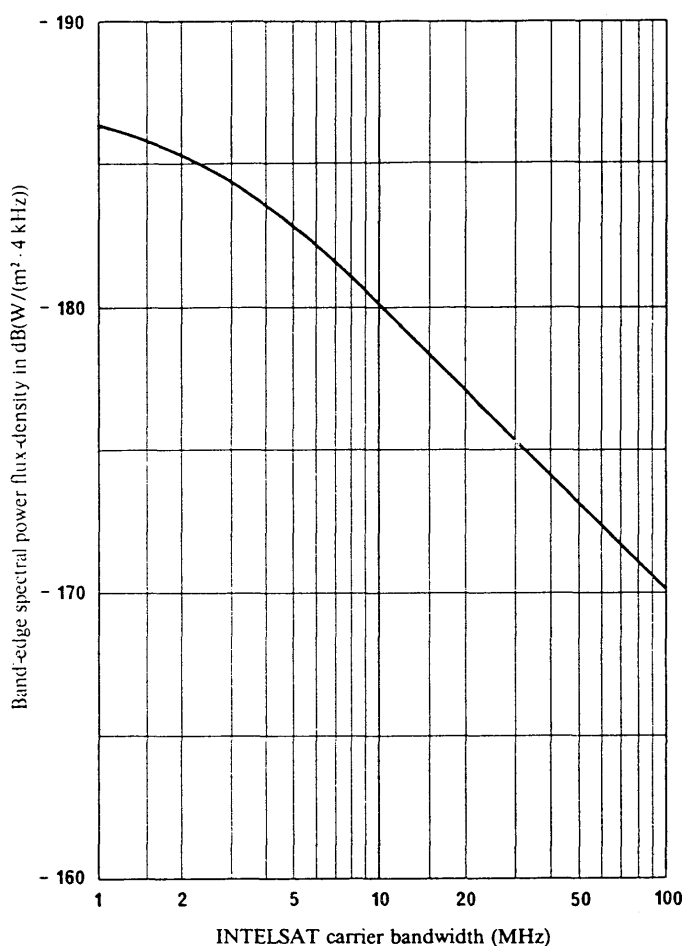

FIGURE 3 — Maximum permissible band-edge spectral power flux-density due to interfering out-of-band emissions as a function of carrier bandwidth in the INTELSAT-V system

(Based on a single entry producing 500 pWOp of interference noise power and assuming a guard band 4 MHz wide within the allocated fixed-satellite service band)

Note. — This curve corresponds to curve A of Fig. 1.

For the particular case of the 20 MHz 612 channel carrier instanced above, it may be seen that the maximum permissible band-edge pfd would be about $-177 \text{ dB(W/(m}^2 \cdot 4 \text{ kHz))}$. It is considered that a standard of protection based on this 20 MHz carrier would afford reasonable protection for most other carrier sizes, apart from narrow-band carriers. Thus by avoiding the use of narrow-band carriers in the upper portion of the 10.7 to 11.7 GHz band a reasonable beam-edge out-of-band interference pfd would appear to be $-177 \text{ dB(W/(m}^2 \cdot 4 \text{ kHz))}$. Further study is required on other broad-band fixed-satellite systems in the 10.7 to 11.7 GHz band.

4. Approaches to protecting fixed-satellite earth stations

To achieve compatibility between unwanted emissions from broadcasting-satellite space stations and permissible levels of interference in the fixed-satellite earth stations, a combination of the following provisions may have to be made:

- 4.1 Provide for adequate angular separation between the orbit location of satellites in the broadcasting-satellite service and the fixed-satellite service;
- 4.2 Provide adequate output filtering in the transmitter of the broadcasting-satellite space stations or in the receivers of the fixed-satellite earth stations; or both;

4.3 Provide adequate frequency separation between the centre of the lowest channel occupied by an emission from a broadcasting-satellite space station and the previously defined protected frequency of the fixed-satellite service.

In the interest of minimizing *a priori* constraints on system design in both services, it may be undesirable or impractical to rely on filtering requirements alone, as outlined under § 4.2 above; however, a relationship between pertinent system parameters including orbit spacing between satellite locations and frequency separation between "protected frequency" and channel centre frequency, as outlined in § 4.1 and 4.3 above, can be developed.

This relationship is shown in Fig. 4 where the required satellite spacing is plotted versus the power flux-density of unwanted emission at the protected frequency of the fixed-satellite earth station, with frequency separation as a parameter. The curves were derived from information regarding the out-of-band emissions from broadcasting-satellite space stations as given by curves A and B of Fig. 1 for a broadcasting-satellite channel with a channel bandwidth of 27 MHz.

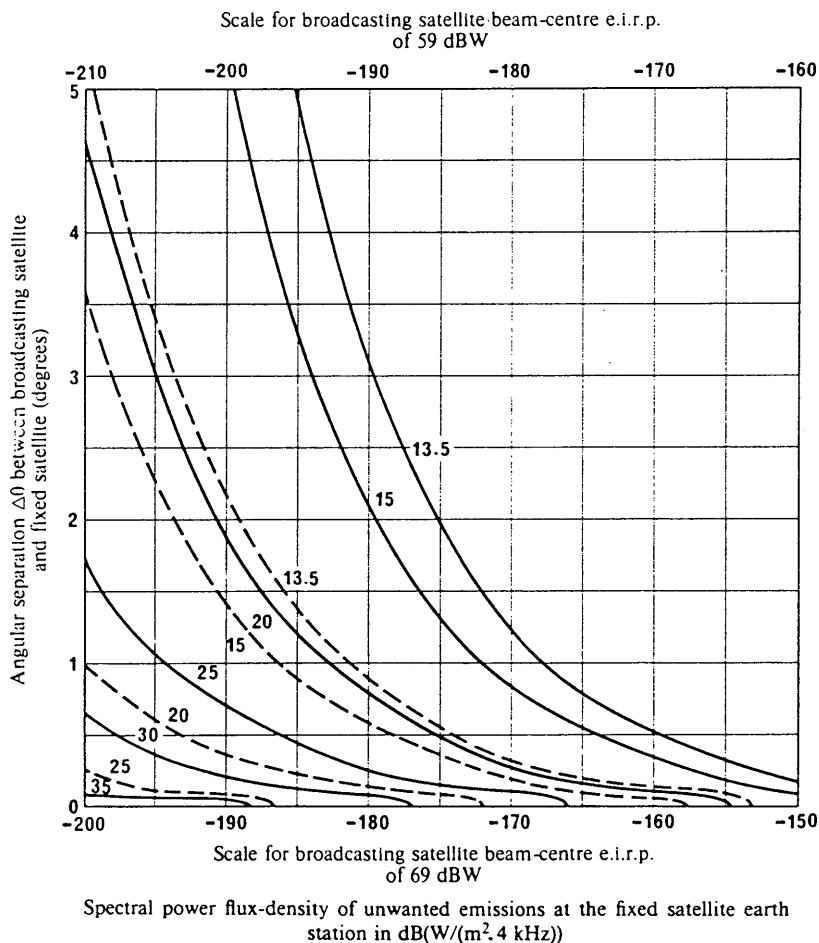

FIGURE 4 — Angular spacing and frequency separation to protect fixed satellite earth stations from unwanted emissions from adjacent-band broadcasting satellites

Note 1. — Channel bandwidth of broadcasting-satellite signal is 27 MHz.

Note 2. — Numbers on curves indicate Δf = frequency separation between fixed satellite protected-frequency and broadcasting-satellite channel centre frequency (MHz).

Note 3. — Solid curves based on curve A of Fig. 1. Dashed curves based on curve B of Fig. 1.

The absolute level of the unwanted emissions at the fixed-satellite earth station depends, of course, upon the e.i.r.p. of the broadcasting satellite. Separate abscissa scales are given in the figure for e.i.r.p.s of 69 dBW and 59 dBW corresponding to clear weather power flux-densities of about $-94 \text{ dB(W/m}^2\text{)}$ and $-104 \text{ dB(W/m}^2\text{)}$, respectively, at the centre of the broadcasting-satellite service area.

The level of unwanted emissions also depends on the type of television signal carried by the broadcasting-satellite space station, on the location of the fixed-satellite earth station, relative to the broadcasting-satellite service area, and on the gain and side-lobe pattern of the earth-station receiving antenna. The solid curves in Fig. 4 were drawn for the worst-case situation in which the broadcasting-satellite signal was a 100% modulated colour-bar transmission (see curve A in Fig. 1). The dashed curves were drawn for the case in which the broadcasting-satellite signal is a line-330 insertion test signal transmission (see curve B in Fig. 1). In both cases, it was assumed that the fixed-satellite earth location is located at the centre of the broadcasting-satellite service area. The earth-station antenna gain was assumed to be 60 dB and its side-lobe pattern to be given by $32 - 25 \log \phi$. If the earth station is located outside the coverage area of the broadcasting satellite, additional interference protection is realized from the angular discrimination of the broadcasting-satellite space station transmitting antenna.

5. Examples of compatible satellite spacing and/or frequency separation (co-coverage)

5.1 Case 1: Both orbit spacing and frequency separation

Using the curves of Fig. 4, it is possible to calculate the combinations of orbital spacing $\Delta\theta$ and frequency separation Δf that will reduce the levels of unwanted emission from a broadcasting-satellite to the maximum permissible level at the protected frequency. The results of such calculations are displayed in Fig. 5 where $\Delta\theta$ is plotted versus Δf for values of maximum permissible pfd ranging from -210 to $-160 \text{ dB(W/(m}^2 \cdot 4 \text{ kHz))}$. Separate families of curves, labelled A and B, are given for the two types of broadcasting-satellite test signals corresponding to curves A and B, respectively, in Fig. 1.

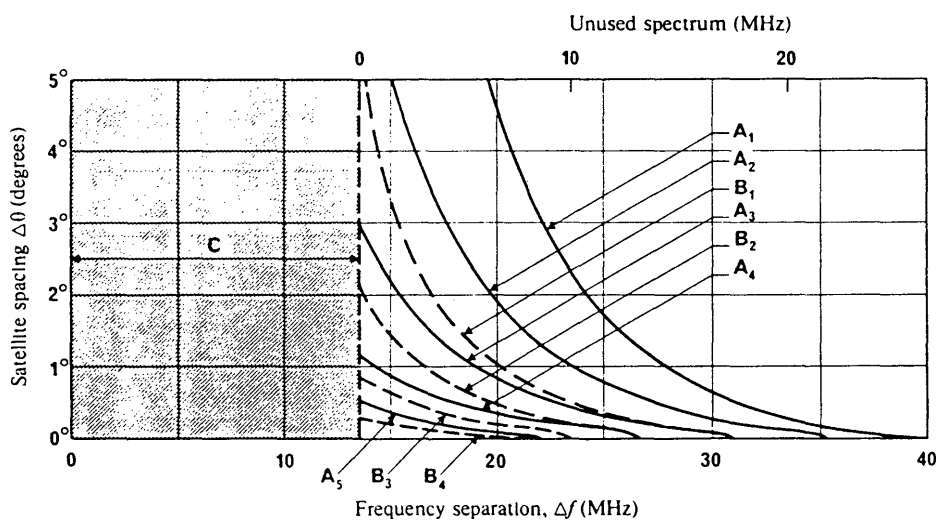

FIGURE 5 — Trade-off between satellite spacing ($\Delta\theta$) and frequency separation (Δf) for various maximum permissible pfd's

- A: 100% modulated colour-bar transmission (solid curves)
- B: line 330 insertion test signal transmission (dashed curves)
- 1: 269, e.g. pfd = $-200 \text{ dB(W/(m}^2 \cdot 4 \text{ kHz))}$ from a 69 dBW satellite
- 2: 259, e.g. pfd = $-200 \text{ dB(W/(m}^2 \cdot 4 \text{ kHz))}$ from a 59 dBW satellite
- 3: 249
- 4: 239
- 5: 229
- C: half-bandwidth of broadcasting-satellite channel (13,5 MHz)

Note. — The letter and number on a curve, respectively, identify the type of baseband signal assumed for the broadcasting-satellite emission and the difference, $E_s - \text{pfd}$ between the satellite e.i.r.p., E_s in dBW and the resultant, unwanted emission level, pfd, in $\text{dB(W/(m}^2 \cdot 4 \text{ kHz))}$ at the fixed satellite earth station.

For example, to keep the unwanted emissions from a 69 dBW e.i.r.p. broadcasting satellite to a maximum level of $-200 \text{ dB(W/(m}^2 \cdot 4 \text{ kHz))}$ at a fixed-satellite earth station, curve A_1 indicates that the following combinations of $\Delta\theta$ and Δf may be used, if it is assumed that the broadcasting-satellite signal is a 100% modulated colour bar transmission:

TABLE II

$\Delta\theta$ (degrees)	0	1	2	3	4	5
Δf (MHz)	40	28	24.5	22	20.6	18.6
Unused spectrum (MHz)	26.5	14.5	11	8.5	7.1	5.1

Thus the required separation between the protected frequency and the centre of the broadcasting-satellite channel decreases from 40 MHz for co-located satellites ($\Delta\theta = 0$) to 18.6 MHz for a 5° satellite spacing. Note that about 13.5 MHz of the required frequency separation (half of the bandwidth assumed for the broadcasting-satellite channel) is required for the essential spectrum of the broadcasting satellite; the remainder is unused spectrum lying between the protected frequency in the fixed-satellite band and the edge of the television channel in the broadcasting-satellite band. Note also that with a 59 dBW e.i.r.p. broadcasting satellite, the same combinations of $\Delta\theta$ and Δf would keep unwanted emissions at the earth station below $-210 \text{ dB(W/(m}^2 \cdot 4 \text{ kHz))}$.

For the same satellite e.i.r.p. and maximum permissible pfd, much smaller satellite spacings and/or frequency separations are required if it is assumed that the broadcasting-satellite signal carries a line-330 insertion test signal. In this case, curve B_1 of Fig. 5 shows that the following combinations of $\Delta\theta$ and Δf may be used:

TABLE III

$\Delta\theta$ (degrees)	0	1	2	3	4	5
Δf (MHz)	30	20	17	15.5	14.5	14
Unused spectrum (MHz)	16.5	6.5	3.5	2	1	0.5

For a fixed-satellite service earth station receiving a 20 MHz bandwidth carrier, the maximum permissible pfd at the (band-edge) protected frequency was cited in § 3 as about $-177 \text{ dB(W/(m}^2 \cdot 4 \text{ kHz))}$. To achieve this level of unwanted emission at the earth station with a 69 dBW e.i.r.p. broadcasting satellite, the interpolation between curves A_3 and A_4 in Fig. 5 shows that for the worst case test signal corresponding to curve A in Fig. 1 the following combination of $\Delta\theta$ and Δf may be used:

TABLE IV

$\Delta\theta$ (degrees)	0	1	2
Δf (MHz)	30	18	14
Unused spectrum (MHz)	16.5	4.5	0.5

Note that for satellite spacings of more than 2° , the required frequency separation is less than half the bandwidth of the broadcasting satellite, and there is no unused spectrum. With a 59 dBW e.i.r.p. satellite, a maximum separation of about 1° would suffice to reduce the unused spectrum to zero.

If the line-330 insertion test signal corresponding to curve B in Fig. 1 is assumed, interpolation between curves B₃ and B₄ in Fig. 5 shows that for any given value of $\Delta\theta$ the required frequency separation will in all cases be reduced from 8 to 10 MHz.

5.2 Case 2: co-located satellites ($\Delta\theta = 0$)

If, in order to avoid placing any constraints on either service in the location of its satellites, the possibility of co-located satellites is assumed, the reduction of unwanted emission to the permissible values may have to be achieved by frequency separation alone. In this case, the values of maximum permissible power flux-density mentioned in § 3, together with the curves given in Fig. 1, can be used directly to deduce the frequency separation between the centre frequency of the bottom (or top) channels in the broadcasting-satellite band and the fixed satellite protected frequency. For convenience, these curves are reproduced in Fig. 6(a), from which the following observations can be made:

- The example of a fixed satellite (data) requiring protection to $-171 \text{ dB(W/(m}^2 \cdot 4 \text{ kHz))}$ in the band 12.5 to 12.75 GHz leads to a frequency separation of about 20 MHz and 28 MHz for curves B and A respectively. As previously noted, this frequency separation is not all unused frequency spectrum, since about 13.5 MHz of it contains some of the essential spectrum of the broadcasting-satellite emission.
- The example of a narrow-band fixed-satellite transmission requiring protection to about $-200 \text{ dB(W/(m}^2 \cdot 4 \text{ kHz))}$ in the band 10.7 to 11.7 GHz leads to a frequency separation according to curves B and A, of about 30 MHz and 40 MHz respectively. Again, about 13.5 MHz of this can be considered to include essential spectrum of the broadcasting-satellite emission.
- The example of a wide-band fixed satellite requiring a protection of $-177 \text{ dB(W/(m}^2 \cdot 4 \text{ kHz))}$ at band-edge in the band 10.7 to 11.7 GHz leads to a frequency separation of about 22 MHz and 30 MHz for curves B and A respectively.

5.3 Case 3: No unused spectrum ($\Delta f = 13.5 \text{ MHz}$)

In certain cases, up-link interference problems will preclude the co-location of 12 GHz broadcasting-satellites and fixed satellites in the adjacent bands. For this reason it is of interest to consider the other special case in which the reduction of unwanted emissions to the permissible levels is achieved by orbital spacing alone.

The curves for this case corresponding to the two test signals previously discussed are shown in Fig. 6(b) and may be read directly. For example, to protect a fixed-satellite earth station receiving a 20 MHz carrier just below the upper edge of the 10.7 to 11.7 GHz band, against a 69 dBW broadcasting satellite just above band-edge, requires a satellite spacing of about 2° . For a 59 dBW broadcasting satellite, the spacing drops to about 0.8° .

Both these examples correspond to the worst case 100% colour bar test pattern signal corresponding to curve A unwanted emission in Fig. 1. With the line-330 test pattern the required spacings are reduced significantly as shown by curve B in Fig. 6(b). In this case, spacings of about 0.7° and 0.3° may suffice for broadcasting satellite e.i.r.p.s of 69 dBW and 59 dBW, respectively.

5.4 Discussion

A consequence of the results presented above is that a set of broadcasting satellites in the geostationary-satellite orbit would make certain orbital arcs unusable by satellites in the fixed-satellite service operating in adjacent bands, depending on the frequency separation between the closest channel used by the broadcasting satellite and the protected frequency of the fixed satellite. This point is illustrated in Fig. 7. An array of broadcasting satellites is shown in the 11.7 to 12.5 GHz band at a spacing of 7.5° . (The WARC-BS-77 has made assignments at 6° inter-satellite spacing in Regions 1 and 3.) At each point shown the full 800 MHz allocated to Region 1 is radiated (different channels being received by different countries). Thus from each point the lowest and highest channels are radiated. The separation between broadcasting satellites is purely illustrative but may be regarded as typical separation determined by inter-broadcasting satellite interference considerations when adjacent broadcasting satellites employ opposite polarizations. The curves shown in Fig. 7 are based on Fig. 5 but the vertical axis gives the percentage of orbit available to the fixed-satellite service in the 10.7 to 11.7 GHz band,

relative to all the orbit being available. Depending on the relative positions of the fixed-service and the broadcasting-service satellites, these additional separation requirements will not necessarily lead to the inability to find a location for another particular fixed-service satellite.

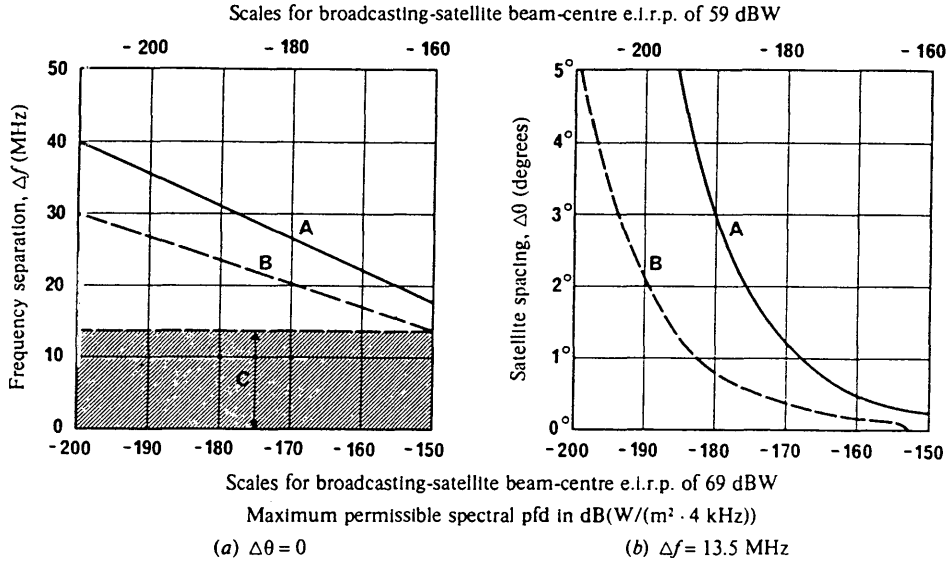

FIGURE 6 — Frequency separation for special cases of co-located satellites ($\Delta\theta = 0$) and zero unused spectrum ($\Delta f = 13.5 \text{ MHz}$)

C: Half-bandwidth of broadcasting satellite channel (13.5 MHz)

Note. — The letters on the curves have the same meaning as in Fig. 5.

The implications of Fig. 7 will need to be assessed for the different parts of the geostationary orbit in the 10.7 to 11.7 GHz band. For example, in those parts where a high density of fixed satellites is anticipated, orbital separation, as shown in Figs. 5 and 6b), may not be feasible for all cases. It may then be necessary to assume no orbital separation as the general case for broadcasting satellites in this part of the orbit.

A solution to this problem, from practical considerations, may have to take into account that it would be generally unacceptable to reposition a broadcasting satellite whose signals are intended for individual reception.

The above studies did not assume guard bands at the edge of the broadcasting-satellite and fixed-satellite service allocations. The WARC-BS-77 has provided for the allocated frequency bands (11.7 to 12.5 GHz in Region 1; 11.7 to 12.2 GHz in Region 3). As a result, interference from broadcasting-satellite emissions caused in fixed-satellite service systems operating in adjacent allocated frequency bands may not be as severe as indicated in these studies. However, these studies did not take into account the possibility of using guardbands for TT&C carriers. Further studies are needed to evaluate whether such an operation will increase the level of unwanted emissions from broadcasting satellites including intermodulation products between TT&C carriers and television carriers.

6. Some technical observations concerning frequency band allocations

Based on the frequency study on unwanted emissions, particularly difficult technical problems arise when a broadcasting-satellite service frequency allocation (in which individual reception is permitted) and a fixed-satellite service allocation (in which systems are developed employing global beams, large diameter earth station antennas, sensitive low noise amplifiers and/or narrow-band modulation techniques) are adjacent to each other in the Table of Frequency Allocations of the Radio Regulations.

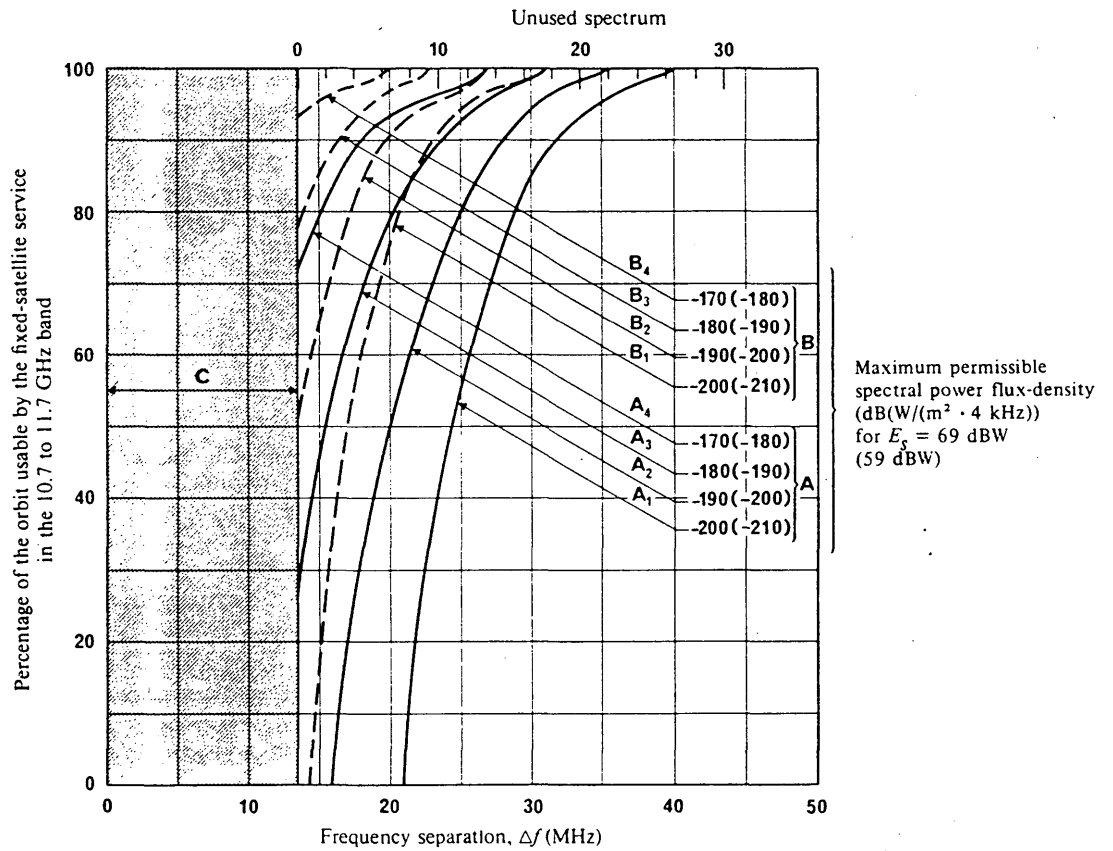
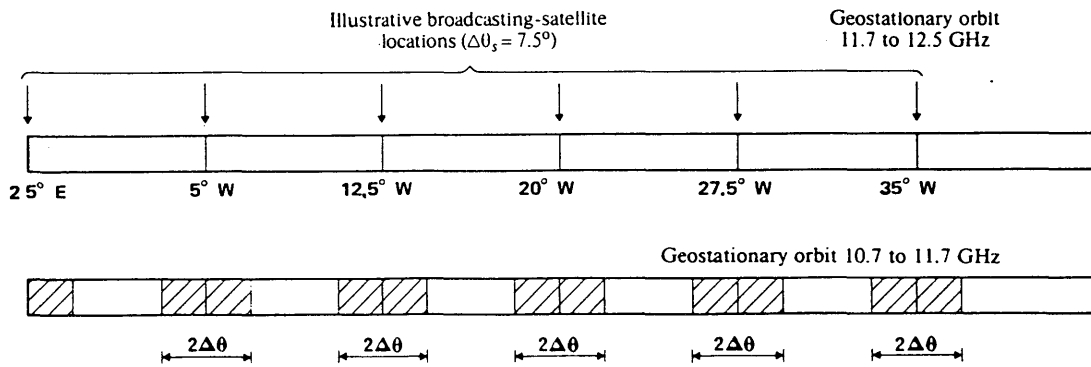

FIGURE 7 — Illustrative example of possible effect of unwanted emissions from 12 GHz broadcasting satellites on the orbital arc usable by fixed satellites in adjacent bands

C: half bandwidth of broadcasting-satellite channel

- Orbit usable by fixed satellites
- Orbit not usable by fixed satellites

Note. — The curves have the same designation as those of Fig. 5.

Fixed-satellite service earth stations located in the service area of a broadcasting-satellite service will be subjected to high-power emissions from the broadcasting-satellite service space stations. These emissions, which are in the band adjacent to the fixed-satellite service, if received unattenuated, could cause overloading of the fixed-satellite service earth station low-noise receiver and a consequent increase in the effective system noise temperature. Therefore, attention must be given to this possible situation during the design phase of the fixed-satellite service earth station.

REPORT 873-2

AN ANALYSIS OF THE INTERFERENCE FROM THE BROADCASTING-SATELLITE
SERVICE OF ONE REGION INTO THE FIXED-SATELLITE SERVICE
OF ANOTHER REGION AROUND 12 GHz

(Study Programme 33A/4)

(1982-1986-1990)

1. Introduction

The WARC-79 allocated common frequency bands to the fixed-satellite and broadcasting-satellite services in different Regions such that, in the band 11.7-12.2 GHz the fixed-satellite service has an allocation in Region 2 and the broadcasting-satellite service in Regions 1 and 3, while in the band 12.5 to 12.7 GHz the fixed-satellite service has an allocation in Region 1 and the broadcasting-satellite service in Region 2. The broadcasting-satellite service in Regions 1 and 3, and in the bands 11.7 to 12.5 and 11.7 to 12.2 GHz, respectively, was organized in a plan by the WARC-BS-77. The WARC-BS-77 established values of inter-regional power flux-density as coordination thresholds, and analogous action was taken by the WARC-ORB-85 in the band 12.2 to 12.7 GHz.

The material presented in this Report discusses some of the problems created by inter-regional sharing between different space services and further information on the subject is to be found in Report 809, and relevant regulatory provisions are contained in the Final Acts of the WARC-ORB-85.

2. System assumptions

2.1 The fixed-satellite service

For the fixed-satellite service three systems have been postulated with the characteristics identified in Table I.

TABLE I*

Relevant parameter	System A	System B	System C
Antenna diameter, D/λ	60	60	≥ 100
Antenna side-lobe gain (dB)	$34 - 25 \log \varphi$	$34 - 25 \log \varphi$	$32 - 25 \log \varphi$
Transmission mode	Digital SCPC	Digital SCPC	Wide-band data
Reference bandwidth	40 kHz	40 kHz	2 MHz
Clear-sky receiving system noise temperature (K)	200	400	100
Clear-sky carrier-to-noise ratio (dB)	12	16	-
Carrier-to-interference ratio ⁽¹⁾ (dB)	20.5 ⁽¹⁾	20.5 ⁽¹⁾	-
Interference-to-noise ratio ⁽²⁾ (dB)	-	-	13.5 ⁽²⁾
Acceptable level of interference ⁽³⁾ (dBW)	-168.1	-161.1	-159.0

⁽¹⁾ This is based on an interference criterion of $C/I = 27.5 + 6 \log \delta$ for "frame rate" dispersal of an interfering video carrier.

⁽²⁾ This is based on the presence of thermal only internal noise, and a 4% single entry predemodulation interference increment.

⁽³⁾ Between two systems in the fixed-satellite service.

* This Table needs to be reviewed based on Recommendation 523-3 and Report 1134.

2.2 The broadcasting-satellite service

For the broadcasting-satellite service, an e.i.r.p. of 63 dBW has been assumed for the purposes of this study as representative for beam centre emissions.

In addition, it has been postulated that, in most cases, the broadcasting-satellite antenna gain towards the "other" region may be held at or below the -30 dB "first side-lobe plateau" of the relevant antenna reference pattern. With these assumptions, the broadcasting-satellite power radiated towards the "other" region will be about 33 dBW.

It should be noted that Region 2 reference patterns do not have this plateau. By the use of shaped beam antennas, the side-lobe characteristics of Region 2 space stations can be improved to meet or exceed this criterion. In some situations, where very large antenna discriminations are required over small areas, the use of nulling horns has been shown to be effective [CCIR, 1982-1986].

With regard to energy dispersal, the Plan for Regions 1 and 3 imposes a value of 600 kHz of peak-to-peak "frame rate" triangular energy dispersal (this, with the assumptions on reference bandwidth in § 2.1 yields $\delta = 0.067$). The Plan for Region 2 imposes an energy dispersal in order to produce a spectral power flux-density in any 40 kHz band 12 dB below the unmodulated carrier power. According to the information in Report 792, the peak-to-peak frequency deviation due to the energy dispersal signal is then 634 kHz which is slightly higher than that adopted by Regions 1 and 3; the very slight reductions in interference obtained have not been taken into account in the remainder of the study.

Table II shows relevant parameters involving broadcasting-satellite characteristics.

TABLE II — Levels of interference from the broadcasting-satellite service

Interfered-with FSS system	System A	System B	System C
Interfering system e.i.r.p. (dBW)	63 – 30	63 – 30	63 – 30
Interference into FSS systems (dBW)	$-138.5 - 25 \log \varphi$	$-138.5 - 25 \log \varphi$	$-140.5 - 25 \log \varphi$

3. Interference potential assessment

The level of interference into fixed-satellite systems is a function of the topocentric angle of separation between the fixed satellite and broadcasting satellite. To assess the compatibility of the broadcasting satellite emissions with the postulated fixed-satellite systems, it is convenient to equate the acceptable levels of interference (Table I) with the interference produced by a broadcasting satellite (Table II) which would yield the following equations for the required inter-satellite spacing for the three fixed-satellite systems:

- for FSS systems of type A,

$$-138.5 - 25 \log \varphi = -168.1 - M$$
 or

$$25 \log \varphi = 29.6 + M$$
- for FSS systems of type B,

$$-138.5 - 25 \log \varphi = -161.1 - M$$
 or

$$25 \log \varphi = 22.6 + M$$
- for FSS systems of type C,

$$-140.5 - 25 \log \varphi = -159.0 - M$$
 or

$$25 \log \varphi = 18.5 + M$$

where M is an inter-service margin below the permissible single-entry level of interference between networks in the fixed-satellite service. The resultant separation angles φ are shown in Fig. 1 for systems A, B and C for margins M between +3 dB and +10 dB. Further study is required to determine the most appropriate value of M .

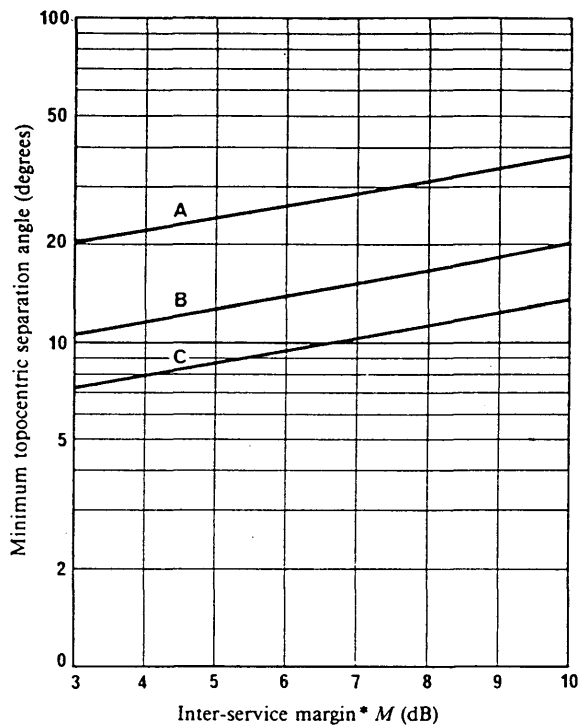

FIGURE 1 — Minimum topocentric separation angles between BSS and FSS systems as a function of acceptable interference inter-service margin below single-entry fixed-satellite interference level

A: System A
 B: System B
 C: System C

* The values used here are chosen only to illustrate the relationships involved. Further study is required to determine the value of M to be used in estimating required separation angles.

4. The BSS Plans

The practical implication of the inter-regional sharing situation described in the preceding sections is that some networks of the FSS serving one Region will find it difficult to locate their space stations close to or within those regions of the GSO which have been systematically assigned to the BSS. This problem arises because in the 1977 BSS Plan for Regions 1 and 3, and in the 1983 BSS Plan for Region 2, the two services are to operate in the same frequency band.

Thus, for example, the Region 1 BSS Plan, with its orbit location assignments every 6° , sets up an interference pattern for an FSS receiving earth station located at Recife (Brazil) which is illustrated in Fig. 2. Figure 2 shows the wanted-to-unwanted carrier ratio (C/I) at the Recife location as a function of the orbit location of an FSS space station transmitting in the band 11.7-12.2 GHz. The wanted signal is characterized by a 13.2 dBW satellite e.i.r.p. as received by a 49.9 dB gain earth-station antenna with a side-lobe radiation pattern of $32 - 25 \log \phi$. For the small angular differences between BSS and FSS satellite locations, it should be noted that the unwanted carrier is within the main beam of the FSS earth-station antenna.

Figure 3 shows a similar example involving the Region 2 (1983) BSS Plan and an FSS receiving earth-station location at Lisbon (Portugal). The left- and right-hand ordinates show the wanted-to-unwanted carrier ratios at the FSS earth station for two wanted transmissions: 64 kbit/s and 2.048 Mbit/s PCM-4-PSK signals respectively; the common frequency band being the band 12.5-12.7 GHz.

An analogous situation exists in the Pacific Ocean area where the Region 2 FSS may encounter difficulties with the Regions 1 and 3 BSS Plan in the band 11.7-12.2 GHz, the Region 1 FSS with the Region 2 BSS Plan at 12.5-12.7 GHz, and the Region 3 FSS with Region 2 BSS Plan at 12.2-12.7 GHz. Figure 4 shows an example of the Pacific Ocean area interference situation between the Region 2 BSS Plan and the Region 3 FSS. The test point for this case is Hong Kong.

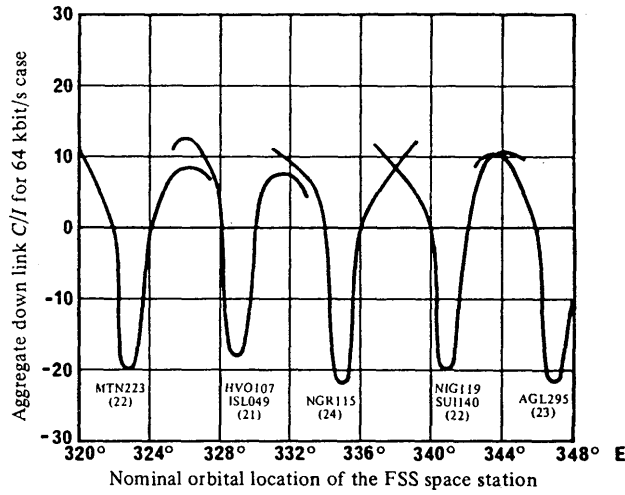

FIGURE 2 - Typical variation of worst-case channel aggregate down-link C/I for 64 kbit/s digital carriers versus nominal orbital location of an FSS space station serving Region 2 in the band 11.7-12.2 GHz

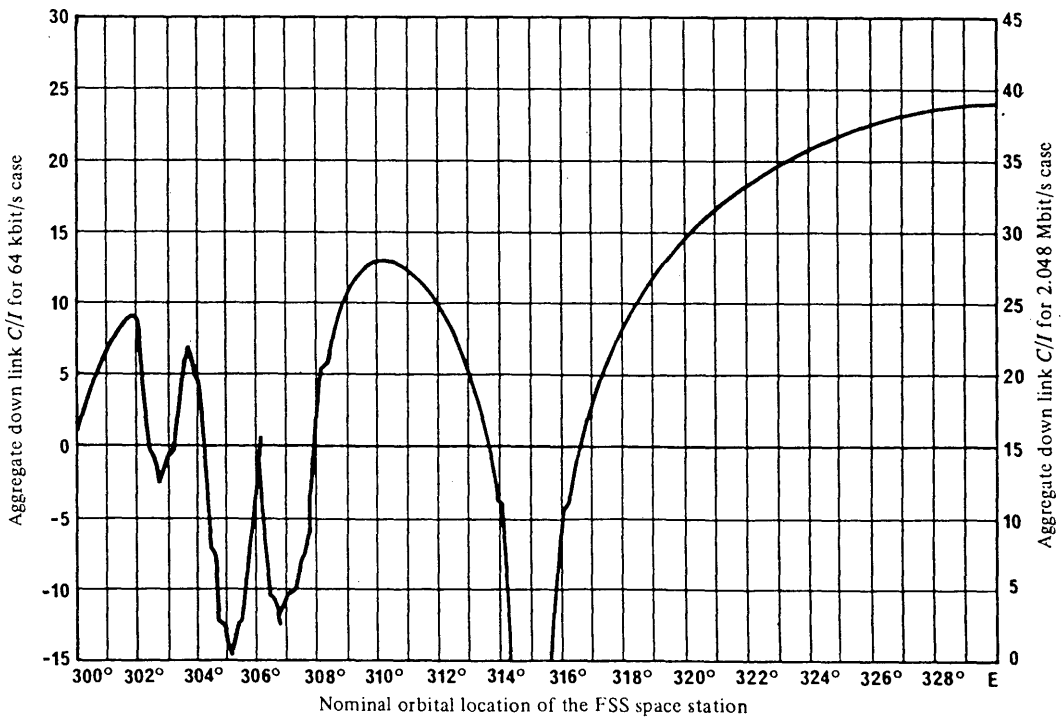

FIGURE 3 - Typical variation of worst-case channel aggregate down-link C/I for 64 kbit/s and 2.048 Mbit/s digital carriers versus nominal orbital location of an FSS space station serving Region 1 in the band 12.5-12.7 GHz

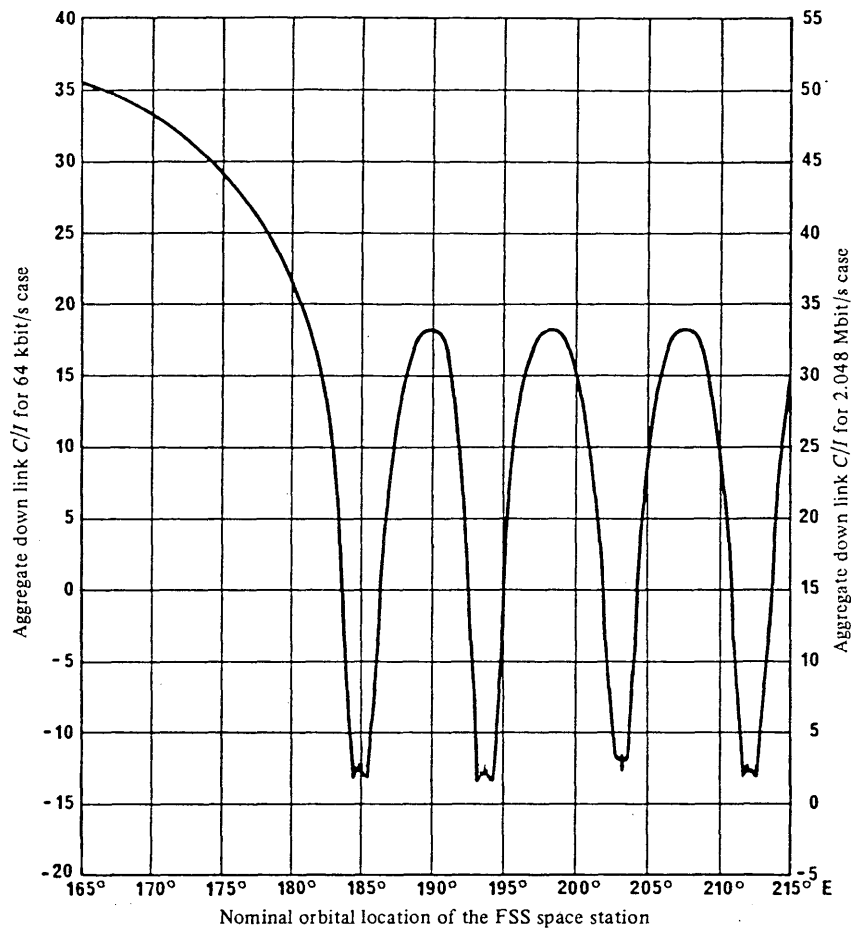

FIGURE 4 - Typical variation of worst-case channel aggregate down-link C/I for 64 kbit/s and 2.048 Mbit/s digital carriers versus nominal orbital location of an FSS space station serving Region 3 in the band 12.2-12.7 GHz

In Figs. 2, 3 and 4, it should be noted that, at each BSS orbit location, not all frequencies in the shared band are subject to the maximum interference that is implied by the curves. Furthermore, the simplistic broadcasting-satellite coverage area and antenna radiation pattern models used for establishing the plans and used in the derivation of these figures are, in general, pessimistic and coordination with actual broadcasting satellites will be considerably easier than the illustrations indicate particularly if the broadcasting-satellite antenna design takes into account the inter-regional interference potential.

It should also be noted that provisions have been made for the implementation of interim BSS systems in Region 2 and consideration of similar provisions may be given in the future for interim BSS systems in Regions 1 and 3. As interim BSS systems may be implemented using parameters outside of the nominal plan assignment parameters, this may compound the sharing difficulties described above.

4.1 Criteria for the determination of the need to coordinate fixed-satellite space stations in Region 2 with BSS assignments of the Region 1 and 3 plan

In Regions 1 and 3, Broadcasting and Broadcasting-Satellite Services are allocated to the 11.7-12.2 GHz band on a primary basis with the Broadcasting-Satellite use subject to the Article 15 and the associated assignment plans of Appendix 30. Annex 4 of Appendix 30 provides criteria for the coordination of a fixed-satellite space station in Region 2 with respect to broadcasting satellite assignments in the Region 1 and 3 plan in the 11.7-12.2 GHz band.

In the application of Appendix 30, administrations whose BSS services may be affected are identified as those administrations having an assignment in the Region 1 and 3 plan whose assigned bandwidth overlaps the assigned band of the proposed Region 2 fixed-satellite system when the above power density values are exceeded. The same values could also be used to determine affected administrations in the application of the Article 14 procedure for the fixed-satellite service in Region 2 with respect to the BSS assignments in the Region 1 and 3 plan in the 11.7-12.2 GHz band.

5. Amelioration of sharing difficulties

It is apparent that an FSS network which is to provide service in the Atlantic Ocean area to both Region 1 at 12.5-12.7 GHz and Region 2 at 11.7-12.2 GHz will be faced with difficulties. A temporary avoidance of these difficulties would be possible if affected BSS operations were to activate first those channels which would not overlap frequencies used by the FSS. In the long run, however, it will be necessary to resort to a number of mitigating measures or techniques, if feasible.

Thus, FSS satellite operators and designers might be able to utilize several techniques to reduce the amount of interference received from BSS satellites, if feasible:

- choose orbit locations of FSS satellites taking into account the orbital locations of BSS assignments in a Plan;
- avoid assigning sensitive FSS carriers on frequencies with BSS FM-TV carriers;
- use power compensation techniques within transponders where possible. Greater power can be assigned to carrier frequencies subject to greater interference from BSS channels;
- use FSS earth-station antennas with an improved side-lobe pattern in the orbital plane; e.g., $29 - 25 \log \varphi$ (for $\varphi < 8^\circ$);
- relax the relevant interference criteria to take into account the fact that BSS carriers are unmodulated for a small percentage of time;
- use frequencies for FSS operations that are not likely to be implemented by BSS operators during the lifetime of the FSS satellite or during the lifetime of the Plan.

BSS satellite operators and designers in all three Regions, on the other hand, can employ only a limited number of interference mitigating techniques to reduce the amount of interference to FSS operations in other Regions. These techniques, if found to be feasible, are:

- employ improved BSS satellite transmitting antenna patterns to reduce the amount of energy in the side-lobes compared with that assumed in the Plan;
- employ adequate energy dispersal in the absence of programming material;
- employ a BSS satellite e.i.r.p. less than that specified in the Plan where consistent with system requirements and with possible interactions with other BSS assignments.

6. Conclusions

It is clear from the above analysis that inter-regional sharing between the FSS and BSS in the neighbourhood of 12 GHz may cause difficulties for the location and operation of the space stations of some FSS networks. The extent of these difficulties is dependent on the specific technical and operating characteristics of systems in both services and this may be particularly important when interim BSS systems are implemented.

Existing criteria are available in the Radio regulations which specify the conditions under which the fixed-satellite service of Region 2 need to coordinate with BSS assignments in Regions 1 and 3 in the 11.7 - 12.2 GHz band. These criteria could be used to identify affected administrations to facilitate the application of Article 14.

Inasmuch as the BSS is subject to the provisions of two Plans (Regions 1 and 3, 1977, and Region 2, 1983) its characteristics are largely established. Nevertheless, in the actual implementation of both FSS and BSS systems certain specific interference mitigating steps may prove possible and useful.

Some of these techniques and practices have been set forth in the preceding section; however, there may be others and continued study of this matter is urgently required, with emphasis on interference - mitigating measures and improvements in FSS earth-station antenna radiation characteristics and space-station radiation characteristics in both services.

REFERENCES

CCIR Documents

[1982-1986]: 4/230(10-11S/141) (Canada).

REPORT 713-1

SPURIOUS EMISSIONS FROM EARTH STATIONS AND SPACE STATIONS OF THE FIXED-SATELLITE SERVICE

(Question 25/4)

(1978-1982)

1. Introduction

Spurious emissions from space stations of the fixed-satellite service could cause interference at receiving stations of other systems and in particular, at stations designed to receive very weak signals. This interference could be particularly objectionable at frequencies in bands allocated to the radioastronomy service. The Radio Regulations do not, at present, define limits of spurious emissions for transmitters operating at frequencies higher than 17.7 GHz, and none for digital transmissions and for the space services beyond 960 MHz.

Spurious emissions from earth stations in the fixed-satellite service might also cause interference. Such cases of interference from spurious emissions that do arise might often be dealt with on an *ad hoc* basis. However, the number of earth stations in the fixed-satellite service is increasing rapidly and the geographical separation between earth stations obtained in the past may not be obtained in the future. Accordingly, it seems desirable to study the problem of spurious emissions from earth and space stations in the fixed-satellite service. Recommendation No. 66 of the WARC-79 lends urgency to the undertaking of such studies.

2. The nature and possible power level of spurious emissions radiated from earth and space stations

Little information is available as to the power level of spurious emissions from earth and space stations and without such information it is difficult to discuss the problem on a realistic basis. In order to provide a starting-point for discussion, a very approximate forecast of the order of magnitude of the power of these emissions and their approximate frequency is made in this section. In the following discussion PD_{WE} and F_{WE} represent the power density and frequency of the wanted emission at the input to the earth station antenna, whilst PD_{WS} and F_{WS} represent the e.i.r.p. density and frequency of the wanted emission of the satellite.

Spurious emissions are typically of the following types:

- harmonics and images of the wanted emission;
- fundamentals and harmonics of oscillators used in the frequency conversion process;
- parasitic oscillations;
- intermodulation products arising from non-linear amplification and perhaps from the presence of non-linearities caused by inhomogeneities in conductors in the waveguide/filter/antenna-feed chain, following the final amplifier.

There may, however, be other significant sources of spurious emission.

Harmonics of the wanted emission will have a spectral power distribution similar to that of the wanted emission. Their frequencies will be multiples of F_W , and their maximum power density level might be $(PD_{WE} - 80)$ dB(W/MHz) or $(PD_{WS} - 50)$ dB(W/MHz).

Since the lowest frequency allocated to the fixed-satellite service for transmissions from space is 2.5 GHz, harmonic emissions will be at 5 GHz or above. These emissions are likely to be spread over a bandwidth of many megahertz and their power density levels might fall in the range of -70 to -60 dB(W/MHz) for earth stations or an e.i.r.p. density of -10 to -30 dB(W/MHz) in the case of emissions from satellites.

Image signals will be broadly similar, but their power is likely to have been reduced by band-pass filters in the transmitter, to a level of the order of -90 dB(W/MHz) for earth stations and about -60 dB(W/MHz) for space stations.

Fundamentals and harmonics of earth-station local oscillators can be expected to be of the order of -50 dBW, whilst in the case of emissions from satellites a maximum e.i.r.p. of the order of -60 dBW can be expected. However, the actual power level radiated in any particular case will depend greatly on details of design. Furthermore, these spurious emissions, being unmodulated, may cause significant interference in sensitive narrow-band systems even though the absolute value of the interfering emission may be very low. The effects of parasitic oscillations may be similar in nature but more unpredictable in frequency and more severe in degree.

Earth-station intermodulation products will have spectral distributions similar to those of the wanted emissions, usually widely spread, and they tend to be concentrated close to F_W . At the edges of the occupied frequency band the level of intermodulation products may be of the order of $(PD_{WE} - 30)$ dB(W/MHz), giving an absolute value of about -20 to -10 dB(W/MHz).

Satellite intermodulation products will also have spectral distributions similar to those of the wanted emissions. At the edges of the frequency band occupied by the transponders of the satellite, the level of intermodulation products may be of the order of $(PD_{WS} - 20)$ dB(W/MHz) giving an absolute value of about 0 to -20 dB(W/MHz).

These levels should decline considerably at frequencies several times the width of the occupied band away from the band edge.

Signal spectrum components due to modulation but lying just outside the necessary bandwidth are out of band emissions and thus excluded by definition from the term "spurious emission", but they too, may be a source of interference, particularly when the carrier frequency is close to the edge of the allocated frequency band.

For earth stations the estimates quoted above are of spurious emission power at the input to the antenna of a transmitting earth station. The e.i.r.p. from the antenna will then depend upon the radiation pattern at the frequency of interest. As a first approximation it is assumed here that the earth station antenna gain in a given direction for spurious emissions is the same as for the wanted emission. In most interference situations of interest, it may be assumed that the spurious emission signal is radiated in a direction far removed from the earth-station antenna's main lobe. A gain of 0 dB has been assumed in this Report.

3. Levels of permissible interference at a receiving station

Before limits could be determined, of the power of spurious emissions by earth stations, it would be necessary to relate the power of such emissions to the level of interference that they would cause at typical receiving stations of the various services likely to be affected. These levels of interference and the percentages of

time for which they occur must in turn be related to levels of permissible interference from all sources. The determination of these total interference levels and the percentage that may comprise spurious emissions must, of course, take place in the Study Groups responsible for the services concerned. The task is a substantial one, since existing limits on spurious emissions as set forth in Appendix 8 to the Radio Regulations do not go beyond 17.7 GHz and do not include space services and digital transmissions above 960 MHz. These studies would need to take into account:

- the probable number of simultaneous interference entries due to spurious emissions from stations of all services;
- the effect that the spectrum of the interfering signal would have on the affected service compared with the equivalent amount of thermal noise;
- the most appropriate bandwidth in which to refer levels of interference;
- the sensitivity to interference of the services within the band; and
- in shared bands, the amount of interference that already arises as a result of the sharing of the frequency band.

In order to gain some understanding of the problem, this Report has assumed the representative situation of a service receiving spurious emissions solely from stations of the fixed-satellite service. Levels of permissible interference have been derived from Reports and Recommendations of the appropriate CCIR Study Groups. It has been generally assumed that the spurious component should be 10 to 20 dB below the level of the permissible in-band interference. This range of values of interference resulting from spurious emission is given for illustration only and should be reviewed as the work continues towards answering Question 25/4. However for the sake of simplicity the value of 20 dB only has been used in the examples that follow.

3.1 *Interference to radio-relay stations from earth stations*

Earlier studies by CCIR Study Groups 4 and 9, in the context of the determination of interference potential between earth stations and terrestrial stations, have determined values of permissible interference powers. Report 448 provides the long-term permissible levels for radio-relay systems operating at frequencies between 1 and 40 GHz. Typical values of the long-term permissible level, for each entry of interference, are -151 dB(W/4 kHz) for analogue modulated systems operating at 6 GHz and -134 dB(W/MHz) for digitally modulated systems operating at 30 GHz, these values being applicable when the interference is present continuously.

A limit corresponding to 20 dB below these values might be of the order needed to define a reasonable allocation of this interference allowance to spurious emissions from earth stations of the fixed-satellite service, which would give values around -171 dB(W/4 kHz) at 6 GHz and -154 dB(W/MHz) at 30 GHz.

With these assumptions, and also assuming that the source of interference is in the direction of maximum sensitivity of the radio-relay station antenna, spurious emissions of which the e.i.r.p. did not exceed -80 dB(W/4 kHz) at 6 GHz or -54 dB(W/MHz) at 30 GHz should not cause more than the permitted level of interference in a radio-relay station receiver situated 25 km away; free-space propagation conditions being assumed.

3.2 *Interference to radio-relay stations from space stations*

Earlier studies by CCIR Study Groups 4 and 9 have determined maximum levels of power flux-density (pfd) set up by the carriers emitted by satellites of the fixed-satellite service working in all frequency bands shared with the terrestrial fixed service. Permissible values of power flux-densities are given in Recommendation 358. For angles of arrival of above 25° , these pfd values range from -144 dB(W/(m² · 4 kHz)) around 2 GHz to -138 dB(W/(m² · 4 kHz)) around 12 GHz; at 20 GHz the corresponding value is -105 dB(W/(m² · MHz)). An e.i.r.p. density limit corresponding to 20 dB below these pfd limits might be of the order needed to define a reasonable allocation of this interference noise allowance to spurious emissions from a geostationary satellite of the fixed-satellite service, giving values of -2 dB(W/4 kHz) at 2 GHz and 37 dB(W/MHz) around 20 GHz. This assumes that the antenna pattern of the space station antenna at the frequencies of the spurious emissions is similar to that at the fundamental frequency.

3.3 *Interference to "trans-horizon" stations from earth stations*

As in the case of line-of-sight radio-relay systems, Report 448 gives values of permissible interference for trans-horizon systems. Assuming that the level of the spurious component may be 20 dB below the level of the permissible interference, a reasonable limit for interference from spurious emission is of the order of

–160 dB(W/4 kHz) for 0.01% of the time. With this assumption, the limit on spurious emission e.i.r.p. density from an earth station, required to avoid exceeding permissible interference values at a trans-horizon station receiver 100 km distant overland, would be –74 dB(W/4 kHz). The corresponding value for 250 km separation is –48 dB(W/4 kHz). This calculation and the other examples of long-distance terrestrial path interference quoted in this Report are based on overland propagation data with no site shielding (see Report 569).

3.4 Interference to "trans-horizon" stations from space stations

The Radio Regulations, No. 2560, require the interference power from a space station at the input of the receiver of a trans-horizon station not to exceed –168 dB(W/4 kHz). Such an interfering signal level would be set up if there is direct entry of a signal from a transmitter in a satellite of the fixed-satellite service with a pfd of –189 dB(W/(m² · 4 kHz)) into the main lobe of the trans-horizon system antenna. It is suggested that a pfd limit of 20 dB below that value would be a reasonable allocation for the aggregate of all satellite spurious emissions. A small further reduction would be necessary to reach an acceptable value for the spurious emissions from any one satellite, to allow for multiple entries, leading to an e.i.r.p. density limit of about –50 dB(W/4 kHz).

3.5 Interference to fixed-satellite earth stations from earth stations

Report 448 contains sufficient information for the calculation of permissible input powers for interference from all sources, with the exception of values for the earth station noise temperature. Making reasonable assumptions for the noise temperature, a value of permissible interference power of about –146 dB(W/MHz) is found for frequencies between 1 and 10 GHz, increasing to –140 dB(W/MHz) for systems operating in the 15 to 40 GHz range, these figures being applicable, for example, to 0.01% of the time. A limit of 20 dB below these values would seem to be a reasonable allowance for spurious emissions. With these assumptions, spurious emissions with an e.i.r.p. density not exceeding the following values should not cause more than the permitted level of interference at another earth station at a distance of 100 km overland:

for frequencies around 4 GHz: –35 dB(W/MHz),
 for frequencies around 12 GHz: –29 dB(W/MHz),
 for frequencies around 30 GHz: –6 dB(W/MHz).

3.6 Interference to fixed-satellite earth stations from space stations of any Service

Earth stations operating in the fixed-satellite service may receive spurious emissions from other satellites over the following transmission paths:

- (a) directly from unwanted satellites;
- (b) indirectly from unwanted satellites after retransmission by the wanted satellite;
- (c) indirectly from earth stations of other networks or terrestrial stations after retransmission by the wanted satellite;
- (d) from the wanted satellite, the spurious emissions having originated either in the wanted satellite or in other earth stations of the same network.

It may be assumed that (c) will be small and that (d) may be disregarded. Furthermore, an examination indicates that the probability of significant interference arriving at an earth station via path (b) is very small; therefore interference limits obtained in considering case (a) should also be acceptable for case (b) (See Annex I).

In exceptional cases it may be necessary to coordinate the location of satellites to control interference from predictable high-level spurious emissions. One such case is band-edge interference from broadcasting satellites. In the general case, however, it is desirable that the level of interference should be so low that it can be tolerated without coordination. Thus it is suggested that an arbitrary allocation be made of 5% of the total inter-network interference budget to cover normal cases (a) and (b) above, i.e., 50 pWp for FDM-FM. No Recommendation has been made yet for permissible interference to digital emissions, furthermore, it is unlikely that spurious emissions would enter a single wanted channel by both routes (a) and (b), so each may be allocated the 5% share.

Since interference from spurious emissions can arise from a satellite which does not use the same frequency bands as the wanted satellite, the normal processes of coordination cannot be assumed to prevent the entry of spurious emission interference in the main beam of the earth station. However, if the level of spurious

emission pfd at the Earth's surface is so low that an in-beam entry can be tolerated at an earth station with a high-gain antenna, it may be assumed that any other spurious emissions which are similarly low in strength will have a negligible effect if they enter via side lobes. Likewise, it is unlikely that a high-gain earth-station antenna would suffer direct entry spurious emissions from more than one interfering satellite at a time. Earth stations with low gain may suffer more than one direct entry, but this will not matter if the acceptable level is determined by the protection of high-gain antennas.

3.6.1 *Direct entry from the interfering satellite (Case (a))*

For a first approach to the calculation of acceptable levels of spurious emission, it would be convenient to follow the pattern set by Recommendation 358, and to divide the spectrum at 15.4 GHz. Below 15.4 GHz the characteristics of existing earth stations receiving FDM-FM signals at 4 GHz might be assumed, the maximum acceptable level of interference spectral pfd being calculated in a bandwidth of 4 kHz. Above 15.4 GHz it would be necessary to make assumptions as to the characteristics of future earth stations receiving at 19 GHz, the limiting spectral pfd being calculated in a bandwidth of 1 MHz.

For a direct entry into a high-gain earth-station antenna, such as INTELSAT Standards A and C, receiving FDM-FM signals, the interference spectral pfd should not exceed $-221 \text{ dB(W/(m}^2 \cdot 4 \text{ kHz))}$ below 15.4 GHz. Above 15.4 GHz the limit might be $-182 \text{ dB(W/(m}^2 \cdot \text{MHz))}$. See Annex I for the justification of these figures.

3.6.2 *Indirect entry from an interfering satellite via the wanted satellite (Case (b))*

The gain of a satellite antenna at angles well removed from the main beam can be assumed to be 0 dB relative to isotropic. This assumption is probably valid for interference received at one satellite from another satellite, provided that orbital eccentricity is kept to a minimum.

With this assumption, a spurious emission conforming to the limits in § 3.1 might set up 50 pWp of interference in a wanted channel if it entered the earth station indirectly via the wanted satellite; and if the separation between the two satellites was about 4 km. (See Annex 1.) This corresponds to the extremely small separation angle of 0.006° . The probability that two satellites would be so close for more than a brief period of time is small. Thus the pfd limit obtained via Case (a) is also acceptable for Case (b).

3.7 *Interference to radioastronomy stations from earth stations*

Report 224 examines the problem of interference into radioastronomy earth stations. Report 224 offers as a target the reduction of interference to the point at which uncertainties due to the interfering signal are not more than 10% of the uncertainties due to the statistical fluctuation of the astronomical signal when both are integrated over 2000 s and an appropriate bandwidth. Recommendation 314 considerations, are also relevant. Applying this criterion, the limiting interfering power at the receiver input in typical cases is given approximately as follows:

- for measurements of the continuous part of the spectrum, -207 dBW in a bandwidth of 10 MHz at 2.7 GHz, increasing to -192 dBW in a bandwidth of 400 MHz at 24 GHz;
- for spectral line measurements, -222 dBW in 10 kHz at 1.7 GHz, increasing to -209 dBW in 100 kHz at 22 GHz.

If it is assumed that the gain of the radioastronomy antenna in the direction of the interfering source is 0 dB, then spurious emissions with an e.i.r.p. density not greater than the following values should not cause these permitted levels to be exceeded for more than 0.01% of the time in the typical cases mentioned above, when the stations are separated by 100 km (or 250 km) overland:

- for measurement of the continuous part of the spectrum, -75 (or -50) dB(W/10 MHz) at 100 km (or 250 km) at 2.7 GHz and -36 (or -2) dB(W/400 MHz) at 100 km (or 250 km) at 24 GHz;
- for spectral line measurements: -96 (or -71) dB(W/10 kHz) at 100 km (or 250 km) at 1.7 GHz and -53 (or -19) dB(W/100 kHz) at 100 km (or 250 km) at 22 GHz.

3.8 *Interference to radioastronomy stations from space stations*

As in § 3.7 the interference criteria of Report 224 are relevant. For many interference situations it has been agreed that protection needs to be provided to the required standards only when the interference is incidental on the side lobes of the radioastronomy antenna with an assumed gain of 0 dBi. With this criterion the power flux-density of an interfering signal should not exceed the following values in the two radioastronomy bands which are taken as examples:

2700 MHz	-247 dB(W/(m ² · Hz))
15.4 GHz	-233 dB(W/(m ² · Hz))

Values for other frequencies can be obtained from Report 224. These values are specified as being necessary for the protection of measurements in the continuous part of the spectrum; they can be relaxed by 10 to 15 dB for measurements of spectral lines when the same integration time is used, but the common use of much longer integration times for line work reduces the difference.

Now, taking as an example a fixed-satellite transmitter at 4 GHz, the maximum pfd at the ground is -142 dB(W/m²) in any 4 kHz band for elevation angles above 25°, this limit being imposed for the protection of terrestrial services in shared bands (No. 2566 of the Radio Regulations). Since the recommended protection level for radioastronomy at 2700 MHz, for example, corresponds to -211 dB(W(m² · 4 kHz)) for continuum measurements, the protection criteria are met if spurious emissions in the radioastronomy band are 69 dB below the maximum permitted flux-density of the wanted signal.

It must be pointed out, however, that while the criteria in Report 224 are acceptable for interference from a terrestrial transmitter and even for a single interfering source in the sky, the possible incidence of interference from a series of satellites distributed around the geostationary-satellite orbit, creates a new situation. Using the recommended antenna pattern of Recommendation 465, it may be deduced that if the individual satellites just meet the criteria of Report 224, radioastronomy observations of the area of the sky within ± 20° of the geostationary-satellite orbit, would suffer harmful interference continuously. It would clearly be of great value to radioastronomy if a more stringent protection criterion could be met. A reduction of the spurious emissions by 10 dB from the value of -69 dB relative to the main signal would reduce the prohibited region to ± 8°, and a further reduction of 10 dB would reduce it to ± 3°. There is an evident need to study the practicability of achieving the minimum spurious emissions compatible with the proper functioning of the fixed satellite operations.

3.9 *Interference to space research earth stations from earth stations*

For earth stations used for deep-space research, Recommendation 365-3 (Kyoto, 1978) proposes an interference limit of -220 dB(W/Hz) at frequencies above 1 GHz, this value not to be exceeded for more than 5 min in any day. This is usually interpreted as protection for 0.001% of the time. If an interfering signal has an approximately uniform spectrum over a 4 kHz band, the limit becomes -184 dB(W/4 kHz). At 100 km the radiated power of a potential source of interference should therefore, for example, be less than -56 dB(W/4 kHz) at a working frequency of about 2 GHz.

For reception of signals from near-earth satellites, the same interference can normally be accepted for 0.1% of the time; this would allow the interfering e.i.r.p. to be increased by about 3 dB, (Recommendation 364). However, for manned missions the additional safety margins that are required necessitate the same degree of protection as for deep-space missions (Recommendation 364).

3.10 *Interference to space research earth stations from space stations*

There is little information in CCIR texts on which to base an assessment of the levels of interference which might be acceptable from satellites. Report 536 indicates that the thermal noise level of a deep-space receiving station would be of the order of -214 dB(W/Hz). If continual interference into such a station is to be no greater than, say, 20 dB below thermal noise, then the interference e.i.r.p. radiated by a geostationary satellite should not exceed about -104 dB(W/Hz). This assumes a receiving antenna operating at about 2 GHz with a main beam gain of 60 dB.

4. *Form of presentation of limits*

Appendix 8 to the Radio Regulations expresses spurious emissions in terms of the mean power level of any spurious component supplied by the transmitter to the antenna transmission line. It specifically indicates the maximum permitted level in two ways. First, for any spurious emission component the minimum required attenuation is expressed as the mean power within the necessary bandwidth relative to the mean power of the spurious component. Secondly, the spurious emission component shall not exceed specified absolute mean power levels.

Recommendation No. 66 of the WARC-79 also recommends that any new maximum permitted level of spurious emissions be expressed in these terms. However, it also recommends that the CCIR establish appropriate measurement techniques for spurious emissions, including the consideration of reference levels for wideband transmissions and the applicability of reference measurement bandwidths.

Thus, Recommendation No. 66 of the WARC-79 expresses the need to study spurious emissions in terms of "mean power" and to develop appropriate CCIR Recommendations to facilitate the interpretation and measurement of "mean power" as it applies to the various classes of emission.

5. Conclusions

5.1 *Spurious emissions from space stations of the fixed-satellite service*

The following very tentative conclusions are drawn from this preliminary examination:

- The probability of interference to terrestrial radio-relay stations by spurious emission from space stations of the fixed-satellite service does not appear to be high, but further examination of radiation levels and their aggregate effects should be made.
- It may be necessary to limit the emissions by satellites of inter-modulation products in the immediate neighbourhood of the occupied band to prevent significant interference to fixed-service earth stations using a nearby satellite and occupying an adjacent band; the same may apply when trans-horizon services use an adjacent frequency band. However, it seems probable that severe interference will be suffered by radio-astronomy stations from direct entries of harmonic radiation and possibly image signals, local oscillator harmonics and parasitic emissions from fixed-satellite space stations and also from intermodulation emissions in cases where the radioastronomy and the fixed-satellite services have adjacent frequency band allocations. Interference entering in the far side lobes of the antennas of radioastronomy stations may also be a cause of serious difficulty, but in these cases the problem is perhaps more open to solution.

5.2 *Spurious emissions from earth stations of the fixed-satellite service*

Interference in excess of levels thought likely to be permissible may arise at various kinds of receiving stations due to spurious emissions from earth stations of the fixed-satellite service, depending, among other factors, upon the distance between the stations, causing and suffering the interference. For example, interference may be significant at distances of a few tens of kilometres at radio-relay receiving stations and at distances of a few hundreds of kilometres at trans-horizon receiving stations and radioastronomy stations; other earth stations of the fixed-satellite service are intermediate in susceptibility to interference. Other services using very sensitive stations, not considered in this Report, may also need to be considered.

5.3 *General*

Before it is possible to draw up Recommendations limiting spurious emissions from space and earth stations of the fixed-satellite service, further studies in the appropriate Study Groups will be needed:

- 5.3.1 to identify all services with stations likely to be susceptible to interference from these emissions and to determine, with sufficient precision, the levels of interference that may be permitted and the relevant frequency ranges, having regard to the possible interference from other sources and to such factors as the percentage of time that the interference is present, and the bandwidth and time over which interference should be integrated;
- 5.3.2 to determine what level of spurious emissions would arise in the various frequency bands from space and earth stations of the fixed-satellite service and the e.i.r.p. densities of spurious emissions from earth stations, particularly in the direction of the horizon;
- 5.3.3 to consider the limits of spurious emissions as a function of frequency separation especially as applied to adjacent frequency bands;
- 5.3.4 to consider whether it is necessary and if so, to what extent it is technically and economically feasible, to improve on the levels identified in § 5.3.2 in general, at all frequencies. Alternatively, it may be desirable to identify more stringent limits on spurious emissions in frequency bands which are allocated to services which use particularly sensitive receivers, with more relaxed limits applied at other frequencies;

5.3.5 to establish appropriate measurement techniques for spurious emissions, including the applicability of reference measurement bandwidths and the determination of reference levels, and to study the categorization of spurious emissions in terms of mean power as well as their interpretation as it applies to the various classes of emission.

It may also be desirable to consider provisions for limiting the level of out-of-band emissions for certain cases.

ANNEX I

1. Derivation of values of acceptable power flux-density

The following assumptions have been made in the derivation of values of acceptable power flux-density:

- To protect fixed-satellite bands below 15.4 GHz, pfd values are calculated for 4 GHz. For the protection of fixed-satellite bands above 15.4 GHz, pfd values are calculated for 19 GHz.
- The wanted satellite network employs FDM-FM telephony transmission with a down-link thermal noise contribution of 5000 pW0p.
- The maximum acceptable interference in a telephone channel from spurious emissions is 50 pW0p.
- The earth-station antenna gain (G_e) is 60 dB at 4 GHz and 64 dB at 19 GHz.
- The earth-station system noise temperature (T_s) is 60 K at 4 GHz and 250 K at 19 GHz.
- The reference bandwidth (B) is 4 kHz at 4 GHz and 1 MHz at 19 GHz.

Then with these assumptions, the maximum acceptable interference $pf d_i$ due to a spurious emission is given by:

$$pf d_i = 10 \log k T_s B + 10 \log \frac{50}{5000} - G_e - 10 \log \frac{\lambda^2}{4\pi}$$

$$= -221 \text{ dB(W/(m}^2 \cdot 4 \text{ kHz)) at 4 GHz}$$

and $-181.6 \text{ dB(W/(m}^2 \cdot \text{MHz)) at 19 GHz.}$

2. Spacing required between two geostationary satellites

From § 1 above the interference spectral pfd should not exceed $-221 \text{ dB(W/(m}^2 \cdot 4 \text{ kHz))}$ at 4 GHz. This corresponds to an interference spectral power density at the earth station receiver input of -195 dB(W/4 kHz) and an interference e.i.r.p. from a geostationary satellite of -58 dB(W/4 kHz) .

The following assumptions are made, in addition to those made for § 1:

- The gain of the wanted satellite antenna in the direction of the interfering satellite is 0 dB relative to isotropic.
- The transmission gain of the wanted system from satellite receiver input to earth-station antenna output is -20 dB .
- The spectral e.i.r.p. density of the spurious emission at the frequency received by the wanted satellite is -58 dB(W/4 kHz) .

The path loss between the two satellites equals $20 \log 4\pi d/\lambda$.

Then, if the interference power density at the earth-station receiver input may not exceed -195 dB(W/4 kHz) ,

$$-195 \leq -58 - 20 - 20 \log \frac{4\pi d}{\lambda}$$

therefore, $d \geq 4 \text{ km}$.

At 4 GHz the corresponding geocentric separation angle is 5.7×10^{-3} degrees. At 19 GHz the minimum satellite separation distances would be less.

REPORT 874

**FREQUENCY SHARING BETWEEN THE INTER-SATELLITE SERVICE WHEN
USED BY THE FIXED-SATELLITE SERVICE AND OTHER SPACE SERVICES**

(Question 31/4)

(1982)

1. Introduction

Inter-satellite links are expected to play an increasingly important role in the utilization of the geostationary-satellite orbit by the fixed-satellite service. In view of this and the fact that, although representing a service of their own (the inter-satellite service), they derive their existence and use solely from the existence of other space services, they will necessarily impose their own characteristics and constraints on the service(s) making use of them.

This Report investigates the technical and operational sharing aspects of links in the inter-satellite service in relation to their use with systems in the fixed-satellite service.

2. Sharing with the earth exploration-satellite service (passive) and with the space research service (passive)

The WARC-79 allocated the frequency bands 54.25 to 58.20 GHz, 116.00 to 126.00 GHz and 174.5 to 176.5 GHz to the inter-satellite service and to the earth exploration (passive) and space research (passive) services.

To the extent that these space services use non-geostationary space stations, interference from a geostationary or a non-geostationary inter-satellite link is a matter of statistics and modest, if any, sharing constraints need likely to be imposed upon any of the services. Nevertheless, little having been done in assessing the sharing question, additional study is required, particularly for the case when interfering systems use the geostationary-satellite orbit.

3. Sharing with the broadcasting-satellite service

The WARC-79 allocated the frequency band 22.55 to 23.00 GHz to the inter-satellite service (ISS) and to the broadcasting-satellite service (BSS) in Regions 2 and 3.

Report 951 examines the probability and severity of interference from the relatively high e.i.r.p. broadcasting satellites to receivers in the inter-satellite service which are part of a geostationary inter-satellite link.

The assumptions made in Report 951 postulate,

3.1 for the inter-satellite link:

- a 1° circular half-power receiving antenna beamwidth;
- a receiving system noise temperature of 1000 K;
- a receiving antenna side-lobe pattern conforming to that composed of curves A, B and C of Fig. 11 of Report 558;
- an interference objective of I/N of no greater than -10 dB within a 40 MHz bandwidth;

3.2 for the broadcasting satellite:

- a maximum main beam e.i.r.p. of 70 dBW;
- a 2.5° circular half-power transmitting antenna beamwidth;
- a transmitting antenna side-lobe pattern conforming to that stipulated by the WARC-BS-77.

3.3 From the results of the study, the following is concluded:

- that it is feasible to share between the broadcasting-satellite service and the inter-satellite service in the subject frequency band when their orbital positions can be coordinated;
- that for a short inter-satellite link (up to about 7° of arc) it is not feasible to place a broadcasting satellite between the two stations comprising the inter-satellite link;
- that for longer inter-satellite links it becomes possible to insert one or more broadcasting satellites, depending on the actual inter-satellite link length;

- that the longer the inter-satellite link, the larger would be the portion of orbital arc in which broadcasting satellites could be placed while meeting the assumed interference objective in the inter-satellite link;
- as for interference to the BSS receiver by emissions in the ISS, there may be no interference by short ISS links with tracking antennas; however, the worst case of interference may arise from short ISS links with non-tracking antennas for an orbital separation between two ISS satellites less than 6° and between two satellites in the BSS and ISS nearly equal to 0° . Interference from inter-satellite links with mutually tracking antennas may be acceptable when the beamwidths are no greater than about twice the expected pointing errors (see Table II of Report 951);
- considering the limited available orbital arc and the high frequency reuse potential in the inter-satellite service (see Fig. 3 of Annex II to Report 451), there may be severe conflicts between space stations of the two services for the same arc of the orbit.

Since both broadcasting satellite and inter-satellite link characteristics may differ from those of the assumptions, further study is desirable to provide additional information on the subject.

PAGE INTENTIONALLY LEFT BLANK

PAGE LAISSEE EN BLANC INTENTIONNELLEMENT

DECISIONS

DECISION 2-7

FREQUENCY SHARING BETWEEN RADIOCOMMUNICATION SATELLITES

**Technical considerations affecting the efficient use
of the geostationary-satellite orbit**

(Study Programme 28A/4)

(1970-1974-1976-1978-1980-1981-1984-1985-1989)

CCIR Study Group 4,

CONSIDERING

- (a) that studies on the technical factors affecting the efficient use of the geostationary-satellite orbit need to be carried out urgently in view of the foreseeable congestion in certain parts of that orbit;
- (b) that the World Administrative Radio Conference, Geneva, 1979, in Recommendation No. 708 requested that studies on a number of subjects related to this matter should be started or continued as a matter of urgency;
- (c) that the CCIR was charged with carrying out certain studies during the WARC ORB intersessional period, and that there is a continuing need to improve Orbit efficiency now that WARC ORB-88 is over;
- (d) the WARC ORB-88 referred certain topics to CCIR for study in Resolution GT PLEN/3 and Recommendation COM 6/D of that Conference. Study Group 4 assigned these topics to IWP 4/1 for consideration;
- (e) that topics relevant to Study Group 4 may be on the Agenda of the WARC-92.

DECIDES

1. that Interim Working Party 4/1, established on the initiative of the Geneva Interim Meeting, 1968, should continue with the following terms of reference with respect to the fixed-satellite service:
 - 1.1 to stimulate the collection when necessary and the critical analysis of relevant data needed to produce a synthesis of views on technical means of achieving the efficient use of the geostationary-satellite orbit with particular emphasis on practical aspects. (See Study Programme 28A/4);
 - 1.2 to hold further meetings at such times as may be agreed;
 - 1.3 to review and consider such contributions as will have been received at the meetings of the Interim Working Party and to present reports on these contributions in a form which will best facilitate the work of Study Group 4 on achieving the efficient use of the geostationary-satellite orbit;

2. to submit reports on the results of studies on the topics identified in Annex I to the Study Group (or to the body referenced in DECIDES 3.1 (where necessary));
3. as a matter of urgency, to hold one meeting at time compatible with the schedules of related activities to provide for the critical analysis needed to produce the guidance requested for the 1992 WARC;
- 3.1 to submit reports on the results obtained on the topics relevant to Study Group 4 to the Joint Interim Working Party charged with producing the CCIR report to the 1992 WARC;
4. that IWP 4/1 should be composed of representatives nominated (one from each administration) by the Administrations of Algeria, Germany (Federal Republic of), Australia, Brazil, Canada, Chile, China (People's Republic of), Colombia, Denmark, United States of America, France, Guinea, India, Indonesia, Iran (Islamic Republic of), Iraq, Italy, Japan, Republic of Korea, Luxembourg, Papua New Guinea, the Netherlands, Poland (People's Republic of), German Democratic Republic, United Kingdom, Sweden, Switzerland, Turkey, USSR, Yugoslavia (Federal Socialist Republic of) as well as observers from the European Broadcasting Union, European Space Agency, EUTELSAT, INTELSAT, and the IFRB.
5. that the coordination of the work of the Interim Working Party, which should be conducted as far as is feasible by correspondence, and the chairmanship of the Interim Working Party be undertaken by a representative of the Administration of the United Kingdom;
6. that the activities of the Interim Working Party should not involve any expenditure, other than normal, on the part of the ITU.

ANNEX I

TOPICS FOR INTERIM WORKING PARTY 4/1 STUDY

DURING THE 1990-1994 PLENARY PERIOD

	TOPIC	OBJECTIVE FOR CCIR VOLUME IV PART-1
1	Simplified methods of estimating interference between satellite networks. Rep. 454	To refine methods which improve the accuracy of interference estimates compared with the Appendix 29 method for determination of the need to coordinate.
2	Efficient use of the GSO for multi-band and multi-service satellite networks.	To fully identify the technical means of facilitating the coordination of such satellite networks.
3	Technical implications of steerable and reconfigurable satellite beams.	To fully identify the implications of steerable and reconfigurable satellite beams for coordination exercises.
4	ABCD parameters used in the FSS Allotment Plan, and other generalised parameter sets.	To consider the various aspects of expressing allotments in ABCD terms, and describe examples of the flexibility thus afforded when allotments are converted to Assignments. Also orbit management techniques related to the allotment plan. To remove unnecessary text.
5	Antenna beam discrimination Rep. 998, Rep. 558, Rec. 465 Rec. 580, 672 .	To review and propose CCIR Recommendations and Reports for satellite and earth stations reference patterns, as related to the efficient use of the GSO.
6	Stochastic approach in the evaluation of interference between satellite networks. Rep. 1137	To present further statistical information and describe methods for its inclusion in interference assessments, with the aim of establishing, during the next plenary period, Recommendations to ameliorate worst case assumptions in coordination exercises.
7	Improved methods of energy dispersal for TV carriers. Rep. 384	To present results of measurements of the dispersal provided by combined frame and line rate waveforms, and of alternative waveforms giving improved energy spreading, and to present assessments of other implications of their use.

	TOPICS	OBJECTIVES FOR CCIR VOLUME IV PART-1
8	Maximum permissible interference levels in FSS analogue and digital channels, caused by other FSS networks. Rec. 466, Rec. 523, Annex IV to Rep. 455.	To revise the single entry and aggregate limits.
9	Optimisation methods to identify satellite orbital positions in the Improved Procedures bands. Rep. 453, Rep. 1135.	To describe methods of interference calculation which would assist in selecting locations for new satellites in congested parts of the GSO.
10	Improvements in geostationary satellite antenna pointing accuracy. Rep. 1136	To present further evidence supporting a design target for antenna pointing accuracy of $\pm 0.2^\circ$.
11	Polarisation discrimination between adjacent satellite networks. Rep. 555, 1141.	To present further evidence of satellite and earth station off-axis cross polar discrimination for both circular and linear polarisations in order to establish cross-polar reference patterns.
12	Improvements in earth station off-axis e.i.r.p. density. Rep. 1001, Rec. 524	To further revise the current limits for 14/11-12 GHz band.
13	Interference from TV carriers into SCPC carriers. Rec. 671 ; Rep. 867	To present further evidence on the protection variation with frequency offset from TV band centre, e.g. using MAC encoded TV. To assess the cumulative effect of multiple interference entries.
14	Calculation of interference and impairment into analogue TV systems. Annex III to Rep. 455	To assess the validity of this method, and the practicability of its use in operational circumstances, for NTSC, PAL, SECAM and MAC TV systems.
15	Intra FSS sharing aspects of slightly inclined orbits. Rep. 1138	Further studies of inter-system interference for general cases involving two or more satellites in its slightly inclined geostationary orbits.
16	Investigation of technical matters relevant to Study Group 4 preparation for WARC-92.	To ensure that the JIWP/WARC-92 is fully advised of the technical aspects relevant to the FSS.

DECISION 64-1

UPDATING OF THE HANDBOOK ON SATELLITE COMMUNICATIONS

(Fixed-Satellite Service)

(1985-1989)

CCIR Study Group 4,

CONSIDERING

- (a) that the Handbook on Satellite Communications (Fixed-Satellite Service) has been prepared in order to provide administrations and organizations with tutorial documents to assist them in the preparation of their programmes and in the education of their personnel;
- (b) that advances in the technology of satellite communications and the expected evolution of the regulatory and planning environment, would justify periodic updating of the Handbook on Satellite Communications;
- (c) that the proper method to prepare updated versions is to establish a Group which could operate with methods similar to those used for the present Handbook, i.e. by correspondence and by some periodic meetings;
- (d) that the updating procedure and content should, as far as possible, keep in step with the current Volume IV editions;

DECIDES

1. that a Group for updating the Handbook on Satellite Communications should be maintained in the framework of Study Group 4;
 2. that, the Handbook Group should consider providing periodic revisions of the Handbook, in the form of supplements and, when appropriate, of a new Edition;
 3. that the Group will provide Progress Reports to the Study Group 4;
 4. that the Chairman of the Group will be Mr. J. Salomon (France);
 5. that the Group should be composed of representatives from the following Administrations and International Organizations: Germany (Federal Republic of), Brazil, Canada, China (People's Republic of), United States of America, France, India, Italy, Japan, United Kingdom, Switzerland, USSR, EUTELSAT and INTELSAT.
-

DECISION 70-1

IMPLEMENTATION OF DIGITAL SATELLITE SYSTEMS

(1985-1989)

CCIR Study Group 4,

CONSIDERING

- (a) that new digital telecommunications services are under study in the CCITT, notably in the area of ISDN, where end-to-end user requirements for a wide range of digital services are being developed;
- (b) that this development may put different demands on transmission systems, including satellites that are used in digital networks;
- (c) that a great deal of study by Study Group 4, in coordination with the CCITT, will be required to ensure that satellite systems are developed to satisfactorily meet these demands;
- (d) that the schedule of meetings of Study Group 4 does not always conveniently match that of CCITT Study Groups,

DECIDES

1. that Interim Working Party 4/2, established on the initiative of the Director of the CCIR and the Chairman of Study Group 4 during the 1982-1986 study period, should continue with the following terms of reference with respect to the fixed-satellite service:

1.1 to carry out detailed studies on digital satellite systems and to develop text for new Reports and Recommendations, as necessary, to ensure that satellite systems will meet the new requirements of these developing digital services;

1.2 to hold further meetings at such times as may be agreed;

1.3 to study the latest CCITT output documents relevant to Study Group 4 and to make timely responses to the CCITT when differing CCITT and CCIR schedules occur;

1.4 to review and consider contributions made to meetings of the Interim Working Party, and to present reports of its activities to Study Group 4;

2. that the Interim Working Party shall be composed of representatives of the following Administrations and International Organizations: Germany (Federal Republic of), Australia, Brazil, Canada, China (People's Republic of), United States of America, France, India, Indonesia, Italy, Japan, United Kingdom, Sweden, Switzerland, USSR, EUTELSAT and INTELSAT;

3. that the coordination of the work of the Interim Working Party, which should be conducted as far as is feasible by correspondence, and the chairmanship of the Interim Working Party be undertaken by a representative of the Administration of the United States of America;

4. that the activities of the Interim Working Party should not involve any expenditure, other than normal, on the part of the ITU.

DECISION 76-1*

SATELLITE NEWS GATHERING (SNG)

(Question 13/CMTT, Study Programmes 13H/CMTT and 22D/CMTT)

(1987-1989)

CCIR Study Groups 4, 10, 11 and CMTT,

CONSIDERING

- (a) that satellite transmissions using transportable or portable earth stations is an invaluable and at times the only viable solution to the timely transmission of television news from remote locations;
- (b) that throughout the world, where news events take place, standardized and uniform technical and operating procedures should be established to ensure prompt activation of SNG service;
- (c) that there was a unanimous Recommendation of the Fifth World Conference of Broadcasting Unions in Prague, 1986, on the use of international auxiliary broadcast frequencies and transportable earth stations;
- (d) that the special characteristics needed for transportable or portable transmitting earth stations may necessitate acceptance of performance objectives differing from those specified in Recommendation 567 for general purpose satellite television connections;
- (e) that there will be a requirement to provide, on the same uplink service, auxiliary circuits for programme and technical coordination, and for the management of the transportable earth station interface;
- (f) that SNG services from any specific location will be classified as occasional and/or temporary;
- (g) that the very nature of SNG requires that earth stations be activated in an expedient manner, the philosophy of which is not compatible with the long advance notice periods normally established for fixed permanent services;
- (h) that it is expected in the future that HDTV transmissions could originate from portable uplink facilities;
- (j) that the ITU Constitution states in its Preamble: "...fully recognizing the sovereign right of each State to regulate its telecommunication... ."

*) This Decision is also published in CMTT as Doc. CMTT/1070

DECIDE

1. that Joint Interim Working Party JIWP CMTT-4-10-11/1 be continued, to prepare, within the Terms of Reference of Study Groups CMTT, 4, 10 and 11, an overall strategy for SNG transmissions, proposals intended to solve the technical, operating and organizational aspects associated with the use of transportable or portable transmitting earth stations for SNG;
2. that the Terms of Reference of the JIWP should be as follows:
 - 2.1 to define the technical quality specifications for the programme video signal acceptable for SNG;
 - 2.2 to define the number and the technical quality specifications for the programme audio signals acceptable for SNG;
 - 2.3 to define the number and the technical quality specifications of auxiliary circuits required for SNG operations;
 - 2.4 to study uniform technical parameters for SNG that may be applicable on a geographically wide scale;
 - 2.5 to study uniform operating procedures for SNG that may also be applicable on a geographically wide scale;
 - 2.6 to study the overall transmission and performance objectives for HDTV transmission by portable satellite earth stations for SNG;
 - 2.7 to determine the technical characteristics of the specific equipment required to meet the objectives in 2.6;
 - 2.8 to identify the operational requirements related to HDTV transmission by portable satellite earth stations for SNG;
 - 2.9 to prepare draft Recommendations on the study items above;
 - 2.10 to investigate and prepare a Report on means to simplify the procedures required to obtain, as expeditiously as possible, temporary authorization to operate SNG facilities;
3. that, in accordance with §2.3.3 of CCIR Resolution 24, Study Groups CMTT, 4, 10 and 11 are jointly entrusted with the responsibility of the work of the JIWP, and in accordance with §2.3.9 of Resolution 24, CMTT is designated to coordinate the work of the JIWP. The JIWP shall submit its reports and results of its work to joint meetings of these Study Groups, when possible;
4. that the work of the JIWP should be completed in the course of the current Study Period; a report and the results of its work shall be submitted to the Final Study Group Meetings in 1993;
5. that the JIWP should, as far as possible, work by correspondence; however it may meet when this is considered necessary by its Chairman, by the Chairmen of Study Groups CMTT, 4, 10 and 11, and by the Director, CCIR;

6. that the JIWP will be chaired by:

Mr. Joseph A. COLSON (NANBA)	Telephone :	+1 416 928 6170
Chairman, NANBA Technical Committee	Telex :	06-22080
CTV Television Network Limited	Telefax :	+1 416 928 0907
42 Charles Street East		
Toronto, CANADA M4Y 1T5		

and the Vice-chairmen will be:

Mr. D. PHAM THAT (EBU)	Telephone:	+33 1 46 57 1115
Télédiffusion de France (TDF)	Telex :	tedif 250738f
Direction de l'Équipement	Telefax :	+33 1 46 54 3341
21-27 rue Barbes		
B. P. 518		
F-92542 MONTRouGE CEDEX		
France		

Mr. Gabor HEGYI (OIRT)	Telephone :	+36 155 0550
Administration centrale des	Telex :	221193 gentel h
Postes et Telecommunications de Hongrie	Telefax :	+36 156 0855
Krisztina krt 6/8		
1540 BUDAPEST		
Hungary		

and

Mr. Kuniharu ASANO (ABU)	Telephone :	+81 3 465 1234
Senior Engineer	Telex :	22377 Radio NHK
Engineering Planning Bureau	Telefax :	+81 3 485 0952
Japan Broadcasting Corporation (NHK)		
2-2-1 Jin-nan, Shibuya-ku		
TOKYO 150		
Japan		

DECISION 87*
DETERMINATION OF THE COORDINATION AREA
Appendix 28 of the Radio Regulations

(1989)

This text may be found in the Annex to Volume IV/IX-2.

*) According to the decision of Chairmen and Vice-Chairmen's Meeting (Geneva, 4-6 July, 1990) the tasks of JIWP 2-4-5-8-9-10-11/1 on the determination of the coordination area are transferred to Study Group 12 for study by Task Group 12/3.

