

ENERGY-INFORMATIONAL AND THE INTELLECTUAL-SPIRITUAL ACTIVITY OF THE UNIVERSE AND OUR WORLDVIEW

Collection of selected works of the city-wide
seminar at the Kharkiv House of Scientists,
dedicated to the 10th anniversary of the
seminar
(1997-2007)



Infobank LLC Kharkiv -
2007

UDK 14+21+524+530.1+539
BBC 20+22.3+22.6+63.(0)+86+87+88
C3

C3 ENERGY-INFORMATIONAL AND

**INTELLECTUAL-LECTUAL -
SPIRITUAL ACTIVITY**

**OF THE UNIVERSE AND OUR WORLDVIEW
SIGHT.** Collection of selected reports of the
city-wide seminar at the Kharkov House of
Scientists, dedicated to the 10th anniversary of
the seminar (1997-2007). - Kharkov: In-fobank
LLC, 2007, 275 p.

ISBN 978-966-8464-10-2

The collection includes papers devoted to the
formation of modern understanding of the world around
us (the Universe, Cosmos, Nature), our place in it,
ourselves, our purpose and goals of our existence.

For all persons interested in the scientific basis of the
universe.

Responsible for the issue N. A. Zhuk

ALL COPYRIGHTS AND PUBLISHER'S RIGHTS
RESERVED.

REPRINTING, MAKING ELECTRONIC COPIES
AND OTHER DUPLICATION OF THE BOOK OR
PARTS THEREOF WITHOUT THE WRITTEN
CONSENT OF THE PUBLISHER IS PROHIBITED.

CITATION REQUIRED

NA.

1705000000

22

SWWithout Announcement. ББК 20+22.3+22.6+63.(0)+86+87+88

8464 2007

ISBN 978-966-8464-10-2

© Infobank LLC, 2007

DEREGULATION

PREDICTION	4
D.A. Pereverzev. CONSCIOUSNESS AND REALITY	10
D.A. Pereverzev. ON THE ORIGIN AND LIFE ACTIVITY OF STELLAR SYSTEMS OF THE UNIVERSE	23
D.A. Pereverzev. ON FORMATION AND DEVELOPMENT OF TRADITIONAL ENERGY OF MANKIND	46
N.D. Kolpakov. HOW POLARIZATION WAVES WERE DISCOVERED OR THE END OF RELATIVISM	70
N.A. Zhuk. THEORY OF RELATIVITY: TRIUMPH OF THE THEORY AND CRISIS OF PHYSICS	86
N.A. Zhuk. PRAVEDES ABOUT TRINITY AS A UNIVERSAL MODEL OF THE UNIVERSE	102
N.A. Zhuk. SLAVIC-ARYAN VEDAS ABOUT GOD AND DEVIL, GOOD AND EVIL, GENIUS AND MADNESS	121
N.A. Zhuk. SLAVIC-ARYAN VEDAS ON THE RATIO OF MALE AND FEMALE PRINCIPLES IN MAN	143
N.A. Zhuk. ALTERNATIVE ENERGY SOURCES	164
I.I. Zima. ROTOR MODEL OF THE ATOM	188
I.I. Zima. NEUTRON MATTER AS A BASIS OF NON-EMPTY VACUUM	204
I.I. Zima. REGISTRATION OF ROTOR ECHOES OF THE NEUTRON ETHER AND ATMOSPHERE ACCOMPANYING THE RADAR OPERATION	213
B.A. Troshenkin. PROSPECTS OF UNCONVENTIONAL ENERGY	219
Y.M. Galaev. EFFECTS OF VORTEX MOTION OF ETHER NEAR THE EARTH SURFACE	225
N.S. Verbuck. CHILDREN OF INDIGO	239
AUTHOR INFORMATION	254

PREDICTION

The seminar "Energy-informational and intellectual-spiritual activity of the Universe and our Worldview" is aimed at forming a modern Worldview - a modern understanding of the World around us (Universe, Cosmos, Nature), our place in it, understanding ourselves, our purpose and goals of our existence. With the growth of our knowledge, our worldview is corrected and sometimes it changes substantially. This is especially evident at the turn of centuries, and even more so at the turn of millennia, and is so evident today at the turn of the 2nd and 3rd millennia.

This is largely due to the huge amount of information on modern scientific achievements, religious-philosophical teachings of Indo-European peoples (Vedas, Bhagavad-gita, "The Secret Doctrine" by H.P. Blavatsky, "Agni Yoga" by E.I. Roerich, etc.), psychic, occult, ufology, etc., which has fallen on us over the last 20 years and which we are now trying to master.

And at the modern stage of cognition, taking into account this new information, it seems appropriate to form a worldview as a result of synthesizing the achievements of science, philosophy, religion, literature (including fantastic literature) and art.

All the activities of the Seminar over the past 10 years (started in September 1997) have been organized in this aspect. This is reflected in the very name of the seminar. Here the phrase "Energy-informational...activity..." takes into account the information on scientific and technical achievements of mankind, the other terms of the name reflect the study and use of its spiritual and moral achievements.

The seminar is held monthly, every third Tuesday (except for the vacation months of July and August). Given its focus, the presentations are mainly in popular science form. More than 100 papers have already been heard and discussed.

Among them, the following basic reports should be noted:

1. D.T.N. Pereverzev D.A. "Some Reflections on the Universe, its Laws and Our Worldview".
2. D.T.N. Pereverzev D.A. "On the 2000th Anniversary of the Nativity of Christ, on the 2000th Anniversary of Christianity".
3. D.A. Pereverzev "On the ways of origin and development of the Universe".
4. D.T.N. Pereverzev D.A. "On the State of our Worldview at the Turn of the 2nd and 3rd Millennium".
5. D. A. Pereverzev, "Consciousness and Reality".
6. D.A. Pereverzev "On the origin and life of stellar systems of the Universe".
7. D. Pereverzev D.A. "On the formation and development of traditional energy of mankind".
8. D.Sc. Kolpakov N.D. "About polarization waves (P-waves) of interstellar and intergalactic medium as superluminal energy-information carriers".
9. D.Sc. Kolpakov N.D. "Origin of life as an organic process of matter development".
10. D.Sc. Kolpakov N.D. "How polarization waves were discovered or the end of relativism".
11. Doctor of Philosophy, Candidate of Technical Sciences Zhuk N.A. "On the newest theories in the field of gravitation and cosmology (based on the analysis of classical and modern unconventional, including original works)".
12. Doctor of Philosophy, Candidate of Technical Sciences Zhuk N.A. "Interaction and Interaction of Science and Religion".

13. Doctor of Philosophy, Candidate of Technical Sciences Zhuk N.A. "Pre-Christian Russia. Unknown Patriotic War of 942-980".

14. Doctor of Philosophy, Candidate of Technical Sciences Zhuk N.A. "Slavic-Aryan Vedas about the structure of micro- and macrocosm".

15. Doctor of Philosophy, Candidate of Technical Sciences Zhuk N.A. "Gravitation and Other Fundamental Interactions in the System of Unified Energy-Information Exchange of the Universe" (on the materials of original works).

16. Doctor of Philosophy, Candidate of Technical Sciences Zhuk N.A., Kopylov Yu. "New in the Theory of the Physical Vacuum of the Universe (on the materials of the International Conference in Tomsk, September 2001)".

17. Doctor of Philosophy, Candidate of Technical Sciences Zhuk N.A. "Theory of Relativity: Triumph of Theory and Crisis of Physics".

18. Doctor of Philosophy, Candidate of Technical Sciences Zhuk N.A. "Pravedes about the Trinity as a universal model of the Universe".

19. Doctor of Philosophy, Candidate of Technical Sciences Zhuk N.A. "Slavic-Aryan Vedas about God and Devil, Good and Evil, Genius and Madness".

20. Doctor of Philosophy, Candidate of Technical Sciences Zhuk N.A. "Slavic-Aryan Vedas on the Ratio of Male and Female Natures in Man".

21. Doctor of Philosophy, Candidate of Technical Sciences Zhuk N.A. "Alternative Energy Sources".

22. D.Sc. Zima I.I. "Influence of rotor geomagnetism on human life activity".

23. D.T.N. Zima I.I. "Anastasia: Myth or Reality?"

24. D.Sc. Zima I.I. "Nostradamus on the events at the turn of the 2nd and 3rd millennia: 1999, 2002 and 2025. Russia".

25. D.Sc. Zima I.I. "Rotor Interactions in the Solar System

and Their Influence on Human Performance".

26. D.Sc. Zima I.I. "Consciousness, Subconsciousness and Intuition in the Representations of Rotor Geomagnetism".

27. D.Sc. Zima I.I. "Rotor Model of the Atom".
28. D.Sc. Zima I.I. "Neutron matter as the basis of non-empty vacuum".
29. D.Sc. Zima I.I. "Registration of rotor echo signals of neutron ether and atmosphere accompanying the radar operation".
30. D.Sc. Trosenkin B.A. "Prospects of non-traditional energy".
31. Бep6yyk H.C. "On informational and spiritual and moral sources of the artist's creativity".
32. Verbuk N.S. "Modern pilgrimage to the Holy Places (artist's impressions)".
33. Verbuk N.S., Pereverzev D.A. "On the 550th Anniversary of Leonar-do da Vinci".
34. Verbuk N.S. "About modern interaction and convergence of science and religion" (on the materials of the books by Tikhoplav V.Y. and Tikhoplav T.S. "Physics of Faith" and "Life on a Roll").
35. Verbuk N.S., Pereverzev D.A. "On the Convergence of Science and Religion" (on the materials of books by Tikhoplav V.Y. and Tikhoplav T.S. "The Great Transition" and "Cardinal Turn").
36. Verbuk N.S. "On Conversations with God (Uncommon Dialogue). Books 1 and 2 by Neale Donald Walsch".
37. Verbuk N.S., Pereverzev D.A. "On Conversations with God (unusual dialog). Book 3 by N.D. Walsh."
38. Verbuck N.S., Dayna R.G. "On Neil D. Walsh's books Oneness with God and Friendship with God."
39. Verbuck N.S. "Indigo Children."
40. Kalnina E.P., Pereverzev D.A. "Phenomenon of millennia - Grigory Grabovoy" (on materials and publications of G. Grabovoy and about him).
41. Candidate of Technical Sciences Galaev Yu. "On modern experimental studies of the ether wind".

42. Candidate of Technical Sciences Galaev Yu. "Effects of vortex motion of ether near the Earth's surface".

43. Galitsky I.M. "Time as the most important indicator of life activity and development of Universes".

44. Galitsky I.M. "Quantum Representations on the Origin, Development and Structures of the Universes".

45. K.f.-m.n. Zabelina B.C. "Superstate and its properties".

46. Gladkikh V.N. "On the manifestation and hierarchy of human super- standing".

47. Kashpur A.D. "On Socioenergetics in Nature and Society".

48. Y.A. Bogdanov, Candidate of Technical Sciences "On energy-information provision of Mankind in anticipation of formidable natural and social phenomena and cataclysms".

49. Candidate of Technical Sciences Stelmakhov Yu.N. "On the newest theories of matter structure in the works of B.V. Bolotov".

50. Y.V. Alexandrov, Candidate of Physical and Mathematical Sciences "Modern State and Prospects of Development of Theoretical and Applied Astronomy".

The following seminars are intended to hear and discuss papers on the worldview issues listed below:

1. What is animate and inanimate? Is there a sharp line between them?

2. What is Truth?

3. From mythological to religious-philosophical and scientific ideas about the Universe - Cosmos - Nature in different ethnic groups of the Earth (Egyptians, Sumerians, Chinese, Hindus, Greeks, Romans, Incas, Aztecs, Mayans, etc.).

4. Thinking activity results in Worlds - Universes. Thought is omnipotent, omnipresent.

5. On the state and prospects of development of creative thought and activity of Man.

6. On the activities and relationships of various spiritual schools in Kharkov.
7. Socioenergetic aspects of rotary geomagnetism.
8. Evolution of the way of life and the human connection with the Cosmos.

This collection presents the most significant papers of the Seminar during its first 10 years of activity. But the seminar also fulfills another function. It has traditionally become a place of communication and information exchange among scientists of Kharkiv region, a peculiar school of innovative ideas and worldview developments.

On this basis, the workshop was significantly contributed to the organization and holding in Kharkiv of three large international conferences on the topics "Gravitation, Cosmology and Relativistic Astrophysics" (2000, 2003), "Anomalous Physical Phenomena in Energy and Prospects of Creation of Unconventional Energy Sources" (2005) and three international scientific seminars (1998, 2001, 2004).

The seminar was repeatedly attended by major academics, de-putators and media representatives.

We invite you to participate in our workshop as well.

Our address: 10 Sovnarkomovskaya St., Kharkiv, House of Scientists, Beketov metro station.

Seminar Leader, Dr. D. A. Pereverzev

CONSCIOUSNESS AND REALITY

D.A. Pereverzev

Reality is understood here as all Being, infinite in Space and Time, innumerable in the changes and transformations of its innumerable objects.

Human consciousness is understood as creative knowledge; knowledge is mastered and actively used information; creative information is a creative act of creating new information and exchanging it with the surrounding world. Informed means armed, comprehensively informed means comprehensively armed, i.e. creative and omnipotent. And these are the possibilities of the Almighty Creator, a human being, in fact, becomes God, who he was originally destined to become (created in the image and likeness of God).

Thus, consciousness is an operational energy-information system located in the aura and encircling the entire human body, i.e. connected with all its cells, forming and controlling human life activity with fantastic speed. The brain is only a transmitting system, like a radio receiver or a TV set.

According to one of the modern scientific concepts (hypotheses) based on the achievements of cybernetics, all objects in the Universe and the processes occurring in them are highly organized and actively interact with each other, starting from elementary particles and atoms and ending with huge stellar associations - Metagalaxies, continuously exchanging and using information and energy. Elementary particles, atoms, planets, stars, galaxies, etc. are surrounded by intellectual-energy-information fields, which, merging together, form a

are the Unified Energy-information field that permeates and binds the entire Universe, infinite in space and time. And, therefore, in essence it (the field) is the Consciousness of the Universe. This concept - energy-informational Universe - begins to prevail more and more in the modern scientific Worldview [1,2].

And in this universal field, in all its components (including man) all the information about the Universe is encoded and concentrated, all the laws of its origin and subsequent development are encrypted.

This Worldview is, in fact, Pantheism (animate and deify all Being), only expressed in modern scientific, including thermodynamic and cybernetic concepts and terms.

In accordance with the above, there must exist the Information Field of the entire Earth, its noosphere (including the biosphere), its Consciousness, covering hundreds and thousands of billions of objects - people, animals, insects, plants, as well as minerals, which can be used to store, process and create information. It is an active component of the Universal Information Field, continuously interacting with it.

All universal processes take place with an active energy-information exchange, including on the Earth. Everything that exists on the Earth is created mainly by the energy of the Sun and to a much lesser extent by the direct influence of energies of other stars and galaxies reaching the Earth.

Everything created by Man (speech, alphabet, writing, literature and art, philosophy, science, religion, industry, etc., the whole civilization) is the result of his energetic interaction with the surrounding World according to the laws by which the Universe is created and exists. - the whole civilization) is the result of his energetic interaction with the surrounding World, according to those laws according to which the Universe is created and exists. Therefore, these laws in one way or another

are encoded (fixed) in all the above-mentioned results of Mankind's activity, including in mathematics and arithmetic. Taking this into account, the secrets of the magic of numbers and numerology are easily explained. After all, numbers reflect the number of energetic inter-actions caused by the number of revolutions of the Moon around the Earth (28 days), the Earth around the Sun (365 days), etc.

All laws in the Universe are realized according to the repetitive cycles of energy-information exchange, conditioned by the periods of rotation of cosmic objects around their centers, which in the vast and eternal (infinite in time and space) Universe leads to countless changes of essentially the same (very similar) objects and processes occurring in them (everything goes back to normal, the Bible, Ecclesiastes). However, there are also some variations, determined by the progressive evolutionary development of all Existence, which allows avoiding degradation - degeneration and preserving the immortality of the Universe.

Since, thus, the laws of energy-information exchange are unified for the whole Being, they are encoded in a single Universal program (matrix, plan, project, field, system) and its specific branches, according to which everything is created and controlled from Metagalaxies to scientific and technical objects, works of art, educational processes, including training and competitions and other various achievements of human civilization.

There is an assumption (and even a statement in [3-6]) that the structure of these programs (matrices, projects, plans, etc.) is very similar to the structure of DNA. Here, depending on the size of the displayed space object, the structural units on which the codes-genes of the programs are fixed can be elementary particles, mole-

In the most general form, these comprehensive universal programs are probably recorded in the form of universal holograms recording the results of energy-information interactions between various cosmic objects and their systems. In the most general form, these comprehensive universal programs are probably recorded in the form of universal holograms that record the results of energy-formation interactions between different space objects and their systems.

There is also an assumption that on the Universal scale they are united in cellular structures, where individual components are represented as "matryoshka dolls", compactly displaying the hierarchical interaction of the programs under consideration, displaying the hierarchy of consciousnesses in ascending order: a human being, a planet, a star system (the same sun), a galaxy, a metagalaxy, the Universe.

In the light of the stated scientific cybernetic concepts, it seems appropriate to show what is understood here as the life activity (life) of individual objects of the Cosmos and the Universe as a whole. The life activity of any object is mastering and active use of all kinds of information, creation of new information on this basis and creative exchange of information with the surrounding world. This definition covers all objects of the Cosmos, starting from the smallest particles and ending with immensely huge stellar associations, i.e. the entire comprehensive, eternal and infinite Universe. And all of them, naturally, possess consciousness, which is their inherent attribute.

Thus, not only biological creatures (including man), but all Being is living, spiritualized. And this is, in fact, what man calls God throughout his meaningful history. Therefore, the cybernetic interpretation of the life activity of the Universe presented here provides a scientific explanation

all former and existing religious and philosophical systems.

As far back as in ancient India and Greece, nature was perceived as the all-powerful root cause of everything and everyone (including gods). As far back as in ancient India and Greece, nature was perceived as the omnipotent root cause of everything and everyone (including the gods); the concept of the human soul as a time- and space-less spiritual substance, an integral part of the World Soul (Nature) was put forward.

Aristotle (384-322 B.C.) in his treatise "On the Soul" presented the Spirit as an ether permeating Everything and Everything. Newton (1643-1727) used Aristotle's term "ether" to refer to the substance that permeates the universe and makes gravity and electromagnetism possible. He believed that the ether was the all-encompassing God, but did not publicize his views for fear of a strong reaction from the Anglican Church (and this is nothing less than pantheism).

Pantheism is characteristic of Renaissance natural philosophy and the philosophy of B. Spinoza (1632-1677). Spinoza (1632-1677), who identified the concept of God and Nature.

G. Leibniz (1646-1716) based his philosophy on the monad, an evolving unit of consciousness-matter. Thanks to monads, all matter is alive and animated. God is the monad of all monads (the same panthe-ism!).

Leibniz's followers also included such prominent scientists as K.E. Tsiolkovsky (1857-1935), A.I. Chivsky (1897-1964), and V.I. Vernadsky (1863-1945).

And for materialists, who recognize that matter possesses such universal properties as Thinking and Consciousness, it is nothing but the Mother of all Being, the all-pervading and all-creating Deity (Goddess). Thus, in essence, materialists are no different from pantheists, who spiritualize and deify all things.

Atheists, who deny the existence of God, were materialists by their Worldview, giving to the self-conscious thinking Matter comprehensive, omnipotent and omniscient properties. And this inevitably, as has already been shown, makes them pantheists.

Since, in Pantheism, God is all Being (including time and space), he can, of course, grant certain controlled self-development to the world created by him, or rigidly (unceasingly) control and direct their life activity. Thus, Pantheism, in fact, combines both Deism and Theism. It excludes the "otherworldliness" of God and "...Everything returns to the way it was" - the original version of God - Nature.

Here Consciousness is indissolubly connected to reality with all Being. This completely removes the basic question of materialist philosophy, "What is primary: matter or thinking, being or consciousness?". Hence it inevitably follows that the worldview of materialists and idealists of all stripes (subjective, objective, etc.) is essentially the same. The same can be said of all Eastern religions, as well as pagan religions - they are different types of pantheism.

One of the most powerful energies produced by creation is thought. Man is a creature of thought: what he thinks about in this life becomes what he thinks about in the next. Our entire earthly civilization is the result of the materialization of our human thoughts.

Every vibration (vibration) is life, every life is vibration. Energy-informational entities (programs, matrices, plans, etc.) monitor the vibrational processes in the Universe. Where the substance is compacting (maturing) and its vibration frequency coincides with the vibration frequency of a certain energy-in-

of the energy-informational essence, resonance occurs, and a spontaneous (chain) reaction of birth and development of a new cosmic object begins, occurring under the control and management of this energy-informational essence. This is how humans, planets, stars, galaxies, metagalaxies, universal etheric vortices (like earth cyclones and anticyclones), from which etheric winds blow, penetrating the expanses of the Universe, etc., originate and develop.

If for any reason the resonance proves to be unreliable (the frequency of oscillations of the object or its control system has changed), the birth and development of a physical object may stop. Thus, for example, premature human death occurs at an early age (often in infants and children); the same is likely to happen with other cosmic objects.

The level of frequency of oscillations in the consciousness of an individual person is probably supported by the collective consciousness of the entire humanity. If for some reason a person is torn out of his community and enters the wilderness for a long time, he also becomes wild and even turns into an animal, like the real "Mowgli" who were there as an infant.

In the process of countless generations of cosmic objects, damage and revitalization of their energy-informational essences probably occur. In human beings it takes place in the form of mental illnesses, which not infrequently lead to serious crimes during a number of generations and are interpreted as a curse of the family. If there are righteous periods of life in the family, i.e. the aspiration of the children to correction, then the curse is removed, as it is known, after 7 generations (250-300 years) by means of gradual improvement of spiritual-moral and energy-informational essence of a person (his soul). If this is not the case, the soul disintegrates and goes into the nothingness.

This can also apply to states and nations. It can be referred also to states and nations.

Thus, for thousands of years, the concepts of "paradise", "purgatory" and "hell" have been established in the human consciousness, in his energy-informational essence at the genetic level, where, after his physical death, rest, recuperation or complete dismantling of souls takes place, respectively. For this purpose certain zones of the Cosmos are used, where, in fact, "paradise", "purgatory" and "hell" are located. And different peoples of the Earth, apparently, have their own laws, taking into account ethnographic and religious differences of these peoples, which is undoubtedly reflected in the genes of their energy-informational essences. This, in particular, is confirmed by the works of Carlos Castaneda (see his "Door to Other Worlds").

The process of birth, development and exploration of a new, more perfect cosmic object is called evolution. The energy-informational entity (soul) comes to this object and creates it to also evolve, that is, to become a greater and greater version of itself. This is the purpose of all our life on Earth and all life in the Universe.

Energy-informational entities (souls) are immortal in principle. But this immortality is gained by countless cyclic lives in temporary gross-material shells of objects, with accumulation of new information each time, which is then used in the subsequent evolutionary development. Without this, any entity can degenerate and disappear without a trace. The remarkable poet N. Zabolotsky reflected this moment very imaginatively in one of his poems: "Do not let your soul be lazy, do not take a step away. The soul must work day and night, day and night.

Thus, new, previously unknown information is an indispensable condition (a kind of elixir) of immortality of all energy-informational entities - matrices, projects, program plans of all kinds of material objects of the Universe.

For guaranteed receipt of such information, man (and other similar objects of the Cosmos) is given free will - spontaneous adoption and execution of any possible permissible decisions and actions. Thus, in the process of evolution a traceable self-development of cosmic objects and their systems is laid down. Free will is one of the most fundamental laws of the Universe, which cannot be violated even by the Supreme Controlling Powers, because it would lead to the disruption of the evolution process with unpredictable destructive consequences.

Outstanding science fiction writers, the Strugatsky brothers, already many years ago (more than 40) played such a situation in one of their best novels: "It is difficult to be a god" [7]. [7]. The action takes place on a distant planet with a medieval civilization, whose rulers mercilessly destroy all the best that has been achieved there, and an impenetrable clerical reaction prevails. Earth's progressive observers, who have truly divine powers, observe this alien life but do not interfere with it.

The scientist of the planet Budah, addressing the earthman Rumata, who had repeatedly manifested his truly divine actions there, asked: "...Lord, erase us from the face of the earth and make us anew more perfect...".

"My heart is full of pity," said Rumata the God slowly, "I cannot do this.

In general, prominent science fiction writers should be considered to be ahead of the curve in the process of human development.

of the civilization. The above-mentioned Strugatsky brothers, I.A. Efremov, and the American Cliff-Ford Saimak have shown themselves to be such. We would especially like to note the science fiction works of Ivan Efremov, such as "The Andromeda Nebula" and "Constellation of the Bull", where he wrote 50 years ago about time tunnels, through which it is possible to travel almost instantly to the past and future of any zone of the Universe.

Recently, I saw on TV how Russian academicians were seriously and even enthusiastically discussing these problems. It dawned on them that there could be tunnels between the supercivilizations of the Universe - "black" and "white" holes. The black holes are where matter goes from one to the other, and the white holes are where matter goes to the other. "white" - energy comes from the others to one. And the energy of time, as the outstanding astronomer Kozyrev N.A. stated, is the "fuel" for our Sun and other Stars.

But let us return to free will. Excessive manifestation of free will leads to permissiveness in bandits of various ranks, maniacs, terrorists, despots, tyrants, dictators. Their emergence and activities are mainly conditioned by the corresponding level of achieved social consciousness. This is especially true in the republics of the collapsed Soviet Union, under the conditions of lawlessness that prevailed there. As the saying goes, "You have fought for what you have fought for, you have met with what you have met!

These degenerates of mankind have a clear damage of their spiritual-moral and energy-informational essence, their immune system - the security system of these entities - is out of order, they should be treated in purgatory, and most likely dismantled (liquidated) in hell.

The immune system (security system) of energy-forming entities should not allow violation of certain spiritual and moral principles and pros-

2], which are based on the fundamental triad of the Universe - Love, Goodness and Beauty. [2].

Love is here understood as the most complete and harmonious course of the vital activity of the Universe in all its innumerable manifestations, and the aspiration of Everything and Everything to such manifestations.

This is naturally connected with harmonious proportional exchange of energy and information, which is understood as Good. This is also conditioned by the harmonious combination of sizes, elegance of the form of objects and their systems, which we call Beauty. It is not without reason that the ancient Greek philosopher and mathematician Pythagoras (6th century B.C.) called numbers the basis of all existing things, and numerical ratios the source of Harmony of the Cosmos.

Thus, Love, Goodness and Beauty act in an indissoluble triunity (triad) as the foundation of the harmonious triple rhythm (pulse) of the vital activity of all Being.

As the human consciousness grows and improves, it will inevitably approach the consciousnesses of the Earth, the Solar System, the Galaxy, etc. Higher and higher levels of reality will be mastered, which, in the end, should lead mankind to mastering and using the information and energy of the Universal energy-information field.

If it is possible to receive energy and information from this inexhaustible Universal energy-information accumulator, then it will not be necessary to create spaceships with sublight and FTL speeds to explore the vastness of the Universe. Besides, as calculations have shown, this is impossible to realize in practice. It is also unlikely that spaceships that can be used for null-transitions in time tunnels, as described in science fiction, will be possible.

In fact, we can do without these ships. It will be enough to turn to the Universal Internet and Universal mobile communication to receive, use and exchange information with everyone, including the most remote corners of the Universe.

There is a centuries-old opinion that man will get closer to the Consciousness of the Universe if he becomes different, perfect in all respects. But then his development and evolution would stop, which will never happen. All kinds of difficulties, including catharsis (purification by suffering), shocks, descents, ascents, evolutionary leaps, etc., non-standard situations are included in the evolutionary process, and by overcoming them our souls are purified, renewed and enriched. It is not without reason that they say: for a beaten man you get two unbeaten men. And so it will always be and this is the eternal renewal and development of the eternally existing Universe.

And let us be inspired and supported by the thought that in the countless changes of the subidentical cycles of life activity of the whole Being, we all (and each of us individually, and this depends on his contribution to the harmonization of energy-informational processes) can live countless more similar lives, with some variations, conditioned by the evolutionary process of perfection of Everything and Everything.

Literature

1. Pereverzev D.A. "Some reflections on the Universe, its laws and our Worldview". // Energy-formation and intellectual-spiritual activity of the Universe and our Worldview. - Collection of selected works of the city-wide seminar at the Kharkov House of Scientists (1997-2004). - Kharkov, 2004. - 279 c.
2. Pereverzev D.A. "On the state of our Worldview at the turn of the 2nd and 3rd millennia". // Energoinfor-

Mational and intellectual-spiritual activity of the Universe and our Worldview. - Collected Works of the General Seminar at the Kharkov House of Scientists (1997-2004). - Kharkov, 2004. - 279 c.

3. Tikhoplav V.Y., Tikhoplav T.S. "Physics of Faith". - SPb.: Vesya, 2002. - 256 c.

4. Tikhoplav V.Y., Tikhoplav T.S. "Life for Hire". - SPb.: Vesya, 2002. - 256 c.

5. Tikhoplav V.Y., Tikhoplav T.S. "The Great Transition". - SPb.: Ves, 2002. - 256 c.

6. Tikhoplav V.Y., Tikhoplav T.S. "Cardinal поворот". - SPb.: Ves, 2002. - 304 c.

7. Arkady Strugatsky, "It is difficult to be a god". // Arkady Strugatsky, Boris Strugatsky. M.: Molodaya Gvardiya, 1966. - Vol. 7, pp. 5-192.

October 2007.

ABOUT THE BIRTH AND OF LIFE IN THE STELLAR SYSTEMS OF THE UNIVERSE

D.A. Pereverzev

According to one of the modern scientific concepts (hypothesis) based on the achievements of cybernetics, all the objects in the Universe and the processes occurring in them are highly organized and actively interact with each other, starting from elementary particles and atoms and ending with huge stellar associations - Metagalaxies, continuously exchanging and using information and energy. Elementary particles, atoms, planets, stars, galaxies, etc. are surrounded by intellectual-energy-information fields, which, merging together, form a Unified Energy-information field, permeating and binding the entire Universe, infinite in space and time. This concept - Energy-informational Universe - is beginning to prevail more and more in the contemporary scientific worldview [1,2].

And in this Universal Field, in all its components (including man) all the information about the Universe is encoded and concentrated, all the laws of its origin and subsequent development are encoded.

This Worldview is, in fact, Pantheism (animate and deify all things), only expressed in modern scientific, including thermodynamic and cybernetic concepts and terms.

In accordance with the above, there must be an Information Field of the entire Earth biosphere, including hundreds and thousands of billions of objects - people, animals, insects, plants, and possibly minerals - that can be used to store, process, and store information.

It is an active part of the Universal Information Field. It is an active integral part of the Universal Information Field, continuously interacting with it.

The Universal processes take place with an active energy-information exchange, including on the Earth. Everything that exists on the Earth is created mainly by the energy of the Sun and to a much lesser extent by the direct influence of energies of other stars and galaxies reaching the Earth.

Everything created by Man (speech, alphabets, writing, literature and art, philosophy, science, religion, industry, etc.) is the result of his energetic interaction with the surrounding World according to the laws by which the Universe is created and exists. - the whole civilization) is the result of his energetic interaction with the surrounding World, according to those laws according to which the Universe is created and exists. Therefore, these laws are coded (fixed) in one way or another in all the above-mentioned results of Mankind's activity, including mathematics and arithmetic. Taking this into account, the secrets of the magic of numbers and numerology are easily revealed. After all, the numbers reflect the number of energetic inter-actions caused by the number of revolutions of the Moon around the Earth (28 days), the Earth around the Sun (365 days), etc.

Among others, the law of conservation of matter-energy during the materialization of solar energy in both purely material and spiritual-moral spheres manifests itself very clearly in the life of Mankind and the whole Earth.

In great works of literature and art the intellectual and spiritual energy of their creators, borrowed, transformed by them from the surrounding World and reflecting the Beauty and Harmony of Nature-Cosmos-Universe, is materialized, condensed. It has been favorably influencing mankind for centuries and thousands of years. Recently-

This is why great works of art have such a high, ever-increasing value over time. Great works of literature and art are energized when they are republished or restored. Most people experience the beneficial energetic effects of visiting museums, theaters and reading great works.

Except for rare specks - galaxies, stars, planets, etc., the entire space of the Universe is filled with Substance of very low material density (what is called ether, vacuum, prana, subtle matter, etc.), which is in a state of continuous rotational and reciprocating motion.

Similar processes in the Earth's atmosphere due to the energy flows of the Sun and the Earth's rotation around it and its axis are quite illustrative. Cyclones and anticyclones, typhoons, tornadoes and other hurricane phenomena in the Earth's atmosphere clearly show (analogy) what is happening in the vast expanses of the Universe: twisting and unwinding Metagalaxies, Galaxies, Constellations, Stars, Planets, etc. And all this in a kaleidoscope of continuous rotations of everything and everything around all kinds of also rotating centers. And yet, all these processes are co-organized.

They proceed according to the recurring cycles of energy-information exchange caused by the periods of rotation of cosmic objects around their centers, which in the vast and eternal (infinite in time and space) Universe leads to countless changes of essentially the same (quite similar) objects and processes taking place in them (everything returns to the way it was, the Bible, Ecclesiastes), with some variations predetermined by the progressive evolutionary development

of all Existence, avoiding degradation and degeneration and preserving the immortality of the Universe.

Since, thus, the laws of energy-information exchange are unified for all Existence, they are encoded in a single Universal program (matrix, plan, project, field, system) and its specific branches, according to which everything is created and controlled from Metagalaxies to scientific and technical objects, works of art, educational processes, including training and competitions, and other various achievements of human civilization.

There is an assumption (and even a statement in [2]) that the structure of these programs (matrices, projects, plans, etc.) is very similar to the structure of DNA. Here, depending on the size of the displayed cosmic object, elementary particles, molecules, constellations, stars with planets, and, perhaps, even galaxies can be the structural units on which the program codes-genes are fixed. In the most general form, these comprehensive universal programs are probably recorded in the form of universal holograms that record the results of energy-information interactions between different space objects and their systems.

There is also an assumption that on the Universal scale they are united in cellular structures, where individual components are represented in the form of "nesting dolls", compactly displaying the hierarchical interaction of the programs under consideration.

The subtle substance Worlds (interstellar spaces) of the Universe are considered here, where life activity is mainly determined by the triad "consciousness-energy-information". In the process of evolution of all Being, the Universe strives for a harmonious interaction of these three basic hypostases, realizing the harmonious interaction of the three basic hypostases.

This is the result of the above-mentioned universal programs (matrixes, etc.).

In this triad, consciousness is the organizing and controlling component, which, of course, applies to all objects of the Universe, including humans. Consciousness is understood as creative knowledge; knowledge is mastered and actively used information; creative information is the creative act of creating new information and its exchange with the surrounding world. Informed means armed. Comprehensively informed means comprehensively armed, i.e. creative and omnipotent. And these are the possibilities of the Almighty Creator, a human being in fact becomes God, who he was originally destined to become (created in the image of God).

In the light of the stated scientific cybernetic concepts, it seems expedient to show what is understood here as the life activity (life) of individual objects of the Cosmos and the Universe as a whole. The life activity of any object is mastering and active use of information, creation of new universal information on this basis and creative exchange of it with the surrounding World. This definition covers all objects of the Cosmos, starting from the smallest particles and ending with immensely huge stellar associations, i.e. the entire comprehensive, eternal and infinite Universe.

Thus, not only biological creatures (including man), but all Being is living, spiritualized. And this is, in fact, what man calls God throughout his meaningful history. Therefore, the cybernetic interpretation of the life activity of the Universe presented here gives a scientific explanation to all existing religious-philosophical systems.

The basic building material of the universe in the formation of stars, constellations and galaxies is hydrogen

and helium [3,4], about 97.6% of all known matter (H=70%, Ne=27.6%).

Let us now consider the process of star and galaxy formation from huge clusters of hydrogen and helium. The nucleation sites (centers) must mature, reach the necessary density level to start the star formation process. The corresponding programs monitor this process and when the frequency of vibrations (oscillations) of energy-information flows in the program and in the center of star formation coincide, there is a kind of resonance - a tremendous acceleration of the star formation process. The gas clouds enveloping the center of nucleation begin to rotate and compact under the influence of gravitational forces.

At a certain critical mass (or more than it) involved in star formation, the pressure in the nucleation zone reaches hundreds of billions of atmospheres, and the temperature reaches tens of millions of degrees; the reaction of thermonuclear fusion of helium from hydrogen atoms begins, with the release of a huge amount of energy and its release into space. Thus, tens and hundreds of billions of stars are ignited from the dark proto-cloud, which by coordinated rotation around a single center are united into a galaxy. The star exists until all the matter involved in thermonuclear fusion is burned out; it turns into a white dwarf, which is a completely different cosmic body.

At the mass involved in the creation of the object and less than the critical mass, a liquid hydrogen-helium planet (like Jupiter or Saturn) can arise. This mass can be formed by itself or detached from the mass of the star.

Earth-like planets with solid surfaces are formed differently, from solid bodies-meteorites, asteroids,

of all kinds of stone clusters, from fragments of comets, etc. Here the solid bodies rotating around the luminary (Star) are concentrated, sticking together, forming their compact spherical formations rotating also around their axis, carried out under the control of the corresponding planetary program, starting from the moment of coincidence of the frequency of its energy-informational vibrations (oscillations) with the similar frequency of the nascent planet.

There is an infinite number of galaxies in the Universe, and they are united into even larger space systems - Metagalaxies (with the number of galaxies up to 200 billion and more). The orbital velocity of a galaxy as it moves around the center of the Metagalaxy can reach tens of thousands of km/s [4]. It seems that there are also unions of Metagalaxies - Supermetagalaxies, where the orbital velocity at rotation around the center of the union can reach the known to us speeds of light (about 300 thousand km/s, and possibly more). Isn't this the secret of galaxies scattering at ever-increasing speeds? Our far from perfect instruments simply fix orbital velocities in the various above-mentioned hierarchical structural associations of galaxies.

It used to be believed that between galaxies, the clots of matter in the Universe, there is a vacuum, a "void". Nowadays it is considered to be established that between galaxies, as well as between stars, the space (called ether, physical vacuum, etc.) is filled with energy currents and interstellar gas. This gas is ionized, i.e. it is a plasma - a mixture of nuclei of hydrogen, helium and other elements, as well as electrons and possibly other smaller particles.

The plasma is produced by thermonuclear reactions in the interior of stars and ejected by them into space.

The fusion is a "cold" fusion. It seems that by "cold" fusion, at low energy inputs (in conditions of almost absolute zero temperatures), the main building materials of stars and galaxies - hydrogen and helium - are produced here from the plasma, with successive complication of particles. But the mechanism of this process is still unclear. One thing is certain that it is organized and controlled by one of the above-mentioned high-level hierarchical programs. And is it not in this way that huge dark matter clusters are created in the vast expanses of the Cosmos, which are being detected more and more every year by as-tronomists?

The following highlights some of the indicators and major stages of the origin and formation of our solar system.

The solar system is more than 12 billion kilometers across, due to the diameter of the nearly circular orbit of the planet Pluto, the farthest planet from the luminary.

The closer a planet is to the Sun, the greater its orbital velocity (gravitational forces must be balanced by centrifugal forces). Thus, Mercury's orbital velocity is 47.9 km/s with a complete revolution around the Sun in 88 Earth days, Earth's is 29.8 km/s with a revolution in 365 days (a year), and Pluto's is only 4.7 km/s with an orbit of 247 Earth years.

Our Galaxy is 68 thousand light-years across. The thickness of the Galaxy disk is 8 times smaller than its diameter. One of the branches of the Galaxy is home to the Solar System, which makes a complete revolution around the Galactic center in about 200 million years, orbiting at a speed of 250 km/sec.

Origin of the Solar System. According to modern ideas [3], the Sun, planets and all other bodies of the Solar System were formed from a single cold cold

A gas-dust cloud, or nebula, about 4.6 billion years ago. The cloud is believed to have originated in one of the branches of the Galaxy as a dispersed rotating medium. Gradually compacting under the influence of gravitational compression and accelerating its rotation, it took the shape of a disk. As a result of increasing compaction of matter, the cloud heated up and in the central region reached such high temperatures that nuclear reactions began there. Subsequently, the Sun was formed from the central part of the cloud, and the planets orbiting the Sun and planetary satellites were formed from the solid material clots.

This is the most general hypothesis of the Solar System formation, which emerged more than 350 years ago, first by R. Descartes and nowadays finally confirmed as the Kant-Laplace hypothesis (Kant - 1755, Laplace - 1796). According to modern astronomers [3,4], the chemical composition of the Universe is dominated by hydrogen (about 70%) and helium (27.5%), with only about 2.5% of the major elements. In general, this ratio of elements holds in the Solar System. But in the Solar System, the Earth and other solids have a completely different chemical composition.

Structure of the Solar System. The Sun and the planets and their satellites, asteroids, comets and other bodies in its gravitational field form one of the countless rotating systems of the Universe, the number of which in our Galaxy alone is estimated to be truly astronomical - from 100 to 250 billion. The Solar System consists of the Sun, a yellow star, nine planets (Mercury, Venus, Earth, Mars, Jupiter, Saturn, Uranus, Neptune, Pluto) with 32 satellites, many thousands of asteroids (small planets), many millions of comets, meteorites, interplanetary gas and dust.

The space occupied by the Solar System is permeated with various kinds of energy flows coming from the Universe, from the Galaxy and its stars, from the interplanetary medium, from each planet and other cosmic bodies, but most importantly from the Sun. The entire interplanetary space is occupied by various physical fields peculiar to cosmic bodies - gravitational, magnetic, thermal, electric and others [3]. And all this, as it was mentioned above, can be represented as a single Energy-Information Field of the Solar System.

The Sun is the closest star in the Universe and is a yellow dwarf. It is a glowing glowing ball of gas formed by 70% hydrogen and 27% helium, with the remaining 3% being high-temperature plasma - a mixture of nuclei and electrons of hydrogen and helium atoms that have not undergone a fusion reaction, as well as a mixture of nuclei and electrons of all other elements in the Mendeleev table. The mass of the Sun is $2.25 \cdot 10^{27}$ t, which is 329400 times the mass of the Earth ($6.2 \cdot 10^{21}$), and its volume is about 1300 thousand times the volume of the Earth. The density of the Sun is 4 times less than that of our planet, the pressure at its center reaches 300 billion atmospheres, and the temperature is 10-15 million degrees Celsius. The combination of ultra-high pressures and temperatures in the center of the Sun causes nuclear reactions to transform hydrogen into helium.

A huge amount of energy is released. Part of it is used to maintain in the central region the ultrahigh temperatures necessary for nuclear reactions, and the rest is radiated by the Sun into outer space. The energy flux emitted by the Sun removes $1.4 \cdot 10^{13}$ tons of matter from it each year. Although this is enormous in our earthly terms, it is negligible compared to the mass of the Sun: it would take an extremely huge amount of energy to remove it from the Sun.

It would take a considerable amount of time for the Sun to use up all of its matter for energy radiation and cease to exist. The Sun will reach this state in about 10 billion years [3]. We cannot agree with this statement. Thermonuclear reactions in the Sun will begin to fade when its mass becomes less than critical, and will finally cease, according to current estimates, in 6 billion years, when the Sun turns into a white dwarf.

The Sun generates and emits two main energy flows into space: electromagnetic radiation, or solar radiation (due to the Sun's surface temperature of about 6000°K), and corpuscular radiation, or solar wind.

The thermal field of all planets of the Solar System is created almost exclusively by solar radiation, since the energy flow from the interior of the planets to their surface is extremely insignificant and is ignored by many researchers, even for the Earth. This is why solar radiation is especially important for the inner (terrestrial) planets - Mercury, Venus, Earth and Mars.

The corpuscular radiation (solar wind) is a flow of plasma - the glowing ionized gas of the solar corona, whose temperature is estimated at 1 million degrees Celsius. The term "corpuscular radiation" means that the process here is not continuous, but occurs in some portions-corpuscles. The plasma flow is based on hydrogen nuclei, to a lesser extent helium and other elements, and electrons [3].

One of the characteristic features of the solar wind is its inherent magnetic field. The planets that do not have a magnetic field (Moon, Venus) allow the plasma flow of this wind to penetrate the atmosphere (where it exists) unimpeded up to their planet.

and interact with its matter at the atomic level. Its influence on the planet's energy will be relatively small compared to the solar radiation. It is different if the planet has a strong magnetic field. This is especially evident on Earth, where the planet's strong magnetic field prevents the plasma flow from penetrating to its surface and it has to flow around the planet at the level of the upper boundary of the atmosphere. Nevertheless, this sometimes causes very strong perturbations in the planet's magnetic field, which affects the rhythm of life of its inhabitants and is particularly unpleasant for people with chronic diseases.

It seems that atmospheric (weather) disturbances, which are so clearly and sharply negative at the present time, can also occur here. Since solar wind increases occur periodically and are therefore predictable, it is necessary to prepare for them in advance and take all possible necessary protective measures.

Next we will look at the evolution of the planets, mainly the main planet where we live, planet Earth.

Despite the seemingly homogeneous source material and mechanism of formation, the bodies of the Solar System are sharply divided into two different groups in terms of composition and structure. The first group is formed by the large bodies - the Sun and the planets of the outer group of the system: Jupiter, Saturn, Uranus and Neptune. They are liquid balls of water and helium with low density (0.7-1.41). But they account for almost the entire mass of the Solar System.

The second group is formed by bodies with a high density of their constituent matter and a solid surface. These are the planets of the inner or terrestrial group: Mercury, Venus, Earth, Mars; planetary satellites, asteroids (density of

their matter content is 3.0-5.5). Their solid surface is in contact either with the air and hydrosphere (Earth, Venus, Mars) or directly with open space (Mercury, Moon, planetary satellites, asteroids, meteorites, etc.). The bodies of the second group account for a small fraction of a percent of the solar system mass ($6 \cdot 10^{-4} \%$).

The giant planets (Jupiter, Saturn, Uranus, Neptune), as well as the Universe as a whole, are formed mainly by light elements - hydrogen and helium. The group of planets made of heavy material with a solid surface can be judged from the Earth, whose chemical composition, with quantitative relationships between elements, is well enough studied. There is neither hydrogen nor helium among the 15 major elements, which together comprise 99.89% of the total matter of our planet [3]. Iron (35.39%), oxygen (27.29%), magnesium (17%), and silicon (12.64%) predominate. Thus, by their physical parameters, the large planets of the Solar System belong to two different levels of organization of the matter of cosmic bodies. The paths of their evolution are also different.

The evolution of planets is very complex, time-varying and disintegrates into a complex of interrelated processes. Any natural process can function only if it is provided with the necessary energy. The most effective energy flows here are the electromagnetic radiation of the Sun (solar radiation) and the gravitational energy of the bodies forming the planet.

Solar radiation forms a thermal field on the surface of the inner group planets. It excites a complex of surface processes. Their quantity and intensity depend not so much on the power of the solar energy flux arriving on the surface of the planet, as on the amount of solar energy flow.

of the absorption capacity of the outer region of the planets - air and water environments.

Gravitational energy initially creates a planet by the sticking together of a cluster of solid bodies and then builds it up by meteorite bombardment, i.e., by the fallout of space bodies of various sizes - from dust particles to blocks of rock with a cross-section of tens of kilometers - onto the growing planet. In essence, the formation of planets is an intensive continuous fallout of rocky material.

In the first hundreds of millions of years of planetary existence, this was the most important factor in the evolution of planets. In the following time, the flux of solid matter falling on the planets decreased gradually as it became concentrated in the growing planets.

On planets with atmospheres and water environments, the effect of meteoritic bombardment was weakened by itself, and especially by its suppression by internal (tectonic) and surface processes, i.e., by factors inherent to the planet itself. Only on the Moon, devoid of atmosphere and hydrosphere, meteoritic bombardment continues to be the most important factor in the formation of surface relief and crust structure, and its effect here has been most pronounced.

A comparison of the physical characteristics of the inner (terrestrial) planets of the Solar System has allowed us to deduce a number of general regularities of their origin and subsequent evolution. In the early history of their existence, all planets experienced three common phases of development: the 1st phase of accretion (nucleation); the 2nd phase of melting of the outer sphere (and possibly of the interior); and the 2nd phase of melting of the outer sphere (and possibly of the interior).

The 3rd "lunar phase" (the stage of creation of the primary crust). The sum of these phases constitutes the early history of the planet. At that time, the Earth did not differ from other planets in its development.

In all subsequent times up to and including the modern epoch, i.e., during 3.5-4.0 billion years, all planets, with the exception of the Earth, developed more or less uniformly, although the degree of activity of both internal and external planetary processes varied. The greater the mass of a planet, the greater the amount of radiogenic and gravitational energy generated in its interior. Accordingly, volcanism and tectonic movements are more active in the planet. They are especially evident in volcanic activity. On the smaller planets (Moon, Mercury), volcanic activity ceased more than 3 billion years ago. On Mars it was present until recently, but it has also subsided. On Venus (according to indirect data) and on Earth, active volcanism has been going on throughout their history and is still going on now.

The following are among the general regularities of the development of the Earth-group planets.

1. All planets originated from a single protoplanetary cloud (nebula) as a result of its condensation and the nucleation of clumps of material from scattered matter about 4.6 billion years ago. Larger clumps grew faster by joining smaller aggregates and became the embryos of planets.

2. At the end of the accretion (nucleation) stage, i.e., approximately 4.5 billion years ago, under the influence of rapidly accumulated thermal energy due to transformed theoretical kinetic energy (transformed gravitational energy), the outer shell of the planets completely melts.

3. The subsequent cooling of the outer layers of the lithosphere resulted in the formation of the crust. The lighter components of the main magma were incorporated into the crust. The heavier ones, thanks to gravitational differentiation, concentrated below the crust to form the mantle of the planets. At the same time.

he melting of the central region of the planets due to the accumulation of radiogenic and gravitational energy also occurred during this period. Thus, at the early stage of the planets' existence, their matter was differentiated into core, mantle, and crust.

4. Unlike other planets, the Earth has a huge amount of liquid water and, importantly, all of it is in an active global cycle. And this has a huge impact on the planet's lithosphere and atmosphere.

5. Due to a number of favorable circumstances (median position in the group of planets, presence of liquid water, moderate stable thermal regime, etc.), organic life arose and developed on the Earth, human beings appeared and rapidly evolved, which has a great and growing influence (not always positive) on the vital activity of everything existing on the Earth and the planet as a whole.

Therefore, the main stages-phases of the Earth's evolution, including human beings, are discussed in more detail below, and their prospects are assessed.

1. Accretion (planetary birth) with a period of about 200 million years (4.6-4.4 billion years ago). During this time, the Earth acquired about 95% of its present-day mass through the attraction of all kinds of solid bodies.

2. At the end of the accretion stage (4.4 billion years ago), under the action of meteorite bombardment and the transformation of gravitational energy into thermal energy, the outer shell and deep layers of the planet melted, releasing water vapor and carbon dioxide; the Earth's gravity held them together and they formed its primary atmosphere.

3. The subsequent cooling of the Earth formed its three main spherical layers: the solid outer crust

- lithosphere and the remaining molten mantle and central core (4 billion years ago).

4. When in the process of further cooling the Earth's surface temperature reached less than 100°C, water vapor condensation began to intensify and fall on the Earth. This is how the first seas and oceans of our planet were formed (about 3.5 billion years ago).

Under the influence of the Sun's energy, water evaporated, vapors rose into the atmosphere, condensed, and rained; the water cycle was established, and lakes and rivers appeared. The accumulation of gravitational and radiation energy in the Earth's interior and its subsequent release led to active tectonic activity in the form of volcanic eruptions and mountain formation processes.

5. The origin and rapid development of organic life in the depths of the hydrosphere led to a dramatic change in the composition of the atmosphere and established it close to today: about 78% nitrogen and 21% oxygen, the rest - other gases (about 3 billion years ago).

6. The single continent of Gondwana splits into continents. The Earth acquires its present-day geographical shape. Plants and animals emerge from the seas and oceans onto land. The development of a solid surface abundantly irrigated by the water cycle. The most ancient vegetation flourished in the form of huge horsetails and ferns. Accordingly, the appearance and dominance of giant herbivorous and predatory reptiles - brontosaurus and ichthyosaurs - on the Earth, and flying lizards in the sky (about 1.5 billion years ago).

7. The appearance of mammalian animals on land and their subsequent partial return to the aquatic environment, the appearance of the ancestors of modern cetaceans (approximately 800-700 million years ago).

8. The emergence of upright apes, the earliest ancestors of modern humans (about 1 million years ago).

9. The emergence of man of reason (homosapi-ens) with a brain volume and thinking capabilities close to modern ones - Cro-Magnon, Australopithecus, etc. (100-50 thousand years ago). (100-50 thousand years ago).

Some scientists believe that this happened 20,000 to 30,000 years ago, and that evolution over the previous million years could not have led to its emergence. It is likely that there was a qualitative leap (a kind of super-state caused by a confluence of exceptional circumstances) that led to the emergence of a sustained brain mutation that finally formed modern humans in a relatively short historical period. It is possible that this occurred off-Earth and that organic life (including man) was brought to Earth through the activities of other, more advanced civilizations. Information from contactors and ufologists confirms this version [1].

10. Emergence of the first ancient human civilizations - Ural, Tripoli, Egyptian, Sumerian, Chinese, Indian (Hindustani), etc. (10-5 thousand years ago). (10-5 thousand years ago).

11. The origin and development of ancient Greek and Roman slave civilizations (3.5-1.5 thousand years ago).

12. Feudal-serfdom civilization (1.5- 0.2 thousand years ago).

13. Private and state capitalist techno-genetic civilization (approximately from the 17th century A.D. to the present day). In the process, man has achieved great power with enormous creative (our ancestors would say divine) capabilities.

But it (this civilization) has already reached the limit of its capabilities, causing enormous damage to the human habitat and the entire organic world (pollution of the ocean, land, atmosphere; destruction of forests and many animals; predation of the Earth's subsoil, etc.), which has put humanity and the Earth itself on the verge of survival.

Modern main energy resources and energy carriers (oil and gas) are not the remains of flora and fauna of previous epochs processed over millions of years, but peculiar blood (lymph) and respiratory products of the Earth's organism. The Earth probably produces them continuously in its depths and there is no special danger to its vital activity from this side (before human production of oil and gas). But the pollution of its surface, oceans, atmosphere, the danger of the greenhouse effect (which has had such a negative impact on Venus) - here the Earth is experiencing great anxiety and is ringing all the bells.

Volcanic eruptions, earthquakes, droughts, fires, hurricanes and floods in recent years have literally shaken the Earth and all of humanity, often with great loss of life. In fact, this is an instruction to mankind to stop the technogenic civilization and to follow a new, life-affirming stage of evolution, to create a new, corresponding civilization.

14. Energy-informational civilization of mankind with obtaining energy and information directly from the Universal Energy-informational accumulator - the Universal Energy-informational field (with the beginning in the 21st century).

The foregoing illustrates the dramatic increase in the rate of evolution of the entire Earth organism and its integral human component, from billions of years ago to the present day.

In the past, it was hundreds of millions, hundreds of millions, hundreds and tens of thousands of years to tens of years in our time.

The ever-increasing speed of mankind's evolution and the corresponding development of energy have led to the fact that over the last decade there has been a sharp qualitative leap in the development and use of various energy-information processes due to the creation and widespread use of the necessary computer-computing and information-awareness technology (all-planet computer network - Internet, mobile communication, television, radio, etc.). In fact, mankind is already on the verge of mastering and utilizing information and energy of the Universal energy-information field. It can be expected that the practical connection to it will take place during the 21st century.

All this is undoubtedly reflected in the Universal cosmic project (program, matrix, plan, etc.) of the origin and development of the Solar System and its planet Earth, destined to become the cradle and home of one of the highest forms of life in the Universe - organic life.

Probably, in this project it was envisaged that the Earth would be reliably protected by its atmosphere from harmful short-wave radiation from the Sun and would have a reliable gravitational protection from large meteorites and asteroids falling on it, thanks to a kind of shield of massive liquid planets - Jupiter, Saturn, Uranus and Neptune. Thus, most of the meteorites and asteroids of the solar system rotate between the orbits of Mars and Jupiter, many solids are collected in the ring of Saturn. These liquid planets have solid satellites, each with a mass close to that of the Moon.

Thus, these dangerous solids are safely away from the Earth and out of its gravity.

The final part of the paper presents some information on the lifespan and age of various universal objects (Metagalaxies, stars, planets, atoms, etc.).

In religious and philosophical works of ancient India (Vedas, Upanishads, Bhagavad-gita, etc.) it is said that the Age of Brahma (the life span of the Universe, in our understanding of the Metagalaxy, which includes over 200 billion galaxies like our Milky Way) from the beginning of birth (expansion) to super-compression (collapse) is $3.11 \cdot 10^{14}$ years [1].

It is an inspirational and poetic description of the immersion of Brahma (the supreme deity of Hindus) into nirvana, his merging and dissolution into ether, his sleep for countless earthly years. ... And, finally, the awakening, the plan of the origin and development of the Universe is revealed.....

Unfortunately, the information that comes down to us from such ancient sources depends to a large extent on interpreters of ancient texts. Therefore, it should be interpreted with caution (critically).

Modern science suggests that the age of our Metagalaxy is about 15 billion years. It has been determined from the rate of galaxy escape since the Metagalactic explosion (the initial explosion theory) and from the half-life of radioactive carbon. A number of researchers believe that this is a very approximate method and that our Metagalaxy is much younger.

According to the same radioactive method, the age of the Solar System (including the Earth and other planets) is estimated at 5-6 billion years. According to calculations, it is certain that a thermonuclear generator of solar energy will be operational.

It would take about 6 billion more years until all available nuclear fuel burns out and the solar system ceases to exist. Thus, its lifespan could be as long as 11-12 billion years.

No one has yet been able to estimate the lifetime of atoms. Some scientists and researchers believe that the atom will live forever after being formed in some other way [1].

According to modern science, the age of mankind can reach both 100 thousand and 1 million years.

But in all these cases the age and longevity of the rough material shells of objects are estimated, but not their energy-informational essences - matrices, plans, programs, projects - which create these objects and manage their life during countless cycles of their existence.

The energy-informational essences of objects (they used to be called, and still are often called souls) are immortal in principle. But this immortality is accrued by countless cyclic lives in temporary gross-material shells of objects, with accumulation of new information each time, which is then used in the subsequent evolutionary development. Without this, any entity can degenerate and disappear without a trace. The remarkable poet N. Zabolotsky reflected this moment very figuratively in one of his poems:

"Don't let the soul be lazy, don't take one step away. The soul is obliged to labor both day and night, day and night".

Thus, the new, previously unknown information is a kind of elixir of immortality of all energy-informational entities - matrices, projects, plans, programs of all kinds of material objects of the Universe.

And may we be inspired and sustained by the thought that in the countless changes of sub-identical cycles

In the life activity of the whole Being, we all (and each of us individually, and this depends on his contribution to the harmonization of energy-information processes) can live countless more similar lives, with some variations, conditioned by the evolutionary process of perfection of Everything and Everything.

Literature

1. Pereverzev D.A. "Some reflections on the Universe, its laws and our Worldview". // Energy-formation and intellectual-spiritual activity of the Universe and our Worldview. - Collected Works of the city-wide seminar at the Kharkov House of Scientists (1997-2004). -Kharkov, 2004. - 279 c.

2. Pereverzev D.A. "On the state of our Worldview at the turn of the 2nd and 3rd millennia". // Energy-informational and intellectual-spiritual activity of the Universe and our Worldview. - Collection of selected works of the general seminar at the Kharkov House of Scientists (1997-2004). - Kharkov, 2004. - 279 c.

3. Krivolutsky A.E. "Blue Planet." - Moscow: "Mysl", 1985. - 336 c.

4. Tomilin A.N. "Zanimatelno o astronomii". - Moscow: Molodaya Gvardiya, 1970. - 304 c.

ON THE FORMATION AND DEVELOPMENT OF TRADITIONAL ENERGY OF MANKIND

Д. А. Pereverzev

According to modern philosophical ideas [1,4], the life activity of the infinite, comprehensive and eternal (infinite in time) Universe is conditioned by the triad "information-energy-consciousness" in subtle sub-stantional worlds (interstellar spaces) or by the triad "matter-energy-consciousness" in denser (including grossly material) substances.

It should be noted that earlier it was reflected in various religious and philosophical doctrines of mankind (Trinity in Christianity, triads in Hegel's philosophy, etc.).

In these triads, consciousness is the organizing and controlling component. This, of course, applies to all objects of the Universe, including man. Here, consciousness is understood as creative knowledge; knowledge is mastered and actively used information; creative information is the creative act of creating new information and its exchange with the surrounding world. In- formed means armed, comprehensively informed means comprehensively armed, i.e. creative omnipotent. And these are already the possibilities of the Almighty Demiurge-Creator, a human being in essence becomes God, who he was originally destined to become (created in the image and likeness of God).

Thus, consciousness is an operational energy-information system located in the aura and encircling the whole human body, i.e. connected with all its cells, forming and controlling human life activity with fantastic speed. The brain is only

A transmitting system, a transmitter, like a radio or television set.

Out of seven known intellectual-spiritual shells of a human being, consciousness is concentrated in the first three or four, subconsciousness - in the last three, where the Universal data bank (holograms of the Universe) is deposited; this is what we call the soul, which after a person leaves the physical world and is replenished with the achievements of his life, is injected into the Universal Energy and Information Field.

In the process of evolution of all Being, the Universe strives for harmonious interaction of these three basic hypostases. Among them, energy most clearly reflects (and provides) the vital activity of all objects in the micro- and macrocosm of the Cosmos. At the same time, the imbalance in receiving and mastering energy-information flows leads to significant shocks in the Universe, including on the Earth, in its biosphere and in the human organism. Explosions of stars (supernovae), collisions of planets with comets and asteroids, etc. are a clear confirmation of this. On Earth, energy-informational distortions lead to volcanic eruptions, earthquakes, floods, hurricanes, etc., most of which are avalanche-like and therefore difficult to control.

In the human body, the lack or inordinate use of energy leads to various physical and, most dangerously, mental illnesses. The same can be said about peoples, their communities, states and even civilizations, in which energy-informational imbalances manifested themselves (appearance of maniacal dictators; growth, prosperity and fall of once powerful empires, such as Roman, Byzantine, Arab Caliphate, Ottoman-Turkish, French, Russian, German, etc.).

Nowadays, due to the sharp increase in the speed of evolutionary processes on the Earth, there is an ever more urgent need for the growth of energy production and consumption, which, at the same time, leads to the strengthening and sharp manifestation of the above-mentioned negative processes. This is clearly manifested in the appearance of numerous homicidal maniacs and kidnapers of young women and children, in wars and confrontations between states for the possession of energy resources, energy carriers, producing and supplying energy systems.

The recent wars of the United States and its allies against Iraq were not primarily aimed at fighting terrorism, but at seizing the world's richest Iraqi oil reserves, which they achieved, albeit at a very high cost. They are trying to achieve the same goal with regard to Iran, assuring the world public about the danger of Iran's allegedly increasing nuclear armament, which, given its weak scientific and technological capabilities, is hard to imagine.

Taking into account that energy is the main driving force and the most visible manifestation of the vital activity of the Cosmos, including mankind (in fact, energy, Cosmos, and mankind are identical concepts), the round table of the seminar was organized on the theme "On the energy of the Earth's mankind in the past, present, and foreseeable future"; and the present article is a certain generalization of the results of the reports of the round table participants.

Here, energy is understood as the organization of production and consumption of various types of energy - thermal, mechanical, electrical, etc., including spiritual and moral energy.

Since primitive times, man, in order to survive, has had to obtain and utilize the minimum amount of energy necessary through the heat of the hearth and food from fruits

It was mainly elastic potential energy that was stored and utilized through the muscular system of humans and, later, domesticated animals. It was mainly elastic potential energy, which was accumulated and utilized through the muscular system of humans and, later, of domesticated animals. Later, the elastic potential energy concentrated in the wood of trees and animal veins, including in various weapons for hunting and warfare (bows, slingshots, wall-breaking weapons, etc.) also became widely used in primitive energetics.

Weapons for the destruction of one's own kind, which have emerged on this basis, are rapidly improving, realizing the best technical and intellectual achievements of mankind. Wars from ancient times (and to this day) had (and still have) the main purpose of conquering by tribes, peoples, states a new living space rich in energy resources and energy carriers (forests rich in animals; lakes and rivers rich in fish; pastures for livestock, etc.), including for the subjugation and slavery of various tribes and peoples. Slavery in those distant times was almost the main direction in obtaining cheap and efficient energy. As is known, it was slave labor that created ancient, once prosperous human civilizations - Egyptian, Middle Eastern, ancient Greek, Roman, Inca and Aztecs in America, etc. The slave labor was the main source of cheap and efficient energy.

The further acceleration of the evolution of human society was largely due to the increase of its energy capabilities through the increasing development and use of the energy of rivers (hydropower) and air currents, the practical realization of which was possible with the tremendous accompanying advances in mechanics, embodied in the industrial sector.

In the Middle Ages (manufactories, water mills, sailing ships, etc., etc., etc.).

The end of the Middle Ages and the beginning of a new period of development in the history of mankind is associated with the development of water steam energy in the last third of the 18th century, which, with the use of steam engines such as J. Watt's and I. Polzunov's, dramatically increased the energy capacity of human civilization in all branches of its activity. But even then it was noticed that this was accompanied by significant environmental pollution, which at first was not paid any attention to.

With good reliability of steam engines, their efficiency factor reached no more than 10%, i.e. only 10% of fuel energy was used to produce useful power (useful work on steam locomotives, steam ships, industrial enterprises, etc.), the remaining 90% of this energy was emitted into the atmosphere, polluting it with fuel combustion products. But due to their reliability and unpretentiousness in fuel (peat, coal, firewood, garbage, etc.), autonomy (independence from other sources of energy production) these heat engines are not expedient to write off completely, at any moment of a long emergency state of energy systems they can be useful. It is not without reason that many steam locomotives are mothballed and still remain in the strategic reserve.

In the last quarter of the 19th century, more than a hundred years after the appearance of the steam engine of J. Watt (1773), a whole family of thermal machines of various types was created, which became the main primary engines for the production of thermal, mechanical and electrical energy in large (power plants), transportation (aviation, shipping, cars, locomotives, etc.), and other industries.

These machines have been used in small-scale power generation (in metallurgy, chemical and sugar industries, etc.) throughout the 20th century and are likely to remain so until the end of the 21st century. The inventors and creators of these machines were:

- Frenchman Etienne Lenoir created the first practical internal combustion engine (d.h.c.) in 1860;

- German designer N. Av. Otto created a 4-stroke gas-powered d.h.p. in 1876;

- German engineer Rudolf Diesel created a d.v.c. named after him in 1897;

- Swedish engineer Gustav Laval built the first active steam turbine in 1889;

- In 1884, Englishman Charles Parsons invented and built a multi-stage jet steam turbine, which played a major role in the development of energy.

In 1939-1940, the Soviet scientist-turbine builder, Professor Vladimir Makovsky created a 736 kW (1000 hp) gas-turbine engine. Its model is still standing at the Department of Turbines of the Kharkiv Polytechnic Institute. After the Patriotic War engines of this type within several years (5-10 years) found the widest application in large aviation (military, passenger, transport), which, thanks to them, mastered supersonic flight speeds. Auxiliary aircraft (used in agriculture, forestry, and training), as well as helicopters still fly with carburetor-type d.h.p. engines.

D.V.S. remain in service in road transport, in ships of small tonnage and on diesel locomotives of railway lines in inaccessible areas; on wide highways they are known to have been replaced by electric locomotives.

The main fuel here is coal (or its gasification products), petroleum products, and oil refining products.

(gasoline, kerosene, diesel oil, fuel oil), gas.

Since 1956, after the launch of the first nuclear power plant in the Soviet Union (Dubna), nuclear power has been playing an increasing role in the energy sector of mankind. In some countries (France, Ukraine, etc.) nuclear power plants generate more than half of the electricity consumed there. This trend is steadily continuing despite the attempts of some countries to suspend construction of NPPs due to the fear of accidents and radiation contamination like Chernobyl. Large tonnage vessels of the civil and naval fleets, mainly powerful military submarines, are also being intensively equipped with thermonuclear power units. The main fuel here is nuclear fuel burned in the fuel elements of nuclear reactors.

In most of these power plants, no more than one-third of the fuel energy is utilized, and about two-thirds of it is uselessly emitted into the atmosphere, resulting in significant thermal, chemical and dust pollution that significantly worsens human health. The resulting environmental problems already require immediate solutions.

Emissions from transportation power plants are increasingly beginning to prevail over power plant emissions due to the dramatic increase in the number of vehicles. Already now the installed capacity of cars is significantly higher than the installed capacity of power plants. But energy production is still not yet feasible, as power plants operate continuously, sometimes for years, whereas in transport they operate for hours, days or months.

One of the most cardinal ways of solving the above-mentioned environmental problems is to increase the efficiency of power plants, i. e. to increase their efficiency.

reducing the share of wasted fuel energy. Unfortunately, in Ukraine, due to the sharp reduction in electricity generation over the last 15 years, the solution to these problems is increasingly being put on the back burner.

According to forecasts [2 et al.], over 20 years (from 1990 to 2010), electric power generation on the Earth should increase more than 2-fold, while the Earth's population increases 1.31-fold, i.e. specific energy consumption per person is increasing at a faster rate, so it is necessary to forecast the prospects of resource saving for present and future generations. Moreover, in the current year 2007, electric power generation on the Earth should amount to about $2.0 \cdot 10^{13}$ kWh, and the installed capacity of energy installations should reach, respectively, $2.3 \cdot 10^6$ MW (with the Earth's population of about 6.7 billion people), of which the share of Ukraine is $4.9 \cdot 10^4$ MW with electric power generation of about $430 \cdot 10^9$ kWh=430 billion kWh.

Currently, the installed capacity of power plants and other energy facilities in Ukraine is about $5.3 \cdot 10^4$ MW, which is close to the forecast [2]. However, it was installed back in Soviet times. However, it is used less than half, often by one third, only about 190 billion kWh is generated, so in 2007 it is planned to generate only 194 billion kWh of electricity. This is explained by the fact that Ukraine practically stands the entire machine-building industry (you can judge by Kharkov, almost all factories are standing!).

But apartments in new buildings are extremely expensive and are not affordable for the majority of the population; therefore, these buildings are less than half occupied. But there is a lot of unrighteous looted money accumulated, and it has to be dealt with in one way or another.

to realize. This is why there are distortions in the development of Ukrainian industry, such as the construction industry.

"The country's leadership loudly proclaims GNP growth of 7%. What such distortions lead to was already mentioned at the beginning of this article-report.

As the analysis of the world energy sector, including the Ukrainian one, shows, until the end of the current century, thermal turbine units will remain the main primary engines for the production of thermal, mechanical and electrical energy in large, transport and small-scale power generation. No serious alternative to them is foreseen for the time being.

At the same time, the last 10 years of operation of Ukraine's large energy sector have shown that there are no alternative power units that can seriously compete with steam-turbine units of TPPs and NPPs with the capacity of 300, 500, 800 and 1000 MW in terms of solving the problems of preserving and, moreover, increasing the energy capacity of Ukraine. It also seems reasonable to equip specialized TPPs with gas-turbine (including cogeneration) and steam-gas power units when zoning the production and use of electric and thermal energy, which can be used in combination with powerful TPPs also to carry semi-peak and peak loads of energy systems.

Therefore, a cardinal solution to the problems of energy and material saving, ecology, and further economical and reliable increase of energy capacity and well-being of the state depends first of all on the efficiency and reliability of the energy units under consideration.

In recent years, the works [3 and others] have identified opportunities to improve energy efficiency.

of thermal power plants in Ukraine, equipped mainly with powerful steam turbine units, and in the future also with gas turbine and combined cycle gas turbine units (CCGT, GTU and CCGT).

It is shown that at rational choice of places and parameters of steam withdrawals, designs of heat exchangers and structure of regeneration system the net efficiency (electrical efficiency) of powerful condensing steam turbine power units (300-1000 MW) with already mastered supercritical steam parameters of 24 MPa and 540-560 C can be brought up to 45%. °

Under the same conditions in powerful combined heat and condensation steam turbine power units, the coefficient of useful utilization of combusted fuel heat can reach 88%, where the share of electric power generation (net efficiency) will be about 37%. It is also expedient to use such units as autonomous sources of electricity and heat energy (independent from the general energy system of the country) to support the life of a large city (district, region, etc.).

In perspective powerful condensing steam turbine power units with supercritical initial steam parameters of 30-40 MPa and 650-750 C the net efficiency can reach 50% and more.

In high-temperature cogeneration GTUs and CCGTs (with initial gas temperature of 1300 C and higher and cooling of the first stages of turbines) with rational use of heat exchange equipment the coefficient of useful utilization of fuel energy is 82-85%, where net efficiency will be at the level of 40% in GTUs and about 52% in CCGTs. These plants can also be widely used for local economical and reliable supply of electric and thermal energy to different areas (cities, towns, cities, etc.).

The main goal of the program is to improve the quality of life of our country.

Thus, in all the considered power plants with different working media, with all the variety of their initial parameters, the net efficiency in principle can be brought up to 50% (in one case by rational use of heat-exchange equipment, in the second case by increasing the initial parameters of working media, in the third case by combining the first two, etc.). In plants for combined generation of electric and thermal energy, the fuel energy utilization factor can reach 82-85%.

In addition to all of the above, it should be added that up to 15-20% of energy is lost in our power lines on the way from power plants to consumers. And this is also one of the most important sources of thermal pollution of the atmosphere and at the same time it is a significant source of energy-saving and a possibility of significant increase of the country's energy capacity if these losses are reduced to 5%, which is maintained in the power lines of Western Europe, the USA and Japan.

Consequently, the above-mentioned possibilities of increasing the efficiency of power plants do not eliminate emissions of more than 50% of fuel energy into the atmosphere when producing only electric energy and about 15% when producing electric and thermal energy at the same time; moreover, due to the relatively warm climate of Ukraine, the first type of plants prevail in our country. Even today, power plants and automobiles strive to install effective means of protection against harmful emissions (filters, chemical agents, etc.), which, despite large material and financial costs, is not always achieved.

New, alternative sources of energy are needed to enable humanity to fully utilize its energy resources.

These sources were described in other reports of the Seminar Roundtable, which are also reflected in the pages of this volume. These sources were discussed in other presentations at the Seminar Roundtable and are also reflected in the pages of this volume.

One of the main directions of the traditional energy of mankind is its spiritual and moral energy. Since ancient times, chants and dances, theatrical spectacles, public forums, religious rites and services, festive processions and caravals, sculptures of gods and ancestors, drawings on rocks and walls of inhabited caves, etc., have created a special environment-aura (nowadays we sometimes say energy-information field - egregor), elevated human life activity and increased its efficiency.

The great creators of brilliant works of architecture, literature and art (music, painting, sculpture) transformed and accumulated inexhaustible spiritual and moral energy from the world around them. Everyone who interacted with these works through reading, visiting museums and theaters, felt and experienced the tides and the beneficial healing influence of this energy. It is not without reason that these works are of immense and growing value over the years. In fact, they are priceless. They should be preserved in museums in the form of holograms, which remain stable formations for a long time, hundreds of years. But holograms are not eternal; like paintings and other works of literature and art, they should be periodically renewed-restored and exhibited so that there is a continuous exchange of spiritual and moral energy between them and visitors.

Now about the role of temples in the spiritual and moral energy of mankind. In all earthly religions it is exceptionally great. After all, temples create a powerful energy-in-

The most obvious manifestation of this is in Catholics and Orthodox Christians. This is most evident among Catholics and Orthodox Christians.

Orthodox and Catholic churches are powerful accumulators of spiritual and moral energy, which has a beneficial effect on the souls of believers. Through their spire-antennae there is a mutual exchange of this energy with the surrounding space, which ennobles it. It is well known that skillfully located and skillfully built churches decorate nature, both rural and urban, and give inexpressible charm to the surrounding landscape, which has a healing effect on the human body and soul. This is especially evident in Orthodox churches, which is clearly shown in the paintings of many famous Russian artists (V.D. Polenov, K.P. Klodt, K.P. Vasilkovsky, etc.).

Through these possibilities of receiving spiritual and moral energy, we most fully perceive Love, Goodness and Beauty, which act in an indissoluble triunity (triad) as the fundamental harmonic triple rhythm (pulsation) of the life of all Being.

The above information was summarized in the form of Table 1, reflecting the formation and development of the energy sector in the process of change of historical formations of human society. Here we used mainly the traditional, historically established by the present time classification of the change of social human formations.

Table 1

Energy in the process of change and development of social human formations

N o. n/ a	Social order, form. Type of energy. Energy resources, energy carriers. Achievements in the energy sector	Historical Periods, duration
1	2	3
1.	<p>The primitive communal system.</p> <p>Muscle energy of humans and domesticated animals.</p> <p>Sources of energy: energy from the sun - fruits of plants and meat of animals, birds and fish; eggs of birds; honey of bees, etc.</p> <p>Achievements of energy: hearth heat and cooking through harnessing the energy of fuel - wood, coal, oil, gas.</p> <p>Spiritual and moral energy: chants and dances; drawings on rocks and walls of inhabited caves</p>	<p>100-10 thousand years BC.</p> <p>90 thousand liters.</p>
2.	<p>The communal slave system.</p> <p>The muscular energy of man, enhanced by the energy of slaves, is preserved and developed.</p> <p>This energy creates the great ancient civilizations - Egyptian, Middle Eastern, ancient Greek, Roman, Chinese,</p>	<p>10,000 BC.</p> <p>400 l. AD.</p> <p>10.4 thousand lit.</p>

3	<p>Feudal-monarchical Middle Ages and Renaissance.</p> <p>Muscle, wind and hydro power, mostly slave-less, air and water currents energy is widely used.</p> <p>Sailing, great geographical discoveries.</p> <p>Windmills and water mills, the development of manufactories with extensive use of mechanics (Leonardo da Vinci, Michelangelo, Francis Bacon, Roger Bacon and others). Industrial achievements of the Renaissance era.</p>	<p>400-1650 BP. 1250 years.</p>
---	---	-------------------------------------

	<p>The development of metallurgy, iron and copper foundries; the appearance and widespread use of light and heavy firearms (rifles, pistols, cannons, etc.) from the 15th century.</p> <p>First bourgeois revolutions (Netherlands, England).</p> <p>Spiritual and moral energy of the Renaissance: great achievements of literature and art, architecture (temples, palaces), sculpture, painting (Petrarch, Dante, Shakespeare, Lope de Vega, Leonardo da Vinci, Michelangelo, Rubens, Rembrandt, Velázquez, Raphael, etc.).</p>	
4	<p>Feudal-monarchical states in the late Middle Ages and early modern times</p> <p>Muscle, wind and hydro power, the beginning of thermal power.</p> <p>Energy resources: human and animal muscles, water and air flows, the beginning of water vapor energy utilization.</p> <p>Energy carriers: human food from plant fruits and animal flesh; all then known fuels, etc.</p> <p>Development of: metallurgy - iron-mining and iron foundry industry, forge-</p>	1650-1773. 123 years.

	<p>The first of these is the manufacture of iron and steel products, including weapons.</p> <p>Achievements of spiritual and moral energy: great architectural creations in France and Russia (palaces and temples of B. Rastrelli, Versailles, Louvre, Notre Dame, etc.), literature, art and philosophy (Molière and his theater, Voltaire, French encyclopedists, Montesquieu, Jean-Jacques Rousseau, music, etc.). Bach and Handel, etc.).</p>	
5	<p>Constitutional monarchies, republics and empires of the new times (England, France, Sweden, USA; Russian, Austro-Hungarian, French and German empires, etc.).</p> <p>Muscle power, wind and hydro power, heat power with wide application of steam engines as primary engines in all industries of the most developed countries.</p> <p>Energy carriers: the same as in the previous historical period.</p> <p>Rapid development of maritime and railroad transport, shipbuilding - steamboat building, steam locomotive building, all branches of industry</p>	<p>1773-1893. 120 years. The age of steam engine dominance in power generation</p>

	<p>heavy and light industry. Achievements of spiritual and moral energy: Geniuses of literature and art, architecture, sculpture, religious and philosophical thought in Russia, France, Italy, Austria-Hungary and Germany (works by Pushkin, Lermontov, Gogol, L.N. Tolstoy, Balzac, V. Hugo, J. Sand, J. Verne and others, music by Mozart, Beethoven, J. Verdi, J. Bizet, Tchaikovsky, Rimsky- Korsakov, Mussorgsky; paintings by itinerant artists; religion - theism, deism, pantheism; philosophy - idealism, materialism, atheism, Marxism, Leninism; philosophers - Kant, Hegel, Feuerbach, Marx, Engels, Lenin and others).</p>	<p>Golden Age of Russian Literature</p>
<p>6</p>	<p>Constitutional monarchies, empires, republics and socialist countries. Muscle power, wind and hydro power, heat power with wide application as primary - internal combustion engines (carburet- In some cases, steam engines are also used.</p>	<p>1893-1940. 47 years old Time of dominance of internal combustion engines (ICE) in the energy sector</p>

	<p>Energy resources - energy carriers: air and water currents, coal, petroleum products (gasoline, kerosene, fuel oil, solar oil), peat, firewood, gas.</p> <p>Automobile and airplane construction for civil and military needs, as well as necessary military equipment (tanks, guns, etc.) are rapidly developing.</p> <p>Achievements of spiritual and moral energy: creation of outstanding works of literature and art, world-famous dramatic and opera theaters, cinemas and their productions (works of A. Blok, Korolenko, Gorky Bunin, Kuprin, Veresaev, A.N. Tolstoy, etc., productions of theaters - the Bolshoi, Khudozhestvo, and others.</p> <p>The great pre-war films and their music by Dunaevsky and Shostakovich; Soviet songs by I. Dunaevsky and M. Blanter, etc.).</p>	<p>The Silver Age of Russian Literature</p>
7	<p>Constitutional monarchies, republics and countries socialism.</p> <p>Muscle power, wind and hydropower, thermal and nuclear power; the main primary engines here are: steam and gas engines.</p>	<p>1940-2007. 67 years old</p>

<p>turbines, and steam boilers and combustion chambers are the generators of working media; internal combustion engines (ICE); hydro- and wind power account for no more than 5-7% of the total energy sector, where the primary engines are wind motors and hydro turbines.</p> <p>The following are rapidly developing: shipping and motor transport, civil and military aviation, submarine fleet, especially nuclear, all energy and machine-building industries, computer-computing and information and information technology (Internet, mobile communication, TV broadcasting, radio, etc.).</p> <p>Achievements of spiritual and moral energy:</p> <p>Restoration and construction of churches in Russia.</p> <p>Creation of outstanding works of literature and art (works by K. Simonov, M. Bulgakov, K. Paustovsky, A. Belyaev, M. Isakovsky, A. Tvardovsky; music C. Prokofiev, Dunayevsky, Dmitri Shostakovich and G. Sviridov; songs by M. Blanter, M. Fradkin, V. Solovyov-Sedogo, A. Pakhmutova and others).</p>	
--	--

There are seven energy time layers from primitive man to the civilization of our days, embedded in each other like matryoshka dolls, similar to the subtle human bodies, which, according to esoteric ideas and modern science of bioenergoinformatics, are also seven (physical, etheric, astral, mental, casual, budhical and atmic bodies) [5]. This is a significant moment testifying to the predetermination of such a development of the energy of mankind.

The initial, starting point here is the original muscular energy, which activates the energy objects of all subsequent time layers, namely: by pressing a button, by the action of hands or by voice through a radio transmitter - this is already the action of the muscles of the vocal cords, etc., etc. Modern man (perhaps with very rare exceptions) does not yet possess telepathic, mental influence, which sets in motion the objects of technogenic industry. And yet there is a branch of human energetics where mental telepathic influences play a significant role - it is spiritual and moral energetics, which, as it was mentioned earlier, is undoubtedly traditional. But even here such a gift is possessed only by selected creators-artists.

The ever-increasing speed of evolution and the corresponding development of energy have led to the fact that over the last decade there has been a sharp qualitative leap in the development and use of various energy-information processes due to the creation and widespread use of the necessary computer-computing and information-intelligence equipment (all-planet computer network - Internet, mobile communication, television, radio, etc.). In fact, humanity is now on the verge of mastering and using information

and energy of the Universal energy-information field. It can be expected that a large-scale practical connection to it will take place during the 21st century. It should be noted that in the past there have probably already been single connections, presumably realized, in particular, by N. Tesla. Allegedly, his energetic influences on the surrounding space led to an unstable vortex plasma formation (energy-information vortex), which disintegrated with the release of tremendous energy in 1908 and was declared the Tunguska me-theory.

If it is possible to get energy and information from this inexhaustible Universal energy-information accumulator, then it will not be necessary to create spaceships with sublight and FTL speeds to explore the vastness of the Universe (in fact, it is impossible, even if the notorious "twin effect" is realized, which does not really exist, it is a great scientific hoax of the 20th century, on the basis of which dozens of science fiction novels were created). It will be enough to turn to the Universal Internet and Universal mobile communication to receive, use and exchange information with everyone, including the most remote corners of the Universe. That is when the human consciousness will truly approach the level of the Consciousness of the Universal Creator, and he (man) will become his companion, his co-creator in all his deeds and thoughts, fulfilling his destiny prepared for him by the Creator.

And here the most part of information (but not energy!) a person can receive from himself, as he is a hologram copy of the Universe [4,5].

The next thing to consider is whether modern man is ready for such a transition in such a short historical period, to which evolution has brought him. Intellectually and psychologically, yes. But physically and spiritually

morally, probably not. Fred Hoyle has a science fiction novel "Black Cloud", where the hero, a brilliant scientist, dies from the inability to digest the unimaginably huge amount of cosmic information that has fallen on him. Unfortunately, the modern Internet and mobile communication are mastered and effectively used first of all by criminals and terrorists, and these processes, naturally, cannot take place without reasonable influence of power structures protecting them from bazaar-market and, especially, criminal elements.

There is a centuries-old belief that man will get closer to God if he becomes different, perfect in every way. But then his development and evolution would be abandoned, which will never happen. All kinds of difficulties, including catharsis (purification by suffering), are part of the evolutionary process, through which our souls are renewed and enriched. This is the eternal renewal and development of the eternally existing Universe.

On the way of our rapprochement and merging with the Universal energy-information field, shocks and evolutionary leaps (law of fluctuations) are possible, for example, collisions of the Earth with large asteroids or comets. Mankind should be prepared for them, mitigating or completely eliminating them with the full power of its energy-informational influences. That is the only way. Through thorns to the Stars! We have no other way. We must be ready for it always and everywhere.

Literature

1. Pereverzev D.A. "On the state of our Worldview at the turn of the 2nd and 3rd millennia". // Energy-informational and intellectual-spiritual activity of the Universe and our Worldview. - Collected Works of the General-

The workshop at the Kharkov House of Scientists. - Kharkov, 2004.

2. Seminozhenko V.P. "Energy and life, ecology and future". / V . P. Seminozhenko, P . M. Kanilo, A.I. Rovensky. - Kharkov, "Filio", 1997. - 176 c.

3. Pereverzev, D.A. "About the Possibilities of Increasing the Eco-Economic Efficiency of Turbine Units at the Thermal Power Plants of Ukraine". / D.A. Pereverzev, A.L. Shubenko // Improvement of turbine units by methods of mathematical and physical modeling. Collection of scientific works. - Kharkov: IPMash of NAS of Ukraine, 2003. - C. 12-17.

4. Tikhoplav V.Y. "Physics of faith". / V.Y. Tikhoplav, T.S. Tikhoplav. - ID. All. - St. Petersburg, 2002. - 256 c.

5. Tikhoplav V.Y. "Life for rent". / V.Y. Tikhoplav, T.S. Tikhoplav. - ID. All. - St. Petersburg, 2002. - 256 c.

AS THEY WERE DISCOVERED POLARIZATION WAVES OR THE END OF RELATIVITY WORLDWIDE

N.D. Kolpakov

1. ANOMALOUS PHENOMENA AWAITING IDENTIFICATION

1.1. The achievements of theoretical physics are modest, to put it mildly, against the background of technological progress. The temporary official physics (universe relativism) is unable to explain many phenomena observed in nature: biological memory of living beings (birds, fish, insects, etc.), telepathy, tele- and psychokinesis, poltergeist, ball lightning, Kozyrev's astronomical effect, etc.

In recognition of this failure, they are called anomalous.

In this interpretation, the main fundamental interaction - gravitation - was among the anomalous ones, since its nature and mechanism were not revealed. But the matter is not only and not so much in the nature of gravitation fields, but in the fact that gravitation is the basis of cyclic motion of the Universe matter and stability of this motion, and since the nature of gravitation could not be revealed, doubts appeared in the possibility of cognition of the Universe by the human mind. On the other hand, these doubts were the basis for the assumption of the possibility of existence of phenomena that have no scientific justification (the twin paradox, teleportation).

1.2. At the same time, there is already a theory of the Universe created on the basis of the discovery of polarization waves [1- 4,7,8]. The main provisions of this theory have already been experimentally verified [5,6]. In this way "anomalous" phenomena are identified (transferred either into the category of "normal" or into the category of hypotheses that have no scientific basis).

It is therefore no longer necessary to begin the presentation of views on the science of the universe with the century-long debate on the validity of the relational theory.

First, let us outline the essence of the new theory. We will call it polarism after the name of its progenitor (the theory of polarization waves), and we will pay attention to the relativism of the Universe based on the theory of relativity, which has possessed the minds of the scientific community for a century, at the end of the article.

2. AETHER - MATERIAL ELECTRICALLY FIELD-RIZABLE MEDIUM

2.1. Since the postulative approach to the study of the foundations of the universe (universe relativism), which requires experimental verification of the postulates, has not achieved its goal, the author decided to start its study by analyzing the already established positions.

2.2. After Galileo-Newton, the most significant development in physics was the empirical creation of electrodynamics (Maxwell's equations) by Faraday-Maxwell.

It follows from Maxwell's equations that the original essence of the universe is a material electrically polarizable medium, the aether.

Indeed, by differentiating both parts of Maxwell's equation for the "free" space

$$\text{rot} \vec{H} = \varepsilon_0 \partial \vec{E} / \partial t, \quad (2.1)$$

we obtain that

$$\text{div}(\varepsilon \vec{E} / t) = \partial / \partial t (\text{div}_0 \vec{E}) = \partial \rho / \partial t = 0,$$

ρ - the average density of electric charges in the electromagnetic field carrier (Maxwell's equations are macroscopic).

But, since the only source of magnetic field are moving electric charges, then at neutrality in the medium it is possible only at its electric polarizability.

In other words, the vacuum is a material electrically

polarizable → polarizable → medium. Then

$$\varepsilon_0 \vec{E} = \varepsilon \vec{E} \quad (2.2)$$

- electric polarization of vacuum, and ε_0 - its polarizability.

A possible model of the structure of vacuum follows from the same (the specific model is not so fundamental): it is a gas of neutral particles (called amers) in which larger electrically polarizable particles (called polars) are embedded.

Polars are dyads of nested vortex toroids of the same americ gas. Note that this representation is consistent with the theory of the Universe formation - the "Big Bang" theory: after the Universe formation, only the most stable (according to Helmholtz) primary formations in the form of vortex toroids remained in space. According to Helmholtz, vortex toroids in an ideal gas live forever, and any deviations from ideality reduce their lifetime.

The parameters of the vacuum (ether) are quantitatively estimated from the above provisions taking into account other observed phenomena [1,2].

Polar mass m_p , its diameter d_p , average distance between polars a_p , equivalent electric charges of toroids in the polar Q_p are determined, respectively, from the known densities of matter, the phenomenon of anomalous magnetic moment of the electron and the phenomenon of dissociation of the vacuum. The following table summarizes the following table rows.

The natural frequency of the polar is determined from the condition of the unified nature of all fundamental forces - mechanical (by equating mechanical and electric forces in the polar) [1,2].

2.3. Clearly obtained ideas about the vacuum structure are illustrated by the charge-discharge mechanism of an electric capacitor.

2.3.1. The electrical capacitor is one of the most widely used elements in electrical engineering. It is well-studied theoretically, empirically understood, and can therefore be used to substantiate the fundamental characteristics of nature and the dynamics of the universe, such as the ether, electric charge, electromagnetic field, etc.

2.3.2. In general, an electric capacitor is a device for accumulating electric charge. The question immediately arises, what is electric charge?

Modern science knows only a few of its characteristics and has very vague ideas about its nature and structure, so we have to start with what we do know.

In the simplest and quite widely used in practice, a capacitor is two parallel plates-

The conductive material walls separated by an air gap d (Fig. 2.1).

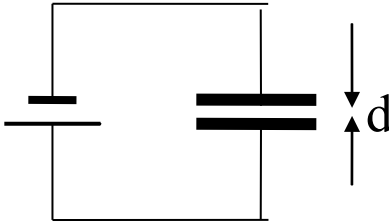

Figure 2.1. Electric capacitor A capacitor is characterized by the amount of charge Q , that he can store up in himself. In the case mentioned.

$$Q = CU, \tag{2,3}$$

C -capacity of the capacitor,

U is the voltage between the plates of the capacitor,

$$C = \frac{S}{d} \epsilon_0,$$

S is the area of the plate,

ϵ_0 - dielectric

permittivity

of the "free" space.

2.3.3. In the case of placing a dielectric between the board-
The capacitance of the capacitor increases by ϵ_r a factor of one

$$C = \frac{S}{d} \epsilon_0 \epsilon_r, \tag{2.4}$$

ϵ_r - relative permittivity

dielectric.

2.3.4. The mechanism of capacitance increase in this case is dielectric polarization. But, as can be seen from relations (2.3, 2.4), the dependences of the capacitors' abilities to accumulate electric charges in the first and in the second case differ only quantitatively in *r-fold* ϵ

Since the mechanism of charge accumulation in the dielectro-
In both cases, the polarizable media are dielectrics, in other words, "free" space (ether) has the properties of a dielectric with polarizability ϵ_0 .

Naturally, the same conclusion ϵ_0 we obtained above through the an analysis of Maxwell's equations.

2.3.5. The mechanism of charge accumulation in a capacitor also leads to even more profound ideas about the fundamental characteristic of the Universe - the nature of electric charge.

Indeed, when charging a capacitor (say, from a dynamo), the weight of the source charge exciter does not change, i.e. the exciter does not transfer any material sub-station to the capacitor.

But the charge carrier is material. So, charge, matter is formed from the material of the environment - ether. The dynamo machine only excites this process of charge formation.

This is the answer to the eternal question: What was the world created from? It has always existed, only in a different state, in a different form. As for the mechanism of "creation", its initial prerequisites have already been stated above: after the big bang, only stable particles in the form of vortex toroids and americ gas remain in space. Interacting with each other, the vortex toroids stick together.

The dyads (polars), triads, etc., up to the formation of matter particles (electrons, protons, etc.).

So what is electric charge? It is one of the structural forms of the ether state. And the seemingly "anomalously" large value of the charge of ball lightning is explained.

3. POLARIZATION WAVES ARE MATTER WAVES

3.1. The carriers of the property of electric polarizability of the ether are polars.

Being under the influence of the thermal motion of the surrounding ether, polars, being resonators, cannot but oscillate and thus perturb the surrounding americ gas - excite "sound waves" in it. The energy of polar oscillations is transmitted to neighboring polars through the chains of the virtual lattice of the ether. The waves appear in the ether, which, as noted above, are called polarization waves after the name of their parent (polarizability of the ether). The stationarity of polar oscillations is maintained by the energetic influence on them of the thermal motion of the americ gas. [3].

Polarization waves are thus a manifestation of the existence of life, of the evolution of matter in its lowest state, i.e. in the state of prima-matter. These are the waves of matter.

3.2. The equivalent scheme of the chain of polars of the virtual lattice of the ether is shown in Fig. 3.1 [1, 2], and the corresponding equation of motion of polarization waves taking into account the interaction of polars only with the nearest neighbors has the form:

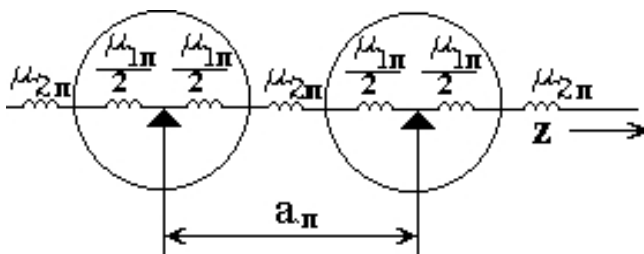

Fig. 3.1 Model of vacuum medium in which P-waves propagate

$$\left(\frac{\partial^2}{\partial z^2} - \frac{1}{v_{ET}^2} \cdot \frac{\partial^2}{\partial t^2} - \mu_0^2 \right) q(z,t) = 0, \quad (3.1)$$

$$v_{ET}^2 = a^2 \omega_{PF}^2 k_{CB}, \quad \mu_0^2 = 1/(a_{\pi}^2 k_{SV}) \quad (3.2)$$

with the law of dispersion

$$\omega_k^2 = v_{ET}^2 (\mu_0^2 + k^2), \quad (3.3)$$

$k = 2\pi m / (a_P N)$ - wave number,

N - number of polars in the half-period of the process, with group and phase velocities

$$V_{PC} = v_{ET} k / (\mu_0^2 + k^2)^{1/2}, \quad (3.4)$$

$$V_{FC} = v_{ET}^2 / V_G \quad (3.5)$$

As can be seen from relations (3.1-3.2) and, accordingly, the content of [1-3], the properties of polarization waves are completely determined by the aether parameters m_n, d_n, Q_n, ω_n

At the same time, special mention should be made of properties that are very important in their applications:

(a) The group velocity of polarization waves is not limited by the speed of light and exceeds it by billions of times

times = 10^{28} m/s);

(V_{II}

(b) Polarization waves are excited at resonant frequencies of the ether, which ensures their low attenuation, and the high frequency of oscillations ($\omega_{II} = 10^{48}$ rad/s) - their high capacity as information carriers;

c) The resonance of polarization waves with the proper frequencies of the Ether ($\omega_{III} = \omega_{II}$) determines the nature of fundamental forces and anomalous phenomena, their energy-information and the possibility of using the Ether energy through them.

4. CODE AND INFORMATION PROPERTIES OF POLARIZATION WAVES

4.1. First of all, it is necessary to note the special properties of polarization waves - the dependence of the direction of the induced forces in the bodies irradiated by them on the structure of the receiving waves, i.e., their codependence.

It is the directionality of the excited forces toward the center of spherical irradiating bodies caused by their $\frac{1}{R^2}$ - ras-

The stability of the motion of bodies in the solar system and the entire Universe is due to its necessity.

4.2. It is the coding of polarization waves, caused by the spatial inhomogeneity of matter location in space, that causes its local cosmic expansions and contractions.

The equations of motion in this case are justified in a natural way.

4.3. "Anomalous" phenomena, both naturally occurring and artificially induced (poltergeist, tele- and psychokinesis), are caused by specifically targeted

by structural inhomogeneities of polarization waves formed in the areas of manifestation of these "anomalies".

4.5. The frequency spectrum of polarization waves is immeasurably wider than that of electromagnetic waves; this provides, together with an extremely large capacity of communication channels, mutual information, energy interconnectedness and interdependence of evolutionary and life processes of the Universe.

4.6. Extremely high propagation speed and penetrating ability of polarization waves provide the necessary mutual information in real time in the entire space of the Universe.

4.7. The code and information properties of polarization waves are used in living matter and mechanisms of life reproduction in a particularly original way.

The fact is that the structure of DNA does not answer the questions about the nature and mechanisms of its assembly, since the forces that could selectively act on the assembled atoms in the conducting medium of the cell (forces excited by P-waves) were not yet known at the time of the discovery of DNA.

Based on the discovery of polarization waves at the cellular level, these mechanisms are supposedly presented as follows. Temporal information about the beginning of certain processes on the formation of new cells (the process of division) is (presumably) embedded in the frequency of oscillations of polars of the dividing cell nucleus (this frequency due to internal friction in the americ gas of the cell nucleus changes with time).

Information about the frequency of polar oscillations during the formation of a dividing cell is stored in the memory of its nucleus. Comparison of this frequency with its frequency at present

time gives information about the age of the cell. If this age matches the programmed age, a command is given to divide the cell.

This, apparently, can be the basis and explanation of hypotheses about life extension of biological organisms.

5. RELATIVISM OF THE UNIVERSE HAS NO SCIENTIFIC BASIS

5.1. While polarism, as a theory of worldview, is based on empiricism (meaningful experience), worldview relativism is a hypothesis.

Indeed, the theory of relativity, on the basis of which universe relativism is developed, was first put forward by A. Einstein to explain the negative results of Michelson-Morley's experiments in search of the ether. This theory makes the concept of space and time in moving bodies dependent on their relative velocity. It is based on Lorentz transformations, which establish a correspondence between real (classical) spatial and temporal coordinates of moving bodies and some hypothetical quantities (corresponding to them), which A. Einstein proposed to consider as real (relativistic) spatial and temporal coordinates.

$$\begin{aligned}
 x' &= (x - Vt) \left(\frac{1}{\sqrt{1 - \frac{V^2}{c^2}}} \right) \\
 t' &= \left(t - \frac{Vx}{c^2} \right) \left(\frac{1}{\sqrt{1 - \frac{V^2}{c^2}}} \right)
 \end{aligned}
 \tag{5.1}$$

V is the relative velocity of the reference frames, x, t are classical quantities,

x' , t' are relativistic.

5.2. The answer to the question about the adequacy of the Lorentz transformations (and, accordingly, the interpretation of the concepts of space and time) to reality lies a priori in the relations (5.1) themselves: they are even applicable only for matter-free space (i.e. when there is no ether). Indeed, the matter parameters are not even included in the transformations themselves.

5.3. On the other hand, by the time the theory of relativity was formed, electromagnetic fields and their laws (Maxwell's equations) were already known.

And it follows from Maxwell's equations (see para. 2) that the phenomenon of electromagnetic fields is possible only in the presence of electrically polarizable matter as their carrier (i.e., in the existence of the ether), and experiments on the search for the ether were no longer necessary.

5.4. In other words, there is a separated (absolute) reference frame - the ether, and therefore the Lorentz transformations and, accordingly, relativism based on them are not adequate to reality (have no scientific basis).

5.5. The same applies to quantum hypotheses of matter structure. They are based on the same relativistic ideas about space, time and waves of matter. And the concept of wave function introduced by quantum hypotheses (which changes instantaneously in the whole space) is in direct contradiction with the postulate of limitation of velocities to the speed of light recognized by them.

6. INSTEAD OF CONCLUDING

6.1. The doctrine of the universe after Galileo-Newton, then Faraday-Maxwell did not develop significantly....

number.

The properties of vortex toroids discovered by Helmholtz did not find a place in the attempts to unravel the nature and mechanism of gravitation, but they, it turns out, together with the recently discovered properties of electric polarization of the ether [1.2], determine the mechanisms of existence of both inanimate and animate matter, including the mechanisms of excitation of polarization waves.

To be fair, it is necessary to note that the theory of relativity, which has possessed the minds of the scientific community for a century, although it did not achieve its goal (creation of the theory of gravitation), fulfilled its mission by attracting attention to the study of the universe and revealed the need for a deeper interpretation of the achieved results.

6.2. Has the discovery of P-waves had an impact, and what impact, on the development of the science of the Universe? P-waves, being a consequence of the most fundamental property of "free" space - its electric polarizability property, after which they received their name, have essentially expanded and enriched our ideas about the Universe. The main provisions introduced by P-waves have withstood experimental verification.

6.3. The most impressive manifestation of P-waves is, of course, the discovery of the nature and mechanics of gravitation on their basis. This fulfilled Newton's testament addressed to subsequent generations.

But more important, apparently, are the P-waves themselves as the primary excitations of the carrier of the "unified field" - the ether, this hot-bird, which unsuccessfully tried to catch throughout the twentieth century.

Polarization waves revealed the nature and mechanism of fundamental interactions. It turned out that all fundamental interactions have a single mechan-

gravitational forces are a special case of polarization interactions. The theory of gravitation has been created and gravitational forces excited by polarization waves have been experimentally recorded. At the same time, gravitational interactions are microinteractions in structure with respect to other fundamental interactions. Therefore, photons as quanta of the macro-structural field (in relation to the field of P-waves) are quasi-particles of this field, but not particles.

6.4. Polarization waves have expanded our knowledge of the Universe by showing that together with the world of electromagnetic interactions with constants c

(the speed of light in free space), \hbar (Planck's constant) and the elementary particle photon, there is a

a whole world of states of matter with constants $v_{ET} \sim v_{PG}$

($v_{PG} \sim 10^{28}$ m/s - group velocity polarization

waves) and $\omega_{\Pi} \sim \omega_{PG}$ ($\omega_{PG} \sim 10^{48}$ rad/s - carrier field frequency-

and the elementary particle polar. This removes the prohibition on the existence of velocities greater than the speed of light.

6.5. The transformation of non-living matter into living matter can be encoded and realized on P-waves. This basic property of living matter is manifested in a living cell by the assembly of new cells from atoms supplied to the cell by its environment. The consequences of the realization of such technology outside living cells are difficult to predict.

6.6. Quantum hypotheses are still undefined in their scientific bases and, therefore, have no progressive movement in the development of the science of the Universe.

6.7. At the same time, it should be noted that all the above-mentioned refers only to the matter of the Universe. Mind and spirituality are and remain divine, i.e. beyond the control of science.

Literature

1. Kolpakov N.D.. "Polarization waves." // *Radiotekhnika*. - Vyp. 101. - Kharkov, 1997, pp. 53-62.
2. Kolpakov N.D. "Polarization waves - a new energy-information carrier". // *Electronics and Informatics*, 1997, No. 1, p. 30-33.
3. Kolpakov N.D. "Polarization waves and the problem of gravitation." // *Spacetime & Substance*, Vol. 1 (2000), No. 2 (2), pp. 1-8. <http://spacetime.narod.ru> (NO. 1, NO. 5).
4. Kolpakov N.D. "Discovery of the nature of gravitation and prospects of applied radio electronics". // Collection of scientific papers Proceedings of the 1st International Radio Electronic Forum MRF-2002. October 8-10, 2002 - Kharkov, Ukraine.
5. Kolpakov N.D., Kolpakov S.N., Surmilo S.A., Pri- ume. "Registration of polarization waves". // Bulletin of the International Slavic University, No. 7, Series "Tekhnichni nauki". - Vol. V, 2002, pp. 7-9.
6. Kolpakov N.D., Dokhov A.I., Chumakov V.I., Ruzhentsev I.V., Dzyubenko M.I., Kolpakov S.N., Surmilo S.A. Pri- emko A.A. "Protocol of the experiment on registration of the effect of artificially excited fields on the gravitational pendulum". - Kharkov, 2002, 4p. The copyright for the discovery of the nature of gravitation is protected by the Certificate of the Copyright Committee of the CM of Ukraine and the publication [3].
7. Kolpakov N.D, "New energy - and information medium". Proceedings of Congress-2000 "Fundamental problems

of natural science and engineering", St.Pet. Russia, v.1, Is.1, 2000, pp. 252-259.

8. N.D.Kolpakov, L.N.Kolpakova. "Polarization waves - psychophysical information medium". Proceedings of the 3rd International Conference "Physical Phenomena in Solids". - Kharkov, 1997, p.141.

THE THEORY OF RELATIVITY: THE TRIUMPH OF THE THEORY AND THE CRISIS OF PHYSICS

N.A. Zhuk

The modern physical foundations of the universe, cultivated by academic science, are based on two basic "whales": the theory of relativity and quantum theory.

It should be noted at once that the general term "theory of relativity" actually includes two theories: the Special Theory of Relativity (STO), created, as is generally accepted, by A. Einstein in 1905, and the General Theory of Relativity (GTR), created by the same author in 1915.

What did the theory of relativity bring to physics? Why was the initial triumph followed by a crisis of physics, which proved unable to explain many phenomena of nature? Why did the studies of space, time and gravitation virtually stagnate for so long?

Let us try to answer these questions and suggest ways to reform physics to overcome the crisis and stagnation.

1. The principles of classical physics and their paradoxicality. In classical physics, i.e., the physics that emerged by the end of the nineteenth century, three fundamental principles (statements based on certain facts) were firmly established:

1) The principle of relativity, which states that in all inertial reference frames the laws of physics are the same-

and that no mechanical experiments can establish the distinguished position of any one of them;

2) The principle of constancy of the speed of light, which states that the speed of light relative to the receiver does not depend on the speed of the source;

3) The principle of time absoluteness, which meant that time flowed equally in all inertial counting systems.

It should be noted that the third principle was not explicitly formulated in classical physics at the beginning, because no one simply assumed otherwise, i.e., this principle was simply implied as a matter of course. But it was formulated after the principles of classical physics began to be transferred to electrodynamic (in particular, optical) phenomena at the turn of the nineteenth and twentieth centuries, and the paradoxical nature of the requirement of their simultaneous fulfillment was revealed.

This paradox was due both to the lack of understanding of the nature of light and to the absence of a different conception of time than that formed within the framework of classical physics. On the one hand, if light were composed of particles (within the framework of the corpuscular theory of light), the first principle would be fulfilled, but not the second. On the other hand, if light were a wave (in the framework of the wave theory of light) propagating in the ether from point to point, the second principle would be fulfilled, but the first principle would not be fulfilled, since a dedicated frame of reference could be associated with this medium, which contradicts the first principle.

The second contradiction can be demonstrated more clearly as follows. Suppose that a spacecraft passes by a stationary (in some reference frame) observer with constant but pre-light speed.

and at the moment of their greatest proximity (when the distance between them can be neglected) a flash of light occurs (it does not matter who made it - the observer or the astronaut on the ship). Then, according to the notions of a stationary observer, after some time the light wave front, taking into account the constancy of the speed of light, will be a sphere of radius OA , in the center of which he himself is located (Fig. 1) [1].

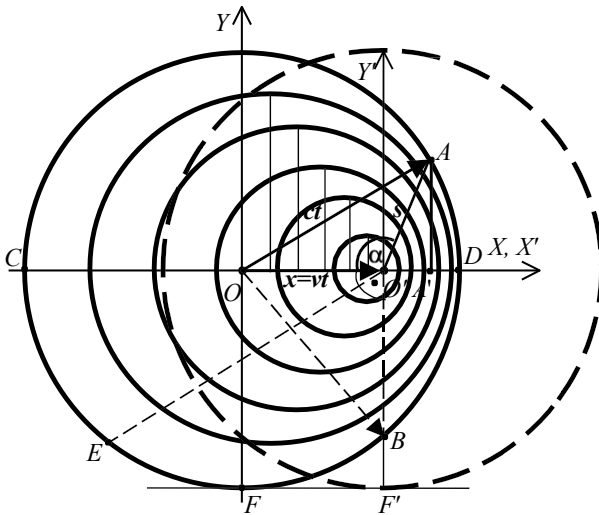

Figure 1. Wave propagation from a moving source

During the same time the spacecraft will also move in space, but the astronaut on board, given the same second principle of physics, must also be in the center of a sphere of the same radius OY , the surface of which is the front of the light wave. But one and the same sphere cannot have two centers O and O' ! This contradiction, based on sound logic and seemingly correct principles, was the main problem of the late 19th and early 20th centuries.

2. Delusions of relativists about the one-dimensionality of time. And what do relativistic physicists do to solve this contradiction? Without singling out any of them, it is necessary to show the logic that led them all to the error. The point is that back in the late 19th century there appeared a belief that, taking into account the limited speed of light, information about simultaneous events for one observer will be non-simultaneous for another observer moving relative to the first one. Then, for the convenience of analyzing the times of events and the intervals between them, it was suggested to use a set of clocks located in those points of space where these events occur. On this basis, a misconception was born, as it firmly established the opinion that time is one-dimensional.

The meaning of the misconception was as follows. If both the first and the second principles for mechanical phenomena are completely fulfilled and do not contradict the laws of mechanics, then it is necessary to modify the third principle (considering that not two but three principles were in contradiction) by introducing the so-called local time, which flows differently on a moving spaceship than the time of a stationary observer. In this way it was possible to reconcile the two first principles and agree that the stationary and moving observers see different (we emphasize - *different!*) spheres formed by the light wave front.

If at the first stages of development of this point of view, beginning with Vogt (1887), Lorentz (1892, 1895, 1904) and ending with Poincaré (1905), one-dimensional local time in a moving frame of reference *was* still regarded as a mathematical device necessary to harmonize the first two principles, *Einstein (1905) transformed it into an objective physical property.*

At the same time, he imposed on all physicists the rejection of the *ether* as a physical medium filling the entire world space. Both the former and the latter was Einstein's mistake, and here is why.

The first is connected with the fact that although at the turn of the above-mentioned centuries a really existing relation between space and time was revealed, this relation was immediately represented asymmetrically: space was measured by three coordinates, and time - by one. Obviously, when passing from one reference frame to another, their totality in the form of the so-called four-dimensional space-time by its nature could not be deformed symmetrically. Hence, the Lorentz transformations, which described this asymmetry, arose. But a question arises: if space and time are related to each other, why are they so asymmetric? And asymmetric means unequal?

However, the Lorentz transformations, which replaced Galileo's transformations, had their own trump card, their own triumph: they finally made Maxwell's equations of electrodynamics invariant in the transition from one inertial frame of reference to another. But these equations have a disadvantage that Maxwell knew - they are not complete because they do not describe moving charges and open currents. Therefore, they lead to the conclusion that only transverse electromagnetic waves (plane or spherical) can exist in nature. With this conclusion, the history of the twentieth century gave birth to a bunch of anomalous phenomena of nature, and only in the 90s of the twentieth century lonely physics enthusiasts finally experimentally discovered longitudinal waves, which do not fit in any way into the "transverse" electromagnetic waves.

Lorentz's "scroll bed" of transformations.

Now let's move on to Einstein's second mistake, the rejection of the ether. Not only did this rejection deprive energy

material carrier, as the space of the Universe has become empty, so it also contradicts the existence of longitudinal electromagnetic waves.

In this case, the reasoning should be carried out from the opposite direction. Let us assume that the ether exists. But then any propagation of waves must be accompanied by displacement of its particles. If there are transverse waves in which vectors of electric and magnetic strengths are mutually perpendicular and simultaneously perpendicular to the direction of wave propagation, i.e., located in a plane opposite to the direction of wave propagation, why can ether particles move only in this plane, i.e., have only two degrees of freedom? If space is three-dimensional, it is legitimate to conclude that the ether particles have three degrees of freedom, and longitudinal waves are also possible. But they contradict the Lorentz transformations. Where is the way out of this vicious circle?

3. Definitions of units of length and time. And the way out is self-evident: if the Lorentz transformations do not satisfy the real phenomena of nature, it is necessary to simply abandon them, return to the basics of physics, analyze them and propose new transformations of space and time in the transition from one inertial reference frame to another. Especially since 100 years ago there was no such a clear definition of the units of length and time as there is now.

From the philosophical point of view, space and time are categories denoting the basic forms of existence of all kinds of matter. Space expresses the order of existence of separate objects, time - the order of change of phenomena.

The measure of space is length, which characterizes the extent, remoteness and movement of bodies

or their parts along a given line. Time characterizes the successive change of phenomena and states of matter, as well as the duration of their existence.

Without going into the history of definitions and characterization of different systems of physical units, we will only mention the temporal definitions of the units of length and time: meter and second. Let us start with the second, since this unit received its modern definition earlier than the meter.

The development of molecular and atomic spectroscopy made it possible to relate the units of time quite precisely to the period of oscillation corresponding to the spectral line of an element. Therefore, by the decision of the XIII General Conference on Weights and Measures (1967), the definition of a second, which is still in force today, was given, according to which a second is the duration of 9,192,631,770 periods of radiation corresponding to the transition between two superfine levels of the ground state of the cesium-133 atom. Consequently, the above number of periods is simply the frequency of radiation of cesium-133.

Increasing the accuracy of measurements made it possible to relate the unit of length, the meter, to the wavelength of a certain spectral line. The orange line of krypton-86 was taken as such. This line corresponds to the transition of an electron in the krypton atom between certain quantum states. According to the definition adopted at the XI General Conference on Weights and Measures (1960), a meter contains 1,650,763.73 wavelengths in vacuum of this spectral line.

However, further advances in laser technology and quantum electronics, as well as the high accuracy achieved in measuring the speed of light, made it possible to link the definition of the unit of length - meter - with the unit of

time - by the second. The XVII General Conference on Weights and Measures (1983) decided to give the following definition of meter, which is still valid today: a meter is the distance traveled in vacuum by a plane electromagnetic wave in $1/299,792,458$ seconds. In this definition of the meter, the value of the speed of light is taken as a value not subject to specification, i.e., it is exactly equal to $299,792,458$ m/s.

Thus, a second is the duration of a certain number of periods of Cesium-133 radiation, and a meter is a certain distance traveled by an electromagnetic wave. But to determine the meter nothing forbids to use the same electromagnetic radiation as to determine the second. Therefore, to simplify the calculations, we will use the radiation corresponding to the transition between two superfine levels of the ground state of the cesium-133 atom.

From the two valid definitions of meter, second and the above agreement it is not difficult to make equal proportions. Thus, from the definition of a second it follows that the wavelength of the above-mentioned radiation of cesium 133 is 0.0326122557 m, and a meter, accordingly, will be equal to 30.6633189 wavelengths of this radiation.

Here we have come to the conclusion that one meter is equal to 30.66331899 wavelengths of radiation corresponding to the transition between the two superfine levels of the ground state of the cesium-133 atom, which is similar to the definition of meter given by the XI General Conference on Weights and Measures in 1960. And cesium-133 is chosen because its frequency is very stable.

Now it is worthwhile to talk about the author's concept of time. But first, we need to recall one winged expression that is most often used among businessmen:

"time is money". Thus, money in society plays the role of a universal equivalent through which goods and services are exchanged. And money invested in business eventually brings profit, i.e. new money. Hence the above-mentioned proverb.

But probably few modern physicists (and even fewer businessmen) have paid attention to the fact that there is another connection between money and time, based on the analogy of use. Strange as it may seem, ancient philosophers were better informed about it than we are now. And even I. Galitsky (2002), who proposed to measure time in mass units (kilograms, grams, pounds, ounces, etc.) [2].

And now I give my author's definition of time: *time is some universal equivalent by means of which the speed of different processes is compared*. Outside of these processes, the concept of time is meaningless. In some cases, a year is used as an equivalent, in others - a month, in others - an hour, in others - an hour, in others - a minute, and in physics in the SI international system of units - a second. If even this is inconvenient (for fast-variable processes, for example), the millisecond, microsecond, or even smaller time interval is used as part of the standard equivalent to compare processes.

4. Three-dimensionality of time. Since processes cannot proceed otherwise than by changing the position (moving, flowing from place to place) of some mass (energy), the transition from the artificial parameter (time) to the natural one (mass) taking into account its minimal possible value (quantization) seems not only crazy (by impression) but also timely (by necessity) idea of the end of the 20th century, which was expressed by I. Galitsky. By doing so, he as if put again

The concept of time in its own framework, beyond which it went out in the XX century, turning into anything but an equivalent for comparing the speed of various processes. Beyond these limits were created and special and general theory of relativity, and other theories. And in some theories, the authors went so far that they began to objectify time and even invented a particle of time - chronon.

Can processes occur in all three spatial directions? They can. Therefore, time is three-dimensional. In other words, the scales of space and time can be different in all three spatial directions. Therefore, in any combination of these two properties, we should generally speak of a six-dimensional space-time (3+3) rather than of a four-dimensional space-time (3+1).

Based on Fig. 1, in which the moving object O' should be represented as a source of radiation of electromagnetic waves, new coordinate transformations follow:

$$\begin{aligned}
 dx' &= \frac{dx}{1 - \frac{v}{c}}; & dy' &= \frac{dy}{\sqrt{1 - \frac{v^2}{c^2}}}; & dz' &= \frac{dz}{\sqrt{1 - \frac{v^2}{c^2}}}; \\
 dt'_x &= \frac{dt_x}{1 - \frac{v}{c}}; & dt'_y &= \frac{dt_y}{\sqrt{1 - \frac{v^2}{c^2}}}; & dt'_z &= \frac{dt_z}{\sqrt{1 - \frac{v^2}{c^2}}}.
 \end{aligned} \tag{1}$$

The new coordinate transformations (1) should replace the Lorentz transformations as those that do not satisfy the definitions of modern units of length and time and the notion of three-dimensional time.

5. Field and geometric approaches in the creation of physical theories. Those familiar with quantum mechanics know that it has two mathematically equivalent formulations: matrix and wave. A similar situation has developed in GR: in addition to the geometric formulation, a field formulation has appeared. While the former describes the motion of matter against the background of space-time curved by it, the latter is a field theory, like Maxwell's theory of electromagnetism, in which field variables are considered against the background of a flat world.

As early as in 1905, in his paper "On the Dynamics of the Electron", Poincaré first expressed the idea of constructing a relativistic theory for all physical forces, including gravitation, in a flat four-dimensional space. He also noted that the gravitational field should propagate at the speed of light, and since the delay of interactions is assumed, there should be its material transporter.

A little later, Poincaré suggested that future physics should include Planck's discovery of the quantum character of the electromagnetic field. Thus, Poincaré can be considered as an ideological founder of that path, which in modern language is called relativistic quantum gravity and in which gravity is considered as a material field in flat space-time.

This path is analogous to the one, along which the development of all non-gravitational physics really followed, which led to the creation of such fundamental theories as quantum electrodynamics, quantum theory of electroweak interactions, quantum chromodynamics. Obviously, this group should have included quantum gravitodynamics.

However, in 1915, Einstein discovered another way in which gravitation is described not as matter moving in space and time, but as the curvature of space-time itself due to the action of all space-time. Einstein discovered another way, in which gravitation is described not as matter moving in space and time, but as the curvature of space-time itself under the action of all non-gravitating matter. This path was later called geometrodynamics. Thus, GR put gravitation in an exceptional position in relation to other physical interactions, since it was conditioned not by material carriers of mutual action, but by the curvature of space-time itself.

In essence, with the creation of GR, the empty space surrounding material objects was itself as if materialized, since it could curve, expand, contract, and even propagate in the form of gravitational waves. There were no special carriers of the gravitational field. In other words, it simply lost its physical essence, while remaining a means of interaction between objects.

Thus, already at the beginning of XX century two ways for the theory of gravitation were clearly recognized, which some tend to consider alternative, mutually exclusive, and others - complementary (for example, wave and matrix forms of quantum mechanics). However, with the creation of GR, the second way was predominantly developed, and the first one was forgotten.

Einstein's creation of the general theory of relativity - as opposed to STO - has always been considered a shining example of one single scientist developing and solving a problem from start to finish. But even here it was not without attempts to climb the scientific Olympus "from the back door". Here too, Poincaré, who had been stolen many times before, was ten years ahead of Einstein, having created the first and until 1916 the only relativistic theory of gravitation.

And it was this theory, which exhaustively explains with the help of a complex mathematical apparatus the physical essence of gravitation, that formed the core of Einstein's work "Foundations of the General Theory of Relativity". The fact that the mathematician D. Hilbert somewhat earlier received and published the basic equation of this theory, which was later called the "General Theory of Relativity" was also silenced "Einstein's equation."

A truly amazing story happened with the Hilbert equation. It was communicated by Hilbert in a private correspondence to Einstein, who pestered the former with questions: what did you get? Hilbert had been "keeping a low profile" for a long time, not wanting to reveal his results to his eager colleague, but then revealed them before publication to the annoying correspondent. Suddenly, he was surprised to read in Einstein's next message: Imagine, I had come to exactly the same conclusion even before receiving your letter.... Then Hilbert grabbed his head and, cursing himself for his rashness, asked him to speed up the publication of the article with his equation, which was later called "Einstein's" anyway. Only this can explain the fact that Einstein's paper on the general theory of relativity of late 1915 was presented without a proof (he had stolen the result and did not know the conclusion).

Except for Birkhoff's 1944 paper, which stands somewhat apart and in which the gravitational field equations are simply postulated, it is only since 1961 with the work of Tierring that a revival of the rigorous field approach to the theory of gravitation began. The revival of this way, most likely, is connected with the inability of GR in its usual form to answer numerous questions, including in the field of cosmology. In this direction I also worked on the monograph "Cosmology" [3].

6. Quadrostatics. My theory of the Universe has been developing for 23 years since the first new results were obtained (I have been studying and researching in this field for about 37 years) and is now either in the shadow of Einstein's General Theory of Relativity or in the shadow of theories opposed to it, while in reality it belongs to neither. While it has a genetic connection with GTR, it is at the same time fundamentally different from that theory and therefore needs its own name.

GR is considered to be a relativistic but non-quantum theory of space, time and gravitation. The theory developed by me is based on the mathematical apparatus of GR (i.e. on tensor calculus and differential geometry of multidimensional spaces), but according to its latest (2002) content it is a relativistic quantum theory of the ether and is actually a unified theory of all fundamental interactions. Since only 4 fundamental interactions (gravitation, electromagnetism, nuclear and weak interactions) are available for our perception (including by means of instruments), and my theory has only 4 basic equations (for free space), this is the reason to call it quadrostatics [4].

7. Results of approbation of the new theory and conclusions. As a result of the development of the field approach on the basis of generalized laws of physics with three-dimensional space and three-dimensional time, a new model of the stationary (non-expanding) Universe was constructed and the suitability of this model and these laws to the description of real nature was proved by more than four dozen examples.

As a result of research based on the new model of the universe and generalized laws of physics, the following proofs and discoveries were made:

- proved the identity of inert and gravitational masses in the spirit of Mach's principle;
- the relativistic law of universal gravitation in the form of the Neumann-Yukawa potential was discovered and it was shown that Newton's law of gravitation is valid only for an empty Universe, which it is not really;
- the gravitational viscosity of the Universe, which is identified with its geodesic curvature and the viscosity of the aether;
- discovered the law of exponential decrease of light frequency with distance, reflecting the loss of its energy in the viscous ether, which knocked out the main stone in the foundation of the theories of the Big Bang and the expanding Universe;
- it is proved that the microwave background of the cosmos is an integral radiation of all stars of the Universe, and its ripples reflect its structure;
- spatial structurality in the distribution of quasars was discovered, which coincided with the spatial distribution of galaxies, and the radius of cells of this structurality was equal to the radius of gravitational interactions;
- complete equations of electrodynamics, the number of which is twice as large as the number of Maxwell's equations;
- new transformations of coordinates are found and the fundamental fallacy of the Lorentz transformations, as well as the special and general theory of relativity built on them, is shown.

So far, quadroynamics has not had a single contradiction with nature, while GR has always been in conflict with the properties of the real world, especially in the field of cosmology. Traditional electrodynamics is also contradictory and incomplete. Therefore, the task is set to further develop not the theory of gravitation, but electrodynamics as the basis of all fundamental interactions.

It seems to me that the way out of the crisis of physics is possible only by transition to three-dimensional time and rejection of Lorentz transformations, as well as by development of field approaches in the description of physical interactions.

Literature

1. Zhuk N. A. "Modern notions of space, time and boundedness of Lorentz transformations". // *Physics of Consciousness and Life, Cosmology and Astrophysics*, 3, (2004). <http://infobank.h10.ru/zhuck/article1.html>.

2. Galitsky I. M. "About new physics (Principles)." // *Spacetime & Substance*, 2, 2, 84-94 (2001). <http://spasetime.narod.ru>.

3. Zhuk N. A. "Cosmology". - Kharkov: LLC "Model of the Universe", 2000, 464 p. <http://zhuck1.narod.ru/cosmolog.rar>.

4. Zhuk N. A. "Quadrodynamics: Relativistic Quantum Theory of Space, Time and Fundamental Interactions" - Kharkov: LLC "Infobank", 2004, 24 p. <http://www.sciteclibrary.ru/rus/catalog/pages/7620.html>.

October 2005.

TRINITARIAN TRUTHS AS OF THE UNIVERSAL MODEL OF CREATION

N.A. Zhuk

Introduction. Until December 2005, I had never given much thought to the difference between God and God, Satan and the Devil, and the role of the Mother of God in all this. In the same way, we always thought that when analyzing all things, they should be divided into thesis and antithesis, i.e. into opposites such as: I - not I, matter - field, war - peace, love - hate, etc. And no one has ever said what would happen when one considers both or neither at the same time. However, in 2005 the book "Praveda" [1] was published, which posed and gave answers to these questions and made many people, including serious scientists, pay attention to it. Scientists had to interrupt their research to study this document. Without its mastering, any movement in science is incomplete, chaotic, and sometimes just treading on the ground.

It should be noted that now the Svarog Night is ending, i.e. the cold half of the 26-thousand-year period of precession of the Earth's axis, during which the worst events of the recent time took place, including world wars and repeated attempts to destroy our ancient knowledge together with its keepers. With the end of the Svarog Night the keepers of the ancient knowledge began their fire (earlier it was simply useless). Thus, in 2001-2002 a part of the Slavic-Aryan Vedas was published. And in 2005 "Pravedi" - the ancient sacred knowledge of the Northern Magi - was published. How did it happen?

In 2001, a man came to the specialists of the International Academy of Meganoscience in Petrozavodsk and said that he was ready to give them some universal knowledge. They, co--

Of course, they didn't believe it. But this man, without telling them anything about his personal life except that he was from the backwoods of Karelia, began to hum the first book of Righteousness to them. And the longer he did this, the more amazed his listeners became. They had no doubts about the authenticity of the knowledge he was imparting. It is not possible for a man to know by heart a huge amount of material - more than 600 pages. He knew the text perfectly well, but not only that, he could also explain this or that definition, which is incomprehensible to the modern man. In other words, he not only had a really unique and profound knowledge, but he also had an excellent understanding of the essence of what he was talking about. It seemed that as long as the world and man had existed, so long had this knowledge existed.

He did not impose any conditions on the Academy's specialists, except that not a single comma be changed in the book to be published, not a single word be altered. This man had a perfect command of both words and the Russian language in general. He had a philosophy of filling words. We are so used to words that we often do not realize what they carry. He pointed out that a word should be written in such a way that its true meaning is understood.

When asked how long this knowledge had been stored, he said it was very old. Knowledge is passed on from generation to generation. And this man is the keeper of the ancestral memory. He keeps this tradition. And now he's passing it on to a student. He says it's time. Knowledge is passed on to a person who is able to comprehend it (regardless of the publication). Specialists note the amazing ability of runespeople to store a huge amount of material. They did not even change a letter. If not

if you understood a word, you never threw it away. That's how the ancestors sang. That's how they sang.

The bearer of "Righteousness" is an unusual person, non-standard. All his behavior, text transmission, deep understanding of the essence shows that he really knows and transmits this knowledge. Believe it or not, he said: I don't care. The specialists had a sense of doubt at first, but when they started writing it down, then reading it, they could not help but believe it. They did not agree with some of the ideas in this book. But it was not their job to agree or disagree. Now that they have received this text, let's study it.

1. General characterization of the "Righteous". It should be noted that the peculiarities of belief and language are related to the World Picture. At the hierarchical top of this trinity is the picture of the World. And this trinity is the most important instrument of power. Therefore, those who had power and lived at the expense of others were in no way interested in giving people the right idea of how the world works. On the contrary, they tried their best to keep people away from the daring outbursts of their minds that the world is one and, because of its integrity, it is simple, that is, comprehensible. The reason for this behavior of the "passers-by" is clear - it is a proven condition for maintaining power: "divide and conquer"! So they divide and rule, doing very simply - dissecting and dosing the unified picture of the World, who gets what.

The "Pravedas" along with the "Slavic-Aryan Vedas" [2] finally open the veil of all this cuisine and give us the Knowledge of our ancient ancestors. [2], finally open the veil of all this cuisine and give us the Knowledge of our ancient ancestors. Therefore, "Pra-vedas" with the stress on the second syllable points us to the antiquity and fundamental essence of this Knowledge, and with the stress on the first syllable - to the righteousness of our ancestors.

"Praveda is a philosophical and worldview treatise. It is, first of all. Secondly, it is a doctrine of the Trinity as the basis and model of the Universe, and, thirdly, it is a hymn to the Prau-language, which is not only a vessel, but also a holding, i.e. not only a carrier of Knowledge, but also this Knowledge itself. That is why the signature at the end of this treatise sounds very convincing: "Written by Vit in Korel in the First Language. There are no other languages.

Indeed, it is known today that Dr. Ivan Petrunin, Professor, Honored Worker of Science and Technology of the Russian Federation, came to the discovery of the 100-syllable code of a single international language. Analyzing word-formation, decoding words and syllables, I. Petrunin came to the conclusion that there are only 100 syllables, which carry all the meanings of words of all languages of the world and, first of all, of Russian. Twenty consonants, five vowels - this is the foundation of the alphabetic script of all national languages. Everything beyond $20 \times 5 = 100$ syllables is introduced into the word for the sake of euphony, to reflect the national specificity of the language.

Thus, the Prajazh language is a kind of genetic code, the elements of which are a sound or a syllable. The ancient runic writing of about 150 runes also corresponds to this. It should also be added that the average person is capable of producing about 200 sounds (some - up to 250). If we exclude whistling, grunting, growling, mooing and other unpleasant sounds, we are left with about 150 sounds. The most economical way would be to attribute to each of them a certain image, phenomenon or action (more precisely, a sign, a letter and a number). Then the new image, phenomenon or action can be described by means of already known signs (or syllables in a temporal language). This is how words are made, i.e. all the words of present-day languages are whole sentences, fixed by

as a unified whole in the process of historical development of both populations. Just as in Ukrainian, Russian or any other language a certain phenomenon can be described by different sentences or different sequences of the same words, so in the Praj-language words are constructed. Whoever knows the code of the Praj-language can understand other related languages of the world (it is understood that different races could have their own Praj-languages).

On the other hand, the one who designed the language managed to make a great invention - he "sewed" into the language itself the knowledge about the world, its principles and basic moral values. "The Praveda reveals how this was done. Unfortunately, with the loss of imagery of writing, with the reduction of the number of signs used, we have lost a lot of knowledge. Nevertheless, their basis remains, and this is very valuable to us.

"The Pravedas is a 624-page volume containing four books: Power, Glory, Consciousness, and Kin. Each of the four books of the Pravedas deals with a key issue of existence, and the information in each successive part builds on the previous ones to create a magnificent thought-form pattern. Here they are:

1. "The Force" tells us about the original principles of the structure of the World.
2. The Glory presents the pantheon of the First and the Noble.
3. "Consciousness" describes connection of human co-knowledge with higher knowledge.
4. "Kin" is devoted to the existence of man in society, his destiny.

The book has already been praised by scientists - its contents are a striking confirmation of many religious beliefs of different peoples as well as the latest scientific discoveries in the understanding of the universe. It is a book that makes you want to return to its pages again and again and again.

The Russian word is the wisdom and sacral power of the Russian word, and we are sometimes horrified and horrified by the truth of life, about which we usually keep silent - it is more peaceful that way.

There are several other aspects associated with the Pravedas. First, their origin. The official version has been stated above. There is also an opinion that this knowledge was received from above, from the energy-information field by a certain contactor who signed himself Vit. There is also a third point of view, which seems to be the most consistent with reality. There are objective prerequisites to believe that the Pravedas are the result of creation: both the keepers of ancient knowledge and its modern researchers from the Academy of mega-science are involved in it. Therefore, the text is, as it were, two-layered: here is the initial matrix and here is the later conceptual layer. But the correspondence between them has been achieved! And the modern sound of the text shows that we are not facing a publication of the original, which can exist only in mental form, but rather a kind of translation with elements of interpretation (given the realities of modern language).

There are nuances that allow us to state from which lineage the keepers of the ancient knowledge originate and for whom they are intended. So, the keepers are representatives of Da'Aryan family, because they lived in the land of Rai in ancient Da'aria, and there is a reference to it in the text "Righteousness". And this knowledge was intended for children from 7 to 12 years old. The first term is indicated by the "Slavo-Aryan Vedas", and the second term is indicated by the mentoring tone of "Praved" and the repeated address "Chado", typical for children under 12 years of age.

Thus, the "Pravedas" are the original knowledge about the world and its principles, human consciousness and morality, which were taught to young and middle-aged children and laid the foundation for their language and socialization.

This is the basis for the development of different ways of thinking, on which other knowledge, skills and competencies are projected.

2. The concept of the Trinity and its names. The beginning of any book is very important. And especially its first chords. In "Rights" they sound especially powerful and affirmative:

*"God is the Truth.
But the Devil is the Ideal.
These are the two extreme hypostases of the
Trinity, the Lord, the Master of all things"
[1].*

The concept of the Trinity permeates all cultures, all eras and all peoples of the world. But I want to start with Ukraine and the names of the Trinity.

Many people probably do not know that in the villages of Ukraine, where Ukrainian is a patriarchal language, images of saints are called "images" with the stress on the last syllable (and images in a frame are called icons). In the singular it would be *Obraz*. The image is the name of the indivisible unity of the Trinity, the Lord, which is beyond human comprehension and understanding.

The above-mentioned name can be written in another way: *Ob- Raz*. Here there was a kind of splitting of the whole into two extremes, two concepts, where *Raz* is the name of God, the Supreme Will, and *Ob* is the name of the Devil, the Reciprocating Will. It is necessary to pay attention to the correct spelling - "*Diabolus*", as it was done in church books 100 years ago, and not "*Devil*", as they write now. Since the prefix

"*dia*" is exactly what "two" means.

Hence several other names of the Trinity: One is the *Gospod*, the indivisible Trinity, One, as already mentioned, is God, and Two is the name of the Devil.

But why does the name of the Lord, composed of the names of His two extreme hypostases, begin with the Devil and not with God? Because God is Right and the Devil is Left. Right and Left

and since the name of the Lord, like everything else, is written from left to right, so it sounds: Image. The Image as the name of the Lord is the Middle, He is neither Right nor Left. He is both, and neither, and neither at the same time. He is like the axis of a scale whose scales are God and the Devil and whose balance he controls. The reflections of the one Lord, of which there are many - innumerable - therefore bear the name "images" with the stress on the last syllable. Since man in this world is closest to the Lord, it is on images that he reflects people and not animals or other objects.

"Pravedes" describes all of existence: from the microcosm, i.e. quantum theory, to the universe, i.e. cosmology. This is on the one hand. On the other hand, they deal with non-living (by our standards) matter as well as with living nature, mind and morality. And everywhere, at every slice, at every level of being and consciousness, the Trinity is manifested. That is why it has many names. In this regard, it should also be added that the concepts of God and the Devil, no matter what other names they are replaced with, are not people, but actions, deeds, processes, so their human image should be considered wrong. It is more correct to speak only of male and female. This is how it is stated in the Laws:

*"Do not make yourself an
image of Ob-Raz in your own
likeness, God and the Devil are
not human!*

*Because what we're saying - Man Woman, Woman
Woman -*

*It is not to be attributed to men or beasts, But only
to the way the worlds act, How Time is spent, what
Prostranstvo is created". [1].*

The Praveda contains answers to many of the most tricky questions that people have been unable to answer for centuries. For example, theologians and philosophers are still unable to answer the question: Is God in nature or out of nature? There can be no simpler and more elegant answer to this question than that offered by the "Laws". There is a Supreme God - the Kin. As a wife is with her husband, so is PriRoda - with Rod! That is all!

At the same time, the Pravedas reveal the essence and role of the masculine and feminine in the Universe: God is Man and the First, Nature is Woman and the Second. Take the key religious symbol, the Image. We will also recall the existence of the great mystery of the unified Trinity, and by means of the Prajadh language we will reveal this mystery in one sentence. God is the First, so it is One. Nature is Second, so it is Two, or Couple, or Both. The Trinity is the Meeting of Genus and Nature, the Wedding of the Husband and the Virgin. In a word: Ob-Raz. The Trinity is the Image, and the World is the Trinity, one-union and ob-union! And the summit is the Essence. Here is the form of the Essence according to the Pravedas:

"The Essence is radiant and sparkling like a star. The Essence is One Middle, which absorbs the Balls of Time from the Middle, And from which the Rays of Space rush into the Medium... To imagine the Trinity simply as a Star shining in the sky, Radiating Time into Space, Taking the surrounding Space into its womb" [1].

Without going into the structure of the World-building in more detail, let us cite the main names of the Trinity (see Table 1).

Table 1

The names of the Trinity

Devil	Lord	God
Ona	Oh, oh, oh, oh, oh, oh, oh, oh, oh, oh, oh, oh, oh.	He's
About	Image	One
Two	One	One
Uhm	O-um.	Raz-Um
PriRoda	Od	Rod
Space	World	Time
Path	Soul	Life
Ideal	Really	Truth
system	Law	Law
Freedom	Share	Will
A second will	Master	Will
Body	Communication	Case
Ob-Lick	Personality	Leek
Word	Glory	C-LOVO
LeWit	Vit	PraVit
SamCa	Myself	male
Death	Genesis	Life
Imaginatively	Truthfully	Truly
equipment	Nov	OsNova
Support, Bed	Pra	It's time
Ray	Meeting	Char
Harmony	Order	Chaos
Chin's wife	Chin	Chin's husband
Queen	Emperor	Czar
Scepter	Crown, Mace	Power
O-obsession	AllHolder	Autocracy
number (beast)	Sign (above)	Letter (of the law)

You must have seen in the above names familiar images that

you used to perceive by the

and now in a unified system, as part of the Trinity.

There are tons of examples of the Trinity. Here are just a few of them.

If we consider such a simple example from physics as water boiling, God is fire (Chaos), the Devil is water (System), and God is steam (Essence), i.e. both.

If we consider the solar system, God is the Sun-Ra, the Devil is the atom (remember that its power is called diabolical), and God is our Mother Earth, who gives us life. She is the True Lord, and the Moon is the Former Lord.

If we consider the whole universe, it is God within whom we all are. The Universe has always existed, exists and will always exist. Everything in the Universe has already happened and there can be nothing new, but only a periodic cycle of matter and events with some new nuances in the process of repetition (Nov). Similarly, the properties of the Universe on different scales are repeated. "Below is the same graceless unrecognizable abyss as above, and what is below is a likeness of what is above, and what is above is the Basis for the likeness of what is below." [2].

If we consider man, he is also God, but only in relation to all that is inside him. God is in the center, the belly, which gives life to himself and his offspring, and the devil is in the periphery, the Left Ob, abbreviated as Forehead.

If we consider consciousness, God is Mind, Raz- Mind or Mind One, the Devil is simply Mind or Mind Two, and the Lord is O-Um or Knowledge, Wisdom, Essence. Let us now recall the folk wisdom that sorrow comes from the mind.

If we consider the antithesis, God is war (strength), the Devil is peace (rest), and the Lord is both and neither

and neither, i.e. a game. Indeed, we say: our whole life is a game. And God is also a game. With Himself. For entertainment. Just as we are entertained when we watch a movie, i.e. someone else's life, similar and different from ours.

3. Properties of the Trinity. The concept of the Trinity, its components and manifestations becomes clear when analyzing the World. But the Trinity has some common properties, which it is reasonable to cite for familiarization (see Table 2).

Table 2

Properties of the Trinity

Devil	Lord	God
Left	Medium	Right
No	Yes (Yes) and No	Yes (Check)
Nothing	Everything and Nothing	All of them
Point	And this and that	The Hole (in the Middle)
Wednesday	Wednesday and Wednesday-on	Middle (not a point)
Private	Unified	General
From-Existence	Essence	Presence
Architect	U-S Trooper	c-Trooper
Desire	Life	Power
Light Bringer	Creator	The Light of Existence
Powerlessness	Rovnia	Force
Attraction	Rovnia	Repulsion
Rest	Rovnia	difference
Equality	Rovnia	c-Reference
Star	Mature	Yoon
Darkness	Source	Light
Past	Present	Future
Memory	Nature	Knowledge

Punished	Knows	Studying
Sequential-immunity	Paradox	Parallelism

Idea, Duma	Knowledge	Thought
co-image	Wisdom	wo-image
Understanding	Creation	Realization
Evil	Fool	Sincere
Desire	Life	Power
Hate	Justice	Love
Satire	Hohma	Humor
Black	Green	White
Form	Essence	Table of Contents

One may wonder why God is called a fool. The Lord is called a fool. It is not better said than it is in the Pravedas:

"Why the Fool?

*And where have you seen a sincere
clever, Or a foolish Evil One?*

*But the Fool - that's the top of
thinking! The Fool is unreasonable
and unthinking.*

*A fool needs neither Wit nor Raz-wit. A
fool does not think and does not think,
But he knows at once, he knows without
error! The Fool's Name is Genius.*

*Genius is always pure and honest. There is no other"
[1].*

4. Nature as a reflection of the Trinity. What is stable is what has area. The minimal figure that has area is a triangle (Trinity). And the minimum common to the minimum number of minimal figures is a quadrilateral: it contains two triangles. "The world is divinely simple. The world is diabolically complex." [1].

The Trinity is the first concept of Righteousness. Second after the Trinity is the concept of reflection. In the trinity one thing is reflected from another, and in this is the whole of God as the Mirror of the World:

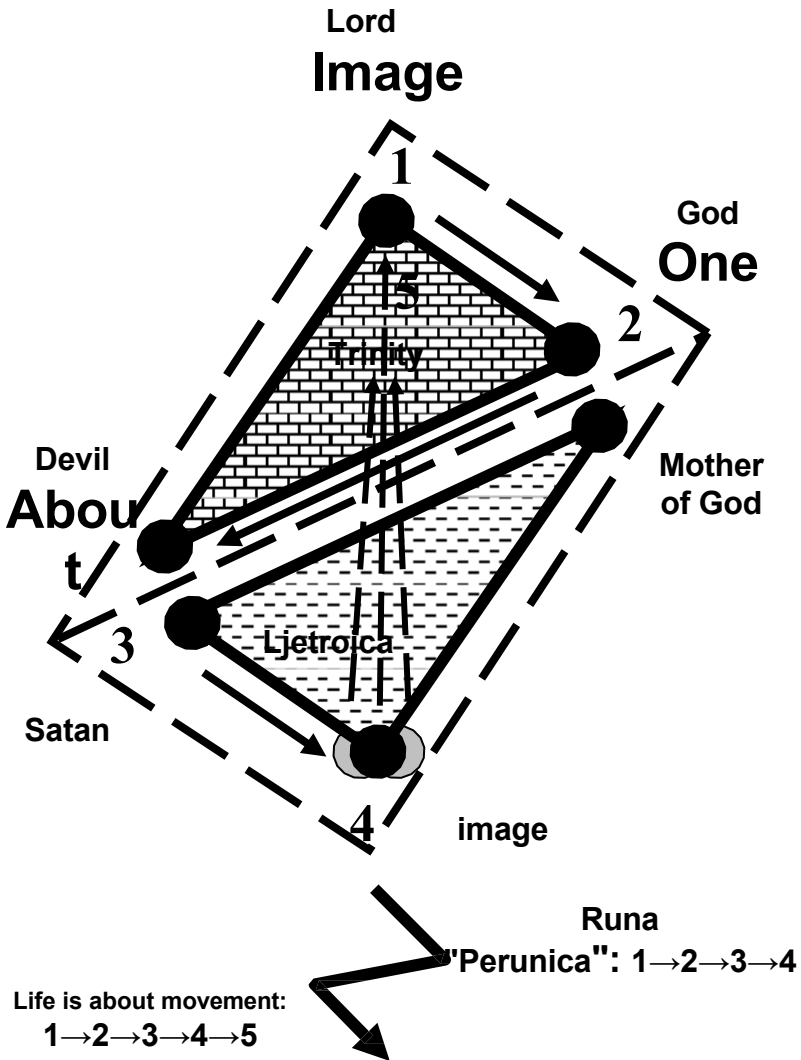

Figure 1. Structure of the Universe

*"Comprehend the complex:
 In the Trinity, the First Law is
 Yes is No and No is Yes.....
 Will the clever understand? The stupid will understand*

without thinking.

*But it is simple: here is a mirror, a simple reflection,
Where on this side, perhaps, is truth, and
on that side, perhaps, is imaginary.
But - who is who? And whence lookest thou?"[1].*

The Trinity is beyond our understanding and comprehension (to put it in modern terms - it is on those subtle scale levels of the microcosm, which are not accessible to our senses or modern instruments). God is Chin. God is the Husband of Chin and the First. The Devil is Chin's Wife and the Second. Their Meeting is the Wedding of the First, the Sacrament. The Devil-Wife through the Lord as the World Mirror reflects God-Man or Rod-Parent and forms the False Trinity - False Trinity, Paratroica or Nature (Fig. 1), in which we ourselves are and only comprehend (with the help of senses and devices).

In Nature, to the right of God is his reflection, the Mother of God (Good), and to the left of the Left is Satan (Evil), the reflection of the Devil. They have their own roles. At the same time, our souls are part of the World Soul-Trinity, the Lord who is on the Way of Life. And as He descends to our level, crumbling and losing the memory of His former Lives, turning into dust with us, He returns to Himself again to regain the memory, to repeat Himself in us, and we to learn the lesson, to receive the precept and the punishment, to be born again and again and either to rise immediately to the Lord or to fall to the Bottom, from which we can ever push back and still rise to the Lord - it is all in our will.

5. Ratios in the Trinity. There is a clear hierarchy in the Trinity without diminishing the importance of any of the components:

"One, holy O, higher than all.....

*...There is no equality in the Trinity,
Therefore God is closer to the Lord and higher than the
Devil." [1].*

Thus the Lord occupies the highest position in the Trinity. He is the master of all things. Below and on opposite sides are God and the Devil, but God is still higher than the Devil. And the Devil should never be higher than God, but in real life in Nature the extreme hypostases of God are realized in different ways. Let us give a couple of examples.

God is Right, God is Law, and the Devil is System. The symbol of the Right in society is the Crown (mace), the Law is the Orb (ball), and the System is the Scepter (ray). The animal images of this Trinity correspond to the Eagle, Bear and Lion. That is why they are often depicted on coats of arms. In a normal Orthodox country Law and System should harmoniously combine within the framework of self-government, called Autocracy. But during the Svarog Night (12948 B.C. - 2012 A.D.) the balance between Law and System was broken. And today, on the territory of the once Great Rassenia, the System boasts of its supposed superiority over the Law, calling it democracy. That is why we have today a shadow economy, corruption, lawlessness and impunity for all this.

I was once asked: Jesus Christ walked on water, teleported and did many other miracles, saying that everyone can do it - why can't we still do it?

My answer, based on the Praveda, was that all that Jesus Christ did was to increase the freedom of man. If you raise the level of freedom of man to unprecedented heights now, but do not strengthen his spirit, i.e., do not raise his will to the same heights, nothing good will come of it. (It is understood that the will is a person's ability to control himself, sometimes in spite of even his feelings). Because even more prisons and

We will have anarchy, because the will is the Law, God, and it must be above freedom - the System, the Devil. Only by raising (strengthening) one's will (not just one person, but everyone in the masses) one can get additional freedom. The will (Law) must control freedom (System). Both in the power and in the individual.

Similarly, you can analyze any other situation, solve any other issue.

6. The First and the Second. God and the Devil are the First. There are two of them. They are never joined together. God, on the other hand, is one. He is the RightFirst.

"The first are themselves held and maintained In Law and System, in Right. But the Right is the Apex. Right is what is above both the System and the Law. Only the Right rules!" [1].

But if there are Firsts, there must be Seconds.

"Look: there are True Firsts, Otherwise Ch-Ist, Honest-The Truth and the Ideal. This is beyond the Pre-Del, in the Trinity. Then there must be another pair that is imaginary - the Imaginary first. Second. Unclean, dishonest - false and false. And there are no more pairs." [1].

Where are the Second Ones? Clearly, in Nature. But there they are supposedly the first. The True Couple is God and the Devil, the First. The Imaginary Couple is the Mother of God and Satan, the Second. Don't confuse the First:

"In the Trinity, the first ones are ManWomanWoman, One and Ob, both are the Apex and the Unmistakable One. In the ParaTrinity, the imaginary firsts are.

Woman, man" [1].

What are the qualities of the First and the Second? The former are Love and Hate. The former don't eat and keep themselves. The first leave no trace. And always in Paradise, where there is no death from the beginning.

"This is Paradise. "In Paradise live and remember. They are the First, the Owners of Time and Light, otherwise White, from God. In Paradise, Everything is true, Nothing is imaginary.

This is Hell. In Hell they dream and do not live.

These are the Second, They are the last.

Owners of Space and Darkness, otherwise Black, of the Devil.

In Hell, Everything is imaginary, Nothing is true. Hell is No, a reflection of Yes...

Here's a joke:

Smart, Second, always exist, live at the expense of the first, Raz-smart.

They know how to do it.

Who are the Seconds? Jokers,

Mischievous brigands and thieves!" [1].

The Second rejected the Kin, and the Kin spewed them into the PriRod. The Second always eat the First and always live at the expense of the Kin. They cannot do otherwise, they do not know how. But to become the First for the Lord is the true meaning of life for any Second.

7. Notables. The Noble Ones are the link between the First and the Second. More than that, they are the Second, who have ascended to the Lord in the Feat and have become like the First. For this they have received from the Lord the right to rule life. How do they differ from the ordinary Second?

"Those who know the Essence have a right from the Lord - To rule life.

Those who have the right to have a name - Know,

*Otherwise the Noble, the god-at-arms of
Knowledge... He who is free - he dares,
He who is free has.
The ability to dare and have without destroying
There is a meta - the Sign of the Significant, the
embodied Person,
What has the right to govern." [1].*

Only the Noble One, the one who is closer to the First Ones, knows what the Lord is. In the reflected world, the Significant One is the Son of the Lord and the Lord Himself. Who is the Noble One? He who feels the Soul of the Lord in his bosom - on his journey through life. He who neither learns nor is punished, but knows.

Antiquity does not mean nobility. Nobility must be earned. There are also gods who are the first among the nobility. For example, the historical figures Perun and his children - son Tarkh and daughter Tara, whose joint name is still the name of the vast territory east of the Ural Mountains - the Land of Tarkh and Tara, Tartary [2].

The Vedic concept of nobility clearly corresponds to the sometime doctrine of Academician B. V. Bolotov about the leaders of society. V. Bolotov about leaders in society. Without natural leaders (heads of families, clans, communities, cities, regions, country) normal life in society is impossible. And it is today that we lack real leaders to make our life acquire the shades of normal development, upward movement - to Godhood.

Literature

1. "Pravedes. Ancient Sacred Knowledge of the Northern Magi". - Moscow: White Alves, 2005, 624 p. <http://zhuck1.narod.ru/pravedy.zip>.
2. "Slavic-Aryan Vedas. Books 1-4. - Omsk: "As-gard", 2001-2002. <http://zhuck1.narod.ru/Sl-Ar-Ve.zip>.

December 2004.

SLAVIC-ARYAN VEDAS ABOUT GOD AND DEVIL, GOOD AND EVIL, GENIUS AND INSANITY

N.A. Zhuk

This paper deals with the degenerative processes in society, which were under discussion in the USSR and in the West. In the USSR, a cooperation agreement between the NKVD and GESTAPO was signed on these issues in 1938, which resulted in the adoption of a top-secret instruction a month later.

"On Basic Criteria for the Selection of Personnel for Service in the NKVD Bodies" [1], which was in force for three decades and listed visible, physiological and mental signs of degeneration (degeneration of the human race). [1], which was in effect for three decades and listed visible, physiological and mental signs of degeneration (degeneration) of the human race.

In this paper all these questions are considered on the basis of knowledge about the laws of heredity and purity (health) of the lineage, given in the "Slavic-Aryan Vedas". [2], some documents of which were written down more than 40000 years ago. Violations of these laws lead to degenerative processes.

The work is a logical continuation of two articles by the same author: "Slavic-Aryan Vedas on the Structure of the Universe and the History of Mankind" [3]. [3], "Slavo-Aryan Vedas on the laws of prolongation of the family and communal and ancestral way of life" [4]. [4].

1. The laws of telegony and RITA. Today we are familiar with telegony, i.e. the basic law of heredity, which in medicine is called "the phenomenon of the first male". But in this sphere our ancestors knew much more.

Our Ancestors knew that on the first wedding night a man transfers to his wife [1]: 1) Images of Spirit and Blood; 2) Energy of one Summer (year) of his life (for carrying offspring); 3) Gift of Motherhood (gift of taking care of a child); 4) Woman's Share (ancestral genetic memory of a girl); 5) Love and himself.

It follows from the above knowledge that the first man who violates a girl's virginity is the only father of all the children she will bear in her life, no matter how many husbands she will have in the rest of her life. However, other men erode (change) the gene-field foundation (genetic profile) of her children, which leads to diseases and even degeneration of the species.

Telegony, in turn, is the basis of the RITA Laws, the celestial laws of purity of Kin and Blood. The basic laws of RITA [2]:

1. Purity and unity of the family union, obligatory parental blessing.

2. Prohibition of blood marriages up to the 7th knee (and knowing one's own lineage and tribe).

3. Banning interracial marriages (without any racial discord or hatred).

4. Prohibiting all homosexual activity, wearing clothes not of the same sex.

Any violations of these laws have severe consequences for the clans, up to their degeneration. For example, out of 420 European aristocratic clans, 140 clans have become extinct in the last 200 years due to close kinship marriages and other violations of RITA laws. The very process of negative consequences of degeneration is called de-generation, and people with the corresponding signs of degeneration are called degenerates.

2. Stages of degeneration. First of all, it should be clarified that we use the term "degenerate" as a purely medical term and not as a swear word. Those who cannot tolerate even the mention of this term may replace it with the word "degenerate". It is the same thing.

Grigory Klimov, a well-known researcher of this topic, has quite clearly defined three stages of degeneration: 1) sexual perversions; 2) mental illnesses; 3) congenital defects [5]. But he did not know the laws of RITA and could not show the true causes of birth degeneration.

And if we analyze the Slavic-Aryan Vedas, we can see that initially the cause of degeneration is the violation of the laws of RITA, which leads to the oscillation of the human sexual constitution (signs of bipolarity appear, and if signs of the second sex are added, the signs of the first sex are weakened, and the interest in the second sex is significantly weakened). These changes are practically invisible outwardly. They are most often manifested in a person's psyche and behavior. But from here, problems in the family immediately arise.

If violations of the laws of RITA continue, the processes of degeneration of man (and, naturally, of his species) begin to be accompanied by sexual perversions, since in a bisexual person sexual satisfaction cannot be achieved through normal sexual intercourse. Depending on the degree of manifestation of the signs of the second sex, sexual perversions range from the "69" position as a necessary (without which nothing is possible) element of the sexual act to full homosexuality and transsexualism (physical change of one's sex to the opposite sex).

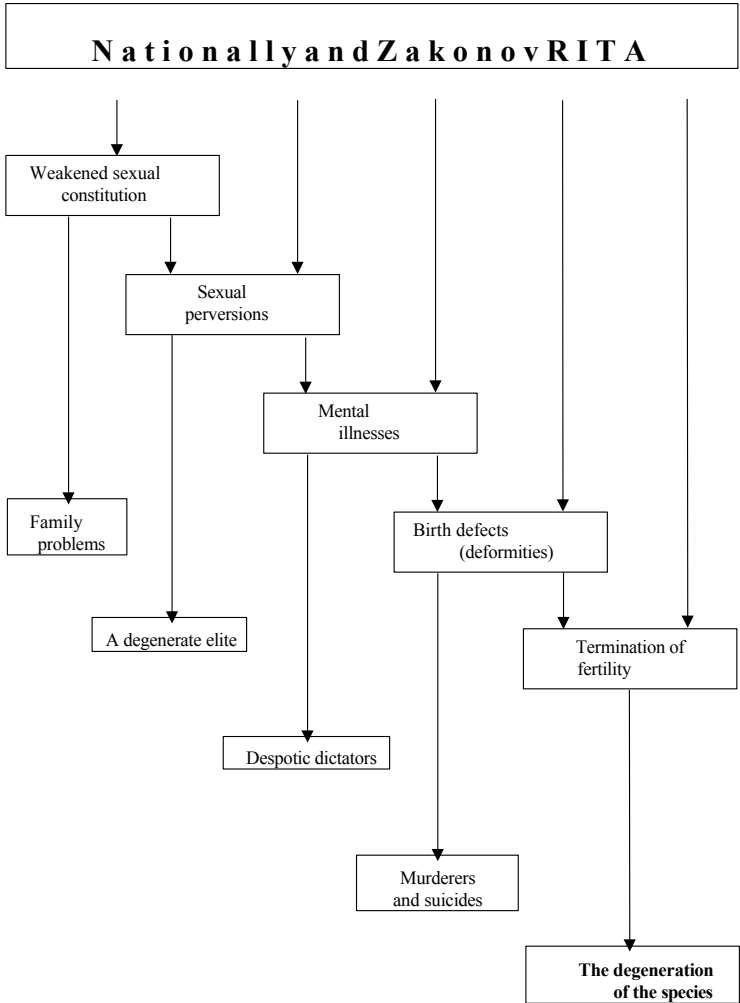

Fig. 1. Stages of degeneration (Klimov-Zhuk's law)

Further violations of RITA laws lead to psi- and birth defects. If birth defects are visible to everyone, then there is a difference between mentally ill people in madhouses and others.

There is no clear boundary for people with mental disabilities, and they are among us. As extreme deviations in the behavior of such people we can name aggression, manifested either in a tendency to murder (when their aggression is directed outward) or to suicide (when their aggression is directed inward).

Five stages of degeneration may therefore be finally distinguished: 1) *weakening of the sexual constitution*; 2) *sexual perversions*; 3) *mental illness*; 4) *birth defects*; 5) *degeneration of the species (cessation of fertility, murder and suicide)* (Fig. 1).

As studies show, there is a certain dependence between all stages of degeneration, manifestations of homosexuality and abnormal human behavior, connected with the manifestations of the split (genetic and field blurring) of human gender.

The process of human gender bifurcation is manifested differently in men and women. As a rule, men are subject to more rapid changes than women (and this has a scientific explanation at the genetic level). But the following *forms of homosexuality* are possible for both sexes: 1) *full (and usually overt)*; 2) *partial (and usually covert)*; 3) *repressed (and covert)*; 4) *latent (unconcealed)*.

Research shows that the safest form is full, open homosexuality, which is uninhibited and finds its outlet and sexual satisfaction. Conversely, latent (unconcealed) homosexuality is the most dangerous. It is not for nothing that the American secret services built their entire work in the Harvard project on Lenin's so-called latent homosexuality complex [5].

3. Statistics on sexual perversion and mental illness.
Statistics for tertiary (mental illness) and

The fourth (congenital defects) stage of degeneration is in the public domain. Each reader can find it for him- or herself. Statistics and signs for the first stage of degeneration are described by the author in the book "Human Sexual Constitution and Methods of its Determination" [6], which has become a bestseller. [6], which has become a bestseller. But statistics for the second stage of degeneration (sexual perversions) are not so easy to find.

Let us take the data published in the United States by Dr. Vitels and Dr. Kinsey. Dr. Vitels, in his work "The Sexual Lives of American Women," gives us the following statistics:

Unmarried women: 20% had multiple homosexual intercourse with other women; 51% dreamed of homosexual intercourse with other women up to orgasm;

Married women: 15% had multiple homosexual intercourse with other women; 32% dreamed of homosexual intercourse with other women up to orgasm.

So how are things going for men? Dr. Kinsey gives us the following statistics: 4% have had repeated homosexual intercourse with other men; 33% have dreamed of homosexual intercourse with other men until orgasm.

Other scientific works give us a slightly different range of data, but most of them are in the range of 33-50%. Thus, today every third (or even every second) person falls into the first stage of degeneration. This is the result of violations of the RITA laws over several hundred or even thousands of years.

When these data were analyzed by occupation, a rather interesting picture emerged. Here are the current data for all

forms of homosexuality affecting the population: 1) peasants - 1%; 2) rural residents - 5%; 3) workers - 10-15%; 4) general population - 37%; 5) intellectuals - 50%; 6) writers, artists, performers - 75%; 7) top state and party officials, their relatives and prisoners - 90%.

A few comments should be added to the above data.

First, these are statistics for the United States. If we take into account that the homosexual revolution took place in 1963, and in the former Soviet Union in 1991, our figures should be lower. Although we are also actively catching up with the Americans.

Secondly, the last group is impressive: top government and party officials, whose homosexuality is the same as that of prisoners in jail. A certain analogy is suggested between these subgroups, one of which found itself at the top of power, while the other, for various reasons, did not get "in the flow" and found itself "on the other side of the barrier".

Thirdly, these same statistics give us a new perspective on the old idea of class struggle (class struggle). But the class struggle is not between rich and poor, but between degenerates and normal people.

The New York Times published the results of a study conducted by a group of American scientists. They analyzed 78 *of the greatest personalities in human history and found that: 37% had acute mental illness during their lifetime; 83% were clearly psychopaths; 10% were mildly psychopathic and only 7% were normal.*

When the study was narrowed down to the 35 *greatest geniuses in human history, it turned out that: 40% suffered*

acute mental illness and 90% were psychopaths [5].

4. The connection between sexual perversions and mental illness. If the connection between sexual constitution and sexual perversions is unquestionable, the other connections are not so obvious.

As it turns out, the devil of degeneration consists not only of sexual perversions, but also of mental illness. More or less official U.S. statistics estimate that 18.5 percent of the U.S. population, that is, one in six people, are clinically mentally ill and in need of psychiatric treatment.

Since these are two faces of the same problem, if you compare Dr. Kinsey's 37% to the 18.5% of psychopaths, it basically turns out that one in two homosexuals has a mess not only in their pants, but in their heads as well.

When talking about the 18.5% of the mentally ill in the United States, it should be noted that these percentages seem to stretch over a person's entire life. Statistics say that in the United States 3% of the population is already born with dementia. Then come the dangerous periods: puberty, menopause and, finally, old age. Some, say, 5% get sick during puberty. Another, let's say, 5% get sick during menopause. And those who skip both of these thresholds get sick in old age, in the form of senile insanity. That's how they add up, the 18.5%. And in their lives they were just a little "weirdos", as Grigory Klimov calls them. As a rule, these "weirdos" are born to those 52-54% (according to Dr. Kinsey's statistics) of parents who have oral sex.

Mental illnesses are the same thing that in the good old days were called demons. These demons are roughly subdivided as follows: psychoses that originate from the brain.

ga, and neuroses that come from the central nervous system. But often one is connected with the other.

In the group of psychoses, the first place is occupied by functional-psychogenetic psychoses, that is, where genetics and bad heredity affect the psyche. On this point *Prof. Lombroso* said: "*In the opinion of most scientists, insanity is 90 cases out of 100.*

— *is the result of heredity.*" [5]. So to speak, for the sins of the parents.

These psychoses include paranoia, delusions of grandeur and persecution. Stalin is a typical example of this. In fact, after Stalin's death, all the Western newspapers said that he was clearly paranoid in the last period of his life.

Then comes *schizophrenia, or split personality*. Brain liquefaction, as the modernists say. *It is the most severe and most frequent chronic mental illness, characterized by persistent mental changes that progress as the disease progresses. It begins gradually, with slowly increasing changes in character.*

— the patient becomes withdrawn, weird. Less often - sudden onset of delirium, hallucinations, fear. In unfavorable outcome leads to dementia.

On a neighboring branch of this tree of evil we can place manic depression, as well as egocentrism or egomania, which gives rise to the incredible morbid vanity so characteristic, as Lombroso says, of many geniuses. For example, the famous writer Balzac was an absolute egocentric and could not talk about anyone but himself. And his father was in bed for 20 years for no apparent reason - depression.

Then there's the guilt and self-destructive complex nearby, the consequence of which is a predisposition to self-murder. When a psycho in the West tries

to commit suicide, he automatically gets checked into an insane asylum.

Next to the guilt and self-destruction complex is the castration complex, which serves as a psychological motivation for the Osprey sect. After all, one could simply become a monk instead of engaging in barbaric self-mutilation. Leo Tolstoy, who towards the end of his life preached mortification of the flesh and in real life had 13 children, was very interested in these Ospreys.

Then come the organic psychoses, that is, where the diseased psyche is reflected in the physicality of the body. *Dr. Berne, professor of neurology at Fordham University in New York, said in this regard: "In over 90% of all human diseases, the dominant factor is the psyche,"* and most of these 90% of human diseases tend to cure themselves if these "dominant psychic factors," i.e., psychiatric disorders, are eliminated.

Cornell University Medical Center has been testing the psyche of New Yorkers from all walks of life for eight years. In 1962, the results were that of *five people, only one was completely mentally healthy.* Of the rest, three were slightly mentally ill and one was severely mentally ill. *The divorced are especially mentally ill: of 25 divorced men (the guilty party) only one is mentally healthy, and of 14 divorced women (the guilty party) only one is mentally normal.*

The New York Times of February 3, 1960, reports that *Dr. Franz Kalman, a psychiatrist at the New York Psychiatric Institute, has determined that schizophrenia is caused by an inherited enzyme in the blood. Schizophrenics account for 50 percent of all patients in insane asylums in the United States.*

The Chronicle of April 24, 1972, reported that *Dr. David Rosenthal of the National Institute of Psychiatry stated at a meeting of the National Academy of Sciences that mental illness is the result of bad heredity, just as homosexuality, crime and alcoholism are.*

In general, there is a clear parallel between sexual perversion and mental illness in the *form of the law of communicating vessels: what is between the legs is also in the head.*

5. Consequences of degeneration processes. It should be noted that in human society, as well as in living nature in general, there is not a complete functional dependence. At least, we can say that the factors influencing human behavior are very numerous and many of them we are simply unable to take into account. Therefore, instead of functional (and unambiguous) dependencies, we can speak about correlation. As applied to the topic under study, we can say that all the identified regularities are 90% correct, and the remaining 10% are exceptions to the rules. Grigory Klimov formulated these regularities in the form of the following five rules:

1. 90% of all crimes, both criminal and political, 90% of all the evils and misfortunes of the human race, from the simplest divorce between husband and wife to world wars and revolutions, are the result of a consequential degeneration that consists of mental illness and sexual perversion.

2. 90% of all diseases are related to mental disorders, which is again degeneration. Of course, not counting infectious diseases caused by microbes.

Let us take as an example such a mysterious and massive disease as cancer, the causes of which are still unknown to this day. It is the No. 2 cause of death after heart disease. Everyone can get cancer. But scientists say that some forms of cancer are 10 times more common in homosexuals than in normal people. The same 90%. Why? Because cancer is a degenerative degeneration of cells.

3. 90% of geniuses are mentally abnormal, again due to degeneration. But here we are not only interested in the good geniuses, whom we guard, as much as the evil geniuses, who need to be put under the microscope.

4. 90% of mental illnesses are the result of bad heredity, which is again related to de-gerentiation. This is from Lombroso, who states, with reference to most authorities, that insanity in 90 cases out of 100 is the result of heredity.

5. Two-sexed people are two-faced people. If they're women — they're unfaithful wives. If they are men, they are false friends who will sell out and betray you in a difficult moment. To some extent, this is due to the sluggish schizophrenia, to the split personality, which gives rise to this duplicity. It is also a characteristic of homo- and semi-homo inability to love truly, giving rise to selfishness.

6. Relativity of Good and Evil. In the "Santhyas of the Veda of Perun" [2] it is said about the difference of all that is not the one God-Creator Ra-M-Ha: "As soon as the Great Ra-M-Ha was manifested in the New Reality, a super-great absolute Something appeared in the Uncreated New Eternity, *and since it was not what the Great Ra-M-Ha is, the super-great absolute Something contained in itself the beginnings of evil, for everything that is imperfect from the highest point of view of the All-perfect is relative evil*".

The "Harbors of Light" [2] adds: *"The struggle against evil must be rightly considered. Evil is not absolute. Evil is only a manifestation of underdevelopment and ignorance.* Even the demons, the lowest entities of the dark world, are not without hope for a spiritual rise in the distant future, for the liberation from filth and evil as a result of a long path of development under the guidance of the Highest Spiritual Guides of the Golden Path.

In the "Santyas of the Veda of Perun" concerning the enemies of Humanity it is said: "By their gray skin, you will recognize the foreign enemies...". Their eyes are of the color of Darkness, *and they are bipolar, and can be wife as well as husband...*". Again bipolarity and degeneration....

But the class of degenerates is not homogeneous. Degenerates can be good, bad and ugly [5].

Good degenerates have always been, are and will always be our friends and allies. In government, they will always fight the nasty degenerates as police officers always fight criminals.

The bad degenerates in the government will pretend that nothing is happening. They will not even try to stop the nasty degenerates from attacking the normal class of people.

The vile degenerates always begin by attacking the good degenerates, for the good degenerates, as the body's defense system, can quickly recognize and neutralize the actions of the vile degenerates. After suppressing the good degenerates in the government, the abominable degenerates, as a rule, immediately start a full-mass war against the entire class of normal people.

In Marxist-Leninist philosophy, this process is called the law of the unity and struggle of opposites as the engine of historical progress. Two thousand years before them, the Romans formulated this law as follows:

like is learned by like (or, more precisely, like is cured by like).

So - how do you determine if there are good degenerates in government?

The same way we determine if there's a cat under the bed. We let a mouse into the room and the cat, if there is one, will jump out to catch the mouse.

Let's get our mice up and running....

How is the government responding to the gay rights movement?

How does the government respond to the death penalty for degenerate criminals?

How does the government protect the interests of the working class?

How does the government protect the interests of the parasitic degenerate class?

Simple questions. Simple answers. Simple test. A simple example: what was the 1st decree of the Soviet government? in 1917? Turns out it wasn't the Peace or Land Decree. After the Great French Revolution of 1789, the Great October Revolution of 1917 in Russia, the homosexual revolution of 1963 in the United States, and a similar revolution in Russia after the collapse of the Soviet Union in 1991, homosexuality was decriminalized.

Since open, repressed or unveiled (i.e. latent) homosexuals are, as a rule, all kinds of revolutionaries and eternal rebels, once they had fulfilled their functions (in the interests, again, of another part of the degenerate strata of society seeking power), they were simply destroyed.

This was the case, for example, with Jeanne Darque. This was also the case with revolutionary-Leninists in the 1930s. Realizing that the revolutionary Leninists would continue to torment the people, Stalin again in May 1934 introduced criminal-

In December of the same year, with the assassination of Kirov and the corresponding case, he began the Great Purge, as a result of which the entire old Leninist guard was almost completely destroyed along with its offspring....

The same test methodology can be applied to any other entity - science, art, military, press, television vision, church...

This test will give you a clear picture of which departments in the organization are completely occupied by the vile degenerates, which are stagnating under the leadership of the bad degenerates, and which are under the control of the good degenerates who are fighting vigorously to save and preserve themselves, and at the same time the whole class of normal workers, from the fierce attacks of the vile degenerates.

People often ask - can there be normal people in power? The answer to this question is as follows: theoretically, yes, but in practice, if a normal person gets into power, he will not stay there for long. It is not for nothing that people say: to live with the wolves is to howl with the wolves.

6. Signs and manifestations of degeneration. In order to avoid evil, you must learn to see it. And for this purpose it is necessary to know well the signs that give away degenerates. This is where the study of the third phase of degeneration, which manifests itself through some physical deformations of the human body, will help us.

The most striking deformities are: strabismus, red-eye, "hare lip", "wolf's mouth", large birthmarks (the devil's seal), dry hands, limpness, humpedness, strangeness, etc.

After all, slanted and redheads were not allowed to be witnesses even in the times of Peter the Great, "because God marks the fool".

Let us review the current list of signs and manifestations of degeneration based on [1], [5] and our personal research.

I. MAJOR NEGATIVE CATEGORIES:

- 1) the presence of murderers and suicides among direct ancestors;
- 2) The presence of child and parent killers among blood relatives;
- 3) increased frequency of criminality (criminal records) in the family;
- 4) Incompleteness of the family (both their own and their parents');
- 5) having few or no children (15% in the USA and 21% in the USSR);
- 6) high mortality of children in the family;
- 7) The wife's seniority over the husband or a very large age difference;
- 8) alcoholism as a side effect (as well as congenital alcohol intolerance);
- 9) Alcoholics among blood relatives;
- 10) looking older than his age;
- 11) Abnormal friends and acquaintances ("tell me who your friend is...");
- 12) Clergy affiliation (father, uncles, or appropriate surname);
- 13) racial crossbreeding in direct ancestry;

II. MAIN VISIBLE FEATURES DEGENERATIONS.

- 14) a nervous tic or facial spasms;
- 15) strabismus and other eye deformities;
- 16) oval pupil shape;
- 17) iris pigmentation; 18) eye discoloration up to astigmatism; 19) presence of a rudimentary third eyelid; 20) abundant freckles on the face or body; 21) abnormal skin pigmentation;

- 22) large birthmarks that are insensitive to pain;
- 23) bad body odor (from heat or exercise, sometimes cadaveric);
- 24) horse teeth;
- 25) asymmetry and disproportion of the face, body;
- 26) the presence of opposite-sex features in the body proportions;
- 27) short stature (dwarfism);
- 28) all kinds of speech defects (whispering, mumbling, stuttering);
- 29) a wolf's mouth or a hare's lip;
- 30) Fingers, toes, fingers or, conversely, "extra" fingers;
- 31) abnormal hairiness of the body and face;
- 32) Asymmetry of leading sides (e.g., right-handed in arms and left-handed in legs);

III. PHYSIOLOGICAL SIGNS OF DEGENERATION AND DEGENERATION

- 33) functional asymmetry of the two halves of the body;
- 34) just like crazy people have a dulled sense of fear;
- 35) It is possible weak sensitivity to hunger and cold; 36) it is possible, on the contrary, increased sensitivity to the stimuli;
- 37) The effects of depressants (e.g., alcohol) are not tolerated;
- 38) Bedwetting (nocturnal urinary incontinence) in an adult;
- 39) White bone and blue blood (calcium metabolism disorder and negative Rh factor, making it difficult to give birth normally);
- 40) genital abnormalities;
- 41) Abnormal labor in women (not 0.5-2 hours, but 10-12 or more);
- 42) Early menopause (statistically 4% before age 40);

43) male impotence or female frigidity;

IV. MENTAL SIGNS OF DEGENERATION AND DEGENERACY

44) just like the crazies have a dulled sense of fear;

45) delusions of grandeur and persecution;

46) the constant wearing of clothing of the opposite sex;

47) presence of mental qualities with signs of hermaphroditism, feminism, masculism, infantilism, senility (premature aging);

48) sadistic tendencies, the urge to bite or hurt;

49) masochistic tendencies, desire for pain; 50) gratuitous or chronic headache (migraine);

51) gratuitous irritability; 52) chronic insomnia;

53) different reactions to the same external stimuli at different times;

54) periodic unreasonable increases in activity and unreasonable apathy;

55) weak-willed, submissive to any assertions of the superior;

56) sexual perversions;

57) claustrophobia, i. e. fear of closed spaces (closed doors in rooms);

58) Menopausal insanity (divorce peaks at 6-7 and 20-25 years of marriage);

V. SOCIAL MANIFESTATIONS

59) breaking toys as a kid;

60) children playing with toys of the opposite sex;

61) weak connection with parents, brothers and sisters (without distinction to them);

- 62) desire to impose one's point of view at any cost; 63) excessive meat-eating (blood greed);
- 64) women's dislike of cooking and women's work and men's dislike of men's work;
- 65) the desire for secret societies and various conspiracies;
- 66) Messianism, the desire for leadership and excessive guardianship over someone;
- 67) Choosing a profession or position other than one's own gender;
- 68) the desire for consanguinity, i.e. sexual relations with relatives;
- 69) An inability to love deeply - even your own children and parents;
- 70) fornication, i. e. the desire to go "to the left" even if the family is well off;
- 71) Bipolarity is duplicity, betrayal of friends, interests, etc.;
- 72) a love of detective movies, action movies and violence in general;
- 73) matriarchy in the family, the dictatorship of the woman and the husband's lack of character;
- 74) envy and hatred of other people's accomplishments;
- 75) the desire to replace the logic of facts with the logic of mental attitudes;
- 76) inactivity, idleness, i. e. the desire to live at the expense of others.

It should be remembered that the presence of one or two traits does not give a definitive answer to the question of whether a person is degenerate or not. For this purpose, five or six of the most significant characteristics are needed. Besides, it should be taken into account that there are a lot of good people among degenerates.

7. Ways of overcoming degeneration. There are many ways of overcoming degeneration, i.e., the degeneration of labor and the trouble caused by degenerate people.

At once it should be stipulated that there is no cure for this affliction. If we remember the biblical thesis that children are responsible for the sins of their parents up to the 7th tribe, we can show what happens in this case.

Suppose one degenerate married a normal person. This is the initial or zero generation. Their child, i.e. the first generation, according to probability theory, will have half as much of the disease, or perhaps it will occur with a probability of 0.5, i.e. half of the children on average.

If descendants will combine only with normal people, then in the seventh generation there will be $1/256$ part of degeneration left. And it is possible to combine with one's relatives only from the eighth generation. In this case, there will be $1/512$ th of degeneration. This is the figure that separates normal people from degenerates - $1/512$ part or less than 0.2% of degeneration. In other words, normal people should have no more than 0.2% of abnormalities. And they are connected with background influences on people of various factors: radiation, radioactivity, viruses, microbes, bacteria, harmful chemicals, etc.

The gene-field structure of a living being can be represented as a unit function for a set of its properties. Deviations from the unit are degeneration. Mating in a family union and the birth of offspring (i.e., heredity replication) is, as it were, the product of one such function by another.

In general, the degeneration function is random, and superimposition (multiplication) of one such function on another leads to a third random function whose deviations from unity are similar. But if close relatives are combined in a family union, it turns out that all abnormalities, which are mostly identical for them, i.e., are in the same places of the function, are in the same places of the function.

The process, if repeated repeatedly, eventually leads to degeneration of the genus. If this process is repeated repeatedly, it eventually leads to degeneration of the genus.

So, what should be done if this happens and degenerates (retards) appear? Taking into account the experience of the Middle Ages, we can name the following ways to overcome degeneration, or, more simply, to stop the emergence of offspring of degenerates:

- 1) The fire, gallows, guillotine, bullet, etc., i.e. physical destruction;
- 2) Prison if the degenerate is a criminal;
- 3) a madhouse if a degenerate is a danger to society, but hasn't done any damage yet;
- 4) oscolation (castration) or self-oscolation of men, sterilization of women;
- 5) celibacy (voluntary refusal to have children) or monogamy among same-sex siblings;
- 6) Pregnancy protection, adoption and adoption of other people's children;
- 7) making babies on the side with healthy people;
- 8) constant labor, self-training of the will by running and hard endurance work.

It is obvious that for modern, i.e. civilized conditions, 5-8 ways of overcoming de- gression in a mild form are the most acceptable, although prisons and madhouses, in which 0.3% of the population is on average, are also still used. If we pay attention to the bohemians, we can notice that well-fed top models more and more often take in orphans from orphanages instead of giving birth to inferior offspring themselves (it is not known what kind of children they find in these orphanages).

8. Conclusion. In conclusion, degeneration as a consequence of the violation of the laws of nature and the precepts of our ancestors is not a disease that can be dedu-

cure. Therefore, the only wish and the only effective way to overcome this phenomenon in society can only be one thing - a return to the intellectual and spiritual heritage of our ancestors, the study of this heritage and the implementation of all its provisions in practice.

Literature

1. "On Basic Criteria in the Selection of Personnel for Service in the NKVD Bodies". NKVD Instruction No. 00134/13, Order No. 00310 of December 21, 1938.

2. "Slavic-Aryan Vedas. Books 1-4. - Omsk: "Asgard," 2001-2002. <http://zhuck1.narod.ru/Sl-Ar-Ve.zip>.

3. Zhuk N.A. "Slavic-Aryan Vedas about the structure of the Universe and the history of Mankind". In Sb. "Ergo-informational and intellectual-spiritual activity of the Universe and our worldview". - Kharkov: LLC "Info-bank", 2004, pp. 115-143. <http://zhuck1.narod.ru/SAV-SVIC.htm>.

4. Zhuk N. A. "Slavic-Aryan Vedas about the Laws of the Rod Production and the Community-Rodovoye Uklad". In vol. "Ergo-informational and intellectual-spiritual activity of the Universe and our worldview". - Kharkov: Ltd. "Infobank," 2004, pp. 144-178. <http://zhuck1.narod.ru/SAV-ZPR.htm>.

5. Klimov G. P. "The Prince of this World". - M.: Molodaya Gvardiya, 1992.

6. Zhuk N. A. "Human sexual constitution and methods of its determination" - Kharkiv: LLC "Infobank", 2002, 64 p. <http://www.moscowuniversityclub.ru/home.asp?artId=1272>.

March 2006.

SLAVIC-ARYAN VEDAS ON THE RATIO OF MALE AND FEMALE IN MAN

H. A. Zhuk

The work deals with pathological problems and related issues of psychology of the male-female ratio in human beings, leading to problems in the family and in society - to the appearance of hermaphrodites, transsexuals, bisexuals, transvestites, lesbians, pederasts, masochists, sadists, etc. The work deals with the laws of nature and ancestral precepts, violations of which lead to all these consequences. The laws of nature and ancestral precepts, violations of which lead to all these consequences, are considered. The signs of violations of human sexual harmony are given.

1. Harmony of masculine and feminine beginnings in a person. In every human being there is a masculine and feminine beginning [1]. Only in a man the masculine is true (or explicit), and the feminine is imaginary (or implicit). In a woman, it is the opposite: the feminine is true and the masculine is imaginary. This is a universal law of nature.

For example, a woman has female breasts and they are real because they can nurse a baby. A man also has breasts, but they are imaginary, because their nipples will not produce milk under any circumstances.

On the other hand, a man has a penis. It is true, as it allows to make a woman pregnant (under appropriate conditions). A woman also has an analog, which is the clitoris. But it is an imaginary penis, as it does not fulfill the function of the male sex organ (i.e. conception).

Thus, everything feminine in man is imaginary, and everything masculine in woman is imaginary. Moreover, the imaginary organs

men and women, as a rule, are smaller in linear dimensions and volume. If such arrangement (harmony) of true and imaginary organs, functions or feelings (visible, invisible, hidden or latent, i.e. not manifested) at least in one of the spouses is disturbed, then there appear problems in family relations - big or small depending on the degree of disturbance. First of all, they are manifested in relations between husband and wife, but they do not exclude manifestations between different generations: parents and children; grandparents and grandchildren; other relatives. Visible violations of the harmony of masculine and feminine in a person are most often an obstacle to the conclusion of a family union, and the person remains alone.

It should be added that human genes contain up to 10^{10} bits of hereditary information. But since they contain a large number of programs of organism development (for adaptation to changing conditions), they actually transmit to a particular individual no more than $10^6 \dots 10^8$ bits of useful information. A complete human being contains (according to estimates based on the study of identical twins) $10^{22} \dots 10^{25}$ bits of information. Thus, approximately 10^{15} bits of information of a human being fall on his subtle matter - biofield [2]. It is not easy to notice deviations in the balance of masculine and feminine in this environment. Only by indirect signs (a person's behavior, feelings, self-esteem).

Thus, the subtle matter of man (his bio-field) contains hereditary information about 100,000 times more than his genes. It is also obvious that violations of hereditary information first of all affect the field level and only when a certain critical value is reached, they manifest themselves on the phi-

The biofield in this case plays the role of a program for the development of the human body, i.e. is at a higher level of organization. The biofield in this case plays the role of a program for the development of the human body, i.e. it is at a higher level of organization.

Indeed, genes contain information only about the structure of the cell. If we use only this information, then from a single initial cell by fission in a nutrient medium, an organism of some spherical shape consisting exclusively of identical cells would develop. But the organism of a living being is much more complex in shape, cell and organ composition. And this is due to the program of its construction contained in the biofield of the initial cell, i.e. in its subtle matter. The body of the organism will never change on its own (except for external influences such as traumas) unless the program is changed. And the program changes only when certain laws of nature are violated (about them below) in behavior, procreation and natural aging (we will not consider the last aspect).

Violations of the harmony of the masculine and feminine in a human being have the character of inversion, i.e. a kind of mirror reflection, when all or only a part of what concerns a person's sex is changed to the opposite: masculine to feminine, and feminine to masculine. Accordingly, the violations can be visible or invisible depending on whether they affect only the biofield or both the biofield and the human body.

2. Invisible violations of harmony. And now let us look at the relationship between spouses when the balance of male and female beginnings is disturbed in at least one of them (which is manifested first of all at the field level).

There is usually a relationship between a man and a woman that does not exist between two men or between two women. It is love and sex. When

they are also accompanied by a dislike of the competition. Sometimes only on a subconscious level. At the same time, it is necessary to separate those types of love that are connected with the attitude of a person, for example, to parents, children, homeland, nature, and only to consider the love for the representative of the opposite sex, which in the Ukrainian language is even given a special name - kohannya.

Now about relationships. Thus, if a man loves (loves) a woman, he can't stand another man who is not indifferent to this woman. He also dislikes the idea of having sex with a man (we do not consider pathology yet). A woman feels the same way about another woman as a competitor.

And now let us imagine, for example, that a woman initially, from birth, has some male part (even if it is not visible to the eye), which from birth has become true and not imaginary, as usual. Let a woman marry successfully (all her friends married and she married for company). May she have a handsome husband. And let this husband show attention to her, and this part of her is always or at this moment or in this situation is masculine. And it turns out: the masculine disgusts the masculine. As a result, a woman gets discord, dislike, which gradually accumulates and grows into hatred accompanied by scandals. And, from a man's point of view, they are completely unreasonable. From our point of view it is a conflict between the true masculinity of a man and the manifested masculinity of a woman. This conflict is neither medically nor psychologically treated and corrected. Only a deep knowledge of the true causes of the conflict can partially compensate for its manifestations by will.

In view of the fact that hidden male harmony disorders

The question arises: how can we recognize these violations or at least find out if they exist in a person at all? And this is where our ancestors give us a clue. It turns out that they knew the most general rule of such violations - it is when the left becomes as if right and the right becomes as if left [3]. Moreover, this rule applies both literally and figuratively. Let us first consider examples of the application of this rule in the literal sense.

Usually, the right hand and the right leg are the leading functions of a human being. However, in some cases of male-female harmony disorders, the leading functions of one half of the body are inverted in relation to the other. For example, in the upper half of the body the right hand remains the leading one, and in the lower half of the body the left leg becomes the leading one. It is checked very simply: which leg is in front when a person slides on ice is the leading one. In this case, as a rule, there is a simultaneous violation of symmetry between the apparent and imaginary halves of a person, leading to the manifestation of a part of the imaginary half, i.e. to the appearance of properties of the opposite sex. Accordingly, in this case, the properties of one's own sex are weakened, which in general leads to the weakening of a person's sexual constitution [4]. A weakened sexual constitution (which does not change with the course of life) can serve as another sign of a possible disorder in the relationship between masculinity and femininity.

A left-handed person is taught to write with the right hand from childhood, developing the corresponding conditioned reflexes. Therefore, not all left-handed people can know for sure that they are left-handed. Especially if the inversion is not complete, but partial. You can check this by simply crossing your arms on your chest: whichever hand is on top, is the right hand.

of the left hand. If the left hand is on top and the right hand is on the bottom, the person will be left-handed. In this case, a person can be left-handed only in his hands, but in his feet he can remain right-handed, which can eventually cause problems in the family.

The above-mentioned examples of breaking the symmetry between imaginary and manifest manifestations of male and female beginnings are often reflections of deep changes in the organism with the dominance of a dominant function (feeling) of a different sex. For example, in a woman, the clitoris becomes such a dominant, and the entire sexual act takes place or at least begins according to the male scenario - with excitation of the clitoris and obtaining a clitoral orgasm. In this case, the woman is uncomfortable with the penetration of the male penis into her vagina before the clitoral orgasm or is not interested in such penetration at all, and the sexual intercourse ends there (i.e. at the clitoral orgasm). As a consequence, the woman becomes either *an onanist* or a *lesbian*. Therefore, the widely publicized 69 position in sex, if it is not only the initial stage (foreplay) of normal sexual intercourse, seems to be the first harbinger of abnormal development of a woman (and possibly of a man).

A man may have a different kind of harmony disorder between the masculine and feminine. This is when the feminine beginning (usually at the level of feelings, sensations and functions) manifests itself only in the sexual sphere. This beginning begins to conflict with the feminine beginning of the same name (even in physics, electric charges of the same name repel each other). At the same time, the man suffers from impotence at times (if the disorders are periodic) or permanently, which leads to conflicts in the family or to the fact that he remains without a family at all.

If a man's imaginary feminine self is manifesting-

The left becomes like the right, and the right becomes like the left. He loses interest in women altogether, but if he does not have them, he becomes a *pederast* - active or passive, depending on the ratio of the components that have undergone inversion.

It is interesting to note that a man with complete impotence does not prolong his corrupted lineage. A woman with the above-mentioned violations between male and female (including completely frigid) is able to prolong and often prolongs her lineage, fixing hereditarily these violations. That is why our ancestors, along with the requirement to observe virginity before marriage (about this below), studied the bride's family environment especially carefully before marrying her son. Only by indirect signs and by the history of the family could it be assessed whether there was a violation between male and female in the future daughter-in-law and not give their blessing to the son for the wedding. This was the ancestors' concern for preserving the strength of their clan (just as breeders scrupulously cultivate good varieties of plants or good breeds of animals).

When considering the invisible disturbance of harmony between male and female, I cannot help but recall my own experience of remote (i.e., field) influence on a girl from my class. When I was in the 5th grade, I came across Anatoly Markusha's book "You Take Off", which determined my fate for several decades to come. In short, I began to rave about aviation. While dreaming of becoming a fighter pilot, I nevertheless showed an interest in designing and building airplanes in practice. I searched for literature in rural libraries with great persistence, and in 8-

I was already able to use simplified methods to calculate the propeller and make a complete aerodynamic calculation of a super-light airplane with a power plant in the form of a tractor launch engine. When I tried to build such an airplane, I crushed a finger on my right hand, and then school was over.

But in that very 8th grade class at school, there was a girl sitting right in front of me who was not indifferent to me. Apparently, she was going through puberty at the same time, and her body was highly susceptible to my biofield. Since I had no personal interest in her, nothing ever happened between us. But what was my surprise when, two and a half decades later, her husband brought their son to me to enroll in the higher military aviation school where I was teaching at the time. He did not qualify for our program because of medical reasons (the fighter school has the strictest mission code), but later on he became a military helicopter pilot. Their younger son also became a helicopter pilot. And both of them built model airplanes and dreamed of aviation from childhood. Like I did when I was at school with their mother.

The above example is not characteristic of any pathology with regard to human sexual properties, but it clearly demonstrates the phenomenon of male field influence on the properties of female oocytes during the period of girl's puberty. Even such an innocent influence as we had in our accidental experience. But there are also more serious examples in life, beginning with seemingly innocent infatuations but ending with serious pathologies in human psyche and behavior.

For example, when a wife caresses her husband's penis with her mouth, it is quite normal. Obviously, there is preparation for intercourse, and the woman is aroused by a gentle and warm

In this way, you can use your tongue on the man's penis to increase the blood flow to it and subsequently experience the pleasure of a well-eroded penis.

But there is an irresistible disease, passion for licking genitals - licking fanaticism or waffling. In waffling, for example, it is no longer the husband who asks her to lick his penis, but the woman herself. Women's waffling, especially in countries with a low moral culture, is quite common, while it is very rare in men.

It was previously thought that such suffering occurred in persons who were mentally deficient, but recent observations by sexologists have shaken this assumption. There is no outward expression of waffling: it is only expressed in the vice itself. Even a specialist in the appearance of a waffler will not be able to draw any conclusion until he has seen her at work.

This strange phenomenon became known to sexologists mainly after the Second World War, indicating that it is a consequence of the moral decline in the post-war period.

The only expert on waffling, an Italian pathosexologist (for some reasons his name is withheld), came to the conclusion that in order for waffling to occur in any woman it is necessary: first, to see the licking of the male penis at a young age (up to 18 years old); at this time there is only sexual curiosity about waffling, the desire for it; second, to kiss the male penis for the first time at the same age - the so-called "waffling". the "first licking phenomenon". This is when waffling itself emerges - an irresistible passion for licking sexual organs.

An Italian pathosexologist claims that certain age groups of women are potential wafflers.

And if they don't become them, it's only because of a lack of the "first licking phenomenon", i.e. if easy access to the male penis was difficult for them at that age. He cited the results of such studies: 4 groups of women kissed the male penis: 1) girls under 13 years of age; 2) girls 14-15 years of age (after the menstrual cycle had been established); 3) girls 16-18 years of age (not sexually active); 4) women over 19 years of age (sexually active for a year or more).

The first three groups of women (ages 13-16) were recruited from state-run closed institutions (orphanages and boarding schools), as no mother would allow her daughter to participate in such an experiment. The results were as follows: two of the seven girls in the first group, 7 in the second, and 5 in the third became wafflers. None of the women in the fourth group became wafflers. The conclusion is that waffling begins when the female body has had no sexual experiences and is most sensitive to sexual activity (puberty with its high sexual curiosity).

The above examples show how strong is not only the field influence, but even the first visual impression of the sexual side of life, on a person's own sexual role during puberty. This is especially true for girls, since their entire hereditary gene-field fund is laid down precisely during this period. But an even stronger influence comes from the confusion of male and female roles, leading to the development of different variants of homosexuality.

Indeed, during adolescence, when interest in the opposite sex is awakening, parents often separate children (relatives, guests, neighbors) by gender, forcing girls to sleep together on the same bed.

and the boys in the other room in the other bed. Sometimes girlfriends like to keep secrets in the same bed. And then there is the interest in mutual intimate places, which some of them eventually lead to a lifelong interest. *That's how lesbian yankees come to be. They are not hereditary, but have become lesbians through adult neglect.* The same applies to teenage boys, whose ignorance of such issues can cost them their true manhood in the future.

In this regard, examples of the protection of virgin purity from other peoples should be cited. For example, in some nations, at the onset of the first menstruation, girls were removed from their families to a small hut in a remote area, where they had to live in strict secrecy in order not to be "dangerous to society". The first blood was considered a sign of demonic forces that for the first time gained power over the girl's body. The timing of the first menstruation depends on both climate and race. In tropical areas of Africa and Asia, it can occur as early as the eighth year of a girl's life. Girls were therefore forced to live in isolation, sometimes for eight to eleven years (until they were married). Their mothers could not see them, i.e. communication took place through the door or screen of the hut [5].

And some peoples went even further - they fought even with imaginary manifestations of the opposite sex in a person.

In many countries of the Arab world, for example, ritual acts are performed that can be traced back to the pre-Islamic era. It is the circumcision of the clitoris, a ritual act that existed and still exists, above all among nomadic tribes. The ritual serves, according to European

The Arabs, on the other hand, see this cultic act as elitist: in this way, the all-powerful prophet distinguishes them from all "uncircumcised" women. The Arabs, on the other hand, see in this cultic act an elitist meaning: in this way the all-loving prophet distinguishes them from all the "uncircumcised". (The Prophet, however, considers circumcision obligatory only for men).

Circumcision of the clitoris is still performed on girls between the eighth and fifteenth years of life among some peoples in Africa, Australia and South America [5].

3. Visible manifestations of harmony violations. The extreme degree of violation of harmony between male and female in a person is the manifestation of external features and the appearance of organs of the opposite sex. This is *hermaphroditism* and *transsexualism*. The psychological manifestation of such violations is *transvestism* - a 100% inversion of a person's personality while preserving the external features of the body of the opposite sex. The characteristics of these manifestations are in the shadow of medicine, and not every ordinary person understands the differences between the terms "hermaphrodite", "transsexual" and "transvestite". Even in medical dictionaries, there is still a lopsided classification of sexual disorders that does not cover some cases. But the porn industry has given its own interpretations to these terms, taking into account the needs of various perverts. And all the diversity boils down to the fact that in addition to the inversion of "right-left" in the upper or lower half of a person, there is also an inversion of the type "male-female" of the "top" (i.e. the upper half of the body) or the "bottom" alone.



Figure 1. Photograph of an African transgender man

For example, in a woman with inversion of the "bottom" only, the upper half of the body may have female breasts, and the lower half of the body may contain a male penis (with testicles, underdeveloped testicles or without them - see the example in Fig. 1). The overall body shape can vary from purely female (with narrow shoulders, narrow waist and wide hips) to purely male (with broad shoulders, implicit waist and narrow pelvis). The voice can also range from purely feminine to roughly masculine. A female upper half (with female breasts and a female voice), a general female body shape with male genitals (penis and testicles) is the typical extreme *transsexual* (*the medical literature attributes a slightly different meaning to this term*) of *female origin*. A quasi-male body with male genitals (penis and testicles) is a typical extreme transsexual of female origin.

A typical extreme *male-to-male transsexual* with a penis and testicles), but with female breasts.

According to statistics, one transsexual per 40-100 thousand people is born in the world, and in women's sports there is one per 500 people, because a transsexual stands closer to a man and shows better results than women (which has caused many scandals).

There can be another form of male-female inversion, when the lower half of the body bears the characteristics of a woman and the upper half of the body bears the characteristics of a man, i.e. in the extreme case it is the absence of female breasts. For some reason, this case is ignored by the medical profession and researchers, believing that it is just a manifestation of a woman's ugliness (underdevelopment of her breasts). In fact, the bra size of a mature woman of number 2 or less can be a manifestation of a violation of the harmony between her feminine and masculine in terms of the inversion of the male-female type of her "top". However, when assessing the presence of such violations, it is necessary to take into account a number of factors, in particular, to take into account the sexual constitution of a person, the methods of assessment of which are described in [4].

The appearance of both male (penis more often without testicles) and female (genital slit more often with underdeveloped uterus) sexual organs in one person is called *hermaphroditism*. In this case, even legally it is difficult to determine the sex of the person. Only by the form and manifestation of secondary sex characteristics, DNA analysis, and psychological feeling. At the same time, such children are most often classified as female from birth, and only later do they begin to show male genitals as well.

But there are cases of a normal looking person (with normal genitals of his or her own sex) in which the person psychologically identifies himself or herself as the opposite sex.

a floor. This is traditionally called *transvestism*. Some transvestites prefer to wear only clothes of the opposite sex (they are officially called transvestites), and some also want to change (and often have surgery to change) their sex. In medicine, they are officially called transsexuals, but we will not do so, as we will omit the important class of the above-mentioned disorders related to the inversion of the male-female type of only the "top" or only the "bottom", and we will refer to both groups as transvestites.

Sexual attraction in transsexuals corresponds to gender identity. Adult male transsexuals are sexually attracted to men, while female transsexuals are sexually attracted to women.

4. Signs of human sexual harmony disorders. People tend to hide their shortcomings, especially in the sexual sphere. Nevertheless, during a medical examination, obvious violations of the harmony between male and female in a person can be detected immediately. These are disorders such as hermaphroditism and transsexualism, which involve the manifestation of genitals of the wrong sex.

Very characteristic (90 percent justified) are the manifestations of secondary sexual characteristics of the opposite sex. In women it is the appearance of male vegetation on the face, male (with a triangular upper edge) hairiness of the lower abdomen, masculinity in the whole face, late (later than 15 years) or no menstruation at all, sexual coldness or even frigidity, non-normal childbirth (not 0.5-2 hours, but 10-12 and more hours; use of forceps, caesarean section; heavy bleeding), early menopause (statistically 4% before the age of 40), menopausal insanity (peak divorce at 6-7 and

20-25 years of marriage). In men it is a weak facial hair, female (with horizontal upper edge) groin hairiness, narrow shoulders and wide pelvis, periodic or permanent impotence.

Less obvious, requiring observation and comparison, are behavioral signs. This concerns, first of all, the identification of transvestites - souls in the bodies of the opposite sex. They are characterized by: over-dressing or wearing clothes of the opposite sex; children playing with toys of the opposite sex; choosing a profession or position not of their own sex; women's dislike of the kitchen and women's work, and men's dislike of men's work.

If a woman thinks she is a man, she carefully copies male behavior: she drinks a lot, smokes, cuts her hair short, wears men's clothes, tries to speak in a lower voice, and courts women. Of course, male hormones in pills come into play, and by the age of thirty or forty, there is little of her female gender left.

A man with mental signs of a woman wears earrings, chains, paints his face, likes colorful clothes, strives, if not to wear women's clothes, then to wear those things that do not have a clear gender distinction (these are - long sweaters, jackets with zippers, etc.).

Disproportions of the genitals can be very characteristic. For example, a female clitoris of more than 2.5 cm in length and a penis of less than 5 cm are the first obvious signs of possible abnormal sexual development. Although there are exceptions. For example, although clitorises over 2.5 cm in length are very rare in normally developed white women, they are found in 2-3% of normal black women, and sizes of 7.5 cm or more are found in about 0.3-0.4% of such women.

Approximately 60% of women have erogenous zones in the

The clitoral area, with 10% of women having the only clitoral area. The 60% figure is very close to the percentage of unmarried women (51% according to Kinsey) who have dreamed of homosexual intercourse with other women until orgasm. And if we divide 60% by 2 (unexpressed violations), the resulting number of 30% is almost identical to the percentage (31% according to Kinsey) of married women who have dreamed of the same thing.

Penis less than 10 cm is found in 0.1% of men, which may indicate underdevelopment (incomplete manifestation) of masculinity.

However, we would like to emphasize that linking the above-mentioned visible signs with violations in the proportions of male and female beginnings should be done with caution, since there is no clear functional dependence among living beings, but only a share of probability, reaching up to 90% for a set of signs.

In addition to all of these categories of people, there are people with an imbalance of hormones. If they have a perfectly healthy sex system (male or female), they may not look quite right.

A man with an excess of female hormones acquires a figure and voice characteristic of women and is even considered homosexual. A woman with an excess of male hormones acquires a moustache, a low voice, narrow hips and broad shoulders.

Some of these people have a humorous attitude towards their appearance, others have a hard time with the situation and sometimes actually become homosexuals to be left alone.

5. Consequences of violations of harmony between masculine and feminine in a person. As a result of violations of harmony between male and female in a person

four characteristic psychological types of people, which are often encountered in everyday life and which it is useful for everyone to know in order not to walk through life blindly and not to get burned. Moreover, it should be borne in mind that a person with one of these types of psychology may not be aware of his illness, if the disease is hidden, latent, not manifested in person. Grigory Klimov characterized these four types of people as follows [6].

1-type: the *active pederast*. Spiritually and physically, this activist sometimes gives the impression of being super-masculine. A kind of ubermensch. Not a man, but a walking dynamo. But the source of energy here is all sorts of psychoses, neuroses and psychoneuroses.

2-type: the *passive pederast*. Physically and mentally, such a passivist gives the impression of being half a man or, if you look closely, half a woman. Neither a candle to God nor a poker to hell. A kind of untermensch. People say about such people: a silent man, a mumbler, a wimp. If it is rather difficult to recognize an activist, it is quite easy to recognize a passivist.

Type 3: the *active lesbian*. At heart, in fact, it is a man in a skirt. The appearance is feminine, but the character is masculine. Such activist women are not only very energetic, but often also self-distinctive. Clever and sneaky. They're real witches. Perhaps the nastiest category. They are easier to identify by their appearance and character than the passive ones, who are more like

on women.

Type 4: *passive lesbian*. This type is externally and internally quite difficult to distinguish from normal women. But they are a kind of snake. Passive lesbians are more likely to get married than activists. And if the husband is normal, they will ruin his whole life: an unhappy marriage, a messy divorce, defective children where you won't know what the hell it is for the rest of your life.

Other appearances of harmony disorders in a person are *sadism*, *masochism* and *sadomasochism*, i.e. a mixture of both. What it is - everyone knows approximately. But few people know that sadism and masochism are closely related to homosexuality and other sexual perversions. Sadism is usually intertwined with active homosexuality and masochism with passive homosexuality. The sadist derives sexual gratification not only from tormenting others physically, but also from tormenting them psychologically - insulting, humiliating, humiliating, trivializing, making them feel powerful over them in every way. Almost all medical authorities agree that the psychological root of sadism is the *desire for power*.

Statistics and a more detailed characterization of various sexual disorders are given in [7]. It should be added that, according to Kinski (1953), homosexuality occurs in 4% of cases among men and 3% among women in the United States. It is the most frequent form of psychopathology. And in England, according to Davis (1960), 27% of women have had homosexual intercourse at least once by the age of 45 and 6% have become current lesbians [8].

Homosexuals are the most at-risk population group in terms of the frequency of partner change and, consequently, the incidence of various sexually transmitted diseases and AIDS.

For example, according to statistics from a Sydney women's conference, 9% of lesbians had more than 50 partners (compared to 2% of heterosexual women). Lesbians and bisexual women were three times more likely than the average woman to have sex with a homosexual or bisexual man. There is also a significant proportion of women who have a history of pregnancy and abortion. Women who had sex with a partner of their own sex were six times more likely to use drugs.

SEALs. They also had an increased risk of hepatitis B or C, hemorrhoids and other diseases.

6. Causes of violations of human sexual harmony. The main reasons for violations of male-female harmony in humans is ignoring the following basic rules reflecting the action of objective laws of nature [3]:

1. *A girl's virginity at marriage.*
2. *Prohibition of consanguineous marriages up to the 7th knee.*
3. *Banning interracial marriages.*

From the above, interesting consequences follow: purity and unity of the family union, obligatory parental blessing, knowledge of one's lineage and tribe, prohibition of all homosexual relations, prohibition of wearing clothes not according to one's sex, and so on. We do not dwell on the details, referring readers to [9]. It should only be noted that interracial marriages were forbidden by our ancestors without any racial discord and hatred, but only on the grounds that different races had evolved in different star systems, adapted to their conditions (viruses, microbes and bacteria) and partially brought these conditions in their bodies.

The first sexual experience is equally important. For both women and men, the first sexual experience is of great, one might even say decisive, importance, as it becomes fixed and imprinted on the rest of their lives. Modern research shows that if the first sexual experience has deviations from the normal sexual life (i.e. has elements of sexual perversion or homosexual orientation), then in the future the behavior of a person in this sphere is dictated by this first experience. And not only in this sphere, but also in the whole of everyday life, this experience continues to guide and dictate a person's behavior,

figuratively speaking, their own conditions. Therefore, our ancestors always protected and shielded young boys and girls from such negative experiences.

Thus, returning to the experience of our ancestors is our main task today in the education of young people.

Literature

1. "Pravedes. Ancient Sacred Knowledge of the Northern Magi". - Moscow: White Alves, 2005, 624 p. <http://zhuck1.narod.ru/pravedy.zip>.

2. Fomin Yu "Anatomy of Miracles. (Telepathy, parapsychology, spiritualism, UFOs and other anomalous phenomena)". - Moscow: Prometheus, 1990, 80 p.

3. "Slavic-Aryan Vedas." Books 1-4. - Omsk: "Asgard," 2001-2002. <http://zhuck1.narod.ru/Sl-Ar-Ve.zip>.

4. Zhuk N. A. "Human sexual constitution and methods of its determination". - Kharkov: LLC "Infobank", 2002, 64 p. <http://www.sciteclibrary.ru/rus/catalog/pages/7792.html>.

5. Vardiman E. "Goddess born a slave". // *Inte- ressnaya Gazeta*, Series G, No. 6 (69), 1999, p. 92.

6. Klimov G. P. "The Prince of this World". - Moscow: Molodaya Gvardiya, 1992.

7. Zhuk N. A. "Slavic-Aryan Vedas about God and Diawill, Good and Evil, Genius and Insanity". (In this collection).

8. Svyadoshch A. M. "Female sexopathology". - *Izvo "Shtiyintsa"*, 1991, 182 p.

9. Zhuk N. A. "Slavic-Aryan Vedas about the laws of the genus production and communal and ancestral way of life". In vol. "Energo-informational and intellectual-spiritual activity of the Universe and our worldview". - Kharkov: Ltd.

"Infobank," 2004, pp. 144-178. <http://infobank.h10.ru/zhuck/sav-zpr.html>.

October 2007.

ALTERNATIVE ENERGY SOURCES

H. A. Zhuk

1. The eternal questions about the perpetual motion machine. Is it possible to make a perpetual motion machine? And if it is possible, why perpetual motion machines do not find application? Or why perpetual energy sources are not produced so far? What should be done to start their mass production? These are by no means a complete list of questions that more and more concern people in civilized countries, especially those where there is an acute shortage of energy resources.

There are already answers to these questions. Let us consider some of them [1].

Firstly, the inventors' fear of losing their idea, of being cheated, of being deprived of income from the implementation of the development. As a consequence, suspicion and secrecy arise, which, in turn, creates doubts among investors and officials about the reality of the existence of a perpetual motion machine or energy source. The situation is aggravated by the fact that developers are afraid to show working models for fear of disclosing the secret of their work.

Secondly, we all know the tremendous power of faith. But so is the power of disbelief. Because people have been indoctrinated for centuries to believe that such devices are impossible, a program has emerged to block the perception of information. Neuro-linguistic programming techniques are now popular. It seems that the French Academy of Sciences used this method to ban perpetual motion machines, so that the mere mention of them simply shuts down the human mind.

Thirdly, there is a danger that the sudden emergence of eternal and inexhaustible energy sources may undermine the world economy, cause mass destruction of enterprises, unemployment and chaos. There is a reasonable grain of reason in this, because the main value in the world is not dollars, gold and diamonds, but energy resources. Without them, the life of civilization will cease almost instantly.

On the other hand, imagine what would happen if everyone had an insane amount of money and jewelry on their hands. It would probably end in disaster. Is humanity ready to accept the precious gift of free energy without degrading?

Fourthly, there is the opposition of various monopolies - oil, gas, forestry and others. There are many examples of large corporations buying up and hiding technical developments that are far superior to existing analogues. It is clear that AIDS prevention organizations do not benefit from the emergence of effective drugs, because it deprives them of huge funding. The same is true for oil monopolies, where an eternal source of energy is a bone in their throat.

And finally, the *fifth reason is* that the world is a self-regulating system and does not allow technical developments that could upset its equilibrium. Let us remember that Leonardo da Vinci invented the submarine and the helicopter, but they appeared many centuries later, when people's consciousness was ready to accept these novelties.

By the way, a brilliant illustration of this is the Strugatsky brothers' story "A Billion Years Before the End of the World". The protagonists of the book got into all sorts of trouble as soon as they came to a decision on how to-

Some force stopped them, gently at first and then more and more firmly, showing them that the knowledge gained at this stage of development could be dangerous for the world. There is even such a thing as premature knowledge.

At the end of the 1960s, the Japanese government approached us with a proposal to sell them the fund of rejected applications of our patent office for 100 million dollars. The then Predsovmin A. Kosygin organized a meeting, inviting a number of academicians of the USSR Academy of Sciences. In response to the question: "Can we sell our fund of rejected applications to the Japanese?" they immediately and unanimously answered: "Absolutely not!" They said that the sale of this fund could cause great damage (!?) not only to our country, but also to others. Thus, this very "intellectual capital" was preserved, and certain scientific clans were able to engage in "patent gesheft" with impunity.

Nevertheless, under the pressure of the results of scientific practice obtained in the leading scientific-applied centers, in 1975 the State Committee for Inventions introduced a special class of pseudo "perpetuum-mobiles", which includes really working experimental machines with an efficiency greater than the efficiency of the Carnot cycle (or greater than one). Only the list of copyright certificates for this class occupies many volumes. But the ban continues to exist.

In 1964, a closed Ordinance was passed, allowing psychiatry to be applied to all those who criticize "holy" academic dogmas. Confirming the inviolability of these "holy" attitudes, Acad. Lifshits publicly declared all those who criticize "holy relativity" and thermodynamics to be paranoid ("LG", No. 24/78).

2. From the history of perpetual motion machines. As another example of removal of scientific achievements from scientific circulation, I will cite the certificate of discovery No. 13 of 18.12.62.

"The study proves that the classical theory of impact has no place in practice and that the rebound energy of a body after impact can be greater than its pre-impact energy. The discovery proves that the classical theory of impact has no place in practice and that the rebound energy of a body after impact can be greater than its pre-impact energy.

To achieve recognition, Dr. E. Alexandrov demonstrated to many commissions a convincing experiment: a hardened steel ball fell freely from a height of, say, 10 m onto a hardened steel plate lying on a rigid base, and bounced for... 14-15 m. This principle can also be used to create a simple power plant with an efficiency greater than one.

It is clear that all these units have an efficiency greater than the "unattainable" efficiency of the Carnot cycle. This also follows from the principle of operation of refrigerators of Dr. V. Zysin, working according to the "triangular cycles" invented by him. Zysin, working according to the "triangular cycles" invented by him. These refrigerators were produced in small series batches since 1962, and during their operation they did not require external energy supply at all (see his publication of 1962). In 1978, V. Zysin was granted patent No. 591667 for an actually working drive-less refrigerator producing cold at the expense of heat of cooled bodies. But... the refrigerators were taken out of production and "forgotten".

3. Nikola Tesla's research. The research of Nikola Tesla is not fully known to most modern scientists and engineers. In his work on the development of wireless communications, Tesla used flat spiral coils as the secondary winding of a transformer. The magnetic field of such a coil is radial and lies in the plane of the coil. Physicists conducted a series of experiments with flat spiral coils in 1995. When using such a coil as the secondary winding and a solenoid as the primary winding, the transformer has an asymmetric mutual induction:

connection of the load in the output circuit does not affect the power supplied to the primary winding.

Another of Tesla's inventions was the resonant transformer. Today, electrical engineering describes the operation of a transformer with forced oscillations, while radio engineering considers the operation of systems in resonance. Tesla addressed the issue of power conversion in a transformer in such a way that the efficiency of a resonant transformer was greater than unity. Working with high frequency and high voltage currents, Tesla used single-wire terminals as a load, i.e. lamps and motors with a single conductor connected to a source of a fast-variable electric field. Such a terminal does not draw power from the primary source because it uses the change in field strength at the point of connection to the conductor, which must be one of the maxima of the standing wave.

In 1934, in Buffalo, USA, Tesla demonstrated an electric-powered car with a generator of unknown design. Tesla coined the term "free vibration" to describe a sinusoidal oscillation in an electrical circuit excited by a short non-sinusoidal pulse. In a resonant situation, the power of the free vibration exceeds the power used to excite it. Observed during a thunderstorm standing waves of the electric field led Tesla to the conclusion that it was possible to create a system to provide electricity to power consumers remote from the generator without using wires. In most references to Tesla, this idea and his experiments in this field are interpreted simplistically as the transmission of energy by directed emission of radio waves. In Tesla's diaries, Colorado Spring Notes

you can find his understanding of the task at hand. There is no need to transmit, emit, expend, etc. power as a radio transmitter does. It is necessary to create a standing wave around the generator, then an unlimited number of consumers can use the change in field magnitude at their location to do work, if they are tuned in resonance with the oscillations of the generator.

4. Avramenko's experiments. Modern research in these areas sounds almost sensational, to such an extent that Tesla's work is unknown to the current generation of scientists. Of course, the element base and instrumentation of today allow to create real "miracles" compared to the research of the last century. In the journal

"Inventor and Rationalizer", Nos. 5, 6 for 1992, for the first time described the results of experiments by Vladislav Viktorovich Avramenko, All-Union Electrotechnical Institute, Moscow (I was lucky to listen to his report back in 1991 at the conference "Phenomenon-91"). The load of a single-wire line is an electric bulb or a fan. The line can be made of a material with high resistance, such as tungsten, but there is no heating of the wire. It can be said that in such experiments the wire does not transmit power from the generator to the load, but serves as a conductor of the information signal, which is generated by the polarization current (i.e. bias current).

The applied value of the technology is discussed in the same journal: R. F. Avramenko demonstrates a "blaster" - a plasma "harness" generator, whose power source is vacuum (ether). F. Avramenko demonstrates a "blaster" - a generator of a plasma "harness" whose power source is vacuum (ether). A 9-volt battery is sufficient to initially start the generator. Avramenko claims that the efficiency of the created installations is more than 150 percent! Later, in 1994, the magazine "Izobretatel

and Rationalizer", No. 10, published another article about Avramenko's work. Alas, in two years his work has not reached the production level. It is not surprising, because these technologies are already more than a century old, but they are not allowed to be implemented.

5. Floyd Sweet's vacuum triode amplifier. In 1990, the American Floyd Sweet demonstrated his invention called the "vacuum triode amplifier". His device consists of two 10 x 15 x 2.5 cm ferrite magnets and three coreless coils (one working coil with a few hundred turns and two excitation coils). It is powered by a 9 V pocket battery. It powers itself as a kind of autogenerator and gives out 1 kW of power at a voltage of 120 V and a frequency of 60 Hz in the form of energy similar to electrical energy.

Why not electric, but similar to electric, is evident from the following properties: when the output wires are short-circuited, they are not heated, but covered with frost, and when electrocution occurs, the frostbite of the body area is not a burn.

The generator's operation is also accompanied by effects: weight loss in proportion to the power produced, a 6-8 degree drop in the ambient air temperature at a load of more than 1 kW, and a terrible noise at some critical load - as if a person were in the center of a giant vortex, but with no visible air movement.

Floyd's research was also accompanied by various incidents. Two people from Australia who had volunteered to help him stole Floyd's workbook and tried to reproduce a generator called a vacuum triode amplifier at another location. But its secret was not in its design, but in its magnet technology.

Floyd received numerous death threats over the phone and several to his face. On one occasion, a well-dressed gentleman in an expensive suit, hat, tie and hundred-dollar shoes approached Floyd on the sidewalk near his home and told him that he represented an organization that did not want his device in the world today. Then he hinted that people who disobey the wishes of others sometimes have accidents.

In Floyd's device, specially prepared barium magnets were used in the "trigger mode". The bistable state of the magnet substance made it possible to switch from one field direction to another when a weak signal from an external generator was applied to the control winding. Moreover, if the material was prepared by repeated remagnetization at a frequency of 60 Hz, its control signal should have the same frequency. The principle of controlling a powerful flow by a weak signal is used in triodes, which is why the device is called Vacuum Triode Amplifier (VTA).

Floyd's prototypes, which he built between 1990 and 1995, generated power up to 50 kW. Floyd observed a strong antigravity effect, once measuring a reduction in the weight of the system in operation of up to 90% of its normal weight. The working material, the magnets, were cooled during the power generation process. It is assumed that the energy source is intense incoherent energy radiation, which exists everywhere in the Universe. This is a very important clarification: it is incoherent radiation. The addition of a set of incoherent signals does not create a process of a certain power, because "process" presupposes ordering - the information component.

Technically, the question of using the free energy of space to do work and create power in a load can be formulated as the conversion of some coherent and therefore hidden radiation existing anywhere in space into coherent radiation. Part of the output power of the Floyd device is looped into a positive feedback loop to excite a process that results in significant power in the output coil.

Tom Burden, a member of the Association of Distinguished American Scientists ADAS, studied the circuitry of a vacuum triode amplifier and argued that it exhibited negative energy operation, in the sense that the operation involved the use of negative time. In this negative time, according to Burden, gravity is a repulsive force. Floyd Sweet's experiments demonstrate that the VTA loses weight in proportion to the power extracted. Floyd tried to document the limits of the weight change, but once he reached a point where he heard a strong, sharp sound like he was in the center of a giant air vortex, and the experiment was terminated. The permanent magnets and coils of the VTA are cooled during operation, showing a temperature difference of 20 degrees compared to the ambient temperature. The question of using the energy of space is the question of using the energy of the planet's gravitational field.

Floyd Sweet died of a heart attack on July 5, 1995 at the age of 83. It is known that the inventor's widow gave Floyd's archives to a famous automobile concern. Maybe they were buried there?

6. Zhev generators. The question of power generation due to nonlinear properties of materials, ferrites or dielectrics was considered by Nikolay Emelyanovich Zhev.

eve, "Journal of Russian Physical Thought", No. 1, 1991. Applications were filed for the discovery "Cooling of some condensed dielectrics by changing electric field with energy generation", No. 32-OT-10159, November 14, 1979; for the invention "Method of conversion of thermal energy dielectrics B electrical", No. 3601725/07(084905), June 4, 1983; and "Method for converting thermal energy of ferrites into electrical energy", No. 3601726/25(084904), April 3, 1983. ZaeV's concept does not address the issue of space conversion, but even in such a form as "conversion of dissipated heat of the surrounding environment", it is extremely important because it provides theoretical prerequisites for non-fuel energy systems. As early as 1905, K. E. Tsiolkovsky considered such a possibility: "If heat can be transferred from colder to hotter bodies, this must have a huge, not only philosophical and general scientific significance, but, as we have seen, also purely practical. The Clausius postulate in its pure form, without reservations, is not justified. The forces of gravitation, as well as other causes - the number of which is unknown - violate it.... Heat passes from a cold body to a warm one, but not by itself..., but due to some exceptional conditions". ("The Second Beginning of Thermodynamics", Kaluga, 1914 edition).

7. "Baumann's Testatica. About three decades ago, according to one account, Paul Baumann, a modest Swiss physicist and, according to another, a watchmaker, came up with a strange motor that resembled a common school electrostatic machine with Leiden jars. It consisted of two acrylic disks with 36 narrow sectors of thin aluminum glued on them, which rotated in different directions. In his first experiments, he used ordinary gramophone records.

The engine was started by pushing the disks in opposite directions with fingers. The speed of rotation of the disks was 50-70 revolutions per minute. After starting, the disks continued to rotate independently indefinitely. The electric circuit develops a DC voltage of 300-350 V at a current strength of up to 30 A. The mechanical power of the motor is low. Since the mechanical power of the motor is negligible (about 100 mW) compared to the electrical power (up to 1 kW, i.e. 1000 times more), it should be called a generator rather than a motor.

The inventor named his device Thesta-Distatica, and stated that he obtained a description of the design and principles of operation during meditation. From a technical point of view, the device is a modernized Wimshurst electrophoric generator whose disks are able to rotate continuously due to electrostatic forces. The design also includes permanent magnets. A machine with a disk diameter of 20 cm produces about 200 W of power, a larger machine with a disk diameter of 2 m produces about 30 kW.

There are reports that Paul Baumann spent a considerable amount of time in prison. But what is more certain is that he is currently (at least a few years ago) the leader of a 500-member Christian religious community in the village of Meterlich (Linden, Switzerland), for which his generators are used. But the secrets of how these generators work are kept secret.

8. Marinov's "Siberian Kolya". This original generator ("Testatika") interested a famous physicist, director of the Institute of Fundamental Physics in Graz (Austria) Stefan Marinov. To study the unknown phenomenon, he specially joined the same community and even joined its board of 28 members. However, for declassifying-

He was the only one to vote for the generator, but the other main members of the board were against it, arguing that mankind was not yet mature enough to accept this discovery (or maybe someone had intimidated them?).

Marinov reflected the results of his research in a number of publications, believing that the key to the mystery is the scalar magnetic field discovered by G. V. Nikolaev of Tomsk. V. Nikolaev from Tomsk. Investigating this field, he developed a new type of electric motor, named "Siberian Kolya" in honor of Nikolaev. Continuing his research, he achieved 10 percent positive feedback in this motor. A little more time and he would have gotten to the bottom of Testatik's secrets.

But it did not come to that, or rather, someone did not allow it. Marinov did not manage to finish his main work with the substantiation of the invalidity of the existing law of conservation of energy as it is usually used. On July 15, 1997, Professor Stefan Marinov died when he was thrown out of the window of the university library in the center of Graz.

The perpetrator was not found, and the case was closed, as has happened many times before in cases of attempts on the lives of inventors who were working outside the orthodoxy of science.

9. Searle's levitating disks. Less tragic, but no less dramatic, was the life of John Searle, the man who discovered the effect named after him and built models of flying saucers called Searle levitating disks.

At the age of 14, Searle joined a factory in Birmingham, England, as an apprentice electrician. Working with permanent magnets for electric meters, in 1946 he made a fundamental discovery about the nature of magnetism and discovered a new electromechanical effect. He discovered

he discovered that adding a small AC component (~100 mA) of radio frequency (~10 MHz) in the process of manufacturing permanent ferrite magnets gives them new and unexpected properties. A radial electromotive force with a vertical vector appeared in the rapidly rotating disk.

In order to increase this force, he first magnetized disks and then began to use permanent magnets. There were many twists and turns: he was allowed to experiment, or forbidden to do so because of the danger of the experiments (or because of pressure?).

One day, his model, consisting of several rings joined together, was tested in the yard. Already at low speeds, a large potential difference appeared in the radial direction of the rings, which was manifested by the characteristic crackle of electrical discharges and the smell of ozone. And then something quite unusual happened: the block of rings broke away from the motor spinning them and hovered at a height of 1.5 m, constantly increasing the rotation speed. A pink glow appeared around the rotating object - a sign of air activation at pressure drop. The volume-

The project started to rise.

Another side effect of this process was that radio communications were cut off and radios in the immediate area were turned off. Finally, the rotation reached such a fantastic speed that the object quickly disappeared from view in the sky.

Inspired by his results, Searle built and tested more than a dozen models of levitating disks between 1950 and 1952. He went on to learn how to control by "accelerating" these disks. And confident of being recognized for the novelty of his discoveries, in 1963 he sent out invitations to the presentation of his flying saucer model in Cor-

to the House of St. Leo and to the highest ministerial officials. But no one responded to the invitations.

The bewildered Searle kept quiet for a while, but in 1967 he turned to English scientists, but they only laughed at the "unstable electrician". As it turned out, the famous biblical saying: "There is no prophet in his own country" was also manifested here.

Strangely enough, the inventor was recognized from abroad. First from the Japanese, and much later from scientists in other countries. But in 1968, an event occurred that probably turned Searle away from his scientific research for a long time.

On July 30 of that year he tested the R-11 apparatus weighing almost 500 kg. During the demonstration, the apparatus again stopped controlling and disappeared from sight in the sky within 3 minutes. The authorities promptly "reacted" to this event. The local energy service charged the inventor with an exorbitant electricity bill for 30 years, even though Searle had his own power plant.

As he was unable to pay the huge sum, he was arrested, tried and imprisoned for 15 months. All the equipment and appliances were destroyed and the house burned down.

In the 1980s, there was a lot of press buzz about Searle as a "the father of flying saucers." But then, as if a new command came from someone and all talk about this immensely talented inventor stopped. And then he just died.

10. The Roschin and Godin Generator. Two Muscovite Russians, Vladimir Roshchin and Sergey Godin, set out to verify the discovery of John Searle. It is reported that in the first half of the 1990s they visited Searle, but he could not help them much, since he obtained his results empirically without any

Theoretically, because he had no higher education and was also afraid to show anything. (Afraid of what? And where can one get a new theory if it is tabooed?)

But Roshchin and Godin did not give up and went the other way: they built not a flying disk, but a free energy generator. Weighing 350 kg, it produced up to 10 kW of electricity without consuming any fuel or requiring torque from outside, i.e. without external power supply. However, the same effects were observed as with Searle disks.

The magnetic rotor of the Russian scientists' generator weighed 115 kg, rotated up to 600 revolutions per minute (the rotation speed was limited by the strength of the compound rotor), a characteristic pink atmospheric glow appeared around the installation, the entire installation lost up to 120 kg in weight (i.e., up to 35% of its original weight), and the temperature in the laboratory decreased by 8 degrees Celsius. The generator produced up to 7 kW of energy. But in 1993, on someone's "orders," the laboratory of Roshchin and Godin was closed and actually vandalized, and the equipment was looted.

11. Klem's conical non-fuel engine. In 1972, Richard Clem (Texas, USA) was working with equipment that sprayed and pumped liquid asphalt. He noticed that the asphalt cone pump continued to run for up to 30 minutes after the power was turned off. This discovery led to the development of a new fuel-free motor. As a result of some modifications, the power output of the 80 kg motor reached 350 hp. According to eyewitnesses, Clem often drove his car, which had such a motor built into it, on the Dallas Central Freeway. He claimed that the car required no fuel, only an oil change every 250,000 kilometers.

Clem never applied for a patent because his motor design was based on a previously patented asphalt pump design. Perhaps because of this, fifteen firms rejected his invention before a large coal company offered him financial support and signed a contract to build the motor. Shortly after the paperwork was signed, Richard Clem died of a heart attack.

Robert Kunz (USA), who subsequently investigated and published the article, wondered why the coal company was interested in Clem's motor. When he found a patent for a conical traction pump and contacted its inventor, Walter D. Hentyens, everything became clear.

Walter D. Hentyens was employed by Barrett Hentyens & Co. (Haleston, Pennsylvania, USA), which was founded by Otto Hentyens in 1916. The business began in the coal mines of Pennsylvania with the original balance opposition pump patented by Otto Hentyens. The company still supplies pumps to the coal mining industry. The company has expanded into other markets and now has pumps installed in numerous plants around the world. Today it is known as Hazleton Pums Inc. (CEO Peter Hentyens). This name was given to the company after it was bought by the Weir Group.

From the above, a simple conclusion follows: if the coal company had not bought the patent for Clem's fuel-less motor (we will not talk about the reasons for the death of the author of the invention here), then the world would not need not only fuel, i.e. conventional motors, but also the fuel itself - coal, oil, gas and the coal company itself, among others.

12. Marsol's molecular engine. The same fate befell J. Marsol, who patented in the 1950s a molecular internal combustion engine powered by water, zinc and antimony. He died shortly after the patent application was published, along with his family and laboratory staff. In this case, it was found that work on the inventor's engine was stopped under pressure from transnational oil monopolies. They would have lost their well-established businesses and huge profits if automobile engines had been powered by water instead of gasoline and diesel.

13. Filimonenko's hydrolysis thermal emission unit. Back in the early 50s, I.S. Filimonenko discovered that when injecting water doses into a jet engine, thrust increases by 15%. He guessed that this was due to the combustion of hydrogen released during the pyrolysis of water. The result of his research was a working device, now called a cold fusion reactor, but at the time it was called a hydrolysis thermo-emission unit. The advantage of the new facility was the absence of neutron flux, which is a radiation hazard for living beings, and which is always emitted by conventional nuclear reactors.

The author's work in the 50's was supported by Academicians I. V. Kurchatov and S. S. Kurchatov. V. Kurchatov and S. P. Korolev, as well as Marshal G. K. Zhukov. Therefore, the new unit in 1962 became the subject of the USSR invention application No. 717239/38. But the expert committee, in which a certain Shpilraen was the "chorus", concluded that the operation of the unit contradicted the laws of physics. Due to the fact that by that time his high patrons were no longer alive, Mr. Filimonenko was first dismissed from his position, and in 1968, when it turned out that he had signed his signature on the invention application.

for banning nuclear weapons, he was sent to the
"and all work on the new plant was canceled.

14. Other water-powered engines. One of the solutions to the energy problem is the use of water in internal combustion engines. For example, U. Brown, USA, has built a demonstration car with water in the tank. Günter Poschl proposes a method of creating a water/gasoline mixture in the proportion of 9/1, and Rudolf Gunnerman has developed a method of refining an engine to run on a gas/water or alcohol/water mixture in the proportion of 55/45.

The newspaper Komsomolskaya Pravda, May 20, 1995, tells the story of a domestic invention by Alexander Georgievich Bakaev from Perm. His "attachment" makes it possible to convert any car to run on water. The inventor does not seek to implement his system at the industrial level and simply "modernizes" the cars of his acquaintances. And this is not the only case. Inventors from different countries have followed this path, but have not achieved market acceptance. Is it possible today that the KAMAZ automobile concern, for example, would want to re-equip its entire assembly line to produce vehicles that run without gasoline?

15. Bolotov's second-order chemistry. It's called "Ukrainian Sakharov", "a polyhedron that has absorbed the wisdom of this world", and ideas and developments are estimated at 10 trillion dollars.

He was born in 1930 in one of the settlements of the Ulyanovsk region in the family of a Russian worker. In 1955, he graduated from the Odessa Electrotechnical Institute of Communications. In 1961, he entered the Moscow postgraduate program, completed the three-year course in a year, and became acquainted with A. Sakharov.

In 1963, Boris and his colleagues performed the first reversible nuclear reaction to decompose molybdenum into niobium and technetium by current. In 1964, he defended his PhD thesis, and A. Sakharov, interested in Bolotov's idea of a "cold" nuclear reactor, invited the Kiev resident to join his doctoral studies.

He prepared his doctoral thesis, but ... in 1970 he was dismissed "due to incompatibility with his position". The inconsistency was that he was not a Communist, had a free speech and, among other things, practiced folk medicine.

In the spring of 1977, he completed his 30-year work "Deathlessness is Real", which was typewritten into 13 folders. Three of them described: 2000 medicinal plants, 6000 recipes from two or three thousand years ago, and methods of treatment with unconventional methods. One of the books was called "How not to get sick, not to grow old". It still has no analogues in the world.

On March 15, 1983, a 15-hour search of his apartment was raided, 750 valuable books were confiscated (and still not returned!), and he was arrested and taken to the KGB detention center. Bolotov spent half a year there, including about a year in psychiatric examinations in Kiev and Moscow. Torture, beatings, abuse ... Eventually he was declared sane, and in 1984 a trial was held. "Slandering the system" in the book "Immortality" was only 2 years in prison, so he was given 6 more years under pseudo-criminal articles such as "illegal doctoring". His wife Nelly Andreevna was dismissed "of her own volition" from the position of assistant professor, and his son's apartment was taken away. And in the zone, in order to sway the criminals against Bolotov, they spread a rumor that he had raped his own daughter (whom he never had!).

In prison, Boris Vasilyevich managed the impossible and

He attracted some officers to his side, got a small laboratory at his disposal, got the necessary equipment from the outside, built a nuclear reactor of his own design and for the first time in the world carried out "cold" (i.e. without gas pedals) nuclear reactions with transformation of phosphorus, lead into other chemical elements.

After full rehabilitation and release from prison, at the founding meeting of the Russian Academy and the World Foundation for Assistance to Scientists, Innovators, Inventors and Cultural Workers, which took place on May 16, 1990, the recent convict made a report on the main discovery of his life, the discovery of the century - a table that contains more than 10380 physical and chemical elements and for which Mendeleev's periodic table of elements is only a partial case.

According to Bolotov, all nuclear reactors can already be converted to work with light chemical elements. The energy of transformation of one substance into another can significantly exceed the power consumption for stimulation of the process, and the initial substances are not radioactive.

Today B.V. Bolotov is an academician of several academies of sciences, but not the one that together with the system that gave birth to it wanted to bury him together with his discoveries. The system itself turned out to be buried....

16. Seven discoveries of the Sobolev group. A group of Russian scientists led by Professor Valyrian Sobolev, Director of the Volgograd Institute of Materials Science of the Russian Academy of Sciences, has discovered a NEW KNOWLEDGE that can completely change the life of the human community and, without any doubt, represents a new page in science and technology.

These discoveries are related to new, previously unknown natural processes, the use of which from-

These discoveries bring with them the creation of new materials that lead to the formation of a new object world. These discoveries bring with them the creation of new materials that lead to a new world of objects. The horizons of practical application of these discoveries are so broad that we cannot fully appreciate their significance today.

A group of authors under the scientific leadership of the Director of the Volgograd Institute of Materials Science of the Russian Academy of Sciences, Academician V.M. Sobolev, announced seven scientific fundamental discoveries:

- 1) discovered depletion process is a special selective electrochemical process;
- 2) a new state of matter has been discovered;
- 3) a new class of materials has been discovered;
- 4) a magnetic charge has been discovered;
- 5) a new source of energy has been discovered;
- 6) a method of low-temperature plasma generation was discovered;
- 7) discovered a superconductor.

The depletion process discovered experimentally is the basic one, followed by all others. This process is similar to electrolysis, and, also like electrolysis, is easily performed. But in it the product is metals and monolithic multi-element chemical compounds

- materials such as quartz glass, i.e. what was the aim of all the research. The composition of these materials corresponds to substances such as silicon oxides, iron oxides, alumina, titanium, titanium diboride, etc. with melting points from 1500 to more than 3000°C. Materials such as quartz glass are the product of this process.

A process that is easy to implement in a laboratory version is also easy to implement in an industrial version to

the large-scale production of high-temperature, chemically inert and ultra-high-strength materials in low-cost technology. In many cases, these materials will replace the current structural materials, as they allow to significantly reduce the weight of products, significantly increase their service life, and have a fundamentally low environmental impact. The creation of the so-called high-temperature "ceramic" engine, which automobile companies are now trying to make in order to reduce fuel consumption, can be easily realized from new materials.

The depletion process is a new one, and according to its results, the multi-element chemical compounds obtained in this process represent a new state of matter characterized by non-stoichiometry of composition. The quantitative composition of these substances is unexplained by the existing laws of chemistry. These substances are characterized by a wide variety of chemical compositions and, accordingly, form a vast new class of materials. The substance in the newly modified state contains ordered structures that emit a time-varying magnetic flux. These ordered structures as a whole are nothing but magnetic charge. His experimental discovery took place. A well-founded theoretical assumption about the existence of magnetic charge was made by Dirac, and there were numerous attempts to detect this charge. It was also discovered that the magnetic charge belongs to a continuous medium and not to a single particle. Materials (solid medium) containing magnetic charge are a new source of energy and, emitting magnetic flux, create EMF in conductors, more precisely in conducting circuits, together with which these materials constitute a new source of current, a physical one.

This source was named for the contra-

The energy of a chemical current source is replenished by the energy of natural force fields. The energy of a physical current source is replenished by the energy of natural force fields. Consequently, the source does not require traditional hydrocarbon, nuclear energy carriers or the energy of the sun, wind, etc. It can operate in any climatic conditions and can be manufactured as an autonomous device. It can operate in any climatic conditions, will be manufactured as an autonomous device for household or industrial use, and will produce electricity without having to pay for it.

The new materials that have been discovered make it possible to develop energy sources for domestic and industrial applications. They will be able to operate continuously, producing clean energy without the use of any fuels. This will allow to refuse from traditional expensive energy carriers - nuclear fuel, gas, oil and coal. At the same time, it will be possible to quickly provide energy supply in hard-to-reach areas without creating infrastructure. However, someone is actively hindering the implementation of this discovery....

17. Bolotov's paraffin-based electrostatic source. As it turned out, an electrostatic energy source similar to Sobolev's source, but not on silicon but on paraffin base, was proposed by B.V. Bolotov back in the 1960s. This source was capable of accumulating static electricity and producing regular discharges through the air space for an unlimited period of time.

Theoretical explanation of the unique phenomenon was not undertaken by anyone, since the authority of traditional academic science was unquestionable at that time, and the revealed phenomenon was in conflict with the laws of conservation and could not be explained against the background of non-recognition of the world ether. Therefore, the head of the department advised Boris Vasilyevich not to demonstrate this phenomenon to anyone else.

18. Invention of Kharkiv scientists. In 2004, a group of Kharkov scientists (V . I. Balabay, Y. V. Ivanko, A. P. Sechkin, V. V. Shapovalenko) made an invention called "Method of electric potential generation in static magnetic fields and device for its realization".

The invention relates to fundamental physics, electrodynamics, electrical engineering, power engineering and can be used for creation of long-term electric energy sources.

The invention is based on the effect of formation of turbulence in the background flow (for example, in a stationary magnetic flow) when it passes through a dielectric with a mesh-cell structure, accompanied by generation of electric potential on metal liners between which a dielectric, including a mesh-cell structure, is enclosed, and due to this the generation of long-term electric energy is realized without the use of external forces and without moving parts.

Conclusion. It is clear that the problem of already created alternative energy sources is not limited to the above-mentioned examples. And despite the opposition of transnational monopolies to the introduction of new developments, the progress of science cannot be stopped. I believe that in the next decade there will be a worldwide breakthrough of technologies, including the emergence of new technologies in transportation, communications and, most importantly, energy.

Literature

1. Evgeny and Marina Golomolzin. "The Edge of a New World." (Chapters from the book).
<http://www.w3.org/TR/REC-html40>.

November 21, 2006.

ROTOR MODEL OF THE ATOM

I.I. Zima

Introducti

on

Currently, the science of the structure of matter is based on the planetary model of the atom, which is called the Rutherford-Bohr model. In this model, the atom is considered to consist of a central positively charged nucleus and negatively charged electrons flying around it. The electrons in the atom move along quantized energetically favorable trajectories.

The theory explaining the principle of operation of the planetary model is quantum mechanics, which replaced classical macroscopic physics in the 20th century as a result of generalization of experimental data related to the study of the properties of the microcosm. The planetary model of the atom is described in quantum mechanics by equations whose solutions have a wave character. From these equations it is possible to obtain the probability of finding a particle in a certain position or the probability of transition of a particle from one energy state to another.

The adequacy of the planetary model of the atom has been largely confirmed by practice. The wide application of spectroscopy, electron microscope, semiconductor devices, atomic energy, etc. in scientific research and technology became possible only after the creation of quantum theory.

However, physical concepts of quantum mechanics do not have the property of visualization, i.e. they cannot be explained with the help of familiar images. This complicates to a certain extent the understanding of its results and requires from the researcher a well-developed abstract thinking.

In addition, the accuracy of the solutions obtained depends greatly on the correctness of the problem formulation and the capabilities of the mathematical apparatus used. In addition, the accuracy of the obtained solutions depends to a large extent on the correctness of the problem formulation and the capabilities of the used mathematical apparatus. Therefore, when modeling atoms containing more than two electrons, it is necessary to make approximations, introduce corrections and stools.

An example of the introduction of such a postulate into quantum mechanics is the postulation of the Pauli principle after the famous Gerlach-Stern experiment and the discovery of the intrinsic rotor motion of particles around their axis. The notion of a particle as a rotating wiggler formed as a result of the experiment was taken into account by the mathematical introduction of the formal notion of spin and Young's commutation schemes. As a result, the planetary motion of particles remained central to the model of the atom, while still abandoning the obvious and familiar notions of rotation used in classical physics.

Of course, this assumption is valid for the separate existence of particles at a distance. But it is not obvious why the negative electron should fly around the positive proton in a distant orbit, instead of rotating together with it, being on its top. Moreover, in the limit the planetary motion of particles is reduced to rotor motion. Consequently, here we come to the rotor model of the atom, which begins with the answer to the question: "Can two or more particles be together in synchronous rotor motion?"

The purpose of this paper is to show the possibility of creating a rotor model of the atom and the fruitfulness of the new approach. The paper is of conceptual character and shows that with the emergence of the planetary model of the atom, the cognition of the world structure is far from the

and with the help of non-traditional approaches the preconditions for the emergence of new materials and manufacturing technologies can be created.

1. General Provisions

The rotor model of the atom is fundamentally the same as the planetary model. The atom as a stable material structure consists of protons, neutrons and electrons, which have known mass, charge, spin and magnetic moment. In this case, the particles are represented as continuously rotating magnetic waves-rotors. For clarity, it is convenient to represent the rotor as a tire with teeth.

As in the planetary model, each atom is characterized by a certain set of particles in accordance with the periodic table of elements. However, the rotor model emphasizes the rotor interaction between particles, i.e., the electric, magnetic, and mechanical interaction of rotors in their synchronous rotation in the state of meshing within the atom. This model of the atom is a dialectical return to class physics and allows us to analyze it using its known representations close to man.

For the joint rotation of particles, the forces of electric and magnetic repulsion must be overcome and the conditions of their mechanical coupling must be ensured. It should be taken into account that the rotors of protons and electrons have: different diameters (due to the difference in masses, the radii of the proton and neutron are 1836 times larger than the radius of the electron); opposite and equal electric charges; opposite directions of the spin and magnetic moment vectors (they are parallel for the proton and antiparallel for the electron). The neutron has no electric charge, but has a mass and magnetic moment approximately equal to that of the proton. However, on-

The spin and magnetic moment vectors of the electron are antiparallel. The magnetic moment of the electron is 1836 times larger than the magnetic moments of the proton and neutron. The spins of the electron, proton and neutron can be equal.

$+ \frac{1}{2}$ or $- \frac{1}{2}$. Mechanical meshing of rotors can be lateral or end-to-end. Therefore, the rotor model of the atom can be single-layer or multilayer, single-link or multilink (chain), single-block or multiblock.

Fig. 1 shows rotor models of the electron (a), proton (b), and neutron (c) that take into account the noted peculiarities of the particles. Here, the arrows show the directions of the spin vectors of the particles, and the dashed lines show the directions of the magnetic moments. The + and - signs show the charges of protons and electrons.



Рис. 1 Роторные модели электрона (а), протона (б), нейтрона (в).

2. Particle fusion

The main condition of formation of an atom from rotating rotors is their bringing together taking into account the noted features of rotors themselves. Thus it is also necessary to take into account the following features of their joint rotation. Firstly, two rotors of different diameters can

rotate together with different velocities only in opposite directions of rotation. In this case the spins of the particles must be antiparallel. This connection can only be lateral. At parallel convergence there is a collision of rotor teeth. It can be assumed that parallel collision of rotors is the cause of Brownian motion and hovering of gas molecules. Secondly, two identical rotors can rotate together with the same velocity at side and end coupling.

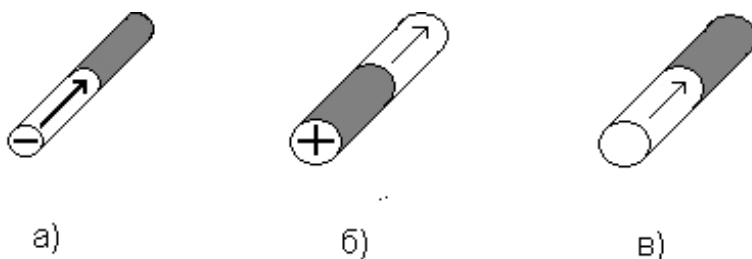
Assuming that the force of electric interaction (attraction, repulsion) is greater than the force of magnetic interaction and considering that other forces do not act on particles, we can obtain the following axioms of particle information.

1. Two protons cannot approach each other due to electrical repulsion.

2. Two electrons cannot approach each other due to electrical repulsion.

3. The proton and neutron cannot approach each other due to magnetic repulsion.

4. Two neutrons can unite by magnetic force in antiparallel side and parallel end meshing.

5. A neutron and an electron can unite magnetically by antiparallel sidechaining. In this case, the electron runs along the surface of the neutron.

6. A proton and an electron can unite electrically by an antiparallel side-chain force. In this case their magnetic repulsion takes place. When magnetic repulsion is compensated by electric attraction, the electron runs along the surface of the proton.

On the basis of the analysis of the above axioms, it can be assumed that there can be four-

In the case of the simplest atoms consisting of two elementary particles:

- proton-electron pair;
- neutron-electron pair;
- a bi-neutron pair;
- a bi-neutron circuit.

Figure 2 shows rotor models of proton-electron pair (a), neutron-electron pair (b), bi-neutron pair (c), and bi-neutron chain (d).



Рис. 2 Роторные модели протонно-электронной пары (а), нейтронно-электронной пары (б), бинейтронной пары (в), бинейтронной цепи (г).

The results obtained testify to the possible existence of proton and neutron matter.

Proton matter is formed by proton-electron pairs, which in the nearest consideration are the familiar isotope of hydrogen - protium. Due to the magnetic repulsion of the proton and electron, the rotor model of this pair is close to the planetary model of atomic hydrogen.

The proton-electron pair is electroneutral and has the total mass and magnetic moment of the proton and electron. Therefore, the pair is externally equivalent to a neutron with the magnetic moment of an electron. The strength of the pair is determined by the electric interaction between the proton and electron. Та-

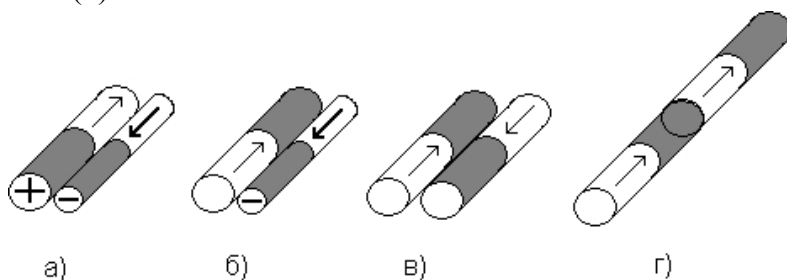
Thus, there can be two such particles in nature: the neutron and the quasi-neutron. At present, the neutron is considered to be an unstable particle that does not exist in free form and decays into proton, electron, and anti-neutrino. It can be assumed that instability and beta decay are rather peculiar to the quasi-neutron and there is a certain confusion in physics. Moreover, the quasi-neutron is also atomic water, which does not really exist in free form.

Neutron matter is formed by bi-neutron and neutron-electron pairs, as well as bi-neutron chains of real neutrons.

The neutron-electron pair has a negative charge and an uncompensated magnetic moment of the electron. By analogy with protium, the neutron-electron pair can be called neutrotium. Externally, the neutron-electron pair is equivalent to an antiproton with a magnetic moment of the electron. The strength of the pair is determined by the magnetic attraction of the neutron and electron. By analogy with the ideas of quantum mechanics, in this case we can speak of a strong magnetic interaction between the electron and the neutron. It can be assumed that there are also two types of antiprotons in nature, differing in the magnitude of the magnetic moment.

A bi-neutron pair is formed by the side-chaining of two neutrons. The pair is magnetically and electrically neutral. The strength of the pair is determined by the magnetic attraction of neutrons. In this case we can talk about weak magnetic interaction of two neutrons.

A bi-neutron chain is formed by end-coupling of two neutrons. The pair is a series connection of two magnets and has a total

magnetic moment. The strength is determined by the weak magnetic interaction of neutrons.

The results obtained do not contradict the modern concepts of matter, in particular, the matter of space [1]. For example, it is known that atomic hydrogen, i.e., proton-electron pairs, is present in large quantities in space. In many galaxies, astronomers detect the so-called hidden mass - invisible matter, the existence of which is attributed to the presence of a large number of particles that have rest mass and interact with each other and visible matter only gravitationally. These particles are probably bi-neutron pairs.

It can be assumed that the presence of neutron stars in space is associated with the existence of neutron-electron pairs. It is believed that these stars have a strong magnetic field and create natural conditions for the birth of antiparticles, which are the neutron-electron pairs themselves. Finally, in the author's opinion, bi-neutron chains form the force lines of the geomagnetic and interplanetary magnetic fields. The parallelism of their magnetic moments leads to the formation of multilink chains of force lines, their mutual repulsion in space, and their ejection into space. It can be assumed that the adequacy of such a model of the magnetic field is confirmed, for example, by the destruction of the geomagnetic field force lines by the solar wind and the formation of a long tail in the Earth's magnetosphere. The basis for this, as can be seen from the analysis, is the fact that neutron matter is not strong because it is bound by weak magnetic forces.

It should be noted that the representation of magnetic line forces as neutron chains does not contradict the physics of visualizing the magnetic field using iron lines.

sawdust and confirms the validity of its interference model proposed by the author in [2]. Apparently, one can find other examples confirming the existence of neutron matter and the adequacy of the proposed rotor models of the simplest atoms.

3. Vapor and particle reduction

The next stage of rotor modeling of atoms is the pairing of pairs and particles. In this case also a number of axioms can be formulated, allowing to analyze more complex atoms and aggregates.

1. Two neutron-electron pairs cannot unite due to the electric repulsion of the electrons.

2. Bineutron pairs cannot combine with other pairs and particles due to their electrical and magnetic neutrality.

3. Electroneutral proton-electron pair and bi-neutron chain cannot unite due to magnetic repulsion.

4. Two bi-neutron chains can be united by the magnetic force at the end meshing. The aggregate is electrically neutral but has a total magnetic moment of neutrons, which creates prerequisites for the formation of multilink neutron chains.

5. Two electroneutral proton-electron pairs can unite magnetically by antiparallel side and parallel end meshing. Lateral meshing can be either through an electron or a proton. The strength of the meshing is determined by the strong magnetic attraction of the electron. In side-chain bonding, the aggregate of two proton-electron pairs is electrically and magnetically neutral. Its composition corresponds to a hydrogen molecule, which is the second difference of proton matter. In the case of end meshing.

the aggregate has a total magnetic moment of electrons. The presence of magnetic moment creates prerequisites for the existence in Nature of another kind of proton matter - chains of hydrogen molecules similar to bi-neutron chains. However, due to the magnetic force of electron coupling, the strength of proton hydrogen chains is three orders of magnitude greater than that of neutron chains.

Figure 3 shows the rotor models of the units of two proton-electron pairs at side (a) and end (b) meshing.



Рис. 3 Роторные модели агрегатов из двух протонно-электронных пар при боковом (а) и торцевом (б) зацеплении.

2. Proton-electron and neutron-electron pairs can be united by the magnetic force of the electron at side and end meshing. In end-coupling, the composition of the aggregate is similar to that of the deuterium isotope D_- . It has a negative charge and a total electron magnetic moment. In side meshing, the neutron-electron pair is destroyed due to magnetic repulsion of the neutron. In this case

an aggregate similar to the H^- ion and a free neutron is formed. The aggregate has a negative charge and a proton magnetic moment like an antiproton.

Fig. 4 shows rotor models of the aggregates arising at the proton-electron and non-tron-electron pairs coupling at side (a) and end (b) meshing.

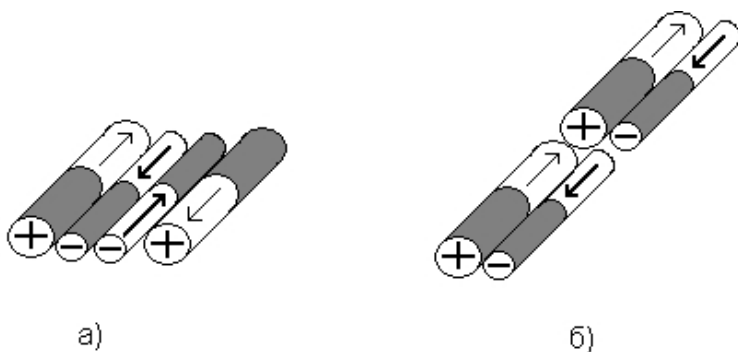

Рис. 4 Роторные модели агрегатов при объединении: протонно-электронной и нейтронно-электронной пар при боковом (а) и торцевом (б) зацеплении; нейтронно-электронной пары и бинейтронной цепи (в).

3. A neutron-electron pair and a bi-neutron chain can unite by sidechaining. In this case, the bineutron chain is broken to form a free neutron and an aggregate consisting of two neutrons and an electron. It has a negative charge and the total magnetic moment of the electron. The aggregate represents another kind of neutron matter and can be classified as a neutrotium isotope. The rotational model of the aggregate is shown in Fig. 4c.

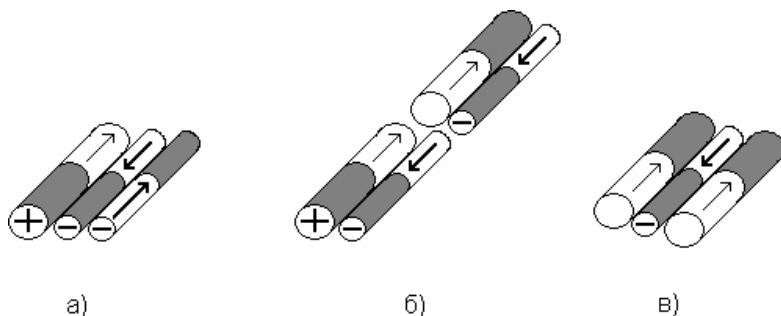

Рис. 5 Роторные модели агрегатов при объединении протонно-электронной пары с нейтроном (а), протоном (б, в), электроном (г, е), протоном и нейтроном (д, ж), протоном и электроном (з, и).

4. An electroneutral proton-electron pair can accept either a proton, an electron, or a neutron. The coupling is magnetic. The coupling with a neutron can only be laterally antiparallel through an electron. When bonding with a neutron, the composition of the aggregate is similar to that of a deuterium atom. The meshing with a proton can be both laterally antiparallel and end-parallel through the proton. The meshing with the electron can be through the electron and antiparallel lateral and parallel end-to-end. Two particles can be meshed simultaneously: proton and electron; proton and neutron.

The corresponding rotor models of possible aggregates are shown in Fig. 5. By their composition, the obtained aggregates correspond to a deuterium atom (a), protium ions (b, c, d, e), and a hydrogen molecule (h, i).

5. A neutron-electron pair can combine with a proton and a neutron. In this case, the coupling with the proton is electrically tric with magnetic repulsion. The coupling can be either antiparallel lateral or parallel end-to-end. The association with the neutron is possible only from the electron side due to its magnetic attraction. The corresponding rotor models of possible aggregates are shown in Fig. 6. The composition of the obtained aggregates resembles the deuterium atom (a, b) and the already mentioned neutrotium isotope (c).

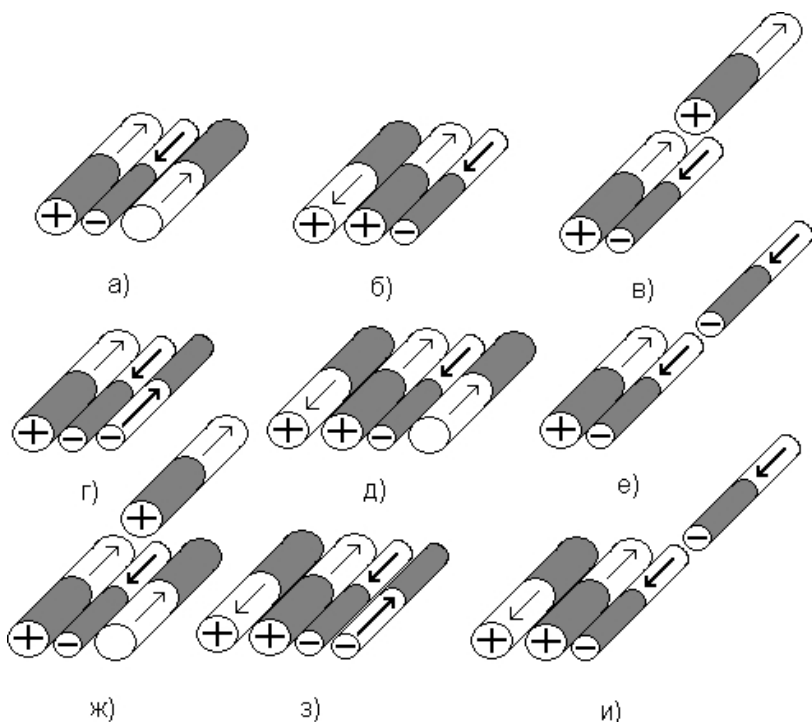
6. A bi-neutron chain can unite only with a neutron by magnetic force at parallel end meshing. In this case the number of links of the neutron chain increases.



Рис. 6 Роторные модели агрегатов при объединении нейтронно-электронной пары с протоном (а, б) и нейтроном (в).

As a result of the analysis of pair and particle information axioms the rotor models of atoms and aggregates including

from three to four elementary particles. Some rotor models correspond to the known planetary models of atoms by their composition, others represent their varieties not obvious from the standpoint of quantum mechanics, and others are new substances. In particular, we obtained models of: four varieties of water molecule; two varieties of deuterium atom; helium; two varieties of protium isotopes; deuterium ion; neutrothium isotope.

It is shown that modern quantum-mechanical ideas about atoms lie mainly in the frameworks of proton-neutron matter models.

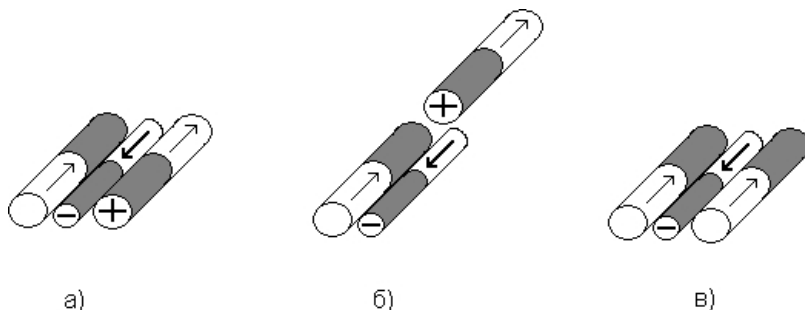
The understanding of the varieties of proton and neutron matter is deepened. In particular, it is shown that proton matter includes, in addition to protium, the isotopes of protium H^+ and H^- and a hydrogen molecule, while neutron matter includes its isotope consisting of two neutrons and an electron.

Interestingly, the possibility of the existence of discrete and chained varieties of atoms and molecules in both neutron and proton matter is shown.

It is also shown that matter can be classified according to its strength. Thus, atoms bound by the force of electric interaction of particles have the maximum strength. Then atoms bound by the force of magnetic interaction of electrons follow. And, finally, atoms bound by the force of magnetic interaction of neutrons have the minimum strength. It is characteristic that the maximum strength is possessed by atoms and aggregates of proton and proton-neutron matter based on proton-electron pairs, and the minimum strength is possessed by neutron matter in the form of neutron chains. It can be assumed that because of its low strength neutron-

This is because the traditional measurement technology consists of proton-neutron matter.

Conclusion

In the present work, a new approach to the problem of synthesizing and analyzing adequate models of matter atoms is proposed, based on the representation of elementary particles in the form of magnetic waves (rotors). In this case, the rotation of particles around their axis (rotation) is put at the head of the angle, and their electric and magnetic interaction occurs in the state of mechanical meshing of rotors. Particles in atoms do not fly, but synchronously rotate, being brought together.

In general, the proposed approach proved to be fruitful. On the basis of the usual concepts of classical mechanics, a number of axioms of the information of particles and their aggregates were formulated, which allowed us to obtain physical models of the simplest atoms and molecules of hydrogen and its isotopes. The models of their discrete and chain varieties, not obvious from the positions of quantum mechanics, as well as atoms of new substances were obtained. In particular, rotor models of a new element called nitrotium and its isotopes were obtained.

Based on the analysis of the structure of the obtained models, it is concluded that in addition to proton and proton-neutron types of matter postulated by quantum mechanics, there may exist neutron matter in nature, the acceptance of which can explain the physics of hidden mass, thin matter, ether, magnetic field, and other controversial problems of modern natural science. In particular, the paper has already proposed a new model of the cosmic magnetic field in the form of a set of chains of neutrons connected by the force of their magnetic interaction.

Obviously, the results obtained require conceptualization and experimental verification. The studies, the results of which are presented in this paper, were performed manually on the basis of familiar images and human logic. Studies of more complex atoms require complication of rotor models and consideration of more factors of information of aggregates and blocks. These studies require the use of computers, the development of special software and the creation of special measuring equipment.

Literature

1. "The Physics of Space. Small Encyclopedia." - Moscow: Soviet Encyclopedia, 1986.
2. Zima I.I. "Rotor Geomagnetism. A new look at the eternal problems". - Kharkov, OOO "Oberig", 2005.

NEUTRON MATTER AS THE BASIS OF THE NON-EMPTY VACUUM

I.I. Zima

Introducti

on

The creation of a physical model of the vacuum, consistent with the phenomena of propagation of light and electromagnetic waves, as well as explaining the nature of inertia and gravitation, is one of the problems that have occupied and occupy the minds of scientists and cause ongoing controversy. Nevertheless, an inconsistent physical model of the vacuum has not yet been created. The purpose of this paper is to show the possibility of solving this problem by using the emerging ideas about neutron matter. The paper is conceptual in nature. The idea to use neutron matter to solve the problem of the non-empty vacuum (ether) arose in the author's mind during the development of the rotor model of the atom, also presented in this collection [1].

The rotor model of the atom is a set of elementary particles, known from D.I. Mendeleev's table, represented as synchronously rotating magnetic waves (rotors) brought together. For joint rotation of the particles, the forces of electric and magnetic repulsion must be overcome and the conditions of mechanical entanglement must be ensured, taking into account the mutual directionality of their spins and magnetic moments. In the case of lateral entanglement their spins must be antiparallel, and in the case of end entanglement their spins must be parallel.

As shown in [1], the modern table of elements consists of atoms formed by the reunion of protons, electrons and

neutrons, and representing the proton-

and proton-neutron matter. In these atoms, the particles are bound by strong forces of electric and magnetic interactions and, therefore, these atoms represent physical bodies familiar to us, which cannot be the basis of the invisible thin ether. As shown in [1], such a basis can be thin neutron matter consisting of neutrons bound by weak forces of their magnetic interaction. Let us show that such matter can exist and investigate its properties.

1. Formation of neutron matter



Рис. 1 Роторная модель солнечного ветра.

It is known that the particles from which matter can be created are brought to Earth by the solar wind. As shown in Fig. 1, the spins of the solar wind particles are oriented in space not randomly, but parallel to each other.

to the spins of photons emitted by the Sun. The figure shows the rotor models of solar wind particles developed in [1]. Here, the arrows show the directions of the vectors of the particle spins and the dashed lines show the directions of the magnetic moments. The + and - signs show the charges of protons and electrons. Neutrons have no charge.

It can be seen that the collinear geometry of particle spins favors the end magnetic entanglement of neutrons and the formation of neutron chains immediately upon leaving the Sun and during the flight to the Earth. It is believed that neutrons, which are not stable in the free state, become stable at high density of matter. Therefore, we can assume that the entire space of the solar system is permeated with invisible, easily broken neutron chains diverging radially from the Sun and forming neutron matter.

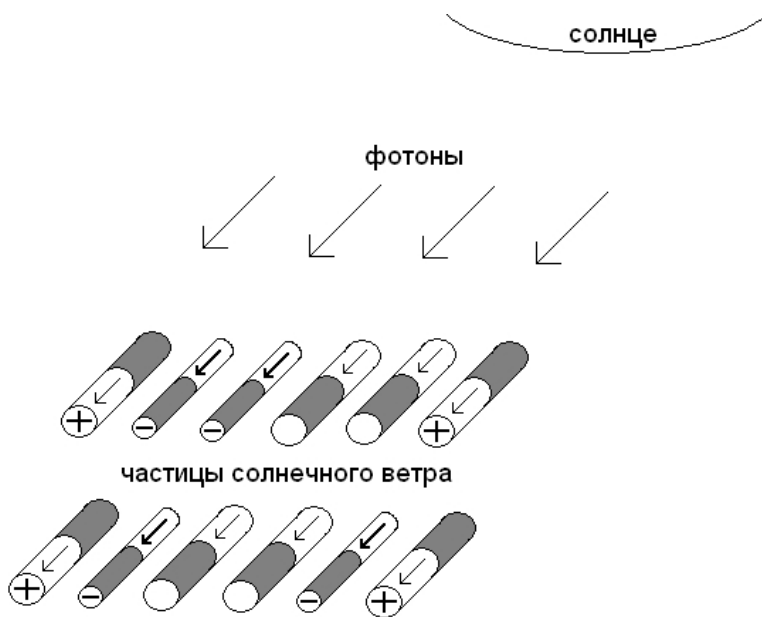
Parallel to the neutron chains from the Sun to the Earth, protons, electrons, and other particles also fly, from which atoms of proton and proton-neutron matter are formed. Since antiparallelism of spins is required for these particles to mesh, the atoms are formed in places of various turbulences, for example, when the Earth and other physical bodies are blown around by the solar wind.

In the author's opinion, neutron chains are simultaneously the magnetic field force lines acting within the reach of the solar wind. Part of these chains extends toward the Earth and smoothly flow around it, forming a magnetopause and a long tail of the main component of the geomagnetic field. Strong local magnets on the Earth's surface are able to break neutron chains and switch them to themselves, forming local magnetic fields and an anomalous component of the geomagnetic field. Note that the density of the circuits and, accordingly, the voltage increases as they circle the Earth.

the geomagnetic field. Thus, if we objectively accept the existence of the cosmic magnetic field, we can discuss also the structure of the non-empty vacuum.

2. Elastic properties of the neutron ether

Does the neutron model meet the requirements for the aether? It is known that the occurrence of wave processes arises in the aether.

is possible only in the presence of some distributed masses and elastic forces uniting the masses into a continuous ether medium. In our case such masses are neutrons united by magnetic attraction forces.

Based on the very high velocity of electromagnetic wave propagation, modern science requires from the ether medium high elasticity and very low density. At the same time, it cannot be a physical body because it is the basis for the propagation of electromagnetic waves with low attenuation.

In our model of the neutron ether, high elasticity is achieved due to magnetic repulsion of neutron chains when propagating in a limited volume of the 4p sphere of the solar system. When filling this volume, neutrons are as if compressed by mutual attraction along and repulsion across the chains. At the same time, they experience continuous pressure from the Sun due to the formation of new neutrons. The particles have nowhere to go and the tron medium expands uniformly. At the same time, the medium flows around physical bodies that occupy a certain space in it. Due to the displacement of neutrons by physical bodies, the elasticity of the ether increases. An additional factor is the magnetic repulsion of particles with parallel magnetic moments.

The characteristics of an unexcited neutron medium cannot be measured, since any physical device will change its state during measurements. Therefore, for

It is advisable to use known theoretical estimates to determine them.

One of the important characteristics of vacuum, which determines the speed of light, is density. Proceeding from the described mechanism of the neutron ether formation, one can assert that it has high homogeneity except for the regions close to physical bodies. In such a case, as shown in [2], the vacuum density δ can be found through its constant wave opposition and the speed of light using the formula

$$\delta = \frac{Z}{C}, \quad (1)$$

Where $Z = \sqrt{\frac{\mu^\circ}{\epsilon^\circ}}$ - wave impedance of vacuum; (2)

$C = \sqrt{\frac{1}{\mu^\circ \epsilon^\circ}}$ =- the speed of light in vacuum; (3)

μ° - magnetic permeability of vacuum; ϵ° - dielectric constant of vacuum.

Substituting (2) and (3) into (1), we can obtain that

$$\delta = \mu^\circ = 1.25664 \times 10^6, \text{ kg m sec}^{-2} \text{ a}^{-2}. \quad (4)$$

Expression (4) shows that the ether medium must be magnetic and its magnetic permeability must play the role of density (inertial mass) and be very small. In the case of the neutron ether model, it follows unambiguously that these conditions are indeed fulfilled, since neutrons form a magnetic medium.

The magnetic permeability is the main characteristic of the system.

3. Electromagnetic properties of the neutron ether

In addition to the considered characteristics of the neutron ether, it is necessary to study its electromagnetic properties related to the possibility of propagation, transversality, and polarizability of light and electromagnetic waves.

It is known that when discussing the physical properties of the ether, Maxwell suggested that "light consists of transverse wave-like motions of the same medium that causes electrical and magnetic phenomena". The transversality of an electromagnetic wave is due to the perpendicularity of the intensity vectors E and H and the direction of its propagation.

The neutron ether model utilizes the transverse motion of neutrons and their magnetic properties. As it was shown above, in the neutron ether the carriers of electro-magnetic waves are neutrons, which form a radial grid filling the circumsolar space.

These particles have only transverse elastic oscillations due to the magnetic repulsion of neutron chains. The longitudinal coupling along the chain is not elastic but hinge. If the starting point of such a chain is displaced, a shear wave will propagate along it, the displacement vector of which will be perpendicular to the chain.

In a spatial lattice of neutron chains, the direction of the displacement vector of such oscillations can be arbitrary or fixed - polarized. In addition, the neutron is an electroneutral particle having a magnetic moment and mechanical spin. Consequently, neutron shear waves are accompanied-

are transverse magnetic and spin waves of the same frequency and polarization.

It can be assumed that here it is possible to distinguish between the propagation mechanisms of light and electromagnetic waves. Thus, it is known that light propagates in the form of photons, the only characteristic of which is spin oriented parallel or antiparallel to the direction of motion. In other words, light is a spin wave of neutron matter. The electromagnetic wave in the neutron medium is associated with a magnetic transverse component.

According to Maxwell's equations, a time-varying magnetic flux must produce a synchronously varying electric field at the same point in space. There should be no electric field in front of or behind it. Physically, this phenomenon can be realized due to the special internal structure of the neutron. For example, it can be assumed that the acceleration of the neutron results in a short-term imbalance of the charges of the proton and electron in its composition. Depending on the direction of acceleration, the neutron may have either a positive or negative charge corresponding to the positive or negative half-wave of the electric field. In this case, it can be stated that magnetic shear waves of neutrons are accompanied by transverse electromagnetic waves.

In addition, due to the gyroscopic properties of neutrons, the neutron medium may have other wave excitation mechanisms, such as precession and soliton, associated with the precession of the rotation and tipping of the magnetic moments of neutrons. The neutron's mechanical moment gives the orientation of its magnetic moment a gyroscope-like stability. Under perturbations, the magnetic moment cannot be instantaneously reoriented.

and precesses around the force line, exciting a rotor magnetic wave. The tipping precession excites a solitary magnetic wave called a magnetic soliton. Since a soliton propagates like a tipping wave of dominoes placed on an edge, such waves can propagate over long distances with virtually no damping.

The neutron model of the ether is a kind of development of the model of one of the creators of classical physics, W. Thomson [2]. According to his concept, it was supposed that the ether is quasi-rigid absolutely resisting any rotations, but can be subject to shear deformation. To make the model of the ether meet the condition of absolute resistance to rotation, W. Thomson placed rotating gyroscopes on rigid links. According to W. Thomson's concept, the aether model constructed in this way is capable of transmitting oscillations similarly to the natural aether. It can be assumed that the proposed neutron model also satisfies the requirements for the electromagnetic properties of the ether.

Conclusion

A new model of the ether is proposed, based on the assumption of the existence of neutron matter formed by the solar wind and filling the near-solar space. The analysis shows its adequacy to the natural ether providing propagation of light and electromagnetic waves. It is shown that the ether and the magnetic field of space have the same non-ferrous physical nature. On the basis of taking into account the peculiarities of the neutron structure, it was possible to physically confirm the mutual connection between the magnetic and electric fields of the electromagnetic wave, its transversality, and low attenuation in the neutron ether. It is obvious that the obtained

The results require experimental verification. But for this purpose, it is necessary to learn how to detect elastic oscillations of the thin neutron medium and to take into account its presence on the Earth and in the cosmos.

Literature

1. Zima I. I. "Rotor model of the atom". (In the present collection).

2. Gorbacevich F.F Fundamentals of Non-Voidal Aether. <http://www.ethertheory.chat.ru>.

REGISTRATION OF ROTOR ECHO SIGNALS OF NEUTRON ETHER AND ATMOSPHERE ACCOMPANYING RADAR OPERATION

I.I. Zima

Introduction

At the 10th Anniversary International Scientific Conference "Theory and Technique of Information Transmission, Reception and Processing" of the KHNURE in 2004, I reported [1] that under the action of powerful magnetic and electric fields, atmospheric vapors and gases in the geomagnetic field emit so-called rotor waves of magnetic and electromagnetic nature. Among the objects capable of influencing the atmosphere in this way are powerful radars.

We considered that only atmospheric electrons, neutrons, protons, rad-cals and ion-radicals having an uncompensated magnetic moment participate in the emission of rotor waves.

Rotor radiation is caused by the rotation of particles around their axis (rotation) and precession of their magnetic moments. Probing the atmosphere with powerful microwave pulses leads to an increase in the precession of magnetic moments of particles and causes rotor radiation that supports radar operation. Rotor radiation of different particles takes place in different ranges of gyromagnetic frequencies. For natural geomagnetic field conditions, the rotor radiation range of protons and neutrons is located in the ultra-long wavelength region, while that of electrons is located in the ultra-long wavelength region.

in the medium-wave region. The atmosphere as if re-radiates microwave pulses at gyromagnetic frequencies of particles.

In connection with the emergence of the idea of the existence of the neutron ether [2], this paper presents an attempt to take a new look at the results of experiments on the registration of rotor radiation.

1. Experimental results

The research was carried out on 23.10.03 from 10.30 to 12.00. Experimental conditions: windless weather; drizzling rain; air temperature 10^0 C; atmospheric pressure 740 mm Hg; air humidity 80-90 %.

The TRLK-10 air traffic control radar located near the urban-type settlement of Pechenegi, Kharkiv Oblast, near the Pechenezhskoye water reservoir, provided an all-round view of the airspace by emitting and receiving pulsed radio signals at 1300 MHz. The power of the radar sounding pulses was 2 MW and their duration was $1\mu\text{s}$. The repetition rate of the sounding pulses was 330Hz. The mirror antenna system of the radar was located on a tower about 10 meters high.

To register ultra-long-wave rotor rays, an electromagnetic wave receiver with an operating frequency range of 0.5...10 kHz and a threshold sensitivity of $10\ \mu\text{V}$ was used.

For registration of medium-wave rotor emissions, an electromagnetic wave receiver with an operating frequency range of 520...1650 kHz and a threshold sensitivity of 0.6 mV was used.

Registration of rotor emissions was carried out by triggering visual and audible threshold devices-

The rotor waves are magnetic in the near-field and electromagnetic in the far-field. Since rotor waves are magnetic in the near zone and electromagnetic in the far zone, the identification of rotor emissions of the excited atmosphere was performed by using low impedance magnetic antennas. In addition, the transmitter of the radio locator was switched on and off systematically.

When the transmitting device is turned on:

- at a distance of up to 50 m from the radar there was a continuous activation of visual and audio channels of the receivers synchronously with the repetition frequency of the sounding signals. When changing the frequency of tuning of the receivers and the directionality of their antennas, there were characteristic changes in the output signals indicating the impact of rotor radiation through the input circuits;

- at a distance of up to 800 m from the radar there was a periodic triggering of the sound channel of the receivers synchronously with the rotation frequency of the radar antenna. The absence of triggering of the visual channel indicated that the level of received signals was at the limit of the receivers' sensitivity and corresponded to the boundary of the rotor radiation area.

When the radar transmitter was turned off, the receivers would stop operating.

2. Discussion of experimental results

These studies are preliminary. They confirmed the assumption that the radar operation is accompanied by rotor radiation in the medium and ultra-long wavelength ranges.

When the radar is operating, an area of rotor radiation with a radius of up to 800 meters is formed around it, shaped by the main lobe of the antenna radiation pattern when viewing the space.

From the experimental results obtained and the considerations given in [2], it also follows that in the formation of rotor echo-signals, in addition to proton-electron matter, neutron matter could make a certain contribution.

First, it can be assumed that the composition of the Earth's atmosphere similarly to protium includes neutrotium atoms and molecules [3] having uncompensated magnetic moments of neutrons and electrons and emitting rotor waves at the corresponding gyromagnetic frequencies.

Second, the entire atmosphere is permeated with neutron chains of the near-Earth neutron ether. Their density determines the strength of the main component of the geomagnetic field and the gyromagnetic frequencies of particles. At the same time, the neutron ether is part of the rotor component of the geomagnetic field. The probing signal of the radar excites in the spatial lattice of neutron circuits, in addition to the shear magnetic waves of the carrier frequency, the rotor magnetic waves of precession of the magnetic moments of neutrons.

Third, the emission of rotor waves by particles occurs only when the condition of the corresponding magnetic resonance is fulfilled, which consists in the equality of the gyromagnetic and excitation frequencies. The analysis of spectral ratios of harmonics of probing signals and gyromagnetic frequencies of particles for geographical coordinates of radar stations confirms the possibility of rotor responses of both protons and electrons of the atmosphere, and

and at ether neutrons. Since the ether neutrons and protons of the atmosphere have approximately equal magnetic moments, the frequencies of their rotor echoes are approximately the same.

Thus, during the emission of sounding radio signals, magnetic shear and rotor waves are excited in the surrounding space. The latter are the cause of rotor echo signals that support radar operation. In the medium-wave range, rotor echoes are emitted by atmospheric electrons. In the ultra-long wavelength range, rotor waves can emit atmospheric protons and ether neutrons. Since space experiments have confirmed the existence of shear waves outside the Earth's atmosphere, it can be assumed that, analogous to shear waves, the main cause of rotor echo-signals of radars is the response of the neutron ether filling the near-solar space, rather than the response of the atmosphere. The atmospheric response can be or not be, but the response of the neutron ether is always there.

The problem of differentiating the ultra-longwave rotor responses of the neutron ether and atmosphere is of interest. To solve this problem, it is necessary to conduct additional experiments using special measuring receivers and methods that take into account the peculiarities of the physics of response formation. In particular, it is fair to assume that the neutron ether and the atmosphere have different propagation velocities, impedance, and refractive index for both shear and rotor waves. In such a case, one should expect that the responses of the ether and the atmosphere should be different in amplitude and lag time. Po-

Since the atmospheric particles are constantly in reciprocal motion, a Doppler broadening of the spectrum of its rotor response is to be expected. The ways of excitation of the atmospheric and neutron ether responses by radar sounding signals are also characteristic. Thus, in the atmosphere, radio pulses affect both the charges of protons and their magnetic moments. In the neutron ether, radio pulses affect only the magnetic moments of neutrons. Apparently, this also leads to an enrichment of the spectral composition of the atmospheric response compared to the neutron ether response.

Conclusions

The results obtained have fundamental and applied significance. In particular, they can be used to solve the fundamental problem of non-empty vacuum and applied problems of increasing air traffic safety, improving environmental ecology and labor protection of radar operators by reducing the influence of rotor radiation accompanying radar operation.

Literature

1. Zima I.I., Kostyuchenko K.A., Strelchenko V.I. "Registration of rotor emissions accompanying radar operation". 10th Anniversary International Scientific Conference "Theory and Technique of Information Transmission, Reception and Processing". Collection of abstracts of reports. Ch.1. - Kharkov: KHNURE, 2004.

2. Zima I.I. "Neutron matter as the basis of non-empty vacuum". (In the present collection).

3. Zima I.I. "Rotor model of the atom". (In the present collection).

PROSPECTS FOR UNCONVENTIONAL ENERGY

B.A. Troshenkin

The development of the modern energy sector follows the path of increasing discrepancy between the structure of energy resources and the structure of actual energy consumption. In particular, energy consumption is growing every year, while it is known that the explored reserves of energy resources are finite. In addition, further increase of energy at the expense of fossil fuels is fraught with complete destruction of the planet's ecosystem. Therefore, it is necessary to shift to the use of renewable environmentally friendly energy sources such as solar radiation and the Earth's heat.

Let us touch upon the state of work on solar energy development.

The reader knows, of course, that 71% of the Earth's surface is occupied by the world's oceans. Therefore, it is the water surface that absorbs most of the Sun's radiant energy.

The equilibrium between absorption of solar radiation on the one hand and long-wave radiation from the sea surface and evaporation on the other ensures a constant thermal state of the seas. This state is characterized by the fact that the surface waters of the ocean in tropical and subtropical regions warm up to 25 - 30 °C, while at a depth of 400 - 500 m the water is at a temperature of 4 - 10 °C. This difference can be used to generate energy.

We will have to assess what is the acceptable power for ocean stations to be able to operate in the ocean.

The Earth's heat balance (which is related to climate change) has not been disturbed.

Previously built power plants using temperature differences between the upper and lower layers of ocean water have a number of very significant disadvantages. For example, the use of the cycle with steam generation by boiling warm water under vacuum conditions (Claude plant, Virginia station and the designed but not built Abidjan station) are the least favorable because of the small amount of useful heat. In addition, high metal intensity, significant dimensions of wet-steam turbines and their small unit capacity require substantial capital expenditures, which further limits the practical realization of this problem.

Power plants with low-boiling working bodies (ammonia, freon, butane, propane, carbon dioxide, etc.) make it possible to increase specific power generation, reduce the size and cost of turbines.

However, these plants also have a number of disadvantages, the main ones being the presence of bulky heat-transfer equipment (heaters and condensers) and the necessary heat losses in it, especially noticeable at small temperature differences between warm and cold water. This is evidenced by the data of plants with ammonia and freon as working agents. For example, an electric power plant installed near Hawaii was able to supply 12-15 kW to the power grid, but used 35 kW for its own needs. The power plant on the island of Nauru performed somewhat better. Here, in the maximum load mode, power generation amounted to 120 kW, while the "net" power was supplied to the grid.

- 31.5 kW. More powerful stations are planned to be commissioned. The specialists developing the projects, post-

We have set ourselves the goal of reducing power consumption by plants for their own needs to 10% of the available energy.

However, these plans will not come true. This situation is explained by the unreasonable transfer of technical solutions used in conventional power engineering to the field of ECO design. In particular, the designers of WPS do not take into account the energy limitations associated with the use of evaporators and steam turbines. The negative properties of these limitations are especially clear when using small temperature differences.

In our opinion, the most promising engine capable of efficiently utilizing small temperature differences between ocean water layers is a turbine operating on boiling water.

Thermodynamic calculations have shown that from the area of the equatorial belt of the ocean with the size of 5 million km² it is possible to get about 3 times more electric power than all electric power stations of the world produce now.

To avoid climate change, the installed capacity of ocean power plants should not exceed 7 TW (currently, the installed capacity of all power plants in the world is about 3 TW). [1].

Photovoltaic conversion is also one of the main methods of solar energy conversion. The main advantage of photovoltaic systems is the absence of moving parts. The main advantage of photovoltaic systems is that there are no moving parts.

The International Energy Agency, which brings together 27 countries, has begun harnessing the solar energy falling into the Gobi Desert. Across its entire area.

solar panels will be installed. If only half of the desert is developed, it will produce as much energy as is currently produced in the world.

Another equally important source of renewable energy is the Earth's heat. As is known, radioactive substances scattered in the earth's strata create the general background of heat emissions. But energy-intensive processes such as earthquakes and the movement of continents require additional energy sources. It seems that the culprit for such significant events could be reactions occurring at a depth of several hundred kilometers. The most probable among them are oxidation reactions of a number of major earth elements.

During reactions, some of the chemical energy is converted into mechanical energy to move the Earth's layers, while other energy is released as heat. Thus, knowing the rate of underground reactions opens up the possibility of predicting earthquake periods.

As a rule, zones of high seismicity correspond to geothermal zones accumulating reaction heat.

It is important to determine the possible capacity of geothermal plants, as well as to find acceptable ways to extract thermal energy without intensifying underground reactions that trigger earthquakes.

Tectonically active zones are known to occupy approximately ten percent of the Earth's surface.

Taking into account the efficiency of underground heat generators and ground equipment, the installed capacity of geothermal power plants may amount to 1.0-1.2 TW.

At the same time, the most promising engine for using superheated liquid energy is also a hydrosteam turbine [2].

The construction of geothermal stations is widespread in most highly developed countries.

In the balance of non-conventional energy it is necessary to take into account electricity generation by wind farms. The construction of these plants is more intensive than, for example, geothermal plants.

Over the past years, a number of wind farms in Ukraine have been equipped with 100 kW and 600 kW units.

In total, Yuzhmash plant has manufactured more than 600 units of the first model and it is planned to complete the production of 160 units of the second model.

Currently there are 6 wind power plants (WPP) operating in the south of the country.

According to the plans of Ukraine's energy sector development, electricity production on the basis of WPPs is planned to reach 20-25% of the total amount of electricity produced in the country.

In Western countries, wind energy will already provide more than 12% of energy consumption by 2010 [3].

The installed capacity of wind turbines is likely to reach 0.5-0.7 TW by the end of the century.

However, the environmental situation is not as good as it seems to the developers of WPP.

First of all, it should be taken into account that heat transfer from the equatorial zone of the Earth to the poles is provided by both air and water flows. Even partial utilization of the kinetic energy of these flows can lead to irreversible climatic **c h a n g e s** [1, 2].

Wind generators are powerful sources of noise. A significant part of the sound energy is in the infrasound range, which is characterized by negative effects on the human body.

Since the rotation speed of the wind generator blades is close to the television synchronization frequency, the operation of wind generators disrupts the reception of television broadcasts within a radius of 1-2 km from the generator. Wind generators are also sources of radio interference.

The ecosystems of fields located in the zone of wind installations were also found to be disturbed. In particular, a drop in crop yields has been observed. This is partly due to the fact that changes in the flow patterns in the air cause insects to lose their spatial orientation.

There are also certain hopes for wave energy [5] and bioenergy [6].

Literature

1. Troshenkin B. A. "Renewable Energy". Ч. 1 - Thermodynamics of the atmosphere and ocean. Oceanic electric power stations. - Kharkov: Izd-v. "Fort", 2003 -104 p.

2. Troshenkin B. A. "Renewable Energy". Ч. 2 -Thermodynamics of the lithosphere. Geothermal power plants. - Kharkov: Fort Publishing House, 2004. -156 c.

3. Krivtsov V. S. "Inexhaustible Energy". Book 1. Vet-rogenerators / V. S. Krivtsov, A. M. Oleynikov, A. I. Yakovlev. - Kharkov:KAI, 2003. -400 c.

4. Trukhin V. I. "Fundamentals of Environmental Geophysics" / V. I. Trukhin, K. V. Pokazeev, V. Pokazeev, V.E. Kunitsin, A. A. Shrader. - SPb.: "Lan" Publishing House, 2004. - 384 c.

5. Ross D. "Energy Warrior". - L.: Gidrometeoizdat, 1981. - 112 c.

7. "More than enough? An Optimistic View of the World's Energy Future". / Edited by R. Clark: Per. from Engl. - Moscow: Energoatomizdat, 1984. - 216 c.

EFFECTS OF VORTEX MOTION OF THE ETHER NEAR THE EARTH'S SURFACE SURFACES

Y.M. Galaev

The development of methods and means of utilizing the energy of surrounding media is considered as an actual direction of energy development. Among possible energy sources, a special place is occupied by the energy of the ether, a medium that fills the world space, which is due to the positively significant internal energy of such a medium [1,2]. In works [1,2] on the examples of the model of atmospheric vortex (tornado, tornado) and vortex ether-dynamic model of ball lightning, possible mechanisms of transformation of the energy of chaotic motion of ether elements into progressive motion are considered, i.e. the idea of using ether energy is shown to be realizable in principle [3]. However, to date, there is no information in the literature about experiments, the results of which could be interpreted as confirmation of the assumption that it is possible to form the vortex motion of the ether in terrestrial conditions, i.e., to consider such results as a possibility to control the ether motion in terrestrial conditions. The purpose of the present work is to fill this gap. The results of experimental works [4 10] were used to achieve this goal.

Experimental results. In [4 10], experimental verification of the hypothesis that the ether exists in nature as a material medium responsible, in particular, for the propagation of electromagnetic waves was performed. In setting up the experiments, the model of a viscous gas-like ether was adopted as a working hypothesis

V. Atsyukovsky [1,2]. The hypothesis defines the effects that can be observed in experiments on the propagation of electromagnetic waves near the Earth's surface. Two measurement methods sensitive to the expected effects have been developed for the research. The first method is implemented in the millimeter-wave range, the second in the optical wave range.

Unlike the Michelson interferometer method, these methods do not require the return of the probing radiation to the starting point. This fundamental difference allowed, all other things being equal, to create measuring devices whose sensitivity to the expected effects of the ether wind is significantly higher than that of the Michelson interferometer.

In [4 10] the principles of measurement methods, theory of experiments, measurement techniques and measurement results processing are described, possible sources of measurement errors are considered and their magnitudes are estimated, stability of measuring devices to changes in environmental parameters is shown. Statistically significant measurement results are obtained. The phenomenon of the predicted effects of the ether wind is shown. The following were measured: ether wind velocity, kinematic viscosity of ether, dependence of ether wind velocity on the time of stellar days, dependence of ether wind velocity on the height above the earth's surface. The research results were compared with the positive results of the previous experimental works [11,12], [13] performed by different authors in order to test the hypothesis of the existence of such a material medium as ether in nature. This made it possible to show the observability, reproducibility, and repeatability of the ether wind effects in experiments performed in different geographical conditions using different measurement methods.

It is shown that the negative results of the first Michelson [14] and Michelson-Morley [15] experiments can be explained by the insufficient sensitivity of the measuring devices used in the experiments. It is shown that the negative results of the first Michelson [14] and Michelson-Morley [15] experiments can be explained by the insufficient sensitivity of the measuring devices used in these experiments.

Thus, in the experiment [7 10] it was obtained that at a height of 1.6 m above the Earth's surface, the velocity of the ether wind does not exceed 200 m/sec. To measure such a velocity of the ether wind with a cross-shaped Michelson interferometer, the geometric length of light rays in such a device should be about 50,000 m, which is technically unrealizable. (In experiments [14,15], the interferometers were placed in the basements of buildings, and the geometric lengths of the light rays were 2.4 m and 22 m, respectively).

The results of works [4 13] do not contradict the provisions of the working hypothesis and can be regarded as an experimental confirmation of the ideas about the existence in nature of the ether— material medium responsible, in particular, for the propagation of electromagnetic waves. (Works [11 15] have been translated into Russian and published in the collection of articles [16]).

Figure 1 shows the average results of three different experiments performed in different years during the epoch of August. (The term "epoch" is borrowed from astronomy, in which observations of different years made in the same months are referred to observations of the same epoch.) On the ordinate axes are the values of the ether wind velocity W_h in m/sec. On the abscissa axes are the solar time T_m in hours. Vertical dashes indicate confidence intervals, which were calculated with the estimation reliability equal to 0.95. Fig. 1a shows the results of optima-

measurements of the experiment [7–10]. Fig. 1b shows the results of measurements obtained in the millimeter-wave range [4 6]. The experiments [7 10] and [4 6] were performed near Kharkov. Figure 1c shows the results of optical measurements obtained by Miller at the Mount Wilson Observatory (USA) [11,12].

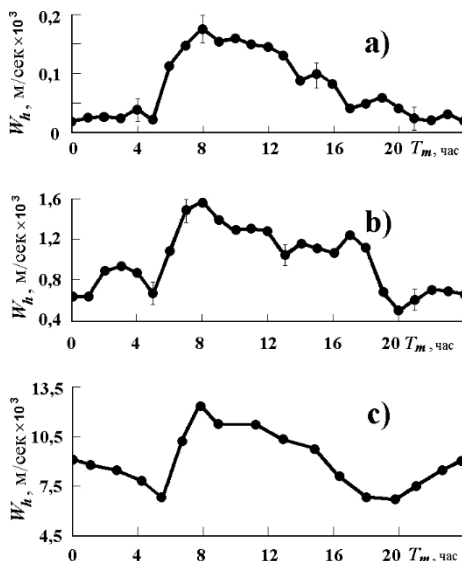

Figure 1. Variation of the ether wind speed during the day at the epoch of August

In [13], the results of the experiment are presented as a statement of the maximum value of the measured relative motion velocity of about 6 km/s, which did not allow us to show the results of this experiment in Fig. 1 as a dependence of the ether wind velocity on the time of day. It follows from Fig. 1 that the results of three different experiments are united by a similar character of the variation of the ether wind speed during the day in the August epoch. The results of the experiments [4 6], [7,9,10] have shown

reproducible and repeatable character of the ether wind effects measured in different experiments performed by different authors using different measurement methods, in different ranges of electromagnetic waves and in different geographical conditions. The correlation coefficients r calculated between the dependences $W_h(T_m)$ lie within the range $0.73 \leq r \leq 0.85$.

The following Fig. 2 gives an idea of the variation of the ether wind speed in the range of heights above the Earth's surface from 1.6 m to 1830 meters. The figure is drawn in logarithmic scale.

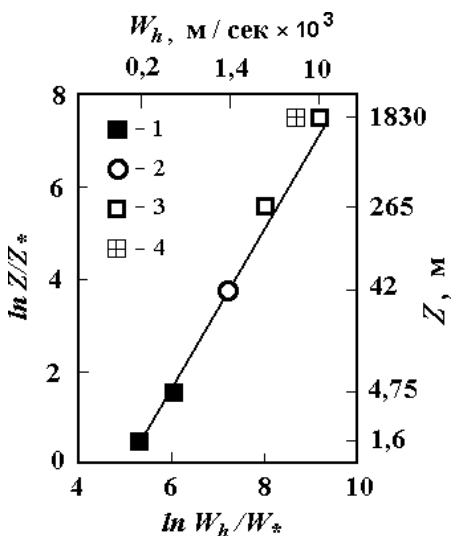

Figure 2. Dependence of the ether wind speed on the height above the Earth surface

- 1 experiment [7,9,10];
- 2 experiment [4 6];
- 3 experiment [11,12];
- 4 experiment [13];

On the axes of abscissa and ordinate are plotted the values of log-rhythms of the ratios of W_h/W_* and Z/Z_* , respectively, where W_h is the velocity of the ether wind, Z is the height above the Earth's surface.

by the surface. The values of W_* and Z_* are taken as 1 m/sec and 1 meter, respectively. (For clarity, the values of W_h in m/sec and Z in meters, respectively, are plotted along the coordinate axes in Fig. 2).

Fig. 2 shows the maximum values of the aether wind velocities measured in experiments [4,6], [7,9,10], [11,12], and [13] at different heights. The first two points at the bottom, indicated by fully shaded elements, reflect the results of the experiment [7,9,10] (heights of 1.6 m, and 4.75 m). The next point labeled with a circle reflects the results of experiment [4,6] (height 42 m). The next two unshaded elements represent Miller's results from Cleveland at 265 m and Mount Wilson at 1830 m [11,12]. The element shaded with an oblique cross shows the result of measurement of the ether wind velocity by May-Kelson, Pease, and Pearson at Mount Wilson at 1830 m [13].

Fig. 2 shows that the results of different experiments follow the same pattern and are located near a straight line. In the height range from 1.6 m to 1830 m, the ether wind speed increases with increasing height above the Earth's surface within the range from 200 m/sec to 10000 m/sec. These data do not contradict the known laws of the flow of viscous media near the surface and Atsyukovsky's model of a viscous gas-like ether [1,2].

In [7] for the first time an attempt to calculate and measure the value of the kinematic viscosity of the ether was made. The calculation was performed in the framework of the mechanism of photon formation proposed by Atsyukovsky as a result of turbulent flowing of an excited atom oscillating in the ether by the ether [1,2]. It turned out that the kinematic viscosity of the ether calculated on the basis of such an assumption has

value of about $7 \cdot 10^5 \text{ m}^2 / \text{sec}$, which does not contradict the same author's ideas about the ether as a gas-like medium with the properties of real gases. It is appropriate to recall that the values of kinematic viscosity of twelve gases common in nature lie in the range from $7 \cdot 10^6 \text{ m}^2 / \text{sec}$ (carbon dioxide) to $1.06 \cdot 10^4 \text{ m}^2 / \text{sec}$ (helium). The theory of the experiment [7], developed in the framework of classical hydrodynamics, the developed and manufactured equipment allowed us to measure the value of the kinematic viscosity of ether, which turned out to be equal to $6.24 \cdot 10^5 \text{ m}^2 / \text{sec}$. The development of the experiment [7] is reflected in [9,10].

In accordance with the initial hypothesis adopted in [4 10], the velocity of the ether wind W_h should change its value with a period of one stellar day.

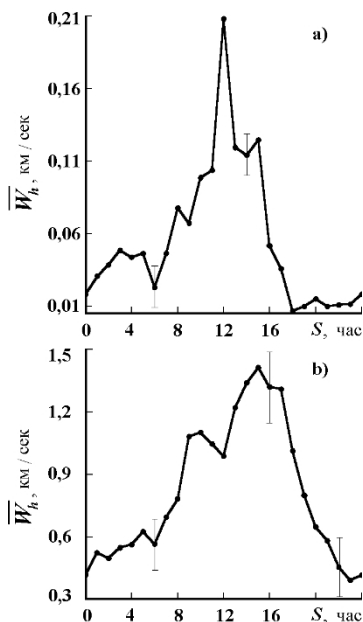

Figure 3. Mean daily variations of the ether wind velocity during the stellar days

To identify the component of the ether wind velocity with such a period, the results of systematic measurements were subjected to statistical processing on the stellar time scale. The results of such processing are shown in Fig. 3. On the abscissa axes are plotted the stellar time S in hours, and on the ordinate axes are the values of the ether wind velocity W_h in km/sec. Vertical dashes indicate the confidence intervals, which were calculated with an estimation reliability of 0.95. Each of the fragments of Fig. 3 shows the average daily variations of the ether wind velocity during the stellar days $W_h(S)$. The upper fragment in Fig. 3a represents the average result of optical measurements from September 2001 to January 2002. [7,9,10]. Fig. 3b shows the average result obtained in an experiment performed in the radio band during the five months of the year with the same name, from September 1998 to January 1999. [4 6].

The fragments of Fig. 3—represent the variation of the W magnitude _{h} with a period equal to one stellar day, which can be explained by the cosmic origin of the observed effect. Both fragments in Fig. 3 have in general a similar character of the ether wind velocity variation during the day. The differences in the shapes of the curves are explained within the framework of the concept of flow of viscous ether around terrain elements, which had different characteristics in these different experiments.

Vortex motion of the ether. Fig. 4 shows a plan of the area where the experiments [4 6] and [7 10] were performed, with higher altitudes indicated by darker shading. The letters "A" and "B" indicate the correspondent points of the radio line, which is marked with a bold line on the plan. The length of the radio line is 13 km. The letter "O"

denotes the location of the optical measuring station. The study of the influence of terrain relief on the ether motion near the Earth's surface was carried out under the assumption that in the case of a flat surface of the interface, the dependences $W_h(S)$ should have the form of "smooth", bell-shaped curves. In this case, the difference between the time of observations of the minimum and maximum values of W_h should be 12 hours. The latter is caused by the movement of the apex of the aether wind, like any other luminary, across the celestial sphere during the stellar days. (The upper and lower culminations are 12 hours apart.)



Figure 4. Site plan

Taking into account the dependence of $W_h(Z)$ presented in Fig. 2, the terrain characteristics (Fig. 4), and the changes in the azimuth and apex height of the aether wind during stellar days (calculated based on the results of [11,10]), we were able to explain the peculiarities of the change in the value of W_h during the day (Fig. 3). However, within the framework of such an analysis of the results of experiments [4 6] and [7,9,10],

failed to explain the statistically observed peculiarities of changes in the value of W_h in the vicinity of the S 12-hour point.

Thus, in Fig. 3a, at the time S 12 hours, a relatively sharp increase in the ether wind speed is observed, while in Fig. 3b, at the same time moment, there is a noticeable decrease in the ether wind speed, which is not explained within the framework of the used model. To explain this anomaly, an assumption was made about the occurrence at the time S 12 hours, in the area where the measuring points are located, of a vortex motion of the ether due to the specific influence of the terrain. The area of the terrain supposed to be responsible for the formation of the vortex motion of the ether is marked in Fig. 4 with a circle marked with a dotted line.

If we consider that the motion of the ether along this circle occurs counterclockwise, then the peculiarities of the change of the W value _{h} in the vicinity of the point S 12 hours noted in Fig. 3 can be explained within the framework of this assumption. Indeed, it can be seen in Fig. 4 that the ether wind flow at point "O" is formed by a "corridor" formed by the hills located to the north and south of point "O". This "corridor" narrows along the etheric wind flow. In this case, in the experiment [7,9,10], one can expect an increase in the velocity of the ether wind at the time S 12 hours. The same aether flow can be turned to the north-east by the ravine, which is located north-west from the village "Cirkuny". In this case, there is a counterflow of the ether in the area of the radio line location, and in the experiment [4 6] one can expect a decrease in the ether wind velocity at the time S 12 hours.

This interpretation, does not contradict the results of the system-
The results of the measurements (Fig. 3) and allowed us to make
an assum-

It is known that the gas temperature in the vortex is lower than the temperature of the gas surrounding the vortex. It is known that the gas temperature in the vortex is lower than the temperature of the gas surrounding the vortex. In this case, if we consider the atmosphere as a Wilson chamber, then, in case of temperature decrease in the area of the space occupied by the vortex, we can expect either local condensation of water vapor or condensation that will occur more intensively than in the adjacent areas of space.



Figure 5. Cloud photographic image

Systematic visual observations were carried out by were taken from the location of the measuring point of radio line "A". It turned out that at the time interval 5 11...13 hours, in the presumed area of the ether vortex occurrence, a cloud development was observed. Depending on the weather conditions, the cloud can take different forms - from a weakly pronounced vortex formation to the

of a powerful cumulus cloud. The development of a "characteristic" cloud was not observed in conditions of relatively low air humidity. It is difficult to identify a characteristic cloud formation in the conditions of solid cloudiness.

It should be emphasized that the formation of the "characteristic" cloud was observed at the time interval S 11...13 hours, i.e., to a first approximation at the same sidereal time. This means that visual observations were limited to daylight hours during the following months of the year: from June (evening hours according to solar celestial time) to November (morning hours according to solar celestial time). This is due to the fact that the difference between the numerical values of sidereal and solar times varies by about four minutes every 24 hours. Figure 5 shows a photograph of such a cloud. The photograph was taken from point "A" along the radio line. One can see the difference in the external parameters of the cloud among others.

Thus, the experimental results obtained in the ranges of radio and optical waves, do not contradict the notion of the ether as a viscous gas-like medium and the assumption that it is possible to form a vortex motion of the ether in terrestrial conditions, i.e., to control the ether motion.

Literature

1. *Atsyukovsky V.A.* "General Ether Dynamics. Modeling of structures of matter and fields on the basis of representations about gas-like ether".— Moscow: Energoatomizdat, 1990. 280 c.

2. *Atsyukovsky V.A.* "General Aether Dynamics. Modeling of structures of matter and fields on the basis of representations about gas-like ether". Second edition.— M.: Energoatomizdat, 2003. 584 e-

3. *Atsyukovsky V.A.* Ephyrodynamic Hypotheses.– Zhukovsky: Petit, 1997. 198 c.

4. *Galaev Y.M.* "Ether wind. Experiment in radio wave range". Zhukovsky: Petit, 2000. 44 c. –

5. *Galaev Y.M.* "Effects of ether wind in experiments on radio wave propagation." // Radiophysics and Electronics. - Kharkov: Institute of Radiophysics and Electronics. NAS of Ukraine. 2000. T5, №1. C.119-132. – – –

6. *Galaev Yu.M.* "Etheral windin experience of millimetric radiowavespropagation". //Space- time & Substance. Kharkov: Research and Technological Insti- tute of Transcription, Translation and Replication. – 2001. – Vol. 2, No. 5 – (10).– P. 211225. (Posted to: <http://www.spacetime.narod.ru/0010-pdf.zip>).

7. *Galaev Yu.M.* "The measuring of ether-drift velocity and kinematic ether viscosity within optical wavesband". // Spacetime & Substance. – Kharkov: Research and Technological Institute of Transcription, Translation and Replication.– 2002. – Vol. 3, No. 5 (15). – P. 207224. (Posted to: <http://www.spacetime.narod.ru/0015-pdf.zip>).

8. *Galaev Y.M.* "Effects of ether wind in experiments on propagation of radio and optical waves." // Collection of selected papers of the city-wide seminar at the Kharkov House of Scientists (1997-2004) Kharkov: LLC "Infobank". 2004. C. 214-232. – – –

9. *Galaev Y.M.* "Optical interferometer for measurement of light speed anisotropy". // *Technologiya pri-borostroeniya.*– Kharkov: State Enterprise Scientific Research Technological Institute-of Instrument Engineering. 2006. №2. C. 8-21.

10. *Galaev Y.M.* "Measurement of-ether wind speed and kinematic viscosity of ether by optical

Interferometer". – Kharkov: LLC "Infobank", 2007. – 44 c.

11. *Miller D.C.* "Ether-drift experiments at Mount Wilson." // Proceedings. Nat. Acad. Sciences. – 1925. – Vol.11. – P. 306-314.

12. *Miller D.C.* "Significance of the ether-drift experiments of 1925 at Mount Wilson." // Science.- 1926.– Vol.63, No 1635. P.433 443.–

13. *Michelson A.A., Pease F.G., Pearson F.* Repetition of the Michelson - Morley experiment // Journal of the Optical Society of America and Review of Scientific Instruments. – 1929.– Vol.18, No. 3.– P.181– 182.: also in Nature.– 1929. – 19 Jan. P.88.

14. *Michelson A.A.* "The relative motion of the Earth and the Luminiferous ether". // The American Journal of Science.– 1881. – III series, Vol.XXII, No. 128– 120129.

15. *Michelson A.A., Morley E.W.* "The relative motion of the Earth and the luminiferous ether." // The American Journal of Science. Third Series. - 1887. – Vol.34. - P.333–345. Philosophical Magazine. -1887. Vol.24. P. 449 463–

16. "Ether Wind". Collection of articles, ed. *V.A. Atsyukovsky.* Moscow: Energoatomizdat, 1993. 289 c.

INDIGO CHILDREN

N.S. Verbuk

Who they are.

Where they come from.

What is required of us...

Introduction. Parents say, "He was born just like that. We have to adjust." "If he doesn't like something, he will never do it. Children began to be given other names, often called by their full name, sometimes by their patronymic, sometimes in jest, but behind it there is a real "You" address.

There has also been a sharp increase in the share of children who deviate from traditional methods of upbringing and education. These children either leave school or are present there formally, i.e. internally absent, resulting in a lower quality of education. More and more parents are looking for and are willing to develop alternative learning systems themselves. Recently, problem children have been diagnosed with attention deficit disorder. The etiology of the syndrome is unclear. Most researchers suggest genetic factors overlaid with social problems.

Not all difficult children are indigo children, and not all indigo children are difficult.

The basis for considering these phenomena is the spiritual-scientific knowledge presented by Rudolf Schneider on the progressive development of human consciousness and its relationship to the cosmos. The spiritual-soul forces and properties of the "autonomous spiritual essence", which shape human development between hereditary and environmental influences, are often still denied.

Most of the contemporaries, or are not sufficiently taken into account.

As a rule, general concepts are used to characterize these children, with their peculiarities, their disproportionate characteristics, which since the beginning of the eighties have been born in increasing numbers: for some "highly gifted" to others "with abnormal behavior" or generally "with abnormal behavior". The term "attention deficit disorder" (ADD) encourages rapid, symptom-oriented, therapeutic or medication-based treatment.

So, who are these children? At the age of one and a half they already say "I", at two they can talk, at three they sit at the computer, at four they form their own group, intervene in adult conversations and tell them what they should do. They often spontaneously recall past lives or talk to their angel. They have not only a strong will of purpose, but also a remarkable sensitivity to the mental processes of their environment: parents, caregivers and teachers. Any non-identity will not go "unnoticed" and will lead to either a silent protest or an explosion of destructive rage. With a high sense of self-importance, they want to be respected and treated as adults, full-fledged individuals. Hyperactivity, or rapid attention span, is only one of many extreme behaviors. of behavioral traits.

Who are these children with their unusual, partly spiritualistic gifts? Psychologist Nancy Tapp has the ability to see people's qualities and life expressions as color radiations. When, by the early 1980s, more and more helpless parents approached her about the uncommon qualities of their troubled children, she noticed that in the early 1980s, she was able to see the color of people's personalities and expressions.

their aura is dominated by blue, the color of indigo, among other colors. Thus a word was found to define the children who bring new impulses, new qualities and manners to our technologically driven civilization: indigo children.

In the new millennium, all these children find themselves at a world-historical turning point in which they have to find their place with their spiritualized capacities. At this time, they are confronted with a dominant mass culture, an educational system and a civilization in which old hierarchical structures still live as great obstacles to their individual development. What role they will play in this drama of human change, and how much depends on us adults to ensure that all children, in this new millennium, are able to understand and cope with the challenges they come with.

The newborn has fear, it lacks the essential unity that is there where it came from, and so it quickly becomes attached to those who care for it.

They transfer the role of the supreme being to the parents. If the parents believe only in material things, they draw the child more and more into physical existence. While they teach him to speak, they limit his thoughts. As children become adults, they become more and more disconnected from their origins. Most people live their entire lives without ever remembering the whole. They have a connection with the higher only as children, and sometimes they reach it again only before they die. They seek external happiness because they have lost their inner happiness. The child of the new age knows that he is part of the whole. They are children who live in different worlds at the same time: on the one hand, they are a part of the whole.

They have a strong memory of the world in which they were as purely spiritual-soul beings. From this they bring with them a very definite wisdom of knowledge. On the other hand, they are in a situation where they have to conquer the physical world, master their body and structure their brain. The result is a focused grasping gaze soon after birth, an affirmative self in the first year of life and an early readiness for confrontation with adults. Why? This hidden self wants to be treated as an equal partner, even if the child cannot communicate verbally. For all the individual differences, these new children share a common, strong self-consciousness, expressed differently in boys and girls. Many deviations from normal qualities and behaviors cannot be understood and explained from a simplistic biological view of the child.

What is expressed in this concept of "indigo children"?

Indigo color.

The possibilities of scientific knowledge of the world are constantly expanding. With the discovery of spectral analysis, it is now possible to study the chemical composition of objects such as distant celestial bodies. But creation is also evolving towards a supersensitive perception of the intangible world. More and more people are discovering (or developing through exercise) the ability to perceive the spiritual qualities of others through their luminous color aura. Those who have learned to understand such color radiations can, like a spectral analyst, judge the spiritual qualities and gifts of people that are hidden from view. The renowned psychologist Nancy N. Tapp, who sees-

of color has defined the aura of a new generation. It's a dark indigo blue.

When more and more helpless parents started coming to see her in the early seventies, it became clear to her that a whole generation of children was beginning to show changes. After many years of observing these children, she saw that indigo blue was becoming more and more predominant in their radiation, replacing the previously dominant orange and red.

To summarize: indigo is a blue that goes up to black. On the one hand it reaches ultramarine, that is, lighter, on the other hand it reaches Prussian blue and black. This is the being that brings to humanity the power symbolized by the black pechas. So, this blue indigo symbolizes the two potentialities of man: one is the desire for the spiritual and the other is that the same forces can slip down into a purely material dimension. Then the person will seek knowledge, which tends to be destructive.

1. Special characteristics of children. They want to be treated as equal individuals. They come into the world already thinking of themselves as royalty and behave accordingly.

They do not like the feeling of guilt and the threat of punishment. They find it difficult to keep themselves within the boundaries of conventional behavior.

They get angry and bored if things are routine and do not require creativity. They often immediately see opportunities for better solutions to problems at home or school and therefore rebel against the established course of life.

School is difficult for them socially, as they are more willing to learn through experience and experimentation.

They want to be consulted and do not like to be ordered around.

They have a keen sense of truth and fairness and expect identity, truthfulness and solidarity.

Any dishonesty, any attempt to mislead will be immediately noticed This will lead to alienation.

They often have memories of past lives, albeit briefly.

Their behavior strongly depends on the human environment: at home, quite courteous; at school, on the contrary. Or at home, with their own mother, they are naughty, at grandmother's house, on the contrary, quiet and peaceful.

2. Panoramic consciousness. Another remarkable feature is panoramic consciousness, a manifestation of imaginative, holistic perception. This imaginative thinking is capable of grasping large real-life interrelationships and texts like lightning. Such thinking is 400-2000 times faster than ordinary thinking, advancing from thought to thought, from word to word. It is this panoramic awareness that is the basis of a creative power that, when properly applied, surpasses so-called linear thinking. Some children see the solution to mathematical problems in this way or read them from the teacher's mind.

So, recommendations: we need to rethink pedagogical paradigms, we need to teach children to think, not tell them what they should think. Our role is to give them knowledge and wisdom. If we give only knowledge and tell them what they should think, we deprive them of the joy of making their own discoveries. I believe that the essence of education is that as well as developing problem-solving skills, we help them to develop the ability to find their own discoveries.

tines. Critical thinking, problem-solving skills, imagination, sincerity and a sense of responsibility should be at the core of educating the children of the 21st century. The education of the future must be based on unconditional love. This is the essence of the new human being.

3. Four groups of children with special characteristics. There are four groups of children with special needs.

The souls of comforters and caregivers. In every classroom today, you can find a few sensitive, fearful, delicate, very thin-skinned children, often girls, who cause anxiety with their defenceless appearance.

Every change in the situation causes them terror. They are tormented by fears of failure, fears of falling asleep. Because of their excessive need for protection, they are known as tyrants in the family. They attach extreme importance to rituals, have a great need for harmony and fear that something bad will happen.

They fear for themselves and for others. Their concern is directed to the well-being of their mother, father, brothers and sisters. The predominant trait of these children is empathy, a sense of responsibility for all living things. They are deeply religious.

They feel through, they see through. They "see in their hearts" the falseness of a teacher who speaks in a friendly manner but is filled with anger and sadness inside. We are dealing here with a quality that has become rare and necessary in our civilization, like water in a drought.

These are the souls of comforters and caregivers. These beings are in a painful mismatch: between the warmth of the soul and the freezing climate of time.

The souls of scouts, sentinels, seekers. This group includes mainly hyperactive children. A lot of activity--

A creative, creative impulse characterizes these children. They are bursting with energy. In the process of their incarnation, the impulse of warmth and movement is breaking through. "I have little time, I have a lot to do," they say. The so-called hyperactivity syndrome is a pure acceptance of life, a pure joy of creativity, an excessive desire to do good.

They have a strong need for communi- cableity, expressed in the willingness to be friends with everyone. They are eager to give to others. They are adventurers in life. Their willingness to take risks is breathtaking. Hyperactive children are little anarchists. For this, they are sometimes resented. Those who bring them up should applaud this thirst for freedom. Those who can see will discover their telepathic abilities. They are called scouts, sentinels, or soul-seekers. They are clearly leaders who go forth and explore unfamiliar terrain for others.

The souls of poets or travelers to dreamland. They are often perceived as pathologically introverted, extremely dreamy (attention deficit disorder). They think about deep questions very early on, pondering death, collapse, infinity.

Travelers to fairyland often have invisible companions with whom communication is a matter of course.

Guardians or guardians of reality. They are ready to fully develop their spiritual abilities if their studies are oriented towards practical life. The child can repair cars, understand motors, handicraft instructions, and everyday appliances.

use, but at the same time makes mistakes in the multiplication table.

From a brief description of these characteristics, it is easy to see that with these children, something comes into the world that we have needed for a long time and that can contribute to the humanization of our culture. Obviously, people are entering life with new impulses that cannot be explained only by external factors in the development of civilization and culture.

4. Neurophysiological aspects. Thanks to sophisticated measurement techniques, it is now possible to measure the activity of the neural functions of the brain that are generated by thoughts and feelings. It is also possible to track and read various subtle states of consciousness from the monitor.

But one question still remains unanswered: Is the brain and its functions consciousness? Philosopher Thomas Metzinger says that solving the riddle of consciousness is tantamount to a scientific revolution that will revolutionize society.

After a long study that began in 1965, researchers have concluded that the human brain is changing so rapidly that in fifty years we will have other human bodies that, thanks to a new brain structure, will think differently, feel differently, act differently.

The soul shapes the body. The latest research allows us to trace how the soul participates in the formation of the body at the early embryonic cellular stage.

This process has been researched for many years by Prof. Johannes Roine. On the basis of spiritual-scientific data, he tried to prove the influence of the mental on the embryonal process of body development.

So what is the soul and how does the "extract" from previous life experiences arise? The origin and essence of the soul may help explain some of the characteristics and behaviors of these children. From these reports it appears that people who have been incarnated many times on Earth go through something in the spirit world before birth that took place in earlier times in the so-called mystery centers on Earth. There people were initiated into the mysteries of birth, life and death. In these centers of education people received not only knowledge but also wisdom. Going through many stages of training and initiation, they had to acquire knowledge in order to pass it on to others. Because of these early initiations, these children come to earth already trained before descending into the physical body through conception and birth. So, nothing of what was achieved in the early forms of existence is lost, but it is manifested in a transformed form and forms the basis for the development of new possibilities.

All souls are nothing but elements of the energy-formation field, its tiny bricks. The cosmos needs this material because each soul is unique, it has its own cosmic niche, and no other soul can replace it in its importance. It is like the voice of a unique singer. So, nothing achieved in previous lives is lost, but it appears in a transformed form and forms the basis for the development of new possibilities.

5. Children, our teachers. Parents and teachers need to realize that children bring their own truth into this world and are therefore already wiser than we are. They are people who have already gone through many incarnations on earth and therefore find themselves quickly, almost impetuously, in our time. They are like mothers.

In some cases, they may be a manifestation of memories of past lives, the ghastly moments between which are often shortened. The high self-awareness and great self-will that can sometimes be traced behind outward rebellion may be a manifestation of memories of past lives, the gaps between which are increasingly shortened.

To all of this we can add the global crisis of pre-belief because, in many cases, they were rejected by abortion when they attempted to incarnate.

Since the beginning of the 20th century, researchers have been predicting upcoming social upheavals due to global changes in consciousness in the form of manifestations of new psychic abilities appearing in more and more people. This includes the perception of people's radiation in the form of auras, visions of future events, and images of fragments of past lives. Spiritual educators have an important role to play.

Without preparation for change, there is a danger that all these phenomena will be misinterpreted. But whoever manages to break down the walls of his own fixed ideas, who walks through the world with open eyes and ears, cannot fail to notice how the new - the spiritual - has already begun to make its way into countless minds. And since the new in human history is often chaotic, the significance of these processes can easily be overlooked.

The gradual change from abstract to increasingly imaginative thinking is a major symptom of progress. The ease with which not only children but also many adults today feel the experience of previous lives is a form of rapid transformation of consciousness.

The Waldorf School was created to take into account new qualities in the psychology of children.

The founder of this school, R. Steiner, said: "If the world is rebelling today, it means that heaven is rebelling, that is what it means."

that heaven which was not allowed into the souls of men. Obviously, there is another kind of people among us whose souls come from other cosmic dimensions. This is certainly not easy to understand, nor are the stories of children who sound fantastic. Perhaps among them there are beings who have not yet passed through any earthly incarnation because they have lived in the spiritual realm of other planets and now, at a time of great change, they come to earth with a special task.

6. A worldwide phenomenon. The children's unusual behavior awakens interest in the dual nature of human nature, as indigo children manifest themselves all over the world, regardless of human and cultural background. They do possess seemingly superhuman abilities with which they can seemingly overturn the laws of time and space. They are not only able to see through walls, move objects in closed vessels, they know literally everything, they can speed up the growth of plants, read minds and many other things. They also have the ability to manipulate and change the structure of living matter at the molecular level.

In a study of some children with congenital AIDS, a few years later blood tests showed that there was no disease, and what was more surprising was the unusual DNA, 4 more genes than in normal people. This means that they have some other properties than we do!

Another group of children is called resilient - the English word means "indestructible". These are children who, against all odds, live in extremely difficult conditions, for example, in completely degraded families. Nothing can make them lose their temper. They remain completely unscathed.

Thus, in some children, it is possible to discover an inner knowledge of the deep mysteries of earthly existence and the soul, which is achieved through multiple passages through earthly lives and contributes to a full understanding of all life, the experiences of others and love for everything.

7. Life and consciousness. Now let us consider the human body as a three-dimensional structure: physical body, soul and spirit. We would have no consciousness, no thoughts, no feelings, no sensations if we were not immersed in energy space. Let's think about where we experience our thoughts? We can't say for sure - in the head, in the brain, ...there are no thoughts there. At the very least, there are traces of thoughts, neural networks, brain streams. The clairvoyant sees all kinds of colors and shapes around a person. The brain itself is comparable to a complex reflective apparatus. We ourselves experience thoughts and feelings not in the brain, but in the space around us. A feeling or a thought, affecting us, also energetically flows from one person to another, like love, hate, aggression, etc. This is real energy that can be measured. For the imaginative clairvoyant perception all this appears in the color and form of the psychic aura.

In the stories of many children, the phrase: "The soul is something you don't get from your mother. Here the help for the child is to explain the concept of the immortality of the human soul. This means a spiritual expansion of time and can mean that with our etheric heart we can feel not only our own inner processes but can also sympathize with the whole environment. Some people feel sometimes also through the atmosphere, so that one cannot distinguish whether it is one's own feeling, or whether it is a feeling of a fellow human being, or whether it is an event that takes place in a people living in another part of the earth.

The human aura can be thought of as an energy field or electromagnetic force that can be measured. These fields can expand into a sphere that can be called the world of ideas or the world of good intelligence, which invisibly surrounds the Earth, like the magnetosphere. From this world of good mind all inventions and ingenious discoveries, as well as visions of the future, are drawn. They arise in the form of intuition from the world beyond time and space. This is the Spiritual Sphere of Eternity. The kind of consciousness in the world before birth is not topical, but on the contrary spiritual-peripheral. This means that consciousness is like a huge environment that encompasses all other beings and all spiritual processes. There is information about incarnation: the soul, as a The "spiritual sprout" brings the extract from the earlier earthly lives into the new incarnation, its efficacy is infused from the spiritual world into the succession of generations. He draws strength from the world ether from which he forms his etheric body. Then begins the process of slow awakening in the physical body.

Thus, the physical birth of a child brings with it an outward curtailment and a re-adaptation of consciousness. The spiritual side of children is thus linked to the not yet perfect corporeality, which, from the point of view of the spiritual dimension, is experienced as cramped and heavy. The love addressed to them is a help. It is the sub-station that connects the spirit and the body. Love is perhaps the most important thing these children expect from all those who live on this earth.

Each child's self and its holistic essence makes the adult activate his or her own self. What we meet in children makes us reconsider all previous attitudes. In this way, children become educators of adults. Of course, without realizing it, they are nurturing them

of their parents and push them towards self-knowledge and self-education.

8. Their mission and our mission. The children say, "We have a mission. We bring the wisdom and knowledge to Earth that we had before we were born. We have consciously chosen our parents.

What is the human self. What really happens during the birth and development of a child? Neurologists can no longer be left to deal with this question. All of us who deal with these children are called upon to help them fulfill their task. It's about making them our partners. And this is possible through infinitely great patience and great love.

I think we have been standing for a long time on the cusp of a time in which we are compelled to watch something new come into the world through these children. This means: looking at their souls, the content of their thoughts, to see to it that we ourselves are changed.

In what direction Indigo children will develop as children of the new age depends on whether we accept and understand the challenge.

In this way, the future will come into our lives, into our culture. For these children carry the testament of the future that the present is looking for!

INFORMATION ABOUT AUTHORS

DMITRY PEREVERZEV



Born on November 7, 1928 in the village of 2nd Nikolskoye, Sverdlovsk District, Orel Region. Graduated from the Moscow Power Engineering Institute (1953), postgraduate studies at the A.N. Podgorny Institute of Machine Building Problems (IPMash) of the National Academy of Sciences of Ukraine (1961).

Doctor of Technical Sciences (1990). Senior Scientific Associate (1967). Leading Researcher at the Institute of Machine Building of the National Academy of Sciences of Ukraine.

The sphere of his scientific activity is creation and improvement of thermal turbine units for large and transportation power engineering. For 54 years of his engineering, design, scientific, scientific-pedagogical and scientific-organizational activity, he took an active creative part in the creation, development and improvement of practically the entire fleet of thermal turbines that equip all of our

domestic large and transport power industry.

He proposed and developed a 100 MW pre-coupled steam turbine with a cooled head, with record steam parameters of 300 ata and 650°C, which remain unsurpassed in our and the world power industry.

He has more than 160 published scientific papers. Among them are two monographs: "Problems of thermal state of basic and maneuverable turbine units" ed. 1980 and "Synthesis of rational thermal state of heat power equipment" ed. 1987, as well as the basic program article "On the Possibilities of Increasing the Efficiency of Turbine Units at Thermal Power Plants of Ukraine" in the collection of scientific papers "Improvement of Turbine Units by Methods of Mathematical and Physical Modeling" ed. 2003 г.

He has trained several candidates of technical sciences. He is the head of the seminar "Energy-informatsi-
he intellectual and intellectual-spiritual activity of the Universe and our worldview" and the "Local Lore" club at the Kharkiv House of Scientists.

He was awarded the medal "For Valorous Labor in the Great Patriotic War of 1941-1945".

For a significant contribution to the preservation of scientific and cultural potential of Kharkiv region, active public activity and in connection with the 75th anniversary of the founding of the House of Scientists he was awarded the Diploma of the State Administration and Kharkiv Regional Council (2000).

For many years of fruitful scientific and organizational work, significant personal contribution to the development of scientific research, development and introduction of the latest technologies in the domestic power engineering industry he was awarded the Diploma of the Presidium of the National Academy of Sciences of Ukraine (2003).

NIKOLAY KOLPAKOV



Born in 1922 in Mendeleevsk, Tatarstan, Russia. Graduated from the Marshal of the Soviet Union Govorov L.A. Artillery Radio Technical Academy of the Air Defense Forces in Kharkov (1953) and adjunct faculty at this academy (1956).

Doctor of Technical Sciences, Professor. By education - engineer of radio engineering, by work experience - radiophysicist.

Established the materiality and revealed the structure of vacuum (ether). He showed the untenability of limiting the speed of propagation of signals to the speed of light.

He discovered and experimentally registered a new energy-information carrier - polarization waves-

The speed of propagation is many orders of magnitude faster than the speed of light.

Solved the "mystery" of gravity - revealed the nature and worked out ways of its artificial excitation. He is working on the creation of a gravity engine and communication systems on polarization waves.

Early works relate to the synthesis of broadband radio signals and corresponding radio transmitting devices. He introduced dynamic magnetization characteristics of transformer steels. He is the author of inhomogeneous shaping lines. Developed the parametric theory of fluctuations.

He combines scientific work with teaching. He has 50 years of teaching experience in higher educational institutions, 30 years of which he was the head of the department, 6 years - the first vice-rector of the Kharkov Institute of Radioelectronics. Author and co-author of four textbooks on radio transmitting devices and many scientific works.

Participant of combat operations in the Great Patriotic War, awarded 4 orders and many medals.

NIKOLAY ALEKSEEVICH ZHUK



He was born on January 25, 1952 in the village of Chernukhi in Poltava region, the birthplace of philosopher G. S. Skovoroda. Graduated from the 2nd Kharkov Military Aviation Technical School (1972), the Zhukovsky Air Force Engineering Academy in Moscow (1981), the Adjunct Academy of Aeronautical Engineering (1981), and the Moscow Air Force Academy. Graduated from the 2nd Kharkov Military Aviation Technical School (1972), the Zhukovsky Air Force Engineering Academy in Moscow (1981), adjunct faculty at the Academy (1984), Voronezh Humanitarian University (1987, 1989), joint doctoral studies at the Interregional Academy of Personnel Management, the International Personnel Academy and the Open University of the USA (1998).

President of the Slavo-Aryan Academy of Sciences (2006), corresponding member of the Russian Academy of Natural Sciences (2004), member of the European Astronomical Society (2000), the International Philosophical Society (2005) and the Kharkov House of Scientists (1999), Doctor of
268

Philosophy in Applied Mathematics (1998), Candidate of Technical Sciences (1985), Associate Professor (1990), Lieutenant Colonel of the Reserve.

President of JSC "Scientific and Technological Institute of Transcription, Translation and Replication" (Kharkov). Editor-in-Chief of the International Physical Journal "Spacetime & Substance."

He is the author of 27 monographs, more than 20 patents for inventions and more than 200 scientific, popular science, educational and teaching works in various fields of knowledge. However, his main research relates to the theory of relativity, gravitation and cosmology (1984, 1988), in the field of which on the basis of generalization of the fundamental laws of physics he developed a new model of a static (non-expanding) Universe with three-dimensional space and three-dimensional time and proved their suitability for describing real nature and solving applied problems by many practical examples.

His latest works relate to the study of the properties of the ether and the unification of gravitation, electrodynamics, nuclear interactions and quantum theory on a single basis - multipole interaction of matter at different levels (scales). He named the theory with a new direction of unification of interactions quadroynamics (2002).

One of the main organizers of two international gravity conferences (2000, 2003), international conference on unconventional energy (2005), organizer of one local (1998) and two international scientific seminars on fundamental physics in Kharkov (2001, 2004).

He actively researches the Slavic-Aryan Vedas, the Praveda, the history of the Earth and global climate change.

For his scientific works he was awarded an international award - the Polish Order of St. Stanislaus II degree (2005, III degree - 2004). For his impeccable service in the Armed Forces of the USSR and Ukraine (1969-1994) he was awarded five medals.

WINTER IVAN IVANOVICH



Born in 1946 in Kaunas (Lithuania). Graduated from the Minsk Higher Engineering Antiaircraft Missile School of Air Defense Forces (1969), the Govorov Military Engineering Radio Engineering Academy (1977), adjuncture (1981), doctoral studies (1994). Graduated from A. A. Govorov Military Radio Engineering Academy (1977), adjuncture (1981), doctoral studies (1994).

Military engineer in radio engineering. Colonel. Veteran of electronic warfare.

Doctor of Technical Sciences (1994). Professor (1999). Academician of the International Academy of Applied Radio Electronics (2001).

Professor of the Aerospace Intelligence Department of the Kharkiv Air Force University.

He is the author of more than 200 scientific papers and 22 inventions.

His research interests lie in geophysics, bionics, information aspects of mini-energy quantum physics, functional microelectronics and information warfare.

Initiator of the creation and development of a new scientific discipline - rotor geomagnetism and its introduction into the main directions of modern science.

Deputy Head of the scientific seminar of the Kharkov House of Scientists "Energy-informational and intellectual-spiritual activity of the Universe and our worldview".

Laureate of the USSR Committee for National Education Prize "For the Best Scientific Work" in 1990.

YURI GALAEV



Born on September 11, 1946 in Poltava. Graduated from the Kharkov Polytechnic Institute (1972), postgraduate studies at the Institute of Radiophysics and Electronics, Academy of Sciences of the Ukrainian SSR (1977).

Senior researcher at the A. Y. Usikov Institute of Radiophysics and Electronics of the National Academy of Sciences of Ukraine. Member of the Kharkiv House of Scientists.

Candidate of Technical Sciences (1988). Senior Scientific Associate (2001). Corresponding member of the Russian Academy of Natural Sciences (2003).

Author of 64 scientific papers. His main scientific interests are in the field of electromagnetic wave propagation in natural media. The most important works are related to the development of methods and means of remote sensing of earth surfaces; experimental methods and means of remote sensing

of earth surfaces.

studies of radio wave scattering by water surfaces; phase characteristics of surface radio wave propagation channels; radio wave propagation over the activities of seas and oceans; properties of anisotropic radio and optical wave propagation near the earth's surface.

BORIS ALEXANDROVICH TROSHENKIN



Born on February 1, 1938 in Ishimbay (Bashkiria, Russia). Graduated from the Institute of Oil, Gas and Geology in Bucharest (Romania), where he was sent from the 3rd year of the Kuibyshev Industrial Institute to complete his studies.

He worked as an assistant at Kuibyshev Polytechnic Institute for two years. After completing postgraduate studies at the Moscow Institute of Chemical Engineering, he worked for 10 years at the Institute "UkrNIIHIMMASH". He has been working in the system of the Academy of Sciences of Ukraine since 1975.

He has held the positions of senior researcher, head of department and laboratory. Currently he is a leading researcher, head of the laboratory "Alternative and renewable energy sources". In 1967 he defended his master's thesis and in 1991 - his doctoral thesis.

Member of specialized scientific councils for the defense of dissertations for the degree of Doctor (Candidate) of Technical Sciences:

- in IPMash NASU on specialties: 05.14.06 - technical thermophysics and industrial heat and power-

getics, 05.05.16 - turbines and turbine installations;
– in NTU KHPI on specialties: 05.17.08 - processes and equipment of chemical technology, 05.18.06 - technology of fats and essential oils.

Research Interests:

- Thermodynamics and kinetics of vapor-gas formation in multiphase flows in elements of power and chemical equipment;
- Calculation methods for evaporators, steam generators, hydrogen reactors and hydro-steam turbines.

The results of the research are presented in 110 publications in domestic and foreign editions. Among them there are 2 monographs and more than 30 author's certificates and patents.

VERBUK NINA SEMYONOVNA



Born July 10, 1949 in Kharkov. A well-known Ukrainian artist. Graduated from the Repin Children's Art School (1964), Kharkov Art School (1968) and Kharkov Art and Industrial Institute (1974).

Member of the National Union of Artists of Ukraine (1988), member of the board of the Kharkov organization of the National Union of Artists of Ukraine (2000). Chairman of the Painting Section of the National Union of Artists of Ukraine. Founder of the A. F. Lunev Foundation at the National University named after V. N. Karazin. V. N. Karazin.

Author of more than 300 works of painting and graphics, as well as many articles in newspapers and magazines. Participant of more than 100 exhibitions, including about 40 personal exhibitions. Her works decorate art galleries and mu-

He has worked in many cities of Ukraine, as well as cultural centers and foundations of Germany and Japan. He passes on his knowledge and experience to numerous students.

As an artist and philosopher, she has a broad outlook, her own views on the world, nature, man, his spiritual essence, worldview and religious beliefs. She draws inspiration for many of her works from the eternal confrontation between Good and Evil, the triumph of Light over Darkness, the spiritual over the spiritless. She has made pilgrimages to the countries and holy places where Christianity was born and first developed - Israel, Egypt, Cyprus, Italy and Turkey.

Based on the results of her research on various philosophical movements, schools of thought and impressions from her pilgrimage to holy places, she made a number of reports at the Kharkiv House of Scientists.

For her significant contribution to the national fine arts she was awarded with a diploma of the Kharkiv Regional State Administration (1998) and received the gratitude of the city mayor (1999). For the largest number of personal exhibitions among the artists of Kharkiv she was included in the "Kharkiv Book of Records" (1999). For the cycle of art exhibitions "Light, Joy and Love" she became a laureate of the creative prize of the Kharkiv City Council (2001). Laureate of the municipal award (2004). Laureate of the regional rating and winner of the medal "Kharkivian of the Year" (2005).

**C3 ENERGY-INFORMATION AND INTELLECTUALLY-
SPIRITUAL ACTIVITY OF THE WORLD AND OUR
WORLD-**

GLYAD. Collection of Selected Papers of the Seminar at the 10th Anniversary of the Seminar. (1997-2007). - Kharkiv: Infobank, 2007, 275 p.

ISBN 978-966-8464-10-2

The collection includes additional papers on the formation of modern understanding of the World (the Universe, Cosmos, Nature) that surrounds us, our place in it, ourselves, our purpose and goals of our existence.

For all those who are interested in the scientific foundations of light.

C $\frac{1705000000}{22}$ Without ob'yawi. ББК 20+22.3+22.6+63.(0)+86+87+88
8464 2007

Popular science edition

**ENERGY-INFORMATIONAL
AND THE INTELLECTUAL-SPIRITUAL
ACTIVITY OF THE UNIVERSE
AND OUR WORLDVIEW**

Collection of selected works of the city-wide seminar at the Kharkiv House of Scientists, dedicated to the 10th anniversary of the seminar (1997-2007)

Responsible for the issue N. A. Zhuk

State Register DK No. 1069 of 03.10.2002
Signed in print 23.10.07. Format 60x84 1/16 Usl. p. I.
17,4. Print run 100 copies. Order No. 22
Publishing house Infobank Ltd,
Sergiy Tarkhov str. Sergiy Tarkhov, 9, Kharkov
61189, Ukraine, tel. +38 050 301-43-31, +38 050
230-26-12

Printed at Finart Ltd,
Lenin Ave. Lenina, 36, office. 420, Kharkov,
Ukraine, tel. +38 057 7176-002, 7175-826.