

DYNAMO THEORY: THE PROBLEM OF THE GEODYNAMO

RAMANDEEP GILL

March 21, 2006

Abstract

Magnetic field of the Earth is maintained as a result of turbulent motions in its core. *Dynamo theory*, based on the framework of magnetohydrodynamics, specifically mean field magnetohydrodynamics and electrodynamics, holds the key to the generation of Earth's magnetic field. Many of its properties such as polarity reversal, westward drift of fields, intensity variations, are approximately explicable with the understanding of Dynamo theory. This paper outlines and briefly discusses important models of the theory, namely the *Kinematic* and the *Turbulent* model. Few simple examples are also provided to aid in the comprehension of such a complex topic.

1 Introduction

Many exotic phenomena of scientific interest, for example the *Aurora Borealis*, *Sferics*, *Whistlers*, and *Tweaks*, are attributable to the magnetic field of the Earth. Yet the generation of this magnetic field is not completely understood. Lots of papers are written everyday in an effort to precisely model the properties of Earth's magnetic field; it is still an open question. Nevertheless with the success of Dynamo theory many new channels have opened to analyse the problem in many different ways. Various proposed models, such as the Kinematic dynamo model as well as the Turbulent dynamo model, have been able to approximately, if not precisely, account for some canonical properties of Earth's magnetic field.

Interest in the problem of the geodynamo was not readily established after Sir Joseph Larmor, in 1919, asked the famous question [1], 'how could a rotating body such as the Sun become a magnet?' At the time, there was no well tested theory to explain this phenomenon and, in the case of the Earth, it was believed that the core maintained permanent magnetization to cause a magnetic field. Soon, through statistical mechanics and with the aid of seismological studies, it was realized that high temperatures ($\approx 4200K$) at the Earth's core exceed the Curie point of most metals. It was evident that Earth's magnetic field could not have originated due to magnetization of its core but something else must be at play here. Larmor also proposed that an electrically conducting fluid in a rotating body may generate a magnetic field in a way akin to a homopolar disc dynamo.

This paper outlines and briefly describes the guiding principles of Dynamo theory using the framework of Magnetohydrodynamics. In the study of Dynamo theory, two important models, namely Kinematic and Turbulent [2], have emerged quite helpful in the understanding of this complex phenomenon. A discussion on both models is presented in this paper. Due to the complexity of the subject, mathematical rigor is kept to a level adequate enough to clearly present the theory. In any case, should one feels unsatisfied with the arguments, references are provided for further reading on this subject. Next, I present some known properties of Earth's magnetic field.

2 Magnetic Field of the Earth

It is not surprising why one would speculate that Earth's core has some permanent magnetization, since the magnetic field of Earth resembles that of a physical dipole or a bar magnet (see fig. 1). Most ferromagnetic minerals, for example Iron ($T_c = 770^\circ C$) and Nickel ($T_c = 358^\circ C$), have Curie point temperatures on the order of $\sim 1000K$ [2]. Temperatures well above the Curie point result in randomization of individual dipole spins in ferromagnets rendering the mineral demagnetized. The core of the Earth comprises of the inner core, mainly composed of Iron/Nickel alloy, and the outer core with Iron and an admixture of other mineral in molten state. As known from various geological observations, temperature at the Earth's core is on the order of $\sim 4200K$ which suggests that most mineral do not retain their magnetization, if it was present initially. The fluid in the outer core is electrically conducting and it is reasonable to believe that some magnetic induction activity is possible due to its non-uniform rotation. Magnetic field on the surface of the Earth has been observed to change

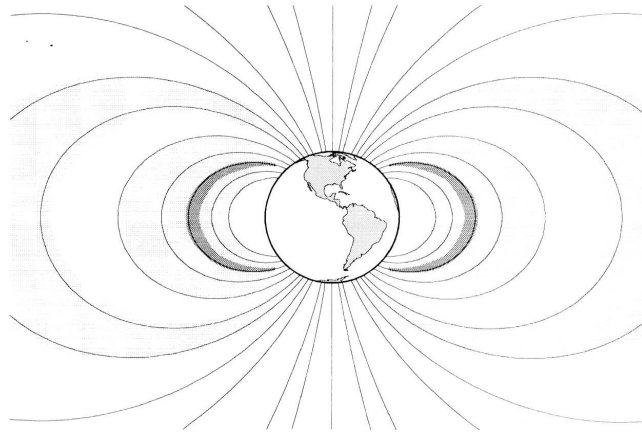

Figure 1: *Magnetic field of the Earth with a dominant dipole structure* [2].

on timescales ranging from milliseconds to millions of years [3]. Such fluctuations in the surface magnetic field, referred to as *geomagnetic secular variation*, are a result of ionospheric interaction with the magnetic field to produce short term variations. However, long term fluctuation arise due to changes pertaining to the fluid motion in the outer core. Paleomagnetic data also indicate the existence of a westward drift of the non-dipole field. From various measurements, it was determined that the average velocity of this westward drift is about 0.18° per year and a period of 2000 years to complete one circuit of the Earth [2].

Another perplexing question in the history of geomagnetism is the phenomenon of field polarity reversals. Archeomagnetic and paleomagnetic studies, strongly suggest the occurrence of polarity reversals in the 4.5 billion years long history of our planet. Some of the data collected from remnant magnetic field found in kiln baked pottery and rock samples do not match the present day field polarity. Calculations performed on the collected data yield an average field polarity reversal timescale of about 250,000 years (see fig. 2). However, this period is highly variable and polarity reversals occur randomly. Surprisingly, no such reversal has been noted to have taken place over the last 780,000 years [4]. Furthermore, the intermediate state between two consecutive reversals is marked by gradual decrease in field intensity up to 50% of the initial field before next reversal occurs. Paleomagnetic observations yield a 10% decrease in field intensity at present from what was measured in 1830s [4]. It is reasonable to believe that another field reversal may take place in the near future. Solution to all the above

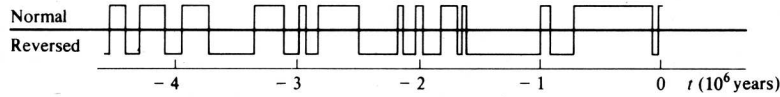

Figure 2: *Magnetic field polarity reversals over the last 4×10^6 years. Only the direction of the dipole is indicated in the figure and not its intensity [1].*

mentioned mysteries can be approximately obtained using the principles of Dynamo theory. A brief discussion is provided in the next section.

3 The Geodynamo

Dynamo theory is a branch of Magnetohydrodynamics which deals with the self-excitation of magnetic fields in large rotating bodies comprised of electrically conducting fluids [4]. The motion of this conducting fluid in a simply connected cavity gives rise to a current distribution. From *Ampère's law*

$$\nabla \times \mathbf{B} = \mu_0 \mathbf{J} \quad (1)$$

with the assumption that $\mu \approx \mu_0$ for most materials, the current distribution materializes a magnetic field which acts to enhance any primary field present, in a way, producing a self sustaining chain reaction. Now, the origin of the initial weak magnetic field is not yet known but the process that follows afterward can be very closely modeled with Dynamo theory. Phase transitions in the Earth's core occur at [1]

$$R_{Oc} \approx 0.55R_E \quad \& \quad R_{Ic} \approx 0.19R_E \quad (2)$$

where R_{Ic} is the inner core radius and R_{Oc} is the outer core radius. The region $R_{Ic} < r < R_{Oc}$, as mentioned earlier, is made of liquid Iron with traces of silicon, sulphur, and carbon. Glatzmair and Olson [4] argue that there are three main requirements for a self sustained Dynamo action. The first and most important condition necessary for geodynamo is the existence of a conducting medium (see fig. 3). Large amount of Iron, comparable to 6 times the volume of the Moon [4], in its molten form very suitably fulfills this basic need. Secondly, continuous supply of energy, provided by thermal convection of fluid, is required to drive the dynamo. Initially during the accretion of Earth from leftover dust in the protoplanetary disk of the Sun, trapped heat in the core dissociated iron in a liquid form. Subsequent cooling as well as pressure from overlying material resulted in the crystallization of iron culminating in the solid inner core. Thermal differences between a hotter core and a colder mantle, cause vigorous convective currents since the viscosity of liquid in the outer core is comparable to that of water [4]. Consequently, blobs of molten iron to rise to the mantle and dissipation of energy through the thin crust cause the blobs to fall back onto the inner core. Moreover, evolutionary history of Earth plays an important part in driving the geodynamo such that the rate of cooling of inner core is directly linked to thermal convection. It will become more clear in the later sections, specifically following the discussion on Turbulent dynamo model, that these convective and non-uniform turbulent motions are closely connected to the generation of Earth's magnetic field. Third requirement is differential rotation of the conducting fluid acquired from the coriolis effect induced by Earth's rotation. Rising blobs of molten iron are forced to follow a helical path, in a way similar to ocean currents (see fig. 4). Now, in the framework of Dynamo theory, fluid velocity \mathbf{u} is presumed to satisfy certain simplistic boundary conditions, such as

$$\nabla \cdot \mathbf{u} = 0 \quad \hat{n} \cdot \mathbf{u} = 0 \quad \text{at } r = R_{Ic} \quad \& \quad r = R_{Oc} \quad (3)$$

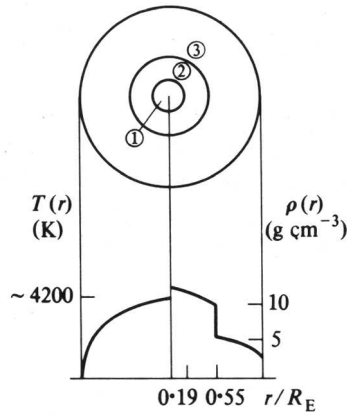

Figure 3: *Interior structure of the Earth.* $R_E = 6380\text{Km}$; 1. solid inner core comprised of iron/nickel alloy; 2. liquid outer core with molten iron and an admixture of other elements; 3. solid mantle [1].

where \hat{n} is the radial normal vector orthogonal to the outer core [1]. Evidence of all the above mentioned activities working in unison to generate planetary or solar magnetic fields can be found universally. For example, Jupiter has a very large mean surface magnetic field strength in comparison to that of Earth [1]. Vast accumulation of liquid hydrogen, with an admixture of helium, under high pressure is the prime cause of such an enormous field. Moreover, the planet spins at twice the rotational speed of the Earth. The conditions at Jupiter's core are very similar to the ones described above. Thus, there is reason to believe that Jupiter's magnetic field, like Earth's, originated from the same dynamo action. The essential question now is that is it

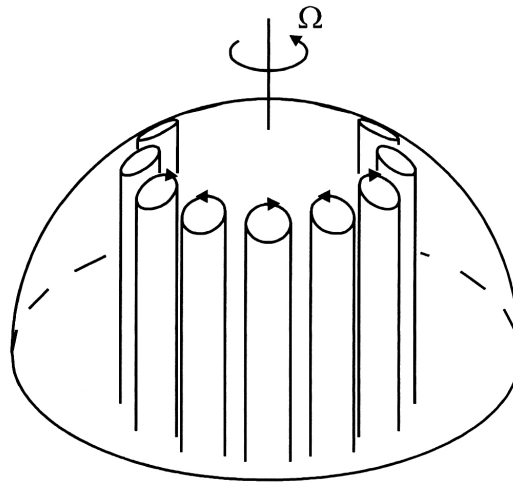

Figure 4: *Convection in a rotating sphere with angular speed Ω .* Blobs of molten iron forced to follow a helical path contained in columns parallel to the rotation axis [2].

possible to construct a mathematical framework using known electrodynamic equations from Maxwell's theory to closely match all the observations? The solution to this complex problem has been found in the construct of Dynamo theory. Before embarking on the mathematically rigorous path to the theory, lets digress to a simpler version of a solution to the generation of magnetic field through magnetic induction.

4 Homopolar Disc Dynamo: A Simple Example

All the required conditions, except convection, for magnetic field generation in a rotating body can be seen at work in this simple example of a homopolar disc dynamo (see fig. 5). In the figure, a metal disc of radius a rotates with frequency Ω in a uniform magnetic field. Initially this magnetic field is created by running a current \mathbf{I} through the wire which is coiled in the same sense as that of the rotation of the conducting disc. To close the circuit, two sliding contacts, one touching the disc at S and the other touching the axil, are installed. Let the magnetic field be oriented in the \hat{z} direction,

$$\mathbf{B} = B\hat{z} \quad (4)$$

Magnetic field produced by some initial current \mathbf{I} in the wire induces a Lorentz force per unit charge on the spinning disc (with tangential velocity $\mathbf{u} = \Omega r \hat{\phi}$) and generates an \mathcal{E} mf.

$$\mathbf{f}_{mag} = \mathbf{u} \times \mathbf{B} \quad (5)$$

$$\Rightarrow \mathcal{E} = \int_0^a (\mathbf{u} \times \mathbf{B}) \cdot d\mathbf{r} \quad (6)$$

$$= \Omega \int_0^a B_z r dr \quad (7)$$

$$= \frac{\Omega}{2\pi} \int_0^a \mathbf{B} \cdot d\mathbf{a} \quad (8)$$

$$= \frac{\Omega\phi}{2\pi} \quad (9)$$

From the process of mutual and self induction then, the magnetic flux passing through

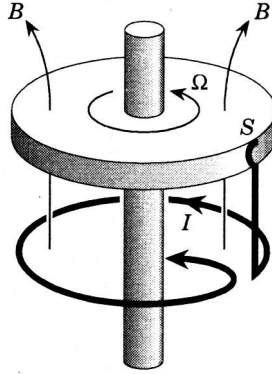

Figure 5: *The self-exciting homopolar disc dynamo* [9].

the disc with mutual induction M is [5],

$$\phi = MI \quad (10)$$

Now, the main equation describing the whole setup, with self induction L and resistance R of the wire, is

$$\mathcal{E} = \frac{M\Omega\mathbf{I}}{2\pi} = L \frac{d\mathbf{I}}{dt} + R\mathbf{I} \quad (11)$$

$$\Rightarrow 0 = \frac{d\mathbf{I}}{dt} + \frac{1}{L} \left(R - \frac{M\Omega}{2\pi} \right) \mathbf{I} \quad (12)$$

$$\mathcal{C} = \mathbf{I}(t) \exp \left[\frac{t}{L} \left(R - \frac{M\Omega}{2\pi} \right) \right] \quad (13)$$

$$\mathbf{I}(t) = \mathbf{I}_o \exp \left[\frac{-t}{L} \left(R - \frac{M\Omega}{2\pi} \right) \right] \quad (14)$$

It is clear from (14) that the system is unstable when $\Omega > \frac{2\pi R}{M}$ since the current increases exponentially in time, but so does the retarding torque. Eventually, the disc slows down to a critical frequency

$$\Omega_c = \frac{2\pi R}{M} \quad (15)$$

where the driving torque just equilibrates the retarding torque, assuming no other frictional components are present, self-maintaining a steady current and a steady magnetic field.

The system of a homopolar disc dynamo is only but a good analogy to the origin of the magnetic field of the Earth. It is completely devoid of the conditions present at the Earth's outer core, as there is no convective diffusion, and in no way resembles or accounts for various complexities. Furthermore, if one carefully notes, the system exhibits axial symmetry of the velocity field which generates a poloidal magnetic field. This is where the homopolar disc dynamo fails, in the context of geodynamo, as suggested by Cowling that axially symmetric systems cannot sustain dynamo action [6]. A discussion on Cowling's theorem is presented in the following section.

4.1 Cowling's theorem

Cowling, in 1934, argued that any axisymmetric toroidal velocity field is unable to maintain an axisymmetric poloidal magnetic field (see fig. 6). The field lines encircling around the toroidal current, as displayed in the figure, must be closed curves. Then, at the two limiting points, N and N', the magnetic field vanishes.

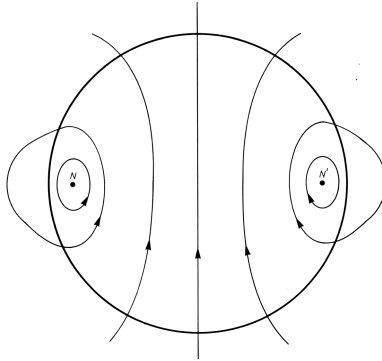

Figure 6: *Axisymmetric poloidal field lines in the meridional plane with a toroidal current distribution; N, N' are neutral points* [6].

$$\nabla \times \mathbf{B} = \mu_o \mathbf{J} \neq 0 \quad (16)$$

However, the current density is not zero there. Since the current is toroidal, it cannot be maintained by an electrostatic force. Then, the current has to decay due to Ohmic dissipations because the magnetic field is zero and cannot maintain the current at the two points. With the decay of toroidal current, the poloidal field also decays. Hence, no axisymmetric field can be maintained by any axisymmetric current.

5 Mathematical Framework of Dynamo Theory

One of the most important equations in Dynamo theory is the magnetic induction equation [7], which states that

$$\frac{\partial \mathbf{B}}{\partial t} = \nabla \times (\mathbf{u} \times \mathbf{B}) + \eta \nabla^2 \mathbf{B} \quad (17)$$

Based on the Magnetohydrodynamic (MHD) assumption that,

$$\frac{\partial \mathbf{D}}{\partial t} = 0 \quad (18)$$

change in displacement current density with time is zero, (17) can be easily derived using Ampère's law from (1) and Ohm's law

$$\mathbf{J} = \sigma(\mathbf{E} + \mathbf{u} \times \mathbf{B}) \quad (19)$$

Taking the curl of (1) on both sides and plugging in (19) for \mathbf{J} yields,

$$\nabla \times (\nabla \times \mathbf{B}) = \mu_o (\nabla \times \mathbf{J}) \quad (20)$$

$$\Rightarrow \nabla(\nabla \cdot \mathbf{B}) - \nabla^2 \mathbf{B} = \mu_o \sigma [\nabla \times \mathbf{E} + \nabla \times (\mathbf{u} \times \mathbf{B})] \quad (21)$$

$$\text{since } \nabla \cdot \mathbf{B} = 0 \quad \nabla \times \mathbf{E} = -\frac{\partial \mathbf{B}}{\partial t} \quad \text{then} \quad (22)$$

$$\Rightarrow -\frac{\nabla^2 \mathbf{B}}{\mu_o \sigma} = -\frac{\partial \mathbf{B}}{\partial t} + \nabla \times (\mathbf{u} \times \mathbf{B}) \quad (23)$$

$$\Rightarrow \frac{\partial \mathbf{B}}{\partial t} = \nabla \times (\mathbf{u} \times \mathbf{B}) + \eta \nabla^2 \mathbf{B} \quad (24)$$

where $\eta = \frac{1}{\mu_o \sigma}$ is the magnetic diffusivity. The first term in the magnetic induction equation gives the interaction of the velocity field and the magnetic field. It provides an insight into the buildup and breakdown of magnetic field as a consequence of the motion of the conducting fluid. The second term in (17) relates to the rate of decay of magnetic field due to Ohmic dissipation. Mechanical energy from the rotating motion is transferred and stored into the magnetic field. Ohmic dissipation drains this energy by transferring it to heat. Thus, to counteract the energy loss, the mechanical energy of the conducting fluid needs to be balanced with Ohmic dissipation. Once this is achieved the magnetic field may settle to a constant value, just like homopolar disc dynamo example, or it may behave completely irregularly. Furthermore, one can assign a Reynolds number to any rotating body exhibiting dynamo action. Reynolds number is defined as the ratio of the rate of buildup of field to the rate of decay of the magnetic field [2].

$$R_m \equiv \frac{\nabla \times (\mathbf{u} \times \mathbf{B})}{\eta \nabla^2 \mathbf{B}} \sim \frac{u_o l}{\eta} \quad (25)$$

where u_o is the velocity scale and l is the characteristic length scale of the velocity field. For any self-sustained dynamo, the Reynolds number has to be greater than 1. Of course, otherwise the decay term would dominate and the dynamo will not sustain for a long time. The velocity length scale for Earth is ~ 10 km per year [3]; with thermal convection providing sufficient inertial effect to balance the dissipative viscous effect, the Earth has been able to maintain a relatively steady magnetic field over its history.

The magnetic induction equation has not been solved in a closed form. The reason behind this is lack of solid experimental data at two interfaces surrounding the outer core - the inner core and the mantle. Nevertheless, the magnetic induction equation can be studied in the realm of few limiting cases which yield valuable insight into the physical process under study.

5.1 Frozen-in Fields

For the case of infinite conductivity,

$$\lim_{\sigma \rightarrow \infty} \frac{\nabla^2 \mathbf{B}}{\sigma \mu_0} = 0 \quad \text{then} \quad (26)$$

$$\Rightarrow \frac{\partial \mathbf{B}}{\partial t} = \nabla \times (\mathbf{u} \times \mathbf{B}) \quad (27)$$

it can be shown that there is no induced $\mathcal{E}mf$ in a perfect conductor moving in a magnetic field [2].

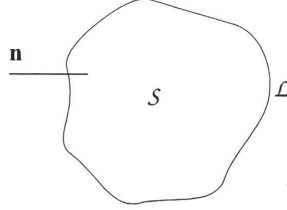

Figure 7: Geometrical arrangement for the frozen-in field theorem proof with surface \mathcal{S} bounded by \mathcal{L} . $\hat{\mathbf{n}}$ is a unit vector normal to the surface [2].

Proof:

Consider a surface \mathcal{S} bounded by curve \mathcal{L} (see fig. 7). Then the flux through the surface is,

$$\int_{\mathcal{S}} \left(\frac{\partial \mathbf{B}}{\partial t} \cdot \hat{\mathbf{n}} \right) da = \int_{\mathcal{S}} [\nabla \times (\mathbf{u} \times \mathbf{B}) \cdot \hat{\mathbf{n}}] da \quad (28)$$

$$= - \int_{\mathcal{L}} \mathbf{B} \cdot (\mathbf{u} \times d\mathbf{l}) \quad \text{by Stokes' theorem} \quad (29)$$

$$0 = \int_{\mathcal{S}} \left(\frac{\partial \mathbf{B}}{\partial t} \cdot \hat{\mathbf{n}} \right) da + \int_{\mathcal{L}} \mathbf{B} \cdot (\mathbf{u} \times d\mathbf{l}) \quad (30)$$

$$= \frac{d}{dt} \int_{\mathcal{S}} (\mathbf{B} \cdot \hat{\mathbf{n}}) da = \dot{\Phi} \quad (31)$$

$$(32)$$

Now, from Faraday's law $\mathcal{E} = -\frac{d\Phi}{dt} = 0$ since $\Phi = 0$. Therefore, no change in internal magnetic field of the conductor occurs, as there is no induced $\mathcal{E}mf$.

5.2 Stationary Fluid

A stationary fluid with $\mathbf{u} = 0$ cannot sustain any dynamo action [2]. Considering the same surface \mathcal{S} , any current distribution $\mathbf{J}(\mathbf{r}, t)$ and the associated magnetic field $\mathbf{B}(\mathbf{r}, t)$ confined to a region with volume \mathcal{V} will decay due to Ohmic dissipation.

Proof:

With zero fluid velocity, the magnetic induction equation becomes a simple diffusion equation

$$\frac{\partial \mathbf{B}}{\partial t} = \eta \nabla^2 \mathbf{B} \quad (33)$$

Also, with the assumption that the external region outside \mathcal{V} acts as an insulator with

$$J = \sigma \mathbf{E} = 0 \Rightarrow \nabla \times \mathbf{B} = 0$$

and

$$[\mathbf{B}] = 0 \quad \text{on } \mathcal{S}, \text{ that is all components of } \mathbf{B} \text{ are continuous} \quad (34)$$

$$\mathbf{J}_{surf} = 0 \quad \text{with no surface currents and} \quad (35)$$

$$B = O(r^{-3}) \quad \text{as } r \rightarrow \infty \quad (36)$$

Solution to (33) can be obtained in natural decay modes [1],

$$\mathbf{B}(\mathbf{r}, t) = \mathbf{B}^\alpha(\mathbf{r}) e^{p_\alpha t} \quad (37)$$

where $\mathbf{B}^\alpha(\mathbf{r})$ satisfies the conditions given in (33-36). Plugging $\mathbf{B}^\alpha(\mathbf{r})$ in (33) yields,

$$\nabla^2 \mathbf{B}^\alpha(\mathbf{r}) = \frac{p_\alpha}{\eta} \mathbf{B}^\alpha(\mathbf{r}) \quad (38)$$

In the above it is apparent that p_α is the eigenvalue and $\mathbf{B}^\alpha(\mathbf{r})$ is the eigenfunction. Then for $t > 0$,

$$\mathbf{B}(\mathbf{r}, t) = \sum_{\alpha} a_{\alpha} \mathbf{B}^\alpha(\mathbf{r}) e^{p_{\alpha} t} \quad (39)$$

Also, it can be shown that,

$$-p_{\alpha} = \frac{\eta \int_{All\ Space} (\nabla \times \mathbf{B}^{\alpha})^2 d\tau}{\int_V (\mathbf{B}^{\alpha})^2 d\tau} \quad (40)$$

Since the right side is positive in (40), all eigenvalues are increasingly negative. Therefore,

$$\lim_{t \rightarrow \infty} \mathbf{B}(\mathbf{r}, t) = \lim_{t \rightarrow \infty} \mathbf{B}^\alpha(\mathbf{r}) e^{p_{\alpha} t} = 0 \quad (41)$$

6 Kinematic Dynamo Model

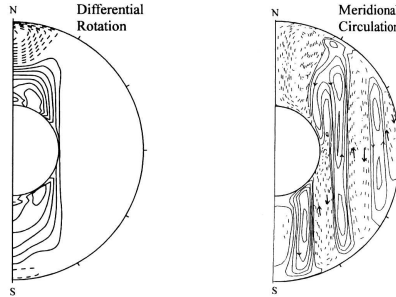

Figure 8: A snapshot of the longitudinally averaged differential rotation and meridional circulation in the outer core for the Glatzmaier & Roberts model. The figure shows streamlines of the meridional circulation with solid contours representing counterclockwise fluid flow and broken contours representing clockwise flow [2].

In a Kinematic dynamo model, it is assumed that the velocity field $\mathbf{u}(\mathbf{r}, t)$ is known, at least statistically, if any chaotic flow exists. Also, the back reaction of the induced magnetic field on the velocity field, resulting in a distortion, is considered negligible. **This model certainly does not apply to the geodynamo because the magnetic-velocity field interactions are not negligible, in actuality, and thus cannot be ignored.** A model that accounts for such interaction is the Turbulent dynamo model; it is discussed in the following section. Nevertheless, the kinematic dynamo model offers deep insight

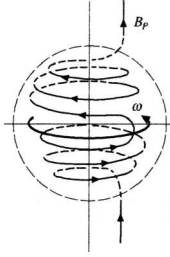

Figure 9: *Toroidal field generation by differential rotation* [9].

into the problem of the geodynamo. The model is marred by computational difficulties which could prove important for the understanding of MHD equations. Moreover, the kinematic dynamo model has been studied for a long period and it has made possible many numerical simulations closely modelling the geomagnetic field. Essentially, the Kinematic model tests steady flow of the conducting fluid for magnetic instabilities [8], assuming the same magnetic induction equation in (17). Important aspects of this model are *differential rotation* and *meridional circulation* of the fluid (see fig. 8). Differential rotation promotes large-scale axisymmetric toroidal fields, while meridional circulation of fluid generates large-scale axisymmetric poloidal fields [9]. A combination of both processes promotes fields resembling that of the Earth with westward drift (see fig. 9).

7 Turbulent Dynamo Model

If the correlation length scale of the fluid l_o is very small relative to the global length scale of fluid flow L_o , then the fluid is said to be turbulent [7].

$$l_o \ll L_o \quad (42)$$

In the turbulent dynamo model, only the averaged properties of the induced magnetic field and the velocity field are considered. However, the behaviour of the mean-magnetic field not only depends on the averaged velocity field but also the residual component of it as well. This residual component arises due to random perturbations in the velocity field, which may have originated due to the back reaction of the induced magnetic field or due to the convective buoyancy of the fluid, making the fluid turbulent on length scales l_o .

To explore this idea in more detail, let's consider a fluctuating field \mathcal{F} . Then, the statistical average or expectation value of an ensemble of identical systems can be defined as $\overline{\mathcal{F}}$. Now, the field \mathcal{F} is comprised of a mean and a residual component

$$\mathcal{F} = \overline{\mathcal{F}} + \mathcal{F}' \quad (43)$$

where \mathcal{F}' is the residual component. The basic condition for the applicability of this model to any other model with turbulent effects is that the Reynolds relations must be satisfied

$$\mathcal{F} = \overline{\mathcal{F}} + \mathcal{F}', \quad \overline{\overline{\mathcal{F}}} = \overline{\mathcal{F}}, \quad \overline{\mathcal{F}'} = 0 \quad (44)$$

$$\overline{\mathcal{F} + \mathcal{G}} = \overline{\mathcal{F}} + \overline{\mathcal{G}}, \quad \overline{\mathcal{F}\mathcal{G}} = \overline{\mathcal{F}}\overline{\mathcal{G}}, \quad \overline{\mathcal{F}\mathcal{G}'} = 0 \quad (45)$$

where \mathcal{G} represents another turbulent vector field. Averaging Maxwell's equations and Ohm's law will yield,

$$\nabla \times \overline{\mathbf{E}} = -\frac{\partial \overline{\mathbf{B}}}{\partial t}, \quad \nabla \times \overline{\mathbf{B}} = \mu_o \overline{\mathbf{J}} \quad (46)$$

$$\nabla \cdot \overline{\mathbf{B}} = 0, \quad \overline{\mathbf{J}} = \sigma(\overline{\mathbf{E}} + \overline{\mathbf{u}} \times \overline{\mathbf{B}} + \overline{\mathbf{u}' \times \mathbf{B}'}) \quad (47)$$

The third term in the averaged Ohm's law is very critical to the model of turbulent dynamo and it is defined as the turbulent electromotive force \mathcal{E} . To study \mathcal{E} in more detail, let's make the necessary substitutions by plugging

$$\mathbf{B} = \overline{\mathbf{B}} + \mathbf{B}', \quad \mathbf{u} = \overline{\mathbf{u}} + \mathbf{u}' \quad (48)$$

into the magnetic induction equation in (17) which yields [7],

$$\frac{\partial \mathbf{B}'}{\partial t} - \nabla \times (\overline{\mathbf{u}} \times \mathbf{B}') - \nabla \times (\mathbf{u}' \times \mathbf{B}') - \eta \nabla^2 \mathbf{B}' = -\frac{\partial \overline{\mathbf{B}}}{\partial t} + \nabla \times (\overline{\mathbf{u}} \times \overline{\mathbf{B}}) + \nabla \times (\mathbf{u}' \times \overline{\mathbf{B}}) + \eta \nabla^2 \overline{\mathbf{B}} \quad (49)$$

It turns out that in the above equation, \mathbf{B}' is a linear function of $\overline{\mathbf{B}}$, $\overline{\mathbf{u}}$, \mathbf{u}' , in turn making \mathcal{E} a functional of these vector fields. Also, knowledge of $\overline{\mathbf{B}}$, $\overline{\mathbf{u}}$, \mathbf{u}' in the neighborhood of a point of interest is sufficient to express \mathcal{E} as a linear functional of $\overline{\mathbf{B}}$

$$\mathcal{E} = \overline{\mathbf{u}' \times \mathbf{B}'} = \alpha \overline{\mathbf{B}} - \beta (\nabla \times \overline{\mathbf{B}}) \quad (50)$$

where α is a pseudo-scalar and β is a scalar and these both depend on $\overline{\mathbf{u}}$.

7.1 The α -Effect

Distortion of magnetic field lines due to cyclical or helical motion of the velocity field produce a mean electromotive force with a component parallel to that of the mean magnetic field. This helical velocity field, as mentioned earlier, result from the convective buoyancy of the fluid coupled with the coriolis force from the rotating body. From (50) then,

$$\mathcal{E} = \alpha \overline{\mathbf{B}}$$

The value of α , which varies with latitude and has been found to be positive in the

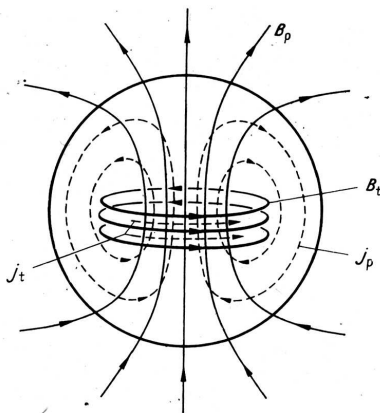

Figure 10: *Geometrical configuration of the α -effect* [7].

northern hemisphere, can be estimated from the exponential growth of magnetic instability [10]. The reason why this effect is critical to turbulent Dynamo theory is because fluid motions associated to this effect lead to the generation of large scale magnetic fields. Fig. 10 displays the α -effect in an electrically conducting sphere. In the figure, the conducting sphere is embedded in empty and insulating space. The magnetic field \mathbf{B} is composed of a toroidal \mathbf{B}_t and a poloidal \mathbf{B}_p component. The poloidal component has its field lines in the meridional plane while the toroidal component encircles the axis of symmetry. Any toroidal velocity field would be influenced by the poloidal magnetic field and, as a result from Ohm's law, a poloidal current \mathbf{J}_p would emerge.

Next, this toroidal current would produce a toroidal magnetic field, interaction of which with any vertical component of velocity vector, would result in a toroidal current \mathbf{J}_t . This toroidal current is accompanied by an additional poloidal magnetic field which reinforces the primary field. This is the α -effect.

8 Present Situation and Future Prospects

In the last decade or so, observations from satellites such as Magsat (1980) and Oersted (1999) in conjunction with supercomputer 3D simulations have improved our knowledge of geomagnetic field to a great extent [11]. As it has been noted, only 1% of the intense field produced by the geodynamo extends beyond the mantle. Even for high precision satellites it becomes really hard to monitor the conditions below the heavy mantle. Nevertheless, these satellites have provided just enough information to reveal secular variations on Earth's surface at specific location such as North America, Siberia, and the coast of Antarctica with high intensity fluctuations. Geomagnetic data provided by Oersted has led to the discovery of reverse flux patches. With the aid of supercomputer 3D simulations, it has been speculated that the emergence of these reverse flux patches hint at the onset of events leading to a spontaneous polarity reversal.

Although these 3D simulations are producing good results, they have not been able to exactly model the conditions necessary to create Earth's magnetic field due to limited resolution. As a complement to computer based models, lab dynamos have just started to model the geodynamo. However, lab dynamos lack thermal convection which, as mentioned earlier, is a necessary condition for any dynamo action.

The task to precisely match Earth like conditions is achievable and not impossible. Significant results using satellite imagery, computer simulations, and lab experiments, can be obtained in the near future with advancements in scientific technology.

References

- [1] Moffat, H. K. *Magnetic Field Generation in Electrically Conducting Fluids*. Cambridge: Cambridge University Press, 1978.
- [2] Merrill, Ronald T., Michael W. McElhinny, Phillip L. McFadden. *The Magnetic Field of the Earth: Paleomagnetism, the Core, and the Deep Mantle*. New York: Academic Press, 1996.
- [3] Buffett, Bruce A., *Earth's Core and the Geodynamo*, Science, 288, 2007-12, 16 June 2000
- [4] Glatzmaier, Gary A. and Peter Olson, *Probing the Geodynamo*, Scientific American, 292, 50-57, 2005.
- [5] Griffiths, David J. *Introduction to Electrodynamics*. Delhi: Pearson Education Inc., 1999.
- [6] Cowling, T. G. *Magnetohydrodynamics*. Bristol: Adam Hilger, 1976.
- [7] Krause, F. and K. H. Radler. *Mean-Field Magnetohydrodynamics and Dynamo Theory*. New York: Pergamon Press, 1980.
- [8] Willis, A. P. and D. Gubbins, (2004). *Kinematic dynamo action in a sphere: Effects of periodic time-dependent flows on solutions with axial dipole symmetry*. Geophys. Astrophys. Fluid Dyn., 98, 537–554.
- [9] Moffat, Keith., *Dynamo Theory*, Encyclopedia of Astronomy & Astrophysics, 2000.
- [10] Brandenburg, A., and D. Schmitt, (1998). *Simulations of an alpha-effect due to magnetic buoyancy*. Astron. Astrophys. 338, L55-L58