

See discussions, stats, and author profiles for this publication at: <https://www.researchgate.net/publication/305807371>

Criticism of the Foundations of the Relativity Theory

Book · January 2007

DOI: 10.5281/zenodo.2578952

CITATIONS

3

READS

1,014

1 author:



Sergey Nikolaevich Artekha
Space Research Institute

48 PUBLICATIONS 101 CITATIONS

SEE PROFILE

Some of the authors of this publication are also working on these related projects:



Математические и эпистемологические ошибки в физических теориях. Исправление ошибок. [View project](#)

S. N. Arteha

**CRITICISM OF THE FOUNDATIONS
OF THE RELATIVITY THEORY**

The present book is devoted to systematic criticism of the fundamentals of the relativity theory (RT). The main attention is given to the new logical contradictions of RT, since presence of such contradictions brings "to zero" the value of any theory. Many disputable and contradictory points of this theory and its corollaries are considered in detail in the book. The lack of logical and physical grounding for fundamental concepts in the special and general relativity theory, such as time, space, the relativity of simultaneity etc., is demonstrated. A critical analysis of experiments that resulted in the generation and establishment of relativity theory is presented in the book. The detailed criticism of dynamical SRT concepts is also given in the book. The inconsistency and groundlessness in a seemingly "working" section of the relativity theory – the relativistic dynamics – is shown.

The given book can be of interest to students, post-graduates, teachers, scientists and all mans, that independently meditate on fundamental physical problems.

Contents

Preface	5
1 Kinematics of special relativity theory	11
1.1 Introduction	11
1.2 Relativistic time	14
1.3 Relativity of simultaneity	33
1.4 The Lorentz transformations	38
1.5 Paradoxes of lengths shortening	41
1.6 The relativistic law for velocity addition	51
1.7 Additional criticism of relativistic kinematics	60
1.8 Conclusions to Chapter 1	71
2 The basis of the general relativity theory	73
2.1 Introduction	73
2.2 Criticism of the basis of the general relativity theory	74
2.3 Criticism of the relativistic cosmology	99
2.4 Conclusions to Chapter 2	104
3 Experimental foundations of the relativity theory	106
3.1 Introduction	106
3.2 Criticism of the relativistic interpretation of series of experiments	108
3.3 Conclusions to Chapter 3	134
4 Dynamics of the special relativity theory	135
4.1 Introduction	135

4.2	Notions of relativistic dynamics	137
4.3	Criticism of the conventional interpretation of relativistic dynamics	152
4.4	Conclusions to Chapter 4	183
Appendixes		
A	On possible frequency parametrization	185
B	Possible mechanism of the frequency dependence	194
C	Remarks on some hypotheses	200
	Afterword	206
	Bibliography	212

Preface

*This book is dedicated to
my kind honest wise parents*

Though the technology achievements have been quite impressive in the elapsed century, the achievements of science should be recognized to be much more modest (contrary to "circumscientific" advertising). All these achievements can be attributed, most likely, to efforts of the experimenters, engineers and inventors, rather than to "breakthroughs" in the theoretical physics. The "value" of "post factum arguments" is well-known. Besides, it is desirable to evaluate substantially the "losses" from similar "breakthroughs" of the theorists. The major "loss" of the past century is the loss of unity and interdependence in physics as a whole, i.e. the unity in the scientific ideology and in the approach to various areas of physics. The modern physics obviously represents by itself a "raglish blanket", which is tried to be used for covering boundless "heaps" in separate investigations and unbound facts. Contrary to the artificially maintained judgement, that the modern physics rests upon some well-verified fundamental theories, too frequently the ad hoc hypotheses appear (for a certain particular phenomenon), as well as science-like adjustments of calculations to the "required result", similarly to students' peeping at an a priori known answer to the task. The predictive force of fundamental theories in applications occurs to be close to zero (contrary to allegations of "showman from science"). This relates, first of all, to the special relativity theory (SRT): all practically verifiable "its" results were obtained either prior to developing

this theory or without using its ideas, and only afterwards, by the efforts of "SRT accumulators", these results have been "attributed" to achievements of this theory.

It may seem that the relativity theory (RT) has been firmly integrated into the modern physics, so that there is no need to "dig" in its basement, but it would be better to finish building "the upper stages of a structure". One can only "stuff the bumps" when criticizing RT (recall the resolution of the Presidium of the USSR Academy of Sciences, that equated the RT criticism to the invention of the Perpetuum Mobile). The solid scientific journals are ready to consider both the hypotheses, which can not be verified in the nearest billion of years, and those hypotheses, which can never be verified. However, anything but every scientific journal undertakes to consider the principal issues of RT. It would seem the situation has to be just opposite. Because RT is being taught not only in high schools, but also in a primary school, at arising even slightest doubts all issues should be seriously and thoroughly discussed by the scientific community (in order "not to spoil young hearts").

However, there exists (not numerous but very active and of high rank) part of scientific elite that behaves a strangely encoded manner. These scientists can seriously and condescendingly discuss "yellow elephants with pink tails" (superheavy particles inside the Moon that remained obligatory after Big Bang, or analogous fantasies), but an attempt to discuss the relativity theory leads to such active centralized acts, as if their underclothes would be taken off and some "birth-mark" would be discovered. Possibly, they received the "urgent order to inveigh" without reading. But any criticism, even most odious, can have some core of sense, which is able to improve their own theory.

RT claims to be not simply a theory (for example, as one of computational methods as applied to the theory of electromagnetism), but the first principle, even the "super-supreme" principle capable of canceling any other verified principles and concepts: of space, time, conservation laws, etc. Therefore, RT should be ready for more careful logical and experimental verifications. As it will be shown in this book, RT does not withstand logical verification.

Figuratively speaking, SRT is an example of what is called an "impossible construction" (like the "impossible cube" from the book cover, etc.), where each element is non-contradictive locally, but the complete construction is a contradiction. SRT does not contain local mathematical errors, but as soon as we say that letter t means the real time, then we immediately extend the construction, and contradictions will be revealed. A similar situation takes place with spatial characteristics, etc.

We have been learned for a long time to think, that we are able to live with paradoxes, though the primary "paradoxes" have been reduced by relativists rather truthfully to some conventional "strangenesses". In fact, however, every sane man understands that, if a real logical contradiction is present in the theory, then it is necessary to choose between the logic, on which all science is founded, and this particular theory. The choice can obviously not be made in favor of this particular theory. Just for this reason the given book begins with logical contradictions of RT, and the basic attention is given to logical problems here.

Any physical theory describing a real phenomenon can be experimentally verified according to the "yes - no" principle. RT is also supported by the approach: "what is experimentally unverifiable – it does not exist". Since RT must transfer to the classical physics at low velocities (for example, for the kinematics), and the classical result is unique (it does not depend on the observation system), the relativists often try to prove the absence of RT contradictions by reducing the paradoxes to a unique result, which coincides with classical one. Thereby, this is a recognition of the experimental indetectability of kinematic RT effects and, hence, of their actual absence (that is, of the primary Lorentz's viewpoint on the auxiliary character of the relativistic quantities introduced). Various theorists try to "explain" many disputable RT points in a completely different manner: everybody is allowed to think-over the nonexistent details of the "dress of a bare king" by himself. This fact is an indirect sign of the theory ambiguity as well. The relativists try to magnify the significance of their theory by co-ordinating with it as many theories as possible, including those in absolutely non-relativistic areas. The artificial character of such a globalistic "web" of interdependencies

is obvious.

The relativity theory (as a field of activity) is defended, except the relativists, also by mathematicians, who forget that physics possesses its own laws. First, the confirmability of some final conclusions does not prove truth of the theory (as well as the validity of the Fermat theorem in no way implies the correctness of all "proofs" presented for 350 years; or, the existence of crystal spheres does not follow from the visible planet and stars motion). Second, even in mathematics there exist the conditions, which can hardly be expressed in formulas and, thus, complicate searching for solutions (as, for example, the condition: to find the solutions in natural numbers). In physics this fact is expressed by the notion termed "the physical sense of quantities". Third, whereas mathematics can study any objects (both really existing and unreal ones), physics deals only with searching for interrelations between really measurable physical quantities. Certainly, a real physical quantity can either be decomposed into the combination of some functions or substituted into some complex function, and then we can "invent" the sense of these combinations. But this is nothing more than the scholar mathematical exercises on substitutions, which have nothing in common with physics irrespective of their degree of complication.

We shall leave for conscience of "showman from science" their intention to deceive or to be deceived (to their personal interests) and shall try to impartially analyze some doubtful aspects of RT.

Note that during the RT life time the papers have repeatedly appeared, which contained some paradoxes and criticism of relativistic experiments; the attempts were undertaken to correct RT and to revive the theory of ether. However, the criticism of RT had only partial character, as a rule, and affected only separate aspects of this theory. The current of the criticism and its quality was considerably increased in the end of the last century only (the article and book titles from the bibliography speak for themselves).

It should be recognized that, as against the criticism, there exists the professional fundamental apologetics of RT [3,17,19,26,30,31,33-35,37-41]. Therefore, the main purpose of the author was to present a successive, systematic criticism of RT just resting upon a fine apologetics of

this theory. Following to the "conventional private tradition", the basic part of the given book was tested in international scientific journals (*GALILEAN ELECTRODYNAMICS, SPACETIME & SUBSTANCE*). As a result this task has been fulfilled step-by-step beginning with the works [48-55], in which the author considered in detail the RT underlying experiments, the baseline kinematic concepts of the special relativity theory and of the general relativity theory, the notions of relativistic dynamics and some consequences of relativistic dynamics. The critical works contain, virtually, no papers on the relativistic dynamics. This fact was one of the main incentives for writing this book.

The present book represents by itself some generalization of published papers from the single standpoint. (Besides, for readers the logical subtleties can always be better grasped in own native language.) To see the most complete "picture of nonsense" we shall, whenever possible, try to discuss each doubtful point of relativity theory irrespective of remaining ones. However, due to the limited scope, the book does not contain the citing from textbooks. Therefore, it is presupposed some reader's knowledge of relativity theory. Besides, often the book considers both the conventional interpretations of relativity theory and possible "relativistic alternatives". This is made to prevent the temptation of rescue of relativity theory with other relativistic choices in disputable points. "Monster" is dead for a long time, and it is not worth to revive it – this is the author's opinion.

It is rather difficult to choose the successive logic of presentation: for any problem there arises the desire for presentation of all attendant nuances in the same place of the book, but it is impossible. The author believe that if a reader can read to the end, majority of impromptu questions and doubts will be consecutively elucidated. The structure of the book is the following. Chapter 1 critically analyzes relativistic notions, like time, space, and many other aspects of relativistic kinematics. Chapter 2 presents the criticism of the basis for general relativity theory (GRT) and for relativistic cosmology. The experimental substantiation of RT will be criticized in Chapter 3. In so doing we shall not consider in detail the experiments pertinent only to electromagnetism or various particular hypotheses of ether (this theme is huge in itself). Instead, we

shall analyze exclusively some general experiments affecting the essence of RT kinematics and dynamics. Chapter 4 contains the criticism of notions of special relativity theory (SRT), results and interpretations of relativistic dynamics. Conclusions are made for each chapter. Some particular hypotheses are considered in Appendixes.

Chapter 1

Kinematics of special relativity theory

1.1 Introduction

Traditionally, standard SRT textbooks begin with a description of the allegedly then existing crisis of physics and experiments that preceded the generation and establishment of SRT. However, there exists the opinion [38] that SRT was originated as a pure theoretical "breakthrough" having no need of any experimental substantiation. The author does not agree with such a view, for physics is destined primarily to explain the really existing world and to find interrelations between observed (measurable) physical quantities. Nevertheless, we begin the book with the theoretical consideration of relativistic kinematics, not with the analysis of experiments. The matter is that several theories can try to interpret the same observed phenomenon in quite different ways (such is and will indeed be the case for physics). However, it is common practice to abandon the theory manifesting logical contradictions. The history of physics demonstrates repeated changes of conventional interpretations for many phenomena. And it is not to be believed that the elapsed century was the last one for these changes.

In textbooks on general and theoretical physics, and in the popular scientific literature, there exists almost advertising support of spe-

cial relativity theory (SRT). This is expressed in headings like: "on the Practical Importance of SRT", "on the Uniqueness and Foundation of all Mathematical Derivations and Corollaries from SRT", "on the Simplicity and Elegance of all SRT Results", "on Full Confirmation of SRT by Experiments", "on the Absence of Logical Inconsistencies in SRT", etc. But if we keep aside issues of particle dynamics (they will be discussed in Chapter 4), and consider only kinematic notions, then the "Practical Significance of SRT" will be obviously zero. The uniqueness and theoretical foundation of SRT can also be attacked [58,65,102,111]. In papers [48-50,52] a series of logical contradictions, related to the basic notions of space, time, and relativity of simultaneity, was analyzed in detail and the complete lack of logical grounding for SRT was proved. Also, the complete lack of experimental grounding for SRT was shown (these issues will be considered in Chapter 3 of the book); and as a demonstration that SRT is not uniquely implied by anything, the possibility of a frequency parameterization of all SRT results was described (although such a parameterization was not the main purpose of the cited work; it will be presented in Appendixes as a particular hypothesis).

In this Chapter, criticism of kinematic notions in SRT will be presented in detail, and attention will be given to some apparent errors from textbooks. All these circumstances force us to return to classical notions of space and time, as advanced by Newton. He formulated these notions in *Mathematical Principles of Natural Philosophy* as a brilliant generalization of works of precursors (including ancient Greeks). Relativists aspired to destroy the former conceptions at any cost (carping, basically, at the word "absolute") and to allege "something new and great". They could present no definitions for notions of time, space and motion, but only manipulated with the mentioned words. Therefore, though brief comments on Newton's classical notions [28] ought to be given in Introduction.

Proceeding from practical demands of natural science, Newton understood that any creature is "excellently familiar" with the mentioned notions and practically uses theirs (for example, insects that are incapable of abstract thinking in opinion of people). So, these notions are the basic ones, i.e. they cannot be defined through anything. Then, it is

possible to give only an enumeration of "things" that will be meant by these notions or will be used in practice and to separate the abstraction that will be implied for idealized mathematical calculations. Because of this, Newton clearly separated absolute, true, mathematical time or duration (all these words simply are synonyms in this case!) from relative, seeming or ordinary time. Thus, time means the mathematical comparison between duration of the process under investigation and duration of the standard process. In classical physics the possibility of introducing the universal time has not been directly connected with the obvious restriction on the speed of signal transmission. More likely obtaining the universal time was connected with the possibility to recalculate it from local times with reasonable exactness. In perfect analogy to this, Newton separated the absolute space notion from the relative one, distinguished absolute and relative place, and distinguished between absolute and relative motions. If the search of relationships of cause and effect is believed to be one of the goal of sciences, then the important positive moment of the classical approach consists in a separation of an object under investigation from the rest of the Universe. For example, in the overwhelming majority of cases "the motion of observer's eyes" does not exert any noticeable influence on a concrete proceeding process and, so all the more, on the rest of the Universe. Certainly, there exist "seeming effects", but to concentrate just upon the process under study, they can be eliminated by the graduating of devices, recalculations etc.. The classical kinematic notions was actually introduced by Newton just for the determination of registration points and standards independent of the process under investigation. This founds the grounds for the common description of different phenomena, for the joining of various fields of knowledge and for the simplification of the description. Also classical notions intuitively coincide with ones given to us in sensations: it is stupid not use they – it equals "to try to go by ears". A centuries-old development of sciences (from ancient Greeks) shows that the classical kinematic concepts lead neither to internal logical contradictions nor to discrepancy with experiments.

Now we shall pass to "the things, created by relativists" in this field, and consider logical contradictions in the fundamental notions of "space"

and "time" in SRT. We begin with the conception of time.

1.2 Relativistic time

Now we remind, how the erroneousness of RT kinematic concepts can be proved most easily. For the "yes-no"-type results only one of different evidences of two observers could be true. Therefore, at least one of moving observers would be wrong in mutually exclusive judgements. However, the situation can always be made symmetrical with respect to the third resting observer. Then his evidences will coincide with the classical (checked for $\mathbf{v} = 0$) result, and in this case the evidences of both first and second observers should transfer to this result. However, since both the first and second observer moves relative to the third one, all three their evidences will be different. Owing to situation symmetry, both the first and second observer occurs to be wrong in his judgements, and only the third, resting observer describes the true (classical) result. Exactly in this manner the inconsistency of the concept of time (the time is irreversible!) was proved in the modified paradox of the twins [48,51], as well as the inconsistency of the "relativity of simultaneity" concept [50]. (Note that the space-time diagram [33] does not change the physics of even conventional paradox of the twins: all additional aging of Earth's inhabitant arises suddenly (!), when the motion of an astronaut changes at the far point and is only geometrically expressed as the change of lines of simultaneity).

We begin the detailed analysis of relativity theory with a modified "twins paradox".

The modified twins paradox

We would remind that in classical physics results are obtained by one observer can be used by any other observer (including investigators not participating in experiments). In such a case, our goal is to formulate some symmetric setting of a problem with results which are evident from the common sense. Relativists renounce the common sense permanently! Therefore, to prove the lack of contradictions and observability of rela-

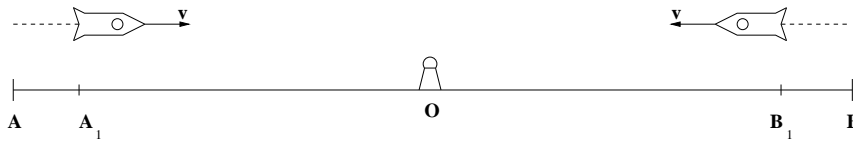

Figure 1.1: The modified twins paradox.

tivistic effects, they must consider different results from the viewpoint of different observers and compare all results between themselves. However, for some reason they do not aspire to the Truth in this question. But few investigators, who carried out such analysis, either ascertained the lack of observable relativistic effects for two-observer schemes (and announced it), or discovered the presence of contradictions for a larger number of observers (the most honest-minded peoples even passed to the camp of critics of RT).

Let two colonies of Earth's inhabitants A and B be at some large distance from each other (Fig. 1.1). A beacon O is at the middle of this distance. It sends a signal (the light sphere), and when it reaches both colonies (simultaneously), each launches a spacecraft piloted by one twin. The laws of acceleration (to reach a large equal speeds) are chosen equal in advance. At the time each twin passes the beacon, at a high relative velocity, each will believe that his counterpart should be younger. But this is impossible, since they can photograph themselves at this instant and write their age on the back side of a picture (or even exchange pictures by the digital method). It is nonsense, if wrinkles will appear on a pictured face of any astronaut during the deceleration of another one. Besides, it is unknown beforehand if one of astronauts will wish to move with acceleration in order to turn around and catch up to the other one.

This paradox can be more reinforced and be formulated as a paradox of coevals – people born in the same year. (In SRT it is declared a change of time course rather than a transfer of initial time, as the time zone on the Earth, for example.) Let now the spacecrafts be launched with families of astronauts. Babies are born on each spacecraft just after

accelerations became equal to zero (accelerations were chosen equal in advance). And these babies are chosen for a comparison of age. All previous history of motion (to the points A_1 and B_1 respectively) does not exist for theirs. The observers at the points A_1 and B_1 can confirm the fact of the baby birth. The babies differ in that they moved relative to each other at speed $2v$ all the time. They travelled the equal distances $|OA_1| = |OB_1|$ to the meeting. This is just the pure experiment to compare the time duration and to verify SRT. Let, for example, the flight of the baby 1 with the constant speed v take place for a time 15 years. Then, from the SRT viewpoint, the first baby will reason in the following manner: the second baby moved relative to me with a large velocity for all my life (15 years); therefore, his age must be less than mine. Besides, if he will count out the age of the second baby starting from the moment of the receipt of signal from B_1 , then he will believe that he will see infant in arms at the meeting. But the second baby will reason about the first baby in the same manner. However, owing to full symmetry of the motion, the result is obvious: the age of both astronauts are the same (this fact will be confirmed by the observer at the beacon).

Recall the explanation of the classical paradox of twins (one an astronaut and one an Earth's inhabitant). These twins have "unequal in rights," since only one of them accelerates (it is just this person who was declared to be younger than the other one). But before acceleration each of the twins thought that the other one should be younger! And, in fact, if one twin is accelerated, then the other grows old faster. (Maybe, it makes sense to prohibit accelerating astronauts and sportsmen in order that everybody around could grow old to a less extent?). Even the "explanation" of the classical twins paradox certainly contains some contradictions. First, everything could have been done symmetrically; the astronauts can take photographs before and after accelerations and even exchange pictures at the center (Can wrinkles appear on photos?!). Second, the explanation cannot lie in the acceleration. We see again at Fig. 1.1 (the modified twins paradox): even with initial equal accelerations, the twins can fly at the same high relative velocity for different times (due to different initial distance $|AB|$, for example). For exam-

ple, we choose these accelerations to be equal to the acceleration of free fall on the Earth. Then, the driving at high relativistic speed requires about one year (but all the distances can be chosen much more: 100 or 1000 light years). It is obvious that neither "accelerated ageing" nor "accelerated rejuvenation" can occur during this year (we can remember the equivalence of accelerated systems and systems in gravitational field from the general relativity theory: just now we have conditions which are analogous to the usual Earth conditions!). It then occurs that accelerations the same in magnitude and in time of action at the same distances $|AA_1|$ and $|BB_1|$ may cause different aging – depending on the time of previous motion (100 or 1000 years) at constant relative velocity (due to time slowing from SRT), i.e. there obtains a violation of causality. Further developing this idea, one can permanently change the sign of acceleration ($\langle v \rangle = 0$), and an arbitrary additional aging will take place in this case (in such a case the SRT formulas for time slowing at a constant rate make no sense). Third, the accelerations and velocities may be different for different astronauts in the process of their motion, but their meeting can always be organized at the same point, and, by the opinion of each of astronauts, the age of the same object will be different, that is nonsense.

Let us consider, for example, a modified paradox of "n twins" (Fig. 1.2). Let them depart on flights in different directions from the same center O , so that all departure angles are different in any pairs (we shall have an irregular n -gon). The schedule of velocities and accelerations is chosen the same beforehand (all spacecrafts are always "situated" at some sphere with the center O). Because of vector character of quantities, all relative velocities and accelerations will be different in pairs. By the opinion of some selected astronaut, each another astronaut must grow old to a different age (and this takes place from the viewpoint of each astronaut), which is impossible (again all astronauts can photograph themselves before each acceleration and after it).

Attempts look naive when "explanations" of different versions of the classical twins paradox are "made" with artificially fabricated auxiliary diagrams: relativists are again cunning and do not check results as a matter of contradictions from viewpoint of all observers (will somebody

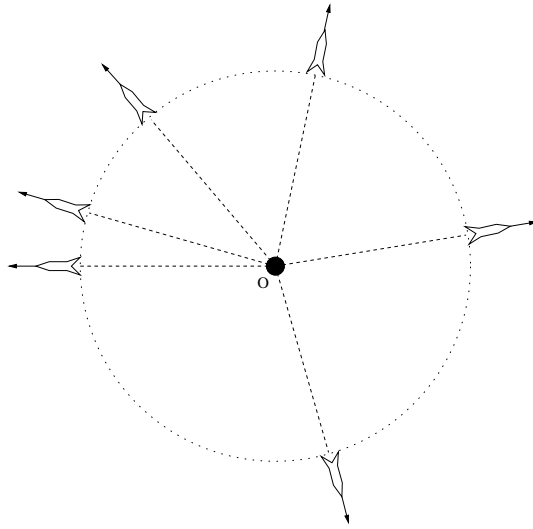

Figure 1.2: The paradox of "n twins".

claim that the Lorentz transformations are insufficient ones, but diagrams present something more thing? really?). Physics and mathematics are "slightly" different sciences to put it mildly. Possible, someone could be interested how pure geometric drawings (a rhombus, a parallelogram, a triangle etc.) can be turned or transformed to pseudo-scientifically rescue the SRT. But these recommendations resemble the proud INSTRUCTIONS "how one can scratch the right-hand ear with the left-hand heel, when this leg is twice wound round the neck, and can provoke the same sensations (they must be elucidated beforehand!) as the normal man (which satisfies his requirements in more natural manner). But even for such "a state of affairs", the following fact is remarkable. In classical physics any logically consistent way leads to the same objective result (each observer can imagine reasoning of any other observer and even appropriates they). The matter is quite different for SRT: it is "necessary" to arbitrarily postulate some reasonings from absolutely single-type ones as false (i.e. there occur the fitting the choice of a way to the classical result). The resulting theory is "surprising": "here

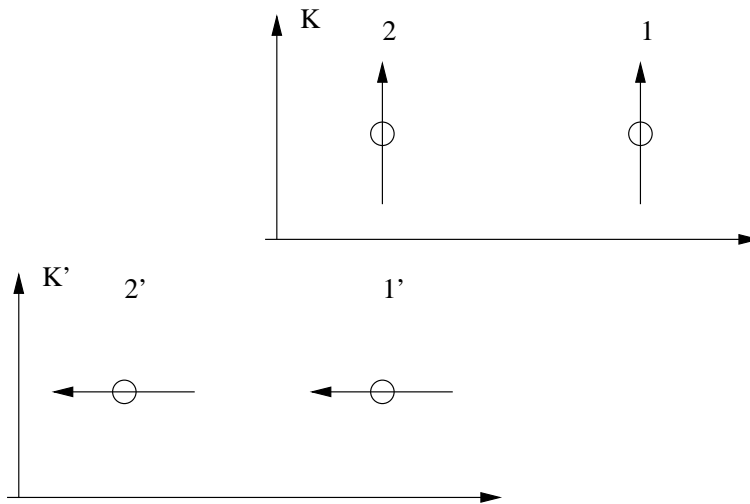

Figure 1.3: The time paradox viewed at $t = 0$.

we read, here we do not read, here we turn over a page by this manner, here we turn inside out by that manner”, and, as it is sung in the song: ”and in other things, the beautiful marchioness, a nice how-d’ye-do...”. It is concocted artfully.

The time paradox

Now we shall pass to the time paradox for moving systems. For ”resolving” it, the Lorentz transformations are often used: they allow one to put in correspondence to one time instant t the whole continuum of times t' . Note, that if we compare the time intervals, then the procedure of synchronizing the time reference point is unimportant. Let us have four clocks $((1, 2); (1', 2'))$, spaced similarly in pairs and synchronized in their own systems K and K' (Fig. 1.3). The synchronization can, for example, be performed by an infinitely remote source located on the axis perpendicular to the plane of all four clocks (it will be further outlined in the subsection on ”establishing the universal absolute time”). Then

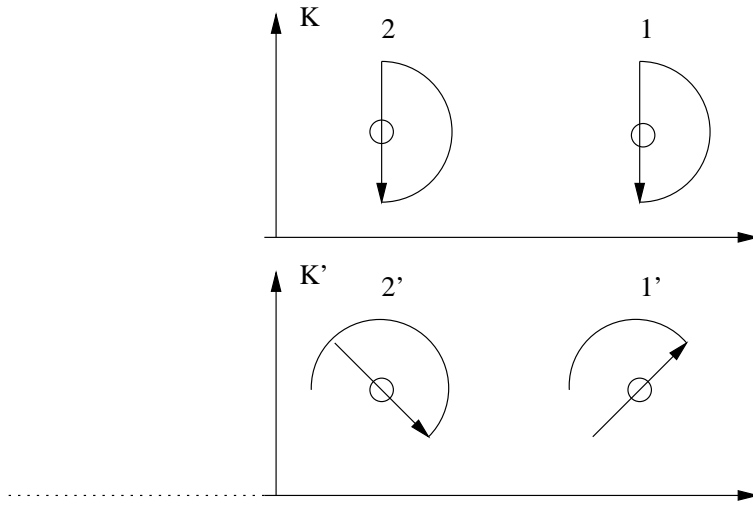

Figure 1.4: The time paradox viewed at $t = t_1$.

for any intervals we have

$$\Delta t_1 = \Delta t_2, \quad \Delta t'_1 = \Delta t'_2 \quad (1.1)$$

However, according to the Lorentz transformations formulas, from the point of view of observers in system K (near the clocks), at the time of coincidence of clocks we have (Fig. 1.4):

$$\Delta t'_1 < \Delta t_1, \quad \Delta t'_2 > \Delta t_2, \quad (1.2)$$

i. e. inequality (1.2) contradicts equality (1.1). A similar contradiction with (1.1) occurs if the inequalities are written from the point of view of observers in system K' (near the clocks). Even the values of differences of time intervals will be different. Thus, these four observers will not be able to agree among themselves, when they meet at one point and discuss the results. Where then is the objectiveness of science?

The paradox of antipodes

The erroneousness of SRT is proved very simply by the whole life of mankind on the planet Earth. Let us consider the elementary logical contradiction of SRT – the paradox of antipodes. Two antipodes situated at the equator (for example, one person in Brazil, the other one – in Indonesia) differ by the fact, that due to the Earth rotation they move relative to each other at constant speed at each time instant (Fig. 1.5). Therefore, despite the obvious symmetry of the problem, each of these persons should grow old or grow young relative to another one. Does the gravitation hinder? Let's remove it and place each of our "astronauts" into a cabin. Each person can determine the time on such a "round robin" (as well as on the Earth) from the direction to the far star, which is motionless with respect to the round robin center, and from the period of intrinsic rotation of a round robin (a whirligig). The running of time will obviously be identical for both "astronauts". The time can be synchronized by the calculation technique knowing the period of revolution (all these problems are technological, rather than principal). Let's increase the linear speed $v \rightarrow c$ for amplifying the effect (for example, in order that according to SRT formulas the difference in time be "running up" 100 years for one year). Does the centrifugal force (acceleration) hinder? Then we shall increase radius R of the round robin, so that $v^2/R \rightarrow 0$ (for example, in order that even for 100 years the overall effect from such an acceleration be many orders of magnitude lower, than the existing accuracy of its measurement). In such a case none of experiments can distinguish the motion of antipodes from rectilinear one, i.e. the system non-inertialness cannot be experimentally detected throughout the test. It is worthless for relativists to fight for the principal necessity of inertialness of the system. Recall that even in such the strict science as mathematics (in the justification of the theory of real numbers, for example), it is used the notion of the number ε given beforehand, which can be chosen as small as one likes. In case discussed for the strict mathematical transition, the ratio of a centrifugal acceleration v^2/R to the Earth's centrifugal acceleration a_c can be made less than any arbitrary value of ε at the expense of a large radius of a "round robin" R (for instance, we can choose $\varepsilon \sim 10^{-10}$ or $\varepsilon \sim 10^{-100}$, whereas all SRT

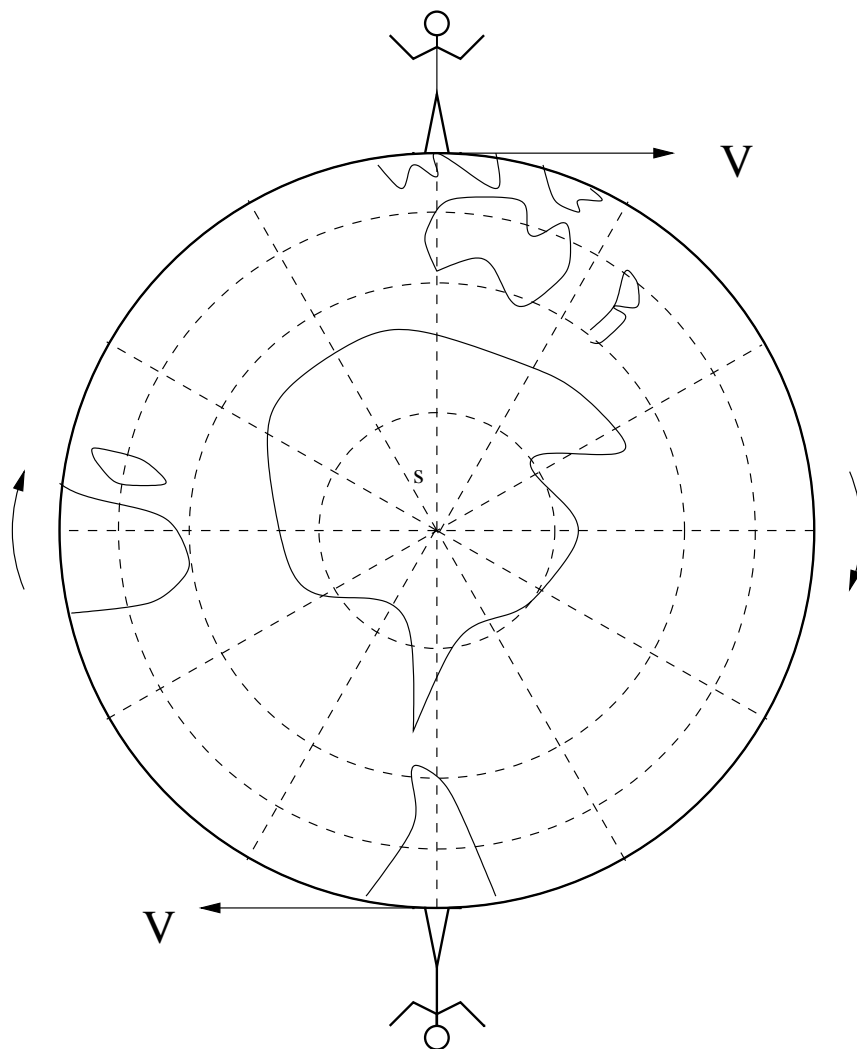

Figure 1.5: The paradox of antipodes.

experiments were made on the Earth with $\varepsilon \sim 1!$). And, further, if you trust in the relativity (either according to SRT or according to Galileo – indifferently, since we compare time durations), then you can transfer the motion of one of antipodes, in a parallel manner, closer to the other antipode and forget about the round robin model at all. Obviously, the reverse mental operation can always be performed for any two mutual opposite motions with the same speed as well. Namely, we can perform parallel transfer of one of trajectories to a great distance $R \rightarrow \infty$ and "bridge" the motions by some "round robin". So, will "the patient be alive or dead" after some years? And who is more pleasant for you – the Brazilian or Indonesian? The full symmetry of the problem and full failure of SRT! Note, generally speaking, that the unique character of time cancels the principality of the issue of its synchronizing: the watch can, for example, be worn with yourself. Some doubts on "near inertial" motions will be discussed below in Chapter 3. If some relativists will on principle try to connive (themselves and somebodies) at the possibility of such a transition to a large R , we can offer to inscribe a regular n -gon into a circle of the large R ($n \geq 3$; stationary observers are placed at all angles) and to consider pure rectilinear motions of spacecrafts with astronauts along the sides of the n -gon. Even the same loops for using the same "earth" accelerations g (to gather the equal large speeds) can be joined to the angles of the n -gon in the identical manner. Obviously, all these inertial systems of the spacecrafts are absolutely identical for a stationary observer (at the center of the circle, for example). The course of time is the same for all spacecrafts in spite of different relative motions of the spacecrafts. We can also draw the obvious symmetric scheme of "a flower type" with the possibility of the simultaneous start and finish of astronauts at the center of a circle (see Fig. 1.6).

Since we will compare the time course (but not time beginning), we can use the equality of the time course for any two mutually resting objects. Then, the model of a whirligig can be easily generalized to the case of arbitrary (in directions and values) velocities of objects. This is purely geometric trivial problem (Fig. 1.7). For example, let us have two motions, which are pictured in Fig. 1.7 with the velocity vectors $\overrightarrow{AA_1}$ and $\overrightarrow{BB_1}$. The both velocities possess the same modulo v which

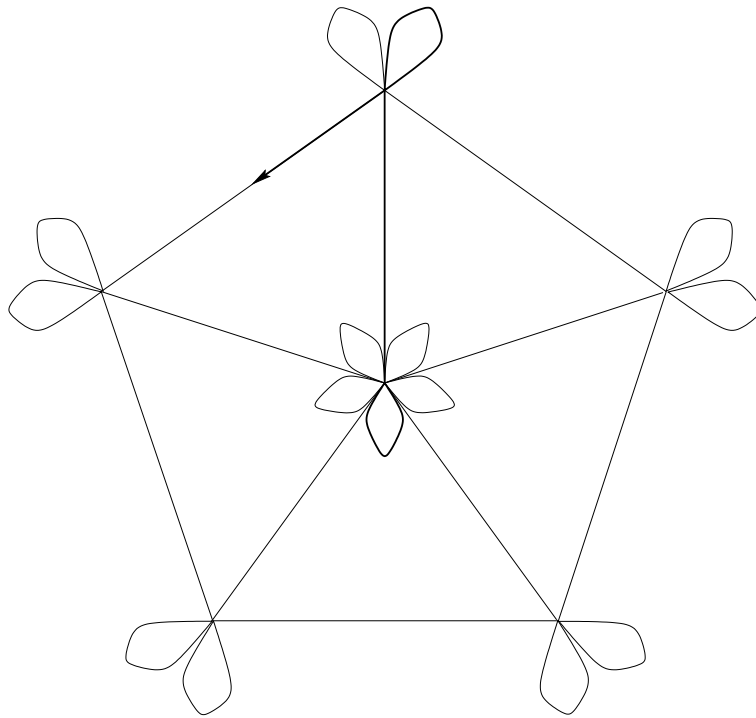

Figure 1.6: The symmetric model of "a flower".

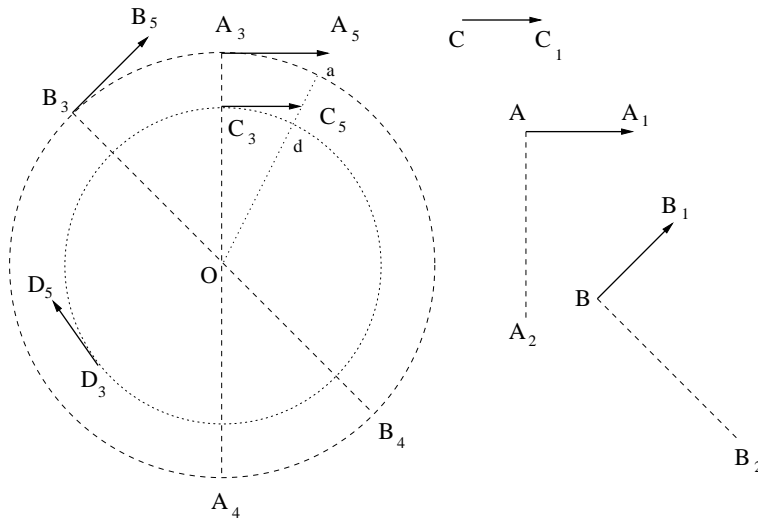

Figure 1.7: The model of a whirligig for arbitrary planar motions.

tends to the speed of light $v \rightarrow c$. Let us choose an arbitrary point O in the space. Furthermore, we draw a circle with the center at the point O and such a radius R that the centrifugal acceleration will be less than some preassigned small value ε_1 (an existing accuracy of measurement of accelerations, for example): $v^2/R < \varepsilon_1$, i.e. $R > v^2/\varepsilon_1$. We draw the straight line AA_2 which is perpendicular to the straight line AA_1 . Thereafter, we draw the line A_3A_4 passing through O and parallel to AA_2 . At a point of intersection of this line and the circle we draw the velocity vector $\overrightarrow{A_3A_5}$ which is parallel to $\overrightarrow{AA_1}$ and has the same absolute value $|\overrightarrow{AA_1}|$. Factually, we simply made a parallel translation of the motion with velocity $\overrightarrow{AA_1}$. Making the analogous procedure with the motion $\overrightarrow{BB_1}$, we obtain motion with velocity $\overrightarrow{B_3B_5}$. Now both the motions are placed at the same circle and they cannot be distinguished from inertial motions with an existing accuracy. Due to obvious symmetry of the problem, the time course will be the same for these objects. For example, the time course can be measured with periodic flashes, which occur at the center O of the circle. Now we take motion with

the velocity vector $\overrightarrow{CC_1}$. It is parallel to $\overrightarrow{AA_1}$, but possesses some other absolute value. We make a parallel translation of $\overrightarrow{CC_1}$ and obtain $\overrightarrow{C_3C_5}$ (here we take the radius $|OC_3| = R|\overrightarrow{C_3C_5}|/|\overrightarrow{A_3A_5}|$). In this case we see that two objects (with velocities $\overrightarrow{A_3A_5}$ and $\overrightarrow{C_3C_5}$) will move along concentric arcs of circles A_3a and C_3d . These objects will remain at the same distance from each other along the radii of the circles. (Some big arcs are shown here for visualization only, i.e. all angular values are increased; in fact, all arcs will be very small and indistinguishable from rectilinear segments.) It is obvious that the time course for such objects will be the same. Time can again be "measured off" by periodic flashes from the center O (number of light spheres which are passed through the circle C_3d is the same as for the circle A_3a : the light spheres do not "disappear, condense, add, or hide themselves" anywhere). We can also draw the circle through the point C_3 and at any new point draw the tangential velocity vector $\overrightarrow{D_3D_5}$ with the same absolute value $|\overrightarrow{C_3C_5}|$. Again, the objects with velocities $\overrightarrow{D_3D_5}$ and $\overrightarrow{C_3C_5}$ are placed at the same circle, and, due to the symmetry of the problem, the time course will be the same. Thus, on the example of motions with velocities $\overrightarrow{A_3A_5}$ and $\overrightarrow{D_3D_5}$ (or $\overrightarrow{B_3B_5}$ and $\overrightarrow{C_3C_5}$) we proved that the time course is independent on both the absolute value and the direction of the velocity of objects, but it is the same. Passage to the three-dimensional case is trivial. At the first, we will transfer the beginning of one velocity vector to the beginning of the second velocity vector. Thereafter, we can draw a plane through these intersecting straight lines. In this plane we can carry out all previously described constructions. Thus, the time course is independent on any motions of inertial systems.

The universal absolute time

The notion of time is broader, than the dimensional factor in transformation laws, and bears much greater relation to the local irreversibility of processes. First, a single-valued "binding" of time to the motion of a body does not take into account internal processes, which can be anisotropic, pass at various "rates" and characterize the local irreversibility (each such rate is in different manner added geometrically with the velocity of a body as a whole). Second, the binding of time

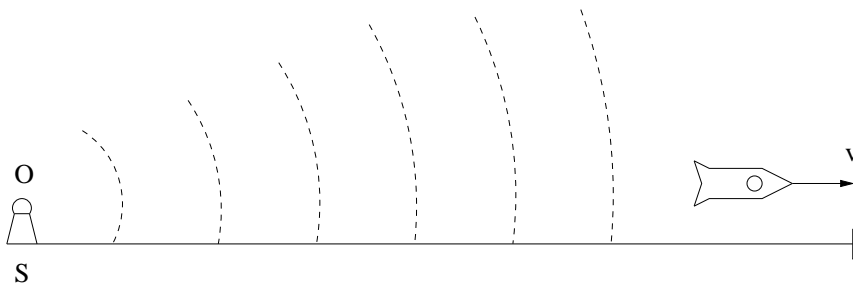

Figure 1.8: The interchange of signals of intrinsic time.

only to the velocity of transmission of electromagnetic interactions does not take into account other possible interactions (which can propagate in vacuum) and actually implies electromagnetic nature of all phenomena (the absolutisation of electromagnetic interactions). Later we shall consider, how the universal absolute time can be introduced.

When we introduce the notion of intrinsic time (actually, subjective time), the following methodological point seems important: We should not calculate intrinsic time of an alien object according to our own rules, but rather "ask" this object itself. Consider the following experiment (Fig. 1.8): Let an observer be situated in the motionless system S at point O , where a beacon is installed. The beacon flashes each second (as a result, the number of flashes N equals the number of seconds passed at point O). Let an astronaut (in moving system S') be launched from point O . Then, when moving away from point O the astronaut will perceive flashes more rarely (at lower frequency), than before launching (in fact, beacon's "time slowing" takes place). But upon approaching to the beacon the astronaut will see the opposite, flashes will occur more frequently than before launching (now we have beacon's "time speed-up"). For $v < c$ it is obvious that the astronaut can neither outstrip any flashes, nor go around any of flashes (light spheres). So regardless of his motion schedule and trajectory, upon returning to point O the astronaut will perceive equally N flashes total, i.e. all flashes, which have been emitted by a beacon. Therefore, each of these two observes

will confirm that N seconds have passed at the beacon.

If the astronaut on board the spacecraft will also have a beacon and will signal about the number of seconds passed on his watch, then no disagreements will arise concerning astronaut's time as well. The situation appears to be fully symmetrical (for the twins paradox, for example). When meeting at the same point, all light spheres will intersect opposite observers (their quantity can neither increase, no decrease). This number is equal to N - the number of seconds passed for both observers.

Consider now the problem of establishing the universal absolute time. (Of course, if we measure the time by beatings of our own heart, it will be subjective and will depend on the internal and external conditions). The attempt to introduce individual "electromagnetic time" and to absolutize it – this is a return to the past. However, even at that time the people could synchronize time, despite miserable data transmission rate (by pigeon-post, for example), because they used a remote source of signals (the Sun or stars). Let us imagine the following mental experiment (Fig. 1.9). The remote source S , which lies on a middle perpendicular to segment AB , sends signals periodically (with period T). At the time of signal arrival to point O , two recording devices (1 and 2) begin to move mirror-symmetrically (at velocities \mathbf{v} and $-\mathbf{v}$), while reflecting from A and B , with period of $2T$. Velocity v can be arbitrary (we can choose the appropriate distance $|AB|$). In spite of the fact, that at each time instant the devices are moving relative to each other at speed $2v$ (except the reflection points), the signals will be received at the same time, namely, at the time of passing by point O (observer 3 can be placed at this point). The time, determined in such a manner, will be universal (at point O), i.e. the same for all three observers. In order to make the following step, we note that for deriving the transformation formulas in the SRT, it is sufficient to consider the relative motion along a single straight line (since the systems are inertial). By choosing the large distance $|SO|$ we may assure that the time difference between signal arrival to point O and to points A and B be smaller than any pre-specified value. As a result, to the given accuracy the time will be the same for the whole chosen segment AB regardless of the velocities of motion of observers 1 and 2. Thus, the infinitely remote source of signals, situated

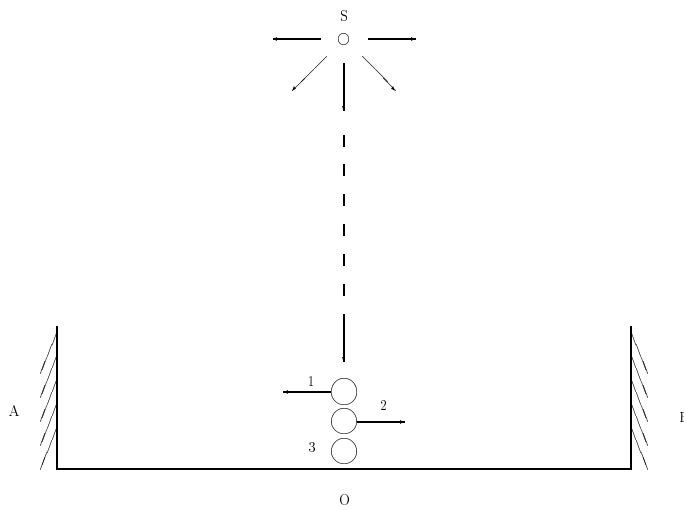

Figure 1.9: An infinitely remote source for establishing unified absolute time.

perpendicular to the direction of relative motion of systems, can serve as a watch counting the universal absolute time (which is the same regardless of the inertial system of reference). The question on the change in the observed direction of signal arrival will be presented below lest a temptation are going to arise in "far-fetched" use of the aberration allegedly demonstrating the change in the wave front direction.

Additional remarks

The next methodological note is as follows: If the Einstein method is used for synchronization, the notion of time becomes limited. First, only one of two independent variables - spatial coordinates or time - remains independent, whereas the other is associated with the state of motion (subjectivism) and properties of light speed (but why is it not associated, for example, with the speed of sound or with the velocity of Earth, etc.?). Second, since the independent determination of spatial coordinates and time is required for determination of velocity, light speed itself becomes

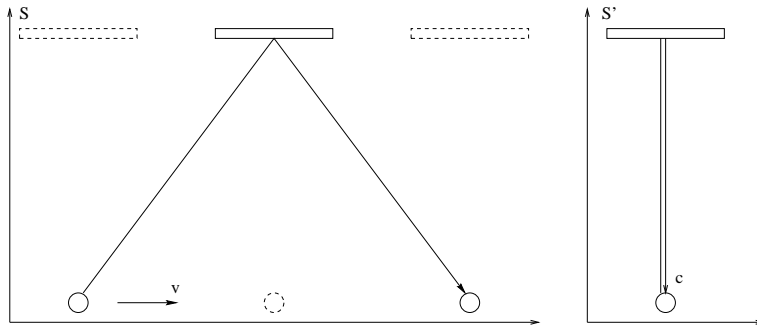

Figure 1.10: The light clock.

indeterminate quantity (immeasurable, postulated).

As relativists like to potter with idle inventions! One of such the "Great" idle inventions of the relativity theory is a light clock (for 100 years anybody did not try to construct a pre-production model at all and will never try to make it!). And it is not because that it is impossible to create ideally flat, ideally parallel, ideally reflecting mirrors. That is why that we cannot observe "TICK-TOCK" sideways as it is described by the SRT. Such a clock "works" to first "TICK" and ceases to be "identical", as a photon at the moment of "TICK" registration should finally be reacted. Nevertheless, we will return "to ours relativists", which often use a "light clock" for demonstrating the time slowing effect [35] (Fig. 1.10). However, in exactly the same manner we can also consider a periodically reflecting particle (or a sound wave) at speed $u \ll c$ and obtain the arbitrary time slow-down $\tau_0/\sqrt{1-v^2/u^2}$. It is known, that the orthogonal velocity components can be described independently: the horizontal motion at velocity \mathbf{v} relative to an instrument will in no way influence the vertical oscillations of a particle moving at former velocity \mathbf{u} . The question on experimental verifications of the postulate of light speed constancy will be analyzed in Chapter 3.

The time slowdown in SRT is nothing else, but the apparent effect. Remind that for a sound the duration of a hooting of trumpet Δt also depends on the velocity of a receiver relative to a source (a trumpet),

but nobody makes the conclusions on time slowdown from this fact. The fact is that observer's "decision" to move at any velocity is in no way bound causally with sound emitting processes (as well as with other processes in a trumpet). Let a singer be continuously singing a song in the resting atmosphere, and his twin brother be moving away from a singer at about the speed of sound v_s : $\alpha_1 \equiv v/v_s \approx 1$, and then he will move toward a singer (with the same ratio α_1). Though the song will be distorted, nobody had yet recorded more rapid aging of a singer. Let now we modulate with the same song the light in pursuit of the twin brother, who departed on a rocket at about the speed of light, but with the same numerical value $\alpha_2 \equiv v/c = \alpha_1 \approx 1$. Now the twin brother will listen the same distorted song. Why the situation must change in this case, and the "home seating" brother must grow old? And, if some living organism will be characterized by some certain radiation frequency, that distinguishes him from the dead organism, then, really, because of your motion (because of the Doppler effect) you will first certify the death of an organism, and then his resurrection? Or it is necessary to postulate the change of objective characteristics of an object, which is not bound with you causally?

Now we make some comments concerning Einstein's time synchronization method. The transitivity of time synchronization by Einstein's method takes place for the trivial case of three mutually resting points. If, however, the points (not lying on the same straight line) belong to the systems moving relative to each other in different (not parallel) directions, then the synchronization procedure can become uncertain: for what time instant the watch can be considered to be synchronized? For the beginning of the procedure, for its termination or for an intermediate instant? Even for the points lying on the same straight line Einstein's method rests upon a completely unverified (experimentally) concept of equality of the speed of light in one and in a directly opposite direction. Actually, the synchronization occurs to be either a half-done calculation procedure, or a multi-iterative process, because the synchronization is performed for two selected points only. These deficiencies are absent in the method of synchronization with a remote source disposed at a middle perpendicular [48]. It allows one to synchronize the time experimentally

(rather than computationally), without attracting additional hypotheses, to a prescribed accuracy throughout the given segment (even on a flat section) at once.

Now we proceed to the time measurement units. Certainly, for a separate phenomenon within the framework of some mathematical model any customary quantity can be described in various measurement units and in various scales (both uniform and non-uniform, for example, in the logarithmic scale). This is basically determined both by the convenience of description for the given model, and, as in the case of generalization, by the possibility of using the same quantities for the other physical phenomena and mathematical models (the matching of various fields of physics). However, Taylor and Wheeler's [33] sarcasm concerning the "sacred units" is completely inadequate. Certainly, we can introduce the factor for converting the time into meters. But this factor is not obliged to be the speed of light: for example, it can be the velocity of a pedestrian. Both aforementioned velocities have, quite equally, no relation to acoustic, thermal phenomena, to hydrodynamics and to many other fields of physics. It is possible to express, generally, all quantities (such as mass, charge, etc.) in meters. However, all these "various meters":

- 1) can not be summed up,
- 2) are not interchangeable,
- 3) very rarely appear in some joint combinations and
- 4) the same combination is unsuitable for various phenomena.

(For example, the interval has relation only to the law of light propagation in vacuum.) All quantities can be made pure numbers (and we must separately look after all these physical values). But in any case physics will not become mathematics. Physics does not study all illusory combinatorial "worlds" of equations, but only that rather small amount of them, which is realized in the nature (the basic problems of physics are: what interrelations are realized in the nature, why and what are the consequences of this).

1.3 Relativity of simultaneity

Now, after criticism of the fundamental concept of time for SRT, we continue the analysis of the logical basis of this theory and consider the subsidiary notion of the "relativity of simultaneity". Recall the mental experiment from SRT: a train $A'B'$ passes along a railroad at speed v . Suddenly, lightning strikes the railroad bed (C) just opposite to the train center C' (at the moment of coincidence $C = C'$). Then, in the coordinate system centered on the moving train, the flashes will simultaneously arrive at points A' and B' , whereas for a motionless observer the flashes will simultaneously arrive at points A and B (with the middle at point C); but up to this instant, points C and C' (the middles of segments) will move to some distance from each other. But a similar situation is possible in classical physics as well, if we want to transmit information from points A', B', A, B to the new single point D (or, conversely, to these points A', B', A, B from D) at some finite speed v_1 (in this case SRT and light speed constancy will be without any relevance).

We can suggest the following mechanical model (Fig. 1.11): Let four material points (without the force of gravity) fall at speed v_1 in pairs over point C (close to the railroad bed) and over the train's centre C' which will arrive to the point C'' near to point C at the moment of intercept of falling points. Let ideal reflectors (isosceles triangles with angle at a base $\alpha = \pi/4$) be installed at point C and at train's center. Then two particles, reflected over the railroad bed (at point C), will fly to different sides at speed v_1 , and simultaneously reach points A and B (in the classics $|AB| = |A'B'|$). This process will take time $t = L/v_1$, where $2L$ is the length of the train. Two other particles, reflected over the train's center C' , will move after reflection (relative to the railroad) at speeds $v' = v_1 + (v/\tan \alpha) = v_1 + v$ (forwards) and $v'' = v_1 - v$ (backwards). During the same time t the first of these particles will traverse the path (forwards) $L' = v_1 t + vt$, and, since the train traverses the path vt , the particle will reach point A' . Similarly, for the second particle $L'' = v_1 t - vt$; hence, it reaches point B' . Thus, the event – the falling of points to the reflectors – will be

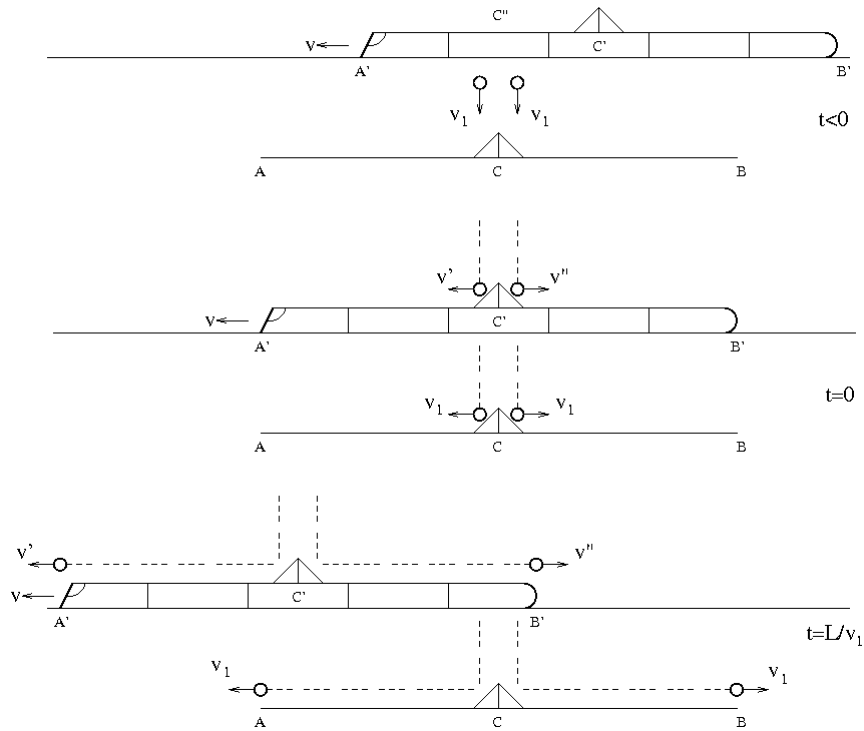

Figure 1.11: The mechanical model for the relativity of simultaneity.

recorded at all four points simultaneously: both at points A and B (over the railroad bed), and at points A' and B' (over the train). It was the case when the points, falling over train, participated in its inertial movement. If the second pair of points falls (over the railroad bed) just over motionless point C'' the triangular reflector at the train (only at it) should have the following corners at the basis: against the train movement - $\alpha_3 = 0.5 \arctan(v_1/v)$, and in the direction of the train movement - $\alpha_4 = \pi/2 - \alpha_3$. In this case particles will fly in parallel to the train and will reach its ends simultaneously (but not simultaneously with the second pair of particles!). If we want, that all four material points "have flown by" simultaneously corresponding points A', B', A, B , corners at the reflector basis (at the train) should be still reduced by corner $\arccos \frac{v_1}{\sqrt{v^2+v_1^2}}$ (if to establish a flat waveguide, the pair of particles over the train will "not rise" too highly, and will move in parallel to the train). Apparently, mechanical analogues are possible for the most different situations.

One can say that these two events are quite different. But in the case of the light flash, we have two different events as well. Indeed, let the light flash occur at the time the centers O and O' of systems S and S' moving relative to each other at \mathbf{v} coincide. At some time instant $t > 0$, the light front will be on the sphere Σ relative to center O in system S and on the sphere Σ' with center O' in system S' (which seems to be impossible). However, there is nothing surprising (i.e. contradicting classical physics) in this situation, because the observers in system S and S' will record the same light to have different frequencies ω and ω' by virtue of the Doppler effect. But in this case these are two identifiably different events: the observers can always compare the results of measurements ω and ω' upon meeting!

Consider now in detail the mental experiment allegedly "demonstrating" the relativity of simultaneity: at the origins O and O' of reference systems S and S' that move relative to each other, a light flash occurs at the time of their coincidence. According to SRT, during the time $\Delta t = t_1 - t_{01}$ on the clock of system S , the light will pass the distance $c(t_1 - t_{01})$ from center O . For the same time $\Delta t = t_2 - t_{02}$ on the clock of system S' , the same light will pass the distance $c(t_2 - t_{02})$ from center

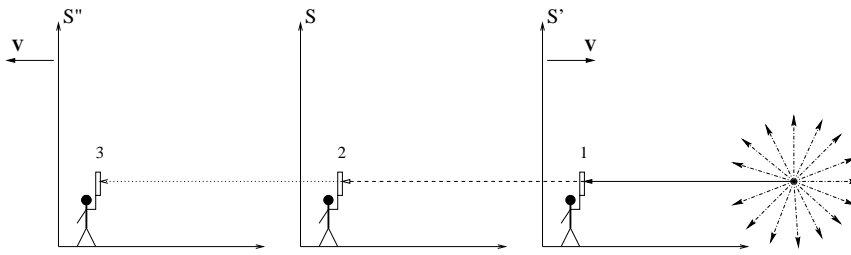

Figure 1.12: The contradictions of the relativity of simultaneity.

O' . The time difference Δt is not influenced by any adjustment of initial times, whether accomplished before the experiment, or after it by any method. For example, an infinitely remote periodic source located perpendicular to the direction of motion can be used. It is possible to agree in advance about the flashes, recorded on the clock of system S (for example, periodically each million years), and "to organize" system S' for one instant before the flash occurs, selected in advance (the paradox of non-locality, associated with this, will be considered in Section 1.7).

Recall that the basic positive idea of SRT consisted in the finiteness of the speed of interactions. The same idea is expressed by a short-range interaction theory, which reflects the field approach (via the Maxwell equations); namely: a light wavefront moving from a source to a receiver passes sequentially through all intermediate points of space. It is just this property that comes in a conflict with the notion of relativity of simultaneity (Fig. 1.12). To prove it, we use two statements from the SRT about observers moving each relative other: 1) one and the same light flash will reach two observers simultaneously despite the fact that the observers will spatially be separated by some distance during the light spreading; 2) kinematic formulas of the SRT (from textbooks) contain squares of velocities only. For example, let the first observer in system S be moving towards the flash source at slow speed $v \sim 10^4$ m/s. Since the distance to the flash point is large (say a million light years), then for one million years both observers will separate from each other to a large distance – about $2 \cdot 10^{17}$ m. According to SRT formulas, the

times of arrival of a signal will be the same for both observers. At what point of space did the first observer "pass" the light wavefront for the second observer? But what if he had held a mirror for the whole million years, and removed it one second before receiving a signal? In the second observer's opinion, the signal was reflected by the first observer somewhere ahead. But in this case what thing was reflected by the first observer, if none of his instruments did still respond to a flash? Similarly, a third observer can go away from the second one at the same velocity, but directed from the source. If the second observer held a mirror for a million of years except one second, would the third one see the light?

On the one hand, since the SRT formulas include the square of velocity only, the second observer will consider the time of signal reception by the first and third observers to be the same. It can be agreed that when observers receive the signal under investigation, each of them will send his signal without delay. If second observer's calculations are correct, then since the problem is symmetric, he must receive the signals from the first and third observers simultaneously. On the other hand, according to Maxwell equations, the light propagates continuously, and the second observer will receive a signal from the first one simultaneously with the event, when he himself will see the signal under investigation. In second observer's opinion, at this time the light has still not reached the third observer. Thus, the second observer comes to a contradiction with himself: the first calculations by SRT formulas contradict the second calculations by the Maxwell equations. Obviously, the observers will see the flash sequentially, rather than simultaneously, since the spatial path of light is sequential: the source, the first observer, then the second and, at last, the third observer.

We additionally note that even within the SRT framework the concept of the relativity of simultaneity is highly restricted: it is applicable to two separated events only (there are no intersecting original causes, no intersecting aftereffects, and, generally, we are not interested in any additional facts). Indeed, even for these selected points the light cones have intersections, to say nothing of all other points in space and time. In fact, we have continuous chains of causally bound (and unbound) events

occurring with multiple intersections through every point of space and time (not every reason, of course, results in a consequence at a speed of light). And all this real (different in scale!) time grid is interdependent for the whole space. Therefore, in the general case we can not change (by choosing the frame of reference) the order of succession of even causally unbound events (in any case, this changing would be reflected somewhere).

1.4 The Lorentz transformations

Let us make some comments concerning the Lorentz transformations. One of the approaches to deriving these transformations uses the light sphere, which is visible in different manner from two moving systems (the flash took place at the time of coincidence of the centers of systems). Or, what is actually the same, this approach uses the concept of interval (displaying the same sphere). The solution of the system of equations

$$x^2 + y^2 + z^2 = c^2 t^2 \quad (1.3)$$

$$x_1^2 + y_1^2 + z_1^2 = c^2 t_1^2 \quad (1.4)$$

represents simply the intersection of two surfaces and nothing more (Fig. 1.13). Under the condition of $y = y_1, z = z_1$ these figures will be the surfaces of a sphere and of an ellipsoid of rotation with the distance vt between the centers of the figures. However, this is actually the other problem – the problem on two flashes: it is possible to find the centers of the given flashes for any time instant, i.e. to solve the reverse problem.

In the other approach to deriving the Lorentz transformations such a transformation is sought, which transfers equation (1.3) into equation (1.4). Obviously, for four variables such a transformation is not unique. First, the separate equating $y = y_1, z = z_1$ represents only one of possible hypotheses, as well as the requirement of linearity, mutual uniqueness, reversibility, etc. (An additional possibility of ω -parametrization is described in Appendixes.) Second, any transformation of light surfaces does not determinate at all the transformation of volumes (in which the non-electromagnetic physical processes may occur). For example, the

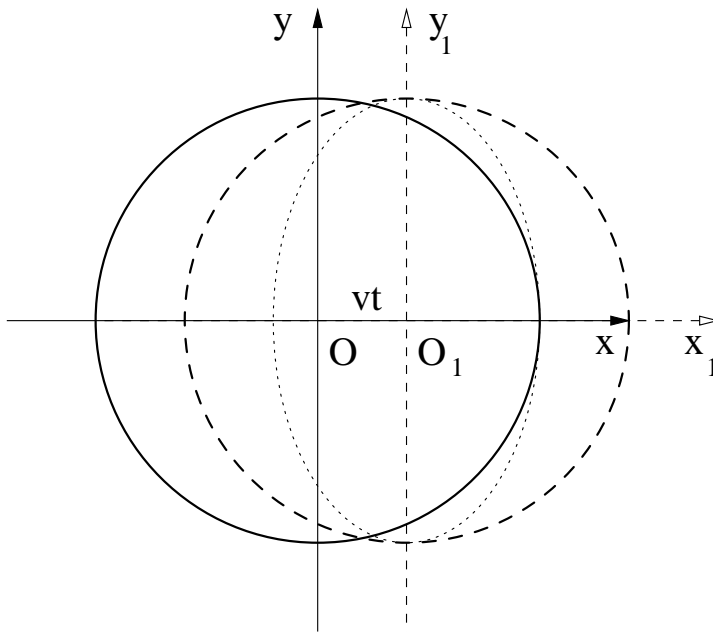

Figure 1.13: The problem of two flashes.

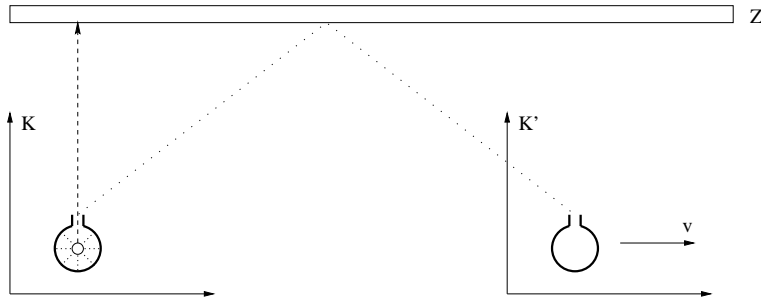

Figure 1.14: The contradiction of a continuum of light spheres.

speed of sound does not depend on the motion of a source as well, but no global conclusions follow from this fact.

In any case, the Lorentz transformations in SRT physically describe two objects, rather than a single one. Otherwise it is easy to see a contradiction (Fig. 1.14). Let a light flash occur. Let us separate, instead of a light sphere, one beam perpendicular to the mutual motion of systems K and K' (and let the remaining light energy be absorbed inside the system). Let us block the path of a beam by installing the long mirror Z at a great distance from sphere's center (along the line parallel to the line of mutual motion of systems). Then the observer situated at the center of system K will record the reflected signal after some time. Let the signal be completely absorbed. However, the other observer moving together with system K' will catch a signal, also after some time, at the other point of space (let the signal be absorbed too). If we take a "continuum" of systems with different mutual velocities v , then the signal can be caught at any point of the straight line. Then where has the additional energy appeared from? May be this is SRT's perpetuum mobile of the first kind?

Note that if some mathematical equation is invariant relative the transformations of Lorentz type with some constant c' , it means only that among particular solutions of this equation there exist "surfaces" of wave type which can propagate with the velocity c' . However, in this case even the given equation can have other particular solutions with other

own invariant transformations, to say nothing of other mathematical equations, i.e. no overall mathematical conclusions do not follow from the fact of invariance. Only relativists try "to blow the big soap-bubble" from the particular phenomenon.

1.5 Paradoxes of lengths shortening

Now we proceed to spatial concepts. Since all SRT conclusions follow from the invariance of an interval, then from the above-proved equality $dt = dt'$ and from (if we trust in it) relativistic equality $c = \text{constant}$ we obtain $dr = dr'$, and so it is not necessary to consider the concept of space further at all. However, to form the most complete viewpoint we shall, whenever possible, consider in this book each disputable point irrespective of remaining ones.

The contraction of lengths in SRT can not reflect a real physical effect, because various observers can see the same object in different manner (the non-objectiveness). Besides, the transition from one frame of reference to another can proceed rather rapidly, and this transition would be reflected in the whole (even infinite) Universe at once, which obviously contradicts the SRT-defended principle of finite rate of transmission of interactions and, hence the principle of causality. Therefore, a similar contraction is nothing more, than supplementary mathematical manipulations with quantities, some of which have no physical sense. The real physical mechanism can not be attracted to explaining the length contraction process in SRT, since the contraction should take place immediately at any velocity $v \neq 0$. In reality, however, it is clear, that in the acceleration process the object can not only be pushed, but also pulled behind yourself, and in such a case, instead of contraction, we would have stretching (experimentally detectable, by the way!). At slow constant acceleration this constant state of stretching would remain the same throughout the motion. Thus, the contraction will never begin.

Since SRT was created just as "a game with Einstein's light beams in absolutely empty space", any pseudo-paradoxes with use of an electromagnetic field (currents with contacts, lasers, light beams with mirrors etc.) can be easily resolved, and relativists slyly present them as allegedly

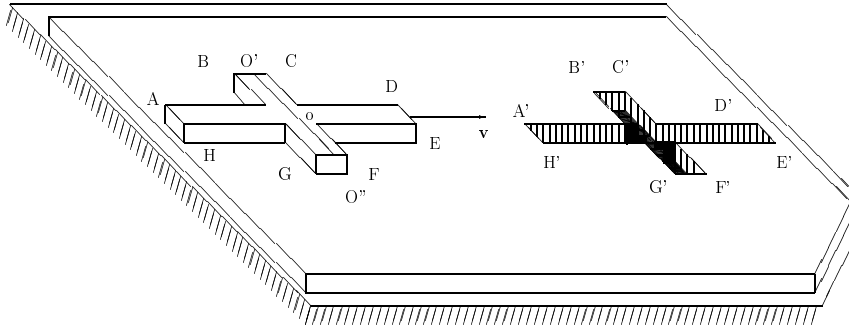

Figure 1.15: The paradox of a cross.

lack of contradictions in SRT. For this purpose they simply make substitution and instead of real paradoxes "discuss" pseudo-paradoxes such invented or "added" by them with any electric contacts, allegedly effective explosions etc. So be attentive to such forgery! And now we proceed to some particular paradoxes of lengths shortening.

The paradox of a cross

Let a thin plate of large size lie on a solid plane. A small cross is cut out of the plate (Fig. 1.15). Let the length of this cross be much larger than its cross-beam width $|AD| \gg |BC|$. Let the cross slide horizontally over the plate, so that in classical physics it would just occupy its niche and fall into it under the effect of gravity. We choose the relative velocity of motion \mathbf{v} such that, in accord with relativistic formulas, the length to be shortened two-fold (or even more). Note that the center of gravity of the cross (point o) lies also at the cross-beam center. Hence, vertical motions of the cross (falling down, or turning over its front end) is possible only if: 1) center o and the whole central line of a cross-beam ($O'O''$) are over empty space, and 2) none of points C, D, E, F has support. From the viewpoint of an observer on the cross, he will slide over a two-fold shortened niche, since either the cross-beam and one of ends, or both ends of the cross lean against the plate. The

known trick with turning of a rod fails in this case (this problem will be considered below). However, from the viewpoint of an observer on the plate, the cross (which became two-fold shorter) will fall down into the niche. Thus, we have two different events: does the downfall of the cross (a push against the plane) take place or not? and what will happen to the observer, who falls down into the niche (will he be crushed or not)? If he escapes, must he promptly begin to move with \mathbf{v} (as well as the cross), or is he bound to be near the end $A'H'$ (or $D'E'$), because the cross became two-fold shorter? If someone very much wants to re-formulate this paradox as a paradox of existence, that (remembering the remark of the previous paragraph about relativistic "electromagnetic forgeries") a detonator should be under the plate, and a push-button contact could be closed under the plate in the center crosswise niche only with the center of gravity of the cross at its possible falling.

Additional paradoxes and "strangenesses"

We can describe another paradox. Let the circle be cut off the plate and begin rotating around its center. Due to length shortening, an observer on the plate should see a clear space and the objects behind the plate. At the same time, the observer of the circle should see, how the plate runs over the circle. The noninertial character of the system does not matter, since the acceleration v^2/R for $v \rightarrow c$ can be smaller than any prescribed value due to large R . The geometry of a circle will be considered in detail in Chapter 2 devoted to the general relativity theory. Similar contradictions demonstrate logical inconsistency of the habitual relativity theory (predictability – the foundation of science – is lost in this theory).

Note one more "strange thing" (the paradox of distances). Since the shortening of lengths of objects is associated with properties of space itself, the distance to objects must also be shortened (regardless of whether we approach the object or move away from it!). Therefore, if the velocity of a rocket is high enough ($v \rightarrow c$), we can not only look at distant stars, but also "touch" them, because in our own reference system our own dimensions do not change. Besides, when flying away from the Earth for a long time (the value of acceleration is not limited by SRT), we will

eventually be at the distance of just "one meter" from it. At which time instant will the observer at this distance in "one meter" see the reverse motion of the spacecraft (contrary to the action of rocket engines)?

The possibility of introducing the absolute time refutes logically paradoxical SRT conclusions about time slowing, relativity of simultaneity, and, besides, about distances shortening, because now the method of simultaneous measurement of distances does not depend on the motion of objects. Let an thin object (a contour portrait cut out a paper, for example) slide with an arbitrary velocity over the photographic film, for example. If a momentary lighting is made by the infinitely remote flashlight, the length of the shadow photograph as well as the length of the object will be the same. We can use an usual distant source (on a middle perpendicular to a plane) in the following case: the flash front will reach the plane at a moment of flight the middle perpendicular by the object (see p.1.7 below - about a "seeming turn" of the wave front).

The distances to the objects are also contradictory for other reason. Even in motion at pedestrian speed, the distance to far galaxies must be noticeably contracted. However, the direction of such a contraction is indeterminate. If someone (moving) casts a look at galaxies, will he fly away beyond Earth limits? Or, on the contrary, will he (moving) attract another galaxy by his glance? Any result is real mysticism!

A strange thing, related to length contraction in SRT, occurs with a belt-driven transmission (Fig. 1.16). From the viewpoint of the observers, on each of two free halves of a belt the cylindrical shafts should be transformed into ellipsoidal drums and then be turned as follows. The points of semimajor axes of ellipses, which are opposite to each observer, should approach each other (we obtain the non-objective description again). In SRT lengths of upper and lower half of the belt is found to be biased, for instance. The contradiction takes place from the viewpoint of the third observer situated on a fixed stand. On one hand, the shafts should approach each other. On the other hand, however, the fixed bearing, which retains the spindles of shafts, should remain at the same place. But what is the thing, on which shafts' spindles will be kept? So, whether the real space is contracted or not? What must be artificially postulated for urgent "saving" SRT: various inserted spaces

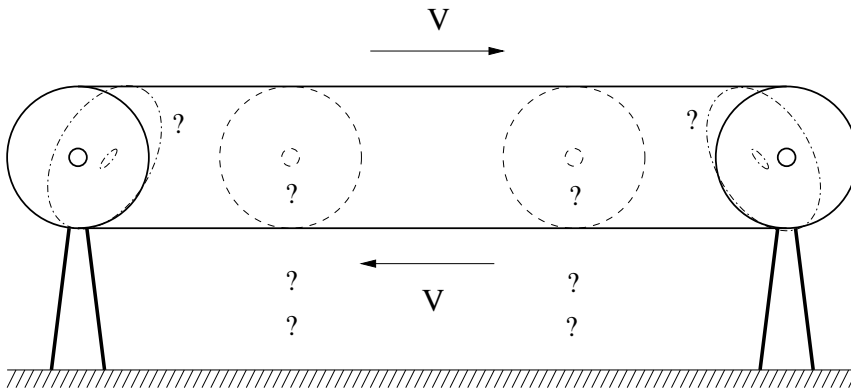

Figure 1.16: Illusions of belt-driven transmission.

for shafts and bearing and the change of objective characteristics (the extensivity) of a belt?

The attempt to hide from explaining the length contraction mechanisms behind the common phrase of type: "this is a kinematic effect of space itself" is unsuccessful because of uncertainty of the "contraction direction" (toward which point of space?). Really, the point of reference (the observer) can be placed at any point of the infinite space – inside, to the left or to the right side from an object; and then the object as a whole will not only contract, but also move toward the given arbitrary point. This fact immediately proves the inconsistency or unreality of the given effect. It is not clear, toward which end the segment will contract, if the moving system with two (moving) observers at segment's ends was made impulsively. The situation can not also be saved by the phrase about the "mutual uniqueness of Lorentz's transformations". This condition is quite insufficient. The mutual uniqueness of some mathematical transformation allows one to use it for convenience of calculations, but this does not imply in any way, that any mutually unique mathematical transformation has physical sense. Also strange is the process of stopping of contracted bodies. The questions arise: toward what side do their dimensions restore? Where has the contraction



Figure 1.17: Slipping inside the sandwich.

of space gone, if various remote observers could observe this body?

Problems on thin rods

Let us consider in detail the problem on 1-meter-long thin rod slipping over a thin plane having a 1-meter-wide hole [106] (see [33], exercise 54). It is rather strange, that any object should contract, turn or "deflect and slip down" in exactly the same manner, as it is required for SRT to be "saved" from contradictions at any cost (however, such an approach is an indirect recognition of principal undetectability of kinematic effects of SRT). What relation to the given problem can have a real rigidity of a rod? None! Let the rod be slipping between two planes (a sandwich), so that only a part of a rod freely hanging over a hole be participating in deflection (Fig. 1.17). If the 1-meter rod can "deflect and slip down" into the hole shortened down to 10 cm (or 10 times), then in exactly the same manner the 1-kilometer-long rod (which should not fall-through neither in the classical physics, nor even in SRT in the plane's frame of reference) could also "deflect and slip down" into the hole. The declarative mentioning of the velocity of acoustic oscillations (for the balance establishment mechanism) is the "plausible" hiding of the truth. Let there are two identical real horizontal rods at the same height (Fig. 1.18). The first rod slips over the desktop (at the pressed position) and begins to hang downwards with one tip at instant $t = 0$. At this instant ($t = 0$) the second rod begins to fall freely downwards. Obviously, for any time instant $t > 0$ the second rod will be displaced downwards (or fall) to a much greater distance as compared to the deflection of first rod's tip (and, actually, SRT tries to replace the real body by a body with zero rigidity). For analyzed problems the relativistic velocities can only decrease the rigidity effect as compared to the case of low velocities, thus ever more approaching a real body to the model of absolutely solid

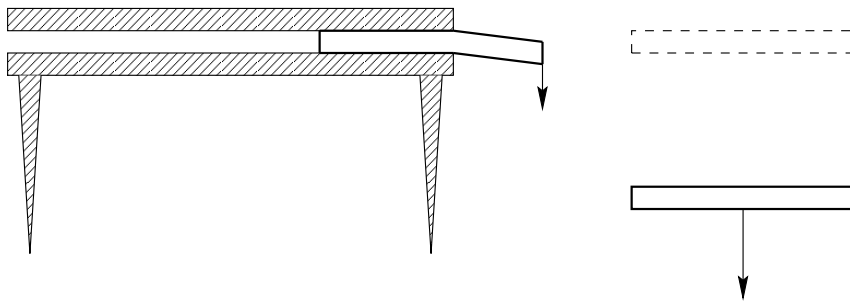

Figure 1.18: Rigidity and the deflection of a rod.

body. Indeed, the rod is deflected in the direction perpendicular to the relativistic motion. Therefore, this problem is similar to the problem on massive body slipping over thin ice on a river: at low velocities the body can fall through (breaching of ice due to its deflection), and at rather high velocities the body can slip over ice without falling through (the ice deflection is small). The rate of acoustic oscillations is much lower, than the speed of light. Therefore, the molecules manage to efficiently participate in rod's deflection for shorter time as compared to the static case; that is, the deflection will be smaller. Let us take the width of the lower plane to be one molecule larger, than the displacement of rod's deflection (for some particular preselected material). At the second end of a hole we shall make a very shallow taper of the plane (Fig. 1.17), so that the given rod could continue slipping over the plane (smoothly). Obviously if the rod does not slip down into the real 10-cm hole at non-relativistic speeds, the more so the rod could not slip down into the hole allegedly shortened down to 10 cm at relativistic speeds. What will happen to the 20-cm or 1-km rod for all former characteristics of the plane? And if we, for the former geometrical characteristics of the experiment, will take various materials for a rod (from zero to maximum rigidity)? Obviously, with precise adjustment of all parameters for one case it is impossible to eliminate the contradiction for all remaining cases. For "saving" SRT it is necessary either to postulate, that the rigidity in the experiment ceases to be an objective property of materials (but ad

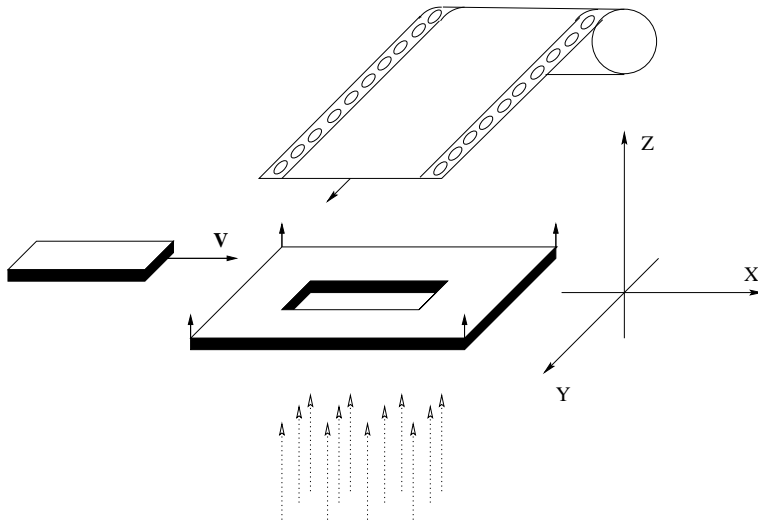

Figure 1.19: "Turning" the rod.

hoc depends on the observer, geometric size and velocity), or to postulate, that the second end of a hole jumps up ad hoc in the "necessary manner". Does the goal justify similar means?

A similar problem on passage of a rod, flying along axis X (now the rod is no longer pressed against the plane) through the niche of the same size (slowly running over the rod along axis Z) has even entered the popular literature [6]. The relativists "eliminate" the contradiction in evidences of the observers by turning the rod in space (then the rod will pass through the niche in any case, as in the classical physics). However, the turning does not eliminate the Lorentzian contraction. Let us illuminate the niche from below along axis Z by the parallel beam of rays (for example, from a remote source). Let now rapidly pass the photographic film high above the niche parallel to the plate, but perpendicular to the mutual motion of a rod and a plane, that is, along axis Y (Fig. 1.19). Then, in spite of rod passage, the result in SRT will all the same will be different for different observers. In the classical physics we would obtain the full darkening of the photographic film at

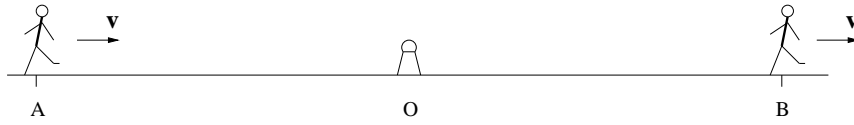

Figure 1.20: The paradox of two pedestrians.

the time of rod passage through the niche (this would be marked by a completely dark section on a light strip). A similar full darkening would take place in SRT from the viewpoint of the observer situated on a rod (since the niche will contract and turn). However, from the viewpoint of the observer situated on a plate (and on the photographic film) the rod will contract and turn. Therefore, the full darkening will never take place. In such a case, who is right? There is the more dramatic situation with an angle of turning of the rod, since it depends on the relation of velocities. Let other small rod slide on our rod at some arbitrary velocity. Observers at the both rods will claim that the clearance between the rods is absent. However, according to the SRT, these rods must be turned at different angles for an observer at the plate. There appears the evident logical contradiction.

Some remarks on lengths shortening

We shall additionally consider now the relativistic effect of contraction of distances (the paradox of pedestrians). We shall "agree in advance" about the following mental experiment (Fig. 1.20). Let a beacon, disposed at the middle of a segment, to send a signal toward its ends. Let segment's length be one million light years. At the time of arrival of a flash two pedestrians at segment's ends begin to walk at equal velocity toward the same preselected side, along the straight line containing the given segment, and they will be walking for several seconds. The moving segment (a system of two pedestrians) should be contracted relative to the ends of a motionless segment by some hundreds kilometers. However, none of pedestrians will "fly away" for hundreds kilometers during these seconds. The moving segment could not also be torn off at the

middle, because the Lorentz transformation laws are continuous. So, where has this segment been contracted in such a case? And how this can be detected?

For "justifying" the relativistic contraction of lengths Fock [37] discusses as follows. In the motionless coordinate system the lengths (factually fixed by tips of a segment) can be measured non-simultaneously, but in the moving system they must be measured simultaneously. From the invariance of the interval

$$(x_a - x_b)^2 - c^2(t_a - t_b)^2 = (x'_a - x'_b)^2 - c^2(t'_a - t'_b)^2$$

at the choice of $t'_a = t'_b, t_a \neq t_b$ we obtain $|x_a - x_b| > |x'_a - x'_b|$. But in such a case, why we can not choose $t_a = t_b$ arbitrarily in order to obtain the objective length $|x_a - x_b|$ in a unique manner? The existence of the process of measuring the length (the tips of a segment), which is independent of time and of the concept of simultaneity for the intrinsic frame of reference, proves a full independence of time and spatial characteristics in this system. But why for the other, moving system must arise any new additional link between the coordinates and time except the kinematic concept of velocity?

Wrong is Mandelshtam's [19] judgement, that there is no "real length", and his example with the angular measure of an object. The angular measure of an object depends not only on object's size, but also on the distance to it, that is, on two parameters. Therefore, this measure can be made unique only if one parameter – the distance to an object – is fixed. Incorrect is also Mandelshtam's statement, that in any method of measuring the lengths the rods moving in different manner have different lengths. For example, possible is the procedure of measurement (direct comparison) of the rods previously turned perpendicular to the relative motion of the rods. Then the rods can be turned in arbitrary manner. They could even be slowly rotating in order to occur to be perpendicular to the motion at the time of coincidence. In such a case this method is completely independent on the relative motion even in SRT.

Some relativists believe that there is no length contraction at all – only the turning exists, for example, for a cube (i.e. they cannot unambiguously agree even between each other). The absence of real turning

of a cube (or the fact that this effect is only apparent) can easily be proved, if the cube will fly being pressed against a ceiling. Generally speaking, the distance to objects, their visible velocity and size can be determined, even with the help of the light, by several techniques which are "self-consistent" by themselves. For example, even for a single observer: from the angular size, from illumination, from the Doppler effect. But the obtaining of different values for the same physical quantity does not cancel at all the only true objective characteristics of a body and its motion (under which the instruments are calibrated).

The SRT tries to "purchase" the consistency of its determination of lengths by refusal from the objectivity of some other physical quantities. However, this trick won't "work" with respect to the time – it is irreversible. Note some strange thing: in the sense of reversibility (in transition from one inertial frame of reference to the other and back!) the linear Lorentz transformation are fully equivalent both for coordinates and for the time (they are reversible). It seems strange, then, that a difference between bodies' lengths vanishes with return at initial place (for twins, for example), but the disparity remains in the time elapsed.

1.6 The relativistic law for velocity addition

Recall that the kinematics does not study the causes of motion, but, for example, knowing the given velocities it finds the result of addition of these velocities. The issues of dynamics of particles (i.e. causes of motions) require independent consideration (see Chapter 4).

We begin with a remark concerning the relativistic law for velocity addition. For two systems participating in relative motion, the determination of their relative velocity causes no doubts (neither in classical physics nor in SRT). Let system S_2 be moving relative to system S_1 at speed v_{12} ; similarly, let system S_3 be moving relative to S_1 in the same directions at speed v_{13} . In fact, the relativistic law for velocity addition defines the relative speed of that motion in which the observer does not participate himself: The speed of motion of system S_3 relative to S_2 is

determined as

$$v_{23} = \frac{v_{13} - v_{12}}{1 - \frac{v_{13}v_{12}}{c^2}}. \quad (1.5)$$

It is precisely this form (although usually v_{13} is expressed in terms of v_{12} and v_{23}), which discloses the real essence of this law: it tells what relative speed of systems S_3 and S_2 will be recorded by the observer in S_1 , if the Einstein light-signal method is used for time synchronization and for measuring length. Actually, we have here the "law of visibility". (For the case of possible frequency dependence of light speed, this expression will change – see Appendixes).

Consider the following methodological remark. One rather strange kinematic notion from SRT is the non-commutativity of the relativistic law for velocity addition of non-collinear vectors. The non-commutativity property (and the fact, that the Lorentz transformations without rotations do not compose a group) is mentioned only briefly in some theoretical physics textbooks. By contrast, a similar property in quantum mechanics essentially changes the entire mathematical formalism and physically expresses a simultaneous immeasurability of non-commuting quantities.

It is seen from the general relativistic law of addition of velocities that

$$\mathbf{v}_3 = \frac{(\mathbf{v}_1 \mathbf{v}_2) \mathbf{v}_1 / v_1^2 + \mathbf{v}_1 + \sqrt{1 - v_1^2/c^2} (\mathbf{v}_2 - (\mathbf{v}_1 \mathbf{v}_2) \mathbf{v}_1 / v_1^2)}{1 + (\mathbf{v}_1 \mathbf{v}_2) / c^2}. \quad (1.6)$$

Clearly, the result depends on the order of transformation. For example, in the case of sequence

$$+v_1 \mathbf{i}, -v_1 \mathbf{i}, +v_2 \mathbf{j}, -v_2 \mathbf{j},$$

where \mathbf{i} , \mathbf{j} are the unit vectors of the Cartesian coordinate system, we obtain a zero sum velocity, and for the other order of the same quantities

$$+v_1 \mathbf{i}, +v_2 \mathbf{j}, -v_1 \mathbf{i}, -v_2 \mathbf{j}$$

we obtain a non-zero sum velocity, which depends on v_1 and v_2 in a rather complicated manner. The successive application of transformations (of motions) of $v_1 \mathbf{i}$ and $v_2 \mathbf{j}$ results in

$$\mathbf{v}_3 = v_1 \mathbf{i} + \sqrt{1 - v_1^2/c^2} v_2 \mathbf{j},$$

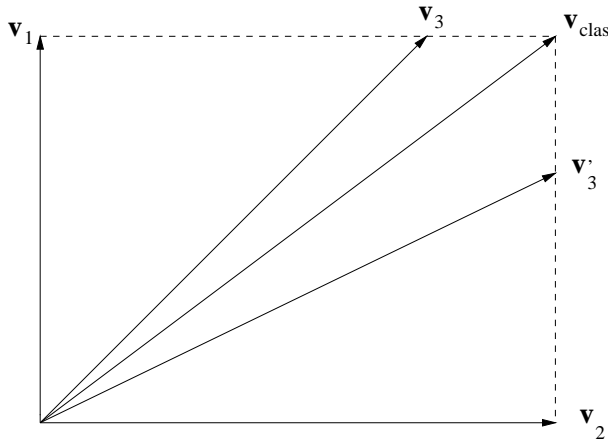

Figure 1.21: Velocity parallelograms in SRT.

and in the other order of $v_2\mathbf{j}$ and $v_1\mathbf{i}$ it results in

$$\mathbf{v}'_3 = v_2\mathbf{j} + \sqrt{1 - v_2^2/c^2}v_1\mathbf{i};$$

that is, we obtain different vectors (Fig. 1.21).

In such a case, what can the decomposition of the velocity vector into components mean? First, the transfer of simplest, classical calculation techniques (the commutative algebra) to relativistic (non-commutative) equations is illegal: even the solution of vector equations in a component-by-component manner requires additional postulates, complications or explanations. Second, a simple application of the methods of classical physics (such as the principle of virtual motions, the variation methods, etc.) is impossible. In this case, even a "zero" had to be "individualized": the number of "zero" quantities, composed of some vector combination, should be equal to the number of "zero" quantities composed of a mirror vector combination. Hence, the theory of fluctuations would also require additional substantiation in such a case. Thus, contrary to the statement "on the simplicity and elegance of SRT", the correct justification of even simplest procedures would require introducing many artificial complications and explanations (which are absent in

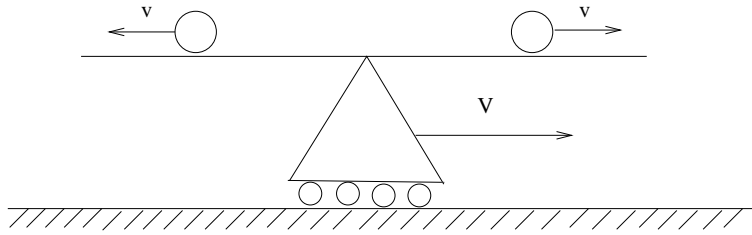

Figure 1.22: The law of addition of velocities and the paradox of a balance.

the textbooks).

Consider the logical contradiction of the relativistic law of velocity addition for the example of one-dimensional case. Let us have a balance in the form of a horizontal groove with a horizontal transverse pivot at the middle. Two identical balls of mass m will roll along a groove from the pivot to different sides (Fig. 1.22).

To avoid discussing properties of the relativistic mass, we shall proceed as follows. Let the balance pivot be frictionless except when the balance is in the horizontal position (the "dead point"). At this position, the threshold of the friction force does not allow the balance to rotate due to any possible small difference between the relativistic masses of the balls. But this sensitivity threshold cannot prevent the balance from rotating off the "dead point" in the absence of one of balls – it will fall downwards. Let the velocities of balls in the system be equal in magnitude. Then the balls in this system will simultaneously reach the edges of the groove and fall downwards, so that the balance will be kept at the horizontal position. Consider now the same motion in the system, relative to which the balance are moving at speed V . Let be $V \rightarrow c$ only, but $v \ll v_s$, where v_s is the speed of sound for the groove material. Then the balance can be considered as absolutely rigid (we can ignore acoustic waves). According to the relativistic law of addition of velocities,

$$v_1 = \frac{V - v}{1 - vV/c^2}, \quad v_2 = \frac{V + v}{1 + vV/c^2}.$$

The motion of a middle point at speed

$$\frac{v_1 + v_2}{2} = V \frac{1 - v^2/c^2}{1 - v^2V^2/c^4} < V$$

always lags the motion of the balance. Thus, the ball moving against the direction of motion of the balance will fall down first. As a result, the equilibrium will be violated, and the balance will begin to rotate. So, we have a contradiction with first observer's data. Will the observer be hit if he will stands under the right-hand part of the balance?

Will the Lorentz transformation laws be able to describe successive transitions from one inertial system to another, and does the relativistic law of addition of velocities correspond to real velocity variations? Certainly not. First, recall the meaning of the relativistic law of velocity addition. It must prove that the addition of any motions cannot lead to a speed greater than light speed. What is the manner (sense) in which motions are added in this case? For example, the Earth moves relative stars (factually, there exists the first reference system), a spacecraft flies up from the Earth with large velocity (in fact, the second reference system is "created"), then, another spacecraft flies up from the first spacecraft (factually, the third reference system is "created"), and so on. It is just the meaning for consecutive transformations. Then the following question no longer arises: in the relativistic law of velocity addition, which velocity must be considered as the first one, and which velocity is the second one (This is important for non-commutative transformations). All the examples in this Section have this meaning.

Let us consider now the Lorentz transformation law for arbitrary directions of motion:

$$\mathbf{r}_1 = \mathbf{r} + \frac{1}{V^2} \left(\frac{1}{\sqrt{1 - V^2/c^2}} - 1 \right) (\mathbf{r}\mathbf{V})\mathbf{V} + \frac{\mathbf{V}t}{\sqrt{1 - V^2/c^2}},$$

$$t_1 = \frac{t + (\mathbf{r}\mathbf{V})/c^2}{\sqrt{1 - V^2/c^2}}.$$

It can easily be verified, that the successive application of the relativistic law of velocity addition (1.6) to quantities

$$v_1\mathbf{i}, \quad v_2\mathbf{j}, \quad -v_1\mathbf{i} - v_2\sqrt{1 - v_1^2/c^2}\mathbf{j} \quad (1.7)$$

will give a zero. To an arbitrary vector $\mathbf{r} = x\mathbf{i} + y\mathbf{j}$ we apply the Lorentz transformation laws successively with the same set of velocities. Then we have:

$$\mathbf{r}_1 = \frac{x + v_1 t}{\sqrt{1 - v_1^2/c^2}} \mathbf{i} + y\mathbf{j},$$

$$t_1 = \frac{t + xv_1/c^2}{\sqrt{1 - v_1^2/c^2}}.$$

Further, we have:

$$\mathbf{r}_2 = \frac{x + v_1 t}{\sqrt{1 - v_1^2/c^2}} \mathbf{i} + \frac{y\sqrt{1 - v_1^2/c^2} + v_2 t + xv_1 v_2/c^2}{\sqrt{1 - v_1^2/c^2} \sqrt{1 - v_2^2/c^2}} \mathbf{j},$$

$$t_2 = \frac{t + xv_1/c^2 + yv_2\sqrt{1 - v_1^2/c^2}/c^2}{\sqrt{1 - v_1^2/c^2} \sqrt{1 - v_2^2/c^2}}.$$

We shall not write down the expressions for r_3 and t_3 in the explicit form because of their awkwardness. However, using graphical programs, we can be convinced of the following properties:

- 1) In the new system, the initial time is desynchronized at any point of space except the coordinate origin.
- 2) The time intervals have changed: $dt_3 \neq dt$; that is, we got into a new moving system, rather than into the initial resting one. Therefore, in the textbooks, as a minimum, the meaning of the Lorentz transformation laws or of the relativistic law of velocity addition is uncovered rather incorrectly.
- 3) Line segments occur to be not only changed in length, but also turned around. We can easily be convinced of this, if we find numerically the angle of rotation; i.e. the difference

$$\alpha = \arctan\left(\frac{y_3[x(1), y(1), t] - y_3[x(0), y(0), t]}{x_3[x(1), y(1), t] - x_3[x(0), y(0), t]}\right) - \arctan\left(\frac{y(1) - y(0)}{x(1) - x(0)}\right).$$

These properties can be discussed mathematically in terms of the "pseudo-Euclidean character of the metric" as much as you like. However, physically the situation is quite simple. These properties prove

the non-objective (i.e. only illusory) character of the Lorentz transformation laws and of the relativistic law of velocity addition, and their disagreement with each other. Indeed, since we have successively passed from one inertial system to another, and the rotation implies the non-inertial character of a system, SRT itself escapes the limits of its own applicability; i.e., it is inconsistent. If this rotation were real, this would imply a non-objective character of the inertial system notion (since the result would depend on the method of transition to the given system) and, as a consequence, the lack of a proper basis for SRT to exist.

Let us try to clear up why it is that treatments from the textbooks result in disagreement between two expressions, the relativistic law of velocity addition and the Lorentz transformation laws, in spite of the fact that the first expression is derived from second one. Recall the following derivation for the example of one-dimensional mutual motion of systems K and K' . Proceeding from the Lorentz transformation laws

$$x_1 = \frac{x + Vt}{\sqrt{1 - V^2/c^2}}, \quad t_1 = \frac{t + Vx/c^2}{\sqrt{1 - V^2/c^2}}$$

we divide the differential dx_1 by dt_1 with regard to definitions $v = dx/dt$ and $v_1 = dx_1/dt_1$ and obtain:

$$v_1 = \frac{v + V}{1 + vV/c^2}.$$

This indicates the following things:

- 1) The observer is at the origin of system K and measures the distance x to the studied body in its system K .
- 2) He considers time t to be universal in his system and determines the velocity of a body in his system $v = dx/dt$.
- 3) He measures speed $-V$ of system K' with respect to K using his own (!) time t , and considers the relative velocities of systems to be mutually opposite in direction. This observer cannot measure any other thing: the summary velocity v_1 is a computable quantity. Thus, we came to the treatment [49] given above: the relativistic law of velocity addition determines the velocity of that relative motion, in which the observer does not participate by himself. This effect is not real, but only

apparent (when we use some particular rules of SRT). In the essence of the formula, we cannot simply pass to the second substitution for determining v_2 , though, formally, any arbitrary number of velocity values can be sequentially substituted into the expression for the relativistic law. In the case of addition of motions along a single straight line, the classical property of commutativity conserves, and the contradiction is veiled over. But if the velocity vectors are non-collinear, then item 3) becomes untrue, and the inconsistency and disagreement of the law of velocity addition and Lorentz transformation laws are immediately exhibited.

But we can apply another approach to the example discussed previously: we shall search for the sequence of three transformations of velocities that retains the initial time in the Lorentz transformation laws invariant. Then it can easily be verified that, instead of (1.7), a single succession can be taken:

$$v_1\mathbf{i}, \quad v_2\mathbf{j}, \quad -v_1\sqrt{1 - v_2^2/c^2}\mathbf{i} - v_2\mathbf{j}. \quad (1.8)$$

However, at first, the turning of segments remains. Second, a new set of velocities does not satisfy, in the given succession, the law of velocity addition, i.e. factually there changes the order of substitution of the velocities v_1 and v_2 in the law of velocity addition (that is inconsistent with the essence of this law). Therefore, the contradictions are not eliminated in this case as well. The Thomas precession is an example of SRT inconsistency also: starting from the sequence of inertial systems (moving rectilinearly and uniformly), the resulting rotation of objects is suddenly obtained (principally noninertial motion). Thus, the passage from the Lorentz transformations (outlined in standard textbooks) of "mathematical space" $1 + 1$ ($t + x$) to the Lorentz transformations of $1 + 2$ "space" (or $1 + 3$) leads to physical contradictions.

Many intuitively clear properties of physical quantities lose their sense in SRT. For example, the relative velocity ceases to be invariant. The particles, flying away along the same straight line at various velocities, form in SRT a complicated "fan of velocities" for a moving system. The isotropic velocity distribution in SRT ceases to be the same for the other moving system. No declared simplification does exist in SRT in reality.

The impossibility of existence of velocities $v > c$ in no way follows from SRT. And the addition, that this statement relates to the signal transmission rate only, is only artificial addition (because of existence of obvious counterexamples to the extended treatment). However, the notion of signal (information) remains insufficiently determinate even with a similar addition. For example, while receiving a signal from the flare of supernova, are we not sure that the same information "is contained" at the diametrically opposite distance from the supernova (that is, we know about it at velocity of $2c$)? Or this is not information? Therefore, SRT can only deal with the information on a material carrier of electromagnetic nature propagating in vacuum sequentially through all points of space from the signal source to a receiver.

Let us make some comment on "astonishingness" of the relativistic law of "addition" of velocities, which allows to exchange light signals even for the algebraic sum of velocities greater than c . We pay attention to the obvious fact: for exchanging information the signals should be sent necessarily in the direction of an object, rather than in the opposite direction. Therefore, there is nothing surprising in exchanging the signals, where in the classical case it occurs also that, as a result of formal addition of velocities, $v_1 + v_2 > v_{signal}$. Let two airplanes to take off from the aerodrome O at velocities of $0.9v_{sound}$ and fly away from each other in the opposite directions of axis X (the relative velocity is $1.8v_{sound}$). Whether the exchanging of signals between them is possible? Certainly yes! Because the sound wave propagates in air irrespective of the velocity of source S_1 at signal issuing time, the first airplane (which has sent a signal) will catch up the wave front propagating in the positive direction of axis X , whereas the second airplane will "compete" with the wave front propagating in the negative direction of axis X . Both airplanes are moving slower as compared to propagation of corresponding wave front sections nearest to them (see Fig. 1.23). Thus, the sum of velocities is compared (in a complicated manner), in reality, with quantity $2v_{sound}$, rather than with the speed of sound (and for light – with the value of $2c$).

It is obvious also that physical restrictions on the value of speeds cannot be applied by mathematics (by the fact that in some expressions

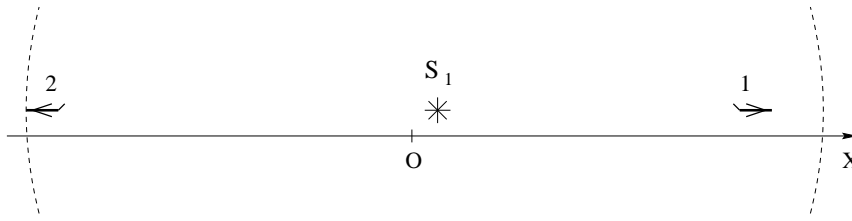

Figure 1.23: Exchange of a signal.

there exists a negative value under the radical sign). It should be remembered that all SRT expressions are introduced with use of a light signal exchange (the method of Einstein's synchronization). But if a body moves faster than light long since, it simply cannot be caught up by signal sent in pursuit. In a similar manner, a synchronization can be made with use of sound (expressions with radicals could be written), but the impossibility of supersonic speeds in no way follows from here at all.

1.7 Additional criticism of relativistic kinematics

We shall begin with some general remarks. The group properties of mathematical equations, as the transformations with mathematical symbols, do not bear any relation to any physical principles or postulates; that is, the group properties can be found without additional physical hypotheses. For example, the Lorentz transformation laws, which reflect the group properties of the Maxwell equations in vacuum (or of the classical wave equation, including that in the acoustics), are not bound at all with SRT's postulate of constancy of the speed of light or with the relativity principle.

The theory of relativity is, in fact, "the theory of visibility": it is about what we see in an experiment, if it is based (with generalization for space and time properties) on the laws of electromagnetic interactions (the absolutisation of electromagnetic phenomena). Similarly, the

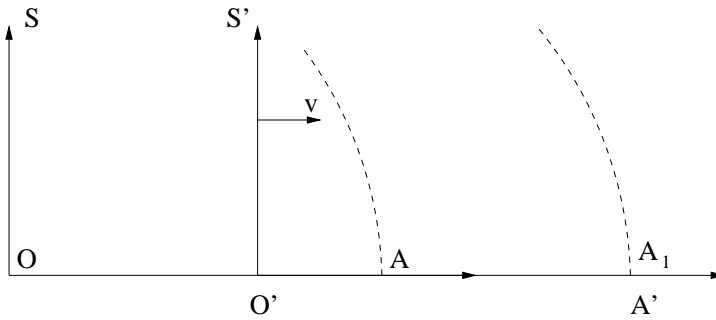

Figure 1.24: The non-locality paradox.

question can be raised: What will the phenomena observed by means of sound, etc., look like? Certainly, the finiteness of the rate of transmission of some interactions alters the phenomena observed with the help of these interactions. But this circumstance does not prevent making unique extrapolations for "binding" to space and time (which are the absolute physical notions) for the unique description of the world without limitation by any "overall" hypotheses.

Newtonian space possesses an important property: systems with lower dimensions can possess similar properties. For example, a vector can be introduced not only in three-space, but also on a plane and on a straight line. In RT, three-dimensional quantities do not possess vector properties (only the 4-vectors do this); that is, there is no continuous limiting transition to classical quantities (the "nearly vector" \rightarrow vector).

As the next remark, we shall describe the "non-locality" paradox. Note that all SRT formulas do not depend on the previous history of motion, i.e. they are local. Let system S' move at velocity \mathbf{v} relative to system S . Let a light flash occur at center O at the time of its coincidence with center O' . At time t in system S , let the wave front reach point A , and in system S' – point A' , respectively (Fig. 1.24). Now we impart, by pulse, velocity \mathbf{v} to a signal receiver in system S at point $A_1 = A'$. It happened that the wave front has moved right away to A'

(since we are now in system S'). But where had the wave front been at the same time instant? Did the time at $A_1 = A'$ change? And if we will stop the receiver at A_1 after a moment? The time will be restored, and the wave front will again return to A ? And the observer will forget that he saw a flash of light? Then, in order to see the future, one must move faster? The fact that the observer at A_1 had not at all times moved together with system S' explains nothing, since another observer, who had all the time moved together with system S' , could be at A' . Does it occur that one of them will see the event, whereas the other one will not? If so, the objective nature of science disappears.

The next additional issue is as follows. Does a wave packet (light) move in vacuum at light speed? If yes, then we cannot break it down into (separate) pulses (signals) by means of a stroboscope: due to length shortening, the length of each pulse and the length of each interval between the pulses must be zero (which is contradictory). If, however, we suppose the dimensions of obtained pulses (signals) and intervals between them to be finite in the resting (laboratory) coordinate system, then in the intrinsic reference system of package, both pulses and intervals should be infinite (but how can we interrelate in this case the pulse and the interval, where it is absent?). In essence, it is the following question: whether light and the space between signals are material or not?

Let us make now some comment about a change of the visible direction of particle motion or about a change of the visible direction of wave signal arrival (remember the aberration, for example) as an observer goes to other moving system. This simple classical fact is described in SRT as the turn of all wave front at some angle. As this takes place, the wave front presents a light sphere at the same time instant. We would remind that the wave front in SRT is different at the same time instant for systems moving relative each other (just as the result of a change in running of time). However, the prehistory of motion of recording instruments is included in none SRT formula. If a photon has been flying in space between a source and a receiver, it is causally connected in no way with motion of the source and the receiver at the same time instant. The interaction of the recording instrument with the photon occurs just

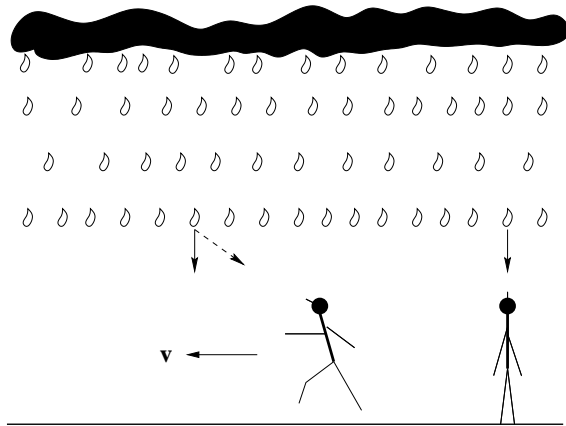

Figure 1.25: The change of the direction of perceiving motion.

at the time of signal reception only. No difference exists whether the receiver had been having a velocity \mathbf{v} all the time and was brought into this space point at the time of signal reception, or it had been being motionless at the same space point, but acquired the same velocity \mathbf{v} at the instant before signal reception (the result of interaction with the photon were the same in both cases). Thus, the only fact of photon arrival to the given place of space matters for the fact of receiving of a photon as such. Obviously, the value of some velocity at the given place of space does not change the **fact** of signal arrival as such (but, according to the Doppler effect, its frequency will be changed only). If the fact itself of the signal receipt were dependent on this, then what does the substitution of values in the Doppler formula at the one of observation systems mean? Therefore, no real turn of all wave front can be (since it reflects the fact of signal arrival). This is the local (at the given point) mathematical (differential) method to determine the visible direction of signal reception. It can be easily understood by analogy with the usual natural phenomena – with rain and snow (Fig. 1.25). If you look at a cloud over your head in the windless weather when it is raining, you see vertical fall of drops (the direction of "signal" reception). But if you will

run (it is better to remember a car travel in a snow day), the direction of drops arrival (the direction of "signal" reception) will far ahead along motion and can be lack of coincidence with the real cloud. However, the horizontal front of rain either already reached the earth surface (the fact of "signal" reception), or not, and this fact does not depend on your motion at the given point of the earth surface at all (see Fig. 1.25).

Let us discuss some speculative constructions of SRT. So, unreal in SRT is the consideration of infinite systems, such as a conductor with current, in "explaining" the appearance of additional volume charge (the game with infinities). In reality, the conductor can be close-loop (finite) only. In this case the explanation is not only complicated methodically, but also contradictory. Let us consider a square loop with current (for example, a superconducting loop). The value of a charge of each electron and ion is invariant; the total number of particles is invariable too. How can change the density of charges in this case? Consider the motion of electrons from the viewpoint of a "system of ionic grid" (Fig. 1.26). According to SRT, the "electronic loop" should decrease in size (the contraction of lengths because of motion of electrons on each rectilinear section). It would seem that, owing to symmetry of the problem, the "electronic loop" should enter inside the "ionic loop". However, in such a case we would have a strange asymmetrical field (of dipole type) near the conductor. Besides, while moving at high velocity, the electrons and ions could appear on different sides from the observer. It is completely unclear, how such a transition through the observer (perpendicular to the motion of particles!) could take place at all? And by what forces the charged electrons (as well as the ions) would be retained together in a flux, not flying away to different sides? Even if we take advantage of the fitting SRT uncertainty (towards what end does the contraction occur?) for one side of a square, all questions still remain for its other sides.

The SRT's system of watches and rules is inconvenient both theoretically and practically, since it supposes that all the data are gathered and analyzed (interpreted!) somewhat later. The uniqueness of interrelation between the classical Newtonian and relativistic Lorentzian coordinates does not imply automatic consistency of latter ones (just in this, phys-

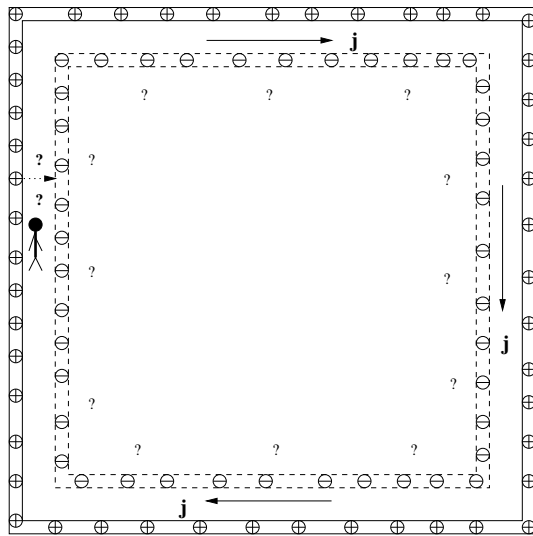

Figure 1.26: The paradox of loop with current.

ical sense consists the distinction of physics from mathematics). For example, we could use in all SRT formulas the speed of sound in air instead of speed of light and consider the motions on the Earth at subsonic velocities in resting air. However, the inconsistency of similar transformations (for the time) would be immediately revealed in the experiment. This fact demonstrates the hazard of formally mathematical analogies for physics.

It is obvious that the relativistic hypothesis for time dilation is wrong, since only the square of relative velocity is included in the formula (the effect does not depend on the velocity direction). Take 4 identical objects. Let second object be moving at some velocity \mathbf{v}_{12} relative to the first one, then its time will be slowed down relative to the time of the first object. You say that it is an objective effect? (We would remind the meaning of the word "objective": an effect does not depend on presence and properties of the observer which not interacts with the object under study.) We even would not fly to check it. Let

the third object be moving relative to the second one in an arbitrary direction with some velocity v_{23} . Then, by analogy, its time will be slowed down relative to the time of the second object. Is this effect objective again? Let the fourth object be motionlessly placed near the first object. We even does not try to debate with which velocity the fourth object moves relative to the third object: it is important only that in the general case this velocity does not zero. Therefore, again we have "objective relativistic" time dilatation of the fourth object relative to the third one. Thus, $dt_1 > dt_2 > dt_3 > dt_4$. But $dt_1 = dt_4$ (and we have no need to fly somewhere), since the fourth and first objects are in relative rest! Similar absurdity was obtained as the result of a fanatic relativistic faith in the uniqueness and infallibility of Einstein's method of synchronization in pairs. Objectiveness melt away from under feet, and a remainder is either the relativistic seeming effect or pure rated combinations ("floating time belts"). What matter is the declared greatness?

Now we shall make some general remarks. The whole SRT kinematics follows from the invariance of the interval $dr^2 - c^2dt^2 = inv.$ However, we see that this expression is written for the empty space. In a medium the speed of light is non-constant, it can be anisotropic, and the light of non-arbitrary frequency can propagate in the given particular medium (remind the attenuation, absorption, reflection, dissipation). There is no sections of physics, where the properties of phenomena in vacuum would be automatically transferred to the phenomena in other media (for example, in liquids – hydrodynamic and other properties; in solid bodies – elastic, electrical and other properties). That is, they are not determined by the properties of the empty space. And only SRT pretends to a similar universal "cloning" of properties.

Generally speaking, the properties of light, which are intrinsically contradictory and mutually exclusive, are simply postulated in SRT. Therefore, wrong is Fock's [37] statement, that the light is a simpler phenomenon, than the rule. It is not worth to extol the role of light signals and all "visible things"; otherwise a teaspoon inside a glass with water could be considered as the broken one (pure geometrically, the fallacy in this consideration can easily be tested by the direct location

of coordinates of all "teaspoon outlets" at the boundary of the liquid). The classical time (or the time determined by an infinitely remote source at the middle perpendicular to the line of motion) possesses some important advantage: we know a priori that it is identical everywhere, and no calculations or discussions are required concerning the prehistory of the process or properties of the space. Actually, SRT uses the speed of light as one of measurement standards. Remind that in the classical kinematics there are two measurement standards: the length and time (we will "formulate" evident "laws of constancy of standards": the length of the standard of 1 m is constant and is equal to one meter, the duration of the standard of 1 sec is constant and is equal to one second, but relativists din "the Great Law of Constancy of the relativistic standard" into everyone's ears). Since the introduction of a standard is the definition, its properties are not subject to discussion [19]. As a result, everything, which is related with the light propagation, ceases to be a prerogative of experiment in SRT. And because all derivations in SRT are written only for the events – the light flashes, then SRT occurs to be logically inconsistent (to say nothing of the fact, that the "use" of properties of light in vacuum is profusely spread to all other "non-vacuum" phenomena).

Feynman in his book [35] says with sarcasm about the philosophers and about the dependence of results on the frame of reference, but he does not emphasize that, in spite of any "appareness", the subjects have real objective characteristics. For example, a man may seem to have a size of ant from the great distance, but this does not mean that he has really reduced (all instruments are used to be calibrated just under objective characteristics). The reasoning on a relativity of all quantities seems to be realistic, but (!) once the time in SRT became relative and the rate of interaction was supposed to be finite, the notion of relative quantity for spatially separated objects has become indefinite (It depends on the path of connection, is not bound causally, depends on the system of observation, etc). The definition of all quantities with respect to "far stars" is senseless, since we can see a "never existing reality". For example, the Alpha-Centaur has been at this particular place and possessed such properties 4 years ago; the other stars have been the same

as we see tens or hundreds years ago and the distant Galaxies – billions years ago, i.e. the signal was sent when the earth observer did not exist yet, and is accepted when, possibly, the source itself no longer exists. In such a case, relative to which should we determine the quantities? It is clear that the relative quantities can be determined only with respect to the local characteristics of space (the unique instantaneous causal bond).

Some important remark concerns the notion of relativity, which has even entered the name of the SRT theory. Contrary to Galileo's ideas on isolated systems, an interchange of light signals between systems is used in SRT. The notion of relativity has been worked up to nonsense in SRT and lost its physical sense: in fact, the system with several (as a rule, two) objects is singled out, and the whole remaining real Universe is eliminated. If such an abstraction can even be postulated in SRT, then, the more so as, one can simply postulate the independence of processes inside the separated system on the velocity of system motion relative to the "emptiness" which remained from the whole Universe. But, even in spite of such an abstraction, no "real" relative quantities will appear for bodies (such as \mathbf{r}_{ij} , \mathbf{v}_{ij} , etc.). Indeed, the response of body i to the attempt of changing its state is determined by the local characteristics: the state of a body i and the state of the fields at the given point of space. But the changes having occurred with body i will have an effect on the other bodies j only in some time intervals Δt_j . Thus, all changes of quantities should be determined relative to the local place (or local characteristics). And these phenomena just represent manifestations of the Newtonian absolute space. The question, whether the separated direction and separated coordinate origin (either moving or resting) exist in this absolute space – is quite different question. In the abstract (model) theories this question can be postulated, for example, from the considerations of convenience of the theory; but for our unique real Universe it should be solved experimentally. The absolute time notion in the classical Newtonian physics was extremely clear as well. The time should be uniform and independent of any phenomena observed in a system. Exactly such a property is inherent in the time synchronized by an infinitely remote periodic source on a middle perpendicular. However,

in SRT the time is not an independent quantity: it is associated with the state of motion of a system v and with the coordinates, for example, by the relation $c^2t^2 - r^2 = \text{constant}$. For uniform running of time the choice of the time reference point is arbitrary. For unified description of the phenomena and for comparability of the results the scales (units of measurement) should be identical for all systems. The time running uniformity automatically ensures the greatest simplicity of description of the phenomena and for the basis notion of time allows to introduce its standard definition.

Let us make some more methodical comments. Generally speaking, in SRT the method of comparison of the phenomena in two various inertial systems supposes, that both these systems have existed for infinitely long time. However, the systems have often been "linked" to particular bodies and have existed for a finite time only. Then, in each particular case the question needs to be studied: whether the prehistory of formation of these systems (its influence) has been "erased" or not?

The Euclidean analogies with projections in the book [33] are completely inadequate to the reality. The projection is only an abstract method of description, the subject itself does not change at turning. In SRT, on the contrary, the characteristics of an (even remote) object instantaneously change with changing the motion of an observer (!).

The limiting transition from the Lorentz transformations to the Galileo transformations (for the time $t = t' + vx'/c^2$) indicates that the Newtonian mechanics is not simply a limit of low velocities $\beta = v/c \ll 1$, but the other condition is required, namely: $c \rightarrow \infty$. But in this case for many quantities in SRT there is no limiting transitions to classical quantities (see below, or [50]). However, in the classical physics $c \neq \infty$: its finite value was measured even in 17th century!

The property of maximum homogeneity of the space-time can be an attribute of either ideal Newtonian mathematical space and time (being actually a "superstructure from above"), or of the model space (for example, with remotely non-interacting material points). The attempt to rest upon the mentioned property in RT as on the principal property of the real space and time is artificial. First, even in the earth scales we can not arbitrarily change the points of space, time instants, directions

of axes and velocities of inertial systems (recall the limited nature of the Earth space, the rotation of the Earth, the gravitational field, the effect of the Moon, the electric, magnetic, temperature fields and so on). We have listed above the real achieved practical limitations, rather than the principal restrictions somewhere at relativistic velocities and huge scales of the Universe. True, in the scales of the Universe with its real objects and gravitational fields this property is not confirmed too: the model of uniform "jelly" does not describe the real Universe. Second, in addition to the form of equations, the solution is still determined mathematically by the boundary and initial conditions. This also actually, on real finite scales, prevents any shifts and changes (or it is necessary to change, in addition, the imposed conditions). How can we approach the existing nonlinear properties and equations with the RT claims? Even the "relativity" notion itself does not allow us to generalize (more likely, to narrow down) the real space with gravity. (As Fock [37] has emphasized, the "general relativity theory" term is inadequate).

Theoretically, the principle of relativity (in any known form) supposes that "without looking" outside the limits of a system it is impossible to discover its uniform motion. Earlier it was the ether, which has played a part of the all-penetrating medium for possible discovering such a motion. Note that the question was not about the discovery of the absolute motion, but only about the motion relative to ether. That is, it would be possible to compare these motions "without looking" outside (here we keep in mind the calculating possibility only, since the system of registration points and standards cannot be tied with the ether). But even with "canceling" the ether, according to the modern concepts, still remains the "candidate" with similar properties – the gravitational field (which is principally non-shielded). For example, from the relic radiation anisotropy, under the additional hypothesis on the equality of the rate of propagation of gravitational interactions and speed of light, may follow the anisotropy of the (all-penetrating) gravitational field. Thus, the non-equal rights of inertial systems in macroscales can be found, in principle, "without looking" outside even at the local point. This can be avoided theoretically under the hypothesis, that the rate of propagation of gravitational interactions is much higher than the speed of light; in

such a case the isotropy could be set up, but in actual practice – it is the prerogative of the Experiment.

1.8 Conclusions to Chapter 1

The given Chapter 1 is basically devoted to general physical issues and to the systematic criticism of the relativistic kinematics. In so doing, a lot of logical and methodical contradictions of SRT is analyzed in detail. If only methodical inaccuracy were included in this theory, it could be corrected, some additional explanations, revisions, additions, etc., could be introduced. However, the presence of logical contradictions brings "to nothing" any results of any theory, and SRT is not an exception in this respect (although rather undemanding attitude to SRT as compared with any other theory is evidenced in science).

We will briefly summarize all of the preceding. In present Chapter such fundamental notions as "space", "time" and "relativity of simultaneity" were analyzed in detail. The logical inconsistency of the fundamental notion of "space" in SRT was demonstrated on the basis of the following contradictions: the modified twins paradox, the paradox of n twins, the paradox of antipodes, the time paradox etc.. Then, the possibility of introducing a single absolute time independent of the velocity of motion was demonstrated by means of a periodic, infinitely remote source situated across the plane (line) of motion.

Further, for numerous examples the inconsistency of the relativistic concept of length was demonstrated. (These examples include: the motion of a cross, rotation of a circle, lengths shortening, the belt-driven transmission, the indefiniteness of the direction of contraction, a loop with current, etc.). The SRT contradictions for the problems of rod slipping over a plane and of flying rod turning, the non-locality paradox, limiting transition to classics, and so on, were considered in detail.

In Chapter 1 the true sense of the Lorentz transformations and of the interval invariance was discussed. The contradiction between the "relativity of simultaneity" and the field approach, founded upon the finiteness of the rate of interactions, was considered in detail. The contradictions between the Lorentz transformations and the relativistic law

of velocity addition were also discussed in detail. Besides, in Chapter 1 the hyperbolization property of the "relative quantity" concept itself and the space-time homogeneity properties were critically discussed in detail.

The ultimate conclusion of the Chapter consists in the necessity of returning to classical notions of space and time, to the linear law of velocity addition, and classical meaning for all derivative values. The questions of experimental verification of SRT kinematics and questions concerning the relativistic dynamics will be considered in detail in Chapters 3 and 4 respectively. The questions of kinematics of noninertial systems will be touched in the next Chapter 2.

Chapter 2

The basis of the general relativity theory

2.1 Introduction

The logical inconsistency of kinematics of the special relativity theory (SRT) was proved in previous Chapter 1. This forces to return to the classical notions of space and time. Since relativists declare that SRT is the limiting case of the general relativity theory (GRT) in the absence of gravitation, then there arise some doubts in validity of GRT kinematics also. Unlike SRT, the GRT contains some rather interesting ideas, such as the principle of equivalence expressed via the idea of "geometrization". (Note that incorrectness of geometrization of electromagnetic fields is obvious: experiments show that neutral particles do not respond to the "electromagnetic curvature of space".) If it's basis were true, the GRT could have a claim on status of a scientific hypothesis about some correction to the static Newton's law of gravitation. Since it is not the case, the gravitation theory must be constructed in a different manner. For the sake of justice it could be mentioned that GRT, in contrast to SRT, never were the universally recognized non-alternative theory. The current of true criticism of this theory has been continuing from its origin. There exist several rather advanced alternative theories (for example, [11,18] etc.). Although we shall not analyze theories

other than GRT, it must be emphasized that theories, "playing" around change of space and time properties and having relativistic kinematics of SRT as its limiting case, are obviously doubtful.

The basic purpose of present Chapter 2 is the criticism of basis notions of GRT. A logical inconsistency of space and time notions in GRT is demonstrated here. The (plausibly hidden) errors and disputable points from the textbooks [3,17,39] are displayed step by step in Chapter 2. In addition to conventional GRT interpretations, we shall also consider some "relativistic alternative" to cover possible loop-holes for salvation of this theory. The time synchronization issues and the Mach principle are also discussed, and the attention is given to doubtful corollaries from GRT.

2.2 Criticism of the basis of the general relativity theory

Many GRT inconsistencies are well-known:

1) the principle of correspondence is violated (the limiting transition to the case without gravitation cannot exist without introducing the artificial external conditions);

2) the conservation laws are absent;

3) the relativity of accelerations contradicts the experimental facts (rotating liquids under space conditions have the shape of ellipsoids, whereas non-rotating ones – the spherical shape);

4) the singular solutions exist.

(Usually, any theory is considered to be inapplicable in similar cases, but GRT for saving its "universal character" begins to construct fantastic pictures, such as black holes, Big Bang, etc.).

General remarks

Let us consider the general claims of the GRT. We begin with the myth "on the necessity of the covariance". The unambiguous solution of any differential equation is determined, except the form of the equation, also by specification of the initial and/or boundary conditions. If they

are not specified, then, in the general case, the covariance either does not determine anything, or, at changing the character of the solution, can even result in a physical nonsense. If, however, the initial and/or boundary conditions are specified, then with substitution of the solutions we obtain the identities, which will remain to be identities in any case for any correct transformations. Besides, for any solution it is possible to invent the equations, which will be invariant with respect to some specified transformation, if we properly interchange the initial and/or boundary conditions.

The analogies with subspaces are often used in the GRT; for example, a rolled flat sheet is considered. However, the subspace cannot be considered separately from the space as a whole. For example, in rolling a sheet into a cylinder the researcher usually transfers, for convenience, into the cylindrical coordinate system. However, this mathematical manipulation does not influence at all the real three-dimensional space and the real shortest distance.

The simplicity of postulates and their minimum quantity do not still guarantee the correctness of the solution: even the proof of equivalence of GRT solutions is a difficult problem. The number of prerequisites should be, on one hand, sufficient for obtaining a correct unambiguous solution, and, on the other hand, it should provide wide possibilities for choosing mathematical methods of solution and comparison (the mathematics possesses its own laws). The GRT, along with artificial complication of mathematical procedures, has introduced, in fact, the additional number of "hidden fitting parameters" (from metrical tensor components). Since the real field and metrics are unknown in GRT and are subject to determination, the result is simply fitted to necessary one with using a small amount of really various experimental data (first we peeped at the "answer", then we will believe with "a clever air" that it must be in the theory in just the same manner).

Whereas in SRT though an attempt was made to confirm the constancy of light speed experimentally and to prove the equality of intervals theoretically, in GRT even such attempts have not been undertaken. Since in GRT the integral $\int_a^b dl$ is not meaningful in the general case, since the result can depend on the path of integration, all integral quan-

tities and integral-involving derivations can have no sense.

A lot of questions cause us to doubt as to validity of GRT. If the general covariance of equations is indispensable and unambiguous, then what could be the limiting transition to classical equations, which are not generally covariant? What is the sense of gravitation waves, if the notion of energy and its density is not defined in GRT? Similarly (in the absence of the notion of energy), what is meant in this case by the group velocity of light and by the finiteness of a signal transmission rate?

The extent of the generality of conservation laws does not depend on the method of their derivation (either by means of transformations from the physical laws or from symmetries of the theory). The obtaining of integral quantities and the use of integration over the surface can lead to different results in the case of motion of the surface (for example, the result can depend on the order of limiting transitions). The absence in GRT of the laws of conservation of energy, momentum, angular momentum and center of masses, which have been confirmed by numerous experiments and have "worked" for centuries, cause serious doubts in GRT (following the principle of continuity and eligibility of the progress of science). The GRT, however, has not yet built up a reputation for itself in anything till now, except globalistic claims on the principally unverifiable, by experiments, theory of the evolution of the Universe and some rather doubtful fittings under a scarce experimental base. The following fact causes even more doubt in GRT: for the same system (and only of "insular" type) some similarity of the notion of energy can sometimes be introduced with using Killing's vector. However, only linear coordinates should be used in this case, but not polar ones, for example. The auxiliary mathematical means cannot influence, of course, the essence of the same physical quantity. And, finally, the non-localizability of energy and the possibility of its "spontaneous" non-conservation even in the Universe scales (this is a barefaced "perpetuum mobile") cause us to refuse from GRT completely and either to revise the conception "from zero", or to use some other developing approaches. Now we shall pass from general comments to more specific issues.

The geometry of space

The question on the change of real space geometry in GRT is fully aberrant. The finiteness of the rate of transmission of interactions can change only physical, but not mathematical laws. Whether shall we assert, that the straight line does not exist, only because its drawing into infinity, even at light speed, will require infinite time? (The same is true for the plane and space). The mathematical sense of derivatives can not change as well. One of GRT demonstrations "on the inevitability of the change of geometry in the non-inertial system" is as follow: in the rotating coordinate system, due to contraction of lengths, the ratio of the length of a circle to its diameter will be lower, than π . Note that nobody can draw a "new geometry" for this case: "non-existing" cannot be pictured. In fact, however, not only the true, but even the observed geometry will not change: whether the mathematical line will move or change as we move? Although the radius, which is perpendicular to the circle motion, must be invariable, nevertheless, we suppose at first, that the circle will move radially. Let we have three concentric circles of almost the same radius (Fig. 2.1). We place the observers on these circles and number them in the order from the center: 1, 2, 3. Let the second observer be motionless, whereas first and third ones are rotating around center O clockwise and counter-clockwise at the same angular velocity. Then, owing to the difference in relative velocities and contraction of lengths, the observers will interchange their places. However, when they happen to be at the same point of space, they will see different pictures. Indeed, the 1-st observer will see the following position from the center: 3, 2, 1, whereas the 2-nd observer will see the different order: 1, 3, 2, and only the 3-rd observer will see the original picture: 1, 2, 3. So, we have a contradiction. Suppose now, that the geometry of a rotating plane has changed. However, what will be more preferable in such a case: the top or the bottom? The problem is symmetric, in fact; to what side the plane has curved in such a case? If we make the last supposition, that the radius has curved (as the apparent motion changes in the non-inertial system), then the second observer will see it as non-curved, whereas the first and third observers will consider it as "curved" to different sides. Thus, three observers will see different pictures at the same point for

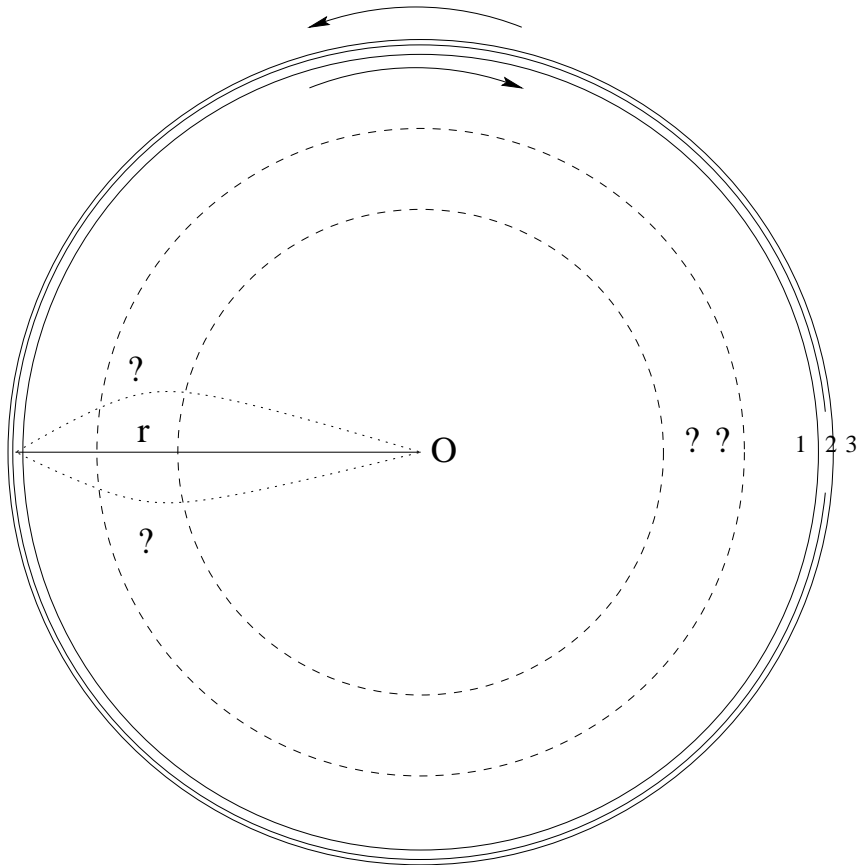

Figure 2.1: The geometry of a rotating circle.

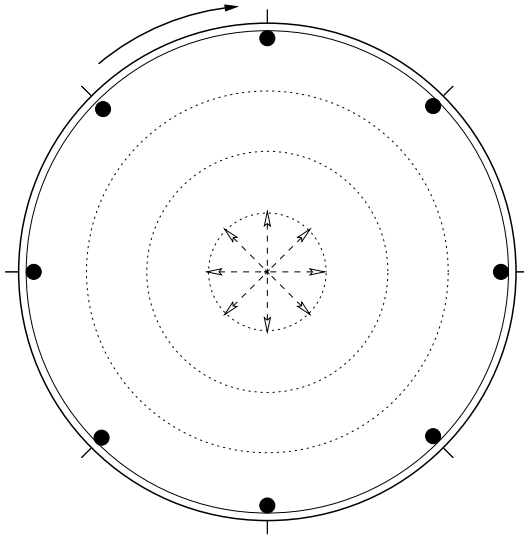

Figure 2.2: Equidistant observers at a circle.

the same space; therefore, the curvature of the radius is not an objective fact (and cannot be a matter for scientific enquiry).

The rotating circle proves the contradictive nature of SRT and GRT ideas. Really, according to the textbooks, the radius, which is perpendicular to the motion, does not change. Therefore, the circles will remain at their places irrespective of the motion. Let us seat the observers on a motionless circle at equal distances from each other and produce a point-like flash from the center of a circle, in order the observers to draw the strokes on a moving circle at the time of signal arrival (Fig. 2.2). Owing to the symmetry of a problem, the strokes will also be equidistant. At subsequent periodic flashes (with the appropriate period) each observer will confirm, that a stroke mark passes by him at the flash instant, that is, the lengths of segments of motionless and rotating circles are equal. When the circle stops, the marks will remain at their places. The number of equidistant marks will not change (it equals to the number of observers). Therefore, the lengths of segments will be equal in the mo-

tionless case as well. Thus, no contraction of lengths (and change of geometry) took place at all.

Now we consider again the space geometry problem, but with the other approach. This problem is entirely confused still since the times of Gauss, who wanted to determine the geometry with the help of light beams. The limited nature of any experiment cannot influence the ideal mathematical notions, does it? Note, that in GRT the light even moves not along the shortest path: instead of Fermat's principle $\delta \int dl = 0$, we have in GRT [17]: $\delta \int (1/\sqrt{g_{00}})dl = 0$, where $g_{\alpha\beta}$ is metric tensor. What does distinguish the light in such a case? The necessity of changing the geometry is often "substantiated" in textbooks as follows: in order the light to "draw" a closed triangle in the gravitational field, the mirrors should be turned around at some angle; as a result, the sum of angles of a triangle will differ from π . However, for any point-like body and three reflectors in the field of gravity (see Fig. 2.3) the sum of "angles" can be written as:

$$\sum \beta_i = \pi + 4 \arctan \left(\frac{gL}{2v_0^2} \right) - 2 \arctan \left(\frac{gL}{v_0^2} \right).$$

It occurs, that the geometry of one and the same space depends on the conditions of the experiment: on L and v_0 . Since the angle α between the mirrors A and B can also be changed (we chose $\alpha = 0$ in our Fig. 2.3), we have a possibility of artificial changing the geometry within wide limits. Note, that the same variable parameters α and L remain for the light as well. In such "plausible" proofs of the necessity of changing the geometry some important points are not emphasized. First, both in the experiment with material points, and in the experiment with the light the geometry is "drawn" sequentially during some time, rather than instantaneously. Second, for accelerated systems the particles (and the light) move in vacuum rectilinearly, according to the law of inertia, and, actually, the motion of the boundaries of this accelerated system is imposed on this motion additively. All angles of incidence (in the laboratory system) are equal to corresponding angles of reflection, and the "geometry of angles" does not change at all. Simply, the figure is obtained unclosed because of motion of the boundaries. Third, the role

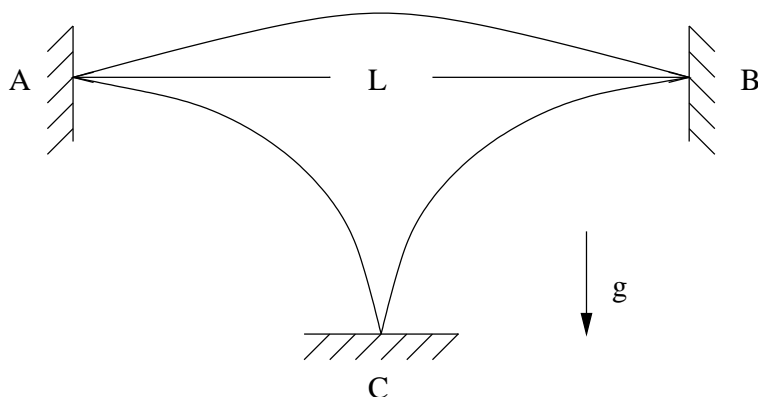

Figure 2.3: "Geometry of a triangle".

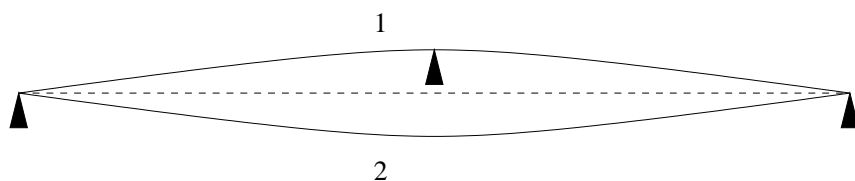

Figure 2.4: Drawing of the straight line in the gravitational field.

of the boundaries is not uncovered at all in determining the relations between the lengths of real bodies. For example, if all points of a real body are subject to the effect of identical accelerating force, then the mutual relation between lengths and angles (the "geometry") remains unchanged. If, however, only the boundaries are subject to acceleration, then all real changes of bodies' size take place only at interaction with the boundaries. In any case the Euclidean straight lines can be drawn. For example, to draw the horizontal straight line in the gravitational field we take two similar long rods (Fig. 2.4). At the middle of the first rod we install a point-like support. As a result of bending of a rod, the upward-convex line is generated. Then we install two point-like supports for the second rod at the level of two lowered ends of the first

rod. As a result of bending of the second rod, the downward-convex line is generated. The middle line between these two bonded rods determines the straight line.

The equivalence principle

Now we shall turn to the next important GRT notion – the equivalence of the gravitational field to some system non-inertiality. In contrast to any non-inertial system, the gravitational field possesses some unique property: all moving objects deflect in it toward a single center. If we generate two light beams between two ideal parallel mirrors and direct them perpendicular to mirrors, then in the inertial system these beams will move parallel to each other for infinitely long time. A similar situation will take place at acceleration in the non-inertial system, if the mirrors are oriented perpendicular to the direction of acceleration. And, on the contrary, in the gravitational field with similar orientation of mirrors the light beams will begin to approach each other (Fig. 2.5). And, if some effect will happen to be measured during the observation, then, owing to a great value of light speed, the existence of namely the gravitational field (rather than the non-inertiality) can also be identified. Obviously, the curvature of mirrors should not be taken into consideration, since, along with gravitational forces there exist also the other forces, which can retain the mutual configuration of mirrors. The distinction of a spherical symmetry from planar one can be found for weak gravitational fields as well. The GRT conclusion on the possibility of excluding the gravitational field for some inertial system during the whole observation time is wrong in the general case.

The equivalence principle of the gravitational field and acceleration can be related to one spatial point only, i.e. it is unreal: it led to a false result for the light beam deflection in the gravitational field, for example (only later Einstein corrected the coefficient in two times). The equivalence principle of the inertial and gravitating mass can be rigorously formulated also for a separate body only (it is unreal for GRT, since GRT involves interdependence of the space-time and all bodies). Because of this, GRT does not physically proceed to any non-relativistic theory at all (but formally mathematically only). All relativistic linear

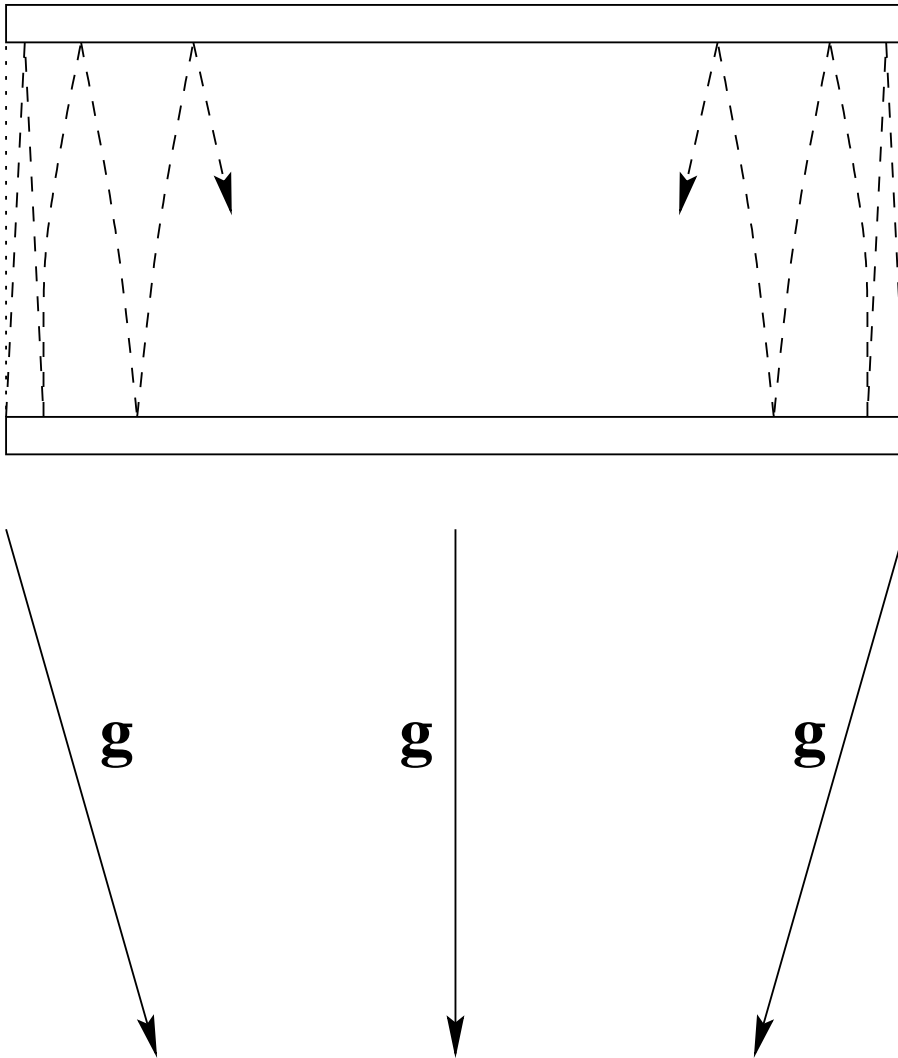

Figure 2.5: Rapprochement of parallel light beams in the gravitational field.

transformations can be related to empty space only, since real bodies (even simply as reference points) lead to nonlinear properties of the space. Then, phenomena differences with changing reference systems must be studied for the same point (in the space and time). But how can two different observers be placed at one point? Therefore, the relativistic approach can possess the approximate model character only (without globality).

It is not any surprising thing, that the same physical value – a mass – can participate in different phenomena: as a measure of inertia for any acting forces, including the gravitational one, and as a gravitating mass (for example, a moving charge produces both electric and magnetic fields). The question on the rigorous equality of inertial and gravitating masses is entirely artificial, since this equality depends on the choice of a numerical value of the gravitational constant γ . For example, expressions (laws) retain the same form in the case of proportionality $m_g = \alpha m_{in}$, but the gravitational constant will be defined as $\gamma' = \alpha^2 \gamma$. It is not necessary to search any mystics and to create pictures of curved space. The substitution of the same value for the inertial and gravitating mass is made not only for GRT, but for the Newton's theory of gravitation as well. It is nothing more than an experimental fact (more precisely, the most simple choice of the value γ).

When one comes to the dependence of a form of equations on space-time properties [37], there exists some speculation for this idea. The impression is given that we can change this space-time to check the dependence claimed. In fact, the Universe is only one (unique). GRT tries to add a complexity of the Universe to any local phenomena, which is not positive for science. The choice of local mathematical coordinates is a different matter (a phenomenon symmetry can simplify the description in this case) and globality is not the case again.

The use of non-inertial systems in GRT is contradictory intrinsically. Really, in a rotating system rather distant objects will move at velocity greater than light speed; but SRT and GTR assert, that the apparent velocities should be lower, than c . However, the experimental fact is as follows: the photograph of the sky, taken from the rotating Earth, indicates, that the visible solid-state rotation is observed. The use of a

rotating system (the Earth, for example) does not contradict the classical physics at any distance to the object from the center, whereas in GRT the value of g_{00} component becomes negative, but this is inadmissible in this theory. What's about astronomical observations (from the Earth)?

Time in GRT

The notion of time in GRT is confused beyond the limit as well. What does it mean by the clock synchronization, if it is possible only along the unclosed lines? The change of the moment of time reference point in moving around a closed path is an obvious contradiction of GRT, since at a great synchronization rate many similar passes-around can be made, and arbitrary aging or rejuvenation can be obtained. For example, considering the vacuum (emptiness) to be rotating (if we ourselves shall move around a circle), we can get various results depending on a mental idea.

If we momentarily believe the GRT dependence of time from the gravitational potential and believe the equivalence of gravitation and non-inertiality (an acceleration), then it could be easily understand that time depends on the relative acceleration in this case (it is an extended interpretation). Really, different accelerations correspond to different gravitational potentials in this case, and conversely. But relative accelerations possess the vector character (and it cannot be "hidden"), that is the extended interpretation is the only possible one. Using the modified paradox of twins [51], the independence of time on acceleration for extended interpretation can easily be proven. Let two astronauts – the twins – are at a great distance from each other. On a signal of the beacon, situated at the middle, these astronauts begin to fly toward a beacon at the same acceleration (Fig. 2.6). Since in GRT the time depends on the acceleration and the acceleration has relative character, each of the astronauts will believe, that his twin brother is younger than he is. At meeting near the beacon they can exchange photos. However, owing to the problem symmetry, the result is obvious: the time in an accelerated system flows at the same rate, as in non-accelerated one. Besides, each astronaut (third observer can be placed at the beacon) can send the signals to the other one about his each birthday. The same number of

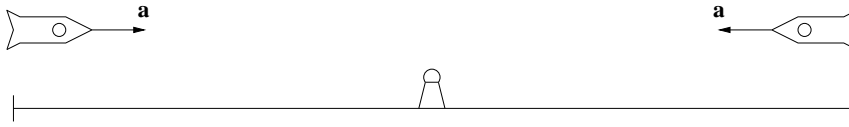

Figure 2.6: The fly of twins with an acceleration.

light spheres will be perceived by each astronaut till they meet at the beacon (there is nowhere to hide the spheres). Having received a "telegram" about 50th birthday of the brother a minute before the meeting, whether the other astronaut will congratulate the brother on his 5th birthday (maybe, he needs the oculist)? If we suppose the gravitational field to be equivalent to the acceleration (according to GRT), then we obtain, that the time intervals do not depend on the gravitational field presence. For example, the extend interpretation which includes the relationship between time and acceleration can be easily disproved in the following manner. Let us consider several mans in different parts of the Earth. If we will use the GRT equivalence of the gravitational field and an acceleration, then, to imitate the terrestrial attraction, they must be accelerated from the Earth's center, that is in different directions (all acceleration vectors will differ their directions). Therefore, all relative accelerations will be different. Owing to the problem symmetry, the result is obvious: the age of these mans will be independent on their location.

Now we make some remarks concerning the method of synchronization of times by means of a remote periodic source disposed perpendicular to the motion of a body [48]. We begin with inertial systems. The possibility of time synchronization on restricted segments of the trajectory makes it possible to synchronize the time throughout the line of motion (Fig. 2.7). Indeed, if for each segment there exists an arbitrarily remote periodic source N_j sending the following information: its number N_j , the quantity n_j of passed seconds (the time reference point is not coordinated with other sources), then the observers at junctions of segments can compare the time reference point for a source on the left and for a source on the right. Transmitting this information sequentially

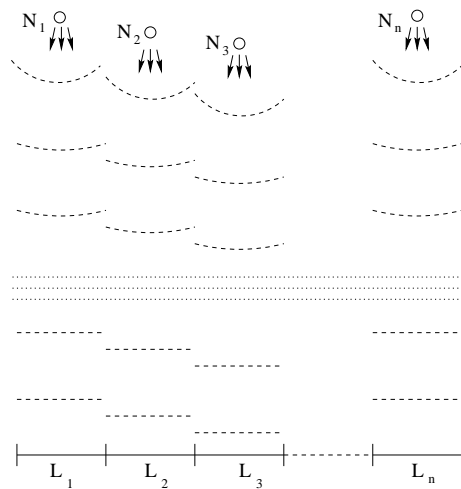

Figure 2.7: The time synchronization throughout the line of motion.

from the first observer to the last one, it is possible to establish a single time reference point (the time itself, as it was shown in Chapter 1, has absolute sense [48]).

Apparently, the observed rate of transmission of synchronization signals has no effect on the determination of duration of times: the pulses (for example, light spheres or particles), which mark the number of passed seconds, will equidistantly fill the whole space, and the number of spheres emitted by a source will be equal to the number of spheres, which reach the receiving observer. (We are not the gods, you see, to be able to introduce the "beginning of times": the time takes already its normal course and elapses uniformly.) Even if we consider the apparent signal propagation rate to be $c = c(\mathbf{r})$, then, irrespective of the path of light, the number of spheres reached the receiving observer (having a zero velocity component in the source direction) will be the same as the number of spheres emitted by a source (simply, the spheres can be spatially thickened or rarefied somewhere). Time as the duration will be perceived uniformly. Thus, the full synchronization is possible in the presence of spatial inhomogeneities (of the gravitational field) as well.

We would remind two well-known experiments which were urgently ascribed by relativists to GRT advantages. The Hafele-Keating's experiment consisted in the following: two pairs of cesium atomic watch flew at an airplane in the east and west directions, and their readings were compared with the resting watch (in so doing the SRT "velocity effect" was taken into consideration, but its lack was proved in Chapter 1 of the present book). The Pound-Rebka's experiment consisted in the following: using the Mossbauer effect, a frequency shift was detected for a photon which passed some distances in the vertical directions (both up and down). In physics it is not accepted to take into account the same effect twice. It is clear, that the acceleration and gravitation express some force, that influences various processes. But this will be the general result of the effect of namely the forces. For example, not any overload can be withstood by a man, the pendulum clock will not operate under zero gravity, but this does not mean, that the time stopped. Therefore, the rough Hafele-Keating's experiment states the trivial fact, that the gravitation and acceleration somehow influence the processes in a cesium atomic watch, and the high relative accuracy of this watch for a fixed site is fully groundless. Besides, interpretation of this experiment contradicts the "explanation" of the Pound-Rebka's experiment with supposition about independence of frequency of emission in "the units of intrinsic atom time" [3] on gravitational field. Besides, a further uncertainty in GRT must be taken into consideration: there can exist immeasurable rapid field fluctuations (with a rate greater than inertness of measuring instruments) even in the absence of the mean field \mathbf{g} . Such the uncertainty exists for any value of \mathbf{g} : since the time in GRT depends on the gravitational potential, then an effective potential will be nonzero even with $\langle \mathbf{g} \rangle = 0$. Whether is it possible to invent, though theoretically, a precise watch, which can be worn by anybody? Probably, a rotating flywheel with a mark (in the absence of friction – on a superconducting suspension), whose axis is directed along the gravitational field gradient (or along the resultant force for non-inertial systems) could read out the correct time. At least, no obvious reasons and mechanisms of changing the rotation rate are seen in this case. Certainly, for weak gravitation fields such a watch will be less accurate

at the modern stage, than cesium one. Outside the criticism of relativity theory, we hypothesize, that atom decay is anisotropic, and this anisotropy can be interrelated with a direction of the atomic magnetic moment. In this case we can regulate atomic moments and freeze the system. Then, the "frozen clock" will register different time depending on its orientation in the gravitational field.

Now we return to synchronizing signals (for simultaneous measurement of lengths, for example). For a rectilinearly moving, accelerated system it is possible to use the signals from a remote source being perpendicular to the line of motion, and for the segment of a circle the source can be at its center. These cases actually cover all non-inertial motions without gravitation. (Besides, for the arbitrary planar motion it is possible to make use of a remote periodic source being on a perpendicular to the plane of motion.) For the real gravitational field of spherical bodies in arbitrary motion along the equipotential surfaces it is possible to use periodic signals issuing from the gravitational field center.

Note, that to prove the inconsistency of SRT and GRT conclusions on the change of lengths and time intervals it is sufficient, that the accuracy of ideal (classical) measurement of these values could principally exceed the value of the effect predicted by SRT and GRT. For example, for a synchronizing source being at the middle perpendicular to the line of motion we have for the precision of the time of synchronization: $\Delta t \approx l^2/(8Rc)$, where l is the length of a segments with the synchronized time, R is the distance to the synchronizing source; that is, Δt can be decreased not only by choosing the great radius of a light sphere, but also by choosing a small section of motion l . From the SRT formulas on time contraction we have for the similar value: $\Delta t = l(1 - \sqrt{1 - v^2/c^2})/v$. If for finite R and specified speed v we choose such l , that the inequality

$$l/(8Rc) < (1 - \sqrt{1 - v^2/c^2})/v, \quad (2.1)$$

be met, then the conclusions of relativistic theories occur to be invalid.

For the system arbitrarily moving along the radius (drawn from the gravitational field center) it is possible to use for synchronization a free falling periodic source on the perpendicular to the line of motion. In

this case R should be chosen of such value, that the field cannot actually change (due to equipotential sphere rounding) at this distance, and corresponding l from (2.1) near the point, to which the perpendicular is drawn. Therefore, the GRT conclusions can be refuted in this case as well. For the most important special cases the "universal" SRT and GRT conclusions on the contraction of distances as a property of the space itself are invalid. In the most general case it seems intuitively quite obvious, that such a position of a periodic source can be found, that the signal to come perpendicular to the motion, and that such R and l from (2.1) to exist, which refute the GRT results. There is no necessity at all in a "spread" frame of reference and in an arbitrarily operating clock: any change of real lengths should be explained by real forces; it is always possible to introduce a system of mutually motionless bodies and the universal time (even if it were the recalculation method). Thus, the space and time must be Newtonian and independent on the motion of a system.

Some GRT corollaries

Now we pass to mathematical methods of GRT and to corollaries of this theory. The games with the space-time properties result in the fact, that in GRT the application of variation methods occurs to be questionable: the quantities are not additive, the Lorentz transformations are non-commutative, the integral quantities depend on the path of integration. Even it is not clear, how the terminal points can be considered as fixed, if the distances are different in different frames of reference.

Because of nonlocalizableness (non-shieldness) of gravitation field, conditions on infinity (because of the mass absence on infinity, it is euclideaness) are principally important for the existence of the conservation laws in GRT [37] (for systems of the insular type only). The classical approach is more successive and useful (theoretically and practically): energy is determined correctly to a constant, since the local energy difference between two transition points has a physical meaning only. Therefore, conditions on infinity is groundless.

Highly doubtful is the procedure of linearization in the general form, since it can be only individual. The tending to simplicity is declared, but

even two types of time are introduced – coordinate and intrinsic time. The fitting to the well-known or intuitive (classically) result is often made. So, for motion of Mercury’s perihelion [3] the $du/d\varphi$ derivative can have two signs. Which of them should be chosen? To say already nothing of the fact, that the dividing by $du/d\varphi$ is performed, but this quantity can be zero. The complexity of spatial-temporal links is stated, but eventually one passes for a very long time to customary mathematical coordinates; otherwise there is nothing to compare the results with. For what was there a scrambling? For pseudo-scienceness?

Till now there is no sufficient experimental proof of whether the rate of transmission of gravitational interactions is higher than, lower than, or exactly equal to, light speed (as is postulated in GRT). For example, on the basis of observations, Laplace and Poincare believed [24,87] that the rate of transmission of gravitational interactions is several orders greater than the light speed.

Now we note on the experimental substantiation of the GRT. Usually, even there exists a hundred different data, a theory is constructed not always: the data can simply be tabulated in a table. But in the case of the GRT we see ”the Great theory of three and half observations”, three of which are the fiction. Concerning the light deflection from rectilinear motion in a gravitational field, we should make the following statements. First, as it was pointed out by many experimentalists, a quantitative verification of an effect essentially depends on the faith of the concrete experimentalist. Second, even from the classical formula $m\mathbf{a} = \gamma m M \mathbf{r}/r^3$ it follows that any ”object” (even of zero or negative mass) will ”fall down” in the gravitational field. Third, with which a value does the effect be compared? With a value in empty space? As early as 1962, a group of Royal astronomers declares that the light deflection near the Sun cannot be considered as confirmation of GRT, because the Sun has an atmosphere stretching for a great distance. We would remind that the effect of refraction is long taken into account by astronomers for the terrestrial atmosphere. Lomonosov discovers the deflection of a light beam in the atmosphere of the Venus long ago. For explanation, imagine a glass sphere. Naturally, parallel rays (from distant stars) will be deflected to the center in it. Such a system is well

known as an optical lens. The similar situation will take place for a gas sphere (the Sun's atmosphere). For accurate calculation of light beam deflection in the gravitational field, one should take into account that the presence of the solar atmosphere and the fact, that the presence of density and temperature gradients on the beam path causes changes to the medium's refractive index and, hence, to the bending of the light beam. Even at the distance of a hundred of meters (near the Earth), these effects cause a mirage, so ignoring them for a beam coming from a star and passing near the Sun (at millions of kilometers) is a pure speculation.

The displacement of the perihelion of Mercury is, of course, a remarkable effect, but whether the sole example is insufficient "to attract" a scientific theory, or not? Therefore, it would be interesting to observe it near solid bodies (for the satellite of the planets, for instance), so that the value of this effect could be estimated for certainty. The matter is that the Sun is not a solid body, and the motion of Mercury may cause a tidal wave on the Sun, which may in turn also cause a displacement of Mercury's perihelion. (Depending on the rate of transmission of gravitational interactions and "hydrodynamic" properties of the Sun, the tidal wave may either outstrip, or lag behind the motion of Mercury.) In any case, it is necessary to know the rate of transmission of gravitational interactions for calculating the effect of a tide due to the Mercury and other planets on Mercury's orbit characteristics, in order that the purely "gravitational" effect (if it exists) of the general relativity theory could be separated.

Calculating the perihelion displacement in GRT (from the rigorous solution for a single attractive point), the impression is given that we know astronomical masses exactly. If we use GRT as a correction to Newton's theory, the situation is in fact opposite: there exists a problem knowing visible planet motions to reestablish the exact planet masses (to substitute the latter and to check GRT thereafter). Imagine the circular planet orbit. It is obvious in this case, that the Newtonian rotation period will already be taken with regard to an invisible precession, i.e. the period will be renormalized. Therefore, renormalized masses of planets are already included in Newton's gravitation theory. Since

the GRT-corrections are much less than the perturbation planet actions and the influence of a non-sphericity, the reestablishment of exact masses can essentially change the description of a picture of the motion for this complex many-body problem. No such detailed analysis was carried out. Generally speaking, the situation with description of the displacement of the Mercury's perihelion is typical for relativist's behaviour. First, it was declared that the effect was predicted, but Einstein compares it with the well known results of approximate calculations, which was produced by Laplace long before origin of the GRT. Hope, each man understands a great difference between "predict" and "explain after the event" (remember the appropriate anecdote of Feynman). Second, there exists the most part of precession already in classical physics: the data of 19th century was found with taking into account influences of some planets. The result obtained was the value of 588", whereas a deficiency in the calculated value make up about 43" only, that is a small correction. (Note, that some data of 20th century indicate the total value of precession to be about 10 times higher than mentioned one, but the "deficiency for GRT" in 43" is maintained - "taboo"; nevertheless, it could be a misprint and we will not cavil to 1/3 of "the great experimental base of GRT"). Third, the exact calculation for a many-body problem cannot yet be made even by the modern mathematics. In classical case the calculation was made as a sum of independent corrections from influences of separate planets (the Sun and planets were considered as material points). Naturally, the classical net result (more than 90 % from observable one!) can some more be improved with taking into account the solar non-sphericity, influences of all planets (including small bodies) of the solar system, the fact that the Sun is not a solid object (a material point) and its local density in different layers must "follow" influences of other moving planets. Most probably, this way of using real physical mechanisms can lead to obtaining the deficient small effect. But the relativist's declaration is inconceivable speculation! They "found" an effect (the small procent only) considering motions of two material points only - the Sun and the Mercury. Sorry, and what will a correction be made with the GRT for the most part of the effect obtained classically? Do you fear to calculate? Then on what "a brilliant coincidence"

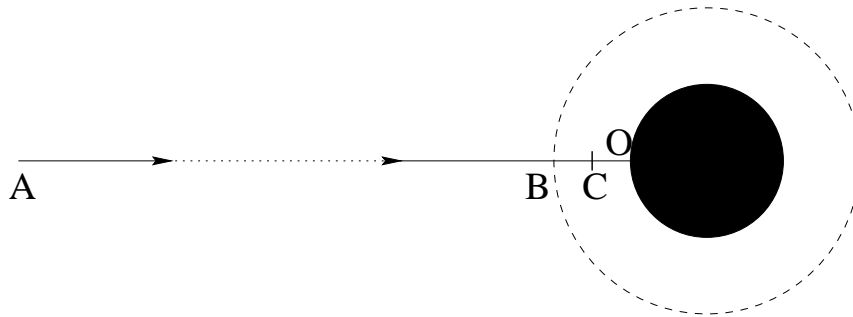

Figure 2.8: The fall on a "black hole".

do you repeat? It is the pure machination to a desired result!

The prototype of the "black hole" in Laplac's solution, where the light, moving parallel to the surface, begins to move over a circle like the artificial satellite of the Earth, differs from the GRT ideas. Nothing prohibits the light with a rather high energy to escape the body in the direction perpendicular to its surface. There is no doubt, that such beams will exist (both by internal and external reasons): for example, the beams falling from outside will be able to accumulate energy, in accordance with the energy conservation law, and to leave such a "black hole" after reflecting. Instead of invoking contradictory properties of light, we simply consider the "fall" of an elementary particle – an electron, for example. Whether the possibility of the elastic reflection is maintained for it, or such the possibility must postulatively be forbidden (to rescue the GRT)? And if such the possibility is not forbidden, then we consider the following process. Let an electron be coming into fall with the zero start velocity from a distant point A (at the distance 100 a.u., for example) to a very massive body (Fig. 2.8). The body absorbs "last surplus nearest molecules" and becomes the "black hole" in a matter of an instant before the electron crosses the Schwarzschild sphere (which is marked as B on the picture). To be visual, the distance $|OB|$ is shown comparatively large. In a matter of an instant before the collision of the electron with the surface of the "black hole" the latter

object was stable, and since neither velocity nor acceleration of this surface can instantly become very large (besides, the collision can take place with a particle flying to meet), then at the elastic collision the electron will fly to the point A with just the same speed as it acquires before the collision. Relativists claim that it cannot get over the Schwarzschild sphere B . Let it come to a stop at the point C (at the distance 10 km from the body center, for example). If the energy conservation law is obeyed, and since the electron's velocity equals to zero at the points A and C , then the potential energy of the electron at the point A is equal to the potential energy at the point C . Therefore, the gravitational field (attractive forces) is absent between the points A and C , or else the potential might be monotonically decreasing. However, the consideration of the situation from the pure GRT positions leads to the still worse result (see below). The "black holes" in GRT is a real mysticism. If we take a long rod, then at motion its mass will increase and the size will decrease (according to SRT). What will happen? Is the "black hole" generated? All the sky will become filled with "black holes", if we shall move rapidly enough. And, you see, this process would be irreversible in GRT. For example, any object of the Universe is a "black hole" for fast moving light (how it can exist?).

Recall some well-known solutions: 1) the Schwarzschild solution describes the centrally symmetric "field" in vacuum (note that the temperature characteristic is absent, i.e. $T = 0\text{K}$); and 2) the axially symmetric Kerr's metric describes the "field" of a rotating collapsing body. The presence of singularities or multiple connection of the solution implies, that, as a minimum, the solution is inapplicable in these regions. Such a situation takes place with the change of the space - time signature for the "black hole" in the Schwarzschild solution, and it is not necessary to search any artificial philosophical sense in this situation. The singularity in the Schwarzschild solution for $r = r_g$ cannot be eliminated by purely mathematical manipulations: the addition of the infinity with the other sign at this point is the artificial game with the infinities, but such a procedure requires the physical basis. (You see, all singularities at zero are not eliminated by artificial addition of $\alpha \exp(-\lambda r)/r$, where λ is a large quantity).

Even from GRT follows the impossibility of observation of "black holes": the time of the "black hole" formation will be infinite for us as remote observers. Even if we were waited till "the End of the World", no one "black hole" could have time to form. And since the collapse cannot be completed, the solutions, which consider all things as though they have already happened, have no sense. The separation of events by infinite time for internal and external observers is not "an extreme example of the relativity of the time course", but the elementary manifestation of the inconsistency of Schwarzschild's solution. The same fact follows from the "incompleteness" of systems of solutions. It is not clear, what will happen with the charge conservation law, if a greater quantity of charges of the same sign will enter the "black hole"? The mystical description of "metrical tidal forces" [39] at approaching the "black hole" is invalid, since it would mean, that the gravitation force gradient is great within the limits of a body, but all GRT ideas are based on the opposite assumptions. The Kerr metric in the presence of rotation also clearly demonstrates the inconsistency of GRT: it gives in a strict mathematical manner several physically unreal solutions (the same operations, as for Schwarzschild's metric, do not save the situation). Thus, such the GRT objects as the "black holes" cannot exist and they must be transferred from the realm of sciences to the province of the non-scientific fiction. All the Universe is evidence of the wonderful (frequently dynamical) stability: there do not exist infinite collapses (an explosion can happen sooner). All this does not cancel a possibility of the existence of superheavy (but dynamically stable) objects which can really be manifested by several effects (for example, by accretion, radiation etc.). No the GRT fabrications are required for these purposes at all. We have no need to seek ways for the artificial rescue of the GRT, such as the "evaporation of the black holes", since such a possibility is strictly absent in the GRT (the speed of light cannot be overcome). On the contrary, in classical physics no problems exist at all.

GRT contains a lot of doubtful prerequisites and results. List some of them. For example, the requirement of gravitational field weakness for low velocities is doubtful: if the spacecraft is landed on a massive planet, whether it can not stand or slowly move? Whether some molecules

with low velocities cannot be found in spite of temperature fluctuations? The consideration of a centrally symmetric field in GRT has not physical sense as well: since the velocity can be only radial, then not only rotations, but even real temperature characteristics can not exist (i.e. $T = 0 K$). The field in a cavity is not obtained in a single manner, but, simply, two various constants are postulated in order to avoid singularities.

The emission of gravitation waves for a parabolic motion (with eccentricity $e = 1$) results in the infinite loss of energy and angular momentum, which obviously contradicts the experimental data.

In fact, GRT can be applied only for weak fields and weak rotations, i.e. in the same region, as the Newtonian theory of gravitation. Recall that the similar interaction between moving charges differs from the static Coulomb law. Therefore, prior to applying the static Newtonian law of gravitation, it must be verified for moving bodies, but this is a prerogative of the experiment.

Let us discuss one more principal point concerning the relativity of all quantities in GRT. The laws, written simply as the equations, determine nothing by themselves. The solution of any problem still requires the knowledge of specific things, such as the characteristics of a body (mass, shape etc.), the initial and/or boundary conditions, the characteristics of forces (magnitude, direction, points of application etc.). The "reference points" are actually specified, with respect to which the subsequent changes of quantities (position, velocity, acceleration etc.) are investigated. The principal relativity of all quantities in GRT contradicts the experiments. The subsequent artificial attempt to derive accelerations (or rotations) with respect to the local geodesic inertial Lorentzian system – this is simply the fitting to only workable and experimentally verified coordinates of the absolute space (GRT does not contain any similar things organically [18]).

The gravitational constant is not a mathematical constant at all, but it can undergo some variations [9]. Therefore, this value can account corrections to Newton's static law of gravitation (for example, these influences do not taken into consideration for the displacement of the perihelion of the Mercury). We are reminded that in finite moving

(periodic, for example) different resonance phenomena can be observed for a coupled many-body system. The effect is manifested in a conforming correction of orbital parameters (especially taking into account a finite size of bodies: non-sphericalness of their form and/or of the mass distribution).

Generally speaking, the theory of short range for gravitation could be useful (but it can be not useful depending on the gravitation transmission rate) for the finite number of cases only: for the rapid ($v \rightarrow c$) motion of massive (the same order) bodies close to each other. The author does not know such practical examples.

The GRT approach to gravitation is unique: to be shut in the lift (to take pleasure from the fall) and to be not aware that the end (hurt oneself) will be after a moment. Of course, the real state is quite different one: we see always where and how we move relative to the attractive center. Contrary to Taylor and Wheeler, it is the second "particle", together with the first "particle" – with the observer. That is the reason that the pure geometric approach is a temporal zigzag for physics (although it could ever be useful as a auxiliary technique). And two travelers from the parable [33] (allegedly demonstrate the approach of the geometry of curved space) have need for "very little": for the wish to move from the equator just along meridians (on the spheric earth surface), but the rest of five billion mans can not have such the wish. Contrary to traveler's wish, the wish "to do not attract to the Earth (or the Sun) and to fly away to space" is inadequate. The notion force (the force of gravity in this case) reflects this fact. Geometry cannot answer to the following questions: how many types of interactions exist in nature, why there exist they only, why there exist local masses, charges, particles, why the gravitational force is proportional just to r^2 , why there realize the specific values of physical constants in nature, and many other questions. These problems are the physical (experimental) prerogative.

2.3 Criticism of the relativistic cosmology

The theories of evolution of the Universe will remain the hypotheses for ever, because none of assumptions (even on the isotropy and homogeneity) can be verified: "a moving train, which departed long ago, can be caught up only at the other place and at the other time". GRT assigns to itself the resolution of a series of paradoxes (gravitational, photometric, etc.). Recall that the gravitational paradox consists in the following: it is impossible to obtain the definite value of the gravitational acceleration of a body from Poisson's equation for the infinite Universe possessing a uniform density. (What relationship to the reality bore pure mathematical uncertainties with conditions on infinity for a physical model?) Recall also the essence of the photometric paradox: for the infinitely existing (stationary) infinite Universe the brightness of sky must be equal to the mean brightness of stars without considering the light absorption and transform (again we have rather many unreal assumptions). However, the classical physics has also described the possibilities of resolution of similar paradoxes (for example, by means of systems of different orders: Emden's spheres, Charlier's structures, etc.). Apparently, the Universe is not a spread medium, and we do not know at all its structure as a whole to assert the possibility of realization of conditions for similar paradoxes (more probably, the opposite situation is true). For example, the Olbers photometric paradox can easily be understood on the basis of the analogy with the ocean: the light is absorbed, scattered and reflected by portions, and the light simply ceases to penetrate to a particular depth. Certainly, such a "depth" is huge for the rarefied Universe. However, the flashing stars represent rather compact objects spaced at great distances from each other. As a result, only a finite number of stars make a contribution into the light intensity of the night sky (to say nothing of the fact that the Doppler effect, or, more better, the red shift as the experimental fact, must be also taken into account in the theory).

The situation with the red shift in spectra of astronomical objects does not be finally clarified. In the Universe there exists a considerable number of objects with quite different shifts in different spectral

regions. Generally speaking, since distances to remote objects do not directly measured (the calculated result is connected with some hypotheses), then their relation with the red shift is hypothesis also (for which it is unknown what the matter could be verified). For example, the expanding of the Universe gives a red shift according to the Doppler effect irrespective of GRT. Besides, it should be taken into consideration, that even the elementary scattering will make contribution into the red shift and filling of the so-called relic radiation: recall that the Compton effect gives waves with $\lambda' > \lambda_0$. The shift of lines in the gravitational field has been well predicted even by mechanistic models from the general energy considerations.

Generally speaking, the theory of Big Bang casts the Big doubts. In addition to the banal questions: "what, where and when was exploded" (since space, time and substance did not exist), the question arises: what about the GRT conclusion on black holes (and the insuperability of light speed)? At the time origin the Universe must be a black hole (and not only at this time instant, but throughout some period). Since we observe the occurring everywhere expansion, the GRT limitations and rather figurative description of compression for black holes disappeared somewhere. Probably, it is interesting to invent something that cannot be verified (only it does not worth to name the science).

Now we pass to the following principal issue. Whether positive is the fact, that the distribution and motion of the matter cannot be specified arbitrarily? And whether is it correct? Generally, this implies the inconsistency of the theory, because there exist other forces, except gravitational ones, which are also capable to transpose the matter. From the practical viewpoint this means, that we should specify all distributions in the "correct-for-GRT" manner even at the initial time instant. In such a case we should refer t_0 instant to "the time of creation", did we? And what principles should be unambiguously determinate for such a choice? This requires more knowledge, than results are expected from GRT. Open to question occurs to be the possibility of point-like description and the theory of disturbances, because the resulting values cannot be arbitrary as well. The joining of a completely unknown equation of state to the system of equations implies artificial complication

of macro- and micro-levels by linkage and reflects the possibility of arbitrary fittings (for example, the temperature dependence is rejected). The possibility of adding the cosmological constant into Einstein's equations is an indirect recognition of ambiguity of GRT equations and of possible outrage. If everything can be specified to such an accuracy, then why cannot we specify in arbitrary manner the initial distribution and the motion of a matter?

The Mach principle

The Mach principle of stipulation of an inert mass and absolute nature of the acceleration due to the influence of far stars is also doubtful, since it explains the intrinsic properties of one body via the properties of other bodies. Of course, the idea is elegant in itself. If everything in the world is supposed to be interdependent and some ideal complete equation of state is believed to exist, then any property of bodies should be determined by the influence of the whole remaining Universe. However, in such a case any particle should be considered to be individual. This way is faulty for science, which progresses from smaller knowledge to greater, since "it is impossible to grasp the immense". Actually, if we take into account the non-uniform distribution of mass (in compact objects) and different values of attraction forces from close and far objects, then the complete "tugging" would be obtained instead of uniform rotation or uniform inertial motion of an object.

The Mach principle cannot be verified in essence: both removal of all bodies from the Universe and mathematical tending of the gravitation constant to zero are the abstractions having nothing in common with the reality. However, it is possible to estimate the influence of "far stars" experimentally by considering the mass of the Universe as mainly concentrated in compact objects. The force of attraction of a star having a mass of the order of the Sun's mass $M \sim 2 \cdot 10^{30}$ kg, being at the distance of 1 light year $\sim 9 \cdot 10^{15}$ m, is equivalent to the action of a load having a mass of only $m_0 \sim 25g$ at the distance of 1 meter. We shall make use, for a while, of the doubtful Big Bang theory and shall consider the time for the Universe to be equal to $\sim 2 \cdot 10^{10}$ years. Even if the stars fly away with light speed, we would have the size of the

Universe equal to $\sim 2 \cdot 10^{10}$ light years. We will suppose the mean distance between nearest stars in 1 light year. We have deliberately increased all quantities; for example, the mass of the Universe and its density $\rho \sim 10^{33}/10^{54} \sim 10^{-21}$ g/cm³. We take into account now, that, as the bodies move away from each other at the two-fold distance, the force decreases four-fold, etc. We try to imitate the effect (on a body) of the gravitational force from the Universe in some direction. Even if we suppose the mean distance between the nearest stars to be 1 light year, then at the distance of 1 meter it is necessary to place the mass (we sum up to $2 \cdot 10^{10}$) of

$$M_0 \sim 25(1 + 1/4 + 1/9 + \dots) = 25 \sum 1/n^2 \sim 25\pi^2/6 < 50$$

grams. In fact, coefficient $\pi^2/6$ expresses some effective increase of the density at the observation line. To simulate the action of the "whole Universe" we can take a thick metal sphere with outer radius of 1 meter and make its thickness varying in the direction to the center (to imitate heterogeneities, we can make the needle-shaped structure near the inner radius).

Let the width of a solid sphere be 0.6 meters, i.e. from the center up to 0.4 meters there is a niche, and further, up to 1 meter, – the metal. Then a cylindrical column of radius ~ 0.35 cm will correspond to mass M_0 at density of ~ 8.3 g/cm³. In reality, we should take into account the influence of stars in a cone, but not only in a cylinder. Though we also have a spherical metal cone, nevertheless, we shall estimate the orders of magnitudes. We shall break a cone into cylindrical layers, which arise as the new layers of stars are involved into consideration (Fig. 2.9). Each new layer will be greater, than a preceding layer, by 6 stars. The distances from the center to the nearest boundary of each layer of stars can be found from the similarity of triangles: $R_i/1 = i/r$. Then we have $R'_i = \sqrt{i^2(1+r^2)}/r$. Therefore, the correction to a mass (we sum up to $2 \cdot 10^{10}$) will be found as

$$m_0(1 + \frac{1}{4} + \dots) \left(1 + \sum_i \frac{6}{R_i'^2} \right) < M_0 \left(1 + 6r^2 \sum_i \frac{1}{i} \right)$$

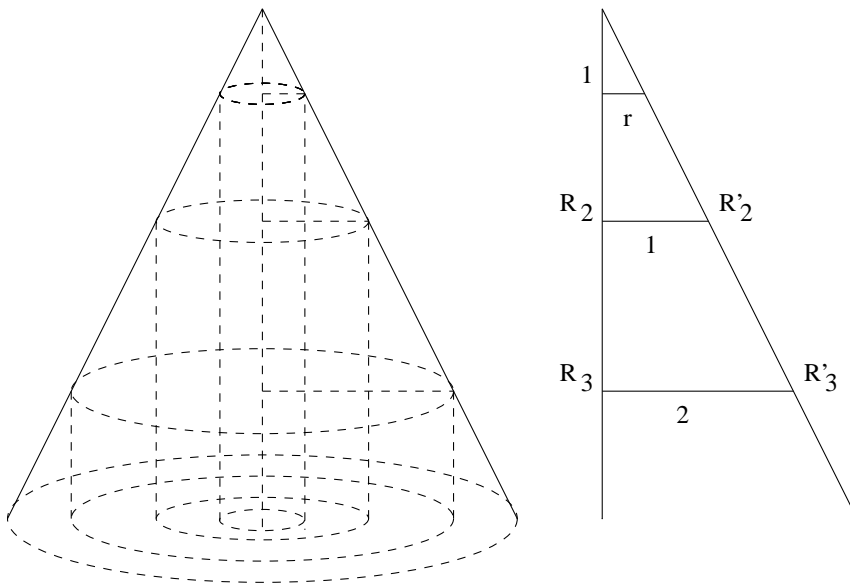

Figure 2.9: The Mach principle and influence of the Universe.

$$\sim M_0 \left(1 + 6 \cdot 10^{-5} \log(2 \cdot 10^{10}) \right) \sim M_0(1 + 0,02).$$

Thus, our construction is quite sufficient for taking into account the "whole Universe". Certainly, if the Universe is infinite, then the obtained harmonic series will diverge, and the construction will be inadequate. This, however, contradicts both GRT and the modern ideas.

Let now place the globules on a spring inside the sphere. To avoid the collateral effects, the air can be pumped out from the structure and, in addition, the globules can be isolated from the sphere by a thin vessel. Now, if we begin to spin up the sphere, then, according to the Mach principle, the centrifugal force should appear, and the globules will move apart of each other. In this case the centrifugal force must be the same, as though the globules themselves would rotate. It seems quite obvious, that this is impossible, since such an effect would be noticed still long ago. Thus, we return to absolute notions of acceleration, mass, space and time defined still by Newton. However, the described experiment could appear to be useful for determining the corrections to the static Newton's law of gravitation. In this case the globules should have sufficient freedom to move and to rotate, since the direction of action of correcting forces and moments of forces is unknown a priori.

2.4 Conclusions to Chapter 2

The given Chapter 2 is devoted to the GRT criticism. A set of striking doubtful points from the GRT textbooks is emphasized, beginning with general concepts of the covariance, baseline physical notions, and finishing with more specific ones. The proof of the geometry invariance in a rotating coordinate system is carried out in detail. The groundlessness and inconsistency of the principle of equivalence in GRT is discussed. The inconsistency of the notion of time and its synchronization in GRT is demonstrated. The methods of time synchronization and simultaneous measurement of lengths are indicated for the most interesting special cases. The invariance of space geometry is demonstrated and the role of boundaries is also discussed in Chapter 2. The doubtful points are emphasized both for the methods and for numerous corollaries of GRT.

The inconsistency of the notion of "black holes", of Schwarzschild's solution and many other GRT corollaries are considered in detail. The Mach principle and its possible verification are also discussed.

The ultimate conclusion of this Chapter 2 consists in the necessity of returning to classical notions of space and time and of constructing the gravitation theory on this established basis.

Chapter 3

Experimental foundations of the relativity theory

3.1 Introduction

The main part of criticism of TO from previous Chapters was founded on the so-called mental experiments. We make some trivial note to prevent the absurd question about the technical practicability and experimental accuracy of mental experiments. It is generally accepted from Galileo's time that the construction of mental experiments uses notions and principles of some theory under criticism and demonstrates their inner inconsistency. As the result, the value which can be compared with experiments is absent at all. A logical contradiction brings the final dot into the development of any theory. Nevertheless, to form the "complete picture", the consideration of the relativity theory will be continued from the experimental point of view. Real experiments will be analyzed in this Chapter 3, and errors in the interpretation of these experiments with the relativity theory will be shown. To initiate the reflection on relativistic experiments, we consider ideas which could be "almost not conflicting" with SRT (but afterwards we step-by-step will pass to the criticism).

Introduction of Chapter 3 we begin with the question, which is principal for the relativity theory: is light speed constant? The answer to

this question was seemingly given by the Michelson-Morley experiment to study the influence of the Earth movement on the speed of light, plus similar optical experiments made by Morley alone, Kennedy - Thorndike, the Jene experiment of Joose and others [7,61,83]. We note, however, that there have been attempts to correct SRT [79,97,116], and to revive the Lorentz ether theory [1,42,64,95,108,119].

However, the term "constant" implies independence from time, spatial coordinates, light propagation direction, and, finally, characteristics of the light itself. An effort must be made to give an unprejudiced answer to the question: What matter could be identified in Michelson's interferometer? Notice that no speed is determined in the Michelson experiment at all, but some remainder of phases of rays is observed (and we can indirectly judge by the speed only). Recall that light was made to traverse two mutually perpendicular directions. We note also the following: To avoid the synchronization of timepieces at different points, both light beams traveled over a closed path; namely, in two mutually opposite directions. Therefore, only some "average" light speed, involving opposite directions, could actually be determined.

Seemingly, Michelson's result can be stipulated as follows: light speed in two mutually **opposite directions** and **at given frequency** in some particular system is independent of the motion of this system. Apparently, at least two questions arise concerning the Michelson-Morley result:

- 1) Is light speed constant regardless of propagation direction $\mathbf{k}_1 = \mathbf{k}/k$, or might it be anisotropic, $c = c(\mathbf{k}_1)$? This question can be put in a broader sense: Does light speed depend on time t and spatial coordinates \mathbf{r} or not? However, such questions are beyond present theoretical and practical test of SRT, since they involve the problem of space-time structure as such. Problems of this type will not be discussed here, since their experimental verification requires the "basic system" to possess the nonelectromagnetic nature in order to measure the distances and synchronize the time pieces.
- 2) Some more practical question arises: Does light speed in vacuum depend on the characteristics of the light itself. In particular, does there exist a dependence on frequency ω ; i.e. does $c = c(\omega)$?

The physical (philosophical) meaning of light-speed constancy is (from SRT textbooks) as follows: Let the light be capable of propagating in vacuum without any intermediate medium. Because the system of reference cannot be rigidly "tied" to the "emptiness", it does not matter at what speed our system moves with respect to vacuum. Therefore, light speed

with respect to our system must be independent of the system motion (although other particles can move in vacuum with different velocities (!) depending on system velocity). However, the following questions arise: 1) Do vacuum properties change when particles (photons) are brought into the vacuum? 2) What is the mechanism for propagation of electromagnetic oscillations in vacuum? Some particular hypotheses answering these questions will be presented in Appendixes.

What in particular can be determined from present experiments will be analyzed in detail in the given Chapter 3. As the result, detailed criticisms of relativistic interpretation of some well-known experiments and of observable data, which were inadequate attributed in active of SRT and GRT, will be given. The single, seemingly "working part" of SRT – relativistic dynamics – will be considered in detail in the next Chapter 4.

3.2 Criticism of the relativistic interpretation of series of experiments

SRT is known to rest upon two basic postulates: (1) light-speed constancy, and (2) the principle of relativity, which is extrapolated to electromagnetic phenomena. One of the main proofs of the validity of light-speed constancy lies in negative results of experiments on observing the ether wind. We shall see below what should be obtained from the experiments by Michelson - Morley and other researchers from the viewpoint of empty space (more precise from Galileo's relativity principle). Note that we cannot suppose in advance anything about the motion of the Earth; at Galileo's time, for example, such experiments would prove that the Earth was resting. Generally speaking, before using a "device", the latter must be tested and graduated under laboratory conditions – we

must know what can be measured by it? (But the present situation was as in the anecdote: -"Test device, Pete", -"Three!", -"What means "three"?", -"But ... what is a device like?") Imagine that somebody were "create" the following "theory": due to the Earth's axial rotation a constant wind with the value of about 400 m/s might be observed along terrestrial parallels. Measuring it by weathercocks with rotators, it would be obtained that the wind is permanently varying within the broad limits both in the direction and in the value depending on time and place. The "conclusion" would be made from this that the atmosphere is absent at the Earth at all. Since the book is specifically devoted to the criticism of the relativity theory, we will primarily broach the conventional modern relativistic concepts, though some ether concepts will briefly be outlined also.

The Michelson-Morley experiment

Light is known to behave in various phenomena as either a particle or a wave (the statement about corpuscular-wave dualism bears no relation to the subject under consideration). At first, let us suppose light to possess a corpuscular nature. Then the Michelson - Morley interferometer may be represented as two mutually perpendicular arms with a single ideal reflector at the middle and two reflectors at the ends of the arms (Fig. 3.1). Let the two particles moving parallel to each other at velocity \mathbf{v}_1 (relative to the "universal reference system") fall into the given set-up, which, in its turn moves at velocity \mathbf{V} with speed $V < v_1$ (relative to the same reference system). Then at point O_1 the speed of particles relative to the set-up will be $v_1 - V$. After reflection at the set-up center, particle 1 will move in the perpendicular direction at the same speed $v_1 - V$ relative to the set-up. The particles will reflect from the ends of arms simultaneously. Likewise, they will reach simultaneously both point O and point O_1 . No difference in speeds of these two particles for two mutually perpendicular directions will be observed, regardless of velocities v_1 and V . Thus, if the light is supposed to be a flow of particles, then the experiments by Michelson - Morley (Kennedy - Thorndike, Tomachek, Bonch-Bruевич and Molchanov et al.) could not give any positive result.

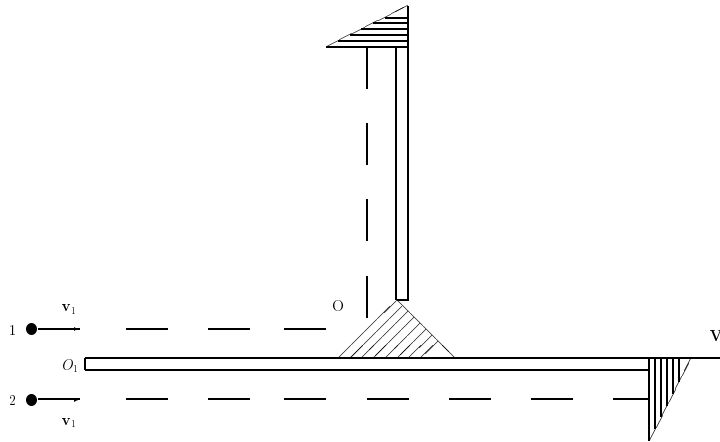

Figure 3.1: Corpuscular model of Michelson-Morley experiment.

Let us now suppose light possesses a wave nature. In this case, light speed can only depend on the properties of the propagation medium (ether or vacuum) and/or intrinsic characteristics of the propagating light itself. If we accept a hypothesis that ether exists, then light speed depends on the properties of this medium (by analogy to sound). It is obvious then that light velocity cannot be added with source velocity (the boom from a supersonic aircraft propagates at the velocity fixed by the medium, and, as a result, the aircraft outstrips the sound). It is also obvious that, since light interacts with both matter (it scatters or absorbs) and ether (it propagates), then some interaction between ether and matter should also be observed. But in the Michelson - Morley experiment, something improbable was assumed; namely, a rigid "binding" of light to ether, along with absolutely no interaction of ether with bodies, (i.e. no ether entrainment by the Earth or by the interferometer). Of course, the theory would be complicated in the case of partial entrainment of the ether (for some local experiments an ether entrainment can practically be complete inside the narrow boundary layer). However, this fact in no way disproves the ether hypothesis (but relativists, like a drunkard under a street lamp, call to seek not there where

it can be really found, but simply there where it were easily to look). We shall briefly discuss the ether concept below, but now we shall rest on the classical relativity principle (in vacuum), since for all paradoxes of the SRT and corollaries of this book it is not important whether we have vacuum or ether.

If light is a wave, then only the light frequency changes with source velocity. So, for given ω , the light speed $c(\omega)$ does not depend on the source velocity. Here we have in mind the following situation: the light waves of the same frequency are identical to each other; and if we perceive the light of frequency ω , then it does not matter, whether it was emitted by a source at the same frequency, or if it was emitted at another frequency ω_1 , and due to source motion the frequency changed: $\omega_1 \rightarrow \omega$ (the Doppler effect). In both cases, the measured value of $c(\omega)$ is the same.

Now we return to the Michelson - Morley experiment and similar ones by other researchers. Since the incident light, the light passed through the thin plate, and the light reflected from the mirrors, all have the same frequency in the same observation system, the light speed $c(\omega)$ remained constant for the two mutually perpendicular directions, and the experiments could not detect anything. Tauson's experiment with two similar lasers could not discover anything either, because in converging the beams to a single pattern (in the same direction), the frequencies become equal, and no regular beatings are observed. Thus, the attempt to find changes in light speed from the experiments with the same fixed frequency is wrong in itself. The only dependence we may try to discover is $c(\omega)$: all other dependences can enter only indirectly, through the Doppler effect.

For methodical purposes we shall consider some apparent errors from textbooks. When researchers proceed from the "classical view-point" (i.e. the hypothesis of motionless, non-involved ether), they often calculate the difference in times of beams propagation in an interferometer using a strange scheme [35], in which the reflection law does not "work": the angle of reflection does not equal the angle of incidence (Fig. 3.2). This "fact" contradicts experiments. In such a circumstance, it is at minimum necessary to explain the mechanism of such a deviation, and to

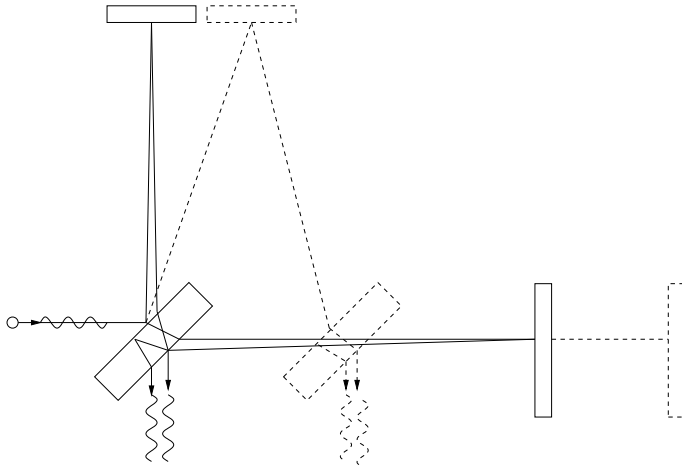

Figure 3.2: Scheme of the interferometer.

determine its effect on the experiment (it could be made in the assumption of classical laws for the addition of light velocity and the velocity of an interferometer's mirror). It is not clear either how we can guess the angle ensuring the interference of the same beam. Actually, since all data are registered only by the observer moving together with the interferometer, the experiment must be analyzed only from the viewpoint of this observer as well [50].

Time synchronization according to Einstein's method introduces artificial limitations even into the ideas of experiments. Obviously, by virtue of the reversibility of relative motion ($-\mathbf{v} + \mathbf{v} = 0$), only an odd-powers effect can exist for the velocity dependence of light speed. However, the Michelson-Morley experiments, and some other ones, try to determine light speed as a mean velocity for two mutually opposite directions (for a closed path). Therefore, a single classical linear dependence on the velocity of motion of a system is mutually excluded. Thus, any similar approach already substitutes the postulate of constancy of light speed, which should be verified experimentally.

The Michelson-Morley experiment and its analogs do not contradict

the Galileo principle and have been considered in detail from the empty space viewpoint above. We consider now the original idea of the experiment from the viewpoint of ether concepts. Note that the Fresnel entrainment coefficient can always be slightly corrected in such a manner, that the experiments of both 1-st and 2-nd order be confirmed to a practical accuracy. For the sake of justice one should note that the Michelson experiment and its analogs (in spite of the disputes concerning the instrument structure and the theory) have always confidently, with allowance for possible errors, given a nonzero velocity of the ether wind [94,95]. Marinov [90,91] and Silvertooth [115] have found a correct velocity relative to a relic radiation. Only at instrument screening with a metal casing the result occurred to be close to zero one. Not accepting the ether theory unconditionally, nevertheless, we recall for the sake of objectivity, that all instruments are vacuumed now (i.e. made a locally closed system). And, for example, the local speed of sound in airplane's saloon will remain constant (independent on the wind outside) even at supersonic motion of an airplane. The ether point of view does not contradict the obtained results: Fresnel's entrainment for metal bodies is complete (Hertz's electrodynamics is valid for metals), and, hence, the ether is resting locally inside the metal casing relative to an instrument, and searching for the ether wind inside is senseless. Yet another moment is usually hidden by relativists. Even in the absence of metal casing, the presence of a thin glass plate (or air in the original experiments) leads to light reradiation from these local rest elements. As the result, in the ether concept the really measured velocity must be wittingly less than the velocity of orbital motion of the Earth. Thus, the Michelson - Morley experiment does not witness the light speed constancy and does not testify against any classical principles.

Aberration, the Fizeau experiment and other experiments

So, which experiments cannot be explained in any way other than invoking SRT? We begin with some subsidiary remarks. We shall not discuss in detail the issues of quantum electrodynamics, because its predictive accuracy depends only slightly on the accuracy: $(\Delta c/c) \sim 10^{-8}$ (this is with motion of the receiver; and light speed can be constant with

motion of the source, for example, by analogy with the sound speed), but nobody even made an attempt to consider light speed to be not a constant.

The stellar aberration phenomenon is fairly explained by the classical physics [23] and is determined by the following two principal facts:

(1) by changes (throughout an year) of the velocity of the observation system, basically by the orbital rotation of the Earth (this absolute state does not depend on the rectilinear motion of inertial systems and on the presence of ether or medium), and

(2) by the rectilinear propagation of light beams between the source and the receiver for inertial systems (it is a result of the light particle inertia for the corpuscular theory, or it is a result of Huygens' principle for the wave theory).

Recall once again that upon "entrance" into our measuring device the light has fixed direction and frequency (the prehistory of the process is not so important: is it the motion of a source, of a "medium", of a receiver), and it is this "particular light", with which all measurements are carried out. The Fizeau experiment is not critical, since it allows to write light speed in a medium as

$$u = \frac{c(\omega)}{n} \pm v\left(1 - \frac{1}{n^2}\right),$$

and the measurement were carried out for a particular fixed frequency ω , i.e. $u(\omega_1)$ and $u(\omega_2)$ have not been compared, which is impossible to be done in the Fizeau experiment.

The attraction of a lifetime of muons for proving the SRT is a pure speculation. The modern mankind cannot create two inertial systems moving relative each other with relativistic velocities. And it is not worth to mask quite a different reality in imitation of the claimed "experiment". The lifetime of unstable particles must depend on the conditions of their formation (even a stable nucleus can become excited or unstable, or, on the opposite, the recombination can take place, etc.), and the conditions of formation of muons at the altitude of 20 – 30 km upon collision of high-energy cosmic rays with nitrogen or oxygen atoms differ from the conditions of their formation and confinement in the laboratory. To say nothing of the fact that even velocities of muons, their

accelerations and intensities of flows do not determined at different altitudes. Measurements, which made in accelerators, most likely testify to influence of accelerations and fields on the concrete decay process of the concrete particles. The "muon proof" was appeared in all SRT-textbooks starting from 1935, but some later it was discovered that 1) muons origin at any altitudes, and 2) their penetrating ability considerably increases with enhancement of energy. But the relativistic pseudo-proof was not be excluded from textbooks for students (to the question on scientific ethics).

The Ritz hypothesis

For the sake of fairness, we note that even the Ritz ballistic hypothesis (in essence, it is the classical law of addition of velocities for corpuscles) could not so easily be disproved at the beginning of 20th century. We shall present briefly the derivation from [29] and make some comments. The time for a signal to arrive from a satellite of a central star at distance L is, upon entering the shadow $t_1 = L/(c - v)$, and upon exiting from the shadow $t_2 = \frac{T}{2} + L/(c + v)$, where T is the orbit period. Allowing for a noticeable effect, the binary system will be seen as threefold when $t_1 = t_2$, for which we obtain $L = T(c^2 - v^2)/(4v)$. For the diameter of orbit we have $D = Tv/\pi$. If α is the observation angle, then $\alpha \approx \tan \alpha \approx D/L$, and, since $v \ll c$, we have $\alpha = 4v^2/(\pi c^2)$. The real velocities of observed satellites are $v \ll 350$ km/s. As a result, for observation of a similar effect we must have $\alpha \ll 2 \times 10^{-6}$ radians (which is beyond the accuracy of modern telescopes).

Of course, this conclusion is rather rough. In the expression for t_2 instead of $\frac{T}{2}$ one must write Tx , where x is the fraction of a period, when the satellite is in shadow; generally $x \ll \frac{1}{2}$, which increases the limiting accuracy of α . Besides, very short time intervals can be recorded now by means of photography (if the exposure allows this), i.e. one may write $t_2 - t_1 = \frac{T}{2} + y$, where $y \ll T$, which ever more increases the limiting accuracy.

However, some remarks can be made for justification as well. Namely:

(1) The study of $t_2 \geq t_1$ is non-productive, since all observed eclipses

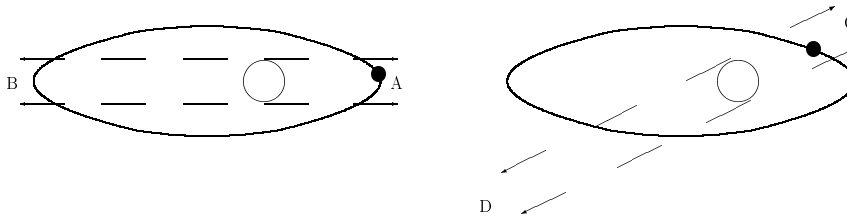

Figure 3.3: Estimation of a shadow region.

will be periodic, and we can not verify in any way, whether we really observe a threefold (or fourfold, etc.) system, or this is only a semblance.

(2) During the orbital motion of a satellite the time of signal arrival to the observation point changes smoothly (the real object – a satellite – does not coincide with its visible image), which distorts the determination of a real orbital motion and quantity x .

(3) Since the light passes through the inhomogeneous medium (the atmosphere, as well as the near-Earth space), the phenomena of scintillation and dispersion can take place. In order to lower their negative effect, the full (rather than partial) eclipses should be observed and, preferably, from the Earth artificial satellites.

(4) Because only the projection of the orbital plane will be accessible for us, we cannot, in the general case, estimate the value x of the section of shadow (Fig. 3.3). The time of motion in a shadow will be different depending on the direction to the observer (to the Earth). Hence, the objects with symmetric orientation are required, and the accuracy of determination of "arms" of the orbit projection and of the size of both bodies imposes limitations on the (calculated) accuracy of determination of signals arrival times.

(5) We have already mentioned above, that the abstract speed of light does not exist, but particular values $c(\omega_1[v])$ and $c(\omega_2[-v])$ will be observed. Therefore, the accuracy of determination of frequencies $(\Delta\omega/\omega_0)$ imposes limitations on the theoretically calculated accuracy $(\Delta c/c_0)$ and, accordingly, on $(\Delta t/t)$.

The most important comment is as follows:

(6) The light of some frequency ω_0 is emitted, not by the object as a whole moving at velocity \mathbf{v} , but rather by the particles moving chaotically within the object with thermal velocities. Therefore, it is impossible to determine the delay of calculated time depending on the velocity of the object as a whole by using any characteristic (in microscales) frequencies (radiation lines). Only if the graph of satellite spectral intensity $I(\omega)$ possesses some particular characteristic form (for example, having a maximum I_{max} at frequency ω_1), and if $I(\omega)$ differs identifiable from the graph of star spectral intensity (for example, in shape), can the observation of changes in spectral intensity $I(\omega, t)$ at the variable frequency $\omega_1(t)$ prove or disprove the Ritz ballistic hypothesis.

As far as the author knows, no such detailed analysis of the astronomical data was carried out. It should be further mentioned that the Ritz hypothesis predicts for binary systems not only a phase modulation of the signal received, but an amplitude one as well (as the result of the varying speed of light propagation, in a fixed space point there occur a pulsation of an intensity due to superposition of light which was emitted at different time instants). As this takes place, the relative intensity of pulsation increases with the distance to the binary system. The frequency of pulsations also increases (to some limits). Some authors [29] believe that the "existence" of quasars and pulsars is one of proofs of the Ritz hypothesis. Really, the smallness of their pulsation period (sometimes less than one second) testifies to the compactness of these objects, but the emitted radiant power (taking into account their remoteness) testifies against the first assumption. And either we must thoroughly test the Ritz hypothesis, or it remains to believe in modern fantastical (non-verifiable) versions. And complications with the processing of radar observations of the Venus compel to meditate on the possibility for the inertial properties of light to exist. However, the defence or development of Ritz's hypothesis is not a subject of this work.

The Sagnac experiment

The Sagnac experiment was sufficient proof of the inequality $c \neq \text{constant}$ (and indirect evidence for the classic law of addition of velocities). Recall that four mirrors (more exactly three mirrors B and

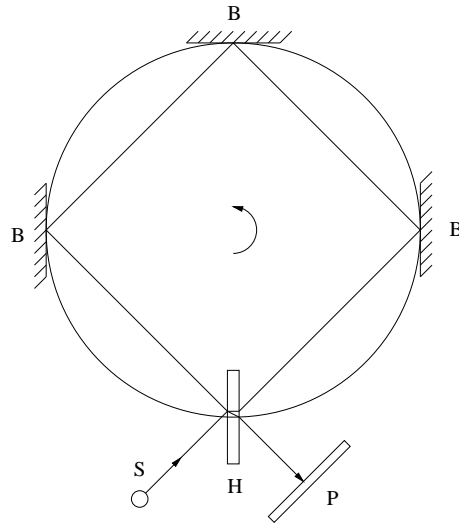

Figure 3.4: The Sagnac experiment.

one plate H – see Fig. 3.4) were installed along the periphery of a disc rotating at angular rate Ω . A light beam was divided (by the plate H) into two beams, and one beam traveled counterclockwise (in the direction of rotation) while the other traveled clockwise. An interference was observed at meeting of these beams. The fringe shift (as a result of the difference in times of propagation of light beams) had magnitude: $\Delta z = 8\Omega r^2/(c\lambda)$. It is obvious that the non-inertial character of the system rotating at Ω is of no concern: nobody saw a curved light beam in vacuum; light travels between two reflections rectilinearly. Nevertheless, we consider the following mental experiment: Imagine that the disc radius tends to infinity $r \rightarrow \infty$, but the value $\Omega r = v$ remains constant. Then we have $\Omega \rightarrow 0$. Therefore, the value of the acceleration $\Omega^2 r$ tends to zero. Let us choose a radius r such that the acceleration is much less than any pre-specified value (the existing experimental accuracy, for example). Nobody can distinguish this "near-inertial" system from a true inertial system. If the number of equidistant mirrors is also increased ($N \rightarrow \infty$), then the straight line (of light beams) between mirrors ap-

proaches the disc circle. As a result the fringe shift can be expressed as $\Delta z = \alpha Lv/c$, where α is a constant for a given λ and L is the circumference. Because of the obvious symmetry of the experiment, the effect is additive in L , and its value can be related to the unit length. A "cumulative" effect of acceleration can be made less than any pre-specified value for a given straightline region. Thus, we have for the magnitude of the fringe shift: $\Delta z \sim v/c$ (some variations in Ω produce appropriate variations in v , since $v = \Omega r$ is a finite value). Therefore, the time of signal propagation linearly depends on the velocity of the motion of the system, that is, $c \neq \text{constant}$.

Say a good word for the "poor ether"

Now we make a supplementary remark concerning the ether. Frankly speaking, the inventing, apart from the "absolute emptiness" (not possessing physical properties), of the other concepts of "physical vacuum"-type (possessing physical properties) is unfair with respect to many previous researchers (plagiarism), since for similar concepts there exists already a special term – "the ether". Only for the ether the problem was stated: to explain all experiments on a simple and clear model or "to go out from the scene". The further development of physics introduced another practice (remember the dualism of light, the quantum mechanics, etc.): the contradictory properties have become to be simply postulated as a fact without explanation and without a real visual model. Let, for example, to be existing a two-component liquid model for describing the contradictory properties of superfluid helium (the flow without viscosity through a capillary and the presence of viscosity at rotation). The reality is far from the model, but the model really works (it is useful). And only the theory of ether was unfairly ruined by the relativists. Though, in fact, for all ether models declared unreal by relativists there were analogies in the nature (but what can be greater expected from the model?). For example, there is nothing surprising in the fact that the speed of light can remain the same as the ether density changes: the speed of sound in air for $T = \text{constant}$ does not depend on the air density as well. There is nothing unnatural also in the fact that the ether density can essentially (60000 times only) increase near

the Earth surface as compared to the open space (the density of the atmosphere grows many orders of magnitude greater). The Stokes model is a model without the atmosphere. The mathematical complications of the model (the supposition on a vortex-free incompressible motion) are pure at anything here: the real (nature describing) solution can occur to be close to that found by Stokes (simply it is mathematically more difficult to find the true stringent solution of nonlinear partial differential equations without simplifications). For the sake of justice we note that rather well-developed concepts of ether are existing now [1,8].

Now we proceed to more specific issues and make brief comments to some well-known experiments. The aberration in the empty space without SRT was analyzed above from the viewpoint of both corpuscular and wave theory. The result will be the same from the viewpoint of the motionless ether theory as well. The full ether entrainment by a medium is not clear in the case, if the medium density gradually decreases (for example, in gases). By this reason nobody (except the relativists) has seriously discussed the full ether-entrainment hypothesis. Even ether were fully entrained by solid and liquid bodies, analysis could not be simple. In this case it is necessary to develop a theory of a transition layer between bodies and a theory of boundary ether layer for gases depending on gas density (for example, we could not dealing with the Earth's orbital speed of 30 km/s as such in Michelson's experiment). However, physics chose the other way, and it was still Fresnel, who introduced the coefficient indicating, that only partial entrainment of ether can be supposed in the optically transparent media. It does not virtually (to achieved accuracy) change the aberration in filling a tube with water, which had been shown by Fresnel himself. (Note that if the observation is non-vertical, it is necessary to take into account the angle of refraction of beams in filling media, but, generally speaking, all similar questions are ascribed not to the theory of aberration but to the theory of refraction.) The only case, where it is lawful to discuss the full ether entrainment hypothesis, is the case of optically opaque media (metals). Maybe it was Hertz, who intuitively felt this situation, when he refused from the very beginning to consider the optical phenomena from the viewpoint of his electrodynamics (by this reason the application

of his theory by relativists with discrediting purposes for dielectrics is invalid).

Trouton and Noble's experiment does not contradict Galileo's principle of relativity for the empty space. Generally speaking, all experiments with dielectrics do not contradict Galileo's principle of relativity, since the light (or the field) passes a part of its path in the emptiness between atoms and the other part of a path – when the light is absorbed and re-emitted by atoms. For the theory of partially entrained ether (if there is no metal screening) the Fresnel entrainment coefficient can always be defined with the practical accuracy which is verified in both the experiments of first and second orders (but frequently the precision turns out small and really it must be introduced some "fitting" coefficients). The Rowland experiment has actually proved that, from the ether theory viewpoint, the ether is fully entrained by a metal, and from the viewpoint of Galileo's principle of relativity he proved the moving charges equivalence to the current. Roentgen, Euchenwald and Wilson have actually obtained in their experiments the Fresnel coefficient of entrainment in dielectrics.

The Kennedy-Thorndike experiment

The only difference between Kennedy-Thorndike's interferometer and Michelson's interferometer is the following: lengths of perpendicular arms were made evidently different in Kennedy-Thorndike's interferometer. However, for the interferometric pattern it is only important the difference of paths of light rays with respect to the wavelength of used light (part of the wavelength). Besides, an interferometer arms (for example, Michelson's interferometer) are always measured with an accuracy which is less, than the wavelength of used light. Therefore, contrary to the judgement of [38], the Kennedy-Thorndike experiment does not principally differ in anything from the Michelson-Morley experiment. As a result, all remarks to the Michelson-Morley experiment, which are indicated previously, will be remained common for both these experiments.

If one proceeds from the experiment tasks (on detecting the effect of the interferometer system motion on the speed of light), then author's

estimate of $v \leq 15$ km/s is more adequate, than that stated in the textbooks, though it is incorrect too (see below). The great stability in temperature, beginning with some limit, does not matter, because at any $T = \text{constant}$ ($T \neq 0$) always exist temperature fluctuations and oscillations of a crystal lattice of the base. Of most importance is the fact, that various speeds of light $c(\omega)$ (the only possible distinction – see above) have not been compared for various frequencies ω , which would be impossible to be done in a similar experiment. Besides, for the empty space all classical considerations for inertial systems remain valid; that is, Galileo’s principle of relativity [48] is met in this case. The general notion about metal screening for the ether model is applicable to this experiment as well. Thus, all listed experiments have no relation even to detecting the motion of the Earth.

The Ivese-Stilwell experiment

Now we shall pass to the Ivese-Stilwell experiment. Note that Ivese himself was a SRT opponent and explained the experiment from the ether theory viewpoint (which means that such an interpretation is also possible). Generally, it is characteristic of SRT to ”put” everything into a personal ”pile” (probably, in order to look more solid) or to ”tie up” SRT with all theories (even not completely verified), pretending that if SRT ”sinks”, then ”all science will also sink”. Generally speaking, unlike the elementary theory of the Doppler effect, determination of a frequency dependence in some arbitrary configuration is a prerogative of experiments (and an implication of an additional hypothesis for time here is rather doubtful). Actually, the Ivese-Stilwell experiments, even in the ideal case (with neglecting real features of a process) would determine not the transversal Doppler effect, but the Doppler effect for two directions close to 0° and 180° , i.e. the effects close to longitudinal ones. These experiments are indirect, since the value of a relativistic correction is a calculated quantity (which is compared, in addition, from various regions, which results in the additional asymmetry). The experiments [22] have shown essential systematic deviations from the relativistic expression (up to $60 \pm 10\%$). Therefore, the effect can be determined not so much by the Doppler expression, as by the feature

of reactions in beams. In addition to mentioning the other alternative experimental data [22,120], we shall give some criticism of considered experiments. Relativists describe the experiment in such a manner, as if the transversal Doppler effect is perceived from one point of an installation at some certain time instant (the time of passage through the middle perpendicular). Actually, the perceived signal is an integral sum from various regions of radiation for various time, and these regions are, in addition, not perpendicular to the motion (where, for example, the aberration has gone?). That is, the studied effect represents some "composite mean value" between two longitudinal Doppler effects. Besides, the theory (and the formulas) in SRT are presented for plane-parallel waves, but in fact we have point-like sources, i.e. the spherical waves at these distances. We write lengths of sides in a triangle: 1) the first side describes a way of the signal along the axis Y from the source to the origin of the reference system O , where the receiver was situated at the moment of emission of the signal: $Y_0 = V_{sig}t$; 2) the second side describes a passed way of the receiver along the axis X from the moment of emission to the moment of the receipt of the signal: $X_1 = vt'$; 3) the third side (diagonal) describes a way of the signal from the source to the point of the receipt: $V_{sig}t'$. Then, from the relation of sides in a triangle it can be found the change of a time delay as compared to the case at rest: $t' = t/\sqrt{1 - v^2/V_{sig}^2}$. In reality, we obtain the transversal Doppler effect for spherical waves which also exists both for light ($V_{sig} \equiv c$) and in acoustics ($V_{sig} \equiv V_{sound}$) as well! As a result, for the real source the displacement into the red area will be observed (a greater time of action of such a displaced line), and the effect should depend on the distance to the observation point. And who could prove that the classical Doppler effect for plane-parallel waves must be applicable for light? This effect possesses the classical form in the case of pure wave motion only, you know. But if light is not entirely a wave, other expressions could be obtained, including the relativistic ones [60]. Thus, the given experiment can not be unconditionally attributed to the experiments confirming the relativistic time slowdown in SRT.

Some relativists [38,107] distinguish three key experiments (by Michelson, Kennedy-Thorndike and Ives-Stilwell) which should unam-

biguously result in the Lorentz transformations (a basis for SRT). We see, however, that all these three experiments are not evidential. SRT "hangs in the emptiness" even from the experimental point of view.

Additional remarks

We shall begin with some general remarks. For the sake of justice it is necessary to note, that the principle of relativity has never been verified to a maximum experimental accuracy even for the mechanical phenomena. If we believe in the absence of all-penetrating ether, then similar properties can be attributed to the gravitational field. How the observer on the Earth wouldn't be moving (in the rectilinear uniform motion or in circular motion over the Earth surface), the gravity force will change in magnitude or in direction, which can be detected from the comparison of quantitative regularities in the experiments. Therefore, the declared hypothetical experiments could be performed only in the absence of gravitation or in the case of strictly symmetrical distribution of the whole Universe relative to the observation point. But in the presence of moving bodies such a strict "compensation" of gravitation could take place at a single point only. In all real cases one can observe the absolute changes of the state (velocity, acceleration, etc.) relative to the point of space the investigated object passes through at the given instant. Besides, it can be admitted that the rigorous notion of inertial systems must be broadened in an experimental sight and extended to "near-inertial systems", i.e. to the systems which cannot be distinguished from rigorously inertial systems within the existing accuracy throughout the experiment. Otherwise this notion would be lost for practical applications and would be found useless for physics. For example, it is clear that all "relativistic" experiments were made indiscriminately on the non-inertial Earth (its non-inertiality can be easily proved by the Foucault pendulum); and if we should approach in the absolute rigorous manner, the explanation of these experiments by the relativity principle of SRT cannot be even taken into consideration (unlimited rigor gives up for lost any section of physics).

Make some more general comment. The erroneousness of the relativity theory is in no way related with the presence or absence of all effects

the SRT tries to describe and speculate on this (as well as the refusal of crystal spheres does not abolish the really observed planet motion). Two questions must clearly be separated: 1) whether there exists some phenomenon as such or not? and 2) whether some theory, which ascribes an explanation of this phenomenon to "own" achievements, is valid or not? By the "reasons", which are claimed in SRT, no extraordinary effects can simply exist (the combination of statements and conclusions of the SRT is mutually exclusive, that is logically contradictory). If, nevertheless, some effect is still observed, then it is necessary to search for another real reason (explanation, interpretation) for it. Each theory contains a series of "if"'s, which should be verified experimentally. For example, whether the running of some processes in the object can change, when its velocity really (!) changes? It can, in principle. For example, the first "if" is as follows: the ether exists; the second "if" is as follows: some process depends on the velocity relative to this ether. But in this case the relative velocity of two observation systems will be pure at anything. So, if the first and second system are moving to opposite sides at the same velocity v relative to the ether, then similar processes in these systems will proceed similarly. If, however, the third system moves to the same side as the first one, but at velocity $3v$ relative to the ether, then, in spite of the same relative velocity $2v$, the processes in the third and first systems will differ. In the given case the principle of relativity itself (and, the more so as, SRT) is violated. Such a situation is also possible, in principle, but should be verified in the course of experiments only (it is yet to be made by nobody with a required accuracy).

One more remark concerning the experimental results. The scattering of data in each of experiments on measuring the speed of light is high, as a rule. And the small tolerances declared in SRT are obtained only after some certain statistical processing (that is, after fitting under desirable results). This has already resulted in discomfiture: the most probable value of the speed of light, declared by relativists, had been twice changed with obvious escaping the limits of declared tolerances (see [25]).

Note that the light dispersion was discovered long ago in the open

space [5]. The dispersion of $c(\omega)$ in vacuum was suggested in paper [49] (this hypothesis will be considered in Appendixes). The example can be mentioned, where the radiation lines have appeared in 2 months after detecting the X-ray flash [13], which can also have relation to light dispersion in vacuum.

The classical law of addition of velocities has relation to the translational motion of bodies only. If, however, there exists also the oscillational motion, then, generally, no definite words can be said about the total velocity (even for non-relativistic velocities). For example, the velocity of hammer impact against a tuning fork has no relation to the velocity of propagating waves. Consider one more example. Let a long rod be moving over the surface of water perpendicular to its length at velocity v_1 , and the point-like source excites the waves in front of a rod. Then these waves will pass some part of the path in water, which rests relative to the rod, at velocity v_2 , and another part of a path – in water, which rests relative to the shore. As a result, the wave velocity will lie between $v_2 + v_1$ and v_2 (and will be, generally speaking, a function of the distance to a source). The next example. The local speed of sound relative to the airplane in airplane's saloon with holes will depend on the velocity of a steady airflow inside airplane's saloon (some analog of Fresnel's entrainment coefficient).

Rather strange is a typical "increase of accuracy" at statistical data processing in SRT. This means that the data are artificially selected and those dependencies are analyzed, which certainly meet the given theory. First, the most probable values of various physical quantities can be completely unbound causally with each other even in separate acts of interaction (recall the distinction between the true value and the mean, most probable or effective value in a particular process of measurement). Second, for essentially nonlinear expressions from the equality of mean (or effective) values it is rather difficult to extract the declared relations for true (instantaneous, or causally bound) quantities. Such an analysis of the data (allegedly confirming SRT) is met nowhere (in this case the theory of fluctuations must be used, you know). Third, the attention should be paid to the following mathematical facts:

1) the statistical averaging of a periodic function with unknown period

over the other (untrue; for example, if the atom re-emission does not taken into account) period can give a zero result or a quantity lower than true one;

2) the attempt to determine a periodic dependence by selecting an incorrectly guessed or shifted harmonics gives zero ($\int \cos(\omega t) \cos(\omega_1 t + \alpha) dt = 0$) or an underestimated quantity. Possibly, the incorrect statistical data processing is just the reason, by which, in spite of considerable deviations of each of separate measurements from a zero level, rather small oscillations of quantities are obtained in some experiments (of Michelson type) after statistical processing (recall Miller's analysis in his experiments [95]).

It is very "fashionable" to investigate any phenomenon by means of the fine Mossbauer effect. It is rather strange, however, to attribute the temperature effect on the resonance frequency shift in the Pound-Rebka experiments to SRT's time slowdown effect – this is a clear speculation. Though temperature variations influence, to a higher or lower extent, all physical phenomena, but the SRT time bears no relation to an obviously classical field of investigation. Otherwise, if we extrapolate the global claim of relativists quite slightly into a close field – up to melting of a specimen (where the effect itself vanishes), then – what should be declared in this case: the time has stopped its running, the time became singular, or some other delirium? Statistical analysis for the temperature Pound-Rebka experiments is also rather doubtful. It is investigated the influence of temperature and its variations on the frequency shift (but what relation has this influence to some aging?). Recall that temperature characterizes the velocity dispersion inside a sample. But how this effect could be attributed to the sample as a whole? Generally speaking, it is rather strange to associate the Doppler effect with time course or to choose some concrete frequency of a specific process as an indicator of time course. Really, let be a system consisting of a great number of atoms which are excited by help of light with a frequency ω_1 . Let us choose the frequency ω_1 as an indicator of time course in this sample. Returning to the basic state, atoms will radiate. Some part of atoms will absorb this radiation; and multiple absorption can also take place. As a result, other frequencies will additionally appear in the system. But, on

these grounds, it is inept to believe that time is changed even for such a given atoms; to say nothing of the fact, that it is absurd to ascribe a "change in time course" to the sample as a whole and all the more to attribute a something to all reference systems, to which can be mentally associated this sample (just similar globalizations are used by SRT and GRT).

The following methodological remark concerns the terminological forgery, frequently committing by relativists (one of "methods" of the self-affirmation by deception). So, terms with a value of c in the denominator (for example, v/c , etc.) came to be called "relativistic" ones, though such the terms frequently appear in the classical case as well, and, at the least, it is necessary to compare analytical expressions for the analogical terms in the classical and relativistic cases. Such the situation of deception takes place in the case of radar observations of the Venus: the rumour was set about an alleged new (!) confirmation of the SRT, though the pure classical formulae were used (see [118]).

GRT experiments

Though this Chapter 3 is not devoted to the general relativity theory (GRT), nevertheless (because of the relativity theory unity declared by relativists), for completeness of the picture we shall present some additional critical comments to the experiments. It is rather strange, that in some cases the relativists declare the equivalence of description (of Sagnac's experiment, for example) both within the SRT framework, and with using the non-inertial system within the GRT framework. In the other cases, however, contrary to the declared equivalence of the gravitational field and the non-inertial nature of a system, the SRT gives an inadequately low result (for example, for the Mercury perihelion displacement).

The Hafele-Keating experiment was declared as confirming the GRT. However, this conclusion was made with use of a little sampling (again reduced). Other investigators, which had a free access to the primary data, made quite the reverse conclusion. Besides, the Hafele-Keating experiment was interpreted as the gravitation dependence of time (actually, the interpretation means change of the generator carrier frequency

itself in the gravitational field). In such the case, however, it contradicts the interpretation of the Pound-Rebka experiment, where the generator was considered to provide the same frequency at any altitude (and some kind of these two experiments must be eliminated from the "GRT money-box"). It would be not bad for theorists to stop to reiterate "what matter must to be", "to extract a cotton wool from the ears" and to listen those peoples whom were named (a modest and imperceptible word) "observer" [134]: it would be interesting to know "what IS to be in reality". Just these "observers" participate in construction of "the preferential reference system" (USA: WGS-84, NAVSTAR GPS; Russia: PZ-90, GLONASS), introduce corrections from the motion of the Earth surface relative navigational satellites in spite of the SRT postulates etc.. Practical workers (land-surveyors, engineers, inventors, experimenters) have no time to listen "explanations after the event from theorists", and they are obliged to act as in the proverb "about a baying dog and coming steam-engine". Thus, generators of the satellite systems NAVSTAR GPS are tuned in the frequency 10.22999999545 MGz at the Earth in order that the frequency would be increased to 10.23 MGz at the satellite orbit in the strict agreement with the Eötvös effect well known before the SRT, that is the long-term navigational experiments disprove the isolated experiment with "flying airplanes".

The gravitational displacement is treated in [33] from the energy point of view, but where the time slowdown in the gravity field has vanished in this case? The attempt to get rid of the relativistic "discordance" was undertaken in [21]. However, the "explanation" with the help of an elevator model (the lift possesses zero initial velocity), given in that paper, is completely groundless; therefore, the comparison of the Pound-Rebka experiment with the Hafele-Keating experiment can not be considered in favor of the gravitational change in the operation of the watch (remember, in accordance with the GRT, the gravitational field is locally "excluded" inside a freely falling lift). The fact is that all formulas in SRT and GRT are local. Actually, in the aforementioned paper the relativists try "to create" mentally a unique object by means of infinitely rapid signals. Whether the fact, that I set moving the receiver inside a laboratory now, can influence the photon that will be

received from the Alpha-Centaur 4 years later? Certainly, it can not! In fact, SRT also considers the signal (a photon and its influence) to propagate at the speed of light (the prehistory of processes is included in none formula). Therefore, we should not consider the elevator velocity at the initial instant to be zero at "explaining" the Pound-Rebka experiment. On the contrary, we should impart to a freely falling elevator such a velocity (it does not influence a remote photon), that at the photon reception instant the "instrument" (perceiving an atom) be at the same place, as a real resting atom, and has a zero velocity too. It is clear that the Doppler effect will be pure at anything in this case, since it depends only on velocity, rather than on acceleration. Both atoms will be at the completely equal position, and the only distinction will lie in the fact that one of the atoms has a support from below, whereas the second one – does not. But, in fact, if the support is removed instantaneously, nothing can change (according to the Doppler effect). However, for obtaining this final state the photons could be sent from different "depths", i.e. the effect would be different for the same state (place). Therefore, the observed effect represents the influence of just changed properties of a photon itself, rather than of the receiving atom position. It is just the photon, which becomes red (but not "the place of reception becomes blue"), which can be quite probably described in classical terms of the energy loss and changing a real frequency of a photon (rather than changing of observed frequency). The GRT's "explanation" of this displacement in terms of "bluing the energy levels of an absorbing atom", given in [21], is rather doubtful by the other reasons as well. Since the question is here about an individual atom, the given effect can not be a "characteristic of the place" (GRT's watch). For example, the atoms of gas are always (except the collision instant) in the free falling state, and no displacement at the given place would be observed. In liquids and solid bodies the atoms are moving too (even for $T \rightarrow 0$). Therefore, instead of distinct displacement of a line (this effect is highly sensitive even to velocities of some cm/s), the complete spreading of a line would be observed. But in any case not a "universal gravitational GRT effect" is obtained [21], but the effect, which depends on particular non-relativistic mechanisms participating in the

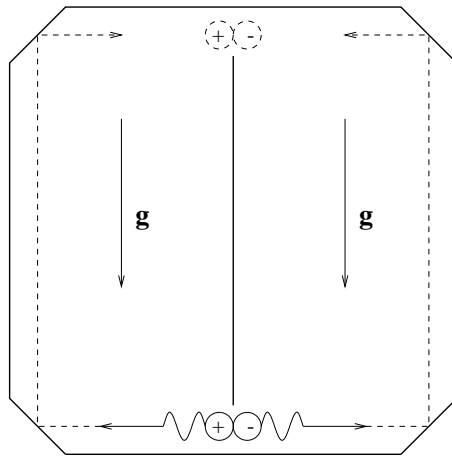

Figure 3.5: Perpetuum mobile of GRT.

given process. It is easy to take refuge in resonance effects (the presence of radiation lines), but if do we consider transitions to the continuous spectrum? Where does the continuous spectrum know the path passed by the photon from? And we must take into account that not each photon "falling" on an atom will be absorbed, but some photons always fly past just the same place "become blue" which waited for them. And if is any medium absent at all? Let a photon leave the "black hole", for example. It fly itself with the same energy, and places, which it flies by on the way, "become more and more blue" all the time. A fine poetry! The manipulation with mathematical symbols can not be considered as the "explanation" in physics. (For example, the masslessness condition in the third "explanation" of [21] is nothing else, but a hypothesis). The fact, that the Pound-Rebka experiment's explanation is correct in the energy terms exactly (the change of energy signifies the change of a photon frequency), is clear from following mental experiment (see Fig. 3.5). Let an electron and positron be annihilated in the gravitational field \mathbf{g} underneath. Let the two obtained photons be reflected upwards. Let now the birth of a pair of particles to take place again overhead. If the

energy of photons did not change at their rising in the field of gravity (recall a customary air on the Earth), then how could we without energy consumption lift the particles in the field of gravity to a high altitude (i.e. we have imparted them some additional potential energy)? Is it a perpetuum mobile, really? The similar contradiction will be more pronounced (and without using auxiliary reflections), if we use reaction of the other type, with radiation of one gamma-quantum, below and the appropriate reverse reaction above.

It seems rather strange that some relativists declare a possibility and necessity of the experimental verification of an "allegedly existing" space curvature (for our sole Universe!): but relative what could this curvature be measured? Experiments can note happening variations with physical values only (the method of comparison with the standards).

Summarizing the criticism of the RT basis, the implication is that we must return to the classical Newtonian notions of space and time. We must also return to the classical additive vector law of velocity addition for particles.

Once again on light speed

The notion of "velocity" is clearly determined (remember police at way), and only for "the secret agent 007 - light" there exist many "passports" (according to relativists): some "Great" constant (for "a relativistic oath"); coordinate velocity (in this case relativists cannot to hide the necessity of "blasphemous" term $c+v$ in any way) – but what can be "taken" from it; phase velocity (with it land-surveyors work [134], opticians calculate microscopes and telescopes with it, astronomers calculate refraction with it etc.); group velocity (which was "with regret" introduced by Rayleigh and which is almost not used by practical workers, but which is often declared as "true" by relativists, if it does "accidentally" not turn out negative, or more than the constant nominated by them themselves). Sheer "a card-sharping with three glasses at a railway station building": have guessed right or not?

Though the problem of light speed has been considered above, we shall here formulate more clearly the law of velocity addition for a light signal (for the corpuscular and wave models of light) in the example of

one-dimensional motion. Let the axis be directed from the source to the receiver. Let the source at distance L from the receiver to emit a light beam having some frequency characteristic ω_0 . Then two situations are possible:

1) Irrespective of the nature of light, when the receiver moves at speed v relative to the source, the signal reception rate (L/t) will be determined by the geometrical sum $c(\omega_0) - v$, and the frequency of received light will be determined by the simplest classical Doppler law: $\omega = \omega_0(1 - v/c)$. The question – what local velocity (all measurements are made inside the receiver of the fixed configuration) will be recorded by the receiver – is completely different: this quantity can depend on the nature of light (a wave? a point particle? a particle with inner degrees of freedom?), on the receiver design, on frequency ω , etc.

2) When the signal source moves at speed v , the result depends on the nature of light. If light represents a flux of particles, then we obtain again the classical linear law of velocity addition: $c(\omega_0) + v$. If light represents a wave, we actually deal with the addition of translational and oscillatory motions, and the theorist cannot write down the $c[\omega(v)]$ dependence and the Doppler law in the explicit form. For the value of velocity, we can find, in principle, the linkage with characteristics of the "medium of propagation". Recall, for example, that the speed of sound in gases can be expressed in terms of the following quantities: the molecular weight of the gas, temperature, adiabatic index. For rigid bodies, the longitudinal and transverse speeds of sound are expressed in terms of density, Young's modulus and Poisson's coefficient; for liquids it is necessary to know some empirical factors. One of the possible hypotheses on the propagation rate for light in vacuum will be presented in Appendixes, where the light propagation process will be supposed to be mainly influenced by virtual electron-positron pairs. As far as the frequency is concerned, we find that it will be determined by the Doppler law $\omega = \omega_0/(1 - v/c)$ within the limit of small oscillations only. In the case of arbitrary distances, directions of motion, arbitrary fields, possible presence of ether or of an inner structure of light (with additional degrees of freedom) for different models of light, essentially all dependencies can be complicated. Thus, in the general case, the determinations of the

law of velocity addition, and the determination of light speed (again – not local, inside the receiver, but in vacuum between the source and receiver!) and the Doppler law, are the prerogative of experiment.

3.3 Conclusions to Chapter 3

Since physics by itself represents a principally experimental science and the majority of textbooks begins just from an experimental "substantiation" of RT, then there existed the necessity (in spite of logical flaws of RT) to analyze the relativistic interpretation of some experiments, showing its error (we do not bear in mind that the experimental data are erroneous: the experimentalist is always right!). The given Chapter 3 above analyzed the experiments for establishing SRT in detail from corpuscular and wave viewpoints for the empty space (with using of relativity principle). It was shown that all these experiments could give nothing except a "zero result", since the only possible light-speed dependence $c(\omega)$ was not studied at all. Further, we analyzed those experiments that seemingly confirm SRT, and presented a series of methodological comments.

The Chapter 3 contained both the general comments on the experimental substantiation of the relativity principle, on the theories of ether, on statistical data processing and others, and the specific critical discussion of the aberration phenomenon, the Michelson-Morley, Kennedy-Thorndike, Ives-Stilwell and other experiments. The complete inadequacy of interpretations of these experiments within the SRT framework was demonstrated here. Such GRT experiments, as the Hafele-Keating and Pound-Rebka experiments, were discussed at the end of the present Chapter 3, and error of their interpretation by GRT was shown. The given Chapter 3 demonstrated a full experimental groundlessness of the RT.

Chapter 4

Dynamics of the special relativity theory

4.1 Introduction

In the previous Chapters we have proved the inconsistency of kinematic concepts of SRT, the groundlessness of GRT, the invalidity of relativistic interpretations of some key experiments (after this we could regard the relativity theory as some mnemonic rule, but it is rather awkward and unwise). Although this is quite enough in order to seek interpretations of observed phenomena other than relativistic ones, nevertheless, the present Chapter 4 supplements to the aforementioned systematic criticism of the relativity theory. The fact is, that all textbooks (beginning with school ones) incite in favour of so-called progress which is based on achievements of modern science. The relativity theory is boosted as one of its foundations, and for some reason atomic bombs and accelerators are mentioned in this case. However, even this situation is not unclouded (though theorists fanatically believe that their written "flourishes" bear a direct relation to the Reality): no one accelerator reaches the rated capacity on "ideal" theoretical calculations. Phenomenological formulae and "fitting" parameters and factors are used in the majority of cases for practical courses and engineering calculations. The main purpose of this Chapter 4 is to demonstrate that even in a seemingly unique practical

SRT section, namely, in the relativistic dynamics, there exist numerous questions, compelling one to doubt in the validity of relativistic ideas and in interpreting their results.

It is well known a philosophical statement (legibly applicable to SRT): "we can see that thing in the experiment we want to see there". Such an attitude is prepared and the situation is aggravated by the theorists, who are "stewed in their own juice" and ready to see in every experiment only confirmation to their tricks with mathematical symbols (although the author belongs to theorists as well). The existing uncertainties of the theory (carefully masked in SRT) allow the theorists to vary interpretation of experiments within considerable limits. And, afterwards, the incompleteness of experiments is masked "in a proper manner" by statistical "adjustment" of the data (data "truncation" under the desirable result).

In deriving the equations of motion of an electric charge and the field equations in theoretical physics' courses an attempt is made to cause an illusion of an "unequivocal idyll". But in such a case the Maxwell equations would be the equations of any fields, and all forces would be of Lorentz type and would have the form of Coulomb's law in a static case. Such an alternative of the general relativity theory (GRT) can be discussed (with some supplementation and modifications) for the gravitational field. However, the situation is different in the general case: for example, the nuclear forces are not proportional to R^{-2} . There exist many counterexamples of various fields and forces. Therefore, the theoretical physics (including the SRT approach) cannot determine all existing phenomena proceeding from their own principles only. This is an exclusive prerogative of the experiment. (Besides, the experimenter should be principally prepared to the fact that any theory can occur to be inaccurate or even wrong).

Also surprising is the apologetic advertising of SRT. For example, the pathos's assertion of [40], that "the relationship between the mass and energy underlies the entire nuclear power engineering" is groundless both in the historical and in the practical respect. This relationship bears no relation either to discovery of elementary particles and radioactivity, or to studying the spontaneous and forced decaying of uranium nuclei, or

to determining the stability of nuclei, or to finding possible channels of nuclear reactions and possibility of practical choice between them, or to the isotope separation technology, or to practical utilization of released energy, etc. Thus, this relationship bears no relation to any key stage in development of nuclear power engineering. And (as paradoxical it may seem) this relationship bears no relation even to determining the released energy in any particular well-known reaction. This is because all things have historically happened just in the opposite order: at first, some reaction has been found, which was detected from the energy release exactly. And then the calculational functions – the combinations from mathematical symbols – can be derived by various methods. As a rule, it is technically impossible to determine the mass variation in a nuclear reaction directly. Even if one uses doubtful theoretical interpretations, the attempt to determine the mass variation will occur to be a rather rough and costly pleasure. Thus, the relationship between the mass and energy plays, in the practical respect, a part of scholar mathematical exercises for reverse substitutions, since desirable results can always be "derived" from the calculated data, which were tabulated post factum.

4.2 Notions of relativistic dynamics

Now we shall proceed to a more complicated problem of dynamical concepts of SRT. It would seem that only in the relativistic kinematics there are no direct experimental comparisons of physical quantities (only doubtful interpretations) for two systems moving relative to each other; but in the relativistic dynamics everything is in order (according to relativists' logic – the accelerators are operating, in fact!). Let us try to clear up the dynamical concepts, even because the relativistic dynamics, under modern interpretation of SRT apologists, rests upon a completely untrue relativistic kinematics.

We begin with general notes. A boundless spreading of the idea of relativity of all quantities in SRT is completely groundless. Really, let the two bodies be at distance \mathbf{r} apart of each other while having relative velocity \mathbf{v} . Then the result of interaction of these bodies at instant $t + dt$ will not be determined by mentioned characteristics, but will depend on

the prehistory of motion. Since the effect spreads at finite velocity, the first body at instant t_1 will be influenced not by the real second body (at instant t_1) with its coordinates and velocity, but by some its "image" from a preceding point of the trajectory, from which the effect had time to come before instant t_1 . Thus, any physical quantity (the force, for instance) can not depend on the relative velocity at the same instant only. The only exception is the frontal collision, at which $\mathbf{r} = 0$. Therefore, it is necessary either to apply more complicated equations instead of the local differential equations (i.e. to take into account the prehistory), or to refuse from the idea of relativity of all quantities. Even the notion of the "relative velocity at the given time instant" itself becomes indefinite, because any real effect will be determined by characteristics at preceding instants. And, you see, SRT does not "know" the absolute velocity organically (it "knows" only the relative one). This fact has already resulted in the discomfiture. For example, Einstein has actually believed the stellar aberration to depend on the relative velocity of the Earth and a star (see [41], v.1). However, the experiment shows the stellar aberration to be dependent on the Earth velocity only, but the velocity of a star has no effect at all. In spite of vast scattering of velocities of stars, the aberration on the Earth is found to be the same for all stars. Where has the relative velocity gone in such a case? Actually, even this fact disproves the original concept of SRT. A similar disproof of SRT is obtained in the problem on a coil in the magnetic field: the motion of a coil induces the current in it immediately, whereas the motion of a magnet (according to the finiteness of the rate of interactions) – only after some time. There is no symmetry of the problem, and the dependence on the relative velocity only is obviously insufficient.

The concept of mass

Now we proceed to more specific dynamical concepts. We begin with the concept of "mass". In order to introduce correctly the new physical concept of the "mass of a moving body" into SRT, it is necessary, first, to determine the procedure of measuring similar moving masses independently of any theory. (A similar procedure in GRT relates to the "mass of a body in the gravitational field": the distinction of the gravitation

mass from inert one, as contrary to its own postulate). And this procedure should be namely the measurement, rather than re-calculation, for example, via the postulated formula for energy or momentum again. Otherwise the theory will try to "retain itself by the hair". A similar measurement procedure does not exist for SRT.

The physical concept of "mass" has no direct relation to all those formulas (it is mathematics), which can include letter "m". For the basis concept of mass there exists the only clear – standard definition. It determines the mass just at the state of rest (for example, the conditions also exist for the standard of length – the temperature ones). And there is no need to "invent a bicycle". In the motion the mass is simply not defined, though letter m can enter quite diverse formulas containing \mathbf{v} , \mathbf{a} , etc. These are different things! Therefore, the definition of an elementary concept of mass in terms of more complicatedly defined concepts of energy and momentum (depending on the theory, interpretation, state of a system, etc.) is a physical nonsense (though, possibly, it is correct mathematically). In such a manner one can "reach" an absurd and define a simple notion of velocity as $\mathbf{v} = \mathbf{p}c^2/E$. Note that any experiment, including measurement one, should be extremely clear defined with respect to all conditions of its performing. And, generally speaking, the "explanations" and "definitions" of theoretical physics (for example, in SRT) often represent by themselves a drop-out from physical understanding and a science-like masking of the essence of quantities behind (often correct) mathematical transformations.

The notion of the center of masses

Even such a simple notion as "the center of masses of a system" becomes ambiguous in SRT in considering the mutual motion of system's components. So, in [33] the "paradox of a center of masses" is considered: in the reference frame of a rocket two identical cannon balls are fired off simultaneously inside a tube, and the ends of a tube are tightly closed immediately by plugs A and B (Fig. 4.1). In the classical physics no contradictions arise in this case: the center of masses in any frame of reference will always coincide with the center of the tube. It can be determined by various methods, namely: by weighing and direct

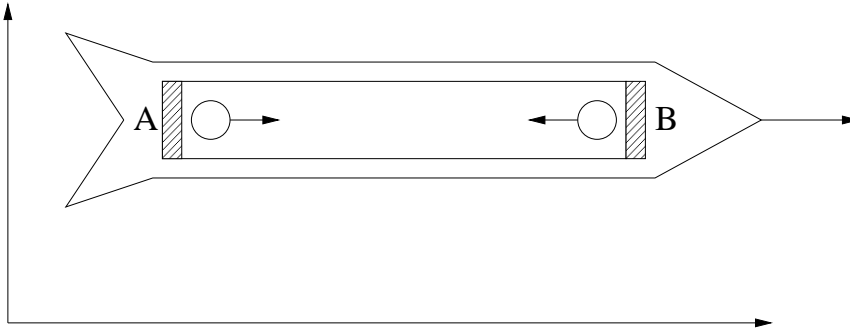

Figure 4.1: The center of mass of a tube with cannon balls.

calculation (the mass and distances are invariant in the classics), as a center of zero momentum, as a center of a baryon number (the number of nucleons in nuclei), as a center of gravitational attraction. The notion of the center of baryon number was declared "non-productive" in [33], since the world line of this center occurs to be irrelevant to the SRT laws (that is, it simply contradicts them!). The gravitation is organically not included into SRT, so that one should transfer to GRT, but the book [33] declares the coincidence of the center of gravitational attraction with the middle of a tube in the laboratory coordinate system (but in this case "the center of zero momentum" is studied). However, immediately after the first collision with a plug (non-simultaneous in the laboratory system) it becomes necessary to refuse from the universality of SRT and to recall about a specific compensation mechanism (for "saving" SRT) – on the acoustic waves in a tube and on the energy (mass) transfer by them. These waves, coming from tube's ends, then suppress each other. But in such a case one should have to postulate various velocities of acoustic waves in various systems for two opposite directions. And if we will change the material of a tube and the geometrical characteristics of the experiment? And if the tube is absent at all and only the plugs of very great mass are present, and the sensitivity of local gravitation measurements will allow for determining the motion of cannon balls? And what should be done with the compensation mechanism in the cases

listed above?

If in the given problem we shall determine the mass from the momentum transfer on plugs A and B or on barriers parallel to them (the "longitudinal" mass), then we obtain some single world line of the center of masses. If, however, the mass will be determined from the pressure on the tube bottom (from the gravitation; from the electrical force for charged cannon balls or from the magnetic force for cannon balls-magnets, etc.), then for this ("transversal") mass the other world lines will exist. Generally speaking, in SRT all these world lines will be different. Some of them have to be postulated as senseless (non-productive for SRT), in some cases it would be necessary to transfer to particular mechanisms "explaining" the contradiction, and in other cases the change of objective characteristics should be postulated. For example, let the plug to be retained on a massive tube with the force slightly greater, than that required for a plug to be torn-off by a cannon ball (with "relativistic" mass) in rocket's frame of reference. Then in the laboratory frame of reference one of cannon balls (with a greater "relativistic" mass in this case) will beat the plug out. So, is the observer behind this plug alive or dead? Or, again, for "saving" SRT it is necessary to postulate that the plug-retaining limit in SRT is not an objective characteristic (but depends on the frame of reference)? And if at tube's ends there will be the "traps" at the bottom, in order that in rocket's frame of reference the ("transversal relativistic") mass be slightly insufficient for a cannon ball to be fallen down there. Then, again, in the laboratory frame of reference one of cannon balls (with a greater "relativistic" mass) will fall down. So, shall we postulate again the change of the threshold strength for "saving" SRT? Note that it would be necessary to postulate different threshold characteristics: both the longitudinal and transversal (generally, tensor) ones. Whether the SRT price is not too great – the price of postulating a loss of the majority of objective characteristics? Whether the number of problems, questions and contradictions is not too great in SRT "at the empty place" – where in the classical physics everything would be elementary simple? And, you see, SRT can not refuse from the concept of the center of masses, since the Einsteinian derivation of the $E = m_0c^2$ equivalence for the "rest mass" is based on this particular

concept.

Forces in SRT

SRT gives nothing useful in the kinematics and for dynamical concepts as well. It occurs that all this huge number of additional complications arises only because of the fact, that the electromagnetic Lorentz force too "complicatedly" depends on the velocity (and on acceleration as well, if we will try to reduce its effect to the classical Newtonian second law)?! We will make a light lyrical digression. On what values can forces be dependent (and, from a conceptual point of view, in what a matter does the distinction of Newton's approach from the Aristotelian one lie)? An interaction of bodies leads to a change of the bodies' state. It is necessary to choose an "indicator" of this change. Aristotel believed the rest as the basis state, and he chose to observe the velocity of body's motion, as an indicator, i.e. $\mathbf{v} = \mathbf{f}(t, \mathbf{r})$ (Aristotel connected the value of $\mathbf{f}(t, \mathbf{r})$ with a force, provoking motion). The choice $\mathbf{v} = \mathbf{f}(t, \mathbf{r})$ is quite sufficient, if we will be satisfied with contemplation. However, if we would try to construct the dynamics of motion, so, after mental Galilean experiment, it became clear that the Aristotelian concept of the force was not conformed to the Reality. Though, strictly speaking, this conclusion is tied to the faith of relativists of "the first wave" - Galilean followers - in existence of empty space (Galilei by itself considered isolated identical systems only and, by contrast to his "pseudo-followers", he not disseminated his principle to mutually penetrating reference systems). If ether exists, the Aristotelian rest is locally tied to the ether, which has no necessity to be "uniformly immovable" as a whole at all, but can participate in complex vortical movements. For example, there exists the theory of vortical dynamics of the solar systems, and a force is only required to maintain motion, which is differ from equilibrium one. However, the analysis of vortical dynamics is not included in the book plan, and so, we will use the statements generally accepted in the present state. The Newtonian choice for the description of bodies' interaction is different - an "indicator" of change of body's state is chosen its acceleration. Factually, the Newton second law presents a definition of the notion of "a force", and, from a standpoint of functional depen-

dence, the force coincides with the acceleration within a dimensional factor (mass). Ideally, this way of a motion description (in the habitual form) must be written as $m\mathbf{a} = \mathbf{F}(t, \mathbf{r}, \mathbf{v})$. However, the problem of finding the explicit expression for such the "ideal" forces $\mathbf{F}(t, \mathbf{r}, \mathbf{v})$ is not yet solved for the case of arbitrary configurations and motions of a body, a force source and a medium, for example, based on expressions for static forces. Nature does not easily unravel its secrets for us: instead of the ideal expression for the force, we are obliged to use an expression that we found $\mathbf{F}(t, \mathbf{r}, \mathbf{v}) = \mathbf{F}_1(t, \mathbf{r}, \mathbf{v}, \dots)$. Thus, generally speaking, the real forces should be determined from the experiment. The following forces are known:

$$\mathbf{F} = \text{constant}, \quad \mathbf{F} = \mathbf{F}(t), \quad \mathbf{F} = \mathbf{F}(\mathbf{r}), \quad \mathbf{F} = \mathbf{F}(t, \mathbf{r}, \mathbf{v}), \quad \mathbf{F} = \mathbf{F}(d^3\mathbf{r}/dt^3)$$

and so on in quite various combinations. From the generalized expression

$$\mathbf{F} = \mathbf{F}(t, \mathbf{r}, \dot{\mathbf{r}}, \dots, d^3\mathbf{r}/dt^3, \dots)$$

it is seen that any derivative, including the second one, is not distinguished by anything, and only the experiment can determine the varieties of forces realized in the nature (recall, for example, the formula with an acceleration dependent force offered by Weber long before SRT). Here we are interested in the fact that the relativistic equation of motion with the Lorentz force $\mathbf{F}(t, \mathbf{r}, \dot{\mathbf{r}})$ can be written as the classical second Newton's law with the force $\mathbf{F}(t, \mathbf{r}, \dot{\mathbf{r}}, \ddot{\mathbf{r}})$. Though, if one believes in the relativistic expression for forces, then, as an alternative, it can be introduced transformations for components of the force, longitudinal and perpendicular to body's velocity (but it does not worth to introduce mythical longitudinal and transverse masses); or we can just write the classical second Newton law $\mathbf{F} = m\mathbf{a}$ and the relationship of new force \mathbf{F} and the static force \mathbf{F}_0 : $\mathbf{F} = \sqrt{1 - v^2/c^2}[\mathbf{F}_0 - \mathbf{v}(\mathbf{v}\mathbf{F}_0)/c^2]$. One should not also exaggerate the possibilities of the methods for obtaining expressions from the Lagrangian, since this function itself is determined to an accuracy of some expansion terms and can not determinate the principles.

Completely unclear methodically looks in SRT the transformation of forces at transition from one frame of reference to another. Let us

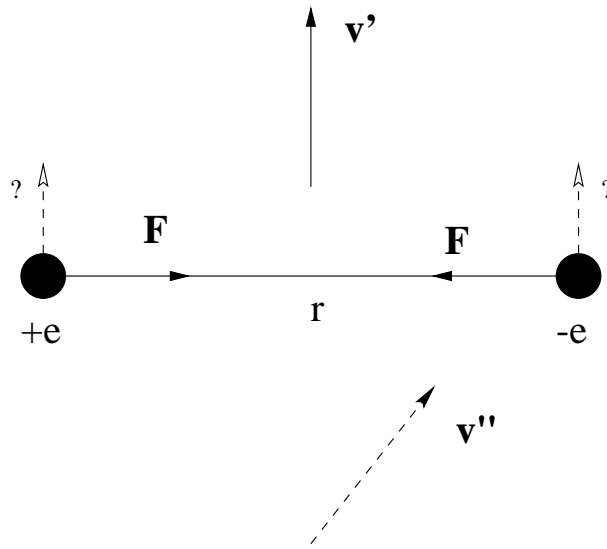

Figure 4.2: Parallel flying charges.

consider, for example, two identical in absolute value charges $+e$ and $-e$ being at distance r apart of each other (Fig. 4.2). In the frame of reference bound with resting charges there exists the electric force $F = e^2/r^2$ acting between the charges. Look now at the same charges from the system moving at velocity \mathbf{v}' perpendicular to the line connecting the charges (in this system the charges are flying parallel to each other). According to SRT [17,32], now between the charges acts the force

$$F' = Ge^2/r^2, \quad \text{where} \quad G = \sqrt{1 - v'^2/c^2}.$$

To what physical quantity should be related the transformation factor G ? The charge is invariant in SRT. Distance r , which is perpendicular to the motion, does not change as well. So, do the forces really lose their physical causes in SRT? Note one more strange thing: if the velocity of an observer \mathbf{v}'' has a component along the line which connects the charges, the force acting on the charges has a component which is perpendicular to this line (i.e. the picture of motion will be essentially changed).

Completely groundless is Einstein's statement, that uncharged bodies must behave under an effect of forces in exactly the same manner as charged ones: all forces must be transformed identically. Still Poincare wrote that we can not arbitrarily "disconnect" some force from one body and arbitrarily "connect" it to the other body. If some force (for example, electrical) acts on some (charged) bodies and does not act at all on the other (uncharged) bodies, then, all the more, is not obvious that velocity dependencies should be identical in transformations of all forces. This is one more hypothesis not confirmed by anything even within the SRT framework. Probably, the transformation of forces has relation to only one particular case – the Lorentz force. And even in this case there are some nuances here. For example, at transition to a moving system the magnetic force magnitude can become zero. These facts represent the manifestations of conventional character of separating a single force into electrical and magnetic forces, don't they? In such a case, why the attention should be concentrated on the transformation of conventionally separated electrical and magnetic fields (and forces)?

Generally speaking, the idea that the same force can be different for different systems of observation is the flat nonsense for all experimental physics. Really, the way of writing arabic cipher on a dynamometer is independent on observer motion, i.e. readings of the dynamometer (fixing the force) will not be changed with observer motions. Any force acts between the "source" of this force and the concrete "object" of the applied force, and motion of some "strange eyes" has no relation at all (i.e. force can depends on the source properties, object properties, and their mutual motion).

Energy and momentum in SRT

We begin with a comment concerning the units of measurement. The expression for the momentum and energy in terms of a mass can not give anything useful, since these quantities are not interchangeable, the number of joint operations with them (as well as combinations) is limited and, all the same, it is necessary to monitor them as various physical quantities. Whether is it worth to introduce confusion into well-agreed units of dimensions?

Whether the SRT approach to the relativistic dynamics is a unique one? Not at all! In the classical physics the separation of energy into kinetic and potential ones can be rather conventional. For example, in the statistical physics at description of motion in non-inertial rotating systems the potential energy includes, in fact, the mean kinetic (!) energy of motion of a system: from $v_\varphi = \Omega\rho$ is generated $E_{pot} = m\Omega^2\rho^2/2$. There exists another educative example from the hydrodynamics, where the apparent ("effective") mass concept is introduced for describing the motion of a body through a medium. The true mass did not obviously change in this case. In exactly the same manner, in the relativistic mechanics a new "velocity" addition to the acceleration can be associated with the potential energy of a body. In this case the kinetic energy of a body can be retained invariable, and the classical Newtonian equations can be considered, but with other, "effective" force and constant mass m_0 .

Contrary to the SRT assertions on the importance and necessity of introducing the 4-dimensional vectors, even for three interacting particles the expressions

$$E = \sum_i m^{(i)} c^2 \gamma^{(i)}, \quad \mathbf{P} = \sum_i m^{(i)} \mathbf{v}^{(i)} \gamma^{(i)}, \quad \text{where } \gamma^{(i)} = \frac{1}{\sqrt{1 - v_i^2/c^2}}$$

do not constitute the 4-dimensional vectors and are not conserved. The introduction of the potential energy of interaction of particles also causes some difficulties. Is SRT a theory of two bodies, really? Where is the declared generality (universality) of the theory? Similar difficulties arise in constructing the Lagrangian and Hamiltonian functions for systems of interacting particles.

A limiting transition to the classical energy is contradictory too. Above we have considered the condition of such a transition: $c \rightarrow \infty$. But in such a case not only the energy of rest, but any other energy will be $E = \infty$ in SRT. Not consistent is also the expression for the relativistic momentum in the form of [26]: $\mathbf{P} = m d\mathbf{r}/d\tau$, since $d\mathbf{r}$ relates to the motionless frame of reference, and $d\tau$ (the intrinsic time) relates to the moving system (i.e. to a body).

The limiting transition to low velocities also raises a series of ques-

tions. All formulas should pass to the Newtonian form where the rate of transmission of interactions is supposed to be infinite (for example, the Lagrangian function, the action, the energy, the Hamiltonian function, etc.). We see, however, that this is not the fact [17]: the four-velocity transfers into a set of four numbers $(1,0,0,0)$ and does not mean anything, the same is true for the four-acceleration; the interval $S \rightarrow \infty$, and quantity dS depends on the order of limiting transition; the four-force components tend to a zero, etc. This clearly indicates, that all aforementioned quantities cannot have independent physical sense.

The Maxwell equations

The following brief comment concerns the Maxwell equations (their conventional present form). Recall that they were obtained by generalization of experimental facts (phenomenologically) at low velocities (by analogy with the hydrodynamics). Therefore, it should not be expected that these equations were guessed in the final form. Maxwell's equations (or the wave equation) define the phase velocity, whereas the theory of relativity "pretends" to the maximum signal velocity (a group velocity). Actually, since some specific light is used always, the quantity c must be marked off some index: instead of c we can write the parametric dependence $c(\omega)$, and the wave equation will then be the equation for the Fourier-harmonics. Since modern apologists of relativism abandoned the visualization and the principal necessity of medium's models for the light propagation, the way of generalization of Maxwell's equation becomes not uniquely defined even for the "absolute emptiness" in the case of non-monochromatic light, not to mention the passage to real nonlinear media (including properties of "intermolecular emptiness", mechanisms of absorption and the light reradiation by molecules etc.). From pure mathematical considerations and without physical principles, such generalizations can be introduced as much as you desire, and all of them are equal in rights. The requirement that these equations be invariant with respect to transformations of coordinates and time is rather vacillating, since if only the measured effects of these fields correspond to the values really observed in the experiment, then the fields and equations for them can be introduced in many ways. So, for instance, it

was shown in [81] that there exist non-local transformations of fields which retain the Maxwell equations with invariable time. It was shown in [14] that non-linear and non-local transformations can be introduced, so that for some particular transformations of fields, the field equations are invariant with respect to the Galilean transformations.

Let us demonstrate the methodological contradiction of generally-accepted transformations for the fields. Let there be two infinite non-charged parallel wires. Let the electrons in both wires move in the same direction at constant speed relative to a positively charged frame (i.e. we have equal current densities \mathbf{j}). Then for the classical case, in the expression for the field the quantity $j dV = en(v_+ - v_-)dV$ is an invariant, i.e. the field H_\perp and the effect of this field do not depend on the velocity of the system. But for the relativistic consideration (since $\mathbf{E} = 0$) we have $H_\perp = H_\perp^0 / \sqrt{1 - v^2/c^2}$, i.e. this field depends on the speed of motion of the observer. However, the following two cases are obviously equivalent:

- (1) the system with velocity $\mathbf{v}_{obs} = 0$, i.e. the observer is resting relative to the frame, and the electrons are moving at velocity \mathbf{v} , and
- (2) the system is moving at velocity $\mathbf{v}_{obs} = \mathbf{v}$, i.e. the observer is resting relative to the electrons, and the frame (with positive ions) is moving in the opposite direction at velocity \mathbf{v} (the same current). But the relativistic formula gives for these cases different values of H_\perp (and effects of fields), which is absurd. Besides, the SRT description of transitions from an inertial system to another ones becomes fully inconsistent for the three-dimensional case with non-neutral currents (with beams of charged particles, for example).

Now we shall analyze the "principal" question on the invariance of the Maxwell equations, which is widely advertised in SRT. The invariance of the Maxwell equations with respect to the Lorentz transformations implies nothing for the other phenomena. First, the Maxwell equations are the equations for fields in the empty space. In such a space we can cut off a half of a segment and increase it as much as twice – then we obtain the same segment. Therefore, in the empty mathematical space one can make use of any frames of references, of self-consistent geometries and conversion factors. All these operations

can be determined by the convenience of mathematical description only. However, we can not simply cut-through a living organism and increase it twice under a microscope – the organism will be dead. The presence of real physical bodies and fields in the space specifies natural reference points ("bench-marks"), characteristic scales and interrelations between the objects. All this determines the distinctions of a real physical space from the empty mathematical space. Second, the property of some interactions to propagate in vacuum at the speed of light does not determine the rate of interactions' propagation in a medium. In spite of a drastic role of electromagnetic interactions, the disturbances in media propagate at the speed of sound. From one vacuum-related constant c it is impossible to determine (for our "electromagnetic" world) the speeds of sound and light in gases, liquids and solid bodies. It is not clear, how the anisotropy of real solid bodies could arise in the isotropic space. All these and many other properties escape the limits of applicability of the Maxwell equations in the emptiness (the SRT, contrary, prescribes "cloning properties of emptiness" on all properties of material bodies and mediums). Therefore, the fitting of the properties of the entire world under the invariance of the Maxwell equations in emptiness is too excessive claim of SRT. Third, the partition of a single (in its effect) field into electrical and magnetic parts is rather conventional and, to a considerable extent, arbitrary. Hence, the invariance of these, artificially singled out parts can not have crucial significance. The presence of ρ, ϵ, μ coefficients (which depend on coordinates, time, properties of light, etc.) for the Maxwell equations in a medium makes these equations non-invariant relative to the Lorentz transformations (or is it necessary to cancel the objectivity of characteristics of media again?).

Additional remarks

In the classical physics all concepts have a clearly definite sense, and they should not be replaced with ersatzes. Let the relativists be inventing other names to their new concepts (or, more correctly to combinations of symbols). The relativistic definition of coordinates of the center of

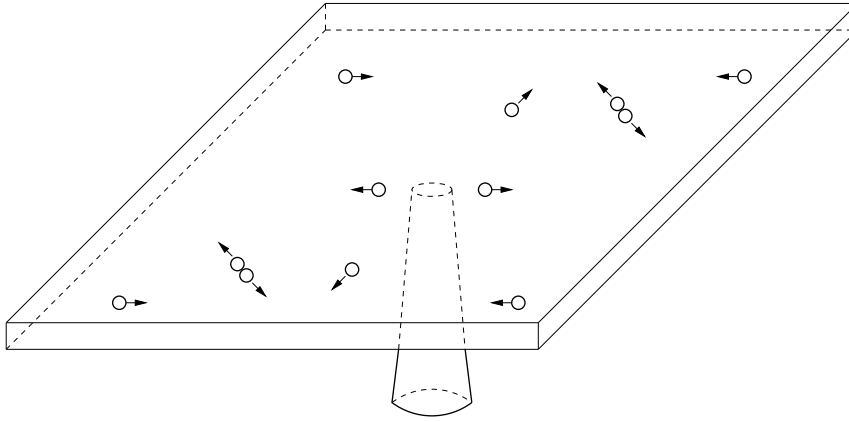

Figure 4.3: Center of inertia and equilibrium.

inertia [17]:

$$\mathbf{R} = \frac{\sum E\mathbf{r}}{\sum E}$$

has no physical sense, since in SRT the center of inertia of the same system of moving particles occurs to be different in various frames of reference. Therefore, it does not fulfill its functional designation of the center of equilibrium. Let us have a massive planar box, in which the massive balls are moving. Let in the classical case the center of inertia of the whole system (in the course of motion and collisions of balls) be always coinciding with the center of a box. Then in the classical case we can balance it (for example, in the Earth's field of gravity or in some other field) on a support of small cross section (Fig. 4.3), and the equilibrium will be kept. In SRT, on the opposite, if we only shall look at this system from a rapidly moving relativistic missile, then the center of inertia can appear to be not above a support, and the equilibrium will be violated. A remarkable objectivity of SRT: in order that the equilibrium of plasma in a controlled thermonuclear fusion not be disturbed, we ask the relativistic missiles not to fly and not to "spy" upon the experiment.

The relativistic bond of the mass and energy actually reflects no

principal thing. Indeed, the classical expression for kinetic energy $E = mv^2/2$ and the relativistic expression $E = mc^2((1 - v^2/c^2)^{-1/2} - 1)$ do not differ in any (qualitatively) significant thing. Both these quantities are calculated quantities. The attempt to measure these quantities (that is, the calibration of an instrument) depends on interpretation of the theory, since these quantities can not be determined from the comparison with a measurement standard. Since the relativistic expression of energy $E = mc^2/\sqrt{1 - v^2/c^2}$ includes, except the mass, the other quantities, then for any possible interrelations the mass and energy will remain different (nonequivalent, independent) quantities. Even for the so-called "energy of rest" $E = mc^2$ the question can not be about mutual transformations of mass and energy. The fact is, that at annihilation (the only "candidate" for a similar process) the photons are generated, for which the "mass of motion" is postulated in SRT according to the same formula. Therefore, in this case the question is simply about mutual transformations of particles too. To say nothing of the fact, that the "energy of rest" is only the hypothesis of SRT, because this theory leads again to the same indeterminate constant, as in the classical physics.

We call attention to a non-invariance of the formula $E = mc^2$ in framework of SRT: mass is invariant, light speed is also invariant. However, energy represents by itself a four-vector. If the kinetic energy of molecules, which move with different velocities \mathbf{v}_i , is included in the full energy of a body, then these velocities will be added up in different manner with the velocity of the body as a whole in other moving system. As the result, the relationship will be violated and in new system this formula will be simple some relativistic definition for some "letter E ".

SRT tries to fight, from principal grounds, "against the windmills": for example, against the notion of absolute rigid body. In the classical physics, however, nobody assigns a literal sense in the abstraction of absolutely rigid body. It is obvious for everybody, that there are no absolutely rigid bodies even at absolutely non-relativistic velocities (we shall mention the role of accelerations, or, more correctly, of forces, in this issue by remembering usual collisions of cars on roads). Simply, in describing some motions the influence of strains is negligible or unessential for the phenomenon under study, and then, only for the sake of sim-

plifying mathematical derivations, the absolutely rigid body abstraction is applied. SRT principally tries to consider elementary particles to be points [17] and immediately encounters another principal problem – the singularity of some quantities.

Now we shall directly pass to remarks on relativistic dynamics (the theory of collisions and laws of motion of charged particles).

4.3 Criticism of the conventional interpretation of relativistic dynamics

As a preliminary, to avoid a series of misunderstandings some comments should be made in respect to relativistic mechanics. First, confirmation within experimental accuracy for the laws of motion (the observable net results) cannot be considered as justification of all the methods used to obtain these results. In a scientific theory net results as well as starting principles and intermediate methods must all themselves be true as such! Second, arguing SRT's basic notions of space and time to be erroneous in no way implies a return to classical mechanics with static forces for the description of real particle motions. These two theories are not interrelated in any way. Classical mechanics is a model theory; it assumes bodies to be absolutely solid, impact of two material points (actually – two absolutely solid elastic spheres, whose radii tend to zero in the limit) to be absolutely elastic; kinetic energy and momentum to be fully "concentrated" in the motion of a body as a whole, and the exchange of energy and momentum to occur instantaneously. Neither classical mechanics nor relativity theory investigates the processes inside colliding particles; the only additional question about the rate of transmission of interactions appears at high velocities (about accounting finiteness of this rate).

Of course, taking account of a finite time for propagation and transmission of interactions results in a change of the observed motion of particles. An additional dependence of quantities on velocity appears; for example, in an effective mass (more precisely for the effective force). This can be understood qualitatively from the following elementary mechanical model: Consider just one-dimensional motion; let a source emit

continuously and uniformly similar particles flying at some constant speed v_1 along the straight line. At any place of the straight line, a sample body put to rest will undergo action of a constant pressure force (from bombarding particles). If we now put a sample body moving away from the source at some velocity \mathbf{v} , then the number of particles reaching this body per time unit will decrease. This can be interpreted as a decrease of the effective force, or increase of the effective mass. In the limit, $v \rightarrow v_1$ the effective mass of the body being accelerated under the effect of particles tends to infinity (more correctly to say, the effective force tends to zero).

Certainly, it is impossible to deduce quantitative dependences from this classical mechanistic model, because the collisions themselves cannot be considered as absolutely elastic and instantaneous. Recall only that there exists the classical Lorentz model (a deformable sphere), which describes the dynamics of an electron (m_{\perp} and m_{\parallel}). The classical equation of motion for particles can also be obtained considering non-locality or non-linearity [14,15,81]. Relativistic effects can be also obtained with assuming change of the effective charge. The aim of this book does not include the analysis of all possible methods of development of relativistic mechanics, or the choice between these methods.

Now we shall directly proceed to the relativistic dynamics. SRT is completely inconsistent in considering accelerations and the dynamics of particles in general. The Lorentz transformations (from which the entire SRT issues) cannot impose any limitations on accelerations of bodies (as well as on studying accelerated systems). However, in such a case some SRT mismatches with the experiment would become too noticeable. As a result, SRT artificially declares that the study of accelerated (non-inertial) systems is a prerogative of GRT. But the successive application of this declaration would remain from SRT only the Lorentz transformations themselves and the velocity addition law (that is, a part of kinematics). To rise the "significance" of the theory, at first, in SRT the 4-acceleration is calculated formally mathematically, and then the relativistic dynamic equations are formally "derived". But what about the transformation of forces? In this case, contrary to SRT's own declaration, it is necessary to transform one accelerated particle (for $v \neq 0$)

into "another" accelerated particle (for $v = 0$). The transformation of electromagnetic fields also contradicts the declared self-limitations, since the fields, introduced in a conventional manner, reflect nothing but the action of electromagnetic forces (the force approach). It would seem that the declaring of equivalence of SRT and GRT approaches could rise the "significance" of the theory. However, in some problems the application of SRT and GRT leads to different quantitative results. These mismatches result in the necessity of sacrificing any of the relativistic theories (or, more correctly, both of them).

On "confirmation" of the SRT conservation laws

Not so unambiguous, as the relativists believe, are SRT confirmations by the nuclear physics and elementary particle physics. Note that one equation (equality) can check no more than one dependence between physical quantities (remember Poincare). Here, all physical quantities appeared in this equation should be defined a priori independently, otherwise it will be not a law, but a postulative definition of some unmeasured quantity. Whether the relativistic conservation laws are confirmed? The properties of a new particle are often simply postulated; for example, in formation or participation of neutral particles they are always postulated. May be it is that particular reason, why so many particles "arose" (to cover a dress of the "bare king")? Consider now in detail the response from the book [33] analyzed with the purpose of demonstrating the SRT "possibilities":

$$H^2(\text{rapid}) + H^2(\text{resting}) \rightarrow H^1 + H^3.$$

Even for such a "demonstration" response (here, seemingly, all values must be measured, and all balances must be agreed), it occurs that:

- 1) it is impossible to measure kinetic energies of all participating particles; therefore, the energy conservation law was not verified;
- 2) in the full energy-momentum balance participate several SRT equations, which have not be (a priori) verified yet (as a result, the quantities to be verified become simply postulated);
- 3) in the momenta balance expression the momenta have to be artificially separated in directions, and there is no warranty that separated

particles belong to the same act of interaction (and that they are still not different in the place and time of formation);

4) there are also no tolerances for particles' dispersion angles, which makes doubtful the relative accuracy of $2 \cdot 10^{-6}$ indicated in the book (so, even the deuteron energy was measured to the relative accuracy of 10^{-3} only!);

5) the process of any collision itself, for large particles' dispersion angles especially, represents the accelerated motion of charged particles. Therefore, according to the modern views some radiation should always be observed. However, except the case of direct recording gamma-quanta, the accounting of the energy and momentum of arising field is not encountered anywhere. Thus, the balance in the conservation laws is not verified. Simply, such a value is assigned (postulated) to the quantities not measured independently, that no contradictions with SRT would arise. And SRT tries to prolong this continuous chain of postulations up to infinity.

Some relativistic solutions and corollaries

Consider now a paradox of transformation of forces. Let we have two charges e_1 and e_2 of opposite sign, which are at rest and separated by two parallel planes being at distance L apart of each other (see Fig. 4.4). Owing to attraction to each other, the charges are at a minimum distance L from one another. (They are at the state of neutral equilibrium with respect to a system of planes.) We shall draw a mark on a plane under each charge, or we shall place the observers nearby. Now we shall observe this system of charges from a relativistic missile moving at velocity \mathbf{v} . Let θ be the angle between vectors \mathbf{v} and \mathbf{L} . Determining the electromagnetic forces, acting between these charges in missile's frame of reference [17], we shall be interested in tangential components of forces, i.e. in the components of forces along the planes. The force influencing charge e_1 is

$$F_\tau = \frac{e_1 e_2 (1 - v^2/c^2)(v^2/c^2) \sin \theta \cos \theta}{L^2 (1 - v^2 \sin^2 \theta / c^2)^{3/2}} \neq 0. \quad (4.1)$$

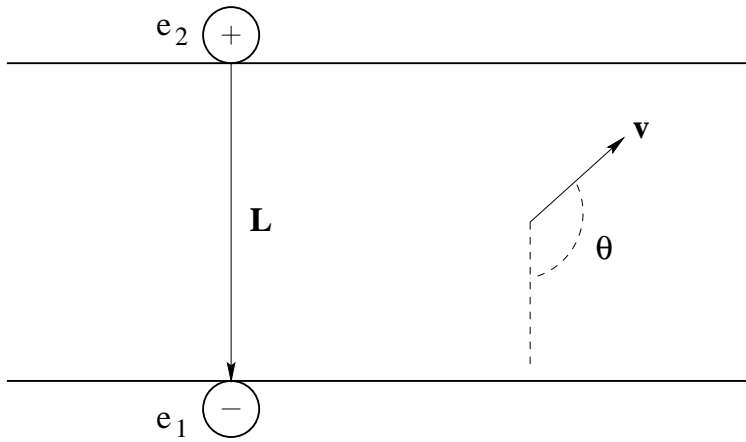

Figure 4.4: Paradox of transformation of forces.

Therefore, the charges will be displaced from their initial position. Let the balls be having huge charges, L be small ($L \rightarrow 0$), and v be large ($v \rightarrow c$). Let the observers to retain the balls with very thin threads. Whether they will be torn? The answer depends on the system of observation. So, who of the observers will be right? Thus, we have another inconsistency of SRT.

Let us consider now some particular problems. Methodically paradoxical is the description of motion of charged e particle of mass m_0 in the constant uniform electric field $E_x = E$ (see [34]). Really, in the classical physics the trajectory for $v_y = v_0$ is parabola $x = eEy^2/(2m_0v_0^2)$, and in SRT it is the chain line

$$x = \frac{m_0c^2}{eE} \left(\cosh \left[\frac{eEy}{m_0v_0c} \right] - 1 \right).$$

But for large y values the relativistic trajectory is close to an exponential curve, i.e. it is steeper, than parabola. But what in this case we should do with the idea on increasing the inertia (mass) of a body with the velocity? Even if we suppose that, despite a slightly greater steepness, the particle is slower moving over the trajectory, then due to which

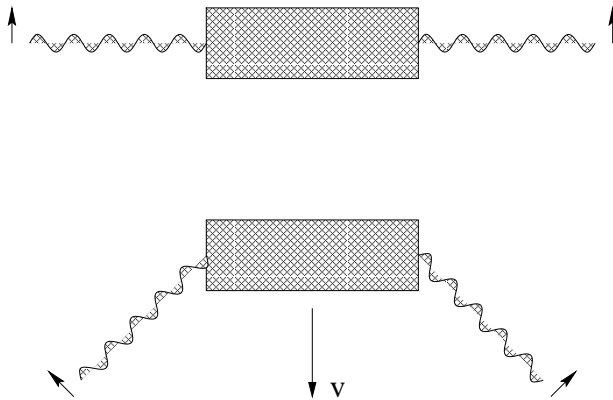

Figure 4.5: To the derivation of the formula $E = mc^2$.

forces it has been slowed down over axis y ? You see, force $F_y = 0$, and it will not appear in SRT as well: $F'_y = 0$. And the initial velocity value $v_y = v_0$ can be non-relativistic (and will remain the same).

Strange is the energy balance for a relativistic missile [33]:

$$m \cosh \theta + M_2 \cosh(d\theta) = M_1.$$

At high ejection rate ($\theta = \tanh(v/c)$) for finite values of initial M_1 and final M_2 masses the following condition (for SRT consistency) should be fulfilled: the mass of a separate ejection $m \rightarrow 0$. However, this quantity is determined by technological design of the rocket only: there are no principal limitations.

One of derivations of Einstein's relation $E = mc^2$ is insufficiently substantiated. The process of absorption of two symmetrical light pulses by a body in this derivation is considered from the viewpoint of two observers moving relative to each other. The first observer is resting relative to a body and the second one is moving perpendicular to the light (Fig. 4.5). It occurs in SRT that the light should "know" beforehand about observer's motion at velocity v exactly, and the momentum should be received in such a manner, that in this second system the velocity of a body be not changed, and only its mass could change. But

in such a case what shall we do with Lebedev's experiments (and to the present conventional concepts) on light pressure, where at momentum transmission by light it was the observed velocity of a body, which has changed? And what will happen to the momentum, if we shall have absolutely absorbing rough (skewed) surfaces? It is also unclear from presented drawings, whether we are dealing with real transversal light (the model, which now is conventional, including in the SRT as well) or with some mystical longitudinal-transversal light (for "saving" SRT).

Rather strange in the modern version of the SRT is the difference in the cumulative radiation mass as a dependence on system's momentum:

$$m = \sqrt{\frac{(E_1 + E_2)^2}{c^4} - \frac{(\mathbf{P}_1 + \mathbf{P}_2)^2}{c^2}}. \quad (4.2)$$

And if we shall change the momentum (direction) of separate photons by mirrors? In this case we shall determine the center of gravitation of a system. Where will it be localized also what will be the structure of the field closely to it? Will this center be skipping, disappearing and appearing, really? Let us make use of presented SRT formula (4.2) for determining the mass of cumulative radiation of two photons, flying apart of each other at arbitrary angle, and consider the radiation diverging from the same center (see Fig. 4.6). Then, depending on the in-pair grouping of photons, we can obtain different cumulative mass of the whole system (whether will it be necessary to introduce artificially the negative masses for "explaining" all possible variations of a mass?). And in GRT it is necessary to take into account the radiation birth pre-history for determining the localization of its center of gravitation and, besides, to take into account the whole unknown space-time structure of the electromagnetic field for correct description of quite different a phenomenon – the gravitation. Infinitely complicated procedure, really!

Spin and the Thomas precession

The relativists permanently emphasize that the Newtonian mechanics does not describe anything as compared to SRT. For example, in the book [33] the so-called Thomas precession is considered (which represents the effect of turning a rod in SRT as the manifestation of the

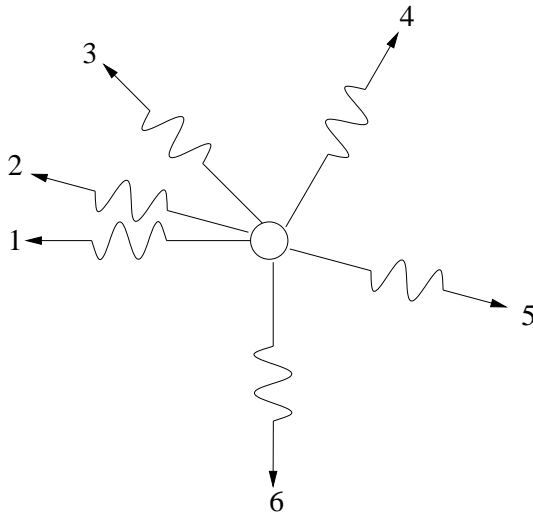

Figure 4.6: An indefinite mass of the photon combination.

"relativity of simultaneity"). It is also alleged in this book that in the Newtonian mechanics the gyroscope always keeps its attitude. However, as known from the quantum mechanics, the electron spin moment is always directed either along, or against the direction of orbital moment. That is, in the given case it is perpendicular to the orbital plane (and to the electron velocity!). And in this generally-accepted case both the Newtonian mechanics and SRT conserve the gyroscope direction perpendicular to the orbital plane. Therefore, the varying spin directions, shown in the book [33], do not meet the reality (Fig. 4.7). If, nevertheless, we suppose the electron spin attitude to be slant and recall, that we have not simply a gyroscope (a rotating ball), but a charged particle that possesses magnetic moment, then in the magnetic field of a charged nucleon under an effect of forces the electron spin precession will be observed, which can be described in the classical manner (as far as it is possible to be done for microscopic world's objects). For classical description of the given phenomenon (without SRT interpretations) it is necessary to know all atomic parameters, including the attitudes of

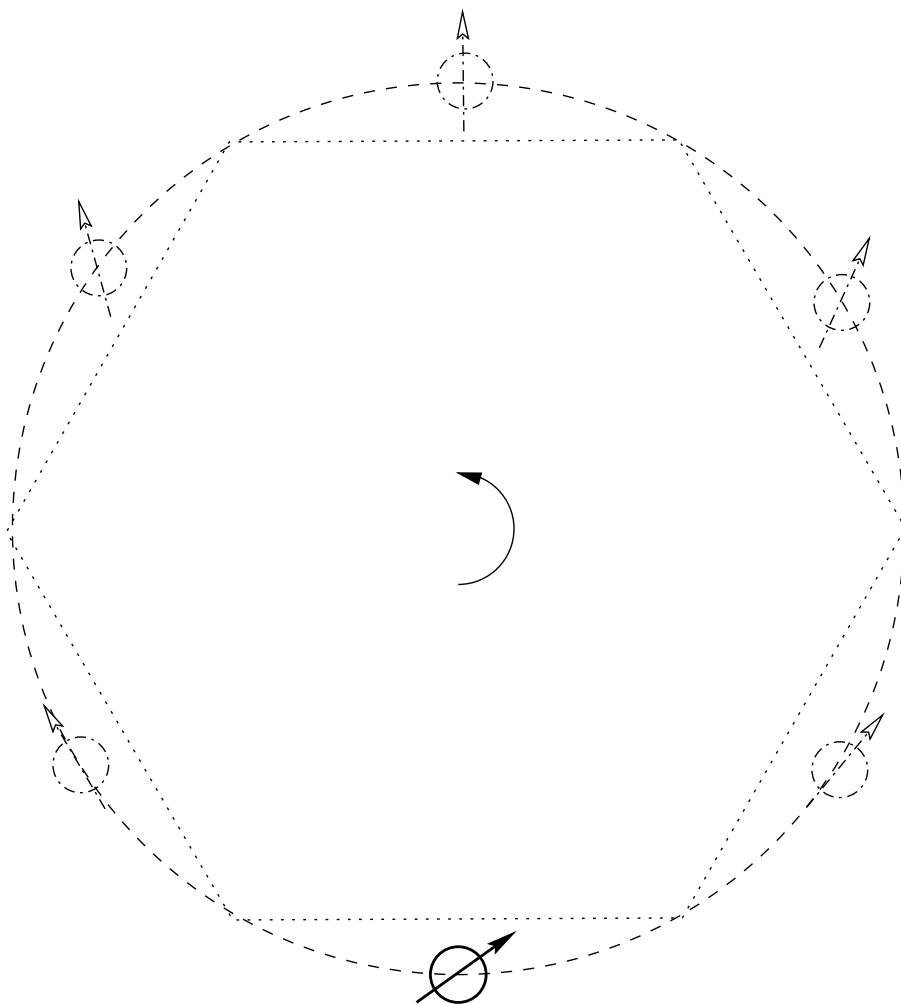

Figure 4.7: The Thomas precession in SRT.

spins and moments. Moreover, in the classical case, even if the electron spin attitude is perpendicular to the orbit, the precession is possible, if the nucleon moment is not perpendicular to the orbit (the nucleon can precess too). A concordance of all motions, including all orbits, all precessions, displacements of all perihelions, takes place in any real many-body problem always.

The use of the particles' spin concept is intrinsically inconsistent in SRT. The fact is, that at collisions the particles move relative to each other and, in addition, change their motion. And in a moving system the angular momentum (both orbital, and the spin) must, according to SRT, differ from the same quantity in a resting system. And how can the spin remain to be invariant and participate in rigorous numerical equalities (conservation laws)?

Besides, the Thomas precession as a kinematic effect of SRT is intrinsically contradictory (see Chapter 1), since this rotation process is beyond the scope of SRT inertial systems (of rectilinear uniform motion).

Once again on mass

The mass conservation law, as an independent law, is confirmed by a vast amount of the experimental data. The elementary particles either do not change at all (but change their kinetic energy and the energy of their concordant electromagnetic field), or completely transform into the other particles. The photon is also a particle, which can be characterized by the velocity and frequency or by the wavelength. Simply, no arbitrary mass transformation into energy does exist.

Still remain in SRT the questions for particles with a zero rest mass. First, from relativistic expressions for energy and momentum in no way follows a rigorous transition to the case of $v = c, m_0 = 0$. How, for example, can arise a continuum of every possible frequencies ω in such a transition? Second, where do the gravitation energy (field) and the bending of space disappear (and where is their center of localization positioned at annihilation), if we have a linear chain of sequentially annihilating and born pairs, or in the case, where from $m_0 \neq 0$ we obtain, by means of reflections, $m_0 = 0$? The problem of photon's rest mass is senseless, generally speaking. In the modern interpretation, the photon

- as a definite particle - is characterized by some definite frequency ω . At rest ($\omega = 0$) the photon would even be not a different particle; simply, it would cease to exist. Therefore, there is no concept of photon's rest mass (as well as the concept of photon's rest energy, etc.). On the other hand, for a real photon it is quite possible to determine not only the energy and momentum, but the mass as well. In the textbook [26] the conclusion was drawn quite incorrectly, that the particles with zero rest mass can not exist in the classical physics, since for $m = 0$ any force must allegedly cause infinite acceleration. First, not any force can act on a photon with $m = 0$. For example, when the gravitation force acts, a zero mass is correctly "canceled" and the acceleration remains finite. Second, both the classical mechanics and SRT do not impose principal limitations on the value of acceleration. This allows one, for example, to consider the collisions of particles and the reflection of light to be instantaneous processes. Third, why the SRT choice is better, when under an effect of force, according to relativists' logic, the acceleration for light remains to be zero? If we appeal to intuition, then the infinite photon mass is obtained in SRT.

The field (possibly, not only electromagnetic?), as a material medium capable of transferring energy and possessing a momentum, can possess a mass as well (such a concept is inner consistent, but an experiment only can give an answer - whether this possibility is realized or not). Hence, for the classical physics it is also not surprising at all, that some field is capable to transfer the mass. In such a case the field must participate in the classical mass conservation law, and then the mass will be conserved in any reactions. The field must also participate in the momentum and energy conservation laws, and then one can not change the classical part of these conservation laws, which relates to particles. Therefore, in the classical physics it is also not surprising at all, that the excited atom can weigh greater than unexcited one, or the body with a greater energy can possess greater mass (by the way, it is impossible to verify this fact with the modern measurement precision). This additional mass is concentrated in the field, which causes particles to oscillate, to move over forceless trajectories or to kick from a particle-retaining wall. If we suppose the particles and the process of their collision itself to possess

a purely electromagnetic nature, then in vacuum it is possible to use the relativistic expressions for the momentum-energy, but only from the viewpoint of unambiguous interrelations between quantities. However, one should remember here, that in this case the energy and momentum characterize the given collision process only, because they are written down, actually, with implicit allowance for the energy and momentum of the field (without explicit accounting and separating).

The theory of collisions and the conservation laws in SRT

Very frequently in SRT, for "simplifying" the description of collisions, the technique of transition to any "conveniently moving" frame of reference is used. Such a procedure, however, has no physical grounds, and the principle of relativity for closed identical systems is for nothing here at all. If the relativistic experiments are carried out on artificial beams of particles, then the sources (accelerators) and recording instruments are bound to the Earth, and accelerators and instruments will not fly, together with a moving observer, from our mental imagination only. If some process in Wilson's chamber is investigated, then the tracks of particles are bound to a medium (that is, to Wilson's chamber), rather than to a flying observer. For example, in the classical physics the angle between the tracks of particles will not change due to motion of an observer. At the same time, the angle between the velocities of particles, which leave mentioned tracks, can depend on observer's motion velocity. In the relativistic physics the angles between trajectories and between velocities of particles depend, also according to various laws, on observer's motion velocity. Therefore, such a seemingly probable from SRT viewpoint transition to a new frame of reference can essentially distort the interpretation of a solution. That is, any process should be considered in the frame of reference of a real observer (or recording instrument) only.

One more distortion of reality is the consideration of the process of collision of two particles (being principally point-like in SRT) as a planar motion. In fact, to fit to an ideal problem of two points, a measuring device cannot simultaneously fly with each pair of particles and differently rotate even in studies of statistical characteristics of point particles: the

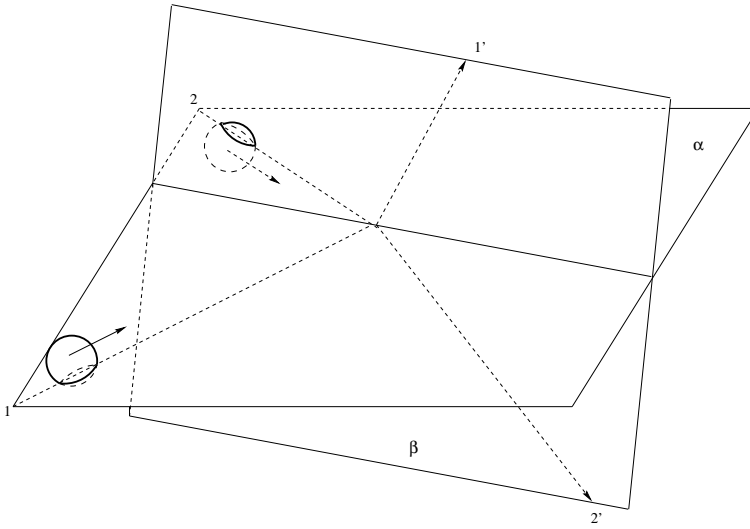

Figure 4.8: Nonplanar motion of two particles.

position of the device is fixed. Besides, point-like particles should be considered as a limiting case of particles having real finite size (otherwise no frontal collisions would be observed, it would be impossible to consider collisions of atoms and molecules, the protons would not have structure, etc.). And in the present case the collision of particles is principally three-dimensional (the probability of planar motion is zero). Let, for example, two identical balls (1 and 2) to approach each other before collision over straight lines crossing in space (the minimum distance between skew straight lines is smaller than the ball diameter). Even from the very beginning of the experiment we cannot draw the plane through these specified straight lines. Nevertheless, we shall take the middle of a minimum distance between crossing straight lines (the trajectories before collision) and draw through it intersecting straight lines parallel to the given trajectories. Now, only one plane α passes through intersecting straight lines (Fig. 4.8). The centers of balls move parallel to this plane before collision: the first ball's center moves slightly above the plane and the second ball's center – slightly below this plane. After collision the

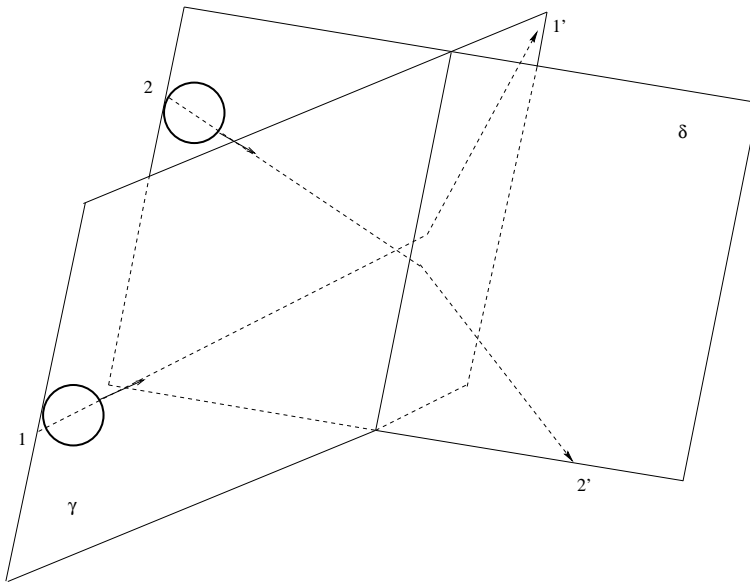

Figure 4.9: Three-dimensionality of collision of two particles.

balls will fly over other crossing straight (skew) lines. And, again, it is impossible to draw the plane through these skew straight lines. Again, we shall perform a similar procedure with parallel transition of straight lines, on which the lines of motion lie after collision, before intersecting at the middle. We shall draw through intersecting straight lines the plane β (the centers of balls will again move on different sides from this plane). However, "the plane before collision" does not coincide with "the plane after collision", but intersects it at some angle.

Second method: let us draw one plane γ through the trajectory of motion of the first particle (intersecting straight lines of its motion before and after collision), and the second plane δ – through a similar trajectory of motion of the second particle. However, these planes are also intersected at some angle (Fig. 4.9).

So, what follows from three-dimensionality of motion? First. Not all relations turn out linear ones. For example, the distance between

bodies occurs some nonlinear function of time even for the rectilinear uniform motion of the bodies along skew lines. Second. We shall write the classical laws of conservation of momentum (in projections) and of energy:

$$v_{1x} + v_{2x} = v'_{1x} + v'_{2x} \quad (4.3)$$

$$v_{1y} + v_{2y} = v'_{1y} + v'_{2y} \quad (4.4)$$

$$v_{1z} + v_{2z} = v'_{1z} + v'_{2z} \quad (4.5)$$

$$\sum_{i=1,2} (v_{ix}^2 + v_{iy}^2 + v_{iz}^2) = \sum_{i=1,2} (v'^2_{ix} + v'^2_{iy} + v'^2_{iz}). \quad (4.6)$$

We see from (4.3-4.6), that for six unknown quantities ($v'_{1x}, v'_{1y}, v'_{1z}, v'_{2x}, v'_{2y}, v'_{2z}$) there are four equations only. Thus, there should remain two indefinite parameters in the solution. If we suppose the motion to be planar (i.e. exclude equation (4.5)), then for remaining four unknowns we shall have three equations. Therefore, in comparing SRT results with the classical physics the substitution of solutions is accomplished, and there remains only one indefinite parameter (the scattering angle is usually considered to be the latter one). Such a substitution results in improper interpretation of the experimental data, especially when the missed quantities are restored. For example, the book [33] demonstrates two tracks of fly-away of particles of identical mass and charge (more correctly, of identical e/m ratio) with dispersion angle lower than 90° , and the conclusion on the classical mechanics invalidity is drawn from this demonstration. Let us write the expression for angle α between the trajectories of dispersed particles:

$$\cos \alpha = \frac{v'_{1x}v'_{2x} + v'_{1y}v'_{2y} + v'_{1z}v'_{2z}}{\sqrt{(v'^2_{1x} + v'^2_{1y} + v'^2_{1z})(v'^2_{2x} + v'^2_{2y} + v'^2_{2z})}}. \quad (4.7)$$

Choose axis Z so, that it will be $v_{1z} = v_{2z} = 0$. Now we express variable v'_{1x} from equation (4.3), variable v'_{1y} – from equation (4.4), variable v'_{1z} – from equation (4.5), and from equation (4.6) we shall express quantity v'^2_{2z} (in this case the condition $v'^2_{2z} > 0$ restricts the region of possible values of all variables). Substitute all aforementioned quantities into equation (4.7). As a result, we obtain the two-parametric dependence

on v'_{2x} and v'_{2y} , which is not written here because of its awkwardness. Using graphical programs, we can be convinced that for the given values of $v_{1x}, v_{1y}, v_{2x}, v_{2y}$ we obtain some surface similar to the inner part of a cylinder; that is, quantity $\cos \alpha$ varies within wide limits. For example, it can easily be verified that the values

$$v_{1x} = 0, 1; \quad v_{1y} = 0, 1; \quad v_{2x} = 0, 7; \quad v_{2y} = 0, 7; \quad v'_{1x} = 0, 6;$$

$$v'_{2x} = 0, 2; \quad v'_{1y} = 0, 4; \quad v'_{2y} = 0, 4; \quad -v'_{2z} = v'_{1z} = \sqrt{0, 14}$$

satisfy all classical conservation laws (4.3-4.6). For these values we obtain $\cos \alpha = 0.29554$, that is, $\alpha \approx 72.8^\circ$. Note: if the velocities are assumed to be expressed in terms of the speed of light, then a lower velocity is quite real for the motion of internal electrons in atoms beginning with $z \geq 60$. And, generally, nobody saw electrons in atoms being at rest! The angle of 90° is unambiguously obtained in the classical physics at collision with a particle being at rest in the coordinate system of a recorder (but only where such a particle can be found?). However, the observed fly-away angle of 90° does not result at all in an unambiguous opposite assertion, that one of particles had been at rest (the mathematical probability of such an event is infinitesimal). Thus, the reverse problem of restoring the missed data is not an unambiguous procedure either in the classical, or in the relativistic physics (there exists an infinite number of various self-consistent solutions).

For more rigorous verification of conservation laws in collisions (independent of any theory) it is necessary to study collisions of particles in vacuum for narrow monoenergetic beams of known particles for the given collision angles. In this case the complete study of the collision process should include the check of the energy balance of particles (for each scattering angle in space), the testing the balance of momenta of particles, the testing the balance of the total number of particles in beams before and after collision (the probability of scattering), the control of the balance of arising radiation in energies and directions. There are two more questions (two more uncertainties), which are not usually emphasized, namely: does the scattering depend on a mutual orientation of spins of colliding particles? And do these spins change during the collision? In the classical physics the answer to these questions is "yes"

(but in the quantitative respect it strongly depends on the "structure" of balls).

The author did not meet any complete analysis of any collision process in SRT with respect to all issues set forth above. This does not imply, however, an unambiguous conclusion on invalidity (within the limits of experimental errors) of usually utilized relativistic conservation laws in any collision process (though this can quite occur to be the fact for many separate cases). The author only asserts that there are no even separate examples of absolute confirmation of relativistic collision laws (to say nothing of the global confirmation).

From a principally rigorous position, the application of relativistic conservation laws to the collision process in the elementary particle physics is rather doubtful. Whether these laws can retain their form irrespective of the charge of colliding particles, collision angles and dispersion angles? You see, the charged particles undergo acceleration during the collision. Therefore, according to the modern concepts (to the SRT as well) some radiation (field) should always be observed. Is it necessary, really, to behave as the students having peeped at the answer to the problem: if the instrument has recorded a γ -quantum ("has seized our hand"), then it should be clearly taken into account "with a clever air". And should one trust in validity of SRT formulas "with a clever air" in remaining cases as well? So, where is the "predictive force" of SRT? Actually, the conservation laws should be explicitly supplemented by the terms, which take into account the energy and momentum of the field.

Generally speaking, the only case, where the discussion of relativistic conservation laws at "collisions" is lawful, is the interaction of particles with the forces of electromagnetic nature (the Lorentz force). For remaining cases the fulfillment of relativistic conservation laws is an unverified hypothesis (the light spheres of SRT bear no relation to the forces of non-electromagnetic nature). However, in the case of electromagnetic interactions no SRT ideas are required for deriving relativistic conservation laws as well. It is known that the equations of motion with the initial conditions completely determine all characteristics of motion, including the integrals of motion. Such an integral of motion can be the

energy (but not always!). It follows from the equation of motion, that

$$\frac{d\mathbf{P}}{dt} = \mathbf{F} \Rightarrow \mathbf{v}d\mathbf{P} = \mathbf{F}d\mathbf{r}. \quad (4.8)$$

Introduce the definition of the potential energy

$$U = - \int_{r_0}^r \mathbf{F}d\mathbf{r}.$$

Knowing the form of the momentum (this is a quantity appeared in the experimental equation of motion (4.8); for example, in the classical case $\mathbf{P} = m\mathbf{v}$ and in the relativistic case $\mathbf{P} = m\mathbf{v}/\sqrt{1-v^2/c^2}$), one can obtain the energy conservation law from $dE = \mathbf{v}d\mathbf{P} - \mathbf{F}d\mathbf{r}$: classical $U + mv^2/2 = constant$, or relativistic $U + mc^2/\sqrt{1-v^2/c^2} = constant$, respectively. Under the condition of equality forces of action and counteraction (the third Newton's law, the hypothesis of central forces) we have: $\mathbf{F}_{12} = -\mathbf{F}_{21}$. Then from the equation of motion (4.8) we can obtain the momentum conservation law (this is again a quantity appeared in the experimental equation of motion (4.8)): from $d\mathbf{P}_1/dt = \mathbf{F}_{12}$, $d\mathbf{P}_2/dt = \mathbf{F}_{21}$ we obtain

$$\frac{d(\mathbf{P}_1 + \mathbf{P}_2)}{dt} = 0, \Rightarrow \mathbf{P}_1 + \mathbf{P}_2 = constant.$$

However, in the presence of magnetic forces $\mathbf{F}_{12} \neq -\mathbf{F}_{21}$, and the relativistic law of conservation of momentum of particles can be violated in the general case. Since the majority of particles, even many electrically neutral ones, have magnetic moment (i.e. they represent not "ideal point charges of the SRT", but charged magnetic rotators of finite size), the application of the relativistic momentum conservation law in the nuclear physics and elementary particle physics without explicit considering the field momentum is completely illegitimate. Therefore, we again arrive at the necessity of explicit considering the momentum (and, hence, the energy) of the field at collisions. (Possibly, this will help to regulate the nuclear physics and elementary particle physics and to decrease the number of particles-ghosts?)

The account taken of the radiation reaction force also results in violation of energy and momentum conservation laws declared in SRT.

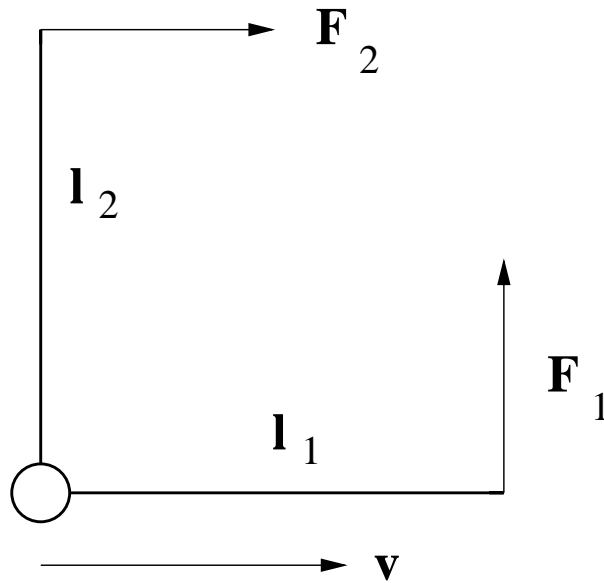

Figure 4.10: Paradox of a lever.

Should we refuse from accounting this force in the process of collision of particles? But this force just should be most significant in this process (there are great fields, owing to rapprochement of high-energy particles, and great variable accelerations).

The angular momentum in SRT

The non-conservation of generally-accepted expressions for relativistic energy and momentum at collisions of particles results, in the general case, in the non-conservation of the angular momentum in SRT as well. However, the relativistic expression of the angular momentum can be easily discredited for much simpler examples [8]. Let us recall, for example, the paradox of a lever. Let two forces, equal in magnitude, $F_1 = F_2 \equiv F$, to act on two identical arms $l_1 = l_2 \equiv l$, disposed at angle $\pi/2$ (Fig. 4.10). The total moment of forces equals zero. The structure

remains motionless. In the classical physics the result does not depend at all on the frame of reference, and, hence, it is not necessary to invent any new physical concepts, processes, phenomena or mathematical derivations.

Different is the situation in SRT. If somebody will only look at this system from a missile moving at velocity v along one of arms, then the total moment will occur to be nonzero. Owing to contraction of lengths and transformation of forces we have: $M_{sum} = Flv^2/c^2 \neq 0$. The lever must begin to rotate. It would seem that such an inconsistency should entail refusal from SRT and returning to the classical physics, that provides an obvious and true result. However, the relativists (following Laue and Sommerfeld) have gone another way [34]. "For the sake" of pseudo-science it was necessary to sacrifice something. Since the common sense is less significant for relativists, than SRT, it was necessary for them to invent the missing pseudo-moment. Now, if you simply rest upon something (on the wall, for instance) or use a lever, then you should store some additional clothes: "something" (the energy) will begin to flow through you, and this quantity can occur huge! Besides, the fluxes (of sweat, probably?) can occur to be different simultaneously, if somebody "spies" upon you from different moving missiles. If you keep both levers with your hands with identical force, then the energy from one hand merely flows away to an axis and "settles" somewhere. Do not worry, however! This "something" can not be measured in any way, but this is just not necessary for relativists: this is not engaging in physics, you see! Simply, the literal expressions should be met with an obvious (from the common sense viewpoint) result. Thus, instead of one principally undetectable relativistic effect (otherwise the inconsistency would be detected) we would obtain two principally undetectable relativistic effects exactly balancing each other. Similar tricks have an effect on many people (the letters just converge!), in spite of the fact that "the dry remainder" of all similar "inventions" is a priory obvious classical result.

The Compton effect

There are also some questions to the Compton effect theory and, in particular, to the interpretation of two key facts of the experimental curve: 1) the dissipation on free electrons being at rest; 2) the declaration of the presence of highly (?) bound electrons with the energy greater than 1 Mev (?!). For the first fact one should make the following comment. First, at real temperatures the possibility for an electron (even free) to have zero velocity is zero, and it is necessary to consider the arbitrary motion of electrons (the real distribution). In particular, the peak should be related to the most probable, rather to zero, velocity (and for an atom – to the velocity of fixed electrons in the atom, which is rather great). Second, it would be interesting to confirm the effect on electron beams in all three quantities independently (the full balance): in angles, energies and in a number of particles. For the second fact we note that with declared high energies it would be strange not to draw out any (even internal) electron. Probably, the Compton effect (as well as Mossbauer's effect) should be considered for a body (or atom) as whole from some resonance conditions (with regard to concrete mechanisms of absorption and radiation in the atom). However, even in this case still remain the questions on the influence of motion of electrons in atoms and on the temperature effect on all three quantities measured in a single (!) experiment.

It would seem that for electromagnetic interactions there should be the least number of reasons to doubt in the relativistic equation of motion: $\frac{d\mathbf{P}}{dt} = e\mathbf{E} + \frac{e}{c}[\mathbf{v} \times \mathbf{B}]$, and, as a consequence, in relativistic conservation laws for the process of collision. Nevertheless, we shall make some remarks on the issue of validity of relativistic description of the Compton effect. Above we have already considered some uncertainties for collision of balls – an analog of the "billiard"-type Compton model. We shall analyze the experiments described in the standard tutorials, for example, in [27,30,40]. Note that if the time of coincidence of instants of recording γ -quanta and electrons $\Delta t > 10^{-20}$ sec, then the experiments not only do not prove the simultaneity of emitting of particles, but also do not allow to attribute unambiguously the particles to any act of scattering. Such an accuracy is outside the limits of even modern

possibilities (that is, this is still a matter of "faith", and no statistics will help here).

It is methodically incorrect to call the electrons, participating in scattering, as free ones, because in such a case their number should be constant in the experiment. However, one has to consider this number to be different depending on a scattering angle, and if this angle is rather small, all electrons "occur" to be bound. In fact, however, all electrons participate in the momentum transfer (owing to their motion in an atom) and capture from a γ -quantum a part of energy (because they are bound in the atomic coordinate system).

Some points in the Compton effect theory are not obvious. For example, what is the role of scattering on larger particles, than electrons, – on nuclei (whether the interference and its influence from radiation, scattered on nuclei, are possible)? Why the non-shifted line is absent in the experiment with lithium (Compton, Wu)? On the contrary, it should always be present, for example, from scattering on a nucleon. Why for all substances there exist two peaks, situated almost symmetrically with respect to the initial line, rather than one shifted peak?

Besides, all tracks are not visualized (as in the ideal theory), but are only restored with the help of auxiliary means (and interpretations). That is, in verifying the conservation laws we are dealing with statistical hypotheses. In the experiments there are no estimates of the probability of double scattering from a specimen (but it can have a noticeable value), and the role of multiply scattered "background" from all parts of an experimental setup is evaluated nowhere. The accuracy of experiments, even on determination of a scattering cross-section, is low about 10% (and this is the statistical accuracy!). In so doing, the most presentable (favorable to the theory) events are chosen. For example, in the experiment by Crane, Gaertner and Turin only 300 cases from 10000 photos have been chosen (whether this is not too little?), and the coincidence of the scattering cross-section data with the Klein-Nishina-Tamm formula is declared. In the case of large thickness of specimens (Kohlrausch, Compton, Chao) the double scattering must obviously be taken into account. Similarly, it is obvious from the scheme of the experiment, that in Szepesi and Bay's experiment the number of double scattering events

is of the same order, as that of single scattering ones. If this fact is not taken into account, the declared accuracy of 17% is rather doubtful. The declarative corrections (adjustments), made by Hofstadter in his experiment due to influence of various factors, cause bewilderment. In this case after all corrections (adjustments up to 30%!) the accuracy of 15% is declared.

In reality, in all experiments not the dispersion directions are detected, but the hitting into the given site of space is recorded. Therefore, the experimental confirmation of a SRT interpretation occurs to be rather doubtful. For example, in the experiment by Cross and Ramsey almost a half of points, with regard to declared limits of tolerances, lie outside the theoretical curve. Of interest is the fact, that after removing a recording device from the plane of scattering the number of coincidences in scattering acts remains to be considerable: it more than three times exceeds the background value. Also rather strange is to compare Skobeltsyn's experiments with the theory with using the ratio of a number of particles scattered to various angles $N_{0^\circ}^{10^\circ} / N_{10^\circ}^{20^\circ}$. You see, each of these quantities (both numerator and denominator separately) represents some averaged (effective) quantity. And how is it possible, in the general form, to compare the ratio of average quantities (two experiments) with the ratio of true quantities (a theory) without using the fluctuation theory?

For more complete theoretical substantiation of the Compton effect not one collimator is required (for incident particles), but three collimators for separating, in addition, each type of scattered particles over narrow directions. The absorbers are also necessary for eliminating the background. Then there will remain "only" the problem of filtering all particles over energies. Thus, even such an, apparently, purely relativistic phenomenon, as the Compton effect, is not experimentally verified to a complete measure.

Additional remarks

The above described possibility of nonplanar motion even for two real bodies must be taken into account in the problem of the displacement of Mercury's perihelion (nobody made this).

Let us make some supplementary remark. In deriving the relativistic expression for the momentum "it is proved" that the momentum should be directed along the velocity, otherwise it would be indefinite. However, this reasoning is not rigorous in any way with respect to a single particle, because in a system, where $\mathbf{v} = 0$, the direction of momentum is indefinite too. The classical expression for momentum follows from the Euclidean nature (homogeneity, isotropy) of space and from the invariance of mass. Following the minimum necessity principle, one can keep the classical expression both for the direction, and for the magnitude of particle's momentum. Then all relativistic changes will be revealed in changing the expression for energy. Simply, it is necessary to remember that for charged particles the field can also possess nonzero energy and momentum. And only the collision of neutral particles without internal degrees of freedom can be strictly elastic.

One more supplementary remark. In the book [33] (exercise 65 – "the momentum without mass") the platform on caster wheels is considered. At one of its ends the motor with accumulator is installed, which rotates, by means of a belt-driven transmission (through the whole platform), the caster wheel with vanes in water at the other end of a platform. As a result, the electrical energy of the accumulator transfers from one end of a platform into the thermal energy of water at the other end of a platform. Again, now we deal with the loss of determinacy (with non-objectivity): for "saving" SRT various observers should draw various artificial conclusions about the paths and rates of energy (mass) transfer. For example, according to SRT, the observer on a platform should assign the energy (mass) transfer to the belt-driven transmission. And if we shall leave to him open for observation only two small chunks of a belt, then in what and how this mass transfer can be confirmed experimentally? The classical physics attitude is more legible: if one body influences the second one, then the committed work is determined by the product of acting force on the relative path: $A = \int \mathbf{F} d\mathbf{r}$ or $A = \int \mathbf{F} \mathbf{v} dt$, where \mathbf{v} is the relative velocity. For example, under an effect of the friction force a moving body stops. The kinetic energy of a body relative to the surface will be numerically equal to the work of the friction force and is numerically equal to the amount of released heat. These quantities

are invariant (do not depend on the observation system).

Now we shall make a methodical remark on confirmation of relativistic formulas. The accuracy of experiments in microscopic world's physics is low, as a rule, in a separate measurement act. However, this accuracy is artificially increased by choosing the events "needed for the theory" and by subsequent statistical processing the results (adjustment under the theory). Unlike the classical field of investigation, nobody measures directly the value of velocity of particles in relativistic ranges of velocities (as well as the mass cannot be directly measured, but it is only possible for e/m with using definite theoretical interpretations and appropriate calibration of instruments). Therefore, it is impossible to substitute, in the explicit form, quantities v and m into calculated (!) values of energy and momentum and verify the conservation laws of SRT. Even if one determines experimentally some nearly-kept numerical quantities, the literal expression for energy and momentum can be extracted from these values by many various techniques with different results. And, you see, even the numerical values of energy and momentum have been measured indirectly (again, we are dealing with theoretical interpretations).

If some object possesses a speed which is large than the speed with which you can moves your hand, then you cannot accelerate this object with the hand; however, the speed of a collision during a contrary motion will be defined by the sum of the velocities. The situation will be quite analogous if we, using the electromagnetic field, will try to accelerate particles flying nearly the speed of transmission of electromagnetic interactions (the efficiency of acceleration will be small); but again the velocities of particles will be added for the head-on collision in an additive manner. Consider the following mental experiment. Let three observers at points A , B and C be placed at one stright line. Let the distance $|AB|$ be equal to the distance $|BC|$. A periodical synchronizing source O is placed at the middle perpendicular OB . The distance $R = |OB|$ is very great. Note that all points are in the relative rest and this synchronizing procedure (from the remote source) is valid in the SRT also. As the result of such the synchronization, a precision of the synchronization at the all three points A , B , C can be made an arbitrary small value by choosing the appropriate large value of R . Let there be

radioactive sources at end points A and C radiating particles at speed $0.9c$. With receiving the first synchronizing signal from O , screens at points A and C are simultaneously opened. Particles from the points A and C fly to the central point B towards each other. The observer at the point B will see that the space between the two beams of particles are to be "eating up" with the speed of $0.9c + 0.9c = 1.8c$. With the same speed particles will "get one's teeth into other's body" (to prove the validity of calculations, an instant of the collision can be arrived just in time of the second synchronizing signal). Just this speed is the speed of the particle's collision. But the relativistic law of the velocity addition bears no relation to the reality at all. In the relativity theory many additional, but really fictive, reaction channels arise as the result of erroneously ascribing reactions at different conditions to the reactions at the same conditions (parameters of the collision).

There arises a question: can superluminal velocities (for usual particles, but not for fairy-tale "tachions") be obtained and be observed by the real resting observer? We answer in such a manner: it is almost improbable that particle's speeds would be principally limited to the light speed (in line with the above mentioned, more precisely – even to the double speed of light). It could be observed under several conditions only: first, true elementary particles must be absent in the Nature; second, all the World must possess the exclusively electromagnetic nature and must strictly obey to the Maxwell equations. However, there is good reason to believe that 1) true elementary particles exist, that 2) in addition to electromagnetic interactions, there exist the other interactions (at least three additional ones) in the Nature, and that 3) even the electromagnetic interactions themselves cannot be exclusively described by the modern form of the Maxwell equations (this fact was pointed out even by Ritz; remember also the fact itself of the birth of the quantum mechanics). In practice, it can be proposed the following. Consider collisions on rarefied contrary beams of particles flying practically with the speed of light. At strictly head-on collisions of true elementary particles of the same charges but of rather different masses (protons and positrons, for example), the more light particles will possess speeds approximately equal to the double speed of light at scattering on 180° . Of course, the

probability of such the events is small (but not zero!), since small deviations from the strictly head-on collision lead to essential change in speeds of particles. It is more difficult to realize a repeated iteration of such the procedure (it is some analog of the Fermi acceleration) for obtaining large speeds, but it is possible in the Universe.

In studying collisions with particles being "at rest" the question arises: where so many resting particles have been found from? And how had this fact been verified (since this circumstance can relate to determination of collision and scattering angles, of an aiming parameter, etc.)?

We concentrate our attention on the fact that the energy acquired in a unit time by a particle in its passage through an electromagnetic field region can be described by one and the same formula $(dE_k/dt) = e\mathbf{E}\mathbf{v}$ both in the classical and in the relativistic cases [17]. This fact provide one of causes for the "near-successful" calculation of accelerators. The same "events" and readings of devices are simply related to different scales of energy (more precisely, to different combinations of letter symbols) in the classical and relativistic cases.

SRT bears no priority relation to explaining the presence of momentum in a photon. Any particle (including a photon) is detected from its interaction with other particles, that is, actually, from the momentum transfer. According to the modern concepts, the experimental basis for defining the presence of photon's momentum are Lebedev's experiments on measuring the pressure of light. The literal expression for a kinetic energy of photon can be elementary deduced from the general definition: $dE = \mathbf{v}d\mathbf{p}$ (from the general equations of motion). If we take into account that the photon moves at a speed of light $v = c$, then after integration we obtain $E = cp$ without any SRT's ideas. However, this formula can be applicable to light in vacuum only (but not in other mediums).

Also fully unsatisfactory is the semi-classical derivation of the Einstein formula [40]: $\Delta E = \Delta mc^2$. First, the notion of the center of masses is contradictory in SRT. Second, for some reason one remembers about acoustic waves in SRT only when they are unessential (distract from apparent paradoxes). But these waves bear some relation to the given

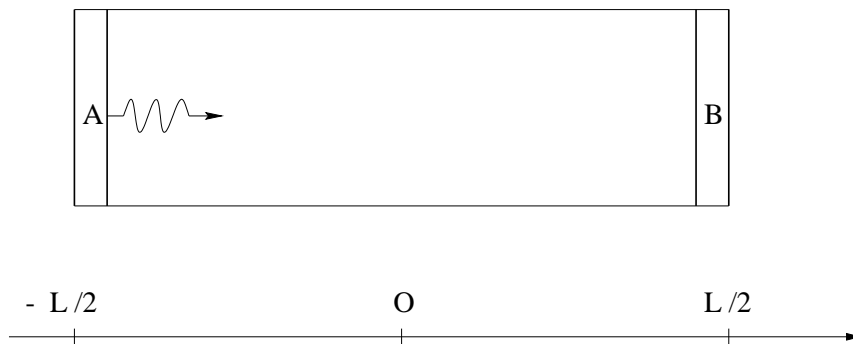

Figure 4.11: Relation of radiation mass with its energy.

situation. Let at the ends of a homogeneous tube of length L and mass M (Fig. 4.11) there are bodies A and B of negligible mass [40] (we take, for example, the monomolecular layers of the same substance). Let the atoms of layer A be at excited state. The following "circular process" is considered in [40]. At first, body A emits a short light pulse in the direction of body B . It is stated that the tube will begin to move as a whole. But this is not the case. Let the length $L = 1$ cm. The emitted pulse will make body A to bend and move to the distance of about intermolecular one from tube's molecules retaining it. Then the elastic force will arise, which tends to return the lost equilibrium. As a result, the complicated system of longitudinal and transversal oscillations will propagate along a tube. During the time, for which the light will reach body B , these acoustic waves will pass the distance not greater than 10^{-5} cm (since $v_{sound} \ll c$). A similar process will be repeated with body B . Thus, the oscillating tube will extend from center O in opposite directions (to the side of body A – to a slightly greater distance), until the acoustic waves will cancel each other and the equilibrium will establish. But even this complicated real process does not matter, indeed. Further on [40] body B with absorbed energy is brought into contact with body A by internal forces; body B returns energy back to body A and returns to its place (and then the mathematical symbols are written). One moment! Third, in what manner could body B transfer electromagnetic excitation

energy without transferring momentum? Besides, it could be only the light pulse (otherwise according to the second thermodynamic law not all energy could transfer to body A). But in such a case we would simply have a mutually reciprocal momentum transfer by means of light, and no global conclusions follow from this situation. The given problem is similar to the classical problem on throwing a ball in a boat from one person to another. The ball has a mass, and in flight it also possesses nonzero momentum and energy. The value of mass enters expressions for a momentum and kinetic energy, but no "all-universe" conclusions follow from this situation. The thing sought in [40] can be obtained much easier. From the general expression $dE = \mathbf{v}d\mathbf{P}$ we have for light $\Delta E = c\Delta P$. If we introduce, in a classical manner, for a photon the mass of motion $P = mv$, then from $v = c = \text{constant}$ follows the only possibility $\Delta P = c\Delta m$. As a result, without any mental SRT ideas, we have $\Delta E = c^2\Delta m$. However, fourth, this result (irrespective of the method of its derivation) relates to the electromagnetic energy only and not to anything more (at least, there are no proofs of generality of the result).

An incorrect procedure may occur to be also the searching for solutions in SRT to an accuracy of up to some expansion in v/c . The rejected terms can cardinaly change the form of a solution. The field of applicability of the approximate solution in time can occur to be such small, that the approximate solution will not have any theoretical and practical value (but how can it be detected without knowing the behavior of a true function?). Also doubtful is to derive the averaged solution from approximate one. A trivial example: it would seem formally, that in the Lorentz force it is possible to neglect the magnetic force containing v/c . This is not the case, however: in the classical limit, instead of a real average drift of a particle at constant velocity perpendicular to both fields, we would obtain the accelerated motion along the field \mathbf{E} . In the relativistic limit [17] the velocities grows most rapidly also in the direction of $[\mathbf{E} \times \mathbf{B}]$. Apparently, due to this reason the approximate Lagrange functions, constructed in SRT up to some term in v/c , can cause some problems, and the construction of an accurate Lagrange function is principally problematic in SRT. The limited nature of SRT results

reveals itself in self-acceleration of charges under an effect of radiation reaction. The radiation is determined in the far-field zone and should not strongly depend on the processes occurring on particle scales: only re-evaluation of SRT rigorousness compels one to consider elementary particles as point-like ones.

Though the following methodical remark concerns kinematics first, it touches also upon the GRT and the relativistic dynamics as well. The problem is setted in [17]: to describe the motion of the system under investigation, which is uniformly accelerated relative to the own inertial system (the latter is instantly in the rest relative the system being investigated). A reader can have the natural question: whether the motion, which is uniformly accelerated relative to one inertial system, can really be nonuniformly accelerated relative to the other inertial systems or not? Unfortunately, in the SRT the situation turns out just the same (we are lucky that the relativity theory practically not use higher derivatives, except the description of radiation, otherwise we could see many new "peculiarities"). However, what will we have with the equivalence principle: in one inertial system there exists an equivalence to some gravitational field (constant), but in the other inertial system in the same space point were we be having the changed gravitational (physical!) field? To "see" the flight of cobble-stones as balloons, with what a speed must the observer fly? But if we will attach the dynamometer to such the uniformly accelerated rocket and hang up a weight to the spring, then, whether differently moving (but with some constant velocities) observers would see that the dynamometer pointer show different Arabic cipher or not?

We mention the well known paradox of a relativistic submarine (the SRT was stopped in choosing as "the Buridan's donkey" between two haystacks): from the viewpoint of an observer at the earth surface, the moving submarine must sink due to increasing it's density as a result of shortening of it's length; contrary, from the viewpoint of an observer at the submarine, the latter must surface due to increasing of density of surroundings water. It was needed to say some "magic pseudo-scientific spell", and relativists chose to allege either an acceleration process or a curved space in increased gravitational field, that is they sent off to

the GRT again. Possibly, it can be written as an epitaph: "the SRT made efforts to fill immensity, but never possessed an own subject for investigation". We re-formulate the present paradox in different manner to evidently see that gravitation bears no relation to this case. Let the following ANSWER be known from the viewpoints of both observers. At the usual earth conditions (i.e. at the weak gravitational field!), an usual submarine had successfully passed a path between two ships with a constant (non-relativistic!) speed at a given fixed depth (in transparent water). Now the question will be: what must declare different moving relativistic observers from the SRT viewpoint? Since the SRT "worked" with the exchange of light signals only, then, naturally, all SRT "claims" must be seen by relativistic observers just with the help of the light by itself. When they will see "it"? Evidently, it will be in just the time, when the light emitted in the moment of an "event" will reach them (as relativists claim, there not exist instantaneous relations). Let from the distance of 20 billions light years two observers (in moving spaceships) will see in the direction of our submarine in 20 billions years (when, "possibly", our submarine and ships will no longer exist), and let the observers catch the signals from the remoute event. Let the observers will be moving with a speed close to the speed of light, the one observer – in the direction of the submarine's course, and the second one – in the opposite direction. It turns out that opinions of these two observers (the submarine was sunk or surfaced) must be different according to the SRT (as the result of a velocity addition). And these observers cannot believe even the our arrived spacecraft (with some delay to not disturb the relativistic sleep) with the report that "the submarine had successfully executed the order at the GIVEN DEPTH". We would like to believe relativists: it may be that Vasilii Ivanovich Chapaev did not drown, in the case if some "right alien", flying with a "right velocity" at some "right time", will look at that remote event.

Of course, all losses of objective characteristics of SRT (which are presented here only for completeness of the picture) look simply as "student's fittings" as compared to the logical gaps and contradictions existing in SRT. It is absolutely strange the stock phrase spreaded by relativists as if the SRT is simply a new geometry and, therefore, it is

allegedly noncontradictory. Possibly, they simply do not sense even the subject of physical investigations by itself (the physics studies causes of phenomena and concrete mechanisms directly influencing on the phenomenon under investigation). Of course, to obtain mathematical solutions, different transformations of coordinates are frequently used in physics (conformal ones, for example). In particular, the Lorentz transformations (but with the speed of sound) can be used for solving some problems in the acoustics (just since they are an invariant). However, if somebody were claim that the real change of the all Universe from the outer region into the inner one of a circle follows from correctness of some solutions, all physicists would understand "the adequate place" for such the claim. But if other but Very Big Relativistic Scientist claims that the all Universe was compressed when He walked to the nearest bakery, then many "yes-mans" will confirm this rubbish (possibly, these poor devils were rather deprived from childhood – the tale "Bare King" was not read to them).

From author's standpoint the most consistent attitude is a principal recognition of the results of relativistic dynamics and electrodynamics as approximate ones, to an accuracy provided by the experiment. One should not overestimate the possibilities of purely theoretical techniques and to overload the physics with globalisms. It is namely this reason and insufficient substantiation of relativistic experiments, why the author does not try to offer any alternative theory. At present, the theory should analyze and generalize those experiments, which have been carried out particularly in the region of high velocities.

4.4 Conclusions to Chapter 4

The given Chapter 4 was devoted to the criticism of relativistic dynamics. The logical inconsistencies in this, seemingly "working" and "verified" field of investigations were presented.

In this Chapter 4 the criticism of the relativity notion was continued. Further on, the relativistic concept of mass was discussed in detail and its criticism was also given. The inconsistency of the concept of a center of masses in SRT was indicated. Then the Chapter 4 gave the criti-

cism of the relativistic concept of force, of the transformation of forces and of the relativistic approach to various units of measurement. After this the true sense (without SRT globalization) of the invariance of the Maxwell equations was considered. The criticism of the relativistic relationship between the mass and energy was also presented in Chapter 4. The so-called "experimental confirmations of the nuclear physics" were further criticized and some particular problems were considered in this respect. Such SRT aspects, as the radiation mass, the so-called Thomas' precession and other problems were critically discussed. The complete groundlessness of a generally-accepted interpretation of the relativistic dynamics was demonstrated, and the SRT interpretation of the Compton effect was analyzed in detail.

The resulting conclusion of the Chapter 4 consists in the necessity of returning to the classical interpretation of all dynamical concepts, in the possibility of the classical interpretation of relativistic dynamical solutions, and in necessity of closer examination of some phenomena in the field of great velocities.

Appendix A

On possible frequency parametrization

In Appendixes some particular hypotheses will be considered. Practically, they do not connected with the criticism of relativity theory from the main part of this book; they only demonstrate nonuniqueness of the SRT approach and a possibility of the frequency parametrization of all formulas. This is the only claim of these appendixes in the book, since we will use incorrect SRT methods (their error was proved in the main part of the book). The author attempted to discuss ideas from Appendixes A and B (plus a part of analysis of the Michelson experiment from Chapter 3) in several well-known journals in 1993-1999. The result was the same: either the work did diplomatically not be considered right away or the approximate answer was "nobody discovered these things in relativity theory and quantum electrodynamics, but the exactness of predictions of these theories was huge". How can theorist discover anything new (instead of explanation its "by late mind")? He must assume some fact and test corollaries from his assumption. But nobody attempts to assume the possibility of frequency dependence of light speed. Besides, the case in point was the precision on one-two orders large than the existing modern precision of experiments. Such a precision can be reached in the immediate future; though there exist experiments, which need in precision on some dozens of orders large than existing one, but they have

been seriously discussing in physics. The author was tired to waste the time at last, and a decision was taken to test the "huge precision of relativity theory" (at the same time remembering a student dissatisfaction by this theory). As a result, my first critical article appeared (and now this book too). So, plus and minus together are presented everywhere.

Now we proceed to discussion of a possible frequency dependence of light speed. It is well known that when particles are in vacuum, there occur various processes, such as the appearance of virtual pairs (a particle and its antiparticle); many interaction processes are described in terms of such virtual pairs. Also, light influences vacuum properties during its propagation (in particular, vacuum polarization takes place). Therefore, by the reciprocity principle there must be a reverse action of vacuum polarization on the light propagation. As a consequence, the light (at a certain frequency) is bound to travel through the vacuum as "the medium" with some certain permittivity ε , which is determined by this light itself; that is, $c = c(\omega)$.

The generalization of the Maxwell equations by adding the mass term explicitly to the Maxwell Lagrangian is known to lead to the Proca equations in the Minkowski space (in the modern view). An electromagnetic wave propagating through the medium is influenced by the latter and this effect is manifested via the generation of massive photons [100]. Even with constant phase speed assumed, an ω -dependence of the group speed (dispersion in vacuum) is known to arise: $v_g = (d\omega/dk) = c\sqrt{\omega^2 - \mu^2 c^2}/\omega$, where μ is the rest mass of the photon. However, the question of mass generation and the gauge theories will not be discussed in these Appendixes. Our aim is just to represent some physical reflections about light velocity and attendant questions.

The questions arise here: 1) How can the ω -dependence be evaluated or measured? 2) Why has it not yet been found, and 3) What corollaries follow?

There exist various methods for measuring light speed: astronomical methods, the method of interruptions, the rotating mirror method, the radio geodetic method, the method of standing waves (the resonator), the independent measurements of λ and ν , and so on. At the present time, the last method [59,67] is the most precise; it is used by the Bu-

reau of Standards for measuring light speed to eight significant digits. However, an important problem arises in this approach [7]. Besides, it must be emphasized that this method is principally limited: either it can be connected with local (inside a device) speed of light only, or it can bear no relationship to light speed at all in the case if light by itself does not represent a pure wave. Why other methods are inadequate (fail to detect $c(\omega)$ dependence) is clear from the previous Chapters and will be clear from given Appendixes for one particular hypothesis.

In further consideration we will follow SRT methods (we will forget their error for the time being; they present an "apparent effect" for two systems under an additional condition only – under the condition of the choice of the Einstein synchronization method). Recall that in deriving the corollaries of SRT (transformation laws, for example) the notion of the interval $ds^2 = c^2 dt^2 - (d\mathbf{r})^2$ is used. Here it is necessary to make two methodological remarks. First, even the equality of intervals $ds^2 = ds'^2$ is nothing more than one possible hypotheses, since only a single point $\Delta s = 0$ remains trustworthy (if we suppose $c = const$). For example, we could pick any natural number n and equate the n^{th} degrees, $c^n dt^n - dx^n - dy^n - dz^n$, and obtain different "physical laws". Or, we could consider $t = t'$, but $c'^2 = c^2 - v^2$, i.e. $v' = v\sqrt{1 - v^2/c^2}$ (the apparent velocity of mutual motion is different for different observers). Such a choice results in coinciding of the relativistic longitudinal Doppler effect with the classical expression. Similar exotic systems could be as much intrinsically self-consistent as the SRT (i.e. for two marked objects only!), and only the experiments could demonstrate which choices are nothing more than theoretical fabrications. We shall not discuss all such exotic hypotheses here.

Second, in the usage of interval, the following point is not emphasized: the specific light, propagating from one point to another, is used in this case, i.e. the value $\mathbf{c}(\omega_i, \mathbf{l}_i)$ should be substituted in the expression for the interval. But in such a case, assuming proportionality of intervals from textbooks, an indeterminate relation is obtained:

$$\frac{a(\mathbf{l}_2, \omega_2, \mathbf{v}_2)}{a(\mathbf{l}_1, \omega_1, \mathbf{v}_1)} = a(\mathbf{l}_{12}, \omega_{12}, \mathbf{v}_{12}),$$

and even the equality of intervals cannot be proved. This indeterminate

relation is associated with the still "unknown" Doppler law, so there is again need for reference to experiments. Thus, theoretical constructions proceeding from intrinsic individual principles are not unique. Since generally accepted derivations results in some corollaries that are confirmed experimentally (within some precision for particle dynamics, for example), we shall rely upon this method, but modify it with regard to the possible $c(\omega)$ dependence.

Physically, this approach implies the following: The apparent result of some measurement depends on the measurement technique; and the calculated result depends, in particular, on the synchronization procedure for timepieces in different frames. According to an idea from this Appendix, no "unique interaction propagation speed" exists (but $c(\omega)$). If light of some definite frequency ω is used for Einstein synchronization of timepieces in the different frames, the result of any experiment depends on ω . For example, if some process with characteristic ω_k takes place in a system, then it is natural to watch the system by using $c(\omega_k)$ (just as the signal propagates). If two systems moving relative to each other are studied in the experiment, then two quantities $c(\omega)$ and $c(\omega')$ (for each frame) appear in formulae. This is due to the fact, that the same light possesses different frequencies in systems moving relative to each other. As this takes place, the quantities ω and ω' are related to each other by the Doppler effect (see below). It is interesting to note the following circumstance. If several various processes with characteristic frequencies ω_i take place in the system, then the observers moving with respect to each other will see (at the same point) various pictures of events (the apparent effect). In the subsequent theoretical description we shall follow [4,17].

Let ω' be the frequency of signal propagation in some system. Substituting $c(\omega')$ (instead of c) into the four-dimensional interval ds'^2 for the intrinsic system and $c(\omega)$ into $ds^2 = c^2 dt^2 - dx^2 - dy^2 - dz^2$ for the system of observation, it follows from $ds^2 = ds'^2$ that the intrinsic time ($d\mathbf{r}' = 0$) can be found from

$$dt' = dt \sqrt{\frac{c(\omega)^2 - V^2}{c(\omega')^2}}, \quad (\text{A.1})$$

but the formula for the intrinsic length retains its validity. We note again, that it is "a visible effect" only. In an arbitrary mathematical expression coefficients can be transferred (according to some rules) from the left-hand side in the right-hand side of the expression and vice versa (all these expressions are equivalent). Then, how can it be determined: accelerats time at one observer or, contrary, decelerats at other one (and increased or decreased lengths)? Simply, if somebody were said to you that just yours time is decelerated by different manner relative several objects, you would right away understand senselessness of the infinite number of such "informations". However relativists say that yours time is OK, but simply "somebody has something somewhere far off", and many people calm right away and continue to listen "the fairy-tales".

To derive the Lorentz transformations, one can use rotation in the t, x plane:

$$\begin{aligned} x &= x' \cosh \psi + c(\omega')t' \sinh \psi, \\ c(\omega)t &= x' \sinh \psi + c(\omega')t' \cosh \psi. \end{aligned}$$

Using $\tanh \psi = (V/c(\omega))$, it follows that the Lorentz transformation reduces to

$$x = \frac{x' + \frac{c(\omega')}{c(\omega)}Vt'}{\sqrt{1 - V^2/c(\omega)^2}}, \quad t = \frac{\frac{c(\omega')}{c(\omega)}t' + \frac{V}{c(\omega)^2}x'}{\sqrt{1 - V^2/c(\omega)^2}}, \quad (\text{A.2})$$

where V is the system velocity. Writing dx and dt in the expression (A.2) and finding $d\mathbf{r}/dt$, one obtains, that the transformations for velocity change into

$$\begin{aligned} v_x &= \frac{\frac{c(\omega)}{c(\omega')}v'_x + V}{1 + \frac{v'_x V}{c(\omega)c(\omega')}}}, \quad v_y = \frac{v'_y \sqrt{1 - \frac{V^2}{c(\omega')^2}}}{1 + \frac{v'_x V}{c(\omega)c(\omega')}}}, \\ v_z &= \frac{v'_z \sqrt{1 - \frac{V^2}{c(\omega')^2}}}{1 + \frac{v'_x V}{c(\omega)c(\omega')}}}. \end{aligned} \quad (\text{A.3})$$

It follows that for the motion along the x axis

$$v = \frac{\frac{c(\omega)}{c(\omega')}v' + V}{1 + \frac{v'V}{c(\omega)c(\omega')}}}. \quad (\text{A.4})$$

We see that the maximum of velocity is $V_{max} = c(\omega)$, where ω is the light frequency in the intrinsic system. Note that all formulae lead to the correct composition law for motion along the same straight line (the transformation from frame A to B and from B to C yields the same result as the transformation from A to C). Recall that, in accord with considerations given in the main part of the book, quantities t' and x' in formulas (A.1), (A.2) have no intrinsic physical meaning (they are fictitious auxiliary quantities). Formula (A.4), by analogy with formula (1.5), can be re-written as

$$v_{23} = \frac{v_{13} - \frac{c(\omega)}{c(\omega')}v_{12}}{1 - \frac{v_{13}v_{12}}{c(\omega)c(\omega')}}. \quad (\text{A.5})$$

This form most clearly reveals the essence of this expression (the apparent effect). The formula

$$\tan \theta = \frac{v' \sqrt{1 - V^2/c(\omega)^2} \sin \theta'}{\frac{c(\omega')}{c(\omega)}V + v' \cos \theta'} \quad (\text{A.6})$$

describes the change of the velocity direction. The relativistic expression for the light aberration holds (the substitution $v' = c(\omega')$). To be on the safe side, we are reminded that the relativistic expression for the stellar aberration is approximate. The transformations of 4-vectors are also valid. From here follow the transformations of the wave four-vector $k^i = (\frac{\omega}{c}, \mathbf{k})$:

$$k_0^0 = \frac{k^0 - \frac{V}{c(\omega)}k^1}{\sqrt{1 - V^2/c(\omega)^2}},$$

$$k_0^0 = \frac{\omega}{c(\omega)}, \quad k^0 = \frac{\omega'}{c(\omega')}, \quad k^1 = \frac{\omega'}{c(\omega')} \cos \alpha.$$

As a result, the Doppler effect can be obtained from

$$\omega' = \omega \frac{c(\omega')}{c(\omega)} \frac{\sqrt{1 - V^2/c(\omega)^2}}{1 - \frac{V}{c(\omega)} \cos \alpha}. \quad (\text{A.7})$$

Note, that from here follows the dependence of light speed on the system motion (different frequencies ω' correspond to different systems). However, as we shall see in the next Appendix, this effect is negligible for the visible region. Relativists declare that the expression of the Doppler effect contains the relative velocity. It is false. Let an explosion occur at some point on the Earth, and let some line of emission be radiated in short time. Let a receiver at the Pluton catch the signal. At which a moment must we determine this mythical relative velocity? The receiver can not see in the direction to the Earth at the moment of explosion, and the source not exists at the moment of the signal receiving, and the Earth will be turned to the back side. Even in the absence of medium, we obtain, instead of the relative velocity, the difference of absolute velocities at the moment of emission and at the moment of signal receiving (and it is not the same!). But the real result can be obtained in the real experiment only.

The energy-momentum vector transforms as

$$P_x = \frac{P'_x + \frac{V\epsilon'}{c(\omega)c(\omega')}}{\sqrt{1 - V^2/c(\omega)^2}}, \quad \epsilon = \frac{\epsilon' \frac{c(\omega)}{c(\omega')} + VP'_x}{\sqrt{1 - V^2/c(\omega)^2}}. \quad (\text{A.8})$$

There should be a closer analogy between light propagation through vacuum and through a medium.

- 1) Various packets of waves diffuse in vacuum variously.
- 2) Light dispersion in vacuum imposes a fundamental limitation on the degree of ray parallelism.
- 3) There is light dissipation in vacuum; that is, the intensity of light decreases as it propagates in vacuum.
- 4) Light "ages"; that is, the frequency of light decreases as it propagates in vacuum. This phenomenon bears on the paradox (Olbers) "why does the sky not flame?" and contributes to the red shift; that is, a correction of the world evolution concept is in order. Since we are factually dealing with an alternative explanation of the red shift, this effect appears to be very small, and, at present, it cannot be confirmed in laboratory experiments: the red shift of lines for cosmic objects is already detected by the most precise optical methods and it becomes to be noticeable for very distant objects only, such the ones that distances

to theirs cannot be found even on the Earth's orbit base (on the triangle). Recall in this connection that even an order of the value of Hubble constant had already been corrected.

Passing to quantum electrodynamics, the substitution $c \rightarrow c(\omega)$ needs to be done in all derivations. For example, this dependence appears in the uncertainty relation

$$\Delta P \Delta t \sim \hbar/c(\omega), \quad \Delta x \sim \hbar/mc(\omega),$$

in the condition for classical description

$$|\vec{E}| \gg \frac{\sqrt{\hbar c(\omega)}}{(c(\omega)\Delta t)^2},$$

and in numerous formulae.

If some formula describes the ω -dependence, then it can substantially change. As an example, we consider the emission and absorption of photons. The new coefficient

$$B = \frac{1}{1 - \frac{d \ln c(\omega)}{d \ln \omega}}$$

appears in the expression for the number $N_{\mathbf{k}l}$ of photons with a given polarization:

$$N_{\mathbf{k}l} = \frac{8\pi^3 c(\omega)^2}{\hbar\omega^3} I_{\mathbf{k}l} B,$$

and in the relation for probabilities (of absorption, induced and spontaneous emission) $dw_{\mathbf{k}l}^{ab} = dw_{\mathbf{k}l}^{ind} = dw_{\mathbf{k}l}^{sp} B$. Quantity B appears in Einstein's coefficients.

Using the substitution $c \rightarrow c(\omega_k)$ for natural field oscillations, one obtains the expression for the Fourier component of the photon propagator:

$$D_{xx} = \frac{2\pi i}{\omega_k} c(\omega_k)^2 \exp(-i\omega_k|\tau|).$$

We cannot find $D(k^2)$ without knowledge of the explicit dependence $c(\omega)$. The explicit form of the ω -dependence is necessary to find a net result for various cross-sections (for scattering, for the origin of a pair, for

disintegration, etc.). As a first approximation, the substitution $c \rightarrow c(\omega)$ can be made in the well-known formulae.

There we shall discuss the possible $c(\omega)$ -dependence.

Appendix B

Possible mechanism of the frequency dependence

We shall try to evaluate the $c(\omega)$ dependence from semiclassical considerations (by analogy with optics). In fact, this is the possible hypothesis for the propagation of electromagnetic oscillations (light) in vacuum. We describe vacuum as some system consisting of virtual pairs "a particle and its antiparticle" (really not existing). In the absence of real particles, the virtual pairs do not manifest themselves (do not exist really) in vacuum. The oscillations of virtual particles arise in the region of light propagation. The light propagation can be described as a successive process of interaction with virtual pairs (oscillatory excitations). The most important influence (wherein oscillations can easily be excited) is exerted by the lightest virtual pairs (electron/positron). So, only these pairs will be taken into account here.

Since the oscillations in an atom or in a positronium are the examples of real particle oscillations, they cannot define the natural frequency of virtual pairs. There exists some unique frequency, which can be related to a virtual (not existing without excitation) pair. The natural frequency of the pair can be defined as the frequency of the electron - positron pair origin, i.e. $\omega_0 = 2m_e c^2/\hbar$, where m_e is the electron mass. From the viewpoint of such a description, it is reasonable to assume that the electron and positron are located at the same point for a virtual pair

(the pair does not really exist - the full annihilation takes place). Using the classical model of oscillators, we can write the following expression for the phase velocity of light:

$$c(\omega) = \frac{c_0}{\sqrt{\varepsilon}}, \quad \sqrt{\varepsilon} = n - i\chi, \quad (\text{B.1})$$

$$n^2 - \chi^2 = 1 + 4\pi \frac{Nfe^2/m_e}{(\omega_0^2 - \omega^2)^2 + 4\omega^2\gamma^2} (\omega_0^2 - \omega^2),$$

$$n\chi = 4\pi \frac{Nfe^2/m_e}{(\omega_0^2 - \omega^2)^2 + 4\omega^2\gamma^2} \omega\gamma.$$

It remains to determine the quantities c_0, γ and Nf . No doubt arises in choosing γ : this quantity is determined by the braking due to radiation (the only possible choice in vacuum). Thus,

$$\gamma = \frac{e^2\omega^2}{3m_e c^3}.$$

For the rest, we may study only those areas where classical electrodynamics is intrinsically non-contradictory and, besides, the quantum effects are insignificant, i.e. $\omega \ll \omega_0/137$ and $\lambda \gg 3.7 \times 10^{-11} \text{ cm} \gg R_0$, where $R_0 = e^2/(m_e c^2)$ is the electron radius. Quantity Nf denotes the number of virtual pairs in a unit of volume, which is sufficient for providing the light propagation process. In fact, this implies the determination of the size of a quantum of light and the quantity of virtual particles acting in it. Obviously, the longitudinal size of a quantum is $l \sim \lambda$. To provide the continuity of variation of fields \mathbf{E} and \mathbf{H} , it is necessary to suppose that the "substance" of a virtual pair be "spread out" along the whole quantum (see Fig. B.1) and rotates at frequency ω around the local axis (perpendicular to the picture plane and intersect the axis C).

The region occupied by one pair has the size: $(2R_0, 2R_0, R_l)$, where $R_l = \lambda/I$, I is the number of "spread out" pairs. Since the mean kinetic energy (the magnetic field energy) is equal to the mean potential energy (the electric field energy), the number I can be found from the equality

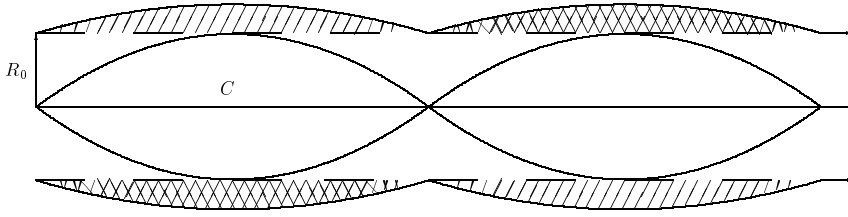

Figure B.1: Light propagation as successive polarization of vacuum.

$2Ie^2/(2R_0) = \hbar\omega$. Then

$$R_l = \frac{2\pi ce^2}{\hbar\omega^2 R_0}, \quad Nf = \frac{\hbar\omega^2}{8\pi ce^2 R_0}.$$

The final approximate expression for the dimensionless phase velocity of light has the form:

$$\frac{c(\omega)}{c_0} = 1 - \frac{\hbar c_0 \omega^2}{4e^2} \frac{(\omega_0^2 - \omega^2)}{(\omega_0^2 - \omega^2)^2 + 4\omega^2 \gamma^2}. \quad (\text{B.2})$$

It is seen from this expression, that $c_0 = c(0)$. The phase velocity of light decreases as the frequency grows.

Now we make some estimations (see (B.2)). For the ultraviolet region: $(\Delta c/c_0) \sim -0.5 \times 10^{-6}$ (in the visible region the effect is negligible). For $\omega \sim 10^{18} \text{ s}^{-1}$ the effect is $(\Delta c/c_0) \sim -1.4 \times 10^{-5}$. Even for the ultraviolet region, the influence of Earth motion via the Doppler effect causes an effect of $(\Delta c/c_0) \sim -10^{-10}$ (negligible); at the boundary of the region of applicability of this description ($\omega \sim \omega_0/137$) we have: $(\Delta c/c_0) \sim -3.6 \times 10^{-7}$. Using the expression $c^2 k^2 = \omega^2 \varepsilon$, we have for the group velocity $U_g = (d\omega/dk)$:

$$U_g \frac{d(\omega\sqrt{\varepsilon})}{d\omega} = c_0.$$

The group velocity also decreases with frequency, virtually coinciding in magnitude with the phase velocity. The greatest difference between

them occurs at the boundary of the region of applicability of this description (for $\omega \sim \omega_0/137$), and equals 0.01 per cent (and in relation to c_0 - of the order of 2×10^{-7}). Note, that the above-used small sizes of a light quantum are quite justified (in the present view). Such a compact object must interact with any object of the microcosm as a whole and practically instantaneously; but, actually, these properties are postulated in quantum mechanics (in explanation of the photo-effect, or the Compton effect, for example).

The universally recognized modern experimental possibilities are inadequate for determining the ω -dependence of light speed c in the visible region (and its dependence on Earth motion). Nevertheless, we are presenting here general considerations concerning the experiments. To detect the ω -dependent $c(\omega)$, a purposeful search is necessary. The measurements must be direct, since any recalculation invokes some theoretical concepts related to the phenomenon under consideration. In particular, the experiments must be carried out in vacuum, because purely theoretical calculations of the interaction between the light and some medium cannot be made fully. In the general case, the interaction with a matter depends on the light frequency ω . Particularly, the mirror must reflect waves of different ω in a different manner (besides, reflection is not an instantaneous process). The recalculation, related with light transformations, does not take into consideration a possible ω -dependence of light speed. In the general case, interruptions of light change the wave packet and, thus, its speed. Since free charged particles influence the effect, it is necessary to avoid the metallic shielding.

The method of interruptions requires simultaneous launch of the rays at different frequencies and adequate accuracy of comparison between time intervals over which the wave fronts travel a certain distance. Alternatively, one can eliminate the spectrum line from a mixture of two spectrum lines (lasers) by interruptions. Since reflections are not instantaneous effects and depend on the light frequency, the standard practice of distance lengthening by mirrors must be ruled out, or the number of reflections for each light beam (for each different frequency ω) must be the same. The latter remark can also be applied to the interferometric method. We separate a ray (ω_1) into two rays. The first is transformed

into ω_2 at the beginning of path L , and the second at the end of L . The path L can be changed. If there exists the dependence $c(\omega)$, then the interferogram will change with L . However, there are some technical problems in changing L without disturbances.

The astronomical research (for the rather wide spectrum ω_i) can help in verifying the $c(\omega)$ dependence. One can observe (from a satellite) the (non-synchronous) appearance and disappearance of spectrum characteristic form in binary systems during the total eclipse. However, for great distances there is no confidence that the light travels through real vacuum (without gases, plasmas, dust etc.). The mathematical analysis of $c(\omega_i)$ for ω_i is necessary to detect the ω -dependent $c(\omega)$.

Of utmost interest is the comparison of $c(\omega)$ for the visible region with that for X-rays or γ -rays. As far as we know, no appropriate experimental data exist for this region. However, there are some difficulties for experiments with γ -rays (see [7,59,67], for the most precise (in the wave model of light) method of direct independent measurements of λ and ν), and absolute assurance of the wave nature of light is missing.

The most general question of these Appendixes is as follows: whether or not the vacuum retains its properties regardless of the presence of particles (photons) inside it. If vacuum properties can change, then there must be an inverse action on the particles (light) propagation process (this is just the interaction principle). The $c(\omega)$ dependence is some manifestation of this principle.

Thus, in Appendixes the appropriate formulas were derived for corollaries from the ω -dependence which were concerned the relativity, quantum electrodynamics, optics, etc. Purposeful experimental investigations are necessary in order to detect the fact of $c(\omega)$ dependence itself. The maximum effect must be observed for the high-frequency region. In spite of serious experimental difficulties, possible outlooks are important and promising.

One possible mechanism leading to $c(\omega)$ dependence was discussed in this Section, but recall that no critical experiments exist to disprove the classical law of velocity addition even for the corpuscular model of light, to say nothing about the wave model of light. The problem is that for light the following three relationships are uniquely interrelated

(in the wave model of light): $c(\omega)$ dependence, the Doppler effect and the velocity addition law. If and only if we know any two of these relationships with certainty can the third relationship be determined uniquely. For the wave model of light, the process of the electromagnetic oscillation (light) propagation through vacuum can be described as a successive origination of oscillation of virtual particles (in pairs) induced by the propagating light itself. (However, for the considered model the questions arise about "elementary character" of elementary particles: whether light properties are different for annihilation of more heavy particles and what is the role of other virtual pairs in this process.)

Appendix C

Remarks on some hypotheses

In this Appendix we shall touch upon some well-known hypotheses, which do not directly connected with the main part of the book. We begin with discussion of gravitation. The same dependence on distance for both gravitational and electromagnetic forces urges on an incorrect idea that there exists the single universal mechanism of action for these forces and gravitation could be explained by means of an electromagnetic field; however, it contradicts experiments (for example, it does not be found any shielding of gravitation). The gravitational force cannot be some force of Van der Waals' type, otherwise some long-range force, which weakly decreases with the distance, must exist (to obtain the squared dependence in the denominator, as in the Newton law), but it is absent. It is also incorrect an attempt to symmetrize gravitation by means of introducing "mass charge" with different signs. Gravitation manifests itself only as the attracting force. In addition to the banal question "where hides antigravitation?", there exists a trivial refutation of "charge" approach. Let us consider a large body, for example, the Earth. Let it be "charged", for example, by "positive mass charge", and attracted bodies be "charged" by "negative mass charge". Consider the opposite process (Fig. C.1). We shall tear off big fragments from the Earth and take away far in space. It is well-known, that fragments which

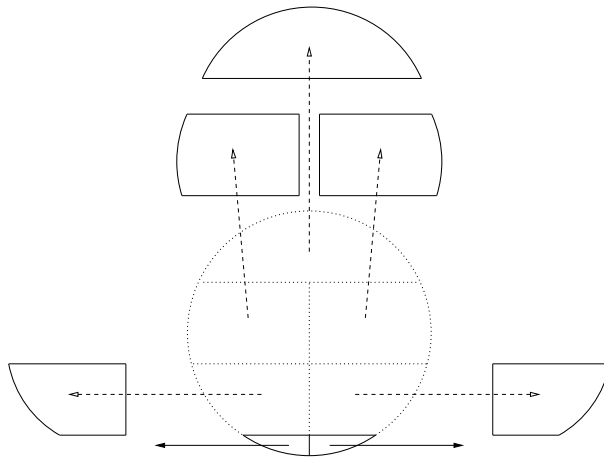

Figure C.1: Contradiction of "charged" gravitation.

are heaved from the Earth, do not fly away by themselves in space, but fall back on the Earth. Therefore, positive "mass charge" must "flow down" on the remaining Earth after each such process. In this case its quantity will increase (to conserve the total "charge"). The last remaining fragment *A* will attract bodies with a force that is large than one from the usual existing Earth. This is contradicts the proportionality of the gravitational force to the quantity of matter. Besides, there exists other contradiction: if the last fragment *A* had been tearing off strictly in half, then which of two halves would be positive and which be negative? Or, by tearing off in half, the parts will repelling each other and we will have antigravitation? (Although, the presence or absence of antigravitation could be not connected with the presence or absence of negative mass.) The incorrect attempt of geometrization of gravitation provokes attempts of geometrization of other fields, for example, electromagnetic one. Error of this idea is obvious: besides charged particles, there exist neutral ones which do not "feel" charges till they collide "head-on" with some particle. Therefore, in the same point of space one particle would demonstrate a curved space, whereas other particle would prove absence of the curvature. Generally speaking, all above considered methods of

formal reduction of one unknown force to some other unknown force have shown little promise.

It can be more useful to generalize the Newton static theory of gravitation with using of Maxwell approach (see [11], for example). Besides, there exists one more well-known interesting model. Unfortunately, mechanistic models are being permanently incited us as "something low-grade". But this is incorrectly. Similar models are the unique ones which can be created; we can "touch" they "by hands" and test capacity for work. They can be understood by anybody (from a schoolboy to a famous scientist), and anyone can discuss they (contrary to models which are "completely proved among several scientist of a particular school of thought"). The model under consideration consists in the following. It is assumed that in the Universe very small neutral particles ("Lesagens"; the author – LeSage) fly in all directions uniformly and interchange momentums with bodies in elastic collisions. Two bodies cast shadows (or penumbra) to each other, and, as a result, they attract each other with the force that varies in inverse proportion to the square of the distance. But there exists one "but". Since protons and electrons are opaque for these hypothetical particles, so it will be observed the departure of the mass dependence of attractive force from the proportionality to the product of masses for bodies with large sizes (with radii of the order of thousands kilometers and more). Unfortunately, this cannot be confirmed or disproved in experiments for the present. There existed yet another objection: a temperature of the Lesage' gas must be very great, and the Universe must "burn", since a thermodynamical equilibrium must quickly be established. However, subsequent modifications of this theory came already into being: 1) new Lesagens can permanently be absorbed by bodies (the latters are permanently "growing" therewith); 2) Lesagens can be transformed into such particles, which can desert the body. Gravitation is not completely investigated even from the experimental viewpoint. For example, no precision experiments exist for measuring the influence of the mutual motion and rotation of bodies on the attractive gravitational force acting between them. There exist hypotheses of gravitational influence on the inert mass (and, therefore, on inertial forces, which arise in a rotating whipping top, for example).

There arises a question (as some manifestation of relativistic clichés inculcated us): relative what must the rotation be determined? There exists a practical method principally to verify an inertial system. Since we can define the **variation** of a state (an extension of a spring between two rotating balls, for example) relative some other previous state only, it can be affirmed that the extension (due to an action of the centrifugal force) will be minimal for some frequency of rotation (naturally, considering the possible change in the direction of rotation). If this state of minimal extension is maintained independently on orientation of rotation axis, then we have some inertial system. The question, whether it will be the heliocentric system or other one, cannot be solved from pure theoretical considerations for our sole Universe (it is no sense to abstract theorize: it is practically impossible to remove almost all bodies from the Universe). It is obvious that inertial forces have the same mathematical form, and we can discuss a dependence of the inert mass itself on gravitation only. Probably, any detectable dependence of the inert mass on the direction of the resulting gravitational vector is impossible (alternatively, rotating liquids in the state of weightlessness could not be observed as ellipsoid of rotation, for example). Any noticeable dependence on the absolute value of the resulting gravitational vector is also improbable: in the opposite case calculations of motion of comets, asteroids and meteorites were differ from accepted data by exponents (for example, due to the law of conservation of linear momentum, the velocity of a body which were moving away from massive bodies, such as the Earth, the Sun etc., would be increased, but it is not the case). At first, to discuss a dependence of the inert mass on the value of the total gravitational potential (for small variations in motion at great distances), it is necessary to define, from the all-physical and general-philosophical viewpoints, what meaning of the zero level of this potential, and what the method of its determination in our sole Universe (to make some quantitative evaluations). It seems reasonable to say that this dependence of the inert mass cannot also be appreciable (see the discussion on the Mach principle in the book). But, in the general case the problem can principally be solved by experiments only. A row of cosmological problems could be theoretically solved, if it was assumed a boundedness of

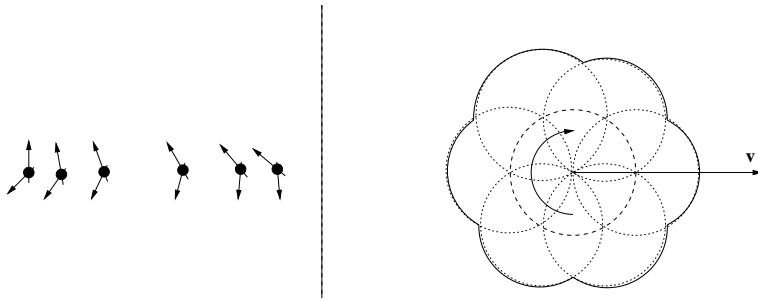

Figure C.2: Models of light.

the radius of gravitational interactions [133]. But it is impossible yet to check this hypothesis, since the effect becomes remarkable for the great astronomical distances only. So, the theory of gravitation remained in the same state as it was left by Newton. This field of knowledge waits for serious investigators.

Now we will mention additional hypotheses that try to answer on the following question: "what is the matter of light by itself?" The postulate of corpuscular-wave dualism should not paralyze the human thought. It is impossible to manage without corpuscular properties. And since it is rather simple to imitate the wave properties with the help of particles (recall the real phenomena: sound in the air, sea waves, etc.), so at present it is also urgent Newton's opinion that "light is rather corpuscles than waves". But light can represent a pure wave, or it can be an intermediate something with a complex inner structure. This allows to construct different models of light (Fig. C.2). Light can be described even by a longitudinal wave (despite the experiment on polarization) in the case of oriented properties of light particles. Or it can be represented as some likeness of a "rotating gear". In this case the electromagnetic wave influence on a medium or instrument can be associated with angular frequency of revolution of the "gear" and even can lead to the relationship $\lambda\nu = c = \text{constant}$. However, such a local (inside the instrument) speed of light c can be absolutely not connected with the velocity of motion of the "gear" as a whole (with the velocity of

passage of the given distance by light in space). Assuming the own rotation of photon and the classical law for velocity addition, the Doppler effect, which coincides with the relativistic one within the grasp of the present state of the art (correct to second order in v/c), was obtained in [60]. Some investigators have doubts even on the conventional Lebedev experiments (on the existence of the light pressure): firstly, some comets fly with tail forward to the Sun; secondly, evaluations show a too small effect, but a considerably greater value for the radiometrical effect. Unfortunately, the questions about the nature of light are also not solved both from theoretical and practical points of view. They also wait investigators.

The more large field relates the foundations of electrodynamics, but practically we do not touch it in the present book. Although achievements in this field for practical applications are really huge, nevertheless harmony in the conventional theory has not been feeling [20]. Many pieces of the theory are seemed as artificially joined to each other. At least there exist many unsolved methodical problems here. If we will believe truth of the differential Maxwell equations, then, instead of the Lorentz force, some other "closing expression" [135] can strictly be obtained with some interesting solutions. Also we mention briefly the interesting idea of the new axiomatic approach to electrodynamics [12], attempts to revive Hertz's electrodynamics and to generalize Weber's force [89]. Recall that original Weber's force was abandoned for the following reason: at some initial conditions it resulted in the self-acceleration of charges. The similar self-acceleration of charges under the action of the braking due to radiation was "discovered" in SRT also, but, for some strange reasons, SRT did not be rejected (a "double standard" is observed). At present the problem of self-acceleration (and other problem of the angular dependence of acceleration) has been rather successfully solving within the framework of Weber's force.

The hypotheses of the given Appendix were mentioned only to awake reader's interest in independent researches.

Afterword

The given book was constructed as a critical review of the fine professional apologetics of the relativity theory. It was rather hard to write a successive criticism of the theory that had been repeatedly "knocking into our head" from different points of view during our studies (starting from school): beginning with anything, the finished stock phrases arise in the head ("beforehand prepared impromptus"). Besides, it is impossible to find the logic of presentation which would be habitual for anybody (nonuniqueness of variants) or to locate the discussion of all nuances at one and the same place of the book. By this reason, the author hoped for reader's patience and benevolence. The reader which read to this afterword will most likely agree that majority of "marginal notes extempore" was further explained. Trying to administratively stop even the slightest doubts in the relativity theory, one of academicians compares it with the multiplication table. Apparently, if somebody wrote a frank rubbish, but placed some examples from the multiplication table between paragraphs, then this academician would recognize "the theory" to be true with "good conscience" and would call doubting mens to check "mathematical calculations". However, physics presents itself not "flourishes" (independently on their truth), but the matter "round the flourishes" and its relation with the Reality. Just the physics was broached in the book. The result can be summarized as following. Many methodical and logical problems of the relativity theory was demonstrated in the book. The presence of methodical "problems of explanation" leads to the "blowing the theory at an empty place". But the presence of logical contradictions puts the final point in the development of any physical

theory. In Chapter 1 of the book the logical inconsistency of SRT kinematics was proved on the basis of mental experiments. Chapter 2 was dedicated to logical contradictions of GRT. The absolute experimental inconsistency of the relativity theory was shown in Chapter 3. Chapter 4 proved the contradictoriness of relativistic dynamical notions and analyzed a possibility of the classical interpretation of relativistic dynamics. The ultimate conclusion of the book consists in the necessity of returning to classical notions of space, time and all derivative values, to the classical interpretation of all dynamical concepts, in the possibility of the classical interpretation of relativistic dynamics, and in necessity of closer examination of some phenomena in the field of great velocities. If the author succeeded already "to remove the RT delusion", the local purpose of the book has been achieved. Some additional criticism of RT and accompanying theories can be found in papers and books (their titles speak for themselves) from the bibliography at the end of the book.

If we look intently at the known human history, an impression arises that somebody "beted on one cent" on the following. Is it possible to deceive all the mankind (first of all, the "skilled specialists")? And it turned out as possible case even for such a comparatively exact science as physics. You know, A. Einstein was wondered that journalese boom arises (but not gold as in the fairy-tale) when he "touch" anything. And he doubted in the rightness of his creation all the time. A quite different matter is the case of modern scientists "near" the relativity theory. They try to consolidate their status by administrative means for ever. We take, for example, the creation of "The Commission for Fight with Pseudo-Science". Simingly, the declared purpose is "rather noble": to protect our land from charlatans. However, analogous organizations are absent in majority of other countries and nothing happens to their purses. In our country the practice of examination before financial decisions was also present always. From ideas viewpoint, the scientific association itself has abilities to separate incorrect ideas, and, especially as immunity to charlatanism. The situation becomes more clear, when the following opinion is scored for sound: someone having doubt as to relativity theory is not physicist. Different opinions, theories, schools can exist on any other question. But suddenly "the hub of the universe" is discovered –

it cannot be discussed. And how must we treat physicists before 1905: whether they are not physicists? And how must we treat physicists from 20th century (including some Nobel Prize winners), since they were opponents to the relativity theory? Are they all not physicists? How can science be generally progressing without free discussion of ideas and their gradual understanding? The statement is well known that no one, including the creator of RT, understood the relativity theory. But relativists declare with pride that understanding and clearness are primitive and are beneath their dignity (it is need to repeat some fixed procedure). Factually, the regular idol is created from the idea (and there exist inviolable priests near it).

Unfortunately, the situation with the relativity theory cannot be remedied with the help of separate publications. Even if most scientist will understand the error of the relativity theory, it will be rather difficult to "blow off this soap-bubble". By the way, it will be interesting to question people having the physical education: whether they believe the relativity theory to be valid or incorrect. Possibly, the result can be predicted for the anonymous poll (since even recently "there organized" the expulsion of SRT opponents from Academy of Sciences). But even this can be yet insufficient. The culture of scientific relations itself must be changed to have the possibility of expression of a free opinion for any scientists ("truth is dearer" than 100-dollar salary – it is modern remake of Aristotel's history as Platon's friend). The final point to SRT would be put with change of the teaching program in schools and institutes (including examinations) only.

The author felt some inner dissatisfaction with the relativity theory in my time as a student, since SRT brought a conflict with the disposition that was primarily laid into man by God. However, there arose no objections at that time and I had to learn the lecture material from program. Probably, many scientists and engineers remember the similar dissatisfaction (the author knows the same opinion of several scientists). It leads often to a loss of the interest by scientists in the fundamental physical problems and to retreating scientists into a research field with clear basis, methods and results.

Although the Russian education gives the many-sided knowledge

(but not "mosaic"), nevertheless, both the Russian and west education have the common defect. They aim students at memorizing the huge flow of information (to move inside a "rut"), but they do not aim at the independent thinking (however, most of existing theories cannot answer all questions in their fields). But learning all lessons (all verisimilar answers) and passing all appropriate examinations in expected manner, one's power for giving back the studied material and wish for a verification of the learnt theories can disappear.

It is strange that in textbooks it is impossible to find mentions of disagreements and a great number of problems in any section of physics (the *Feynman Lectures on Physics* are the pleasant exception to the rule). They do not be problems of type "to count up anything or to prove the existence of a solution" (these are mathematical rather than physical problems). The problems of physics are the following: what the matter "stands behind equations", what is the physical sense of values and laws, how an appropriate model can be constructed, how experiments and theoretical solutions can be interpreted?

Some famous scientists try to suppress the interest for physics. From time to time, there appear their statements on the "imminent end of science". The situation looks in such a manner that they will determine a "strategy of the end", but we must faster fuss and "go without a moment's thought to count 108th item in some third approximation". The author believes that the independent thought is the most important matter of studies for anybody. By this reason the author does not propose own alternative theories to the relativity theory in the book (only gives the brief mention of some known hypotheses without criticism – the "lash" must be adequate to pretensions of the theory).

In the end we would like to dream. Can anything change for the better in physical association? At first, we indicate existing problems. Unfortunately, the past century led to considerable deterioration of the culture of scientific relations. Formerly scientists were unhurried and could thoroughly investigate separate phenomena, leaving unsolved problems to progeny (recall Newton's phrase "I do not contrive any hypotheses"). But the past century "amended". There appeared some haughty relation to notions, methods and ideas from the past. They say, since

we "dive" into such a depth of microcosm and fly in space, almost all phenomena are well-known. Although a majority problems of type "under foots and around" are really left at the same level as one century ago (simply at the other fields real results can be harder differentiated from declarative interpretations, since there exist few "witnesses"). A number of publications became the basic criterion for scientist (can ten dried-up peels replace the juicy orange?). The Nobel Prizes played a considerable part in this "hurry", since their criterion included illusory "novelty" instead of the eternal TRUTH. For the sake of justice it must be emphasized that the healthy conservatism of the Nobel Committee in the early 20th century can allow awarding neither SRT nor GRT. Nevertheless, the politics of type "to separate and to rule" penetrated into the scientific community little by little. And the scientific community, which searched the TRUTH, was transformed to a collection of some competing clan organizations for making a lot of money (even references at the same theme have no common citation).

What would we like to see as some ideal? We would like that on seminars the main goal were to understand the idea of a lecturer (does not splash out a "baby together with water") rather than to ask an own question. We would like that scientists were having the courage to admit own mistakes (both mistakes and their admission have no fatal at all) and were searching the truth in science rather than were fighting for the own name at science. We would like that scientific schools (and reviewers) were adopting leader's better but not bad outward manners (fatal guessing "right": "all this is false" → "all this is well-known long ago" → "all this is necessary for nobody"). We would like that authors do not seek quantity and do not "dilute" new work with previously published results. We would like that reviewers were more responsibly (otherwise, it is impossible to find useful information among the large flow of "got sodden information"). Possibly, it is worth to depart from a collective irresponsibility of the "friend's group" and to publish who reviews an article, who from editors recommend it, and (as an appendix at last journal pages) what manuscripts were rejected and by who (and extracts from the review). We would like that scientific journals present the really broad spectrum of opinions on scientific topics rather than the

particular opinion of editor-in-chief (and controlled by him collective). We would like that the basic criterion to any scientific article were the following: the absence of logical contradictions, mathematical error and the agreement with experiments (as it is accepted in *GALILEAN ELECTRODYNAMICS*, for example). The presence of the other conventional (at the given time instant) theory must be no influencing the consideration of an article. We would like that all above mentioned dreams could be realized in real actions of people. If we would dream, then we must dream of the something "BIG".

Bibliography

In Russian

- [1] V.A. Atsyukovsky, **General Etherodynamics**, (Energoatomizdat, Moscow, 1990).
- [2] V.A. Atsyukovsky, **Critical Analysis of Basis of the Relativity Theory**, (Zhukovskii, 1996).
- [3] P.G. Bergmann, **Introduction to the Theory of Relativity**, (Inostrannaya Literatura, Moscow, 1947).
- [4] V.B. Berestetskii, E.M. Lifshitz and L.P. Pitaevskii, **Quantum Electrodynamics**, (Nauka, Moscow, 1989).
- [5] V.A. Bunin, "Eclipsing Variable Stars and the Problem on the Light Speed Dispersion in Vacuum", **Astronomical Journal**, N 4, 768-769, (1962).
- [6] M. Gardner, **Time Travel and other Mathematical Bewilderments**, (Mir, Moscow, 1990). [In English: (W.H. Freeman and Company, New York, 1988).]
- [7] V.P. Danilchenko, V.S. Solov'ev and J.P. Machekhin, **The current Status of Calculations and Measurements of the Speed of Light**, (Nauka, Moscow, 1982).

- [8] A.I. Zakazchikov, **Returning of Ether**, (Sputnic+ Company, Moscow, 2001).
- [9] V.P. Ismailov, O.V. Karagios, A.G. Parkhanov, "The Investigation of variations of experimental data for the gravitational constant", **Physical Thought of Russia** 1/2, 20-26 (1999).
- [10] F.M. Kanarev, **Are you Continuing to Believe? or Decided to Check?**, (Krasnodar, 1992).
- [11] Ja.G. Klyushin, **Some Consequences from Maxwell Approach to Description of Gravitation**, (L'ubavitch, S-Peterburg, 1993).
- [12] Ja.G. Klyushin, **The Basis of Modern Electrodynamics**, (S-Peterburg, 1999).
- [13] V.N. Komarov, **Universe Visible and Invisible**, (Znanie, Moscow, 1979).
- [14] G.A. Kotel'nikov, "Group Properties of Wave Equation with Non-invariant Speed of Light", **Theor. Math. Phys.** 42, 139-144 (1980).
- [15] G.A. Kotel'nikov, "The Galilean Group in Investigations of Symmetric Properties of the Maxwell Equations" in **Group Theoretical Methods in Physics** 1, 466-494 (Nauka, Moscow, 1983).
- [16] L.V. Kurnosova, "Scattering of Photons of Different Energy on Electrons", **Uspekhi Fizicheskikh Nauk**, 52, 603-649 (1954).
- [17] L.D. Landau and E.M. Lifshitz, **The classical Theory of Fields**, (Nauka, Moscow, 1988).
- [18] A.A. Logunov, M.A. Mestvirishvili, **Relativistic Theory of Gravitation**, (Nauka, Moscow, 1989).
- [19] L.I. Mandelshtam, **Lectures in Optics, Relativity Theory and Quantum Mechanics**, (Nauka, Moscow, 1972).

- [20] G.V. Nikolaev, **Modern Electrodynamics and Causes of its Paradoxicality**, (Tverdynya, Tomsk, 2003).
- [21] L.B. Okun', K.G. Selivanov, V.L. Telegdi, "Gravitation, Photons, Clocks", **Uspekhi Fizicheskikh Nauk**, **169**, 1141-1147, (1998).
- [22] L.A. Pobedonostsev, Ya.M. Kramarovskiy, P.F. Parshin, B.K. Selesnev, A.B. Beresin, "Experimental Determination of the Doppler Shift of Hydrogen Lines on Beams of H_2^+ Ions in the Energy Region 150-2000 KeV", **Journal of Technical Physics**, **59**, N 3, 84-89, (1989).
- [23] **Problems Space, Time, Motion**, Collected Articles of 4th International Conference, v. I, St-Petersburg, 1997.
- [24] A. Poincare, **On Science**, (Nauka, Moscow, 1983).
- [25] G. Rozenberg, "Speed of Light in Vacuum", **Uspekhi Fizicheskikh Nauk**, **48**, 599-608, (1952).
- [26] I.V. Savel'ev, **Physics**, v. 1, (Nauka, Moscow, 1989).
- [27] I.V. Savel'ev, **Physics**, v. 3, (Nauka, Moscow, 1987).
- [28] V.D. Savchuk, **From Relativity Theory to Classical Mechanics**, (Feniks+, Dubna, 2001).
- [29] V.I. Sekerin, **The Relativity Theory - the Mystification of the Century**, (Novosibirsk, 1991).
- [30] D.V. Sivukhin, **Atomic and Nuclear Physics**, part 1, (Nauka, Moscow, 1986).
- [31] D.V. Sivukhin, **Optics**, (Nauka, Moscow, 1985).
- [32] D.V. Sivukhin, **Electricity**, (Nauka, Moscow, 1977).
- [33] E.F. Taylor, J.A. Wheeler, **Spacetime Physics**, (Mir, Moscow, 1968). [In English: (W.H.Freeman and Company, San Francisco, 1966).]

- [34] V.A. Ugarov, **Special Relativity Theory**, (Nauka, Moscow, 1969).
- [35] R.P. Feynman, R.B. Leighton, M. Sands, **The Feynman Lectures on Physics**, Part 2, (Mir, Moscow, 1977). [In English: V.1, (Addison-Wesley, London, 1963).]
- [36] **Physical Encyclopaedia**, v. 2, (Sovetskaya Encyclopaedia, Moscow, 1962).
- [37] V. Fock, **The Theory of Space, Time and Gravitation**, (Physmatgis, Moscow, 1989). [In English: (Pergamon Press, London, 1959).]
- [38] N.U. Frankfurt, A.M. Frank, **Optics of Moving Body**, (Nauka, Moscow, 1972).
- [39] E. Schmutzer, **Relativitätstheorie - Aktuell**, (Mir, Moscow, 1981).
- [40] E.V. Shpolskii, **Atomic Physics**, (Nauka, Moscow, 1974).
- [41] A. Einstein, **Collected Scientific Works**, (Nauka, Moscow, 1967).
- [42] **Ether Wind** (ed. V.A. Arts'ukovskii), (Energoatomizdat, Moscow, 1993).

In English

- [43] A. Agathangelides, "The GLORY in Small Letters", **Galilean Electrodynamics** **13**, Spec.Iss., 19-20 (2002).
- [44] A. Agathangelides, "The Sagnac Effect is Fundamental", **Galilean Electrodynamics** **13**, 79-80 (2002).

- [45] V. Aleshinsky, "Electrodynamics: the Consistent Formulas of Interaction for a Current Elements, a Moving Charges and New Effects", **Spasetime and Substance** **3**, N 1/11, 1-14 (2002).
- [46] G. Antoni and U. Bartocci, "A Simple Classical Interpretation of Fizeau's Experiment", **Apeiron** **8**, 139-145 (2001).
- [47] C. Antonopoulos, "A Bang into Nowhere: Comments on the Universe Expansion Theory", **Apeiron** **10**, 40-68 (2003).
- [48] S.N. Arteha, "On the Basis for Special Relativity Theory", **Galilean Electrodynamics** **14**, Special Issues 2, 23-28 (Fall 2003).
- [49] S.N. Arteha, "On Frequency-Dependent Light Speed", **Galilean Electrodynamics** **15**, Special Issues 1, 3-8 (Spring 2004).
- [50] S.N. Arteha, "On Notions of Relativistic Kinematics", **Galilean Electrodynamics** **16**, Special Issues 1, 9-13 (Spring 2005).
- [51] S.N. Arteha, "On the Basis for General Relativity Theory", **Spasetime and Substance** **3**, N 5/15, 225-233 (2002).
- [52] S.N. Arteha, "Some Remarks to Relativistic Kinematics", **Space-time and Substance** **4**, N 3/18, 114-122 (2003).
- [53] S.N. Arteha, "On Notions of Relativistic Dynamics", **Spacetime and Substance** **4**, N 4/19, 174-181 (2003).
- [54] S.N. Arteha, "Some Remarks to Relativistic Experiments", **Spacetime and Substance** **4**, N 4/19, 188-192 (2003).
- [55] S.N. Arteha, "Critical Comments to Relativistic Dynamics", **Spacetime and Substance** **4**, N 5/20, 216-224 (2003).
- [56] A.K.T. Assis and M.C.D. Neves, "History of the 2.7 K Temperature Prior to Penzias and Wilson", **Apeiron** **2**, 79-87 (1995).
- [57] P. Beckmann, "Sagnac and Gravitation", **Galilean Electrodynamics** **3**, 9-12 (1992).

- [58] S. Bertram, "The Lorentz Transform", **Galilean Electrodynamics** **6**, 100 (1995).
- [59] T.G. Blaneu, C.C. Bradley, G.J. Edwards, B.W. Jolliffe, D.J.E. Knight, W.R.C. Rowley, K.C. Shotton, P.T. Woods, "Measurement of the Speed of Light", **Proc. R. Soc. London A** **355**, 61-114 (1977).
- [60] L.B. Boldyreva and N.B. Sotina, "The Possibility of Developing a Theory of Light Without Special Relativity", **Galilean Electrodynamics** **13**, 103-107 (2002).
- [61] A. Brillet and J.L. Hall, "Improved Laser Test of the Isotropy of Space", **Phys. Rev. Lett.** **42**, 549-552 (1979).
- [62] R.T. Cahill and K. Kitto, "Michelson-Morley Experiment Revisited and the Cosmic Background Radiation Preferred Frame", **Apeiron** **10**, 104-117 (2003).
- [63] J.O. Campbell, "Black Holes – Fact or Fiction?", **Apeiron** **5**, 151-156 (1998).
- [64] J.P. Claybourne, "Why an Ether is Positively Necessary and a Candidate for the Job", **Galilean Electrodynamics** **4**, 38-39 (1993).
- [65] J.P. Claybourne, "The Reciprocity of Einstein's Special Relativity Theory", **Galilean Electrodynamics** **3**, 68-71 (1992).
- [66] D.M. Drury, "Lorentz's Galilean-Invariant Form of Maxwell's Equations in Free Space", **Galilean Electrodynamics** **3**, 50-56 (1992).
- [67] K.M. Evenson, J.S. Wells, F.R. Petersen, B.L. Danielson, G.W. Day, R.L. Barger, and J.L. Hall, "Speed of Light from Direct Frequency and Wavelength Measurements of the Methane-Stabilized Laser", **Phys. Rev. Lett.** **29**, 1346-1349 (1972).
- [68] T.V. Flandern, "On the Speed of Gravity", **Galilean Electrodynamics** **4**, 35-37 (1993).

- [69] T.V. Flandern, "What the Global Positioning System Tells Us about the Twin's Paradox", **Apeiron** **10**, 69-86 (2003).
- [70] T.V. Flandern, "The Top 30 Problems with the Big Bang", **Apeiron** **9**, 72-90 (2002).
- [71] L.P. Fominskiy, "To Concept of an Interval or Basic Mistake of the Theory of Relativity", **Spasetime and Substance** **3**, N 2/12, 49-54 (2002).
- [72] Yu.M. Galaev, "Etheral Wind in Experience of Millimetric Radiowaves Propagation", **Spasetime and Substance** **2**, N 5/10, 211-225 (2001).
- [73] Yu.M. Galaev, "The Measuring of Ether-Drift Velocity and Kinematic Ether Viscosity within Optical Waves Band", **Spasetime and Substance** **3**, N 5/15, 207-224 (2002).
- [74] G. Galeczki, "Physical Laws and the Theory of Special Relativity", **Apeiron** **1**, 26-31 (1994).
- [75] G. Galeczki and P. Marquardt, "A Non-expanding, Non-relativistic Universe", **Apeiron** **3**, 108-113 (1996).
- [76] Jo. Guala-Valverde, "The Identity of Gravitational Mass/Inertial Mass. A Source of Misunderstandings", **Spasetime and Substance** **2**, N 1/6, 42-43 (2001).
- [77] R.R. Hatch, "Relativity and GPS-II", **Galilean Electrodynamics** **6**, 73-78 (1995).
- [78] R.R. Hatch, "In Search of an Ether Drift", **Galilean Electrodynamics** **13**, 3-8 (2002).
- [79] H.C. Hayden, "Is the Velocity of Light Isotropic in the Frame of the Rotating Earth", **Physics Essays** **4**, 361-367 (1991).
- [80] H.C. Hayden, "Stellar Aberration", **Galilean Electrodynamics** **4**, 89-92 (1993).

- [81] J.P. Hsü, L. Hsü, "A Physical Theory Based Solely on the First Postulate of Relativity", **Phys. Let.A** **196**, 1-6 (1994).
- [82] P. Huber and T. Jaakkola, "The Static Universe of Walther Nernst", **Apeiron** **2**, 53-57 (1995).
- [83] T.S. Jaseja, A. Javan, J. Murray, and C.H. Townes, "Test of Special Relativity or of the Isotropy of Space by Use of Infrared Masers", **Phys. Rev.** **133**, A1221-A1225 (1964).
- [84] Ph.M. Kanarev, "Photon Model", **Galilean Electrodynamics** **14**, Spec.Iss., 3-7 (2003).
- [85] A.L. Kholmetskii, "Is the Theory of Relativity Self-consistent?", **Apeiron** **8**, 74-83 (2001).
- [86] P. Kolen and D.G. Torr, "An Experiment to Measure the One-Way Velocity of Propagation of Electromagnetic Radiation", **Found. Phys.** **12**, 401-411 (1982).
- [87] P.S. Laplace, **Mechanique Celeste**, English transl. reprinted by Chelsea Publ., (New York, 1966).
- [88] R.B. Lindsay, **Theoretical Physics**, (Dover Publications, New York, 1969).
- [89] Ch.W. Lucas and J.C. Lucas, "Weber's Force Law for Finite-Size Elastic Particles", **Galilean Electrodynamics** **14**, 3-10 (2003).
- [90] S. Marinov, **Czech.J.Phys.** **24**, 965 (1974).
- [91] S. Marinov, **Gen.Rel.Grav.** **12**, 57 (1980).
- [92] P. Marmet, "GPS and the Illusion of Constant Light Speed", **Galilean Electrodynamics** **14**, 23-30 (2003).
- [93] A. Martin, "Light Signals in Galilean Relativity", **Apeiron** **1**, N 18, 20-25 (1994).

- [94] F.F. Michelson, F.G. Pease and F. Pearson, "Repetition of the Michelson-Morley Experiment", **J.Opt.Soc.Amer.** **18**, 181-182 (1929).
- [95] D.C. Miller, "The Ether-Drift Experiment and the Determination of the Absolute Motion of the Earth", **Revs. Mod. Phys.** **5**, 203-242 (1933).
- [96] C.I. Mocanu, "Is Thomas Rotation a Paradox?", **Apeiron** **1**, N 16, 1-7 (1993).
- [97] H. Montanus, "Special Relativity in an Absolute Euclidean Space-Time", **Physics Essays** **4**, 350-356 (1991).
- [98] H.A. Munera, "Michelson-Morley Experiments Revisited: Systematic Errors, Consistency Among Different Experiments, and Compatibility with Absolute Space", **Apeiron** **5**, 37-53 (1998).
- [99] U. Nascimento, "On the Trail of Fresnel's Search for an Ether Wind", **Apeiron** **5**, 181-192 (1998).
- [100] M.M. Novak, "The Effect of a Non-Linear Medium on Electromagnetic Waves", **Fortsch. Phys.** **37**, 125-159 (1989).
- [101] H.A. Papazian, "On the Mass of the Photon", **Galilean Electrodynamics** **4**, 75-77 (1993).
- [102] B.I. Peshchevitskiy, "Relativity Theory: Alternative or Fiasco", **Galilean Electrodynamics** **3**, 103-105 (1992).
- [103] V.V. Petrov, "The Michelson-Morley Experiment and Fresnel's Hypothesis", **Galilean Electrodynamics** **13**, Spec. Iss., 11-14 (2002).
- [104] R. Prasad, "A Non-Riemannian Universe", **Apeiron** **3**, 113-116 (1996).
- [105] C.E. Renshaw, "The Radiation Continuum Model of Light and the Galilean Invariance of Maxwell's Equations", **Galilean Electrodynamics** **7**, 13-20 (1996).

- [106] W. Rindler, **American Journal of Physics** **29**, 365 (1961).
- [107] H. Robertson, "Postulate Versus Observation in the Special Theory of Relativity", **Rev.Mod.Phys.** **21**, 378-382 (1949).
- [108] W.A. Rodrigues,Jr. and J. Tiomno, "On Experiments to Detect Possible Failures of Relativity Theory", **Found. Phys.** **15**, 945-961 (1985).
- [109] S.A. Sannikov-Proskuryakov, M.J.T.F. Cabbolet, "Towards the Ether Theory (Apology of the Ether)", **Spasetime and Substance** **2**, N 4/9, 171-174 (2001).
- [110] S.A. Sannikov-Proskuryakov, M.J.T.F. Cabbolet, "Non-Einsteinian Theory of Gravity", **Spasetime and Substance** **4**, N 1/16, - (2003).
- [111] Xu Shaozhi, Xu Xiangqun, "A Reexamination of the Lorentz Transformation", **Galilean Electrodynamics** **3**, N 1 (1992).
- [112] Xu Shaozhi and Xu Xiangqun, "On the Relativity of Simultaneity", **Apeiron** **1**, N 16, 8-11 (1993).
- [113] Ch.W. Sherwin, "Measurement of the One-Way Speed of Light", **Galilean Electrodynamics** **13**, 9-13 (2002).
- [114] E.I. Shtyrkov, "Time Evolution of Vacuum Parameters as the Bases for a Cosmological model", **Galilean Electrodynamics** **8**, 57-60 (1997).
- [115] E.W. Silvertooth, **Specul.Sc. and Technol.** **10**, 3 (1986).
- [116] D. Sutliff, "Why Physics Cannot Assume the Relativity of Motion or an Infinite Universe: Problems with Special and General Relativity", **Physics Essays** **4**, 217-222 (1991).
- [117] T. Theodorsen, "Relativity and Classical Physics", **Galilean Electrodynamics** **6**, 63-72 (1995).

- [118] S.A. Tolchelnikova-Murri, "The Doppler Observations of Venus Contradict the SRT", **Galilean Electrodynamics** **4**, 3-6 (1993).
- [119] D.G. Torr and P. Kolen, "Misconceptions in Recent Papers on Special Relativity and Absolute Space Theories", **Found. Phys.** **12**, 265-284 (1982).
- [120] K.C. Turner, H.A. Hill, **Bull.Amer.Phys.Soc.** **8**, 28 (1963).
- [121] A.P. Volchenko, "About the new Approach to Construction of the Special Relativity", **Spacetime and Substance** **1**, N 3/3, 130-134 (2000).
- [122] Zh.Y. Wang, "Failure of the Relativistic Energy-Momentum Relation for Photons in Media", **Galilean Electrodynamics** **14**, 56 (2003).
- [123] C.K. Whitney, "Finding Absolution for Special Relativity Theory", **Galilean Electrodynamics** **7**, 23-29 (1996).
- [124] C.K. Whitney, "The Twins, the Mesons, and the Paradox", **Apeiron** **4**, 104-109 (1997).
- [125] E.T. Whittaker, **A History of the Theories of Aether & Electricity** (Longman, Green and Co., London, 1910).
- [126] H.E. Wilhelm, "Galilei Covariant Electrodynamics of Moving Media with Applications to the Experiments of Fizeau and Hoek", **Apeiron** **1**, N 15, 1-5 (1993).
- [127] W.F. Wolff, "A Modified Newtonian Treatment of Gravity", **Galilean Electrodynamics** **13**, 55-58 (2002).
- [128] Y.-G. Yi, "On the Nature of Relativistic Phenomena", **Apeiron** **6**, 205-216 (1999).
- [129] N.A. Zhuck, "The Cosmic Microwave Background as Aggregate Radiation of all Stars", **Spacetime and Substance** **1**, N 1/1, 29-34 (2000).

- [130] N.A. Zhuck, "New Concepts about the Universe and its Laws", **Spacetime and Substance** **1**, N 3/3, 98-104 (2000).
- [131] N.A. Zhuck, "Modern Concepts of Space, Time and Boundedness of Lorentz Transformation Laws", **Spacetime and Substance** **4**, N 1/16, 1-6 (2003).

Additional references:

- [132] L. Brillouin, **Relativity Re-Examined**, (Academic Press, 1970).
- [133] N.A. Zhuck, **Cosmology**, ("Model Vselenny" Ltd, Kharkov, 2000). [In russian]
- [134] E.B. Klyushin, **The Lectures on Physics Delivered to Myself**, (Publishing House "Bumazhnaya Galereya", Moscow, 2005). [In russian]
- [135] I.I. Smulsky, **The Theory of the Interaction**, (Publishing House of the Novosibirsk University, NIC OIGGM SD RAS, Novosibirsk, 1999). [In russian]
- [136] S.N. Arteha, "Critical Remarks to the Relativity Theory", **Space-time and Substance** **6**, N 1/26, 14-20 (2005).